

ENVIRONMENTAL EDUCATION IN THE COMMUNITY

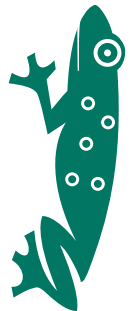

Information Collection and Exchange
Publication No. M0075

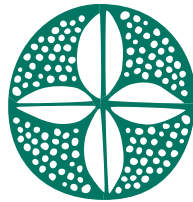

ENVIRONMENT EDUCATION IN THE COMMUNITY

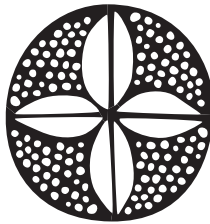

**PEACE CORPS
2005**



**INFORMATION COLLECTION
AND EXCHANGE
ICE No. M0075**



INFORMATION COLLECTION AND EXCHANGE

This publication was produced by the Peace Corps Center for Field Assistance and Applied Research. It is distributed through the Information Collection and Exchange (ICE). For further information or additional copies, please contact ICE at the Peace Corps and refer to the ICE Catalog number that appears on the publication.

Peace Corps

Paul D. Coverdell Peace Corps Headquarters
Center for Field Assistance and Applied Research
Information Collection and Exchange
1111 20th Street, NW – First Floor
Washington, DC 20526

Add your experience to the ICE Resource Center. Send your materials to us so that we can share them with other development workers. Your technical insights serve as the basis for the generation of ICE manuals, reprints, and training materials. They can also ensure that ICE is providing the most up-to-date, innovative problem-solving techniques and information available to you and your fellow development workers.



CONTENTS

ACKNOWLEDGMENTS iv

CHAPTER ONE 1
What is Environmental Education?

CHAPTER TWO 8
Assessing and Discovering the Environmental Situation

CHAPTER THREE 47
Identifying the Target Group

CHAPTER FOUR 54
Identifying the Message

CHAPTER FIVE 63
Creating an Educational Strategy

CHAPTER SIX 68
Implementation

CHAPTER SEVEN 73
Monitoring and Evaluation

CHAPTER EIGHT 82
Environmental Education Camps

CHAPTER NINE 112
Environmental Education Centers

CHAPTER TEN 142
Environmental Education Community Projects

APPENDIX 295
Training Modules



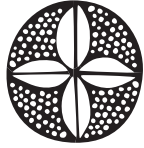

ACKNOWLEDGMENTS

This new manual updates two older Peace Corps' manuals: *Teaching Conservation in Developing Nations* [ICE No. M0007] and *Conservation Education: A Planning Guide* [ICE No. M0023]. In addition to the time- and field-tested wisdom of the older manuals, this new manual incorporates current research and practice in the field of environmental education. *Environmental Education in the Community* includes many new ideas, activities, and tips drawn from the experiences of Peace Corps Volunteers and staff around the world.

The Peace Corps recognizes and appreciates the work from the field, the contractors, and the environment specialists, as well as additional headquarters staff who made this new publication possible. Gratitude is also expressed to the various writers and publishers who gave permission to reprint and adapt their materials for the purpose of this publication.



CHAPTER ONE

WHAT IS ENVIRONMENTAL EDUCATION?

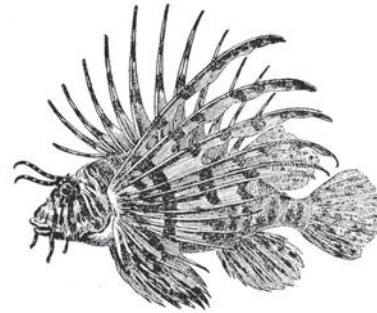

For years, Peace Corps Volunteers have assisted communities to create and engage in a broad range of environmental education activities. A nature walk and observation of natural processes in a nearby tropical rainforest, for example, increases farmers' awareness about the causes of erosion. A water and sanitation training increases knowledge of sources of pollution and disease. A community forestry working group helps to develop attitudes that will improve forestry practices. A role playing simulation assists a town council to develop communication skills. Planning a recycling center helps local people develop the skills to open a small business. Although the content and setting of each of these activities is different, the educational goal is the same: to help communities appreciate, protect, and sustain their natural surroundings.

In 1977, the United Nations Educational, Scientific and Cultural Organization (UNESCO) hosted an Intergovernmental Conference on Environmental Education in Tbilisi, Georgia. At that conference, the sixty-six member states, along with intergovernmental agencies and nongovernmental organizations, adopted the Tbilisi Declaration.¹ The Tbilisi Declaration defines the framework, principles and guidelines for environmental education. As stated in the Tbilisi Declaration:

“The goals of environmental education are:

1. To foster clear awareness of, and concern about, economic, social, political, and ecological interdependence in urban and rural areas.
2. To provide every person with opportunities to acquire the knowledge, values, attitudes, commitment, and skills needed to protect and improve the environment.
3. To create new patterns of behavior of individuals, groups, and society as a whole towards the environment.”

The categories of environmental education objectives are:

Awareness—to help social groups and individuals acquire an awareness and sensitivity to the total environment and its allied problems.

Knowledge—to help social groups and individuals gain a variety of experience in, and acquire a basic understanding of, the environment and its associated problems.

¹ For complete text, see www.gdrc.org/uem/ee





Attitudes—to help social groups and individuals acquire a set of values and feelings of concern for the environment and the motivation to actively participate in environmental improvement and protection.

To achieve these goals, Peace Corps Volunteers strive to create environmental programs that promote a world population that is aware of, and concerned about, the total environment and has the knowledge, skills, attitudes, and commitment to work toward the improvement and maintenance of a healthy environment. Effective programs have the following characteristics.

The participants:

- see how modifying environmental practices can benefit the community.
- are actively involved in all aspects of the program (e.g., program planning, implementation, monitoring, etc.).
- help to determine the curriculum.
- discover ecological principles, patterns, and processes through experimentation and action that have practical applications to daily activities.
- can work toward making a positive change and see the results of their actions.

The activities:

- link new information to the experience and knowledge of the participants.
- are active, engaging, and participatory.
- take place in the field, outdoors, and on-site.
- lead to environmentally responsible behavior.
- present knowledge that is relevant to the economic needs of participants.
- are relevant to participants and facilitate decision-making.
- present new knowledge that can be easily incorporated into existing daily routines.
- allow teams to learn cooperatively.



The environmental educators:

- know the audience.
- understand themselves to be learners as well as teachers, and approach the community with humility, respect, and enthusiasm.



HOW TO USE THIS BOOK

To create a successful environmental education program, you and your community counterparts will need to identify, discuss, and carry out six tasks, each of which will result in a component of the education program. There is value in reading chapters Two through Seven *before* you begin planning your program since these chapters will outline the overall process of planning and implementing environmental education projects in your community, and can help guide you and your counterparts as you proceed. Become familiar with the entire process before beginning your work, since creating effective environmental education programs is not a linear process. Rather, you will go back and forth between the stages of program development, and should keep in mind what you will need to do or know at the various stages. For example, you and your counterparts should think about evaluation indicators from the very beginning stages of program development, even though they are not discussed until Chapter Seven. This will help you to implement ongoing monitoring activities.

Make sure to involve community members and community-based organizations in leadership roles from the very beginning of the program development process, including the Assessment and Discovery phase. This helps to facilitate community ownership of the project, and increases the likelihood that the project is relevant to local circumstances.

	Task	Key Questions
Chapter 2	Assess and discover the environmental situation—issues, solutions, community assets, and constraints that can help or hinder an environmental program. The assessment process should be <i>participatory</i> , that is, it should involve individuals who are based in the community, and who will continue the program after the Volunteer’s departure. It is crucial to conduct a thorough assessment, as it will lay the groundwork for creating a strategy to achieve the solution.	What important environmental issues in your community might you successfully address? What behavior changes will improve environmental quality? If these solutions are such good ideas, why aren’t people already implementing them?
Chapter 3	Identify the target groups.	Who in the community can help alleviate the constraints to environmental improvement?
Chapter 4	Identify the message.	What information will enable your target groups to implement environmental solutions?
Chapter 5	Select the educational strategy.	How will you deliver the key information?
Chapter 6	Implement.	When, where and to whom will you deliver your message?
Chapter 7	Evaluate.	How will you determine the success of your program and make necessary changes?





Question and Reflect

Questions are inserted from time to time throughout the text to remind you to continually process and reflect upon what you have read. Typically, these questions are non-judgmental and appreciative in nature. They are meant to help you to learn about, rather than assess or judge, your community and its strengths. What you discover can serve as the foundation for environmental education activities.

Environmental Education in the Community is part of three-volume set of Peace Corps-developed environmental education manuals that also includes *Environmental Education in the Schools* [ICE No. M0044], and *Adapting Environmental Education Materials* [ICE No. M0059]. Additionally, other Peace Corps' training and project design materials can enhance the use of this manual. Some of the most relevant publications are listed at the end of this chapter, and can be obtained through your post's resource library, or online where noted.

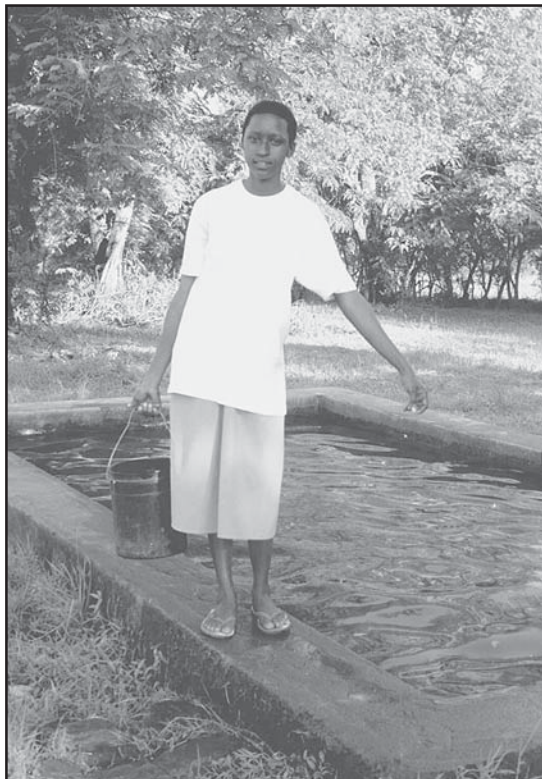

EXAMPLES OF PEACE CORPS ENVIRONMENTAL EDUCATION PROJECTS

- In Romania, an annual “Procession of the Species” parade is held that celebrates the natural world with art, music and dance. The parade increases biodiversity awareness, encourages networking among organizations, and introduces potential future project partners.
- In Guatemala and Ecuador, environmental projects are offering support for income generation projects in bee-keeping and recycling paper.
- In Mongolia, a traveling snow leopard interpretation display was developed to increase knowledge of snow leopard biology in preserve buffer-zone areas.
- Health programs in Mauritania and Cameroon focus on access to and maintenance of potable water and sanitary facilities.
- In China, the Sino-American Environmental Education Program encourages students to find, research and develop their own environmental projects.
- In Niger, children take an extended river field trip to learn about a national park ecosystem and interact with a forest agent.
- In Panama, educators work in schools to help communities understand protected areas, and participate in natural resource management.
- In Togo, Volunteers work with farmers to introduce sustainable farming practices.
- In Nicaragua, in the aftermath of Hurricane Mitch, teams work to rehabilitate land, reforest and stabilize stream banks.



RESOURCES

Print

Adapting Environmental Education Materials. Washington, DC: Peace Corps. [ICE No. M0059]

http://www.peacecorps.gov/library/pdf/M0059_adaptenviron.pdf

This publication walks Volunteers through the steps of evaluating the appropriateness of existing materials to their school setting, determining how useful materials can be adapted, and making those adaptations. It includes training sessions for skill development and worldwide examples of adaptations to simpler and fewer materials, to local realities, to traditional classroom subjects, and to nonformal youth programs. This is an excellent resource for anyone who teaches, and is a companion to *Environmental Education in the Schools: Creating a Program that Works!* [ICE No. M0044].

Environmental Education in the Schools: Creating a Program That Works! Washington, DC: Peace Corps. [ICE NO. M0044]

<http://inside.peacecorps.gov/content/documents/documents/m0044e00.cfm>

This practical guide offers useful information for introducing environmental issues into the academic curriculum and contains a wealth of activities, enlivened with illustrations, case studies, and Volunteer examples. Each of the nine chapters deals with a different aspect of developing and implementing an environmental education program, starting with assessing local environmental problems and school conditions to determining goals and objectives, ways of gaining program support and evaluating results.

Windows on the Wild: Biodiversity Basics—An Educator’s Guide to Exploring the Web of Life. Tustin, CA: Acorn Publishing, 1999. [ICE No. FC258]

This guide is a complete course book for teaching young people about the environment, the variety of life on earth and the importance of protecting the web of life. It includes unit plans, resources, games, charts and other activities for teachers and their students in grades 6-8.

Windows on the Wild: Biodiversity Basics—Student Book. Tustin, CA: Acorn Publishing, 1999. [ICE No. FC259]

The student’s guide is a companion piece to FC 258 *Windows on the Wild: Biodiversity Basics—An Educator’s Guide to Exploring the Web of Life.*

Pachamama: Our Earth—Our Future. Young People of the World. United Nations Environment Programmes, 1999. [ICE No. FC260]

This resource is a colorfully illustrated global introduction to the state of the environment in the 21st century. It consists of contributions from youth around the world and covers topics such as the earth’s atmosphere, marine and coastal areas, biodiversity and urbanization and uses poetry, stories, pictures and case studies to highlight concerns of young people about the future of the environment. It also contains activity sheets and a game board.

Environmental Activities for People Who Use English as a Foreign Language. Washington, DC: Peace Corps, 1994. [ICE No. R0092]

<http://inside.peacecorps.gov/content/documents/documents/r0092e00.cfm>

This publication provides a variety of practical activities to foster discussion about environmental problems while at the same time improving students’ English language skills. It contains separate units for such topics as land use planning, global warming, recycling, air pollution, environmental





health and environmental ethics, with specific activities, drawings, stories and bibliographies for each unit.

Learning Local Environmental Knowledge Training Manual. Washington, DC: Peace Corps. [ICE No. T0126]

http://www.peacecorps.gov/library/pdf/T0126_llekmanual.pdf

This manual serves as a complement to *Learning Local Environmental Knowledge: A Volunteer's Guide to Community Entry*. The book suggests ways to introduce the process of community entry to prospective Volunteers while they are still in pre-service training, and strengthen competencies during subsequent in-service training. Approaches for integrating these sessions in all aspects of Volunteer training (language, technical, cross-cultural and health) correspond with tools and exercises found in the Volunteer's guide.

Learning Local Environmental Knowledge: A Volunteer's Guide to Community Entry. Washington, DC: Peace Corps. [ICE No. M0071]

http://www.peacecorps.gov/library/pdf/M0071_llekguide.pdf

To be used with the *Learning Local Environmental Knowledge Training Manual*, this handbook provides Volunteers in any sector with a structured way to learn about the biophysical, economic and social aspects of a host community during pre-service training and the initial months of service. This is an excellent tool for Volunteers to use in their role as a learner.

New Project Design and Management Workshop Training Manual. Washington, DC: Peace Corps. [ICE No. T0107]

http://www.peacecorps.gov/library/pdf/T0107_projectdesign.pdf

This training manual is based on a one-and-a-half- to four-day workshop reinforces the importance of community participation in designing and implementing local projects. Intended for use during in-service training, sessions show Volunteers and their counterparts how to involve and work with the community through each step of the project design process, from analysis of community assets and needs to planning, implementation, monitoring and evaluation. The initial sessions can be covered in pre-service training. Supplement to *Participatory Analysis for Community Action (PACA)*.



PACA Idea Book: Participatory Analysis for Community Action. Washington, DC: Peace Corps. [ICE No. M0053]

This Idea Book updates an older Peace Corps resource which introduced the Peace Corps' approach to participatory analysis. PACA tools were initially used to institutionalize the inclusion of women in all Peace Corps development programming, monitoring, and implementation. Currently, PACA tools promote the inclusion of all representative voices in a community in Peace Corps project planning and implementation. The Idea Book offers practical, field-based examples of how PACA tools have been applied in a Peace Corps' context and Volunteers can use it as a self-paced study guide in the field.

Camp Glow: Girls Leading Our World. Washington, DC: Peace Corps. [ICE No. M0056]

http://www.peacecorps.gov/library/pdf/M0056_campglow.pdf

Camp GLOW (Girls Leading Our World) is a week-long leadership camp. The purpose of the camp is to encourage young women to become active citizens by building their self-esteem and confidence, increasing their self-awareness and developing their skills in goal setting, assertiveness and career and life planning. Begun in Romania in 1995 by Peace Corps Volunteers and Romanian teachers, the camp has been replicated by Peace Corps Volunteers and their local colleagues in more than 21 countries worldwide. This handbook provides details about organizing the camps, schedules and lessons learned. The content of the camp sessions is found in *Choices: A Teen Woman's Journal for Self-Awareness and Planning* by Mindy Bingham, et al, Advocacy Press, Santa Barbara, CA. 1993.

Web

Global Development Research Center, "Tbilisi Declaration," and "Agenda 21, Chapter 36."

www.gdrc.org/uem/ee/

Peace Corps Panama Friends webpage.

www.pcpfpanama.org

RPCVs in Environment and Development.

www.cboss.com/rpcv-eandd/index.html

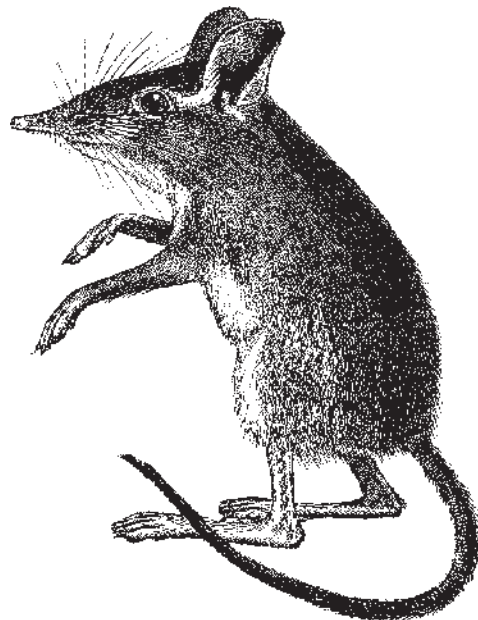



CHAPTER TWO

ASSESSING AND DISCOVERING THE ENVIRONMENTAL SITUATION



The first step to create a powerful environmental education program is to find out which environmental issues are important to the people in your community by conducting an **environmental assessment**.

The purpose of assessment and discovery is to identify and characterize the community's environmental assets, problems, concerns, and advantages. By understanding and describing the environmental situation in a community, you and the community will be able to prioritize and better organize activities. A thorough assessment will lay the groundwork for creating an environmental program that responds to community desires and is specific to community realities.

It is crucial to conduct a thorough assessment because you and the community will refer back to the assessment as you create each piece of the program development strategy. The information and learning that you gain during the assessment process must help in deciding, for example, what **environmental message** (see Chapter Four) would resonate in the community, or who will be most affected by any environmental program and how to use indicators during the **evaluation** (see Chapter Seven). Additionally, it is important to identify solutions that reflect both the existing assets (the building blocks of the program) and aspirations (the expectations and desires) of the community.

MACHHA BAZAR

Imagine you have been posted to the small town of Machha Bazar (Fish Town). Machha Bazar is located on the bend of a river with particularly rich fish resources. Until recent times, Machha Bazar was an isolated town and fish were the primary source of food and money. Recently, a road has been built, which has brought more people and goods. Across from the town is a national park that was created to protect the dwindling wildlife in the area, especially tigers.

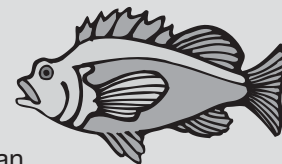

Your job is to work with a small NGO called River Conservation to help the community of Machha Bazar develop and implement an environmental education program. During training you learned about community development, sustainable development, and building capacity. You hope to work in the community to help community members create and maintain sustainable projects.



The environmental assessment is organized into 15 different topical areas (see sidebar), with an assessment tool for each topic (see examples at the end of the chapter). Remember that your inquiry should not be limited to the biological aspects of each of these topical areas, but should also include social, economic and cultural components. The assessment should seek to learn, for example, how different segments of the community interact with each of these biological areas, how these areas are important to livelihood, etc. A thorough assessment will discover not only environmental problems and constraints, but also community assets. These assets can be used to build an effective environmental program that recognizes and uses the skills and knowledge of the community.

To further organize the assessment, three geographic units are used.

- towns
- farms
- natural areas

Most Volunteers work in communities where these three areas exist. However, they won't always be distinct and/or separated. For example, people may deliberately maintain or cultivate certain plants and/or trees in "natural areas" for various reasons (e.g., spiritual, economic, etc.), while in many communities, farming or gardening may occur within the "town" limits. Try to become familiar with the various land-use practices and a number of livelihood strategies employed in your community. Some, but perhaps not all, of the 15 environmental elements can be found in your community's town, farms, or natural areas. In some communities they are in all three places.

The environmental education program in your community cannot address all of these issues at once—and certainly not within your period of Peace Corps' service—you and your counterparts will need to make strategic choices about which elements to address. The assessment should focus on the areas that have been identified as community priorities, but your and your counterparts' interests and observations should also inform how you carry out the assessment. Although the environmental elements are organized as individual topics, you, your counterparts, and other involved community members can use a mix-and-match process to identify and select 15-20 research questions that reflect community priorities and that guide the information-collection phase of the environmental assessment.

15 TOPICAL AREAS FOR ENVIRONMENTAL ASSESSMENT

1. Biodiversity
2. Coastal Areas
3. Climatic Conditions and Natural Disasters
4. Cultural Values
5. Farming and Grazing
6. Forests, Grasslands, and Natural Areas
7. Gender Roles
8. Human Settlements
9. Institutional and Community Environmental Management Structures
10. Livelihood Security
11. Parks and Protected Areas
12. Soils and Land
13. Waste Management
14. Water Resources and Watersheds
15. Wildlife and Livestock



You can gather environmental information about your community from three general sources:

1. Your own first-hand field observations;
2. Specialists and local residents; and
3. Literature and the Internet.

Remember, you are learning about the local environment and how the community interacts with it. You and your counterparts must approach your tasks as “learners,” as well as “assessors.” This is an important distinction. As a **learner**, you recognize the community to be a classroom and community members to be teachers. As an **assessor**, the community and community members become the subjects of your investigation.

PRE-ASSESSMENT ACTIVITY: BECOME FAMILIAR WITH THE PHYSICAL LAYOUT OF THE COMMUNITY

MACHHA BAZAR

So you have arrived in Machha Bazar all fired up and ready to go, but where do you begin? You are acutely aware of how much you need to learn about Machha Bazar.

You have settled in with your host family and met your counterpart. Perhaps your first task is to get oriented to the town. You are able to converse fairly well with your host brother, so you ask him to take you on a tour of the town. You take a notebook and make a sketch of the town as you go.

You learn that the town is on the inside of a large bend in the river. Along the river there are different kinds of boats, and a dock for large boats. Your host brother tells you that most people in the village fish; some just for their families, while others sell fish in the capital city. The main street runs along the riverbank and has a variety of small stores owned by local people. One block back from the main street is the school. Across the street from the school are the government offices and the post office. The town has been cleared from the surrounding forest, but a few trees have been left for shade. On the main street are benches placed under trees. Children are swimming in the river in a calm area near the boat landing.

The far side of the river is solid forest. Your host brother tells you it is a national park, and there are regulations about what you can do. The park was created to protect tigers, but tiger skins and bones bring lots of money, so sometimes people come from upstream to camp and hunt for tigers. Sometimes the tigers can be seen when they come down to the river for a drink, but, usually, they stay away from town. In fact, since the new road was built, your host brother has hardly ever seen them on this side of the river. Your brother believes this to be a good thing, since they used to eat people's goats and get into their fish stores.

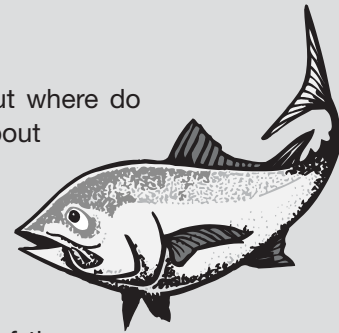

(continued)



You ask about the road. Your brother tells you it was built five years ago and has made life much easier. Everyone used to have to go to town by boat, but now they can go by bus or truck. Some people have cars. Lots of new things have come into the stores and it is easier to get things like clothes, radios or soda pop. It has also brought more people. Truck drivers, for example, are coming and going at all hours, and the trucks are noisy. Your brother tells you that when the road came in, the town had to move the dump because it was in the way. The old dump was filled in and a new dump was made closer to the river and behind the school. As a result of the digging and cutting down of the forest during road construction, there was a lot of dust and the water got cloudy, but it has settled down now. Your brother tells you that the best thing about the road is that people can stay home with their families and make a living whereas they used to have to go to the capital to find work or sell fish. Townspeople were poorer then. Things are better now, although fish have been scarce for the last couple of years, which your brother believes has been caused by an increase in fishing activities.

After spending a couple of hours with your host brother, you go back to your rooms and reflect on what happened, making a few notes so you won't forget. You now have a map of the town with many of the buildings and points of interest on it. You know a little about the history of the road and how it changed the town. You were actively listening, which encouraged your host brother to talk. As a person new to the area, you asked a lot of questions that you thought must sound stupid to your host brother, although your host brother was more than willing to explain. In fact, perhaps there is an advantage to being new. Now is the time to ask all those basic questions, because no one expects you to know, and they are happy to talk about their town and their lives.

It is likely that activities such as community walks will generate more questions than they answer. Write those questions down as soon as you finish the activity. Those questions can guide your learning as you acclimate to the community. If you are learning a local language, translate your questions and ask them of as many people as you can. Make sure to learn from a broad range of people, including those you wouldn't normally encounter. Asking yourself questions following an activity can reinforce your learning, help you to look at your community from a variety of viewpoints, and can trigger other important questions. The list of questions below provides some ideas on the types of questions that our fictional Volunteer might ask of herself following the walk with her host brother. Remember to focus your learning on what a community has to offer (appreciative approach), rather than what it lacks (problem-based approach).



Reflection Questions

- In addition to fishing, how else did you see people using or interacting with the environment? In addition to livelihood uses, note any recreational and other uses.
- What did you learn about how people use the various natural resources? Do women use resources differently than men? Do women use different resources? How might resource knowledge differ





among men and women? Among young and old? How might resources be valued differently? Make a point of discussing your various speculations with men and women.

- What season is it? Project how resource use may change over the course of a year. Project how the landscape might change. How might this affect resource use?
- What kinds of trees were used as shade trees? Do they have other uses? What other trees seemed to be deliberately maintained? Mark these on your map and make a point of going back to inquire about those trees.
- How was the site for the new dump picked? Who picked it? Who was affected by the relocation of the dump? Were they affected positively or negatively?
- How was land use affected by landscape features (e.g., hills, rocky soils, flat areas)?
- Who do you want to interview and learn from?



PRE-ASSESSMENT ACTIVITY: ENVIRONMENTAL ASSESSMENT REVIEW

Prior to conducting the formal assessment, and as you become familiar with your host community, you and your counterparts should review your thinking about the reasons for conducting an environmental assessment. This will help later, as you, your counterpart(s), and community members design the assessment, define roles and responsibilities, and identify goals, objectives, and tasks. Ensure consensus by asking and discussing:

1. Why are you doing an environmental assessment in your community?
2. Who should participate in the environmental assessment?
3. When should you do the environmental assessment?
4. What should be the products of the environmental assessment?
5. What resources might be available to support the environmental assessment?
6. How can the products of your environmental assessment be used in environmental education?



PRE-ASSESSMENT ACTIVITY: LISTENING TO AND COMMUNICATING WITH COMMUNITY MEMBERS

MACHHA BAZAR

Soon after you move in to Machha Bazar, your counterpart informs you that there will be a town meeting. You feel a bit nervous about going because your language isn't very good, and you don't know very many people yet, but you decide to go so you can see what can be learned from the meeting. Your counterpart and brother agree to act as your interpreters. Taking notes can often be considered a suspicious activity, so you decide to make mental notes of important people and ideas and go home afterwards to jot them down on paper.

The meeting is being held in the community building. Your counterpart introduces you to an overwhelming number of people. You make a note to ask her to go over those names and positions at a later time. There is one person who seems to be chairing the meeting. He seems very knowledgeable and authoritative. As the meeting progresses, your brother tells you that the main issues of concern are outsiders coming in and interfering with traditional subsistence use of natural resources, a perceived threat from the poachers, and decreasing fish numbers.

You notice that there are definite leaders and people who speak up more often than others. Most of these leaders are men, but not all of them. Your counterpart indicates that one of these men is the headmaster of the school. Another is the leader of the organization your counterpart works for. Another woman is the leader of a mother's group.

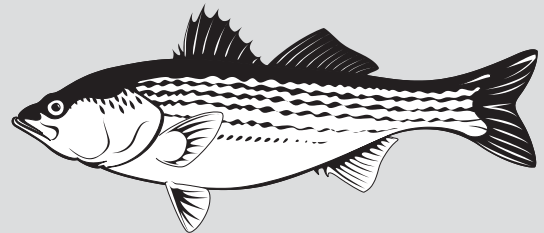

When discussing the decreasing fish numbers, some people say they think it is because there are more outsiders taking the fish, and some say the water is polluted. Your brother tells you that no one can agree why the fish are decreasing, but that everyone fears that there will not be enough fish to feed their families this year. They are concerned that they will have to buy more food, but with less money. Generally, there is animosity expressed towards some of the newer residents of the community.

Most of the discussion about the poachers has to do with safety. The poachers apparently camp in a secluded area upstream of the village. They are former soldiers who have no work. They hunt tigers for the huge profit of selling hide and bones to another country. When they are hunting, they take boats across to the park in areas where it is difficult for the rangers to see them. They try to hunt on days when the ranger is far away. Sometimes they hunt at night. After a successful hunt, they often come into town to celebrate, which can involve guns and drunkenness. People have been hurt and frightened. Someone wonders if they will kill off all the tigers, or make the tigers angry so they will come into town and eat livestock.

After you get home, you jot down your observations and reflect on a number of different topics.



Reflection Questions

- Who seems to command respect? Who are the community leaders?
- What do various community members think can be done about the fishing issue and the poaching issue?
- What is the role of local government in environmental issues and land use?
- What concerns did men express vs. the concerns of women? Did you see any consistency among concerns of men, concerns of women, or concerns of youth?
- What, if any, solutions were offered? How were they received?
- Who are the stakeholders? What interests were represented at the meeting? What interests were not represented at the meeting?
- Which people would you like to talk to more?
- Who might seem a good candidate for an advisory group?
- What livelihoods were represented at the meeting? How are various livelihoods dependent upon the environment?
- How would people like to see the community develop?

USING THE ENVIRONMENTAL ASSESSMENT

Think of the environmental assessment as an extensive dialogue on the environment with the community. Other Peace Corps' publications, such as *Learning Local Environmental Knowledge* [ICE No. M0071], *Promoting Powerful People* [ICE No. T0104] and *The PACA Idea Book* [ICE No. M0086] can help you with some specific methods and activities to engage in this dialogue. These same publications can help you create a forum to analyze the information and interpret results after the group has collected it.

It is crucial to involve community members in the assessment, and you and your counterpart should find interested members of the community who would like to participate in development of the environmental program. A community environmental advisory or working group can fulfill this role, as well as keep the inquiry process on track by helping to make sense of the information you gather and applying it in meaningful ways.

On the next page, you will see a guide sheet for exploring one of the environmental elements noted above (*biodiversity*). Determining the specific content of the assessment can begin with the questions on the guide sheet. The sheet is structured with one table for each environmental element. Each table has three columns: *Town, Farms* and *Natural Areas*, which you can use to organize your inquiry.

These questions are intended to guide your research. The questions are not exhaustive, and you'll likely be able to add more questions based on the specific circumstances of your experience. Share questions with your counterparts, community members and advisory group, and ask for input on additional questions that the assessment should address.

The other 14 guide sheets are located at the end of the chapter.



Guide Sheet

BIODIVERSITY

From *Educating for Life: Guidelines for Biodiversity Education*, edited by Ewan McLeish.
Copyright © 1997, Council for Environmental Education. Adapted with permission.

Biodiversity education should enable people to:

- Understand what biodiversity means.
- Consider biodiversity as part of their cultural, spiritual and economic heritage.
- Recognize the relationship between biodiversity and the maintenance and quality of life.
- Know what factors influence biodiversity in constructive and destructive ways.
- Take action to preserve and enhance biodiversity.

GENERAL ISSUES

1. What agencies are working on biodiversity conservation?

2. How are these agencies addressing biodiversity conservation?

3. What have been the results of these agencies' conservation efforts?

4. What are local people's perceptions of *biodiversity*? How do they express this concept?

5. Are there any traditions or beliefs that contribute to conserving and managing biodiversity?

(continued)





Guide Sheet

BIODIVERSITY

Optional Assessment Questions	Town Areas	Farming Areas	Natural Areas
1. What is the major plant type in the area (trees, grasses, shrubs, mixed)?			
2. What is the greenest area (stream banks, sacred groves, meadows, shrub land, pockets of trees, orchards)?			
3. What wild mammals, reptiles, amphibians, fishes, birds can be found in the area?			
4. Are there “heritage” seed varieties (land races) available in the local market? Do farmers save heritage seed varieties for planting as crops? Do people collect heritage seed varieties from natural areas? What are these varieties?			
5. What are the threats to biodiversity in the area (e.g., road or housing construction, commercial development, chemical or material debris pollution of waterways, smoke-filled air)?			
6. Which plants found in area (including the marketplace) are used for local medicinal purposes? What wildlife (include fetish use)?			
7. Is hunting an important economic activity? (Check the marketplace; ask farmers.)			
8. When people cut trees for firewood and forage, which species are they using? (Check the marketplace.) How do they prune them? Do the trees die once cut?			
9. Is there enough forage and pasture for livestock? (Check market prices; ask farmers.)			
10. What flowering plants are available in towns for bees to utilize, including fruit trees?			



WHAT TO DO WITH THE INFORMATION

The next task is to analyze the data and succinctly describe the environmental situation in the community. Interpreting the data is best done in conjunction with the community environmental working group. With that information, you, your counterpart, and the working group can prioritize problems and decide where you should focus your resources and efforts. Keep in mind that the final result that you are looking for is curriculum content for the EE program. The next step that you and your counterparts will take to reach this will be detailed in the following chapters.

Moving from environmental information to environmental education

Within the information that you and your counterparts gathered, what are the *environmental facts* that relate directly to each priority environmental issue? For example, if a community's priority environmental issue is *water quality and quantity*, you may have discovered these key facts:

- Certain sources of water in the community are less murky than others. Some are closer to most residences than others. Some dry up during certain parts of the year.
- The water table is 20 or so meters below the surface, except in areas close to the stream.
- Some folks collect rainwater from their roofs but most don't. One family has plumbing.
- Livestock use the same sources of water used by people for drinking.

Given such environmental facts (and this is just a sample), what can you and your counterparts determine to be important environmental issues in the host community? In other words, what questions related to these facts will provoke people in the community to ask their own set of questions about the situation, what are the implications, and what can be done about it? Here are some examples of possible questions:

- Why does some water appear to be “clean” while other water looks “dirty?”
- Is water that looks clean safe to drink?
- What causes some water to be muddy? Does it even matter if water is muddy or clear?
- Why does the depth of the water table vary within the community?
- Are there things we can do to keep water sources from drying up? What are they?
- Are there ways to bring water closer to homes, if we can't build houses close to water?
- What difference does it make that livestock and people use the same water for drinking?
- Is water that falls from the sky the same as water that runs off a roof into a barrel?

Once you and your counterpart(s) have determined the issues that you would like to address, you are ready to move on to the next component of your environmental education program: **Identify the Target Groups.**





ENVIRONMENTAL ASSESSMENTS



Biodiversity 15

Coastal Areas 19

Climactic Conditions and Natural Disasters 21

Cultural Values 23

Farming and Grazing 24

Forests, Grasslands, and Natural Areas 29

Gender Roles 30

Human Settlements 31

Institutional and Community Environmental Management Structures 33

Livelihood Security 35

Parks and Protected Areas 37

Soils and Land 39

Waste Management 41

Water Resources and Watersheds 43

Wildlife and Livestock 45



Guide Sheet

COASTAL AREAS

Optional Assessment Questions	Town Areas	Farming Areas	Natural Areas
1. What appear to be the major people-related factors affecting coastal resources in the area? To what extent are these factors related to the actions of local people, outsiders, and visitors?			
2. What are the principal species of land and aquatic life residing near or in the water resources of the coastal zone in the area? How are these species harvested and utilized?			
3. Which coastal species are available to buy in the local market? Are any of these species sold in markets in the capital, or exported?			
4. If people are clearing marshes and mangroves near the area, why are they doing this (e.g., to construct landfills, homes, marinas, shrimp farms, build enterprises, other)?			
5. If people living in towns dump their waste directly into the coastal resource, what is this doing to the water and lands bordering these coastal resources?			
6. If you have noticed garbage on the coastlines, what is its source?			

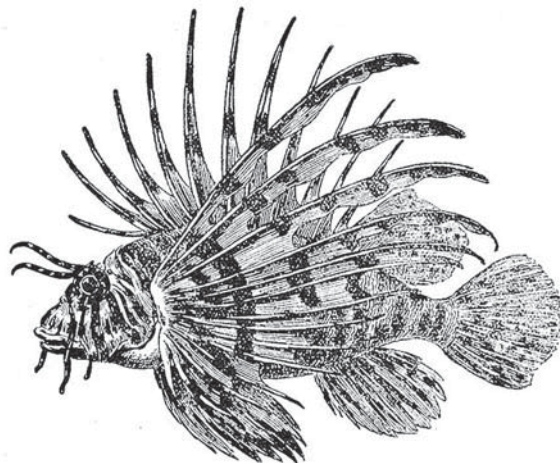



Guide Sheet

CLIMATIC CONDITIONS AND NATURAL DISASTERS

Optional Assessment Questions	Town Areas	Farming Areas	Natural Areas
1. Is there a history of any disaster related to the climate—or other natural (or non-natural) source—having occurred in the area?			
2. What are the most common natural disaster risks (e.g., floods, tornadoes, landslides) or non-natural hazards (e.g., toxic waste disposal site, power-generation plant) in the area?			
3. How have people in the area modified their behavior or infrastructure to mitigate the impact of natural or non-natural hazards?			
4. What demographic trends, changes in infrastructure, or adoption of new natural resource management practices could affect the severity or frequency of natural or non-natural disasters in the area?			
5. What opportunities are readily available for mitigating natural disasters or non-natural hazards in the area?			





Guide Sheet

CULTURAL VALUES

From Educating for Life: Guidelines for Biodiversity Education, edited by Ewan McLeish. Copyright © 1997, Council for Environmental Education. Adapted with permission.

Environmental education about cultural values should enable people to:

- Articulate their cultural values with regard to environmental stewardship;
Consider culture as part of their environmental heritage;
Recognize relationships between cultural values and the quality of life;
Know what environmental factors influence cultural values; and
Take action to enhance the positive impacts of cultural values on the local environment.

GENERAL ISSUES

- 1. What agencies and institutions are working on cultural values and the environment?
2. How are these agencies and institutions addressing cultural values and the environment?
3. What have been the results of these organizations' efforts regarding cultural values?
4. What are local people's perceptions of cultural values? How do they express this concept?
5. Which traditions or beliefs define the role of cultural values in environmental management?

CULTURAL VALUES

Table with 4 columns: Optional Assessment Questions, Town Areas, Farming Areas, Natural Areas. It contains three rows of assessment questions related to cultural values and environmental management.





Guide Sheet

FARMING AND GRAZING

Optional Assessment Questions	Town Areas	Farming Areas	Natural Areas
1. Which grain, vegetable, fruit, and forage crops are being grown? What percentage of the landscape area is being used for farming?			
2. Which livestock are raised? What percentage of the landscape area is used for grazing?			
3. In what ways has farming appeared to have changed the environment (positive/negative)?			
4. In what ways has grazing appeared to have changed the environment (positive/negative)?			
5. Are farming and grazing practiced so that people have enough food to eat, or are they selling some of their products for cash?			
6. In what ways have farming and grazing practices changed over the years? (Ask.)			
7. What is the agricultural production calendar?			
8. Is it possible to determine who owns the land that is farmed and grazed, and who rents? If so, what are the landlord/tenant relationships?			
9. What are the major constraints to farming and grazing, if any? What makes it easy to farm and raise livestock (e.g., rivers, flat land, etc.)?			
10. How do livestock owners and cultivators of trees and crops interact with each other?			
11. What is the carrying capacity of the local landscape for farming and grazing activities? (Ask local or regional technical authorities.)			
12. How many plants per hectare do farmers plant on their cropland? Do their crops grow and develop in a uniform way? If not, why not?			

(continued)





Guide Sheet

FARMING AND GRAZING

Optional Assessment Questions	Town Areas	Farming Areas	Natural Areas
13. What percentage of cropland is covered by vegetation or plant residue in the off-season?			
14. How many head of livestock per acre do the livestock owners manage on the available land? What is the physical condition of the livestock? How do the livestock find water?			
15. How do farmers classify and name the different soil types in the community?	May not be applicable		
16. What do farmers say are the best lands for raising crops? What makes these so good?			
17. What do livestock owners say are the best lands for grazing? What makes these so good?			
18. What productivity issues (crops and livestock) are faced by farmers and livestock owners? What do they do to improve productivity?			
19. What pest problems (insects, diseases, weeds) are faced by farmers and livestock owners? What do they do to control these pests?			
20. Do farmers and herders leave land in fallow (i.e., no cultivation or grazing on it for a certain period)? How long are these lands in fallow?			
21. Do farmers and livestock owners know certain “indicator plants” that signify land as being ready for production or ready for fallow?			
22. Do any farmers use mulch on any crops to control weeds and conserve soil moisture? What do they use to mulch?			
23. Do any farmers use nitrogen-fixing plants in fields or pasture to improve soil fertility or improve livestock nutrition?			

(continued)



Guide Sheet

FARMING AND GRAZING

Optional Assessment Questions	Town Areas	Farming Areas	Natural Areas
24. How are crops and livestock integrated? (e.g., Do farmers use animal manure to fertilize their croplands? Do herders graze their livestock on the residues left in fields after harvest?)			
25. Which varieties of grain crops are grown? Which breeds of livestock do farmers raise?			





Guide Sheet

FORESTS, GRASSLANDS, AND NATURAL AREAS

Optional Assessment Questions	Town Areas	Farming Areas	Natural Areas
1. What percentage of the land area is covered by forest, grassland, and natural areas?			
2. Are there traditional and official names for the local forests, grasslands, and natural areas?			
3. How might you characterize the health of the habitat that is, in broader terms, either forest, grassland, and natural areas?			
4. Which commercial or home-use products are taken from forests, grassland, natural areas?			
5. Who owns these forests, grasslands, and natural areas? Who uses them, and for what?			
6. Which people-related factors appear to affect, positively or negatively, the health of forests, grasslands, and natural areas in the community?			
7. Which maps of the forests, grasslands, and natural areas are available for reference?			





Guide Sheet

GENDER ROLES

From *Educating for Life: Guidelines for Biodiversity Education*, edited by Ewan McLeish.
 Copyright © 1997, Council for Environmental Education. Adapted with permission.

Environmental education about gender roles should enable people to:

- Understand what is meant by *gender roles* with regard to environmental conservation;
- Consider how gender roles in natural resource management are part of their cultural heritage; and
- Recognize relationships between gender roles and environmental conservation.

GENERAL ISSUES

1. What agencies and institutions give attention to gender roles in environmental conservation?
2. How do these agencies and institutions address gender roles as a tool for conservation?
3. Which traditions or beliefs address gender roles and environmental conservation?

GENDER ROLES

Optional Assessment Questions	Town Areas	Farming Areas	Natural Areas
1. What work do women do to manage local natural resources? For example, do they grow crops (which ones), raise livestock (which), or clean up garbage?			
2. What work do the men do to manage local natural resources? For example, do they grow crops (which ones), raise livestock (which), or clean up garbage?			
3. What work do youth do to manage local natural resources? For example, do they grow crops (which ones), raise livestock (which), or clean up garbage?			
4. What roles have changed over time with respect to the work that men, women, and youth in natural resource management do? (You will need to ask people to learn about this.)			
5. In what ways does the knowledge that women and men have about natural resources differ?			



Guide Sheet

HUMAN SETTLEMENTS

Optional Assessment Questions	Town Areas	Farming Areas	Natural Areas
1. Where do most people live in the community?			
2. What is the relationship between where people live and what they do to earn their livelihood?			
3. Which areas are considered public lands?			
4. What percentage of the land area is used for housing? What percentage of the land area is for commercial use? What are the other uses?			
5. What are the predominant colors in settlements in and around the community? What accounts for the various colors (green, brown, red, etc.)?			
6. What is the density of population in the community (people/square kilometer)?			
7. What are some positive aspects about the way people have settled and established their living spaces and structures in the community?			
8. What are some problematic aspects of the way people have settled and established their living spaces and structures regarding conservation of the community environment?			
9. Generally speaking, who owns the land where people have settled? How is that ownership legally enforced?			
10. What are the similarities and differences in the environmental quality of land that is owned by its occupants versus land that is rented, or land that is accessible to everyone?			



Guide Sheet

INSTITUTIONAL AND COMMUNITY ENVIRONMENTAL MANAGEMENT STRUCTURES

Optional Assessment Questions	Town Areas	Farming Areas	Natural Areas
1. What is the geographic scope of influence of institutions and management already operating in the realm of environmental conservation?			
2. What is the nature of these institutions' environmental conservation work?			
3. What environmental work are these institutions <i>not</i> doing for which there is need?			
4. What work by these institutions might be considered detrimental to the environment?			
5. What rules, laws, policies, or regulations are applicable to the management of certain areas in support of environmental conservation?			

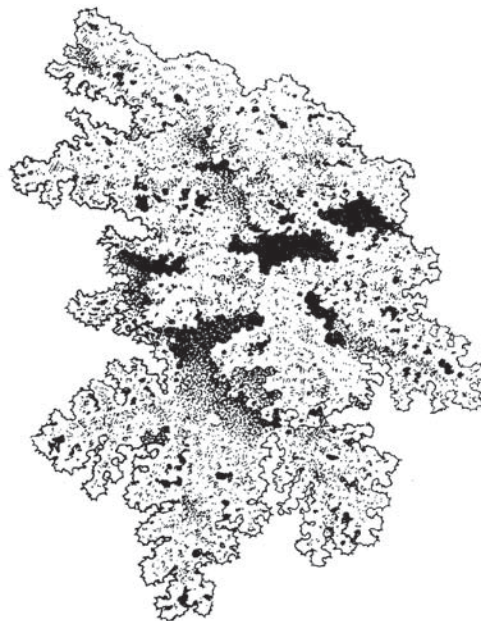



Guide Sheet

LIVELIHOOD SECURITY

Optional Assessment Questions	Town Areas	Farming Areas	Natural Areas
1. Which local natural resources are used in the community by people for their livelihood? (Hint: look in the markets; do not forget resources like soil, water, plants, animals, etc.)			
2. What indications exist that use of these natural resources by people for their livelihood may have negative effects on the environment?			
3. How have livelihood strategies evolved in the community during the past generation? Are any aspects of this evolution due to changes in people's access to natural resources?			
4. How do local people think livelihood strategies might change in the years to come?			
5. What opportunities may exist for making livelihoods more sustainable through improved management of the local environment?			
6. Are there any livelihood strategies in danger of extinction due to degraded natural resources? Which ones? Why might this be happening?			

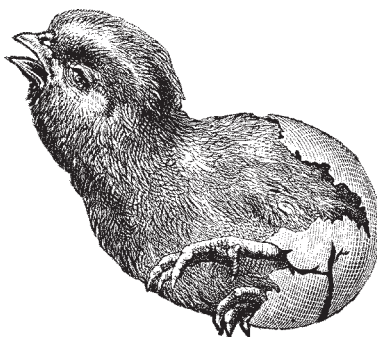



Guide Sheet

PARKS AND PROTECTED AREAS

Optional Assessment Questions	Town Areas	Farming Areas	Natural Areas
1. How would you characterize the parks and protected lands that exist in the community? Are they public or private? Are they well-maintained? Do local people make use of them? Do they attract visitors?			
2. Who is responsible for the management of the parks and protected lands? Who owns them?			
3. What resources exist within the parks and protected areas? For example, are there water bodies, unique geologic formations, biodiverse wildlife and vegetation, accessible entrances and exits, and paths or road throughout?			
4. To what extent does the community depend on the resources inside the parks and protected lands for their livelihoods and sustenance? How does the community benefit from the presence of the parks and protected lands?			
5. What may be opportunities for improving the management of the parks and protected lands?			





Guide Sheet

SOILS AND LAND

From Educating for Life: Guidelines for Biodiversity Education, edited by Ewan McLeish. Copyright © 1997, Council for Environmental Education. Adapted with permission.

Volunteers, counterparts, and those learning about soils and land need to understand the recycling of nutrients in and out of the soil/land resource with particular regard to the role of organic matter. They need to understand the underlying causes of soil/land degradation and the suite of options that people can use for soil regeneration and land restoration.

Environmental education about soils and land should enable people to:

- Understand how soil fertility and land productivity are keys to environmental conservation;
Conserve and regenerate soils and land in ways that are consistent with their cultural heritage;
Identify socioeconomic factors that support or constrain soil and land conservation; and
Take action to adopt, adapt, and promote land-use practices to conserve and regenerate soils.

GENERAL ISSUES

- 1. What are the different soil and land types in the community and what are they used for?
2. How does the condition of soils have an impact on community health and well-being?
3. What changes in soil and land-use management might lead to more positive impacts?
4. Which cultural traditions or beliefs lend positive support to soil and land conservation?

SOILS AND LAND

Table with 4 columns: Optional Assessment Questions, Town Areas, Farming Areas, Natural Areas. Contains two rows of assessment questions.

(continued)





Guide Sheet

SOILS AND LAND

Optional Assessment Questions	Town Areas	Farming Areas	Natural Areas
3. How do the characteristics of soils and land change at different points in the landscape?			
4. Are there lands that are either being opened up to agriculture for the first time, abandoned, or converted to other uses? What are the trends?			
5. Who has access to land in your community? How is that access determined?			
6. What may be opportunities for improving the management of the parks and protected lands?			
7. Who are the progressive and innovative soil managers in your community? What is it that makes them progressive innovators?			
8. What soil management and land-use practices and technologies in your community appear to be sustainable? What makes them sustainable?			
9. What are some opportunities for improving soil and land management in your community?			
10. What constraints or enabling conditions exist or are needed to nurture these opportunities?			
11. Are there traditions or beliefs that contribute to conserving local soil and land resources?			
12. Have the local soil and land resources been mapped out in any way? Have these maps been shared and discussed with local folks?			
13. What agencies and institutions in the community are working on the conservation and management of soil and land resources? What have been the results of their efforts?			



Guide Sheet

WASTE MANAGEMENT

From Educating for Life: Guidelines for Biodiversity Education, edited by Ewan McLeish. Copyright © 1997, Council for Environmental Education. Adapted with permission.

Environmental education about waste management should enable people to:

- Understand how well-managed waste management contributes to environmental conservation;
Design and implement waste management activities consistent with their cultural heritage;
Identify socioeconomic factors that support or constrain waste management activities; and
Take action to adopt, adapt, and promote waste management practices.

GENERAL ISSUES

- 1. What are the different types of, and options for, waste management in the community?
2. How does waste management have an impact on community health and well-being?
3. What changes in current waste management practices are socially and economically viable?
4. Which cultural traditions or beliefs lend positive support to waste management?

WASTE MANAGEMENT

Table with 4 columns: Optional Assessment Questions, Town Areas, Farming Areas, Natural Areas. Contains two rows of assessment questions.





Guide Sheet

WASTE MANAGEMENT

Optional Assessment Questions	Town Areas	Farming Areas	Natural Areas
3. What percentage of waste materials in your community can be recycled? What kinds of materials are these (glass, metal, plastic, etc.)?			
4. How is waste currently managed in the community? Which waste materials are not used? How much? Which kinds are recycled?			
5. To what extent do farmers use some form of compost material on their crops as compared to their use of synthetic fertilizers?			
6. Do people in the community use latrines? If not, how do they manage their human waste?			
7. How is livestock manure managed, if at all? Are there other uses besides crop fertilization for which livestock manure is used?			
8. Is there a significant fly problem at certain or all times of the year? What explains this (fish waste; fruit waste; excessive manure; etc.)?			
9. Does anyone pay, in one form or another, to have their waste collected and taken away? What is the going rate for this service?			
10. Is there a reliable water supply (i.e., for making compost on a large or small scale)?			
11. What institutions are currently working on the challenges of waste management in the community, and what have been their results?			
12. What are some opportunities for working in waste management and who might participate?			



Guide Sheet

WATER RESOURCES AND WATERSHEDS

From *Educating for Life: Guidelines for Biodiversity Education*, edited by Ewan McLeish.
Copyright © 1997, Council for Environmental Education. Adapted with permission.

Water availability and potability is a potentially significant catalyst for community action. Volunteers, counterparts, and those learning about water resources and the watershed need to distinguish among issues that are associated with subterranean water versus surface water sources. Surface water sources in particular present great opportunities for building community awareness and involvement. In addition, Volunteers, counterparts, and learners should explore the value of local watersheds, as well as threats to water quantity and quality.

Environmental education about *water resources and watersheds* should enable people to:

- Understand the link between water quality and watershed management;
- Understand the link between watershed management and environmental conservation;
- Design and implement water resource activities that are consistent with their cultural heritage;
- Identify socioeconomic factors that support or constrain water resource management; and
- Take action to adopt, adapt, and promote sustainable water resource management practices.

GENERAL ISSUES

1. What are the options for water resource and watershed management in the community?

2. How does water resource and watershed management have an impact on community health?

3. What changes in current water resource practices are socially and economically viable?

4. Which cultural traditions or beliefs support water resource management in the community?

(continued)





Guide Sheet

WATER RESOURCES AND WATERSHEDS

Optional Assessment Questions	Town Areas	Farming Areas	Natural Areas
1. What are the various sources of surface and subterranean water sources in the community?			
2. What are the fundamental water quality and quantity issues in the community?			
3. Do people and their domesticated livestock draw from the same water sources to drink?			
4. What is the range of uses that people have for the different water sources in the community?			
5. What are people's perceptions of why streams dry up periodically or permanently?			
6. Have the community water resources been mapped out in any way? If so, have these maps been shared with community folks?			
7. What institutions are currently working on the challenges of waste management in the community, and what have been their results?			
8. Where does water flow in the community? In other words, where do waterways originate and to which areas do their waters flow?			





Guide Sheet

WILDLIFE AND DOMESTIC LIVESTOCK

Optional Assessment Questions	Town Areas	Farming Areas	Natural Areas
1. What laws govern wildlife and domestic livestock management in the community?			
2. Are there areas in the community in which wildlife reside and are legally protected? Describe these areas.			
3. Are there species of wildlife unique to your area that could potentially draw tourists (these are sometimes called <i>charismatic species</i>)?			
4. What are the major factors that determine the size and well-being of populations of potential or actually useful wildlife species in your area?			
5. Which habitats are favored by wildlife and to what extent are these habitats influenced by human activities, including the management of domestic livestock?			
6. Which local institutions work with wildlife conservation or livestock management?			
7. What traditional knowledge and practices promote wildlife conservation or the well-being of domestic wildlife?			
8. What are the opportunities for improving the management of wildlife and livestock?			
9. What are the natural predator/prey relationships among wildlife (as well as domestic livestock) in the community?			





CHAPTER THREE IDENTIFY THE TARGET GROUP

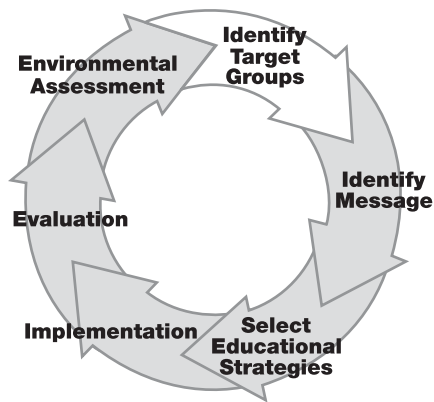
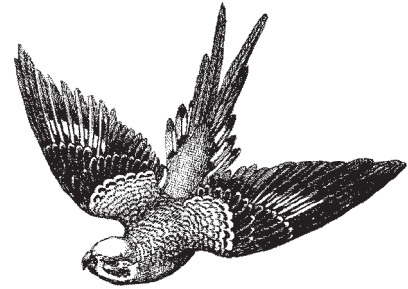

By now, you have identified the environmental issues that your education program will address by using an environmental assessment. In this chapter, you will learn how to identify the target group(s): the group(s) of people who will actually implement the solutions. Environmental educators can waste time and energy by directing education toward inappropriate target groups who have little or no impact on environmental management and decision-making. Therefore, target groups should be made up of people whose practices directly affect the environment, such as poachers, as well as the people who influence those people, such as community leaders, government officials, and/or the general public. There may, in fact, be several target group possibilities, with the most obvious not always being the most appropriate. Therefore, an effective environmental education program may focus on several different audiences.

MACHHA BAZAR

You have been having long discussions with your counterpart and her manager about what River Conservation wants to do. They are concerned with the impact from increased numbers of vehicles, fishermen, and boaters, which is causing fish numbers to decrease, the riverbank to erode, and which may be infringing on wildlife habitat. They are also concerned about the economic impact to residents and the safety issues posed by the new people who aren't considered part of the community. Prior to your arrival, they decided to initially focus their resources on environmental issues. Their mission is for local residents, local organizations and government to work together to develop and implement management guidelines that protect and sustain the natural resources of Machha Bazar for future generations. Their goals are to:

- work with the schools to educate children about the environment and sustainable development;
- help the fishermen organize and develop a plan for management of the fisheries that will maintain healthy river habitat and healthy populations of river fish; and
- work with the park, especially the local ranger, to develop educational materials for the public that will increase respect for wildlife and wildlife habitat, and decrease misuse of the park.



(continued)





Environmental Education Plan for Machha Bazar

In an effort to get organized, you have drawn yourself a chart to put on the wall to organize the steps that you'll follow when creating and implementing an environmental education program.

Activity	Target Group	Message	Strategies	Implementation	Evaluation
Class					
Eco-club in school					
Fishermen's advisory group					
Environmental education for the park					

GUIDELINES FOR IDENTIFYING TARGET GROUPS

The target group of an environmental education program must be able to:

- significantly contribute to the solution of the identified problem; and,
- perceive that the advocated behavior changes are in its best interest.

It is crucial to identify target groups that meet both of these requirements in order to achieve the desired environmental results. Educators need to approach this task with as few preconceptions as possible. Although the target group possibilities are virtually endless, some generalizations might help you, your counterpart, and the community advisory group focus on the groups of people who might be most appropriate:



People directly affecting natural resources.

This is usually the easiest group to identify because its practices directly affect the environment. Unfortunately, this group is frequently maligned, although they may have few alternatives to current practices. They may also be quite aware of the negative effects their actions have on the environment, but are economically or socially constrained from implementing alternatives. Environmental education programs directed at these people are frequently most appropriate when they offer alternatives and/or specific methods for managing resources and demonstrate advantages to the community.



Extension Workers or Resource Management Educators.

As a rule, these people work for forestry, agriculture, or other national extension services. They usually do not harvest natural resources themselves, but introduce new products and techniques to those who do. Educators, therefore, may find it appropriate to assist extension agents with environmental education programs or to train them in environmental management. Involving extension workers in education efforts can maximize the program's impact, since those workers can reach many more people. They may also effectively establish communication links among community residents and distant government officials and other decision-makers. Through these extension workers, environmental educators also create local capacity to maintain the program.



Local Leaders, Government Officials and Agencies.

Government officials and local leaders can significantly affect environmental management by passing and enforcing laws and by initiating and supporting projects that negatively or positively affect natural resources. They are responsible for projects to construct dams and roads, colonize large tracts of land, and can encourage or discourage reforestation. They fund health, sanitation, education, and extension programs; and act to establish parks and reserves. To work effectively with this group, environmental educators need to determine which government officials and agencies can impact environmental problems and how. An effort should be made to understand how relevant programs and positions are funded, the interests and concerns of the individual or agency, and official mandates.

Influential Community Members.

These people are often "opinion leaders" and may be members of the political party in power or respected community residents. Since the people the educator wants to influence will often follow the example of influential community leaders, this can be a very productive target audience.

The General Public.



This group is the most targeted by environmental education programs. Mass-media approaches are generally used to reach this audience. A mass approach often does not require the detailed community knowledge that a more narrowly targeted program demands and can seem easier to implement. When implemented as stand-alone activities, such "short-cut" approaches usually fail to adequately address environmental problems.

On the other hand, a broad public appeal implemented as a complement to more tailored approaches can be extremely effective, especially in creating receptivity for more detailed follow-up environmental education programs. Development workers and educators should have a specific reason for directing a program towards the general public, and it should be clearly stated in the program objectives how the general public can contribute to the resolution of an environmental problem.



Schoolchildren.

Environmental educators often address this group with the intent of creating environmentally knowledgeable adults. While programs in the schools are an important component of environmental education programs, serious environmental problems may exist that require more immediate attention, and to which priority must be given. Although children may not be able to contribute to such an effort, they can be an appropriate target group if some of the following conditions are met:

- Are a significant number of schoolchildren likely, some day, to play a role in managing the environment? Will they be future farmers, government decision-makers, or members of an influential general public? In many rural areas, environmental education can be justified because so many of the children drop out of school early to work on family farms. For this reason, educators should consider designing rural school-based education programs that have objectives similar to those of adult education programs in the same area. For example, teaching basic soil conservation and reforestation techniques to rural school children can be appropriate.
- Can teaching schoolchildren effectively reach community adults? A school environmental education program can involve parents through school field trips and tree planting, litter clean-up, and other community campaigns. In effect, school environmental education programs can supplement or complement adult extension services.
- Can schoolchildren significantly contribute to the resolution of present environmental problems (e.g., can the children plant windbreaks or fuelwood plantations?).
- Have the identified priority environmental education objectives been achieved, so that education efforts can be redirected towards creating awareness and changing attitudes in future decision-makers?
- Has the host country itself requested that environmental education be incorporated into the school program?

After identifying the target groups most capable of contributing to environmental management, educators must determine which group is likely to be receptive to the messages of the program. Behavior change is based on the assumption that people will do what they think will most benefit them, provided that their socioeconomic circumstances allow them to change their behavior and implement alternatives.

People are not likely to change behaviors that they perceive to be contrary to their own interests. This can be as basic as a place to live, a job and enough to eat; or as intangible as social status and ego satisfaction. When people must be convinced to do something that they believe is not in their best interests, education is not the tool to use. Law enforcement, financial compensation, or social pressure, for example, must be used instead.

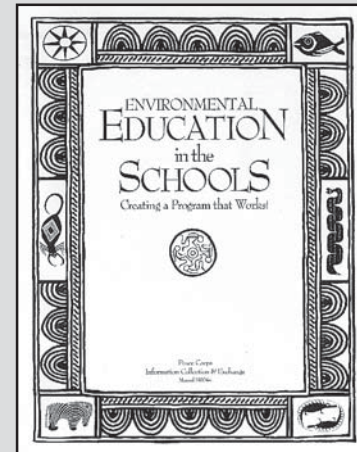

In addition to the information contained in this manual, the Peace Corps' publication *Environmental Education in the Schools* [ICE No. M0044] can be used as a resource for creating and conducting in-school EE programs.



Often, the people closest to an environmental problem are the least able to alter their actions. Take, for example, farmers who are over-harvesting wildlife and trees in a natural forest. To convince the farmers to do otherwise, an environmental education effort has to advocate practical alternatives that can meet their need for animal products and wood. Without alternatives, the effort will not be able to convince the farmers to change, even if their actions are detrimental to the natural resources and the community.

Another way to change the farmers' behavior may be to direct an educational effort at people who can motivate the farmers to change, and have it in their best interest to do so. For instance, the educational program may be directed at community leaders who can provide the farmers with financial incentives to plant trees, or at neighbors being harmed by the farmers' behavior who can pressure leaders to provide farmers with alternatives.

At times, environmental education programs can more effectively affect people's behavior when focused indirectly at them. For this reason, environmental educators should not assume that the people whose behavior ultimately needs to change are the best or only target groups for their educational efforts.



MADAGASCAR



A Volunteer was placed at a forest station, which serves as a zoo and captive breeding center for endangered lemurs. Although her job to assist with developing environmental education programs and materials was well-defined, she wanted to engage in community development activities. However, she was a long way from the closest village, with its market and community center. Because her day-to-day contact was with the other people who worked and lived at the zoo, she decided to make them her community. The result turned into something much bigger than she ever imagined.

Zoo workers had the right to farm in order to satisfy some of their food needs, and had been growing rice when the Volunteer arrived. Through her conversations with zoo personnel, she found that they were interested in further developing their small tracts of land. The workers and their families worked with the Volunteer to develop a project plan and proposal to train themselves in small animal production, beekeeping, agroforestry and improved farming practices. The Volunteer has reported early success and in her last report, she wrote: "as of the end of September, all the houses have been built and populated with their respective chickens and ducks. Many of the local material hives already have bees in them...there really is no other project like this going on in our area so I feel that the potential to pass this [information] on is high. I also feel like this is paving the way for my community [the zoological park] to truly become a regional leader in conservation."



MACHHA BAZAR

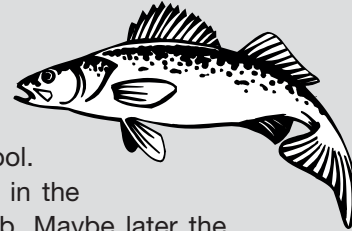

As you explore the activities that you and your counterpart are thinking about implementing, you try to imagine what will happen. It seems obvious that the first project requires working with the school. Your counterpart told you that environmental science was not taught in the school, but that you, she, and the teachers can form an ecology club. Maybe later the biology and social studies teachers could incorporate environmental topics into their curriculum, but for now, a club seems the most feasible. The fishermen pose a different problem: how to organize the fishermen, or bring them together to discuss their ideas? Developing educational materials for the park would have to be discussed with the ranger to find out if he is interested, if there are any rules regarding an educational or interpretation project, and if the park could accept materials from a nongovernmental organization (NGO). For that project, it seems that the people to target are the general public who use the park for all sorts of purposes, and maybe less directly, the poachers. You return to your chart and fill in the new information.

Activity	Target Group	Message	Strategies	Implementation	Evaluation
Class	students and teachers				
Eco-club in school	students and teachers				
Fishermen's advisory group	fishermen – advisory group				
Environmental education for the park	general public; maybe poachers				





Ask the following questions to help select target groups:

- Who affects the natural resource(s) under consideration?
- Is it in their interest to change their behavior?
- What intervention is needed to change behavior (e.g., law enforcement, education, government policy, social pressure, financial incentives)?
- Who will benefit from the education program? Who will benefit from the measures advocated by the program? Can they play a role in getting the education program implemented?
- What influential community members can help to convince people to change behavior?
- Are there influential community members who can provide incentives for people to change behavior (e.g., financial inducements, law enforcement, social pressure, government policy)?
- Does the environmental solution require government input (e.g., laws, policy, leadership, law enforcement, funding, support for new programs)?
- Which government agencies can contribute to solving the problems? How?





CHAPTER FOUR

IDENTIFYING THE MESSAGE

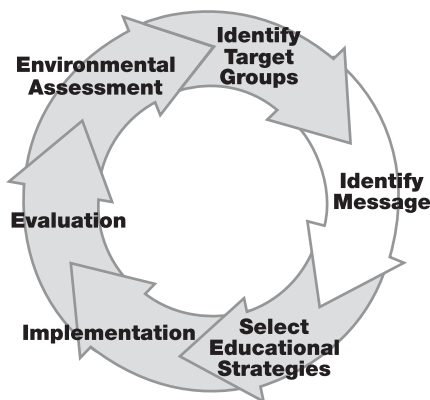
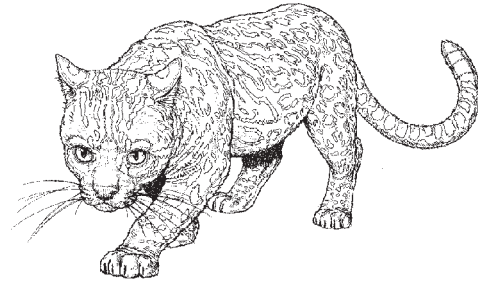

Creating and identifying content for an environmental education program should be a dynamic, participatory process that involves the Volunteer, counterparts, and community educators. It should reflect the specific circumstances of the community and target group, including social, cultural, environmental and economic realities. A thorough understanding of the community on the part of educators, and a careful planning process that defines the community vision, goals, objectives, and tasks will likely yield effective and relevant program content.

Now that you have identified priority environmental problems (Chapter Two) and the groups most capable of implementing identified solutions (Chapter Three), you are ready to prepare appropriate information to present to the various groups. This chapter assists in identifying and organizing the types of information most appropriate for each particular situation. Specific information that can form the actual content of the lessons can then be assembled from the environmental assessment (Chapter Two), other technical manuals and locally available sources.

Careful selection and organization of content is crucial for a program's success. This task can be challenging since there is often abundant information. The guidelines below may help in developing such efforts.



DETERMINE THE LEVEL OF ENVIRONMENTAL AWARENESS IN THE TARGET AUDIENCE

The first step in determining program substance is to learn why people are behaving in a way that needs changing. Educators may have some good ideas about why this behavior is occurring as a result of the extensive environmental assessment, which should be referred to regularly. Educators can build upon the information gathered during the assessment to further explore specific issues with the target group.

It may help educators to use a continuum when thinking about the educational content of the program.

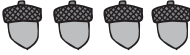

Where do target groups lie on the following continuum?

<p>STAGE 1</p> 	<p>Unaware of the problem.</p>
<p>STAGE 2</p> 	<p>Aware of the problem, but not aware of their relationship to it, or their role in creating or perpetuating it.</p>
<p>STAGE 3</p> 	<p>Aware of the problem and their relationship to it, but not aware of its solution.</p>
<p>STAGE 4</p> 	<p>Aware of the problem, solution and what they should do, but for whatever reason, unable to implement solutions. What circumstances must change in order for behavior to change? Economic, social, political?</p>

The continuum provides a tool that educators can use when thinking about next steps, and demonstrates how achieving competence and awareness in one stage provides the foundation for the next stage. Approximating the position of the target group on the continuum can help educators to create program content that is relevant to the current situation, and provide some indication of future programming needs. If, for example, the target group clearly understands and agrees that there is an environmental problem, educators need not spend a lot of time on defining the problem (Stage 1), and can begin to explore with participants how the problem affects them, and how certain behavior or practices may create or exacerbate the problem (Stage 2).

For target groups at Stage 1: 

The education program’s message should be straightforward and informative. Educators don’t need to focus on details; the main effort should be on creating awareness in the target population. Accuracy is crucial and educational content should build on locally relevant circumstances and knowledge. Avoid over-sensationalizing or emotionalizing messages.

For target groups at Stage 2: 

A more substantive message is needed and a thorough knowledge of the community is required. Here, people’s general awareness of an issue should be developed into an understanding of how they are affected by and are affecting the environmental situation. The environmental problem should always be related to the target group’s particular interests. For example, firewood shortages and flooding of residential areas might be presented as the consequences of the deforestation of a watershed, since those consequences affect them directly. The disappearance of a rare bird species and the loss of scenic beauty that are also the result of deforestation will be of less concern to this target group.





For target groups at Stage 3:

Stage 3 is a turning point for the environmental educator and is where many programs fall short of their intended goal. The target group must clearly understand what they should do to help solve an environmental problem. It is counterproductive for the educator to generate awareness and concern about an environmental problem and then abandon the program, which can cause frustration and apathy in the target group. Environmental solutions can be as simple as requesting children not to throw candy wrappers on the ground, or as major as recommending that farmers change their planting and plowing methods. Whatever the solution, the education program must identify it and present it in a way that relates to the target group's interest.

For target groups at Stage 4:

Further investigation by educators may be required at this stage. There are many reasons why people do not do something that appears to the outsider to be in their best interest. Behavior may result from economic circumstances, religious taboos, traditional customs, and/or other sociopolitical factors. Educators may find that proposed earlier solutions were developed without sufficient local participation. If there appears to be no "logical" explanation for a certain behavior, the process and assumptions that led to the selection of that particular solution should be reviewed. Take time to go back to determine where something may have been missed or misinterpreted.

MACHHA BAZAR

The first set of tasks in the development of the environmental education program for Machha Bazar is to contact school personnel, fishermen, and the park ranger to engage in a dialogue about how to proceed with environmental education.

After meeting with the school personnel, you, your counterpart and other community-based educators have agreed to come into the school and teach one class a week on local ecology and basic environmental studies. It will be in the middle school biology class, so you will have to coordinate your lessons to the subject of the week. You and your counterpart will design activities to guide the students along the continuum from environmental awareness to participation. You have also agreed to lead an after-school ecology club for secondary students. The club will meet weekly and the goals will be to learn about the environment, develop community service projects, and have fun.

After speaking to the park ranger, you have learned that he is eager to have someone do some interpretation in the form of signs and printed matter. He tells you that the ministry supports this type of education, but he doesn't have the time or background to complete it himself. He wants to publicize the regulations of the park because he is short of resources to enforce the rules. He would also like it if people who see poachers would contact him. Although poachers might try to tear down signs, he thinks enlisting public support would be helpful.

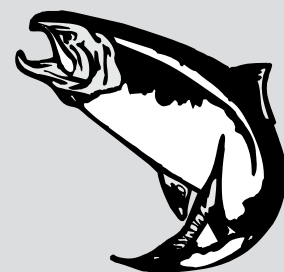

(continued)



You and your counterpart also went down to the riverbank and talked with fishermen about forming an advisory group, which would eventually provide knowledgeable and appropriate suggestions on how to best protect and utilize the river and fish resources. The fishermen were receptive to the idea and got quite vocal about how to protect the fish. They wanted to know the purpose of an environmental education program, and they talked about who should be on the advisory group. Later, you discussed the idea with your counterpart and decided that you needed to meet with fishermen so that all interested parties could discuss the potential roles and responsibilities of an advisory group.

PARTICIPATORY DEVELOPMENT OF PROGRAM CONTENT

Program content should be developed using a participatory approach that includes, at a minimum, your counterpart and the advisory group.

- 1. With your counterpart and advisory group, write a statement that describes what they hope for in the future regarding to their selected priority.**

The first step is to have a clear and concise statement of what the future would be if they were able to resolve the environmental situation.

Statement Example: In our community, people are able to meet their household fuel demand in a way that is sustainable with respect to the surrounding forest. Women and children are able to easily access fuel, which leaves them time to engage in other activities.

- 2. Identify the resources in the community that will allow the community to achieve this vision.**

The environmental assessment should contain information that would help identify the strengths and assets that will be helpful to defining program content.

For example:

- A motivated core group of community members.

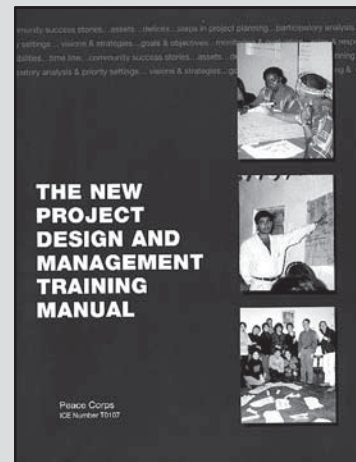

This section is based on the project design sessions in *The New Project Design Manual* [ICE No. T0107], which presents a much more extensive and rich process for developing projects. If possible, Volunteers should refer to that manual.





- Many individuals with diverse knowledge of forest ecology and how to harvest forest products in a traditional and sustainable manner.
- Several well-functioning NGOs with contacts outside the community and access to many informational resources.
- Several different funding options.
- A Peace Corps Volunteer with knowledge of environmental education programs, and the ability to travel and make contacts outside of the community.
- Several unused and commonly held areas within town limits.
- Local artisans.



3. Select the best strategies and approaches for the project.

The group should brainstorm ways for achieving its vision given the resources available.

For example:

- With all the knowledge and resources available to us, the community will establish woodlots of fast-growing native tree species that can be used for firewood and/or other purposes.
- The core group will work with women to experiment with different fuel-saving methods, and to test other types of fuel.

4. Develop project goals and objectives.

Project goals:

- Restate the vision and approach in terms of what is to be accomplished;
- Define the long-term results or changes that the project will bring about; and
- Are realistic and include an overall time frame.

Project Objectives:

- Are short-term results you need to meet the longer-term goal(s) of the project;
- Are SMART: **S**pecific, **M**easurable, **A**ttainable, **R**ealistic, and **T**ime-bound; and



■ Answer these questions:

- Who is the target group or individuals expected to change?
- What action or change is expected?
- When will the desired action or change be accomplished?
- How much change is expected?

Goal Statement Example: By the end of one year, the core advisory group, in conjunction with neighborhood representatives, will have initiated community woodlots in each of the neighborhoods in Machha Bazar so that communities have access to a sustainable source of fuelwood.

Objective 1 – By XX month, core group members will have conducted community meetings in each of the five neighborhoods to discuss with at least 80 percent of the community the rationale for community woodlots.

Objective 2 – By XX month, core group members will have implemented community-wide environmental education campaigns that demonstrate the necessity and benefits of woodlots so that in each of the five neighborhoods, at least 50 percent of the community supports the implementation of the woodlot.

Objective 3 – By XX month, members from the core group will have trained five neighborhood volunteer representatives (men and women) in skills on how to develop and maintain community woodlots.

Objective 4 – By XX month, the five volunteer representatives, in conjunction with the core advisory group, will have planted 750 seedlings in each of the five woodlots.

5. Develop an action plan for achieving objectives.

To develop a plan, the group must identify the tasks and activities that will be necessary to achieving the objectives. For example:

Objective 3 – By XX month, members from the core group will have trained five neighborhood volunteer representatives (men and women) to develop and maintain community woodlots.

Tasks:

- Ask community to select five responsible men and women to run the woodlots.
- Select and train teachers who will train community members.
- Develop curriculum.
- Research and pick tree species.
- Acquire materials and tools needed to conduct classes (these can later be used at the woodlots).
- Develop a class schedule.

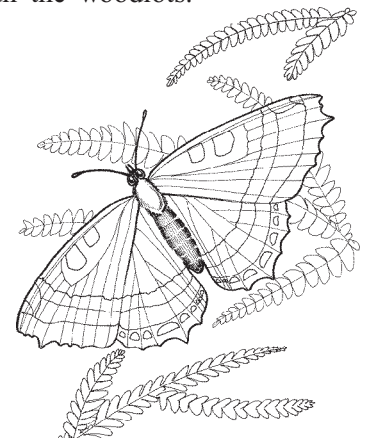



MACHHA BAZAR

You and your advisory committee found that schoolchildren and park visitors are at Stage 1 on the continuum. You will need to use the participatory process to develop an awareness program that points out features of the environment and demonstrates ecological interactions and dependencies among these features. For the children, that will be in the form of a class and an outdoor club. For the park visitors, it will be in the form of signs, brochures, posters, and radio announcements. The fishermen are at a different level of awareness. They want to take action, and they have some ideas about what action they think will be helpful. The program for the fishermen will include the formation of an advisory group that will act as a forum for their ideas. Prior to that, you and your counterpart will need to gather data about the fish, and find out how the advisory group can have input into policy making. In conjunction with the advisory group and counterpart, you should develop a description of service that outlines the responsibilities of the advisory group.



You and your counterpart have decided on a set of messages for the schoolchildren. In the classroom, you will focus on using the students' real environment to expand their knowledge of biology. For example, if the teacher is teaching about arthropods one week, you will bring in some local bugs and teach the children about the importance of insects to the ecosystem. The eco-club will be different. You will focus on natural history and observation skills. Each meeting will feature a nature walk where students learn to identify components of an ecosystem and ecosystem services.

The park project will have a different focus. Some of the signs will describe components of the ecosystem along with descriptions of their importance to the whole system and to humans. Some of the signs will describe proper ways to behave in the park and why, and some will list regulations, how to comply, and how to report infractions. Brochures, posters and radio spots will focus more on the outstanding features in the park and on development of a respectful attitude. When all these are ready to be distributed, there will be an afternoon kickoff event focusing on the park, its beauty, importance, and care.

Fishermen will convey the message that they have developed. They will be organized to give advice on an education program that will inform the public about the importance of fish as a resource and how to protect that resource. They will also offer advice to governmental organizations about policies for fishing and the protection of fish.



Environmental Education Plan for Machha Bazar					
Activity	Target Group	Message	Strategies	Implementation	Evaluation
Class	students and teachers	<ul style="list-style-type: none"> relationship of humans to environment environmental aspects of school curriculum 			
Eco-club in school	students and teachers	<ul style="list-style-type: none"> observation local natural history 			
Fishermen's advisory group	fishermen – advisory group	<ul style="list-style-type: none"> fish ecology specific concerns of fishermen 			
Environmental education for the park	general public; maybe poachers	<ul style="list-style-type: none"> ecological information about park park rules 			

BASIC EDUCATIONAL PRINCIPLES

Frame the program in a familiar context.

An education program should build on existing knowledge and affirm the beliefs and practices that have a positive effect on the environment. An education program should occur in the context of the community and should relate environmental problems to current socioeconomic and environmental realities. For example, it is likely that farmers in an agricultural community will understand far more about the local agriculture and environment than an outsider. Educators should use this knowledge to inform the educational program. In addition to creating an environmental education program that affirms local knowledge, educators should frame information in a context that is understood by the target group. An educator will be far more likely to inspire behavioral change if the education program is related to existing concerns and presented in terms familiar to the target group.

Educators should be alert to the factors that can inspire behavior change.

Some of those might be economic, cultural, or social. To accept unfamiliar ideas and knowledge, people need to adjust attitudes and beliefs. Most individuals resist change because altering beliefs and practices can cause stress and confusion. Therefore, educators must discover motivating factors that can elicit change. For example, people with no real interest in nature or outdoor activities may become





motivated to preserve natural areas because these areas represent a unique and valuable national heritage that can be admired by both nationals and foreigners.



When learning new information, people look for patterns, generalities, relationships, and organized structured wholes, rather than separate details.

A program should be structured so that the learners move from more general to more specific information, from the “big picture” to the smaller details. Broad concepts should first be presented to learners so they have a framework in which to incorporate further information. Details get lost over time when not linked to general themes. For example, in the case of deforestation, town leaders are unlikely to benefit from an environmental education program that begins by detailing the biological components of a tree. Although this may be useful to those caring for the trees, it does not really address the larger issue of why planting trees can benefit the community. Rather, exploring the broad concept of reforestation would allow the leaders to incorporate more specific information about the species and growth patterns meaningfully.

The following questions can help educators determine if they are on track:

- What environmental problem does the education program address?
- Why is the program directed at this particular problem?
- How does the education program lead to a solution of the problem?
- What target groups have been identified and why?
- What knowledge and attitudes is the program trying to convey to the target group?
- How has the content been informed by the local environment, and community and target group socioeconomic and cultural circumstances?
- What are some of the best avenues and/or methods for communicating program content to the target group?

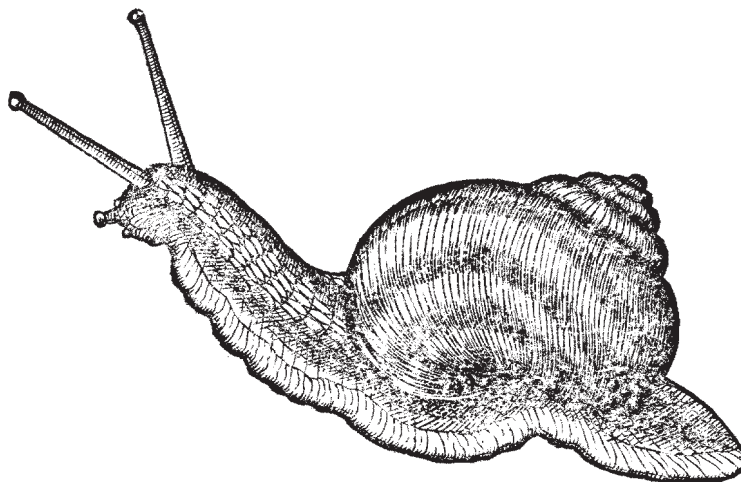



CHAPTER FIVE

CREATING AN EDUCATIONAL STRATEGY

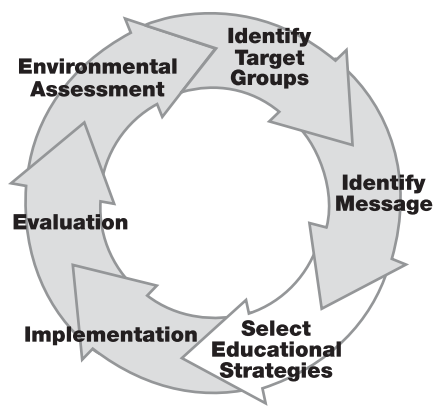
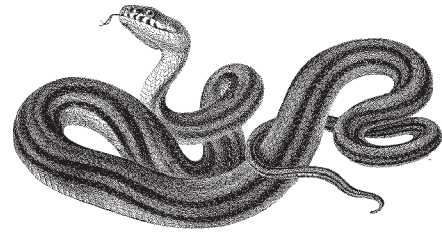

Strategies used in environmental education programs range from producing posters to developing national forestry extension programs. In the development context, environmental education strategies must fit existing environmental, political, and social situations to be effective. Environmental education Volunteers are likely to find that the methods with which they are familiar are inappropriate in the context of the host country, and they will be challenged to create innovative and culturally appropriate approaches that resonate with the community and target group. Effective environmental education Volunteers will collaborate closely with community educators, advisory groups, and counterparts to create an education program that is shaped by the people who will be participating in, and affected by, the program.

As outlined in Chapter Four, each target group will require an approach that is crafted with their particular interests, abilities, and circumstances in mind. It may help to find out what education and/or other development programs have been successful in the past and why. Following are some considerations that can help you, your counterpart, and other educators determine what the strategy should be for the particular group you are trying to influence.

CONSIDERATIONS

An effective environmental education strategy will:

1. Reach the program's target group(s).
2. Effectively communicate the program's information.

There are several factors to consider when selecting an appropriate and effective environmental education strategy. To craft a good strategy, you, your counterpart, and other community-based educators will need to consider who your target group is, the amount and type of information to be communicated, existing assets and building blocks that can facilitate the education program, and various logistical and financial factors.





Review the following questions and issues when selecting a strategy or strategies.

Tailor your strategy to your community and target groups:

● **Who is the target group?**

Define the group(s) by age, occupation, and relationship to environmental problems.

● **What are the avenues of communication in the community?**

How do the target groups receive information? Do they listen to the radio or television; read a certain newspaper or magazine; watch for bulletins posted in the town square; communicate with friends at the central market? Do they listen to the local extension agent, the religious leaders or the local political leader at party meetings? Who are considered reliable community leaders, role models, and conveyors of information? Can any existing communication mechanisms be used in an environmental education program?

● **What is the level of literacy and availability of printed information?**

What kinds of printed material might work for the target group(s)? Experiment with a number of formats to discover which is most effective.

● **What kind of message is to be conveyed?**

- Awareness messages are often conveyed with the following techniques: mass media, exhibits and posters, brochures and booklets, traveling road shows, special events and campaigns, audiovisual programs.
- Messages concerning practical, “how-to” information are often conveyed using the following techniques: field trips, demonstration plots, brochures, posters, flyers, newspaper supplements, extension programs.
- Messages that convey intensive, complicated information use the following techniques: school curricula, training workshops, extension programs, seminars, one-on-one communication, clubs.

DON'T FORGET:

You may have discovered some other relevant information during the environmental assessment, so be sure to refer back to it periodically.

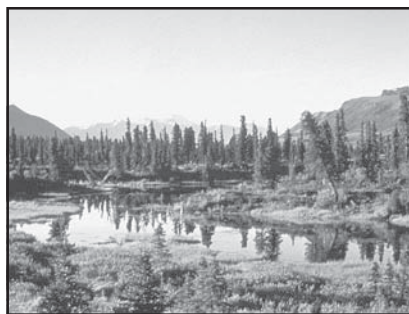



● **Which strategy corresponds with the message most effectively?**

How much information does the target group need to know to change its environmental behavior? Is the message to be communicated short and simple, or long and more complex? Will it have to be repeated periodically or will one presentation suffice? Will the education program be long- or short-term?

Practical and logistical considerations:

● **Personnel**

Who is available to carry out the educational program? How much time can they devote to the program? What skills do they have, and how can these skills be used? How much training, supervision, and direction do they need?

● **Logistical**

How accessible are the target groups? What type of transportation do you (or they) need? How much time will be spent in travel?

● **Time**

How much time does the development worker have to devote to the program? For the program to succeed in the long run, what must be done before the development worker leaves?

● **Policy**

Are there any policy considerations that can help or hinder the program?

● **Resources**

How much money, equipment, and other resources are likely to be available? Are there any potential outside agencies able to provide these resources? How much can be contributed “in-kind”?



Depending on the answers to these questions, an education strategy can be created that fits both the target group and the program content. A number of educational strategies are described in Chapter Ten, “Environmental Education Community Projects.”



MACHHA BAZAR

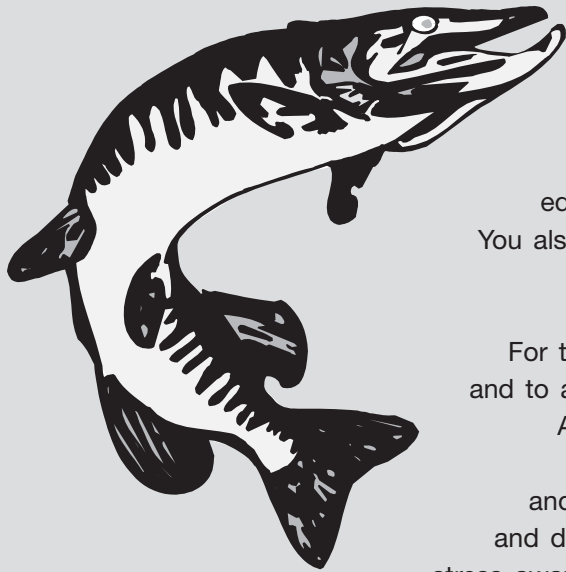

Now you are ready to get specific about your project in Machha Bazar. In the classroom, you decide you want to use lessons that include demonstrations and outdoor activities. So you search for environmental education resources that have those kinds of lessons. You also need to find out what is in the biology curriculum so you can coordinate with the teacher weekly.

For the Eco-Club, you want it to be fun and informative, and to align the activities along the Awareness, Knowledge, Attitudes, Skills, and Participation continuum. To find out the children's level of environmental knowledge and behavior you will need to conduct an assessment, and decide from there if you begin with nature walks that stress awareness, or if you can emphasize particular skills and behavior. It is your hope that the students can create and implement a community project.

You, your counterpart, and park personnel are already quite sure about the strategy for the park; the park team will implement an education campaign that uses signs, brochures, posters, radio spots, and community awareness events. Although it is clear how you will convey information, it is not yet clear what the exact message will be. In crafting the message, you will have to consider literacy levels and what kinds of visual representations will resonate with park visitors. Consider creating messages that build on cultural ideas and images already familiar to visitors.

You will act as a catalyst for organizing the fishermen's advisory group. You decide a good first step would be to meet with your counterpart and fishermen to introduce the idea of an advisory group and to explore what the purpose, goals, and activities of the group would be. After this meeting, your counterpart suggests that she and you visit a number of fishermen, both those who have been vocal and those who have not, and elicit their opinion about forming such a group. As you chat with fishermen, try to notice not only what is said, but also what is not said. Who seems to be the most respected individual? Who seems to be a good listener? As you seek to learn about the existing dynamics between individuals and within the fishing community, maintain confidentiality.

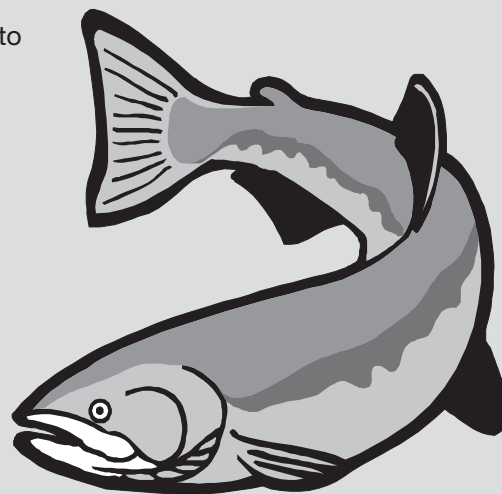

(continued)



Environmental Education Plan for Machha Bazar					
Activity	Target Group	Message	Strategies	Implementation	Evaluation
Class	students and teachers	<ul style="list-style-type: none"> • relationship of humans to environment • environmental aspects of school curriculum 	<ul style="list-style-type: none"> • Teach one class/week using interactive approaches and incorporate local field study 		
Eco-club in school	students and teachers	<ul style="list-style-type: none"> • observation • local natural history 	<ul style="list-style-type: none"> • Club meets one afternoon/week for field based EE 		
Fishermen's advisory group	fishermen – advisory group	<ul style="list-style-type: none"> • fish ecology • specific concerns of fishermen 	<ul style="list-style-type: none"> • Gather info • Description of service • Call organizational meeting • Meetings • Develop plan 		
Environmental education for the park	general public; maybe poachers	<ul style="list-style-type: none"> • ecological information about park • park rules 	<ul style="list-style-type: none"> • Interpretative signs • Brochures and posters • Kickoff event • Radio spots 		





CHAPTER SIX

IMPLEMENTATION

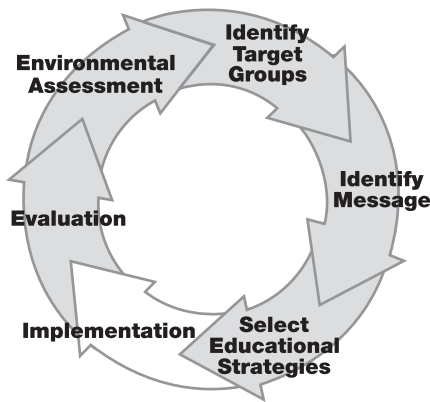
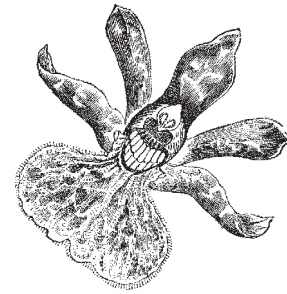

Before implementing the project, you, your counterpart, and community educators should have created an environmental education program that includes the following components:

- a description of program content and rationale;
- a description of the target audience;
- the education strategies that you'll use;
- goals and objectives of the program;
- a budget; and
- an estimate of personnel needs.

Prior to the actual implementation of the plan, there will be a number of necessary tasks including: acquiring funds, equipment, and any additional personnel; training of personnel and/or community educators; finalizing interagency agreements; and confirming logistics.

MACHHA BAZAR

You, your counterpart, and the various groups with whom you work have planned your program and you are ready to start! You will prepare your first two or three lesson plans for the school, including an assessment to find out what the students already know. For the first meeting of the Eco-Club, you plan some awareness and knowledge activities that can be used during a group walk. You will focus on observing the area adjacent to the school and try to generate some understanding of ecosystems. At the end of the session, you will have a closing activity that provides a review and reinforces what has been learned. You will meet with the park ranger and make a list of objectives for visitor behavior, so you can begin to work up language for the signs and other media. You and your counterpart will also focus on forming an advisory group with the fishermen.

You and your counterpart are ready to go to the schools, fishermen, and park to try your ideas. In an effort to discover potential problems, you and your counterpart decide to do a few pilot tests. Your counterpart suggests that she teach one of the lessons in the school, which you can observe, and you decide to take the children outside to see what their reaction is to learning in a different setting. You incorporate some observation



(continued)



skills into the lesson so you can estimate the students' observation skills, which will help you to plan the first Eco-Club session.

Your conversations with fishermen have yielded some interesting information, and overall, there seems to be support for forming an advisory group.

However, you have some concern that only the richest fishermen will be represented on the panel, and you discovered some animosity among various individuals, especially between those who have lived in the community for many years, and those who have just arrived. Given what you and your counterpart have learned about the skills, needs, and concerns of the fishermen, together you create the basic plan for forming the group, and establish the basic purpose and goals of the group. You and your counterpart recognize that it is important for all views to be represented, which figures into the creation of an advisory group purpose statement, as well as the strategy for selecting representatives. You decide on an initial time period that members will serve, and come up with a very basic 'description of service', which clearly states roles and responsibilities. In the next meeting with the fishermen, you present this plan, and ask for input on how to improve the process of forming an advisory group.

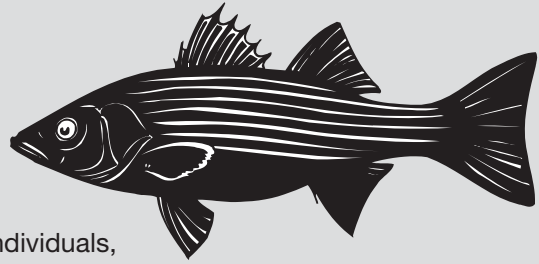

GUIDELINES

Implementation of the program will occur much more easily if the design process has been participatory. The success of any program relies on how much it reflects the concerns and ideas of the target group, as well as how much it reinforces positive cultural and community values and behaviors.

As a Volunteer, your role is often that of a catalyst and/or obtaining and organizing host agency interest and participation. You and your counterpart are likely to conduct tasks such as: approaching a funding agency; arranging meetings among different agencies; or organizing a personnel training workshop.

You must implement the plan in a way that helps to ensure the program's long-term viability. The following practices have been found to promote successful and sustainable environmental education programs:

- 1. Prepare an action plan** of the work that has to be done to implement the project. Document the tasks that need to be accomplished (e.g., fund-raising, signing interagency agreements, arranging project logistics), and a timeline for accomplishing tasks. Be sure to include any seasonal considerations (e.g., what needs to be accomplished prior to the onset of the rainy season?), and/or reporting requirements (e.g., when do budgets have to be submitted by the partner agency?).
- 2. Think of your action plan as a living document!** Your initial action plan will provide only a rough guide, and you should approach the implementation timeline with a good measure of flexibility. As you proceed with the program, any number of events might occur that hinder or halt the program's progress. For example, perhaps you didn't consider how the rainy season affected school schedules, or one of the most vocal and enthusiastic community educators is called away to fulfill other obligations. To accommodate new realities, you, your counterpart, and other involved community members should meet regularly to discuss changed circumstances and, if necessary, make adjustments to the action plan.





- 3. Create sustainability whenever possible.** In-country resources should be relied upon for financing, personnel, and equipment. Although it may be tempting to rely on foreign sources of funding, as well as easier to acquire them, in-country resources are likely to be more sustainable and more easily accessed by the local population in the long run.

When searching for funding sources, determine how often outside funding will be needed. Large foreign donor agencies may be able to provide some money to get a project started, but they probably will not provide funds on a regular basis. A project that requires ongoing funding should seek resources within the community. Explore options with the community. There are a number of small, but effective, fund-raising activities that Volunteers have found to be useful. Selling tickets to dances, raffles and contests have been successful money making activities, as have making and selling t-shirts, soap, baked goods, posters, and various handicrafts. The more invested in a project, and the more all aspects of that project occur within the community, the more committed participants will be to the project's success.

- 4. Encourage participation by the host country agency** that is responsible for implementing the education project. Seek to involve representatives of these organizations in a variety of ways, and keep them informed of the project's progress. Invite them to workshops or to observe education sessions, and involve them when any significant changes take place.

REMINDER!

One of the greatest challenges that many Volunteers face is achieving a high level of community and host agency involvement and commitment. The impulse for many Volunteers is to “just do it themselves.” Although initially easier, this approach is ultimately counterproductive, and is likely to result in a program's failure. To increase the chances that the program will have a lasting effect, and continue after your departure, community members and host country agencies must be thoroughly involved from the start.





5. Identify the project as a host country agency project, rather than a Peace Corps or foreign development project. Written materials, for example, should name the host agency, not Peace Corps, as the main publisher. Local press and television coverage of the project should identify the host country agency as the project’s sponsor. Involving the host agency in this way can significantly increase their commitment to making the project a success.

MACHHA BAZAR

You have a meeting with the park ranger to discuss what his objectives for the media campaign are, and what behaviors he wants to see by visitors. You discussed having a big kickoff event for the media campaign. The ranger suggests trying out one of the regulatory signs before the kickoff, just to see how it is received. He wants to know if the signs will be ignored or vandalized. The two of you work on the wording of the sign and plan to put it up within the month, depending on Ministry approval.



Environmental Education Plan for Machha Bazar

Activity	Target Group	Message	Strategies	Implementation	Evaluation
Class	students and teachers	<ul style="list-style-type: none"> relationship of humans to environment environmental aspects of school curriculum 	<ul style="list-style-type: none"> Teach one class/week using interactive approaches and incorporate local field study 	Weekly <ul style="list-style-type: none"> Volunteer and teacher 	
Eco-club in school	students and teachers	<ul style="list-style-type: none"> observation local natural history 	<ul style="list-style-type: none"> Club meets one afternoon/week for field based EE 	Weekly <ul style="list-style-type: none"> Counterpart and Volunteer 	
Fishermen’s advisory group	fishermen – advisory group	<ul style="list-style-type: none"> fish ecology specific concerns of fishermen 	<ul style="list-style-type: none"> Gather info Description of service Call organizational meeting Meetings Develop plan 	<ul style="list-style-type: none"> Month 1 by RC staff and Volunteer Month 2: chair RC manager * Monthly; elected chair 	
Environmental education for the park	general public; maybe poachers	<ul style="list-style-type: none"> ecological information about park park rules 	<ul style="list-style-type: none"> Interpretative signs Brochures and posters Kickoff event Radio spots 	<ul style="list-style-type: none"> Contact ranger to develop plan Interpretive signs Brochures and posters Kickoff event Radio spots 	



IMPLEMENTATION CHECKLIST

- What tasks need to be done to implement the project?
- What is the timeline for completing tasks?
- Which tasks will the host country agency and community members do, and which will you or other outside development workers do?
- In what ways will the host country agency be involved?
- What sources of funding are available? How can funding occur within the community, and within the country? What “in-kind” resources are available? How will funding and the acquisition of other resources be accomplished over the long term?
- What is the level of commitment among host country agencies and community members? What are your reasons for this perception? How can the level of commitment be increased, if necessary? Is there a sense of community ownership for the project?

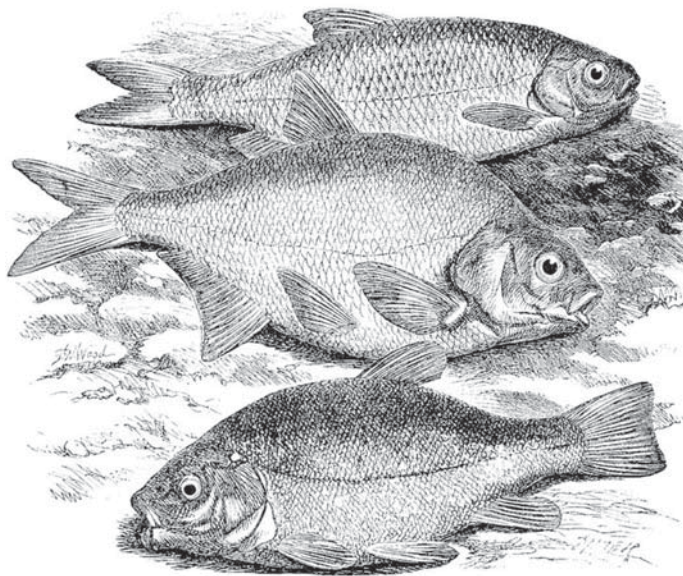



CHAPTER SEVEN

MONITORING AND EVALUATION

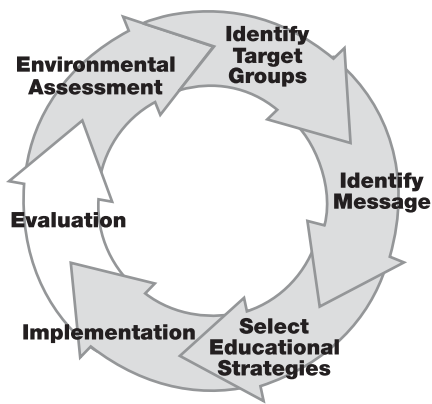

Monitoring and evaluation are critical, but often neglected, parts of any successful environmental education program. **Monitoring** is a systematic and ongoing effort to collect and analyze information to learn if a program is achieving the desired results. Carrying out periodic assessments while a program is in progress allows you and your counterpart to make mid-program changes and improve its effectiveness.

Evaluation takes place at a specific point in the program, such as mid-program, to verify that a program is on track; any time there are significant issues or changes that affect the program’s goals and objectives; and at the end of the program.

MACHHA BAZAR

Throughout your planning, you wonder if the plan that you and your colleagues created will result in a successful program. Will students learn? Will fishermen conduct organized environmental activities that result in positive change? Will the new signs convey knowledge to park visitors? Will poachers change their behaviors?

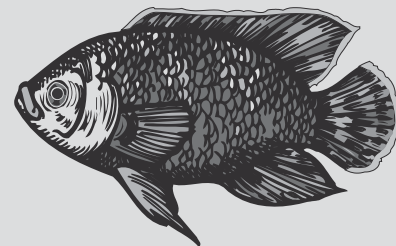

The next questions are: How will you know if you succeed? What are the indications that success has been achieved? How will you know if the program is not going well and what changes need to be made to improve it?

The monitoring and evaluation process can also benefit from the perspectives of others. This is especially true with program-end evaluations, which are generally done with the assistance of an external evaluator. Understandably, people are often reluctant to have their “performance” assessed. Properly done, however, program monitoring and evaluation can help you, your counterpart, and others to assess your program’s effectiveness and to better accomplish the goals of the program.

For more a more detailed explanation of Monitoring and Evaluation, please refer to the Peace Corps’ publication *Programming and Training Booklet 4: How to Assess a Project* [ICE No. T0116].





MACHHA BAZAR

You consider creating a multiple choice answer test to evaluate how well the students have learned the material. This would be easy to grade and would help you see what the kids did not learn well – but how can you tell what the students really know and what they were simply able to guess right? It might be helpful to know what the kids DID learn, so you plan an activity that you think will be more engaging than the pencil and paper test. The students will create a big mural of ecosystems, and each student will be asked to draw a biome with all its parts. You can tell how well they learned about biomes by the detail in the drawing. Also, if you have the time, you might reinforce some of the information that kids may have missed—as evidenced by any missing pieces of the biomes they create.

You decide that Eco-Club students can demonstrate their knowledge by participating in a community project, like making a walking trail. You also institute an ongoing monitoring system where students demonstrate their learning by giving feedback at the end of each meeting.

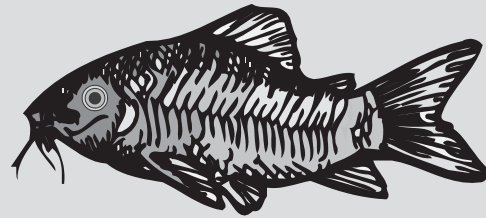

In order to find out if the signs are helping park visitors behave properly, you must first define proper behavior. You, your counterpart, and the park ranger define a list of behaviors to assess: picking up trash, staying on trails, being respectful around animals by not getting close or disturbing them, and being respectful to plants by not vandalizing them.

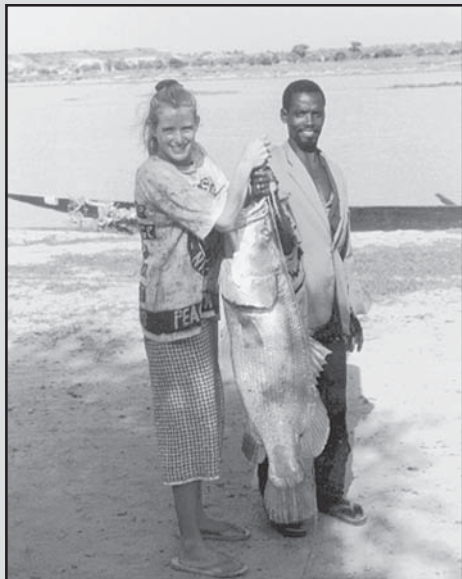

As a group, the fishermen have defined two objectives: to give advice on an education program that aims to inform the public about the importance of, and how to protect, fish resources, and to offer advice on fishing policy to governmental organizations. In order for this to happen in a constructive way, the fishermen’s advisory group needs to function with a high degree of organization and decide how to make and convey decisions. You, your counterpart, and the newly formed advisory group decide to hold several meetings to confirm these details. Therefore, your immediate gauge of success should focus on the organizational and logistical functions of the group: Do the fishermen define a decision-making process? Does everyone on the panel participate, and are a number of views represented? Does the group meet regularly? Does the group define goals? Has the group organized itself in a way that is satisfactory to all members?





GUIDELINES FOR EFFECTIVE MONITORING AND EVALUATION

The ultimate goal for environmental education programs is to improve attitudes and behavior towards the environment. While it may be several years before a program's effect becomes evident, progress toward a program's goal can be regularly monitored from the beginning.

Monitoring and evaluation involve several principal steps, which include:

- Review the program's intended goals and objectives;
- Review the program's indicators;
- Collect and analyze data; and
- Interpret and use the results.



Review the program's intended goals and objectives

The first step in effective monitoring and evaluation is to clearly identify the program's intended goals and objectives. Obviously, it is impossible to determine how successfully a program has achieved its desired outcomes unless its goals and objectives are clearly stated. Are the goals relatively broad, brief and measurable? Do the objectives meet the SMART criteria, i.e., are they specific, measurable, attainable, relevant, and time-bound?

Review the program's indicators:

After reviewing the intended goals and objectives, it is important to make sure that the indicators, or the markers that show progress and help measure change, are relevant, specific, measurable and feasible. Have people acquired new knowledge, attitudes and skills? Are people changing their behavior? If not, why not? Are there social, cultural, or economic circumstances that prohibit or hinder the new practices, which weren't addressed by the EE program? Are farmers willing and able to plow on a contour? Do they operate insecticide application equipment correctly? Are they planting trees on the hillside? Do coastal dwellers understand the value of the mangrove swamp, and are they able to preserve them? Are they able to stop harvesting sea turtle eggs recklessly?

Collect and analyze data:

Once you have reviewed a project's goals, objectives and indicators, it is important to review your sources of data, and how you are collecting that data.

Getting accurate data that demonstrates people's knowledge and attitudes before and after the program will be a challenge. It is relatively easy to determine whether people have learned the material, but more difficult to determine why they are behaving as they are. Formal questionnaires and controlled interviews can provide accurate information, but may be difficult to administer. People may be taken aback when a relaxed and friendly educator suddenly confronts them with paper, pencil and formal questions. Informal data gathering, on the other hand, will probably be more feasible, but will generally produce less precise data.





It always helps to highlight the need for monitoring and evaluation from the earliest stages of a program's development. During a teaching session, for instance, you can ask questions to see if participants understand the material. Or, if teaching manual skills, ask participants to demonstrate them. Listening and asking questions as part of normal conversation can also reveal much that people are thinking. Keep in mind, however, that people often say what they think evaluators want to hear.

Interpret and use the results

One of the biggest challenges of monitoring and evaluation is analyzing and then applying what you have learned to your work. What does it all mean, and how can you respond to what you have learned?

Common challenges

If the intended audience has failed to grasp the information being conveyed in the activity, and/or they have failed to put this new knowledge into practice, it may be because:

1. They have not received the message – e.g., they do not listen to a radio or read the newspapers where the message has been communicated;
2. They have not understood the message – e.g., the message was written and they cannot read, or it was conveyed in a complicated manner;
3. They do not believe the message because it is either inconsistent with their established beliefs and customs, or they do not trust the educator or the agency he or she represents;
4. They do not feel they have any reasonable alternatives; or
5. The message was poorly communicated, misdirected, or faulty—e.g., educators didn't use appropriate methodologies to convey the message, didn't communicate the message to the appropriate target group, misidentified the actions or attitudes that have led to environmental problems, and/or misunderstood the behavior that caused the environmental problem.

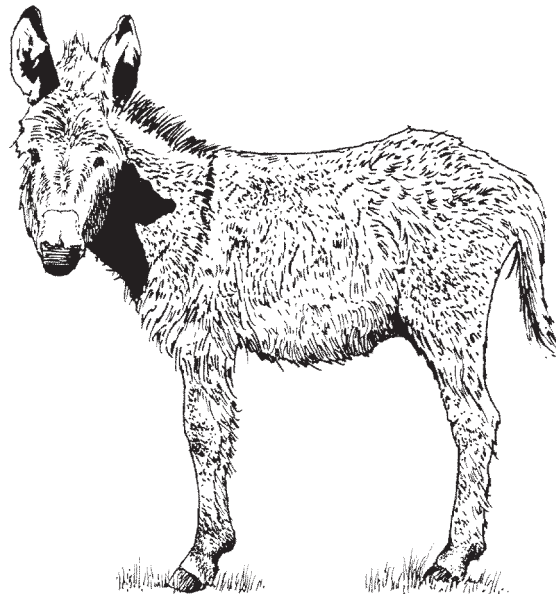

For example, although people may appreciate the ecological value of mangroves, they may continue to clear-cut wood because they require firewood. In this case, the message of the program would have to be paired with viable alternatives for cooking and heating needs.

It is also possible that some people's attitudes may have changed because of the educational effort, but these people were not the ones affecting the resource. In this case, the target audience was misidentified. A wildlife educational program presented in the capital city's newspaper may be ineffective if the people hunting wildlife are nomads in the country's interior.



Keep expectations realistic

Attitude and behavior change does not happen overnight. Rather, it is an ongoing process that occurs over a long period of time, and occurs as people slowly change their perceptions. Often, personal behavior change (e.g., trying something new) is perceived as risky. Farmers, for example, cannot afford to make mistakes, and so they depend on tried and true methods. Asking them to change behavior that they know has yielded at least some success is also asking them to risk the welfare of their family. Plowing a field differently or planting trees on their land may be profitable, or it may be devastating. In this case, you might try to convince farmers to devote a small portion of their holdings to this new method, or you might try to elicit interest through the use of a demonstration plot.

The continuum presented on page 55, illustrating the level of awareness and motivation of target audiences, can assist in evaluating a program's progress. If people are not aware a problem exists, it would be unrealistic to expect a program to have immediate results in changing behavior. Helping people move through the various stages is the role of an environmental education program, and how effectively it does this is a measurement of its success.

Almost assuredly, it will not be possible at the beginning of a program to predict how long it will take to affect people's behavior, or how many people will need to change their behavior for a program to be considered a success. You and your counterparts will have to determine this as you proceed through the program, and establish the measures of success that are appropriate for your specific program.

It is crucial that educators listen to what is said, and what is not said. Educators from outside the community are likely to miss important clues as to why a certain behavior occurs if too many assumptions are made. Initially, the reasons for behaving in certain ways may not be apparent, and will not be explained. Misunderstandings on the part of educators often arise, and may result in a program based in a faulty or incomplete understanding of why a behavior occurs. It is crucial that educators listen carefully, engage in extensive dialogue with community members and counterparts, and involve community members at all stages of program development to avoid any misunderstanding.

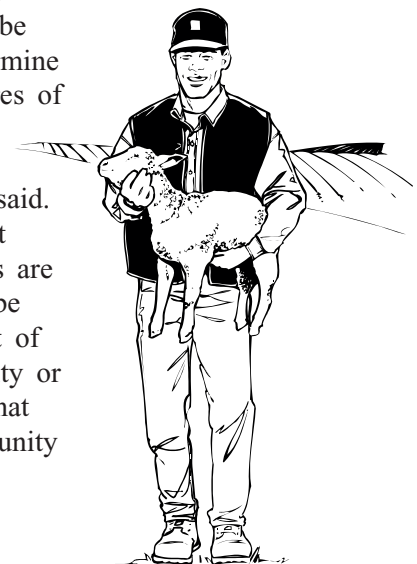



KEY QUESTIONS

If people are not using the measures advocated by the education program, ask yourself the following questions and consider the possible solutions:

● **Has the message been clearly communicated? How do you know?**

If you find that the message has not been received, review the educational methods to see if the message has reached the intended audiences. Who came to the teaching sessions? Who listened to the radio programs? Who read the series of newspaper articles or saw the posters delivering the message?

Possible Solution: *An adjustment in education method. Find creative, innovative ways of presenting the message.*

● **Is the message appropriate to the circumstances? How do you know?**

If you find that people have not understood the message, ask the people to answer questions that indicate their understanding of the material.

Possible Solution: *An adjustment in how the content is presented. Try to find locally appropriate means for presenting information.*

● **Does the target group believe the message?**

If people do not believe the message because it is inconsistent with their beliefs and traditions, ask counterparts, close friends, or the people being educated if relevant customs and beliefs have been neglected.

Possible Solutions:

1. *An adjustment in how the program's content is presented;*
2. *an adjustment in the program's technical solution; or*
3. *additional time for people to become accustomed to message.*





- If you find that the educator is not trusted, talk to counterparts or close friends about solutions.

Possible Solution: *Time or a change in approach.*

- If the program material is understood, but behavior change has not occurred:

Is there is a lack of concern about the environmental problem?

Possible Solution: *Develop activities to raise awareness of the problem's relevance to their own lives.*

Does social pressure exist? Do influential people distrust or not believe the educational program's message?

Possible Solution: *Inclusion of group applying social pressure as a target audience of the educational program.*

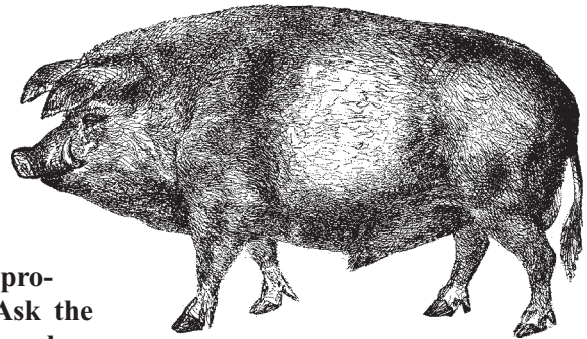

Are the actions advocated by the education program unrealistic or economically unsound? Ask the people you have been trying to educate if they have doubts about the effectiveness of the measures advocated by the education program.

Possible Solution: *An adjustment of the technical solution to be sure it is locally appropriate and feasible.*

Are people nervous about the consequences of changing behavior? Have you been able to discount other possible reasons for the lack of implementing the education program's measures but still sense a general reluctance?

Possible Solution:

1. *More time;*
2. *Concentration of educational efforts on community leaders;*
3. *Change in education methods, perhaps including demonstrations or field trips to sites where actions being advocated by the educational effort are being used successfully; or*
4. *Financial or other incentives to encourage people to take chances on changing their behavior (e.g., payment for planting trees or tax incentives for leaving land fallow or implementing soil conservation techniques).*

- If people are implementing the measures advocated by the program, but the condition of the environment has not changed, is it because:

The technical solution advocated by the program is inappropriate? What do outside experts say? What do community members and local experts say?

Possible Solution: *An adjustment in the program's technical solution.*





The people whose behavior has changed are not those affecting the natural resources in question? Who has the education program reached? Are they the people affecting the environment?

Possible Solution: *An adjustment in the program's target audience.*

More time is needed to evaluate the situation? The effects of changing certain environmental practices often appear gradually.

Possible Solution: *Find ways to measure incremental progress toward achieving goals.*



MACHHA BAZAR

After the two pilot lessons you and your counterpart taught and observed, you have a better idea of how the students will behave and what they already know. You are glad that you did the pilot, because you will now revise the lessons you were going to use in the school and the Eco-Club. In two weeks, you will start teaching in the school and facilitating the Eco-Club.

The sign at the park has had mixed results. The ranger has been asked what it means several times, so the wording needs to be adjusted. He is pleased that when people do understand what it is saying, they are willing to comply. Some people have said that the poachers won't like it, but the ranger's superiors have said they will support him, and help him enforce the regulations. Overall, it has been positive and he wants to move forward with the preparation of the other media.

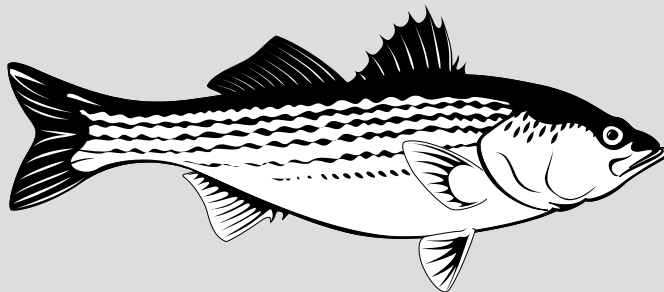

The fishermen have formed their advisory group and are now working to establish by-laws and a workplan. Overall, because you and your counterpart did a thorough job in laying the groundwork for forming the advisory group, and most individuals feel like their views are fairly represented, you think that the advisory group is in a good position to make sound judgments and to achieve positive

change. However, you and your counterpart sense that there is potential for decision making to stagnate, so you suggest to the group that you all work on participatory decision making. You and your counterpart schedule a two-day workshop to train the fishermen in skills and processes for participatory decision making.



Environmental Education Plan for Machha Bazar

Activity	Target Group	Message	Strategies	Implementation	Evaluation
Class	students and teachers	<ul style="list-style-type: none"> relationship of humans to environment environmental aspects of school curriculum 	<ul style="list-style-type: none"> Teach one class/week using inter-active approaches and incorporate local field study 	Weekly <ul style="list-style-type: none"> Volunteer and teacher 	<ul style="list-style-type: none"> Classroom assessment
Eco-club in school	students and teachers	<ul style="list-style-type: none"> observation local natural history 	<ul style="list-style-type: none"> Club meets one afternoon/week for field based EE 	Weekly <ul style="list-style-type: none"> Counterpart and Volunteer 	<ul style="list-style-type: none"> Attendance, participation and closing activity
Fishermen's advisory group	fishermen – advisory group	<ul style="list-style-type: none"> fish ecology specific concerns of fishermen 	<ul style="list-style-type: none"> Gather info Description of service Call organizational meeting Meetings Develop plan 	<ul style="list-style-type: none"> Month 1 by RC staff and Volunteer Month 2: chair RC manager Monthly; elected chair 	<ul style="list-style-type: none"> Attendance Satisfaction with members List of topics
Environmental education for the park	general public; maybe poachers	<ul style="list-style-type: none"> ecological information about park park rules 	<ul style="list-style-type: none"> Interpretative signs Brochures and posters Kickoff event Radio spots 	<ul style="list-style-type: none"> Contact ranger to develop plan Interpretive signs Brochures and posters 	<ul style="list-style-type: none"> List of visitor behaviors Draft language for media





CHAPTER EIGHT

ENVIRONMENTAL EDUCATION CAMPS

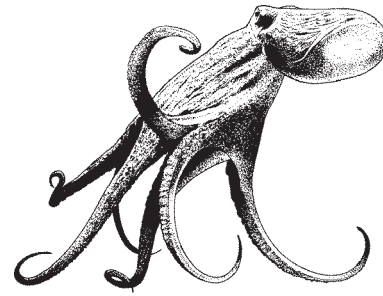

Many Americans fondly remember summer camp as a week or more of outdoor activities where they hiked, canoed, swam, made craft items and sat around campfires with friends and sang songs. Perhaps they attended an outdoor school that involved challenging physical activities, or a work camp where they built trails. More recent camps may have included computer, math or science camps where young people more fully develop knowledge and skills in an area of interest. Camps may have been residential or day camps.

Environmental education camps usually involve bringing people together in an outdoor setting for several days to a week of activities related to nature. Camps can take many forms depending on the goals and financial resources of the sponsoring organization or participants.

There is a cultural component to camps. Communities may see camps as pure recreation, as relaxation for health, as educational, as a time to pass on cultural values and skills, a coming of age experience or a combination of some of these. Camps have been used to reinforce political philosophy as well. In some places, camping experiences are available only to certain segments of the population.

Before moving forward with planning a camp, research the camp culture, and ideas and stigmas of camps in your community/country:

- What kinds of camps are there? (Themes, residential or day, for what age groups?)
- Are there any particular cultural taboos that would limit attendance, for example, young women not being able to travel or stay away from home overnight?
- What happens at these camps? (Are they highly structured with group “lessons” or activities, or are they basically just recreational where participants determine their own schedules? If camps are considered highly unstructured, might you need to call what you want to do a workshop or a conference?)
- Who staffs the camps? (Are they run by teachers or adults associated with specific clubs—e.g., scouts, boys and girls clubs? Is staff paid or volunteer?)
- Who pays the attendance fees for the camps? (If participants pay, does this limit who can attend? Are there patterns of fund-raising to help people go to camp?)

If you determine that an environmental camp is feasible, this chapter will help you. It is about planning and implementing a camp and it is organized chronologically the way a camp is planned. Many ideas are drawn from *Camp GLOW (Girls Leading Our World) Handbook for Volunteers*, Peace Corps, Washington, DC [ICE No. M0056].



ADVANCE PLANNING

SIX TO NINE MONTHS IN ADVANCE

- Identify partner organizations and individuals
- Together, do a needs assessment
- Research past camp reports
- Determine type of camp that addresses needs and wants
- Establish planning committee
- Discuss goals and themes for camp
- Develop a timeline
- Investigate possible funding sources and begin grant application process, if necessary

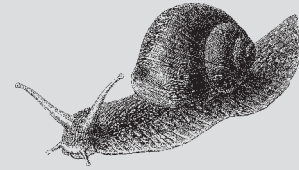

IDENTIFY PARTNER ORGANIZATIONS AND INDIVIDUALS

Creating and running an environmental camp should not be solely a Volunteer activity. If there is merit to doing a camp, others in the community should be willing and able to assist. From the outset, you should be working with others.

Partners may offer their support in a variety of ways. They may be people who know the local environment and can help determine what is needed and appropriate to the community. They may be organizations such as local businesses, entrepreneurs, or ecology groups that can help fund a camp or provide transportation, food, medical help or a campsite. They may have skills that they are willing to teach the campers. Partners help make culturally appropriate plans and contribute to sustainability.

Partners may include:

- Teachers or other school staff
- Doctors, nurses, or community health workers
- Community organizations with an interest in environmental education or in supporting youth programs
- Local, national and international organizations interested in environmental education or youth, such as World Wildlife Fund, Girl/Boy Scouts, or 4-H
- Local government offices or other political entities

INVOLVING THE COMMUNITY

Explore how you can make use of community expertise, such as farmers who use soil conservation techniques or environmentally benign pest control measures. Elders in the community have a profound understanding of local ecology, and know how to sustainably use local resources. Involving these local experts also helps to foster a sense of cultural pride.





- NGOs that address community needs
- Businesses wanting to support community programs
- Skilled crafts people, storytellers, naturalists or outdoor enthusiasts
- Parks or protected-area personnel

DO A NEEDS ASSESSMENT

A camp should respond to the needs and desires of the community. Partners may have some reason for wanting to develop a camping experience, such as providing youth with an engaging learning experience, furthering the school curriculum in science or environmental education, or addressing a critical environmental issue. For example, if an environmental NGO wants to sponsor a summer camp for local middle school students to make them aware of the local reef ecology, then it is important to find out which middle school students would be interested/able to attend, what their level of understanding is, and what type of camping experience would be appropriate in the culture. Exploring the needs and desires of both participants and sponsors should lead to identifying potential resources and support, and possible follow-up for the campers, such as a community or school project.

RESEARCH PAST CAMP REPORTS

Often camp reports exist that can give you an idea of what camps have been conducted in the past along with recommendations for the future. Past camp reports may also indicate local expectations for camp that can help you plan appropriately.

DETERMINE THE TYPE OF CAMP

The needs assessment and research should provide the information you and your partners require to determine the type of camp to run. Generally, camps are either residential (campers and staff stay full-time for a week or so), or day camps (campers and staff gather each day for their program and go home in the evening). Day camps must be close to where staff and campers live. Residential camps may be located outside of the immediate community and must offer housing and meals in a safe environment. Most camps are held during the summer when young people are out of school, but camping experiences can be held any time of year.

Day camps generally last a few days to a week and typically feature hands-on activities such as nature walks, arts and crafts, short field trips or environmental games. They are easier to organize and less

IDENTIFYING COMMUNITY STRENGTHS

A program that builds on and uses the existing strengths and skills of the audience, specifically, and the larger community, more generally, is more likely to produce positive change than a program that blames participants for detrimental environmental practices. When developing curricula for the camp, use an approach that recognizes and appreciates positive local environmental beliefs and practices. This creates a base from which participants can develop environmental strategies that are appropriate to the community. The Peace Corps' publication *Learning Local Environmental Knowledge* [ICE No. M0071] may help you to discover some of these practices.





expensive to operate than overnight camps. Costs can be kept down or eliminated by having the campsite and field trips within walking distance for the campers and asking campers to bring their own lunches and supplies for crafts (if they are able). Alternatively, having campers (or donors) make a small contribution for cooking out can be an excellent learning and bonding activity for the group. Day camps may be a summer activity for a school, and may help organize campers for environmental clubs during the following school year. Disadvantages of day camps include unpredictable attendance and a more limited scope of activities.

Overnight camps offer more complex and richer experiences for the campers. Because you will be spending 24 hours a day with the campers, you have the opportunity for more in-depth activities. It means planning for all the waking hours of the campers, even if those activities include quiet times. Overnight camp activities include all the activities possible at a day camp plus opportunities for extended field trips, and early morning and evening activities. These camps may bring campers from different areas, enabling them to form friendships with people from other places. For some campers, an overnight camp may be the first time they have ever slept outdoors or slept away from home. In some cultures, girls are not permitted to attend these types of camps.

Overnight camps require arrangements for meals and sleeping quarters for campers and staff. They may require transportation, and more extensive health and safety considerations must be anticipated. Camp staff must include a nurse or adults with first-aid training, and arrangements for a nearby medical person or facility who can respond to emergencies. Not all campsites will have electricity or plumbing, so water and waste disposal must also be planned.

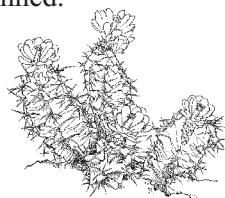

CAMP WALIYAH

— NIGER —

GOALS:

Camp Waliyah was designed as a conservation education camp for 11-16 year olds to teach youth about environmental degradation, the importance of conservation and protection of the environment. The goals of the camp included collaborating with local service agents, creating a forum for service agents to begin working with youth, and creating a theater group.

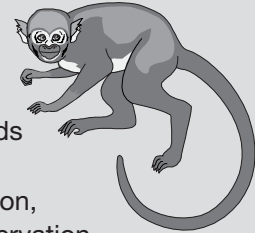

LOGISTICS:

Each month, several children participated in a five-day field trip by boat along 100 kilometers of park boundary. They interacted with forest agents about particular issues facing the environment. Activities included talks by the forest agents, games, and drawings, and follow-up activities included review and extension of concepts, skill development, participation workshops and skits. Badges were awarded to campers, each representing a different topical area explored during camp.

LESSONS:

Be flexible! Youth are not always easy to work with, nor are government agents, especially when the latter work with youth for the first time. Be patient—this will be an extremely rewarding experience, but it takes a lot of preparation, and the messages are sometimes difficult for youth or community members to accept. The environmental messages you are trying to convey may seem to run counter to a community's belief that their own actions do not influence the environment; therefore, change may come slowly.



Overnight camps that involve traveling away from the site have additional considerations. Food and shelter (and even water) may have to be brought along, or purchased locally. A plan for medical emergencies will need to be developed. Consider the time in transit: will you need to plan observation activities while campers are in a boat, or songs or games for a bus ride?

At any type of camp, day or overnight, the Peace Corps or an individual Volunteer cannot be held responsible for potential accidents and/or injuries related to the activity. Therefore, other adults, such as representatives of teachers' or parent associations or sponsoring organizations, must accept responsibility, especially if there are minors in the group.

ADAPTATIONS OF CAMPS

Environmental education camps can be adapted to special situations or to focus on a combination of topics and skills. If your camp has developed from a school or university program, or a forestry, agricultural, fisheries, natural resources or water sanitation program, it will already have an environmental education focus. If your environmental education camp has developed from a Teaching English as a Foreign Language (TEFL) program, a small business development, or health program, you will need to think about where your program intersects with environmental education. Likewise, if you want your environmental education camp to focus on cultural issues or on building democracy, you will need to think about how to adapt your camp to achieve these ends. One way of approaching these situations is to involve partners and Volunteers from other sectors in planning and running the camp.

Some examples of camps with combined goals are:

Health Focus: Environmental factors that affect health include topics such as water quality and treatment, agricultural practices and nutrition, nutritional value of wild foods, wilderness safety and first aid, and living well in the wilderness. A health/EE camp could also focus on achieving and maintaining general physical health, or on a particular group of clients whose physical and mental health might benefit from an outdoor experience.

Small Business Development Focus: Business and EE intersect in the areas of using resources in a sustainable and economically profitable way and developing value-added products from environmental resources, including tourism. Tourism camps could focus on developing interpreters and guides, nature programs and signs, and developing trails and campsites for tourists.

Cultural Focus: If you are working in a situation where different ethnic, religious or cultural groups are living, and you want to work toward increased positive interaction among these groups, you can bring them together in an environmental education camp that fosters positive interactions between the groups. Using principles of cooperative learning, and requiring the use of a common language can foster increased communication and mutual understanding. Some good activity suggestions for this type

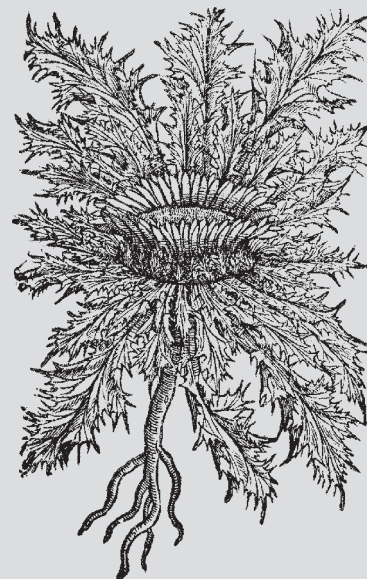

(continued)



of camp can be found in *Camp GLOW (Girls Leading Our World) Handbook for Volunteers*, Peace Corps, Washington, DC [ICE No. M0056].

TEFL Focus: In a TEFL /EE camp, the focus is on teaching and practicing English through the content area of environmental education. “Green English” camps usually require that all campers speak English throughout camp. The activities are similar to an environmental education camp, except for the emphasis on language. Learning environmental vocabulary and activities which require campers to read, write, listen and speak about the environment in English are the goals of the activities. The selection of campers should include an assessment of their English proficiency. In this type of camp it is possible to bring together campers who speak different languages, but who will function in English throughout the camping experience. This kind of multilingual camp can help campers cross ethnic and linguistic barriers to discover their common ground. Some examples of language lessons related to environmental topics can be found in the *Community Content-Based Instruction* publications, Peace Corps, Washington, DC [ICE No. T0112 and ICE No. M0073].

ESTABLISH PLANNING COMMITTEE

Once you and your partners have decided to conduct a camp, you will need to create a planning committee. It might include counselors and teachers for content or members of any sponsoring organizations. It could also include nurses or medical people, representatives of the place where camp will be held (e.g., national park rangers), camper representatives, or other interested parties. The responsibilities of the planning committee include:

- establishing goals and objectives
- making a budget
- choosing a campsite
- looking for partners or sponsors
- seeking funding (if necessary)
- determining selection of camp staff and campers
- motivating/educating parents about the benefits of the camps
- planning for sustainability

TEAMWORK IN THAILAND

One Volunteer, based at a wildlife sanctuary in the northeastern region of Thailand, had organized many environmental education activities for teachers and students in her area before she realized something very important. While conducting these camps, she noticed that though co-workers had good potential to be excellent environmental educators, they had no experience working on a team. Through discussion with her program manager and approval from the director of the sanctuary, the Volunteer created an in-house workshop for 5-8 staff on team building, vision creation, and leadership development using an environmental education theme. The success of this workshop was shown when, for the first time, people started to work together and help each other conduct environmental activities.

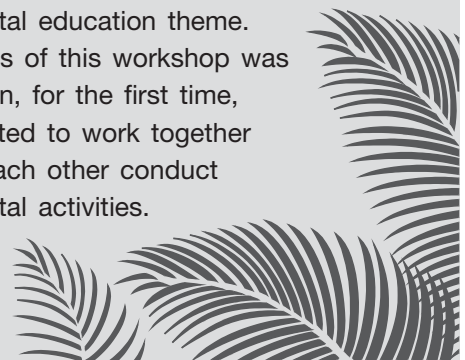



Roles that members of the organizing committee need to take include:

- **director/administrator/coordinator** – central organizer and contact person
- **scribe** – keeps records
- **fundraiser** – seeks funding, keeps track of requests, organizes events and makes sure donors get reports and thank you letters
- **campsite coordinator** – researches and visits campsites and acts as liaison between the director and the camp owner; ensures health and safety measures are in place
- **supply and transportation person**
- **promoter** – educates the parents, teachers and community members about the camp; registers campers
- **curriculum developer** – ensures camp activities are developed; identifies appropriate teachers, rangers, other staff



One person can assume more than one role. What is important is that all the tasks are clearly assigned and someone is responsible for them. There may be other tasks that need to be done in your particular situation as well.

DISCUSS GOALS AND THEMES FOR CAMP

The goals and purposes of your camp will depend on the needs of the community and your partners. Goals may include:

- Teaching children about the local ecology
- Building environmental maintenance skills, such as water quality assessment, or trail building
- Building environmental awareness, comfort in the natural environment, and empathy for the environment
- Teaching traditional knowledge and skills to young people
- Teaching environmentally friendly practices for agriculture, fisheries or forestry
- Involving a target group (e.g., women who use the forest) in environmental work
- Implementing environmental service projects such as building parks, trails, or interpretive signs
- Increasing responsible participation in environmental projects and practices
- Building positive attitudes towards the environment
- Building capacity and self-esteem



- Helping campers understand the linkage between the environment and other fields

Goals determine a theme or themes for the camp. Themes are helpful for planning, and focusing campers. For example, if your goal is teaching children about local ecology, a theme might be “Forest Mysteries” or “Savanna Ecology.” If it is building awareness, comfort and empathy, a theme might be “Mountain Magic” or “Wonderful Rivers.” Other possibilities include: “Understanding Water Quality,” “Productive Fish Farms,” “Forest Resources for You,” or “Making *Almatinsky Zapavednik* a More User-Friendly Park.”

The theme(s) will guide planning and can be used for publicity to attract and inform campers and supporters.

DEVELOP A TIMELINE

When planning a camp, give your organizing committee plenty of time to plan funding, personnel, logistics, content and schedule, and recruiting campers and staff. It will take several months to coordinate all the people, logistics, funding and materials. Everything will probably take longer than you think! Together, develop a timeline that has set dates to complete tasks yet leaves time for the unforeseeable.

INVESTIGATE POSSIBLE FUNDING SOURCES AND BEGIN GRANT APPLICATION PROCESS

Camps vary in cost depending on many factors. Local day camps may be very inexpensive. Residential camps will be more, but can vary depending on distance, length of camp, services provided, and so on. Costs include: use of the campsite, food, electricity, water, transportation, materials, and staff (cooks, teachers, nurse, chaperones, security people, etc.).

As soon as possible, develop at least a general budget, determine any needs for seeking funds, and have your fund-raising person on the organizing committee get started.

- Some costs may be defrayed by in-kind donations, such as the use of the site, food, supplies, staff.
- Donations of money may come from local government, organizations, businesses.
- Grants may be available from large multinational organizations or local businesses.
- Fundraisers, like benefit concerts, sporting events, dinners, art sales, and bake sales may be culturally appropriate ways to generate money.
- You can also pass the costs of camp on to the campers in the form of a fee for all or part of the cost of camp. In order to for some campers to be able to attend, scholarships may be necessary.

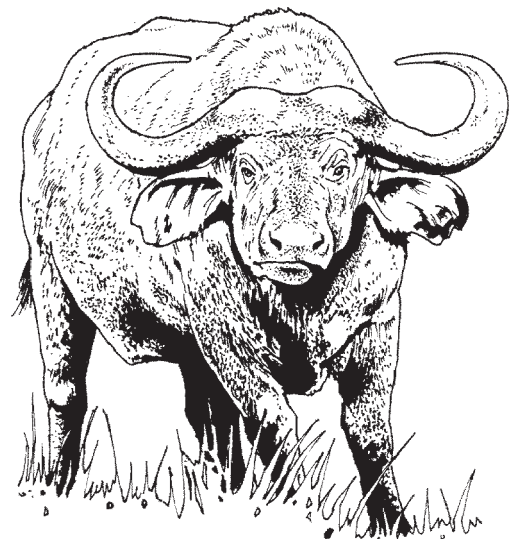



Fund-raising is an area where Volunteers should not be working on their own. With your planning committee or partners, develop a plan for others to be involved. There is helpful information in *Camp GLOW (Girls Leading Our World) Handbook for Volunteers*, Peace Corps, Washington, DC [ICE No. M0056].

PREPARATION

Four to Five Months in Advance

- Determine size of the camp and decide on approximate dates
- Investigate possible camp locations; select and reserve a site
- Build a detailed budget and system for handling money
- Determine camper selection process
- Develop a daily schedule for camp
- Consider sustainability

Determine size of the camp and decide on approximate dates

Decide how many campers you want to serve. Considerations:

- What kinds of activities or classes will you have? What is the best group size for them? How many class or activity leaders will you have, and how many campers can they handle?
- Consider the age of the campers – younger campers require more supervision than older campers.
- Consider safety and “crowd control.” How many people do you have on staff and how experienced they are in dealing with campers?
- Male/female ratios and numbers: if counselors will stay with campers, how many male and females do you need?
- Are there other cultural considerations or community expectations?

When deciding dates for camp, consider other schedules, such as school schedules and holidays, and special seasonal demands on the time of adults or young people. Consider seasonal environmental constraints such as heat, rain, insects or road conditions. A good way to look at all of these factors together is to create a seasonal calendar. With a group that represents all the necessary perspectives to consider (teachers, parents, bus drivers, park service agents, medical people, sponsors, etc.) create a calendar together. Locate the best time of year, based on the goal of your camp. The calendar on the following page is an example of many factors considered, including illness and dangers from animals. See the *PACA Idea Book*, Peace Corps, Washington, DC [ICE No. M0086], for details on how to create a calendar.



Investigate possible camp locations

When you are choosing a campsite, consider the facilities and services as well as the cost and location. One or two persons on the planning committee may scout out a number of sites, and then the planning committee should visit the best one or two for your purposes.

Things to consider:

- **Goals for camp:** Is there an appropriate environment to involve campers in the purpose of your camp during the time of year you want to be there (streams, forests, grasslands; animal migration, blooming or fruiting of plants, snow or rain, soil conditions or ease of getting around, and so on)?
- **Safety:** Check out the water supply, hiking trails, sports fields, access roads, campfire area and kitchen. How would you handle sick, injured, or lost campers? Usually, there is a greater chance of injury at camp than at home simply because the campers are outdoors and more active than usual. Ask if the camp has a doctor or nurse available. Locate the nearest medical facility.
- **Sanitary facilities:** Are there sufficient toilets and bathing facilities? If you will be wilderness camping, how will you manage water, bathing, and toilets?
- **Campsite services:** Are there prepared meals or cooking facilities?
- **Lodging:** How many per room? Campers and counselors together? Bedding provided?
- **Phone:** On site or where is nearest? Do cell phones work at the camp? Are there sports facilities such as playing fields?
- **Campsite schedules and rules:** Are there existing schedules at the campsite, such as meal or lights out times? Are there activities at the campsite in which you will be required to participate? Does the campsite have rules, including rules about smoking and drinking? How does the campsite handle discipline?
- **Access and transportation:** Often camps, by their very nature, are off the beaten track. Can a vehicle navigate the road to deliver campers and supplies or in case of emergency? If you are in a park or preserve, are there hours when the park is closed or gated? How close are the nearest stores?
- **Indoor and outdoor facilities:** Are there sufficient and appropriate meeting rooms if weather pushes you indoors and an all-weather eating area?
- **Other campers:** Will there be other groups at the camp at the same time as yours? Will you share facilities? Will the campers be older or younger than your campers? Are the other campers male or female?
- **Wilderness camps:** While you are checking out the campsite, make a list of camping gear you will need to bring or ask campers to bring: tents, sleeping bags, water, firewood? How will you cook? Will you need to prepare for excessive rain, sun, wind, snow, or insects? Are there dangerous animals or places? What will you do for light in the evening?



When you have agreed on a site, develop a written campsite contract, if the camp does not have its own. The agreement with the owner or administrator of the camp should clearly state what the camp will provide and what you will need to provide, the dates, and total cost for the use of the camp.



Build a detailed budget and system for handling money

Create a very detailed budget; consider every expense that will arise. The budget will tell your fund-raisers exactly what they need to look for (in-kind donations, funds, and grants) and what fund-raising activities might be needed. Important expenses to consider include:

- any staff salaries
- expenses for guest speakers such as transportation, food, lodging or honoraria
- food including water, meals, and snacks
- transportation for staff and campers
- campsite rental
- lodging, if different from above
- insurance
- materials and supplies for all activities
- costs of photocopying, film development, publicity or computer use
- translation services
- activity fees if you are taking campers to places that charge admission
- communication to advertise camp, enroll campers, and while at camp (phone, computer, copying, mailing, and so on)

Devise a system for handling the money. Volunteers are encouraged not to be responsible for money. A checking account that requires several signatures, or a money box that has multiple keys, makes several people accountable for money. Handling money can become quite delicate; it is worth the effort to set up a reliable and credible system.





Determine camper selection process

Your organizing committee will have decided who its target audience is. The next task is to decide how individuals will be selected and notified. Some camps require an interview to assess camper language skills, or determine suitability of campers. Other camps have a task that is required, like an essay or school project or teacher nomination. When you decide what criteria you will use to judge who is accepted and who is not, plan for how you will notify those accepted, those on a waiting list and those not accepted.

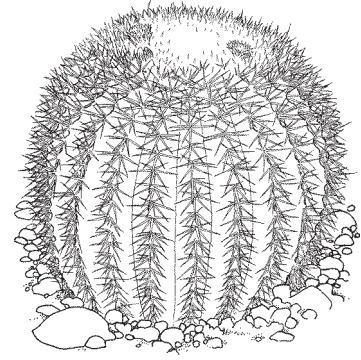

Develop an application process. Applications for campers may include:

- Camper name, address, phone, age, sex, as appropriate
- Names and contact information for each camper's parents or guardians
- Emergency contact information
- Any medical information that should be considered (dietary or medication concerns, etc.)
- Description of camp including dates, location, and facilities
- Any costs, fees, or deposits
- Camper drop-off and pick-up information
- Any special rules (bring a water bottle, no smoking, no electronic devices, etc.)
- Packing list
- Date the application is due
- Date the camper will be informed of acceptance
- Your contact information

Develop a daily schedule for camp



A typical camp schedule combines class time with outdoor activities and recreational events as well as rest periods or free time. A balanced schedule is essential to a smooth, productive camping experience. Allow time for transitions between activities. For example, it can take some time for campers to go from breakfast to their morning activity. It is also important to schedule downtime for counselors and daily staff meetings. Counselors work very hard and need some time to relax. Counselors also need time to share ideas, help each other, plan for the next day, and troubleshoot. Post the schedule in a frequently traveled area so everyone can refer to it easily.



SAMPLE CAMP ACTIVITIES

ENVIRONMENTAL EDUCATION CLASSES AND ACTIVITIES

- Local ecology
- Ecological principles and concepts
- Field ecology
- Environmental issues
- Ecology games and adaptations of games to ecology themes
- Recognizing the environment: simple identification of plants, insects, birds, etc.
- Connecting with the environment: quiet activity for self-reflection

OUTDOOR SKILLS

- Camping skills
- Hikes
- Nature walks
- Stargazing
- Boating skills and safety
- Ropes courses or trust building activities
- Orienteering
- Survival skills
- Team-building activities
- First aid
- Outdoor recreational activities, (e.g., rock climbing, swimming, boating, games)
- Field research skills (transects, making accurate and precise observations, etc.)

SERVICE ACTIVITIES

- Trail building
- Trail maintenance
- Interpretive signs
- Docent training
- Naturalist training
- Clean up of parks and preserves
- Camp building or maintenance

OTHER CLASSES

- Cooking with wild foods
- Drama and disco
- Arts and crafts using nature as a theme or using natural materials
- Music

LIFE SKILLS

- Democracy building¹
- Leadership development
- Confidence building or self-esteem building activities
- Team-building

¹ For a description of this activity, see Peace Corps' *Camp GLOW (Girls Leading Our World) Handbook for Volunteers*, Peace Corps, Washington, DC [ICE No. M0056], page 36.





MANAGEMENT ACTIVITIES

- Making nametags
- Developing rules
- Tent or camper group activities (clean up or other duties; can be competitive)
- Daily announcements and open discussion time

SOCIAL EVENTS

- Skits
- Songs
- Games
- Campfires (with songs, storytelling)
- Getting to know you activities (introductions)

SPECIAL EVENTS

- Opening ceremonies including ice breakers and name games
- Closing ceremonies including awards and skits
- All day hike
- Excursions
- Last night staying up late
- Wilderness overnight camp-out
- Last day time for exchange of addresses and good byes

There are several things to consider when making a schedule:

- **Goals and objectives:** Start by identifying the key activities that will meet the goals of the camp. That may sound obvious, but it is tempting to schedule activities that you know will work, or are fun, but may not meet objectives of camp. In order to meet objectives, it may be necessary to create activities that are designed for the objectives.
- **Time of day:** Generally campers have more energy and are better able to focus in the morning. Afternoons are good for active pursuits, and evenings for relaxation and fun. This implies that teaching and discussion will be more fruitful in the morning. However, sometimes other considerations affect scheduling. Wildlife viewing is best near sunrise or sunset, so hikes for this purpose may be in the morning with discussion or classroom activities in the afternoon.
- **Scheduling campers:** If you have large numbers of campers, think through a system that will easily allow you to rotate activities or give campers a choice of activities. See *Camp Glow Handbook* for ideas.
- **Camper/counselor ratio:** Overall, a ratio of one counselor for every six or seven campers is desirable. You may make adjustments if you have very young counselors, or very experienced campers. Some types of activities require a lower camper/counselor ratio, usually due to safety concerns. For activities that have any potential for injury, there should be at least two counselors.
- **Activity leaders:** If activity leaders are different from the counselors, such as a park ranger, a member of the camp staff needs to be present as well to act as moderator, as well as to be responsible for campers.



- **Quiet time:** Often, quiet time for reading, writing or even napping is scheduled after lunch, which is a low energy time for many people.
- **Scheduling transitions:** Allow sufficient time for meals, for moving between activities, and for sleep. This is especially true if there are large numbers of campers, long distances to walk or times when campers have to change clothes (e.g., swimming).
- **Back up plans:** No matter how much planning happens, things can go wrong. Disruptions are often caused by bad weather or unexpected delays in the arrival of supplies or people. It is a good idea to have several activities in reserve, just in case.
- **Logistics:** Consider the locations of activities and materials required for each activity. Do the campers have a long walk to the activity site? Will materials have to be transported to a distant site? Do you need to have a water source for a particular activity? Is there enough space for the activity?

Consider sustainability

If you are helping to create a camp that may be repeated in the future, consider sustainability throughout the planning and operation stages of the camp. By working with partners from the very beginning, the details of the planning process will be clear to everyone. If the planning committee carries out many of the roles outlined, that part of the process will also be shared and skills will be built.

If the camp truly reflects the needs and wants of the community, it is much more likely to be continued. This gets back to the initial assessment of community needs and desires that you carried out with your partners, or what you will learn during the camping experience about community desires.

As in the Thailand example, another step might be to train staff...either in specific duties or in teamwork. That will require assessing the staff to ascertain their training needs, and then trying to meet those needs.

The community must also have the resources to implement camp after you leave. If you use some of your personal resources such as expensive binoculars or your own computer as an integral part of the camping experience, and you take them with you, the community cannot continue the program. Likewise, if you applied for a grant that required college-level English skills to write, it may not be possible for the community to duplicate the application. All aspects of the camp project must be immediately accessible to community members, not only equipment and money, but leadership, planning, implementation and maintenance skills as well. To put this another way, the only parts of the camp that will be sustainable are the ones that community members can and will do themselves. Sometimes that means you will have to leave out the high-tech binoculars, or make them a small, unnecessary part of the camp.





Two to Three Months in Advance

- Choose counselors and staff
- Develop counselor and staff training
- Design publicity for recruiting campers and publicizing camp
- Decide rules and policies for camp
- Plan logistics (transportation, food, lodging, supplies, health and safety)
- Develop an emergency plan



Choose counselors and staff

Begin by identifying the needed skills: activity leaders, counselors, cooks, drivers, and so on.

Define their jobs: Skills, time needed per day, responsibilities for supervision and discipline of campers.

Consider where counselors and staff can be located. Are any provided by the campsite? Will any work for free if their expenses (transport, room and board) are covered? Look to the following groups as potential pools for finding staff:

- The partner organization
- Parents
- University students
- Past campers (Older campers can often serve as junior counselors)
- Other Peace Corps Volunteers
- Other local organizations
- Teachers
- The community

Develop counselor and staff training

Prior to camp, schedule a training and planning workshop for counselors to serve several purposes:

- Clarify the goal(s) of the camp
- Skills training
- Matching skills and talents to camp goals
- Clarify roles and responsibilities of the various staff members
- Clarify mutual expectations of campers and staff
- Clarify camp policies and procedures
- Planning and scheduling
- Introduction to campsite



Training topics may include:

- Team building
- Staff expectations, joys, and fears
- Clarifying the camp schedule (practice all activities)
- Assigning roles and responsibilities; perhaps including a duty roster
- Reviewing environmental topics, as needed
- Teaching and group leadership techniques
- Rules for camp and disciplinary roles of staff; discipline in an outdoor setting
- Planning time for counselors
- Evaluation methods
- Small group dynamics
- Safety and first aid

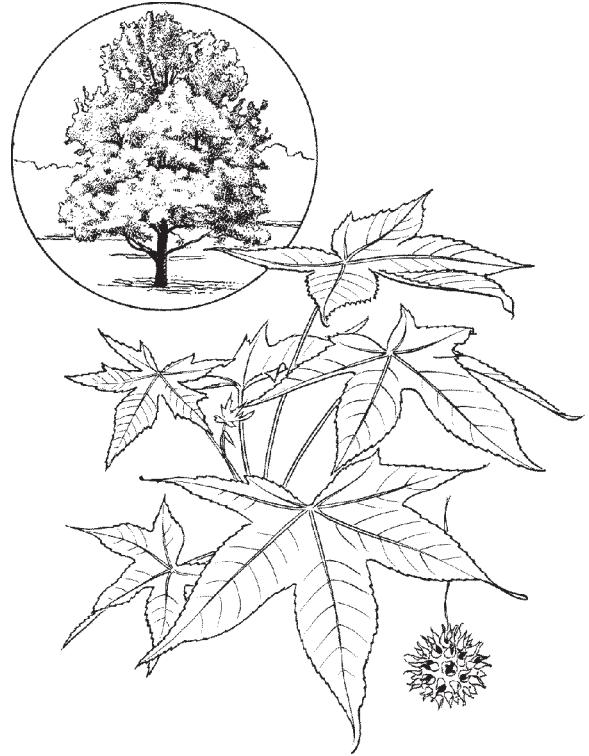

Design publicity for recruiting campers and publicizing camp

Designing a publicity campaign depends on how your target audience and interested community members get information. Depending on your situation, you may post flyers, or you may use TV or radio spots. You want to make sure all interested or influential parties—including potential campers and staff, parents, and teachers—know how, when, and where to apply for camp. Design your publicity strategy well in advance of your camp dates.

Decide rules and policies for camp



Ideally, there should be a few clear rules. Rules usually deal with participation in and timing of activities; health and safety; and camper responsibilities. While you may choose to draw up the rules ahead of time, campers are more likely to respect rules if they had some responsibility in creating them. It takes some time to conduct a camper session, but usually the campers come up with the same rules the staff would have drawn up. Before meeting with the campers, discuss with staff any rules that must be on the list, especially safety rules. If the campers do not mention these, then you can add them at the end of the session and tell the campers your reasons for having them.



SAMPLE CAMP RULES AND POLICIES

- Obey all safety procedures! NEVER swim, hike or participate in other activities without a counselor on duty.
- No leaving the campsite.
- Wear name tags during all activities.
- Go to all scheduled activities and BE ON TIME.
- Respect each other.
- Obey counselors.
- Be in your cabin at lights out. Do not leave your cabin after lights out.
- Do not open your door after lights out for anybody except camp staff.
- No boys in girls' area; no girls in boys' area.
- Shoes must be worn outside at all times.
- Sports shoes must be worn for sports events.
- All campers must help at clean up and kitchen duty.
- Try to speak English at all times.
- Return all camp property to supply area.
- All campers must be in their cabins or in the cabin area at rest time and must be quiet.
- No fighting, bad language, alcohol, smoking or drugs.
- Drink a minimum of two bottles of water per day.
- Have fun. Tell counselors if you are not having fun.

From "Summer Camp Manual: Guidelines for a Community Organizing a Safe and Fun Summer Camp" Peace Corps Kazakhstan, 2004.

Plan logistics

Logistical concerns include transportation, communication, food, supplies and health. Allow plenty of time to locate or purchase materials needed for camp and make sure to keep all receipts. Set up a record keeping system early on in the process because it may be difficult to recall purchases, contacts, contracts or agreements during or after the camp. A checklist follows of possible logistical considerations.

Transportation:

- Who will provide transportation for staff? For supplies? For campers?
- What emergency transportation will be available?
- Do transportation providers have insurance?



- How will you contract service with transportation providers?
- Will you have transportation throughout camp? If not, what are the alternatives?

Communication:

- Will you have telephones or other means of communication available during camp?
- How will you handle emergencies?
- How will you communicate with staff? Campers?
- How will you communicate with the sponsoring organization or other participating organizations?

Food:

- How many meals per day will you have? Will you have snacks?
- What foods will offer the best nutritional balance?
- Are there any special dietary accommodations to consider?
- How much liquid per person per day will be required?
- Are there adequate food storage facilities? Refrigeration?
- Will it be possible to deliver all the food at the beginning of camp, or will other deliveries be necessary?
- Will you have hired food service providers? If so, what services will you contract?



Supplies:

- What supplies will be needed for camp activities? For health purposes? For lodging? For the kitchen?
- How will those supplies be purchased or collected?
- How will supplies be transported?
- How will supplies be safely stored at camp?
- Supply needs vary considerably from place to place and camp to camp.

Health and Safety:

- How will you handle emergencies?
- How will you handle camper and staff illness and injuries?
- How will you contact medical help, should it be needed?
- Who will be liable in case of accident?
- Are there first-aid supplies available to counselors?





- Who will be in charge of treating campers and staff for injury or illness?
- How will you deal with lost campers?



Develop an emergency plan

Camp emergencies can range from illness of an individual to natural disasters that require a complete evacuation. The most common types of medical situations at camp are cuts, bruises, sprains, strains, colds and flu. In your particular area, you may have to take into account certain dangerous animals (e.g., insects, snakes, or other animals) or sicknesses endemic to the region, such as intestinal infections or certain skin rashes. You may also need to plan for treatment of weather or altitude related injuries, such as sunburn, dehydration, hypothermia or mountain sickness.

As part of the camp planning process, an emergency camp evacuation plan should be devised, along with a plan for evacuating individuals. When creating the plan, consider the most likely situation for your particular circumstances and plan accordingly. Be sure to consider relevant precautionary measures, ways to assemble campers and staff, and escape methods and routes. Your plan should consider:

- How will you learn of the emergency? Will the park ranger notify you? The police? The military? If you will be dealing with these officials, do they have a plan in place that you will need to train your counselors and campers to use?
- Devise a way to signal all campers and staff in case of an emergency, and train them to gather at a central meeting point.
- Devise a way to make sure you have accounted for all campers and staff both initially and during the evacuation.
- Plan a variety of escape routes in case one is closed off. For example, what would you do if the only access road washed out?
- Make sure you have supplies and personnel to treat injured people.
- Assign responsibilities to the staff. Who will drive, who will treat injuries, who will count heads, and so on.
- Plan for the types of likely emergencies. For example, fires move uphill and downwind, so that needs to be considered in making an evacuation plan; during earthquakes, people should leave buildings and meet in open places; floods are likely to contaminate water supplies, so you will need a reserve and a way to purify water.



FINAL PREPARATION

One Month in Advance

- Implement publicity strategy
- Hold training for counselors and staff
- Select and orient campers and parents

Implement publicity strategy

Now is the time to tell the community about camp. Put the flyers up. Run the announcements. Hand out applications. Interview or screen potential campers. Whatever your plan for recruitment and publicity was, now is the time to implement that plan.

Hold training for counselors and staff

Implement the training you developed—see pages 98 and 99 of this chapter.

Select and orient campers and parents

During recruitment, give campers all the information they will need in advance, including:

- What to bring
- Application dates
- Selection dates
- Date/time/place of travel to camp
- Camp contact information for families
- Camp schedule and curriculum

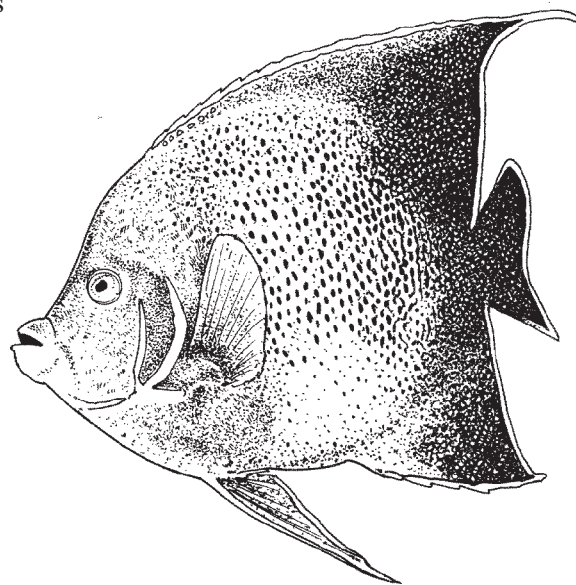



LAST MINUTE ADJUSTMENTS

One Week in Advance

- Reconfirm all camp plans (staffing, food, lodging, transportation, supplies)
- Try to get some sleep
- Send a few counselors to the camp early to prepare

CONDUCTING CAMP

The First Day of Camp

- Greet and orient campers to set the tone of camp
- Conduct first day activities
- Confirm that all campers are present and settled in
- Relax and have fun
- Meet with counselors to process the day and troubleshoot

Greet and orient campers to set the tone of camp

As campers arrive, welcome them and help them to feel at home. Introduce yourself and other staff to campers, and explain how campers will be organized, the layout of the camp, and the schedule. Setting a cheerful and organized tone on the first day is necessary for the camp to be fun and well-run. Campers need to know where they will live, the rules, staff roles and responsibilities, the schedule and their responsibilities.

As campers arrive, they will need to be shown where to put their gear and given a tour of the campsite. One of the first activities you may do as a group is to convene with campers, and ask them to choose a camp name and/or place them in teams for activities. The names and teams are usually chosen from the nature of the region and the theme of the camp. Nametags with this information can be made from all sorts of natural materials.

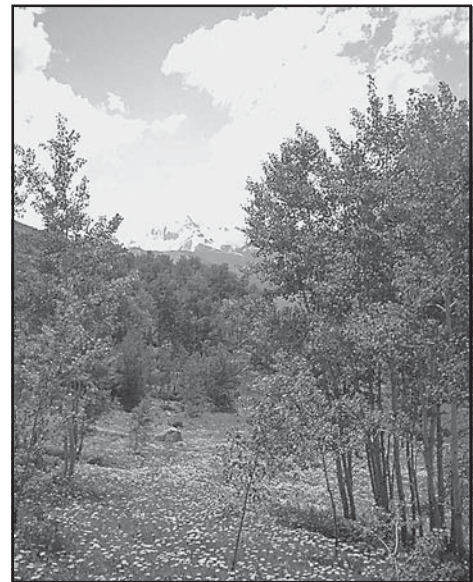

Conduct first day activities

Plan time for explaining the schedule and discussing the expectations of campers and staff. The first day is usually used for introductions and orientation, often through the use of skits performed by counselors. Orientation should include some discussion of how to behave in the outdoors. Campers, especially if they are from an urban environment, need to think about how to minimize the impact they will have on the area around the campsite. Below is an example of behaviors expected in the field.



DO'S AND DON'TS OF FIELD WORK

- | | |
|---|---|
| <ul style="list-style-type: none">■ Do make sure you have all the materials you need before you head to the study site.■ Do be a careful observer.■ Do take careful notes about what you find, including information about locations and characteristics of plants and animals.■ Do handle animals with care and handle them as little as possible.■ Do return animals you find to the places where you found them.■ Do replace logs and rocks to the position you found them.■ Do stay within the boundaries of your study area.■ Do try to identify unknown species while you are in the field.■ Do look for animal signs as well as actual animals.■ Do wash your hands carefully as soon as you return to the classroom. | <ul style="list-style-type: none">■ Don't damage trees or other plants by digging them up, ripping off leaves, or tearing at the bark. Be careful when collecting specimens.■ Don't put anything you find—such as berries, leaves, mushrooms and bark—in your mouth. Also, don't put your fingers in your mouth until after you have returned to the classroom and washed your hands thoroughly.■ Don't chase after, yell at, or throw things at animals.■ Don't touch or collect animal droppings, dead animals, mushrooms, or human refuse such as bandages, rusty cans, broken glass or needles.■ Don't reach under logs, rocks or crevices, or other spaces if you can't see into them. |
|---|---|

Copied, with permission, from *Biodiversity Basics – An Educator's Guide to Exploring the Web of Life*, ©1999, a publication of World Wildlife Fund's *Windows on the Wild* biodiversity education program. For more information, please visit www.worldwildlife.org/windows. To order *Windows on the Wild*, *Biodiversity Basics*, contact Acorn Naturalists at 800.422.8886 or www.acornnaturalists.com.

Confirm that all campers are present and settled in

Make sure that all campers that signed up are present. Double check that all campers have settled in and are comfortable in their assigned quarters.

Relax and have fun!

Enjoy the day. Enjoy the campers. Often a campfire is held the first night (and maybe every other night), with songs and snacks, or perhaps skits or stories.

Meet with counselors to process the day and troubleshoot

After camp is settled in for the night, meet with counselors to review the day and troubleshoot any problems or questions. Make sure all the counselors are clear about their tasks.





RUNNING AN EFFECTIVE CAMP

During the Camp

- Check in with campers and staff daily
- Follow schedule as planned
- Take pictures and/or videotape
- Seek feedback



Check in with campers and staff daily

It is a good idea to have a regular check-in time for announcements, questions, or any issues that may come up. Many camps have a check-in time at the morning meal because everyone is there. The first day or two of camp may have lengthy check-in times as the campers get used to the schedule and find out how everything works.

Follow schedule as planned

You have spent a lot of time preparing a schedule that will work, and training counselors and campers to use it. Sticking to the schedule will prevent headaches and frustration because people will know what is expected. If something unavoidable or unexpected occurs that forces you to change the schedule, try to keep change to a minimum, which will limit confusion.

Take pictures and/or videotape

Pictures and videotape can be used as a visual record, and can help the planning process for the next camp. A visual record will also allow you to show supporters what you did, and to gather new supporters for the next venture.

Seek feedback

Hold daily or weekly check-in meetings with counselors to review highlights, revise agendas and troubleshoot. Spend some time every day troubleshooting with campers and staff. Ask them for feedback on how they are doing, and what they are enjoying. Give them the opportunity to ask questions and talk about difficulties, as appropriate. This will give you a sense of what is going on at camp, and it will also send the message that you really care about the experience they are having. Make any modifications campers suggest that are feasible. Keep track of the feedback for future planning and for reporting.

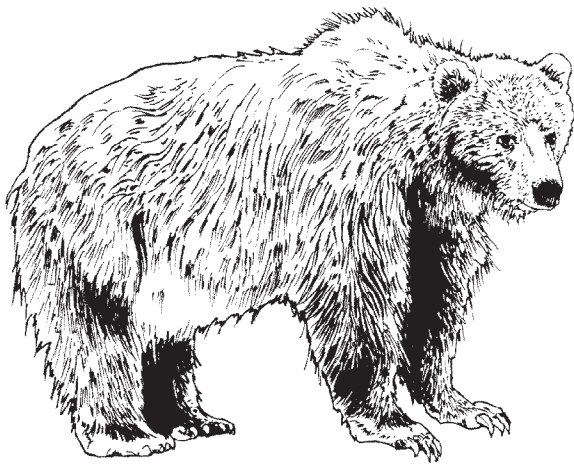



ENDING THE CAMP

Evaluate and celebrate

- Evaluate the camp
- Plan follow-up activities with the campers, counselors, parents and/or staff
- Celebrate! Conduct an end of camp ceremony

Evaluate the camp

At the end of camp, ask campers and staff for an evaluation of camp. When creating the evaluation, consider what kind of information will be useful to you and to future efforts. The evaluations should tell you if you achieved your goals, and give feedback on how camp went. Campers and staff can say what they liked about camp and what they would change for next time. Ask the staff to make recommendations for the next camp including descriptions of what were the good features of camp and what they would change for next time. Add that to camper evaluations, and write up recommendations to be included with the report. Discuss evaluations with staff and record lessons learned and recommendations for the future.

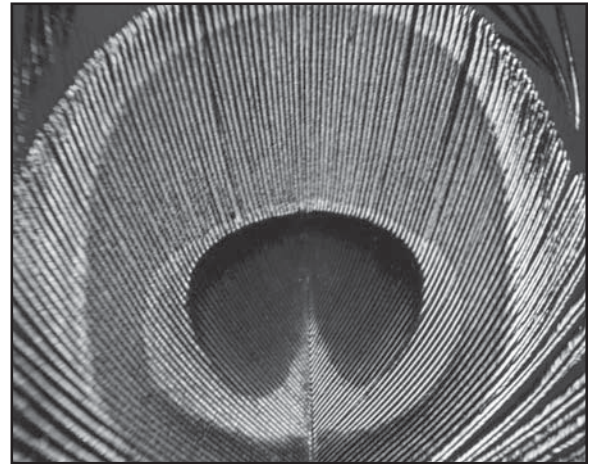

Plan follow-up activities with the campers, counselors, parents and/or staff

Sometimes directors or counselors get together with staff and campers after camp to share photos and videos, and socialize. Some camps are part of a larger program and have built in follow-up activities, such as improving school performance, increasing volunteerism, service projects, or ongoing environmental clubs. Camp planners may have a set of follow-up activities to maintain the relationships that were formed at camp, or to work with campers on a long term basis of continuing environmental education, personal growth or community service.

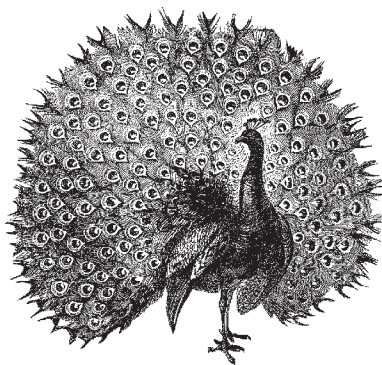

Celebrate! Conduct an end of camp ceremony

Traditionally camps end with a celebration that includes awards and other recognition, singing and skits, exchange of souvenirs and addresses and goodbyes. On the last day, there is usually a “graduation” where all campers and staff assemble to recognize achievements.



AFTER THE CAMP

Reporting and Documenting

- Compile camp evaluations
- Write reports
- Send thank-you notes to donors and all others who helped

Compile camp evaluations

Compile both camper and staff evaluations. Summarize them for the report, below.

Write reports

A good report will leave a record of the camp for future planners, share evaluations, and inform camp sponsors. Include a narrative that summarizes the camp experience and has the statistics. A budget should also be included for sponsors and future planners. It should contain the planning budget as well as actual expenses and income. Photos and videos add interest to the final report.

Camp reports may include:

- Overview and description
- Camp goals and objectives
- Logistics - dates, transportation, meals, lodging, etc.
- Camper application, selection, and demographics (how many, who, ages, etc.)
- Staffing patterns, roles and responsibilities
- Budget versus actual cost
- Funding sources
- Daily schedule of activities
- Publicity strategies and materials
- Evaluation and recommendations for the next camp
- Supply list
- Resource list – people, information and supplies
- All forms, flyers, applications, etc.





Send thank-you notes to donors and all others who helped

Make sure to thank everyone who helped. Camps are group efforts and people should be recognized for their work. Thank-you notes are investments in the future of camps. It is important to remember to do this. At the end of camp, people are often tired, so it may take an effort to get the end of camp work done.





RESOURCES

Peace Corps' camp reports are useful sources of information. Check the local Peace Corps offices for these reports. There may be camp reports from other countries available at your local office as well.

Print

Environmental Education in the Schools. Washington, DC: Peace Corps. [ICE No. M0044]

Adapting Environmental Education Materials. Washington, DC: Peace Corps. [ICE No. M0059]

Camp GLOW (Girls Leading Our World) Handbook for Volunteers. Washington, DC: Peace Corps. [ICE No. M0056]

Community Content-Based Instruction (CCBI) Manual. Washington, DC: Peace Corps. [ICE No. T0112]

Working with CCBI: Volunteer Workbook. Washington, DC: Peace Corps. [ICE No. M0073]

Environmental Education Curricula

Windows on the Wild: Biodiversity Basics—An Educator's Guide to Exploring the Web of Life. Tustin, CA: Acorn Publishing, 1999. [ICE No. FC258]

This guide is a complete course book for teaching young people about the environment, the variety of life on earth and the importance of protecting the web of life. It includes unit plans, resources, games, charts and other activities for teachers and their students in grades 6-8.

Windows on the Wild: Biodiversity Basics—Student Book. Tustin, CA: Acorn Publishing, 1999. [ICE No. FC259]

The student's guide is a companion piece to FC 258 *Windows on the Wild: Biodiversity Basics—An Educator's Guide to Exploring the Web of Life.*

Project W.E.T. (Water Education for Teachers): K-12 Curriculum and Activity Guide. The Watercourse and the Council for Environmental Education, 1995. [ICE No. E0333d]

Project Learning Tree: Environmental Education Pre K-8 Activity Guide. American Forest Foundation, 1995. [ICE No. E0330]

These two curricula have many useful activities for all age levels and subject areas. They are all available by training; often Volunteers have the training or can receive training in-country. They also all have curriculum frameworks that can be used for curriculum planning. Many Peace Corps' In-Country Resource Centers have these books.



Web

Campfire USA has information about camping.
<http://www.campfire.org/default.asp>

Campfire Chaos has songs, skits and other activities
<http://freespace.virgin.net/mre.davis/campfire.html>

Campfire Sing-along Index has lyrics to favorite camp songs
<http://www3.sympatico.ca/cottagecountry/dir-cam.htm>

Becky's Campfire Songbook has songs, skits, and other activities for camp.
<http://www.geocities.com/EnchantedForest/Glade/8851/>

EE-Link has resources for EE professionals including publications, grant resources, general information and professional development opportunities. It also has classroom materials, activities and programs.
<http://www.nceet.snre.um>





CHAPTER NINE

ENVIRONMENTAL EDUCATION CENTERS

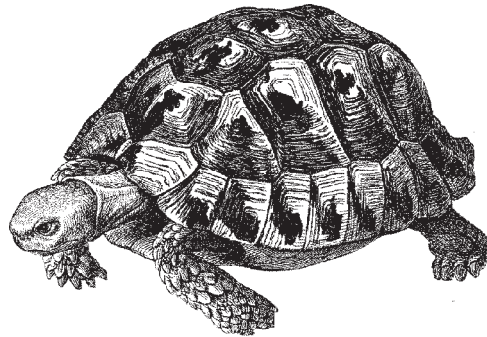

Very few environment Volunteers will have the luxury of starting up and/or running a center dedicated solely to environmental education. More likely, environmental education will take place in conjunction with other community activities related to such things as health or community development. Therefore, this chapter is devoted to providing suggestions and ideas for Volunteers who would like to integrate environmental education and awareness along with a broader set of activities. For example, in a health center, the agenda may include environmental health in addition to vaccination or prenatal care programs.

In an EE center, the staff may have more flexibility in choosing the target audience and content of the program. Therefore, the first section of this chapter deals with centers specifically designed for EE programs; while the second part offers suggestions on how to integrate EE activities into other areas. In schools and in community centers, environmental programs are often broadly defined, and focus on a particular target audience, such as children or women. In parks, preserves, agricultural extension centers, small business development centers, or health centers, the environmental education program is typically more narrowly focused on parks, agriculture, business, or health.

ENVIRONMENTAL EDUCATION CENTERS

Environmental education centers are buildings and outdoor areas planned around the local environment and conduct programs that focus on local ecosystems and environmental issues. These centers may be associated with parks, reserves, or other protected or reserved lands. In an EE center, all activities deal directly with environmental education. Many of the activities held in an EE center can be held in other venues as well. The possibilities for environmental education are limitless and should be based on the circumstances specific to the community. The following section can help to generate ideas about what might be effective (and fun!) in your community.

Indoor facilities

Ideally, an environmental education center blends well with its surroundings. The architecture or decorations on the outside and inside of the building reflect the surrounding natural and cultural environment. Themes and motifs that bring attention to the ecosystem can attract visitors to the center. Signs can help to orient visitors.



EE centers often devote space to interpretive displays or exhibits to capture a viewer's interest and make a point about the environment or an environmental issue. Environmental concepts are interpreted in a way that resonates with a particular audience and usually reflects the surrounding ecosystem. Exhibits can be visual, auditory, interactive, or multimedia, and they are often held in open areas where visitors can browse without a guide. Exhibits may be permanent or temporary, and may include live plants or animals. They may be on a wall or a partition; they may be on a counter or in a display case. For a more detailed description of creating exhibits and caring for animals see Chapter Ten.

EE centers often offer classes and presentations, so there may be classrooms, or large open areas for giving presentations. Classrooms may include laboratory or workspace, sinks, chalkboards, bulletin boards, tables and chairs or desks, and storage space. Presentation rooms are used for larger audiences for presentations, meetings, and conferences. Presentation rooms may include podiums, display tables, seating, and screens for slide shows, films, videos and other visual presentations. These activities may also take place in any open space where people gather. Sheets of cloth or paper may serve as screens; walls as bulletin boards; and boxes as storage space.



If your EE center wishes to house research activities, space is needed for the researchers to work in controlled conditions, and to store their equipment and materials. This type of laboratory or workspace can be used for a variety of activities, including housing animals or plants, making materials or equipment for the center, looking at field trip collections, or any other messy activity that requires space.

EE centers usually have office space for staff, resource rooms or libraries, and storage space for equipment and supplies. Equipment may include communication equipment: phones, faxes, computers or typewriters. It may include lab equipment such as microscopes, glassware, cages, terraria or aquaria. It may include audio-visual equipment including slide projectors, video players, film projectors or overhead projectors.

There are often local adaptations that will serve the purpose of your organization. Community members will know what local resources may be available to obtain equipment or skilled workers who can build facilities for the center. Another alternative is to contact large corporations in the area who might be interested in donating (or providing funds to purchase) equipment and supplies.

Outdoor Facilities

Outdoor facilities usually include natural areas and areas for conducting demonstrations and projects. Natural areas include nature trails, ponds and wetlands, forests or coastlines. Demonstration areas are places where people learn about agricultural practices, soil conservation, water use, forest practices, fish farming, gardening, food processing, crop storage, composting or other activities. Project areas are places where center projects are conducted and might include forests, farms, a recycling center, compost piles, a greenhouse or garden, beehives, or alternative energy sources. Outdoor areas may be landscaped to reflect local ecosystems or goals of the organization. Parking areas, latrines, and picnic areas may also be included.





Possibilities may include:

Natural areas:

- Ponds for fish, turtles, frogs or water plants
- Trails with plants labeled (medicinal, alpine, forest, etc.)
- Trails demonstrating different ecosystems or plant communities (wetland, coniferous forest, tropical forest, etc.)
- Wildlife viewing areas
- Trails highlighting human impact
- Trails showing animal signs
- Trails giving a historical perspective
- Trails showing geological features and change
- Bird-feeding areas
- Soil profile
- Rock collection
- Forests with forest practices highlighted

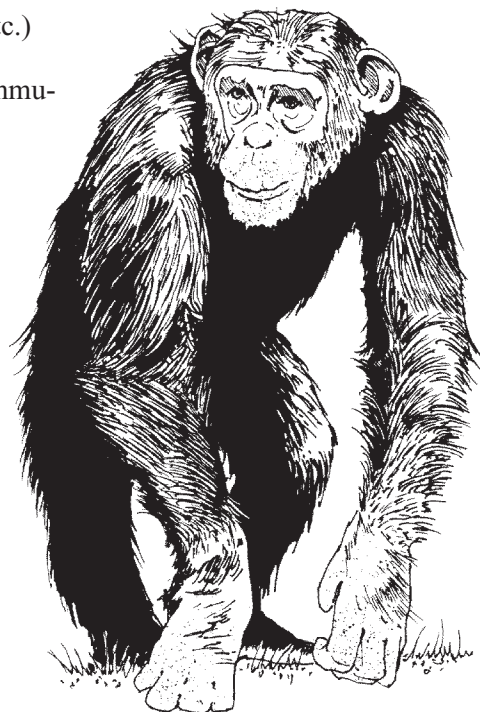

(See page 194 in Chapter Ten for a more detailed description of nature trails.)

Demonstration areas:

- | | |
|--------------------------------------|---|
| ● Crafts with natural materials | ● Animal identification |
| ● Planting or improving crops | ● Smoking, drying or canning food |
| ● Water well construction | ● Building solar or wind energy sources |
| ● Storing crops | ● Marketing local products |
| ● Water treatment | ● Gardening |
| ● Reducing/reusing/recycling methods | ● Soil conservation or erosion control |
| ● Solid waste disposal | ● Habitat restoration and maintenance |

Project areas:

- | | |
|---------------------------------------|---|
| ● Gardens | ● Beehives |
| ● Wind, hydro, solar or methane power | ● Animal husbandry or wildlife rehabilitation |
| ● Forests or orchards | ● Water wells and/or treatment |



- Greenhouses
- Zoo
- Soil conservation practices
- Botanical gardens
- Protected areas for wild animals or plants
- Research projects

ENVIRONMENTAL EDUCATION — BELIZE —



A marine biologist assigned to Green Reef/Belize in San Pedro, Ambergris Caye, focused her work on environmental education, research and sustainable resource development for the benefit of the community. As an environmental education Volunteer, she was very interested in the conservation awareness of the community. To raise local environmental awareness, she wrote a weekly column called “Reef Brief” in the *San Pedro Sun*, which is devoted to topics relevant to marine conservation.

The Volunteer presented environmental education programs in San Pedro schools and to other visitors. She featured topics that pertain to the marine environment of Ambergris Caye. Children received an introduction to marine biology by taking a glass-bottom boat tour of the local reef.

Along with her colleagues at Green Reef, the Volunteer worked with the citizens of San Pedro to set up additional mooring buoys for boats, sought ways to improve and modify the sewage system, and trained tour guides, all of which helps to stave off damage to the delicate coral reef located just offshore.

ACTIVITIES IN AN ENVIRONMENTAL EDUCATION CENTER

The content of environmental education programs will depend on the goals of the organization or group visiting the center. The list below presents some possible options for achieving the goals of the center.

- **Classes and informational presentations:** Classes or workshops can take many forms. School or university teachers may bring their students to a center for a special class topic. Classes may be used to inform community members about methods, techniques, or practices they can use. Informational presentations enhance knowledge in the community, as well as increase the center’s visibility in the community. Regular presentations on a variety of topics bring people in to the center. The presentations might cover topics like farming practices, wildlife biology, ecotourism, gardening or geology. If the presentations are regular, the community may think of the center as a comfortable place that offers pleasant experiences and a forum for ideas. A positive community image can go a long way to supporting the work of the center. Classes at the center may include trainings for volunteers at the center, or for community environmental educators, including teachers.





- **Research:** Your organization may or may not be involved in research. If it is, then the research will be by, and in support of, the goals of the organization. If not, it is worth encouraging researchers who are doing work in related fields to use the center for research and share information with the center. For example, the center manager in a waterfowl refuge in Fairbanks, Alaska, encouraged a migratory songbird research project to use the refuge land. The songbird research project has brought in many community members and given the refuge data to use in making management decisions. Forming alliances with researchers can benefit both the researcher and the center.
- **Children's activities:** Besides classes, there are several types of children's activities that can be done at EE centers. Summer day camps offer opportunities for environmental education. Special events put on by or for children, like Family Science Nights, Forest Fun Day or Recycled Inventions, bring families to the center. Some aquariums, zoos or farms allow children to stay overnight in the facility near the animals with their teachers or group leaders.
- **Special events:** An organization's mission can often be well-served by organizing special environmental education events. Some examples are: Arbor Day tree planting, litter clean up days, environmental street theater, game days using all environmental games, art displays (natural fibers, recycled materials, ceramics, wood carving, or other art using local natural materials).



- **Fund-raisers:** Many EE centers must raise funds, and there are many ways to do this. Most cultures have preferred methods, so be sure to discuss appropriate plans with your counterpart. There are many creative ways to raise funds: auctions and raffles raise money by asking for donations of goods or services to be sold; musical or artistic performances raise money by asking performers to donate their time and talents and selling tickets; an organization can host an arts and crafts sale. Organizing and selling tickets for a special ethnic dinner, or a dessert and music evening not only brings in money, but also increase the organization's visibility.
- **Interactive displays:** Most EE centers have informational displays. If displays can be made to be interactive, they will draw community members for the fun. Interactive displays involve the audience directly; the audience actually does something (makes guesses, gives input or makes something). Some examples are: guessing what an artifact (bone, feather, pine cone) is by touch only, using the sense of smell or hearing as a way to identify elements of the environment, placing pictures of animals in the correct habitat on a bulletin board display. Interactive displays are particularly effective with children. Using recycled items to make imaginative



animals, or walking through an imaginary habitat and finding all the birds, are the kinds of activities that appeal to children.

- **Temporary thematic displays:** Most EE centers have some permanent displays that highlight elements of the local environment. Temporary displays add both flexibility and interest to the program at the center, and can highlight seasonal events, timely themes or local talent. An example of a seasonal event might be a harvest display, or a display about migratory animals. A timely theme such as Arbor Day, a conference, or a current issue in the news can be used in a display. Anniversaries of events important in environmental work can be highlighted in displays. Such anniversaries may include the Tbilisi Declaration, the earth summits, or the work of Rachel Carson, John Muir, Aldo Leopold or a local environmental figure. Local artists and photographers who depict environmental subjects may warrant a display. Displays of recycled materials, natural fibers or ceramics, or art with environmental subject matter demonstrate the impact of environment on art. The work of a particular scientist or environmental organization can be highlighted.
- **Theme weeks:** A theme week is devoted to the multidisciplinary study of a topic such as wildlife populations, food from the sea, or insects. During that week, many activities for all age groups are organized for community members to participate. Sometimes theme weeks coincide with fund-raisers or promotional activities. Involving local schools in theme weeks can be an effective educational tool.
- **Meetings or conferences:** Conferences are often an opportunity to share information and to network. Sponsoring a conference can bring together interested parties to work on community projects.





DARWIN RESEARCH STATION — ECUADOR —

A married Volunteer couple was assigned to be environmental educators at the Charles Darwin Research Station on San Cristóbal Island, Galápagos. They provided formal and nonformal environmental education for children, youth, and adult audiences.

The Volunteers had the dual task of working with children as well as inspiring and training teachers to do environmental education. With the development of inexpensive didactic materials and the use of several different teaching techniques, the Volunteers sparked interest in teachers and students in various environmental subjects.

They also brought teachers and students to the Center for Environmental Education (CEE) that the Charles Darwin Research Station runs in San Cristóbal. Here, the Volunteers developed numerous materials and activities. Those materials, along with audiovisuals and the consistent quality of the services provided, gained the center an excellent reputation among the students, teachers and the general public of the Galápagos Islands.

Small groups of children toured around their own island by boat with an educator to learn about and appreciate their own fascinating island. This gave the children a unique opportunity to experience the wonders of Galápagos while applying the knowledge they learned in the CEE.

Some other effective strategies that have been used to attract interested participants are vacation environment courses and ecology clubs. Part of the success of these strategies is due to field activities in which the participants engage.

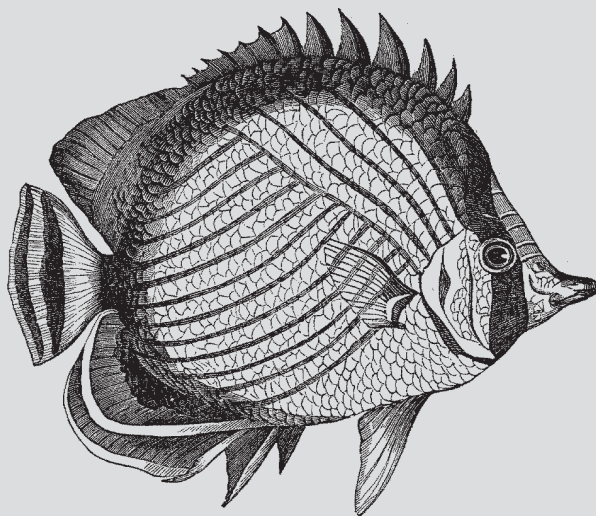

In order to reach a larger audience, the Volunteers do a radio presentation once a week to make people aware of news from the CEE and give small ecological messages to those listening. There is only one radio station on the island and the Volunteers have used this means of communication to encourage the people to learn about Galápagos, giving various quizzes and motivational spots.

In addition to work with the CEE and teachers' and students' environmental education, both Volunteers have worked with women's groups in hands-on activities. She has conducted a course and workshop on making recycled paper. He

has begun work with wives of fishermen, the largest economic generator on the island. Currently he is collaborating in the design, analysis, and implementation of a socioeconomic study of the fishing sector. This study will be the basis for strengthening and educating of the sector through training.



Taking Stock

- What is the focus of the center you are working in?
- What are environmental issues in your community?
- If you do not work in an EE center, what ideas can you borrow from EE centers?
- What kinds of spaces does your center have available for public displays, offices, storage or resource rooms?
- What outdoor spaces are available and how can they be used to further the work of your organization?
- Are there ways that the available spaces can be used to enhance the program?
- With the staff, brainstorm a list of activities that the center could host. Discuss and prioritize them.

COMBINING ENVIRONMENTAL EDUCATION WITH OTHER ACTIVITIES

Environmental Education in Schools

Class projects can teach a number of environmental principles at one time. For example, asking older students to create a nature trail for younger students will increase observation skills, focus attention on the immediate environment, teach about the skills and knowledge required to make a nature trail, and practice critical thinking about what components to include. Other class projects may include gardens, weather stations, newsletters, clean up days, or making videos. Scientific investigations of the environment are powerful ways to teach and motivate students.

There are several ways to add interest to your curriculum. For example, because students generally enjoy being outside, activities that take place outdoors may increase student motivation. Many activities can be adapted to an outdoor classroom and the local environment. Refer to *Adapting Environmental Education Materials*, ICE No. M0059.

There are many excellent volumes on environmental education in schools, including the companion volume to this manual, *Environmental Education in the Schools*, ICE No. M0044. Also, be sure and look in the resource section for more ideas.

EARTH SPORT PROJECT

— UKRAINE —

The Earth Sport Project was developed and administered by three Volunteers as a national environmental awareness campaign for secondary school students of their community in Kyiv oblast, Ukraine. It used Ukrainian and American knowledge, skill, and teamwork in an effort to help Ukrainian children and prospective teachers explore how ecology is valued and what it means to society. Through a series of 45-minute lessons, students explored the local and global implications of air and water pollution, solid waste and recycling. They also developed a public awareness campaign with the Ministry for Environmental Protection and worked with eight prospective English teachers in developing school curriculums that use content-based instruction to convey environmental themes.





A CYBER CENTER — JAMAICA —



A third-year Volunteer worked with her supervisor to apply for grants from several environmental education sources, including the Canadian Green Fund, the Environmental Foundation of Jamaica and the UNDP to establish the Cyber Center, the profit from which would be used to support environmental projects.

The Volunteer designed the physical layout of the Center. The programs included educational courses, walk-in Internet use, business publication services, basic computer literacy and training of trainers workshops. She developed all the training materials for the educational programs. She also provided instruction for the initial training course, which covered introduction to computers, basic keyboarding and Internet use. She trained more than 200 people including coworkers, teachers, high school students, government workers, local business persons, nongovernmental organizations and the disabled.

Environmental Education in Community Centers

Clubs, professional societies, or nonprofit organizations often operate “centers” that serve as gathering places in small communities or for particular groups of people (e.g., youth, women, or senior citizens). Peace Corps Volunteers may find opportunities to conduct environmental education activities in these types of centers, which include orphanages, centers for displaced people, women’s centers, youth centers, urban recreational centers or other community centers.

It is often possible to develop environmental education activities around the main goals of a center. For example, a program at a women’s center and a program at an urban youth center will differ considerably based on the varying ages, needs, and interests of the audience. Therefore, direct your initial efforts toward listening to and observing staff and the target audience, as well as assessing the environment.

A center might serve no other purpose beyond that of a meeting or gathering place. In that case, find out what kinds of environmental education programs may be of interest to the staff or governing board. People from other area organizations may also be able to offer advice as to what an environmental education program should address. Agricultural extension workers, health workers, foresters, teachers, soil conservationists, wildlife managers, nutritionists or others may have useful ideas about programs important to the community.

A community center may benefit by working with other organizations to develop programs. Community gardens bring together agricultural and health organizations. Business and agricultural organizations can work together to create markets or bazaars. Civic organizations may want to become involved and support children’s programs or community economic development projects such as summer camps, scholarship programs, or the development of small economic enterprises using local natural resources.



NGO DEVELOPMENT CENTER — BULGARIA —

A Volunteer in Bulgaria began working with the NGO Development Center in Bourgas to provide management and technical assistance for environmental and other NGOs dealing with local and regional issues in the greater Bourgas area. Her main activities included the organization and start up of the resource center; creation of a monthly bulletin for the Plovdiv and Bourgas NGO Development Centers; researching on the Internet to find useful technical and financial resources for Bulgarian NGOs; and assisting the Single Mothers



NGO of Bourgas in developing a Bulgarian Cookbook in English to be sold to raise funds to support their activities. She and a nearby environmental education Volunteer worked with the National Parks and Bulgarian Scouts to develop a project for a ropes course in Bulgaria intended for youth development and environmental education.

This Volunteer also worked closely with the Youth Initiative Alliance, helping the young people organize seminars in peer counseling, set up a crisis hotline and promotional campaigns, organize office structure and place youth in responsible leadership and decision-making roles.

She and a nearby business Volunteer also helped the Bourgas Youth Business Center to develop a survey to identify the interests and service needs of small merchants in the central Bourgas NGO Development Center and also helped to organize a two-part customer service seminar.

Community center environmental education programs may vary in scope from very small, focused projects, such as planting a small vegetable garden on the site, to large, sophisticated projects with associations, by-laws, logos, and regular meetings. Projects may occur as one-time events (tree planting), or short-term projects (adult education classes), or long-term projects (ongoing park docent programs).

A strength of community center programs is that participants are usually there voluntarily because they want to support the program. There are often influential people involved in these projects who can help move the projects forward and gain support from other organizations.

Environmental education activities appropriate to community centers may include:

- Presentations on agriculture, soils, community forestry, health care, sanitation, gardening, environmental science or related topics
- Community gardens
- Community beautification projects such as parks or rest areas
- Community clean up or recycling projects
- Native plant gardens
- Tree planting





- Community litter cans or other solid waste disposal projects
- Events that celebrate environmental ideas like Arbor Day, solstice, biodiversity, water, forests, wildlife, or Earth Day
- Special topic field trips such as birds of the forest or fish farms
- Studies of local environments leading to recommendations for care and maintenance, or the development of special areas like city parks or protected forests
- Lobbying for responsible environmental legislation
- Educating the general public about local and global environmental issues
- Fund-raising or planning for natural resource management projects
- Clubs formed around environmental interests, like birding clubs or native plant societies; children's clubs like Boy Scouts, Girl Scouts, or 4-H, or wildlife clubs

Taking Stock

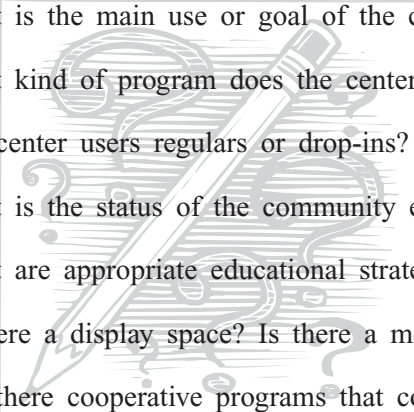
- 
- What is the main use or goal of the center you are working in?
 - What kind of program does the center staff want?
 - Are center users regulars or drop-ins?
 - What is the status of the community environment?
 - What are appropriate educational strategies for the center?
 - Is there a display space? Is there a meeting space?
 - Are there cooperative programs that could be done at the center?

Environmental Education in Parks and Preserves

Environmental education in parks usually centers on the ecosystem of the park, or the special species or landforms for which the park was created. There can be displays and presentations, as well as guided and unguided nature tours and camping. Some of these may be operated by park personnel or by private businesses. Some parks may have interpretive centers where classes and other activities are conducted.

In addition to conducting educational outreach activities, Volunteers may also help the park devise environmental policies, which can become political. For example, there may be contentious feelings around issues such as hunting, foraging, and protected species. Poaching is a serious issue, and can sometimes result in dangerous confrontations and violence. Although Volunteers should not become involved in enforcement practices, there may be opportunities to conduct environmental education with poachers.

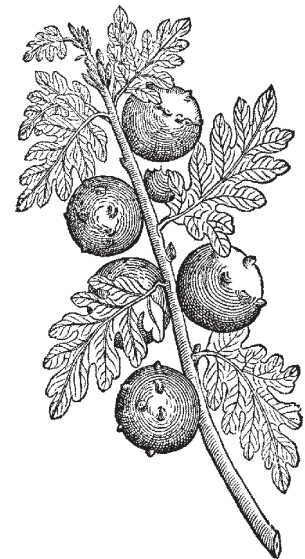



It is important to discover how the park is used, relevant issues and constraints, and the hopes and goals of park staff. The park may have multiple uses, some of which may be different than you expect. Learn the rules of the park and how they are enforced. It is not the job of a Volunteer to become involved in enforcement, but it is important to know the level of enforcement and the people in charge of it, as well as their expectations of you.

Buffer Zones:

Often there are communities located in buffer zones or protected areas that are in close proximity to the park, and Volunteers may work with these communities to link them more closely with the park. Volunteers may work in community centers to implement environmental education programs related to the park, or help with income-generation projects, such as nature tourism or value-added activities.

Buffer-zone communities may be dealing with several issues related to the park:

- Buffer-zone communities may want to take advantage of economic opportunities offered by proximity to the park, such as tourism.
- Buffer-zone communities may have lost access to resources as a result of the formation of the park, and therefore may need to develop alternatives.
- Communities may need to develop infrastructure (lodges, restaurants, public facilities, communication facilities, roads, etc.) as a result of the increased numbers of people visiting their town.
- Increased visitation could also mean a desire to limit impact and use by visitors.

AMBORO NATIONAL PARK — BOLIVIA —

A Volunteer worked in Bolivia's Amboro National Park and the surrounding tropical communities promoting ecotourism and environmental education. As part of his effort to increase environmental awareness and augment local income, he implemented a program to train eight community members as park guides. The eight young men selected to participate in this program received training over a six-month period in bird watching and nature interpretation. In conjunction with this work, the Volunteer also instituted an educational exchange program. The trained local guides invited school children from the urban Santa Cruz area to visit the national park and participate in environmental activities related to park preservation and appreciation.

The goals of these projects were twofold. First, by training local residents as park guides, the project helps buffer-zone communities realize the value of the park and surrounding natural resources, and work to further protect and conserve them. Second, by providing a structured program where students can visit the park, the project promotes urban environmental awareness in the region, and provides a future locally based tourist resource. Through the completion of these two goals, this project will have lasting impact on both local and regional communities.

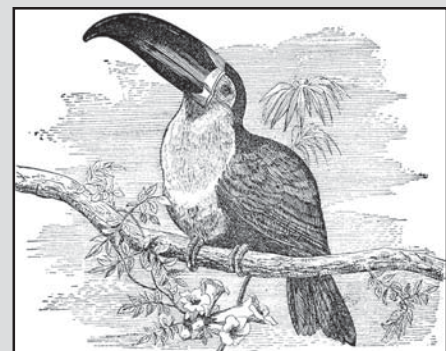



- These communities may find themselves competing with large tourism companies, or needing to develop skills in dealing with large tourism companies. Community members may be concerned about protecting the interests of local people.

Planning Environmental Programs:

Planning an environmental education program requires the input of all stakeholders. Stakeholders in buffer zone communities may include community members and local businesses, park officials, tour operators from outside the community, or environmental organizations interested in the park. In planning the program, you may need to interact and communicate with all or some of these groups.

When planning an environmental education program, consider park staffing. Parks may not have sufficient funds to provide year-round consistent staff. Find out the history of staffing and plan the program to adapt to the park's staffing pattern and capability. If, for example, there is more staff during the summer season, plan on conducting an ambitious summer program and a limited winter program. If there is high staff turnover, the program should be easy to learn and implement. If acquiring enough staff is a problem, consider developing a volunteer group. University students, secondary students, or other community members may be able and interested in helping with the development of exhibits, leading tours, or office tasks.

Activities:

Environmental education activities in parks and preserves may include:

- Development of displays and exhibits that highlight the features of the park and its ecosystems. (For more information on creating displays, see Chapter Nine.)
- Development of displays and exhibits that teach appropriate, responsible behavior in the park. (See Chapter Nine.)
- Development of nature trails with interpretive signs. (See Chapter Nine.)
- Summer camps for children or adults. (See Chapter Eight.)
- Programs or exhibits for resorts and sanitariums (health and relaxation facilities).
- Camping and picnicking areas with interpretive materials or interpreters who give nature talks. (See Chapter Nine.)
- Explanation and interpretation of scientific research taking place in the park.
- Environmental education aimed at specific groups of park users, such as fishermen, hunters, and gatherers.
- Environmental education in buffer-zone communities.
- Guided wildlife watching.
- Orientation for backcountry hikers, boaters, or other outdoor enthusiasts, as well as for guides for these groups.
- Education for income generation projects such as beekeeping, grazing, wildlife tour operators, backcountry adventure operators, use of products of the park as value-added products (berries or other food items, handicrafts, medicinal plants, etc.).

The term “**stakeholder**” refers to the individuals and groups who are affected by the program, and who should have input into its creation.



IT'S NOT EASY BEING GREEN — SLOVAK REPUBLIC —



In the past four years, a national park in central Slovakia has been dealing with a very serious loss of amphibian populations in the southern part of the park. Every year during the spring migration, vehicles kill thousands of frogs as they migrate across roads that were built in the migration route. To minimize this hazard, the national park began conducting environmental education programs for local communities and schools. They also began setting up migration barriers along busy roads to restrict the amphibians from entering the roadways. These amphibians were then manually transported from one side of the road to the other by school children and community volunteers.

With the help of a Peace Corps Volunteer, it was possible to enlarge this project to include eight communities in the northern part of the park. The Volunteer assisted in acquiring the necessary funding for supplies (partially funded by a SPA grant), helped to develop new educational materials, and helped with the biological aspect of the project. Together with his counterparts at the national park, they issued leaflets to children and teachers in the communities, conducted interpretative programs in schools, held public meetings, instituted photo and art contests, recruited students, children, and adults to help manually move the migrating amphibians across the road in buckets, organized data collection for the types of species existing in the area, and coordinated development of new wetlands.

The project was very successful, particularly in the interest it generated in the communities involved, its promotion of local leadership skill development, the data generated by school children and volunteers, and the development of new wetlands within the national park. As a follow up, the project team also developed an environmental education program to generate research data on amphibians, and the mapping of wetland areas located close to high volume roadways, especially those close to communities. The plan is to sustain the project with government and private funding, and to include all communities within and around the park.

Nature tours:

A common activity that park visitor centers can offer is a nature tour. Nature tours show off the natural resources and increase appreciation for the park. Environmental educators can develop nature tours and train tour guides for the park.

Nature tours:

- Are a preplanned sequence of narrated stops along a nature trail
- Are an opportunity to increase awareness of the park ecosystem
- Are a chance to highlight aspects of the ecosystem that people might overlook, or do not have the training to observe
- Can feature information about plants, animals, geology, history, ecology, weather or water
- Should be interesting, entertaining, informative, humorous or even mysterious





- Have several parts to the presentation, including:

(1) Staging:

- As people arrive, welcome them and assure them they are in the right place.
- Greet as many individuals as possible, and establish a friendly relationship.
- Ask about any special interests such as birding or plants or geology, so you can customize your tour.
- Inform them about the length, duration, and difficulty of the tour.
- Remind them about any special clothing, water, bug repellent, etc., that they will need.
- Hand out any equipment such as binoculars, head nets, or trail guides.

(2) Introduction:

- Create an interest in the theme of the tour.
- Orient the audience to the theme.
- Present an example of what they will see.
- Repeat information about length and duration of tour, and show a map to orient them.

(3) During the tour:

- Show and describe to your audience interesting and pertinent sites that relate to the theme.
- Use a storytelling style rather than a lecture style.
- Encourage questions from the audience.

**HOL CHAN MARINE RESERVE VISITOR CENTER
— BELIZE —**

Working as an environmental educator with the Hol Chan Marine Reserve on the Island of San Pedro, a Volunteer conducted environmental monitoring and education programs, and assisted with the management of the reserve.

The Volunteer and his counterpart successfully carried out an environmental monitoring program that surveyed lobster, conch, fish and coral populations. The upkeep of the visitor center was also an essential part of the Volunteer's work and he collaborated with other members of the staff to ensure that the brochures and other materials produced by the agency were relevant, current, and in good supply. The Volunteer and his colleagues maintained visitation records to determine the reserve's visitor capacity.

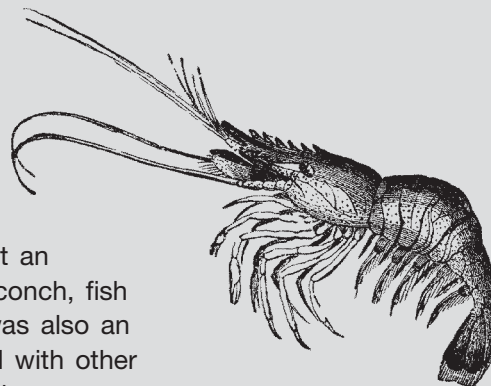



- Respond to their interests along the way.
- Ask questions of the audience and use humor.

(4) Conclusion:

- Collect any loaned equipment.
- Summarize the tour, the sites you visited, and their relation to the theme.
- Answer any remaining questions.
- Ask for evaluations of the tour.
- Thank your audience for coming.

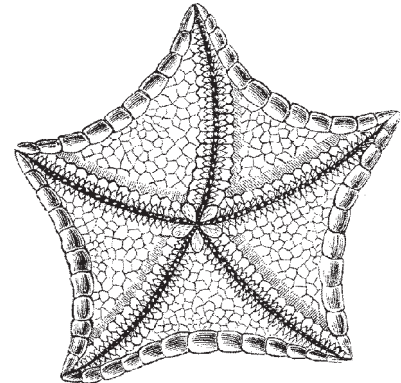

Tour guides should:

- Be interested in the ecosystem of the park.
- Be enthusiastic and friendly.
- Be trained in the natural history and interesting features of the park.
- Be trained how to design and implement tours based on themes relevant to the overall mission of the park.
- Practice taking tours by observing more experienced guides, or practicing with each other.
- Deliver dynamic, interesting, and enjoyable tours.
- Have safety and first-aid training.

Taking Stock

- Why was the park you are working with created? What is being protected?
- Do a biophysical assessment. What are the environmental features of the park and what are its issues?
- What are all the uses of the park? Are there conflicts?
- Are there areas within the park that have special uses? Are there features that can be highlighted?
- Are there buffer-zone communities that would benefit from environmental education programs?
- What is the focus of the environmental education program?
- What are the facilities for environmental education? Will your education program be at the park center, in the field, or both?
- Are there currently environmental education programs in place? What kind of environmental education programs might be created?

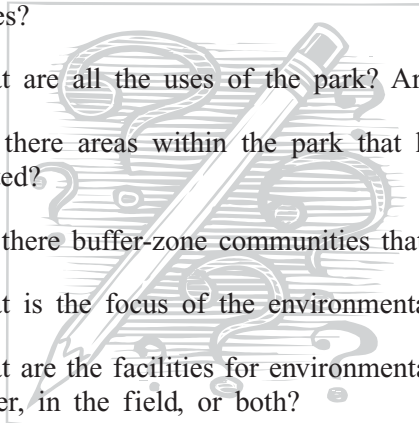



- What are the interests of the staff? The visitors? The government? Any private businesses concerned?
- How are the rules for the park enforced? Is there a need for public education about the rules and regulations? Do park users understand the reasons behind the rules?

Environmental Education and Community Economic Development

Community economic development (CED) programs focus on enhancing the quality of life in communities by creating opportunities for income generation. CED focuses on building the capacity of the community, and in this way is different from traditional economic development programs, which focus more on providing capital.

CED is closely linked with environmental education because people are often forced to make decisions that negatively affect the environment, but ensure survival from one day to the next. In park or forest buffer-zone communities, for example, there may be issues with sustainable resource use, such as collecting wood for fuel. The community economic development approach seeks to help people use their natural resources in ways that are both economically and environmentally sustainable. Environmental educators may find themselves in situations that require a blending of environmental education and economic development. Here are two examples:

CASE STUDY: KUBEASE AND THE BOBIRI BUTTERFLY RESERVE

Kubease is a small village in Ghana, located about two and a half miles from the Bobiri Butterfly Reserve, a busy tourist destination. Although the road to Bobiri passes right through the village, residents gained very little economic benefit from the tourists and scientists that visited the reserve.

A business Volunteer in collaboration with a committee of nine community members explored a number of ideas to boost the economy using the principles of community economic development. An impressive entrance to Kubease with a welcome sign was erected, and a tourism information center and toilet facilities were built. Houses were replastered and a village artist painted murals depicting local life on some of the houses. Sidewalks were built, trees planted, and an open pavilion constructed. Village merchants learned what goods and services visitors like and how to provide customer service. A bicycle rental shop opened to serve those that came by bus and wanted to ride rather than walk to the butterfly reserve. Kubease became a pleasant place for visitors to stop and spend some of their money, and as a result, citizens enjoy new prosperity and an improved community environment.

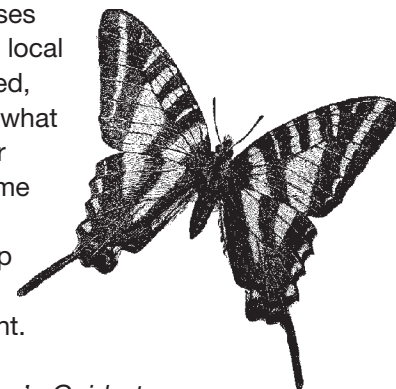

For a more complete discussion, see *A Peace Corps Volunteer's Guide to Community Economic Development (CED)*, Washington, DC: Peace Corps. [ICE No. M0069]



CASE STUDY: WOOD IN THE HIMALAYAS



People in many parts of the Himalayas cook and heat water with wood. Teahouses, which cater largely to tourists, burn large amounts of wood to cook and to heat water for showers. As a result, deforestation has accelerated. Initially, efforts to reduce deforestation were frustrated because there were few viable alternatives to wood fuel. From a CED perspective, the task of the community developer is to work with the community to find ways to cook and make a living without further deforesting the mountains. Volunteers in Himalayan communities have helped residents find alternative ways of heating water (solar), and facilitated local decisions about forest management. As a result, some teahouses have actually been able to expand their businesses without increasing their use of wood fuel.

Taking Stock

- What are the environmental issues in your community that have an economic impact?
- If community behavior changed to protect or enhance the environment, what economic impacts would that have?
- What are ways the community could generate income that would:
 - protect, enhance, or restore the environment, and
 - use the environment in sustainable ways?
- What are assets of the community that could support an environmentally-friendly economy?
- What changes could facilitate both environmental and economic sustainability?
- Which people and organizations are, or could be, the most likely implementers of these ideas?

Environmental Education in a Small Business Development Center

Sometimes business development and environmental interests are perceived to be at odds with each other. But as ecologist Gretchen Daily of Stanford University says: “I see ecosystems as a kind of capital. If managed properly, they will provide a steady stream of benefits. These include not only obvious goods like food and timber, but also life supporting services such as water purification, flood control, stabilization of climate and pollination of crops. Right now we have unprecedented demand for such ecosystem services and a decreasing supply, which increases their value.”²

The international community, governments, businesses, and large corporations increasingly take into account the environmental impact of their practices. Some of that is from regulatory pressure, some

² “Ecologist Gretchen Daily: A Green Who Understands the Power of Greenbacks.” *Discover Magazine*, Vol. 23, No. 9, Sept. 2002, page 15.





from the cost of clean up, the prevention of pollution or the depletion of resources, and some is from the pressure of public opinion.

Because business Volunteers usually work with small communities and organizations, they are often in advantageous positions to facilitate discussion, design and implement locally meaningful business development initiatives that employ environmentally-friendly practices.

Environmental education programs in a small business development center may take several approaches. If you work with small business owners or on cottage industry development, you might be able to help your clients understand how environmental concepts can affect their businesses, analyze their own practices, and look for alternatives. As an example, a Volunteer could help clients identify market niches that desire traditionally made and environmentally-friendly crafts which may be locally perceived as old-fashioned. Existing community assets, such as the natural landscape or craft-making expertise, may provide untapped opportunities to boost the local economy and protect the environment.

Environmental business topics may include:

- Producing environmentally-friendly products
- Developing and using environmentally-friendly materials
- Making and selling traditional arts and crafts using local materials (e.g., wool, hemp, or nettle fiber)
- Buying and selling local materials and products
- Marketing locally made, traditional, environmentally-friendly products (“locally grown or made,” “this product supports...,” “traditional, natural product of...,” “made from all natural materials” etc.)
- Low cost production using appropriate technology and materials
- How using environmentally-friendly practices can save money and promote products
- Environmental effects of manufacturing practices
- Turning traditional products and practices into money-making businesses (e.g., weaving, knitting, spinning, wood carving, ceramics, sewing, raising free-range chickens)
- Ecotourism possibilities (e.g., living in a yurt, helping on a farm, birds of Indonesia, medicinal plants of Panama, river rafting, hiking the Romanian mountains, fishing in Zambia, experiencing rural Barbados)
- Developing a business plan

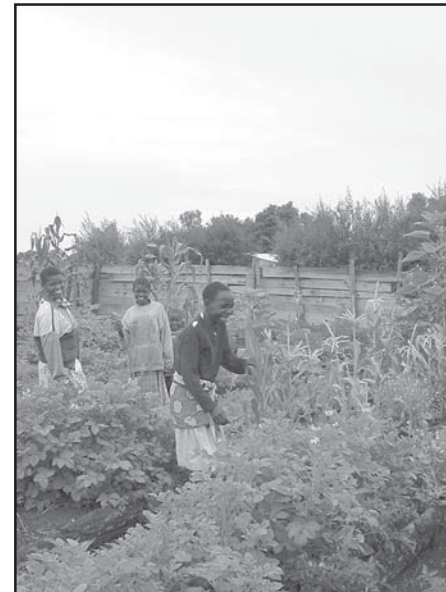



Taking Stock

- What businesses are in your community? How and what do they make and/or sell? Are their products and practices environmentally-friendly and sustainable?
- From your environmental assessment, what resources are available and what are some resource-use issues?
- What would local businesses like to add or change in the community?
- What possibilities are there for new business ventures that use natural resources in sustainable ways?
- Are there local products or services that could be built into income generators?

ENVIRONMENTAL EDUCATION IN A HEALTH CENTER

In many parts of the world, the major health problems are also environmental problems. Malnutrition is often due to poor agricultural practices that damage the environment, outdated food storage methods, and insufficient nutritional awareness. An environment that supports disease-carrying insects, such as malaria-carrying mosquitoes and sleeping sickness-carrying tsetse flies, may result from the presence of an out-of-balance habitat that favors the growth of these insects, but is unfavorable to their natural predators. Diseases such as cholera may result from environmental catastrophes, and may be perpetuated by circumstances that often exist in communities with limited infrastructure, such as safe waste disposal systems.

If they understand the problem and learn what steps to take, people can change the environment to improve the soil, agricultural production, and nutrition; to break the lifecycle of disease vectors; or to slow the growth and spread of bacteria.

In addition to providing medical care, a health center can also provide health education that demonstrates the relationship between health and the local environment. Programs to educate the community in some aspect of environmental health should be based on the specific circumstances of the surrounding area. Rather than disease or nutrition, a community's concern might be mental health; community members may be suffering from the stress of a crowded and competitive urban environment. Perhaps air pollution is severe enough to cause lung or skin damage, and needs to be explained. Many health fields have an environmental component, and health Volunteers have opportunities to introduce environmental topics and explore the connections between the environment and health with co-workers, patients, clients, and students.

ENVIRONMENTAL THREATS TO CHILDREN

"The biggest threats to children's health lurk in the very places that should be safest—home, school and community. It is a little known but devastating fact that every year over 5 million children ages 0 to 14 die, mainly in the developing world, from diseases related to their environments—the places where they live, learn and play."

General Dr. Gro Harlem Brundtland, World Health Organization Director. Delivered during a speech to launch the 2003 World Health Day in New Delhi, India.

<http://www.who.int/world-health-day/2003/infomaterials/brochure1/en>





Environmental health topics may include:

- Clean water
- Nutrition and diet
- Effect of heavy metals, pesticides, and fertilizers on food or water quality
- Food preparation and storage
- Vector-borne diseases (diseases carried by animals or insects)
- Sanitation practices at home
- Pollution and disease
- Sanitary waste disposal
- Health effects of sun, altitude, temperature, or moisture/dryness

The information from the environmental assessment (Chapter Two) will help you to determine levels of knowledge, interest, and priorities as they apply to environmental health. Where you carry out environmental education activities depends on the schedule and existing activities at the health center. If you work in a clinic or hospital, the waiting room can be an effective place for environmental education activities. Posters, informational brochures, or videos can occupy the patients while they are waiting. If your center offers classes to its audience, it may be possible to integrate environmental education concepts into those classes or to conduct presentations on appropriate topics such as: recipes for local foods high in vitamin A or protein; housekeeping to prevent infection; or care of farm animals to prevent disease. It may be appropriate to launch community information campaigns with posters or brochures or through local radio and television stations.

Some health Volunteers may work primarily with women and children. If so, educational efforts will need to be directed to this audience. Sometimes it may be possible to work with groups of children while the mothers are being treated or vice versa.

Nutrition

Nutrition education can be supported through the schools where children can learn the basic principles of good nutrition. They could grow fresh vegetables or fruits in a school demonstration garden, and take the vegetables home to eat. A government-sponsored food program might be available to provide school children with a nutritionally balanced meal each day.



HUMAN RIGHTS AND THE ENVIRONMENT

“Human rights cannot be secured in a degraded or polluted environment. The fundamental right to life is threatened by soil degradation and deforestation and by exposures to toxic chemicals, hazardous waste and contaminated drinking water... Environmental conditions clearly help to determine the extent to which people enjoy their basic rights to life, health, adequate food and housing, and traditional livelihood and culture. It is time to recognize that those who pollute or destroy the natural environment are not just committing a crime against nature, but are violating human rights as well.”

Klaus Toepfer, Executive Director of the United Nations Environment Programme. Delivered at the 57th Session of the Commission on Human Rights, Geneva, 2001.

<http://www.who.int/peh/ceh/taskforce.htm>



If floods or erosion are a frequent cause of crop loss in your area, encourage efforts in flood and erosion control by farmers, with help from agricultural agents, which improve and secure the local food supply.

In urban areas, nutritional problems are intensified by the fact that consumer goods compete for whatever money is earned, and often the family diet suffers as a result. An approach to this problem could be to conduct interventions that demonstrate how a balanced diet improves weight, muscular strength, endurance, and capacity to work, as well as resistance to disease. There may also be opportunities to organize urban gardens.

The World Health Organization (WHO) believes that protein calorie deficiency is one of the greatest public health problems in the world today. A health center project developed in cooperation with an agricultural agency could demonstrate how to develop better soil, how to choose an acceptable protein-rich plant food to grow, and how to prepare it for eating. If diet deficiencies of any kind are an important problem in your area, a demonstration garden could experiment in growing fruits and vegetables that could contribute to a more complete diet. Work with the agricultural agent to identify the plants that are compatible with the environment and local culture. For example, if the climate is suitable, papaya trees might be introduced to provide an easily grown source of vitamins A and C.

Sanitation

Sanitation is the planning and application of measures to maintain a healthy environment. These measures should apply to water supply, sewage and garbage disposal, and control of disease-carrying insects and animals.

Water supply:



A community's water supply may come from a ground water well, a spring, a stream, a river, or a lake. Unless there is a community-wide water purification system, whatever water there is should be considered to be a potential source of infection and parasites. Therefore, each user should disinfect water. The most effective method of preventing waterborne infection and parasites is to boil the water for at least 10 minutes to kill bacteria and parasite eggs in the water. Water purification can be done on a community-wide basis by adding chlorine or iodine to a water storage area.

Health centers are concerned with educating a community to develop a clean water source. This would involve educating people to:

1. build and use latrines, not the river or lake;
2. put garbage in compost piles, not in or near the water supply;
3. not bathe in the water supply;
4. keep domestic animals out of the water supply; and
5. use erosion control techniques to keep topsoil from washing into the water supply.

Other local sources of water contamination should be studied and remedied.





Sewage:

Sewage is the term used for human waste. Sewage can be disposed of properly through the use of latrines. Latrines can be built for each family, or one or several can be built for the community as a whole. Family latrines are usually more effective in dealing with sewage since a family is likely to use the latrine and keep it clean. Community latrines are often neglected since no one feels personal responsibility for keeping it clean or in good repair. Where possible, encourage people to build family rather than community latrines.

Pit Latrines:

A pit latrine is basically a hand-dug hole in the ground, covered with a slab, preferably of concrete, either for squatting or with a seat. A shelter is built around it. Human waste is isolated and stored in the pit latrine, so that no harmful bacteria or parasites can be passed on from the waste to new hosts. In the pit, the waste decomposes, first into odorous ammonia products, then into nitrites and nitrates. This decomposition process generally kills the majority of harmful organisms.

A health center should provide help and information about latrine building. See the list of resources at the end of the chapter for resources on this topic. You can also ask the health APCD in your country, or health Volunteers.

There are different cultural taboos about the collection and disposal of human waste, which should be considered when developing sewage disposal solutions. Privacy and the separation of the sexes may be important considerations.



Garbage:

Garbage is largely composed of food waste, but can also contain other unwanted materials such as paper, cans and bottles. From a conservation standpoint, food waste should be returned to the soil as a compost material. This adds both nutrients and organic materials to the soil, which will increase its fertility. A compost pile can be a family or a community project. If there is space available outside a health center, a demonstration compost pile can be built with organic waste from the community members. When the compost is ready for garden use, it can form the basis for a demonstration garden, or can be divided among the community members for their own garden use. (For directions on making a compost pile, see Chapter Ten.)

If people are not reusing items such as jars, bottles, cans or other containers, try to find ways to encourage recycling. Plastic bags, batteries and other toxic waste should be disposed of properly. If there is not an appropriate disposal site for toxic materials, help the community designate a site that is away from water sources and inaccessible to animals or children. A single community site (e.g., a large pit) can keep the community clean and free from litter. If possible, the disposal area should be visually separated from the community, either by distance or by a screen of plants.



Hygiene

Health centers are also concerned with the personal hygiene of its community members. Because many hygiene problems occur as the result of invisible bacteria, it is up to educators to come up with creative ways to convey hygiene information. The health center can develop an education program that teaches the relationship of cleanliness to health. The washing of hands with soap and water before handling food; bathing to keep the body free from harmful bacteria; wearing sandals or shoes to prevent penetration of parasites through the soles of the feet; keeping the home swept and aired to discourage insect or bacteria breeding places; and keeping farm animals out of the home should all be part of a program to upgrade the health of the community.

Vector-borne Disease

Vector-borne diseases such as malaria, encephalitis, West Nile virus and bubonic plague are transmitted by insects or other animals. These diseases have an environmental component since, often, the habitat that permits the survival and reproduction of vectors results from some environmental imbalance.

Health centers help people understand the causes of these diseases and the measures they can take to prevent them. For example, mosquitoes, which breed in stagnant water, are the vectors for several diseases. Where possible, efforts should be made to eliminate standing water. Old tires, discarded plastic containers, plugged up gutters and drains, water troughs, open latrines, etc., are all potential mosquito breeding grounds.

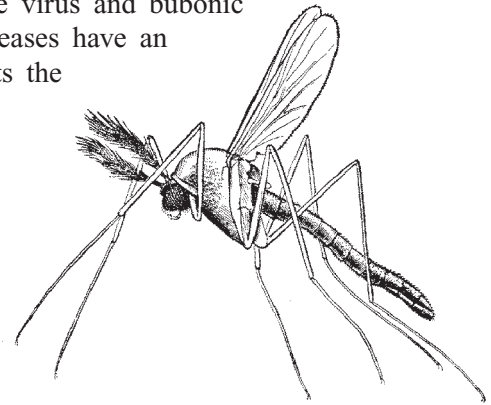

Rodents not only destroy food crops and stored grain; they also carry fleas, which carry diseases. Certain rat fleas carry typhus and bubonic plague, and fleas also transmit several species of tapeworm. Although there are chemical methods to control rodents such as rats and mice, their environment can be altered in ways that will discourage or reduce their population. Keep the community free from trash, litter and debris where rodents can hide and nest. Make the grain storage rodent-proof as illustrated in the Peace Corps manual, *Small Farm Grain Storage* [ICE No. M0002]. Most especially, encourage the protection of the predators of rats and mice, such as hawks, owls, and snakes, many of which are nonpoisonous. The health center might display pictures of birds and snakes that help eliminate rodents, or you might be able to keep a harmless, helpful snake as an education aid (see Chapter Ten on keeping live animals).

Parasites

A parasite is an organism that lives off of another organism (host). The host will lose vitality, and could eventually die. Humans can be hosts to a wide variety of intestinal worms and protozoan that may cause disease. If people know how parasites live and how they are transmitted, they can prevent the introduction of parasites into their body. Most parasites enter through ingestion of food or water, or burrow through the skin.

An effective method of demonstrating these types of health problems might be to illustrate the cycle on a flannel board or flipchart. Two suggestions follow:





Hookworm:

The hookworm is one of a number of nematodes found in tropical and subtropical climates that lives as a bloodsucking parasite in the intestines of humans.

1. The larvae of the hookworm live in moist soil, which is contaminated by human feces.
2. They penetrate exposed skin, usually the soles of bare feet, and are carried by the blood stream.
3. They travel to the lungs, where they cause coughing.
4. They are raised into the mouth with bloody mucous and are then swallowed. (They can also be swallowed in polluted water.)
5. They then travel to the intestine where they attach themselves with “hooks” and feed on the body’s blood supply.
6. A female hookworm can discharge 30,000 eggs a day into the human feces, which will then further contaminate the soil and more people.

As a result of the loss of blood to an infestation of hookworm, people will suffer anemia, abdominal pain, diarrhea, and weakness that will make them susceptible to other diseases.

In explaining this cycle of the hookworm, you can show that if a latrine is used, the soil will not be contaminated with hookworm eggs; if shoes or sandals are worn, the larvae cannot enter the soles of the foot; if water is boiled, live hookworm larvae will not be swallowed. If a person has bloody mucous, he should go to the health center to be treated with drugs that will kill the hookworms. Each of these actions will break the hookworm’s life cycle, and will help to destroy it.

This person is protected from hookworm by wearing shoes.

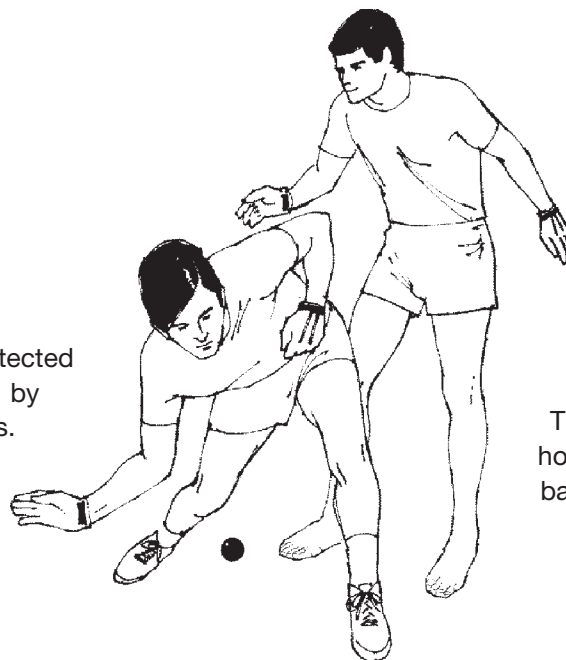

This person may get hookworm through the bare soles of the feet.



HIV/AIDS

Millions of people worldwide are infected with human immunodeficiency virus (HIV). HIV can cause acquired immune deficiency syndrome (AIDS), a fatal disease. When substantial portions of the population are infected, there is a loss in the labor force, because fewer people are able to work full time. In towns, this can lead to loss of services. In farming communities, it can mean that farmers are unable to plant as much and care for the crops as well. It may mean a switch to less labor-intensive crops or subsistence crops, less land under tillage, poor pest control, decline in yield, loss of livestock, all of which add up to decreased food security. It may mean population changes, where only the elderly and very young are left in an area.

Health centers are concerned with the multiple effects of the HIV/AIDS epidemic. In addition to educating community members about prevention, Volunteers can help people with lifestyle changes brought about by decreased ability to work or care for children. Farming practices may have to change, which may change nutrition. Environmental education may focus on changed farming practices, or alternative sources of nutrition in the local environment.



PERMACULTURE AND HIV/AIDS

— MALAWI —

Two Volunteers, one an HIV/AIDS educator and the other a nutritionist, have developed a unique cross-sector and collaborative approach to their projects. They teamed up with the various extension workers that serve the local geographical area. Six project areas are currently represented: health, nutrition, agriculture, environment, forestry, and agroforestry. As a result, this group approaches their development work as a team.

These Volunteers have also incorporated a philosophy known as permaculture (permanent agriculture) into their project. Permaculture is an agricultural-based school of thought, rooted in the fact that no single problem or solution stands on its own. The health of an individual with an immune-related disease like AIDS can be linked to a healthful (or a nutrient-deficient) diet. Nutrition levels can be improved with increased soil fertility and proper environmental practices. The ability to make educated, healthy decisions is directly related to all of these sectors.

Permaculture is composed of four basic principles:

1. Working with nature rather than against it.
2. Thoughtful observation rather than thoughtless labor.
3. Each element of the system should perform many functions, rather than one.
4. Everything is connected to everything else.



Since the beginning of this “team” approach, more than 3,000 trees have been planted. Health education has been given in the areas of HIV/AIDS, diarrhea prevention, and nutrition. Composting, mulching, and alternatives to synthetic fertilizers have been introduced, and community members and Volunteers are exploring the possibility of seed exchanges for indigenous plants, and alternative fuel sources. All solutions come from the community, which helps to provide the self-confidence and ownership that it will take to address future problems in a sustainable way.

From *HIV/AIDS: Integrating Prevention and Care into Your Sector*. Washington, DC: Peace Corps. [ICE No. M0081]



NUTRITIONAL PLANTS AND STRENGTHENED IMMUNITY

— MALAWI —

A Volunteer conducted research into the indigenous food plants that are presently used by communities, as well as those that were used in the past, but have now been displaced as a result of current environmental and agricultural practices. The Volunteer identified 600 edible plants that could be incorporated into the Malawian diet, and which can supplement current diets and add nutritive value to food that is normally derived from agricultural systems. Proper nutrition, in turn, can help boost and support the immune systems of those infected by HIV. Because these plants are indigenous, they are well adapted to the local environment and require less maintenance (and less energy expenditure) than agricultural systems. Volunteers conducted trainings with counterparts, extension workers, and representatives from village outreach programs and encouraged them to implement nutrition education based on indigenous plants in their respective communities.



From *HIV/AIDS: Integrating Prevention and Care into Your Sector*. Washington, DC: Peace Corps. [ICE No. M0081]

Air and Water Pollution

Water pollution may result from contamination with toxic chemicals such as heavy metals, or from biological agents that cause disease, such as *giardia*, bacteria, or amoebas. Air pollution may be the result of airborne automotive exhaust, industrial waste, dust, or other particulate matter. Chemical air and water pollutants can poison and damage body organs. Biological water pollutants can cause intestinal disease. Air pollutants can cause respiratory irritation and disease.

A health center is concerned with identifying and treating the resulting conditions and then preventing and eliminating the causes of these conditions. Environmental education programs can focus on preventative measures such as boiling, filtering or distilling water, or wearing protective masks. Programs may also focus on identifying sources of pollution and mobilizing the community to eliminate them.

Taking Stock

- What are the environmental issues in your community? What is the level of awareness of the connection between environment and health?
- Which environmental issues might be addressed by your organization? Which issues does the staff want to address? Who is the audience for these issues? How and when can these issues be addressed?
- Which educational strategies are most effective for your circumstances? Considering how you could reach your target audience, what strategies will work under those circumstances?
- Are there environmental issues you would like to address with the staff? What educational strategies would be most useful for those purposes?



RESOURCES

Print

Adapting Environmental Education Materials. Washington, DC: Peace Corps. [ICE No. M0059]

Environmental Education in the Schools. Washington, DC: Peace Corps. [ICE No. M0044]

Ham, Sam H., *Environmental Interpretation: A Practical Guide for People with Big Ideas and Small Budgets.* Golden, Colorado: Fulcrum Publishing, 1992. [ICE No. FC190]

HIV/AIDS: Integrating Prevention and Care into Your Sector. Washington, DC: Peace Corps. [ICE No. M0081]

Mitchell, Mark K., William Stapp, and Kevin Bixby, *Field Manual for Water Quality Monitoring.* Dubuque, Iowa: Kendall/Hunt Publishing, 1996. [ICE No. C0800]

Nonformal Education Manual. Washington, DC: Peace Corps. [ICE No. M0042]

Project Learning Tree: Environmental Education Pre K-8 Activity Guide. American Forest Foundation, 1995. [ICE No. E0330]

Promoting Powerful People. Washington, DC: Peace Corps. [ICE No. T0104]

Rural Water/Sanitation Projects: Selected Technical Fact Sheets. Washington, DC: USAID, 1982, from the "Water for the World" series. [ICE No. C0103]

Small Farm Grain Storage. Washington, DC: Peace Corps. [ICE No. M0002]

Winblad, Uno and Wen Kilama, *Sanitation Without Water.* Oxford, United Kingdom: Macmillan Education, LTD., 1985. [ICE No. C1003]

Windows on the Wild: An Educator's Guide to Exploring the Web of Life. Washington, DC: World Wildlife Fund, 1999. [ICE No. E0320]





Web

4-H. Environmental education resources.
www.4-H.org

Audubon Society. Information on birds as well as educational information.
www.audubon.org

Food and Agriculture Organization of the United Nations (FAO). Information on agriculture, nutrition, fisheries, forestry and sustainable development.
www.fao.org

Global Learning and Observations to Benefit the Environment (GLOBE). Science and education program for schools to collect global environmental data for scientific research.
www.globe.gov

National Wildlife Federation. Wildlife education information.
www.nwf.org

National Park Service. Nature Net plus information for teachers and students.
www.nps.gov

Pit Latrines Listserv. This site connects you to the Pit Latrines Listserve Network. This site allows you to communicate with other practitioners and it may help answer questions you have about different pit latrine construction techniques.
www.jiscmail.ac.uk/lists/pitnet.html

SanPlat. This link takes you to the SanPlat latrine slab construction system website. It offers information on how to construct SanPlat latrine slabs and provides the information you need to purchase SanPlat mold kits.
www.sanplat.com/

U.S. Department of Agriculture (USDA). Wide variety of information including biotechnology, drought, rice, food safety, gardening, soil conservation and sustainable development.
www.usda.gov

U.S. Forest Service. Information on forestry and recreation, as well as a kids' section.
www.fs.fed.us

Volunteers in Technical Assistance (VITA). Information on agriculture, communication, construction, crafts and village industry, energy, food processing, health and sanitation, home improvement, recycling, solar power and water supply.
www.vita.org





WELL Resources. This link provides you with technical briefs that were originally published individually in the journal *Waterlines*. The technical briefs cover a wide range of technologies like hand pump maintenance, desalination, small earth dam construction, the use of *Moringa Oleifera* seeds as a coagulant, and many more. This site also offers you access to the whole collection of briefs in PDF from the publication, *Running Water*.

www.lboro.ac.uk/well/resources/technical-briefs/technical-briefs/technical-briefs.htm

World Health Organization (WHO). Environmental health criteria series as well as a publication list from 1950 to the present.

www.who.org

World Neighbors. Educational programs for community development.

www.wn.org

World Wildlife Federation. Wildlife education information by country.

www.wwf.org





CHAPTER TEN

ENVIRONMENTAL EDUCATION COMMUNITY PROJECTS



There are an infinite number of ideas for doing excellent environmental education programs. How you and your community decide what works best in your community will depend on your particular circumstances. In this chapter, ideas are described and resources provided that can spark creativity as you and your partners explore environmental education options. There are many additional resources in libraries and on the Internet. You'll also find that local program managers, counterparts, teachers, and colleagues provide a wealth of knowledge and ideas.

In this chapter the following activities are described:

EDUCATIONAL ACTIVITIES

1. Traveling Road Shows
2. Dramatic Presentations
3. Media Campaigns
4. Special Events
5. Science and Eco-Fairs and Family Nights
6. Simulations
7. International Programs
8. Endangered Species Projects
9. Agriculture
10. Parks, Preserves, Protected Areas and Buffer Zones
11. Youth Projects and Activities



FIELD TRIPS

- 12. Field Trips
- 13. Field Ethics

FACILITIES AND TRAILS

- 14. Public Facilities
- 15. Nature Trails
- 16. Landscaping, Composting and Planting
- 17. Signs, Labels, and Guides
 - Making Signs
 - Making Labels
 - Trail Guides

EXHIBITS

- 18. Exhibits
 - Farmland Ecosystem Study Wheel
 - Hidden Uses of Forests
 - Life Pyramid
 - Wetland Connections
 - What Makes Soil?
 - Why Do We Need Trees on Hillsides?
 - Animal Skin Guessing Game
 - Bird Beaks
- 19. Collections
 - Displays
 - Insect Collections
 - Track Castings
 - Plant Collections
 - Tree Cookies
 - Water Organisms





- Soil Types

- Bones

20. Living Museums

21. Live Animals

- Aquarium

- Terrarium

- Jar Terrarium

- Desert Terrarium

- Forest Terrarium

- Ant Farm

- Earthworm Colony

- Insect Box

- Mammal Cage

- Attracting Birds

MATERIALS

22. Flannel Boards and Pagivolt

23. Pocket Charts

24. Ecotrunks

FIELD EQUIPMENT

25. Field Equipment

26. Weather Stations

- Weather Instruments

- Thermometer

- Rain Gauge

- Barometric Pressure and Humidity

- Wind Direction

- Wind Speed

- Cloud Cover and Type

27. Plant Presses

28. Watershed Models

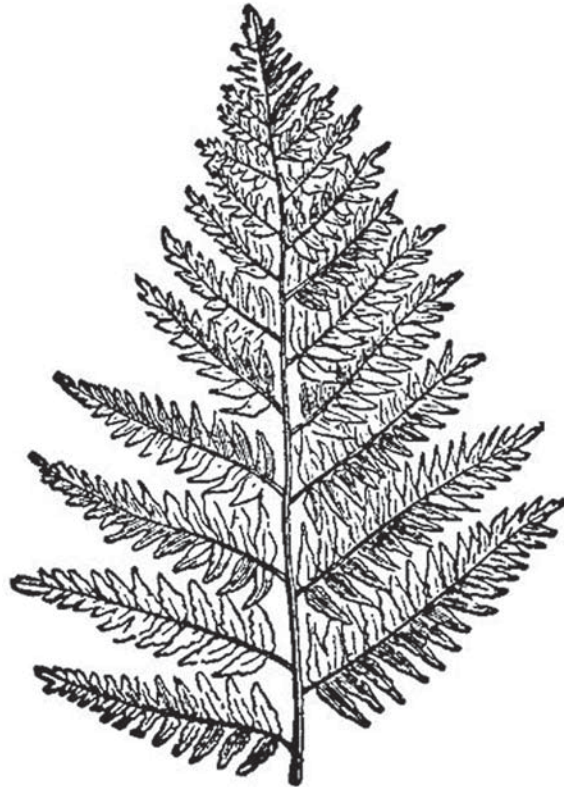



29. Water Sampling Equipment

30. Measuring Acidity

RESEARCH

31. Field Research

32. Making Maps

- Making maps using a compass and measuring tape (or pacing)
- Making maps using a Global Positioning System (GPS) instrument

33. Transects



EDUCATIONAL ACTIVITIES

1 TRAVELING ROAD SHOWS

DESCRIPTION

A traveling road show travels from place to place and presents a program to a target audience that is spread out over a large geographical area. Road shows often attract attention and draw crowds.

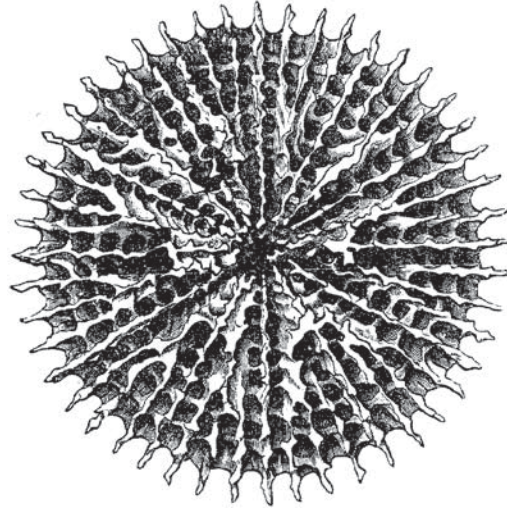

USES

Road shows are especially effective for remote audiences or for people who are beyond the reach of mass media.

EXPECTED OUTCOMES

Road shows can be used to increase awareness, knowledge, and skills. They can also be used to change attitudes or increase participation. The main focus is to bring environmental education to people who would not otherwise be involved.

EXAMPLES

Examples of programs include presentations with audiovisual aids, puppet shows, street theater, films, videos, or slide shows. A few specific examples of past Peace Corps' road shows include:

- ▶ Puppet shows to increase awareness about a particular threatened species.
- ▶ A compost demonstration.
- ▶ A community meeting to receive community input on some pertinent issue.
- ▶ A mobile interpretive station that can move to different parts of a park.



HOW TO DO IT

Once you have determined a need to get information or skills to a remote area, contact the communities to set up a time, place, and audience for the show. Consider your transportation to the communities. Will it be difficult to transport equipment to the community? Will there be cost associated with transportation and freight? Will all necessary materials be available? Will you have to build anything, such as a stage, at each site? Do you need to consider lodging and food? What is the most effective medium for communicating your message to these remote locations?

If you have a vehicle, cart, or other place where you could display interpretive materials, you may want to make a display board and carry informational literature with you. A display board can be made of plywood to exactly fit your vehicle or cart. When you arrive at a destination, set up the board and display the informational material. Consider ways to waterproof displays that will be outside. Paint it with acrylic or urethane, or make a roof for it. Plexiglass or plastic sheeting could be used to cover the information to keep it dry. Informational literature that is not on the board could be kept in a pocket chart (see Exhibits and Materials/Equipment below).



RESOURCE

Ham, Sam H., *Environmental Interpretation: A Practical Guide for People with Big Ideas and Small Budgets*. Golden, Colorado: Fulcrum Publishing, 1992 [ICE No. FC190].



2 DRAMATIC PRESENTATIONS

DESCRIPTION

Songs, parables, stories, dances, plays, street theater or other oral or musical presentations are powerful tools for getting an environmental message out. Potentially controversial issues can be presented in a non-confrontational manner. Many cultures have oral or musical traditions that lend themselves to environmental education. Ask co-workers and community members about this possibility.



USES

Dramatic presentations are fun, informative and profitable. They often introduce an idea or theme to an audience using humor. Role playing is used to involve the audience in entertaining ways. A puppet show is a non-threatening way to discuss controversial issues. Adaptation of local songs and stories to environmental themes can be used to introduce environmental concepts. For example, the story of the three little pigs can illustrate locally appropriate building materials.

Other types of dramatic presentations include:

- ▶ **Environmental theater:** a play with an environmental theme; this is probably the most ambitious of the dramatic presentations, but the most rewarding.
- ▶ **Talent show:** a collection of local talent; ask local performers to perform while you arrange for the master of ceremonies.
- ▶ **Open “mic” night:** similar to talent show, but all you do is advertise the event and invite local performers. The rest is unscripted.
- ▶ **Play:** a scripted performance that involves assigning parts, memorizing a script and having multiple rehearsals prior to the performance.
- ▶ **Skit:** an unscripted dramatic performance that has a theme, and one or two rehearsals.
- ▶ **Role play:** an unscripted impromptu dramatic presentation where participants act the part they have been assigned.
- ▶ **Community theater:** a local non-professional theater group; may produce a wide variety of theater from skits to scripted, rehearsed productions.
- ▶ **Street theater:** usually a group of people who produce skits or plays with a theme, and perform them in public squares, parks or in the street.



- **Puppet show:** performances using puppets; could be plays, skits or role plays. Puppet shows are entertaining and very versatile.

ENVIRONMENTAL THEATER — CHINA —

It is easily more than 100 degrees here where I am sitting in the sun watching the final rehearsal of my students' environmental program. I am nervous because in only a short hour the audience will arrive. This is the grand finale to a three-week long intensive environment and theater class conducted in English. It is (as far as I know) the first of its kind to be taught in Sichuan Province and certainly the first of its kind to be taught in the city of Mianyang. It has generated so much interest locally that the TV station has done a short documentary about the class and the radio has interviewed us about the performance that will happen shortly. The students who have participated in the experiment were hand picked from the top juniors in Nanshan High School. They were selected for excellence in English, environmental science and a desire to be creative. For most of them, this is their first time performing in front of an audience. Three weeks ago, these same students were shy, nervous bookworms but the class has transformed them into confident, creative actors.



The idea for the class came about one cold afternoon in February when a good friend was visiting me during her vacation from school. She had been studying in Beijing for the last semester and wanted to return to China in the summer to do a project for her university. After talking for some time, it was agreed that we should create an environmental education theater class together. Our vision was to take a group of students and give them the knowledge and tools to make their own performance that would educate the community about various environmental issues in China. It seemed like an impossible goal. There were so many questions to be answered. As the spring progressed, the serious planning of the project began and all the details quickly fell into place.

Now it is a few months after the show and school is back in session. I have had a chance to meet again with several of the students from the summer class and honestly discuss what the class was like for them. It has been overwhelmingly positive. The students say their English fluency is much higher along with their grades; they are much more confident and willingly participate in class; and many say they want to study environment, biology or urban planning in university. They want to make a difference in the future of China.

— Environment Volunteer, China



EXPECTED OUTCOMES

Dramatic presentations are highly effective at raising awareness and can be used to increase knowledge or change attitudes. They are public entertainment and, as such, are useful at reaching wide audiences. They are also a great deal of fun and can be powerful team-builders.

EXAMPLES

Some examples of dramatic presentations used for environmental education:

- ▶ Earth Day parades
- ▶ Musical festivals using an environmental theme
- ▶ Puppet shows about endangered species, recycling, etc.
- ▶ Skits that demonstrate good/bad solid waste disposal
- ▶ Weekly story hour using books with environmental themes
- ▶ Story presentations about traditional uses of resources

HOW TO DO IT

Decide on an appropriate message for the target audience. Plan what you want to do, contact or recruit the performers and arrange a time and place for auditions and the performance. Verify that equipment functions well, such as microphones and lighting. Allow enough time to prepare any stages, floats, costumes, or other materials.

Allow enough time to rehearse. Rehearsing is a good idea, not only because all the participants get a chance to practice, but because participants will have suggestions for improvements. Rehearsals also let you know what equipment or how much space may be needed.

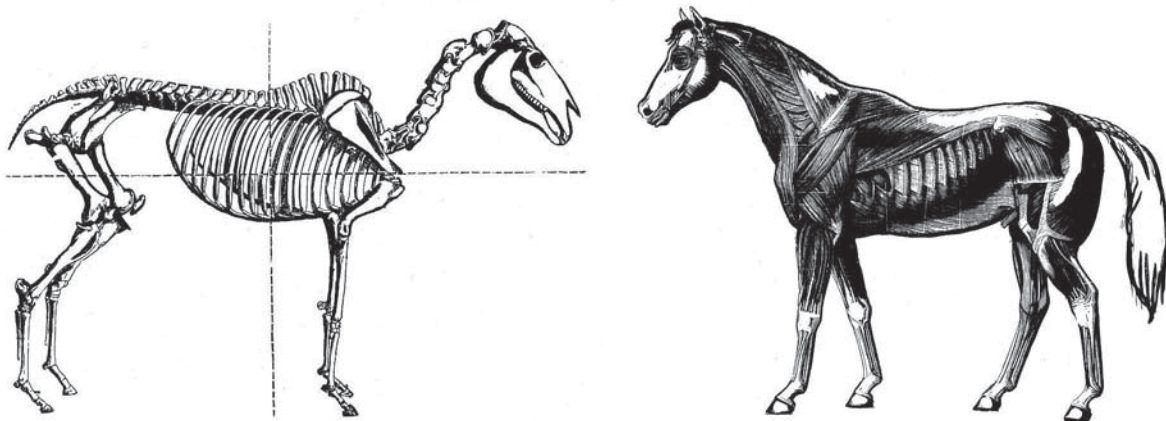



PUPPET THEATER



Puppet shows have universal appeal, and many cultures have a tradition of puppetry. Puppets can be people or animals and puppet shows can be on any topics. Puppets can be simply made or they can be quite elaborate. One advantage to puppet shows with environmental themes is that the puppets can broach controversial topics that people can't often discuss.

Puppets can be used as part of an interpretive talk or as part of a show. For example, a Canada goose puppet can speak for the geese about habitat, lifestyle, or migration patterns. The goose could also be the one to tell an audience about rules or expected behaviors. (It is often easier to deliver the rules with a puppet. People respond well to a puppet, but may respond with more resistance to a person delivering the same message.)

A puppet show would include two or more puppets and a story line about environmental themes such as habitat or the impact of human behavior. Or, they can be about related social issues such as land use decisions or hunting regulations. Often, slapstick is part of puppet shows.

Effective puppet shows are generally short (7–10 minutes), have a lot of action, and some dialogue. When planning a puppet script, base the cast on the people you have available. Tapes or radio can be used for sound effects. Use colorful cloth for the stage and paint plain cloth for backdrops. Expressive faces help establish puppets' personalities.

There are many types of puppets that can be used. Marionettes are puppets that are controlled by strings from above that move the head, arms and legs. Indonesian puppets are made of cut paper shapes and are controlled by sticks that are attached to the arms and legs of the puppets. The puppets are silhouetted on a screen with a light from behind. Hand puppets are made to fit over the puppeteer's hand. There may be rods attached to the hands or head of the puppets for more elaborate movement.

Puppets can be made from almost any material but the most common puppets are made from cloth. A wide variety of "found" materials can be used to make puppet faces, such as buttons, shells, yarn, beads or string. Puppet heads can be made of Styrofoam balls, wood, recycled plastic containers, stuffed socks, cardboard tubes or even vegetables.

The essence of a puppet stage is that the puppets will be seen but the puppeteers won't. Perform behind a simple stage built from light wood or cardboard. The puppeteers can be hidden by the panels forming the stage or by curtains.



RESOURCES

In some environmental education curricula, there are scripts for skits or suggestions for dramatic productions. Books or stories about environmental issues may be adapted to skits. An example of such a book is *The Lorax*, by Dr. Seuss.

There are quite a few tapes of environmental songs composed mostly for children. Check to find out if any are available to you.

Environmental Education in the Schools. Washington, DC: Peace Corps. [ICE No. M0044]
See the skit called "The Awful Eight" about air pollution, page 125.

Ham, Sam H., *Environmental Interpretation: A Practical Guide for People with Big Ideas and Small Budgets*. Golden, CO: Fulcrum Publishing, 1992. [ICE No. FC190]

Promoting Powerful People: A Process for Change. Washington, DC: Peace Corps. [ICE No. T0104]
pp. 249-258.

Web resources on making puppets:

<http://www.legendsandlore.com/sockpuppets.html>

<http://www.legendsandlore.com/puppet-resource.html>

<http://www.gis.net/~puppetco/>

<http://www.enchantedlearning.com/crafts/puppets/>

http://lala.essortment.com/childrenpuppets_rhws.htm

<http://www.newton.mec.edu/Angier/DimSum/Zodiac%20Puppet%20Lesson.html>

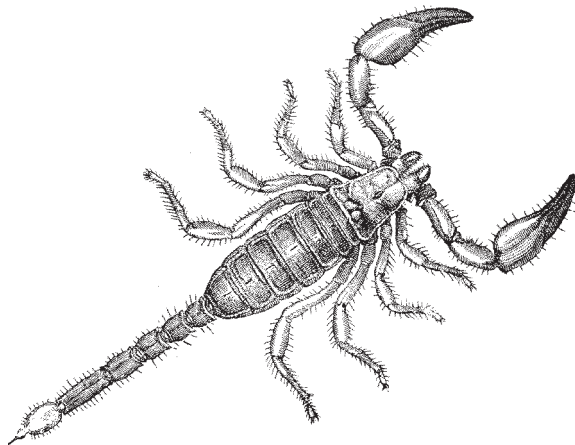



3 MEDIA CAMPAIGNS

DESCRIPTION

A media campaign is an effort to publicize ideas or events over a period of time. Media campaigns use radio, television, loudspeakers, the Internet, posters, flyers, newsletters or other printed materials to convey messages. To attract attention, the presentation of the message must be memorable but the content should be culturally appropriate and locally relevant. A media campaign spreads a message widely and often. It may include several types of media and/or several events, and use motivators such as prizes or recognition.



USES

Use media campaigns to announce events or educate. A media campaign is particularly useful for reaching large numbers of people.

Typically, mass media cover environmental events that are newsworthy. In some places, mass media are put to educational uses, especially when books and other educational materials are in short supply. Sometimes, radio or television stations are looking for local programming.

EXPECTED OUTCOMES

Generally media campaigns increase awareness and knowledge. A media campaign may change attitudes, and could increase participation by announcing events that bring people together to work on a specific task.

EXAMPLES

Environmental education can take place in the mass media in many forms:

- ▶ Weekly educational radio or television shows, or newspaper columns.
- ▶ One-time shows or articles.
- ▶ Newspaper columns or radio shows that feature a particular species or topic of interest, such as how to grow an herb garden.
- ▶ Radio or TV shows that highlight a demonstration project.
- ▶ Panel discussions (e.g., the best methods for reforestation or fisheries management).



- ▶ Contests or puzzles in newspapers that highlight environmental awareness or knowledge.
- ▶ Announcements of upcoming events, meetings or trainings.
- ▶ Recognition of community members for projects or achievements.
- ▶ Endorsements by local leaders of projects or programs.
- ▶ Interviews with local leaders, experts or people who have made a notable achievement.
- ▶ School programs.

The Internet has become a valuable tool for reaching people through websites and e-mail, but the target audience has to have access to computers and the ability and language skill to use them.

While print media, such as flyers, posters, coloring books, comic books, story books or giveaways with logos (like pencils with an environmental slogan on them) can be useful tools for environmental education, they must be designed and produced, and that can take time and money. However, print materials can often be reused and some print materials can be sold to raise money.



HOW TO DO IT

In designing a media campaign, think about how the audience will respond. Using phrases and idioms that are familiar to your audience will make your campaign more attractive. Likewise, use voices that the listeners trust. For example, if you are making a radio spot to ask farmers to use organic methods, use the voices of farmers who have tried the methods.

Each radio spot, flyer, TV promotional or newspaper article should focus on a single action or announcement. Radio and TV spots should be succinct and repeat the message at least twice. Radio and TV spots or programs are more effective if they sound natural and spontaneous, and they make people feel happy, confident or excited.

Involve community members in all phases to make it culturally appropriate and locally relevant. To learn the skills used to create the campaigns, community members should work as counterparts on all steps. There is the danger that media-savvy Volunteers can end up implementing a media campaign that locals are unable to duplicate.

Evaluate your media campaign after it has run for a while. Survey people to find out how many people have seen or heard the effort and what they have learned from it. If your goal is to change behavior, develop an assessment that will show if behavior has changed and how. You may want to develop a pre-campaign assessment for the target behavior, so that you can assess change after the campaign. For example, if you are going to launch a litter clean up campaign, think of some way to measure litter so that you can assess change. Take photographs around the community before and after the campaign. Collect all the litter along a 500-foot stretch of a public thoroughfare before and after to quantify change.

RESOURCES

Ham, Sam H., *Environmental Interpretation: A Practical Guide for People with Big Ideas and Small Budgets*. Golden, CO: Fulcrum Publishing, 1992. [ICE No. FC190]

Oberbillig, Deborah Richie, *Providing Positive Wildlife Viewing Experiences: A Practical Handbook*. Watchable Wildlife Incorporated, April 2001.

Promoting Powerful People. Washington, DC: Peace Corps. [ICE No. T0104] See “Developing and Using Locally Recorded Materials” p. 234-245.

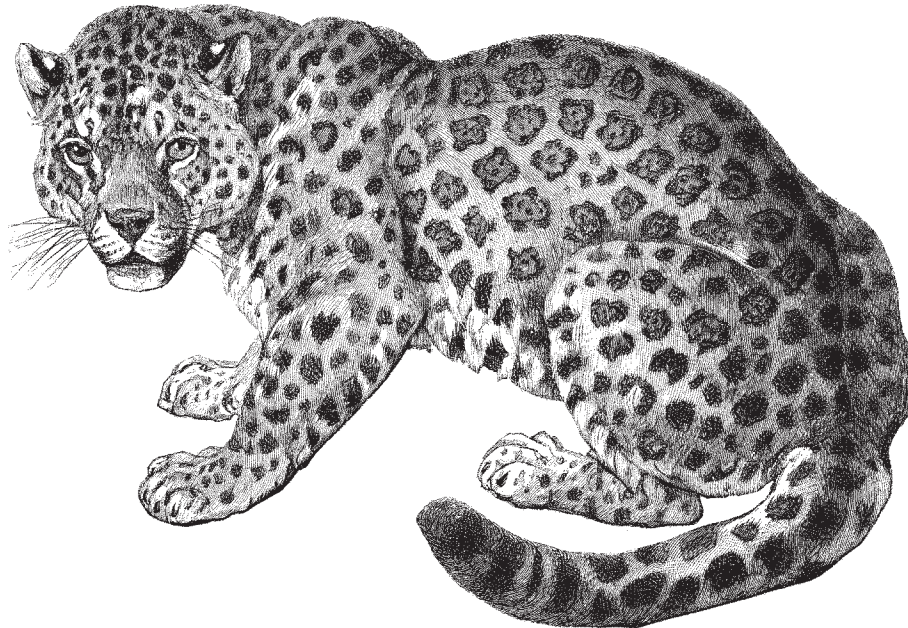



4 SPECIAL EVENTS

DESCRIPTION

Annual holidays or other special days are opportunities for environmental education. Most communities have annual days that celebrate historical events, honor famous people, or commemorate events on a local or national level.



EARTH DAY CELEBRATION — SLOVAKIA —

One Volunteer served in the protected area in central Slovakia and facilitated the cooperation among various local environmental NGOs. During the first year at her site, the Volunteer organized an Earth Day celebration to foster cooperation among the staff at the protected area, local schools, local government and NGOs. The first celebration took place with the support of a Small Projects Assistance (SPA) grant, and involved an eco-parade, natural crafts, production of post cards, tree planting, an eco-theater, an art contest and presentations/discussions of environmental problems. All agreed that Earth Day was a success and it was repeated the following year.



The following year, four local NGOs and 14 schools planned the Earth Day celebration. A planning committee began meeting well in advance of Earth Day, with representatives from each NGO and school contributing ideas for the overall plan. Eventually, the Volunteer served as a facilitator rather than the lead organizer. Part of the celebration was financed with proceeds from the previous year, and donations were solicited from local sponsors. The NGO community in the area prepared an advertising and fund-raising campaign. The program consisted of grammar school presentations in the morning, information booths on environmental topics during the day, and a town-square clean up in the evening, accompanied by live music. There were advertisements in the papers asking people to ride bikes or walk to work throughout the week in order to show that Earth Day is every day, not just one day of the year.

USES

Often special events take the form of parades or fairs. People participate by being part of the parade, acting in a performance or setting up an informational table or booth. An organization increases its visibility by sponsoring an activity.



EXPECTED

OUTCOMES

Special events are opportunities to increase visibility, recruit people to your cause or facilitate an educational activity.

EXAMPLES

Some international holidays that are especially appropriate:

- ▶ World Environment Day – 5 June
- ▶ Earth Day – 22 April
- ▶ World Water Day*
- ▶ Plant for the Planet tree planting campaign*
- ▶ Africa Environment Day – 3 March
- ▶ Clean Up the World Campaign*
- ▶ Arbor Day*

*These days have variable dates. Some vary by location, such as Arbor Day, while others change each year. Check the U.N. Environment Programme for details at: www.unep.org.

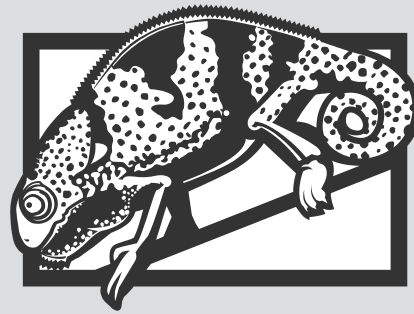

FESTIVALS

– MADAGASCAR –

A Volunteer and an agent of a local wildlife preservation trust put together a series of community festivals that focused on developing and sharing messages about the environment and local culture. First, they held two environmental education teacher trainings with local teachers spaced several months apart. This was done with the help of the Ministry of Education and World Wildlife Fund.

At the second teacher training, the Volunteer and her counterpart introduced the idea of the festivals and final competition. Twelve different communities had a school participating in the series of festivals.



Each school prepared a presentation that contained an environmental message and included an element of the local culture (myth, lore, music, dance, etc.). The Volunteer and her counterpart visited each town to assist teachers with program planning. On the day of the festival, a panel judged the presentations. Later, the winners went to the regional capital to compete with the other villages as part of the World Environment Day. Villages were encouraged to make a festival out of the presentations to ensure participation and increase the number of people hearing the messages.



PARADE OF THE SPECIES — ROMANIA —

“...the species parade was an unexpected success, with 50 percent more than expected attendance and perfect weather. It promoted collaboration among local governments, NGOs, schools and other community groups.”

One Volunteer developed a species parade activity for Earth Day that informed and educated school-aged children and the public on the importance of preserving biodiversity. The activity raised awareness about the importance of maintaining a conscious respect for the environment in the community’s everyday behavior. As part of her preparations, the Volunteer trained a community group on conducting environmental education and producing a large-scale community event. She also provided instructional materials. The participants in the species parade learned about the environmental implications of their everyday actions. They worked together as a team to construct art, music and dance creations for the event. Instructors guided them in channeling their creativity by using recycled materials, thus demonstrating conservation principles in using materials normally discarded in the community.

HOW TO DO IT

Your participation in a special event depends on the community and how they celebrate events. Below are some ideas for community participation.

Parades

- ▶ Make a float
- ▶ March in costume
- ▶ Carry a banner
- ▶ Perform (e.g., drill team, band, dance)

Fairs

- ▶ Informational booth
- ▶ Food booth
- ▶ Environmental activity (e.g., ecosystem mural)
- ▶ Forest crafts sale booth
- ▶ Demonstration project (e.g., composting)
- ▶ Organic or medicinal food products
- ▶ Sponsor trash cans or recycling bins

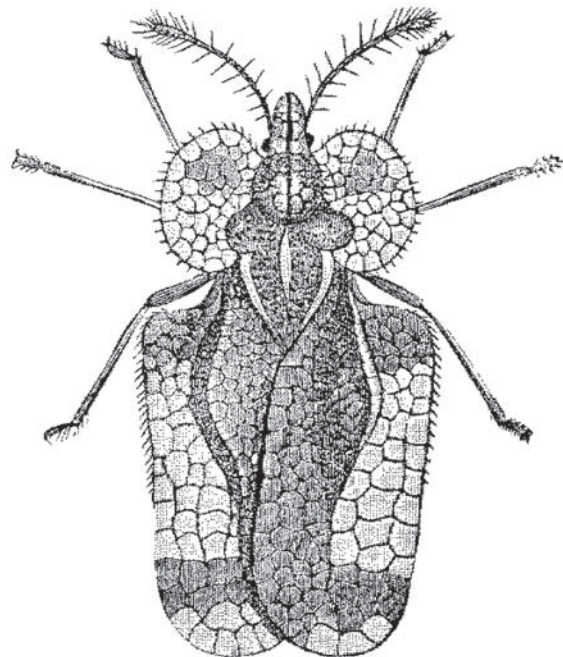



RESOURCES

Ham, Sam H., *Environmental Interpretation: A Practical Guide for People with Big Ideas and Small Budgets*. Golden, CO: Fulcrum Publishing, 1992. [ICE No. FC190]

Earth Day Network – current campaigns, programs and events
www.earthday.net

National Arbor Day Foundation
www.arborday.org

United Nations Environment Programme – World Environment Day ideas and themes as well as information about other celebrations
www.unep.org

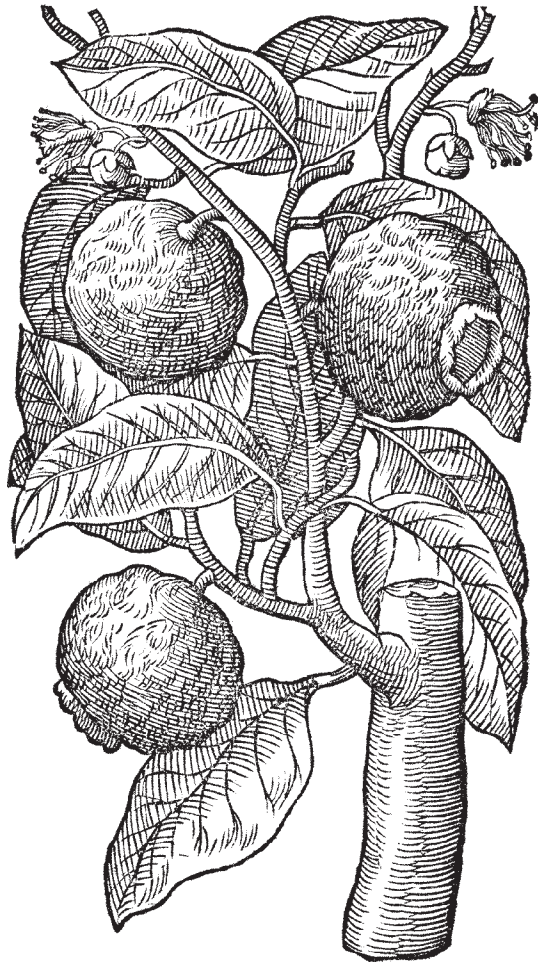



5 SCIENCE AND ECO-FAIRS AND FAMILY NIGHTS

DESCRIPTION

A science fair, eco-fair, or family night is an event that highlights environmental events, projects or products produced by local people. Like a state fair that highlights farm products, a science or eco-fair highlights science projects or ecological projects. A family night is a time when children conduct fun, educational activities and invite their families to participate.



USES

Science or eco-fairs effectively recognize and publicize work that students or other groups have been doing. Fairs are also useful to showcase locally produced products like organically grown vegetables or forest product crafts. Science and eco-fairs usually contain experiments, demonstrations or collections.

Family nights allow children to demonstrate their knowledge to parents and other community members. The events recognize the work of the children and raise the awareness or knowledge of the community members.

ECO-FAIR — HONDURAS —



Eight local agencies, in collaboration with Volunteers, organized the first Agricultural and Ecological Fair for a community. This three-day-long event included activities such as ecological parades, clean up campaigns, music and theater festivals, folk music presentations, organic production technical talks, sports competitions for youth and adults, dances, community exchange, educational trail walks, display booths of organic agriculture products, educational booths that provided information regarding host country agencies' (HCAs) work, and disaster preparedness

and mitigation. All these events were coordinated with local agencies and economically supported by the HCAs participating in the event. Thousands of participants came and state government officials actively participated.

As a result of this event, one of the Volunteers supported another regional Agriculture and Environmental Fair in the state capital. Farmers benefited directly, because they were trained and invited to participate in the booths delivering informal sessions to share their experiences. The host country agency, along with the Volunteer, developed a concrete follow-up plan to support farmers who participated and/or were trained during this event.



EXPECTED OUTCOMES

The two main advantages to fairs and family nights are that children learn a great deal about environmental issues by doing their projects; and visitors learn by observing the exhibits. An added benefit is that families become increasingly involved in their children's education.

EXAMPLES

Fairs and family nights can feature exhibits that demonstrate environmental principles or methods, such as recycling, composting, or make-and-take workshops (e.g., construct planters and take them home). Science or eco-fairs can show comparisons of products (e.g., which soap cleans the best or which fertilizer shows the greatest growth), demonstrations of methods (e.g., terracing, irrigation, replanting, etc.) or the results of scientific tests.

HOW TO DO IT

Fairs and family nights require significant advance planning. If you are planning a science fair for children, it will probably take a month or more to teach and conduct an experiment or demonstration. If you want to showcase existing community projects, participants will need enough advance warning to grow or prepare the items to be shown. Family nights may require less time if children are demonstrating concepts you have taught them. For example, if your students have been studying water quality, students could demonstrate the methods for testing water (acidity, dissolved oxygen, turbidity, etc.). Or a station might include a student showing adults how to do a soil nitrate test or how to identify medicinal plants.

Depending on what you are showcasing, you will need tables, stalls, pens or cages. Plan for the amount of space necessary to display the items so that all the visitors can see them without crowding. Decide what kinds of signs or instructions you will need to display.

RESOURCES

Use the keywords "science fair" to search the Teachers First website for information on how to plan and conduct a science fair. www.TeachersFirst.com

Other websites with science fair information are:

- ▶ National Science Teachers Association:
www.nsta.org
- ▶ Virtual Library of Science Fairs:
www.physics.usc.edu/~gould/ScienceFairs
- ▶ Internet Public Library:
www.ipl.org

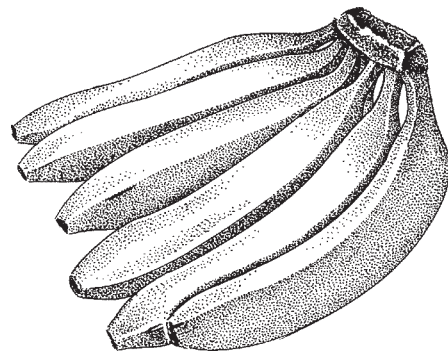



6 SIMULATIONS

DESCRIPTION

A simulation attempts to teach a principle by involving people in an activity that mimics the principle. You may be familiar with *Barnga*, a game used during pre-service training that teaches Volunteers about cultural differences by simulating the effect of cultural differences on human interaction. Players undergo a mini culture shock similar to actual experiences when entering a new culture. The players find they do not know the rules of the card game, but still must try to figure out how to play. It simulates the entry of people into a new culture where they don't know the rules and must figure them out.



Environmental simulations usually simulate some biological system or a public process. “The Commons Dilemma” from *Environmental Education in the Schools* highlights the problem of population growth and resource availability.

USES

Simulations are useful for teaching about complex principles or situations with many variables such as population dynamics or human water use. By involving people in an activity, they learn the dynamics of the situation better than if they were simply told.

EXPECTED OUTCOMES

Participants will be able to discuss complex ecological principles or environmental dilemmas.

EXAMPLES

Simulations are used to communicate concepts about many complex ecological principles, such as:

- ▶ Population dynamics
- ▶ Interdependence
- ▶ Animal behaviors
- ▶ Community issues
- ▶ Public processes for dealing with environmental issues





Some simulations available in Peace Corps' publications are:

“The Commons Dilemma” in *Environmental Education in the Schools*

“Key Mangrove” in *Environmental Education in the Schools*

“Mining the Moon” in *Environmental Education in the Schools*

HOW TO DO IT

Simulations are common in environmental education curricula, but you can also make your own to demonstrate a particular principle. You can find an appropriate simulation in an environmental curriculum that you can use or find a related simulation and adapt it to your needs. For curricula and a resource on adapting activities, see Resources at the end of this section.

Tips on creating simulations:

- ▶ Choose the concept or principle you want your audience to understand.

In the example “A Steppe in Time” below: How did farming affect the water and biodiversity around the Aral Sea in Kazakhstan?

- ▶ Decide the most important parts of the concept to simulate.

Interdependence of animals and farmers on water and land availability

Water and space as limiting factors

Impact of seasonal change, erosion, water use by wheat versus cotton, growth of cities, prices of crops, use of pesticides and accidents

Historical accuracy (Virgin Lands policy in former Soviet Union)

- ▶ Imagine a simple way to demonstrate the ideas. Often you can use common children's sports and games as models. The various forms of tag, Mother May I, card games (Old Maid, Concentration/Memory) or baseball are examples of sports and games that can be modified for use in simulations.

In this simulation, space is important, so desks were chosen to simulate finite space. Limited water resources became a limited number of cards that recycle, like water. Students represented the farmers and the animals. Change over time is shown through successive rounds of play. Historical political decisions, weather and erosion are represented on situation cards. Rules define parameters and control variables.

- ▶ Practice the simulation to find out if it will work. Do a dry run to make sure your numbers will work, the rules will work, and the simulation will go smoothly.
- ▶ Build in a discussion at the end so participants can process the ideas and deliver feedback.



When creating a simulation, it is important to control variables, that is, make sure you don't have too many things going on so that the point gets lost. The strong point of simulations is that they can demonstrate complex ecological principles that are very difficult to show in real life situations. The weak point is that they need to be designed carefully to isolate the desired principle without being confused by extraneous variables. Also, participants can get caught up in the fun of the simulation and lose the point, so it is important to design in a piece that checks for understanding.

– Simulation – A STEPPE IN TIME

Arrange a classroom such that the desks and tables become nine parcels of land, one of which is the Aral Sea. Students should then draw character cards to become two wheat farmers, one cotton farmer, three fish, three sheep, two saiga antelope, two birds, two wolves and two deer. Students who drew animal cards should choose one of the eight parcels of land to inhabit (maximum of four animals per parcel).

The Aral Sea receives 70 (out of 150) water cards; all fish live there. Each parcel begins the game with three water cards. Every parcel receives annual rain and all people and animals use water. Years are represented by rounds of the simulation. Situations are represented by cards.

RULES:

1. Every year it will rain three water cards per land area and five to the sea.
2. Fish have to pay five water cards per year to live.
3. Animals have to pay one water card per year to live.
4. No more than four animals may occupy an area at one time.
5. Wheat farmers need four water cards per year to operate.
6. Cotton farmers need six water cards per year to operate.
7. Farmers may farm an area for two years. After this, the area must remain fallow for one year (indicated by fallow card).
8. Fallow land receives rainfall, but may not be used by animals or farmers.
9. When a farmer takes over, animals must find another home, one that is not fallow or urban.
10. If a farmer leaves the game, his land becomes available to other animals or farmers.
11. If farmers need more water, they must first get it from the sea. If the sea dries up, farmers may then draw from adjoining land.
12. When crop prices fall, land must remain fallow for one year.
13. In the event that all of the fish in the Aral Sea die, another fish may be added when the sea again has 25 water cards; thereafter for each multiple of 25 water cards, add an additional fish (25, 50, 75, etc.).





PLAYING CARDS:

You will need to create playing cards according to the following charts for use with this game. Situation and character cards may be adapted for relevance to your particular environment.

SITUATION CARDS

Number of cards	Text of Card
2	Very rainy year. Steppe floods. <i>(Two extra water cards at three adjoining desks.)</i>
2	Hot, dry year. Drought. <i>(Only one water card per desk this year. Two go into the sea.)</i>
1	Urban Sprawl <i>(Desk is out of the game; it cannot ever be used.)</i>
1	Price of wheat drops. <i>(No wheat farms this year.)</i>
1	Price of cotton drops. <i>(No cotton farms this year.)</i>
1	Irrigation pipes burst spilling water. <i>(Six extra water cards here; no new water at adjacent desks.)</i>
1	Wind erosion ruins one wheat farm. <i>(Must remain fallow for three years.)</i>
1	Pesticides and chemicals used on the cotton fields spill into the sea. <i>(Remove five water cards from the sea.)</i>
1	Government opens land for agricultural development. <i>(One new wheat farm added.)</i>
1	Harsh winter weather. <i>(Animals at this desk perish.)</i>

CHARACTER CARDS

Number of cards	Text of Card
3	Wheat farmers <i>(One card reserved for related situation card.)</i>
1	Cotton farmer
3	Fish
3	Sheep
2	Saiga antelope
2	Birds
2	Wolves
2	Deer

WATER CARDS

Number of cards	Text of Card
100	Water
10	Water x 5





GENERAL ORDER OF STEPS EACH YEAR

Step Number	Action
1	Draw situation card (<i>Follow instructions on card.</i>)
2	Receive rainfall. (<i>Three cards to land parcels, five to sea.</i>)
3	Animals migrate if necessary.
4	Pay water usage. (<i>One per animal, five per fish, four per wheat farmer, six per cotton farmer.</i>)
5	Discuss what has occurred during round.
6	Record information on chart (<i># of water cards in sea, # of animals, # of fish</i>)
7	Begin next round.

(Remember that one year = one round.)

ROUNDS:

- 1. Year One:** All desks have three water cards. All animals are in place. All animals must pay the water they have used (one water card). If there are no water cards, they must move or die. Make a chart showing the number of water cards in the Aral Sea, the number of animals and the number of fish for each year. Enter the starting numbers.
- 2. Year Two:** Pass out three water cards per desk (rain) and five to the lake. Analyze. Does anyone have to move? Pay water cards. Enter new information on chart.
- 3. Year Three:** Pass out water cards (rain). The government has decided to open up this area for agricultural development. They want to open it first to wheat farmers. Wheat farmers choose a land area to farm for two years. Does anyone have to move? All animals and farmers pay up water cards. Enter new information on chart.
- 4. Year Four:** Pass out water cards (rain). Since the wheat farming appears successful, the government is now opening the land to cotton farmers. Cotton farmers choose sites. Do any animals have to move? Wheat farmers are on their second year. All animals and farmers pay up water cards. Enter new information on chart.
- 5. All subsequent years:** Choose situation card and act accordingly. Pass out water cards. Do any farmers need to let land lay fallow and find new land? Do any animals need to move? Analyze what is happening in each round. All animals and farmers pay up water cards. Enter new information on chart. Are there any trends? What might need to be done?

DRAWING CONCLUSIONS

At the end, analyze what happened with the group and discuss what could have changed. Follow up with a discussion about making another simulation for another situation. What factors would have to be considered? Who and what would be impacted?



SUGGESTED DIALOGUE QUESTIONS: *(Please feel free to create your own.)*

- What is the relationship among water availability, agriculture, and animal biodiversity represented in this game?
- What happened to the amount of water in the lake after farms were established?
- Did the introduction of farms upset the natural balance (supply/demand) of water?
- In what ways could farmers reduce their impact on the natural environment?
 - Could/should the government have fostered a more environmentally sustainable method of introducing agriculture into this environment?
 - What factors need to be considered (e.g., type of crop, maximum number of players water system able to support, environmentally friendly farming practices, type of ecosystem, etc.)?
- How does this game represent the reality of your particular situation?

From "A Steppe in Time" by Rob Mocsarsky and Anja Pearson, Kaz 7, 1999. Personal communication.

RESOURCES

Environmental Education in the Schools. Washington, DC: Peace Corps. [ICE No. M0044] See page 125.

Windows on the Wild: Biodiversity Basics—An Educator's Guide to Exploring the Web of Life. Tustin, CA: Acorn Publishing, 1999. [ICE No. FC258]

Ham, Sam H., *Environmental Interpretation: A Practical Guide for People with Big Ideas and Small Budgets.* Golden, CO: Fulcrum Publishing, 1992. [ICE No. FC190]

Adapting Environmental Education Materials. Washington, DC: Peace Corps. [ICE No. M0059]

Project Wet (Water Education for Teachers): K-12 Curriculum and Activity Guide. The Watercourse and the Council for Environmental Education, 1995. [ICE No. E0333d]

Project Learning Tree: Environmental Education Pre K-8 Activity Guide. American Forest Foundation, 1995. [ICE No. E0330]

Thiagarajan, Sivasailam, and Steinwachs, Barbara. *Barnaga.* Yarmouth, Maine: Intercultural Press Inc., 1990. [ICE No. TR098]





7 INTERNATIONAL PROGRAMS

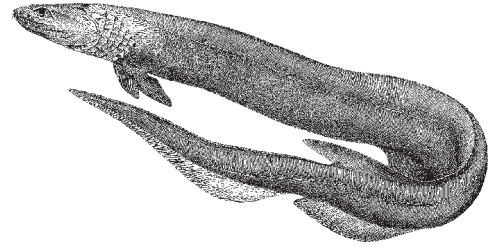

DESCRIPTION

International programs are environmental programs that community members can participate in on an international or local level. Four are listed below, but there are many more that Volunteers have collaborated on effectively.

USES

These programs are useful because you can use their program designs and apply them to your own activities. Participation in international programs can contribute to international scientific databases.

EXPECTED OUTCOMES

International programs allow communities to learn about other parts of the world. They may enable communication with other communities that are dealing with similar issues.

EXAMPLES

- ▶ **Adopt-a-Stream:** Adopt-a-stream programs are environmental education and habitat restoration programs based on stream monitoring. They were started by the Adopt-A-Stream Foundation (www.streamkeeper.org) in 1981. Adopting a stream means that people provide long-term care of a stream by establishing stream monitoring, restoration, and environmental education. It means testing for water characteristics and quality, monitoring fish populations or other important populations, restoring habitat, providing environmental interpretation and education to the public. Water quality monitoring is done on a regular basis and long term data are kept to assess changes. Habitat restoration and environmental education can be undertaken, as well.

This idea can be applied to other critical environmental areas, such as watersheds, forests, lakes, reefs, or rangelands. The interested group decides what area they will monitor, and then determines what types of data will tell them about the health of that area. With streams and other water bodies, data taken include turbidity (clarity of water), temperature, flow rate, acidity, dissolved oxygen, alkalinity, conductivity and indicator species populations. For descriptions of how to do these measurements using methods that require little or no technological equipment, see the “Water Sampling Equipment” section later in this chapter.

- ▶ **Global Learning to Benefit the Environment (GLOBE):** GLOBE is a coalition of scientists and students who are collecting data on earth systems. Data are collected in atmospherics, hydrology, soils, land cover, and earth systems. GLOBE teachers receive training in how to collect the data according to international scientific protocols. The data is then submitted to a database that both scientists and students access. GLOBE is available in those Peace Corps countries that have an official government agreement with this agency and have a country



coordinator in charge of training. Check the website to find out if there is a GLOBE program in your country. For more information see: www.globe.gov.

► **Journey North:** Journey North is a web-based program that brings together students and scientists to study migrations and seasonal change. Students track migrations and seasonal changes and compare their data with students from other places. Most participants are in North America, but every year Journey North seeks people from places all over the world for a project called Mystery Class. Mystery classes submit sunrise and sunset data over the course of the spring, and students try to identify the exact location of the mystery class. For more information see: www.learner.org/jnorth.

► **Birdathons:** Many organizations sponsor birdathons. Birdathons are a fun way of collecting data about bird populations. Often they are organized during migrations in an effort to understand complex migratory patterns and document species and numbers. Ideally, they are an annual event that produces long-term data.

A birdathon may be a school event during Earth Day or Wildlife Week celebrations, or a community event. A birdathon may be a competitive activity, used as a fundraiser, where teams of people try to find as many species of birds as they can in a 24-hour period. Usually, birdathons are held during spring migration to maximize the numbers of possible species. Serious competitors seek out potential “hot spots” prior to the birdathon day so they can have the winning number of species. The data collected can be used to establish which birds are in an area, and if there are any noticeable changes in species.

You can participate in a formal birdathon, or set up your own local event. To create your own, you need to decide on a time, and publicize the event. You will probably need to find a local bird book. You may need to help participants learn to identify local birds. Participants do not need to be bird experts to participate. You may want to have categories of participants – expert, novice, youth, or family. During the 24-hour period, participants look for birds in a specified area, and keep a list of species. At the end of the period, lists are compared. If there is a bird list for the area, it can be used as a resource. If not, your participants can start a bird list for the area.



BIRDATHONS

For more information about birdathons:

- Bird Studies Canada
www.bsc-eoc.org/brdathon.html
- SEEDS Foundation
www.greenschools.ca/seeds/May/Maystart.html
- Point Reyes Bird Observatory
www.prbo.org
- American Birding Association helps schools organize youth birdquests
www.americanbirding.org/ygbqstann.htm
- National Audubon Society
www.audubon.org/sa/birdathon
- Cornell Lab of Ornithology
www.ornith.cornell.edu
- Journey North
www.learner.org/jnorth
- Partners in Flight
www.PartnersInFlight.org/





8 ENDANGERED SPECIES PROJECTS

DESCRIPTION

Many endangered or threatened species are fascinating animals that can be used by environmental educators to attract people to their programs. These programs can raise awareness and knowledge, and change behavior.

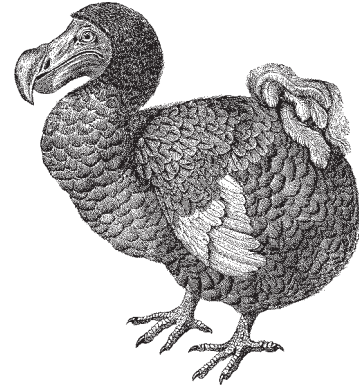

USES

Activities about threatened and endangered species increase awareness of the fragility of plant and animal populations. Participants gain knowledge about the species in their area and look at actions currently being taken to protect the species. They may also explore ways in which their behavior affects these species, for good or ill. By extension, they learn how their behavior affects all the species around them.

EXPECTED OUTCOMES

Participants understand concepts such as threatened, endangered and extinct. Participants identify threatened or endangered species in their region and discuss appropriate actions to protect these species.

EXAMPLES

Most environmental education curricula have activities about endangered and threatened species. In “Endangered Species Gallery Walk” from *Windows on the Wild*, participants research an endangered species and create a poster about that species. The posters are then displayed for others to see.

HOW TO DO IT

There are many ways of approaching the topic of endangered species. Listed here are some topics related to endangered species that could be used:

- ▶ Populations and population dynamics
- ▶ Habitat and habitat depletion
- ▶ Individual species adaptations, and how those adaptations can help or hurt the species
- ▶ How species adapt to climate change (or don't)
- ▶ How humans can threaten a species, and how populations can be returned to a healthy level



- ▶ Studies of specific cases of how animals became threatened, endangered or extinct, or how they were saved from extinction
- ▶ The role of food chains in animal population levels

Community projects about endangered or threatened species:

▶ Fact Finding

- Survey to determine the status of a species population, and any threats to its survival
- Long-term ecological study to identify the species' requirements, the factors limiting its population growth, and the relationship between the species and the local human population
- Ascertain the legal and enforcement situation

▶ Propose action

- To acquire land as a reserve
- To promote the formation by a government or other appropriate agency of a national park or nature preserve
- To establish a research foundation possibly within an existing organization (such as a university) that will focus scientific attention on the species concerned
- To create a continuing scientific presence by any other means
- To promote a program of captive propagation or translocation
- To offer bounties for successful rearing of young (chiefly applicable to birds)
- To control feral animal species or introduced animal species
- To increase food supply or living space



▶ Use of influence

- To persuade someone of importance to write a personal or official letter
- To send a high-level mission to confer with the heads of governments or ministers concerned
- To promote a local meeting on the subject
- To promote a resolution or recommendation at a conference
- To secure recognition in high places by some other means



► Publicity

- To promote a publicity campaign
- To propose the adoption by a group (e.g., city, school) of the species or project
- To promote the program of long-term education

► Finding

- To seek financial aid from an individual or organization that may be linked with the species or project
- To get help in-kind from industry or commerce
- To obtain the services of people able to give practical help

RESOURCES

The International Union for Conservation of Nature and Natural Resources (IUCN) maintains a database of endangered and threatened species called the Red List. Periodically a Red Book of endangered and threatened species is published. Often these Red Books (or Red Data Books) are for a particular region. They may be published by IUCN, or by governments or other organizations. Check libraries, particularly U.N. libraries, for Red Books for your region. See the IUCN website: www.redlist.org.

Publications having activities about endangered or threatened species include:

Windows on the Wild: Biodiversity Basics—An Educator's Guide to Exploring the Web of Life. Tustin, CA: Acorn Publishing, 1999. [ICE No. FC258]

Environmental Education in the Schools. Washington, DC: Peace Corps. [ICE No. M0044]

Endangered Species: Wild and Rare. Ranger Rick's Nature Scope, Vol. No. 3, 1989.

Project Wet (Water Education for Teachers): K-12 Curriculum and Activity Guide. The Watercourse and the Council for Environmental Education, 1995. [ICE No. E0333d]

Project Learning Tree: Environmental Education Pre K-8 Activity Guide. American Forest Foundation, 1995. [ICE No. E0330]



9 AGRICULTURE

DESCRIPTION

Agriculture Volunteers may be working with groups or individuals, in a center or in the field. Delivery of environmental education programs will depend on your working circumstances.

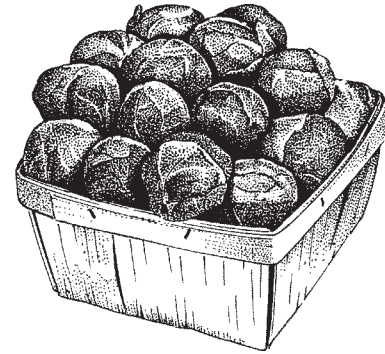

USES

Environmental education in agricultural settings may focus on identifying, analyzing and offering solutions for a wide variety of crop, livestock, or soil issues. Or it may be more narrowly focused on a single area such as fish farming, coffee growing or community forestry.

EXPECTED OUTCOMES

Agricultural environmental education is directed at farmers and groups that produce agricultural products. The expected outcome is that by adopting more environmentally friendly practices, the agricultural sector will become more ecologically sustainable.

EXAMPLES

Agricultural environmental education topics may include:

- ▶ Crops – new varieties, fertilizers, pesticides, treatment methods, rotation, intercropping
- ▶ Forests – conservation, thinning, propagation, logging methods, reforestation
- ▶ Livestock – varieties, feeding, rearing, fodder crops
- ▶ Grazing – enclosures to keep animals out in order to identify the effects of animals on plants and types of feed
- ▶ Water treatment
- ▶ Solid waste treatment
- ▶ Developing environmentally-friendly practices
- ▶ Analyzing costs and benefits of alternative agricultural practices
- ▶ Soil quality and crop growth
- ▶ Causes, consequences, and control of erosion



- ▶ Appropriate use of fertilizers and pesticides
- ▶ Soil improvement
- ▶ Fish farming/aquaculture/coral reef management
- ▶ Watershed management
- ▶ Alternative and organic farming methods
- ▶ Nutrient value of crops
- ▶ Irrigation systems
- ▶ Marketing products
- ▶ Developing value-added products using agricultural resources, such as fruit processing, nature tourism, handicrafts organic products, or recycling

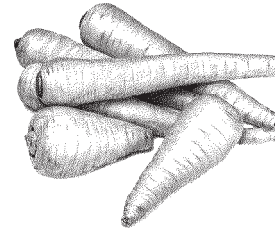

ORGANIC FARMING WITH WOMEN'S GROUPS — BOLIVIA —



A Volunteer in Bolivia worked with three women's groups in three separate communities. She worked with approximately 150 producers to implement organic farming practices and established three experimental agricultural plots to demonstrate sustainable farming practices.

The Volunteer worked to educate the local women on the benefits of organic farming, as well as the economic advantages created through such practices. In addition to garlic, the women harvested broad beans, mustard, quinoa, peas, and chamomile in the plots as part of a five-year rotation plan. Participation has been between 95–99 percent, with the women doing all of the organizing in their communities. The women plan to start an educational program on sustainable farming techniques using their plots as demonstration models.

In addition, the Volunteer also worked with the local growers' association to negotiate better prices for their products and promoted membership in the association to a variety of local producers. She has also educated farmers in several communities in greenhouse construction, production, and maintenance as a nutritional and economic alternative.

HOW TO DO IT

The techniques used will vary depending on your situation. Demonstration projects show community members what can happen if a particular method, technique, or technology is applied to a given circumstance. Usually demonstration projects use a small area to demonstrate or test an environmental management idea.



AGRICULTURE — NICARAGUA —

A Volunteer in Nicaragua was assigned to an agricultural program in a tiny community of the central-north region of Nicaragua. The program promoted sustainable agricultural practices, including contour cultivation, live barriers, soil conservation practices, and farm diversification. Although the community was quite accepting of the Volunteer, they were not quite as open to implementing new production practices.



After a few months of agricultural technical demonstrations with no interest or response from the community, the Volunteer and his counterpart decided to start working with the next community. There they found a disabled farmer with a keen interest in new methods. They established a successful two-by-two meter organic vegetable garden for family consumption. They grew radishes, carrots, tomatoes, basil, and cabbage. The experience was positive and translated into new ideas from the farmer, who wanted to grow vegetables for marketing.

Over the course of two years they established 0.34 hectare of cabbage and sold them very cheaply to the other community members, and 1.02 hectares of tomatoes for marketing purposes outside of the community.

GARDENING — GUATEMALA —

An agriculture Volunteer worked with a local farming association in a mainly coffee-growing community in the department of Zacapa. After her first trip to the market it was apparent that although the climate and soils were perfect for growing most vegetables, the people in town paid extremely high prices for vegetables that were brought 12 hours from the other side of the country. The Volunteer formed a group of eight women that had an interest in making a group garden in one of the small villages surrounding the department center. Together they used soil conservation techniques to make garden beds on a sloping hill, planted and harvested a variety of vegetables, and planted again with other vegetables. All of the gardens were managed organically.



RESOURCES

Nonformal Education Manual. Washington, DC: Peace Corps. [ICE No. M0042]

Refer to the ICE Catalog and the Peace Corps' Online Library for resources recommended for agriculture projects.





10 PARKS, PRESERVES, PROTECTED AREAS AND BUFFER ZONES

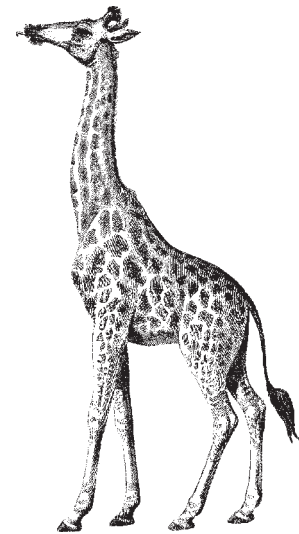

DESCRIPTION

There are two important components to working with parks and preserves: creating educational programs for visitors, park staff or people who use the resources of the park for subsistence or commercial purposes, as well as developing programs for the communities impacted by the park or buffer zones.

USES

Parks, preserves and protected areas often surround or are near communities, and the communities are impacted by the uses and regulations of the park. These communities are impacted economically as well, both positively and negatively. Perhaps the park brings visitors that generate income for the community. Perhaps the park does not allow certain traditional practices, such as hunting, that negatively impact the livelihood of the community members.

The boundaries of the park may be unclear, which means the boundaries of the buffer zone community are equally unclear. This can make it difficult for buffer-zone community members to know how and where they can use resources. Similarly, regulations and laws may either be unclear to community members, or conflict with traditional practices or cultural norms. Access to park resources by community members may be in question. There may be questions of enforcement of park regulations.

EXPECTED OUTCOMES

Generally, park visitors already value protected areas, but may or may not be interested and receptive to environmental messages. Providing information to visitors can help them develop more respect for the natural environment, and can mitigate their effect on the protected area by establishing appropriate behaviors. By working with the communities surrounding protected areas, Volunteers can increase the effectiveness of area personnel by taking the conservation message to the local communities and working with them to develop sustainable alternatives to traditional uses of the area's resources.

EXAMPLES

Park, preserve, and protected area environmental education programs typically include:

- ▶ Interpretation, natural history education, and appropriate behavior in the park.



- ▶ Training of park staff to learn interpretation techniques, explore resource management issues, or develop environmental policies.
- ▶ Programs that entail education on sustainable resource use and low impact practices. These resource users may be tour guides, hunters, loggers, miners, or beekeepers, but in all cases the park management will want them to understand appropriate resource use.

Issues that Volunteers may encounter when working in buffer-zone areas include:

- ▶ Adoption of non-extractive practices
- ▶ Absence of well-defined protected area and buffer-zone boundaries
- ▶ Absence of legal and official recognition of the protected area
- ▶ Acceptance of longer-term investments using fruit trees and woodlots over strictly annual crops
- ▶ Presentation of environmental education in schools utilizing proper teaching methodologies
- ▶ Promotion of community-level environmental organizations
- ▶ Determining the effect of ecotourism on natural resource management
- ▶ Motivation of service providers
- ▶ Absence of environmental education in official school curriculum
- ▶ Land tenure laws and cultural perception of them
- ▶ Marketing products and services from the buffer zone
- ▶ Need for participatory needs assessment of the buffer zone
- ▶ Access to buffer-zone communities year round
- ▶ Acceptance of different land use practices by Volunteers or by local residents
- ▶ Participation by the local population in the management of the resources (such as fishing and hunting limits)
- ▶ Need for activities which improve livelihood security. Volunteers may come in with sufficient training to look for these opportunities and help develop them. Volunteers can bring marketing skills and a new vision.
- ▶ Presentation of environmental education in schools utilizing proper teaching methodologies
- ▶ Consideration of indigenous knowledge

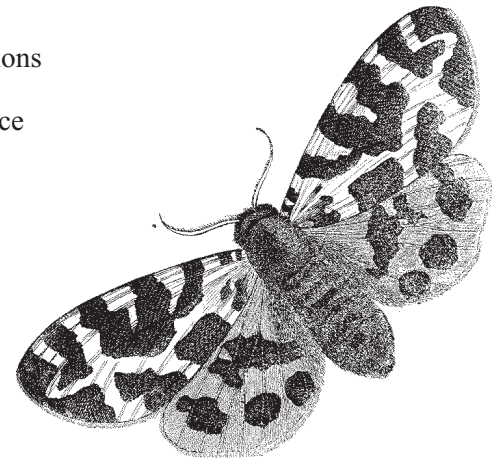



Environmental education programs in these areas may deal with:

- ▶ Ecological reasons that the park was created
- ▶ Ecology of park ecosystems or significant species
- ▶ Exploration of alternative uses of the park
- ▶ Development of economic activities that will replace lost sources of income, take advantage of the park visitors, or respond to increased interest in the park as an ecological system
- ▶ Community members may want to explore the level of their participation in management of resources in and around the park
- ▶ Exploration of the relationship between ecotourism and natural resource management
- ▶ Exploration of the relationship between park regulations and ecological systems, and the logic behind the regulations
- ▶ If the communities are agriculturally based, do land-use practices need to be changed and, if so, how? What alternative land-use practices might be developed that are non-extractive or require less clearing of forests? Are there long-term land-use options to annual crops, such as fruit trees or woodlots?

HOW TO DO IT

One possible activity is to conduct trainings for park personnel on issues such as sign making, constructing nature trails, or general interpretation techniques. Talk with the personnel first to determine their level of interest and specific course material.

Another productive activity is conducting nature talks or guided nature walks for park visitors. Have a plan beforehand where you will take the group, know what you're going to say, plan for emergencies, and carry a first-aid kit.

RESOURCES

Ham, Sam H., *Environmental Interpretation: A Practical Guide for People with Big Ideas and Small Budgets*. Golden, CO: Fulcrum Publishing, 1992. [ICE No. FC190]

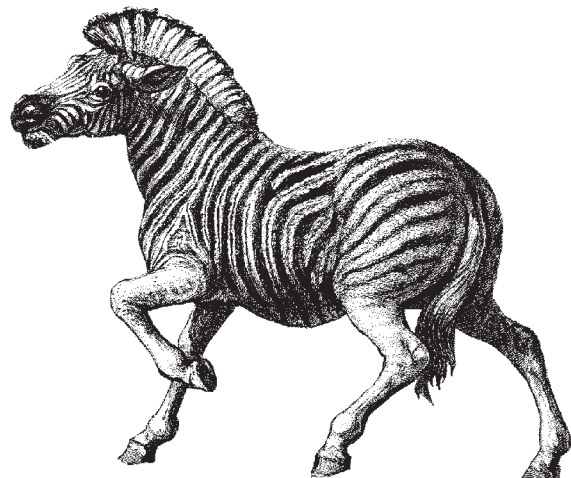



11 YOUTH PROJECTS AND ACTIVITIES

DESCRIPTION

Many Volunteers work with youth, and an increasing number of Peace Corps projects are focused on youth who are out of school and on the streets. Young people want to learn and to contribute to their communities. They are at an age when they have high energy and are passionate and impressionable. They often lack experience and need guidance to achieve their goals.



USES

Youth can be involved in camps, clubs, conservation and service organizations, income-generating activities, events, and education.

- ▶ Camps focus on environmental education, service projects, and skill building.
- ▶ Ecology clubs promote environmental understanding and community service in an enjoyable setting.
- ▶ Youth Conservation Corps (YCC) work on conservation projects such as construction of interpretive trails in parks, restoring wetlands, building public cabins or bunkhouses, or road repair in protected areas. Usually these projects require blocks of time, so YCCs are often conducted as summer camps or work camps where youth work in teams under a supervising adult.
- ▶ Service organizations or projects, such as housing construction and rehabilitation, park trail building and maintenance, solid waste management, canal maintenance and construction, elderly or disabled assistance projects, clean-up, erosion abatement or tree planting.
- ▶ Income generation, such as ecotourism (tour guides, food sellers, camp maintenance, tourist information, transportation rental), value-added resource products for manufacture and sale, or solid waste removal.
- ▶ Events such as Earth Day celebrations or environmental theater.
- ▶ Educational activities such as community school classes, income-generation skills training, basic education, or environmental science classes.

EXPECTED OUTCOMES

- ▶ Awareness, attitude and knowledge: Ecological knowledge, appreciation of natural systems, and understanding natural resource use help young people participate responsibly in sustainable community development.





- ▶ Life skills development: Young people want and need to develop skills and talents they can use for their own futures and to contribute to their communities.
- ▶ Building self-confidence: Young people want to discover their own worth, learn to be leaders, and become responsible citizens.

EXAMPLES

One activity that Volunteers frequently use with youth groups is an ecology club. Volunteers often form clubs at schools or universities. With a club, there is usually more freedom to choose what to teach because there is no established curriculum. Clubs often work well if there are field trips to a variety of places and projects (e.g., forest, stream, experimental farm).

Projects and activities for ecology clubs will depend on the purposes of the clubs and community interests. Usually the expectation is that the club will be fun for the club members while they are learning. Some possible types of activities are:

- ▶ Field trips to ecosystems, farms, fishponds, orchards, zoos, or other places of environmental interest. A club in the Philippines snorkels to learn about marine life.
- ▶ Stream monitoring or other long-term monitoring projects
- ▶ Local environmental research
- ▶ Public service projects such as media campaigns, urban park construction, recycling, litter clean-up campaigns, tree planting, butterfly gardens or trail building
- ▶ Environmental games
- ▶ Participatory ecology classes
- ▶ Team-building activities
- ▶ Fund-raising activities that both raise awareness in the community and raise funds to pay for club activities
- ▶ Planting gardens, raising rabbits, or other educational projects

HOW TO DO IT

To form an ecology club, first get to know your potential audience. Students are the most common members of clubs, but there may be other interested community members. Find out where their interests lie. Adults usually have fairly focused interests, such as organic gardening or hiking clubs. Youth clubs tend to be more flexible and relaxed. Clubs are voluntary, so you need to offer an appropriate incentive for the members to come. For adults it may be learning a skill, gaining knowledge, or working together on a project. For youth, the incentive is more likely to be enjoyment, socializing, interesting projects, community service projects or learning something that will benefit them in the short term (help pass exams, get extra credit, learn a useful skill that will help them get a job or get into a school). Knowing what your potential members want and expect will help you plan a club that will recruit excited members and maintain membership.



Include the members in the planning of activities, which will help them to be more committed. Be careful to schedule meetings at times that are convenient for the members. If they have too many conflicts with other commitments, they will not be able to come. Schedule regular group-building activities, such as picnics or pizza parties to keep interest high. Over time, develop traditions for the club. Design a logo and put it on t-shirts or notebooks. Develop slogans and nicknames. Publicize the club's meetings, activities and achievements. Since the club is voluntary, people will appreciate recognition. Publicity will also make the club look enticing and "cool."

At your first few meetings, you will not know how long it will take to get things done, so plan extra activities and assume you won't get to all of them. In the beginning, spend time getting to know the members and having icebreaking activities. Clubs often have an informal atmosphere, so you can chat with the members about their interests and hopes for the club. If possible, bring food, which helps to convey a relaxed and friendly atmosphere. In addition to icebreakers, plan one main ecological activity that is fun and informative and a shorter fun activity such as a song or skit or game. Start and end on time and, at the end, ask for feedback on how the meeting went and what they would like to do next time.

ENVIRONMENTAL CLUBS

— BENIN —

After environment Volunteers initiated environmental clubs in their areas, enthusiasm spread to many high school teachers who began to implement environmental education into their curriculum. Short-term activities include playing "environmental Chutes and Ladders" and reproductions of Dr. Suess' environmental classic *The Lorax*. Long-term activities include planting fruit tree orchards, indigenous tree nurseries and organic gardens.

Students appreciated the opportunity to break away from the normal classroom structure and rigid assignments and gained an appreciation for their environment, and the importance of individual action.

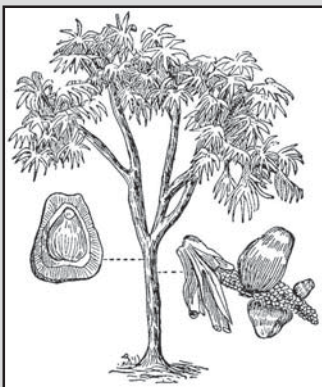

After a simulation activity on the importance of forests and reforestation in which students acted as trees in a local forest used for firewood, traditional medicine and construction, a Volunteer asked a student to describe the forest. She said: "It's overused, dead and ugly. All of the animals have fled or died. I wouldn't want to live there anymore." When the Volunteer asked what could have been done to prevent the destruction of the forest, students shouted out ideas ranging from "cut only the largest trees" to "always plant a tree for each one you cut" to "forbid cutting in the forest and start a special tree garden."

In another village, after the previous week's session on air pollution, an 11-year-old student approached the Volunteer and asked her why she took a taxi, which pollutes, to school; she has ridden her bike to club ever since!

(continued)



Beninese teachers were inspired by a weeklong workshop on environmental education and a few preschool teachers started incorporating practical environmental education activities into their lessons. Using local languages as a base, they teach French vocabulary and environmental appreciation at the same time. In a local language a teacher asked: “Who can tell me what the word for tree is in French?” Wanting to answer quickly, all hands went up. “And,” she continued, “who can find a tree in the school yard?” Again, all hands were in the air. When asked why the tree was there however, the students needed more time to think. One little boy finally ventured an answer: “Because we like trees!”

There are several principles that are helpful when working with youth:

- ▶ Focus on assets more than problems. People need to build from their strengths to move forward.
- ▶ Young people need clear expectations. They need to know exactly what you want, but they also need to know that you will listen to their ideas. As a group leader, you will need to create a balance between having some expectations, rules and standards, and listening and adapting to their ideas and needs.
- ▶ Help young people build their own goals, standards, and skills. Find out what their skill levels are, and what their needs are. Find out what their hopes are. Then help them get there.
- ▶ Help the young people in the community become part of the community. They need to know they belong and have a contributing role in the community. Service learning projects help young people to understand how they can be of service and participate in the community.
- ▶ Let them learn from experience and practice new skills such as leadership, decision-making, planning, assessment and revision. Let them learn by doing. Give youth responsibility. It is the best way for them to learn it. Teach them how to be self-directed.
- ▶ Model stability, patience, and perseverance.
- ▶ Start small and allow your project to grow by small increments. Be satisfied with small achievements.
- ▶ Provide a safe and caring atmosphere. You may be dealing with youth who have been living in frightening and unstable circumstances. Be trustworthy and considerate. Try to view your project from their perspective. Be free with praise, but private with advice.
- ▶ Consider the age, gender, and culture of participants.





TARGETING YOUTH AND WOMEN — ECUADOR —

One Volunteer was assigned as an environmental educator to two neighboring communities in the province of Carchi, Ecuador. Near these communities, there is a native forest that is one of the few remnants of cloud forests found in the Carchi Province. As with most natural areas of Ecuador, Nueva America Forest faces threats of size reduction and degradation of its resources due to the need for additional agricultural and grazing land. Additionally, resources such as timber and wildlife are also exploited for firewood, construction, and food.



In order to reduce the pressure on the natural resources of the Nueva America Forest, the Volunteer took two courses of action. The first was aimed at the youth by providing environmental education, and the second was with a women's group to generate income through the sale of medicinal plants.

With the youth, the Volunteer organized an ecological club named *Amigos del Bosque* (Friends of the Forest). Youth members met weekly to carry out activities such as clean ups of a lake, educational walks in the forest, painting a mural in the environmental education

center, establishing a small herbarium with plants of the forest and more recently, promoting bird guiding and bird conservation among the club's members.

With the women's group, she successfully implemented a small project to sell medicinal plants. She led the group in weekly meetings in which they planned to obtain a sanitary registration; designed and produced labels; collected, cleaned and dried plants; found markets; implemented an accounting workshop; and opened an office in Ibarra, a major city near Nueva America. Currently, the group is beginning to distribute their products for sale in Ecuador and market research is being done to export their products to Galapagos and the United States.

Sustaining youth programs can sometimes be difficult. Recruit adults who are committed to youth programs and can provide sustainability and leadership. Mentor these adults to encourage them to be caring positive role models. Build networks of interested people and organizations that will help sustain the youth programs.

RESOURCES

Working with Youth: Approaches for Volunteers. Washington, DC: Peace Corps. [ICE No. M0067]





FIELD TRIPS

12 FIELD TRIPS

DESCRIPTION

Field trips are an effective way of showing people real situations. Groups of people go into the field with an interpreter who shows them interesting and important aspects of an environment, and helps sharpen their observations.

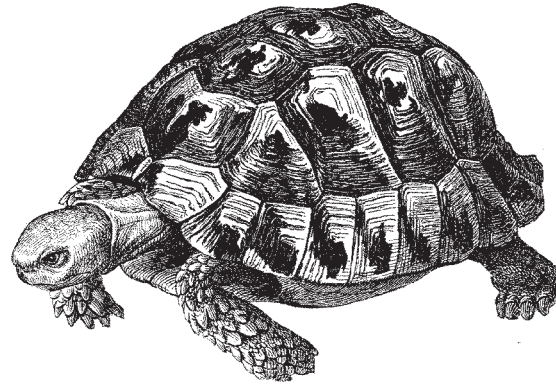

USES

Field trips encourage participants to look carefully at the environment around them. They are useful for teaching participants about ecosystems, human behavior and impact, or for determining future land use actions such as building trails.

EXPECTED OUTCOMES

Participants gain a more realistic understanding of the ecosystem, forest, farming practice or other place visited.

EXAMPLES

Often field trips are used to teach people about specific ecosystems, or to show them projects of interest, such as farming methods or forestry practices. Potential field trips include:

- ▶ Rainforest
- ▶ Wetlands
- ▶ Desert
- ▶ Grasslands
- ▶ Forest
- ▶ Specific plant community
- ▶ Specific habitat
- ▶ Organic farms
- ▶ Water treatment facilities
- ▶ Managed forest
- ▶ Game preserve
- ▶ Forest products' manufacturing site
- ▶ Fish farm
- ▶ Site of geological processes, such as erosion, rebound, etc.



HOW TO DO IT

Field trips are most effective when they have structured activities that participants understand beforehand. Structured activities may include:

- ▶ Treasure hunts or scavenger hunts that focus participant observations on plants, animal homes, sounds, smells, tracks and signs, or examples of human impact. You can add a bit of competition by asking who will see the most things on the list.
- ▶ Natural history interpretation by the leader. People are generally interested in what they are looking at, but having someone explain and point out interesting features can make the outing even more interesting and educational. See the section “Signs, Labels and Guides” later in this chapter for ideas.
- ▶ Data collection and transects. A transect is a sampling, or counting of all the species within a given plot. The plots lie along a line that crosses the area of interest. You may set a transect from a water line to a ridge top of a small hill to discover how the vegetation changes. Your field trip may have a particular focus that requires certain data to be collected, like canopy cover, species of birds, or soil characterization. See the section “Transects” later in this chapter.
- ▶ Awareness activities help broaden the focus of participants. For example, ask participants to find a spot where they can sit quietly for 20 minutes and listen to all the sounds. Ask participants to imagine that a tree is an apartment building, and, starting at the roots, tell you who lives there. Ask participants to identify odors in a particular environment.
- ▶ Games are particularly effective with children. Environmental education curricula have many examples of environmental games that are active and teach a concept.

In addition to structure, consider group size, terrain, safety, appropriate clothing and how you will introduce the field trip. Maximum group size is about 15 people per leader. If there are more, some participants will not be able to hear the leader, and may wander off or become distracted. Assess the outdoor experience of your participants, and choose the terrain accordingly. Many people do not get outdoors on a regular basis beyond their work, which may mean they are unaware of their own best pace, or of proper clothing. Watch the participants as you go and adjust your pace accordingly. Make sure they bring proper clothing, water, and food.

Assess the difficulty of the terrain and any safety risks. Will there be any tricky footing? Could anyone fall? Could wind or rain make the terrain slippery or treacherous, or decrease visibility? Once you have assessed any risks, decide how you will inform the participants. It is best to explain any risks to participants in advance of going on the field trip. You may also want to make some rules that will decrease the risks, such as requiring that everyone stay together, or using a buddy system. You may want participants to bring special clothing or wear an identifying pin or armband. You may ask participants to join hands when crossing streams or negotiating difficult terrain.

Before going on the field trip, brief all the participants on where you will be going, what you hope to accomplish, how they should dress, what they should bring and how they should behave. Focusing the field trip on the study of ecosystems helps people look at the whole system, and keeps people from focusing on animals and disturbing them. People find themselves very interested in parts of the ecosystem that they would normally ignore if the leader can tell them what is interesting. An example is slime molds. Slime molds have a repellent name, but a very interesting lifestyle. Once people know about the lifestyle, they become interested in looking for slime molds.





FIELD TRIP CHECKLIST

BEFORE THE FIELD TRIP

- Choose your objectives and theme for the field trip.
- Go over the route of the field trip in advance to find interesting sites to point out and to check for any difficulties or safety concerns.
- Plan a variety of activities for the field trip.
- Develop guidelines for field trip behavior either with participants or separately.
- For children, get permission slips and pertinent medical information about participants from parents. On some field trips, it may be wise to get medical information from adults as well.
- Gather materials and equipment.
- Announce meeting time and place, and notify participants about any special clothing, food, water or equipment. Tell them the expected return time.
- Pack all equipment, first-aid kit, teaching materials, food, water, clothing, bug repellent and sunscreen.
- Recruit co-leaders, parents or chaperones to achieve a good leader-to-participant ratio. For little children, there should be one adult for every five children. For older children and adults, the ratio can be one leader to every 10-15 participants in easy to moderate terrain.

STAGING THE FIELD TRIP

- Make sure all participants are present, and take a head count.
- Orient participants to the route, theme, and purpose of the field trip.
- Make sure all participants are prepared for the field trip and have proper clothing, supplies, and equipment.
- Make sure all participants understand any safety concerns and know all rules.

DURING THE FIELD TRIP

- Take head counts every so often to make sure no one gets lost.
- Stop at interesting sites and present enthusiastic, knowledgeable interpretations of the natural world.
- Ask questions and encourage questions from the participants.
- Know pertinent phrases in the local language, even if you are presenting in English.

(continued)



- Vary the activities. Mix nature interpretation with observation activities, taking measurements, identifying species, art and literature.
- Play an active game
- At the end of the trip, ask participants what they learned, and what they liked about the trip.

FIELD TRIP SAFETY

- Keep track of time.
- Take a compass and map of the area.
- Maintain frequent communication among leaders.
- Protect participants from the sun by limiting exposure, utilizing shady areas, and requiring them to wear hats or use umbrellas.
- Take plenty of water and high-energy foods along.
- Carry a whistle.
- Check the weather forecast beforehand if possible, and be prepared to deal with changes in weather.
- Be aware of background noise.
- Be aware of safety hazards such as poisonous plants, venomous animals, cliffs, loose rock, uneven footing, and have a plan to deal with them.
- Facilitators should look into the sun, not the participants.
- Have a plan in case of fire, wild animal contact or other emergency.
- Have a plan about any water bodies you may encounter. Will you allow swimming? Under what circumstances? Consider supervision for swimming. Participants should not drink alcohol or eat just before swimming.

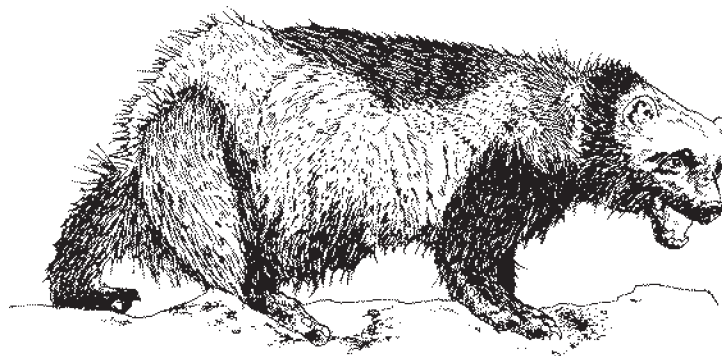



RESOURCES

Windows on the Wild: Biodiversity Basics—An Educator’s Guide to Exploring the Web of Life. Tustin, CA: Acorn Publishing, 1999. [ICE No. FC258]

Environmental Education in the Schools. Washington, DC: Peace Corps, 1993. [ICE No. M0044]

Ham, Sam H., *Environmental Interpretation: A Practical Guide for People with Big Ideas and Small Budgets.* Golden, CO: Fulcrum Publishing, 1992. [ICE No. FC190]

Learning Local Environmental Knowledge: A Volunteer’s Guide to Community Entry. Washington, DC: Peace Corps. [ICE No. M0071]

Adapting Environmental Education Materials. Washington, DC: Peace Corps. [ICE No. M0059]

Project Wet (Water Education for Teachers): K-12 Curriculum and Activity Guide. The Watercourse and the Council for Environmental Education, 1995. [ICE No. E0333d]

Project Learning Tree: Environmental Education Pre K-8 Activity Guide. American Forest Foundation, 1995. [ICE No. E0330]

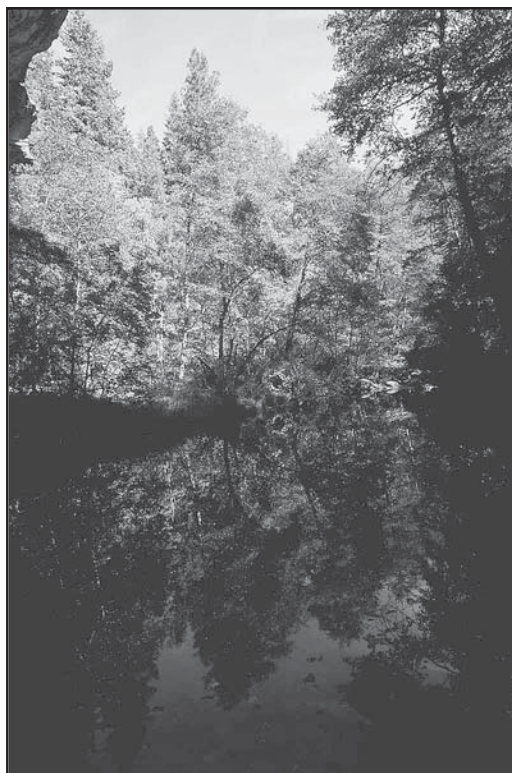



13 FIELD ETHICS



DESCRIPTION

Taking community members out into the environment is a powerful learning tool. And, of course, the best place for environmental education is in the environment. However, questions of impact will arise. Ideally, people “take only photographs and leave only footprints,” but there are times when this may not work, and there are cultural considerations that affect behavior in natural settings. Perhaps you or community members may want to collect samples for further study. Some cultures are inclined to kill every snake they see. Some cultures revere certain types of trees, so those trees cannot be disturbed. There are also issues of land ownership or ownership of animals or plants.

USES

Codes of ethics may be used at the beginning of trips into the environment to explain to people what is expected of them. These codes may also be part of publications, exhibits, or signs at sensitive areas. Ethics are usually part of environmental education.

EXPECTED OUTCOMES

Codes of ethics or codes of conduct encourage people to behave responsibly.

HOW TO DO IT

It is important to develop a code of ethical outdoor behavior before taking people into the out of doors. Various organizations have developed codes or tips or suggested behaviors. Most have a few behaviors in common:

- ▶ All living things must be respected and should not be injured. This includes plants, insects, etc., not just birds and mammals.
- ▶ Staying on trails minimizes damage to plants and animals.
- ▶ All living things are best studied in their natural environment without interference from people.





- ▶ If collecting specimens is appropriate and instructionally powerful, decide in advance how much will be collected and from where, so as to minimize negative impact. Only collect if there is an abundance and only those specimens you can learn from while keeping damage to a minimum.
- ▶ Make sure to seek permission from land-owners before going onto their land.

RESOURCES

Oberbillig, Deborah Richie, *Providing Positive Wildlife Viewing Experiences: A Practical Handbook*. Watchable Wildlife Incorporated, April 2001.

Project Learning Tree: Environmental Education Pre K-8 Activity Guide. American Forest Foundation, 1995. [ICE No. E0330] See pages 379-382.

Leave No Trace
www.lnt.org/

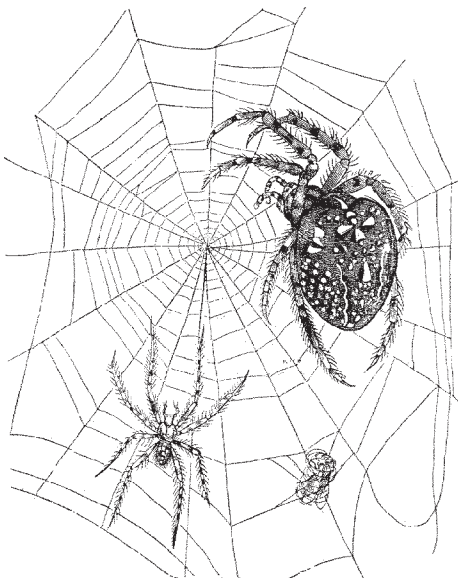

PRINCIPLES OF LEAVE NO TRACE

- Plan Ahead and Prepare
- Travel and Camp on Durable Surfaces
- Dispose of Waste Properly
- Leave What You Find
- Minimize Campfire Impacts
- Respect Wildlife
- Be Considerate of Other Visitors

The Leave No Trace Center for Outdoor Ethics is a national nonprofit organization dedicated to promoting and inspiring responsible outdoor recreation through education, research and partnerships. Leave No Trace builds awareness, appreciation and respect for our wildlands.

Principles printed with the permission of the Leave No Trace Center for Outdoor Ethics. For more information, Leave No Trace, www.lnt.org.





FACILITIES AND TRAILS

14 PUBLIC FACILITIES



DESCRIPTION

Public facilities include interpretive kiosks, viewing blinds, fences, rest stops, benches, restrooms, litter containers and parking. A facility may be as simple as a sign signifying a view or as complex as a nature center with multimedia interpretive displays and guided trails.

USES

Facility design can allow people to interact with the environment responsibly by attracting people to interesting outdoor experiences while managing their impact. For example, if you want to bring people to see waterbirds in a wetland, but you don't want people walking on delicate wetland plants or disturbing the birds, build a walkway and viewing area that channels people to walk in certain places, but not others. To attract them to the viewing area, a sign showing the types of waterbirds in the area, and a couple of benches will encourage people to use the area properly.

— Case Study — SHEEP VIEWING AREA

Herds of up to 100 bighorn sheep spend the winter close to a highway with heavy truck traffic. People who wanted to watch the wildlife pulled over on the side of the road and got out of their cars to take photographs. Some even climbed the fence into private property to get a closer look. The truckers on the highway were frustrated by the congestion; the landowner was upset by the trespassing and wanted to get rid of the sheep; the viewers were frustrated by having to dodge each other.



In this case, a highway patrolman took the lead to bring together biologists, landowners, engineers and the local community to create a partnership. They built a viewing area off the highway that concentrated viewers, solved traffic problems and created a facility that allowed the sheep to become habituated to viewers being in a specific place. Local students built a fence and benches. The local chamber of

(continued)





commerce marketed the viewing area. The landowner donated land for the viewing area, and became interested in the sheep. An interpretive kiosk and pullout completed the facilities.

Adapted with permission from *Providing Positive Wildlife Viewing Experiences: A Practical Handbook*. Marine on St. Croix, MN: Watchable Wildlife Incorporated, April 2001, page 28.

EXAMPLES

Facility design depends on the site sensitivity, access and target audience. Some sites require minimum facilities because the natural area itself offers an exciting viewing opportunity and encourages responsible behavior. You can take advantage of natural features to maximize enjoyment and minimize negative impact. For example, building a viewing area on the top of a bluff will offer good views and discourage people from walking into sensitive areas.

Other areas may require more elaborate facilities due to fragile environments or difficult access. One area in South Africa has a long tunnel with tarps and poles that lead to a blind for viewing vultures. The blind is a simple small building with a plastic window along one side. Viewers entered and departed using the tunnel so as not to disturb the birds.



HOW TO DO IT

The goal of the facility is to maximize viewing enjoyment while minimizing negative public impact. Assess the location of the site to determine the fragility of the environment. If the ecosystem and species in it can withstand the projected numbers of people with little or no disruption, then the facility can be simple. If the site contains a fragile environment or sensitive species, but is already being used, the aim of the facilities is to protect the species and environment while offering visitors a managed opportunity to view.

When designing the facility, start with an interpretive theme or message that is relevant to the ecosystems that will be viewed. Involve the community in the planning, including biologists, recreation planners, users, park officials, or other stakeholders. The goals of the facility are:

- ▶ To attract people to where you want them to be
- ▶ Protect sensitive areas
- ▶ Meet user and community expectations
- ▶ Create a quiet educational adventure



Apply nature's designs to the facilities. Mimicking natural systems makes the facility harmonize with the ecosystem and contributes to the educational value. Often using local materials can save money as well. There may be a need to balance the construction of facilities with the environment they are built to show. For example, if the construction of a viewing area could substantially change the area, then a more appropriate design may be necessary. As a general rule, the less disturbance the better.

Likewise, designing benches, picnic tables, fire pits, toilets or other "furniture" should take into consideration the available natural materials and designs. Often local low-tech designs will serve well.

RESOURCES

Oberbillig, Deborah Richie, *Providing Positive Wildlife Viewing Experiences: A Practical Handbook*. Watchable Wildlife Incorporated, April 2001.





15 NATURE TRAILS

DESCRIPTION

A nature trail can be very useful as an environmental education tool. It can be a single trail that traverses an area of ecological interest, or a system of trails that each has different highlights.

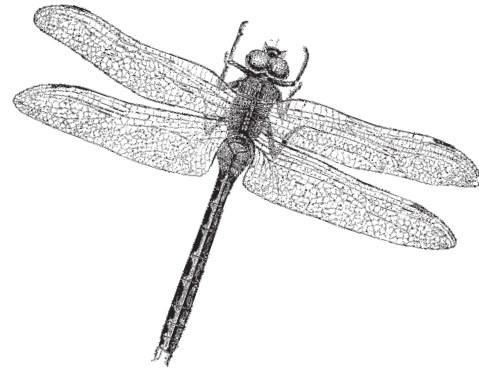

USES

In choosing a nature trail, consider the features to highlight, the route of the trail, traffic patterns, and trail maintenance.

- ▶ Who are the users? How will they use the trail? Will there be large or small groups?
- ▶ Where will you locate benches, overlooks or tranquil alcoves in order to highlight features of interest and invite people to slow down and let nature express itself?
- ▶ Where are signs of animal presence? A well-planned trail will allow animals to predict human behavior, and adapt accordingly. That may mean the animals will tolerate being viewed, if they know they will be safe.
- ▶ What natural vegetation can you take advantage of for viewing areas to minimize either cutting vegetation or building viewing areas?
- ▶ How will the different seasons affect the experience of the trail and the species present?
- ▶ How can you plan your trail to minimize people leaving the trail and creating their own?
- ▶ Respect wildlife corridors as much as possible, so as not to drive away wildlife.
- ▶ Are there any endangered or threatened species that need to be considered? How can they be protected?
- ▶ How will you monitor changes that affect the trail or its wildlife? Maintain flexibility so trail managers can respond to changes in ways that will protect wildlife and people.
- ▶ Which areas will people come to? Plan trails there, or they will make their own. Provide for peoples' interests and prevent damage.
- ▶ Design an interesting trail. What large trees can the trail pass or go under? Are there cliffs or rock outcroppings that the trail could highlight? Where can interesting curves in the trail be located? Winding trails give a sense of discovery.



- ▶ Take advantage of natural barriers that separate people from wildlife while allowing a view. For example, if the hippos are in the river, route the trail along a high embankment so the hippos can be seen but not approached.
- ▶ How can you use boardwalks, observation decks and towers to concentrate people and protect terrain? What materials will be most durable for constructing these facilities?
- ▶ What safety measures need to be taken to protect people and wildlife?
- ▶ How will you label features of interest? Where will you put interpretive signs that will attract people without interfering with the experience of the trail?

EXPECTED OUTCOMES

The purpose of a nature trail is to offer an enjoyable and interesting natural experience while protecting the environment. A nature trail is a teaching tool that can increase public awareness and knowledge.

EXAMPLES

Nature trails can be enhanced to offer interpretive information to walkers. Walkers can be given a printed guide to the trail that indicates points of interest. Interpretive signs along the way can point out a feature and how it fits in to the whole ecosystem. Keep signs separated from each other so people will stop and look without feeling rushed by the next sign. Nature guides may take groups of people and interpret the ecosystem for them. Printed trail guides can describe the features of the trail in detail and be coded to small signs or markers on the trail.

Possible features on a nature trail could be:

- ▶ Characteristics of a particular ecosystem – dominant trees or special plants, examples of animal homes or special geological features
- ▶ Grassy areas that show ways plants adapt to sun
- ▶ Sandy areas that demonstrate how plants hold soil
- ▶ Successional zones that show the sequence of plants colonizing an area
- ▶ Beaches that demonstrate plant adaptations to salt water or storms
- ▶ Rotting logs that are mini-systems showing decomposition
- ▶ Rocks with lichens that show soil formation and highlight these unique organisms
- ▶ Caves, rock shelters, and fallen tree-root systems that show animal homes and natural geological processes
- ▶ Historical features of local interest
- ▶ Browsed plants that show signs of animal foraging and plant adaptation to browsing
- ▶ Feeding areas that have tracks of the animals that use the area





- ▶ Road or trail cuts that show soil profiles with layers of sediments
- ▶ Streams that demonstrate the action of water and the adaptations of organisms that live in them
- ▶ Areas of human impact that demonstrate the effects of human activities
- ▶ Evidence of fungus or insect impact on trees, such as bore holes or burls
- ▶ Microclimate differences in plant growth between wet soils, sunny spots or shady areas

HOW TO DO IT

Nature trails are generally short—a mile or so—and are loops, or one loop with side loops for special interests. Nature trails are inviting and the trailhead is easy to locate. The trail should be wide enough for two people to walk side by side. It should be as flat as possible, smooth surfaced and free of obstacles. The trail should drain well so muddy places do not develop. If they do develop try to fill them, place logs or bamboo (a corduroy) across them for easy walking. It may be necessary to build a boardwalk along certain sections.

Place benches along the trail for rest stops. The walk should be easy and require no special clothing or shoes. The trail should be clean and well maintained with animal-proof waste receptacles. The route of the trail should be obvious with few, clearly marked intersections. Try to avoid switchbacks so people will not make short cuts. It may be necessary to restore areas that have been degraded, such as stream corridors or sections of trail.



RESOURCES

Proudman, Robert D. and Reuben Rajala. *Trail Building and Maintenance*, 2nd ed. Appalachian Mountain Club, 1981. [ICE No. FC196]

Oberbillig, Deborah Richie. *Providing Positive Wildlife Viewing Experiences: A Practical Handbook*. Watchable Wildlife Incorporated, April 2001.



16 LANDSCAPING, COMPOSTING, AND PLANTING

DESCRIPTION

Landscaping involves working with plants, soil, water, and space to improve outdoor surroundings, or to showcase natural systems. If you have an area in your community or around your center that will allow for landscaping, you can take the opportunity to highlight the natural plants and environmental features of the region. Careful selection of native plants can encourage wildlife to come to the area. Native plants show community members the assets they have right in front of them. If you are in an area that has few natural plants, you can landscape with rocks and gravel to make an attractive display of native materials.

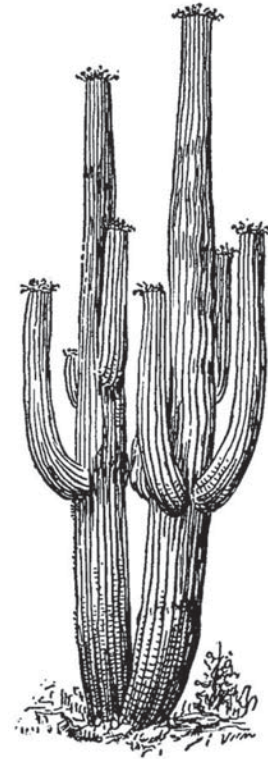

USES

Landscaping provides an opportunity to demonstrate conservation methods, such as composting or terracing. It can also be an opportunity to highlight aspects of the local ecosystem, such as native plants or soil types. Interpretive signs or species labels increase the educational value of the landscaped area.

EXPECTED OUTCOMES

A beautifully landscaped area will attract people to visit. Landscaping can also attract local wildlife such as butterflies or birds. A landscaped area highlights native plants of the area, and educates people about those plants. Landscaping can also conserve soils, decrease erosion and provide shade.

EXAMPLES

Some examples of landscaped areas include:

- ▶ Herb garden
- ▶ Shaded sitting area
- ▶ Grasses that hold soil
- ▶ Butterfly gardens
- ▶ Plantings that attract birds
- ▶ Terracing
- ▶ Rock garden that shows xeric plants
- ▶ Alpine plants
- ▶ Native ornamentals
- ▶ Meditation gardens





HOW TO DO IT

Landscaping:

Planning: Start by making a plan for the land to be landscaped. Remember to leave space to allow for growth. It may take years for full results, especially if you are planting trees or shrubs. When planning, take advantage of natural features, such as rocks or paths or water sources. Check the soil to see if you need to add compost or other elements to enrich or loosen soil, or improve drainage. Plan for benches, walks, and play or viewing areas.

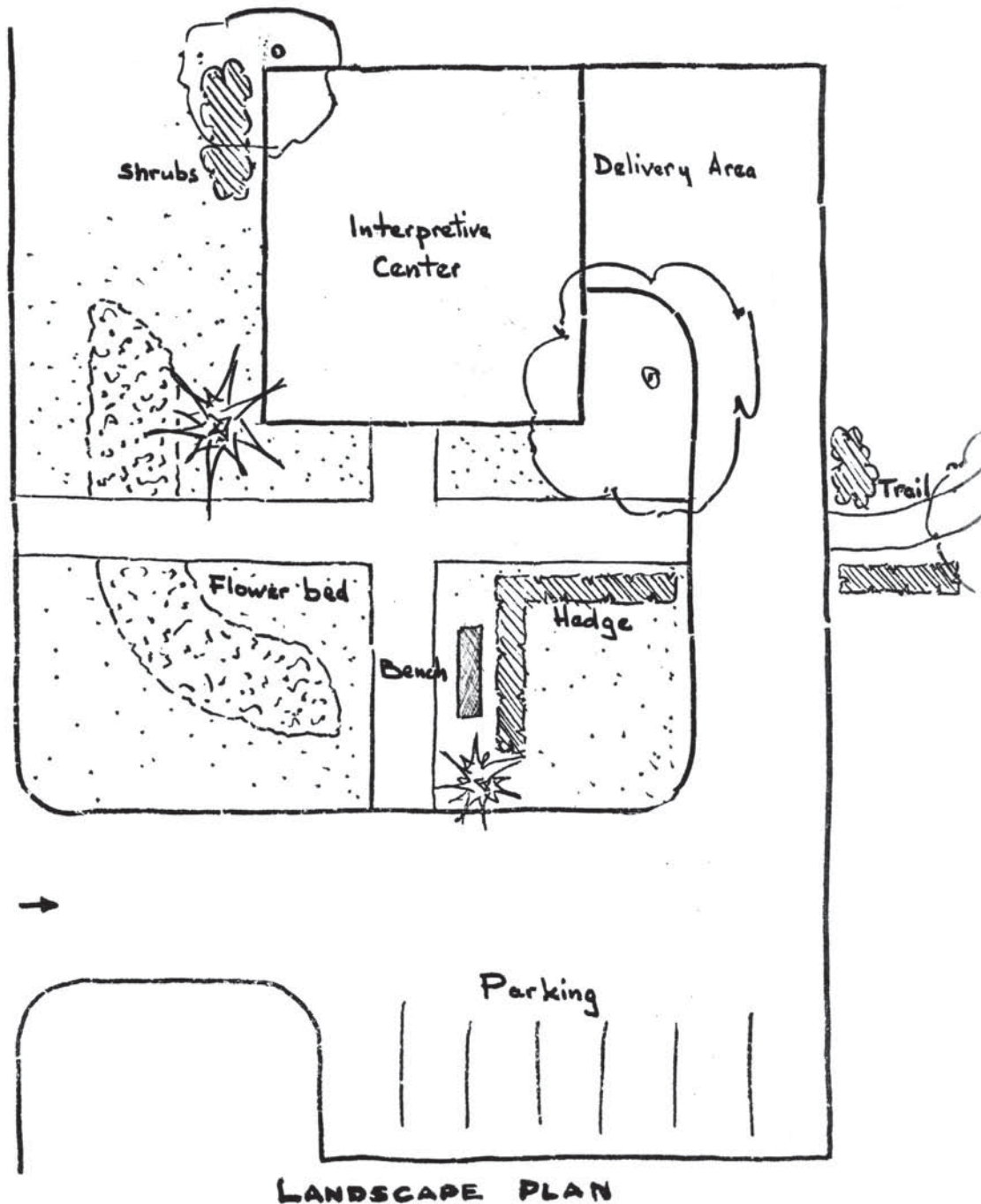



Choosing Plants: When choosing plants, consider the soil and climate. If you can't grow grass, look for another ground cover. If flowers won't grow in the soil, plant them in pots. Will you want shade trees? Or will you need to build shelters from the sun, rain or other elements? Will you need temporary shelters while trees grow? Which plants can you plant that will attract birds or other watchable wildlife? When choosing plants, try for variety and contrast of shapes and colors.

Composting:

Compost is a kind of fertilizer made from a variety of organic materials that have fermented or decomposed in a compost pile. The reason for making a compost pile is to make good use of all garbage, manures, vegetable waste and ashes, returning them to the soil to enrich it, and to help plants grow better.

A small compost pile should be cone-shaped so that rain will run off rather than into the pile. A large compost pile should be long and narrow to make mixing easy. A large compost pile can also be made in a pit. A pit bottom needs a drainage channel for water to escape. Compost piles can be in containers if attracting animals is a concern. If you are concerned about attracting large animals like bears, you may need to compost in an enclosed container or building to eliminate attracting odors.

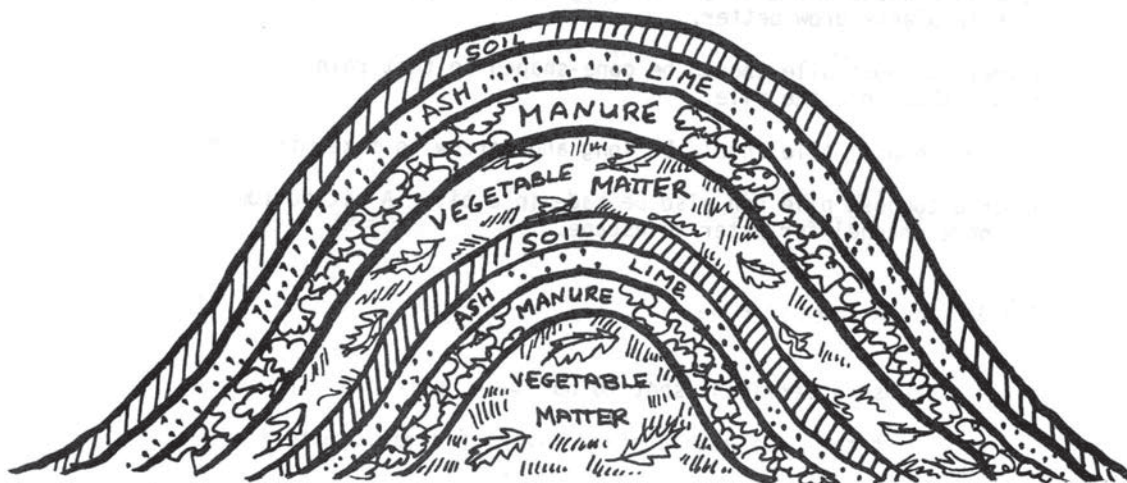



HOW TO MAKE A COMPOST PILE

1. Choose a permanent spot to build the pile away from homes.
2. Start the pile with a mixed layer of organic material such as:

soft leaves	garbage (no plastic, metal or glass)
grass cuttings	rice husks
straw	seed pods
paper	banana skins
3. Build up this layer approximately 30 cm high.
4. Put a layer of animal manure (pig, chicken, cow, horse or goat) on top of the first layer.
5. Sprinkle ashes and lime on the manure, and water if the pile is dry.
6. Add a thin layer of sand, fine soil or mud.
7. Repeat these layers of plant material, manure, ashes and lime, and soil, until the pile is about 1.5m high and 1.5m wide.
8. The pile should never become dry or the decomposition process stops.
9. Turn the pile every three weeks with a shovel for about three months.
10. If odor is a problem, you need to add more carbon (brown material, such as dried leaves, straw, paper, etc.), or turn the pile to allow air to circulate.
11. Use the pile in three months. It will have decayed and shrunk to about 1/10 of its original size.



TO SPEED UP THE PROCESS

- Make the same 1.5m x 1.5m pile of plant material, manure, and lime. This time, however, use more household garbage and animal manure. (Animal manure supplies nitrogen, a nutrient used by microorganisms during the decay process. A good compost mixture is about one shovel full of manure to 30 shovels full of the other organic materials).
- Mix the material well. Then cut all of it into small pieces, using a shovel, machete, scythe, etc. The pieces should be about 3 to 5 cm long. Cutting the material speeds the composting process.
- Turn the pile every few days. Use a shovel to mix it since composting is an aerobic process and depends on air. To test whether or not the composting process is occurring, put a stick into the middle of the pile. Leave the stick in the pile for three minutes, and then pull it out. If the stick is hot, you know that active composting is occurring, and you don't need to mix it yet. If the stick is dry, smelly, or cool, the pile must be turned to moisten it and allow air circulation. You may also have to add more carbon (dry, brown material such as straw, leaves, cardboard, etc.).
- Keep the pile moist, but not wet. Protect it from the rain. Urine can be used to keep the pile moist, and helps add nitrogen to the pile. A compost pile made in this way will be ready for use in only three weeks.



Planting:

- ▶ Try to transplant so that the plants are in the same soil, sun, and water conditions they are in the wild.
- ▶ Plants should be transplanted when they are dormant, such as just before the cold season, in spring before new growth, or before the rainy season.
- ▶ When digging up plant specimens, have a piece of burlap or plastic sheet ready to receive the roots and attached soil, and water, to keep the root ball moist. Dig the plant up with a spading fork so as not to cut the roots. The small feeding roots are more important than the large ones, which should be cut back to encourage new root growth.
- ▶ Replant the plant immediately in a hole 1/3 deeper and 1/3 wider than the root spread. A cool, cloudy day is best for transplanting.

1. Put topsoil or topsoil mixed with compost at the bottom of the hole before putting in the plant. If the soil does not have good drainage, a layer of gravel should be placed on the bottom, then topsoil or the mixture.
2. The old soil line on the plant should determine how much topsoil goes in the bottom.
3. Place the root ball of the plant in the hole, gently spreading the roots out.
4. Fill in the hole with more of the same soil or mixture. It should be very firmly packed so that there are no air holes.
5. Do not fill the hole quite to the ground level; leave a depression to catch and hold water.
6. Pile compost around the base of the plant.
7. Water the plant daily for a week while it adjusts to the change.
8. If the area is windy or the plant delicate, place a stick taller than the plant in the hole before planting. Tie the plant to the stick with a piece of plant material such as raffia.

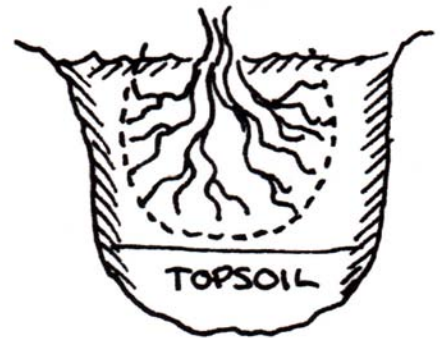

How to select and collect seeds:

Whether you are going to collect flower, shrub, or tree seeds, the basic methods apply to each.

1. Select adult plants that are healthy, strong, free from disease or insect infestation, from which to collect seeds.
2. Collect the seeds during the time of seed production.
3. Select species that grow in the same kind of environment as that in which the seedlings will be planted.





4. Select mature seeds.
5. Select seeds that are of the same color, size and shape.
6. Be certain that the seeds are free from disease.
7. Dry the seeds well before storing them. Those seeds that are naturally moist or sticky should be washed well before drying.
8. Do not mix seeds of different plants. Put them in jars or envelopes, labeling each by name, date and plant location.
9. If needed, a locally available dust insecticide can be mixed with the seeds to control insect pests.
10. Keep the seeds in a cool, dry place.

Growing seeds:

Seeds planted directly in the earth

Fine, small seeds should be covered with just a thin layer of soil that has first been turned over, mixed with compost, if needed, and raked to a fine texture. Lightly press the seeded earth with a board to make it firm. So that the seeds don't dry out, they should be gently watered in the late afternoons. (Use a seed shaker can with small holes punched in the bottom with a hammer and small nail.)

For larger seeds, plant them two or three times as deep as they are wide, pushing them into the soil, or placing them in an open row, then covering them over with the soil. Keep the earth moist. When seedlings are several centimeters high, pull out the weaker ones to leave the stronger ones more room to grow.



Ground cover

Ground cover of the variety recommended by the local agriculture agent should be sprinkled generously over soil that has been turned over, mixed with compost, if needed, and raked firm. Press seed into the soil with a board. The seeds should then be gently watered and protected from birds with a thin layer of straw or similar material. Seeded ground should not be walked on until the ground cover is growing well. Bare spots can be re-seeded.

Seeds for transplanting

Seeds of flowers, vegetables, shrubs and trees can be germinated for planting later in a permanent location. They can be started in pans, pots, cans, boxes or other containers. Seeds may germinate in a few weeks, or take as long as several months. Be patient. If the seeds have been started indoors, let them grow large enough to be able to withstand the open outdoor environment.



Prepare a soil of half sand and half soft rich soil (or compost). Place the soil in a container that has good drainage at the bottom, provided by gravel or pieces of broken pots. Plant the seeds as described above. Screen the top of the container with lattice, bamboo matting, a sheet of plastic or paper, so that the soil does not receive direct sun and dry out.

You need to keep seeds warm, moist and shaded, but not so moist or shaded that the seeds rot.

After the seeds have germinated and seedlings are several centimeters tall (4-6 cm), you can transplant them into individual containers whose soil is 3/4 of the former soil and 1/4 soil from where it will be permanently planted.

RESOURCES

Look for gardening books for your local area, or similar ecosystems. Search the following websites for current publications:

Volunteers in Technical Assistance (VITA)

www.vita.org

World Health Organization (WHO)

www.who.int

Smith, Marny and June Plecan. *School Garden Manual: A Step-By-Step Handbook for Teachers and Trainers Interested in Taking a First Step Towards Agricultural Development*. Save the Children, 1989. [ICE No. AG 243]





17 SIGNS, LABELS AND GUIDES

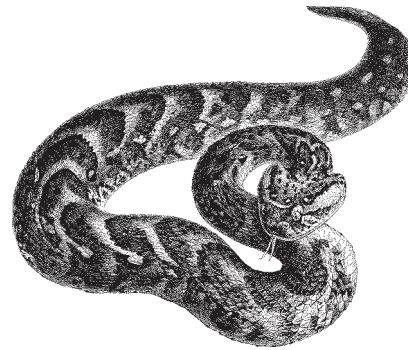

DESCRIPTION

Interpretive signs, labels and trail guides offer natural history, or other information to visitors, or notify them of locations or regulations. Planning for signs, labels and guides needs to begin when the site is being planned. Once the purpose of the site has been determined, the content of the interpretive signs, labels and guides can be decided.

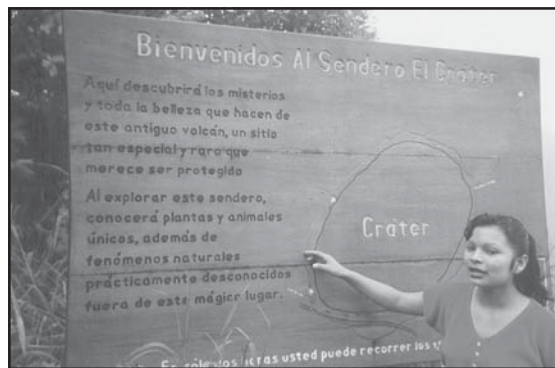

USES

Signs, labels, and guides should be accurate, simple, clearly understood, and attractive. They reflect the purpose of the interpretive site. For example, if you are creating a nature trail and you decide to highlight the cacti of the area, then the interpretive signs will be about cactus ecology and will identify types of cactus.

EXPECTED OUTCOMES

Signs, labels and guides help the visitor to notice important or interesting features. They identify species of plants, geological features, animal homes or use areas, and notify visitors of directions or expected behaviors.

EXAMPLES

► Signs

- Directions, distances, location of facilities
- Describe a view, ecosystem, or natural features
- Historical information
- Cultural information
- Maps
- Explain demonstration project
- Species information
- Code of ethics



- Expected behavior
- Warnings
- Regulations

► **Labels**

- Identify objects such as plant species

► **Guides**

- Self-guided nature trail information
- Give information about points along the trail
- Give seasonal information
- Include illustrations, graphs and charts
- Give directions and maps
- Describe habitats
- Describe natural features

**FEATURES TO HIGHLIGHT FOR SIGNS, LABELS
AND GUIDES ON A NATURE TRAIL
— SOUTH EAST ASIA —**

MAIN TRAIL

■ **OPEN FIELD:** In sun-filled areas like this, the plants have to deal with special problems: too much light, periods with too little water and, often, poor soil. Pick a blade of grass. Examine it. The size of the leaf is small so moisture will evaporate out slowly. The roots are a thick mass of fibers that can grip the hard soil, but they don't go very deep. They get their moisture mostly from rain and dew.



■ **EDGE OF FOREST:** Bigger plants like trees will slowly invade a field of bushes. They grow taller and make shade. This means that plants that love sunlight must slowly die and new plants that like more shade move in. The edge of the forest is rich in biodiversity.

■ **INSIDE THE FOREST:** Look around you and up in the air. Notice how the forest is made of several different layers. High above, the branches of the big trees weave together to form a canopy. Beneath these, we see a sparse layer of trees trying to grow up through the canopy. Lower down there is a layer of shrubs and small trees. Below that is a layer of small plants like ferns and seedlings.

■ **STRANGLER FIG TREE:** This is a fig tree. It grows around another tree. Its leaves shade out the sun until finally the other tree dies. Sometimes the original tree will rot away and the trunk of the fig tree will then be hollow.

■ **REST STOP:** (Any pretty place about halfway through the trail, especially good on top of a hill where people will want to stop anyway. Provide a log or a bench to sit on.) This is a good place to rest a minute. Sit and be absolutely quiet. Can you hear nature around you? The birds singing? The insects buzzing? The wind blowing?

(continued)





- **A BENT TREE:** As the tree grows, it twists and turns to reach as much light as possible. This tree may have started growing toward a hole in the forest canopy. At some point a new hole with more light opened up and the tree changed directions. Why might a hole in the canopy occur?
- **A BURL ON A TREE:** The lump on this tree is called a burl. It is caused by a virus infection. It does not kill the tree but it results in a malformation. The growth rings of the tree take on interesting shapes and the wood is used in tables, bowls and pipes.
- **CANOPIES:** High above your head, the branches of the tallest trees lace together to form another world. Trees bloom and fruit there, and animals live out their lives without touching the earth. Can you catch a glimpse of the happenings in that other world?
- **TREE STUMP:** This tree stump is decaying. It is becoming soil again. This process returns the energy that it used as a growing tree. Mosses, fungi, and insects are breaking it down.
- **YOUNG TREES IN A CLEARING:** As the old trees die, holes develop in the forest canopy and new spots of sunlight reach the forest floor. Here seeds sprout and new trees begin to take the old ones' places. The forest will regenerate itself, but if people destroy it, a tropical forest like this takes hundreds of years to grow again. The forestry department is protecting this land for your children.
- **SHADY AREA WITH BIG-LEAVED PLANTS:** Plants adapt to where they live. Usually big, thin or lacy leaves are for shady places because they allow the plant to catch as much sun as possible. They will not dry out because their environment is cool and moist. A fern is an example.
- **PATCH OF ABANDONED FARMLAND:** The soil was too thin for good farming here and the land was abandoned. The forest is returning in stages. First grasses, then thick brush, third low, thin jungle, and after many years, there will be tall, thick jungle.
- **BUTTRESS ROOTS:** Wide roots like these help to balance the tree. The roots cannot go deeply into the ground because it is hard clay just under the surface and all the nutrients are in the top two inches. The wide flanges give the trunk a wider base of support. Otherwise the weight of the trunk would tip and the roots would be pulled out of the ground.
- **CAVE:** This cave may have been formed many years ago when water slowly dissolved away some of the limestone in the earth. Some time later the surface of the earth changed, causing the cave to dry out and be revealed. Now it is a home for bats, snakes and other creatures.
- **A VERY TANGLED, DENSE AREA OF VEGETATION:** More kinds of plants and animals live in a tropical jungle than any place else in the world. Notice how dense the plant life is. A mixture of many things living together makes a stable environment because of the natural control all the species have on one another.
- **RATTAN PALM:** This rattan palm sends out long runners covered with thorns. They hook on to passing animals. They pull the runner to a new place where it can touch the earth and start another plant far away from the competition of the first.

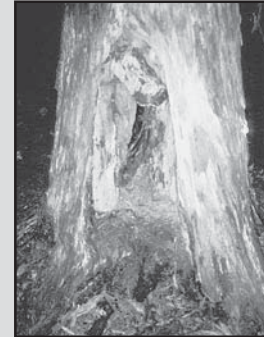

(continued)



SOIL LOOP

- **CLUMP OF PRETTY BUSHES:** Good soil allows plants to grow plentifully. It is a thin layer, however, and easily destroyed. Plants like these would soon die in a hot dry soil without water.
- **ROTTING LOG:** As this tree trunk rots, it builds up a soft, spongy layer of soil, called humus. This holds rainwater and provides food for other plants and insects. How does the rotting log feel? How does the ground nearby feel?
- **ROCK WITH LICHENS:** What looks like paint on this rock are actually lichens. A lichen is an alga and a fungus living together in a symbiotic relationship. They can live under very severe conditions, like on bare rock. They help to make soil by dissolving some of the rock into fine sand. Feel the rock around the lichen. Can you feel a sandy texture?
- **PLACE WITH MANY LEAVES ON THE FOREST FLOOR:** Leaves collect and rot, making new soil, just as the tree trunk did. Animal droppings and dead animals also add to the soil.
- **A WATER SPRING:** Rain soaks into the ground until it reaches a layer of rock that holds it. That water slowly moves underground until it comes out at springs or into rivers. If the soft topsoil is missing, the rain is not soaked up, but runs off. The water table underground is not replenished if the rain doesn't soak through the soil. The springs will then dry up.
- **EROSION SITE ON A TRAIL OR HILLSIDE:** Water is a powerful force. Can you see what it has done to the soil here? Compare this place to a place with plants. In a place with forest cover, the grid of roots holds the soft topsoil while the leaves slow the speed of the raindrops' fall. Shade keeps the ground from getting dry and hard.
- **DEEP CUT INTO A HILLSIDE WHERE A TRAIL OR ROAD WAS BUILT, WHERE SOIL LAYERS ARE VISIBLE:** Soil is found in layers. The top one is rich with plant food; the others are not. In the tropics the hot, wet weather makes things decay quickly, but topsoil does not build up because the food is utilized almost immediately by plants.



FOREST LOOP

- **VERY LARGE TREE:** Trees are the oldest living things on earth. Some can be more than 4,000 years old. They give us lumber, rich soil, clean air, and homes for wildlife.
- **A CLEARING OR BREAK IN THE FOREST WHERE THE SKY IS VISIBLE:** Look at the leaves of the trees above. Each one is helping you. Leaves produce the oxygen you breathe. They also take away carbon dioxide (which you breathe out) and other poisonous gases. Where does it smell the best, in the middle of the city or here? The leaves release moisture into the air, helping to form new clouds; they shade the ground and air, keeping them cool and comfortable. Think for a moment. Where is it cooler? Here or in the city?

(continued)





■ **ROOTS ON A ROCK:** Just as the roots of this tree have encircled this rock, so they are holding the soil below it. Small roots weave a mat that traps the soil in tiny pockets. This protects the light topsoil, from the force of rainwater. If the forest is cut or burned, the roots no longer hold the soil, and in a short time the rich topsoil is washed away by rain.

■ **TINY STREAM:** Forests help with the water supply. The leaves release moisture into the air, helping to form new rain clouds, while water in the spongy ground moves downhill slowly to emerge in springs and streams.



■ **LEAVES ON THE GROUND:** Leaves fall all the time, but especially in the dry season when the trees don't want to lose moisture through their leaves. These leaves rot quickly in the rainy season and help make new soil.

■ **TREE WITH HOLE IN TRUNK:** Trees provide a nesting place for animals to raise their young, to store their food, and to escape from their enemies.

WILDLIFE LOOP

■ **ROCK LEDGE WITH ANIMAL HOLE:** Under the large rock in front of you is a former animal home. The occupant may have moved away because so many people looked into it. See what a dry place this animal chose.

■ **TANGLED MASS OF BUSHES ON EDGE OF LARGE CLEARING:** The edges of forests often produce as much or more food and shelter for wildlife as the deep forest itself. Edges are good places to view wildlife.

■ **DEAD TREE ON GROUND:** A dead tree is a home for a great variety of things as it decomposes. Under the bark there are beetles and termites. Millipedes eat the decaying wood; centipedes hunt for other insects to eat. Inside, perhaps a mouse, a weasel or a porcupine has dug out a den. The home territory of a wild animal is usually a place where it can easily find food and shelter—perhaps a patch of grass, a whole pond, or a fallen tree like this.

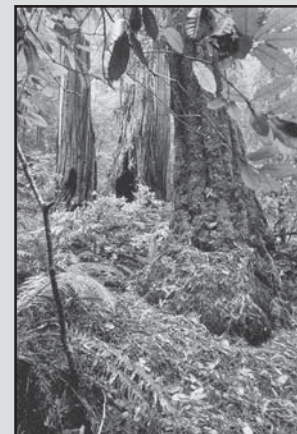

■ **A SALT LICK:** Just as you like salt on your food, so animals like and need certain minerals in their diet. Water deep in the ground rises to the surface carrying dissolved minerals that are deposited there. Look in the mud around you and see how many kinds of animal tracks you can identify.

(continued)



- **CLEAR STREAMSIDE:** The water here is cool and clear. You may see some fish. Compare this to any of the streams outside the park. Is the color the same? Just as some animals need a forest where the canopy is complete, so certain fish, snails and insects need streams where the water is clean. The forest and its soil filter the water and keep it clean.
- **LARGE TREE THAT HAS FOOD FOR ANIMALS IN MONTH WHEN MOST VISITORS COME:** In the month of _____ this tree has fruit that is eaten by (name some animals, birds). This also attracts animals that eat the fruit-eaters. All these animals help the tree in return by spreading the seeds and fertilizing the soil.



HOW TO DO IT

The style of the signs and labels should be patterned after the environment of the region. Local materials can be used that reflect the ecosystem being highlighted. The signs and labels should blend in with their surroundings, and not outshine the objects they are explaining. They must be made of sturdy, weather-proof materials, and use a consistent style throughout.

Making signs:

Signs and their supports should be of natural materials of the region, such as wood, bamboo, or stone, to blend with the environment. The style of lettering should be the same for each sign. Signs should be varnished to protect them from rain, humidity, sun, etc. The following suggestions for making trail signs can be adapted to your needs and to local supplies.

1. Select good quality dry wood (or other suitable material).
2. Cut wood into desired sizes, depending on the amount of lettering or artwork planned.
3. Sand the flat sides and edges until smooth, if you are using wood.

TIPS FOR LOW TECH SIGNS AND LABELS

- Use local wood
- Paint or varnish on both sides
- Carve lettering and then use a soap bottle with a small opening in the lid to apply paint to the gouged letters
- Labels can be made from many materials but should be backed with wood if the materials can be torn, bent or broken
- Use waterproof ink
- Paper labels can be dipped in paraffin or put in a picture frame to protect them



4. Apply undercoat enamel (or varnish) to sides and edges. Let dry and apply another coat of enamel or varnish. Smooth with fine steel wool or sandpaper.
5. Trace letter pattern. Ink or paint the letters.
6. When letters are dry, apply two coats of waterproof varnish.
7. You may wish to soak your signposts in a preservative solution. Check locally for environmentally friendly options.
8. Place your signposts in well-drained holes by digging the holes an additional 25 cm deeper than post bottoms will be. Fill with 25 cm of gravel, then bury posts at the desired depth and apply the treatment preservative around the base, if desired.
9. Mount the sign with screws on posts. A center post mount 5 cm x 5 cm is good for small signs; a hanging post is good for larger signs (use screw hooks in a 10 cm x 10 cm post).

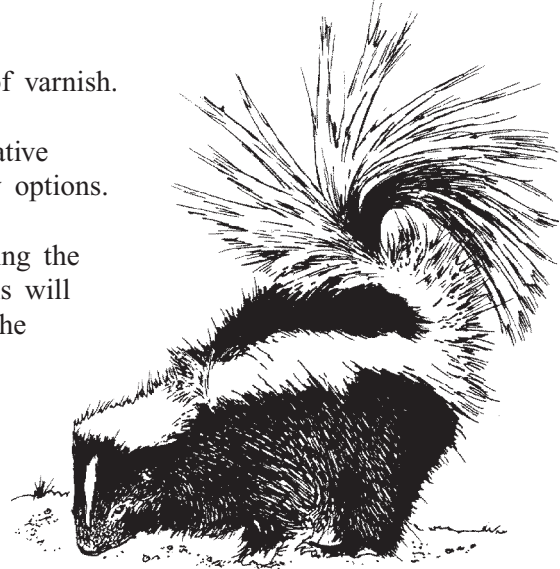

An alternate method of lettering is to trace a letter pattern on cut, sanded wood, then cut out the letters with gouging tools to a shallow depth (.3 cm). The cutout letters can then be painted a contrasting color (white paint on dark wood). A good way is to put the paint into a plastic bottle with a screw-top spout and squeeze the paint into the letters. When the paint is dry, apply two coats of waterproof varnish.

Making Labels:

Labels are generally smaller than signs and identify species along the trail. They enable the users to guide themselves over the trail. In addition to identifying the species, labels may have interesting information about the species including links to the visitor's experience.

A good label will be accurate, interesting, short and easy to read and understand. Labels can be made of paper, plastic, masonite, wood, plywood, sheet metal, cardboard, paper baggage tags. Labels can be backed by wood, metal or plastic to be mounted or seen better. Materials that could be torn, bent or broken can be glued to wooden blocks.

Lettering on the labels can be inked or painted by hand or stencil, or press-on letters, a typewriter or computer can be used. The writing should be neat and clear.

Paper labels should be waterproofed after they are lettered. To do this, melt some white wax or paraffin in a large can (coffee can, dry milk can); dip the label in the wax to cover it completely; dry. (Be careful: melted wax can cause burns.)

Nature trail labels can be mounted on simple stakes at the trailside.

For indoor use, in special cases where a newspaper clipping, magazine article or photograph needs special protection, a picture frame or plastic lamination can be used.



Trail guides:

Trail guides allow users to use a site by themselves. They are usually in booklet form that includes a map of the trail showing the location of the features of interest, and natural history of the area. Remember to include the smaller and less visible members of the ecosystem in trail guides, such as insect homes, lichens, mosses, etc. The lifestyles of these less flashy organisms can be very interesting to visitors.

Trail guides can be very attractive if they use a storytelling style. In addition to the statistics about an organism, the guide can relate a tale of its lifestyle. For example, when telling about a pine, the trail guide can describe the many ways pines are used by people, what organisms live in the pine, how the Pine Bark Beetle invades, and how the pines fight back. Key characteristics for identification help the visitor to learn about the organisms they are viewing.

RESOURCES

Ham, Sam H., *Environmental Interpretation: A Practical Guide for People with Big Ideas and Small Budgets*. Golden, CO: Fulcrum Publishing, 1992. [ICE No. FC190]

Oberbillig, Deborah Richie. *Providing Positive Wildlife Viewing Experiences: A Practical Handbook*. Watchable Wildlife Incorporated, April 2001.



Community Environmental Sourcebook

This project can be initiated with various community members and groups. The idea of an environmental sourcebook is to document community knowledge in visual and creative ways and make it accessible to community members to ponder and discuss. Suggestions for potential groups to involve include students of all ages, youth organizations, women's groups, farmers associations, religious organizations, and other community based organizations. A Community Environmental Sourcebook does not necessarily need to be in a classic book format, although that is an option. In conjunction with the community group, think of creative ways to display information about the environment in the community, and to represent people in the community.

From *Learning Local Environmental Knowledge: A Volunteer's Guide to Community Entry*, Washington, DC: Peace Corps. [ICE No. M0071]



EXHIBITS

18 EXHIBITS

DESCRIPTION

Exhibits explain and interpret the surrounding environment. Exhibits should be thematic, specific and informative. Photographs, charts, maps and models may be used to support the theme. Exhibits can be only for viewing, or they may be interactive. Exhibits mounted on panels usually include text, photos or illustrations, and maps, charts or graphs. To increase interest, they may ask questions or pose problems to the visitor, who can lift a flap to find the answer. If the technology is available, slide shows, videos or computer displays can be effective.

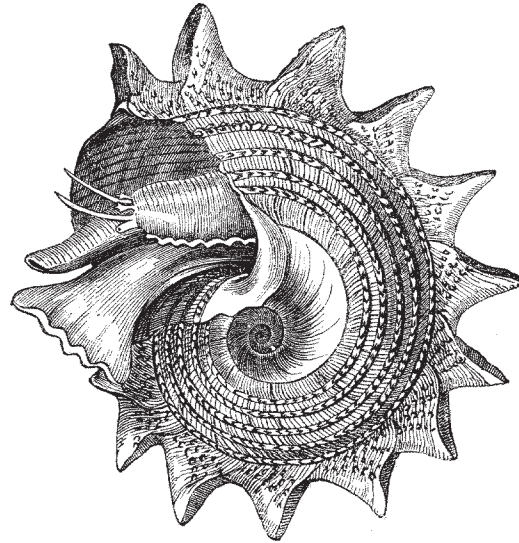

USES

- ▶ Exhibits display live animals in aquariums or terrariums.
- ▶ They might be mystery boxes that challenge the visitor to use the sense of touch to identify a sample from the ecosystem.
- ▶ Exhibits can include collections of identified specimens of bugs or minerals, or they may offer the visitor an opportunity to handle (sturdy) specimens.
- ▶ An exhibit may identify birds or trees in the area, or show all the ways the particular tree is used by local people.
- ▶ A panel may show the many inhabitants of a coral reef, or a rainforest canopy.
- ▶ Dioramas might compare ecosystems in the region, such as desert, alpine or woodland.
- ▶ An exhibit could describe endangered species in the area, or the effects of irrigation.
- ▶ A traveling interactive snow leopard board might describe leopard characteristics, habits, habitat, and other information. The board could be used in buffer-zone schools.
- ▶ Visitors can learn how to determine rock hardness by doing scratch tests, or learn about soil porosity by pouring water through several types of soil.
- ▶ Visitors can experiment with erosion by playing with a model watershed.



- ▶ Visitors can make leaf prints or fish prints.
- ▶ An exhibit could showcase a demonstration project on the effect of various fertilizers, or show people how to build a solar cooker.

When constructing exhibits, you will want to make them withstand visitor use. They should be attractive and easy to look at (or hear or touch). Pointing out relationships among parts of the ecosystem enriches the educational value. The exhibit should be designed for the target audience. Exhibits can be costly to construct, but often they will last a long time.





Exhibit Example

FARMLAND ECOSYSTEM STUDY WHEEL

How to do it:

The Farmland Ecosystem Study Wheel involves the visitor in learning about the components of a particular ecosystem. The components include the living and nonliving parts of the system. The non-living parts are sun, water, soil and air. The living components include the plants and animals that form the interdependent food webs of the system. In this exhibit, a simplified ecosystem that is characteristic of farmland is represented.

A spinning wheel with an arrow and a reading window is mounted over a set of information cards such that the arrow will point to a particular illustration and the reading window will show information about that illustration.

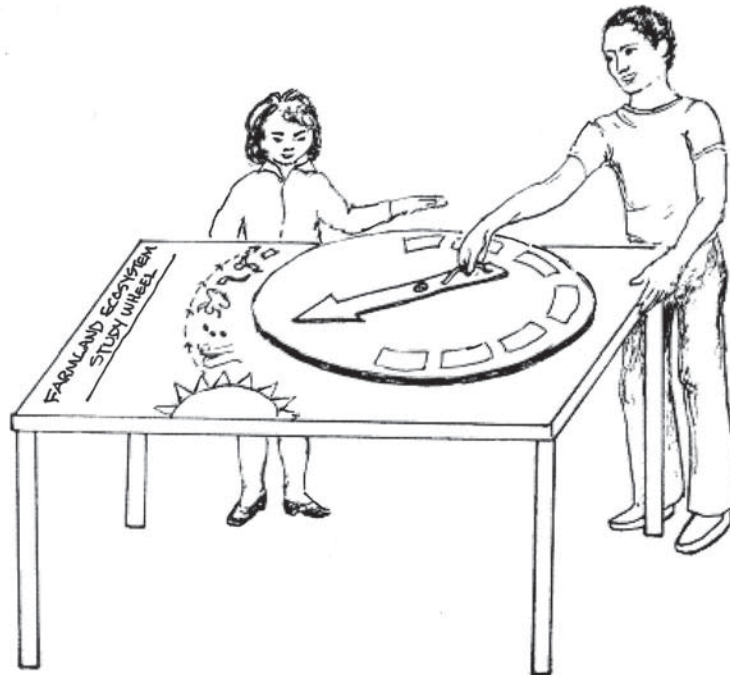

Study Wheel Figure 1

Illustrations and Cards

- 1. Sun:** The sun provides the heat and light needed by all living things.
- 2. Grain:** Plants use sunlight, water and soil to grow. Plant leaves give oxygen and water to the air. Grain grows better and stronger in soil rich in nutrients.
- 3. Insect:** Most insects are plant eaters. Some of them help to return dead plant material to the soil.
- 4. Frog:** Frogs and toads are insect eaters. There would be many more insects without insect eaters.



5. **Snake:** Snakes eat frogs and toads. Snakes will live where there are frogs to eat.
6. **Hawk:** Hawks hunt for snakes and other small animals. Since hawks can fly, their hunting area is very large.
7. **Dead bird:** When an animal like a bird dies, other animals use its body, or decomposers return it to enrich the soil.
8. **People:** People need good plentiful grain to be strong and healthy.

Materials needed:

- ▶ 1 board of medium plywood or heavy cardboard 100 cm x 100 cm
- ▶ 1 board of medium plywood or heavy cardboard 100 cm x 125 cm
- ▶ 1 strong bolt 5.5 cm with nut
- ▶ 6 washers
- ▶ 1 arched door handle or wooden knob
- ▶ 1 or 2 screws
- ▶ Small nails
- ▶ Assorted enamel paints
- ▶ 9 white cards 5 cm x 10 cm

Illustrations for Revolving Wheel:

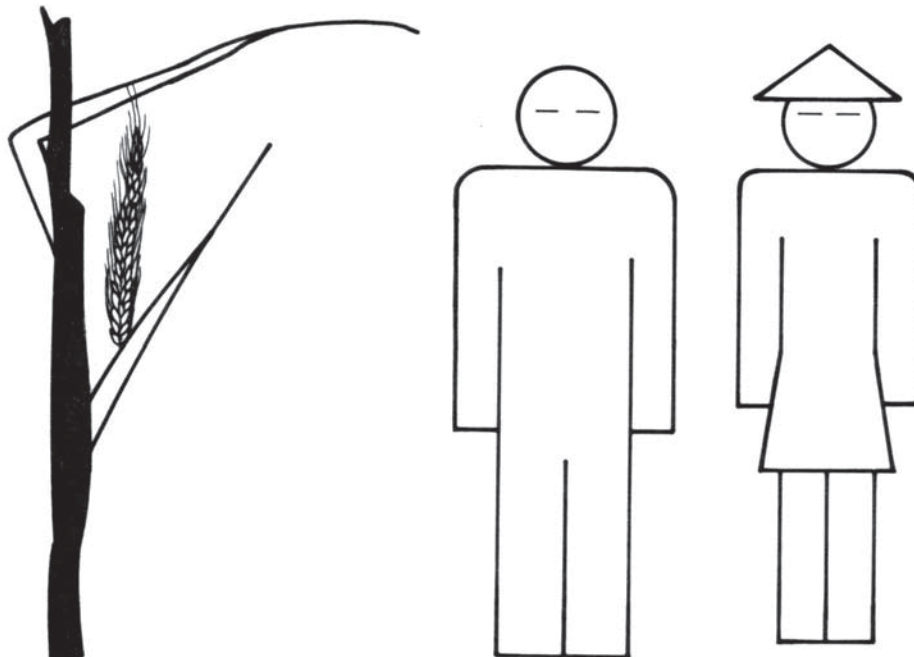

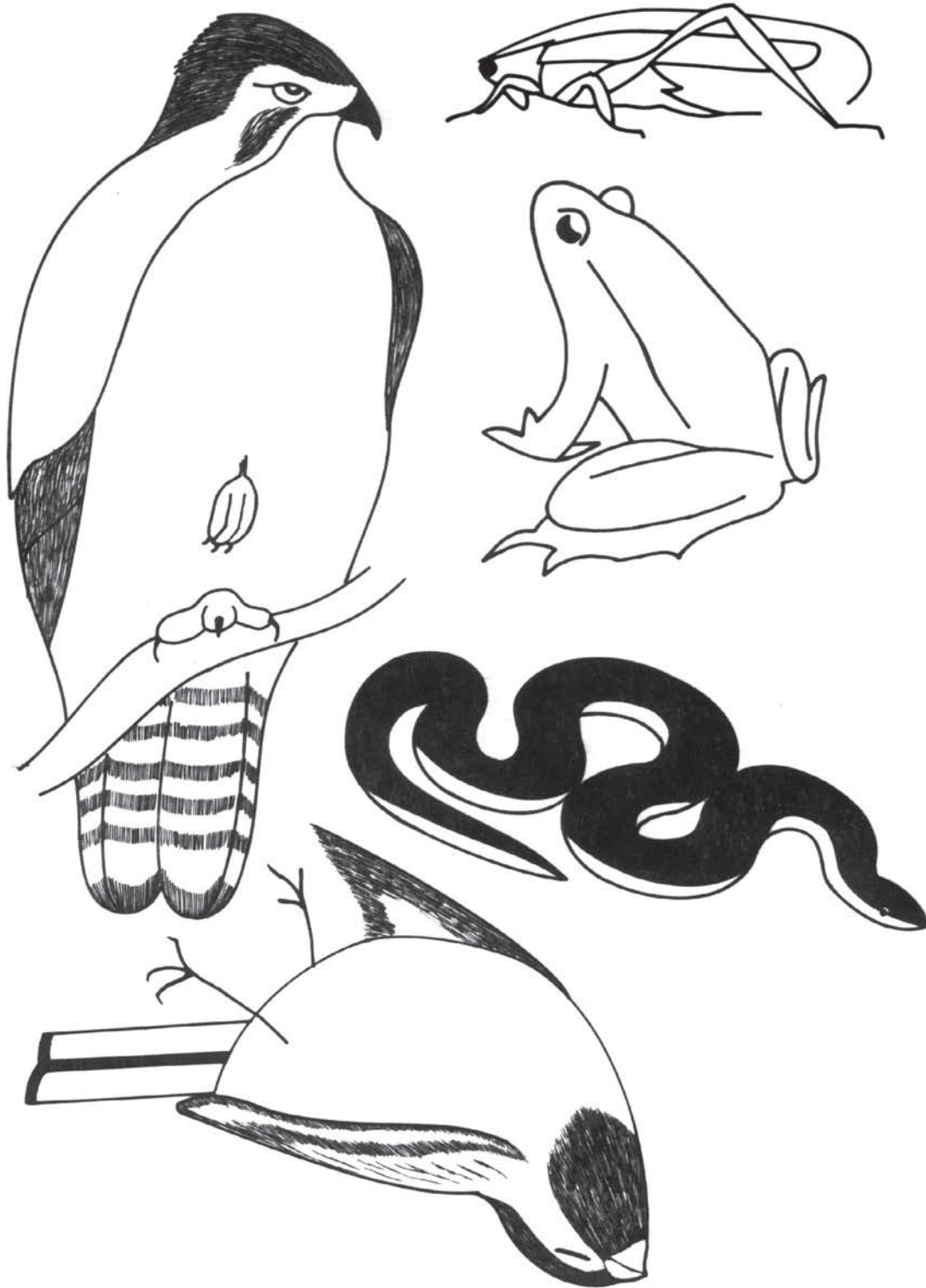

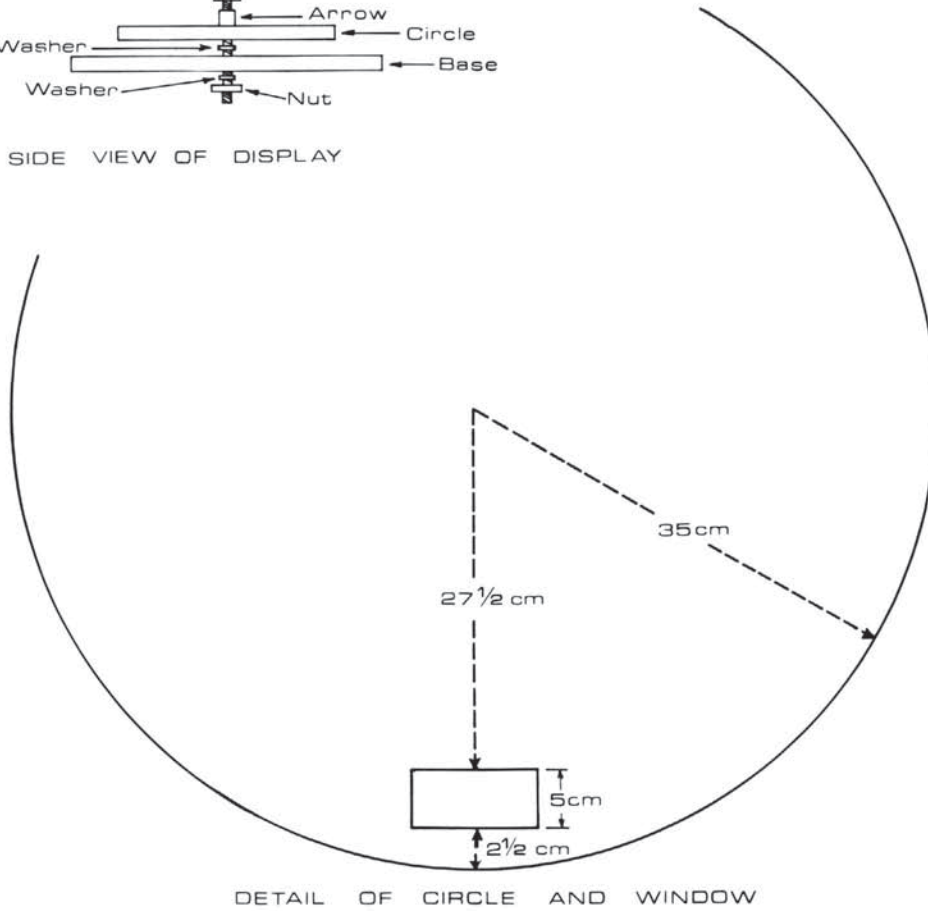
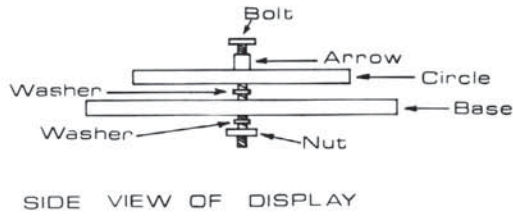
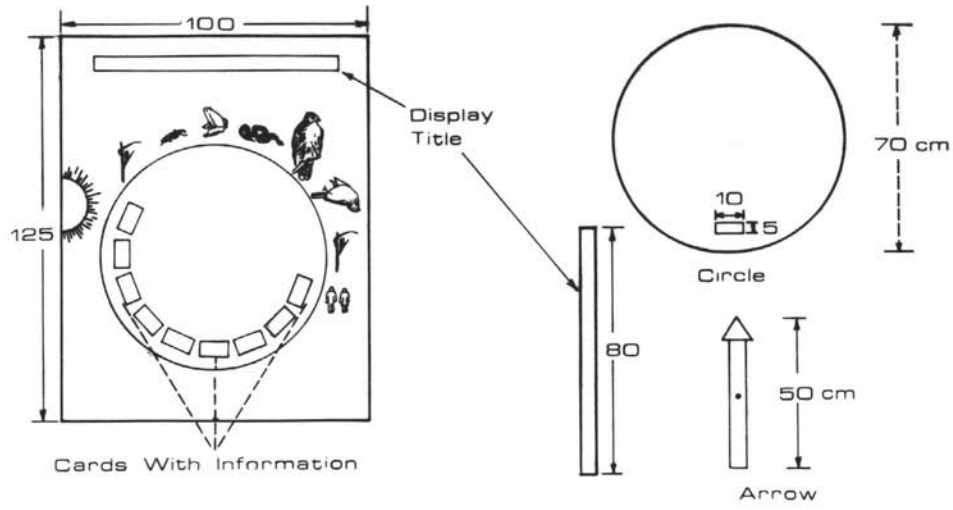

Study Wheel Figure 3



Procedure:

1. Cut out a 70 cm circle from the corner of 100 cm x 100 cm board.
2. Cut arrow 5 cm x 50 cm from 100 cm x 100 cm board.
3. Cut display title strip 80 cm x 5 cm from 100 cm x 100 cm board. (Title can also be lettered directly on base after base is painted.)
4. Paint the various parts: the baseboard, 100 cm x 125 cm might be dark green; the circle a lighter green; the arrow red.
5. Transfer outline drawings to the baseboard as shown in Study Wheel Figure 2. Use black ink outline, or paint in natural colors.
6. Type or print text on cards. Nail or glue cards on base, directly opposite the corresponding illustration.
7. Cut a 5 cm x 10 cm reading window in the circle.
8. Drill a hole for the bolt through the center of the arrow, the center of the circle and the center of the board.
9. Attach the handle or knob to the arrow with screws.
10. Nail the arrow with small nails to the circle so that the base of the arrow is directly above the reading window.
11. Pass the bolt through the arrow and circle, place washer(s) between the circle and the base; pass the bolt through the base; add washer(s) and the nut. Test the turning of the circle. Add washers until it turns easily.





Exhibit Example

HIDDEN USES OF A FOREST

The purpose of this exhibit is to highlight ecosystem services. On a display board showing a forest, lift-up panels are placed at strategic points to describe services provided by the forest. Visitors lift panels and read about ecosystem services.

How to do it:

Materials needed:

- ▶ 1 medium plywood or heavy cardboard 75 cm x 100 cm
- ▶ 7 medium plywood or heavy cardboard covers 5 cm x 10 cm
- ▶ 1 plywood or heavy cardboard sign strip 5 cm x 60 cm,
- ▶ 1 plywood or heavy cardboard sign strip 10 cm x 30 cm
- ▶ 14 lengths of leather lacing or string, 15 cm each
- ▶ Paint: green (leaves), brown (trunks and ground), blue (water), light blue (sky), black (roots, signs), yellow (sun), white
- ▶ 7 white cards, 5 cm x 10 cm for text under covers

Note: 1 plywood board 90 cm x 100 cm is sufficient for all parts

Procedure:

1. Using a grid, enlarge Forest Figure 1 onto the 75 cm x 100 cm board.
2. Drill 3 mm holes in the 7 covers and the main board as shown in Forest Figure 1 and below.
3. Paint the board picture as indicated under “paint” above.

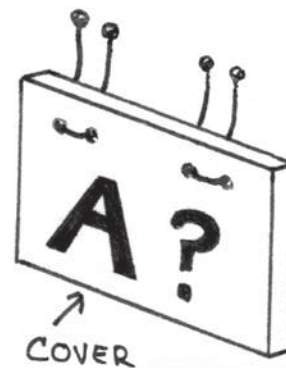
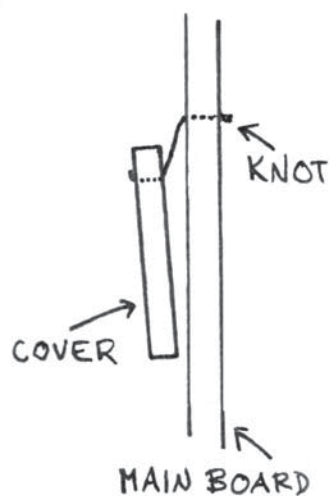

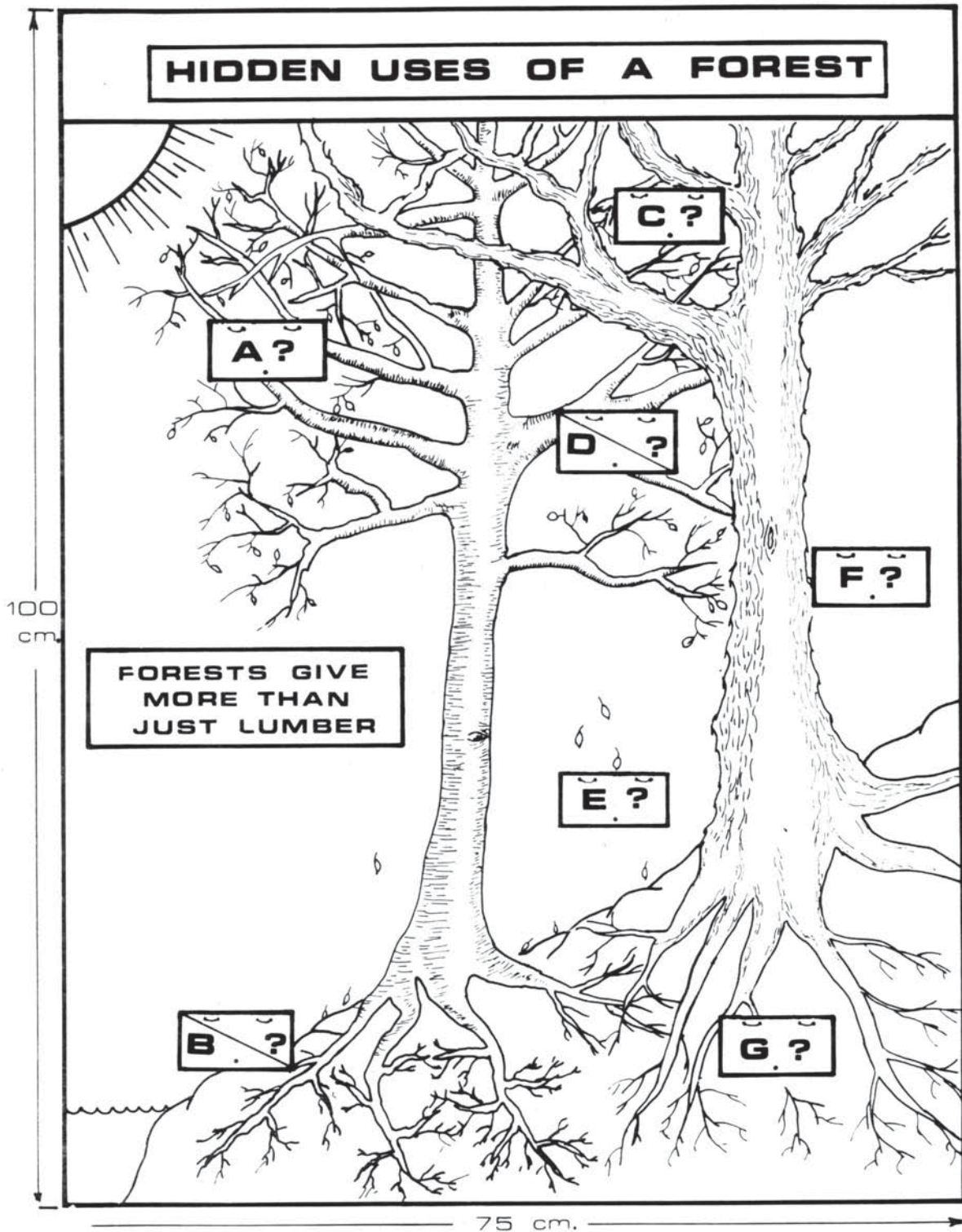

Forest Figure 1





4. Type or print text on cards.
5. Paint the covers.
6. Paint text on signs (black paint).
7. Paint black question mark (?) and letter on covers as in Forest Figure 1.
8. Glue or nail signs to main board as in Forest Figure 1.
9. Attach covers to main board by weaving the lacing or string through the drilled holes and tying a knot at the back as shown above.
10. Glue text cards under covers.

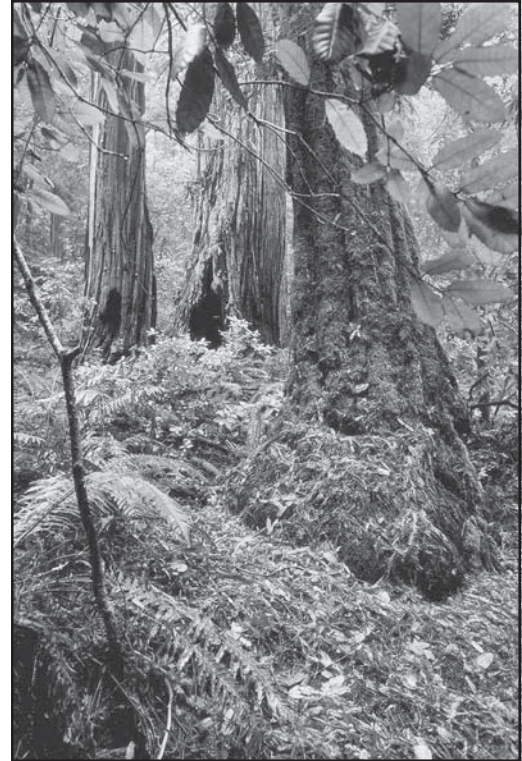

Text:

Panels

- A** = Leaves make oxygen that animals breathe.
- B** = Roots hold moisture and retain soil.
- C** = Leaves, flowers, bark, seeds, and fruit provide food for animals and people.
- D** = Tree canopy provides shade and shelter for plants, animals and people.
- E** = Trees add moisture and clean the air.
- F** = Trees provide homes for animals in their branches, trunk, canopy and root systems.
- G** = Roots and soil organisms work together to build soil, retain water and cycle nutrients.

5 cm x 60 cm sign strip = **Hidden Uses of a Forest**

10 cm x 30 cm sign strip = **Forests Give More Than Just Lumber**





Exhibit Example

LIFE PYRAMID

How to do it:

The life pyramid poster shows the trophic levels of an ecosystem and the relative numbers of organisms each can support. At the base of the pyramid are the producers; the plants that need soil, sun, air and water to grow. The next level has the primary consumers that eat plants and do not produce their own food. Secondary level consumers prey on primary consumers. Tertiary consumers prey on secondary consumers, and so on. Each trophic level has fewer organisms. For example each insect eats many plants, and each frog eats many insects. Trophic levels form a food chain, and the predators at the top of the food chain are dependent on all the organisms at the lower levels. At each trophic level energy is transferred up to the next level, but energy is also lost during the process.

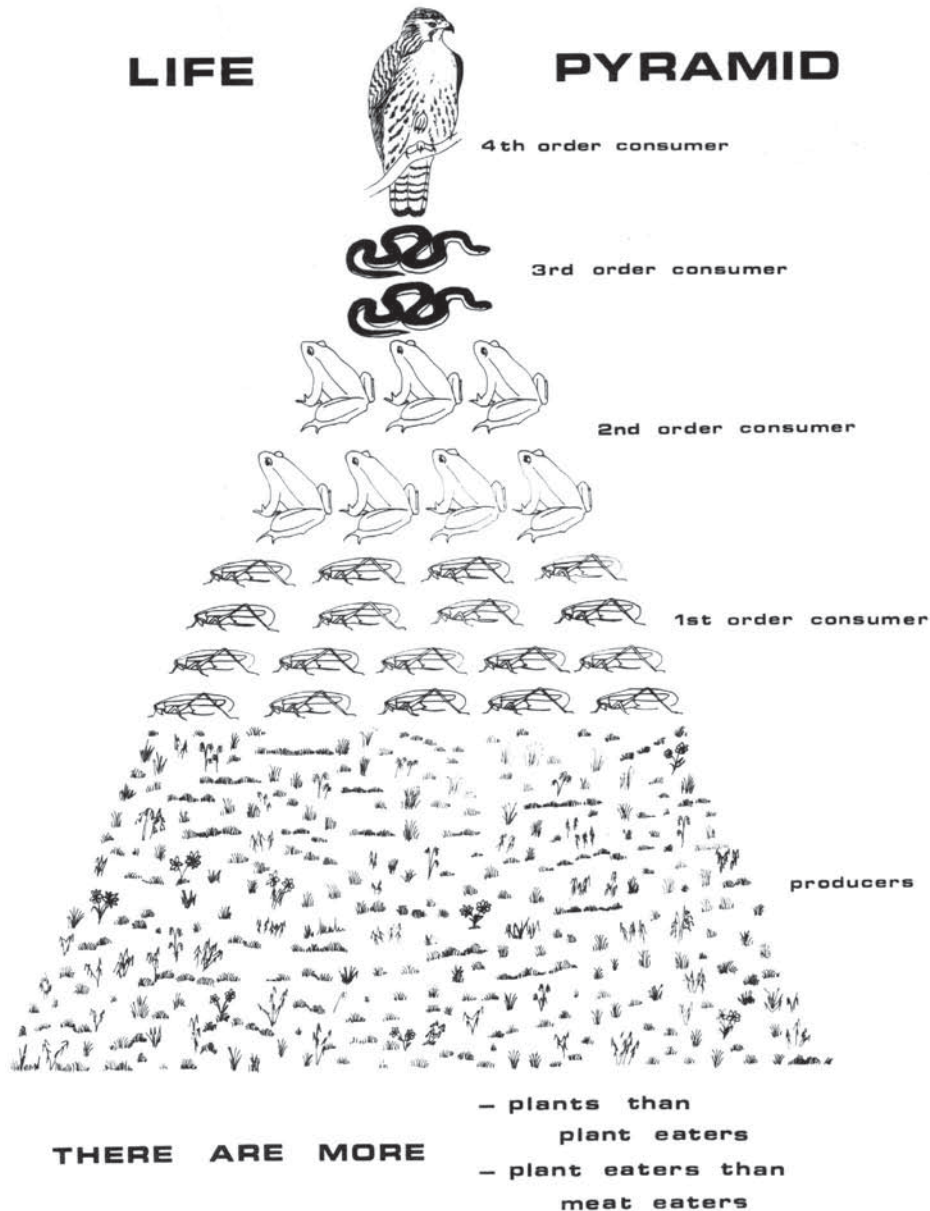



Exhibit Example

WETLAND CONNECTIONS

A Wetland Connections exhibit shows the complexity of interrelationships of organisms in a wetland. The visitor will discover the connections between the organisms in a wetland by tracing the energy from the eagle through the ecosystem back to its source, the sun.

How to do it:

Materials needed:

- ▶ 4' x 3' piece of plywood for background painting of wetland scene
- ▶ 13 small pieces of wood with pictures of organisms on them (organisms listed below)
- ▶ 13 small hinges for attaching wood pictures to plywood
- ▶ 13 cards with text to attach under the pictures (text below)



Organisms and text:

(Title) Wetland Connections: Where does an eagle get its energy?

Eagle: The eagle gets energy by eating ducks, large fish and mice. Where do ducks, fish and mice get their energy?

Duck: Ducks eat spiders, insects and plants. Where do they get their energy?

Large Fish: Large fish eat smaller fish and insects. Where do they get their energy?

Mouse: Mice eat seeds, fruits and grasses. Where do they get their energy?

Spiders: Spiders get their energy from eating insects. Where do insects get their energy?

Insects: Insects get their energy from eating zooplankton. What are zooplankton and where do they get their energy?

Small fish: Small fish get their energy by eating insects and zooplankton. Where do they get their energy?



Zooplankton: Zooplankton are very small creatures that live in the water. They do not make their own food, but eat even smaller creatures called phytoplankton. Where do phytoplankton get their energy?

Phytoplankton: Phytoplankton are very small organisms that can photosynthesize their own food. They get the energy to make their food from the sun.

Plants: Plants can make their own food from air and sunlight. They also get nutrients in the soil and water. Their energy mainly comes from sunlight.

The Sun: The sun is where it all starts. The energy from the sun is converted into plants and plant food. Plant eaters use the energy from plant food to grow and stay healthy. Consumers that eat plant eaters use their energy to grow and stay healthy. The eagle eats the consumers that ate the consumers that ate the plants that used the energy from the sun to make food.

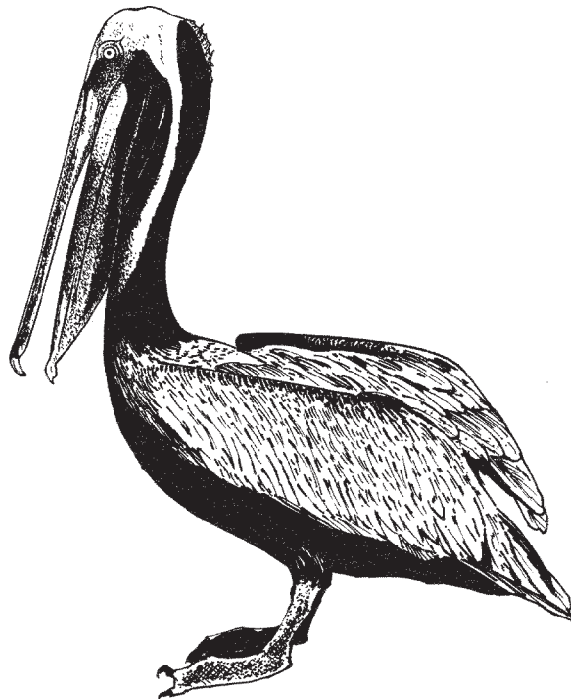
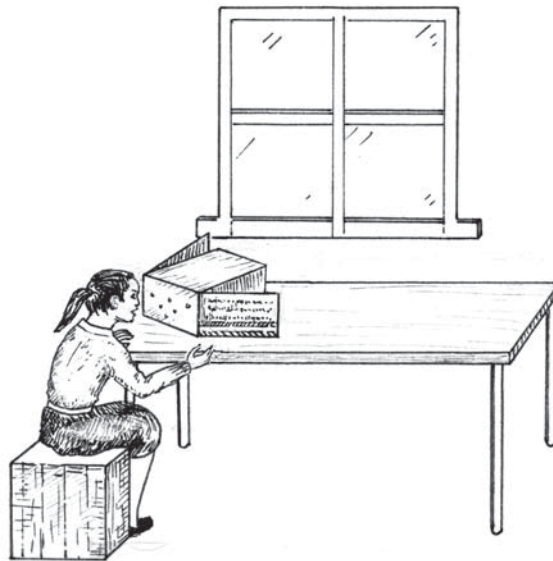



Exhibit Example

WHAT MAKES SOIL?

The soil exhibit is a peephole box that shows visitors pictures of soil-making animals that work on and beneath the soil. It describes three levels of soil and the organisms that live in them.



How to do it:

Illustrations:

- ▶ **Top level:** Millipede, Fungi, Beetle
- ▶ **Middle level:** Earthworm, Mole
- ▶ **Bottom level:** Water

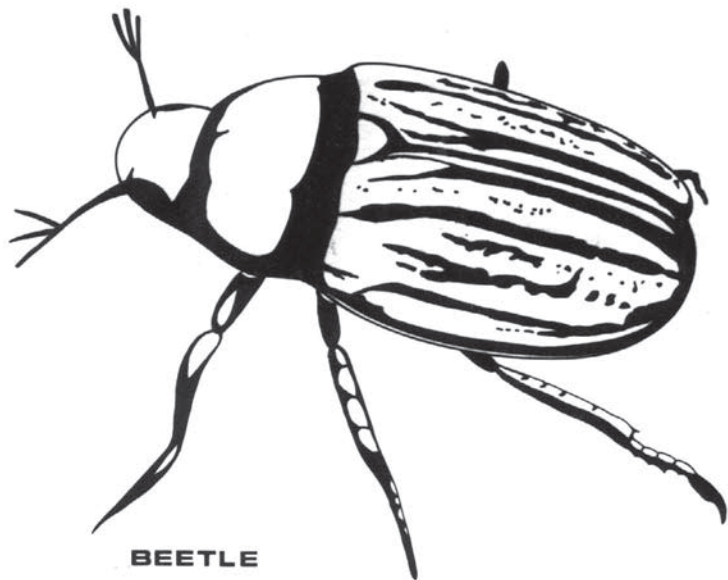

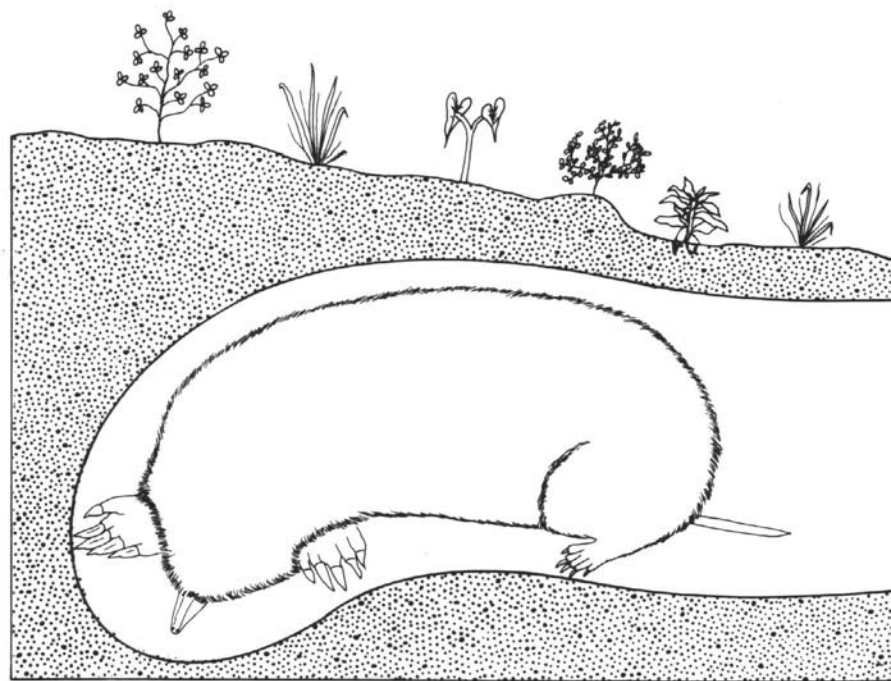
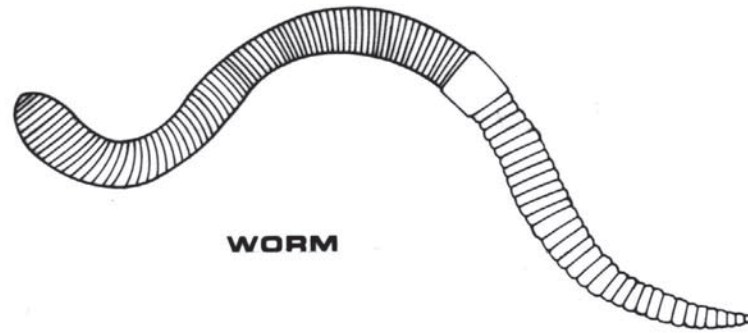

Materials needed:

- ▶ 2 plywood or heavy cardboard 100 cm x 150 cm
- ▶ 4 plywood or heavy cardboard 50 cm x 100 cm
- ▶ 1 plywood or heavy cardboard 50 cm x 150 cm
- ▶ 6 bamboo tubes 25 cm long, 2.5 - 3 cm diameter
- ▶ 12 wood blocks 5 cm x 5 cm x 10 cm
- ▶ 6 panes of glass*, frosted or covered with a thin coat of white paint, 20 cm x 20 cm
- ▶ 24 corner braces to hold glass
- ▶ 4 medium hinges



- ▶ 2 hooks and eyes
- ▶ enamel paint (optional): small amounts of gray, reddish brown, brown; tan for entire box

* Alternatives for the glass pane, especially if you are using cardboard, could be:

- Translucent polyethylene sheet, cut to size
- Transparent polyethylene sheet made translucent by rubbing with fine sandpaper
- Thin white paper
- White cloth

The illustrations could be transferred and inked directly onto these materials, which could be taped over the openings.

Procedure:

1. Measure and cut square holes 19.5 cm x 19.5 cm in one board 100 cm x 150 cm as in Soil Figure 1. This will be the back panel.
2. Place the other 100 cm x 150 cm board under the back panel, and mark the position for the viewing holes on the front panel so that they will be in the middle of each rear square.
3. Cut or drill the holes for the viewing tubes in the front panel; attach the wooden blocks at top and bottom of holes to support tubes; place tubes in position so that they point directly at each corresponding glass.
4. Assemble the box and paint tan (optional).
5. Letter the information on Soil Figure 2 onto the foldout wings and attach them to the box with hinges. Attach hooks and eyes to keep wings in position.
6. Glue paper illustrations with their names to the panes of glass; attach panes to rear panel with corner braces: top level: Millipede, Fungi, Beetle; middle level: Earthworm, Mole; bottom level: Water (use illustration of raindrops).
7. Place box at a window where light will shine through rear panel openings.

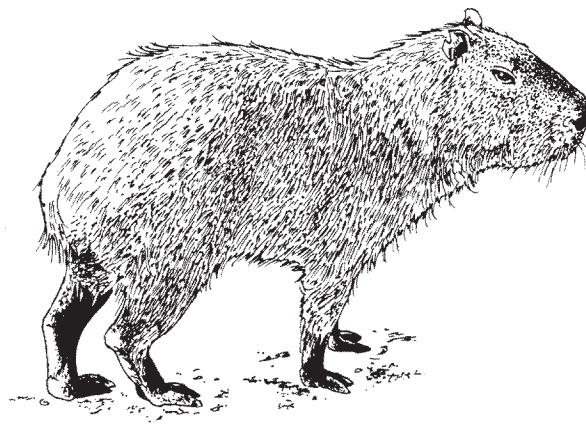

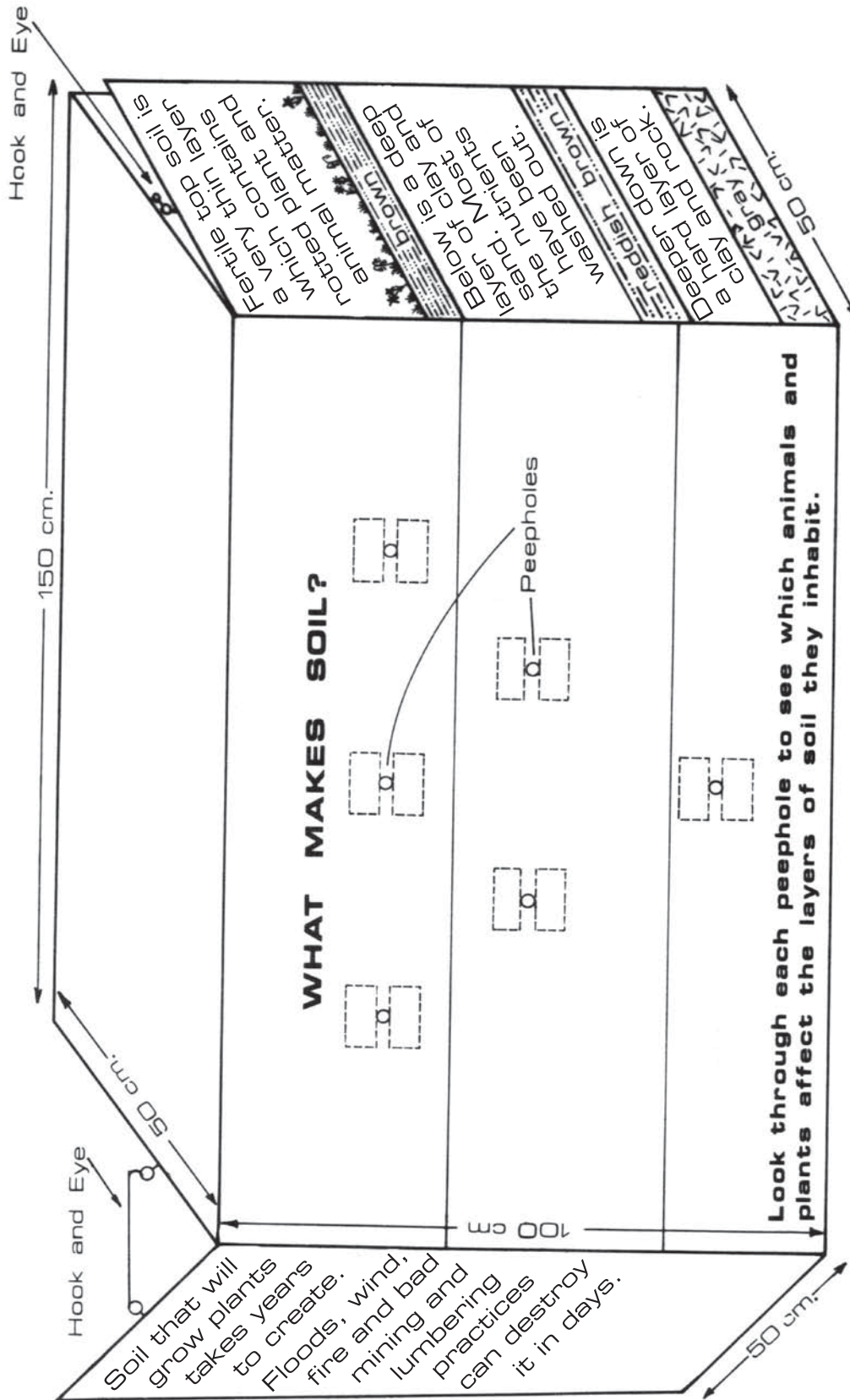

Soil Figure 1



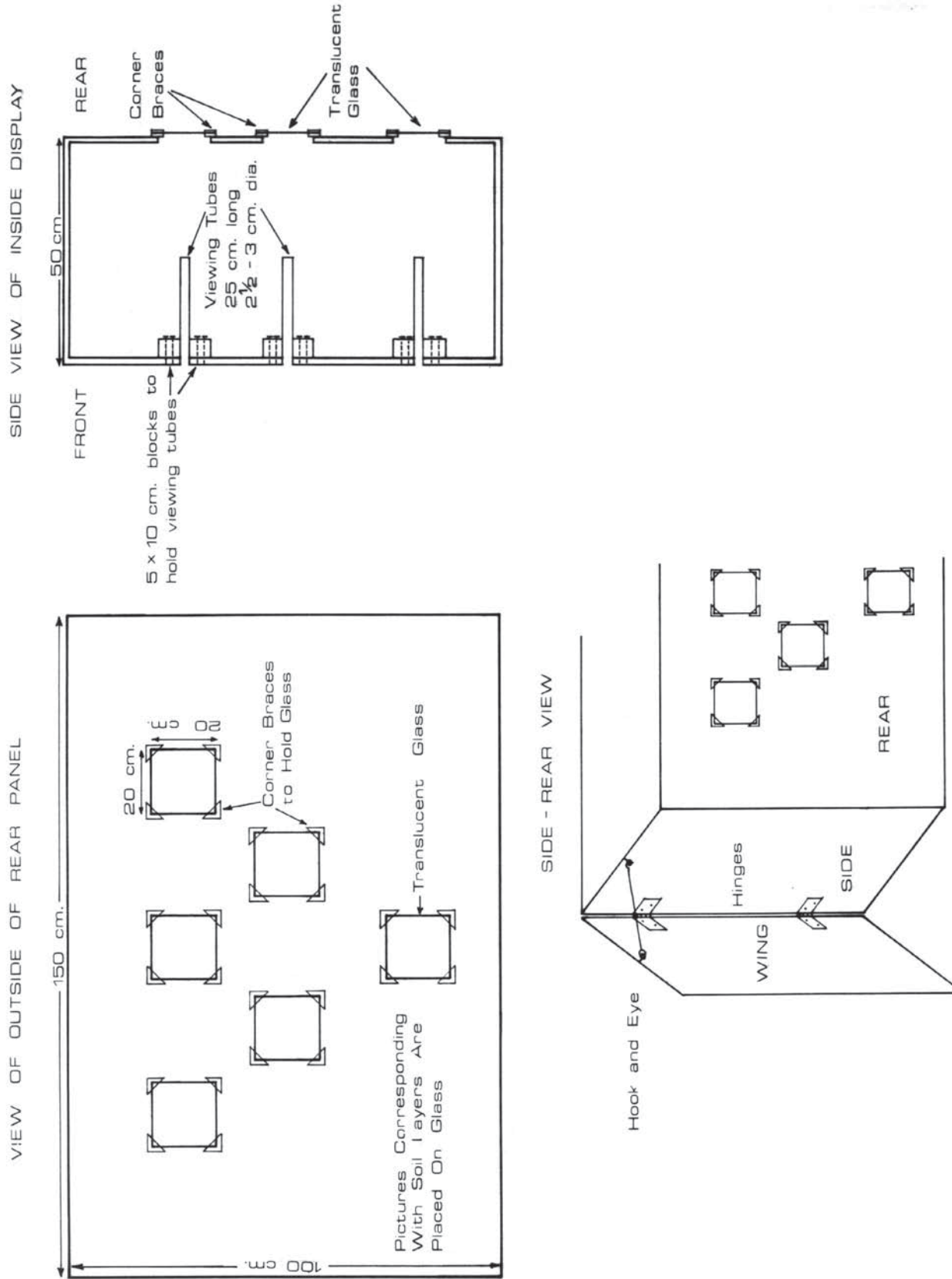

Soil Figure 2



Exhibit Example

WHY DO WE NEED TREES ON HILLSIDES?

This exhibit simulates a hillside with groups of trees. A tilted board simulates a hillside, with nails simulating trees. More trees are on one side than the other. Marbles are used to simulate the flow of water downhill. Visitors will see that the trees will slow the flow of water.

How to do it:

Materials Needed:

- ▶ 1 plywood board 65 cm x 109 cm
- ▶ 2 pieces of wood 2 cm x 2 cm x 5 cm (part D)
- ▶ 1 triangular block of wood 15 cm x 15 cm x 40 cm long
- ▶ 100 nails 5 cm long or slender sticks of wood or bamboo 6 cm long
- ▶ 12-15 marbles, cowrie shells, round stones, round beans
- ▶ green enamel paint

(*Optional:* brown paint; sheet of glass or plastic to cover top)

Procedure:

1. Cut a piece of plywood 50 cm x 75 cm for the main board.
2. From the remaining piece of plywood cut:
 - part A - 3 strips 5 cm x 75 cm
 - part B - 2 strips 5 cm x 50 cm
 - part C - 2 strips 2 cm x 42 cm
 - part E - 1 piece 20 cm x 50 cm
3. Attach A and B at the board's sides with nails to form an edge around the board, and to divide it up the middle. See Trees Figure 1.
4. Attach the two strips C on the bottom of the board to form parallel strips, then nail part D, the 2 cm x 2 cm x 5 cm wood pieces at each end so the board will stay on the triangle.
5. Label end board (part E) with text and nail into place, as in Trees Figure 1.
6. Hammer many nails approximately 1 cm into one side of the divider and only a few nails on the other side.
7. Paint the board green.



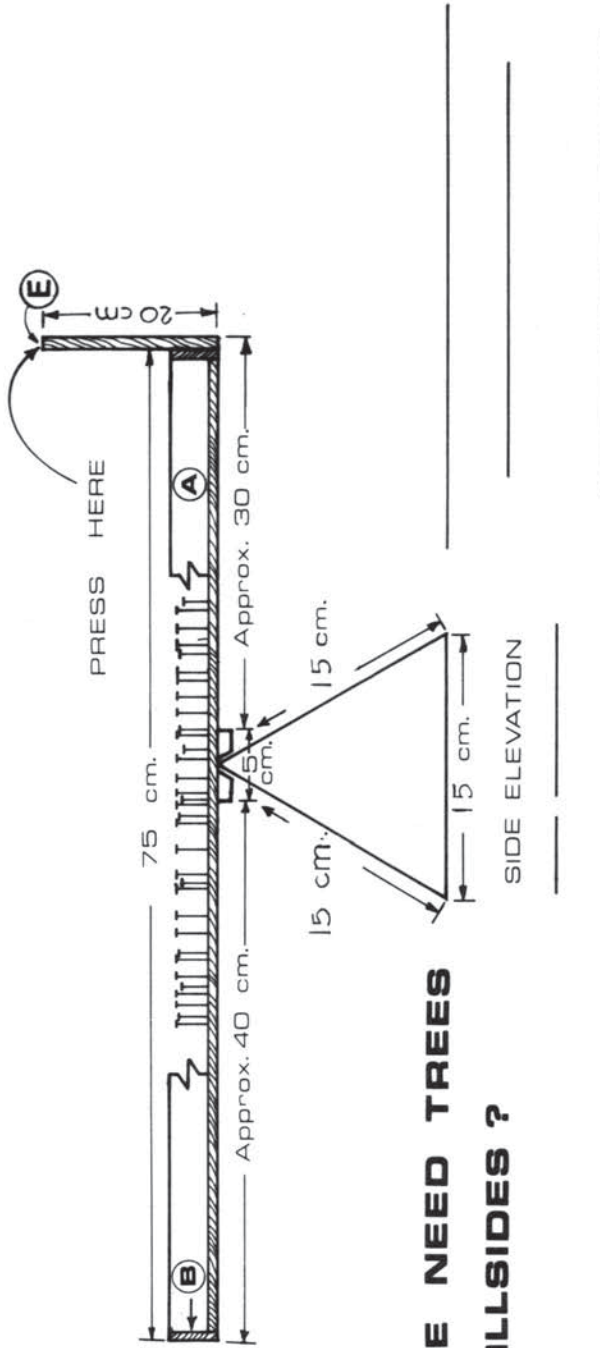

**WHY DO WE NEED TREES
ON HILLSIDES ?**

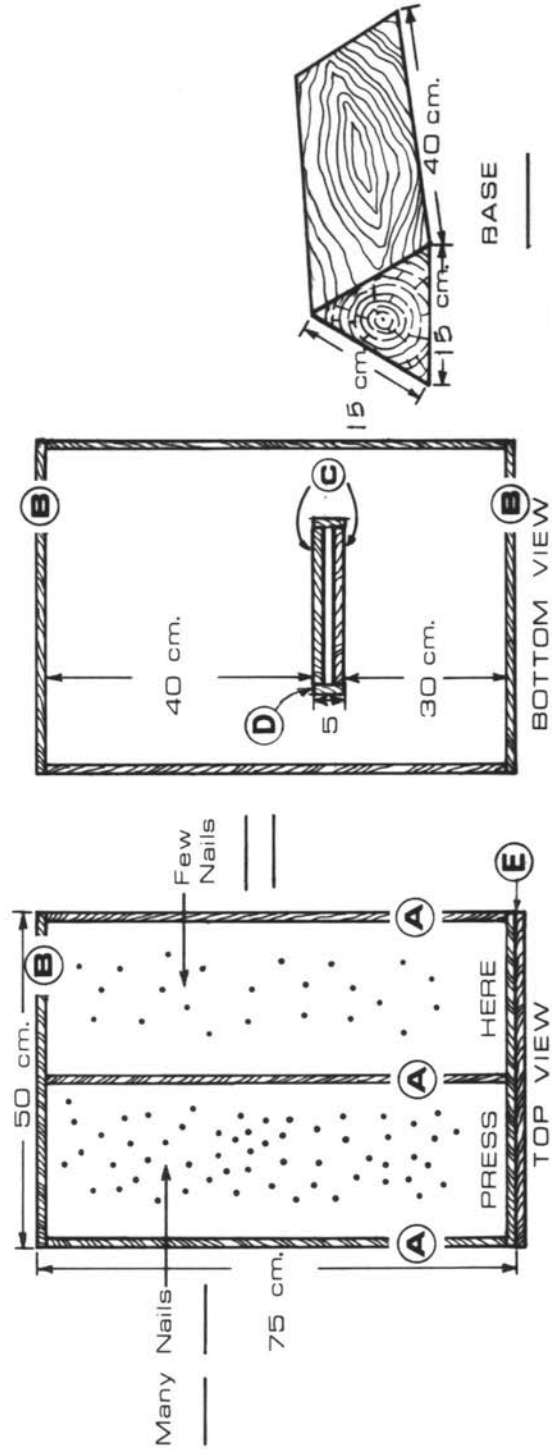

Trees Figure 1



(Optional: Add streaks of brown paint to the side with few nails to look like rain washing soil away. Glue balls of cotton colored green to the nails to look more like trees; Cover the top of the board with glass or plastic to protect marbles and keep out dust.)

- 8. Place the tilt-board on the triangle, on a surface approximately 75 cm high.

Text for end board:

Trees hold water on hillsides
Marbles = Water
Nails = Trees

Text for questions: (To be placed on cards next to exhibit)

- What happens if the water runs off quickly?
- What happens if the water sinks into the ground?
- Trees on slopes act as small dams. Have you ever noticed the way soil washing downhill is caught by tree trunks?

Other ways to make the board tilt:

- 1. Use two V-notched blocks, 10 cm high, in each of which pivots a section of bamboo nailed to a piece of wood secured to the bottom of the main board.

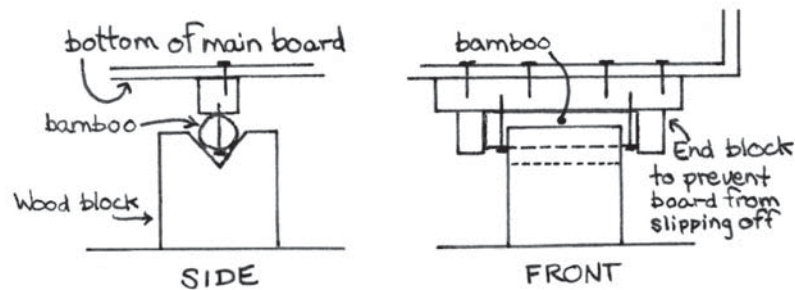

- 2. Nail 4 cm x 4 cm angle brackets, with the corners facing up, to an 8 cm x 10 cm wood block 40 cm long. Place tilt-board groove (part C) over angle.

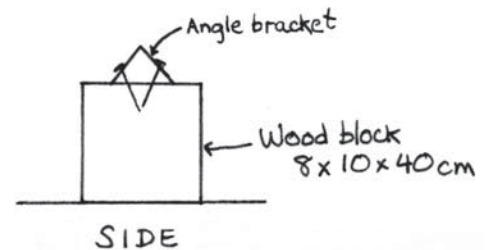

- 3. Onto an 8 cm x 10 cm x 40 cm block of wood, nail off-center a piece 2 cm x 2 cm x 40 cm. Against this piece lean a length 2 cm x 4 cm x 40 cm and nail also to the block. Place tilt board groove (Part C) over angle.

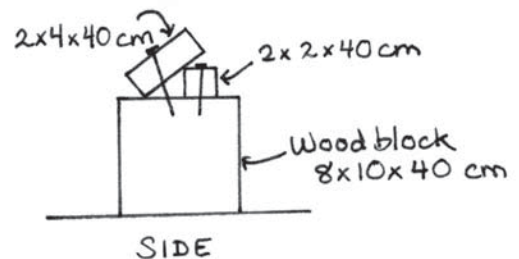
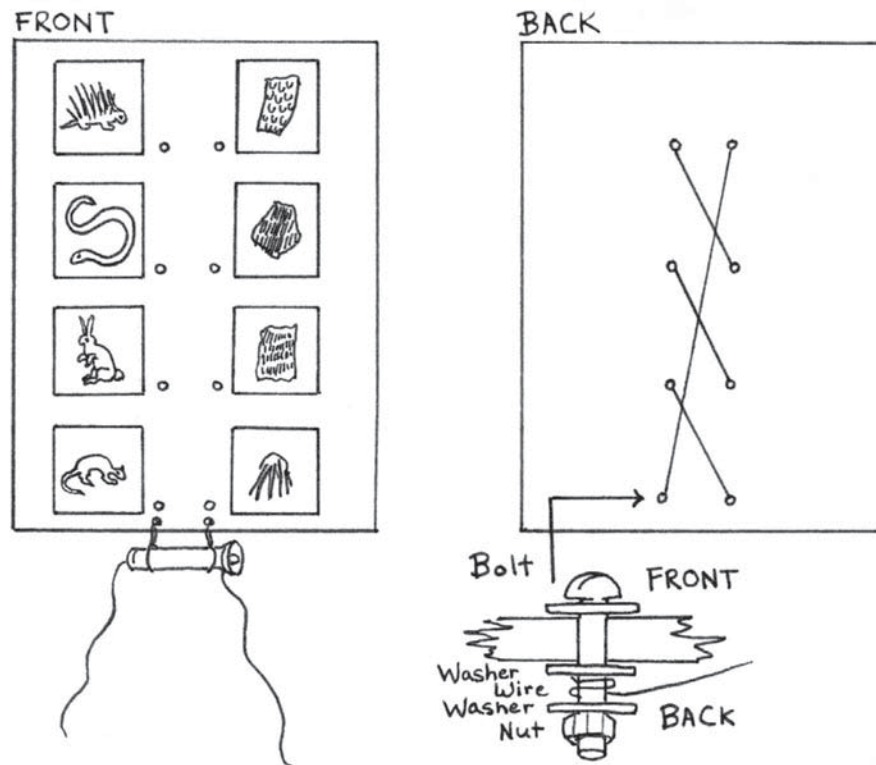



Exhibit Example

ANIMAL SKIN GUESSING GAME

The format used for this exhibit can be used for many other topics. It is a battery powered matching game where the visitor tries to match a sample of an animal skin to a picture of the animal. The visitor touches a wire to the bolt near the animal skin and another wire to a bolt next to the picture. If the visitor has chosen correctly, a small light bulb will go on. The principle of the game is that the wires behind the game board make a circuit when the correct choices are made.



How to do it:

Materials needed:

- ▶ 1 wooden board 60 cm x 80 cm (painted, whitewashed if desired)
- ▶ 8 wooden or heavy cardboard squares 15 cm x 15 cm
- ▶ 4 animal skin samples
- ▶ 4 pictures of animals corresponding to skins (sketches, photographs)
- ▶ 8 heavy metal bolts and nuts
- ▶ 24 metal washers
- ▶ 6 meters (approx.) electrical wiring
- ▶ Flashlight with batteries, light bulb



- ▶ 2 screw hooks
- ▶ Paint, varnish, whitewash (optional)
- ▶ Screws (optional)
- ▶ Glue or wire
- ▶ Drill

Procedure:

1. Paint or prepare wood or cardboard as necessary.
2. Glue or wire prepared skin samples to 4 of the 15 cm x 15 cm squares.
3. Glue pictures of animals to 4 of the 15 cm x 15 cm squares.
4. Screw (wood) or glue (cardboard) the four skin samples down one side of the board as illustrated.
5. Screw (wood) or glue (cardboard) the four animal pictures down the other side of the board. Be sure the pictures are not in the same order as the skins.

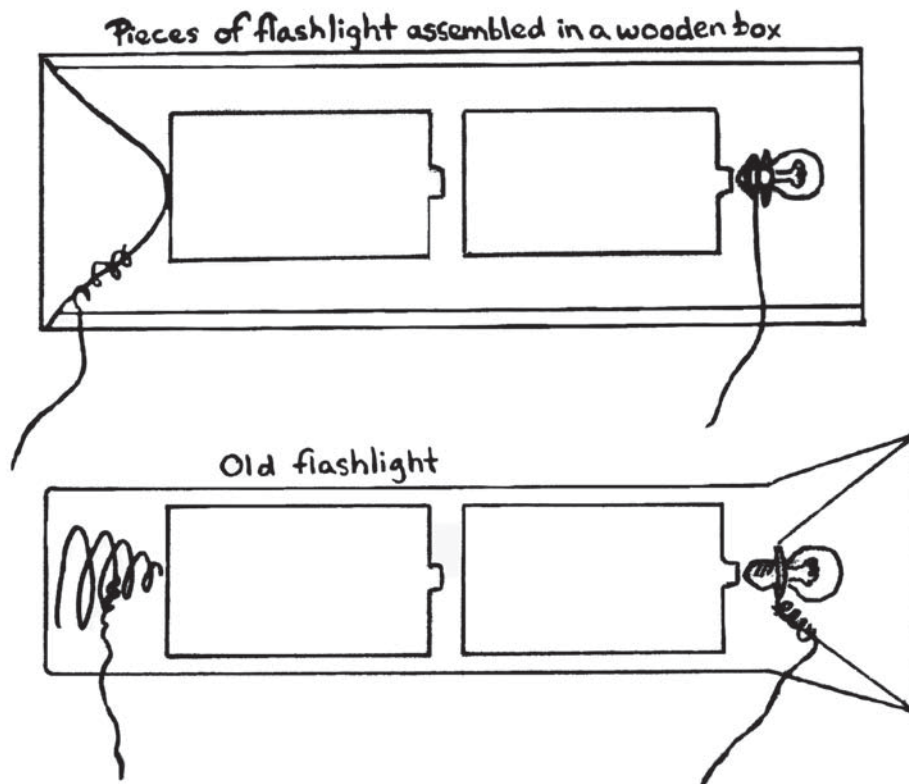



6. Drill holes for bolts next to each skin sample and picture, as illustrated.
7. Place a bolt and washer through each hole on the front of the board.
8. Place two washers, then a nut on each bolt at the back of the board.
9. Draw a line on the back of the board from the bolt of each skin sample to the bolt of its matching animal picture. Measure the length of each line.
10. Cut a length of electrical wire, plus 5 cm for each of these four measurements.
11. Peel back 2.5 cm of the rubber coating on each end of each of the four lengths of electrical wire, to leave metal wire bare.
12. Following the drawn lines on the back of the board, wrap the exposed end of the wire between the washers of each corresponding bolt (see back view illustration).
13. Take approximately 90 cm of electrical wire and wrap 2.5 cm of bare wire on the metal spring at the base of the flashlight.
14. Take approximately 90 cm of electrical wire and wrap 2.5 cm of bare wire on the metal sheath of the light bulb.
15. Hang the flashlight with wire on two screw hooks at the bottom of the board.
16. Take the free ends of the two flashlight wires and touch one to each of a wired pair of bolts. The light bulb will go on.

Note: You can assemble batteries, light bulb, wire and spring tightly in a wooden box to give the same result as a flashlight.





Exhibit Example

BIRD BEAKS

The purpose is to show the relationship between beak size and shape and bird diet. The exhibit is in two parts. One is a poster display that shows pictures of beaks and food along with descriptions. The second part of the exhibit involves the visitor in using a variety of beaks (tools) to try to pick up different types of foods (nuts, bolts, seeds, buttons, etc.).

How to do it:

Bird Beaks display board:

10, 10, 5, 10, 5, 10, 5, 10, 10

WAYS BIRDS GATHER FOOD

10		Curved Beak	Tearing prey	
10		Short, thick	Crack Seeds	
5		Crossed		
10		Slender, fine	Extract nectar	
5		Awl-like		
10		long, stout	catch marine life	
5		short, wide, weak		
10		pointed, bristly	catching insects	





Suggested types of beaks:	Adaptation for:
1. Hooked	tearing prey
2. Short, thick, strong	cracking seeds
3. Broad, shovel-like	scooping and straining
4. Awl-like	boring in wood
5. Crossed	extracting cone seeds
6. Slender, fine	extracting nectar
7. Long, stout	catching marine life
8. Slender, sensitive	probing in mud or water
9. Short, wide, weak	catching insects
10. Pointed, bristly	catching insects

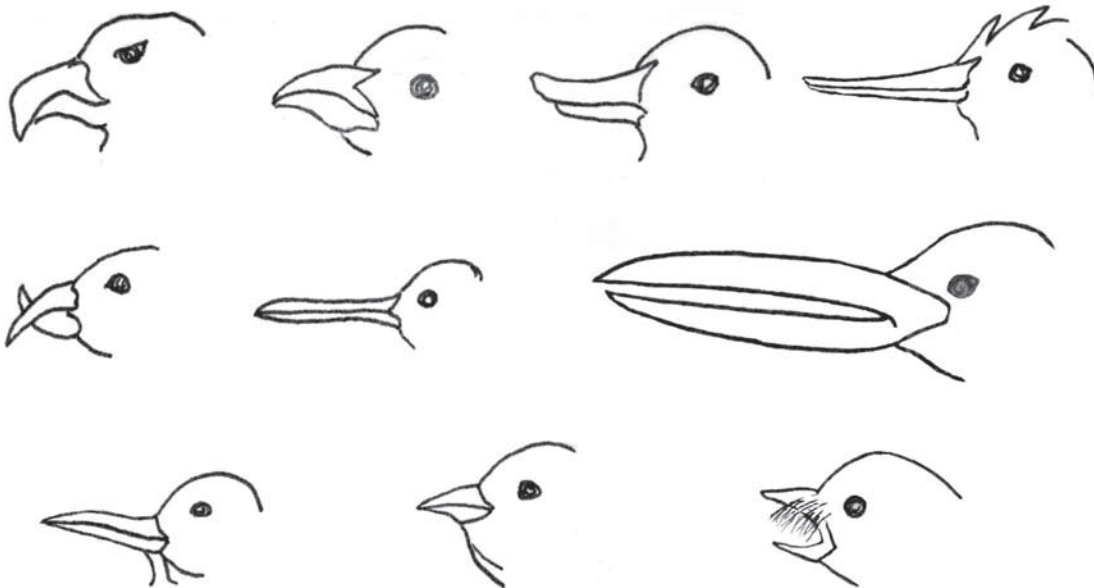

Materials needed:

For the display board -

- ▶ Plywood or cardboard 75 cm x 150 cm (painted, varnished, if desired)
 - *Note:* For horizontal use, two boards 75 cm x 75 cm can be used and hinged together with hinges, leather or cloth
- ▶ 16 wooden or heavy cardboard squares 10 cm x 10 cm (painted or varnished, if desired)



- ▶ 8 pictures of bird beaks (sketches or photographs)
- ▶ 8 samples or pictures of food eaten by the 8 birds
- ▶ Glue or paste
- ▶ Screws (optional)
- ▶ Wire (optional)
- ▶ Paint/varnish (optional)



For the interactive activity -

A variety of implements, such as:

- | | | |
|--------------|-----------------------|--------------|
| ■ Spoons | ■ Forks | ■ Tweezers |
| ■ Toothpicks | ■ Nutcracker | ■ Spatula |
| ■ Straws | ■ Needle-nosed pliers | ■ Chopsticks |

A variety of items to be used as food, such as:

- | | | |
|------------------------------|-------------------|---------------------|
| ■ Marbles or grapes | ■ Sunflower seeds | ■ Peanuts |
| ■ Glass of water | ■ Popcorn kernels | ■ Washers |
| ■ Nuts and bolts | ■ Coins | ■ Jell-O or pudding |
| ■ Cooked spaghetti or string | | |

Procedure:

For display board -

1. Prepare wood, cardboard or flannel board as necessary.
2. Glue bird beak pictures to eight of the 10 cm x 10 cm squares. (Varnish if desired.)
3. Glue pictures of wire samples of the birds' food to eight of the 10 cm x 10 cm squares.
4. Label eight of the 5 cm x 10 cm rectangles with the use adaptation of the beaks.
5. Label eight of the 5 cm x 10 cm rectangles with the beak descriptions.
6. Attach squares and rectangles to board, as illustrated, with screws for wood, with glue for cardboard or paper.

Notes:

- * This kind of exhibit can be adapted for kinds of teeth and food, skin coverings and camouflage, etc.
- * This kind of information can be adapted to a battery-powered electric game

**For interactive activity –**

1. Place “food” items in bowls on a table or other flat surface.
2. Lay out tools.
3. Attach instructions to table.

Instructions:

Title: “The Right Beak for the Right Job.” Certain beak shapes are suited for certain foods and food-gathering methods. Try it for yourself. Choose a tool and discover which type of food you can gather.

MAKING PAPER — ROMANIA —

At a GLOW (Girls Leading Our World) camp, Volunteers introduced girls to the life cycle of paper. They first asked the girls what they knew about the origins of paper: Where did paper come from? How was it made? etc. Next, the group made paper by ripping up collected scrap paper into tiny pieces, mixed it with water in a blender to make a slurry, and then poured it into tubs. The girls dipped small wooden frames covered with wire mesh into the tubs. After carefully pulling the frames up from the tub, with the slurry settling on the mesh, the leaders explained how to gently slough off the excess water, using sponges, and then to carefully flip the frame over and settle the paper on the stacks of newspaper. From the initial instructions, the girls came up with creative twists—adding flower petals, flowing threads, leaves, even some spurts of dye left over from tie-dying. As a final touch, the girls wrote a poem about trees on their homemade paper.





19 COLLECTIONS

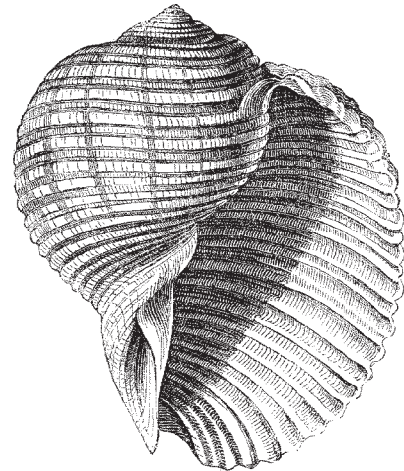

DESCRIPTION

Collections of living and non-living things from your local environment can be a very effective way to show the diversity of the area and to focus attention on parts of the environment people might not otherwise notice. Collections benefit the visitors who see them and the people who collect them.

Some ideas for collections are described below with tips for collecting the items. For collections of living things, please see the section on working with live animals. Remember to collect carefully. Usually a single sample is sufficient for the collection. When collecting, try to cause the least amount of disturbance possible and the least possible stress to organisms.

With some collections of live organisms, bring them back to look at for a short period of time, then return them to their previous location. This type of collection is especially useful for water animals.

USES

Use collections to display:

- Leaf types
- Insects
- Flowers
- Track castings
- Animal signs, such as browsed twigs
- Plants to transplant or to mount
- Animal homes that are no longer being used
- Rocks
- Bones
- Types of bark
- Feathers that have been molted
- Soil types
- Shells
- Water animals

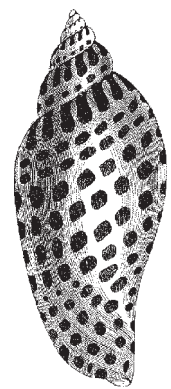
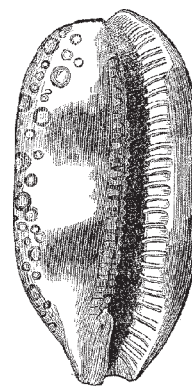
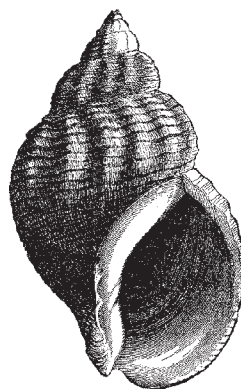
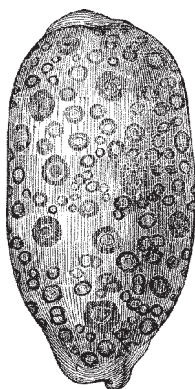



Collection Example

DISPLAYS

Most collections only require bags of some sort to make the collection in the field. Likewise, most collections require some sort of display.

How to do it:

For items such as rocks, shells, feathers and animal signs, a display box can be made by placing cotton or cloth in a box and spacing the items far enough apart to show each one off well. Choose a color that shows the items best. Cover the box with a transparent lid so people can see the items without disturbing them. Make sure to label the items clearly.

For items such as an old bird's nest or other animal homes, you may want to display them in a diorama that shows the environment they came from. Stand a box of the appropriate size on its side so it becomes a sort of stage for displaying the item. Using paint or cut paper or pictures, make a background for the item that indicates its habitat. Then mount the item in the middle of the box. For example, if you have a bird's nest, paint the background to show the bird's habitat, add a picture of the bird and mount the nest on a branch that shows where the bird built the nest.





Collection Example

INSECT COLLECTION

Insects can be collected live or dead. If you want to collect them live, put them in a terrarium (see section on terraria below). Remember you will have to feed them, so make sure you know what they eat. Some interesting insects to study live are caterpillars that will hatch into butterflies or moths, dragonflies that will molt into adults, and spiders. Most insects are harmless, but be careful not to choose an insect that can cause harm or damage.

Collections of dead insects for display might include insects in your area, butterflies, insects at all their life stages or insects and their food.

How to do it:

Materials:

- ▶ A collecting net
- ▶ Absorbent cotton
- ▶ Long, non-rusting straight pins
- ▶ Box, cardboard sheets, heavy cards, Styrofoam
- ▶ Mothballs or crystals of paradichloride of benzene
- ▶ Jars with screw tops
- ▶ Carbon tetrachloride or ether
- ▶ Paper strips

Collecting Net

A collecting net can be made from wire, flexible bamboo or willow, and mosquito netting, cheesecloth or other type of netting. Bend the wire or bamboo into a ring about 35 centimeters in diameter, and twist or tie in place. The netting can be cut and sewn into a cone about 35 centimeters in diameter and 60 centimeters long. The net is then sewn onto the wire or bamboo ring. A handle can be made of a stick or piece of bamboo 75 centimeters long. The stick is notched and lashed onto the ring and net.

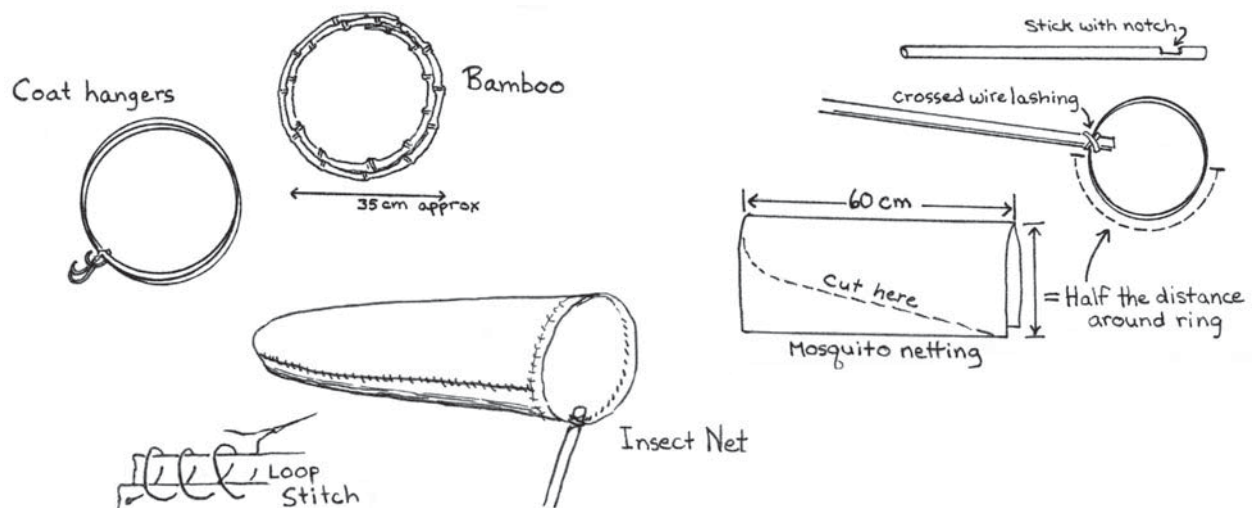



Insect Kill Jar

A kill jar or killing bottle is a wide mouthed jar with absorbent cotton in the bottom that has been soaked in carbon tetrachloride or ether. You can make a cardboard shelf for the insect that goes over the cotton. Do not add the carbon tetrachloride or ether until just before you go collecting. When you capture an insect in your net, shake it to the tip of the net and hold the net and insect in the kill jar until the insect is stunned. Then drop the insect in the jar and close it. The insect should be dead in 15 minutes.

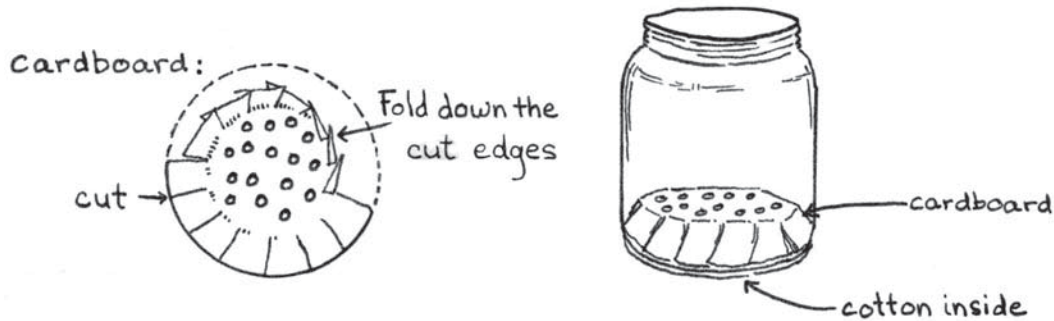

Insect Drying Board

Prepare a drying board from pieces of cardboard or styrofoam. See the diagram below. If it is a winged insect, position the insect so that its body lies in the slot. Pin the insect to the board by pushing a pin through the insect's thorax. Lay strips of paper over the wings and pin the strips of paper to the board. If the insect is not winged, press a pin through the thorax and into the board. Arrange the legs and pinchers neatly. Let the insects dry. When they are completely dry, they can be displayed.



Insect Collection Display Table

In some areas, there may be problems with live insects eating your mounted specimens. To prevent this, place mothballs in your display box. You can also modify the display table to prevent ants or other insects from climbing the legs. Place the legs of the table on small cans that are placed in larger cans containing oil, disinfectant or water with a layer of oil on top.

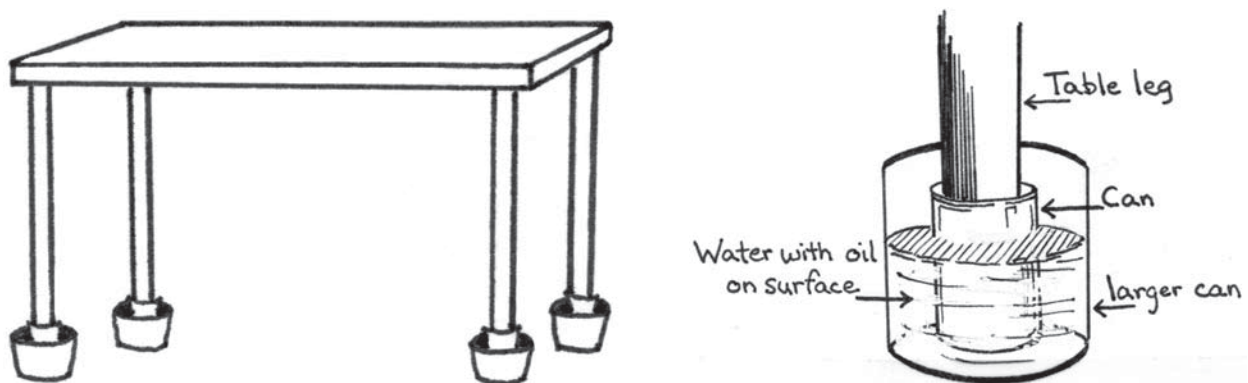



Collection Example

TRACK CASTINGS

If you find a good clear set of tracks you may want to make castings of them. Good tracks can usually be found in moist areas like muddy banks of ponds and streams, or damp forest trails.

How to do it:

Materials:

- ▶ Plaster of Paris
- ▶ Strip of stiff cardboard
- ▶ Plastic container and stick for mixing plaster
- ▶ Water
- ▶ Paper clip

Procedure:

Brush away any loose material from the imprint with a length of stiff grass. Make a ring with the cardboard and paper clip that is slightly larger than the track imprint, and press it slightly into the ground encircling the track. Mix the plaster with water to make a creamy consistency, and pour it *slowly* into the track. The plaster will take a minimum of half an hour to harden, and it will get warm. Dig up the track and the surrounding soil and put it in a plastic bag. Let it set until it is really hard and dry. Once it is very dry, you can clean off the soil with an old toothbrush and water. Label it with the location and date as well as the identity of the track maker.





Collections Example

PLANT COLLECTIONS

There are two ways to collect plants. One is to transplant growing plants, and the other is to press them and save them for viewing or reference. If you will be transplanting them, try to duplicate the natural habitat in the container. Do they live in a sunny or shady location? Is it moist or dry? Make sure to dig up some soil along with the plant root system for transplanting.

Plant collections can have several themes such as:

- ▶ Wildflowers
- ▶ Seeds
- ▶ Fruits
- ▶ Epiphytes or parasitic plants
- ▶ Medicinal Plants
- ▶ Flowers
- ▶ Grasses
- ▶ Trees (leaf, bark, flower, fruit, seed, cone)

If you intend to press plants, note that they will lose some color as part of the process. If you want to remember the colors, take photographs. For pressing plants, you will need a plant press (see directions later in this chapter). To get the best specimens, dry the plants as quickly as possible. They will lose less color and retain their features better. The basic idea of a press is to sandwich the plants between pieces of absorbent paper, apply pressure and allow ventilation while they dry. If you will be using the pressed plants for study, take samples of the entire plant, leaves, stems, flowers, roots, and seeds.

When the plants are completely dry, they can be mounted with tape or glue onto paper. Label the specimen with the name of the plant, its habitat and the date and location gathered.

TREE COOKIES

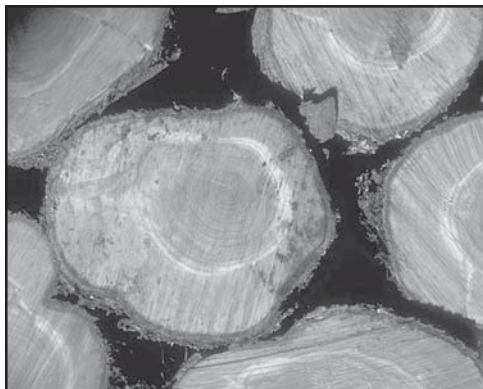

A tree cookie is a slice across the trunk of a tree that shows the tree growth rings. Each ring represents a growing season followed by a dormant season. The ring on the outside is the bark and cambium or growth layer. The next ring is the year the tree was cut down. Each ring represents one year, so counting them gives you the age of the tree. Tree cookies of different species can be compared. Cookies from the same tree in different habitats can be compared to show the difference habitat makes. Tree rings can also be labeled to show historical events.

If you have an increment borer available, you can get a sample of growth rings by boring into a tree. The borer will give a long thin sample of the rings without killing the tree.



Collections Example

WATER ORGANISMS

Around the verges of ponds, or in quiet parts of rivers, there are many small animals. On rocky ocean beaches at low tide, denizens of marine animals live. These animals are relatively easy to collect in a bucket. They can be displayed in a glass jar or aquarium. When collecting these animals and plants, make sure to collect plenty of the water they live in. Their food supply is the plankton in that water. If they live in a fast running stream or the ocean, you may need to include an “airstone” to maintain high levels of oxygen in the water.

How to do it:

Collecting Equipment:

- ▶ Large bucket (2-5 gallons)
- ▶ White basin for viewing animals (1-2 gallons)
- ▶ Sieves or small nets for capturing animals
- ▶ Plankton net for capturing animals (see water sampling equipment)
- ▶ Magnifying glasses for viewing animals
- ▶ Ice cube tray for sorting animals



When collecting animals and plants, look under rocks and in grassy areas. Animals tend to live in sheltered places in streams and oceans. Areas that have quiet water or lots of plant matter are good places to look. Make sure to check with local people about any potential hazards before wading in.

Once you have collected the organisms, place them in a large glass or transparent plastic container. You can probably observe them for a few days to two weeks without damage. If you keep them longer than a couple of days, get more water from the same place so they will have food. You can try feeding them very small amounts of fish food, or other foods you know they eat. Be careful not to over feed them because decaying uneaten food can foul the water and kill the animals. If they come from fast flowing water, place an airstone from an aquarium in the water. If you can't get an airstone, just keep them for a short time then return them to their home. If you are not sure you can care for them, just look at them at the site and return them to the water.

See also the sections following on: Aquaria, Terraria, and Water Sampling Equipment.

**Collections Example**

SOIL TYPES



Soil can be collected by type or by making profiles. If soil is collected by type, gather samples representing a variety of types of soil and display them. If you want to take a profile, take samples from each stratum (layer) of soil in a given place. You can dig a hole or use a road cut or other area that shows all the layers in a particular place.

To take a sample of soil, use a can (like a tuna can) with a single nail hole in the bottom. Push the can into the soil and remove. It may take a trowel or spoon to help remove the sample. Dry the sample in an oven at low temperature overnight. If an oven is not available, a warm dry place that is well ventilated can be used. Display soil sample in glass jars or other transparent containers. If you are displaying a profile, use a large jar and place the layers of soil in the jar just as they were in nature.

BONES

Sometimes you will be lucky to find the bones of an entire animal. Other times, you will just find one or two bones. In either case, make sure to clean the bones well. You can make displays comparing the bones of different animals. Big, heavy animals have large dense bones. Birds have hollow bones to make them light for flying.

If you are lucky enough to find an entire animal, you can develop an interesting display by asking visitors to try and put the unidentified animal back together again. Once it is back together, examine its characteristics to learn about its lifestyle. Does it have the long legs of a runner? Does it have the large rib cage of a swimmer? Does it have the teeth of an herbivore or a carnivore? Does it have the hollow bones of a bird?

If you have a single bone, try to find out what kind of bone it is. Then it can be displayed showing its characteristics. Is it a heavy bone of a heavy animal or a hollow bone of a bird? What part of the body does it come from? How does it connect to the other bones near it? Are there signs of another animal or human chewing on it or using it to make a tool?

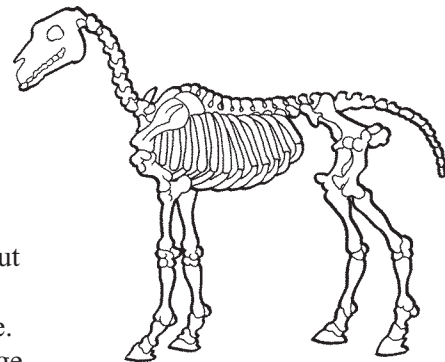



RESOURCES

Durrell, Gerald, *The Amateur Naturalist*. New York: Alfred A. Knopf, 1983.

GLOBE (Global Learning and Observations to Benefit the Environment) Teacher's Guide. The GLOBE Program, 1997. www.globe.gov

New UNESCO Source Book on Science Teaching. UNESCO, 1973. Also available on the Internet at http://upo.unesco.org/details.aspx?Code_Livre=377

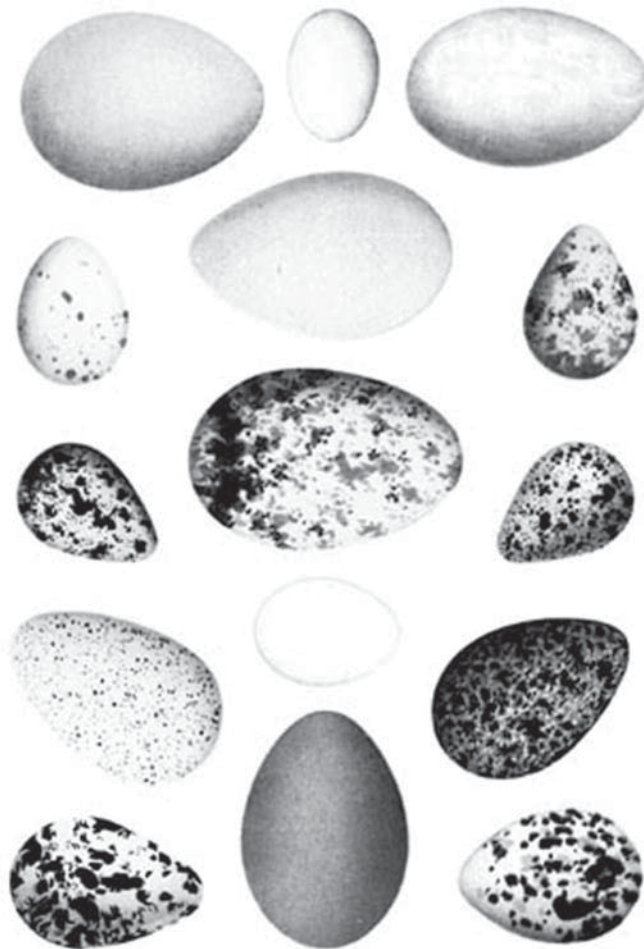



20 LIVING MUSEUMS

DESCRIPTION

A living museum is an exhibit that involves real people acting the part of historical figures or non-human characters. As visitors pass through the museum, they can talk with the actors to find out about the character. The character may be a person, such as a traditional fisherman, an ancient chieftain, or an herbal healer. The character could be an animal or a tree or a rock.



The characters may be stationed at a particular place, or roving. They could be an interpreter or appear at an appropriate moment in a tour. For example, a character could be a fisherman who explains how fish traps were built and used, or a honeybee that describes its life.

HOW TO DO IT

► Do the research.

Find out all that you need to know about the character you are playing. This includes not only what the character knew or did, but also the context in which he or she lived. If, for example, the character is an Indian farm woman, she should be dressed in a sari with bangles and sandals. She would probably not have a watch. She would be able to speak knowledgeably about farming, monsoons, farm animals, raising children, water availability, seasons, etc. If the character is a pine in the forest, it would be able to speak about the life of a pine, and also about the animals and plants nearby, as well as the seasons. It might be dressed in brown with green needles attached to its arms.

► Strive for authenticity and accuracy.

For characters to be convincing, they need to be completely accurate. That means they look and act like the character they are portraying. Audiences are more likely to play along with characters that are completely in character at all times. It is important to have the details correct for credibility.

► Avoid famous personalities.

People have expectations of famous people, and it may be difficult to live up to those expectations.

► Stay in the first person.

The character should always speak from the perspective of the character being portrayed. That means using the present tense and “I.” For example, if you were portraying traditional fisherman from the 1800s, you would talk about how *we* make nets *nowadays*, not how *they* made nets in



those days. If you are a frog, you would have to work most of the day to catch your meals and still be on the lookout for large shadows flying overhead.

► **Create an appropriate setting.**

Choose a location that fits the character, and use props that evoke the time and place where the character is supposed to be. It may be helpful to stay away from cars or phones or buildings that interfere with the setting you wish.

► **Rehearse.**

Plan when and how you will enter and exit, and how you will interact with other people. If you will be working with an interpreter, plan the timing and choose a cue for your entrance and exit. Will you be in character when the audience arrives or will you assume your character after you have spoken with them? Will you appear at a particular place or time in character, or wait for a cue from a tour guide? Practice what you will say and in what order you will say it. You do not necessarily need to memorize a script, but you do need to practice the topics you will cover and how you will respond to audience questions or comments.

► **Converse with the audience.**

Involving the audience in a dialogue makes for a more effective performance. But be ready for the audience to trip you up. They may ask questions that you know the answer to, but your character does not.

► **Enjoy assuming your role.**

You will be convincing and effective if you enjoy what you're doing. If you are portraying a non-human character, do it with humor. Audiences know that rocks don't talk, so acting the part of a rock is done with tongue-in-cheek.

► **Costumes for humans should be accurate for the character.**

But costumes for animals or other non-human characters can exaggerate notable characteristics. For example, a duck might wear swimming flippers to highlight webbed feet.

RESOURCES

Ham, Sam H., *Environmental Interpretation: A Practical Guide for People with Big Ideas and Small Budgets*. Golden, CO: Fulcrum Publishing, 1992. [ICE No. FC190]

For examples of living museum projects see:

Virginia Living Museum
www.valivingmuseum.org

Melbourne West Living Museum
www.livingmuseum.org

Tulsa Zoo and Living Museum
www.tulsazoo.org





21 LIVE ANIMALS



DESCRIPTION

Having live animals in your center or schoolroom is a wonderful opportunity for people to see how animals live; that they need food, water, shelter and space; and that they lead busy lives. Often the most instructive animals are the ones from the local environment, especially some of the often unnoticed smaller animals like insects. But, be very careful in choosing which animals you want to work with, and in recreating their habitat. Wild birds and mammals are difficult to keep in captivity. They require more care and food. They often require complex cages and enough space to move about freely. Take care when working with animals that bite, scratch or sting.

Choose a container that will display the animals well and give them enough space, food, water, air, and shelter. Make an effort to recreate the living circumstances of their natural habitat.

One easy and interesting display is a collection of water animals—insects, fish, frogs or salamanders. You can gather up a large bucket full of the natural water adding fish, snails, insects, or whatever is there. Be sure to include lots of the tiniest water plankton, and water plants which are food sources for the others. Include rocks and sticks and other natural debris that provide shelter. These animals can be fed by replenishing the water with their natural foods every few days.

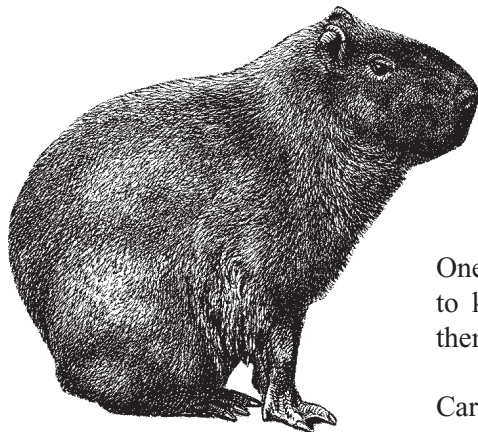

Be careful in experimenting with foods for animals you are unfamiliar with. Fish food (usually dried algae, shrimp or worms), hard-boiled egg yolks and small insects may work. Beware of overfeeding. If you are able to find the eggs or nymphs of water creatures, you may be able to watch them hatch or metamorphose into adults.

One way to enjoy the animals, but not have to try to figure out how to keep them, is to just keep them for a short time, then release them back in their natural habitat.

Caring for injured animals can be very interesting, and hopefully, you can return them to health and release them. Seek information about the care and feeding of these animals. It can be difficult to care properly for an injured animal. Some young animals cannot be returned to the wild because they need to be taught how to survive by their parents. Others can be successfully rehabilitated.



AQUARIUM

An aquarium is a container for freshwater or marine plants and animals. A successful aquarium recreates the natural environment of the animals and plants as closely as possible.

How to do it:

Preparing the aquarium:

You will need a glass container for the aquarium. The glass container needs to be thoroughly cleaned before adding water and plants and animals. Use lots of clean water, and avoid soaps or detergents. If you have to use soaps, rinse many times to remove all soap from the aquarium. Fill the aquarium with water and let it sit for a few days so the water will absorb any impurities. Then throw this water away.

Place the aquarium in a place where the temperature will remain constant. Do not place it in direct sunlight. The temperature will vary quite a bit between noon and night, and algae growth will be a problem.

Reproduce the habitat:

Gather soil, gravel and/or sand from the place you will gather the animals and plants. Wash the substrate (soil, gravel or sand) before putting it in the aquarium. Put the soil in first, and then add gravel, then sand. Place a heavy sheet of paper or cloth on top of the substrate, and siphon or drip water from the habitat onto the paper so as not to disturb the substrate. Wait twenty-four hours before adding plants.

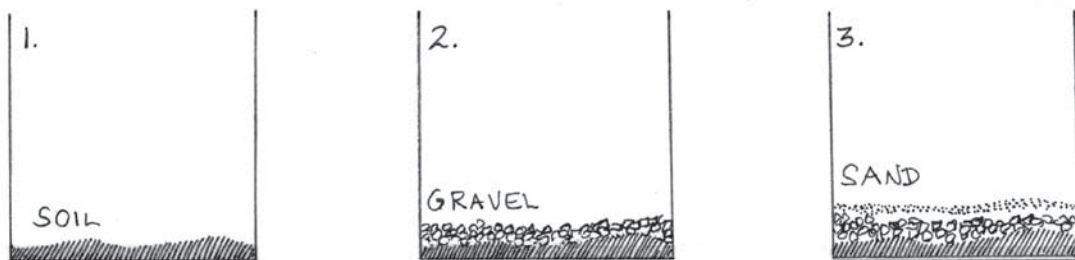

Inspect plants for pests before putting them in the aquarium. Look for snail or insect eggs and remove them. Rinse the plants before putting them in the aquarium. Then plant them carefully so as not to disturb the substrate. Push the roots down into the soil gently. Place taller plants at the back. To oxygenate the water for the animals, plant one or two plants for every liter of water. Let the aquarium sit for a week or so before adding animals so that the plants can take root and the substrate bacteria can grow. Substrate bacteria process wastes. If they are not there, animal wastes will accumulate and poison the water.





When selecting the animals, be aware of who eats who or what. If the aquarium is for children, be prepared to discuss predation with the children. As a general rule, one inch of fish can live in one gallon of water, so a five-gallon tank can support five one-inch fish, or a two-inch fish and a three-inch fish. It is tempting to add many animals, but consider that the aquarium is an ecosystem that needs enough food, oxygen, and bacteria to decompose wastes.

When adding the animals, float them in the collecting container for half an hour or so, until the aquarium and the container have the same temperature. Then add the aquarium water to the container a little at a time to balance the water chemistry and allow the animals to become accustomed to the changes.

Don't feed the animals for a day. Watch the animals, and remove any sick or dead ones. Feed animals carefully. Make sure they have enough, but not too much. Too much food shows up as decomposing waste on the bottom.

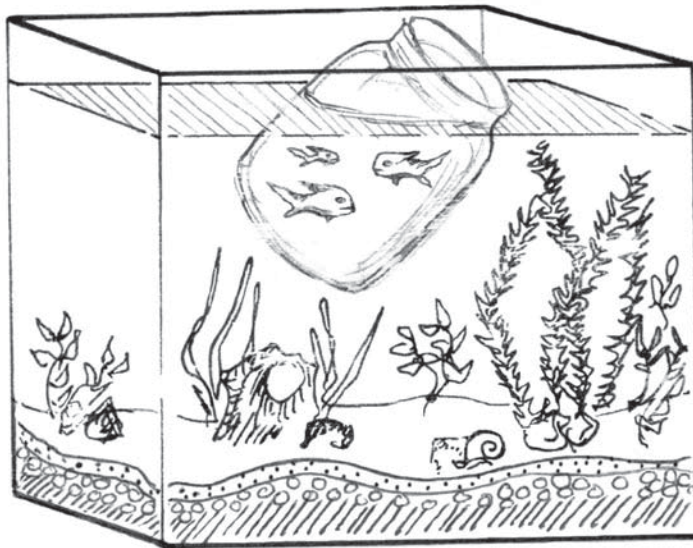

PUSH THE
ROOTS DOWN
INTO SOIL

A Note on Marine Aquariums:

In addition to the above tips, marine aquaria need to keep the proper balance of salt to water. The water will evaporate, which will concentrate the salt. Mark the waterline of the aquarium, and when it gets below that, add fresh water. If you have a hydrometer available, you can monitor the salinity of the water and keep it stable. Try to keep the marine aquarium at the same temperature as the sea the organisms came from. If the animals get too warm, they will die. Likewise, animals that come from great depth need pressure to stay alive. They are very difficult to keep in an aquarium.

RESOURCES

James, Daniel E., *Carolina's Freshwater Aquarium Book*. Gladstone, OR: Carolina Biological Supply Company, 1981.



Live Animals Example

TERRARIUM AND OTHER LAND ANIMAL CONTAINERS

A terrarium is a container for terrestrial or land plants and animals. So, in the broadest sense, bird-houses and cages are kinds of terrarium. There are as many types of terrariums as there are land habitats. You can create a terrarium that holds a desert habitat, a forest habitat, or a wetland habitat. A successful terrarium recreates the natural environment of the animals and plants as closely as possible by considering the temperature, light, moisture, food sources, plants and shelter of the animals in the terrarium. Small mammals, reptiles, amphibians and insects commonly live in terrariums.

A terrarium can be made from any transparent container. Clean recycled plastic containers make good field terraria because they are light, portable, and often abundant. Samples of plants or animals can be carried back to study, or studied in the field. To make a terrarium from a clean water or soda bottle, cut a hole in the side about half way up, or cut the top off so you can place soil and plants inside. The hole allows air into the terrarium, and you can water the plants.

When making an aquarium or terrarium, consider the natural environment of the species. Make sure there is enough food, water, shelter and space for the species to survive. Place a screen lid on terrariums and aquariums to prevent unwanted debris or curious fingers from disturbing the terrarium, and to prevent escapes. Often, it is a good idea to have temporary terrariums. You can bring the plants and animals back to the center or classroom for a few days of observation and then return them to their habitat.

BUILDING A TERRARIUM

How to do it:

Materials:

- ▶ 1 metal tray, a sheet of metal or a board approx. 35 cm x 50 cm
- ▶ 1/2 kilo plaster of Paris
- ▶ 2 pieces of glass 30 cm x 45 cm
- ▶ 2 pieces of glass 30 cm x 30 cm
- ▶ 1 piece fine wire screen 35 cm x 50 cm for the top
- ▶ 1 large can or other disposable container (for mixing plaster of Paris)
- ▶ 1 roll adhesive or plastic tape 4 cm wide
- ▶ Water





Procedure:

1. Lay the four pieces of glass out flat with the 30 cm sides together, leaving about 3 cm between them.
2. Cut four pieces of tape 30 cm long and press the pieces of tape along the sides A, B & C of the glass.
3. Pull the glass inward carefully and tape the last corner D together.
4. Mix plaster of Paris with water in a large can until it is a smooth thick mixture.
5. Pour the mixture quickly (it dries very fast) onto the metal sheet and smooth it evenly.
6. Gently and quickly press the taped glass into the mixture.
7. Let the mixture harden.

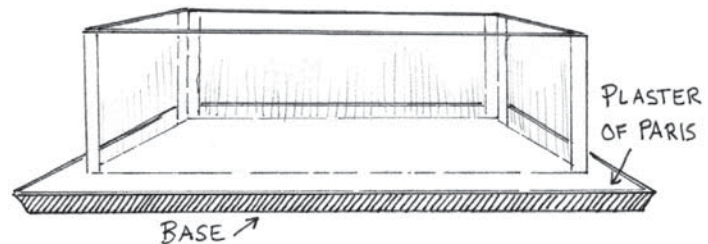
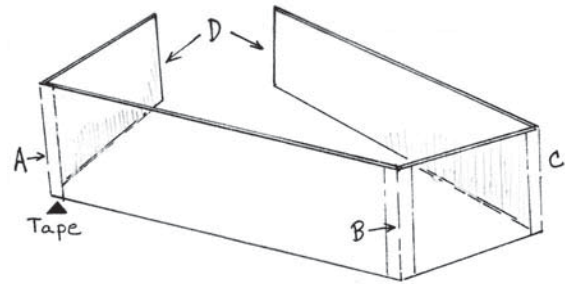

If plaster of Paris is not available, you might be able to sink the glass into sand or gravel in a flat box, making sure that the glass touches the base continuously, so that animals cannot crawl under it. Another alternative might be to use waterproof tape to fix the glass sides onto a base. This would not be as sturdy, and tape would probably need frequent replacement. A wooden frame could be constructed to hold the terrarium with a glass base.

Jar Terrarium

How to do it:

Materials:

- ▶ 1 clean 4-liter glass jar with a large opening and lid (or wire mesh)
- ▶ 1 box about 3 cm x 30 cm x 18 cm (a shoe box)
- ▶ 1/4 kilo plaster of Paris
- ▶ 1 large can or other disposable container (for mixing plaster of Paris)

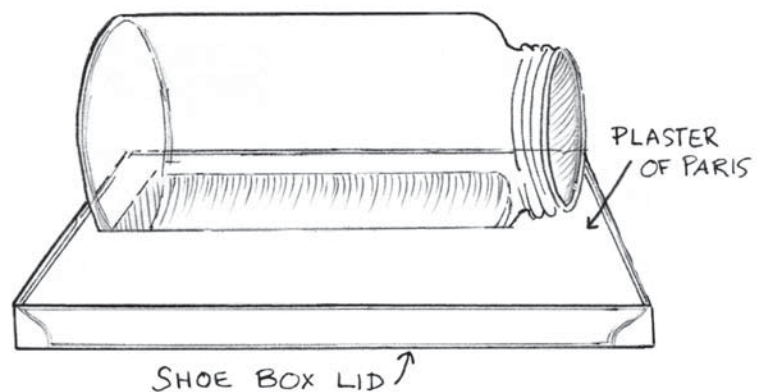



Procedure:

1. Mix plaster of Paris with water in a large can until it is smooth and thick.
2. Pour mixture quickly into the box and place the jar on its side in the plaster mixture.
3. Dry till hard.

If plaster of Paris is not available, you can make a small terrarium habitat with the jar standing upright, or construct a wood or bamboo cradle to hold the jar.

Desert Terrarium

How to do it:

Procedure:

1. Put a layer of soil on the bottom.
2. Cover the soil with a deep layer of clean (washed and dried) sand.
3. Plant one or two desert plants in the soil.
4. Place a small dish (or other container) for water in the sand, which can be removed for cleaning.
5. Place clean rocks carefully so as to give shelter for an animal.
6. Cover the terrarium with wire screening.
7. Hold the screening down with stones if necessary.

Desert snakes, lizards, tortoises or insects are the kinds of animals you can keep in this terrarium. Snakes like live food, and depending on the type, will eat insects, earthworms, frogs or mice. They may also eat eggs or small bits of meat. A snake will not eat every day. However, if it does not eat at all, you should let it go. Lizards are meat and insect eaters; a few are plant eaters. Identify an animal's food needs *before* you decide to collect and keep it.

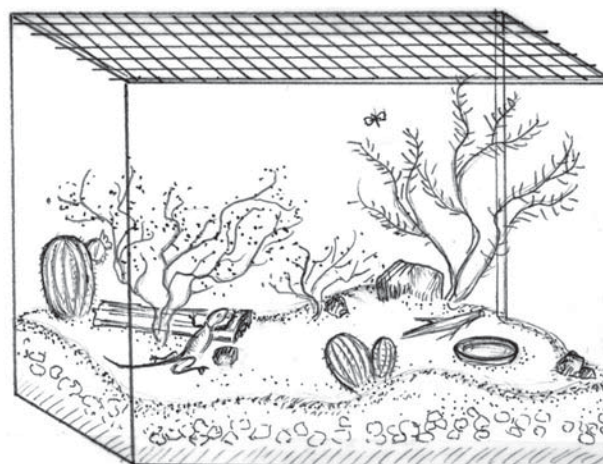

DESERT
TERRARIUM



Forest Terrarium

How to do it:

Procedure:

1. Cover the bottom of your container with a mixture of gravel, charcoal (optional) and soil. This will give air and drainage, and nutrients for the plants.
2. Plant forest-type plants, ferns, mosses, in the soil to the same depth that they were growing in their original habitat.
3. Place a removable water dish in one corner. If the animal needs to swim, the water container should be large enough for this.
4. Place stones, sticks or small branches to provide climbing and shelter for animals.
5. Water the soil by sprinkling it, so that it will retain moisture. It should not be soggy with water, however.
6. If the terrarium becomes too moist and mold starts to grow, raise the top or open the lid for a day or two until the excess moisture has evaporated. Tie a piece of cloth over the opening to prevent the animals' escape while the top is open.

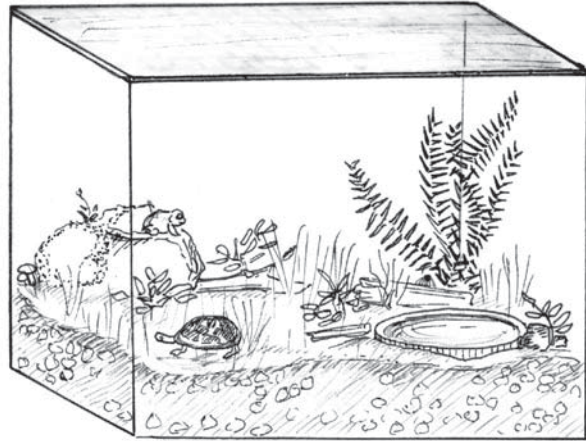

FOREST TERRARIUM

This can be the habitat for insects, spiders, frogs, salamanders and turtles, for example. Spiders eat insects that they have caught, and the insects will often be plant-eaters. Frogs and toads eat flies and earthworms. Some turtles will eat both plants and worms. Be sure you can find food for your animals before you collect them.



Live Animals Example

ANT FARM

A large glass jar will make a fine home for an ant colony. You should choose only ants that are not dangerous, and that live in the soil. To make an ant colony, you will need a queen, workers, and some eggs. To find them, dig into a small ant nest. The queen is larger and shinier than the others.

How to do it:

Procedure:

1. Fill a jar with soil from the area of the ant nest.
2. Put in the queen, workers and eggs.
3. Place a wet sponge on the top of the soil to provide moisture, Wet it whenever it dries out.
4. Cover the top of the jar tightly with fine mesh wire so no ants can escape.
5. Wrap the jar with black paper. This way the ants will make their tunnels against the sides of the jar. Remove the paper only to observe the ants.
6. Feed the ants bits of earthworm, flies, live aphids, scraps of rice, leaves, a drop of honey, until you know what food they prefer.

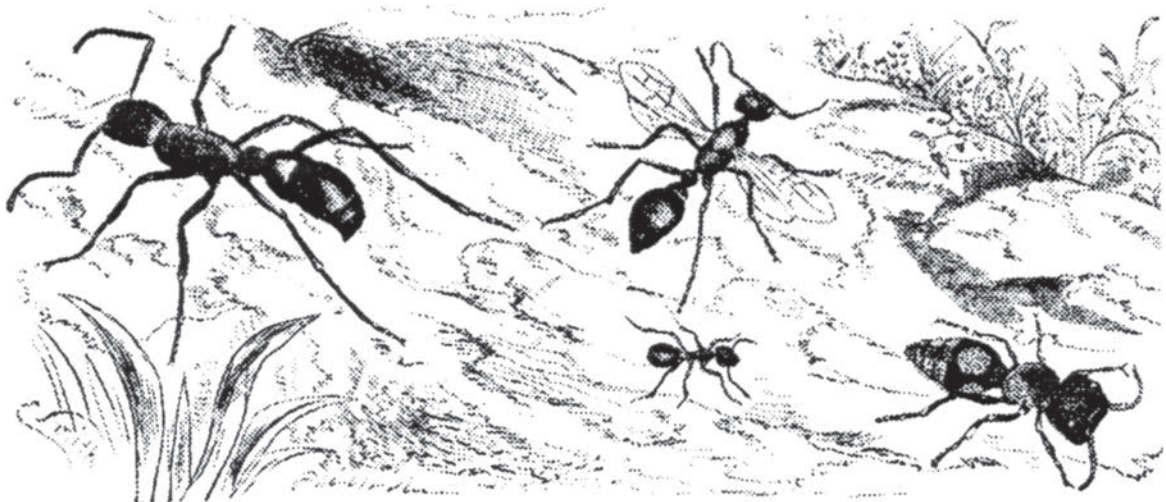



Live Animals Example

EARTHWORM COLONY

You can make an earthworm colony in a large jar, just as you do for ants. Earthworms live in and eat decaying plant matter. That is the habitat you will find them in.

How to do it:**Procedure:**

1. Fill a jar with a mixture of sand, leaf mold and rich topsoil.
2. Put in several small earthworms.
3. Keep the soil moist so that the worms can burrow.
4. Wrap the jar with black paper. This way the earthworms will tunnel against the sides of the jar, and can then be seen.
5. Cover the jar with fine mesh wire.
6. Feed the worms by putting fresh leaves, dead leaves, bits of discarded vegetables, or grass cuttings into the jar.
7. Add worms as you find them, but do not let the jar get too crowded.
8. These worms can be a food supply for other animals.



WRAP JAR IN
BLACK PAPER

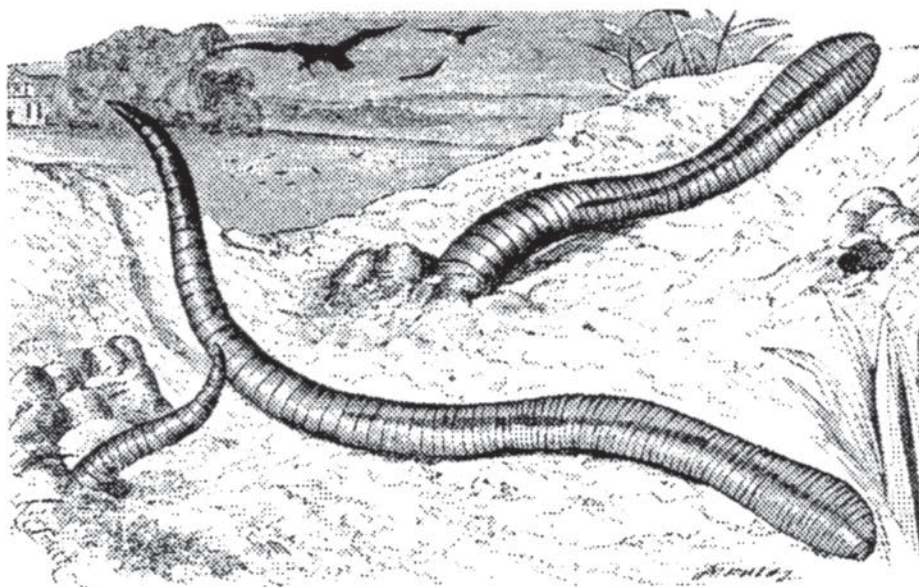



Live Animals Example

INSECT BOX

For short-term insect study, you may want to build a simple cardboard container. It will not be waterproof, so use a container (any kind of low-sided can, pot, dish, calabash) filled with moist soil into which you can stick cut branches, flowers, moss, or other plant material, rather than putting soil directly on the box bottom. For this type of box, be careful to choose insects that do not eat cardboard.

How to do it:

Materials:

- ▶ 1 cardboard box (any size) with at least five sturdy sides
- ▶ Transparent paper, plastic, glass, cloth netting, or wire screening
- ▶ Glue or adhesive tape
- ▶ Scissors and knife

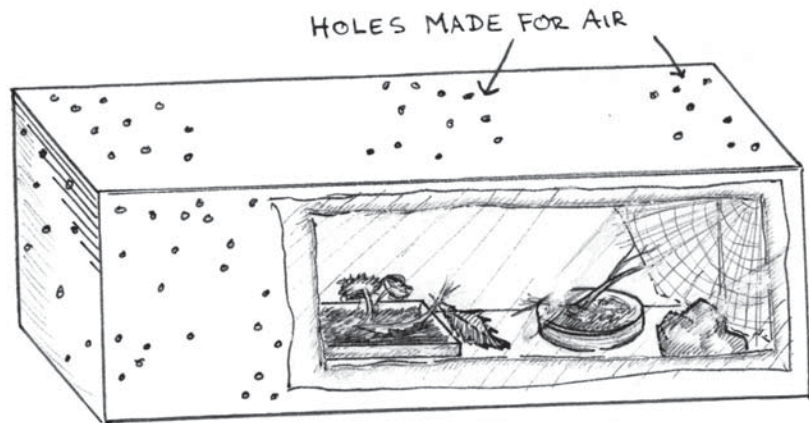

Procedure:

1. If the box has all six sides, cut a large rectangle in one side, for a window.
2. Glue or tape transparent paper, plastic, glass, cloth or screen over the window.
3. If the box has only five sides, glue or tape transparent paper, plastic, glass, cloth or screen over the sixth side.
4. Make a large door by cutting three sides of a rectangle through one side of the box, and bending along the fourth side. Glue or tape a piece of cardboard on the door for a handle.
5. If you have used cloth for your window, the box will have enough air. If you used other material, you may need to punch air holes in the box with a nail.
6. Place a piece of paper on the bottom to make cleaning the box easier.
7. Place containers of moist soil with branches, flowers, etc. on the bottom.
8. Place a small rock or log on the bottom and add insects.
9. Keep the soil moist, replace the plant material when necessary, and keep the box clean.





Live Animals Example

MAMMAL CAGE

You can keep a small mammal in a glass box with a wire top, like the one made for a terrarium or you can make a wood and screen box type. Another cage type can be made of small bamboo slats tied together to make sides, floor and top. Whichever you use, there must be a dish for water, a climbing branch, a small nest box or hollow log to hide in. Old newspapers, wood chips or straw can be used for nesting material. Make sure your cage has sufficient space for the animals that will live in it.

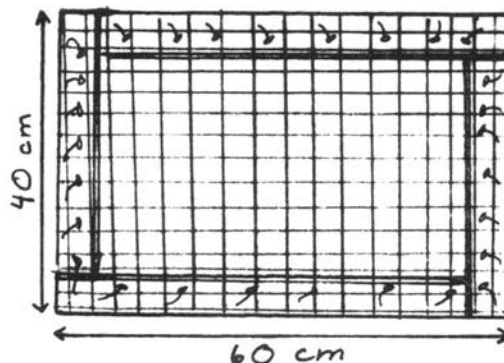

This wood and screen cage has a removable top, and should be large enough for two mouse-sized animals. It can be increased or reduced in size depending on your animal. Sizes of wood strips are approximate.

How to do it:

Materials:

- ▶ 8 pieces of wood 2 cm x 5 cm x 55 cm
- ▶ 8 pieces of wood 2 cm x 5 cm x 35 cm
- ▶ 8 pieces of wood 2 cm x 5 cm x 25 cm
- ▶ 4 pieces of wood 2 cm x 3 cm x 28 cm
- ▶ 2 pieces of wire screen 40 cm x 60 cm
- ▶ 2 pieces of wire screen 30 cm x 60 cm
- ▶ 2 pieces of wire screen 30 cm x 40 cm
- ▶ Nails and hammer

Procedure:

1. For the top and bottom:
 - 2 pieces of wood 2 cm x 5 cm x 55 cm
 - 2 pieces of wood 2 cm x 5 cm x 35 cm
 - 1 piece of wire screen 60 cm x 40 cm

Nail the four pieces of wood together as shown, and attach the wire screen with small nails pounded in, then hammered sideways to secure the screen.

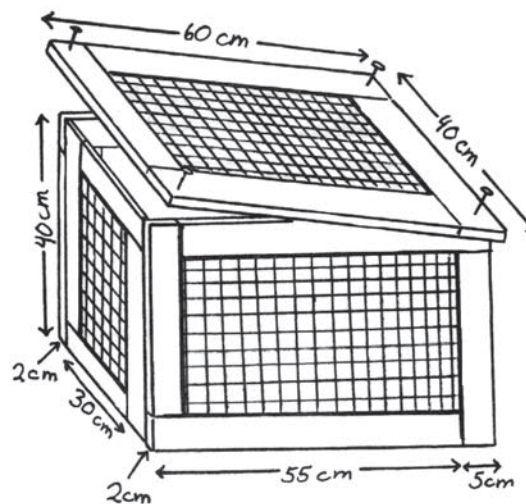



- 2. For the front and back:
2 pieces of wood 2 cm x 5 cm x 55 cm
2 pieces of wood 2 cm x 5 cm x 35 cm
1 piece of wire screen 60 cm x 30 cm

Nail the four pieces of wood together as shown, and attach the wire screen with small nails pounded in, then hammered sideways to secure the screen.

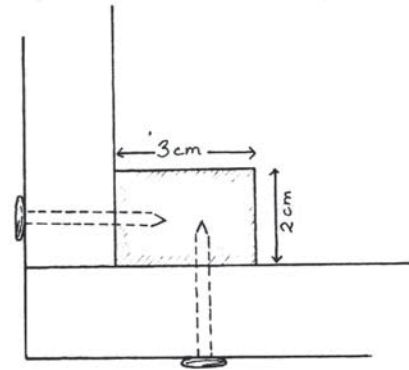

- 3. For each side:
2 pieces of wood 2 cm x 5 cm x 35 cm
2 pieces of wood 2 cm x 5 cm x 25 cm
1 piece of wire screen 30 cm x 40 cm

Nail the four pieces of wood together as before, and attach the wire screen with small nails pounded in, then hammered sideways to secure the screen.

- 4. Nail the two completed sides to the completed front and back.
- 5. Nail the bottom to the sides, front and back as shown.
- 6. Nail a piece of wood 2 cm x 3 cm 3 28 cm in *each* corner for bracing and support.
- 7. Lay top on completed cage or attach with a hinge.

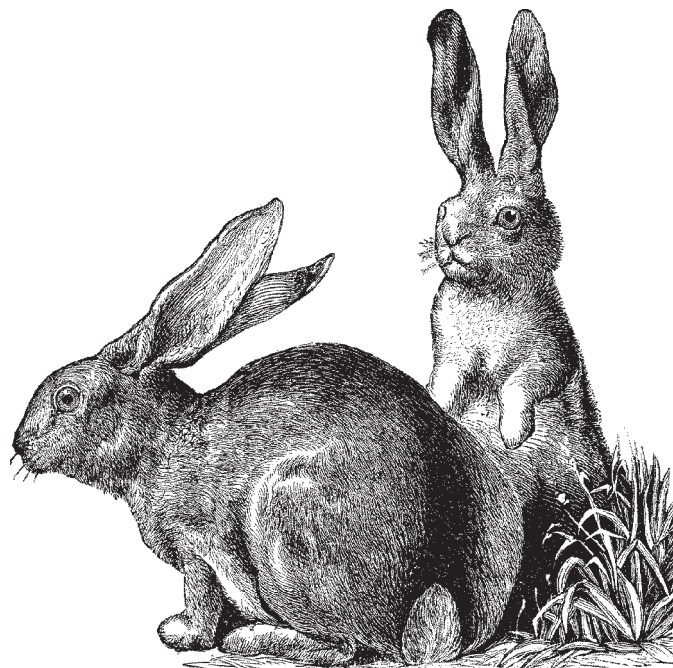
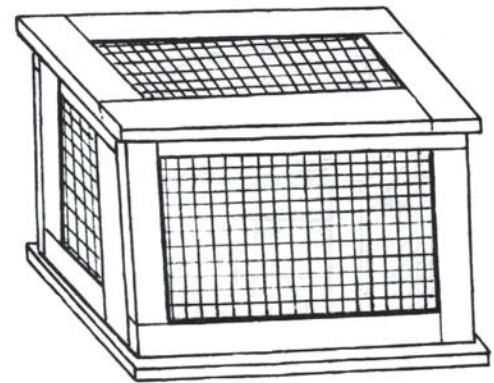



Live Animals Example

ATTRACTING BIRDS

Birds can be attracted to your center by providing feeders, birdbaths, plants, and nest boxes for them.

How to do it:

Feeders

Birds eat seeds, fruits, nectar, insects, meat, suet, greens, and nuts. Depending on the types of birds and animals you have in your local environment, you can place food out for the birds you want to attract. Seeds are the easiest to use in feeders because they keep well and are less likely to attract unwanted animals. Feeders can be made easily from plastic bottles with a hole cut in the side big enough for the birds to reach through to get the food. Or you can build covered wooden or plastic feeders. Feeders can be mounted on poles or attached to the side of buildings. Fruit or suet can be nailed to poles. Suet is particularly attractive in winter; it tends to become rancid in hot weather.

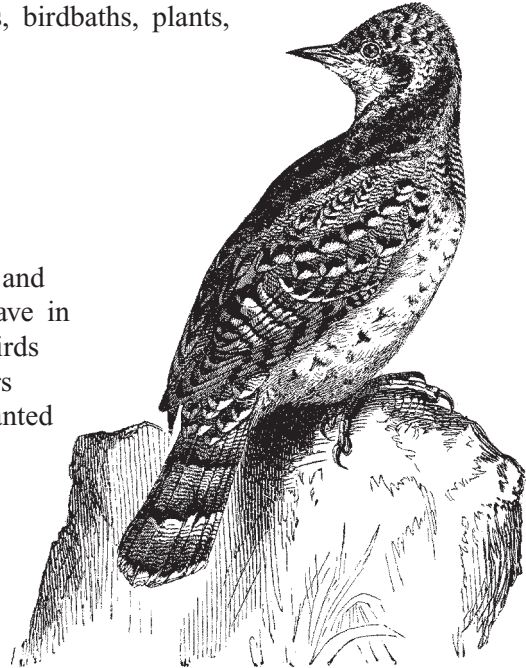

Birdbaths

An added attraction can be a birdbath. Since most birds love to bathe, you could provide a bath near a favorite tree or shrub. A calabash washstand would make a very good birdbath. Since dripping water makes a birdbath even more attractive, hang a large can of water with a hole punched in the bottom, from a branch over the bath. Keep the bath clean and the can filled.



Plants

You can attract birds that live nearby if you provide the kinds of vines, shrubs and trees that give them shelter and food. Plants that attract birds include shrubs that have berries. Hummingbirds like red or pink tubular flowers. Watch what the birds and butterflies are attracted to in your community, and transplant them into your garden.



Nesting Boxes

Nesting boxes, or bird houses, will attract birds that nest in cavities in trees. The boxes should be in low traffic areas and should be in colors that blend with the surroundings. An overhanging roof will keep rain out of the nest. The size of the nest boxes will vary with the species. A chickadee, for instance, will use a box about 4 x 4 x 5 inches with a 2-inch hole in the front. You can also leave nesting materials out in a conspicuous place. Nesting materials include short lengths (no more than two inches) of string or yarn, fleece, dried grass, small feathers, lichens, hair, moss or spider webs.



RESOURCES

Bottle Biology. Dubuque, Iowa: Kendall/Hunt Publishing, 1993.

Durrell, Gerald, *The Amateur Naturalist.* New York: Alfred A. Knopf, 1983.

New UNESCO Source Book on Science Teaching. UNESCO, 1973. Also available on the Internet at http://upo.unesco.org/details.aspx?Code_Livre=377





MATERIALS

22 FLANNEL BOARDS AND PAGIVOLT

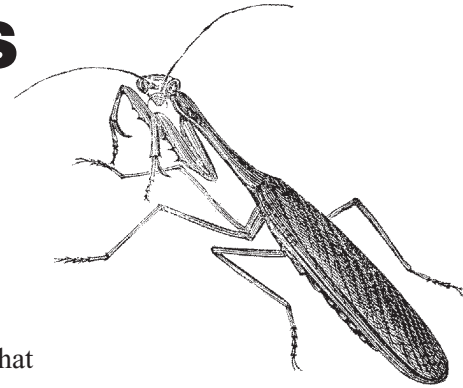

DESCRIPTION

A flannel board is a visual aid that utilizes a flannel or felt covered board as a background, and cut paper or felt figures that stick to the background. A pagivolt is a series of figures drawn on cloth. The figures are used to tell a story, teach a lesson, or describe a problem with suggested solutions. Both techniques are useful ways to teach. They are visual representations that enhance lessons, and are especially useful in areas where literacy is low. Flannel boards and pagivolts are portable and reusable.

USES

Flannel boards and pagivolts can be used to tell a story, describe a process, show relationships, or teach a concept. For example, a flannel board used to teach about the importance of clean water might have figures representing unclean water and how it got unclean, cleaning methods, and clean water. It could include figures and/or words representing bacteria, viruses, protozoans, heavy metals, or toxic chemicals, and a figure representing a sick person and the diseases or conditions caused by unclean water. For water cleaning solutions, the presenter could demonstrate how boiling, filtration, and distillation remove certain bacteria and toxins.

HOW TO DO IT

Materials for Flannel Board:

- ▶ 1 stiff board (wood, cardboard, etc.) any size desired.
- ▶ 1 piece of flannel, felt, or other rough-surfaced material large enough to cover the board plus 5 extra centimeters on each side to fold over edges.
- ▶ Staples, tacks or paste.

Procedure:

1. Cover the board with the material and turn it over.
2. Fold the extra material onto the back and staple, tack or paste it tightly to the back of the board.



Materials for figures:

- ▶ Figures cut from paper or felt, or photographs or drawings pasted onto paper or felt
- ▶ Paste or glue
- ▶ Sand or small pieces of sandpaper or Velcro (two per figure)

Procedure:

1. Spread paste on back of figures.
2. While paste is wet, sprinkle sand over the paste, or paste a piece of sandpaper at the top and at the bottom of each figure.

Materials for pagivolt:

- ▶ Plain fabric, like muslin, in desired size
- ▶ Sketch paper and pencil
- ▶ Paint, markers, fabric paint, wax crayons

Procedure:

1. Plan your presentation beforehand. Decide what you want to depict and draw a sketch. Decide how large you want your fabric to be so your audience will be able to see it clearly.
2. Sketch the presentation on the fabric in pencil.
3. Paint the presentation, or use markers or fabric paint.
4. Crayons can be used to draw the presentation. Then cover the fabric with newspapers or other absorbent paper, and iron the fabric to set the images.

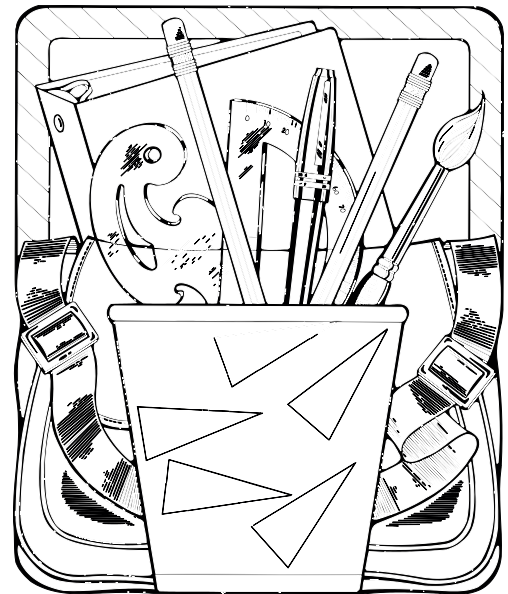



23 POCKET CHARTS

DESCRIPTION

A pocket chart is a chart with pockets for putting cards, word strips, photos or any other visual material.

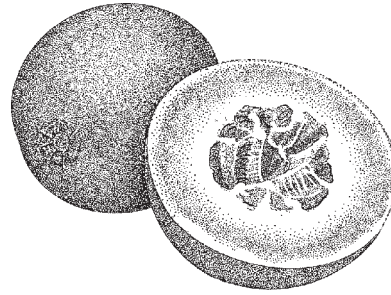

USES

Pocket charts are useful because you can move the cards around as your discussion requires. You can add or subtract cards, and ask participants to add their own ideas on cards.

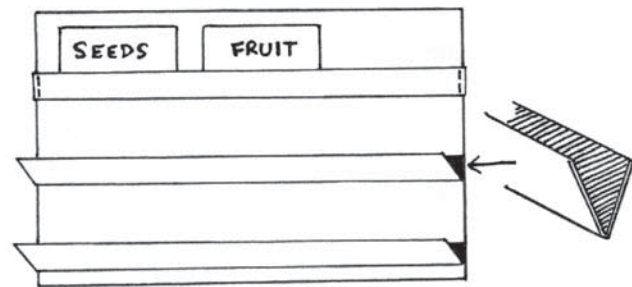

HOW TO DO IT

Materials for cloth pocket chart:

- ▶ Plain colored fabric 1m x 1m
- ▶ 0.5 m clear plastic sheeting
- ▶ 6 strips, 8 cm x 1 m

Procedure:

1. Cut clear plastic into strips.
2. Lay strips on fabric evenly spaced.
3. Stitch sides and bottom of strips to create a transparent pocket. Hem fabric.

Note: This method may be used for constructing a heavy paper pocket chart as well. The cloth model is sturdier than the paper model.

Materials for paper pocket chart:

- ▶ Large piece of heavy paper or light cardboard
- ▶ Glue or staples



Procedure:

1. On a large sheet of heavy paper, draw a solid line 15 cm from the top. Three cm below that, draw a dotted line.
2. Fold solid lines toward the top of the paper, and dotted lines toward the bottom (see diagram) to make pockets.
3. Tape, staple or glue pockets at the side of the chart to hold.

Note: When using cards in this pocket chart, remember that the bottom 3 cm will be covered, so don't write anything there.

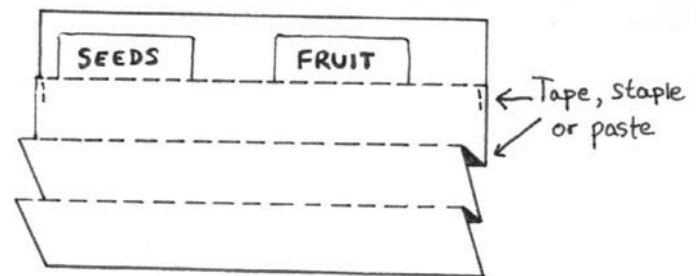
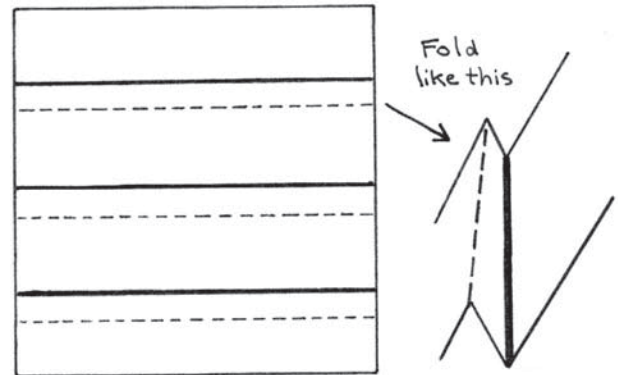



24 ECOTRUNKS

DESCRIPTION



Ecotrunk kits are self-contained kits of educational materials on a particular topic or theme. The kit is meant to have everything a teacher or trainer would need to implement a set of lessons on a particular topic. Schools develop a few kits per year and slowly build a wide selection of topics that any teacher can pick up and use. Museums also develop these traveling educational kits.

HOW TO DO IT



When preparing an ecotrunk, you will need to plan for all possible materials that might be needed. You may even need to plan for blackboards or chart stands. Plan for a normal class size, and then suggest adaptations for classes that are of very different sizes if necessary. A teacher's manual should be included that has lesson plans, materials lists, background information, resources for further information, and contact information for the owner of the kit. You may want to add evaluation information as well. Enclose a complete list of contents so the teacher can make sure to gather up all the materials at the end. If you use consumable materials, make sure to supply sufficient amounts, or let the teacher know if they are responsible for replacing any materials they have used up.



— ECO TRUNK —

“EXPLORING FORESTS” POSSIBLE CONTENTS

Audience: Middle school students, class of 25

Checklist of contents of kit, to be used upon receipt and at the end:

- Teacher's guide including background information on temperate rainforests, lesson plans, list of resources and glossary
- Forest cards with illustrations of organisms that live in the forest as well as cards for sun, water, soil and air
- Succession illustrations and season illustrations
- Increment core borer, 50-meter tape, clinometer, soil thermometer, and plant press
- Field guides to trees and plants, birds, and insects
- Set of 20 forest task cards
- Set of five forest mystery cards (one per 5 students)
- Consumable worksheets: Three sets of 25 per class
- Field white board with three markers and erasing rag
- Five sets of binoculars
- Evaluation forms



EQUIPMENT

25 FIELD EQUIPMENT

DESCRIPTION

Creating “low-tech” equipment is both fun and challenging. Using local materials and local technologies allows community members to make their own equipment in the future. If you are used to expensive manufactured scientific equipment, it may take some thought to devise a low-tech alternative. You need to think about what the equipment is supposed to do, or what it is supposed to measure. A balance and weights, or a spring balance may be able to do just as good a job as the electronic scale in a laboratory. A meter stick can be made from any straight stick or heavy paper. Volunteers have made projecting microscopes from local materials.



For ideas, look in Peace Corps ICE publications or check VITA (Volunteers in Technical Assistance) publications or VITA’s website, www.vita.org.

New UNESCO Source Book on Science Teaching. UNESCO, 1973. Also available on the Internet at http://upo.unesco.org/details.aspx?Code_Livre=377.





26 WEATHER STATIONS

DESCRIPTION

Weather stations usually measure temperature, rainfall, wind direction and intensity, cloud cover and type, barometric pressure and humidity.





Weather Stations Example

WEATHER INSTRUMENTS

Thermometer

Ideally, a maximum/minimum thermometer can be used for temperature. If that is not available, any working thermometer in the proper temperature range will do. It should be kept in a location that is out of the sun and safe from breakage. Often, thermometers are kept in ventilated boxes.

Rain Gauge

A simple rain gauge can be made by placing a funnel in the opening of a bottle. The height of the rain collected is then measured with a ruler in centimeters.

Another slightly higher-tech rain gauge can be made with a can, a straight-sided bottle and a funnel.

How to do it:

Materials:

- ▶ Large can 10 cm in diameter and 14 cm in height
- ▶ Straight-sided glass bottle
- ▶ Funnel
- ▶ Ruler
- ▶ Marker for glass bottle

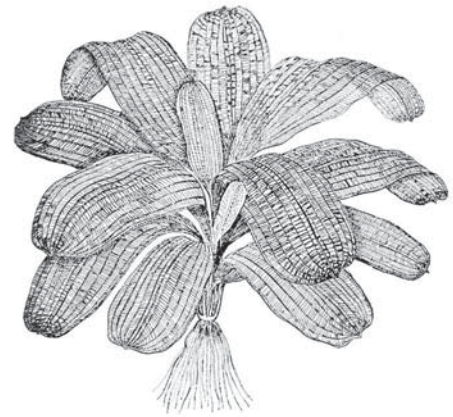

Procedure:

1. Place the can on a level table and fill it with water to exactly one-centimeter depth as measured by a ruler.
2. To calibrate the glass bottle for measuring, pour the water from the can into the glass bottle and mark the level of water. Label it 1 cm.
3. Repeat at 2 centimeters, etc.
4. To assemble the rain gauge, place the funnel in the top of the calibrated glass bottle and then place the bottle in the can. Set it in an open place where it will not be upset. If the rain is more than the bottle can hold, it will spill into the can and can be measured separately.

Rain gauges are mounted in open, unobstructed areas and must be level. The number of millimeters or inches that is collected is the measure of rainfall.





Barometric Pressure and Humidity

Barometric pressure is measured in millimeters of mercury. The air presses on a column of mercury and pushes it up a thin glass tube. Higher pressure causes the mercury to rise more and indicates the presence of a high-pressure system (usually clear weather, which is hot in summer and cold in winter). Barometers are used to measure pressure, and psychrometers are used to measure humidity. Humidity is the amount of water vapor in the air. When humidity is low, the air is dry. If these instruments are available to you, you can use them in your weather station.

Wind Direction

Wind direction can be measured with a weather vane. Weather vanes can be made of any sturdy weatherproof material and must be mounted so they can swivel easily to indicate wind direction.

How to do it:

Materials:

- ▶ 1 x 1 x 25 cm piece of wood
- ▶ Thin piece of wood or plastic, 10 cm wide x 36 cm long, that will fit into slots (see below)
- ▶ Glass part of a medicine dropper
- ▶ Supporting rod to mount weather vane
- ▶ Nails

Procedure:

1. With a saw, cut a 6 cm slot in both ends of the piece of wood.
2. Cut the thin piece of wood into two pieces shaped like the head and tail of an arrow. Slide one into each end of the slotted wood and fasten with glue or small nails.
3. Balance this wind vane on the blade of a knife to find the exact center, and mark the center.
4. Close the small end of the glass part of a medicine dropper by rotating it in a gas or alcohol flame. Drill a small hole in the center of the wind vane just slightly larger than the small end of the medicine dropper. Drill the hole about three-quarters of the way through the vane.
5. Drive a small nail into the top of the supporting rod. Cut the head off the nail and file it to a point.
6. Balance the medicine dropper on the nail in the top of the supporting rod, and the wind vane on top of the medicine dropper.



Wind Speed

Wind speed is measured with an anemometer. A simple anemometer can be made from local materials and will measure relative wind speed.

How to do it:

Materials:

- ▶ Two pieces of light wood, 1 x 1 x 50 cm
- ▶ Four small plastic dishes or tins (e.g., tuna cans)
- ▶ Medicine dropper
- ▶ Supporting rod
- ▶ Nails



Procedure:

1. Cut a notch 1 cm wide by 0.5 cm deep in the exact center of both pieces of wood.
2. Fit the sticks together to form a cross arm and glue or nail together.
3. Attach plastic dishes or tins to the ends of the four cross arms such that they all face the same direction.
4. Close the small end of the glass part of a medicine dropper by rotating it in a gas or alcohol flame. Drill a small hole in the center of the cross arms just slightly larger than the small end of the medicine dropper. Drill the hole about three-quarters of the way through.
5. Drive a small nail into the top of the supporting rod. Cut the head off the nail and file it to a point.
6. Balance the medicine dropper on the nail in the top of the supporting rod, and the cross arms on top of the medicine dropper.

Calibrating the wind speed indicator (anemometer):

- ▶ You can get a rough idea of the speed of the wind in miles per hour by counting the number of revolutions in 30 seconds and dividing by 5. If it is difficult to count, paint a red dot on one of the dishes, and use that dish to count. If you want the wind speed in kilometers per hour, divide your above result by 0.62.
- ▶ Another way to calibrate your anemometer is to have someone drive on a calm day while you hold the anemometer out the window. Count the number of revolutions per minute at 10, 15, 20, 25, 30 and 40 miles per hour.



Cloud Cover and Type

Cloud type can be determined from cloud type charts. If you are in a country that is a member of the GLOBE program, GLOBE has cloud charts. If not, cloud charts may be available at bookstores or libraries.

Cloud cover is measured in percentages of sky covered: no clouds (0%), clear (0-10%), isolated (10-25%), scattered (25-50%), broken (50-90%) and overcast (90-100%). It takes practice to estimate the percent cover. Standing in an open area and facing one direction shows half the sky. You can use your arms to block off half of that to estimate the cover in one quarter of the sky. Then estimate the other quarter, and then the other half. Decide if half the sky is covered by clouds. If it is slightly more covered, then it is broken. If it is slightly less, it is scattered. If it is less than one quarter covered, it is isolated. If there are only a few clouds, it is clear. If it is entirely covered, it is overcast.

RESOURCES

GLOBE (Global Learning and Observations to Benefit the Environment) Teacher's Guide, The GLOBE Program, 1997. Gives instrument specifications for atmosphere, hydrology, land cover, soils and seasonal change. Includes directions for making some of the equipment.

New UNESCO Source Book on Science Teaching. UNESCO, 1973. Also available on the Internet at http://upo.unesco.org/details.aspx?Code_Livre=377.





27 PLANT PRESSES

DESCRIPTION

Plant presses are used to preserve plant specimens for reference or future examination. The basic idea is to place plant specimens between absorbent materials, usually paper, and then apply pressure to press them flat and allow them to dry with minimal loss of color and detail. The absorbent paper is usually placed between layers of cardboard, and finally all the layers are placed between two pieces of wood (or under a stack of books), and pressure applied. The press can be compressed by using Velcro, weights, or bolts.



HOW TO DO IT

To get good results from pressing plants, it is best to use fresh specimens. If you can't press them immediately, put them in a vase with water until you can get to them.

Plant presses allow you to preserve flowers, leaves, stems and roots. The basic idea is to place the specimens between absorbent pieces of paper and apply pressure. There are several ways to do this.



The Old-Fashioned Book Method:

Place your specimens between paper towels or other absorbent paper. Place the specimen and paper inside a big book, or between several books.

Tennis Racket Press:

A tennis racket frame is a four-sided frame that can be tightened with four wing nuts and bolts at the corners. To turn it into a plant press, cut two boards to the size of the racket frame. Place your specimen and paper between the two boards, and place the boards inside the racket frame. Tighten the wing nuts.



PLANT PRESS

The basic materials that you need for constructing a plant press are:

- Newspaper
- Several pieces of corrugated cardboard (30 centimeters by 45 centimeters is a standard size)
- Straps or cords
- Plywood or lattice made of wooden laths (cut to 30 centimeters by 45 centimeters)

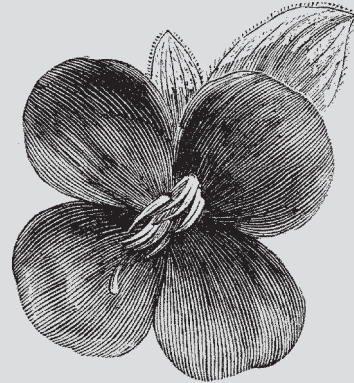

Leaf samples should be put in the press within a few hours of their collection. Place the sample between several sheets of newspaper. Sandwich the sample between two cardboard separators. Place another sample on the flip side of one of the separators and repeat the process until you have prepared all the samples you have gathered for the day. Samples with thicker stems or small fruits can be accommodated by inserting pieces of foam rubber between the newspaper and cardboard separator. Bind the press together with the straps. Check samples daily and change any damp newspaper. Remove them when they are dry. In particularly humid conditions, dry the samples where dry heat is available, e.g., well above or beside (not too close!) a cooking fire. Stiff white paper works best for mounting. Plants can be mounted using sticky tape or rubber cement. Affix a label that includes information on the name(s) of the plant, date of collection, traits used by local people to identify the plant, and notes on habitat. Include other interesting characteristics/uses.

From *Learning Local Environmental Knowledge: A Volunteer's Guide to Community Entry*. Peace Corps [ICE No. M0071], page 61.

RESOURCES

Durrell, Gerald, *The Amateur Naturalist*. New York: Alfred A. Knopf, 1983.



OR

1. Split the bamboo in half lengthwise.
2. Clean out any center nodes.
3. Attach wire screening to the open ends.

Make a sprinkling can by punching holes in the bottom of a large can with a hammer and small nail.

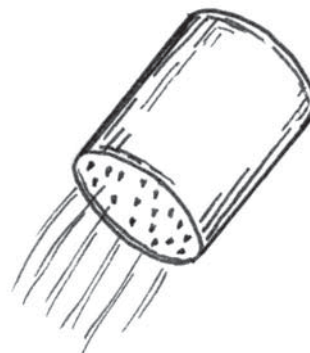

4. Fill one box with loose soil, the other with tightly packed soil. Tilt the boxes so the screened ends are lower, and place containers under the lower ends to catch run-off water.

Sprinkle with water from the sprinkling can and watch to see which soil washes away most, and what the water that is collected looks like.

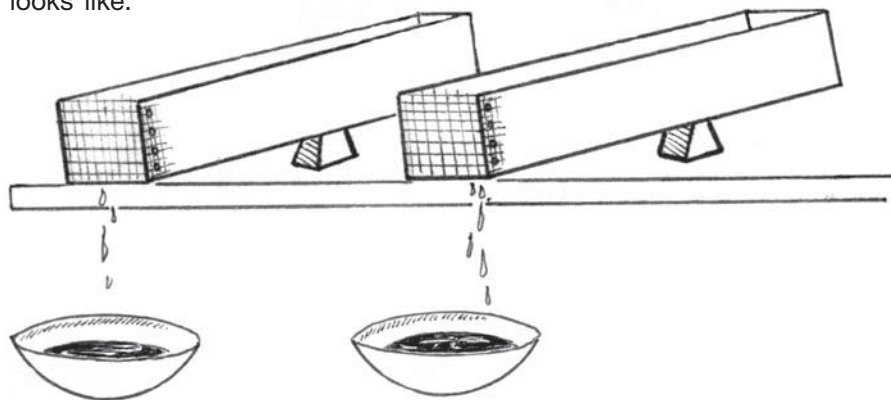

5. Smooth loosely packed soil in each box, and in one box make three or four grooves in the surface with a stick, running the length of the box; in the other, make grooves across the box every 6-8 cm. Tilt the boxes as before.

Sprinkle each box heavily with water from the sprinkling can. Note how water flowing downhill follows the grooves and makes them deeper. Note how grooves cut against the flow of water helps keep the soil from washing away. Note how much soil was washed from each box into the catch containers.

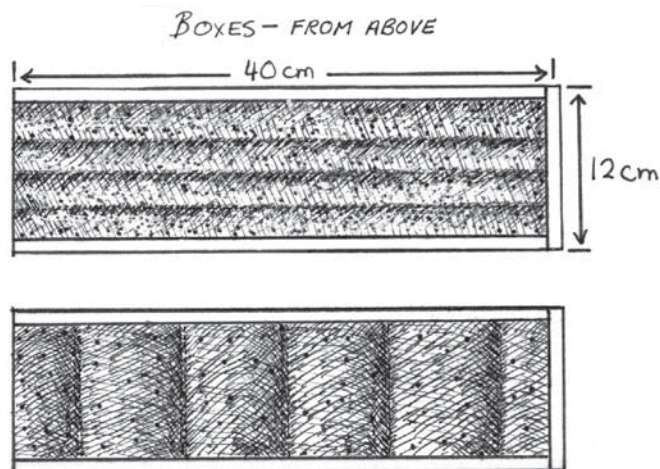

(continued)



6. Sprinkle loosely packed soil in each tilted box with water until the water washes its own grooves into the soil. With little sticks and stones, block the grooves at intervals and sprinkle again. How do obstacles help prevent erosion?
7. In one box, seed the surface generously with some grass or other ground-cover seed. Give the box water and light for the seeds to grow. When the grass is thick and about 2.6 cm high, tilt the box it is in, and the second box which has only soil, as before.

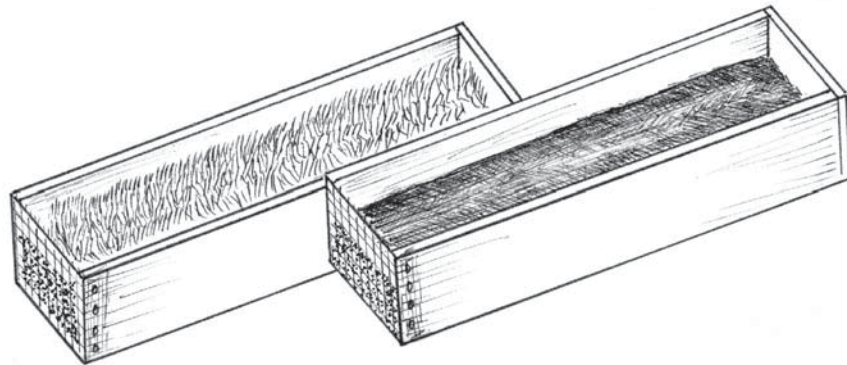

Sprinkle heavily with water from the sprinkling can. Note how the grass prevents the water from moving the soil down and into the catch container. (A piece of sod placed on the soil in one box could demonstrate this also.)

A class project could be to locate a place in the community where water erosion has taken place. Plan and carry out ways that could prevent further erosion; plan ways to upgrade or restore the soil (such as filling with gravel or stones, channeling the water in another direction, planting ground cover).





29 WATER SAMPLING EQUIPMENT

DESCRIPTION

Water quality measurements include flow rate, transparency, chemistry and temperature, as well as biological indicators. Temperature is measured with a thermometer, and water chemistry measurements require chemicals for measuring dissolved oxygen, nitrates, etc. Transparency is measured with a Secchi disk or turbidity tube.

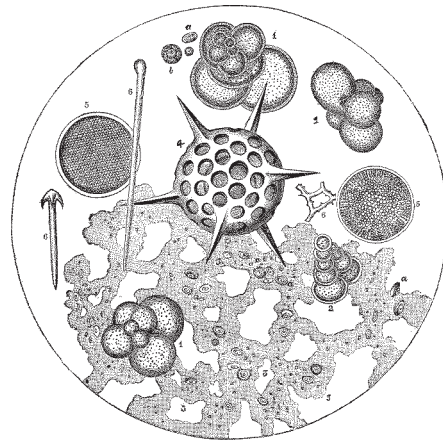

HOW TO DO IT

To examine the plants and animals in the water body, you will need several simple pieces of equipment. The best places for gathering water creatures are grassy areas and under rocks. They tend to be abundant in shallow, warm areas with lots of hiding places. A simple measure of water health is diversity: generally, the more types of life you have in a water body, the healthier the water. That doesn't mean the numbers of organisms, but rather the number of different species.

Examining animals:

White-bottomed basin or tray to temporarily put animals into for examination.

Sorting tray:

If you want to sort them, an ice cube tray works well, or small jars.

Collecting water creatures:

To gather water creatures from the water, use an ordinary kitchen sieve or a net. Simple nets can be made with wire (coat hangers work well), panty hose or fine mesh netting and small jars. The size of the mesh will determine the minimum size of organisms you can capture.

Magnifying water creatures:

Hand lenses are useful for looking at small animals and plants.





Flow rate:

To determine the flow rate of a stream, mark two places along the bank for a start and finish. Measure the distance between these two markers. To make this easy, try to place the markers 10 meters apart. Find a small floating stick to use for timing. You will need a timer with a stopwatch, or a watch with a second hand. When the timer says, “go,” another person drops the stick at the upstream starting stick and watches it as it floats to the downstream finish stick. When it is even with the finish stick, the person tells the timer. To determine the flow rate, divide the number of meters by the number of seconds. For example, if the stick took 20 seconds to float between two markers 10 meters apart, $10 \text{ meters} / 20 \text{ seconds} = 1/2 \text{ meter per second}$.

Water chemistry kits:

The most common water chemistry kits are for dissolved oxygen and nitrates. If these are available to you, they will have directions for their use. Dissolved oxygen is an indication of the capacity of the water to allow growth. Generally, the more oxygen there is, the more growth. Colder waters hold more oxygen than warmer waters. When algae blooms in water bodies, it uses up the oxygen, so dissolved oxygen is also a measure of eutrophication, or excessive algal growth. Nitrate chemistry is a general measure of decomposition or pollution. High nitrates are deleterious to organisms because bacteria are not able to process nitrogenous wastes fast enough.

Secchi disk:

Make a Secchi disk from a disk with a black and white pattern on it that is lowered into the water until the pattern cannot be seen. The depth at which the pattern is no longer visible is a measure of the water transparency.

A Secchi disk is a circle of wood or plastic that you can paint black and white. Divide the circle in fourths and paint alternating quarters black and white. This design is highly visible. Attach a sturdy eye screw to the center of the disk, and attach a long rope to the eye screw so the disk may be lowered into the water. Mark the rope at 10-centimeter intervals with survey tape or permanent marker or knots. Lower the disk slowly into the water until you can no longer see the design. Read the depth of the disk by counting the number of marked intervals on the rope.

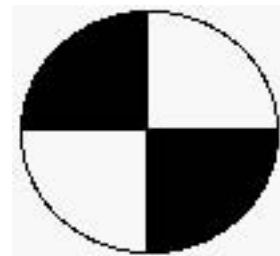

Turbidity tube:

A turbidity tube is a long transparent tube that is marked along its side by centimeters. Water is poured into the tube until the black and white pattern at the bottom can no longer be seen. An easy way to make a turbidity tube is from the clear plastic covers that florescent lights are shipped in. Remove the end caps. Inside one of the caps paint the black and white pattern described above. Replace the cap and seal it with waterproof tape. Along the side of the tube, mark off centimeters with a waterproof marker or paint.

To use the tube, pour the water you are testing into the tube until you can no longer see the pattern at the bottom. Read the height in centimeters off the side of the tube to determine transparency. If you fill the tube and can still see the pattern, the water is highly transparent.





RESOURCES

Angel, Heather and Pat Wolseley, *The Water Naturalist*. New York: Facts of File, 1982.

Durrell, Gerald, *The Amateur Naturalist*. New York: Alfred A. Knopf, 1983.

GLOBE (*Global Learning and Observations to Benefit the Environment*) *Teacher's Guide*, The GLOBE Program, 1997.

Stapp, William, and Mark K. Mitchell, *Field Manual for Global Low Cost Water Quality Monitoring*. Dexter, MI: Thomson Shore Inc, 1995. [ICE No. FC234]

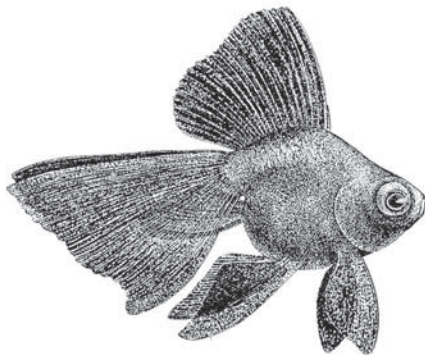
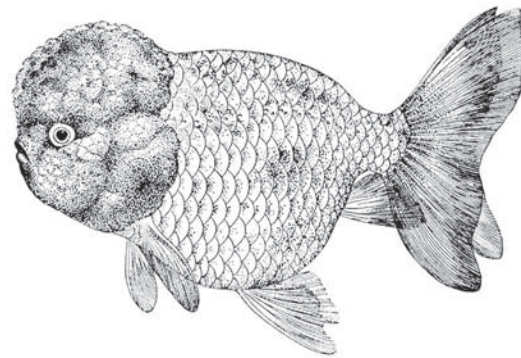
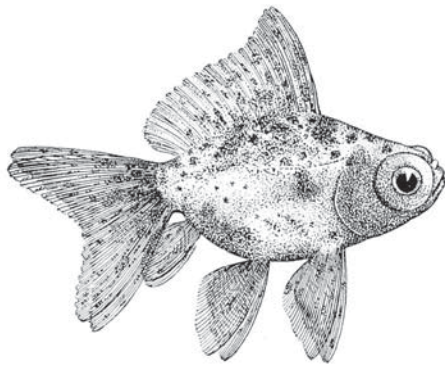



30 MEASURING ACIDITY

DESCRIPTION

Acidity (pH) is measured on a scale of 1.0 (extremely acidic) to 14.0 (extremely basic or alkaline). Pure water has a pH of 7.0. (Lemon juice has a pH of about 2.0; stomach acid is about pH 0.9; blood is about 7.5; seawater is 8.6 and Drano is about 13.5)

For living organisms, the pH of their environment should be neither too acidic nor too basic. Both acids and bases damage cell walls. There are several geological processes that can make water slightly acidic due to dissolved minerals in the water. Many water plants and animals are adapted to slight acidity (a slightly low pH of 5.6-7.0). Excess acidity from either natural sources or human sources such as acid rain or agricultural or industrial chemicals can be harmful to living organisms. Likewise, excess alkalinity (high pH above 8.0) can be harmful. Measuring acidity and alkalinity can, therefore, be an indication of water quality.

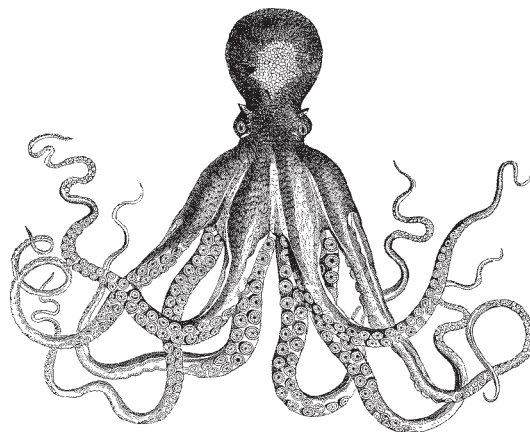

HOW TO DO IT

There are several ways to measure acidity. If you have a pH pen, pH meter or pH paper, measuring acidity is a simple matter of putting the pen, meter probe or paper into the water for two minutes and reading the results on a scale that comes with the instrument.

There are also indicator solutions, such as phenolphthalein, bromthymol blue, phenol red and a range of others. To use a solution, collect a small sample of water or test solution in a cup and add several drops of the indicator. The indicator will be a specific color, depending on the indicator and the acidity of the water. At a specific pH, indicators change color. The indicator's container will give the pH range for that indicator. If you have indicator solutions available to you, the most useful ones for testing water quality will be indicators that test pH 4.0 to 8.0.

Red cabbage juice is also an indicator of acidity. The juice turns from bluish purple to yellow at a pH of 2.4 - 4.5. If this indicator turns yellow, the water is too acidic for most organisms. To make this indicator, cut up a red cabbage and place it in a pot with enough water to completely cover it. Boil it to extract the juice. You will see the water turn purplish. Let the juice cool, and store in a dropper bottle. Add 10 drops to one tablespoon of the indicator to your water sample to test for acidity.

RESOURCES

Bottle Biology. Dubuque, Iowa: Kendall/Hunt Publishing, 1993.





RESEARCH

31 FIELD RESEARCH

DESCRIPTION

You and your community members do not have to have Ph.Ds in science to conduct research. All research is an effort to answer a question by finding evidence. The evidence is in the form of data. Anyone can conduct research, from 7-year-olds to 70-year-olds. There was a first grader in Nenana, Alaska, who wanted to know if the bread really always did fall jelly side down. So he designed an experiment where he dropped bread slices with jelly on them from a standard height (30") with a standard method (pushed off a table jelly side up) 100 times. Bread only drops jelly side down half the time. This experiment was a real, original piece of research.

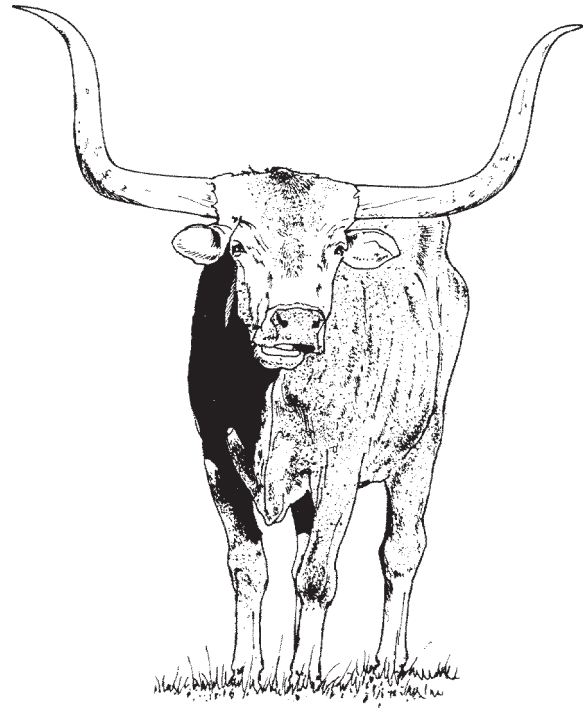

USES

Environmental research is usually more difficult because environmental systems are more complex and less controllable. It may take some thought to figure out what to measure, and how to measure it in order to find an answer to your question. Often community environmental research focuses on taking longitudinal data on a system of interest, like a water system, or fertilizer use. People want to know things like: if the water is clean enough to drink, or if the fertilizer or pesticide really works to increase growth or decrease pests, or if a certain grazing pattern makes for healthier cows. So the research then becomes measuring water quality, testing crops with and without the fertilizer or pesticide, or comparing cow health with different grazing patterns.

HOW TO DO IT

Usually the first step is to create definitions that can be tested. What, for example, defines a healthy cow? Is it weight, or growth over a given time period or hide quality or being disease-free? The next step is to gather baseline data. What do the cows weigh, how fast do they grow and how much, what does their hide look like and how often do they get sick under normal conditions? For the fertilizer example, you would want to know how tall your crop grows before treatment with the fertilizer, or how much you can harvest per hectare before treatment with the fertilizer. Then you apply the question you are studying: in these cases, grazing pattern and fertilizer, and measure again after the treatment to see if there is any difference.



In countries that are just beginning to be aware of environmental issues, much environmental research is gathering baseline data about what their current situation is: how many species, which species, how much area is affected, how many acres of forest, extent of water pollution in a given stream. Volunteers can be very helpful by facilitating the gathering of **inventory and baseline data**.

Another type of research is **demonstration projects**. Communities can set up research to determine the effects of a variety of treatments on their gardens, forests, fishponds, etc. Generally people don't want to experiment on their own cash crop. However, small studies can be conducted by organizations that will not make or break a family. For example, to test types of pesticides, separate plots of the same species can be planted, and all but one treated with a pesticides. One would not be treated at all to act as a control. (What if we did nothing?)

RESEARCH — ECUADOR —

A Volunteer worked with a natural resources foundation in Ecuador. Primarily working in the field of agroforestry with his counterpart agency and its various surrounding communities, he spent much time in the field, observing and using mist nets for the study of the migration of birds to the Podocarpus National Park and its buffer zone. This information was incorporated in his environmental education work in the various communities to help promote and preserve the biodiversity of Ecuador.

During his second year of service, he participated in a study researching the conservation of bird habitats in Podocarpus National Park which is a nationally protected area. This study was in conjunction with the Nature Conservancy and Alas de las Americas (Wings of the Americas). Alas de las Americas collaborated with both the Poconos State Park in Pennsylvania and the National Park of Podocarpus. Through observation and data collection, relations were formed and information regarding migrating birds was shared and exchanged between the two parks. Afterward, the Volunteer was interviewed on a national TV program, which was then aired internationally. This brought worldwide attention in the area of conservation of bird habitats and biodiversity. On a personal level, he used this experience as an opportunity to expand his research techniques.



After completing an initial training period, he taught university students and park guards in the area of biodiversity and bird research. Topics covered included optimal methods to observe, investigate, capture, mark and release bird species.

In addition, the Volunteer developed a bee project with two complementary goals in mind; the first, to conserve the protected forest of El Tundo, and the second to provide an income-generating activity. This was a highly successful project as it fulfilled both goals, using natural resources to better the lives of Ecuadorians without disrupting, but instead fostering, the delicate ecosystem.



EXAMPLES

Some sample research projects:

Ecosystem Studies:

- ▶ Biodiversity: catalogue species living in a certain area,
- ▶ Phenology: Record timing of seasonal changes including budburst, senescence (leaves falling), flowering, harvest, arrival of migratory species, temperature and daylight changes,
- ▶ Species of Interest: in depth observations of a particular species of interest, such as elephants, bees, or medicinal plants. These studies might include population size, seasonal changes, food, breeding season, hibernation, migration, soil and water conditions, or predation,
- ▶ Effects of flooding, fire or drought.
- ▶ Erosion patterns and amounts,
- ▶ Impact of human use on plants, animals, water, air, or soil.

Soil Studies:

- ▶ Types of soil in the area
- ▶ Layers of soil
- ▶ Soil moisture
- ▶ Drainage in different types of soil
- ▶ Soil texture and composition
- ▶ Soil chemistry
- ▶ Methods of preventing erosion
- ▶ Effects of fertilizers or pesticides
- ▶ Which seeds grow in which soils
- ▶ Soil contamination



Water Studies:

- ▶ Indicator species: Insect biodiversity as an indicator of water health
- ▶ Acidity/alkalinity
- ▶ Transparency/turbidity
- ▶ Flow rate
- ▶ Dissolved oxygen
- ▶ Water chemistry
- ▶ Possible sources of water
- ▶ Water filtration methods



- ▶ Water treatment methods
- ▶ Water pollution

Plant Studies:

- ▶ Which plants grow in an area
- ▶ Which plants indicate what soil and water conditions
- ▶ Which plants need sun or shade
- ▶ Which plants are eaten by animals (domestic and wild)
- ▶ Which plants are used by people for what purposes

Animal Studies:

- ▶ Identify resident animals
- ▶ Identify migratory animals
- ▶ Identify animals impacted by humans
- ▶ Identify animal pests
- ▶ Study animals of interest to determine their food, feeding habits, migratory patterns, reproductive behavior, shelter, defensive behaviors or reaction to humans
- ▶ Study dangerous animal behaviors so as to prevent injuries
- ▶ Study animal-human interactions to learn about the impact of humans on animals and vice versa





32 MAKING MAPS

DESCRIPTION

Maps are useful instruments for indicating topography, distance, and characteristics of land areas. Maps can be useful to Volunteers to show where geographic features are located, and the extent of land area covered by certain types of terrain, plant communities, crops or other items of interest. Maps also show the relationship of different types of land use, such as irrigation and farmland, or waste disposal and water supplies.

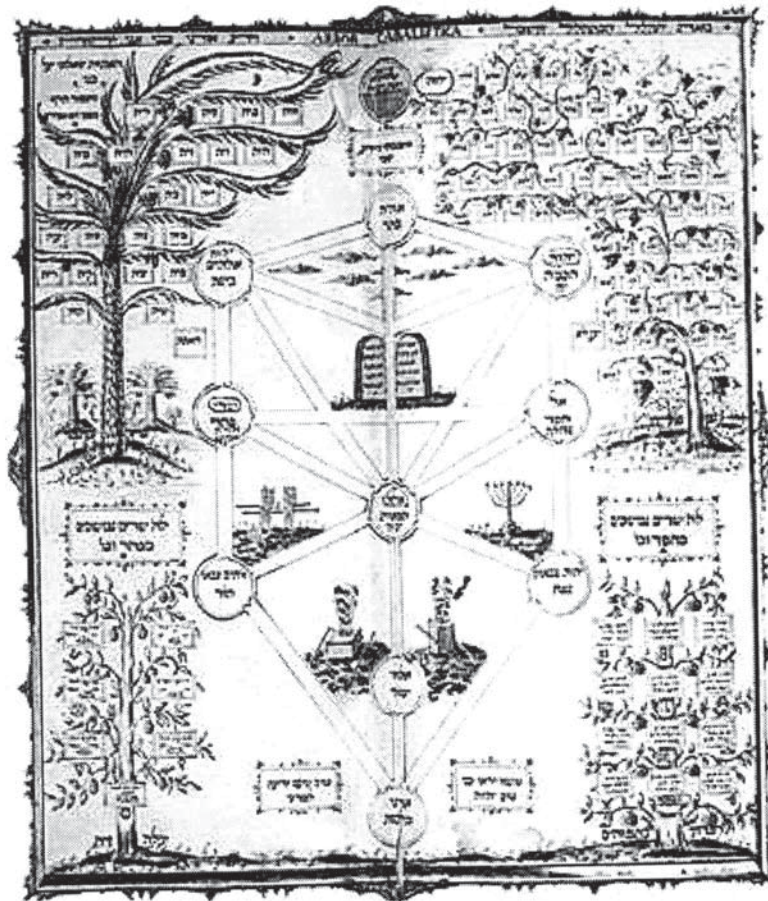



Making Maps Example

MAKING MAPS USING A COMPASS, AND PACING OR MEASURING TAPE

Before you start mapping, determine your pace. A pace is two steps, that is, the distance you travel as you step from your right foot to your left and back on to your right. Lay out a 10-meter line, or measuring tape on flat ground. Place your right heel at the beginning of the line and walk naturally to the other end counting every time you put down your right foot. Divide the number of paces you counted by 10 to determine the length of your pace. Repeat three times to get an average. This will be very useful in determining distances.

How to do it:

Make a plan for how you want to map the area of interest. How much area do you want to map? What features do you want to map? Have at least one other person help you with the mapping.

Materials:

- ▶ Compass
- ▶ Measuring tape, 50 meters long if available
- ▶ Grid paper to record landmarks
- ▶ Flagging to record landmarks on the ground

Procedure:

1. Walk the area to be mapped before taking any measurements to get a general idea of what you will be working with. Pace the length and width to get an idea of how large the area will be.
2. Develop a grid sheet with an appropriate grid scale (e.g., 1 cm = 1 m, or 1 cm = 100 m) and take a blank grid sheet into the field to record measurements.
3. Determine a starting point. It should be something easy for anyone to find, like the front door of the Park headquarters, or the corner where a road and a river intersect.
4. From your starting point, choose a direction to walk (e.g., along a perimeter, along a river bank, etc.) and find the compass direction you will be walking. Using the compass to keep you pointed in the same direction while you walk, measure the distance (by pacing or tape) from the starting point in a straight line to a landmark.
5. Using the grid scale, draw a line on the grid that represents that length and direction. For example, if you walked north 100 meters from your starting point, and your grid had a scale of 1 cm = 100 m, you would draw a line in a northerly (towards the top of the paper) direction, one centimeter long. Lay the compass on the grid with North pointing to the top of the grid to determine direction.





6. From that point, choose another compass direction and measure off another segment, marking it on the grid to scale.
7. Continuing in this way, you can map your area of interest. If you are noting buildings, growth patterns or other features, measure their perimeters and compass directions and mark them on the grid.

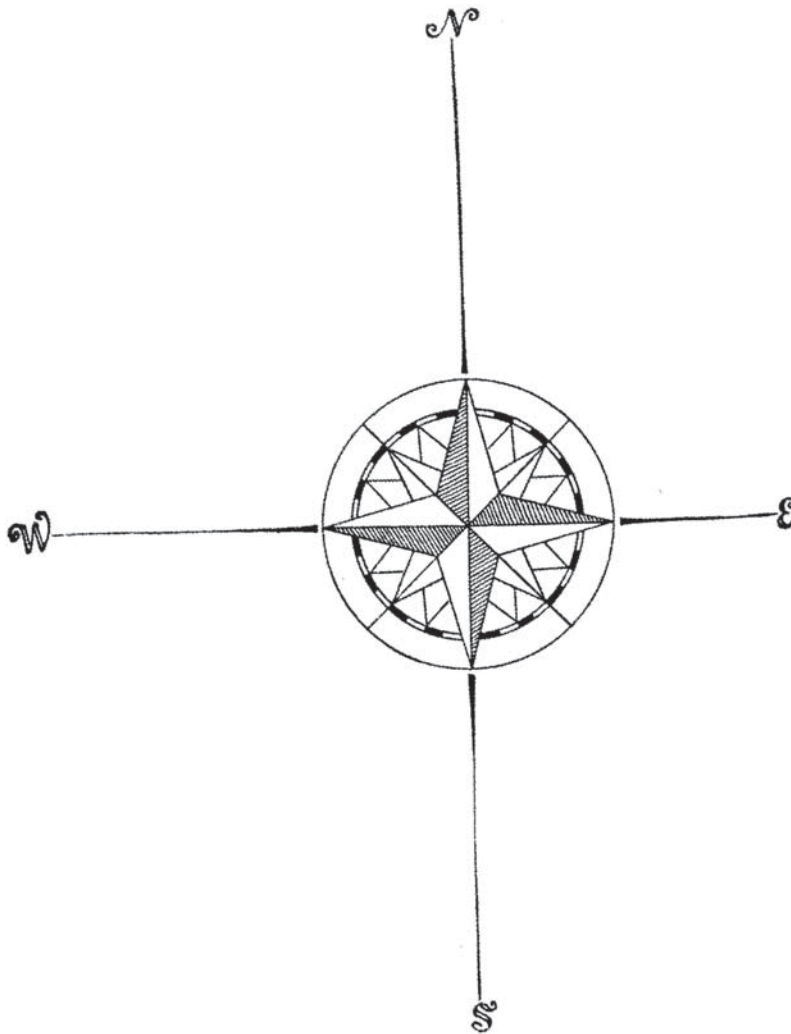



Making Maps Example

MAKING MAPS USING A GLOBAL POSITIONING SYSTEM (GPS) INSTRUMENT

How to do it:

To read a GPS, stand in an open area with a clear view of the sky. Hold the GPS in your hand with the antenna pointing towards the sky. Turn the GPS on by pressing the Power button (it may be labeled PWR or ON or some other designation.) Press Enter to get the Status screen. The Status screen will be showing while the GPS is receiving satellite data. It will show circles with numbers indicating the nearby satellites. It will also show a graph indicating the reading of satellite information. The bars on the graph will turn black when the satellite signal is strong. It will take three or four strong signals before the GPS can determine your location. When the GPS has determined your location, the screen will shift to a position screen that will show your longitude, latitude, elevation date, time and perhaps other data.

There are several ways you can use a GPS to map.

- ▶ If you are mapping a large area, you can take latitude and longitude readings at key points and “connect the dots.” For example, if you want to determine the boundaries of a site, you can take a GPS reading at each corner and transfer that information to a grid. You can set your longitude and latitude readings as waypoints and the GPS will compute the distances between them.
- ▶ A GPS will also allow you to establish waypoints and routes between the waypoints. It will also tell you what direction you are going, like a compass. GPS technology is constantly being updated, so refer to the manual for your particular GPS for operational procedures. GPS readings are taken off satellites and can be constantly updated as you move. The GPS will have a plotting function, or Plot Screen that will allow you to identify waypoints and track your movements. You can set the scale of the plot screen so as to view larger or smaller areas. It will also allow you to compute distances between points.

RESOURCES

GPS 315/320 User Manual, Magellan Corporation, 1999.

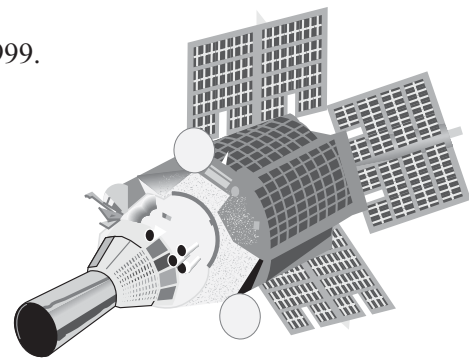



33 TRANSECTS

DESCRIPTION

A transect is literally a set of measurements along a line across an area. For example, if you wanted to know which plants grow at what elevations, you could run a transect from high elevation to low, listing all the plants in a square meter, every 100 meters along a straight line. You would end up with an idea of how plant communities change with elevation. Transects are useful for learning about changes over an area, for studying succession, or for sampling an area.



HOW TO DO IT

1. Determine the area to be studied and the observations to be taken.
 - a. Do you want to know how many trees per hectare?
 - b. Do you want to know which species of trees grow in an area?
 - c. Do you want to know, on average, how many eagle's nests are in a square mile?
 - e. What kind of ground cover plants live in your garden?
2. Determine the most appropriate sampling method. For the above examples:
 - a. Count the trees in 10 samples of 100 meters square, find the average and multiply by 100.
 - b. Choose three transect lines through the study area and walk them identifying every species of tree.
 - c. Determine a transect across eagle nesting areas, count the nests, measure the length of the transect, and divide the number of nests by the length of the transect to determine a per mile average.
 - d. Tie a four-meter long string into a loop. The loop will measure one square meter (one meter per side). Start at one corner of your garden and throw the string. Wherever it lands, spread it out to its full size and identify every plant inside the loop. Walk the diagonal of your garden, throwing the loop every 10 meters. Count up how many of each type of plant you identified to determine percentages for ground cover plants.



APPENDIX - TRAINING MODULES

1

SESSION 1: DO AN ENVIRONMENTAL ASSESSMENT

OVERVIEW



In this session, participants will practice the first step of developing an environmental education program — plan and conduct an environmental assessment of a local community using the templates in Chapter 2.

Note to Trainer: Please read Chapter 2: “Assessing and Discovering the Environmental Situation” to prepare for this lesson.

PURPOSE



- To introduce the concept of environmental assessment and the specific tools and structure contained in *Environmental Education in the Community*.
- To practice the techniques and methodologies of environmental assessment.

TIME



Two hours to all day, depending on how much time is available.

STEPS



1. Break the group up into pairs.
2. Give each pair two copies of the same environmental element (e.g., “biodiversity” or “soils and land”).
3. Explain that each pair will go outside, walk through the community and answer the questions on their sheets as best as they can.
4. Agree upon a time for all pairs to return.





5. Depending on how much time is available, the participants can answer just a few questions, only the questions for the “town” areas, or they can complete the entire form. The length of time that it takes to complete this task will also depend on the language level attained by the participants.

QUESTIONS FOR DISCUSSION



- What did you observe?
- What did listening and observing tell you?
- How did people respond to your questions?
- What can you do next time to be more effective? (List answers on a flip chart.)

FOLLOW-UP ACTIVITY



Have each team choose one environmental issue (or more) that came out of the assessment and make a list of possible solutions and constraints that the issue presents.

Discuss: Is it feasible to work past the constraints to address the issue? If not, choose a different issue.

REVIEW THE SESSION



Remind participants that they have just done a practicum on the first activity in developing an environmental education program. Suggest that participants read Chapter 2: “Assessing and Discovering the Environmental Situation” for more information.





2 SESSION 2: DEVELOPING AN ENVIRONMENTAL EDUCATION ACTIVITY

OVERVIEW

In this session, participants will identify a target group, choose a message and pick an appropriate educational strategy (methodology) based on the issue that they chose in Session 1.

Note to trainer: Please read Chapters 3-5 in *Environmental Education in the Community* to prepare for this lesson.

PURPOSE

- To introduce and practice the concepts of targeting a group, choosing a message and picking an appropriate educational strategy.
- To plan the activity that participants will facilitate in Session 3.

TIME

Three to three-and-a-half hours.

MATERIALS

- Participants' environmental assessment materials from Session 1.
- Flipcharts: Target Group Guidelines (See page 48 in Chapter 3.)
Awareness Continuum (See page 55 in Chapter 4.)
Preparing the Program (See box, next page.)
- Pens
- Paper

STEPS

1. Tape up the Target Group Guidelines flipchart and review it with the group.
2. In the same pairs as Session 1, have participants develop a list of potential target groups for the environmental issue they identified in the previous session.





3. Explain: The goal of an environmental education program is to move the target group along this continuum, so the specific message should be tailored to the needs of a target group depending on their position on the continuum.
4. Discuss the four stages of the continuum with the group.
5. Then, tape up the Awareness Continuum flipchart and have participants determine where their target groups are on the continuum.
6. Tape up the Preparing the Program flipchart and have the pairs develop a statement that describes their environmental issue, a rationale, a goal, and learning outcomes for the environmental education program.
7. Have each pair select a strategy to use to present their environmental message. (Chapter 10: “Environmental Education Community Projects” has many ideas and suggestions.)

REVIEW THE SESSION

Suggest that participants read Chapters 3 through 5, and browse Chapter 10 to review what was presented in this session.

PREPARING THE PROGRAM

Statement

Describe the issue in a short, concise manner.

Rationale

Explain why this situation merits an EE program. Discuss ways to improve the situation and how getting information to the target group will help.

Goal

State what the program intends to accomplish.

Learning Outcomes

List what the target group has to understand and believe in order to change their behavior.





3 SESSION 3: PRACTICE TEACHING (IMPLEMENT, EVALUATE, ADAPT)

OVERVIEW

During this session the participants will practice the activities that they have planned.

Note to trainer: Depending on the needs of the group, an optional session to this is asking the entire group to plan a one-day (or one week) camp using the guidelines in Chapter 8: “Environmental Education Camps.” This optional activity could also be used as a Session 4, after Session 3, if time permits.

PURPOSE

- To give the participants hands-on experience delivering environmental education messages in the culture in which they will be working.
- To provide the participants with constructive feedback on their teaching.

TIME

Will vary.

MATERIALS

Participants will organize their own materials.

STEPS

Each team should prepare and present a short activity. These activities could last anywhere from 15 minutes to half a day, depending on the time available for this session. Working with groups of visitors to a protected area or school groups in the local language would be ideal, but using other participants as “students” is also fine. The goal is to organize and lead an environmental education activity that is similar to their actual situation.

REVIEW THE SESSION

At the end of the session, the participants should evaluate their sessions.

- Did the session meet the goals they had set?
- What went well?



- What would they change for the next time?

Suggest that participants read Chapters 6 and 7, (or Chapter 8, depending on your chosen activity) to review what was presented in this session.

