



Risk Management Series

Design Guide

for Improving School Safety in Earthquakes, Floods,
and High Winds

January 2004



FEMA

FOREWORD AND ACKNOWLEDGMENTS

BACKGROUND

 Our society places great importance on the education system and its schools, and has a tremendous investment in current and future schools. Currently, approximately 53 million kindergarten to grade 12 (K-12) students attend over 92,000 public schools and it is estimated that the public student population will have reached 54.3 million by 2004¹; to this figure must be added the substantial population of private school students. The sizes of these school facilities range from one-room rural schoolhouses to citywide and mega schools that house 5,000 or more students. The school is both a place of learning and an important community resource and center.

This publication is concerned with the protection of schools and their occupants against natural hazards. These hazards must be recognized as part of the natural environment and as extensions of phenomena that designers have always considered. Natural hazards can be reduced to extreme phenomena related to the four elements (i.e., earth, water, wind, and fire). Earthquakes are highly accelerated and exaggerated forms of motion that are always occurring in the earth and floods occur when rivers overflow or the wind stirs up the ocean along coastal waters. High winds and tornadoes are an extreme form of the beneficial breezes that freshen the air. Fire has been a threat to buildings for centuries and was one of the first threats to be the subject of regulation. Because of its familiarity and the extensive provisions for fire protection in building codes, it is not a subject for detailed consideration in this publication. However, some considerations relating to the fire protection of schools are presented in Chapter 3, Section 3.4.

Architects and engineers deal with these natural elements all the time; building codes always have provisions for protection against fire and wind and the local building code (if adopted by the com-

¹ U.S. Department of Education, National Center for Education Statistics, *Baby Boom Echo Report*, 2000.

munity) will also dictate whether earthquakes or floods must be considered as design parameters. However, the major decisions in reducing flood damage may be in site selection and layout, not in building design.

This manual introduces two core concepts: multihazard design and performance-based design. Neither is revolutionary, but represents an evolution in design thinking that is in tune with the increasing complexity of today's buildings and also takes advantage of developments and innovations in building technology:

- The concept of multihazard design is that designers need to understand the fundamental characteristics of hazards and how they interact, so that design for protection becomes integrated with all the other design demands.
- Performance-based design suggests that, rather than relying on the building code for protection against hazards, a more systematic investigation is conducted to ensure that the specific concerns of building owners and occupants are addressed. Building codes focus on providing life safety and property protection is secondary: performance-based design provides additional levels of protection that cover property damage and functional interruption within a financially feasible context.

This publication stresses that identification of hazards and their frequency and careful consideration of design against hazards must be integrated with all other design issues, and be present from the inception of the site selection and building design process. Although the basic issues to be considered in planning a school construction program are more or less common to all school districts, the processes used differ greatly, because each school district has its own approach. Districts vary in size, from a rural district responsible for only a few elementary schools, to a city district or statewide system overseeing a complex program of all school types and sizes, including new design and construction, renovations, and additions. A district may have had a

long-term program of school construction and be familiar with programming, financing, hiring designers, bidding procedures, contract administration, and commissioning a new building, but another district may not have constructed a new school for decades, and have no staff members familiar with the process.

SCOPE

This publication is intended to provide design guidance for the protection of school buildings and their occupants against natural hazards, and concentrates on grade schools (K-12); the focus is on the design of new schools, but the repair, renovation, and extension of existing schools is also addressed. It is intended as the first of a series of publications in which hospitals, higher education buildings, multifamily dwellings, commercial buildings, and light industrial facilities will be addressed.

The focus of this publication is on the safety of school buildings and their occupants, and the economic losses and social disruption caused by building damage and destruction. The volume covers three main natural hazards that have the potential to result in unacceptable risk and loss: earthquakes, floods, and high winds. A companion volume, *Primer to Design Safe School Projects in Case of Terrorist Attacks* (FEMA 428), covers the manmade hazards of physical, chemical, biological, and radiological attacks.

The intended audience for this manual includes design professionals and school officials involved in the technical and financial decisions of school construction, repair, and renovations. A short brochure based on this manual will also be available for school district and school board decision-makers.

ORGANIZATION AND CONTENT OF THE MANUAL

Chapters 1-3 present issues and background information that are common to all hazards. Chapters 4-6 cover the development of specific risk management measures for each of the three main natural hazards.

Chapter 1 opens with a brief outline of the past, present, and future of school design. Past school design is important because many of these older, and even historic, schools are still in use and their occupants must be protected.

Chapter 2 introduces the concepts of performance-based design in order to obtain required performance from a new or retrofitted facility. Chapter 3 introduces the concept of multihazard design and presents a general description and comparison of the hazards, including charts that show where design against each hazard interacts with design for other hazards. This latter section includes fire and building security in its considerations.

Chapters 4, 5, and 6 outline the steps necessary in the creation of design to address risk management concerns for protection against earthquakes, floods, and high winds, respectively. Information is presented on the nature of each hazard and its effect on vulnerability and consequences of building exposure. Procedures for risk assessment are outlined, followed by descriptions of current methods of reducing the effects of each hazard. These vary, depending on the hazard under consideration. A guide to the determination of acceptable risk and realistic performance objectives is followed by a discussion to establish the effectiveness of current codes to achieve acceptable performance.

Appendix A contains a list of acronyms that appear in this manual.

The information presented in this publication provides a comprehensive survey of the methods and processes necessary to create a safe school, but is necessarily limited. It is not expected that the reader will be able to use the information directly to develop plans and specifications. The information is intended to help designers and facility decision-makers, who may be unfamiliar with the concepts involved, to understand fundamental approaches to risk mitigation planning and design. By so doing, they can move on to the implementation phase of detailed planning, involving consultants, procurement personnel, and project administration, from a firm basis of understanding.

ACKNOWLEDGMENTS

Principal Authors:

Christopher Arnold, Building Systems Development, Inc.

Jack Lyons, School Facilities Consultant

James Munger, James G. Munger and Associates

Rebecca C. Quinn, Consultant

Thomas L. Smith, TLSmith Consulting

Contributors:

Milagros Kennett, FEMA, Project Officer, Risk Management Series Publications

Eric Letvin, Greenhorne & O'Mara, Inc., **Consultant**
Project Manager

John Plisich, FEMA

Mike Robinson, FEMA

Joe Agron, American School and University

Connie Deshpande, Department of Education

Randy Haslam, Jordan, Utah, School District

Danny Kilcollins, Florida Department of Community Affairs

Fred Krimgold, World Institute for Disaster Risk Management

Tom Kube, Council of Educational Facility Planners International

Bill Modzeleski, Department of Education

Jack Paddon, Williams and Paddon Architects and Planners

Bebe Pinter, Harris County Department of Education

John Sullivan, Portland Cement Association

Jon Traw, Traw Associates

French Wetmore, French and Associates

Deb Daly, Greenhorne & O'Mara, Inc.

Wanda Rizer, Greenhorne & O'Mara, Inc.

Julie Liptak, Greenhorne & O'Mara, Inc.

Bob Pendley, Greenhorne & O'Mara, Inc.

This primer will be revised periodically and EP&R welcomes comments and feedback to improve future editions.

Please send comments and feedback via e-mail to riskmanagementseriespubs@dhs.gov

TABLE OF CONTENTS

FOREWORD AND ACKNOWLEDGMENTS	i
Background.....	i
Scope	iii
Organization and Content of the Manual.....	iii
Acknowledgments.....	iv

CHAPTER 1– AN OVERVIEW OF THE SCHOOL DESIGN AND CONSTRUCTION PROCESS

1.1 Introduction	1-1
1.2 School Construction: The National Picture	1-1
1.3 Past School Design.....	1-2
1.4 Present School Design	1-9
1.5 Future School Design	1-10
1.6 The Design and Construction Process	1-12
1.7 School Design and Construction	1-16
1.7.1 Structure	1-16
1.7.2 Nonstructural Systems and Components	1-17

CHAPTER 2 – DESIGNING FOR PERFORMANCE 2-1 |

2.1 Introduction	2-1
2.2 Definitions of Performance-based Design	2-1
2.3 The Prescriptive Approach to Codes	2-2
2.4 The Performance-based Approach.....	2-3
2.5 Hazard, Risk, and Probability.....	2-6
2.6 Acceptable Risk and Performance Levels	2-9
2.7 Correlation Between Performance Groups and Tolerated Levels of Damage	2-10

2.8	Roles of Designers, Code Officials, and the School District	2-13
2.9	Changes to a Building Designed for Performance	2-14
2.10	Current Performance-based Codes	2-15
2.11	The O&M Manual and the Occupants’ Handbook.....	2-17
2.12	Performance-based Design for Natural Hazards	2-19
2.12.1	Performance-based Seismic Design	2-23
2.12.2	Performance-based Flood Design	2-30
2.12.3	Performance-based High Wind and Tornado Design	2-32
CHAPTER 3 – MULTHAZARD DESIGN		3-1
3.1	Introduction	3-1
3.2	The Hazards Compared.....	3-1
3.2.1	Location: Where are They?	3-2
3.2.2	Warning: How Much Time is There?.....	3-6
3.2.3	Frequency: How Likely are They to Occur?.....	3-6
3.2.4	Risk: How Dangerous are They?	3-8
3.2.5	Cost: How Much Damage Will They Cause?	3-10
3.3	Comparative Losses.....	3-11
3.4	Fire and Life Safety	3-16
3.5	Hazard Protection Methods Comparisons: Reinforcements and Conflicts.....	3-19

CHAPTER 4 –MAKING SCHOOLS SAFE AGAINST EARTHQUAKES	4-1
4.1 Introduction	4-1
4.2 The Nature and Probability of Earthquakes	4-1
4.2.1 Earthquakes and Other Geologic Hazards	4-1
4.2.2 Earthquakes: A National Problem	4-3
4.2.3 Determination of Local Earthquake Hazards	4-11
4.3 Vulnerability: What Earthquakes Can Do to Schools	4-15
4.3.1 Vulnerability of Schools	4-15
4.3.2 Earthquake Damage to Schools	4-20
4.3.3 Significant School Damage in Recent U.S. Earthquakes	4-27
4.3.4 Consequences: Casualties, Financial Loss, and Operational Disruption	4-32
4.4 Scope, Effectiveness, and Limitations of Codes.....	4-33
4.4.1 The Background of Seismic Codes	4-34
4.4.2 Seismic Codes and Schools.....	4-36
4.4.3 The Effectiveness of Seismic Codes	4-37
4.5 Evaluating Existing Schools for Seismic Risk and Specific Risk Reduction Methods.....	4-38
4.5.1 Rapid Visual Screening.....	4-38
4.5.2 Systems Checklist for School Seismic Safety Evaluation	4-41
4.5.3 The NEHRP Handbook for the Seismic Evaluation of Existing Buildings (FEMA 178/310)	4-47
4.6 Earthquake Risk Reduction Methods.....	4-48

4.6.1	Risk Reduction for New Schools	4-49
4.6.2	Risk Reduction for Existing Schools.....	4-61
4.7	The School as a Post-earthquake Shelter	4-69
4.8	References and Sources of Additional Information.....	4-71
4.9	Glossary of Earthquake Terms	4-72
	CHAPTER 5 – MAKING SCHOOLS SAFE AGAINST FLOODS	5-1
5.1	Introduction	5-1
5.2	Nature and Probability of Floods.....	5-1
5.2.1	Characteristics of Flooding	5-3
5.2.2	Probability of Occurrence	5-7
5.2.3	Hazard Identification and Flood Data.....	5-8
5.2.4	Design Flood Elevation	5-13
5.3	Scope, Effectiveness, and Limitations of Building Codes and Floodplain Management Requirements	5-14
5.3.1	Overview of the NFIP.....	5-14
5.3.2	Summary of the NFIP Minimum Requirements	5-16
5.3.3	Model Building Codes and Standards	5-18
5.4	Risk Reduction: Avoiding Flood Hazards	5-19
5.4.1	Benefits/Costs: Determining Acceptable Risk	5-20
5.4.2	Identifying Flood Hazards at School Sites.....	5-22
5.5	Risk Reduction: Flood-resistant New Schools	5-26
5.5.1	Site Modifications.....	5-26
5.5.2	Elevation Considerations.....	5-28

5.5.3	Floodproofing Considerations	5-31
5.5.4	Accessory Structures	5-33
5.5.5	Utility Installations	5-33
5.5.6	Potable Water and Wastewater Systems	5-34
5.5.7	Storage Tank Installations	5-34
5.5.8	Access Roads	5-35
5.6	Vulnerability: What Floods Can Do to Existing Schools	5-36
5.6.1	Site Damage	5-36
5.6.2	Structural Damage	5-37
5.6.3	Saturation Damage.....	5-40
5.6.4	Utility System Damage	5-42
5.6.5	Contents Damage	5-45
5.7	Risk Reduction: Protecting Existing Schools	5-46
5.7.1	Site Modifications	5-48
5.7.2	Additions	5-51
5.7.3	Repairs, Renovations, and Upgrades.....	5-52
5.7.4	Retrofit Dry Floodproofing	5-53
5.7.5	Utility Installations	5-53
5.7.6	Potable Water and Wastewater Systems	5-56
5.7.7	Other Damage Reduction Measures	5-57
5.7.8	Emergency Measures	5-57
5.8	The School as an Emergency Shelter	5-59
5.9	References and Sources of Additional Information	5-60
5.10	Glossary of Flood Protection Terms	5-63

CHAPTER 6 – MAKING SCHOOLS SAFE AGAINST WINDS	6-1
6.1 Introduction	6-1
6.2 The Nature and Probability of High Winds	6-2
6.2.1 Wind/Building Interactions	6-6
6.2.2 Probability of Occurrence	6-15
6.3 Vulnerability: What Wind Can Do to Schools	6-17
6.4 Scope, Effectiveness, and Limitations of Building Codes	6-23
6.4.1 Scope	6-24
6.4.2 Effectiveness	6-25
6.4.3 Limitations	6-25
6.5 Priorities, Costs, and Benefits: New Schools	6-27
6.5.1 Priorities	6-27
6.5.2 Cost, Budgeting, and Benefits	6-28
6.6 Priorities, Costs, and Benefits: Existing Schools	6-30
6.6.1 Priorities	6-31
6.6.2 Cost, Budgeting, and Benefits	6-32
6.7 Evaluating Schools for Risk from High Winds	6-33
6.7.1 Tornadoes	6-35
6.7.2 Portable Classrooms	6-36
6.8 Risk Reduction Design Methods	6-36
6.8.1 Siting	6-36
6.8.2 School Design	6-37
6.8.3 Peer Review	6-42

6.8.4	Construction Contract Administration	6-42
6.8.5	Post-occupancy Inspections, Periodic Maintenance, Repair, and Replacement	6-43
6.9	Structural Systems	6-44
6.10	Exterior Doors.....	6-48
6.10.1	Loads and Resistance	6-48
6.10.2	Durability	6-48
6.10.3	Exit Door Hardware	6-49
6.10.4	Water Infiltration	6-49
6.10.5	Weatherstripping.....	6-50
6.11	Non-load Bearing Walls, Wall Coverings, Soffits, and Underside of Elevated Floors	6-53
6.11.1	Loads and Resistance	6-53
6.11.2	Durability	6-55
6.11.3	Wall Coverings.....	6-55
6.11.4	Underside of Elevated Floors	6-59
6.12	Roof Systems.....	6-59
6.13	Windows and Skylights	6-68
6.13.1	Loads and Resistance	6-68
6.13.2	Durability	6-69
6.13.3	Water Infiltration	6-69
6.14	Exterior-mounted Mechanical, Electrical, and Communications Equipment	6-71
6.14.1	Loads and Attachment.....	6-72
6.14.2	Equipment Strength	6-74
6.14.3	Durability	6-76

6.15	Schools Located in Hurricane-prone Regions	6-79
6.15.1	Design Loads	6-80
6.15.2	Structural Systems	6-80
6.15.3	Exterior Doors.....	6-80
6.15.4	Non-load Bearing Walls, Wall Coverings, and Soffits	6-81
6.15.5	Roof Systems.....	6-81
6.15.6	Windows and Skylights.....	6-84
6.15.7	Emergency Power.....	6-86
6.15.8	Construction Contract Administration	6-86
6.15.9	Periodic Inspections, Maintenance, and Repair	6-86
6.16	Design for Tornado Shelters	6-88
6.17	Remedial Work on Existing Schools.....	6-91
6.18	References and Sources of Additional Information	6-94
6.19	Glossary of Wind Terms.....	6-96

APPENDIX A – ACRONYMS

TABLES

CHAPTER 2

Table 2-1:	ICC Performance Code Criteria for Seismic, Flood, and Wind Events	2-8
Table 2-2:	Performance Groups and Tolerated Levels of Damage	2-11
Table 2-3:	Seismic Expectations Checklist	2-26
Table 2-4:	Damage Control and Building Performance Levels.....	2-28

CHAPTER 3

Table 3-1	HAZUS-MH Earthquake, Hurricane, and Flood Losses	3-13
Table 3-2	HAZUS-MH Estimated Losses by Percentage of School Building and Contents Inventory.....	3-15
Table 3-3	Multihazard Design System Interactions	3-20

CHAPTER 4

Table 4-1:	Known Historic (1568-1989) Earthquakes in 47 U.S. States	4-5
Table 4-2:	School Seismic Safety Evaluation Checklist.....	4-42
Table 4-3:	Roofing Maintenance and Repair/ Re-roofing	4-67

CHAPTER 5

Table 5- 1:	Flood Hazards at School Sites	5-22
Table 5-2:	Characteristics of Existing School Buildings	5-47

CHAPTER 6

Table 6-1:	Summation of Risk Reduction Design Methods.....	6-76
Table 6-2:	Summation of Design of Schools Used for Hurricane Shelters and/or for Emergency Response After a Storm	6-87
Table 6-3:	Summation of Design for Tornado Shelters.....	6-90
Table 6-4:	Summation of Remedial Work on Existing Schools.....	6-93

FIGURES

CHAPTER 1

Figure 1-1	One-room schoolhouse, Christiana, DE, 1923	1-3
Figure 1-2	High school, New York City, 1929	1-3
Figure 1-3	Elementary school, Washington, DC, 1930	1-4
Figure 1-4	Typical finger plan school, 1940s. In California, the access hallways would be open to the air. The cross-section diagram shows the simple and effective day lighting and ventilation.....	1-5
Figure 1-5	Compact courtyard plan, 1960s.....	1-5
Figure 1-6	Fountain Valley High School, Huntington Beach, CA, 1964 (330 students)	1-6
Figure 1-7	Open enclosure plan teaching area, with movable screens and storage, Rhode Island, 1970	1-7
Figure 1-8	Typical modular classrooms, 1980s, still in use	1-7
Figure 1-9	Elementary school, Fairfield, PA, 1980s	1-8
Figure 1-10	Private high school, Palo Alto, CA, located in a remodeled industrial building. Note the exterior cross bracing; the building required extensive retrofitting to meet school seismic requirements.....	1-8
Figure 1-11	West High School, Aurora, IL, 2000	1-10
Figure 1-12	Elementary school, Oxnard, CA, 2000	1-11
Figure 1-13	The design and construction process flow chart	1-15

CHAPTER 2

Figure 2-1 Performance-based design approach
flow chart 2-12

CHAPTER 3

Figure 3-1 Peak accelerations (%g) with 10 percent
probability of exceedance in 50 years.
Color code shows %g for areas between
contour lines. These values are used for
seismic design. 3-4

Figure 3-2 Presidential Disaster Declarations for
floods, January 1965 to November 2000.
The incidence of declarations is shown
by counties. 3-4

Figure 3-3 Presidential Disaster Declarations for
hurricanes, January 1965 to November
2000. The incidence of declarations is
shown by counties. 3-5

Figure 3-4 Presidential Disaster Declarations for
tornadoes, January 1965 to November
2000. The incidence of declarations is
shown by counties. 3-5

CHAPTER 4

Figure 4-1 School, Anchorage, AK, 1964, severely
damaged by earthquake-induced landslide..... 4-3

Figure 4-2 Map of the continental United States
that shows counties and probabilities
of earthquakes of varying magnitude 4-4

Figure 4-3 Map showing older seismic zones in
part of the United States, from the 1997
Uniform Building Code. The area in the
box corresponds to the area in Figure 4-4..... 4-12

Figure 4-4	Portion of an earthquake ground motion map used in the International Building Code 2003 that shows contours that identify regions of similar spectral response accelerations to be used for seismic design. Spectral response acceleration includes both ground acceleration and effect of building period.....	4-13
Figure 4-5	These maps compare the seismicity of the Southeast U.S. and California. The larger acceleration values for the latter are symbolized by the darker colors.	4-14
Figure 4-6	These maps show a comparison for the Southeast U.S. between the acceleration values for a 1-second (long) and a 0.2-second (short) building period.....	4-14
Figure 4-7	Ductility	4-15
Figure 4-8	Collapse of portion of nonductile concrete frame school structure, Helena, MT, 1935	4-16
Figure 4-9	Modular classrooms pushed off their foundations; note stairs at left, Northridge, CA, 1994.....	4-17
Figure 4-10	Fallen filing cabinets and shelves, Northridge, CA, 1994.....	4-17
Figure 4-11	Fallen shop equipment, Coalinga, CA, 1983.....	4-18
Figure 4-12	Fallen light fixtures, library, Coalinga, CA, 1983.....	4-19
Figure 4-13	Fallen heavy lath and plaster ceiling across auditorium seating, Northridge, CA, 1994.....	4-19

Figure 4-14	Damage to the John Muir School, Long Beach, CA, 1933	4-20
Figure 4-15	Damage to shop building, Compton Junior High School, Long Beach, CA, 1933	4-21
Figure 4-16	A dangerous passage way between two buildings, Polytechnic High School, Long Beach, CA, 1933	4-23
Figure 4-17	A heavy corridor lintel ready to fall, Emerson School, Bakersfield, Kern County, CA, 1952	4-23
Figure 4-18	Overturnd shop equipment and failed light fixtures, Kern County, CA, 1952	4-23
Figure 4-19	Destroyed exit corridor, Bakersfield, Kern County, CA, 1952	4-24
Figure 4-20	Typical school damage, Helena, MT, 1935.....	4-25
Figure 4-21	The student body president was killed here by falling brickwork, Seattle, WA, 1949	4-25
Figure 4-22	Another dangerous entry collapse, Seattle, WA, 1949.....	4-26
Figure 4-23	Collapse of roof over stage, Seattle, WA, 1949.....	4-26
Figure 4-24	Damage to library shelving, Seattle, WA, 1949.....	4-27
Figure 4-25	Severe structural damage to the West Anchorage High School, Anchorage, AK, 1964	4-28
Figure 4-26	Brittle failure at nonductile concrete column, West Anchorage High School, 1964.....	4-28

Figure 4-27	Ceiling damage, Northridge, CA, 1994	4-30
Figure 4-28	Damage to ceramic kiln, including fractured gas line, Northridge, CA, 1994	4-31
Figure 4-29	Line of suspended light fixtures fallen on teacher’s station, Northridge, CA, 1994	4-31
Figure 4-30	Example of rapid visual screening information form	4-40
Figure 4-31	The structural and nonstructural components	4-59
Figure 4-32	Suspended ceiling and light fixture bracing and support.....	4-60
Figure 4-33	Bracing tall shelving to the structure	4-60
Figure 4-34	Connection of nonstructural masonry wall to structure to permit independent movement	4-60
Figure 4-35	Bracing for existing unreinforced masonry parapet wall	4-61
Figure 4-36	Design strategies for seismic retrofit of existing buildings	4-63
Figure 4-37	Retrofit of B.F. Day Elementary School, Seattle, WA.....	4-65
Figure 4-38	Sections and plans of the B.F. Day School: existing at bottom, retrofitted at top	4-65

CHAPTER 5

Figure 5-1	The riverine floodplain.....	5-3
Figure 5-2	The coastal floodplain	5-4
Figure 5-3	Riverine flood hazard zones	5-12
Figure 5-4	Definition sketch – flood elevations	5-13

Figure 5-5	A high school in Bloomsburg, PA, elevated on fill	5-29
Figure 5-6	Elementary school in Jefferson County, OH, elevated on columns	5-30
Figure 5-7	Hydrostatic force diagram	5-39
Figure 5-8	Fractured concrete basement floor, Gurnee, IL, 1986	5-39
Figure 5-9	Damaged walls and cabinets, Peoria County, IL	5-42
Figure 5-10	Basement damage at a grade school in Gurnee, IL, 1986	5-42
Figure 5-11	Schematic of typical earthen levee and permanent floodwall	5-49
Figure 5-12	Masonry floodwall with multiple engineered closures at Oak Grove Lutheran School, Fargo, ND	5-50
Figure 5-13	Elevated electric transformer at an elementary school in Verret, LA	5-54
Figure 5-14	Elevated utilities behind an elementary school in Wrightsville Beach, NC.....	5-55

CHAPTER 6

Figure 6-1	Hurricane-prone regions and special wind regions	6-2
Figure 6-2	Tornado occurrence in the United States based on historical data	6-5
Figure 6-3	Design wind speeds for community tornado shelters	6-6
Figure 6-4	Schematic of wind-induced pressures on a building	6-7

Figure 6-5 Schematic of internal pressure condition when the dominant opening is in the windward wall 6-10

Figure 6-6 Schematic of internal pressure condition when the dominant opening is in the leeward wall..... 6-11

Figure 6-7 Relative roof uplift pressures as a function of roof geometry, roof slope, and location on roof, and relative positive and negative wall pressures as a function of location along the wall..... 6-13

Figure 6-8 The aggregate ballast on this single-ply membrane roof was blown away in the vicinity of the corners of the wall projections at the window bays. The irregular wall surface created turbulence, which led to wind speed-up and loss of aggregate in the turbulent flow areas. 6-14

Figure 6-9 The metal roof is over a stair tower. The irregularity created by the stair tower caused turbulence that resulted in wind speed-up..... 6-14

Figure 6-10 This high school in northern Illinois was heavily damaged by a strong tornado 6-17

Figure 6-11 A portion of the built-up membrane at this school lifted and peeled after the metal edge flashing lifted. The cast-in-place concrete deck kept a lot of water from entering the school. Virtually all of the loose aggregate blew off the roof and broke many windows in nearby houses. This school was being used as a hurricane shelter at the time of the blow-off. 6-18

Figure 6-12 The outer panes of these windows were broken by aggregate from a built-up roof. The inner panes had several impact craters. In several of the adjacent windows, both the outer and inner panes were broken. The aggregate had a flight path in excess of 245 feet. The wind speed was less than the design wind speed..... 6-18

Figure 6-13 The metal wall covering on this school was applied to plywood over metal studs. The metal stud wall collapsed in this area, but, in other areas, it was blown completely away. The CMU wall behind the studs did not appear to be damaged. This school was on the periphery of a violent tornado. 6-19

Figure 6-14 The unreinforced CMU wall at this school collapsed during a storm that had wind speeds that were less than the design wind speed 6-19

Figure 6-15 The roof and all the walls of a wing of this elementary school were blown away by a violent tornado 6-20

Figure 6-16 This portable classroom was blown up against the main school building during a storm that had wind speeds that were less than the design wind speed. Depending upon the type of exterior wall, an impacting portable classroom may or may not cause wall collapse. 6-20

Figure 6-17 This newly-constructed gymnasium had a structural metal roof panel (3-inch trapezoidal ribs at 24 inches on center) applied over metal purlins. The panels detached from their concealed clips. A massive quantity of water entered the school and buckled the wood gym floor..... 6-21

Figure 6-18 A portion of the roof structure blew off of this school, and a portion of it collapsed into classrooms. Because of extensive water damage, a school such as this can be out of operation for a considerable period of time. 6-23

Figure 6-19 The HVAC unit in the parking lot in the photo's lower right corner blew off the curb during a storm that had wind speeds that were less than the design wind speed. A substantial amount of water entered the building before a temporary covering could be placed over the opening. 6-30

Figure 6-20 This figure illustrates load path continuity of the structural system. Members are sized to accommodate the design loads and connections are designed to transfer uplift loads applied to the roof, and the positive and negative loads applied to the exterior bearing walls down to the foundation and into the ground. 6-40

Figure 6-21 View of a steel joist after the metal decking blew away 6-46

Figure 6-22 View of another weld near the weld shown in Figure 6-21 6-46

Figure 6-23 Portions of this waffled precast concrete roof deck were blown off. Bolts had been installed to provide uplift resistance; however, anchor plates and nuts had not been installed. 6-47

Figure 6-24 Several of the precast twin-Tee roof and wall panels collapsed. The connection between the roof and wall panels provided very little uplift load resistance. 6-47

Figure 6-25	Door sill pan flashing with end dams, rear leg, and turned-down front leg	6-50
Figure 6-26	Drip at door head and drip with hook at head.....	6-50
Figure 6-27	Door shoe with drip and vinyl seal	6-51
Figure 6-28	Neoprene door bottom sweep	6-51
Figure 6-29	Automatic door bottom	6-51
Figure 6-30	Interlocking threshold with drain pan	6-52
Figure 6-31	Threshold with stop and seal	6-52
Figure 6-32	Adjustable jamb/head weatherstripping.....	6-53
Figure 6-33	This suspended metal soffit was not designed for upward-acting wind pressure	6-54
Figure 6-34	The interior walls of this classroom wing were constructed of unreinforced CMU	6-55
Figure 6-35	Failure of brick veneer	6-56
Figure 6-36	EIFS blow-off near a wall corner	6-57
Figure 6-37	The metal edge flashing on this modified bitumen membrane roof was installed underneath the membrane, rather than on top of it and then stripped in. In this location, the edge flashing is unable to clamp the membrane down.....	6-61
Figure 6-38	This metal edge flashing had a continuous cleat, but the flashing disengaged from the cleat and the vertical flange lifted up. However, the horizontal flange of the flashing did not lift.	6-62
Figure 6-39	This coping was attached with ¼-inch diameter stainless steel concrete spikes at 12 inches on center. When the fastener is placed in wood, #14 stainless steel screws with stainless steel washers are recommended.	6-63

Figure 6-40 Continuous bar near the edge of edge flashing or coping. If the edge flashing or coping is blown off, the bar may prevent a catastrophic progressive failure..... 6-63

Figure 6-41 On this school, the fastener rows of the mechanically attached single-ply membrane ran parallel to the top flange of the steel deck. Hence, essentially all of the row’s uplift load was transmitted to only two deck fasteners at each joist 6-66

Figure 6-42 View of the underside of a steel deck. The mechanically attached single-ply membrane fastener rows ran parallel to the top flange of the steel deck. 6-66

Figure 6-43 The parapet on this school was sheathed with metal wall panels. The panels were fastened at 2 feet on center along their bottom edge, which was inadequate to resist the wind load. 6-67

Figure 6-44 This air terminal (“lightning rod”) was dislodged and whipped around during a windstorm. The single-ply membrane was punctured by the sharp tip in several locations. 6-68

Figure 6-45 Two complete windows, including their frames, blew out. The frames were attached with an inadequate number of fasteners, which were somewhat corroded..... 6-69

Figure 6-46 View of a typical window sill pan flashing with end dams and rear legs. Windows that do not have nailing flanges should typically be installed over a pan flashing..... 6-70

Figure 6-47 Protection of sealant with a stop. The stop retards weathering of the sealant and reduces the wind-driven rain demand on the sealant. 6-71

Figure 6-48 The rooftop mechanical equipment on this school was blown over. The displaced equipment can puncture the roof membrane and, as in this case, rain can enter the school through the large opening that is no longer protected by the equipment. 6-72

Figure 6-49 This HVAC equipment had two supplemental securement straps. Both straps are still on this unit, but some of the other units on the roof had broken straps..... 6-73

Figure 6-50 The communications mast on this school was pulled out of the deck, resulting in a progressive peeling failure of the fully adhered single-ply membrane. There are several exhaust fans in the background that were blown off their curbs, but were retained on the roof by the parapet..... 6-74

Figure 6-51 To overcome blow-off of the fan cowling, which is a common problem, this cowling was attached to the curb with cables. The curb needs to be adequately attached to carry the wind load exerted on the fan. 6-75

Figure 6-52 These wire-tied tiles were installed over a concrete deck. They were attached with stainless steel clips at the perimeter rows and all of the tiles had tail hooks. Adhesive was also used between the tail and head of the tiles. 6-83

Figure 6-53 At this school, a missile struck the fully adhered low-sloped roof and slid into the steep-sloped reinforced mechanically attached single-ply membrane. A large area of the mechanically attached membrane was blown away due to progressive membrane tearing. 6-84

Figure 6-54 This fully adhered single-ply membrane was struck by a large number of missiles during a hurricane 6-84

Figure 6-55 View of a metal shutter designed to provide missile protection for windows 6-85

Figure 6-56 A violent tornado passed by this high school and showered the roof with missiles 6-88

Figure 6-57 View of an elementary school corridor after passage of a violent tornado. Although corridors sometimes offer protection, they can be death traps as illustrated in this figure (fortunately the school was not occupied when it was struck)..... 6-90

Figure 6-58 This school had a cementitious wood-fiber deck (commonly referred to by the proprietary name “Tectum”) 6-92

1.1 INTRODUCTION

This chapter presents an overview of the school building, to provide a context for the chapters that follow. Every building is unique and there is great variety in school design; however, the purpose of schools, their occupancy, their economic basis, and their role in the social scene mean that there are certain common features of schools that distinguish them from other building types.

A summary of the national public school inventory is presented (i.e., how many students it houses and how many schools it contains) and projections of future needs are also outlined. School design of the past is discussed, because many older schools are still in use and must be renovated periodically to meet today's needs. The present state of school design is also discussed and some trends and ideas that might influence future schools are identified.

1.2 SCHOOL CONSTRUCTION: THE NATIONAL PICTURE

The estimated value of the national public school inventory is well over \$361.6 billion.¹ Of the almost 15,000 local education agencies found throughout the United States (U.S.), 41.9 percent are in small towns and rural areas, and enroll 30.4 percent of the students; 25.9 percent are in large towns and cities, and enroll 30.7 percent of the students; and 32.2 percent of the education agencies are in suburban areas, and enroll 39 percent of the students.²

Over half of our school facilities are at least 40 years old³ and, even with minor renovations, have passed their prime in terms of adapt-

¹ Conservative estimate based upon elementary and secondary school averages developed with the help of Paul Abramson, President of Stanton Leggett & Associates, Education Consultants.

² U.S. Department of Education, National Center of Education Statistics; *The Digest of Education Statistics*, 2001.

³ U.S. Department of Education, National Center of Education Statistics, *The Digest of Education Statistics*, 2001.

ability to modern teaching methods and tools (e.g., computers, in-class electronic information displays, and group learning activities). Almost all states require new construction once replacement costs reach a certain level (usually 60 percent⁴). The most recent studies (completed at the close of the last decade) show a range of \$100 to over \$300 billion would be needed to bring our nation's schools into good teaching condition.

In 2001, the decade-long growth in kindergarten to grade 12 (K-12) school construction reached a peak. A propensity for deferred maintenance and the poor construction quality of many post-World War II schools have resulted in a huge renovation demand, and population increases mean that additional space will also be necessary.

If new construction, remodeled space, and additions are included, 2001 witnessed over \$29.5 billion in school construction throughout the United States, with primary school projects slightly edging out high school projects in total number, but not in construction dollars. The overall school construction intensity dropped slightly to \$28.2 billion, but is forecast to rise to \$29.15 billion by mid-decade. From 2001 through 2005, it is estimated that almost a billion square feet of either new, renovated, or additional square feet will be added to the national school inventory.

1.3 PAST SCHOOL DESIGN

Schools are typically in use for long periods of time; as a result, teaching continues to be conducted in facilities that were designed and constructed at the beginning of the 20th century. Early 20th century school design was based on late 19th century models and was relatively static until after World War II. Schools ranged from one-room rural school houses to major symbolic civic structures in large cities. Other inner city schools were more modest, inserted into small sites on busy streets and constrained by budget limits (see Figures 1-1, 1-2, and 1-3).

⁴ Use of this estimate as a decision tool was developed by Basil Castoldi, *Education Facilities, Planning, Modernization and Management*, fourth edition, Allyn & Bacon publishers, page 385.



Figure 1-1
One-room schoolhouse,
Christiana, DE, 1923
SKETCH BY: CHRIS ARNOLD



Figure 1-2
High school, New York City,
1929
SKETCH BY: CHRIS ARNOLD

The typical city school was one to three stories in height and consisted of rows of classrooms on either side of a wide, noisy corridor lined with metal lockers; asphalt play courts; and, sometimes, rooftop recreational areas. The larger schools sometimes had a library, special rooms for art, science, and shop, and an auditorium.

The surge to meet the school construction demands of the post war baby-boom was primarily a suburban development. Much larger sites were available, schools were one or two stories in height, auditoriums became multiuse buildings, and large parking lots appeared. However, many rural schools were located far away from towns and their resources, such as fire departments and other services.

Figure 1-3
Elementary school,
Washington, DC, 1930



But the fundamental school program of classrooms along double-loaded corridors did not change very much. However, in warm climates, the one-story finger plan school, constructed of wood and a small quantity of steel, was both economical and more human, and the noisy tiled double-loaded corridor became a covered walk, open to the air, with the classrooms on one side and a grassed court on the other (see Figure 1-4). Compact versions of these plans appeared as schools became larger and sites smaller (see Figure 1-5).

Inner-city high schools were usually large facilities, housing 2,000 to 3,000 students (basically small towns with complex social, economic, and class systems; see Figure 1-6). In the 1960s and 1970s, some design experiments were tried, such as team teaching, which spawned large open classrooms with poor acoustics (see Figure 1-7). Some of the new large high schools were built as air-conditioned enclosures, with many windowless classrooms, in buildings similar to the shopping malls that replaced the main street retail centers (see Figure 1-7). At the same time, many schools were expanded by adding prefabricated classrooms to accommodate a surge in enrollment. Although the prefabricated classrooms were originally intended as temporary space, many are now used as permanent classrooms (see Figure 1-8).

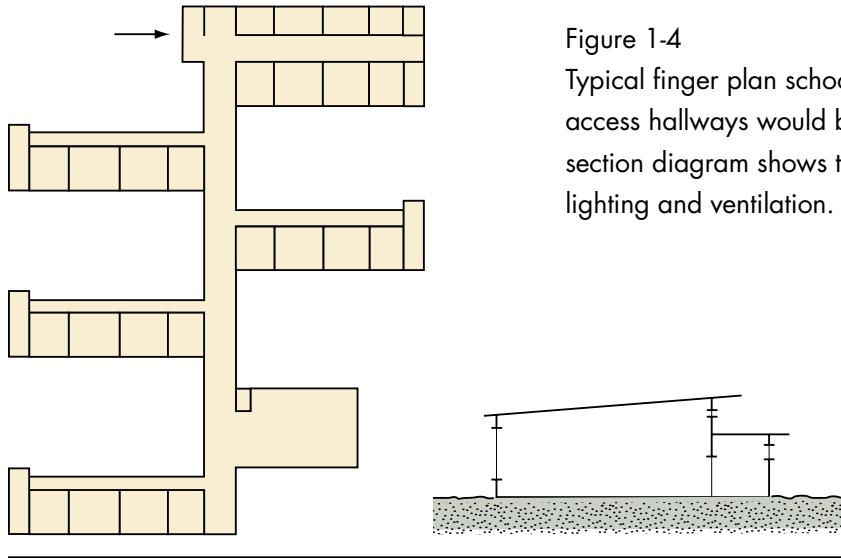

Figure 1-4
 Typical finger plan school, 1940s. In California, the access hallways would be open to the air. The cross-section diagram shows the simple and effective day lighting and ventilation.

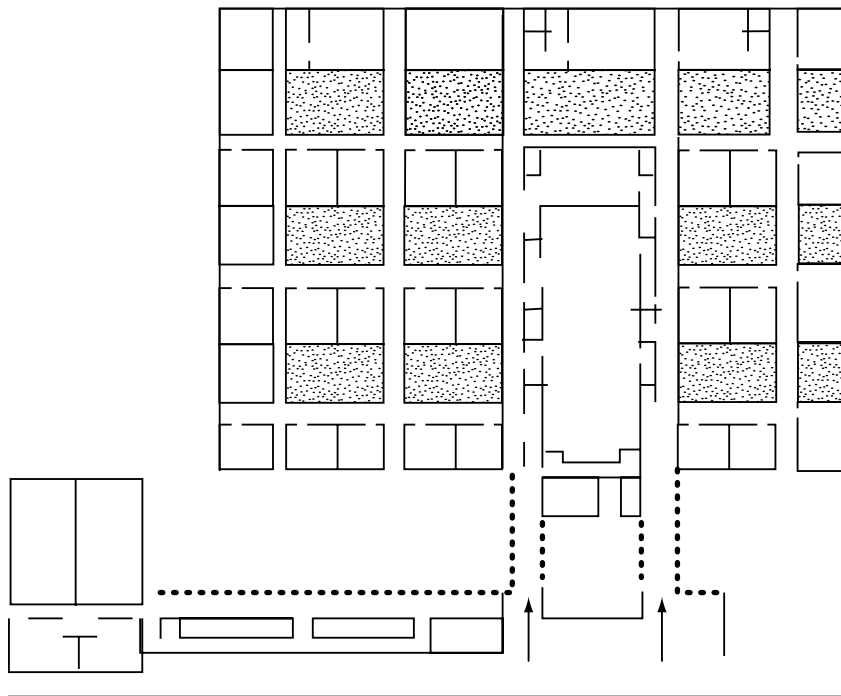

Figure 1-5
 Compact courtyard plan, 1960s

Schools built in the 1980s and 1990s assumed a wide variety of forms, often combining classrooms into clusters and focusing on providing an attractive learning environment (see Figure 1-9). However, demographic needs, shortage of affordable land, and limited funding has also resulted in instances of the adaptation of existing non-educational buildings into schools (see Figure 1-10).

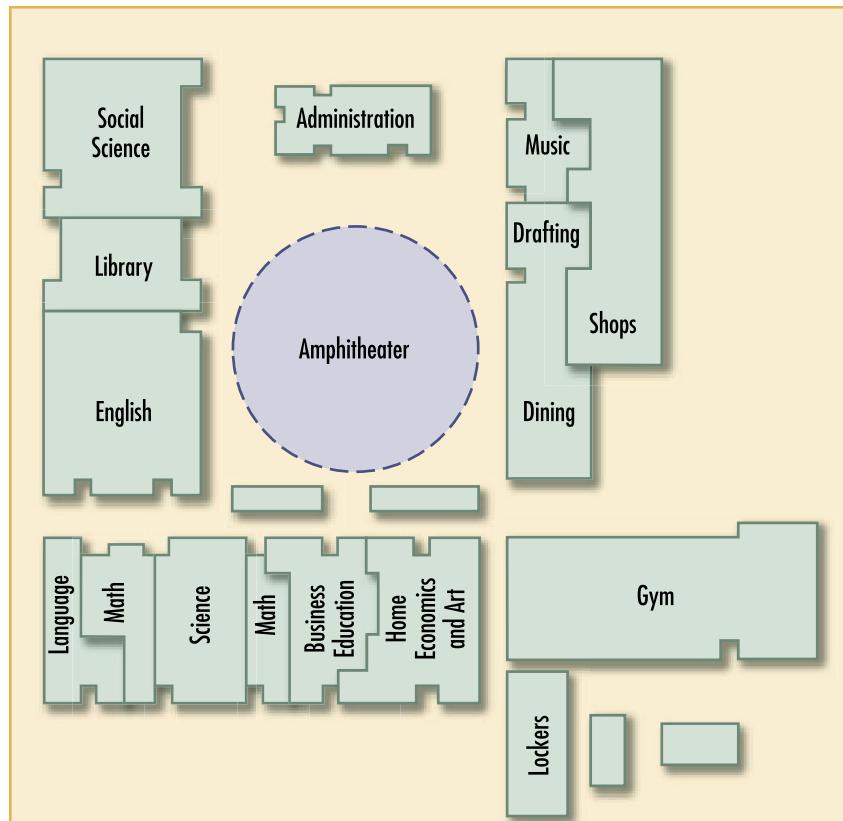

Figure 1-6
Fountain Valley High School, Huntington Beach, CA, 1964
(330 students)

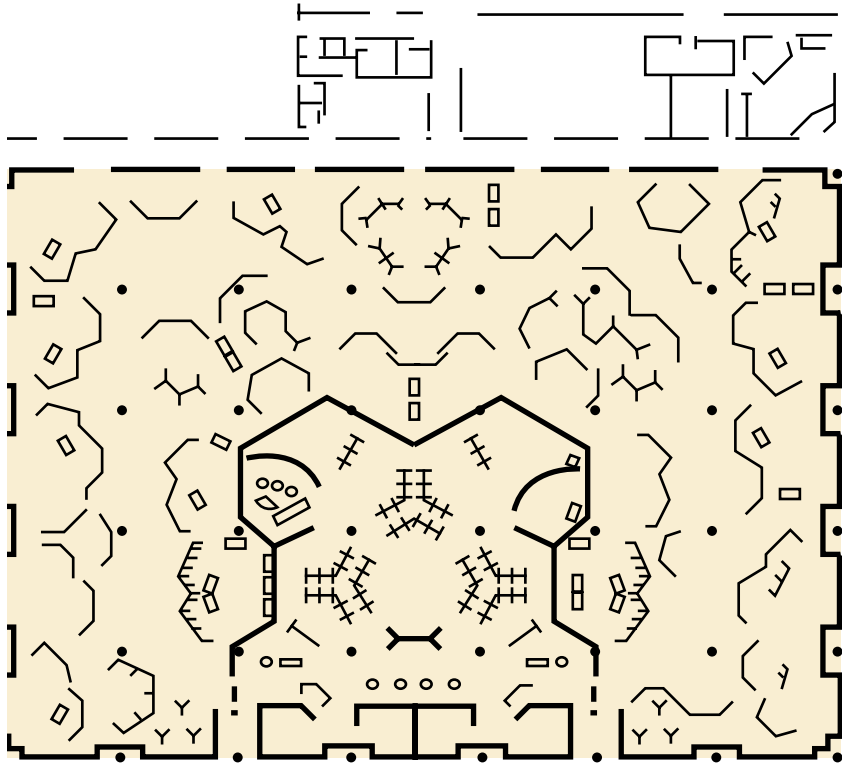

Figure 1-7
Open enclosure plan teaching area, with movable screens and storage,
Rhode Island, 1970



Figure 1-8 Typical modular classrooms, 1980s, still in use



Figure 1-9
Elementary school, Fairfield, PA, 1980s



Figure 1-10
Private high school, Palo Alto, CA, located in a remodeled industrial building. Note the exterior cross bracing; the building required extensive retrofitting to meet school seismic requirements.

1.4 PRESENT SCHOOL DESIGN

As the U.S. begins a new century, there are indications that a new era of social, economic, and educational concerns is evolving that will impact school design. New statements of design principles are beginning to emerge, although some of the following represent perennial concerns:

- The building should provide for health, safety, and security.
- The learning environment should enhance teaching and learning and accommodate the needs of all learners.
- The learning environment should serve as the center of the community.
- The learning environment should result from a planning/design process that involves all stakeholders.
- The learning environment should allow for flexibility and adaptability to changing needs.
- The learning environment should make effective use of all available resources.

These principles lead, in turn, to a number of current design principles, including:

- Design for protection against natural hazards
- Increased design attention to occupant security
- Careful lighting design and increased use of day lighting and comfort control
- Design for durability
- Long life/loose fit approach: design for internal change and flexibility
- Design for sustainability, including energy efficiency and the use of “green” materials

Some new schools already respond to these needs⁵ and, indeed, their originators, school districts, communities, and designers are among those defining the schools of the next decade. Some of the changes are the result of ideology and analysis; others are enforced by the effort to provide an improved learning environment and enhanced learning resources in an increasingly financially limited school construction economy. Some school districts will be hard pressed to provide a minimal learning environment with buildings of the utmost simplicity, while meeting the requirements for health, safety, and security.

1.5 FUTURE SCHOOL DESIGN

Schools will continue to vary widely in size; however, even in the suburbs, land has become scarce and expensive. New schools will be more compact and the sprawling one-story campus will become less common (see Figure 1-11). The desire for more supportive environments and the rejection of traditional school plans will result in more imaginative and often more complex layouts (see Figure 1-12). Moreover, the move to repopulate the inner cities will result in the construction of even more dense and compact schools.

However, many educational researchers believe that students improve their learning skills in smaller schools.

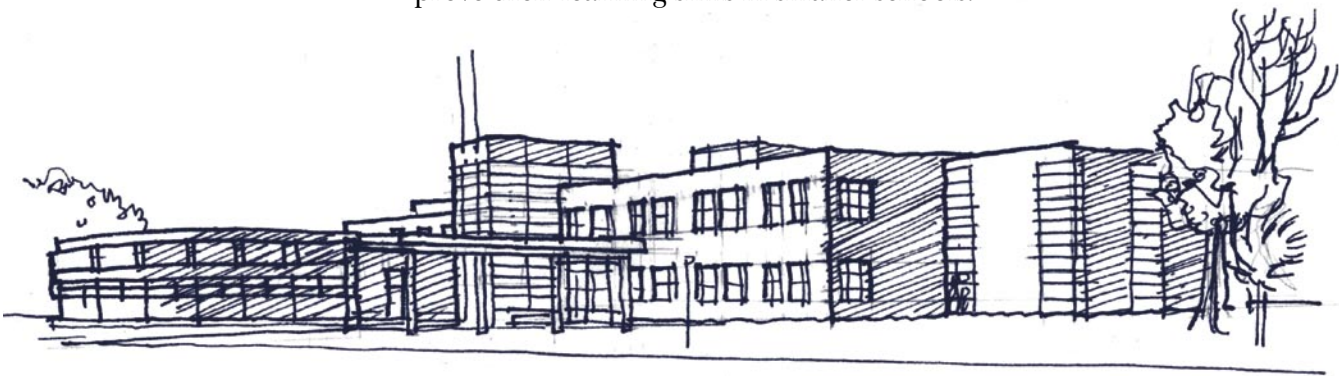

Figure 1-11 West High School, Aurora, IL, 2000

SKETCH BY: CHRIS ARNOLD

⁵ Data provided by the National Clearinghouse for Educational Facilities, Washington, DC.

Although small schools may be economically unrealistic, methods of organization are being explored that provide some of the benefits of small size within a large physical complex. Some schools are organized into “learning academies” for each grade, with classrooms that can expand and contract, and other activity rooms of various sizes.

Other researchers believe that the conventional library will disappear. The trend in many new schools is for the library to take the form of a multi-media center and material collections, including laptop computers, that are distributed from mobile units to “classroom clusters.”

Schools are increasingly seen as community resources that go beyond the educational functions. Adult education and community events now take place on evenings, weekends, and throughout the traditional vacation periods; therefore, the school day and week have been expanded. These uses are seen as ways of finding affordable methods of enhancing community service resources by ensuring that a facility’s utilization is maximized.

Indications are that the school building will probably increase in importance to the community, as its roles expand beyond that of merely providing a K-12 education for students during a school year. At the same time, modern technology means that today’s schools, already far more complex than the relatively simple buildings of a few decades ago, will tend to be more fragile and consequently more vulnerable to nature’s and society’s threats unless special attention is paid to their design and construction.

The natural hazards will remain: earthquakes and tornadoes will continue to be, for some locations, a source of worry and fear. Besides protecting their occupants, schools in earthquake-prone

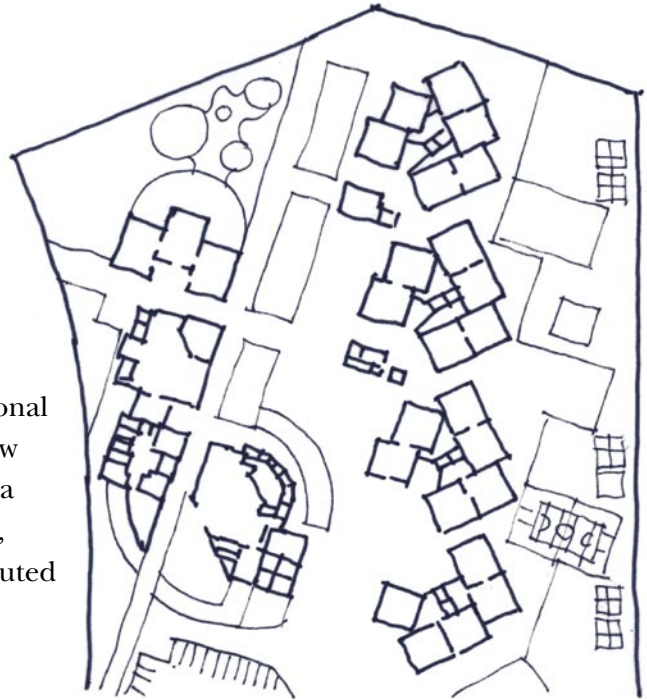

Figure 1-12
Elementary school, Oxnard, CA, 2000
SKETCH BY: CHRIS ARNOLD

regions are often used as post-earthquake shelters. In California, this is particularly appropriate because the State's Field Act, enacted in 1933, following the Long Beach earthquake, requires that public schools be designed by a licensed architect or engineer, their plans checked, and the construction on site inspected by staff of the Department of State of Architecture. Elsewhere, floods and high winds are a familiar threat that also must be addressed by knowledgeable design and good construction practice. Schools, or designated areas within them, located in hurricane- and tornado-prone areas are increasingly being constructed to provide shelter for the occupants.

1.6 THE DESIGN AND CONSTRUCTION PROCESS

Regardless of the size of a school construction program, certain steps are necessary and certain procedures must be followed. These will vary greatly in scope between the design of a small elementary school and the development of a multi-school program of new and remedial construction. Review and regulation procedures by outside agencies will also vary. Internal district decisions as to the design and construction process (e.g., conventional architect design and competitive construction bid, design/build or construction manager) will affect the scope and timing of some of the activities.

However, regardless of the size and scope of the project, the following steps should be taken; for a small project, they may entail relatively informal meetings among a few district staff, the school board, and others; for a large program, formal procedures must be established. These steps are summarized in a flow chart (see Figure 1-13) that follows this listing.

- Conduct an in-house assessment of the educational needs, with the assistance of a public education committee and consultants. Public committees continue throughout the programming and design process, acquiring specialist members as necessary at different stages for a large program.

- Determine the size and scope of the proposed program. (In a small district, an architect may be employed to assist the school district with this task, who may later become the design architect).
- Conduct an assessment of the site needs to determine the size and availability of sites (and lease/purchase as necessary).
- Develop educational specifications, both in-house and/or consultants.
- Conduct an assessment of financial needs.
- Identify financial resources, including alternative sources of funding (e.g., state and federal programs, local taxes, bond issues).
- Ensure funding (e.g., pass bond issue).
- Appoint a district building program management staff (appointed officials or a committee).
- Determine the design and construction process (i.e., conventional design and bid, design/build or construction management).
- Select and hire architects and other special design consultants or design/build team members; the timing of hiring will vary, depending on number of projects, whether programming is involved, and other variables.
- Develop building programs, including building size, room size, equipment, and environmental requirements; this may be done in-house and/or architects or independent program consultants may assist.
- Appoint the district staff and public stakeholders committee for the design phase.
- Develop designs (architects), together with cost estimates. Hold public meetings with architects and encourage public input into the design, together with district progress reviews.
- Design completion, district review of contract documents.

- Submit construction documents to the district and any permitting agencies for review and approval.
- Submit documents to building department and other required agencies.
- Select the contractor (bidding) or finalize design/build or construction management contracts.
- School construction.
- School district administration of construction contract.
- Observation by architect and inspection as required.
- School completed by contractor
- School inspected and accepted by architect.
- School inspected and accepted by school district.
- School commissioned and occupied.

The sequence of the above steps may vary, depending on the complexity of the program; some steps may be implemented simultaneously.

Figure 1-13 shows a flow chart of this typical process. Also shown (in the five boxes to the right) are specific activities related to design for multihazards and how these fit into the general construction process.

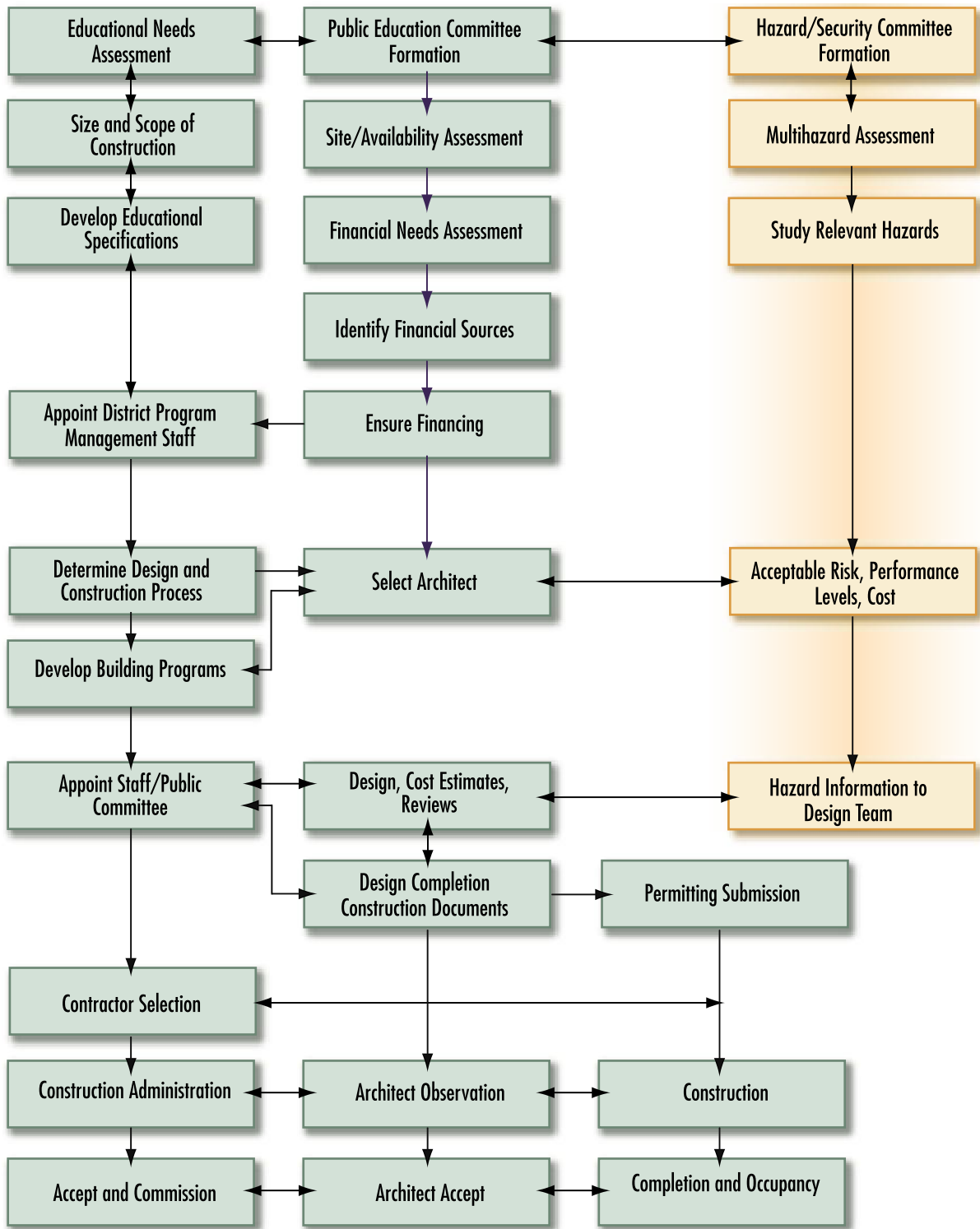

Figure 1-13 The design and construction process flow chart

1.7 SCHOOL DESIGN AND CONSTRUCTION

1.7.1 Structure

The structure provides support for all the elements of a building and ensures that the building can sustain all the loads and forces that it will encounter during its life. Often concealed behind ceilings, exterior cladding, and decorative facing materials, the structure plays a critical role in providing a safe and secure school building.

Because of the relatively small size of most school buildings and the simplicity of design of the traditional school, with numerous internal walls, structural design is relatively simple and a well designed and constructed school should not collapse unless struck by a severe tornado or terrorist.

Most suburban schools built in the last few decades are typically one or two stories in height, with light steel frames or mixed structures of steel and wood frames and also with some concrete or concrete masonry walls. Except in the western states, and the Atlantic and Gulf coasts, concrete masonry walls may have nominal or no steel reinforcing. Reinforced masonry perimeter and/or interior classroom separation walls sometimes are used as shear walls to provide lateral support. First floors are generally concrete slab-on-grade.

Many schools may have long-span gymnasiums or assembly spaces, using glued-laminated wood beams, steel trusses, or precast reinforced concrete tees or double tees. In these long span structures, large diaphragm and wind uplift forces must be transmitted to the perimeter walls or frames and the design and construction of wall/roof connections are critical.

Typical prefabricated teaching spaces consist of classroom-sized wood frame boxes, are air-conditioned where necessary, and generally have minimally adequate lighting and electrical services. They provide an economical way of solving a problem, but rows of prefabricated classroom boxes do not provide an appropriate

long-term learning and social environment. Also, they are typically less resistant to natural hazards.

Inner city schools may be three or four stories in height and are often built on congested sites. Structurally, they are usually constructed of reinforced masonry, reinforced concrete, and/or steel frames, and sometimes are a mix of these types of systems.

Older structures (i.e., pre-World War II) often had unreinforced masonry walls with wood floors and roof structures. Another common type was a lightly reinforced concrete frame infilled with hollow tile or masonry for walls, together with a wood floor and roof structure. Small schools were often of wood frame construction throughout, and basements and crawl spaces were common in these structures. Older structures are particularly vulnerable to natural hazards. Unreinforced masonry structures have performed very poorly in earthquakes and high winds, as have older reinforced concrete frames with infill. Older wood frame structures are often deficient in their design and construction detailing and are frequently weakened by insect attack or dry rot.

1.7.2 Nonstructural Systems and Components

Nonstructural components and systems comprise architectural components such as ceilings and partitions, mechanical, plumbing, and electrical items that provide utilities and services to the building and cladding and roofing that provide weather protection and insulation.

A wide variety of exterior cladding materials are used for schools. The most common materials include brick or concrete masonry, stucco on metal or wood stud frame walls, exterior insulation finish systems (EIFS), and various natural and synthetic sidings on wood frame structures. Metal or stucco faced insulated panels are also used. Metal and glass curtain walls are used infrequently, generally in an urban setting.

Newer schools usually have suspended grid ceilings that support light acoustic panels and inset lighting fixtures. Pendant fixtures are also used, in the form of rows of linear fluorescent fixtures or single high intensity (HID) fixtures. The latter are often large in size when used in assembly spaces or gymnasiums. Incandescent fixtures may still be found in older school buildings, but are a source of high energy use and should be replaced.

Non-load bearing partitions are often of hollow tile or concrete masonry; however, especially in the western states, partitions are of gypsum board over wood or metal framing, although concrete masonry or tile may be used in restrooms or other service areas.

School mechanical systems are relatively simple. Older schools and some new ones employ perimeter hot water heating together with natural ventilation or forced air. Very old schools may still employ steam heating, but most of these systems should have been replaced by hydronic systems. Newer schools, particularly when large, often employ forced air heating, ventilating, and cooling systems. Concern for energy conservation has resulted in the use of innovative systems, including a return to the use of natural ventilation and day lighting.

Plumbing tends to be concentrated in restroom areas, although science, art spaces, and school kitchens require more complex plumbing services. Specialized plumbing will also be found in mechanical/boiler rooms, the water service and fire protection service entrances, and domestic water heaters.

Electrical services have become increasingly complex with the need for ready access to power and communications services. The trend in communications devices to become wireless may serve to slightly reduce the extent of hard wired communications. Fire alarm and security services, however, require increasingly extensive electrical and electronic services.

Fixed classroom desks and teachers units have been replaced by lighter mobile furniture. Libraries still require extensive

shelving, although ready access to the internet may tend to reduce the use of hard-copy materials.

Some special spaces, such as science labs, shop, and art rooms, need storage for hazardous chemicals and operate heavy equipment, and are vulnerable to earthquake damage. Music spaces and gymnasiums all have special equipment and storage needs, some of which would be costly to replace in the event of damage.

2.1 INTRODUCTION

This chapter introduces a performance-based design process that is recommended for adoption by a school district starting a program of school construction, addition, or repair. The principles of performance-based design can be applied to the design of a single school, of any size, or to a school construction plan for a large school district launching a major program.

Performance-based design seeks to augment current code approaches rather than replacing them. However, there is a significant drive to introduce performance-based codes and, particularly in the field of fire safety, performance-based codes are now used for many applications. In the natural hazards area, although performance-based design is well developed for seismic design, prescriptive approaches are still typical for floods and high winds. A sound multihazard design approach should provide an impetus to adopt a performance-based philosophy for design against risk.

2.2 DEFINITIONS OF PERFORMANCE-BASED DESIGN

Performance-based design is an evolving concept. The term as currently used has multiple definitions and three are presented below:

- A design approach that meets the life safety and building performance intents of the traditional code while providing designers and building officials with a more systematic way to evaluate alternative design options currently available in codes. In this regard, performance-based design facilitates innovation and makes it easier for designers to propose new building systems not covered by existing code provisions.

- A design approach that identifies and selects a performance level from several performance level options. Some provisions in the current version of the International Building Code (IBC) are sometimes called performance-based because they incorporate distinctions between performance goals for different building uses. These performance options are conceived to achieve higher-than-code-minimum design requirements.
- A design approach that provides designers with tools to achieve specific performance objectives such that the performance of a structure can be reliably predicted. In the hazards area, this approach has been highly developed for seismic design although considerable research is still necessary to ensure the requisite reliability and predictability that would allow a performance-based code to be possible.

2.3 THE PRESCRIPTIVE APPROACH TO CODES

The traditional approach used in building codes in the United States has been that of prescriptive-based codes. Prescriptive-based codes are quantitative and rely on fixed values that are prescribed by the codes and intended to achieve a reasonable level of fire and life safety as well as reasonable levels of safety from other hazards such as earthquakes, floods, and high winds. Prescriptive requirements are based on broad classifications of buildings and occupancies, and are typically stated in terms of fixed values such as travel distance, fire resistance ratings, allowable area and height, and structural design (e.g., dead loads, live loads, snow loads, rain loads, earthquake loads, wind loads, etc.).

Prescriptive codes provide limited rules for addressing various design and construction issues (e.g., establishing limits on the allowable area and height of a building, based upon construction type and occupancy classification). One of the current prescriptive building codes limits the basic area of a non-combustible, unprotected school building to 14,500 square feet. Why are this building and its occupants considered reasonably safe or accept-

able at 14,500 square feet and unsafe or unacceptable at 15,000 square feet? This traditional approach is assumed to provide an “acceptable level of risk.”

This is not to say that buildings designed and built under the prescriptive based codes are unsafe, but it is important to understand that the requirements in the prescriptive-based codes are judged to be only the minimum necessary to safeguard the public health, safety, and general welfare. In some instances, it may be desirable, appropriate, or even necessary to raise the level of safety above the prescribed minimums.

Under the prescriptive approach, all schools are essentially treated alike. Thus, the requirements for an elementary school with 500 students are the same as those for a high school with 500 students, although clearly there are differences in these buildings due to the age of the occupants and their ability to take proper and appropriate action under various emergency conditions.

Another issue involving school buildings is the use of the facility for purposes other than education. In many communities, school buildings are designated as emergency shelters to be used in the event of a natural or manmade disaster event. The “normal” prescriptive code approach does not address the building features and systems necessary for the continuity of service required for an emergency shelter (for security, flooding, high wind, or hazardous material release issues).

How can the issues such as these and others be addressed? An innovative procedure that is becoming increasingly adopted is the use of a performance-based approach to improve or supplement the prescriptive requirements.

2.4 THE PERFORMANCE-BASED APPROACH

Although having detailed requirements for “performance” is relatively new to the building and fire codes used in the United States, the concept is not. The various “prescriptive” building,

fire, and life safety codes have all contained provisions for what was known as “alternative methods and materials” or “equivalencies.” These code provisions allow for the use of methods, equipment, or materials not specified or prescribed in the code provided the alternative is approved by the code official. It is under these provisions of the traditional codes that the performance-based design approach can be undertaken.

Under the concept of an alternative method, material, or equivalency, the code official must approve the alternative or equivalency if it can be shown to be equivalent in quality, strength, effectiveness, fire resistance, durability, and safety. The proponent of the alternative method or equivalency is responsible for providing all necessary documentation to the code official. Based on the ability of the code official to permit alternate methods and materials in the existing prescriptive codes, performance-based codes simply offer the code official a system with which to accept alternative designs based on performance. In other words, this is nothing new to the code official, it is just a more formal way to review designs.

As mentioned previously, taking a “performance” approach is not new to building design because decisions based upon performance occur in all most every project. As an example, constructing corridor walls out of either gypsum board and steel studs or concrete masonry units (CMUs) will meet the prescriptive code requirements for a rated corridor in an educational occupancy. However, from a “performance” standpoint, the concrete masonry assembly is more desirable due to its ability to withstand the normal wear and tear of such occupancy. Another example would be the selection of the heating, ventilating, and air conditioning (HVAC) system. Although either rooftop units or central boilers/chillers might provide the requisite thermal performance, life-cycle cost analysis might support the choice of the central boiler/chiller.

Performance-based design provides a structured way of making decisions that is particularly applicable to the issue of life safety

and damage reduction from natural and manmade hazards. From a designer's standpoint, the performance-based codes provide a more formalized system to develop, document, and submit alternative materials, methods, and equivalencies.

Unlike relying solely on a prescriptive code, performance-based design addresses an individual building's unique aspects or uses, and specific and "stakeholder" needs. "Stakeholders" include everyone who has an interest in the successful completion of a school project (i.e., the school board members, responsible officials, members of the design team, the builders, the community at large, parents, and the code enforcement officials). The design team is a sub-group of the "stakeholders," which includes individuals such as representatives of the architect, school district, and other pertinent consultants.

It is critical to the proper development, approval, and implementation of any performance-based design for all of the stakeholders to be actively involved in the process. Because the stakeholders establish the acceptable level of risk, it is crucial that all stakeholders be involved in the project from the earliest stages. It is also important that the stakeholders realize that an incident in a school facility can be measured in more ways than just monetary. The loss of a school facility for any reason can have organizational, legal, political, social, and psychological impacts.

The performance-based procedure provides the basis for the development and selection of design options, based upon the needs of the specific project, to augment the broad occupancy classification requirements. The approach structures a comparison of safety levels provided by various alternative designs, and also provides a mechanism for determining what level of safety, at what cost, is acceptable to the stakeholders. Performance-based design aims at property protection and life safety strategies in which the systems are integrated, rather than designed in isolation.

2.5 HAZARD, RISK, AND PROBABILITY

But what about “risk”? We often use the terms “hazard” and “risk” interchangeably. However, in the performance-based design environment, this substitution is incorrect. The definitions of these two words are distinctly different when assessing various challenges, and they must be used in the correct context when working with stakeholders, especially those not familiar with the terms.

No one should confuse “hazard” or “risk” with “safety.” “Safe” is a subjective condition that everyone views differently. Society establishes what it considers to be “safe” through a process of legal documents: both laws and court interpretations of them. Is a building that meets the prescriptive code requirements “safe?” Are you “safe” when you occupy a building that is entirely fire-resistant and protected by the latest in sprinklers and fire alarm technologies? “Hazard” and “risk” are recognized terms in the design, construction, engineering, architectural, and scientific worlds; “safe” is not.

The stakeholders must properly and thoroughly evaluate the risk or probability of a hazard event occurring in the performance designed facility. The basic questions they should ask are:

- What events are anticipated?
- What level of loss/damage/injury/death is acceptable?
- How often might this happen?

As they ask themselves these questions, and develop the variety of scenarios to which to apply them, the stakeholders must remember that obtaining consensus on acceptable levels of risk is essential to the successful outcome of the project.

Risk analysis incorporates the likelihood of a specific event and the severity of the outcome. This process combines both the severity and the probability of all relevant hazard loss scenarios. Remember that it is the intent of a performance-based code to establish the acceptable or tolerable level of risk. The

overall analysis must consider not only the frequency of an events' occurrence, but the effectiveness and reliability of the entire building as a system. Risk analysis provides a quantitative measure of the risk. It also can establish the basis for evaluating acceptable losses and selecting appropriate designs.

Risk managers use two different evaluative methods in risk and hazard analysis: deterministic and probabilistic.

Deterministic analysis relies on the laws of physics and chemistry, or on correlations developed through experience or testing, to predict the outcome of a particular hazard scenario. In the deterministic approach, one or more possible designs can be developed that represent the worst possible credible events in a specific building. In this approach, the frequency of possible occurrences need not be evaluated.

Probabilistic analysis evaluates the statistical likelihood that a specific event will occur and what losses and consequences will result. This approach may use both statistics and historical information.

History from events involving similar buildings or equipment, building contents, or other items can be considered. The frequency of occurrences of a particular type of event is evaluated.

Any risk analysis method must anticipate a certain level of "uncertainty." Uncertainty describes those factors or circumstances that, if altered, affect the desired outcome.

Risk is the product of potential consequences and the expected frequency of occurrence. Consequences may include death, serious injury, or time lost from work, the extent of structural damage, monetary loss, interruption of use, or environmental impact. The occurrence frequency may be an estimate of how often the project loss might occur.

Risk binning is an alternative to the more classic risk analysis, and is considered to be much simpler. Instead of identifying and

evaluating every possible hazard, it quantifies (measures) the consequences of the most severe events and matches them with an approximate event frequency. The concept is based on the idea that, if one prepares for the worst-case scenario, lesser damaging events will result in favorable outcomes.

For each type of event, the maximum consequence must be established. Consequences may include death or serious injury; or massive structural damage, absolute loss of production, severe environmental damage, or total business interruption. The consequences should represent the largest realistic event of each type.

The provisions of the International Code Council (ICC) *Performance Code for Buildings and Facilities* (2003 edition) describe this as the “magnitude of events.” These range from small, medium, large, and very large. Table 2-1 shows the correlation between the “magnitude of events” and acceptable levels of damage

For seismic, flood, and wind events, the ICC *Performance Code for Buildings and Facilities* has established criteria for the various magnitude of events as shown in Table 2-1.

Table 2-1: ICC Performance Code Criteria for Seismic, Flood, and Wind Events

		Events		
		Seismic	Flood	Wind
Magnitude of Events	Very Large	2,475 years	Determined on a site-specific basis	125 years
	Large	475 years, but not to exceed 2/3 of the intensity of very large	Determined on a site-specific basis	100 years
	Medium	72 years	500 years	75 years
	Small	25 years	100 years	50 years

2.6 ACCEPTABLE RISK AND PERFORMANCE LEVELS

The performance-based design process begins with establishing the acceptable risk and appropriate performance levels for the building and its systems. The basic concept of acceptable risk is the maximum level of damage to the building that can be tolerated, related to a realistic risk event scenario or probability. For each hazard, there are methods of measuring the magnitude of events and their probability, as well as terminology to describe levels of damage or performance levels. There are four performance levels, each of which addresses structural damage, nonstructural systems, occupant hazards, overall extent of damage, and hazardous materials. The types of damage that are defined will vary according to the type of hazard that is being addressed. The ICC *Performance Code for Buildings and Facilities* formalized four design performance levels in terms of tolerable limits to the building, its contents, and its occupants that apply to all types of hazards. These levels are as follows:

Mild Impact. At the mild impact level, there is no structural damage and the building is safe to occupy; injuries are minimal in number and minor in nature; damage to the building and contents is minimal in extent and minor in cost; and minimal hazardous materials are released to the environment.

Moderate Impact. At the moderate level, there is moderate, repairable structural damage, and some delay in re-occupancy can be expected; injuries may be locally significant, but generally moderate in numbers and in nature; there is a low likelihood of a single life loss and very low likelihood of multiple life loss; and some hazardous materials are released to the environment, but the risk to the community is minimal.

High Impact. At the high impact level, it is expected that there will be significant damage to structural elements, but with no falling debris. Significant delays in re-occupancy can be expected. Nonstructural systems needed for normal building use are also

significantly damaged and inoperable. Emergency systems may be damaged, but remain operational. Injuries to occupants may be locally significant with a high risk to life, but are generally moderate in numbers and nature. There is a moderate likelihood of a single life loss, with a low probability of multiple life loss. Hazardous materials are released to the environment with localized relocation required.

Severe Impact. With severe impact, there will be substantial structural damage, and repair may not be technically possible. The building is not safe for re-occupancy, because re-occupancy could cause collapse. Nonstructural systems for normal use may be completely nonfunctional, and emergency systems may be substantially damaged and nonfunctional. Injuries to occupants may be high in number and significant in nature. Significant hazards to life may exist. There is a high likelihood of single life loss and a moderate likelihood of multiple life loss. Significant hazardous materials may be released to the environment, with relocation needed beyond the immediate vicinity.

2.7 CORRELATION BETWEEN PERFORMANCE GROUPS AND TOLERATED LEVELS OF DAMAGE

The provisions of the ICC *Performance Code for Building and Facilities* correlate the performance groups and the tolerated levels of damage. Table 2-2 shows this relationship. Events are classified as small, medium, large, or very large. Each hazard will have its own definitions that modify these generic magnitudes.

Building groups in the ICC *Performance Code* include:

- Group I - Buildings that represent a low hazard to human life in the event of failure
- Group II - All buildings except Groups I, III, and IV
- Group III - Buildings with a substantial hazard to human life,

including schools or day care centers with a capacity greater than 250

- Group IV - Buildings designed as essential facilities, including designated earthquake, hurricane, or other emergency shelters

Table 2-2: Performance Groups and Tolerated Levels of Damage

Building Groups		Increasing Level of Performance (Performance Groups)			
		Group I	Group II	Group III	Group IV
Magnitude of Events	Very Large (very rare)	Severe	Severe	High	Moderate
	Large (rare)	Severe	High	Moderate	Mild
	Medium (less frequent)	High	Moderate	Mild	Mild
	Small (frequent)	Moderate	Mild	Mild	Mild

Using an elementary school with an occupant load of less than 250 as an example (Group II), it can be seen that there is a significant difference in the level of performance required when the building is to be used as a designated emergency shelter (Group IV). These performance levels clearly are not addressed by the prescriptive code requirements.

For hazards such as earthquakes and winds, it may be desirable to set different performance objectives for nonstructural versus structural design. Although the prescriptive code may provide acceptable structural safety, it may be cost effective to spend a small additional amount of resources to enhance the attachment and bracing of key nonstructural components and provide for independent inspection of their installation. Local information on the characteristics of flood may suggest that it is prudent to allow an increased factor of safety above the expected flood elevation at the property. Similarly, local experience may suggest that projects should be designed for higher wind speeds than the code values.

The flow chart shown in Figure 2-1 summarizes a typical performance-based design process for a major design and construction program. It can be used as a checklist for a single construction project to structure early discussion between the stakeholders and the designers to establish the acceptable risk, performance goals, and objectives for the design.

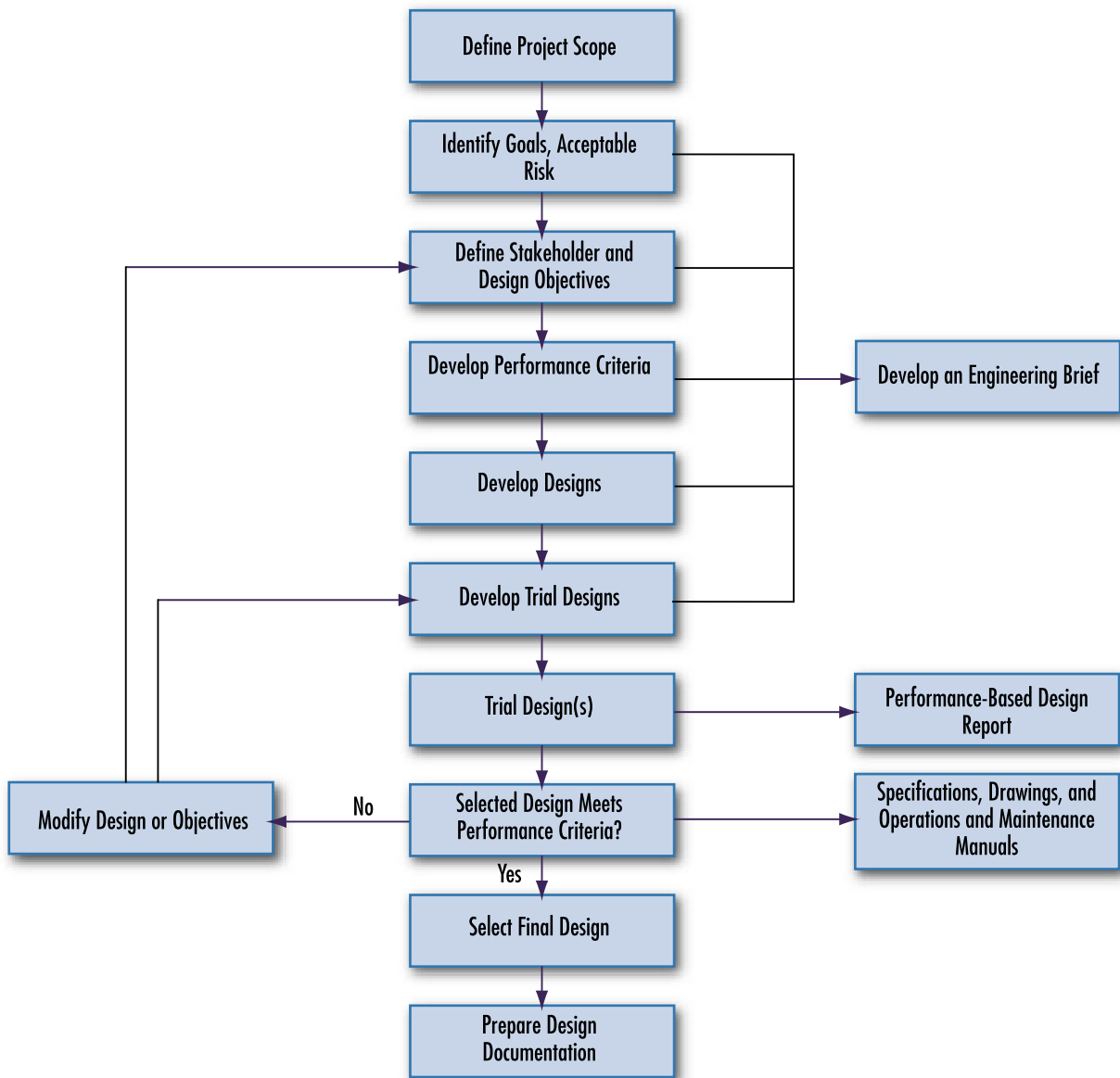

Figure 2-1 Performance-based design approach flow chart

SOURCE: BASED ON A CHART TAKEN FROM THE SFPE GUIDE TO PERFORMANCE-BASED FIRE PROTECTION, NFPA, QUINCY, MA, 2000

2.8 ROLES OF DESIGNERS, CODE OFFICIALS, AND THE SCHOOL DISTRICT

The school district is responsible for retaining the services of the design professionals and for the costs of any special services, including contract or third-party reviews and inspections required by the code official. The district must also retain all required documents and reports on the premises and is required to operate the building in accordance with the approved design throughout the life-cycle of the building.

The design professional is an individual who is registered or licensed to practice his or her respective design profession as defined by the statutory requirements of the professional registration laws of the state or jurisdiction in which the project is to be constructed. The design professional must possess the required knowledge and skills to perform design analysis and verification in accordance with the code requirements and applicable standards of practice. Design professionals may include architects, civil and structural engineers, mechanical engineers, and fire protection engineers, to name only a few.

The design professionals and special experts must be able to apply performance requirements; provide appropriate analysis, research, computations, and documentation; utilize authoritative documents and design guides; and review (inspect) the completed construction elements to verify compliance with the prescribed design.

All design documentation must be prepared by the design professional. Required documentation includes a concept report, a design report, and an operations and maintenance (O&M) manual. The design professional must coordinate all plans and documents for consistency, compatibility, and completeness, and submit them to the code official for review and approval.

The code official is required to perform a “knowledgeable” review of the proposed design and is permitted to use a third-party or peer review. When such third party or peer review is used, the cost for such services may be passed on to the submitter. After

the plans and specifications have been reviewed and approved, a permit is issued for the start of construction. During the construction process, inspections and tests must be conducted in accordance with the design documents, code official procedures, and applicable codes. Upon completion, acceptance testing must be undertaken prior to occupancy.

After completion of the project and acceptance testing, the design professional must prepare and submit to the code official documentation that verifies that all performance and prescriptive code provisions have been met. The code official is permitted to require a third-party or peer review of this documentation. After completion of construction, final inspection, and testing and submission of all required documentation, the code official must issue the certificate of occupancy. A temporary certificate of occupancy may be issued for a limited timeframe with specified conditions, provided that all life safety items are accepted. The code official may also require that a temporary certificate be issued for a specific period of time and/or be “renewable” on a periodic basis.

The school district is responsible for proper maintenance and operation of the building, in accordance with the O&M manual, throughout the life of the building.

The school district is also responsible for periodically verifying compliance with the approved design at a frequency approved by the code official. Documents verifying that the building, facilities, premises, processes, and contents are in compliance with the approved design documents must be filed with the code official.

2.9 CHANGES TO A BUILDING DESIGNED FOR PERFORMANCE

When a building that was designed and constructed using a performance-based design is remodeled or altered, or its use changed, a design professional must evaluate the existing building and applicable documentation. Any change that results in an increase in hazard or risk must undergo a full review and evaluation of the de-

sign. The review and evaluation must be documented in a written report and submitted to the code official for review and approval. Such written review must be submitted to the code official even when the proposed changes do not exceed the original conditions.

One area of change that can occur is in one or more of the original bounding conditions. Bounding conditions by definition are conditions that, if exceeded, invalidate performance-based design. These could be maximum allowable conditions such as fuel load or type and arrangement of fuel load that must be maintained throughout the life of a building to ensure that design parameters are not exceeded.

Some examples of a change in bounding conditions are:

- The original design assumed that the gym would be used only for spectator sporting events. Such an arrangement would present a relatively low HVAC load. The desire is to now use the same gym for a science fair with the display of many project and other related materials. The new use represents a much higher HVAC load than originally intended and thus would represent a change in bounding condition.
- The building was originally designed for use as a high school. Characteristics of these occupants to respond to an emergency situation are a bounding condition. The desire is now to change the school to one on the elementary level. Because the ability of these occupants to respond to an emergency is different, this would represent a change in bounding conditions.

2.10 CURRENT PERFORMANCE-BASED CODES

Performance-based codes are not based on broad or generic classifications, but are qualitative. They establish, by a consensus process, acceptable or tolerable levels of hazard or risk for a variety of health, safety, and public welfare issues. Three model

codes that are currently available are the ICC *Performance Code for Buildings and Facilities*, the National Fire Protection Association (NFPA) 101 *Life Safety Code*, and the NFPA 5000 *Building Code*. Any one or a combination of these documents would be appropriate for use in a performance-based design.

Although the ICC *Performance Code for Buildings and Facilities* addresses all types of building issues, the provisions of the NFPA 101 *Life Safety Code*, “Performance-based Option,” address only those issues related to “life safety systems.” The provisions of the NFPA 5000 *Building Code* apply not only to life safety issues, but to all traditional “building code” issues as well.

This design approach is based on a life safety evaluation, which is a written review dealing with the adequacy of life safety features relative to fire, storm, collapse, crowd behavior, and other related safety considerations.

The performance-based design must be prepared by a person with qualifications acceptable to the code official. The code official is permitted to require an approved, independent third-party review of the proposed design and provide an evaluation of the design to the code official. All data sources are required to be identified and documented. The code official is empowered to make the final determination as to whether the performance objectives are met.

Design specifications and other conditions used in the performance-based design must be both clearly stated and shown to be realistic and sustainable. The characteristics of the building or its contents, equipment, or operations that are not inherent in the design specifications, but that can affect occupant behavior or the rate of hazard development, are required to be explicitly identified. The anticipated or expected performance of a fire protection system and building features must also be documented.

In addition, the selection of the occupant characteristics must be approved by the code official and must reflect the expected population of building users. Response characteristics of the occupants

should include their sensibility (sensory awareness), reactivity, mobility, and susceptibility. Sources of data for these characteristics must be documented. It must also be assumed that, in every normally occupied room or area, at least one person will be located at the most remote point from the exits. The design must also reflect the maximum number of people that every occupied room or area is expected to contain.

In those instances where the ability of trained employees (occupants) is part of the overall performance design concept, the number of employees, and their training and abilities should be identified and documented.

2.11 THE O&M MANUAL AND THE OCCUPANTS' HANDBOOK

The last critical component of the performance-based design process is the O&M manual. The design professional is responsible for developing this important document, which can be described as an owners manual for the building and all of its systems. This document should clearly establish the requirement that the school official must ensure that all components of the performance-based design are in place, operational, and properly maintained for the entire life-cycle of the building.

The ICC *Performance Code for Buildings and Facilities*, the NFPA 101 *Life Safety Code*, and the NFPA 5000 *Building Code* all provide for the continued use and maintenance of a performance-based design facility. Each building or facility designed and constructed using a performance-based design relies on certain conditions remaining stable throughout the life of the building.

The O&M manual documents agreements with stakeholders and clearly states that the building owner must ensure that the components of the performance-based design remain in place and in proper operating condition. The manual provides instructions that place restrictions on the building operations, and communicates to the building tenants and occupants the limits of

building use and their responsibilities. It also provides a guide to renovation and documents what actions are to be taken if a fire protection system is impaired or removed. The importance of the O&M manual cannot be understated. It is the glue that holds the on-going use of the building together.

The O&M manual must be submitted with the final design documents, and all of the stakeholders must agree on its contents. The manual should contain the requirements for the testing, inspection, and maintenance of all systems; outline restrictions on building operations; and provide guidelines on how to address any changes in occupancy or use.

This manual also must be made part of the legal documents of the property so that they are transferred with any change in ownership. The O&M manual should include:

- Descriptions of the commissioning requirements of all fire protection systems
- Identification of all subsystems
- Descriptions of all inspections, testing, and maintenance procedures and schedules
- Information on emergency electrical power systems
- Details on building operations (e.g., critical fuels loads, sprinkler design requirements, building use and occupancy, reliability and maintenance of fire protection systems)
- Details of the maintenance plans for critical design components
- Qualifications of inspection personnel or inspectors
- Fee schedules for unique or third party inspections required by the code official and provisions of changes to the fee schedules
- Requirements to be followed if any fire protection system is impaired or out of service

- Testing criteria for initial acceptance, including pass/fail criteria, inspection/testing schedules, periodic testing criteria, and recordkeeping requirements

In addition, the manual should spell out any requirements or restrictions, such as storage height, commodity type, or fire protection system modifications.

The O&M manual should also contain the occupants' handbook. In the case of school occupancies, this is the portion of the O&M manual that would be provided to the faculty and support staff. Less technical than the O&M manual and similar to the handbook that comes with a new automobile, this publication informs all occupants of the specific building about the design features of the building and its equipment, as well as the occupants' responsibilities. It also serves as a guide for renovations and changes to workspaces. In addition, the occupants' handbook should provide details for the development and submittal of modifications for review and approval by the Authority Having Jurisdiction (AHJ), building owner, insurance carrier, or other appropriate stakeholders.

2.12 PERFORMANCE-BASED DESIGN FOR NATURAL HAZARDS

As noted in Section 2.4, a performance-based approach to building design is not new, because decisions based on performance occur frequently in almost any project. What is new is the attempt to formalize a decision-making process related to expected performance and, ultimately to develop performance-based codes to regulate building design and construction.

In the natural hazards area, “performance” is used to signify a level of damage or load. This, in itself, represents a major change in perception, because the building owner or occupant generally believes that adherence to building codes provides a safe environment and anticipated degrees of damage are not a normal source of conversation between an architect and owner, or even an archi-

tect and his engineer. Earthquake experience in recent years has forced recognition that damage (sometimes severe) will occur in a building designed in accord with the code.

The theory and practice of performance-based design currently is most advanced in seismic design and virtually non-existent in design for floods and high winds. Advanced seismic engineering practitioners have, for some time, recognized several performance objectives in relation to owner's needs, and have used them as a basis for establishing design parameters. These objectives, or performance levels, can be simply stated as follows:

- **Level 1:** The building is essentially undamaged and can be immediately operational.
- **Level 2:** The building is damaged, and needs some repairs, but can remain occupied and be functional after minor repairs (of a nonstructural nature) are complete.
- **Level 3:** The building is both structurally and nonstructurally damaged, but the threat to life is minimal and occupant injuries should be minor and few.
- **Level 4:** The building is severely damaged and will probably have to be demolished; it has not collapsed, although there is some likelihood of occupant injury.

In this spectrum, the code conforming building is fairly far down the scale (at Level 3) and many private and public owners are prepared to pay more to achieve a higher level of performance. A hospital should achieve at least Level 2, and preferably Level 1. A high-tech manufacturing plant might desire to achieve the same level, because of the high value of its contents and the business losses if the plant must shut down production. The owner of a warehouse that houses a modest and easily replaced commercial inventory, with very few occasional occupants, might opt for the economies of Level 4.

In the last decade or so, this informal pragmatic approach to performance-based seismic design has become formalized; the

performance levels have been named and carefully defined. Detailed observation of damaged buildings, together with advances in materials science, experimental research, and analytical methods, have led to much more sophisticated understanding of building response and have enabled engineers predict more reliably how a structure will behave under various levels of shaking. This prediction is still far from a guarantee, but it has a scientific and engineering basis that was non-existent even 2 decades ago. Meanwhile, extensive studies of all aspects of performance-based seismic design are underway around the country, largely sponsored by FEMA and the National Science Foundation.

The same degree of research and development activity does not, however, apply to design for floods and high winds. One reason is that these fields have not had the same sophisticated (and fairly expensive) research support that the seismic community has enjoyed. Before performance-based design for floods and winds can become a reality, a solid research base must be established. The kind of research would be different from that of seismic engineering; the engineering problems are much simpler, but research into simulating the probabilities and effects of floods and winds could yield rich rewards. The objective is to reduce the uncertainties associated with these hazards, thus avoiding wasted money and resources. Wind design could benefit from materials and component research to improve exterior envelope design and construction: at present, many of the available protective methods are labor intensive in the most primitive way, often using only hammers, nails, and stapling guns.

If design for performance against floods and high winds is to approach the sophistication of seismic performance-based design, a new approach to thinking about buildings subjected to floods and winds is necessary, paralleling the new thinking that has occurred around buildings subjected to earthquakes. When engineers began to think about buildings from the owners' viewpoint, and the different ways in which buildings were occupied, it became clear that a seismic code that focused only on methods and technical design criteria instead of results was not responding to

owners' (and society's) needs. Performance-based seismic design is still in its infancy, and much research needs to be done, but the essential shift in thinking has occurred.

Performance-based design is not proposed as an immediate substitute for design to traditional codes. Rather, it is seen as an opportunity for enhancement and the tailoring of the design to match the objectives of the community. Design to the code remains as the minimum baseline to ensure safety for school occupants, but the special importance to our society of protecting the school population suggests that design to a generic code minimum is not sufficient.

To achieve a building code that regulates performance rather than easily inspected design construction methods will not be easy, but ultimately one can expect to see a rational mix of performance and prescription in the regulatory mix. That shift took place in advanced industries (e.g., airplane design) a few decades ago, and airplanes are now habitually designed to stringent performance requirements, specified by the military or the airline companies.

Designers and owners of buildings in flood or high wind-prone regions need to begin to think in terms of a few basic objectives:

- Can the real probabilities and frequencies of events during the useful life of the building be defined with a useful degree of accuracy?
- Can the extent and kinds of damage (if any) that can be tolerated be defined?
- Are there ways (if any) in which this acceptable level can be achieved?
- Are there alternative levels of performance that can be achieved and how much do they cost over the lifetime/ownership of the building?
- Are these levels below, at, or above design to code enforced criteria?

Serious thought about these basic issues by all the stakeholders is the beginning of design for performance.

2.12.1 Performance-based Seismic Design

As discussed in Section 2-12, procedures for the application of performance-based design seismic design are well advanced. However the procedures are still evolving and issues such as terminology, analytical methods, and achieving reliable performance prediction are still subject of much research and development. This section outlines the general approaches that are current in performance-based seismic design; considerable refinement of the approaches and procedures that are outlined herein are expected to occur in the next few years.

Determining Acceptable Risk. The performance-based design procedure starts with the definition of acceptable risk. Prior to inception of design work for a new or retrofitted school building, discussions should be initiated between the design team, the school district, and community representatives to explain the level of seismic performance that will be achieved by conformance to the code, and other possible performance options that may be available. In these discussions, “seismic performance” refers to the extent of damage and loss that is likely to occur in earthquakes of differing magnitudes. These discussions focus on ensuring that all parties understand that “earthquake” or damage-free performance is not possible, and compromises must be made between seismic performance, cost, and design for learning. “Acceptable risk” refers to the extent and types of damage and loss that the school officials and community can tolerate. Clearly, avoidance of casualties is of the highest priority, but what are the priorities for issues such as damage to the building’s structure, nonstructural components, and systems and contents?

The discussion of acceptable risk begins with determining the answer to the following question: If the building is designed strictly to the minimum code requirements, are the damage and loss that might occur in the design level earthquake acceptable? If the an-

swer to this question is positive, an implicit level of acceptable risk has been set and design can proceed. If the answer is negative or undecided, the following should be addressed:

- What lesser extent and types of damage can be accepted?
- What are the implications for long-term costs and benefits over the life of the school building?
- Is the desired performance level affordable within the first-cost resources of the district (minimum code requirements must always be provided)?

Issues of uncertainty must also be made clear. It should be noted that the degree of uncertainty in predicting performance will be dependent on the existing school design in addition to the application of code requirements. The design team for a new building has control over this issue; however, for a retrofit, some of the existing school characteristics may be less than desirable.

A new design in which key parameters of good seismic design are provided (i.e., continuous load path, structural redundancy, symmetry in plan and section, short spans, and well designed nonstructural connections and bracing) will be more economical and more predictable in performance than a design in which these characteristics are not present. (The simple concept design shown in the How Buildings Resist Earthquakes illustration in Section 4.6.1 represents an “optima” seismic design that incorporates these features.)

Discussions of these issues should lead to a formal conclusion on performance objectives that then serve as a target for the designers, but it is the school district representatives who must make the final performance objective decision. The implications of this decision must be fully understood and it is the responsibility of the design team to provide necessary information, to the extent that it is available.

Traditionally, the architect has been the source of all design information for the school authorities but, due to the technical sophistication of performance-based design, the structural engineer will probably be consulted. On large projects, the key consultants may be involved in early meetings, particularly when the school district is represented by a facilities manager or other technical staff. In these instances, the district's professional staff may be expected to be able to discuss the project on equal terms with the design team. Whether all parties are familiar with the language of performance-based seismic design may have significant impact on the extent to which seismic performance issues can be a subject for useful discussion and decision-making.

If community representatives or committees, whose technical expertise may be more limited, are involved, the design team should try to ensure that the issues are understood.

For most school districts and communities, the discussion of acceptable risk will be an entirely new kind of discussion and the language of seismic performance may be unfamiliar. Historically, it has not been common practice to initiate a discussion of damage tolerance for a new project. The seismic expectations checklist in Table 2-3 provides a basis for these discussions. The checklist takes the form of a matrix of design expectations that can assist design team members, the school district, and the community to agree on seismic performance goals that are reasonably in line with the available resources. Agreement on such goals and expectations can help achieve a desired level of performance and limit later surprises due to unexpected earthquake damage. Such performance objectives statements might properly be part of a project's building program and serve as the basis for a performance-based design procedure.

The checklist can be completed or used merely as a basis of discussion. The intent is for the school district to arrive at a seismic performance objective that is understood and approved, both as to its opportunities and its limitations.

Table 2-3: Seismic Expectations Checklist

Earthquake Performance of Structural Systems				
Damage				
Earthquake Magnitude	Severe: No life threat or collapse	High: repairable damage; building not usable	Moderate: repairable damage; building usable	Mild: no significant damage
Low-Moderate				
Moderate-Large				
Large				
Earthquake Performance of Nonstructural Components and Systems				
Damage				
Earthquake Magnitude	Severe: No life threat or system failures	High: Repairable damage; building not usable	Moderate: Repairable damage; building usable	Mild: No significant damage
Low-Moderate				
Moderate-Large				
Large				
Functional Disruption: Structural and Nonstructural				
Time to Reoccupy				
Earthquake Magnitude	6 months plus	up to 3 months	up to 2 weeks	Immediate
Low-Moderate				
Moderate-Large				
Large				

Notes: Earthquakes:
 Low-Moderate: up to Magnitude 6.5 on the Richter scale
 Moderate-Large: Magnitude 6.5 - 7.5 on the Richter scale
 Large: Magnitude 7.5 plus on the Richter scale

SOURCE: (MODIFIED) ERIC ELSESSER: *BUILDINGS AT RISK*, AIA/ACSA COUNCIL ON ARCHITECTURAL RESEARCH, WASHINGTON, DC, 1992

The above classifications may be modified by poor soil conditions or specific seismological forecasts. Note that this table adds a short description to the four damage level categories identified in the ICC *Performance Code for Buildings and Facilities* outlined in Section 2.12.

Table 2-4 shows the expected overall and nonstructural damage for the four building performance levels defined in FEMA 273, *NEHRP Guidelines for the Seismic Rehabilitation of Buildings*. These performance levels are developed versions of the four general performance levels described on page 2-20. The bottom row relates the damage levels to those expected for a building designed to a conventional code. FEMA 273 contains six such tables that show expected damage to vertical and horizontal structural elements; architectural, mechanical, electrical, and plumbing components; and building contents. These expectations refer to a building designed using the appropriate analytical tools available in FEMA 273, which provides the necessary methods of analysis and detailing to achieve these performance levels for high, moderate, and low earthquake intensity regions. Some of the terminology in these tables may be expected to change as a result of studies now underway.

Table 2-4: Damage Control and Building Performance Levels

	Building Performance Levels			
	Collapse Prevention Level	Life Safety Level	Immediate Occupancy Level	Operational Level
Overall Damage	Level 4 (Severe)	Level 3 (Moderate)	Level 2 (Light)	Level 1 (Very Light)
General	Little residual stiffness and strength, but load bearing columns and walls function. Large permanent drifts. Some exits blocked. Infills and unbraced parapets failed or at incipient failure. Building is near collapse.	Some residual strength and stiffness left in all stories. Gravity-load bearing elements function. No out-of-plane failure of walls or tipping of parapets. Some permanent drift. Damage to partitions. Building may be beyond economical repair.	No permanent drift. Structure substantially retains original strength and stiffness. Minor cracking of facades, partitions, and ceilings as well as structural elements. Elevators can be restarted. Fire protection operable.	No permanent drift. Structure substantially retains original strength and stiffness. Minor cracking of facades, partitions, and ceilings as well as structural elements. All systems important to normal operation are functional.
Nonstructural components	Extensive damage.	Falling hazards mitigated, but many architectural, mechanical, and electrical systems are damaged.	Equipment and contents are generally secure, but may not operate due to mechanical failure or lack of utilities.	Negligible damage occurs. Power and other utilities are available, possibly from standby sources.
Comparison with performance intended for buildings designed, under the <i>NEHRP Provisions</i> , for the Design Earthquake	Significantly more damage and greater risk.	Somewhat more damage and slightly higher risk.	Much less damage and lower risk.	Much less damage and lower risk.

SOURCE: NEHRP GUIDELINES FOR THE SEISMIC REHABILITATION OF BUILDINGS (FEMA 273)

Reducing Seismic Risk Through Performance-based Design. The general principles of performance-based design are discussed in earlier sections of this chapter. For seismic risk reduction, performance-based design starts with the recognition that some damage will be incurred in a severe earthquake even in a well designed and constructed building. Prior to the seismic design,

the school districts and the design team reach agreement on the desired seismic performance of the building (i.e., the extent and type of damage that the school district can tolerate). The extent of this damage can be reduced by seismic design measures based on more precise analysis of the earthquake forces that the building will encounter, rather than relying on the simplified analytical methods of the current seismic code.

These more precisely estimated forces may, in some instances, be less than the forces determined by a simple code analysis because less allowance will need to be made for uncertainty in the calculations, and the seismic design and construction cost may be reduced. Increased protection beyond the minimum code expectations, however, will almost inevitably add to the initial cost of the building. The trade-off that the school district must consider is that damage reduction will probably result in design and construction cost increases.

The value to the district of increased investment in seismic protective design and construction is dependent on the likelihood of damaging earthquakes, and some economic analysis can assist in arriving at an affordable solution with satisfactory safety and damage control characteristics. This implies that the cost of protection must be evaluated over the life of the building, rather than only as an item of the initial building cost. As with design to the current code, performance-based design starts with the assumption that the basic purpose of seismic design is to protect the building occupants from collapse and damage that may be life-threatening.

The performance-based design procedure uses inputs from the information evaluations previously described to develop designs that balance the desired performance levels with the available resources.

2.12.2 Performance-based Flood Design

The performance objectives (or performance levels) for flood hazards can be stated as follows:

Level 1: The school building sustains no structural or nonstructural damage, emergency operations are fully functional, and the building can be immediately operational; the campus is not affected by erosion but may have minor debris and sediment deposits.

Level 2: The school building is affected by flooding above the lowest floor, but damage is minimal due to shallow depths and short duration. Cleanup, drying, and minor repairs are required, especially of surface materials and affected equipment, but the building can be back in service in a short period of time. Site improvements such as bleachers and fences are damaged, and athletic fields are damaged by erosion and deposition of sediment and debris.

Level 3: The school building may sustain structural damage that requires extensive repair and partial reconstruction. If the school is used as a shelter, threats to occupants are minimal. Nonstructural damage to equipment and finish materials requires cleanup, drying, and repairs. Site improvements such as bleachers and fences are damaged, and athletic fields are damaged by erosion and deposition of sediment and debris.

Level 4: The school building is severely damaged and likely requires demolition or extensive structural repair. Threats to occupants are substantial and warning plans should prompt evacuation prior to the onset of this level of flooding. (Note: Level 4 is applicable to schools affected by flooding due to failure of dams, levees, or floodwalls.)

In addressing the question “what level of loss/damage/injury/death is acceptable?”, an assessment of the probable magnitude and frequency of flood events during the life of a school is relatively straightforward. With the exception of floods caused by

or exacerbated by failure of dams and levees, an examination of available information regarding mapped flood hazard areas, predicted flood elevations, and historic floods should identify an adequate estimation of the flooding that may affect a school site. It is reasonable to exceed the minimum design flood elevation and loads for essential and critical facilities, including schools.

Flooding of buildings rarely results in loss of life and injuries, although that is a likely consequence of extreme and unpredictable flooding caused by events such as dam or levee failures. Beyond identification of the normal design flood magnitude, further examination is required to identify those contributory hazards. State water resources agencies can identify the high hazard dams and significant hazard dams that are present in the watershed and the failure scenarios that may result in catastrophic consequences. Similarly, local agencies or authorities that maintain and operate levee and floodwall systems can characterize failure scenarios for protected areas. Schools located in areas threatened by these very low probability, high consequence events should have emergency response plans that are closely coordinated with the appropriate emergency management authorities.

Chapter 5 identifies a number of recommendations to exceed minimum flood-resistant requirements to achieve an appropriate level of protection for essential and critical facilities, primarily avoidance of flood hazard areas and adding a factor of safety to the elevation requirement. Consideration of these recommendations is in the spirit of performance-based design. To some degree, the benefits can be quantified: the National Flood Insurance Program's (NFIP's) statistics on building that exceed the minimum requirements indicate lower damage. It is notable, however, that there is insufficient experience with non-residential buildings that are exposed to extreme flooding to quantify the benefits.

2.12.3 Performance-based High Wind and Tornado Design

The performance objectives (or performance levels) for the wind hazard can be stated as follows:

Level 1: The school building is essentially undamaged and can be immediately operational.

Level 2: The school building is damaged, and needs some repairs, but can remain occupied and be functional after minor repairs (of a nonstructural nature) are complete.

Level 3: The school building may be structurally damaged, but the threat to life is minimal and occupant injuries should be minor and few. However, nonstructural damage (i.e., the building envelope or rooftop equipment) is great, and the cost to repair the damage is significant. If rain accompanies the windstorm, or if rain occurs prior to execution of emergency repairs, water damage to the interior of the school can prohibit occupancy of all or a portion of the school from several weeks to several months.

Level 4: The school building is severely damaged and will probably have to be demolished. Significant collapsing may have occurred, and there is great likelihood of occupant deaths and many injuries unless the school has a specially designed occupant shelter. (Level 4 is applicable to schools struck by strong or violent tornadoes. For other types of windstorms, Level 4 should not be reached.)

For the wind hazard, loss of life and injuries due to collapsing building components or wind-borne debris is quite rare. Except for strong and severe tornadoes, the major threat posed by high winds is damage to the school itself, which can be very costly to repair and may prohibit use of the school for a considerable period of time.

In addressing the question “what level of loss/damage/injury/death is acceptable?”, an assessment of the probable magnitude

and frequency of wind events during the life of a school is relatively straight forward. With the exception of strong and violent tornadoes, complying with the design procedure in ASCE 7 should typically result in adequate estimation of the wind loads that a school will experience. (For strong and violent tornadoes, wind and wind-borne debris loads derived from FEMA 361 should typically provide an adequate estimation.) However, the great challenge with performance-based wind design is the assessment of the wind resistance of the building envelope and rooftop equipment and the corresponding damage susceptibility.

Assessment of the true performance of the building envelope and rooftop equipment is challenging because of several unrelated factors:

- Analytical tools (i.e., calculations) are currently not available for many envelope systems and components. Because of the complexity of their wind load response, many envelope systems and components require laboratory testing, rather than analytical evaluation, in order to determine their load-carrying capacity. Unfortunately, current test methods typically have many limitations. For example, test assemblies normally test unaged materials. Hence, the test may adequately indicate how the system will perform during the first few years of its life, but it may not indicate how the system will perform after being exposed to sunlight (which may result in heat and/or ultraviolet radiation induced degradation), water (which may degrade the system via corrosion or dry rot), or repeated modest wind events (which may induce fatigue failure). Also, tests are typically static (i.e., uniform pressure distribution), rather than dynamic (i.e., cyclically-induced loading). In addition, test assemblies are not typically subjected to wind-driven water while simultaneously being subjected to design-level wind pressures.

It is likely that finite element analysis (FEA) will eventually augment or replace laboratory testing, but substantial research is necessary before FEA becomes available for the

numerous building envelope systems from which architects are able to choose.

- Architects have traditionally given little attention to wind resistance of building envelopes, and mechanical engineers have given little attention to wind resistance of rooftop equipment. For those architects and engineers that try to give attention to envelopes and rooftop equipment, their task is hampered by lack of comprehensive design guides, lack of analytical tools and lack of realistic long-term wind resistance data as discussed above.
- Building envelopes are often constructed by several different trades. For example, an exterior non-load bearing wall may be framed by one subcontractor, another subcontractor may install the insulation and wall covering and another subcontractor may install the windows. It is challenging to successfully integrate these various subsystems so that wind-driven water infiltration is inhibited and load-path continuity is maintained.
- Because the building envelope is exposed to weather, it is natural for various envelope components to lose strength over time. If naturally-deteriorated components are not replaced before they become overly weak, they can be damaged during storms that are well below design wind speed conditions. Although appropriate maintenance and repair criteria may be included in the O&M manual, it is often difficult to determine if serious corrosion, dry rot, or termite attack has occurred in concealed portions of the envelope.
- Modifications may inadvertently weaken the resistance of the building envelope. For example, if a roof system incorporates an air retarder, and a future penetration (such as an exhaust fan) through the roof does not maintain the continuity of the air retarder at the penetration, the roof system could receive a sufficiently high unexpected load to result in roof covering damage. In this example, even though maintaining

air retarder continuity should be included in the O&M manual, compliance with this O&M requirement could easily be overlooked.

Because of the great uncertainty of the true resistances of the building envelope and rooftop equipment on a given school, the level of wind and subsequent water infiltration damage that could be reasonably expected to result from a design-level windstorm at some future time is difficult to quantify at this time. With development of comprehensive wind design guidelines for building envelope systems and rooftop equipment, development of greatly enhanced test and analytical methods, and greater awareness on the part of designers and construction trades on basic design and installation techniques to inhibit water infiltration and practices necessary to achieve load-path continuity, the magnitude of the uncertainty can be decreased. However, significant research funding is needed in order to reduce the uncertainties associated with the wind and water resistance of building envelopes and rooftop equipment.

Except for strong and violent tornadoes, schools designed and constructed with one of the current model building codes (and adequately maintained and repaired), typically present a low risk of casualties and injuries. However, some existing schools may present higher risk. For example, a glass curtain wall at a cafeteria, or tall unreinforced and inadequately braced CMU wall at a gym may be blown in or out during a strong thunderstorm. If students or faculty are nearby, they could be injured or killed. Or, a roof could blow off and injure students that are on their way to the buses. There is also increased risk of casualties and injuries to people seeking refuge in a school during a hurricane if the school was not originally designed for this purpose.

By considering the recommendations provided in Chapter 6, and implementing those that are appropriate for a given school, the spirit of performance-based design can be achieved, with respect to both casualties/injuries and building damage/interrupted use, for new construction, as well as existing schools. However, because of the limitations discussed above, it is not possible at this time to

quantify the actual performance that the various enhancement recommendations will offer. In some cases, the recommendations may be overly conservative and, in others, they may be non-conservative. The recommendations will result in enhanced performance, but additional research is needed to quantify the magnitude of the enhancement.

3.1 INTRODUCTION

This chapter compares the effects of three natural hazards that are the subject of this publication, in terms of their geographical locations, relative warning times, frequency, risk, and potential for damage and loss. Comparative losses are discussed and fire and safety considerations are presented. The design methods used to protect against the hazards by looking at the ways in which these methods reinforce or are in conflict with one another are compared. This is a key aspect of multihazard design because the similarities and differences in the ways in which hazards affect buildings and how to guard against them demand an integrated approach to natural hazards design. This must be pursued as part of a larger integrated approach to the whole building design problem.

3.2 THE HAZARDS COMPARED

Natural hazards are not aberrations; they are part of the natural environment in which we live and in which our buildings should be designed to function. Therefore, it is necessary for designers to become knowledgeable about all natural hazards in order to gain an understanding of how they act and how they can be accommodated within the design process, rather than treating them as adversaries that the designer must reluctantly accommodate at the expense of more traditional design aspirations.

This section presents a comparative sketch of the three natural hazards covered in this publication together with some issues relating to the common hazard of fire. The threat of physical attack is covered in a companion publication, FEMA 428, *Primer to Design Safe School Projects in Case of Terrorist Attacks*. A general understanding of all hazards is necessary in order to develop an integrated multihazard approach to design. It has been a tenet of multihazard design that design for two or more hazards may rein-

force one another, thus reducing cost and improving protection, but it has also been recognized that at times there may be conflicts between designs for different hazards. This section presents, for the first time, a systematic analysis of the reinforcements and conflicts between hazard protection methods. This takes the form of the matrices shown in Section 3.5. This section is presented to stimulate discussion and analysis at the outset of project design and to provide a format for further development and discussion of the issues involved.

3.2.1 Location: Where are They?

The public perception of natural hazards is that earthquakes occur in California, floods in many riverine and coastal locations, tornadoes in the Midwest, and hurricanes along the Atlantic and Gulf coasts. Although there is some truth to this perception as it relates to the highest probabilities for each hazard, hazard maps show that the entire United States is vulnerable to one or more of the three main natural hazards: earthquakes, floods, or high winds. Earthquakes are predominant in the West, but also threaten specific regions in the Midwest, Northeast, and Southeast. The great earthquakes centered on the little town of New Madrid, Missouri, in 1811 and 1812 caused little damage and only a few casualties; a recurrence of these earthquakes would impact some of the most populous cities of the Midwest. The worst earthquake in the eastern states occurred in Charleston, South Carolina, in 1886; 60 people were killed and the modest sized city suffered the equivalent of about \$25 million damage in today's dollars. Riverine floods occur along rivers, largely but not exclusively in the Midwest, and coastal flooding is associated with storm surges caused by high winds. Flash floods caused by sudden, intense rainstorms may occur anywhere. Some of the worst floods in U.S. history have been caused by dam failures, often when rivers are swollen by flood waters. Extreme winds are regional (e.g., hurricanes along the Atlantic and Gulf coasts, the Caribbean, and the South Pacific; tornadoes typically in the Midwest; and downslope winds adjoining mountain ranges), but high winds can also occur anywhere.

Floods are fairly specific and predictable in their location, and effective design against floods is less a matter of design concept than of siting. A building can be located in such a way that floods will never be a problem; however, flood-free locations are relatively rare and our floodplains are full of existing buildings. Other than use of elevation, which can be reasonably effective, design against floods consists of a number of detailed measures (e.g., dry and wet floodproofing, which is discussed in Chapter 5 of this publication), all of which can be overwhelmed by flooding that exceeds the design flood. In some regions of the country, the designer must consider two or three natural hazards. In parts of California (in certain coastal and river delta regions), buildings are vulnerable to both floods and earthquakes, although the probability of simultaneous occurrence is remote. The Hawaiian Islands, Guam, the Virgin Islands, Puerto Rico, and parts of the East coast may all be impacted by earthquakes, floods, and high winds; although all three are lateral forces, they have many different characteristics that must be taken into design consideration.

Figures 3-1, 3-2, 3-3, and 3-4 provide four maps that show an overview of the incidence of earthquakes, floods, hurricanes, and tornadoes in the United States. Figure 3-1 shows the earthquake hazard for the United States; the contour lines on the map indicate the 10 percent probability of exceedance of ground motion accelerations within each contour area (or the “odds” that there is a 10 percent chance that the accelerations will be exceeded in a 50-year period). Maps such as this are used for seismic design to estimate the forces for which structures must be designed. Figures 3-2, 3-3, and 3-4 show the Presidential Disaster Declarations between January 1965 and November 2000 for floods, hurricanes, and tornadoes, respectively. These maps show only major events, and do not show all the regions where there are hazards. Chapters 4, 5, and 6 provide information to enable the reader to establish the risk for each of these hazards (earthquakes, floods, and high winds) in a local region, respectively.

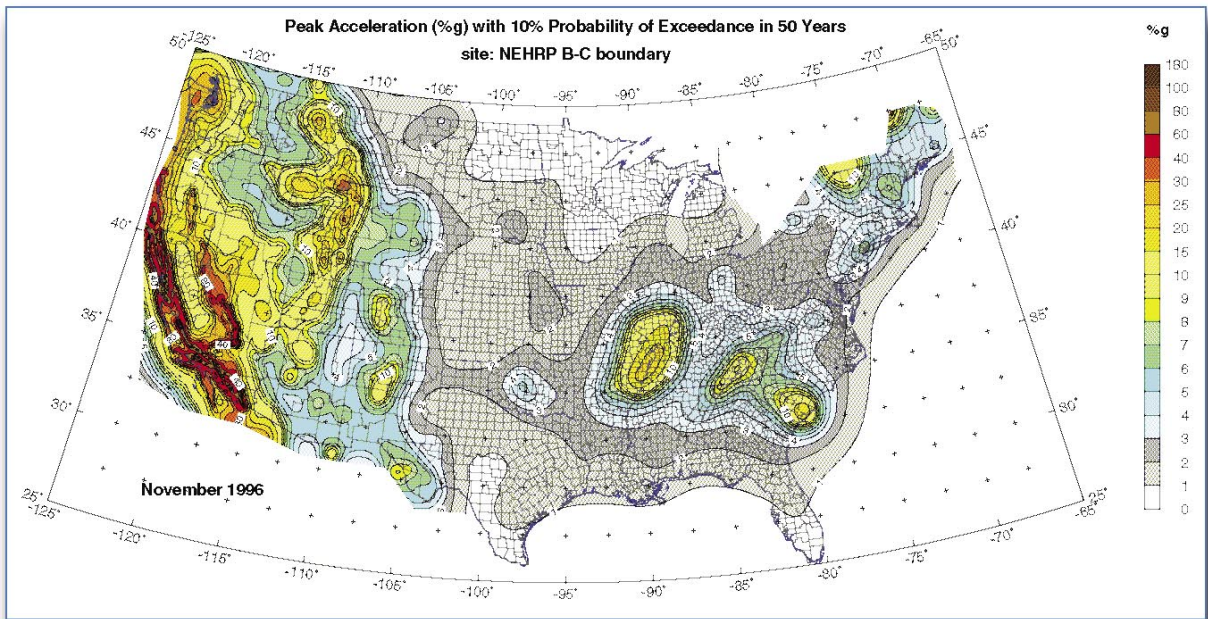

Figure 3-1
Peak accelerations (%g) with 10 percent probability of exceedance in 50 years. Color code shows %g for areas between contour lines. These values are used for seismic design.

SOURCE: USGS

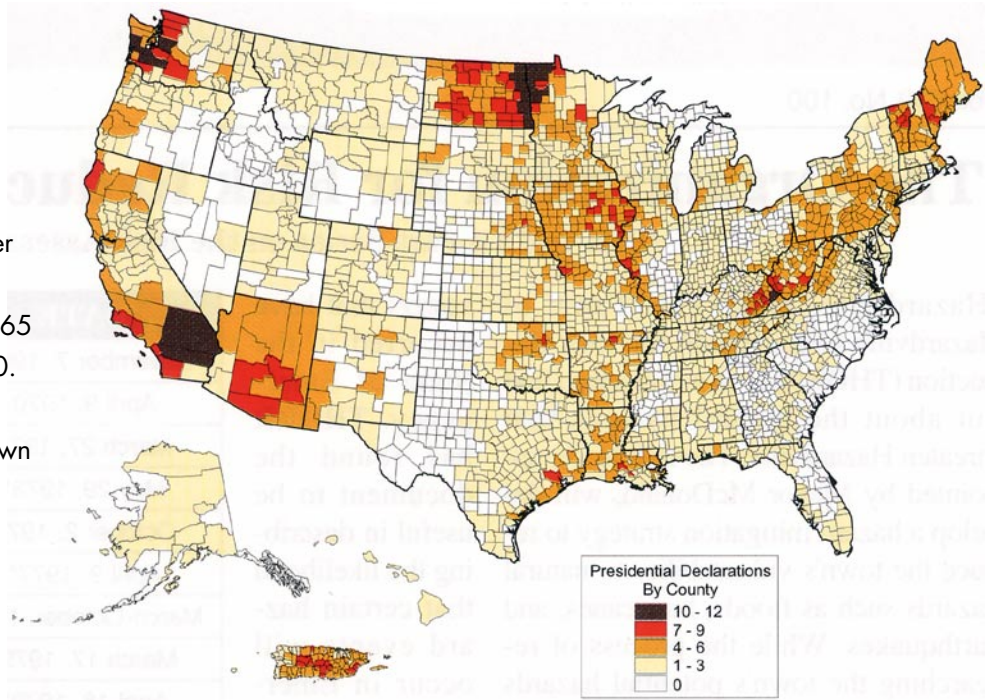

Figure 3-2
Presidential Disaster Declarations for floods, January 1965 to November 2000. The incidence of declarations is shown by counties.

SOURCE: FEMA 386-2

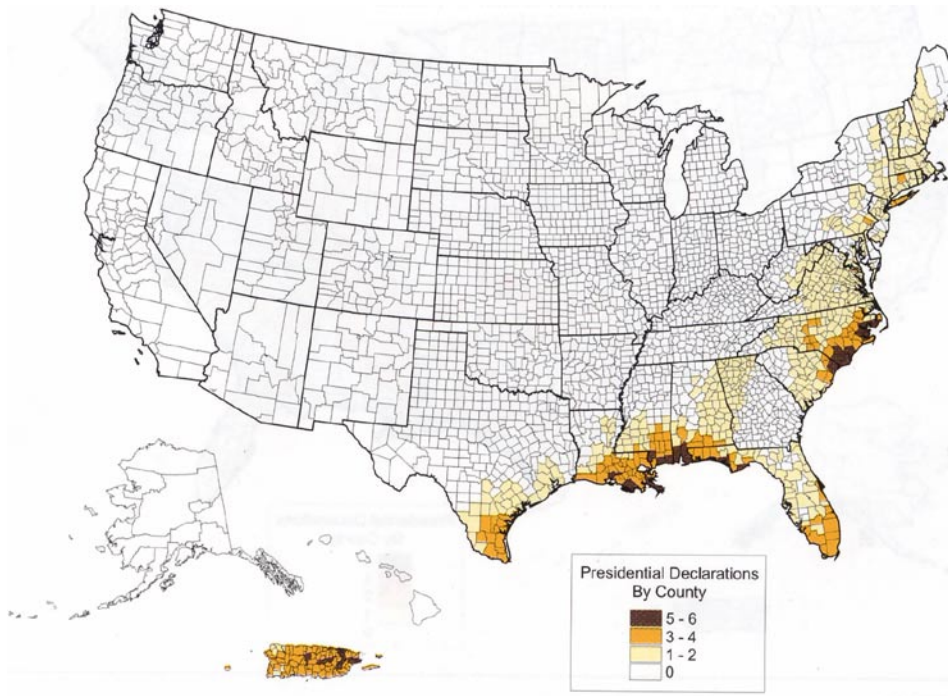

Figure 3-3
 Presidential Disaster
 Declarations for
 hurricanes, January
 1965 to November
 2000. The
 incidence of
 declarations is
 shown by counties.

SOURCE: FEMA 386-2

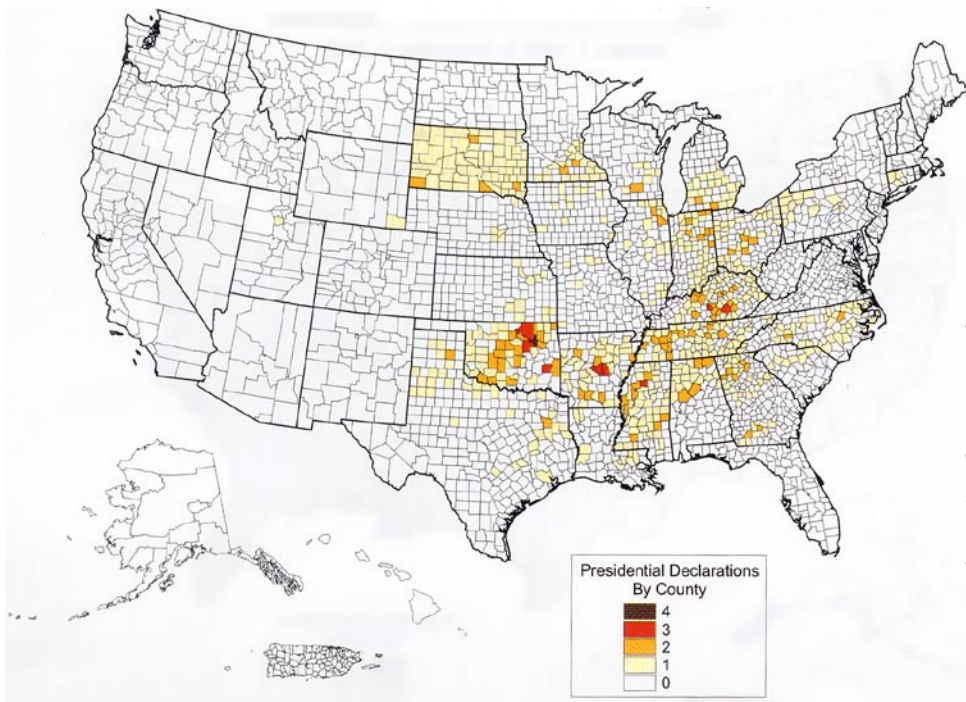

Figure 3-4
 Presidential Disaster
 Declarations for
 tornadoes, January
 1965 to November
 2000. The incidence
 of declarations is
 shown by counties.

SOURCE: FEMA 386-2

3.2.2 Warning: How Much Time is There?

The warning times for these hazards vary. Earthquakes are unique among the natural hazards because there is no warning at all, although new sensing devices can now give a few seconds warning to locations far from the epicenter. Floods (except flash floods) can be predicted so as to give hours or days of warning; hurricanes can be tracked for days and give several hours of warning before hitting a specific location. Tornadoes are more localized and, though visible, may hit a specific location almost without notice.

Although the tornado gives warning and its approach is visible during daylight, its winds are often so strong that damage or destruction in its immediate vicinity is common. Hurricanes are tracked by the national hurricane tracking system and their movement is carefully and thoroughly reported. The hurricane's movement along its path is slower and its size is much larger than a tornado, yet even then its precise route and timing cannot be predicted until a few hours before making landfall.

In earthquake-prone areas that experience frequent events, such as California and Alaska, there is a continuous generalized prediction, but the earthquake always strikes totally without warning. Although much work has been done throughout the world to develop a scientific prediction methodology (based on characteristics such as changes in the dimensional or physical nature of the ground prior to an earthquake; detailed investigation of the geologic strata; or statistical data on the incidence of previous earthquakes), earthquakes must still be regarded as random events within a general envelope of probability.

3.2.3 Frequency: How Likely are They to Occur?

For all hazards, the regional probabilities are much higher than the local ones, and the extreme events are relatively rare for a given site. Inundation of floodplains in riverine areas and flooding of poorly protected or sited coastal locations may be

relatively frequent; the general threat along rivers occurs each winter and spring, and a succession of hurricanes roam the Atlantic seaboard every year, bringing the risk of extreme winds and storm surge. Traditionally, residents in tornado-prone areas retreated to their basements, but engineered safe rooms are now being constructed in homes, schools, and other buildings. Earthquakes are perhaps the most difficult to deal with, because of their complete lack of warning, their rarity, and their possible extreme consequences. Although an earthquake of a given magnitude is still, in practical terms, unpredictable, its probability of occurrence can safely be predicted as far higher in California or Alaska than in, for example, Massachusetts or Tennessee. Even in California, the rarity of a large earthquake is such that many people will not experience one in their lifetime. In less seismic parts of the country, one must go back several generations, or to folklore, for earthquake stories, but even then there is a probability of an event.

Because natural hazards are only broadly predictable, the incidence of future events can only be expressed as probabilities. This presents a problem because what may be perfectly rational and useful to a mathematician may be confusing or even counterproductive to the public and their decision-makers. The probability of occurrence of earthquakes, floods, and high winds is commonly expressed by use of the term “return period” or “mean recurrence interval.” This is defined as the *average or mean time in years between the expected occurrence of an event of specified intensity.*

For example, until recently, earthquake codes used as a basis of severity a level of shaking (an acceleration value) that corresponded to a 10 percent probability of exceedance in 50 years (or a probability that it would be exceeded one time in approximately 500 years, a 500-year return period). More recently, it has become apparent that certain areas, such as the Mississippi embayment area, may, in fact, be vulnerable to much larger but more infrequent quakes. Therefore, a new set of hazard maps has been produced by the United States Geological Survey (USGS) that shows acceleration values for a 2 percent probability

of exceedance in 50 years (approximately 2/3 of design value). Designing to this level would provide real protection against a large earthquake.

Values for high winds are commonly expressed in codes as a 50-year return period, much shorter than earthquakes because their incidence is much more frequent. Floods are expressed as a 100-year return period (i.e., the “100-year flood”). To the public, these return periods seem very long (i.e., why would a business owner confronting small crises every day and large ones every month be worried about an event that might not occur for 500 years - let alone 2,500 years?). And if the return period for California is 500 years, would it not be another 400 years before something of the magnitude of the 1906 San Francisco earthquake occurs?

The problem is that these figures represent mean or average return periods over a very long period of time, with the result that the return period is often quite inaccurate in relation to the shorter time periods in which most of us are interested (i.e., the next year or the next 10 years). Because floods and high winds are relatively frequent, the discrepancy between the actual return period and the mean return period used in the codes is much more noticeable than the corresponding probabilities for earthquakes.

Currently, these statements of probability are the best we can do. Because they express mean values over long periods of time, they tell little about what will really happen this year or next year, but they may give a hint as to what will happen in our lifetime. Professional disaster planners must assume that disastrous hazards may occur at any time.

3.2.4 Risk: How Dangerous are They?

Deaths and injuries from natural hazards are serious, but are not statistically large on an annual basis (e.g., compared to deaths from automobile accidents); nor have we recently encountered the number of deaths caused by the Johnstown, Pennsylvania, dam

failure and flood of 1889 (3,000 killed) or the Galveston, Texas, hurricane of 1900 (6,000 killed).

Deaths from earthquakes in the United States have been quite small (e.g., less than 200 people have been killed since 1971, including the San Fernando, California, earthquake that killed 65 people in that year and the later Loma Prieta and Northridge, California, earthquakes). However, the experience of Kobe, Japan, in 1995, when over 6,000 people were killed, shows that we cannot be complacent as to the ability of a modern city to withstand a direct hit.

A major concern for those working on reducing earthquake risks is that the United States has yet to experience a large earthquake in an urban location (such as the 1906 San Francisco earthquake or the New Madrid, Missouri, earthquakes of 1811 and 1812) that seismologists believe to be inevitable. The Northridge earthquake of 1994 caused approximately 60 deaths, with economic losses estimated to be over \$30 billion. In January 1995, on the anniversary of the Northridge earthquake, an earthquake in Kobe, Japan, caused more than 6,000 deaths and economic losses estimated to be over \$85 billion.

Since the Loma Prieta, Northridge, and Kobe earthquakes occurred, several analyses have been conducted on the potential effects of large earthquakes in California. It is estimated that a repeat of the 1906 earthquake on the San Andreas Fault near San Francisco would result in 3,000 to 8,000 deaths (depending on the time of day) with economic losses from \$170 billion to \$225 billion in today's dollars. It is also estimated that a magnitude 7 earthquake (a moderate to large shock) on the Newport-Inglewood Fault in Southern California would kill between 3,000 and 8,000 people and the economic losses would range from \$175 billion to \$220 billion.¹

¹ Bendimerad, F., *Earthquake Scenarios in Three Cities: San Francisco, Los Angeles and Tokyo*, Proceedings, 11th World Conference on Earthquake Engineering, Acapulco, Mexico, 1996.

Earthquake-caused fires have historically been a major cause of casualties, most notably in the Tokyo earthquake of 1923. Approximately 30,000 people were killed in a single fire storm in a park along the Sunida River. Severe damage and casualties were caused by fires in the San Francisco earthquake of 1906 and the Kobe, Japan, earthquake of 1995.²

In the period between 1987 and 1997, floods caused 407 deaths: 187 were caused by the 1996 blizzard and flood in the Northeast. Hurricanes caused 599 deaths, 270 of which occurred in the 1993 blizzard and storm in the eastern United States. Although these numbers for hurricanes are substantial, relative to the size of the impacted area, the number of casualties is much less than in tornadoes. Between 1985 and 1997, the National Weather Service Storm Prediction Center reported 15 deaths in schools alone, of which 9 occurred in 1989.

Statistics for deaths from natural hazards over a recent 20-year period, on a mean annual basis, are as follows:³

- Earthquakes 6
- Flash floods 160
- Hurricanes 30
- Tornadoes 100

3.2.5 Cost: How Much Damage Will They Cause?

In the last two decades, losses from natural hazards have escalated. During the period from 1987 to 1997, floods caused \$30 billion to \$37 billion in damage, of which \$15 billion was due to the Midwest floods of 1993. In the same 10-year period, hurricanes caused losses of between \$60 billion to \$66 billion, of which \$27 billion was due to Hurricane Andrew in Florida and Louisiana.

² Arnold, C., *Reconstruction After Earthquakes*: Chapter Vb Tokyo, Japan 1923 and 1945, Building Systems Development, Inc., Palo Alto, CA, 1990.

The three major California earthquakes that occurred in the period (Whittier Narrows, 1987, Loma Prieta, 1989, and Northridge 1994) caused some \$36.5 billion in damages.

A statistical comparison of percentage of occurrence of property and economic losses between January 1986 and December 1992 is as follows:⁴

- Earthquakes 3
- Hurricanes/Tropical storms48
- Tornadoes/Other winds40
- Fire/Explosion5
- Miscellaneous4

Although these statistics relate to events prior to the Northridge earthquake of 1994 and also predate a number of significant floods and hurricanes, the relative importance of each hazard has not changed significantly, even though the overall dollar values involved have increased sharply.

One cause of this serious increase in the social and economic impacts of natural hazards is the rapid pace and intensity of urban and suburban development since World War II, particularly in states such as California, the Carolinas, and Florida, all of which have their own high hazard probability. Another is the high cost of construction, now soaring to levels inconceivable only a few decades ago. A third problem is that our political, economic, and social mechanisms for decision-making are still ill equipped to deal with the multi-faceted problems of reducing the risks and consequences of natural disasters.

3.3 COMPARATIVE LOSSES

The HAZUS-MH (Hazards U.S.-Multihazards) program was developed by the Federal Emergency Management Agency (FEMA)

⁴ Perry, D., *Buildings at Risk, Multi-Hazard Design for Earthquakes, Winds and Floods*, American Institute of Architects, Washington, DC, not dated.

to produce loss estimates for use by federal, state, regional, and local governments to plan for damage, prepare emergency response and recovery programs, and to help examine options to reduce future damage. HAZUS-MH is a Geographic Information System (GIS)-based program designed to help communities estimate future losses. The methodology covers nearly all aspects of the built environment and a wide range of losses. Originally developed to assess risks from earthquakes, the methodology has been expanded to address floods throughout the U.S. and hurricanes in the Atlantic and Gulf coast regions.

In order to obtain an indication of the magnitude of losses and their relative significance for the three hazards considered in this manual, a “Level 1” HAZUS-MH analysis was conducted for

educational facilities in six areas of the United States. A Level 1 analysis uses the building inventory in the HAZUS-MH program and is intended to give a broad picture of damage and loss on a regional basis.

Due to the developmental status of HAZUS-MH Build 27E at the time of publication of this manual, it was not possible to use the program for the flood values. Instead the following procedure was used: Q3 flood data were used for each of the counties listed below in defining the extent of the 100-year and 500-year flood areas (this is similar to a Level 2 approach in HAZUS-MH). The Q3 flood data are developed by electronically scanning the current effective map panels of existing paper Flood Insurance Rate Maps (FIRMs). Q3 flood data capture certain key features from the existing paper FIRMs. 30-meter resolution USGS digital elevation data and the Q3 flood data were used to obtain flood elevation depths at different locations (using ArcGIS 3-D Analyst).

The analysis was a regional loss analysis and was based on the building information for the EDU 1 occupancy class in the general building stock module from the upcoming release of HAZUS-MH. (This occupancy class is the HAZUS-MH designation for the school building inventory.) The regions chosen were those prone to two or more of the hazards addressed in HAZUS-MH, and deemed to provide a useful range geographic range. For each region and applicable hazard, probabilistic losses for a 100-and 500-year return period event (earthquake, flood, or high wind) were computed. The column “EDU 1 Exposure” in Table 3-1 refers to the total school inventory in each region.

The following regions were evaluated:

- Charleston County, South Carolina (Charleston) (earthquake, flood, and hurricane)
- Shelby County, Tennessee (Memphis) (earthquake and flood)
- Bexar County, Texas (San Antonio) (hurricane and flood)
- Salt Lake County, Utah (Salt Lake) (earthquake and flood)
- Suffolk County, Massachusetts (Boston) (earthquake, flood, and hurricane)
- Hillsborough County, Florida (Tampa) (hurricane and flood)

Table 3-1 is a summary of the results for the earthquake, wind, and flood scenarios as outlined above.

Table 3-2 shows another comparison of these losses in the form of the percentage loss of school inventory for each event. It is instructive to note, in some cases, the wide disparity in losses between the 100-year and 500-year events.

Table 3-1: HAZUS-MH Earthquake, Hurricane, and Flood Losses (All values are in \$1,000s (2002 valuation))

Charleston, SC	Earthquake		Hurricane		Flood		EDU 1 Exposure
	100-yr	500-yr	100-yr	500-yr	100-yr	500-yr	
Building Damage	31	3,449	5,802	22,290	1,378	1,554	63,787 Building
Contents and Inventory	4	1,365	3,690	16,897	392	557	63,787 Contents
Business Interruption	5	320	2,052	6,558	NE	NE	
TOTAL	40	5,134	11,544	45,745	1,770	2,111	

Shelby, TN	Earthquake		Hurricane		Flood		EDU 1 Exposure
	100-yr	500-yr	100-yr	500-yr	100-yr	500-yr	
Building Damage	243	10,464			4,184	6,784	137,927 Building
Contents and Inventory	53	3,723			1,203	2,002	137,927 Contents
Business Interruption	29	916			NE	NE	
TOTAL	325	15,103			5,387	8,786	

Table 3-1: HAZUS-MH Earthquake, Hurricane, and Flood Losses (All values are in \$1,000s (2002 valuation)) (continued)

Bexar, TX	Earthquake		Hurricane		Flood		EDU 1 Exposure
	100-yr	500-yr	100-yr	500-yr	100-yr	500-yr	
Building Damage			94	2,753	1,502	2,384	238,608 Building
Contents and Inventory			5	1,259	487	727	238,608 Contents
Business Interruption			7	2,078	NE	NE	
TOTAL			106	6,090	1,989	3,111	

Salt Lake, UT	Earthquake		Hurricane		Flood		EDU 1 Exposure
	100-yr	500-yr	100-yr	500-yr	100-yr	500-yr	
Building Damage	2,175	30,313			15	204	177,728 Building
Contents and Inventory	881	9,016			4	57	177,728 Contents
Business Interruption	259	2,488			NE	NE	
TOTAL	3,315	41,817			19	261	

Suffolk, MA	Earthquake		Hurricane		Flood		EDU 1 Exposure
	100-yr	500-yr	100-yr	500-yr	100-yr	500-yr	
Building Damage	0	1,544	4,837	58,640	254	907	268,311 Building
Contents and Inventory	0	484	2,258	40,665	70	305	268,311 Contents
Business Interruption	0	172	2,871	18,316	NE	NE	
TOTAL	0	2,200	9,966	117,621	324	1,212	

Hillsborough, FL	Earthquake		Hurricane		Flood		EDU 1 Exposure
	100-yr	500-yr	100-yr	500-yr	100-yr	500-yr	
Building Damage			10,257	47,213	10,727	11,776	175,981 Building
Contents and Inventory			6,045	39,016	4,329	4,624	175,981 Contents
Business Interruption			4,291	13,004	NE	NE	
TOTAL			20,593	99,233	15,056	16,400	

Notes:

EDU 1 Exposure: total school and contents inventory in each region (2003).

NE: HAZUS did not estimate these losses.

0: Evaluated, but no losses.

Boxes left blank have little or no activity for the referenced hazard.

Table 3-2: HAZUS-MH Estimated Losses by Percentage of School Building and Contents Inventory

County	Earthquake		Hurricane		Flood	
	100-year	500-year	100-year	500-year	100-year	500-year
Charleston, SC	0.2	17.3	4.54	17.50	1.38	1.65
Shelby, TN	0.12	5.47			1.95	2.46
Bexar, TX			0.02	1.27	0.40	0.65
Salt Lake, UT	1.1	11.76			0.01	0.07
Suffolk, MA	0	0.8				
Hillsborough, FL			5.85	28.20	4.27	4.65

Notes:

Boxes left blank have little or no activity for the referenced hazard.

This HAZUS-MH study, though limited in scope and relying on built inventory information, reveals some useful information:

- Generally, the 100-year earthquake causes insignificant damage, except in Salt Lake City, UT (\$3 million).
- The 500-year earthquake causes the most damage in Salt Lake City, UT (\$42 million), followed by Shelby, TX (\$15 million) and Charleston, SC (\$5 million).
- The 100-year flood causes by far the most damage in Hillsborough, FL (\$15 million; however, the 500-year flood causes only another \$1 million in damage). In Shelby, TN, the 100-year flood causes \$5 million in damage and the 500-year flood causes \$9 million. Elsewhere, flood damage is insignificant.
- The 100-year hurricane causes the most damage in Hillsborough, FL (\$20.5 million), followed by Charleston, SC (\$11.5 million) and Suffolk, MA (\$10 million).
- The 500-year flood causes \$118 million in damage in Suffolk, MA, \$99 million in damage in Hillsborough, FL, and \$46 million in damage in Charleston, SC.

Charleston, SC, has the greatest combined threat from earthquakes and hurricanes; Hillsborough, FL, has the greatest combined threat from hurricanes and floods.

The relatively modest damage figures shown in this study could be changed dramatically by a single large event, whether an earthquake, flood, or hurricane. It should also be noted that none of these locations were on the west coast and, thus, the damage figures for earthquakes are low.

3.4 FIRE AND LIFE SAFETY

Of the many hazards that can endanger a school facility and its service to the community, the most prevalent is fire. This is more pervasive than any of the hazards noted above. However, design against fire has long been built into our building codes, in the form of approved materials, fire-resistant assemblies, exiting requirements, the width and design of stairs, the dimensions of corridors, fire suppression systems, and many other issues. In fact, fire considerations are now so embedded in our design culture and regulation that there is a real danger that some designers may not fully realize that fire hazard is a specific design issue that must be considered.

According to the *Special Report on Educational Property Structure Fires in the United States* published by the NFPA in 1989, an average of 11,100 structural fires occur annually in educational properties. These fires resulted in a direct property loss of nearly \$100 million, with 236 injuries and 3 fatalities. According to both NFPA and the United States Fire Administration (USFA), a substantial number of fires in schools are the result of arson.

Fires in older school buildings often result in a total loss of the building. This is due to a variety of factors, which include: delay of discovery and alarm, remote locations, lack of fire walls and/or compartmentation, lack of draft stopping in combustible attics, lack of automatic fire sprinkler systems, and inadequate water supplies for manual fire suppression activities. Losses in build-

ings without automatic fire alarm and detection systems are twice those in buildings with such systems. Additionally, fire losses in buildings without automatic fire sprinkler protection are five times higher than those in buildings protected by sprinklers.

Often there appears to be a concern that there is not enough water for automatic fire sprinklers. The reality is that the water supply necessary for the proper operation of an automatic fire sprinkler system is far less than the amount of water necessary for manual fire suppression by the fire department. As an example, the water supply for a fire sprinkler system protecting a typical school building would be in the 350 gallons per minute (gpm) range, although 2,500 gpm or more would be required by a typical school building without sprinklers.

Since the 1970s, the provisions of the various building codes have continued to improve the level of fire and life safety of new school facilities. The level of fire and life safety in existing buildings is, however, another matter because the provisions of the various building codes are generally not applied to existing facilities except when renovations or additions are made and then only to the new work. Given that the average age of a school facility in the United States is currently 42 years, it is highly likely that older buildings do not provide the same level of protection as newer buildings. In order to protect these older facilities, their levels of fire and life safety must be evaluated. After an evaluation has been conducted, solutions using prescriptive and/or performance approaches can be developed and undertaken.

One system of evaluation is that contained in the existing structures chapter of the *International Building Code*. The “compliance alternatives” section provides a way of evaluating the overall level of fire and life safety in an existing building. Although the provisions of this section are generally intended to be applied to an existing building during changes in occupancy or renovation, it can provide the basis for the evaluation of any existing building.

The evaluation comprises three categories: fire safety, means of egress, and general safety. The fire safety evaluation includes structural fire resistance, automatic fire detection, and fire alarm and fire suppression systems. Included within the means of egress portion are the configuration, characteristics, and support features for the means of egress. The general safety section evaluates various fire safety and means of egress parameters. The evaluation method generates a numerical score in the various areas, which can then be compared to mandatory safety scores. Deficiencies in one area may be offset by other safety features.

Another method of evaluating and upgrading an existing facility is the application of the provisions of the NFPA 101 *Life Safety Code*. Unlike the provisions of the various building codes, this document is intended to be applied retroactively to existing facilities and has a chapter specifically for existing educational occupancies. Even if this code is not adopted by the local jurisdiction, it can be used as the basis for an evaluation of any existing facility.

There is no question that upgrading an existing school facility can be costly. However, the cost of upgrades is far less than the direct and indirect losses of the facility to fire. The most effective method of providing fire protection is through automatic fire sprinklers, but other lower cost methods can be utilized, including:

- Automatic fire alarm and detection
- Draft stopping in combustible attic spaces
- Smoke and fire compartmentation walls in occupied spaces

Upgrades in fire and life safety can often be coordinated with other building renovations or upgrades to help reduce costs. For instance, draft stopping could be installed in a wood framed attic during roof deck replacement. Fire sprinklers could be installed during asbestos abatement or ceiling replacement/upgrades for seismic concerns.

3.5 HAZARD PROTECTION METHODS COMPARISONS: REINFORCEMENTS AND CONFLICTS

An important aspect of designing against all hazards in an integrated approach is that the methods used for design may reinforce one another or may conflict with one another; in the former case, the costs of multihazard design can be reduced, but, in the latter, they may be increased. Table 3-3 summarizes the effects that design for more than one hazard may have on the performance and cost of the building, addition, or repair.

The horizontal rows show the five primary hazards. The vertical rows show methods of protection for the building systems and components that have significant interaction, either reinforcement or conflict. These methods are taken from the extended descriptions of risk reduction methods for the three main natural hazards discussed herein, together with the methods for security/blast protection presented in FEMA 428, *Primer to Design Safe School Projects in Case of Terrorist Attacks*. In addition, the interactions of these four categories of risk protection with fire safety, where they occur, are also shown.

The designations are intended to provoke thought and design integration; they are not absolute restrictions or recommendations. In general, reinforcement between hazards may be gained and undesirable conditions and conflicts can be resolved by coordinated design between the consultants, starting at the inception of design. The reader is encouraged to use the list as a basis for discussion relative to specific projects and to structure the benefits and conflicts of multihazard design depending on local hazards.

Table 3-3 also provides information to help the reader to develop a list of reinforcements and conflicts for the particular combination of hazards that may be faced. Development of lists such as these can be used to structure initial discussions on the impact of multihazard design on the building performance and

cost that, in turn, guide an integrated design strategy for multihazard protection. The system and component heading list is similar to that used for the building security assessment checklist in FEMA 426, *Reference Manual to Mitigate Potential Terrorist Attacks Against Buildings*.

Table 3-3: Multihazard Design System Interactions

Key	
✓	Indicates desirable condition or method for designated component/system
✗	Indicates undesirable condition or method for designated component/system
☐	Indicates little or no significance for designated component/system
	Split box indicates significance may vary, see discussion issues

Building System Protection Methods: Reinforcements and Conflicts							
System ID	Existing Conditions or Proposed Protection Methods	The Hazards					Discussion Issues
		Earthquake	Flood	Wind	Security/Blast (FEMA 428)	Fire	
1	Site						
	1-1 Building elevated on fill	☐	✓	☐	☐	☐	Excellent solution for flood.
	1-2 Two means of site access	✓	✓	✓	✓	✓	
	1-3 In close proximity to other facilities that are high risk targets for attack	☐	☐	☐	✗	☐	

Table 3-3: Multihazard Design System Interactions (continued)

Building System Protection Methods: Reinforcements and Conflicts								
System ID	Existing Conditions or Proposed Protection Methods	The Hazards					Discussion Issues	
		Earthquake	Flood	Wind	Security/Blast (FEMA 428)	Fire		
2	Architectural							
2A	Configuration							
	2A-1 Large roof overhangs	✗	☐	✗	✗	✗	☐	Possibly vulnerable to vertical forces in earthquake, uplift wind forces. The wall to roof intersection will tend to contain and concentrate blast forces if the point of detonation is below the eaves.
	2A-2 Re-entrant corner (L-, U-shape, etc.) building forms	✗	☐	✗	✗	✗	☐	May concentrate wind or blast forces; may cause stress concentrations and torsion in earthquakes.
	2A-3 Enclosed courtyard building forms	✗	☐	✓	✓	✗	☐	May cause stress concentrations and torsion in earthquake; courtyard provides protected area against high winds. Depending on individual design, they may offer protection or be undesirable during a blast event. If they are not enclosed on all four sides, the "U" shape or re-entrant corners create blast vulnerability. If enclosed on all sides, they might experience significant blast pressures, depending on building and roof design. Because most courtyards have significant glazed areas, this could be problematic.
	2A-4 Very complex building forms	✗	✗	✗	✗	✗	✗	May cause stress concentrations and torsion in highly stressed structures, and confusing evacuation paths and access for firefighting. Complicates flood resistance by means other than fill.
2B	Planning and Function (No significant impact)							

Table 3-3: Multihazard Design System Interactions (continued)

Building System Protection Methods: Reinforcements and Conflicts								
System ID	Existing Conditions or Proposed Protection Methods	The Hazards					Discussion Issues	
		Earth-quake	Flood	Wind	Security/Blast (FEMA 428)	Fire		
2C	Ceilings (No significant impact)							
2D	Partitions							
	2D-1 Block, hollow clay tile partitions	✗	✓	✗	✗	✓	Wind and seismic force reactions would be similar for heavy unreinforced wall sections, with risk of overturning. Tile may become flying debris during a blast. It is possible, but difficult, to protect structures with blast walls, but a weak nonstructural wall has more chance of hurting people as debris. Desirable against fire and not seriously damaged by flood.	
	2D-2 Use of non-rigid connections for attaching interior non-load bearing walls to structure	✓	☐	✓	✓	✗	Non-rigid connections are necessary to avoid partitions influencing structural response. However, gaps provided for this threaten the fire resistance integrity and special detailing is necessary to close gaps, but retain ability for independent movement.	
	2D-3 Gypsum wallboard partitions	✓	✗	☐	✗	✗	Although gypsum wallboard partitions can be constructed to have a fire resistance rating, they can be easily damaged during fire operations. Such partitions can be more easily damaged or penetrated during normal building use.	
	2D-4 Concrete block, hollow clay tile around exit ways and exit stairs	✗	☐	☐	✗	✓	✓	May create torsional structural response and/or stress concentration in earthquakes in frame structures unless separated and, if unreinforced, wall is prone to damage. Properly reinforced walls preserve evacuation routes in case of fire or blast.

Table 3-3: Multihazard Design System Interactions (continued)

Building System Protection Methods: Reinforcements and Conflicts								
System ID	Existing Conditions or Proposed Protection Methods	The Hazards					Discussion Issues	
		Earthquake	Flood	Wind	Security/Blast (FEMA 428)	Fire		
2E	Other Elements							
	2E-1 Heavy roof (e.g. slate, tile)	✗	☐	✗	✗	✗	✓	Heavy roofs are undesirable in earthquakes; slates and tiles may detach. Heavy roofs provide good protection from fire spread, but can also cause collapse of a fire-weakened structure. Almost always used on steep-sloped roofs; if wind-blown debris or a blast wave hits them, they become flying debris and dangerous to people outside the building.
	2E-2 Parapet	✗	✓	☐	✓	✗	✓	Properly engineered parapet is OK for seismic; unbraced unreinforced masonry (URM) is dangerous. May assist in reducing the fire spread.
3	Structural Systems							
	3-1 Heavy structure: reinforced concrete (RC) masonry, RC or masonry fireproofing of steel	✗	✓	✓	✓	✓	✓	Increases seismic forces, but generally beneficial against other hazards.
	3-2 Light structure: steel/wood	✓	✗	✗	✗	✗	✗	Decreases seismic forces, but generally less effective against other hazards.
	3-3 URM exterior load bearing walls	✗	✗	✗	✗	✗	✗	
	3-4 Concrete or reinforced CMU exterior structural walls	✓	✓	✓	✓	✓	✓	
	3-5 Soft/weak first story	✗	✗	✓	✗	✗	✗	Very poor earthquake performance, and vulnerable to blast. Generally undesirable for flood and wind. Elevated first floor is beneficial for flood if well constructed, but should not be achieved by a weak structure that is vulnerable to wind or flood loads.

Table 3-3: Multihazard Design System Interactions (continued)

Building System Protection Methods: Reinforcements and Conflicts							
System ID	Existing Conditions or Proposed Protection Methods	The Hazards					Discussion Issues
		Earthquake	Flood	Wind	Security/Blast (FEMA 428)	Fire	
	3-6 Indirect load path	✗	☐	✗	✗	✗	Undesirable for highly stressed structures, and fire weakened structure is more prone to collapse. Not critical for floods.
	3-7 Discontinuities in vertical structure	✗	☐	✗	✗	✗	Undesirable for highly stressed structures causes stress concentrations, and fire-weakened structure is more prone to collapse. Not critical for floods.
	3-8 Seismic separation joints	✓	☐	☐	☐	✗	Possible path for toxic gases to migrate to other floors.
	3-9 Ductile detailing and connections/steel	✓	☐	✓	✓	☐	Provides a tougher structure that is more resistant to collapse.
	3-10 Ductile detailing/RC	✓	☐	✓	✓	☐	Provides a tougher structure that is more resistant to collapse.
	3-11 Design for uplift (wind)	✓	☐	✓	✓	☐	Necessary for wind; may assist in resisting seismic or blast forces.
	3-12 Concrete block, hollow clay tile around exit ways and exit stairs	✗	☐	☐	✗	✓	May create torsional structural response and/or stress concentration in earthquakes in frame structures unless separated, and if unreinforced wall is prone to damage. Properly reinforced walls preserve evacuation routes in the event of fire or blast.
4	Building Envelope						
4A	Wall Cladding						
	4A-1 Masonry veneer on exterior walls	✗	✗	✗	✗	☐	In earthquakes, material may detach and cause injury. In winds and attacks, may detach and become flying debris hazard. Flood forces can separate veneer from walls.

Table 3-3: Multihazard Design System Interactions (continued)

Building System Protection Methods: Reinforcements and Conflicts							
System ID	Existing Conditions or Proposed Protection Methods	The Hazards					Discussion Issues
		Earth-quake	Flood	Wind	Security/Blast (FEMA 428)	Fire	
4B	Glazing						
	4B-1 Metal/glass curtain wall	✓	☐	✗	✗	✗	Fire can spread upward behind the curtain wall if not properly fire-stopped. Not blast-resistant without special glass and detailing. Light weight reduces earthquake forces.
	4B-2 Impact-resistant glazing	☐	☐	✓	✓	✗	Can cause problems during fire suppression operations, limiting access and smoke ventilation.
5	Utilities (No significant impact)						
6	Mechanical						
	6-1 Heating, ventilation, and air conditioning (HVAC) system designed for purging in the event of fire	☐	☐	☐	✓	✓	Can be effective in reducing chemical, biological, or radiological (CBR) threat if it has rapid shut-down and efficient dampers, and is located in an airtight building.
	6-2 Large rooftop-mounted equipment	✗	✓	✗	✗	☐	Vulnerable to earthquake and wind forces. Raises equipment above floor level.
7	Plumbing and Gas (No significant impact)						
8	Electrical (No significant impact)						
9	Fire Alarm (No significant impact)						
10	Communications and IT (No significant impact)						
11	Equipment O&M (No significant impact)						
12	Security (No significant impact)						
12A	Perimeter Systems (No significant impact)						
12B	Interior Security (No significant impact)						
12C	Security System Documents (No significant impact)						
13	Security Master Plan (No significant impact)						

Notes:

The table refers to typical school structures: steel frame, concrete block or RC walls, wood frame, 1-2 stories suburban, 2-4 stories urban.

4.1 INTRODUCTION

This chapter outlines the earthquake risk to schools and the processes and methods that can be used to reduce it. An explanation of the nature and probability of earthquakes is provided, together with procedures for determining the earthquake threat to specific locations. An assessment of the scope and effectiveness of seismic building codes is followed by an explanation of how to evaluate the vulnerability of a school building. Current methods of designing for seismic resistance in new buildings and upgrading existing buildings lead to a discussion on determining acceptable risk and the use of performance-based design to achieve community objectives in providing for seismic safety.

4.2 THE NATURE AND PROBABILITY OF EARTHQUAKES

Although earthquakes cannot be prevented, modern science and engineering provide tools that can be used to reduce their effects. Science can now identify, with considerable accuracy, where earthquakes are likely to occur and what forces they will generate. This information is readily available and can be obtained for local geographic regions (see Section 4.2.3).

4.2.1 Earthquakes and Other Geologic Hazards

Earthquakes have long been feared as one of nature's most terrifying phenomena. Early in human history, the sudden shaking of the earth and the death and destruction that resulted were seen as mysterious and uncontrollable. We now understand the origin of earthquakes and know that they must be accepted as a natural environmental process. Scientific explanations, however, have not lessened the terrifying nature of the earthquake experience. Earthquakes continue to remind us that nature can, without

warning, in a few seconds create a level of death and destruction that can only be equaled by the most extreme weapons of war.

This uncertainty, together with the terrifying sensation of earth movement, creates our fundamental fear of earthquakes. Beyond the threat to life is the possibility of the destruction of public and private property. Jobs, services, and business revenues can disappear instantly and, for many, homelessness can suddenly be very real. The aftermath of a great earthquake can endure for years or even decades.

Other types of phenomena sometimes accompany earthquake-caused ground shaking and are generally identified as geologic hazards:

- **Liquefaction** occurs when loose granular soils and sand in the presence of water change temporarily from a solid to a liquid state when subjected to ground shaking. This condition occurs mainly at sites located near rivers, lakes, and bays.
- **Landslides**, which involve the slipping of soil and rock on sloping ground, can be triggered by earthquake ground motion (see Figure 4-1).
- **Tsunamis** are earthquake-caused wave movements in the ocean that travel at high speed and may result in large coastal waves of 30 feet or more. They are sometimes, and incorrectly, called tidal waves.
- **Seiches** are similar to tsunamis, but take the form of sloshing in closed lakes or bays; they have the potential to cause serious damage, although such occurrences have been very rare.

For all of the above geologic hazards, the only truly effective defense is the application of good land-use practices that limit development in hazard-prone locations. Seismic design and construction is aimed at reducing the consequences of earthquake-caused ground shaking, which is by far the main cause of damage and casualties.



Figure 4-1
School, Anchorage, AK,
1964, severely damaged
by earthquake-induced
landslide

SOURCE: NATIONAL INFORMATION
SERVICE FOR EARTHQUAKE
ENGINEERING, UNIVERSITY OF
CALIFORNIA, BERKELEY



4.2.2 Earthquakes: A National Problem

Earthquakes in the United States are a national problem. This was recognized by the U.S. Congress in 1977 when it passed legislation authorizing the National Earthquake Hazards Reduction Program (NEHRP), which has supported considerable research and hazard mitigation implementation since that time.

Most people now know that earthquakes are not restricted to just a few areas in the United States, most notably California and Alaska, and that two of the greatest earthquakes known occurred not in California, but near New Madrid, Missouri, in 1811 and 1812. As shown on a map of earthquake probability in the U.S., more than 40 of the 50 states are at risk from earthquake-caused damage, life loss, injuries, and economic impacts (see Figure 4-2). Certainly the likelihood of a damaging earthquake occurring west of the Rocky Mountains, and particularly in California, the states of Oregon and Washington, and Salt Lake City, is much greater than it is in the East, Midwest, or South. However, the New Madrid, Missouri, and Charleston, South Carolina, regions are subject to the possibility of severe earthquakes, although with a lesser probability than the western U.S.

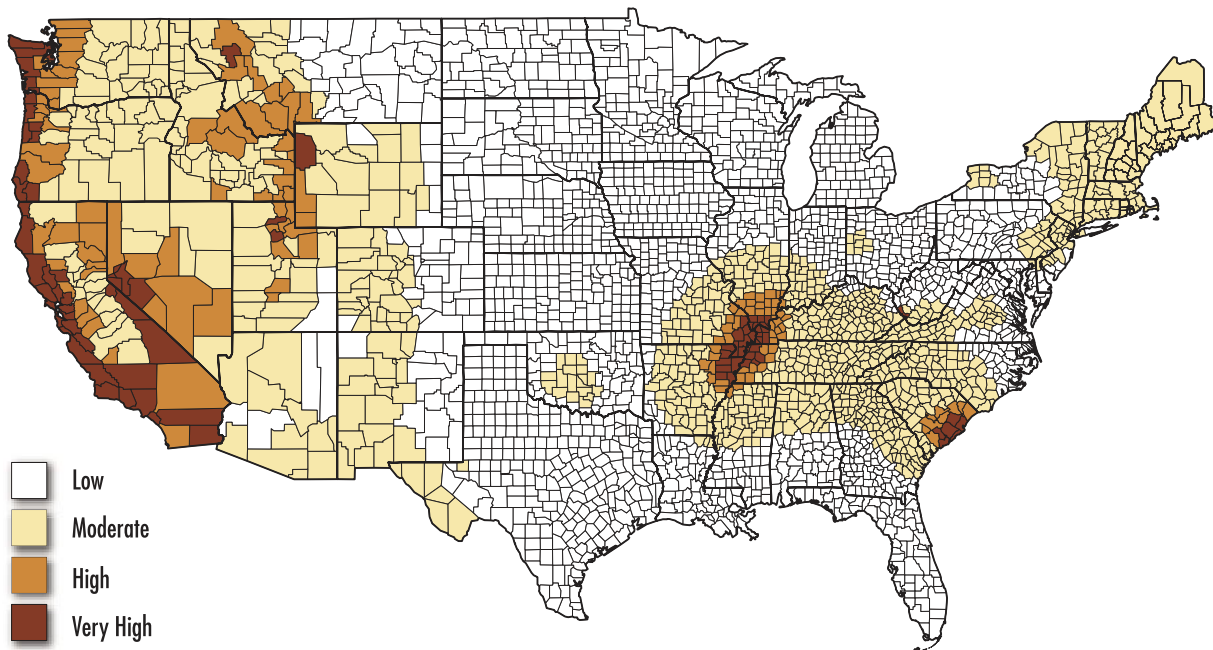

Figure 4-2 Map of the continental United States that shows counties and probabilities of earthquakes of varying magnitude

SOURCE: USGS

There are several common measures of earthquakes. Perhaps the most familiar is the Richter Magnitude, devised by Professor Charles Richter of the California Institute of Technology in 1935. Richter's scale is based on the maximum amplitude of certain seismic waves recorded on a standard seismograph at a distance of 100 kilometers (km) from the earthquake epicenter. Because the instruments are unlikely to be exactly 100 km from the source, Richter devised a method to allow for the diminishing of wave amplitude with increased distance. The Richter scale is logarithmic, and each unit of magnitude indicates a ten-fold increase in wave amplitude. The energy increase represented by each unit of scale is approximately 31 times. The scale is open-ended, but a magnitude of about 9.5 represents the largest possible earthquake.

Table 4-1 shows significant earthquakes (Magnitude 6 or over) that occurred in 47 of the 50 U.S. states between 1568 and 1989.

Table 4-1: Known Historic (1568-1989) Earthquakes in 47 U.S. States

Number of Quakes with Reported Maximum Modified Mercali Intensity (MMI) of:			
State	VI	VII	VII+
Alabama	5	7	—
Alaska	41	21	13
Arizona	11	3	1
Arkansas	8	3	2
California	329	131	66
Colorado	19	1	—
Connecticut	2	1	—
Delaware	—	1	—
Florida	2	—	—
Georgia	5	—	—
Hawaii	30	13	10
Idaho	12	4	2
Illinois	18	12	—
Indiana	5	2	—
Kansas	4	2	—
Kentucky	8	1	—
Louisiana	1	—	—
Maine	7	2	—
Massachusetts	8	7	3
Michigan	1	1	1
Minnesota	3	—	—
Mississippi	2	—	—
Missouri	14	2	3
Montana	35	4	5
Nebraska	4	2	—
Nevada	28	10	8
New Hampshire	7	2	—
New Jersey	5	1	—
New Mexico	29	10	8
New York	16	6	2
North Carolina	5	2	—
North Dakota	1	—	—
Ohio	9	5	1

Table 4-1: Known Historic (1568-1989) Earthquakes in 47 U.S. States (continued)

State	Number of Quakes with Reported Maximum Modified Mercalli Intensity (MMI) of:		
	VI	VII	VII+
Oklahoma	9	2	—
Oregon	10	1	—
Pennsylvania	7	1	—
Rhode Island	1	—	—
South Carolina	17	2	1
South Dakota	6	—	—
Tennessee	12	2	—
Texas	7	1	—
Utah	31	8	5
Vermont	1	—	—
Virginia	12	1	1
Washington	37	6	3
West Virginia	1	—	—
Wyoming	8	1	—

SOURCE: U.S. GEOLOGICAL SURVEY, PROFESSIONAL PAPER 1527, 1993

NOTE: This list includes only earthquakes that affected human settlements.

Records show that some seismic zones in the United States experience moderate to major earthquakes approximately every 50 to 70 years, while other areas have “recurrence intervals” for the same size earthquake of about 200 to 400 years. These frequencies of occurrence are simply statistical probabilities and one or several earthquakes could occur in a much shorter than average period. With current knowledge, there is no practical alternative for those responsible for schools located in earthquake-prone regions but for them to assume that a large earthquake is likely to occur at any time and that appropriate action should be taken.

Moderate and even very large earthquakes are inevitable, although very infrequent, in areas of normally low seismicity. Consequently, in these regions, buildings are very seldom designed

to deal with an earthquake threat; therefore, they are extremely vulnerable. In other places, however, the earthquake threat is quite familiar. Schools in many areas of California and Alaska will be shaken by an earthquake perhaps two or three times a year and some level of “earthquake-resistant” design has been accepted as a way of life since the early 20th century.

Although, on a national basis, the areas where earthquakes are likely to occur and the potential size or “magnitude” of these earthquakes are well identified and scientists have a broad statistical knowledge of the likelihood of their occurrence, it is not yet possible to predict the near-term occurrence of a damaging earthquake. Therefore, lacking useful predictions, it makes sense in any seismic region to take at least the minimum affordable prudent actions directed at saving lives. Because most lives are lost in earthquakes when buildings collapse, U.S. seismic building code provisions focus on requiring that the minimum measures necessary to prevent building collapse are taken.

In California, schools are further protected by the Field Act of 1933, which mandated additional requirements relating to design qualifications, plan checking, and site inspection. (The Field Act is discussed in more detail in Section 4.3.2.)

The following graphics explain some earthquake terminology and characteristics of ground motion.

WHAT EARTHQUAKES DO

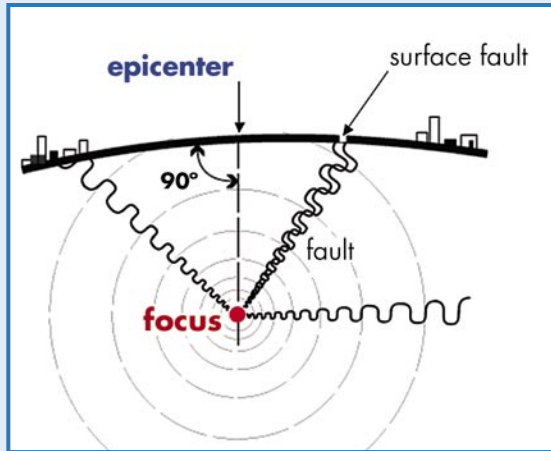

The Origin of Earthquakes

This diagram explains some of the common terms used in talking about earthquakes. Waves of vibration radiate out from the fault break.

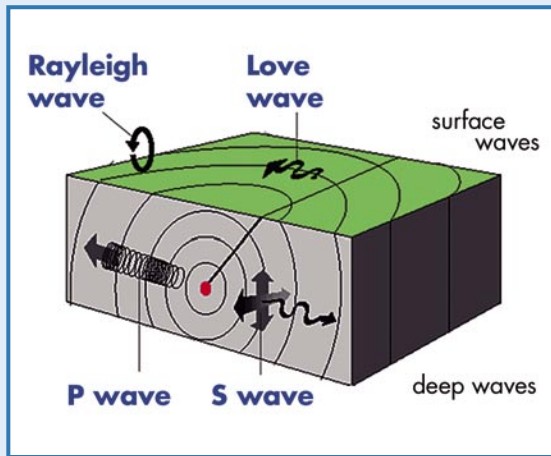

Types of Seismic Waves

Four main types of waves radiate from a fault break. The P or Primary wave, a back-and-forth motion, arrives first, followed by the S wave (secondary or shear) that is more of a rolling motion. These are deep waves that travel through the earth to the surface. The Love and Rayleigh waves, named after their discoverers, travel along the earth's surface.



Motion at Site

Scratch left on a floor by a kitchen range in the 1933 Long Beach earthquake that shows the random nature of earthquake motion.

ACCELERATION FORCES

... NEWTON'S SECOND LAW OF MOTION

$$F = MA$$

force

mass

acceleration



NEWTON'S APPLE

acceleration is measured in "gs".

one **g** is the acceleration due to gravity

1.0 g = 32 feet/second

Forces and Gravity

Because ground motion waves produce inertial forces within structures, these forces obey Newton's Second Law of Motion. This fundamental equation establishes the forces for which buildings must be designed to resist earthquakes.

Acceleration

The acceleration, or the rate of change of the velocity of the waves that set the building in motion, is used in an equation, derived from Newton's Second Law of Motion to estimate the percentage of the building mass or weight that must be dealt with as a horizontal force.



one "g" parachute team



four "g" roller coaster



nine "g" airforce display team



0.0001 "g" human perception

Acceleration

Some common examples of acceleration. The skydivers are falling under the action of gravity, 1g.

PERIOD AND RESONANCE

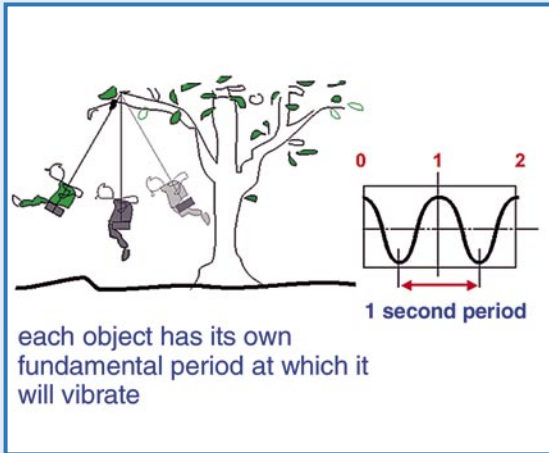

Fundamental Period and Resonance

Every object has a fundamental period at which it vibrates if it is set in motion. It cannot vibrate at another period unless it is dragged back and forth. The ground also has a fundamental period. If an object is set in motion by an external force such as ground shaking, which is at the fundamental period of the object, the result will be "resonance" and the motion of the object will tend to increase. When you push a child on a swing, you instinctively give it a push at its fundamental period, which results in an enjoyable increase in the motion with very little force applied.

Similarly, if the ground pushes a building with the same period as the motion, the accelerations in the building will increase, perhaps four or five times.

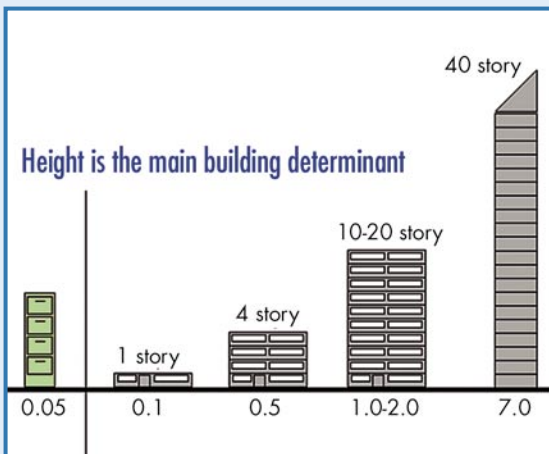

Fundamental Period in Seconds

This shows typical periods for structures. The main determinant of period is building height and proportion; thus, a tall slender object will have a long period and sway back and forth quite slowly. So the 40-story building will sway gently back and forth once every 7 seconds.

SOURCE: BSSC: PRESENTATIONS TO THE ARCHITECTURAL COMMUNITY, 2001, CHRIS ARNOLD AND TONY ALEXANDER

4.2.3 Determination of Local Earthquake Hazards

Until quite recently, the United States was divided into a number of seismic zones, which were shown on the maps in the model codes. Zones ranged from Zone 0 (indicating no seismicity) to Zones 1, 2A, 2B, 3, and 4. Zone 4 indicates the highest level of seismicity (see Figure 4-3; only Zones 0, 1, 2A, and 3 are shown). Each zone was allocated a factor, or coefficient, from 0.075 to 0.40; this value was a multiplier representing the acceleration value for which the building was to be designed. These values indicate a four-fold range in acceleration values between Zones 1 and 4. Within a zone, all buildings must be designed to the same acceleration value (or greater); contour lines show the boundaries between zones.

Current codes, such as the International Building Code, define site seismicity in a different way. The United States is still divided into zones by contour lines, but their areas are much smaller. Numerical values are also shown on the maps and also represent the acceleration value to be used for design, but they are calculated in a different way, and many more values are shown that reflect greater precision of knowledge. Also, acceleration values for both long and short period buildings are shown in a separate series of maps. Figure 4-4 shows a portion of the earthquake ground motion map in the International Building Code 2003 corresponding to the region shown in Figure 4-3. The simplicity of the old seismic zones is lost, but the design information is much more detailed.

If the school district or community desires to obtain more detailed information on the seismic hazard than is shown on the code maps, or if the location does not enforce a seismic code, but there is concern about seismicity, the U.S. Geological Survey (USGS) web page at www.USGS.gov, Earthquake Hazards Program, is an excellent resource. The USGS provides more detailed earthquake hazard maps for general regions such as the Western, Central, and Eastern U.S.

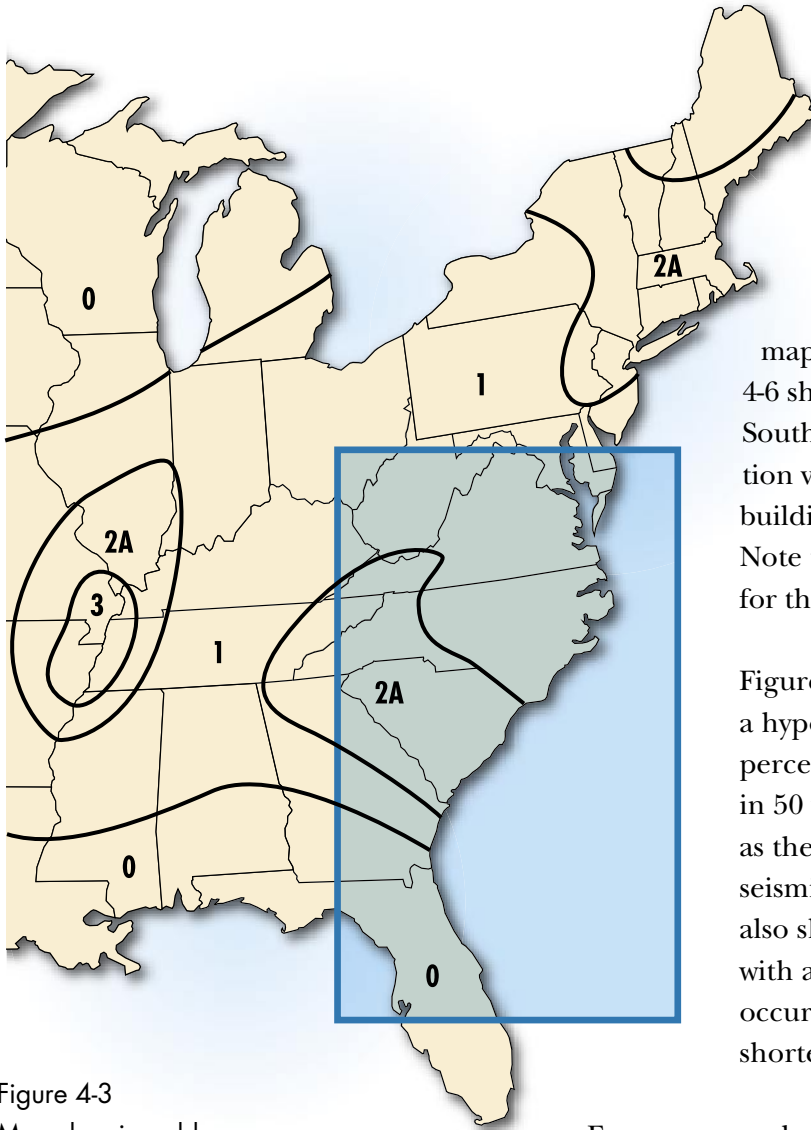

Figure 4-3
Map showing older seismic zones in part of the United States, from the 1997 Uniform Building Code. The area in the box corresponds to the area in Figure 4-4.

SOURCE: INTERNATIONAL CONFERENCE OF BUILDING OFFICIALS, WHITTIER, CA

Figure 4-5 shows a comparison between the Southeast U.S. and California. The larger acceleration values for the latter are symbolized by the darker colors. These maps are used as the basis for the maps shown in the IBC. Figure 4-6 shows a comparison, for the Southeast U.S., between acceleration values for a 1.0-second period building and a 0.2-second building. Note the larger acceleration values for the shorter period building.

Figures 4-5 and 4-6 show values for a hypothetical earthquake with a 2-percent probability of exceedance in 50 years. This can be visualized as the odds of occurrence. The seismic code section of the IBC also shows values for earthquakes with a 10-percent probability of occurrence in 50 years (i.e., much shorter odds).

For even more localized information, the USGS provides seismicity information for any location in the United States on the basis of latitude and longitude, or Zip Code. This information can be obtained by opening the Seismic Hazard listings on the USGS web page, and opening Hazards by Latitude and Longitude, or Hazards by Zip Code. These listings show information on the expected maximum shaking that is estimated for the location. The information and terminology are quite technical and may need to be interpreted by qualified staff at the responsible local code office, a structural engineer, or perhaps a knowledgeable seismic professional.

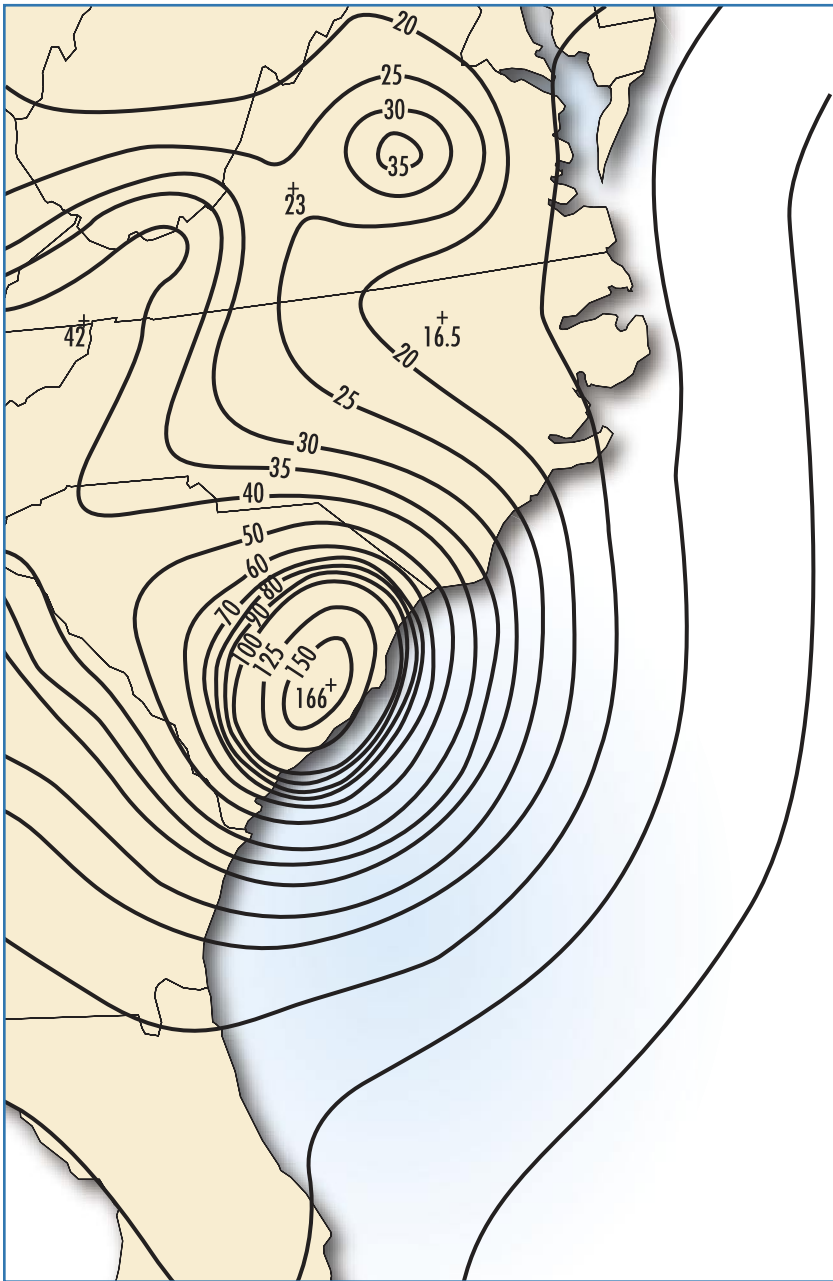

Figure 4-4
 Portion of an earthquake ground motion map used in the International Building Code 2003 that shows contours that identify regions of similar spectral response accelerations to be used for seismic design. Spectral response acceleration includes both ground acceleration and effect of building period. This area corresponds to the area in the box in Figure 4-3. Many more acceleration values are shown in the newer map.

SOURCE: USGS/BSSC PROJECT 97 BY BUILDING SEISMIC SAFETY COUNCIL, FEDERAL EMERGENCY MANAGEMENT AGENCY

0.2 sec Spectral Acceleration (%g) with 2% Probability of Exceedance in 50 Years

site: NEHRP B-C boundary

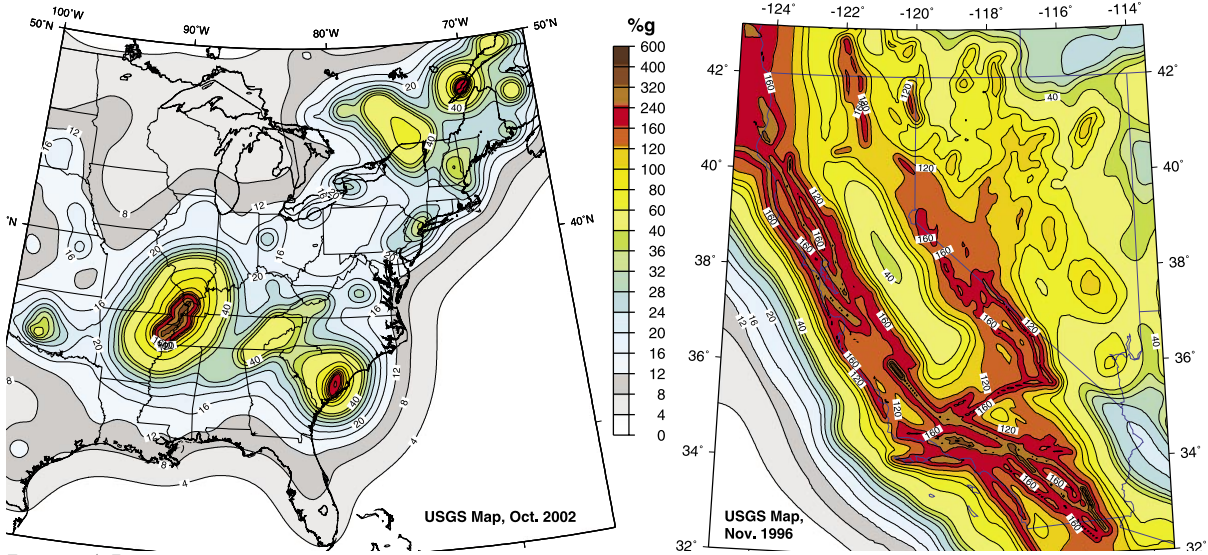

Figure 4-5

These maps compare the seismicity of the Southeast U.S. and California. The larger acceleration values for the latter are symbolized by the darker colors.

SOURCE: USGS

1.0 sec Spectral Acceleration (%g) with 2% Probability of Exceedance in 50 Years

site: NEHRP B-C boundary

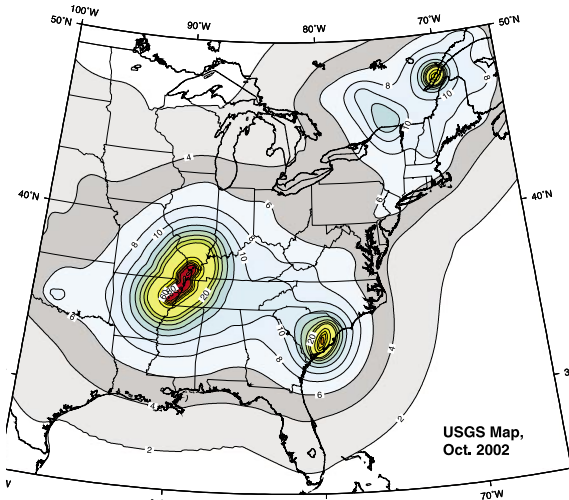

0.2 sec Spectral Acceleration (%g) with 2% Probability of Exceedance in 50 Years

site: NEHRP B-C boundary

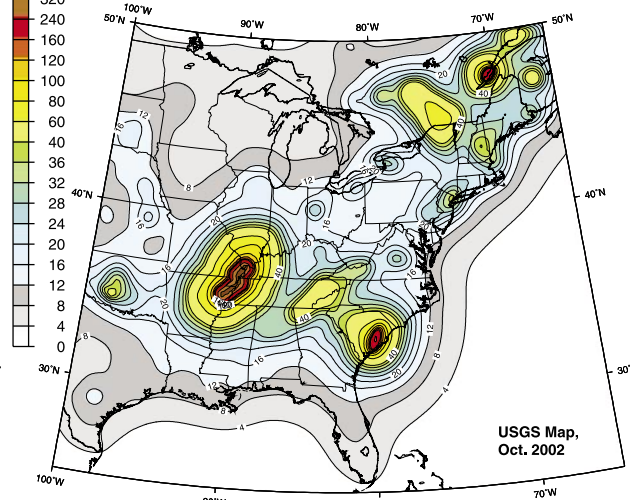

Figure 4-6

These maps show a comparison for the Southeast U.S. between the acceleration values for a 1-second (long) and a 0.2-second (short) building period.

SOURCE: USGS

4.3 VULNERABILITY: WHAT EARTHQUAKES CAN DO TO SCHOOLS

This section reviews the experience of schools in earthquakes. Much of the information presented comes from California, because of the prevalence of earthquakes in that state. In general, the seismic performance of newer buildings has been good, although considerable costly and dangerous nonstructural damage still occurs. California public school design and construction has been subject to strict regulation since 1933 which undoubtedly contributes to good performance. Many of the damage examples shown in this section are of older buildings: this is relevant because schools are long-lived buildings and many schools constructed in the early decades of the 20th century are still in use.

4.3.1 Vulnerability of Schools

Older unreinforced masonry school buildings present a very high risk, and this type of structure has been prohibited by law in California since the mid-1930s, following severe damage to schools of this type in the 1933 Long Beach earthquake.

A structural type that poses perhaps an even greater risk than unreinforced masonry is that of the mid-rise nonductile reinforced concrete frame. “Nonductile” refers to the frame’s lack of ductility (flexibility), or ability to deform considerably before breaking (see Figure 4-7).

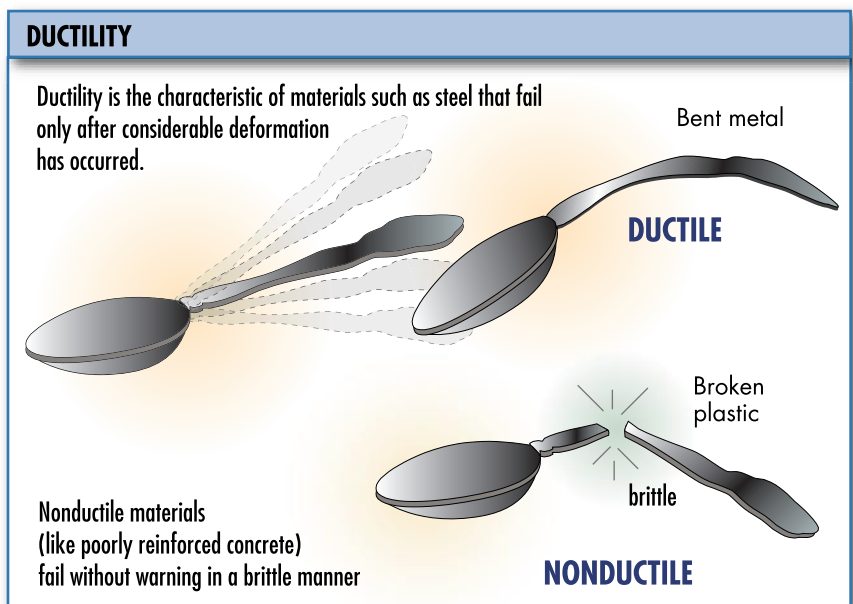

Figure 4-7 Ductility

SOURCE: BSSC: PRESENTATIONS TO THE ARCHITECTURAL COMMUNITY, 2001, CHRIS ARNOLD AND TONY ALEXANDER

Reinforced concrete frames are made ductile by introducing an appropriate, code-specified amount of specifically designed steel reinforcing; unfortunately, the need for this was not recognized in seismic codes until the mid-1970s and so a large inventory of these types of structure exists (see Figure 4-8).

Figure 4-8
Collapse of portion of
nonductile concrete frame
school structure, Helena,
MT, 1935

SOURCE: NATIONAL INFORMATION
SERVICE FOR EARTHQUAKE
ENGINEERING, UNIVERSITY OF
CALIFORNIA, BERKELEY



Wood frame structures perform effectively, provided that they are well constructed, particularly with respect to correct nailing of shear walls as specified in the code and properly detailed roof-to-wall connections. Good maintenance, ensuring continued protection against moisture and wood attacking insects, is also critical for wood frames.

Newer structures, employing frames and fewer walls, also perform effectively if well designed and constructed; however, their response differs from that of shear wall structures, which are stiff and resistant to lateral forces. Frame structures are more flexible, which reduces the forces on the structural members and enables a light and safe structure to be designed.

Modular classrooms are liable to topple off their foundations unless securely attached and braced. This damage is not life-threatening, but makes the building unusable; fractured power, gas, and waste lines may be a hazard (see Figure 4-9).



Figure 4-9
Modular classrooms
pushed off their
foundations; note stairs
at left, Northridge, CA,
1994.

SOURCE: GARY MCGAVIN,
REDLANDS, CA

If long-span roof and floor members are employed, however, there may be excessive drift, or sway, which causes damage to nonstructural components such as hung ceilings, light fixtures, light partitions, and contents. Piping, ductwork, electrical conduits, and communication pathways (cable trays) may also be damaged. Storage units, filing cabinets, and library shelving in any type of structure may be hazardous if not properly braced (see Figure 4-10). Broken pipes can create an additional hazard in the form of flooding, lack of fire protection water, and, with heating piping or domestic hot water piping, this could result in a flood of hot water.

School occupants are particularly vulnerable to nonstructural damage. Although students and staff may duck under desks and be safe from falling objects such as lighting fixtures and ceiling tiles, ceiling components that fall in hallways and stairs can make movement difficult, particularly if combined with power failure and loss of lights. Additional falling



Figure 4-10
Fallen filing cabinets and shelves, Northridge,
CA, 1994

SOURCE: GARY MCGAVIN, REDLANDS, CA

hazards that are common in schools are large wall-mounted televisions (TVs) or ceiling mounted liquid crystal display (LCD) projectors. Heavy equipment can be hazardous and falling debris can also cause panic (see Figure 4-11).

Figure 4-11
Fallen shop equipment,
Coalinga, CA, 1983

SOURCE: GARY MCGAVIN,
REDLANDS, CA

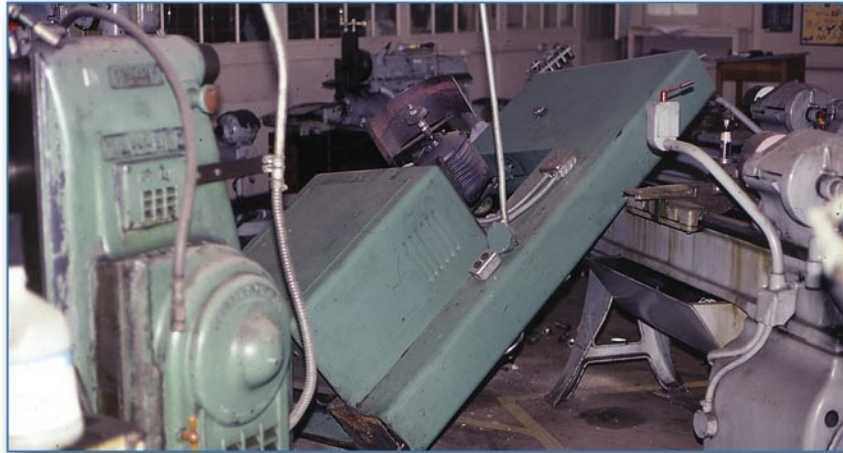

Pendant light fixtures have sometimes fallen if they are insecurely attached and not designed to swing freely (see Figure 4-12). Sudden breakage of large glass areas is a specific hazard because of the dense occupancy in many school rooms; design of glazing to resist wind-borne debris and physical attack may also assist in protecting it from earthquake motion. This kind of damage has been significant in California schools that have suffered recent earthquakes.

Heavy hung lath and plaster ceilings in older auditoriums (and assembly buildings) can be dangerous and need careful inspection of their attachment and materials. If deficient in safety, replacement is the only acceptable solution (see Figure 4-13).



Figure 4-12
Fallen light fixtures, library, Coalinga, CA, 1983
SOURCE: GARY MCGAVIN, REDLANDS, CA



Figure 4-13
Fallen heavy lath and
plaster ceiling across
auditorium seating,
Northridge, CA, 1994
SOURCE: GARY MCGAVIN,
REDLANDS, CA

4.3.2 Earthquake Damage to Schools

Most information on earthquake damage to schools comes from California. Its high incidence of earthquake activity has also resulted in sophisticated seismic building codes for all buildings and special plan checking and inspection requirements, enforced by the state, for school buildings.

Considering the number of significant earthquakes in California since the early years of the 20th century, there has been remarkably little severe structural damage to schools, except in the Long Beach earthquake of 1933, and there have been very few casualties. In California, no school child has been killed or seriously injured since 1933. This good fortune has been primarily because all major California earthquakes since 1925 have occurred outside school hours (see Figure 4-14).

Figure 4-14
Damage to the John Muir
School, Long Beach, CA,
1933

SOURCE: NATIONAL INFORMATION
SERVICE FOR EARTHQUAKE
ENGINEERING, UNIVERSITY OF
CALIFORNIA, BERKELEY



In the Long Beach earthquake that occurred at 5:55 p.m. on March 10, 1933, damage to unreinforced masonry school buildings was so severe that there would have been many casualties had they been occupied. As a result, the state passed the Field Act within a month of the earthquake (see Figures 4-15 and 4-16).



Figure 4-15
Damage to shop building,
Compton Junior High
School, Long Beach, CA,
1933

SOURCE: NATIONAL INFORMATION
SERVICE FOR EARTHQUAKE
ENGINEERING, UNIVERSITY OF
CALIFORNIA, BERKELEY



Figure 4-16
A dangerous passage way between two
buildings, Polytechnic High School, Long
Beach, CA, 1933

SOURCE: NATIONAL INFORMATION SERVICE FOR
EARTHQUAKE ENGINEERING, UNIVERSITY OF
CALIFORNIA, BERKELEY

The Field Act required that all public school buildings be designed by a California licensed architect or structural engineer; all plans were to be checked by the then Department of General Services and construction was to be continuously inspected by qualified independent inspectors retained by the local school board. The Department of General Services set up a special division, staffed by structural engineers, to administer the provisions of the Act. The Field Act, which is still enforced today, has greatly reduced structural damage to California schools.

The earthquake also resulted in the passage of the Riley Act, which governed all buildings, with a few exceptions. The Riley Act required all buildings in the state to be designed to a specified lateral force, and effectively outlawed unreinforced masonry construction.

In 1952, a series of earthquakes occurred in Kern County, in the Bakersfield region, some 70 miles north of Los Angeles. Two groups of earthquakes occurred; the first, in the last week of July, included one with a magnitude of 7.6 on the Richter scale. The second group occurred in late August, and one earthquake, near the city of Bakersfield, had a magnitude of 5.9 on the Richter scale. There were 10 deaths in the July earthquake and 2 in the August earthquake.

This earthquake was of particular interest because the incidence of school damage might represent that of comparable earthquakes striking in regions today where seismic codes have not been adopted and enforced due to the rarity of seismic events (see Figures 4-17, 4-18, and 4-19).

There were no casualties in schools in 1952, because these earthquakes also occurred outside school hours. At that time, the Field Act had been in force for nearly 20 years, and the newer schools had been constructed to conform to its requirements. Of the 58 masonry schools in the region, 18 had been constructed after the Field Act. Of these, one suffered moderate damage; this school was constructed of grouted reinforced brick masonry and in-



Figure 4-17
A heavy corridor lintel
ready to fall, Emerson
School, Bakersfield, Kern
County, CA, 1952

SOURCE: NATIONAL INFORMATION
SERVICE FOR EARTHQUAKE
ENGINEERING, UNIVERSITY OF
CALIFORNIA, BERKELEY



Figure 4-18
Overturned shop equipment and failed
light fixtures, Kern County, CA, 1952

SOURCE: NATIONAL INFORMATION SERVICE FOR
EARTHQUAKE ENGINEERING, UNIVERSITY OF
CALIFORNIA, BERKELEY

Figure 4-19
Destroyed exit corridor,
Bakersfield, Kern County,
CA, 1952

SOURCE: NATIONAL INFORMATION
SERVICE FOR EARTHQUAKE
ENGINEERING, UNIVERSITY OF
CALIFORNIA, BERKELEY



curred approximately 1 percent damage. Of the 40 non-Field Act schools, 1 collapsed, 15 suffered severe damage, and 14 suffered moderate damage. In the Bakersfield City School District, 175 classrooms and 6,500 students were displaced and only about 10 classrooms could quickly be put back in service. There was considerable nonstructural damage to ceilings and light fixtures.

In other states, similar damage to unreinforced masonry (URM) and early reinforced concrete structures occurred. Considerable damage to schools occurred in Helena, Montana, in 1935 (see Figure 4-20). In 1949, severe damage was inflicted on several URM schools, resulting in one fatality, in Seattle (see Figures 4-21 and 4-22). At Puyallup High School, three boys on the stage just managed to escape when the roof collapsed (see Figure 4-23). Widespread damage to furniture and contents also occurred (see Figure 4-24).



Figure 4-20
Typical school damage,
Helena, MT, 1935

SOURCE: NATIONAL INFORMATION
SERVICE FOR EARTHQUAKE
ENGINEERING, UNIVERSITY OF
CALIFORNIA, BERKELEY



Figure 4-21
The student body president was killed here by
falling brickwork, Seattle, WA, 1949.

SOURCE: EARTHQUAKE ENGINEERING RESEARCH INSTITUTE,
OAKLAND, CA. PHOTO FROM A.E. MILLER COLLECTION,
UNIVERSITY OF WASHINGTON ARCHIVES

Figure 4-22
Another dangerous entry
collapse, Seattle, WA,
1949

SOURCE: EARTHQUAKE
ENGINEERING RESEARCH
INSTITUTE, OAKLAND, CA. PHOTO
FROM SEATTLE SCHOOL ARCHIVES



Figure 4-23
Collapse of roof over stage, Seattle, WA,
1949

SOURCE: NATIONAL INFORMATION SERVICE FOR
EARTHQUAKE ENGINEERING, UNIVERSITY OF CALIFORNIA,
BERKELEY





Figure 4-24
Damage to library shelving,
Seattle, WA, 1949

SOURCE: NATIONAL INFORMATION
SERVICE FOR EARTHQUAKE
ENGINEERING, UNIVERSITY OF
CALIFORNIA, BERKELEY

4.3.3 Significant School Damage in Recent U.S. Earthquakes

In the Anchorage, Alaska, earthquake of 1964, which registered 8.4 on the Richter scale, a number of public schools were damaged, but there were no collapses. The earthquake occurred on Good Friday at 5:36 p.m., when the schools were unoccupied. The most seriously damaged school was that shown previously in Figure 4-1; the school was subsequently demolished. At the West Anchorage High School (see Figures 4-25 and 4-26), a two-story nonductile concrete frame and shear wall classroom wing suffered severe structural damage and near total failure in a number of columns. Structural distortion also created a number of severe glass breakages. The second floor was removed during reconstruction and the first floor was repaired and retained.

In the San Fernando, CA, earthquake of 1971, there were no injuries and no schools collapsed; however, the earthquake caused \$13.2 million in damages (in 1971 dollars), and 100 pre-Field Act schools were demolished within 1½ years after the earthquake.

Figure 4-25
Severe structural damage to
the West Anchorage High
School, Anchorage, AK,
1964

SOURCE: NATIONAL INFORMATION
SERVICE FOR EARTHQUAKE
ENGINEERING, UNIVERSITY OF
CALIFORNIA, BERKELEY



Figure 4-26
Brittle failure at nonductile concrete column,
West Anchorage High School, 1964

SOURCE: NATIONAL INFORMATION SERVICE FOR
EARTHQUAKE ENGINEERING, UNIVERSITY OF CALIFORNIA,
BERKELEY



A survey of 1,544 public school buildings showed that only three schools sustained severe damage as a result of the Loma Prieta (San Francisco Bay area) earthquake of 1989. A portable classroom near Santa Cruz was rocked off its unbraced and unanchored supports. An elementary school in Los Gatos was subjected to severe shaking, but damage was limited to non-structural and contents shifting, except in one classroom wing, where ground heaving raised and cracked the floor slab, jamming a door and window shut.

A San Francisco High School suffered severe structural cracking. This school was constructed in 1920 as an automobile manufacturing building and was structurally upgraded in 1947. Restoration costs were estimated at \$10 million. Total restorations for the San Francisco school district were estimated to be \$30 million; for Oakland, the district losses were \$1.5 million. Though undamaged, an elementary school in San Francisco was closed because of the potential collapse of a nearby elevated freeway structure, which was considered a hazard to the building and its occupants. Hazards from unbraced and unanchored nonstructural items were evident in many buildings, including pendant-mounted light fixtures, suspended acoustical ceilings, and unanchored furniture and contents such as filing cabinets and shelving.

In the Northridge, California, earthquake of 1994, state inspectors red-tagged 24 school buildings and yellow-tagged 82 school buildings, although this was later considered

TAGGING

A post-earthquake evaluation procedure has been developed in California that employs colored placards, or "tags," affixed to buildings, that show that the building has been inspected and indicate the level of safety. The colors of the tags and their safety level classification follow:



A red tag indicates **UNSAFE**: Extreme hazard, may collapse. Imminent danger of collapse from an aftershock. Unsafe for occupancy or entry, except by authorities.



A yellow tag indicates **LIMITED ENTRY**: Dangerous condition believed to be present. Entry by owner permitted only for emergency purposes and only at own risk. No usage on continuous basis. Entry by public not permitted. Possible major aftershock hazard.



A green tag indicates **INSPECTED**: No apparent hazard found, although repairs may be required. Original lateral load capacity not significantly decreased. No restriction on use or occupancy.

over-conservative. No structural elements collapsed. There was, however, considerable nonstructural damage that was costly to repair, resulting in the closure of a number of schools and, if the schools had been in session, would have caused casualties. The Field Act focused on structural design and construction, and only recently were nonstructural elements included in the scope of the Act (see Figures 4-27, 4-28, and 4-29).

Figure 4-27
Ceiling damage,
Northridge, CA, 1994

SOURCE: GARY MCGAVIN,
REDLANDS, CA





Figure 4-28
Damage to ceramic kiln, including fractured gas
line, Northridge, CA, 1994

SOURCE: GARY MCGAVIN, REDLANDS, CA



Figure 4-29
Line of suspended light
fixtures fallen on teacher's
station, Northridge, CA,
1994

SOURCE: EARTHQUAKE
ENGINEERING RESEARCH INSTITUTE,
OAKLAND, CA, AND GARY
MCGAVIN, REDLANDS, CA

4.3.4 Consequences: Casualties, Financial Loss, and Operational Disruption

Casualties in California schools have been few and minor, primarily due to regulation by the Field Act and by chance. Significant Alaskan and California earthquakes, from Santa Barbara (1925) to Northridge (1984) have all occurred outside of school hours: therefore, the effects of a major earthquake when schools are fully occupied have not been experienced. In other regions, casualties have been few; in the Seattle earthquake of 1949, two school children died in Tacoma when bricks cascaded onto exit ways. The closure of Seattle schools for spring vacation had averted fatalities and serious injuries in similar building failures at a number of sites in the city.

The impact of school closure as a result of damage is the loss of public service and severe disruption for students, faculty, and staff. Ultimately, the taxpayer will pay the costs, but this is spread over the whole community, the state, and the Federal Government. Typically, schools are self-insured and do not purchase insurance on the private market. For a private school, closure means a serious loss of revenue; in addition to the costs of repair, the students may not return if the school is closed for a long period of time. Therefore, obtaining insurance may be a prudent measure.

As with any of the natural hazards reviewed in this manual, an earthquake can close a school, keeping the school district from doing its main job (i.e., teaching students). The length of the closure will depend on the severity and types of damage. It may also depend on whether the building was fully insured or whether disaster assistance will be available quickly enough to allow speedy repairs and reconstruction. Sometimes repairs are put on hold, pending a decision on whether the building should be repaired or condemned.

There are also social and psychological factors, such as difficulties imposed on students, parents, faculty, staff, and the administration during the time the school is not usable. This is illustrated by the following quotation that, although it refers directly to hurricanes, also applies to earthquakes and other disasters.

- “From the standpoint of children and families, after an impact is a particularly bad time for schools to be closed. Damaged homes and neighborhoods are dangerous and depressing places. Children are often left with no safe place to play when yards, playgrounds and recreational programs are lost, no one to play with when playmates and friends are forced to dislocate and parents are too busy dealing with survival and rebuilding issues to have much time for them.”
- “The closing of a local school is highly disruptive to social networks and, if it becomes permanent, can rob a neighborhood of its identity and cohesion. One of the most dramatic effects that can occur to a severely impacted community is when a school is closed for a long time, maybe even permanently, due to regional depopulation after homes are destroyed.”
- “Getting schools reopened quickly has been found to be an important step toward rebuilding the community as a whole.”
- “An understudied area is the long-term effect of major disasters on the education and development of children.”
- “The shock of being uprooted and moved to a new school, even temporarily, can be very difficult for children. The effects can be particularly traumatic if they occur at a critical developmental time, such as the senior year with its preparation for college and graduation festivities.”

SOURCE: THE HEINZ CENTER, *HUMAN LINKS TO COASTAL DISASTERS*, H. JOHN HEINZ III CENTER FOR SCIENCE, ECONOMICS AND THE ENVIRONMENT, WASHINGTON, DC, 2002

4.4 SCOPE, EFFECTIVENESS, AND LIMITATIONS OF CODES

Building design in the United States has typically been regulated by the provisions of one of three model building codes: the National Building Code (NBC), published by Building Officials and Code Administrators International (BOCA); the Standard Building Code (SBC), published by Southern Building Code Congress International (SBCCI); and the Uniform Building Code (UBC), published by International Conference of Building Officials (ICBO). The UBC tended to be most commonly adopted in the Western U.S., the NBC was used predominantly in the Northeast and Midwest, and the SBC was most commonly used in the South and Southeast.

4.4.1 The Background of Seismic Codes

Seismic codes currently in use in the United States have been very highly developed since the initial regulations for the protection of buildings against earthquakes first appeared in the UBC in California in 1927. Beginning in the 1950s, the earthquake-resistant design provisions of the three model codes used as the basis for building regulation in the U.S. were based on recommendations developed by the seismology committee of the Structural Engineers Association of California (SEAOC) and contained in their publication known as the “*Blue Book*.”

FEMA, one of the lead agencies in NEHRP, provided support for updating and continued development of a seminal document, ATC-3-06, produced by the Applied Technology Council (ATC), a non-profit research foundation set up after the San Fernando earthquake of 1978 to work on recommended improvements in the seismic building code. The ATC-3-06 document, now titled the *NEHRP Recommended Provisions for Seismic Regulations for New Buildings and Other Structures*, has been updated every 3 years since 1985. These provisions were adopted by the SBC in 1992 and, in 1997, the seismic provisions of the UBC and NEHRP were combined.

Depending on which code regulated the structural design, seismic design was conducted in accordance with one of two significantly different sets of provisions. Seismic design of structures under the UBC is governed by provisions developed by the SEAOC and structures designed under the NBC and the SBC are governed by somewhat different provisions developed by the Building Seismic Safety Council (BSSC) of the National Institute of Building Sciences (NIBS). Following a major effort by both groups, the 1997 editions of both the UBC and NEHRP *Provisions* resulted in a unification of these design approaches.

Meanwhile, after years of negotiation, all three model code entities have now consolidated their services, products, and operations into one member service operation, the International

Code Council. The ICC first published a unified model building code, the International Building Code (IBC) in 2000, with revisions planned on a 3-year basis. The seismic provisions of the IBC are based primarily on the unified UBC/NEHRP provisions. Subsequently, however, the National Fire Protection Association has also developed a model building code, the NFPA 5000, *Building Construction and Safety Code*, first issued in 2002. The American Society of Civil Engineers (ASCE) published ASCE 7 *Minimum Design Loads for Buildings and Other Structures*, which gives requirements for dead, live, soil, flood, wind, snow, rain, ice, and earthquake loads. ASCE 7 is referenced in the UBC, IBC, and NFPA model codes.

Thus the seismic codes are in a state of transition, and the intent of developing a single, nationally applicable model code has not yet been realized. Currently, jurisdictions are faced with continuing with one of the three original model codes, which will become increasingly out of date because they will no longer be revised and published, or adopting the IBC or NFPA 5000 model codes. Some large municipal jurisdictions will continue to produce their own codes, which will be derived from some combination of the model codes.

As noted above, seismic codes have the primary purpose of establishing the minimum lateral forces for which buildings must be designed. To do this, the code provides an equation, in which the vibrating seismic forces are represented by a single static force, called the “base shear,” applied at the base of a building. Variables in the equation enable the designer to adjust the design force for varying site seismicity, alternative soil conditions, different structural and nonstructural systems and materials, different building heights, and occupancies of varying importance.

In addition, the codes have a number of provisions that deal with the detailed design of some building components, such as reinforcing steel in concrete structures and welding in steel structures. Because the actual forces on the building are

estimated in a very simplified manner, a large safety factor is introduced, so that the design forces tend to be over-estimated.

4.4.2 Seismic Codes and Schools

Seismic codes are concerned primarily with types of structures and there are a few provisions that relate to specific occupancies. The IBC categorizes school buildings as Type II: "...buildings and other structures that represent a substantial hazard to human life in the event of failure..." Type II buildings are assigned an Importance Factor of 1.25. This means that the seismic force calculated by use of the Equivalent Lateral Force procedure would be multiplied by 1.25 so that schools are designed to a higher standard than ordinary buildings.

As previously mentioned, in California, K-12 schools are regulated by the Field Act, which is the only significant legislation that singles out the design and construction of schools to resist earthquakes and is an important model. However, the Field Act is not a code; it requires that schools be designed by a licensed architect or structural engineer, that plans and specifications be checked by a special office of the Department of the State Architect, and that independent testing and inspection be conducted during construction. The Greene/Garrison Act of 1976 made the Field Act provisions retroactive and required that all non-conforming schools be brought up to the current code level.

Implementing the nonstructural provisions of the seismic code will significantly reduce damage to the nonstructural components and reduce the possibility of closing the school because of ceiling and lighting damage, partition failures, and loss of essential utilities. In this instance, the code goes somewhat beyond the structural objective of only reducing the risk of casualties. However, this is an important issue for schools, for recent experience in earthquakes has shown that nonstructural damage to schools is dangerous to the occupants, costly to repair, and operationally disruptive.

4.4.3 The Effectiveness of Seismic Codes

Building codes originated in the effort to reduce risk to health and safety, rather than reducing property loss, but, as they evolved, they indirectly and directly assisted in reducing building damage. They establish the minimum standards for safety commensurate with affordability and other impacts such as measures that might create extreme inconvenience to occupants or seriously reduce the building's functional efficiency.

Among engineers, there is general agreement that, based on California's earthquake experience, regulation through a properly enforced seismic code has largely fulfilled the intent of ensuring an acceptable level of safety against death and injury. The performance of school buildings in recent California earthquakes substantiates this; structural damage has been minimal in the more recently designed schools. Application of the Field Act ensures that schools are designed and constructed to more rigorous standards than most other buildings.

Some qualifications, however, follow:

- Even in California, the standards of code enforcement vary considerably, and smaller jurisdictions may not have trained engineering staff to conduct effective plan checks and inspections.
- The nonstructural provisions of the seismic codes are often not adopted at the local level. Even in California, nonstructural components have not been regulated to the same level of care as structural components, and have been the cause of considerable economic loss and disruption of operation.
- In regions of moderate earthquake risk that have recently introduced seismic design regulation, the code may be misinterpreted and design errors made due to inexperience of both designers and building officials.

4.5 EVALUATING EXISTING SCHOOLS FOR SEISMIC RISK AND SPECIFIC RISK REDUCTION METHODS

A set of well developed procedures exists for the seismic evaluation of buildings, and a number of FEMA-sponsored publications are available to assist in the evaluation process. These guides have been developed since the 1980s and have been used extensively. However, this section also provides a simple seismic evaluation checklist that focuses specifically on schools.

The procedures are listed below in the order in which they would be used, starting with a simple screening process.

4.5.1 Rapid Visual Screening

The Rapid Screening Procedure (RSP) was published in FEMA 154, *Rapid Visual Screening of Buildings for Potential Seismic Hazards: a Handbook*. The procedure is intended as an initial step in identifying hazardous buildings and their deficiencies. Buildings identified by this procedure to be potentially hazardous must be examined in more detail by a professional engineer experienced in seismic design. Because this screening is aimed at providing a low cost method of identifying large inventories of potentially hazardous buildings for public and private owners, and thus reducing the number of buildings that should be subject to a more detailed evaluation, it is designed to be performed from the street without benefit of entry into a building.

The screening process can be completed in 20-30 minutes for each building. In some cases, hazardous details may not be visible, and seismically hazardous structures will not be identified as such. Nonstructural interior components are not evaluated. Conversely, buildings identified as potentially hazardous may prove to be adequate.

Typically, a school district will not be faced with the problem of lack of building access and the RSP procedure is most useful for

large school districts, municipalities, or even states that wish to get an economical preliminary evaluation of the seismic risks faced by their school inventory. The procedure is not intended to provide a definitive evaluation of the individual buildings.

The methodology is based on a visual survey of the building and a data collection form used to provide critical information. The collection form includes space for sketches and a photo of the building as well as pertinent earthquake-safety related data. The FEMA handbook for the procedure provides the inspector with background information and data required to complete the form (see Figure 4-30). The procedure is designed to be usable by people with some knowledge of buildings who are not necessarily professional architects or engineers or familiar with seismic design. It has been successfully applied by architectural and engineering students. The methodology enables the inspector to identify significant seismic-related defects and to arrive at a numerical score, with a hazard ranking of 1-6 (see Figure 4-30).

The ranking of surveyed buildings can be divided into two categories: those acceptable as to risk to life safety or those that may be seismically hazardous and should be studied further. A score of 2 is suggested as a “cut-off” based on current seismic knowledge (i.e., if a building has a structural “score” of 2 or less, it should be investigated by a structural engineer experienced in seismic design).

ATC-21/ (NEHRP Map Areas 5, 6, 7 High)		NUMBER <u>123</u>													
Rapid Visual Screening of Seismically Hazardous Buildings		NAME <u>EAST SANDY ELEMENTARY</u> ADDRESS <u>SANDY, UT</u> ZIP <u>84089</u> USE <u>SCHOOL</u> YEAR OCCUPIED <u>1969</u> NO. STORIES <u>1</u> U.B.C. YEAR <u>1967</u> TOTAL FLOOR AREA (sq. ft.) <u>60,540</u> INSPECTOR <u>J.M.</u> DATE <u>10/4/90</u>													
		SEISMIC RATING: GOOD <input checked="" type="checkbox"/> FAIR <input type="checkbox"/> POOR <input type="checkbox"/> VERY POOR <input type="checkbox"/>													
SCALE		COMMENTS: <u>ROOF DIAPHRAGM NOT CONNECTED TO WALLS AT JOIST BEARING ENDS (PERPENDICULAR TO JOISTS). DIAPHRAGM IS CONNECTED TO WALLS PARALLEL TO JOISTS. ROOF DECK WELDED AND BUTTON PUNCHED TO PROVIDE DIAPHRAGM.</u>													
PHOTO															
OCCUPANCY		STRUCTURAL SCORES AND MODIFIES													
Residential	No. Persons	BUILDING TYPE	W	S1	S2	S3	S4	C1	C2	CS/C5	PC1	PC2	RM	URM	
Commercial	0-10	Basic Score	4.5	4.5	3.0	5.5	3.5	2.0	3.0	1.5	2.0	1.5	3.0	1.0	
Office	11-100	High Rise	N/A	-2.0	-1.0	N/A	-1.0	-1.0	-1.0	-0.5	-N/A	-0.5	-1.0	-0.5	
Industrial	100+	Poor Condition	-0.5	-0.5	-0.5	-0.5	-0.5	-0.5	-0.5	-0.5	-0.5	-0.5	-0.5	-0.5	
Pub. Assem.		Vect. Irregularity	-0.5	-0.5	-0.5	-0.5	-0.5	-1.0	-0.5	-0.5	-1.0	-1.0	-0.5	-0.5	
School		Soft Story	-1.0	-2.5	-2.0	-1.0	-2.0	-2.0	-2.0	-1.0	-1.0	-2.0	-2.0	-1.0	
Govt. Bldg.		Torsion	-1.0	-2.0	-1.0	-1.0	-1.0	-1.0	-1.0	-1.0	-1.0	-1.0	-1.0	-1.0	
Emer. Serv.		Plan Irregularity	-1.0	-0.5	-0.5	-0.5	-0.5	-0.5	-0.5	-0.5	-1.0	-1.0	-1.0	-1.0	
Historic Bldg.		Pounding	N/A	-0.5	-0.5	N/A	-0.5	-0.5	N/A	N/A	N/A	-0.5	N/A	N/A	
Non Structural	<input type="checkbox"/>	Large Heavy Cladding	N/A	-2.0	N/A	N/A	N/A	-1.0	N/A	N/A	N/A	-1.0	N/A	N/A	
Falling Hazard		Short Columns	N/A	N/A	N/A	N/A	N/A	-1.0	-1.0	-1.0	-N/A	-1.0	N/A	N/A	
		Post Benchmark Year	+2.0	+2.0	+2.0	+2.0	+2.0	+2.0	+2.0	N/A	+2.0	+2.0	+2.0	N/A	
DATA CONFIDENCE		SL2	-0.3	-0.3	-0.3	-0.3	-0.3	-0.3	-0.3	-0.3	-0.3	-0.3	-0.3	-0.3	
* - Estimated, Subjective, or Unreliable Data		SL3	-0.6	-0.6	-0.6	-0.6	-0.6	-0.6	-0.6	-0.6	-0.6	-0.6	-0.6	-0.6	
DNK - Do Not Know		SL3 & 8 to 20 stories	N/A	-0.8	-0.8	N/A	-0.8	-0.8	-0.8	-0.8	N/A	-0.8	-0.8	-0.8	
		FINAL SCORE												3.0	
COMMENTS														Detailed Evaluation Required?	
														YES NO	

Figure 4-30 Example of rapid visual screening information form

SOURCE: JORDAN SCHOOL DISTRICT, SANDY, UT, RANDY HASLAM

4.5.2 Systems Checklist for School Seismic Safety Evaluation

Table 4-2 represents a simplified version of the FEMA 178/310 Evaluation Procedure; also see Section 4.5.3. This version focuses on structural and nonstructural systems and components that will be found in schools. The data are organized on a systems basis and are designed to establish whether the building is a potential seismic hazard and, if so, what its specific vulnerabilities are. Use of the checklist requires some seismic engineering knowledge, but the information can be obtained by inspection and no engineering calculations are necessary. The checklist can be used in conjunction with the RSP procedure, and will augment the RSP analysis because it assumes that the building will be accessible and design drawings are available. Both of these conditions are likely to be met in evaluating a public school building.

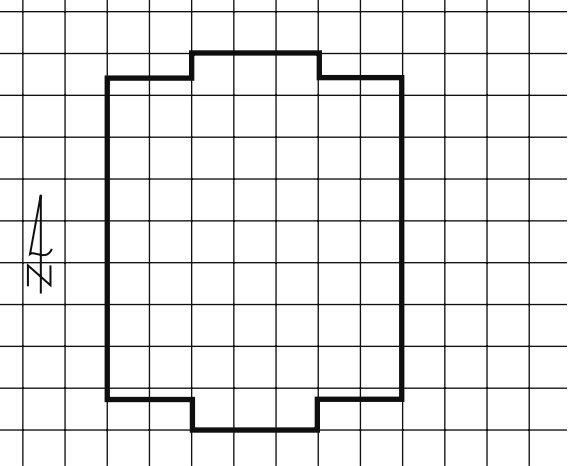
The checklist can also be useful in interdisciplinary discussions between consultants and school district personnel, and can assist in fee negotiation with the client.

Table 4-2: School Seismic Safety Evaluation Checklist

System Identifier	Evaluation Question	Evaluation Y or N or comment	Guidance	Data References
1	Site			
	Is there is an active fault on or adjacent to the site?		If suspected, site-specific geologic investigations should be performed.	Local building department, state geologist, local university, or local geotechnical consultant
	Does the site consist of stiff or dense soil or rock?		If softer soils that can lead to force amplification are suspected, site-specific geologic investigations should be performed.	Local building department, state geologist, local university, or local geotechnical consultant
	Are post-earthquake site egress and access secured?		Alternative routes, unlikely to be blocked by falling buildings, power lines, etc., are desirable.	Inspection by district personnel/architect
	Are utility and communications lifelines vulnerable to disruption and failure?		Security of the entire utility and communications network is the issue: the school may be impacted by off-site failures.	Inspection on site by district personnel and Mechanical/Electrical/Plumbing (M/E/P) consultants. For off site, contact local power and communications providers.
	Are there alternate or backup sources for vital utilities?		Increase the probability of the school remaining functional after an event, particularly if the school is used for post-earthquake shelter.	Inspection and district personnel, M/E/P consultants, and local utility suppliers
	Are building setbacks adequate to prevent battering from adjacent buildings?		Inadequate spaces between building walls may occur in dense urban settings.	FEMA 178, Section 3.4 FEMA 273, Section 2.11.10
	Is there adequate space on the site for a safe and "defensible" area of refuge from hazards for building occupants?		Outside spaces can be used as safe post-earthquake assembly areas for school occupants and possibly the community.	Inspection district personnel/architect/local emergency staff
2	Architectural			
	Configuration			
	Is the architectural/structural configuration regular?		Irregular vertical and horizontal configurations, such as re-entrant corners and soft first stories, may lead to significant stress concentrations.	FEMA 178, Section 3.7 FEMA 273, Section 2.7.1

Table 4-2: School Seismic Safety Evaluation Checklist (continued)

System Identifier	Evaluation Question	Evaluation Y or N or comment	Guidance	Data References
Planning and Function				
	Are exit routes, including stairs, protected from damage and clear from nonstructural elements or contents that might fall and block exit ways?		Schools sometimes have large unbraced lockers in hallways, or store other materials, such as tall filing cabinets or bookcases, that may block exits.	Inspection by district personnel FEMA 274, Section C11.94.4
Ceilings				
	Are light suspended grid ceilings braced and correctly attached at walls?		Grid ceilings easily distort (particularly in light and flexible frame structures), thus causing ceiling panels to fall.	FEMA 274, Section C11.9.4
	Are heavy plaster suspended ceilings securely supported and braced?		Heavy lath and plaster ceilings in older schools are very dangerous if poorly supported.	FEMA 274, Section C11.9.4.4
Partitions and Space Division				
	Are partitions that terminate at a hung ceiling braced to the structure above?		Partitions need support for out-of-plane forces and attachment to a suspended ceiling grid is inadequate.	FEMA 178, Section 10.5.2 FEMA 273, Section 11.9.2.4
	Are masonry or hollow tile partitions reinforced, particularly those surrounding exit stairs?		Heavy partitions attract strong earthquake forces because of their stiffness and mass, and are prone to damage. They are particularly dangerous around stairs and exit ways.	FEMA 273, Section 11.9.2.4
Other Elements				
	Are exterior entrance canopies and walkways engineered to ensure no collapse?		Post-earthquake safety of these structures is critical to ensure safe exiting after an event. Also, at certain times they may be used as gathering places and be densely occupied.	FEMA 273, Section 11.9.6
	Are parapets, appendages, etc., securely attached and braced to the building structure?		Unreinforced masonry parapets are especially vulnerable. Also include items such as cornices, signs, large satellite communication "dishes."	FEMA 273, Section 1.9.5
	Are heavy lockers, library shelves, and vertical filing cabinets that could fall on people braced to the structure?		These can topple and injure occupants, and also block exit ways.	FEMA 178, Section 10.9.5

Table 4-2: School Seismic Safety Evaluation Checklist (continued)

System Identifier	Evaluation Question	Evaluation Y or N or comment	Guidance	Data References
3	Structural System			
	Is there a continuous load path from the foundation to the roof?		This is an important characteristic to ensure good seismic performance. This also sometimes relates to irregularity in configuration.	Engineer to check design of school structure
	Does the structure provide adequate redundancy in the event of the loss of some structural supports?		Short spans with many vertical supports are desirable, but long spans are sometimes necessary and require special care in design.	FEMA 178, Section 3.1
	Is all load-bearing structural masonry reinforced according to code?		Unreinforced masonry has limited ductility and therefore cannot withstand large earthquake-induced repetitive displacements.	Engineer to check against local code requirements
	Is the structure's reinforced concrete designed to seismic code later than 1976?		The reinforced concrete codes changed in 1976, and structures designed before these codes were adopted may be inadequate.	Check date of design, and edition of code used
	Is the structure's wood frame well maintained, with little or no deterioration?		Wood framing is subject to attack by termites and water damage, which may seriously weaken the structure.	School district personnel to inspect
	Are horizontal structural members securely connected to walls and columns?		Good connections between all structural members are very important for structural integrity.	Structural engineer to check FEMA 178, Chapter 8
	Are horizontal diaphragms correctly designed and constructed with necessary chords and collectors?		Large diaphragm openings and the edges of diaphragms need careful design to ensure forces are properly transmitted to walls and frames.	Structural engineer to check FEMA 178, Chapter 7
4	Building Envelope			
	Wall Cladding			
	Is the building cladding attached to structural frames so that it can accommodate drift?		Frames are flexible and cladding must be detailed to accommodate calculated drifts and deformations.	FEMA 273, Section 11.1.9.4

Table 4-2: School Seismic Safety Evaluation Checklist (continued)

System Identifier	Evaluation Question	Evaluation Y or N or comment	Guidance	Data References
	Are heavy veneer facing materials such as brick or stone securely attached to the structural walls?		Shear wall structures are very stiff and carry large earthquake forces; heavy attachments must be securely attached.	Structural engineer to check design and field condition
	Are heavy roofing materials such as tile and slate securely attached to the structure?		Installation of these materials over points of egress may be dangerous.	IBC Table 1507.3.7
Glazing				
	Are glazing and other panels attached so that they can accommodate drift?		Glazing must be installed with sufficient bite, and adequate space between glass and metal.	FEMA 274, Section C11.9.1.5
	Is the glazing material inserted into a surrounding structure that limits drift and racking?		Glazing is dependent on the surrounding structure to limit racking.	Structural engineer to inspect framing and structural conditions
5	Utilities			
	Are building utility distribution systems well supported and adequately braced?		Flexible connections may be necessary where utilities enter the building.	FEMA 273, Section 11.10.8
6	Mechanical			
	Is heavy mechanical equipment adequately secured and isolators provided with snubbers?		Spring isolated equipment must be restrained from jumping off isolators.	FEMA 174, Section 11.10.1
	Is the heating piping properly braced and provided with expansion joints?		Increase likelihood of continued post-event function.	Inspection by school district personnel and M/E/P consultants
	Is ductwork properly supported and braced?		Increase likelihood of continued post-event function.	Inspection by school district personnel and M/E/P consultants
	Are water heaters and other tanks securely braced?		Gas heaters or tanks with flammable or hazardous materials must be secured against toppling.	FEMA 174

Table 4-2: School Seismic Safety Evaluation Checklist (continued)

System Identifier	Evaluation Question	Evaluation Y or N or comment	Guidance	Data References
7	Plumbing			
	Are plumbing lines adequately supported and braced?		Protection of joints is especially important.	FEMA 174, Section 11.10.3
	Is fire protection piping correctly installed and braced?		Increase likelihood of continued post-event function.	Inspection by school district personnel and M/E/P consultants
	Are ducts and piping that pass through seismic joints minimized and provided with flexible connections?		Differential movement between sections of the building can cause breakage and leaks in pipes and ducts if no provision is made for movement. If walls at joint are firewalls, penetrations should be fireproofed.	FEMA 174
8	Electrical			
	Are suspended lighting fixtures securely attached, braced, or designed to sway safely?		Older suspended lighting fixtures have performed badly in earthquakes and are an injury hazard.	FEMA 174 FEMA 273, Section 11.10.9.1
	Are light fixtures supported in an integrated ceiling, braced, and provided with safety wires?		Light fixtures within a grid often fall when the grid is distorted, unless the fixtures are secured with safety wires.	FEMA 174 FEMA 273, Section 11.10.4.1
	Is heavy electrical equipment adequately secured?		Switch gear and transformers are heavy and failure can shut down the electrical system.	FEMA 273, Section 11.10.7
9	Fire Alarm			
	Is the fire alarm system connected to a secondary power supply?		This is also necessary to support daily operational needs, including lighting, heating, communications, etc., and also if the building is used as a post-earthquake shelter.	Inspection by district maintenance personnel and M/E/P consultants
	Is the fire alarm system provided with a battery backup system capable of operating the system for 24 hours after power loss?		Required by code even if the building will not be used after an event, so that the school can be evacuated.	Inspection by district maintenance personnel and M/E/P consultants

Table 4-2: School Seismic Safety Evaluation Checklist (continued)

System Identifier	Evaluation Question	Evaluation Y or N or comment	Guidance	Data References
10	Communications and IT Systems			
	Are communications components adequately braced and supported?		Post-event communications are vital for issuing instructions to school administrators, students, faculty, and staff. Some components, such as large satellite dish antennas, are easily damaged if not properly supported.	FEMA 273, Section 11.10.8
	Are building intercom systems connected to a standby generator?		Necessary to enable continued use of utility power, whether earthquake-caused or not.	Inspection by maintenance personnel and M/E/P consultants
11	Equipment Operations and Maintenance			
12	Security Systems			
13	Security Master Plan			

4.5.3 The NEHRP Handbook for the Seismic Evaluation of Existing Buildings (FEMA 178/310)

For those buildings that, as the result of a preliminary screening, are candidates for a more detailed investigation, the BSSC developed a procedure for the systematic evaluation of any type of building (FEMA 178 and 310, *The NEHRP Handbook for the Seismic Evaluation of Existing Buildings*). This procedure can be used to evaluate the structural and nonstructural systems and components for any type or size of individual school building. However, the procedure focuses on evaluating whether the building is a potential earthquake-related risk to human life posed by the building

or a building component. The procedure does not address code compliance, damage control, or other aspects of seismic performance not related to life safety.

The handbook methodology involves the use of two sets of questions: one set addresses the characteristics of 15 common structural types and the other, instead of addressing complete structural systems, deals with structural elements, foundations, geologic site hazards, and nonstructural components and systems. These questions are designed to uncover the flaws and weaknesses of a building, and are in the form of positive evaluation statements describing building characteristics that are essential if the failures observed in past earthquakes are to be avoided. The evaluating architect or engineer should address each statement and determine whether it is true or false. True statements identify conditions that are acceptable and false statements identify conditions in need of further investigation. The handbook also specifies a process for dealing with statements that are found to be false.

The evaluation requires some basic structural calculations and a site visit and follow-up field work will be necessary. The primary product of the evaluation is the identification of weak links in the building that could precipitate structural or component failure. Although the procedure will provide guidance on structural deficiencies, it is not intended to identify appropriate seismic retrofit options. The design engineer needs to understand the overall deficiencies of the building before attempting to identify retrofit design approaches. The overall deficiencies may be due to a combination of component deficiencies, inherent adverse design, construction failures, deterioration, or a serious weak link.

4.6 EARTHQUAKE RISK REDUCTION METHODS

Although the general principles of design are similar for new or existing schools, there are differences in code requirements and

overall project delivery processes that reflect the design freedoms of new buildings and the constraints of existing ones.

Engineering of structural and nonstructural risk reduction methods is similar for new and existing schools. New school design offers the possibility of construction on a site subject to less ground motion because of better soil conditions or further proximity to a fault. It can be designed with the most appropriate structural system, using known and tested materials and a good building configuration. These possibilities are not available when retrofitting an existing school; the building may have been designed to an obsolete seismic code or no code at all, its materials may be questionable, and the building configuration and structural system may be inappropriate. Therefore, the protection of an existing school must start with a careful evaluation of its vulnerability. Seismic retrofitting is expensive and time-consuming; however, the adoption of an incremental retrofit procedure, as described in Section 4.6.2, can help to keep time and cost within reasonable limits.

4.6.1 Risk Reduction for New Schools

Methods of design for earthquake protection involve three main aspects of the school: its site, its structure, and its nonstructural components.

In terms of risk reduction, the first priority is the implementation of measures that will reduce the risk of casualties to students, staff, and visitors. The second priority is the reduction of damage that leads to downtime and disruption. The third priority is the reduction of damage and repair costs.

Alternative measures to achieve these objectives are as follows, in ascending order of cost:

- New Schools Regulated by Seismic Codes
 - Provide personal protection training.

- Evaluate code provisions against risk priorities. Evaluate whether design to current code will meet acceptable risk objectives for damage costs and reduction of downtime.
 - Consider adopting California’s Field Act model for quality control of design and construction; can be administered by a single district with specification provisions for inspection in contract documents.
 - Use performance-based design procedures if code-based design does not meet acceptable risk objectives.
- New Schools Not Regulated by Seismic Codes
- Provide personal protection training.
 - Design to appropriate code standards on a voluntary basis.
 - Use performance-based design procedures to meet acceptable risk objectives.
 - Consider adoption of seismic code; requires community-wide cooperation.

Damage reduction is common to all the objectives. The following sections give an overview of the design strategies that are used to achieve acceptable levels of protection in new schools.

School Sites. Protection of schools and their occupants from earthquakes depends on correct seismic design and construction to resist the estimated earthquake forces that the building could encounter at its site. Because ground motion from a single earthquake may vary considerably, depending on the nature of the soil and the distance of the building from known earthquake faults, careful site selection is a critical first step in reducing the forces on the building, although a single school site or a small district will rarely have this option. School sites are generally selected based on factors such as availability, served student population, cost, convenience of access for the school students and staff, and general demographic concerns rather than seismicity. However, a large district that is developing a multi-school plan of new facilities

should include recognition of any natural hazard vulnerabilities as a factor in the evaluation of alternative sites. A school district can reduce its seismic vulnerability by reducing the intensity of earthquake shaking to be expected at a site over the life of the building. There are several ways in which this can be accomplished:

- Locate the building in an area of lower seismicity, where earthquakes occur less frequently or with typically smaller intensities. Although it would be very rare for a school district to make a site selection decision based solely on seismic risk, moving a school even a few miles in some cases can make a big difference to its seismic hazard, such as locating a school within 1 mile of a major fault versus being 5 to 10 miles away from it.
- Locate the building on a soil type that reduces the hazard. Local soil profiles can be highly variable, especially near water, on sloped surfaces, or close to faults. In an extreme case, siting on poor soils can lead to liquefaction, land sliding, or lateral spreading of the soil. Frequently, similar buildings located less than 1 mile apart have performed in dramatically different ways because of differing soil conditions in earthquakes. Even when soil-related geologic hazards are not present, earthquake motions that have to travel through softer soils will be amplified more than those traveling through firm soils or rock. If general knowledge of site conditions is a concern, the effects of soil hazard on risk should be determined by the use of geotechnical and structural engineers to assess the potential vulnerabilities associated with differing site conditions. Variables in vulnerabilities should be weighed against the costs, both direct and indirect, of locating the facility on soils that will result in better performance.
- Engineer the building site to increase building performance and reduce vulnerability. If building relocation to an area of lower seismicity or to an area with a better natural soil profile

In the late 1960s, the small school district of Portola Valley, California, was faced with declining enrollment for its intermediate school, which was also outdated. In addition, the school was located very close to the San Andreas Fault. Concerned about seismic risk, the district deemed the site unsuitable for school purposes and sold the site to the city for 1 dollar, which used it for recreational purposes.

is not a cost-effective option, the soil at the designated site can sometimes be treated to reduce the hazard. For example, on a liquefiable site, the soil can be grouted or otherwise treated to reduce the likelihood of liquefaction occurring. Soft soils can be excavated and replaced, or combined with foreign materials to make them stiffer. Alternatively, the building foundation itself can be modified to account for the potential effects of the soil, reducing the building's susceptibility to damage even if liquefaction or limited land sliding does occur. The school board should weigh the additional costs of modifying the soil characteristics or the building foundation with the expected reduction in damage and loss. However, because most schools are one or two stories in height, site area usage is considerable, and site treatment is likely to be costly.

In most cases, it is probable that a designated school site will be accepted. Proposed construction directly over a fault is probably the only location characteristic that would lead to rejection of an otherwise suitable site. The forces for which the school must be designed

The ELF equation in the IBC is $V=C_s W$, where V = the shear, or pushing, force at the base of the building, which represents the total earthquake force on the building, C_s is a coefficient representing the estimated site acceleration (derived from maps provided in the code), modified by factors related to the characteristics of the structure, the importance of the building, and the nature of the soil. W is the weight of the building. This equation is the same as Sir Isaac Newton's equation in his second law of motion, $F=MA$ (Force = Mass times Acceleration), with some added modifiers.

are also increased if it is in close proximity of a fault, which will increase the structural cost. Sites are assigned to one of six categories, from A, which represents hard rock, to F, which represents soils vulnerable to potential failure or collapse such as liquefiable soils, sensitive clays, and weak soils and clays. Variations in soil type are covered by increasing or decreasing the design forces by application of a coefficient within the calculation of the Equivalent Lateral Force (ELF) equation, which is used to establish the design lateral forces on the building.

The ELF procedure assumes a soil type B. For categories A through E, design forces must be modified by application of a coefficient, or multiplier. For Category A soils, the multiplier is 0.8 (i.e., the values are reduced). For Category E soils, the multiplier can be as high as 2.5 for short-period buildings such as schools. For buildings located on

type F soils, a site-specific geotechnical investigation must be performed to establish design values.

Reducing Damage to School Structures. Minimum standards and criteria for structural design are defined in the seismic codes. The codes provide maps that show whether the location is subject to earthquakes and, if so, the probability of occurrence, expressed by varying levels of seismic forces for which a building must be designed. Seismic codes are adopted by state or local authorities, so it is possible for a seismically-prone region to be exempt from seismic code regulations if the local community feels that the adoption of a seismic building code is not desired. Based on historic and scientific data, although the seismic hazard exists, some communities may choose to ignore the risk, because no one has experienced an earthquake in their lifetime. Such a policy should be of serious concern to school district officials, the local school board, and parents.

This is a difficult issue because, although the risk may appear to be minimal, the effects could be catastrophic if a significant event were to occur. The very fact that such an event is rare means that the community may have no history of design for earthquakes and the building stock will be especially vulnerable. School buildings are an important community resource (along with other essential buildings such as hospitals, and fire and police stations) that should not gamble on the avoidance of a rare event.

Because of systematic observation of earthquake damage to buildings and extensive analytical and experimental research, seismic design in the 20th century has become a highly developed technology.

Reducing structural damage in earthquakes depends on:

- The correct application of code criteria and analytical methods. Seismic codes have become increasingly complex and a high standard of care and engineering judgment is necessary to ensure correct application.

- The correct selection and application of structural systems and materials. Different structural systems have varied characteristics that must be matched to the nature and purpose of the school. Flexible planning, for example, implies the use of a frame structure rather than relying on shear walls that may impact planning freedom.

The following two graphics show the basic types of structural lateral force resisting systems.

HOW BUILDINGS RESIST EARTHQUAKES

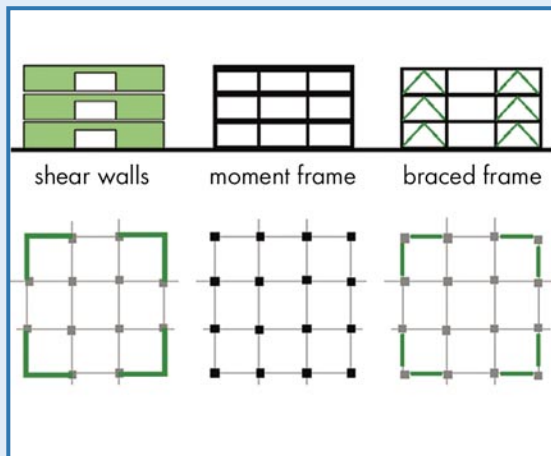

Lateral Force Resisting Systems – Basic Types

This figure shows the basic types of lateral force resisting structural systems. They tend to be mutually exclusive (i.e., it is desirable not to mix the systems in a single building because of the different strength and stiffness characteristics of the systems). Shear walls are very stiff while moment-resistant frames are flexible. Braced systems are in between.

The systems have major architectural implications. Shear walls, which should run uninterrupted from foundation to roof, may impose major planning constraints on a building. Moment frames create unobstructed floors, but, because of their special connection requirements, are expensive. They are subject to more deformation that may result in costly damage to nonstructural components and systems. Braced frames are a common compromise.

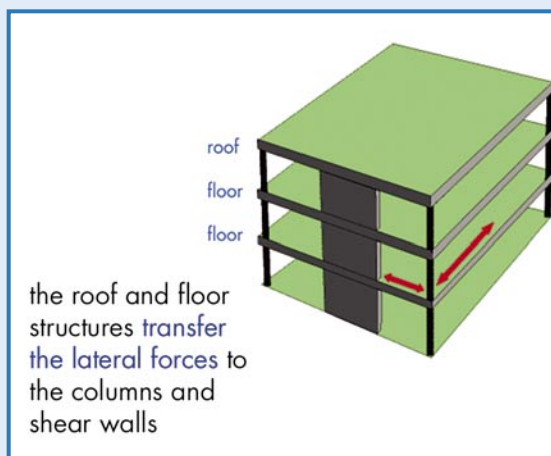

Diaphragms

Together with the lateral force resisting system, diaphragms form a horizontal system that connects the vertical elements and carries their loads down to the foundation. Large openings in the diaphragm may limit its ability to be effective in transferring forces.

SOURCE: BSSC: PRESENTATIONS TO THE ARCHITECTURAL COMMUNITY, 2001, CHRIS ARNOLD AND TONY ALEXANDER

- The correct design of critical elements such as frames, shear walls, and diaphragms and their connections to one another: earthquake forces search out the weak links between structural members. Serious damage and collapse is often initiated by connection failure. These are the critical elements that provide seismic resistance; they must be correctly sized, located, and detailed.
- Careful attention to key structural design principles such as provision of a direct load path and structural redundancy.
- The correct design of the connections between structural elements and nonstructural components.
- Configuration of the building (its size and shape) to be as simple and regular as planning and aesthetic requirements permit. Experience has shown that certain building shapes and architectural design elements contribute to bad seismic performance and need expensive structural design methods to make them achievable.
- A high level of quality control to ensure that the building is properly constructed. Careful seismic design is valueless if not properly executed.
- A high level of maintenance to ensure that the building retains its integrity over time. Corrosion of steel and termite infestation or dry rot in wood can seriously affect structural integrity.

The following graphics show some problems caused by irregular building configurations.

SOME TYPICAL DESIGN PROBLEMS

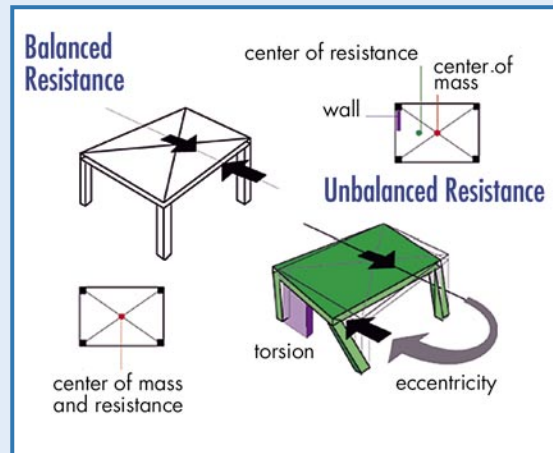

Torsional Forces

This figure shows how torsion occurs. If the center of mass and center of resistance do not coincide, the building tends to rotate around the center of resistance.

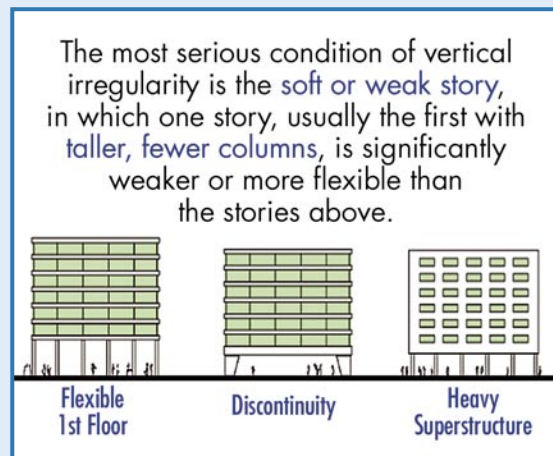

Stress Concentrations

Stress concentration means that an undue proportion of the overall forces is concentrated at one or a few points of the building such as a particular set of beams, columns, or walls. These few members may fail and, by a chain reaction, bring down the whole building.

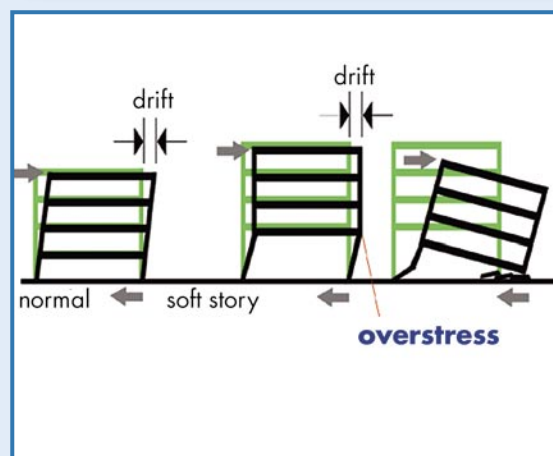

Soft Stories

This figure shows the failure mechanism of a soft or weak story. A regular building with equal floor heights will distribute its drift equally to each floor so that each is subjected to manageable drift. In the soft story building, the overall drift is the same, but the second floor connections are subject to all, or almost all, the drift and a failure mechanism is created.

SOURCE: BSSC: PRESENTATIONS TO THE ARCHITECTURAL COMMUNITY, 2001, CHRIS ARNOLD AND TONY ALEXANDER

TORSIONAL FORCES AND STRESS CONCENTRATION



Soft Stories

Typical examples of soft story-induced damage.

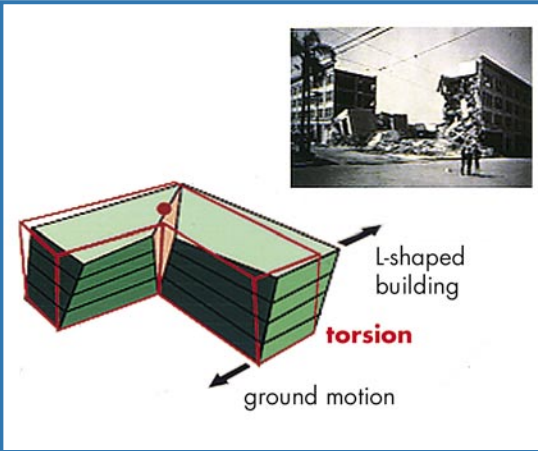

Re-entrant Corners

Buildings with re-entrant corners (L-shape, U-shape, etc.) are subject to torsion and stress concentrations. Special design measures are necessary to counteract these tendencies.

SOURCE: BSSC: PRESENTATIONS TO THE ARCHITECTURAL COMMUNITY, 2001, CHRIS ARNOLD AND TONY ALEXANDER

Reducing Damage to Nonstructural Components and Systems.

Nonstructural components and systems are defined as those elements that do not contribute to the seismic resistance of the building (see Figure 4-31). They typically comprise from 75 to 80 percent of the total school building by value, and they transform the structure into a working environment that provides weather protection, heating, cooling, lighting, and acoustic control. Damage to these components can be costly and render the building functionally useless even if the building structure

performs in accordance with the intent of the seismic code. Non-structural components are generally broadly classified as:

- Architectural
 - Exterior envelope - opaque or glazed, roof and wall coverings
 - Veneers
 - Interior partitions
 - Ceilings
 - Parapets and appendages (e.g., signs and decorative elements)
 - Canopies and marquees
 - Chimneys and stacks
- Mechanical
 - Boilers and furnaces
 - HVAC source equipment and distribution components
- Electrical and Electronic
 - Source power equipment and distribution components
 - Source communications equipment and distribution components
 - Light fixtures
- Plumbing
 - Storage vessels and tanks
 - Piping systems
 - Hazardous materials distribution
- Furnishings and Interior Equipment
 - Bookcases, filing cabinets, and other storage
 - Shop and art equipment
 - Hazardous materials (HazMat) storage

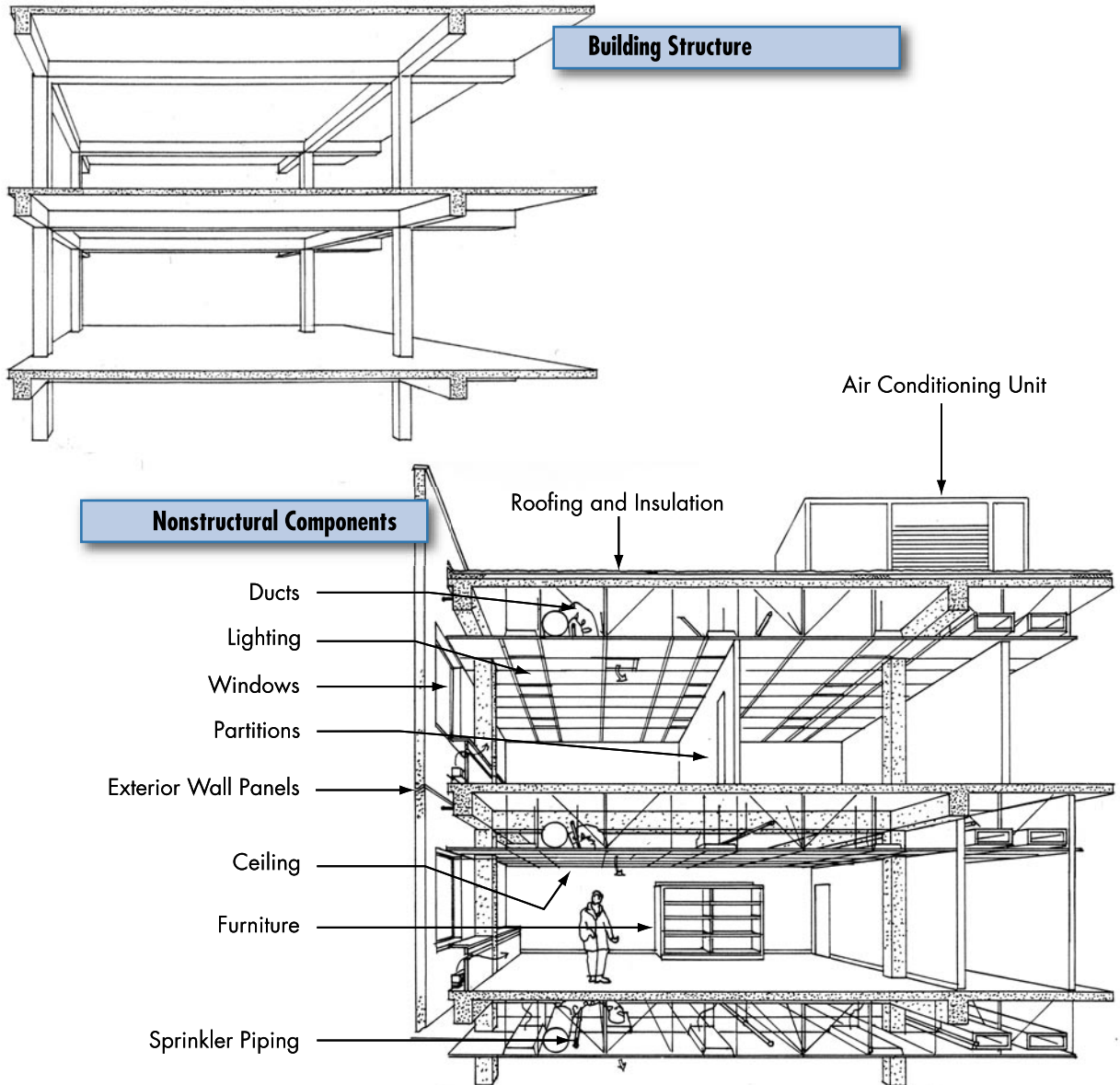

Figure 4-31
 The structural and nonstructural components. The upper graphic shows the building structure. The lower graphic shows the addition of the main nonstructural components.

Reduction of damage to nonstructural components depends on using methods of supporting and bracing the components to prevent failure (see examples in Figures 4-32, 4-33, 4-34, and 4-35). Seismic codes provide the design force for which the above components must be designed, together with a number of specific design requirements that must be followed.

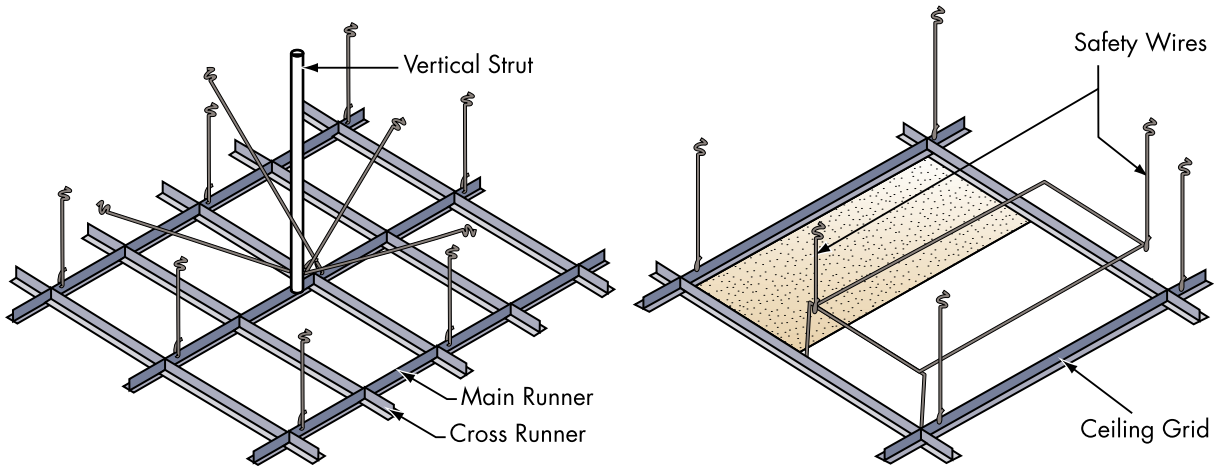

Figure 4-32 Suspended ceiling and light fixture bracing and support

Figure 4-33
Bracing tall shelving to the structure

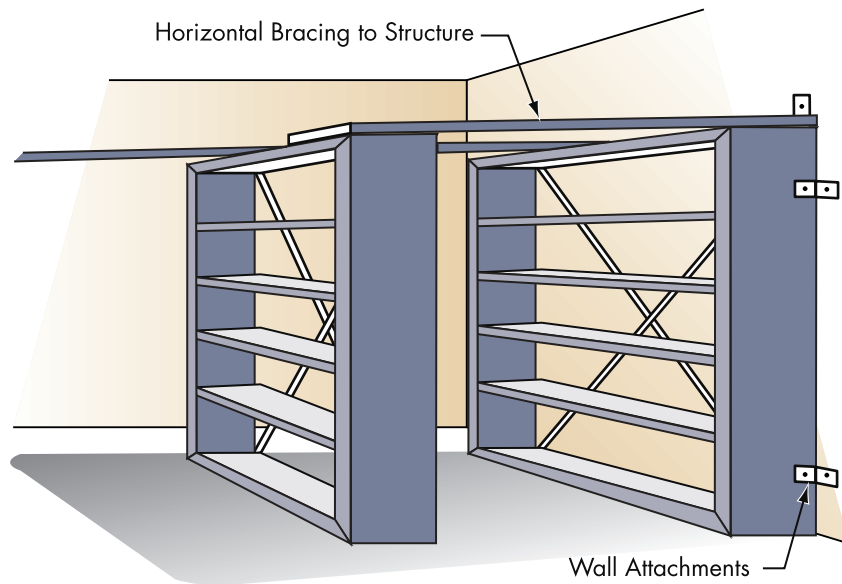
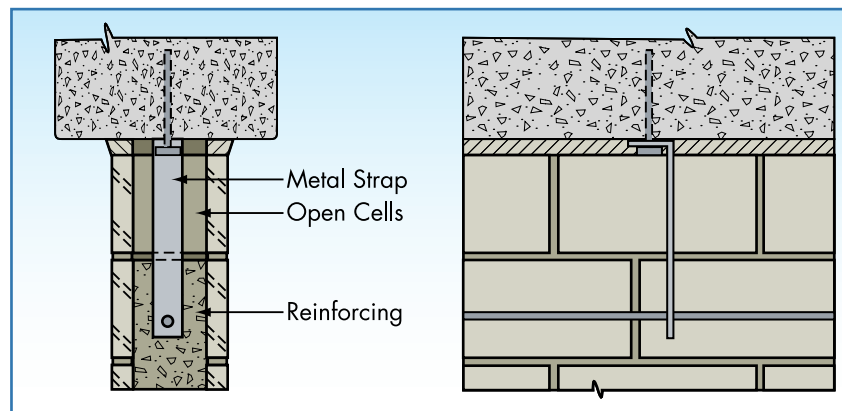

Figure 4-34
Connection of nonstructural masonry wall to structure to permit independent movement



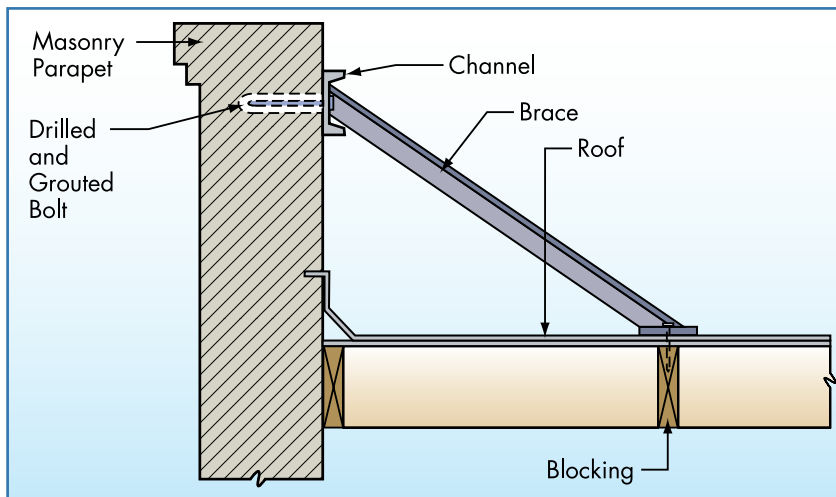

Figure 4-35
Bracing for existing
unreinforced masonry
parapet wall

4.6.2 Risk Reduction for Existing Schools

Procedures and Design Strategies. Additions to an existing school must meet all of the code requirements for a new building. There is currently no seismic code that applies to the retrofit of existing schools. Typically, the standards to be applied are derived from the code for new buildings and negotiated with the applicable building department. It is generally recognized that it is difficult or almost impossible to bring an existing structure up to full compliance with a current code and so some compromises have to be made; there is, however, no general agreement as to how the code for new buildings is applied to the retrofit design of existing ones.

Reducing the seismic risk for an existing building requires the same general design principles as those necessary for a new building, but the architect and engineer are faced with existing structural and nonstructural systems and materials that may be far from ideal and, as previously stated, to bring them up to the standard of a new building could be difficult or almost impossible.

The process should begin with an evaluation procedure similar to those outlined in Section 4.5. If the result of these evaluations is the need to retrofit an existing school or schools, the *NEHRP*

Guidelines for the Seismic Rehabilitation of Buildings (FEMA 273) is the authoritative source document and can be used to help a school district select seismic protection criteria. The architect and engineer can also use the document for the design and analysis of seismic retrofit projects.

FEMA 273 adopted the approach of providing methods and design criteria to achieve several different levels and ranges of seismic performance (unlike a conventional code that implies, but does not define, a single performance level). In doing this, the document shows that there is always the possibility of damage in a seismic event and the term “seismic performance” refers to the nature and extent of damage that the building exhibits. FEMA 273 provides a thorough and systematic procedure for performance-based seismic design, intended to result in the development of a design that targets achieving the owner’s level of acceptable risk within the owner’s available resources.

The performance-based design approach outlined in FEMA 273 provides uniform criteria by which existing buildings may be retrofitted to attain a wide range of performance levels, when subjected to earthquakes of varying severities and probabilities of occurrence. The process starts by requiring that the user select specific performance goals as a basis for design. In this way, users can directly determine the effect of different performance goals on the design requirements, including their complexity and cost.

Typical design strategies for improving the protection of an existing school include (see Figure 4-36):

- Modifying and improving local components or materials, such as beam/column connections. This involves retrofitting connections and strengthening structural members by such methods as adding reinforcing or replacing them with new components.

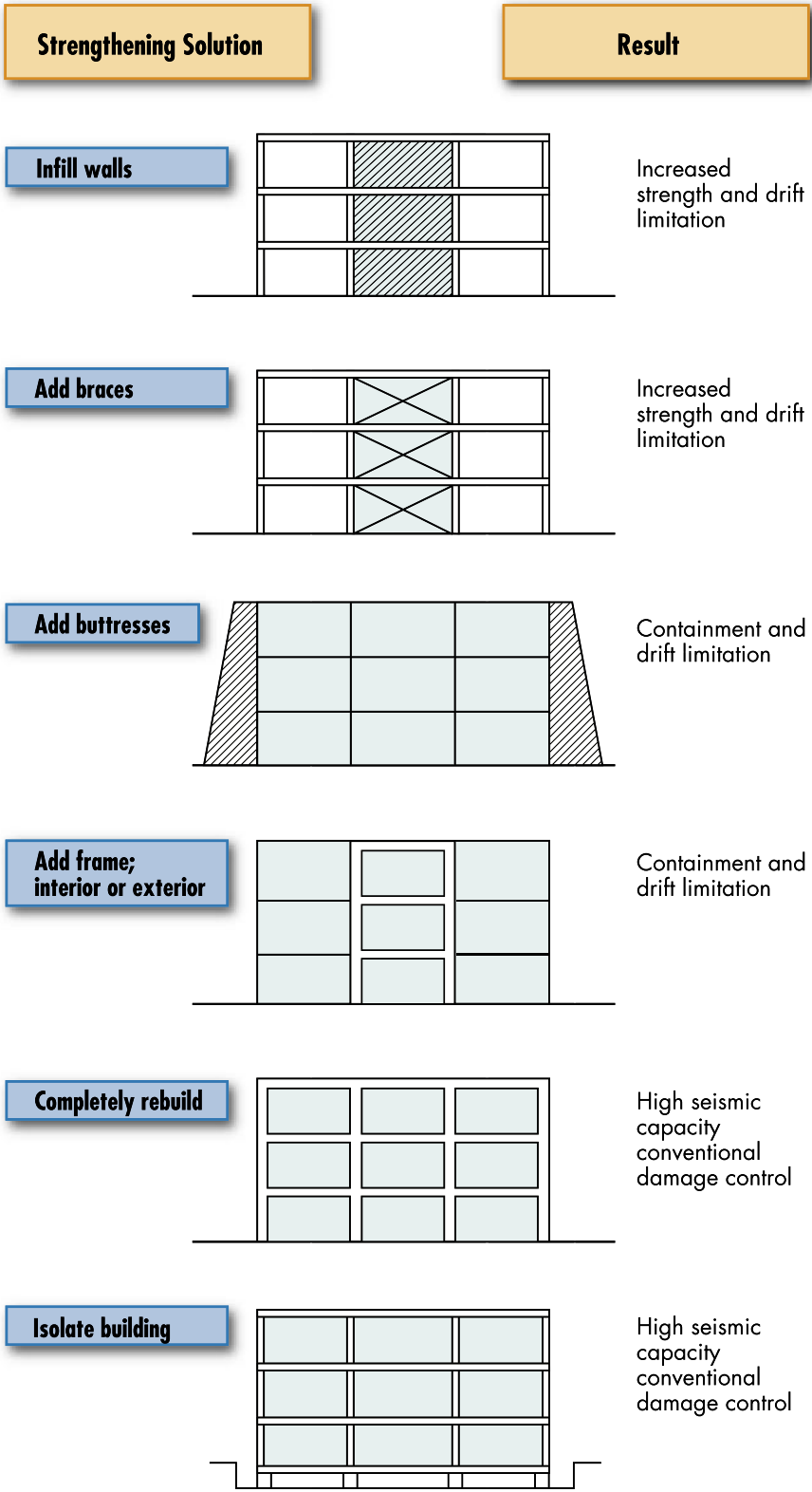

Figure 4-36
Design strategies for seismic retrofit of existing buildings

SOURCE: *BUILDINGS AT RISK: SEISMIC DESIGN BASICS FOR PRACTICING ARCHITECTS*, AIA/ACSA COUNCIL ON ARCHITECTURAL RESEARCH, WASHINGTON, DC, 1994, ERIC ELSESSER

- Removing or reducing configuration irregularities. This involves providing seismic separations in irregular configurations or adding shear walls or bracing to reduce torsional effects, thereby strengthening and/or stiffening the entire structural system. This is a major retrofit that involves adding bracing or shear walls, replacing many structural members.
- Reducing the mass of the building (to reduce forces). This involves changing the location of heavy items (e.g., bookcases) within the building, but would not apply to a one-story building, except where a tile or slate roof covering might be replaced with a lightweight material.

Retrofit Methods. Seismic (base) isolation (to reduce force on the building superstructure) is a new technique that has been successfully used in the retrofit of large buildings, but it is not appropriate to the scale and nature of school buildings unless the school building is considered a historical building. A newer technique is passive energy dissipation, the insertion of supplemental energy devices (to reduce movement), which might be applicable to certain types of school structures (e.g., large gymnasiums, multiuse buildings, or auditoriums).

Seismic retrofit at any large scale is expensive, both in design and construction, because of the more complex analyses that must be conducted and the construction constraints that must be overcome. In addition, closure of a school for an extended period (beyond that of the normal summer break) is usually unacceptable. Major seismic retrofit is rare, although some successful projects have been done, primarily with the goal of saving a building that is not only a place of learning, but a historic community resource as well. The retrofitting of the B.F. Day School in Seattle was one such project (see Figures 4-37 and 4-38).



Figure 4-37
Retrofit of B.F. Day
Elementary School, Seattle,
WA

SOURCE: EARTHQUAKE
ENGINEERING RESEARCH
INSTITUTE, OAKLAND, CA; B.F. DAY
ELEMENTARY SCHOOL, SEATTLE,
TODD W. PERBIX AND LINDA L.
NOSON, 1996

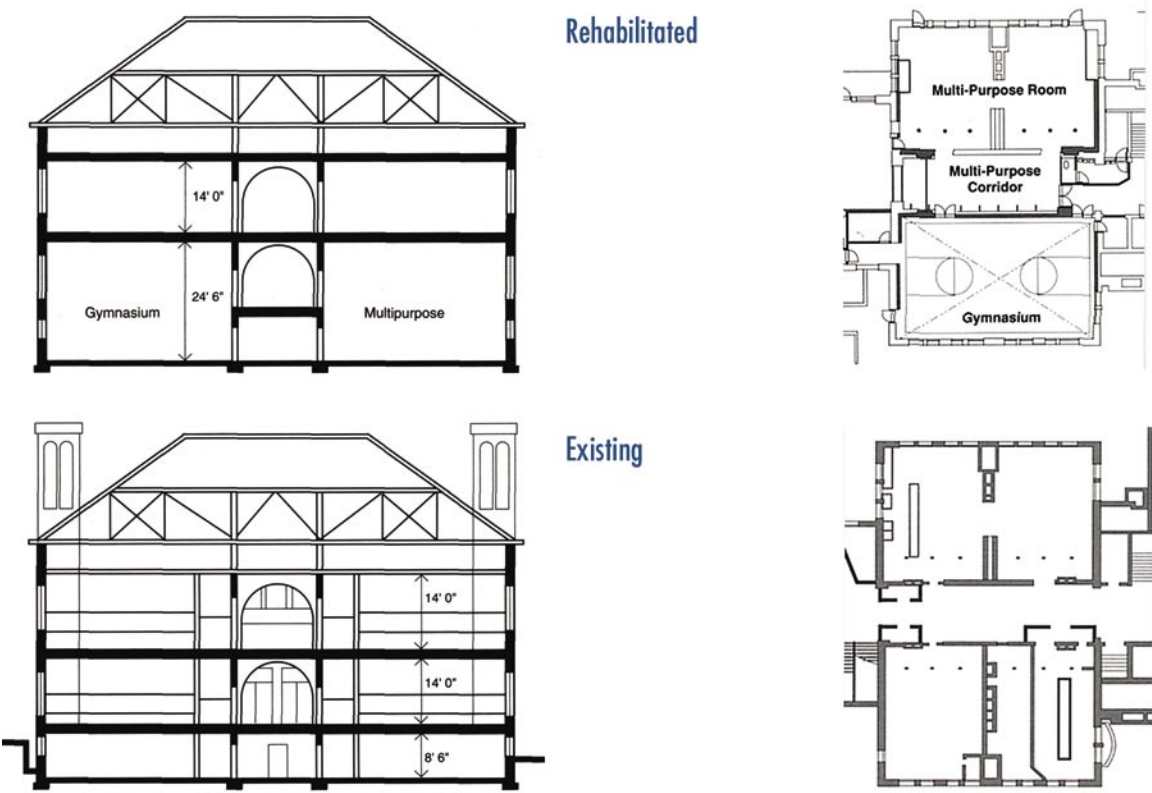

Figure 4-38

Sections and plans of the B.F. Day School: existing at bottom, retrofitted at top. Note that the retrofit has also opened up the basement and first floor to provide large spaces suitable for today's educational needs.

SOURCE: EARTHQUAKE ENGINEERING RESEARCH INSTITUTE, OAKLAND, CA; B.F. DAY ELEMENTARY SCHOOL, SEATTLE, TODD W. PERBIX AND LINDA L. NOSON, 1996

Incremental Seismic Rehabilitation. An approach that greatly improves the feasibility of retrofitting a school is that of “Incremental Seismic Rehabilitation.” A full description of this procedure is presented in *Incremental Seismic Rehabilitation of School Buildings (K-12)* (FEMA 395). The principles of this process follow.

Whereas extensive single-stage seismic retrofitting of an existing school represents a significant cost, retrofit actions can be divided into increments and integrated into normal repairs and capital improvement projects. Implementation of incremental seismic retrofit requires assessing the buildings, establishing retrofit priorities, and planning integration with other projects. Integration will reduce the cost of the seismic work by sharing engineering design costs and some aspects of construction costs. An “integration opportunity” occurs when a seismic retrofit measure can be paired with other repair or replacement tasks or categories. Integration opportunities are a key consideration in determining the sequence of operations that will be conducted.

School districts often categorize maintenance and capital improvement projects in the following eight categories;

- Re-roofing
- Exterior wall and window replacement
- Fire and life safety improvements
- Modernization/remodeling/new technology accommodation
- Under floor and basement maintenance and repair
- Energy conservation/weatherizing/air conditioning
- Hazardous materials abatement
- Accessibility improvements

FEMA 395 provides five matrices that show possible combinations of seismic improvement measures with typical work categories. A typical matrix from FEMA 395, showing possible seismic improvements relating to roof maintenance and repair is shown in Table 4-3.

Table 4-3: Roofing Maintenance and Repair/Re-roofing

Rank*	Level of Seismicity			Building Structural Element	Structural Subsystem	Seismic Performance Improvement	Vertical Load Carrying Structure						
	L	M	H				Wood	Masonry ¹		Concrete		Steel	
							Unreinforced Masonry	Reinforced Masonry	Wood Diaphragm	Concrete Diaphragm	Wood Diaphragm	Concrete Diaphragm	
Nonstructural													
1	✓	✓	✓	n/a	n/a	Bracing of Parapets, Gables, Ornamentation, and Appendages		■		■	■	■	■
2	✓	✓	✓	n/a	n/a	Anchorage of Canopies at Exits	■	■	■	■	■	■	■
3		✓	✓	n/a	n/a	Bracing or Removal of Chimneys	■	■	■	■	■	■	■
10		✓	✓	n/a	n/a	Anchorage and Detailing of Rooftop Equipment	■	■	■	■	■	■	■
Structural													
n/a		✓	✓	All Elements		Load Path and Collectors	□	□	□	□	□	□	□
n/a		✓	✓	Horizontal Elements	Diaphragms	Attachment and Strengthening at Boundaries	■	■	■	■	□	■	□
n/a		✓	✓	Horizontal Elements	Diaphragms	Strength/Stiffness	■	■	■	■	□	■	□
n/a		✓	✓	Horizontal Elements	Diaphragms	Strengthening at Openings	□	□	□	□		□	
n/a		✓	✓	Horizontal Elements	Diaphragms	Strengthening at Re-entrant Corners	□	□	□	□	□	□	□

Table 4-3: Roofing Maintenance and Repair/Re-roofing (continued)

Rank*	Level of Seismicity			Building Structural Element	Structural Subsystem	Seismic Performance Improvement	Vertical Load Carrying Structure						
	L	M	H				Wood	Masonry ¹		Concrete		Steel	
							Unreinforced Masonry	Reinforced Masonry	Wood Diaphragm	Concrete Diaphragm	Wood Diaphragm	Concrete Diaphragm	
n/a		✓	✓	Horizontal Elements	Diaphragms	Topping Slab for Precast Concrete	<input type="checkbox"/>	<input type="checkbox"/>		<input type="checkbox"/>		<input type="checkbox"/>	
n/a	✓	✓	✓	Vertical Elements	Load Path	Lateral Resisting System to Diaphragm Connection	<input checked="" type="checkbox"/>	<input checked="" type="checkbox"/>	<input checked="" type="checkbox"/>	<input checked="" type="checkbox"/>	<input checked="" type="checkbox"/>	<input checked="" type="checkbox"/>	
n/a	✓	✓	✓	Vertical Elements		Out-of-Plane Anchorage of Concrete or Masonry Wall	<input checked="" type="checkbox"/>	<input checked="" type="checkbox"/>	<input checked="" type="checkbox"/>	<input type="checkbox"/>	<input checked="" type="checkbox"/>	<input type="checkbox"/>	

* Nonstructural improvements are ranked on the basis of engineering judgment of their relative impact on improving life safety in schools.

Structural improvements are not ranked, but are organized by structural element and subsystem.

- Work that may be included in the building rehabilitation/maintenance/repair project using little or no engineering.
- Work requiring detailed engineering design to be included in the project.
- Work requiring detailed engineering design and evaluation of sequencing requirements. The “x” designates work that could redistribute loads, overstressing some elements.

Note 1: Masonry buildings with a concrete roof should use the concrete building, concrete diaphragm for integration opportunities.

n/a = Not Applicable.

Incremental seismic retrofit is an effective, affordable, and non-disruptive strategy to achieve responsible seismic risk mitigation.

At the lower levels of protection, some effective construction measures (e.g., bracing nonstructural bookcases and filing cabinets, and anchoring key desktop equipment such as computers) can be

implemented by school district maintenance personnel. As a last resort in cases of extreme risk and badly antiquated school buildings, demolition is the only solution.

4.7 THE SCHOOL AS A POST-EARTHQUAKE SHELTER

In the aftermath of any damaging earthquake, there is an immediate need of shelter for people who have been displaced from their homes. There are three kinds of shelters:

- First is the immediate need for shelter on the day or night of the earthquake. The American Red Cross has a congressional mandate to provide this after any disaster, with the intent that this will be available only for a few weeks.
- Following the immediate need, there is a need for longer-term housing, while homes and apartments are being repaired. This is generally accomplished by governmental subsidies that enable people to move into vacant hotel rooms or apartments. This kind of shelter depends, to some extent, on the availability of these forms of housing on the market in the local area. This is sometimes augmented by temporary housing; where the season and climate allow, this can be provided by tents and FEMA has, in the past, maintained a stock of modular housing that can be moved to a local site within a month or two, depending on the availability of land. This housing may be occupied for a year or so, depending on the scale of the disaster.
- Finally, there is permanent replacement housing that is typically provided by the home building industry and non-profit housing organizations, with possible financial aid programs from the Federal Government.

It is common in earthquake-prone regions for school sites to provide the first kind of immediate shelter. There are several good reasons for this. First, schools are conveniently located in every community, with easy and known access to the local population

that they serve. Second, schools have suitable space (e.g., gymnasiums or multiuse rooms) where large numbers of people can be accommodated for a few days. Food services are often available and there is ample space for assembly, processing, and delivery of goods and equipment. Third, because schools are public property, the financial costs of making use of the facilities for a few weeks are minimal, and arrangements can be worked out in advance. Finally, particularly in California, where schools are subject to the Field Act, schools are well constructed and probably among the most likely of all the community's buildings to survive intact and in a usable condition.

The only problem that has been encountered is that of ensuring that the time of use is limited; no school district wishes for its schools to be used as shelters for weeks, unless it is during the summer break. However, improvisation can generally ensure that some semblance of a normal school teaching program can be reinstated within a day or so of a moderate event.

No specific design decisions are necessary for this use, nor is it necessary to stockpile emergency supplies, because they could use up valuable storage space for years and then be useless if needed. The exact circumstances of the event and the number and types of people to be accommodated will determine the supplies that are necessary. Experience has shown that local and even regional manufacturers and suppliers are very effective in providing services after an event. Following the Coalinga 1983 earthquake, temporary shelter was provided in the high school gymnasium. A regional beer canning plant substituted drinking water for beer for a few shifts and rapidly delivered the chilled cans to the site.

However, pre-event planning should be undertaken between the school district and the local emergency services agency to anticipate key issues that will need quick solutions if an event occurs. This includes determining what spaces will be available and how many people can be accommodated, signing a pre-contract with a local engineer or architect for immediate post-earthquake in-

spection to determine safety, looking at strategies for continued operation in the event some spaces are occupied by refugees, and the possible provision of food and sanitary supplies by the district.

Possible use of school buildings as a safe haven for the community in the event of chemical, biological, radiological, or explosive attack involves complex design and construction issues. This use of school property is discussed in FEMA 428, Chapter 6, and FEMA 453.

4.8 REFERENCES AND SOURCES OF ADDITIONAL INFORMATION

ASCE, 2000, Prestandard and Commentary for the Seismic Rehabilitation of Buildings, American Society of Civil Engineers, FEMA Publication 356, Washington, DC (FEMA 273 published as a standard).

Building Construction and Safety Code NFPA 5000, National Fire Protection Association, Quincy, MA, 2002 .

Incremental Seismic Rehabilitation of School Buildings (K-12) (FEMA 395), Virginia Polytechnic Institute/Building Technology Incorporated, Silver Spring, MD/Melvyn Green & Associates, Inc., Torrance, CA, Federal Emergency Management Agency, Washington, DC, 2002.

International Building Code 2003, International Code Council, Birmingham, AL, 2003.

Minimum Design Loads for Buildings and Other Structures, ASCE 7-02, American Society of Civil Engineers, Reston, VA, 2002.

NEHRP Commentary on the Guidelines for the Seismic Rehabilitation of Buildings (FEMA 274), Building Seismic Safety Council, Washington, DC, 1997.

NEHRP Guidelines for the Seismic Rehabilitation of Buildings (FEMA 273), Building Seismic Safety Council, Washington, DC, 1997.

NEHRP Handbook for the Seismic Evaluation of Existing Buildings (FEMA 178), Building Seismic Safety Council, Washington, DC, 1992.

The NEHRP Recommended Provisions for Seismic Regulation for New Buildings, 2000 Edition, 2 volumes and maps (FEMA 368) and Commentary (FEMA 369).

Primer to Design Safe School Projects in Case of Terrorist Attacks (FEMA 428), Federal Emergency Management Agency, U.S Department of Homeland Security, Washington, DC, 2003.

Rapid Visual Screening of Buildings for Potential Seismic Hazards (FEMA 154), Applied Technology Council, FEMA, Washington, DC, 1988.

Reducing the Risks of Nonstructural Earthquake Damage: a Practical Guide (FEMA 74), Wiss, Janney, Elstner Associates, Inc., Washington, DC, 1994.

Seismic Design Criteria of Nonstructural Systems for New School Facilities, EQE International/Salt Lake City School District, Salt Lake City, UT, 2001.

4.9 GLOSSARY OF EARTHQUAKE TERMS

Acceleration. Rate of change of velocity with time.

Amplification. A relative increase in ground motion between one type of soil and another or an increase in building response as a result of resonance.

Amplitude. Maximum deviation from mean of the center line of a wave.

Architectural Components. Components such as exterior cladding, ceilings, partitions, and finishes.

Building. Any structure whose use could include shelter of human occupants.

Component (also Element). Part of an architectural, structural, electrical, or mechanical system.

Configuration. The size, shape, and geometrical proportions of a building.

Connection. A method by which different materials or components are joined to each other.

Damage. Any physical destruction caused by earthquakes.

Deflection. The state of being turned aside from a straight line, generally used in the horizontal sense; see also “Drift.”

Design Earthquake. In the IBC, the earthquake that produces ground motions at the site under consideration that are two-thirds those of the “Maximum Considered Earthquake.”

Design Ground Motion. See “Design Earthquake.”

Diaphragm. A horizontal or nearly horizontal structural element designed to transmit lateral forces to the vertical elements of the seismic force resisting system.

Drift. Vertical deflection of a building or structure caused by lateral forces; see also “Story Drift.”

Ductility. Property of some materials, such as steel, to distort when subjected to forces while still retaining considerable strength.

Earthquake. A sudden motion or vibration in the earth caused by the abrupt release of energy in the earth’s lithosphere.

Effective Peak Acceleration and Effective Peak Velocity-Related Acceleration. Coefficients shown on maps in the IBC for determining prescribed seismic forces.

Elastic. Capable of recovering size and shape after deformation.

Epicenter. A point on the earth's surface that is directly above the focus of an earthquake.

Exceedance Probability. The probability that a specified level of ground motion or specified social or economic consequences of earthquakes will be exceeded at a site or in a region during a specified exposure time.

Exposure. The potential economic loss to all or certain subsets of the built environment as a result of one or more earthquakes in an area; this term usually refers to the insured value of structures carried by one or more insurers.

Fault. A fracture in the earth's crust accompanied by displacement of one side of the fracture with respect to the other in a direction parallel to the fracture.

Focus. The location of a fault break where an earthquake originates; also termed "Hypocenter."

Force. Agency or influence that tries to deform an object or overcome its resistance to motion.

Frame, Braced. Diagonal members connecting together components of a structural frame in such a way as to resist lateral forces.

Frame, Space. A structural system composed of interconnected members, other than bearing walls, that is capable of supporting vertical loads and that also may provide resistance to seismic forces.

Frame System, Building. A structural system with an essentially complete space frame providing support for vertical loads; seismic forces are resisted by shear walls or braced frames.

Frame System, Moment. A space frame in which members and joints are capable of resisting lateral forces by bending as well as along the axis of the members; varying levels of resistance are provided by ordinary, intermediate, and special moment frames as defined in the IBC with special frames providing the most resistance.

“g”. The acceleration due to gravity or 32 feet per second.

Ground Failure. Physical changes to the ground surface produced by an earthquake such as lateral spreading, landslides, or liquefaction.

Hypocenter. See “Focus.”

Intensity. The apparent effect that an earthquake produces at a given location; in the United States, intensity generally is measured by the modified Mercalli intensity (MMI) scale.

Irregular. Deviation of a building configuration from a simple symmetrical shape.

Joint. Location of connections between structural or nonstructural members and components.

Liquefaction. The conversion of a solid into a liquid by heat, pressure, or violent motion; sometimes occurs to the ground in earthquakes.

Load, Dead. The gravity load created by the weight of all permanent structural and nonstructural building components such as walls, floors, roofs, and fixed service equipment.

Load, Live. Moving or movable external loading on a structure; it includes the weight of people, furnishings, equipment, and other items not permanently attached to the structure.

Loss. Any adverse economic or social consequences caused by earthquakes.

Mass. A constant quantity or aggregate of matter; the inertia or sluggishness that an object, when frictionlessly mounted, exhibits in response to any effort made to start it or stop it or to change in any way its state of motion.

Maximum Considered Earthquake Ground Motion. The most severe earthquakes effects considered in the IBC. These are represented by the mapped spectral response accelerations at short and long periods, obtained from maps reproduced in the IBC, adjusted for Site Class effects using site coefficients.

Mercalli Scale (or Index). A measure of earthquake intensity named after Giuseppe Mercalli, an Italian priest and geologist.

Nonbuilding Structure. A structure, other than a building, constructed of a type included in Chapter 14 of the IBC.

Occupancy Importance Factor. A factor, between 1.0 - 1.5, assigned to each structure according to its Seismic Use Group (SUG).

Partition. See “Wall, Nonbearing.”

Period. The elapsed time (generally in seconds) of a single cycle of a vibratory motion or oscillation; the inverse of frequency.

P-Wave. The primary or fastest waves traveling away from a fault rupture through the earth’s crust and consisting of a series of compressions and dilations of the ground material.

Quality Assurance Plan. A detailed written procedure that establishes the systems and components subject to special inspection and testing.

Recurrence Interval. See “Return Period.”

Resonance. The amplification of a vibratory motion occurring when the period of an impulse or periodic stimulus coincides with the period of the oscillating body.

Return Period. The time period in years in which the probability is 63 percent that an earthquake of a certain magnitude will recur.

Richter Magnitude (or Scale). A logarithmic scale expressing the magnitude of a seismic (earthquake) disturbance in terms of the maximum amplitude of the seismic waves at a standard distance from their focus named after its creator, the American seismologist Charles R. Richter.

Rigidity. Relative stiffness of a structure or element; in numerical terms, equal to the reciprocal of displacement caused by unit force.

Seismic. Of, subject to, or caused by an earthquake or an earth vibration.

Seismic Event. The abrupt release of energy in the earth’s lithosphere causing an earth vibration; an earthquake.

Seismic Force Resisting System. The part of the structural system that is designed to provide required resistance to prescribed seismic forces.

Seismic Forces. The actual forces created by earthquake motion; assumed forces prescribed in the IBC that are used in the seismic design of a building and its components.

Seismic Hazard. Any physical phenomenon such as ground shaking or ground failure associated with an earthquake that may

produce adverse effects on the built environment and human activities; also the probability of earthquakes of defined magnitude or intensity affecting a given location.

Seismic Risk. The probability that the social or economic consequences of an earthquake will equal or exceed specified values at a site during a specified exposure time; in general, seismic risk is vulnerability multiplied by the seismic hazard.

Seismic Use Group. A classification assigned in the Provisions to a structure based on its occupancy and use as defined in the IBC.

Seismic Waves. See “Waves, Seismic.”

Seismic Zone. Generally, areas defined on a map within which seismic design requirements are constant; in the IBC, seismic zones are defined both by contour lines and county boundaries.

Shear. A force that acts by attempting to cause the fibers or planes of an object to slide over one another.

Shear Panel. See “Wall, Shear.”

Shear Wall. See “Wall, Shear.”

Speed. Rate of change of distance traveled with time irrespective of direction.

Stiffness. Resistance to deflection or drift of a structural component or system.

Story Drift. Vertical deflection of a single story of a building caused by lateral forces.

Strain. Deformation of a material per unit of the original dimension.

Strength. The capability of a material or structural member to resist or withstand applied forces.

Stress. Applied load per unit area or internal resistance within a material that opposes a force's attempts to deform it.

S-Wave. Shear or secondary wave produced essentially by the shearing or tearing motions of earthquakes at right angles to the direction of wave propagation.

System. An assembly of components or elements designed to perform a specific function such as a structural system.

Torque. The action of force that tends to produce torsion; the product of a force and lever arm as in the action of using a wrench to tighten a nut.

Torsion. The twisting of a structural member about its longitudinal axis.

Velocity. Rate of change of distance traveled with time in a given direction; in earthquakes, it usually refers to seismic waves and is expressed in inches or centimeters per second.

Vulnerability. The degree of loss to a given element at risk, or set of such elements, resulting from an earthquake of a given intensity or magnitude; expressed in a scale ranging from no damage to total loss; a measure of the probability of damage to a structure or a number of structures.

Wall, Bearing. An interior or exterior wall providing support for vertical loads.

Wall, Cripple. A framed stud wall, less than 8 feet in height, extending from the top of the foundation to the underside of the lowest floor framing.

Wall, Nonbearing. An interior or exterior wall that does not provide support for vertical loads other than its own weight as permitted by the building code; see also “Partition.”

Wall, Shear. A wall, bearing or nonbearing, designed to resist lateral forces parallel to the plane of the wall.

Wall System, Bearing. A structural system with bearing walls providing support for all or major portions of the vertical loads; seismic resistance may be provided by shear walls or braced frames.

Waves, Seismic. Vibrations in the form of waves created in the earth by an earthquake.

Weight. Name given to the mutual gravitational force between the earth and an object under consideration; varies depending on location of the object at the surface of the earth.

5.1 INTRODUCTION

This chapter introduces the nature and probability of floods and the types of flood damage that result when school facilities are located in flood hazard areas.

Avoidance of such areas is the most effective way to minimize risks to occupants, including health hazards and damage to property. When a school must be built in a flood hazard area, site layout and facility design measures can minimize damage and risks. The chapter also provides an overview of measures that designers should consider in order to reduce risks at existing schools that are already located in areas prone to flooding.

5.2 NATURE AND PROBABILITY OF FLOODS

Flooding is the most common natural hazard in the United States, affecting over 20,000 local jurisdictions and representing more than 70 percent of Presidential Disaster Declarations. Several evaluations have estimated that 10 percent of the Nation's land area is subject to flooding. Some communities have very little land that is identified as exposed to flooding, although others lie entirely within the floodplain.

Flooding is a natural process that may manifest in a variety of forms: long-duration flooding along rivers that drain large watersheds; flash floods that send a devastating wall of water down a mountain canyon; and coastal flooding that accompanies high tides and on-shore winds, hurricanes, and Nor'easters.

Four Examples of Schools Vulnerable to Flood Hazards

Two schools in Gurnee, Illinois, were damaged by floods in 1986. The school district's actual costs were over \$1.6 million to repair and replace the facilities, supplies, and materials. Not included in these figures are the costs for transportation and rental, and disruption of the school year for children who, for several months, attended school in a vacant department store 4 miles away. For an additional 2 years of renovation and reconstruction, the children attended school in another community, 8 miles away. One school was later rebuilt as a flood protected facility for a cost of \$17 million, all of which was paid by local taxpayers.

In April 2003, a dry floodproofed private school in Jackson, Mississippi, experienced a soaking when a sudden downpour dumped 9 inches of rain on the area. Because the event occurred in the pre-dawn hours when no one was on site to install the floodproofing measures (e.g., water-tight doors and special seals), water entered the building, causing damage to carpets, walls, furniture, and equipment.

Continued on next page

In 1989, Hurricane Hugo vividly revealed the importance of knowing whether schools are prone to flooding. The local emergency manager's records identified the McClellanville, South Carolina, school as an approved hurricane shelter. Unfortunately, that designation was based on erroneous information because the school turned out to be four feet lower than indicated in those records. When storm surge flooding inundated the school, people had to break through the ceiling and lift everyone up to the attic.

Flooding in the spring of 2001 tested flood protection for the Oak Grove Lutheran High School in Fargo, North Dakota. Prompted by the failure of temporary earth and sandbag dikes during the 1997 Red River flood of record, which resulted in over \$3.5 million in damage to the school, the city designed and constructed a brick-faced permanent floodwall. Five access points, wide enough for vehicles, were protected with an "invisible" closure that is an integral part of the floodwall. A crew of six was able to install the closures in less than 2 hours.

When the natural process is unaltered by human activity, flooding is not a problem. In fact, species of plants and animals that live adjacent to bodies of water are adapted to a regimen of periodic flooding.

Flooding is only considered a problem when human development is located in flood-prone areas. Problems can result, not only exposing people to dangerous situations and property to damage, but also disrupting the natural functions of floodplains and redirecting surface flows onto lands that are not normally subject to flooding.

Flooding along waterways normally occurs as a result of excessive rainfall or snowmelt that creates flood flows that exceed the capacity of channels. Flooding along shorelines is usually due to coastal storms that generate storm surges or waves above normal tidal fluctuations. Factors that can affect the frequency and severity of flooding and the resultant types of damage include:

- Channel obstructions due to fallen trees, accumulated debris, and ice jams
- Channel obstructions due to road and railroad crossings where the bridge or culvert openings are insufficient to convey floodwaters
- Erosion of shorelines and stream banks, often with episodic collapse of large areas of land
- Deposition of sediment that settles out of floodwaters or is carried inland by wave action
- Failure of dams (whether due to seismic activity, lack of maintenance, flows that exceed the design, or destructive acts) may suddenly and unexpectedly release large volumes of water

- Failure of levees (whether associated with flows that exceed the design, weakening by seismic activity, lack of maintenance, or destructive acts) may result in sudden flooding of areas thought to be protected

5.2.1 Characteristics of Flooding

Each type of flooding has characteristics that are important aspects of the hazard and that must be considered in the selection of school sites, the design of new schools, and the expansion or retrofit of existing flood-prone schools in ways that minimize damage.

Riverine flooding is due to the accumulation of runoff from rainfall or snowmelt such that the volume of flow exceeds the capacity of waterway channels and spreads out over the adjacent land. Riverine flooding flows downstream under the force of gravity. Its depth, duration, and velocity are functions of many factors, including watershed size and slope, degree of upstream development, soil types and nature of vegetation, steepness of the topography, and characteristics of storms (or depth of snowpack and rapidity of melting). Figure 5-1 illustrates a cross-section of a riverine floodplain.

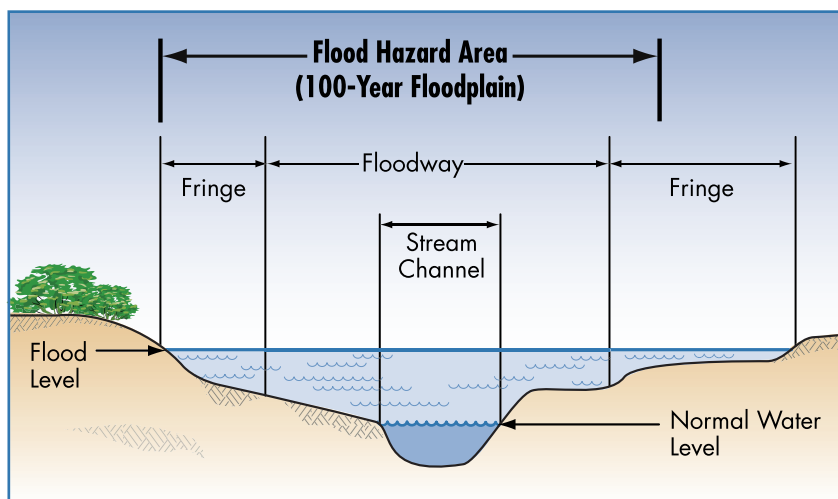

Figure 5-1
The riverine floodplain

Coastal flooding is experienced along the Atlantic, Gulf, and Pacific coasts, and many larger lakes, including the Great Lakes. Coastal flooding is influenced by storm surges associated with tropical cyclonic weather systems (hurricanes, tropical storms, tropical depressions, typhoons), extratropical systems (Nor'easters), and tsunamis (surge induced by seismic activity). Coastal flooding is also generally characterized by wind-driven waves. Wind-driven waves affect reaches along the Great Lakes shorelines, where winds blowing across the broad expanses of water generate wind-driven waves that can rival those experienced along other coastal shorelines. Some Great Lakes shorelines experience coastal erosion, in part associated with fluctuations in water levels. Figure 5-2 is a schematic of the coastal floodplain.

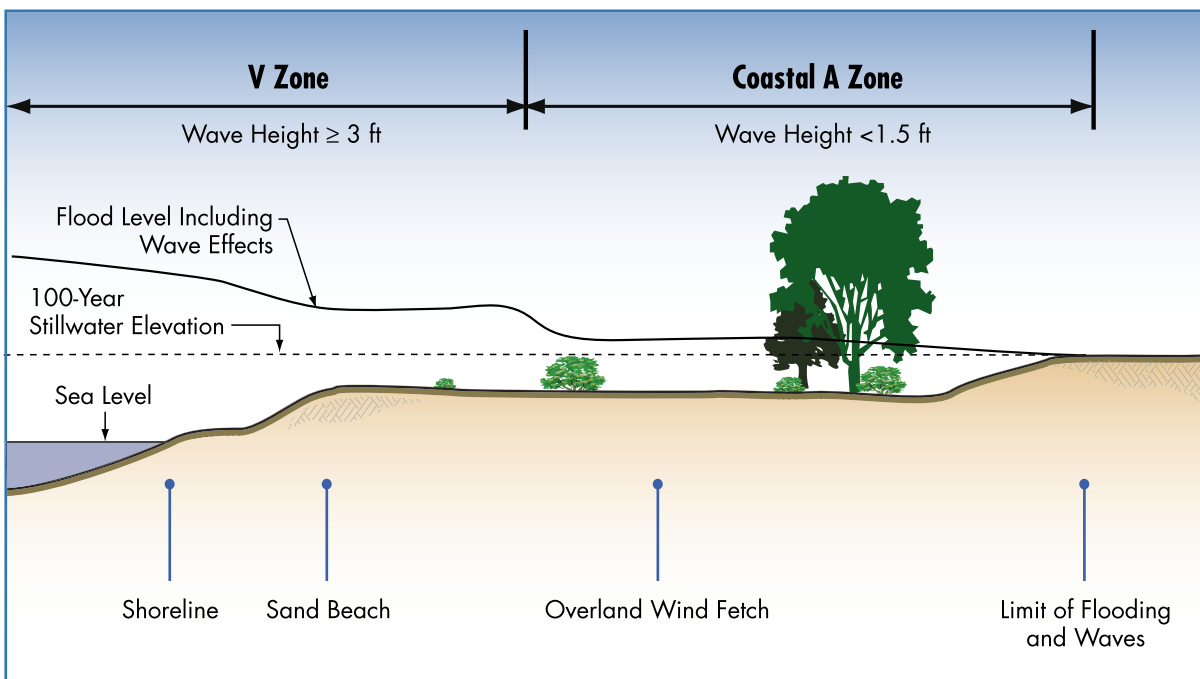

Figure 5-2 The coastal floodplain

Riverine and coastal flooding can be characterized by a number of factors that become important in the selection of school sites, site design, and design of school buildings:

- **Depth.** The most obvious characteristic of any flood is the depth of water. Depending on many factors, such as the shape of a river valley or the presence of obstructing bridges, riverine flooding may rise just a few feet or tens of feet above normal. The depth of coastal flooding is influenced by such factors as the tidal cycle, the duration of the storm, the elevation of the land, and the presence of waves. Depth is a critical factor in building design because the hydrostatic forces that are exerted on a vertical surface (such as a foundation wall) are directly related to depth and because costs associated with protecting buildings from flooding significantly increase with depth.
- **Duration.** Duration is the measure of how long the water remains above normal levels. The duration of riverine flooding is primarily a function of watershed size and the longitudinal slope (which influences how fast water drains away). Small watersheds are more likely to be “flashy,” which refers to the rapidity with which floodwaters rise and fall. Areas adjacent to large rivers may be flooded for weeks or months. Most coastal flooding is influenced by the normal tidal cycle, as well as how fast coastal storms move out of the area. Areas subject to coastal flooding can experience long duration flooding where drainage is slow, or may be impacted on the order of 12-24 hours if storms move rapidly. Flooding of large lakes, including those behind dams, can be of very long duration because of the sheer volume of water that must flow past a control point. For building design, duration is important because it affects access, building usability, saturation and

Local drainage problems create ponding and local flooding that often is not directly associated with a body of water such as a creek or river. Although these problem areas generally are relatively shallow and often are not characterized by high velocity, considerable damage may result, especially when poor drainage causes repetitive damage. Some local drainage problems are exacerbated by old or undersized drainage system infrastructure. Because drainage problems typically occur as sheetflow or along waterways with very small drainage areas, this type of flooding often is not mapped or regulated.

stability of soils, and building materials. Information about flood duration is sometimes available as part of a flood study or could be developed by a qualified engineer.

- **Velocity.** The rates at which floodwaters move range from extremely rapid (associated with flash floods) to nearly stagnant (in backwater areas and expansive floodplains). Velocity is important in site planning because of the potential for erosion. In structural design, velocity is a factor in hydrodynamic loads, including impact loads and drag forces. With respect to public safety, even shallow high velocity water poses threats to pedestrians and vehicles. Accurate estimates of velocities are difficult to make, although limited information may be found in floodplain studies.
- **Wave action.** Waves contribute to erosion and scour, and also contribute significantly to loads on buildings. The magnitude of wave forces can be 10 or more times higher than wind and other design loads. Waves must be accounted for along coastal shorelines, in flood hazard areas that are inland of open coasts, and other areas subject to waves, including areas with sufficient fetch that winds generate waves (such as lakes and expansive riverine floodplains).
- **Impacts from debris and ice.** Floating debris and ice contribute to loads that must be accounted for in design. The methods and models used to predict and delineate flood hazard areas do not specifically incorporate debris, thus there are few sources to characterize potential impacts other than past observations.
- **Erosion and scour.** Erosion refers to a lowering of the ground surface in response to a flood event or the gradual recession of a shoreline due to long-term coastal processes. Scour refers to a localized lowering of the ground surface during a flood due to the interaction of currents and/or waves with structural elements, such as pilings. Erosion and scour may affect the stability of foundations and filled areas, and can

cause extensive site damage. Soil characteristics influence susceptibility to scour.

5.2.2 Probability of Occurrence

In order to guide and regulate development, and to develop specific designs to resist flood forces, it is necessary to identify the “design flood.” For decades, the design flood has been referred to as the “base flood.” More precisely, it is the “1%-annual chance flood,” but is commonly called the “100-year flood.” The latter term is often mis-understood because it conveys the impression that a flood of that magnitude will occur only every 100 years. Statistically, the 1%-annual chance flood has one chance in 100 of occurring in any given year. The fact that a 1%-annual chance flood is experienced at a specific location does not alter the probability that a comparable flood will occur at the same location in the next year, or even twice in one year.

Regardless of the flood selected for design purposes, the designer must determine specific characteristics associated with that flood. A flood of a specific return frequency is determined in a multi-step process that typically involves using computer models that are in the public domain. If a sufficiently long record of floods exists, the design flood may be determined by applying statistical tools to the record. Alternatively, sometimes water resource engineers apply computer models to simulate different rainfall events over watersheds and to predict how much water will run off and accumulate in channels. Other computer models are used to characterize the flow of water down the watershed and predict how high it will rise. For coastal areas, both historical storms and simulated storm models can be used to predict the probability that floodwaters will rise to a certain level.

The National Flood Insurance Program (NFIP), described in Sections 5.3.1 and 5.3.2, uses the 1%-annual chance flood as the basis for flood hazard maps, for setting insurance rates, and for application of regulations in order to minimize future flood damage. The 1%-annual chance flood is also used to examine

older buildings to determine measures that are applied in order to reduce future damage.

Communities are encouraged to treat schools as essential critical facilities because of the significant and long-term impacts on students and the community if a damaged school is closed for an extended period of time. Essential and critical facilities usually are intended to remain operational in the event of extreme environmental loading from floods, hurricanes, snow, or seismic events. A higher level of protection has been determined to be appropriate for facilities that are important to protect in order to enhance rapid recovery, including hospitals, emergency operations centers, emergency shelters, water treatment plants, and other buildings that support vital services.

5.2.3 Hazard Identification and Flood Data

Flood hazard maps are prepared to identify areas of the landscape that are subject to flooding, usually flooding by the 1%-annual chance flood. Maps prepared by the NFIP are the minimum basis of state and local floodplain regulatory programs. Some states and communities have prepared maps that reflect a floodplain determined using a “higher standard,” such as assuming the upper watershed area is built-out completely according to existing zoning. Some communities use a flood of record or a historically significant flood as the basis for regulation.

The flood hazard maps used by the appropriate regulatory authority should be consulted during site selection, site design, and building design (whether for new buildings or existing buildings). Since the NFIP began producing Flood Insurance Rate Maps (FIRMs), these maps have been prepared for over 19,200 communities. FIRMS are prepared for each local jurisdiction that has been determined to have some degree of flood risk and, typically, the maps may be viewed by visiting community planning or permit offices¹. Many FIRMs do not show detailed information about

¹ Flood maps may also be viewed online at FEMA’s Map Store at <http://www.fema.gov>. For a fee, copies may be ordered online or by calling (800) 358-9616. The Flood Insurance Study (FIS) and engineering analyses used to determine the flood hazard area also may be ordered through the FEMA webpage.

predicted flood elevations along all bodies of water and the 0.2%-annual chance flood hazard areas often are not shown. In these cases, additional engineering analyses are necessary in order to determine the flood-prone areas and the appropriate characteristics of flooding required for site layout and building design.

If a proposed school site or an existing school is affected by flooding, a site-specific topographic survey is critical for delineating the land that is below the design flood elevation (DFE). If detailed flood elevation information is not available, a floodplain study may be required to identify the important flood characteristics and data required for sound design. Having flood hazard areas delineated on a map conveys a degree of precision that may be misleading. Flood maps have a number of limitations that should be examined, especially during site selection and design of essential and critical facilities such as schools:

- Flood hazard areas are approximations: the flood elevations shown and the areas delineated should not be taken as absolutes, in part because they are based on numerical approximations of the real world.
- NFIP FIRMs and Flood Insurance Studies (FISs) were prepared to meet the requirements of the NFIP. For the most part, floodplains along smaller streams and drainage areas (less than 1 square mile) are not shown.
- Especially for older maps, the topography used to delineate the flood boundary may have had contour intervals of 5, 10, or even 20 feet, which significantly affects the precision with which the boundary is determined. The actual elevation of the ground relative to the flood elevation is critical, as opposed to whether an area is shown as being in or out of the mapped flood hazard area.
- Older maps may not reasonably account for upland development that increases rainfall-runoff and tends to increase flooding.

- The scale of the maps may not itself to precise determinations.
- Flooding may have been altered by development, whether upland development that increases runoff or local modifications that alter the shape of the land surface of the floodplain (such as fills or levees).
- Local conditions are not reflected, especially conditions that change regularly, such as streambank erosion and shoreline erosion.

The flood hazard maps prepared by the NFIP show different zones that identify some differences in flooding characteristics:

- **A Zones.** Flood hazard areas where engineering analyses have not been performed to develop detailed flood elevations and boundaries, also called “unnumbered A Zones” or “approximate A Zones,” for the base flood (1%-annual chance flood). Additional engineering analysis and site-specific assessments usually are required to determine the design flood elevation.
- **AE Zones or A1-A30 Zones.** These designations are used for flood hazard areas where engineering analyses have produced detailed flood elevations and boundaries for the base flood (1%-annual chance flood). For riverine waterways with these zones, FISs include longitudinal profiles showing water surface elevations for different frequency flood events.
- **Floodways.** The floodway includes the waterway channel and adjacent land areas that must be reserved in order to convey the discharge of the base flood without cumulatively increasing the water surface elevation more than a designated height. Floodways are designated for most waterways that have AE Zones. FISs include data on floodway widths and mean floodway velocities.

- **AO and AH Zones.** Areas of shallow flooding are generally shown where the flood depth averages from 1 to 3 feet, where a clearly defined channel does not exist, where the path of flooding is unpredictable, and where velocity flow may be evident. These zones are characterized by ponding or sheetflow.
- **Shaded X (or B) Zones.** This zone shows areas of the 500-year flood (0.2%-annual chance flood), or areas protected by flood control levees. This zone is not shown on many NFIP maps and its absence does not imply that flooding of this frequency will not occur.
- **Unshaded X (or C) Zones.** These zones are all land areas not mapped as flood hazard areas (either 1%- or 0.2%-annual chance flood hazard areas) that are outside of the floodplain that is designated for the purposes of regulating development pursuant to the NFIP. These zones may still be subject to small stream flooding and local drainage problems.
- **V Zones (V, VE, and V1-V30).** Also known as “coastal high hazard areas,” V Zones are relatively narrow areas along open coastlines and some large lake shores that are subject to high-velocity wave action from storms or seismic sources. V Zones extend from off-shore to the inland limit of a primary frontal dune or to an inland limit where breaking waves are predicted to be at least 3 feet in height.²
- **Coastal A Zone.** The principal sources of flooding in Coastal A Zones are astronomical tides, storm surges, seiches, or tsunamis. These zones extend inland to include areas where the potential for breaking wave heights exists during conditions of the base flood. Coastal A Zones are not delineated on NFIP maps; this zone is identified in ASCE 7 and ASCE 24 because waves sufficient to contribute to damage are present.

² Because V Zones are generally limited in extent, such areas are unlikely sites for schools. The specific design and construction provisions for V Zones are not addressed in this manual. More information can be found in FEMA 55, *Coastal Construction Manual*.

Flood Hazard Zones

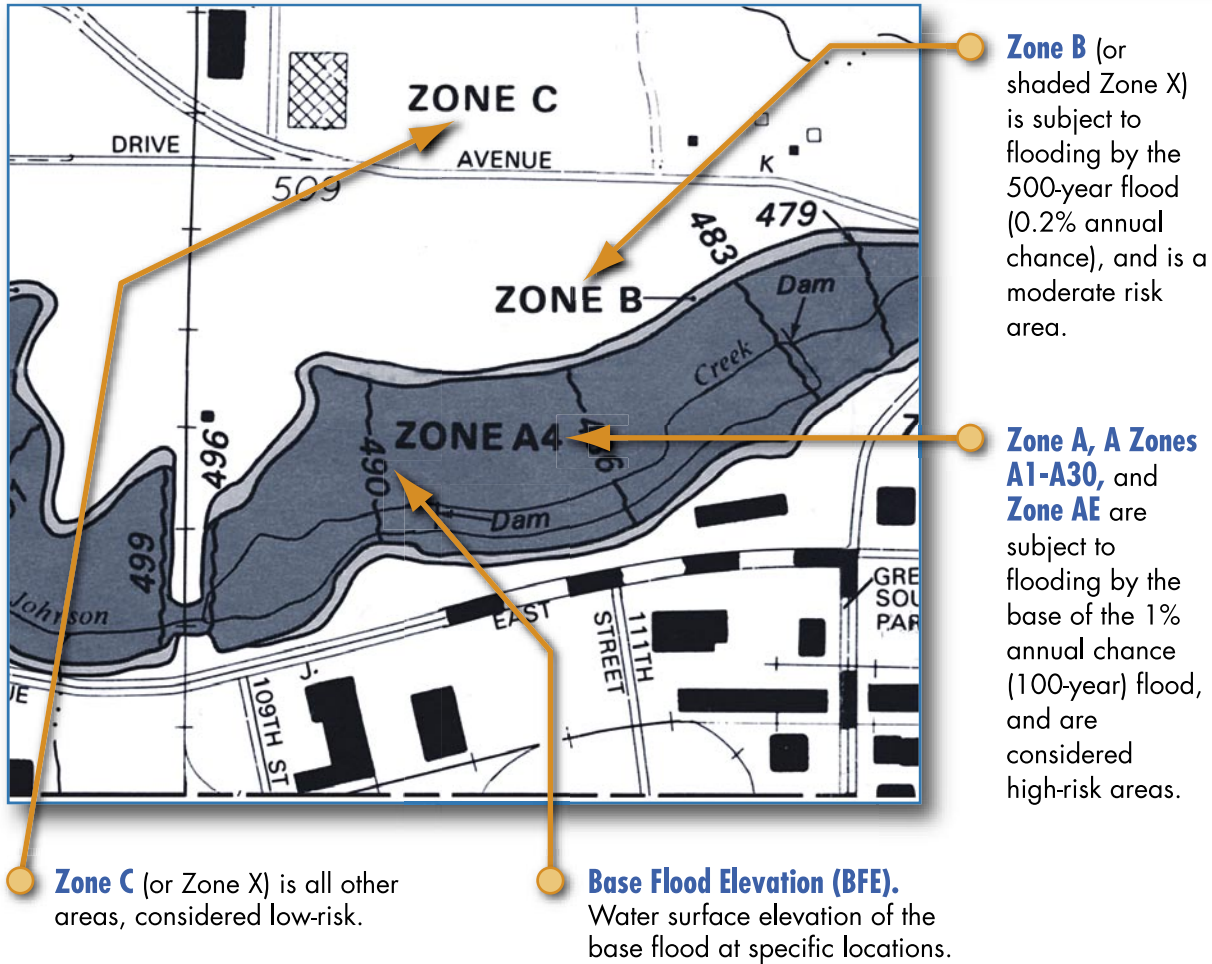

Figure 5-3 Riverine flood hazard zones

Flood hazards and characteristics of flooding must be identified in order to appropriately evaluate the impact of site development, to calculate flood loads, to design floodproofing measures, or to identify and prioritize retrofit measures for existing schools. Many characteristics are not shown on the flood hazard maps but may be found in the FIS or the study or report prepared by the entity that produced the flood hazard map. Otherwise, additional research is required. Table 5-1, on page 5-22, outlines a series of questions to facilitate this objective.

5.2.4 Design Flood Elevation

The design flood elevation establishes the minimum level of flood protection that must be provided. DFE as used in the model building codes is defined as either the base flood elevation (BFE) determined by the NFIP or the elevation of a design flood designated by the community, whichever is higher.

The DFE will always be at least as high as the BFE. Communities may use a design flood that is higher than the base flood for a number of reasons, (e.g., to account for future upland development, recognize a historic flood, or incorporate a factor of safety, known as freeboard).

The DFE is the highest elevation of either the flood hazard area shown on a community's Flood Insurance Rate Map, or another flood as legally designated by a community (e.g., accounting for future development).

Figure 5-4 shows the relationship between the BFE and the DFE. School planners and designers should check with the appropriate regulatory authority to determine the minimum flood elevation to be used in site planning and design. For essential and critical facilities such as schools, it is common that state and local regulations cite the 0.2% chance flood (500-year flood) as the design minimum or the regulations may call for added freeboard of 1, 2, or 3 feet above the minimum flood elevation.

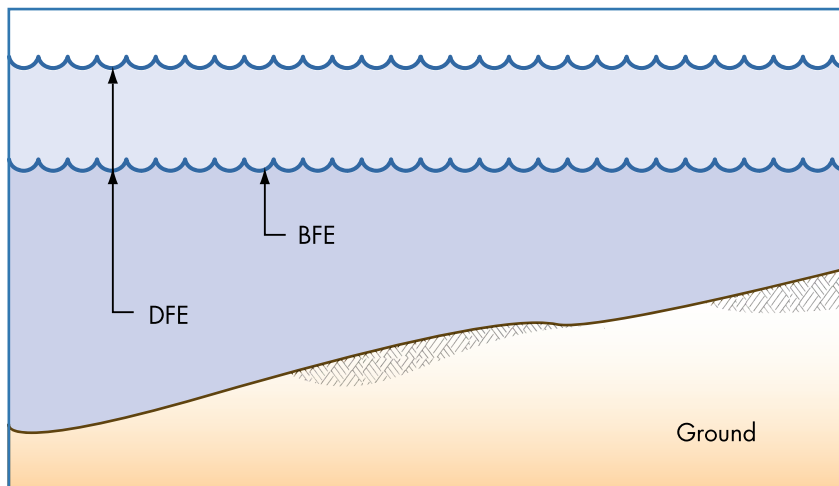

Figure 5-4 Definition sketch – flood elevations

5.3 SCOPE, EFFECTIVENESS, AND LIMITATIONS OF BUILDING CODES AND FLOODPLAIN MANAGEMENT REQUIREMENTS

With respect to design and construction to resist flood damage, the existing minimum requirements in model building codes and regulations are based on the National Flood Insurance Program. The original authorizing legislation for the NFIP was passed in 1968. Congress expressly found that “a program of flood insurance can promote the public interest by encouraging sound land use by minimizing exposure of property to flood losses . . .”

The most convincing evidence of the effectiveness of the NFIP minimum requirements is found in flood insurance claim payment statistics. Buildings that pre-date the NFIP requirements are, by and large, not constructed to resist flood damage. Buildings that post-date the NFIP (i.e., those that were constructed after a

community joined and began applying the minimum requirements) are designed to resist flood damage. The NFIP reports that aggregate loss data indicate that buildings that meet the minimum requirements experience 70 percent less damage than do buildings that pre-date the NFIP. There is ample evidence that buildings that exceed the minimum requirements are even less likely to sustain damage.

Construction of public schools may be regulated by a state board or agency and thus may not be subject to local permit requirements, including local floodplain management regulations. In these cases, the NFIP minimum requirements must still be satisfied, whether through regulation, executive order, or a state building code.

5.3.1 Overview of the NFIP

The NFIP is intended to encourage states and local governments to recognize and incorporate flood hazards in land use and development decisions. In some states and communities, this is achieved by guiding development to areas with lower risk. When decisions result in development within flood hazard areas, application of the criteria set forth in Federal Regulation at 44 CFR §60.3 minimize exposure and flood-related damage. State and local gov-

ernments are responsible for the application of the provisions of the NFIP through regulatory permitting processes. At the federal level, the NFIP is managed by FEMA and has three main elements:

- Hazard identification and mapping, under which engineering studies are conducted and flood maps are prepared in partnership with states and communities to delineate areas that are predicted to be subject to flooding under certain conditions.
- Floodplain management criteria for development, which establish the minimum requirements to be applied to development within mapped flood hazard areas with the intent of recognizing hazards in the entire land development process.
- Flood insurance, which provides financial protection for property owners to cover flood-related damage to buildings and contents.

Federal flood insurance is designed to provide property owners, including school districts, an alternative to disaster assistance and disaster loans. Disaster assistance has limited coverage for full costs to repair and clean up and is available only after the President of the United States signs a disaster declaration for the area. Importantly, school districts should be aware that they may be subject to a mandated reduction in disaster assistance payments if a public school building is not covered by flood insurance. NFIP flood insurance claims are paid any time damage from a qualifying flood event occurs, regardless of whether a major disaster is declared.

Another important objective of the NFIP is to break the cycle of flood damage. Many buildings have been flooded, repaired or rebuilt, and flooded again. Before the NFIP, in some parts of the country, this cycle occurred every couple of years, with reconstruction taking place in the same flood-prone areas using the same construction techniques that did not adequately resist flood damage. By guiding development to lower risk areas and

by requiring compliance with performance measures to minimize exposure of new buildings and buildings that undergo major renovation or expansion, the long-term objective of disaster resistant communities can be achieved.

5.3.2 Summary of the NFIP Minimum Requirements

The performance requirements of the NFIP are set forth in federal regulation at 44 CFR Part 60. The requirements apply to all development, which the NFIP broadly defines include buildings and structures, site work, roads and bridges, fills and other activities. Buildings must be designed and constructed to resist flood damage, which is primarily achieved through elevation (or floodproofing). Additional specific requirements apply to existing development, especially existing buildings. Existing buildings that are proposed for substantial improvement, including repair of substantial damage, are subject to the regulations.

“Substantial improvement” is any repair, reconstruction, rehabilitation, addition or improvement of a building, the cost of which equals or exceeds 50 percent of the market value of the building before the improvement or repair is started (certain historic structures may be excluded).

Although the NFIP regulations primarily focus on how to build, one of the long-term objectives of the program is to guide development to less hazardous locations. Preparing flood hazard maps and making the information available to the public is fundamental in satisfying that objective. With that information, people can make informed decisions about where to build, how to use site design to minimize exposure to flooding, and to how to design buildings that will resist flood damage.

The NFIP’s broad performance requirements for site work are as follows:

- Building sites shall be reasonably safe from flooding.
- Adequate site drainage shall be provided to reduce exposure to flooding.

- New and replacement sanitary sewage systems shall be designed to minimize or eliminate infiltration of floodwaters into the systems and discharges from the systems into floodwaters.
- Development in floodways shall be prohibited unless engineering analyses show that there will be no increases in flood levels.

The NFIP's broad performance requirements for new buildings proposed for flood hazard areas (and substantial improvement of existing flood-prone buildings) are as follows:

- Buildings shall be designed and adequately anchored to prevent flotation, collapse, or lateral movement resulting from hydrodynamic and hydrostatic loads, including the effects of buoyancy.
- Buildings shall be constructed by methods and practices that minimize flood damage (primarily by elevating to or above the base flood level or by specially designed and certified floodproofing measures).
- Buildings shall be constructed with electrical, heating, ventilation, plumbing, and air conditioning equipment and other service facilities that are designed and/or located so as to prevent water from entering or accumulating within the components.

Designers should determine if there are any applicable state-specific requirements pertinent to floodplain development. Some states require that local jurisdictions apply standards that exceed the minimum requirements of the NFIP. Some states have direct permitting authority programs that impose higher standards, while some states have direct permitting authority over certain types of construction or certain types of applicants.

As participants in the NFIP, states are required to ensure that development that is not subject to local regulations, such as state

construction, satisfies the same performance requirements. If schools are exempt from local permits, this may be accomplished through a state permit, a governor's executive order, or other mechanism that applies to entities not subject to local authorities.

5.3.3 Model Building Codes and Standards

The 2000 and 2003 editions of the International Building Code (IBC) and the 2003 edition of the National Fire Protection Association's Building Construction and Safety Code (NFPA 5000) are the first model codes to include comprehensive provisions to address flood hazards. Both codes are consistent with the minimum provisions of the NFIP that pertain to design and construction of buildings. The NFIP requirements that pertain to site development and floodways generally are found in other local ordinances. The codes require designers to identify anticipated environmental loads and load combinations, including wind loads, seismic loads, snow loads, soil conditions and flood loads.

The IBC and NFPA 5000 reference standards that are developed through a rigorous consensus process. The best known is *Minimum Design Loads for Buildings and Other Structures* (ASCE 7), produced by the American Society of Civil Engineers (ASCE). The model building codes require that applicable loads be accounted for in the design. The designer must identify the pertinent, site-specific characteristics and then use ASCE 7 to determine the specific loads and combined loads. In effect, it is similar to a local floodplain ordinance that requires determination of the environmental condition (in/out of the mapped flood hazard area, DFE/depth of water) and then specifies certain conditions that must be met during design and construction. The 1998 edition of ASCE 7 was the first version of the standard to explicitly include flood loads, including hydrostatic loads, hydrodynamic loads (velocity and waves), and debris impact loads.

The IBC and NFPA 5000 also refer to a standard first published by ASCE in 1998, *Flood Resistant Design and Construction* (ASCE 24). Developed through a consensus process, ASCE 24 addresses spe-

cific topics pertinent to designing buildings in flood hazard areas, including floodways, coastal high hazard areas, and other high-risk flood hazard areas such as alluvial fans, flash flood areas, mudslide areas, erosion-prone areas, and high velocity areas.

5.4 RISK REDUCTION: AVOIDING FLOOD HAZARDS

Flood hazards are unlike earthquake hazards and wind hazards. Those hazards often are assigned at the county level because the hazards themselves do not significantly vary from one geographic location within a county to another. Of course, there may be site-specific variations in those hazards, such as soils susceptible to liquefaction during seismic activity, or local topographic differences that influence wind speeds. However, for the most part, the earthquake and wind hazards cannot be avoided by choosing alternative locations.

Flood hazards are site-specific. When a flood hazard map is prepared, lines drawn on the map appear to precisely define the hazard area. Land that is on one side of the line is “in” the mapped flood hazard area, while the other side of the line is “out.” Although the delineation may be an approximation, having hazard areas shown on a map facilitates avoiding such areas to the maximum extent practical. Where it is unavoidable, school districts should carefully evaluate all of the benefits and all of the costs in order to determine long-term acceptable risks and to develop appropriate plans for design and construction of new schools.

Section 5.6 describes the damage that is sustained by existing buildings that are exposed to flood hazards, including: site damage; structural and nonstructural building damage; destruction or impairment of service equipment; loss of contents; and health and safety threats due to contaminated floodwaters. These types of damage, along with loss of function and community service, are avoided if schools are located away from flood hazard areas. Damage is minimized when schools that must be

located in flood hazard areas are built in compliance with minimum requirements.

5.4.1 Benefits/Costs: Determining Acceptable Risk

Many decisions that are made with respect to schools are, in part, based on a determination of acceptable risk. Risk includes the potential losses associated with a hazard. Ideally, risk is defined in terms of expected probability and frequency of the hazard occurring, people and property exposed, and potential consequences. Choosing a site or accepting donated land that is affected by flooding is a decision to accept some degree of risk. Although the flood-prone land may have a lower initial cost, the incremental costs of construction plus the likely increased costs of maintenance, repair, and replacement may be significant. Another cost of locating a school in a flood-prone area is access. Although the building may be elevated and protected, if access is restricted periodically, the use of the school also is affected.

The school district's planning team and the design team can influence the degree of risk (e.g., the frequency with which flooding may affect the site). They control it through selection of site design and building design measures. Fundamentally, this process is a balancing of the benefits of an acceptable level of disaster resistance with the costs of achieving that degree of protection. With respect to mitigation of future hazard events:

- Benefits are characterized and measured as damage avoided if the mitigation measures (including avoiding flood hazard areas) are implemented.
- Costs are the costs associated with implementing measures to eliminate or reduce exposure to hazards.

Section 5.6 describes damage and losses that are incurred by buildings exposed to flooding. Direct damage includes damage to physical property, including the site, the building, building materials, utilities, and building contents. Indirect damage that is not listed includes health hazards, functionality impacts, emergency response, evacuation, and expenses associated with occupying another building during repairs.

For the most part, benefits are difficult to measure because they are associated with damage that does not occur, cleanup that is not required, and service that is uninterrupted because flooding does not shut down a school. In addition, benefits accrue over long periods of time, thus making it more difficult to make a direct comparison of benefits with costs of mitigation. Mitigation costs can more readily be expressed in terms of the higher costs of a flood-free site or the initial capital costs of work designed to resist flood damage. Thus, without a full accounting of both benefits and costs, decision makers may not be able to make fully informed decisions. Some questions that should be answered include:

- If the site is flood-prone and the building is out of the flood hazard area or elevated on fill, what are the average annual cleanup costs associated with removal of sand, mud, and debris deposited by floods of varying frequencies?
- If the school building is elevated by means other than fill, will periodic inundation of the exposed foundation elements cause higher average annual maintenance costs?
- If the school building meets only the minimum elevation requirements, what are the average annual damage and cleanup costs over the anticipated useful life of the building, including the occurrence of floods that exceed the design flood elevation?
- How do long-term costs associated with periodic inundation compare to up-front costs of selecting a different site or building to a higher level of protection?

- If access to the school is periodically restricted due to flooding, especially long-duration flooding, what cost impacts will result? How often would the school district have to provide an alternate location to continue classes?

5.4.2 Identifying Flood Hazards at School Sites

To the extent practical, schools and attendant athletic fields and facilities should be located outside of known flood hazard areas. The best available information regarding flooding should be examined, including flood hazard maps, records of historical flooding, and advice from local experts, and others who can evaluate flood risks.

As part of site selection and to guide locating the school building and other improvements on a site, designers should investigate site-specific flood hazard characteristics. Table 5-1 outlines questions that will produce information that must be determined prior to initiating site layout and design work.

Table 5-1: Flood Hazards at School Sites

Evaluation Question	Evaluation Y or N or Comment	Guidance	Data Reference
Is the site near a body of water (with or without a mapped flood hazard area)?		All bodies of water are subject to flooding, but not all have been designated as floodplain on FIRMs. This provides information about the flood hazard on the site and, if present, determines certain regulatory requirements.	FIRM or local flood hazard maps; available for review in local planning and permit offices. Site-specific analyses should be performed by qualified water resources engineers.
Is the site affected by a regulatory floodway?		Development in floodways, including fill and construction of buildings, is prohibited unless demonstrated that there will be no resulting increase in flood elevations.	FIRM, Flood Hazard Floodway Boundary Map, local flood hazard maps; available for review in local planning and permit offices.

Table 5-1: Flood Hazards at School Sites (continued)

Evaluation Question	Evaluation Y or N or Comment	Guidance	Data Reference
Has the site been affected by past flood events?		Records of actual flooding augment studies that predict flooding, especially if historic events resulted in deeper or more widespread flooding.	Local planning and permit offices; local historical society; State Department of Transportation; State Water Resources or Emergency Management Agency; Natural Resources Conservation Service; U.S. Army Corps of Engineers.
Can the site be accessed by emergency and fire vehicles during flood events?		Firefighting efforts during floods are compounded when access roads are flood-prone.	Topographic map with delineated flood hazard area and flood depths used for site layout and access road design.
What is the required minimum protection level required by regulatory authorities?		The 100-year and 500-year flood levels are the minimum required protection levels for projects in mapped flood hazard areas. Critical facilities (including schools) may be required to be above the 500-year flood level. Lower levels of protection may be allowed outside the regulated areas, but are not recommended.	Authority having jurisdiction that establishes design criteria for schools; state building codes and floodplain regulations; local building codes and floodplain regulations.
What is the DFE?		Land below the DFE is in the “floodplain” and subject to regulatory provisions. The DFE is the basis for minimum protection measures; critical facilities (including schools) should be protected to at least 2- or 3-feet higher.	FIRM; local flood hazard map; flood profiles along waterways with detailed studies; site-specific studies for flood hazard areas identified without flood elevations.
What is the predicted depth of flooding?		The depth of flooding influences site layout, site modifications, design of protection measures, and computation of loads on buildings. Sites with deep flooding are less feasible to develop efficiently and cost effectively.	The DFE minus the ground elevation at specific site yields the predicted depth of water. For large parcels of land, the depth of flooding is likely to vary over the site.

Table 5- 1: Flood Hazards at School Sites (continued)

Evaluation Question	Evaluation Y or N or Comment	Guidance	Data Reference
What is the expected velocity of floodwaters on the school site?		Velocity is the rate at which water moves and is measured in feet per second. Velocity is a factor in computing loads associated with hydrodynamic forces, including drag on building surfaces. Depending in part on soil types and vegetative cover, velocity is related to erosion, including streambank erosion, erosion of earthen fill, and local scour around buildings. Velocity also affects public safety.	Approximations of velocity may be interpolated from data in the Floodway Data Table if the waterway was studied using detailed methods, application of approximation methods based on continuity, local observations and sources, or site-specific studies.
Are waves expected to affect the floodplain on the site? (Note: Coastal high hazard areas (V Zones) are not addressed in this manual.)		Waves can exert considerable dynamic forces on buildings and contribute to erosion and scour. Wind-driven waves occur in areas subject to coastal flooding (see discussion on Coastal A Zones) and where unobstructed winds affect wide floodplains (large lakes and major rivers). Standing waves may occur in riverine floodplains where high velocities are present.	FIS (coastal areas); local observations of past events; interpolation of results of site-specific engineering analyses (hydraulic modeling).
Are heavy debris loads and sediment deposits expected (e.g, on alluvial fans)?		Removal of debris and sediment deposits can be expensive, especially from finely graded athletic fields. Impact loads associated with floating debris must be accounted for in design.	Local observations of past events; examination of local land forms created by flood-borne sediments.
How long will water remain on the school site?		Duration of flooding affects the stability of permeable and porous building materials. Unless specifically designed for total saturation, earthen fills may become unstable under long-duration flood conditions. Duration may affect site access and emergency response.	Local observations of past events; examination of site-specific engineering analyses (hydrologic modeling).
How quickly will floodwaters affect the site?		Warning time is a key factor in the safe and orderly evacuation of a school. Certain protective measures require adequate warning time so that specific actions can be taken by skilled personnel.	Local emergency manager; local observations; National Weather Service.

Table 5- 1: Flood Hazards at School Sites (continued)

Evaluation Question	Evaluation Y or N or Comment	Guidance	Data Reference
If the waterway is on or adjacent to the school site, is there evidence of bank erosion?		Erosion is a natural riverine process. Land adjacent to actively eroding waterways is considered unstable over the long term. Improvements should not be exposed to active erosion, or the site design must include stabilization measures.	Site inspection; local observations of past events; soils testing.
Is the site within the area predicted to flood if a levee or floodwall fails or is overtopped?		Flood protection works may be distant from sites and not readily observable. Although a low probability event, failure or overtopping can cause unexpected and catastrophic damage because the protected lands are not regulated as flood hazard areas.	Local public works department; state floodplain management agency; U.S. Army Corps of Engineers.
Is the site within the area predicted to flood if an upstream dam fails?		The effects of an upstream dam failure are not shown on the FIRM or most flood hazard maps prepared locally. Although dam failure is considered a very unlikely event, the potential threat should be evaluated due to the catastrophic consequences. (Note: Owners of certain dams should have Emergency Action Plans geared towards notification and evacuation of vulnerable populations.)	Local emergency management office; state dam safety office.
Is there a formal channel maintenance program?		Flooding can be exacerbated by debris blockages or build-up of excessive sediment in the channel.	Local public works or road maintenance department.
Are there nearby locations on the waterway where debris may affect the flow of water (e.g., bridges, culverts, narrow valleys)?		Flooding may be exacerbated by debris blockages where flow is constricted.	Local public works or road maintenance department.

5.5 RISK REDUCTION: FLOOD-RESISTANT NEW SCHOOLS

When a decision is made to build a new school on a site that is affected by flooding, the characteristics of the site and the nature of flooding must be examined prior to making several design decisions. The most important consideration is location of the buildings.

Risks and certain costs associated with flood-resistant construction are minimized by putting principal buildings on the highest available ground. Positioning the buildings, parking lots, and athletic fields is influenced by identification of all site constraints, which include such factors as presence of flood hazard areas (see Table 5-1), wetlands, poor soils, steep slopes, sensitive habitats, mature tree stands, and other environmental factors required by the authority that approves development plans and all applicable regulatory authorities.

Several aspects of design of flood-resistant buildings and sites are important and are described in this section, including site modifications, foundation type and elevation considerations, flood-proofing options, flood-resistant accessory structures, building service equipment and utility installations, and access roads.

5.5.1 Site Modifications

When sites that are affected by flood hazard areas must be used, and when flood hazard areas cannot be avoided, it may be appropriate to evaluate certain site modifications that may be feasible to provide a level of protection to buildings. The evaluations involve engineering analyses in order to determine if the desired level of protection can be provided cost-effectively, while ensuring that site modifications do not alter the floodplain in ways that increase flooding. Typical site modifications (with cautions that must be examined to determine effectiveness) include:

- **Earthen fill.** Fill can be placed in the flood hazard area with the effect of moving the floodplain boundary. If the fill is

placed and compacted to be stable during the rise and fall of floodwaters and is protected from erosion, modifying a site with fill in order to elevate a school is preferred over other methods of elevation. Not only will the building be less exposed to flood forces, but, under some circumstances (long duration floods), the school may be able to continue to function. Whether nonstructural fill is placed solely to modify the site, or structural fill is placed for the purpose of elevating buildings, placement of fill can change flooding characteristics. Engineering analyses can be conducted to determine if eliminating floodplain storage by fill will result in changing the flow of water, creating higher flow velocities, or increasing the water surface elevation.

- **Excavation.** Excavation alone rarely results in significantly altering the floodplain on a given parcel of land. It is more commonly used in conjunction with fill in order to off-set or compensate for the adverse impacts of fill.

- **Earthen levee or dike.** A levee is a specially designed barrier that modifies the floodplain by keeping the water away. Levees are significant structures that require detailed, site-specific geotechnical investigations; engineering analyses to identify whether flooding will be made worse on other properties; structural and site design to suit existing constraints; design of interior drainage (on the land side); and long-term commitment for maintenance, inspection, and repairs. It is important to remember that areas protected by levees are protected only up to a certain design flood level; once overtopped, most levees fail and catastrophic flooding of previously protected areas results. Levees that protect essential and critical facilities usually are designed for the 0.2%-annual chance flood (500-year) and have added height (called “freeboard”) to increase the factor of safety (see Figure 5-4).

- **Floodwall.** Floodwalls are similar to levees in that they provide protection only up to a certain design flood level, and overtopping can result in catastrophic flooding. A floodwall

typically is a significant structure that is designed specifically to hold back water of a certain depth based on the design flood for the site. Generally, due to design factors, floodwalls are most effective in areas with relatively shallow flooding. As with levees, designs must accommodate interior drainage on the land side, and maintenance and operations are critical for adequate performance. Floodwalls that protect essential and critical facilities usually are designed for the 0.2%-annual chance flood (500-year) and have added height (freeboard) to increase the factor of safety.

5.5.2 Elevation Considerations

The selection of the appropriate method of elevating school buildings above the design flood elevation depends on many factors,

“Lowest floor” means the lowest floor of the lowest enclosed area (including basement). An unfinished or flood-resistant enclosure, usable solely for parking of vehicles, building access, or storage in an area other than a basement, is not the lowest floor provided the enclosure is built in compliance with applicable requirements.

including cost, level of safety and property protection desired, nature of the flood hazard area, etc. The minimum requirement is that the lowest floor (including basement) be at or above the DFE (plus freeboard, if required); given the importance of school buildings, additional height above that elevation is appropriate. Elevation can be accomplished by different foundation methods:

- **Slab-on-grade on structural fill.** This is considered to be the safest method to elevate a building. Structural fill can be placed and shaped so that, when water rises up to the DFE, it will not touch the building (Figure 5-5) and building access is maintained. The fill must be designed to minimize adverse impacts such as increasing flood elevations on adjacent properties, increasing erosive velocities, and causing local drainage problems. To ensure stability, especially as floodwaters recede and the soils drain, fill must be designed for the anticipated water depths and duration. A geotechnical engineer or soil scientist may need to examine underlying soils to determine if consolidation over time may occur. In addition, the effects of long-term compaction of the fill should be

considered, and may prompt additional elevation as a factor of safety. The horizontal extent of fill from the foundation should be designed to facilitate access by emergency and fire vehicles, with a minimum 25-foot width recommended. Designers are cautioned to avoid excavating a basement into fill without added structural protection due to the potential for significant hydrostatic loads and uplift on basement floors.



Figure 5-5 High school in Bloomsburg, PA, elevated on fill

SOURCE: U.S. ARMY CORPS OF ENGINEERS, *FLOOD-PROOFING SYSTEMS & TECHNIQUES*, 1984

- **Stem walls (earth-filled perimeter walls).** Stem wall foundations are designed to come in contact with floodwaters on the exterior. They are more stable than perimeter walls (crawlspaces), but could experience structural damage if undermined by local scour and erosion. Designs must account for anticipated debris and ice impacts and incorporate methods and materials to minimize impact damage.
- **Columns or shear walls.** Open foundations minimize changes to the floodplain and local drainage patterns, and the area under the building can be used for student activities or parking (see Figure 5-6). Columns and shear walls must also account for hydrodynamic loads and debris and ice impact loads. Flood loads on shear walls are reduced if they are

oriented parallel to the anticipated direction of flow. Erodible soils may be present and local scour may occur; both must be accounted for in designs by extending the foundation wall below the expected scour depth.



Figure 5-6 Elementary school in Jefferson County, OH, elevated on columns

SOURCE: U.S. ARMY CORPS OF ENGINEERS, *FLOOD-PROOFING SYSTEMS & TECHNIQUES*, 1984

- **Extended solid perimeter walls (crawlspaces).** Unlike stem wall foundations, solid perimeter walls enclose an open area and must be designed with openings specifically intended to equalize interior and exterior water levels to prevent differential hydrostatic pressures that could lead to structural damage. Wall design must also account for hydrodynamic loads, and debris and ice impact loads. The enclosed area (the crawlspace) must not contain equipment (including ductwork) below the DFE (plus freeboard, if required). Designers must provide adequate underfloor ventilation and subsurface drainage to minimize moisture problems after flooding.
- **Pier supports for portable classroom units.** Manufactured buildings must be elevated above the DFE (plus freeboard, if required). Pier supports must also account for hydrodynamic

loads, and debris and ice impact loads, and units must be anchored to resist wind loads. Although written specifically for manufactured housing units, FEMA 85, *Manufactured Home Installation in Flood Hazard Areas*, has useful information that is applicable to portable classrooms.

5.5.3 Floodproofing Considerations

According to the model building codes and the NFIP regulations, schools are treated as nonresidential buildings and may be dry floodproofed using measures to prevent water from penetrating the building envelope and utilities. However, careful consideration of the implications of potential physical damage and safety should be undertaken before a decision is made to construct new schools using floodproofing methods.

All flood protection measures are designed for certain flood conditions. Therefore, there is always a chance that the design will be exceeded (i.e., water will rise higher than accounted for in the design). When this happens to a dry floodproofed building, the consequences can be catastrophic. As a general rule, floodproofing is a poor choice for new essential and critical facilities (including schools) when avoidance of the floodplain or elevation methods to raise the building above the flood level can be applied. Floodproofing may be acceptable for retrofitting existing schools under certain circumstances (see Section 5.7.4).

Dry floodproofing involves a combination of design and special features that are intended to prevent the entry of water into a building while also resisting flood forces. It involves structural reinforcement so that exterior walls are sufficiently robust to withstand the loads described in Section 5.2.1 (hydrostatic pressure, hydrodynamic loads, wave loads, and debris impact loads). For NFIP flood insurance, floodproofing must extend at least 1 foot above the BFE or premiums will be very costly. Therefore, a higher level of protection is recommended. Exterior walls

Floodproofed schools must never be considered safe for occupancy during periods of high water; floodproofing measures are intended only to reduce physical damage.

must also be designed to prevent infiltration and seepage of water, whether through the wall itself or through any openings, including where utility lines penetrate the envelope. Floodproofing techniques are considered to be permanent measures if they are always in place and do not require any specific action to be effective.

If located below the DFE, typical doors and windows present significant failure points. Special doors and window shields are available commercially and can be designed to provide protection against fairly deep floodwaters. The building must be specifically designed for these protective measures or loads may cause frames to separate from the building.

Use of contingent floodproofing measures that require installation or activation, such as window shields or inflatable barriers, significantly reduces the certainty that floodproofing will be effective. Rigorous adherence to a periodic maintenance plan is critical to ensure proper functioning. Not only must the school have a formal, written plan, but the people responsible for implementing the measures must be informed and trained. Also critical to success is that school personnel must receive a credible warning with sufficient time to allow getting to the site and putting the measures in place. In addition, floodproofing devices often rely on flexible seals that require periodic maintenance and that, over time, may deteriorate and become ineffective. Therefore, a maintenance plan must be developed and an annual inspection and training must be conducted.

Safety of occupants remains a concern with floodproofed buildings. Regardless of the degree of protection provided, floodproofed buildings should not be occupied during flood events because failure or overtopping of the floodproofing measures is likely to cause catastrophic structural damage. When human intervention is required, the people responsible for implementing those measures remain at risk while at the school, even if a credible warning system is in place because of the many uncertainties associated with predicting the onset of flood conditions.

5.5.4 Accessory Structures

Depending on the nature of structures that are accessory to a school, full compliance with floodplain management regulations is required and is appropriate to minimize future damage. Buildings that serve educational purposes (e.g., offices, classrooms), even if detached from the primary school building, are not accessory in nature. Portable classrooms are not accessory structures; accessory structures commonly associated with schools include storage sheds, bleachers, garages, restrooms, and refreshment stands.

Accessory structures may be “wet floodproofed” using techniques that allow them to flood while minimizing damage. They must be anchored to resist flotation, collapse, and lateral movement. Flood-resistant materials must be used and utilities elevated above the DFE (plus freeboard, if required). Openings must be provided to allow the free inflow and outflow of floodwaters to minimize hydrostatic loads that cause structural damage. Other flood damage and flood loads must be accounted for by other means. Because wet floodproofed accessory buildings are designed to flood, school staff must be aware that contents will be damaged.

5.5.5 Utility Installations

Utilities associated with new schools in flood hazard areas must be protected either by elevation or special design measures. Utilities subject to this provision include all systems, equipment, and fixtures, including mechanical, electrical, plumbing, and heating, ventilating, and air conditioning systems and equipment. Potable water systems (wellheads and distribution lines) and wastewater collection lines are addressed in Section 5.7.6.

Utility systems and equipment are best protected when elevated above the DFE (plus freeboard, if required). Equipment inside elevated buildings is also elevated and equipment inside accessory structures must be elevated if the accessory building is wet floodproofed. Exterior equipment must be elevated on fill or on platforms, or other support structures. Designers should pay par-

tical attention to underfloor utilities and ductwork to ensure that they are properly elevated.

Although it is difficult to achieve, the model building codes and NFIP regulations provide an alternative that allows utility systems and equipment to be located below the DFE. The alternative requires that such systems and equipment be designed, constructed, and installed to prevent floodwaters from entering or accumulating within the components during flood events.

5.5.6 Potable Water and Wastewater Systems

New installations of potable water systems and wastewater collection systems are required to resist flood damage, including damage associated with infiltration of floodwaters and discharge of effluent. Health concerns arise when water supply systems are exposed to floodwaters and contamination from flooded sewage systems pose health and environmental risks. On-site water supply wellheads should be protected with watertight casings to minimize infiltration of surface waters.

Sewer collection lines should be located and designed to avoid infiltration and backup due to rising floodwaters. Devices designed to prevent backup are available and are recommended to provide an added measure of protection.

On-site sewage disposal systems are unlikely for most new school construction. However, in the event such systems are considered, designers are advised that local or state health departments may impose constraints that limit or prevent locating septic fields in floodplain soils or within a mapped flood hazard area. If allowed, septic fields should be located on the highest available ground to minimize inundation and impairment by floodwaters.

5.5.7 Storage Tank Installations

Whether above ground or under ground, storage tanks located in flood hazard areas must be designed to resist flotation, collapse,

and lateral movement. Aboveground tanks must be elevated or adequately anchored to account for maximum buoyancy under design flood conditions, assuming the tanks are empty. Similarly, underground tanks must be anchored for maximum buoyancy under design flood conditions, assuming the tanks are empty. In all cases, designers are cautioned to address hydrodynamic loads and debris impact loads that may affect tanks that are exposed to floodwaters. Vents and fill openings or cleanout accesses should be elevated above the DFE or designed to prevent the inflow of floodwaters or outflow of the contents of tanks.

5.5.8 Access Roads

Access roads to schools should be designed to minimize impacts on flood hazard areas, minimize damage to the road itself, and to minimize exposing vehicles to dangerous situations, although balancing those elements can be difficult, depending on the site and specific flood characteristics. Designers should take the following into consideration:

- **Safety factors.** Although a school's access road is not required to carry regular traffic like other surface streets, a flood-prone road always presents a degree of risk to public safety. To minimize those risks, some regulatory authorities require that access roads be designed to be no more than 1 foot or 2 feet below the DFE. To maximize evacuation safety, two separate accesses to different feeder roads are recommended. In some circumstances, especially long-duration flooding where a school is built on fill, dry access may allow continued operations.
- **Floodplain impacts.** Engineering analyses may be required to document effects on flood elevations and flow patterns if large volumes of fill are required to elevate a road to minimize dangerous flooding above the driving surface.
- **Drainage structure and road surface design.** The placement of multiple drainage culverts, even if not needed for local drainage, can facilitate the passage of floodwaters and

minimize the potential for a road embankment to act as a dam. Embankments should be designed to remain stable during high water and as waters recede, and should be sloped and protected to resist erosion and scour. For roads that are designed to flood, the surface and shoulders should be designed to resist erosion.

5.6 VULNERABILITY: WHAT FLOODS CAN DO TO EXISTING SCHOOLS

Existing flood-prone schools are exposed to damage, and the nature and severity of damage is a function of site-specific flood characteristics. As described below, damage may include: site damage; structural and nonstructural building damage; destruction or impairment of service equipment; loss of contents; and health and safety threats due to contaminated floodwater.

Regardless of the nature and severity of damage, flooded schools are closed while cleanup and repairs are undertaken. The length of the closure, and thus the impact on the ability of the school district to return to teaching, depends on the severity of the damage and lingering health hazards. It may also depend on whether the building was fully insured or whether disaster assistance is made available quickly to allow speedy repairs and reconstruction. Sometimes repairs are put on hold pending a decision on whether a school should even be rebuilt at the flood-prone site. When damage is substantial, reconstruction is allowed only if compliance with flood-resistant design provisions is achieved (see Section 5.7.3).

5.6.1 Site Damage

The degree of site damage associated with flooding is a function of several variables related to the characteristics of the flood, as well the site itself:

- **Erosion and scour.** All parts of a school site that are subject to flooding by fast moving flows could experience erosion, and local scour could occur around any permanent obstructions

to flow. Graded areas, filled areas, and cut or fill slopes are especially susceptible. Stream and channel bank erosion is a natural phenomenon that may, over time, threaten site improvements and buildings.

- **Debris and sediment removal.** Even when buildings are not subject to flood damage, floods can produce large quantities of debris and sediment that can damage a site and that are expensive to remove, especially from athletic fields.
- **Fences.** Some fences trap floating debris and can significantly restrict the free flow of floodwaters. Fences can be damaged by flowing water and can be flattened if the buildup of debris results in significant loads.
- **Playing field surfaces.** In addition to damage by erosion and scour, graded grass fields and applied track surfaces can be damaged by standing water and deposited sediments.
- **Accessory structures.** Accessory structures such as storage sheds, bleachers, restrooms, and refreshment stands can sustain both structural and nonstructural damage. Such structures may be designed and built using techniques that minimize damage potential.
- **Access roads.** Access roads that extend across flood-prone areas may be damaged by erosion, washout of drainage culverts, failure of fill materials, and loss of surface.
- **Other.** Objects outside of buildings, including cars and school buses, can be damaged or washed away.

5.6.2 Structural Damage

Structural damage includes all damage to the load-bearing portions of a building. Damage to other components of buildings is described below: finish materials (Section 5.6.3), utility service equipment (Section 5.6.4), and contents (Section 5.6.5). Struc-

tural damage can be caused by each of the characteristics of flooding described in Section 5.2.1:

- **Depth.** The hydrostatic load or pressure against a wall or foundation is directly related to the depth of water (see Figure 5-7). Standard stud and siding, or brick faced walls, may collapse under hydrostatic loads associated with relatively shallow depths of water. Reinforced masonry walls perform better than unreinforced masonry walls, although an engineering analysis is required to determine performance. Walls and floors of below-grade areas (basements) are particularly susceptible to damage by hydrostatic pressure. When soils are saturated, pressures against below-grade walls are a function of the total depth of water, including the depth below-grade and the weight of the saturated soils.
- **Buoyancy and uplift.** If below-grade areas are essentially watertight, buoyancy or uplift forces can rupture concrete floors or float a building out of the ground (see Figure 5-8). Flood-prone buildings that are not adequately anchored can be floated or pushed off foundations. Although rare for large and heavy school buildings, this is a concern for outbuildings and portable (temporary) classrooms.
- **Duration.** Long duration saturation can cause dimensional changes and contribute to deterioration of wood members, although saturation is unlikely to result in significant structural damage to masonry construction. Saturation of soils, a consequence of long duration flooding, increases pressure on below-grade foundation walls.
- **Velocity, wave action, and debris impacts.** Each of these components of dynamic loads can result in structural damage if buildings are not designed to resist overturning, repetitive pounding by waves, or short-duration impulsive loads generated by floating debris or ice.

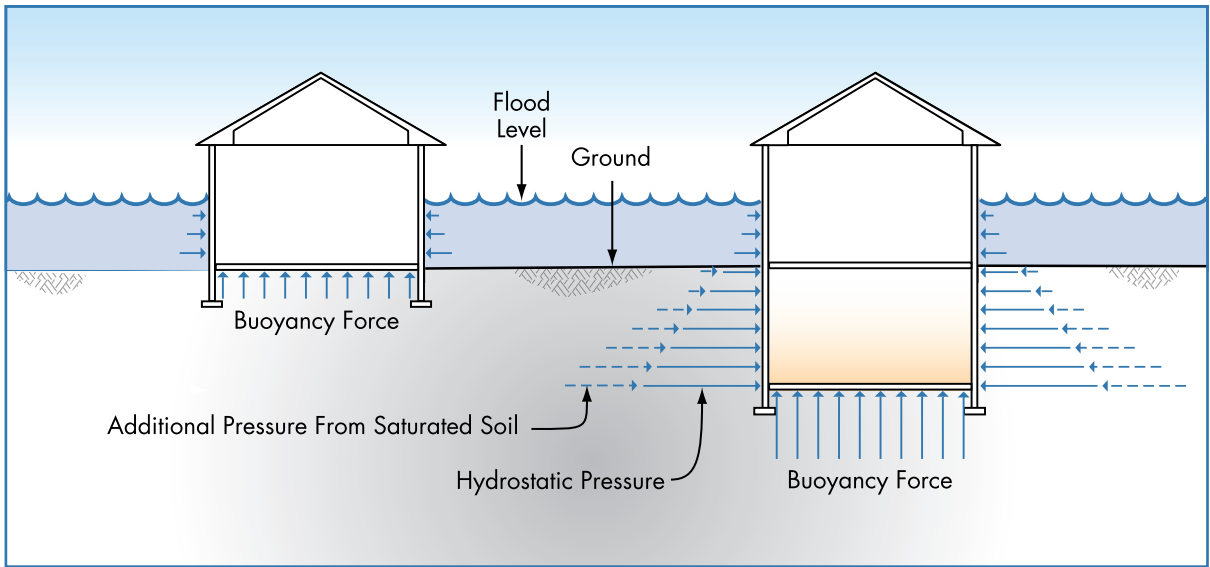

Figure 5-7 Hydrostatic force diagram



Figure 5-8
Fractured concrete basement floor, Gurnee, IL,
1986

- **Erosion and scour.** Structural damage is associated with foundation failure when erosion or scour results in partial or complete removal of supporting soil. Erosion of slopes, especially unprotected slopes, can lead to slope failures and loss of foundation supporting soil.

5.6.3 Saturation Damage

Many flood-prone buildings are exposed to flooding that is not fast moving or that may be relatively shallow and not result in structural damage. Simple saturation of the building and its furnishings can result in significant and costly damage, including long-term health complications associated with mold. Floodwaters often are contaminated with chemicals or petroleum products. Under such circumstances, recovery generally involves removal of nonstructural materials and finishes because cleanup and decontamination is expensive and time-consuming. Damage to contents is discussed in Section 5.6.5.

Saturation damage varies somewhat as a function of duration. Use of water-resistant materials will help to minimize saturation damage and reduce the costs of cleanup and restoration to service (see Flood-Resistant Materials Requirements, FIA-TB-2):

- **Wall finishes.** Painted concrete and concrete masonry walls usually resist water damage, provided the type of paint used can be readily cleaned. Tiled walls may be acceptable, depending on the type of adhesive and foundation (gypsum board substrate and wood-framed walls with tile typically do not remain stable).
- **Flooring.** Most schools have durable floors that resist water damage. Ground floors typically are slab-on-grade and finished with tile or sheet goods. Flooring adhesives since the early 1990s likely are latex-based and tend to break down when saturated. Most carpeting, even indoor-outdoor materials, are difficult to clean. Wood floors are particularly susceptible to saturation damage. Short duration inundation

may not cause permanent deformation of some wood floors, such as may be present in older buildings. However, because of low tolerance for surface variations, gymnasium floors are particularly sensitive and tend to warp after flooding of any duration.

- **Wall and wood components.** When soaked for long periods of time, some building components change composition or shape. Wet wood will swell and, if dried too quickly, will crack, split or warp. Plywood can delaminate and wood door and window frames may swell and become unstable. Gypsum wallboard, wood composition panels, other wall materials, and wood cabinetry not intended for wet locations can fall apart (see Figure 5-9). The longer these materials are wet, the more moisture, sediment, and pollutants they will absorb. Some wall materials such as the paper facing on gypsum wallboard, “wick” standing water, resulting in damage above the actual high-water line (see Figure 5-10).

- **Metal components.** Metal structural components are unlikely to be permanently damaged by inundation. Metal partitions are particularly susceptible when saturated because they cannot be thoroughly dried and cleaned. Depending on the degree of corrosion protection on the metal, repetitive flooding by saline coastal waters may contribute to long-term corrosion.

- **Metal connectors and fasteners.** Depending on the composition of the metal, repetitive flooding, especially by saline coastal waters, may contribute to long-term corrosion. Connectors and fasteners are integral to the structural stability of buildings, therefore, failure due to accelerated corrosion would jeopardize the building.

Figure 5-9
Damaged walls and
cabinets, Peoria County, IL



Figure 5-10
Basement damage at a
grade school in Gurnee,
IL, 1986



5.6.4 Utility System Damage

Utility system service equipment that is exposed to flooding is vulnerable to damage. Damage may result in total loss or may require substantial cleaning and restoration efforts. The degree of damage varies somewhat as a function of flooding characteristics. Certain

types of equipment and installation measures will help to minimize damage and to reduce the costs of cleanup and restoration to service:

- **Displacement of equipment and appliances.** Installation below the flood level exposes equipment and appliances to various flood forces, including drag due to flowing water and buoyancy. Gas-fired appliances are particularly dangerous: flotation can separate the appliance from the gas source, resulting in building fires, and explosive situations. Displaced equipment may dislodge lines from fuel oil tanks, not only contributing to the threat of fires, but also causing water pollution and environmental damage. Firefighting efforts are compounded if access to the school is limited due to flooded roads.
- **Corrosion.** Corrosion related to inundation of equipment and appliances may not be apparent immediately, but can increase maintenance demand and shorten the useful life of some equipment and appliances.
- **Electrical systems and components.** Electrical systems and components, and electrical controls of HVAC systems, are subject to damage simply by getting wet even for short durations. Unless specifically designed for wet locations, switches and other electrical components can short out due to deposits of sediment or otherwise not function even when allowed to dry before operation. Wiring and components that have been submerged may be functional, although generally it is more cost-effective to discard flooded outlets, switches, and other less expensive components than to attempt thorough cleaning.
- **Ductwork damage.** Ductwork is subject to two flood-related problems. Flood forces can displace ductwork and saturated insulation can overload support straps, causing failure.
- **Mold and dust.** Furnaces, air handlers, and ductwork that have been submerged must be thoroughly cleaned

and sanitized. Otherwise, damp conditions contribute to the growth of mold and the sediment can be circulated throughout the school, causing respiratory problems.

- **Gas-fired systems.** Water-borne sediment can impair safe functioning of jets and controls in gas-fired furnaces and water heaters, necessitating that they be professionally cleaned and inspected prior to restoration of service.
- **Tanks (underground).** Underground storage tanks are subjected to significant buoyant forces and can be displaced, especially when long-duration flooding occurs. Computations of stability should be based on the assumption that the tank is empty in order to maximize safety. Tank inlets, fill openings, and vents should be above the DFE or designed to prevent the inflow of floodwaters or outflow of tank contents during flood conditions.
- **Tanks (aboveground).** Aboveground storage tanks are subject to buoyant forces and displacement due to moving water. Standard strapping of propane tanks may be inadequate for the anticipated loads. Tank inlets, fill openings, and vents should be above the design flood elevation or designed to prevent the inflow of floodwaters or outflow of tank contents during flood conditions.

Damage to public utility service (potable water supply and wastewater collection) can have consequential damage to schools:

- **Water supply.** Potable water supply systems may become contaminated if public water distribution lines or treatment facilities are damaged, or if wellheads are submerged.
- **Sewer backup.** Sewers back up during heavy rains due to infiltration and inflow of stormwater into the sewer lines and manholes, cross connections between storm and sanitary sewers, and/or flooded wastewater treatment plants. Sewer backup into a school poses a major health hazard. Even when the water has receded, exposed building components, finish materials, and

contents are severely contaminated and usually must be removed because adequate cleaning is difficult, if not impossible.

5.6.5 Contents Damage

Schools may contain high value contents that can be damaged and unrecoverable when subjected to flooding. For the purpose of this discussion about the nature of flood-related contents damage, the term “contents” includes furniture, computers, laboratory equipment and materials, records, and library materials. The following types of contents often are considered total losses:

- **Furniture.** Depending on the nature of wood furniture, it may withstand short-duration inundation, requiring only cleanup. In long-duration flooding, porous woods become saturated and swollen, and joints may separate. Furniture with coverings or pads generally cannot be restored. Metal furniture is difficult to thoroughly dry and clean, is subject to corrosion, and typically is discarded.
- **Computers.** Flood damaged computers and peripheral equipment cannot be restored after inundation, although special recovery procedures may be able to recover information on hard drives.
- **School records.** When offices are located in flood-prone space, valuable school records may be lost. Although expensive, some recovery of computerized and paper records may be possible with special procedures.
- **Library books and collections.** It is generally not economical to recover library materials and special collections that are saturated by floodwaters.
- **Laboratory materials and equipment.** Depending on the nature of laboratory materials, cleanup may require special procedures. Generally, equipment is difficult to restore to safe functioning.

- **Kitchen goods and equipment.** Stainless steel equipment and surfaces generally have cleanable surfaces that can be disinfected and restored to service. Because of contamination, kitchen contents and perishables cannot be recovered.

5.7 RISK REDUCTION: PROTECTING EXISTING SCHOOLS

Schools that already are located in flood hazard areas may be made more resistant to flood damage. School districts may take

School districts should be aware of the importance of flood insurance for flood-prone existing schools. If not insured for flood peril, the amount of flood insurance coverage that should have been in place will be deducted from any federal disaster assistance payment that would otherwise have been made available. A district may have to absorb up to \$1 million in unreimbursed flood damage per building because the NFIP offers \$500,000 in building coverage and \$500,000 in contents coverage.

such action when flood hazards are identified and there is a desire to proactively undertake risk reduction measures. Interest may be prompted by a flood or by the requirement to address flood resistance as part of proposed substantial improvements or additions. Table 5-2 offers some questions to help identify building characteristics that are important when considering risk reduction measures.

Work on existing school buildings and sites is subject to codes and regulations and the appropriate regulatory authority with jurisdiction should be consulted. With respect to

reducing flood risks, work generally falls into the following categories described in Sections 5.7.1 through 5.7.8.

Table 5-2: Characteristics of Existing School Buildings

Question	Guidance
What is the construction type and the foundation type and what are their bearing capacities?	Dry floodproofing creates large unbalanced forces that can jeopardize walls and foundations that are not designed to resist the hydrostatic and hydrodynamic loads.
Is the building suitable for elevation-in-place or relocation to higher ground?	Elevating a building provides a higher degree of protection than dry floodproofing. Depending on the type and soundness of the foundation, even large buildings can be elevated or relocated.
Are any building spaces below-grade (basements)?	Below-grade spaces and their contents are most vulnerable. If flooding is allowed, rapid pump out can unbalance forces if the surrounding soil is saturated, leading to structural failure. If intended to be dry floodproofed, buoyant forces must be taken into consideration.
What types of openings penetrate the building envelope below the DFE (doors, windows, cracks, vent openings, plumbing fixtures, floor drains, etc.)?	For dry floodproofing to be effective, every opening must be identified and measures taken to permanently seal or to prepare special barriers to resist infiltration. Sewage backflow can enter through unprotected plumbing fixtures.
Are utility systems and HVAC equipment (including ductwork) below the DFE?	Relocating utility equipment to higher floors or elevated additions or platforms minimizes damage and facilitates rapid reoccupancy.
Are electrical panels and primary service below the DFE? Is the emergency power generator?	Relocating electrical panels to higher floors or elevated additions or platforms minimizes damage and facilitates rapid reoccupancy.

5.7.1 Site Modifications

Modifying an existing school property that is subject to flooding requires careful examination by an experienced professional engineer. Determining the suitability of a specific measure requires a complex evaluation of many factors, including the nature of flooding and the nature of the site. Table 5-1 identifies questions to be examined relative to flood hazards that influence the measures that may be applicable to modifying existing school sites. Some characteristics may make it infeasible to apply flood-resistant measures to existing schools (e.g., depths greater than 3 to 4 feet, very high velocities, flash flooding or rapid rate of rise [insufficient warning], and very long duration). Each of these measures has limitations, including the fact that the level of protection will be exceeded by floods that are larger than the design flood.

Site modifications may be designed to keep water away from a building. In each case, careful attention must be given to internal drainage. The rain that falls on the school and the portion of the site inside these flood protection measures will collect and must be accounted for or it may contribute to damage. Two general approaches are taken: provide sufficient ponding storage capacity or install pumps to transfer accumulated runoff outside the protection measure. Site modifications include:

Schools protected by local berms, levees, and floodwalls should never be occupied during flood conditions. The consequences of failure or flood levels overtopping these measures can be catastrophic and create high-risk conditions.

- **Regrading the site (berm).** Where a school is exposed to relatively shallow flooding and sufficient land area is available, regrading the site or construction of a non-engineered earthen berm may provide adequate protection.

- **Earthen levee or dike.** Earthen levees are engineered structures that are designed to keep water away from land area and buildings (Figure 5-11). Hydraulic evaluations

and geotechnical investigations are required to determine their feasibility and effectiveness. For existing school sites, constraints include the availability of land (levees have a large “footprint” and require large land areas), cost (including availability of suitable fill material and long-term maintenance), and difficulties with site access. Levees rarely are used to protect a single site, although they may offer a reasonable solution for a group of buildings. Locating levees and floodwalls within a designated floodway generally is not allowed. Rapid onset flooding makes it impractical to design a flood levee with access points that require installation of a closure system. Earthen levees may also be subject to high velocity flows that cause erosion and affect the stability of earthen levees.

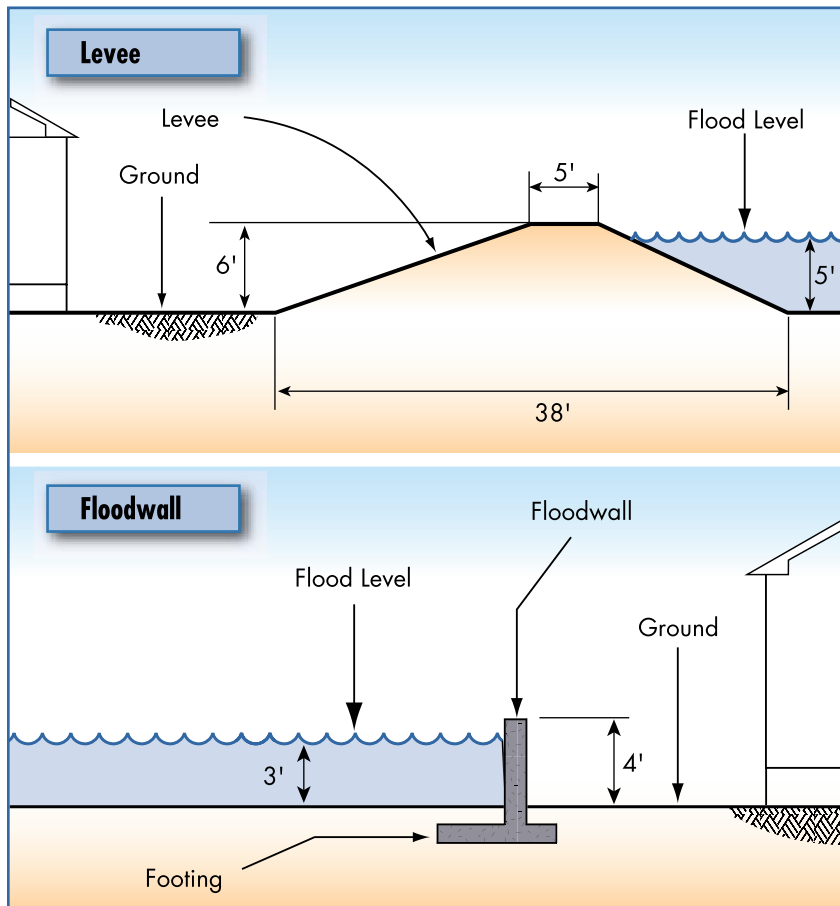
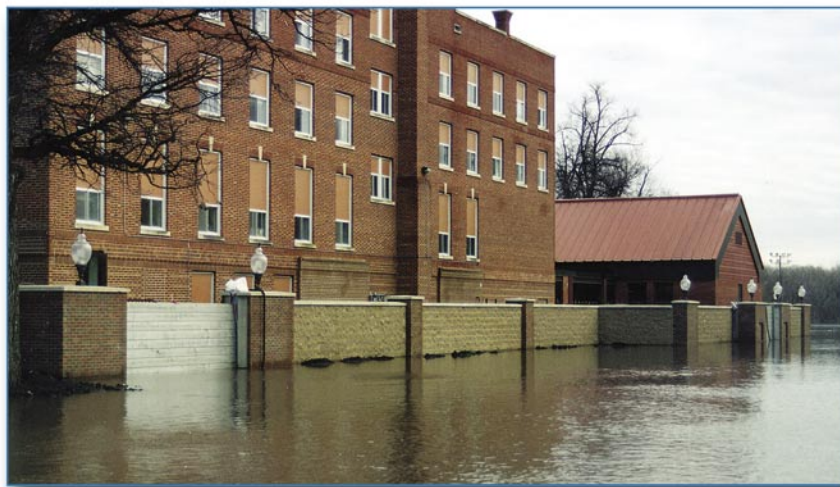

Figure 5-11
Schematic of typical earthen levee and permanent floodwall

- **Permanent floodwall.** Floodwalls are freestanding, permanent engineered structures that are designed to prevent encroachment of floodwaters. Typically, floodwalls are located at some distance from buildings so that structural modification of the existing building is not required. Floodwalls may protect only the low side of a site (in which case they must “tie” into high ground) or completely surround a site (which may affect access because special closure structures are required and must be installed before the on-set of flooding, Figure 5-12).

Figure 5-12
Masonry floodwall with
multiple engineered closures
at Oak Grove Lutheran
School, Fargo, ND

SOURCE: FLOOD CONTROL
AMERICA, LLC.



- **Mobilized floodwall.** This category of flood protection measures includes fully engineered flood protection structures that have permanent features (foundation and vertical supports) and features that require human intervention to mobilize when a flood is predicted (horizontal components called planks or stop-logs). Mobilized floodwalls have been used to protect entire sites or to tie into permanent floodwalls or high ground. Due to the manpower and time required for proper placement, these measures are better suited to locations with sufficient warning times.

A common problem associated with the site modifications listed above is access. Depending on the topography of the site, construction of barriers to floodwaters may require special access

points. Access points may be protected with manually installed stop-logs or designed gates that drop-in, slide, or float into place. Whether activated by automatic systems or manually, access protection requires sufficient warning time.

Other significant constraining factors include poor soils and insufficient land area. These also make site modifications either infeasible or very costly. A school may be among several buildings and properties that can be protected, increasing the benefits. For any type of barrier, rainfall that collects on the land side must be accounted for in the design.

5.7.2 Additions

The model building codes treat additions as new construction. Therefore, additions to existing schools that are located in flood hazard areas are required to comply with the code. Elevation of an addition on fill may not be feasible unless structural fill can be placed adjacent to an existing building. Section 5.5.2 outlines other elevation options that are applicable to additions. Utility service equipment for the addition must also meet the requirements for new construction and new installations (see Section 5.5.5).

With respect to code compliance and designing additions to resist flood damage, one of the more significant issues that may come up is ease of access. If the lowest floor of the existing school building is below the DFE, steps, ramps, or elevators will be required for the transition to the new addition. Under the regulations of the NFIP and guidance that FEMA offers to jurisdictions that may wish to consider variances, it is not considered appropriate to grant a variance to the elevation requirement for an addition because alternative means of access are available.

5.7.3 Repairs, Renovations, and Upgrades

Every school that is considered for upgrades and renovations, or that is being repaired after substantial damage from any cause,

must be examined for structural integrity and stability to determine compatibility with structural modifications that may be required to achieve acceptable performance. When an existing school is located in a flood hazard area, that examination should include consideration of measures to resist flood damage and reduce risks.

Selected References: *Flood Proofing: How to Evaluate Your Options* (USACE, 1993); *Floodproofing Non-Residential Structures* (FEMA 102); *Non-Residential Floodproofing—Requirements and Certification* (FIA-TB-3); and *Engineering Principles and Practices for Retrofitting Flood-prone Residential Buildings* (FEMA 259). Although written primarily for homes, this last reference contains very detailed checklists and worksheets that can be modified for school buildings. They also provide some guidance for evaluating the costs and benefits of various measures.

The model building codes and the regulations of the NFIP and the model building codes require that work that constitutes ‘substantial improvement’ of an existing building be in compliance with the flood-resistant provisions of the code. Non-substantial improvements should take into account measures to reduce future

flood damage, such as many described in Section 5.7.7 and wet floodproofing measures that allow water to enter the building to avoid structural damage, and emergency measures (see Section 5.7.8).

Compliance with flood-resistant provisions means the building must be elevated or dry floodproofed. Both options can be difficult for schools, given the typical size and complexity of school buildings. Dry floodproofing is described in Section 5.7.4 and is generally limited to water depths on the order of 3 to 5 feet.

Elevating an existing building presents an entirely different set of challenges and also requires detailed structural engineering analyses. It involves the same equipment and methods used to move other types of buildings, and expert building movers have successfully moved large, heavy, and complex buildings, sometimes by segmenting them. A school building that is elevated-in-place must meet the same performance standards set for new construction (see Section 5.5).

5.7.4 Retrofit Dry Floodproofing

Modifications of an existing building may be required, including construction of a reinforced supplementary wall, measures to counter buoyancy (especially if there is below-grade space), installation of special watertight doors or barriers, and providing watertight seals around points of entry of utility lines. The details of structural investigations and structural design of such protection measures are beyond the scope of this manual.

Dry floodproofing refers to measures and methods to render a building envelope and utility systems substantially impermeable to floodwaters.

Detailed structural engineering evaluations are required to determine whether an existing building can be dry floodproofed due to the tremendous loads that may be exerted on a building not originally designed for such conditions. The following elements must be examined:

- Structural strength of walls.
- The effects of buoyancy on below-grade areas.
- Protection where utilities enter the building; and the seepage of water through walls. Secondary walls can be constructed immediately adjacent to existing walls, with a waterproof membrane, to provide adequate strength.

Application of waterproofing products or membranes may minimize infiltration of water through exterior walls, although there are limitations and concerns with durability. Measures that require human intervention are considered emergency measures and are discussed in Section 5.7.8.

5.7.5 Utility Installations

Some aspects of an existing school's utility systems may be modified to reduce damage. The effectiveness of such measures depends not only on the nature of flooding, but the type of utility and the degree of exposure. Table 5-2 listed some questions that will help facility planners and designers to examine risk reduction measures.

Even if a school building is unlikely to sustain extensive structural damage due to flooding, high costs and delayed reoccupancy may result from flood-damaged utility systems. Risk reduction design measures can be applied whether undertaken as part of large-scale retrofits of existing schools or as separate projects:

- **Relocate from below-grade areas.** The most vulnerable utility installations are those located in below-grade areas, and the most effective protection measure is to relocate them to properly elevated sites or platforms that are at least 2 feet above the DFE. The complexity of re-routing pipes, conduits, ductwork, electrical service, lines, and connections will depend on site-specific factors.
- **Elevate components.** Whether located inside or outside of the building, some components of utility systems can be elevated-in-place on platforms, including electric transformers, water heaters, air conditioning compressors, furnaces, boilers, and heat pumps (see Figures 5-13 and 5-14).

Figure 5-13
Elevated electric
transformer at an
elementary school in
Verret, LA

SOURCE: U.S. ARMY CORPS OF
ENGINEERS, *FLOOD-PROOFING
SYSTEMS & TECHNIQUES*, 1984

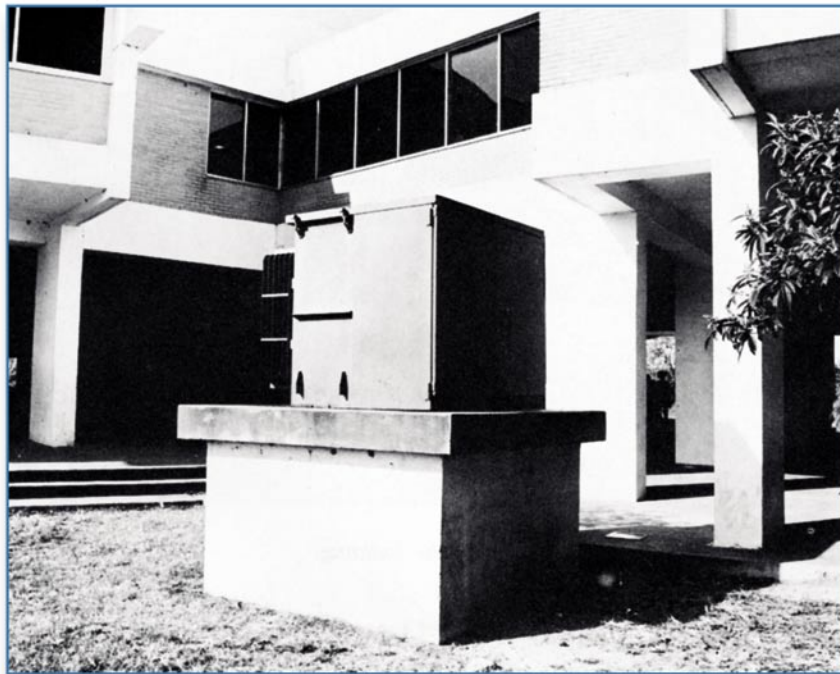



Figure 5-14
Elevated utilities behind
an elementary school in
Wrightsville Beach, NC

- **Anchor tanks and raise openings.** Existing tanks can be elevated or anchored (both underground and aboveground tanks), as described in Section 5.5.7. If anchored below the DFE, tank inlets, vents, fill pipes, and openings should be elevated above the DFE or fitted with covers designed to prevent the inflow of floodwaters or outflow of the contents of the tanks.
- **Protect components.** If utility components cannot be elevated, it may be feasible to construct watertight enclosures or enclosures with watertight seals that require human intervention to install when flooding is predicted.
- **Elevate control equipment.** Control panels, gas meters, and electrical panels can be elevated, even if the equipment cannot be protected.
- **Separate electrical controls.** Where areas within an existing school are flood-prone, separation of control panels and electrical feeders will facilitate shutdown before floodwaters arrive and help protect the safety of workers during cleanup.

5.7.6 Potable Water and Wastewater Systems

All plumbing fixtures that are connected to the potable water system may become weak points in the system if they allow floodwaters to contaminate the system. Relocating such uses to at least 2 feet above the DFE provides protection. Wellheads can be sealed with watertight casings or protected with a sealed enclosure.

Wastewater system components become sources of contamination during floods. Rising floodwaters may force untreated sewage to backup through toilets. Specially designed back-flow devices can be installed or restrooms below the DFE can be provided with overhead piping that may require specially designed pumps in order to operate properly. Septic tanks can be sealed and anchored.

5.7.7 Other Damage Reduction Measures

A number of steps can be taken to make existing schools in flood hazard areas more resistant to flood damage, which also facilitates rapid recovery, cleanup, and reoccupancy. Whether these measures are applicable to a specific school depends, in part, on the characteristics of the flood hazard and the characteristics of the building itself. School facility planners and designers should consider the following:

- Retrofit the building envelope with openings specifically designed to allow floodwaters to flow in and out to minimize hydrostatic pressure on walls. Although allowing water to enter the building, this measure minimizes the likelihood of major structural damage. Walls that enclose interior spaces would also be retrofitted with openings.
- Replace interior walls that have cavities with flood-resistant construction or removable panels to facilitate cleanup and drying.
- Abandon use of below-grade areas (basements) by filling to prevent structural damage.

- Permanently relocate high-value uses that often are found on the ground floor of schools (e.g., offices, school records, libraries, and computer laboratories) to higher floors or elevated additions.
- Install backflow devices in sewer lines.
- Pre-plan actions to move damageable furniture and high-value contents from lower floor to higher floors, when a flood warning is issued.
- Replace wall, flooring, and finish materials with flood-resistant materials.
- Use epoxy or other impervious paints on concrete and other pervious surfaces to minimize contamination.
- Install separate electric circuits and ground fault interrupter circuit breakers in areas that will flood. Emergency measures should be provided so that electrical service can be shut down to avoid electrocution hazards.
- Relocate chemicals to areas not subject to flooding.

5.7.8 Emergency Measures

Emergency response to flooding is outside the scope of this manual. However, because some existing schools may not be retrofitted to provide protection against the design flood, it may be appropriate to examine feasible emergency measures that may provide some protection. The following discussion pertains only to emergency measures that have been used to reduce flood damage to older buildings that are already located in flood hazard areas. These measures do not achieve compliance with building and life safety codes, do not provide protection to occupants, and experience a very high frequency of failure.

Emergency barriers are measures of “last resort,” and should be used only when a credible flood warning with adequate lead-time is available and dependable. These measures have varying degrees of success, depending on the available manpower, skill

required, long-term maintenance of materials and equipment, suitability for site-specific flood conditions, and sufficiency of warning. Complete evacuation of protected buildings is required as these measures should not be considered adequate protection for occupants. Further, emergency barriers are not acceptable in lieu of designed flood resistant protection for new buildings. Typical examples include:

- **Sandbag walls.** Unless planned well in advance or emergency workers are under the direction of trained personnel, most sandbag barriers are not constructed in accordance with proper practices, leading to leakage and failures. Because of the intensive work effort and length of time required for protection from even relatively shallow water, sandbag walls are not a reliable protection measure. To be effective, sandbags and sand should be stockpiled and checked regularly to ensure the sandbags have not deteriorated. Sandbags have some drawbacks, including high disposal costs and their tendency to absorb pollutants from contaminated floodwaters.
- **Water-filled barriers.** A number of vendors make barriers that can be assembled with relative ease, depending on the source water for filling. The barriers must be specifically sized for the site. Training is important so that personnel know how to place and deploy the barriers. Proper storage, including cleaning after deployment, is necessary to protect the materials over long periods of time.
- **Panels for doors.** For shallow and short-duration flooding, plywood panels or panels of other sturdy material can be made for doorways to minimize the entry of floodwaters. Effectiveness is increased significantly if a flexible gasket or sealant is provided and the mounting hardware is designed to apply even pressure. Personnel must know where the materials are stored and be trained in deployment.

5.8 THE SCHOOL AS AN EMERGENCY SHELTER

Emergency managers regularly identify schools to serve as short-term and/or long-term shelters. They are attractive sites for shelters because they have kitchen facilities that are designed to serve many people, restroom facilities that are likely to be adequate for many people, and space for cots in gymnasiums, cafeterias, and wide corridors.

New schools that are to be used for emergency sheltering are appropriately designed as essential or critical facilities that warrant a higher degree of protection than other schools. If located in or adjacent to flood hazard areas, it is appropriate to provide protection for the building and utility systems to at least the 0.2%-annual chance (500-year) flood level or, at a minimum, 2 to 3 feet above the DFE. Additional guidance on hazard-resistant shelters is found in FEMA 361, *Design and Construction Guidance for Community Shelters*.

Additional measures that may be appropriate for consideration by the school district and designer include:

- Wastewater service must be functional during conditions of flooding.
- Emergency power service must be provided.
- Dry-ground access is important in the event flooding exceeds design levels.

5.9 REFERENCES AND SOURCES OF ADDITIONAL INFORMATION

Obtaining Selected Publications:

- FEMA publications may be obtained at no cost by calling (800)480-2520, faxing a request to (301)497-6378, or downloaded from the library/publications section online at <http://www.fema.gov>.
- U.S. Army Corps of Engineers publications can be found online at: <http://www.usace.army.mil/inet/functions/cw/cecwp/NFPC/nfpc.htm>.

American Society of Civil Engineers, Inc. *Flood Resistant Design and Construction*, ASCE/SEI 24-98, Reston, VA, 2000.

American Society of Civil Engineers, Inc. *Minimum Design Loads for Buildings and Other Structures*, ASCE-7-02, Reston, VA, 2002.

Federal Emergency Management Agency, *Answers to Questions about Substantially Damaged Buildings*, FEMA 213, Washington, DC, May 1991.

Federal Emergency Management Agency, *Answers to Questions about the National Flood Insurance Program*, FEMA 387, August 2001.

Federal Emergency Management Agency, *Coastal Construction Manual*, FEMA 55 (3rd Edition), 2000.

Federal Emergency Management Agency, *Design and Construction Guidance for Community Shelters*, FEMA 361, Washington, DC, July 2000.

Federal Emergency Management Agency, *Engineering Principles and Practices for Retrofitting Flood-prone Residential Buildings*, FEMA 259, Washington, DC, January 1995.

Federal Emergency Management Agency, *Floodproofing Non-Residential Structures*, FEMA 102, Washington, DC, May 1986.

Federal Emergency Management Agency, *Protecting Building Utilities From Flood Damage: Principles and Practices for the Design and Construction of Flood Resistant Building Utility Systems*, FEMA 348, Washington, DC, November 1999.

Federal Emergency Management Agency and American Red Cross, *Repairing Your Flooded Home*, FEMA 234/ARC 4477. Washington, DC. (available at <http://www.redcross.org>, local Red Cross chapters, and FEMA).

Federal Emergency Management Agency, NFIP Technical Bulletins:

- *User's Guide to Technical Bulletins*, FIA-TB-0, April 1993.
- *Openings in Foundation Walls*, FIA-TB-1, April 1993.
- *Flood-Resistant Materials Requirements*, FIA-TB-2, April 1993.
- *Non-Residential Floodproofing—Requirements and Certification*, FIA-TB-3, April 1993.
- *Elevator Installation*, FIA-TB-4, April 1993.
- *Free-of-Obstruction Requirements*, FIA-TB-5, April 1993.
- *Below-Grade Parking Requirements*, FIA-TB-6, April 1993.
- *Wet Floodproofing Requirements*, FIA-TB-7, December 1993.
- *Corrosion Protection for Metal Connections in Coastal Areas*, FIA-TB-8, 1996.
- *Design and Construction Guidance for Breakaway Walls Below Elevated Coastal Buildings*, FIA-TB-9, 1999.
- *Ensuring That Structures Built on Fill In or Near Special Flood Hazard Areas Are Reasonably Safe From Flooding*, FIA-TB-10, 2001.
- *Crawlspace Construction for Buildings Located in Special Flood Hazard Areas*, FIA-TB-11, 2001.

International Code Council, Inc. *ICC Performance Code for Buildings and Facilities*TM, Country Club Hills, IL, 2003.

International Code Council, Inc. *International Building Code*[®], Country Club Hills, IL, 2003.

National Fire Protection Association. *Building Construction and Safety Code* (NFPA 5000), Quincy, MA, 2003.

U.S. Army Corps of Engineers, *Flood-Proofing Systems & Techniques*, 1984.

U.S. Army Corps of Engineers, *Flood-Proofing Regulations*, EP 1165-2-314, 1992.

U.S. Army Corps of Engineers, *National Flood-Proofing Committee, Flood-Proofing – How To Evaluate Your Options*, Washington, DC, July 1993.

U.S. Army Corps of Engineers, *Flood-Proofing Programs, Techniques and References*, Washington, DC, 1996.

U.S. Army Corps of Engineers, *Flood-Proofing Performance - Successes & Failures*, Washington, DC, 1998.

Organizations and Agencies

Federal Emergency Management Agency: 10 regional offices (www.fema.gov) can be contacted for advice and guidance on NFIP mapping and regulations.

NFIP State Coordinating offices help local governments to meet their floodplain management obligations and may provide technical advice to others; the offices are listed by the Association of State Floodplain Managers, Inc., (www.floods.org/stcoor.htm).

State departments of education or agencies that coordinate state funding and guidelines for schools may have state-specific requirements.

U.S. Army Corps of Engineers: District offices offer Flood Plain Management Services (www.usace.army.mil/inet/functions/cw/).

5.10 GLOSSARY OF FLOOD PROTECTION TERMS

Base flood. The flood having a 1 percent chance of being equaled or exceeded in any given year; sometimes referred to as the 100-year flood.

Base flood elevation (BFE). The height of the base (1 percent or 100-year) flood in relation to a specified datum, usually the National Geodetic Vertical Datum of 1929 or the North American Vertical Datum of 1988.

Design flood. The greater of the following two flood events: (1) the base flood, affecting those areas identified as special flood hazard areas on a community's Flood Insurance Rate Map (FIRM); or (2) the flood corresponding to the area designated as a flood hazard area on a community's flood hazard map or otherwise legally designated.

Design flood elevation (DFE). The elevation of the design flood, including wave height, relative to the datum specified on a community's flood hazard map.

Dry floodproofing. An adjustment, modification, or addition of a feature or combinations of these that eliminate or reduce the potential for flood damage by sealing walls and closing openings to keep water from entering a building.

FEMA. Federal Emergency Management Agency, the federal agency that administers the National Flood Insurance Program (NFIP).

Flood Insurance Rate Map (FIRM). Insurance and floodplain management map issued by FEMA that identifies areas of base flood hazard in a community. Some areas' maps also include base flood elevations, 500-year floodplain boundaries, and regulatory floodway boundaries.

Flood Insurance Study (FIS). Engineering study performed by FEMA to identify flood hazard areas, flood insurance risk zones, and other flood data in a community; used in the development of the FIRM.

Floodplain. The area including a watercourse and the land adjacent to it that is flooded during a flood of a given recurrence interval (e.g., 10-year flood, 50-year flood, 100-year flood, etc.).

Floodplain management regulations. Zoning ordinances, subdivision regulations, building codes, health regulations, or special-purpose ordinances, that set flood protection standards for new construction and land use.

Floodway. The stream channel and that portion of the adjacent floodplain that must remain open to permit passage of the base flood.

Freeboard. The additional height to which a building is protected from flooding above the base flood elevation to provide additional factor of safety and to account for uncertainties, usually 1 to 3 feet for critical/essential facilities.

Human intervention. Actions that must be taken by one or more persons in order for a building to be floodproofed before floodwaters arrive.

Hydrodynamic force. The force of moving water, including the impact of debris and high velocities.

Hydrostatic pressure. The pressure put on a structure by the weight of standing water. The deeper the water, the more it weighs and the greater the hydrostatic pressure.

Lowest floor. The lowest floor of the lowest enclosed area (including a basement) of a building.

National Flood Insurance Program (NFIP). Federal program to identify flood-prone areas nationwide and make flood insurance available for properties in communities that participate in the program.

Substantial damage. Damage to a building from any cause such that the cost to repair it to its pre-damaged condition is equal to 50 percent or more of its pre-damaged value.

Substantial improvement. A modification or remodeling of a building such that the value of the addition or remodeling is equal to 50 percent or more of the building's original appraised value.

Wet floodproofing. Permanent or contingent measures applied to a building and/or its contents that prevent or provide resistance to damage from flooding by modifying interior finishes, removing damageable items from lower areas, and allowing water into the building.

6.1 INTRODUCTION

A well-designed, constructed, and maintained school may be damaged by a wind event that is much stronger than what the building was designed for; however, except for tornado damage, this scenario is a very rare occurrence. Rather, most damage occurs because various building elements have limited wind resistance due to inadequate design, application, or material deterioration. Wind with sufficient speed to cause damage to weak schools can occur anywhere in the United States and its possessions.¹ Although the magnitude and frequency of strong windstorms varies by locale, all schools should and can be designed, constructed, and maintained to avoid wind damage (other than that associated with tornadoes). In tornado-prone regions, consideration should be given to designing and constructing portions of schools to provide occupant protection.²

This chapter discusses structural and nonstructural building components and illustrates a variety of wind-induced damages. Because of the frequency and significant consequences of non-structural component failure, emphasis is given to these elements.

Numerous examples of best practices pertaining to new and existing schools are presented for consideration. Incorporation of those practices that are applicable to a specific project will result in greater wind-resistance reliability and will, therefore, provide enhanced protection for occupants and decreased expenditures for repair of wind-damaged facilities.

¹ The U.S. possessions include American Samoa, Guam, Puerto Rico, and the U.S. Virgin Islands.

² Tornado-prone regions are defined in Section 6.7.1.

6.2 THE NATURE AND PROBABILITY OF HIGH WINDS

A variety of windstorm types occur in different areas of the U.S. The characteristics of the type of storms that can impact the site should be considered by the design team. The primary storm types are:

- **Straight-line wind.** This type of wind event is the most common. The wind is considered, in general, to blow in a straight line. Straight-line wind speeds range from very low to very high. High winds associated with intense low pressure can last for upward of a day at a given location. Straight-line winds occur throughout the U.S. and its possessions (see Figure 6-1).

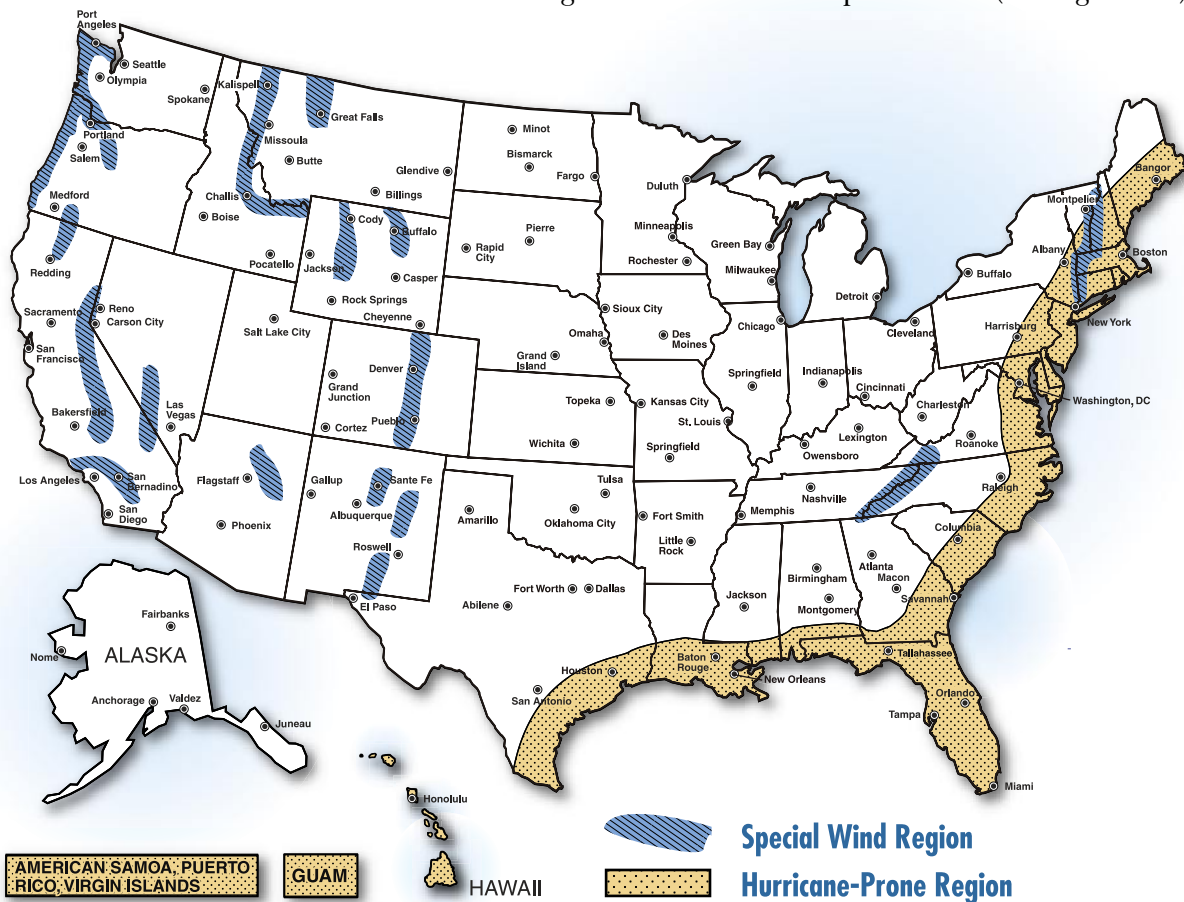

Figure 6-1 Hurricane-prone regions and special wind regions

Note: Hurricane/typhoon-prone regions also include American Samoa, Guam, Puerto Rico, and the U.S. Virgin Islands.

SOURCE: ADAPTED FROM ASCE 7-02

- **Down-slope wind.** Wind flowing down the slope of mountains is referred to as down-slope wind. Down-slope winds with very high wind speeds frequently occur in Alaska and Colorado. In the continental U.S., mountainous areas are referred to as “special wind regions” (see Figure 6-1). Neither ASCE 7 or model building codes provide guidance on wind speeds in special wind regions. If the local building department has not established the basic speed, use of regional climatic data and consultation with a wind engineer or meteorologist is advised.

- **Thunderstorm.** This type of storm can rapidly form and produce high wind speeds. Approximately 10,000 severe thunderstorms occur in the U.S. each year, typically in the spring and summer. They are most common in the Southeast and Midwest. Besides producing high winds, they often create heavy rain. Hail and tornadoes are also sometimes produced. Thunderstorms commonly move through an area quite rapidly, often causing high winds for only a few minutes at a given location. However, thunderstorms can also stall and become virtually stationary.

- **Downburst.** Also known as microburst, it is a powerful downdraft associated with a thunderstorm. When the downdraft reaches the ground, it spreads out horizontally and may form one or more horizontal vortex rings around the downdraft. The outflow is typically 6,000 to 12,000 feet across and the vortex ring may rise 2,000 feet above the ground. The life-cycle of a downburst is usually between 15 to 20 minutes. Observations suggest that approximately 5 percent of all thunderstorms produce a downburst, which can result in significant damage in a localized area.

- **Northeaster (nor’easter).** This type of storm is cold and violent and occurs along the northeastern coast of the U.S. These storms blow in from the Northeast and may last for several days.

- **Hurricane.** This is a system of spiraling winds converging with increasing speed toward the storm’s center (the eye

of the hurricane). Hurricanes form over warm oceans. The diameter of the storm varies between 50 and 600 miles. A hurricane's forward movement (translational speed) can vary between approximately 10 to 25 miles per hour (mph). Besides being capable of delivering extremely strong winds for several hours, many hurricanes also bring very heavy rainfall. Hurricanes also occasionally spawn tornadoes. The Saffir-Simpson Hurricane Scale rates the intensity of hurricanes. The five-step scale ranges from Category I (the weakest) to Category V (the strongest). Hurricane-prone regions are defined in Section 6.2.1.

Of all the storm types, hurricanes have the greatest potential for devastating a very large geographical area and, hence, affect great numbers of people. The terms "hurricanes, tropical cyclones, and typhoons" are synonymous for the same type of storm. See Figure 6-1 for hurricane-prone regions.

- **Tornado.** This is a violently rotating column of air extending from the base of a thunderstorm to the ground. The Fujita scale categorizes tornado severity based on observed damage. The six-step scale ranges from F0 (light damage) to F5 (incredible damage). Weak tornadoes (F0 and F1) are most common, but strong tornadoes (F2 and F3) frequently occur. Violent tornadoes (F4 and F5) are rare. Tornado path widths are typically less than 1,000 feet; however, widths of approximately 1 mile have been reported. Wind speed rapidly decreases with increased distance from the center of a tornado. A school on the periphery of a strong or violent tornado could be subjected to moderate to high wind speeds, depending upon the distance from the core of the tornado. However, even though the wind speed might not be great, a school on the periphery could still be impacted by many large pieces of wind-borne debris. Tornadoes are responsible for the greatest number of wind-related deaths each year in the U.S. Figure 6-2 shows frequency of occurrence for 1950 to 1998 and Figure 6-3 shows the design wind speeds used for the design of community tornado shelters.

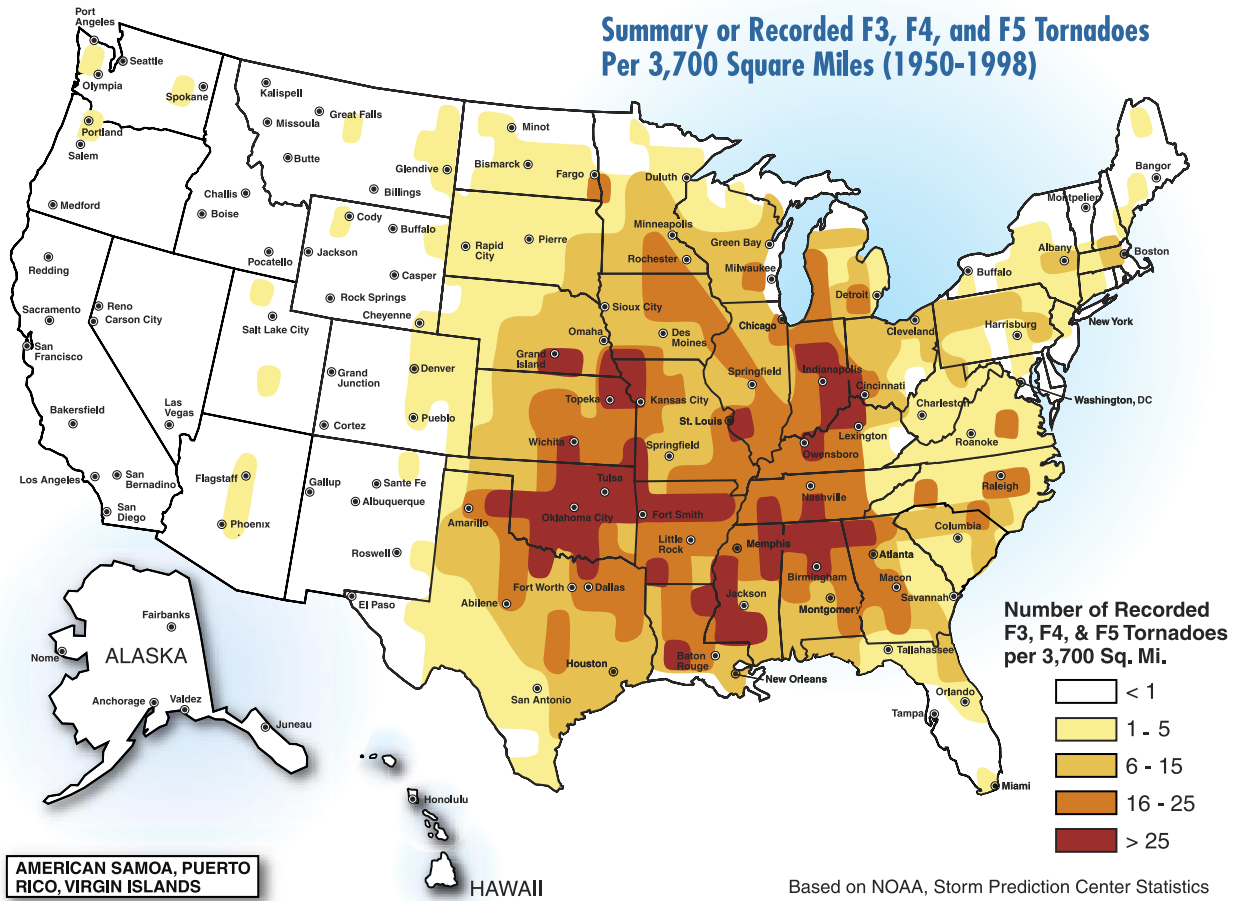

Figure 6-2 Tornado occurrence in the United States based on historical data

SOURCE: FEMA 361, *DESIGN AND CONSTRUCTION GUIDANCE FOR COMMUNITY SHELTERS*, 2000

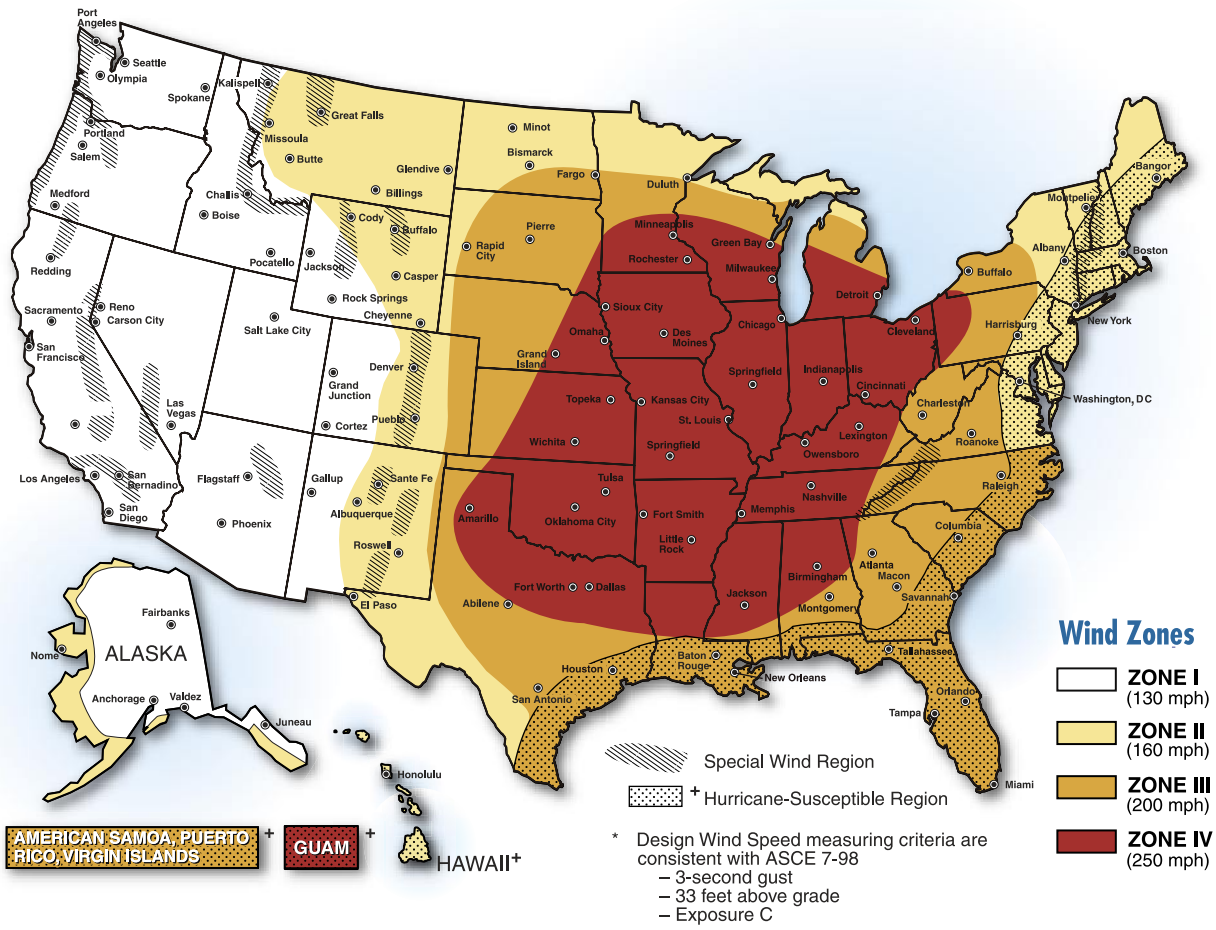

Figure 6-3 Design wind speeds for community tornado shelters
 SOURCE: FEMA 361, DESIGN AND CONSTRUCTION GUIDANCE FOR COMMUNITY SHELTERS, 2000

6.2.1 Wind/Building Interactions

When wind interacts with a building, both positive and negative (i.e., suction) pressures occur simultaneously (see Figure 6-4). (Note: negative pressures are less than ambient pressure, and positive pressures are greater than ambient pressure.) The school must have sufficient strength to resist the applied loads in order to prevent wind-induced building failure. The magnitude of the pressures is a function of the following primary factors:

- **Exposure.** The characteristics of the ground roughness and surface irregularities in the vicinity of a building influence

the wind loading. ASCE 7 defines three exposure categories, Exposures B, C, and D.³ Exposure B is the roughest terrain and Exposure D is the smoothest. Exposure B includes urban, suburban, and wooded areas. Exposure C includes flat open terrain with scattered obstructions and areas adjacent to water surfaces in hurricane-prone regions (which are defined below under “basic wind speed”). Exposure D includes areas adjacent to water surfaces outside hurricane-prone regions, mud flats, salt flats, and unbroken ice. Because of the wave conditions generated by hurricanes, areas adjacent to water surfaces in hurricane-prone regions are considered to be Exposure C rather than the smoother Exposure D.

The smoother the terrain, the greater the wind load; therefore, schools (with the same basic wind speed) located in Exposure D would receive higher wind loads than those located in Exposure C.

For additional information, see the *Commentary* of ASCE 7, which includes several aerial photographs that illustrate the different terrain conditions associated with Exposures B, C, and D.

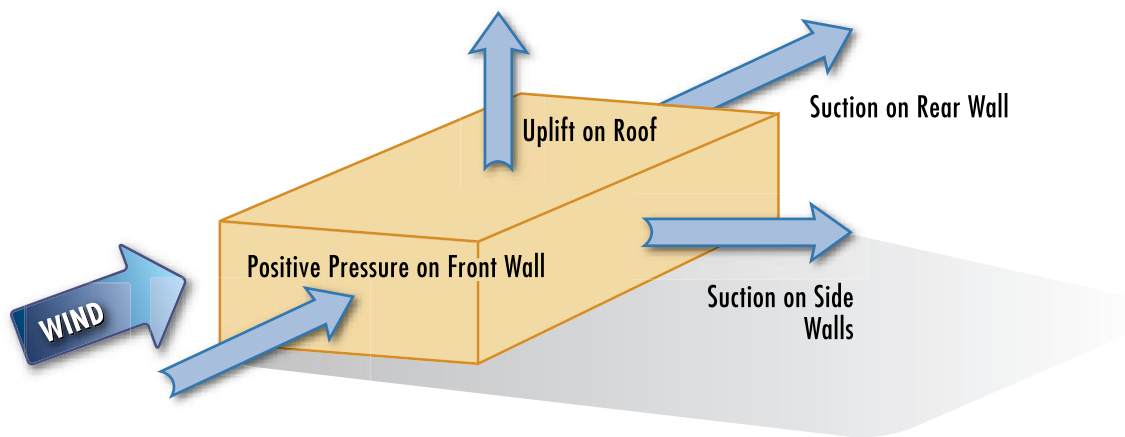

Figure 6-4
Schematic of wind-induced pressures on a building

³ Chapter 6 of ASCE 7 provides guidance for determining wind loads on buildings. The IBC and NFPA 5000 refer to ASCE 7 for wind load determination.

- **Basic wind speed.** ASCE 7 defines the basic wind speed as the wind speed with a 50-year mean recurrence interval (2 percent annual probability), measured at 33 feet above grade in Exposure C (flat open terrain). If the building is located in Exposure B or D, rather than C, an adjustment for the actual exposure is made in the ASCE 7 calculation procedure.

Since the 1995 edition of ASCE 7, the basic wind speed has been a peak gust speed. Prior to that time, the basic wind speed was a fastest-mile speed (i.e., the speed averaged over the time required for a mile-long column of air to pass a fixed point). Because the measuring time for peak gust versus fastest-mile is different, peak gust speeds are typically about 20 miles per hour (mph) faster than fastest-mile speeds (e.g., a 90-mph peak basic wind speed is equivalent to a 70-mph fastest-mile wind speed). Most of the U.S. has a basic wind speed (peak gust) of 90 mph, but much higher speeds occur in Alaska and in hurricane-prone regions. The highest speed, 170 mph, occurs in Guam.

Hurricane-prone regions are along the Atlantic and Gulf of Mexico coasts (where the basic wind speed is greater than 90 mph), Hawaii, and the U.S. possessions in the Caribbean and South Pacific (see Figure 6-1).

In determining wind pressures, the basic wind speed is squared; therefore, as the velocity is increased, the pressures are exponentially increased. For example, the uplift load on a 30-foot high roof covering at a corner area of a school in Exposure B is 37.72 pounds per square foot (psf) with a basic wind speed of 85 mph (per ASCE 7-02). If the speed is doubled to 170 mph, the roof corner load increases by a factor of four to 151 psf.

- **Topography.** Abrupt changes in topography, such as isolated hills, ridges, and escarpments, cause wind speed-up; therefore, a school located near a ridge would receive higher wind loads than a school located on relatively flat land. ASCE 7 provides a procedure to account for topographic influences.

- **Building height.** Wind speed increases with height above the ground. Therefore, the taller the school, the greater the speed and, hence, the greater the wind loads. ASCE 7 provides a procedure to account for building height.
- **Internal pressure (i.e., building pressurization/depressurization).** Wind striking a building can cause either an increase in the pressure within the building (i.e., positive pressure), or it can cause a decrease in the pressure (i.e., negative pressure). Internal pressure changes occur because of the porosity of the building envelope. Porosity is caused by openings around doors and window frames, and by air infiltration through walls that are not absolutely airtight. A door or window left in the open position also contributes to porosity.

Wind striking an exterior wall exerts a positive pressure on the wall, which forces air through openings and into the interior of the building (this is analogous to blowing up a balloon). At the same time the windward wall is receiving positive pressure, the side and rear walls are receiving negative (suction) pressure; therefore, air within the building is being pulled out at openings in these other walls. As a result, if the porosity of the windward wall is greater than the combined porosity of the side and rear walls, the interior of the building is pressurized. But if the porosity of the windward wall is less than the combined porosity of the side and rear walls, the interior of the building is depressurized (this is analogous to letting air out of a balloon).

When a building is pressurized, the internal pressure pushes up on the roof. This push from below the roof is combined with the suction above the roof, resulting in an increased wind load on the roof. The internal pressure also pushes on the side and rear walls. This outward push is combined with the suction on the exterior side of these walls. Therefore, a pressurized building increases the wind load on the side and rear walls (see Figure 6-5) as well as on the roof.

Figure 6-5
Schematic of internal
pressure condition when
the dominant opening is
in the windward wall

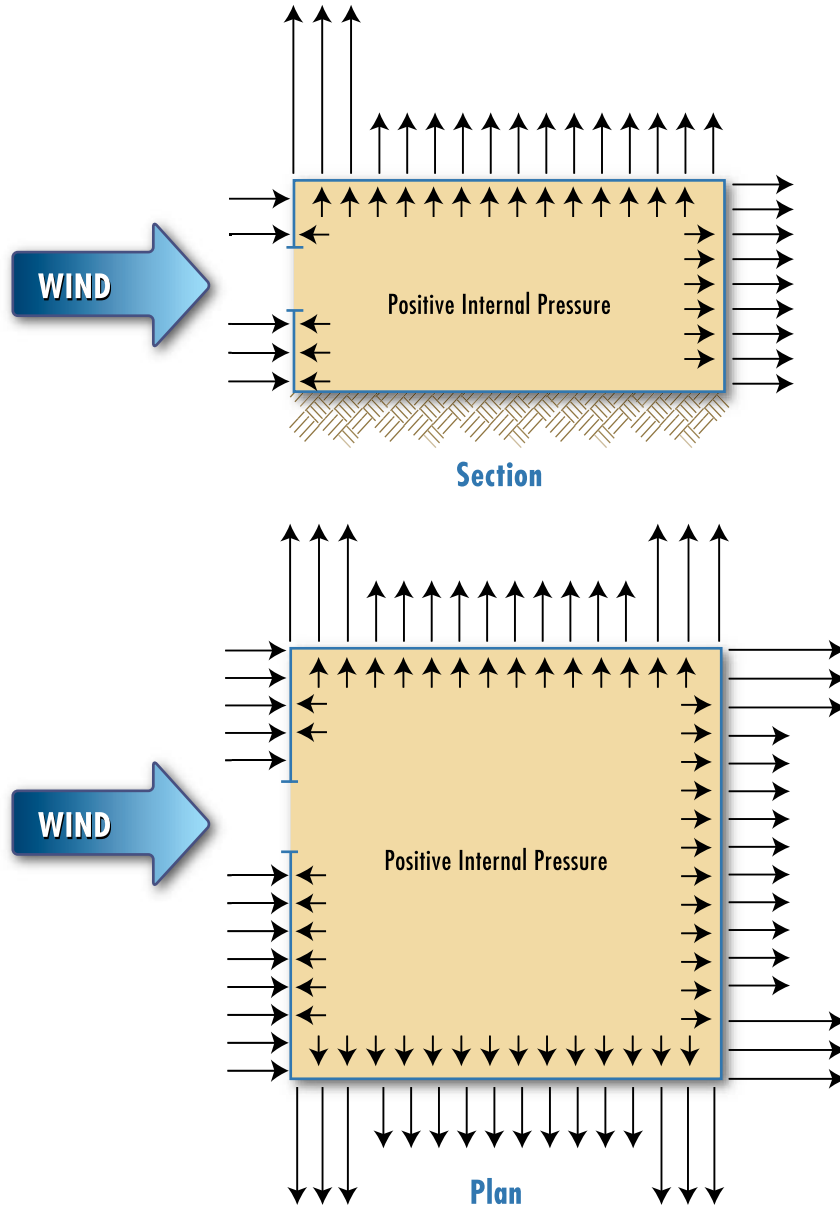

NOTE: Arrows indicate direction and magnitude of applied force.

When a building is depressurized, the internal pressure pulls the roof down, which reduces the amount of uplift exerted on the roof. The decreased internal pressure also pulls inward on the windward wall, which increases the wind load on that wall (see Figure 6-6).

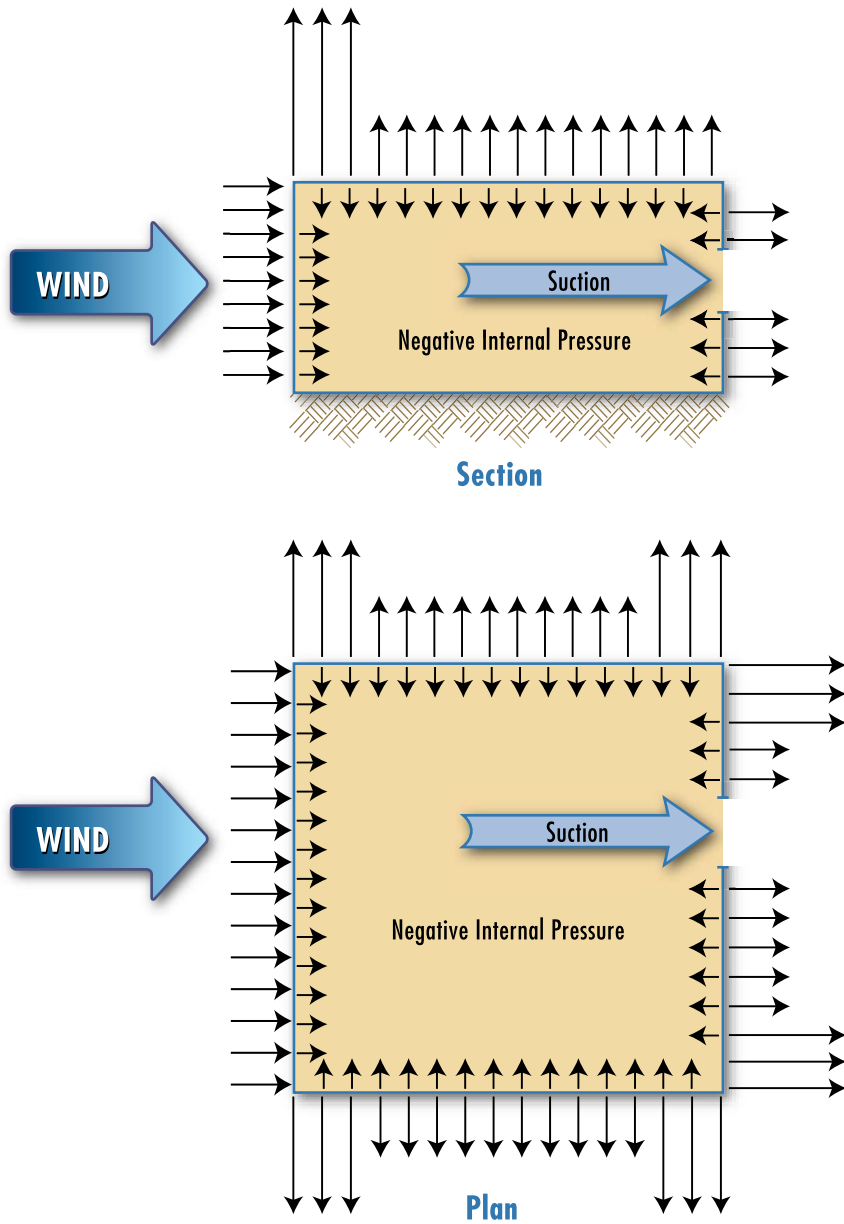

Figure 6-6
Schematic of internal
pressure condition
when the dominant
opening is in the
leeward wall

NOTE: Arrows indicate direction and magnitude of applied force.

When a school becomes fully pressurized (e.g., due to window breakage), the loads applied to the exterior walls and roof are significantly increased. The build-up of high internal pressure can also blow down interior partitions and blow ceiling boards out of their support grid. The breaching of a small window is typically sufficient to cause full pressurization of the school's interior.

ASCE 7 provides a design procedure to assess the influence of internal pressure on the wall and roof loads, and it provides positive and negative internal pressure coefficients for use in load calculations. Buildings that can be fully pressurized are referred to as partially enclosed buildings. Buildings that have limited internal pressurization capability are referred to as enclosed buildings.

- **Aerodynamic pressure.** Because of building aerodynamics (i.e., the interaction between the wind and the building), the highest uplift loads occur at roof corners. The roof perimeter has a somewhat lower load, followed by the field of the roof. Exterior walls typically have lower loads than the field of the roof. The ends of walls have higher suction loads than the portion of wall between the ends. However, when the wall is loaded with positive pressure, the entire wall is uniformly loaded. Figure 6-7 illustrates these aerodynamic influences. The negative values shown in Figure 6-7 indicate suction pressure acting upward from the roof surface and outward from the wall surface. Positive values indicate positive pressure acting inward on the wall surface.

Aerodynamic influences are accounted for by use of external pressure coefficients, which are used in load calculations. The magnitude of the coefficient is a function of the location on the building (e.g., roof corner or field of roof) and building shape as discussed below. Positive coefficients represent a positive pressure, and negative coefficients represent negative (suction) pressure. External pressure coefficients are found in ASCE 7.

Building shape affects the magnitude of pressure coefficients and, therefore, the loads applied to the various building surfaces. For example, the uplift loads on a low-slope roof are larger than the loads on a gable or hip roof. The steeper the slope, the lower the uplift load. Pressure coefficients for monoslope (shed) roofs, sawtooth roofs, and domes are all different from those for low-slope and gable/hip roofs.

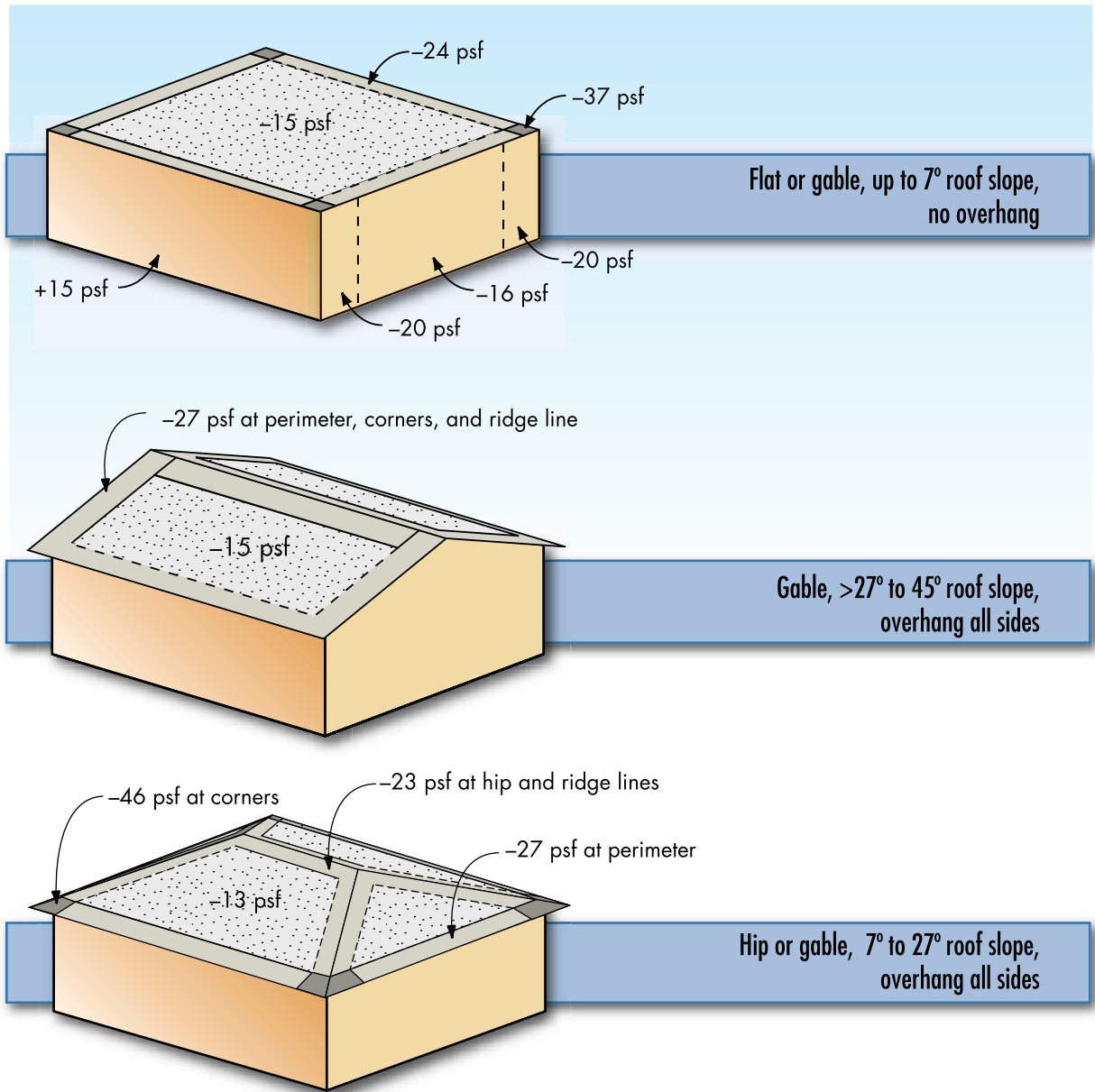

NOTE: Design pressures all assume an enclosed building with the same basic wind speed of 90 mph, exposure B, and 30' roof height.

Figure 6-7

Relative roof uplift pressures as a function of roof geometry, roof slope, and location on roof, and relative positive and negative wall pressures as a function of location along the wall.

Building irregularities such as bay window projections, a stair tower projecting out from the main wall, dormers, chimneys, etc., can cause localized turbulence. Turbulence causes wind speed-up, which increases the wind loads in the vicinity of the building irregularity as shown in Figures 6-8 and 6-9.

Figure 6-8
The aggregate ballast on this single-ply membrane roof was blown away in the vicinity of the corners of the wall projections at the window bays. The irregular wall surface created turbulence, which led to wind speed-up and loss of aggregate in the turbulent flow areas.



Figure 6-9
The metal roof is over a stair tower. The irregularity created by the stair tower caused turbulence that resulted in wind speed-up.



As shown in Figure 6-9, the built-up roof's base flashing was pulled out from underneath the coping and caused a large area of the membrane to lift and peel. Some of the wall covering on the stair tower was also blown away. Had the stair tower not existed, the built-up roof would not have been damaged.

Loads exerted on the building envelope are transferred to the structural system, where they are transferred through the foundation and into the ground.

Information pertaining to load calculations is presented in Section 6.8.2.

For further general information on the nature of wind and wind-building interactions, see *Buildings at Risk: Wind Design Basics for Practicing Architects*, American Institute of Architects, 1997.

To avoid damage in the vicinity of building irregularities, attention needs to be given to attachment of building elements located in turbulent flow areas.

6.2.2 Probability of Occurrence

Most buildings are designed for a 50-year mean recurrence interval wind event (2 percent annual probability). A 50-year storm would be expected to happen about once every 50 years; however, a 50-year storm can occur more or less frequently. A 50-year storm may not occur within any 50-year interval, but two 50-year storms could occur within 1 year.

ASCE 7 requires schools with a capacity greater than 250 occupants and schools used for hurricane or other emergency shelters to be designed for a 100-year mean recurrence interval wind event (1 percent annual probability); therefore, these schools are designed to resist stronger, rarer storms than most buildings. The importance factor is used to adjust the mean recurrence interval. For a 50-year interval, the importance factor is 1.00. For a 100-year interval, the importance factor is 1.15.

When designing a school, architects and engineers should consider the following:

- **Routine winds.** In many locations, winds with low to moderate speeds occur daily. Damage is not expected to occur during these events.
- **Stronger winds.** At a given site, stronger winds (e.g., winds with a basic wind speed in the range of 70 to 80 mph peak gust) may occur from several times a year to only once a year or less frequently. 70 to 80 mph is the threshold at which damage normally begins to occur to building elements that have limited wind resistance due to problems associated with inadequate design, strength, application, or material deterioration.

Missile damage is very common during hurricanes and tornadoes. Missiles can puncture roof coverings, many types of exterior walls, and glazing. The IBC does not address missile-induced damage, except for glazing in wind-borne debris regions. (Wind-borne debris regions are limited to portions of hurricane-prone regions.) In hurricane-prone regions, significant school damage should be expected even during design level hurricane events, unless special enhancements are incorporated into the school's design (see Section 6.15).

- **Design level winds.** Schools that experience design level events and events that are somewhat in excess of design level should experience little, if any damage; however, design level storms frequently cause extensive building envelope damage. Structural damage also occurs, but less often. Damage experienced with design level events is typically associated with inadequate design, application, or material deterioration. The exceptions are wind-driven water infiltration and wind-borne debris (missiles) damage. Water infiltration is discussed in Sections 6.10.4, 6.11.3, and 6.13.3.

- **Tornadoes.** Although more than 1,200 tornadoes typically occur each year in the U.S., the probability of a tornado occurring at any given location is quite small. The probability of occurrence is a function of location. As shown in Figure 6-2, only a few areas of the U.S. frequently experience tornadoes, and tornadoes are very rare in the west. The Oklahoma

City area is the most active location in the U.S., with 106 recorded tornadoes between the years 1890 and 2000.

Except for window breakage, well designed, constructed, and maintained schools should experience little if any damage from weak tornadoes. However, because many schools have wind-resistance deficiencies, weak tornadoes often cause building envelope damage. Most schools experience significant damage if they are in the path of a strong or violent tornado (see Figure 6-10). In the classroom wing, shown in Figure 6-10, all of the exterior windows were broken, and virtually all of the cementitious wood-fiber deck panels were blown away. Much of the metal decking over the band and chorus area also blew off. The gymnasium collapsed, as did a portion of the multi-purpose room. The school was not in session at the time the tornado struck.



Figure 6-10
This high school in northern Illinois was heavily damaged by a strong tornado.

6.3 VULNERABILITY: WHAT WIND CAN DO TO SCHOOLS

When damaged by wind, schools typically experience the following types of building component damage in descending order of frequency of occurrence (see Figures 6-11 through 6-16):

Roof covering damage (including rooftop mechanical, electrical, and communications equipment).

Figure 6-11

A portion of the built-up membrane at this school lifted and peeled after the metal edge flashing lifted. The cast-in-place concrete deck kept a lot of water from entering the school. Virtually all of the loose aggregate blew off the roof and broke many windows in nearby houses. This school was being used as a hurricane shelter at the time of the blow-off.



Exterior glazing damage – very common during hurricanes and tornadoes, less common during other storms.

Figure 6-12

The outer panes of these windows were broken by aggregate from a built-up roof. The inner panes had several impact craters. In several of the adjacent windows, both the outer and inner panes were broken. The aggregate had a flight path in excess of 245 feet. The wind speed was less than the design wind speed.



Exterior wall coverings and soffit damage.



Figure 6-13
The metal wall covering on this school was applied to plywood over metal studs. The metal stud wall collapsed in this area, but, in other areas, it was blown completely away. The CMU wall behind the studs did not appear to be damaged. This school was on the periphery of a violent tornado.

SOURCE: OKLAHOMA AND KANSAS MIDWEST TORNADOES OF MAY 3, 1999, 1999

Collapse of non-load bearing exterior walls.



Figure 6-14
The unreinforced CMU wall at this school collapsed during a storm that had wind speeds that were less than the design wind speed.

Structural damage (e.g., roof deck blow-off, blow-off or collapse of the roof structure, collapse of exterior bearing walls, or collapse of the entire school or major portions thereof). Structural damage, along with damage to the building envelope, is the number one type of damage during strong and violent tornadoes.

Figure 6-15
The roof and all the walls of a wing of this elementary school were blown away by a violent tornado.



Figure 6-16
This portable classroom was blown up against the main school building during a storm that had wind speeds that were less than the design wind speed. Depending upon the type of exterior wall, an impacting portable classroom may or may not cause wall collapse.



Ramifications of the above types of damages include:

- **Property damage.** Including repair/replacement of the damaged components (or replacement of the entire facility), plus repair/replacement of interior building components, mold remediation, furniture, equipment, and books caused by water and/or wind entering the school. Even when damage to the building envelope is limited, such as blow-off of a portion of the roof covering or broken glazing, substantial water damage frequently occurs because heavy rains often accompany strong winds (particularly in the case of thunderstorms, hurricanes, and tornadoes; see Figure 6-17).



Figure 6-17
This newly-constructed gymnasium had a structural metal roof panel (3-inch trapezoidal ribs at 24 inches on center) applied over metal purlins. The panels detached from their concealed clips. A massive quantity of water entered the school and buckled the wood gym floor.

Debris such as roof aggregate, gutters, HVAC equipment, and siding blown from schools can damage automobiles, residences, and other buildings in the vicinity of the school.

Debris can travel well in excess of 300 feet in wind events. If non-school property is damaged by school building debris, the school district will likely be responsible for the damage.

Portable classrooms are often particularly vulnerable to significant damage because they are seldom designed to the same wind loads as permanent school buildings. Portable

Modest wind speeds can drive rain into the school's exterior walls. Unless adequate provisions are taken to account for water infiltration (see Sections 6.10.4, 6.11.3, and 6.13.3), damaging corrosion, dry rot, and mold can occur within the walls.

Although people are not usually outside a school during a high wind event, exceptions are schools used as hurricane shelters. In this case, it is common for people to arrive at a school during very high winds. Missiles such as roof aggregate shedding from the school could injure or kill late arrivers to the shelter. Another exception is the period of time when students are arriving at or departing from school. Thirteen students at the Belvidere High School in northern Illinois were killed and many others were seriously injured by a tornado in 1967. School had been dismissed shortly before the tornado struck and many students were in school buses as the tornado approached the school. An attempt was made to get the students back inside the school, but 12 of the buses were thrown about by the tornado before the students could seek shelter within the school. Aggregate from the school's built-up roof penetrated the flesh of several students.

classrooms are frequently blown over during high-wind events because the inexpensive techniques that are typically used are inadequate to anchor the units to the ground. Wind-borne debris from portables or an entire portable classroom may impact the permanent school building and cause serious damage.

- **Injury or death.** Although infrequent, school occupants or people outside schools have been injured and killed when struck by collapsed building components (such as exterior masonry walls or the roof structure) or wind-borne building debris. The greatest risk of injury or death is during strong hurricanes and strong/violent tornadoes.
- **Interrupted use.** Depending upon the magnitude of wind and water damage, it can take days, months, or more than a year to repair the damage or replace a facility (see Figure 6-18). In addition to the costs associated with repairing/replacing the damage, other financial ramifications related to interrupted use of the school can include the cost of bussing students to an alternative school and/or rental of temporary facilities. These additional costs can be quite substantial.

There are also social and psychological factors, such as difficulties imposed on students, parents, faculty and the administration during the time the school is not usable.



Figure 6-18

A portion of the roof structure blew off of this school, and a portion of it collapsed into classrooms. Because of extensive water damage, a school such as this can be out of operation for a considerable period of time.

6.4 SCOPE, EFFECTIVENESS, AND LIMITATIONS OF BUILDING CODES

In the following section, the IBC is discussed. In some jurisdictions, NFPA 5000 or one of the earlier model building codes or a specially written state or local building code may be used. The specific scope and/or effectiveness and limitations of these other building codes will be somewhat different than that of the IBC. It is incumbent upon the architect/engineer to be aware of the specific code (including the edition of the code and local amendments) that has been adopted by the authority having jurisdiction.

6.4.1 Scope

With respect to wind performance, the scopes of the model building codes have greatly expanded since the mid-1980s. Significant improvements include:

- **Recognition of increased uplift loads at the roof perimeter and corners.** Prior to the 1982 edition of the Standard Building Code and Uniform Building Code and the 1987 edition of the National Building Code, these model codes did not account for the increased uplift at the roof perimeter and corners. Therefore, schools designed in accordance with earlier editions of these codes are very susceptible to blow-off of the roof deck and/or roof covering.
- **Adoption of ASCE 7 for wind design loads.** Although the three model codes permitted use of ASCE 7, the 2000 edition of the IBC was the first model code to require ASCE 7 for determining wind design loads. ASCE 7 has been more reflective of the current state of the knowledge than the model codes, and use of this procedure has typically resulted in higher design loads.
- **Roof coverings.** Several performance and prescriptive requirements pertaining to wind resistance of roof coverings have been incorporated. The majority of these additional provisions were added after Hurricanes Hugo (1989) and Andrew (1992). Poor performance of roof coverings was widespread in both of those storms. Prior to the 1991 edition of the SBC and UBC and the 1990 edition of the NBC, these model codes were essentially silent on roof covering wind loads and test methods for determining uplift resistance. Code improvements continued to be made through the 2003 edition of the IBC.
- **Glazing protection.** The 2000 edition of the IBC was the first model code to address wind-borne debris requirements for buildings located in the wind-borne debris regions of hurricane-prone regions (via reference to the 1998 edition of

ASCE 7). (The 1995 edition of ASCE 7 was the first edition to address wind-borne debris requirements).

- **Parapets and rooftop equipment.** The 2003 edition of the IBC was the first model code to address wind loads on parapets and rooftop equipment (via reference to the 2002 edition of ASCE 7, which was the first edition of ASCE 7 to address these elements).

6.4.2 Effectiveness

Except for hurricanes and tornadoes, the 2003 edition of the IBC is believed to be a relatively effective code, provided that it is properly followed and enforced. This code is also believed to be an effective code for hurricanes, except that it does not account for water infiltration due to puncture of the roof membrane by missiles, nor does it adequately address the vulnerabilities of brittle roof coverings (such as tile) to missile-induced damage and subsequent progressive cascading failure.

The 2003 IBC relies on several referenced standards and test methods developed or updated in the 1990s. Most of these standards and test methods have not been validated by actual building performance during design level wind events. Therefore, the actual performance of buildings designed and constructed to the minimum provisions of the 2003 IBC remains to be determined. Future post-storm building performance evaluations may or may not show the need for further enhancements.

The 2003 IBC does not account for tornadoes; therefore, except for weak tornadoes, it is ineffective for this type of storm.

6.4.3 Limitations

Limitations to building codes include the following:

- Because codes are adopted on the local or state level, the adopting authority has the power to not adopt all wind-

related provisions of a model code, or to write their own code rather than follow a model code. In either case, important provisions of the current model code may be stricken, thereby resulting in schools that are more susceptible to wind damage when they are designed and constructed in accordance with the minimum requirements of the locally adopted code. Also, often there is a significant time lag between the time a model code is updated and the time it is implemented by the adopting authority. When lag occurs, schools designed to the minimum requirements of the outdated code are not taking advantage of the current state of the knowledge. Therefore, these schools are prone to poorer wind performance compared to schools designed according to the current model code.

- Adoption of the current model code does not ensure good wind performance. Rather, the code is a minimum tool that should be used by knowledgeable design professionals in conjunction with their training, skills, and professional judgment. To achieve good wind performance, in addition to good design, the construction work must be effectively executed and the school must be adequately maintained and repaired.
- Specific limitations of the 2003 IBC include lack of provisions pertaining to blow-off of aggregate from built-up and sprayed polyurethane foam roofs, and limitations of some of the test methods used to assess wind and wind-driven rain resistance of building envelope components (improved test methods need to be developed before this code limitation can be overcome). In addition, the code does not address protection of occupants in schools (and other buildings) located in tornado-prone regions.
- The 2003 IBC does not address the need for continuity, redundancy, or energy-dissipating capability (ductility) to limit the effects of local collapse and to prevent or minimize progressive collapse in the event of the loss of one or two

primary structural members such as a column. However, even though this issue is not addressed in the IBC, Chapter 1 of ASCE 7 does address general structural integrity, and the ASCE 7 Chapter 1 *Commentary* provides some guidance on this issue.

6.5 PRIORITIES, COSTS, AND BENEFITS: NEW SCHOOLS

Prior to evaluating schools for risk from high winds and beginning the risk reduction design process, it is first necessary to consider the priorities, costs, and benefits of potential risk reduction measures. These factors, as discussed below, should be considered within the context of performance-based wind design as discussed in Section 2.12.3.

6.5.1 Priorities

As previously discussed in this manual, the first priority is the implementation of measures that will reduce risk of casualties to students, faculty, staff, and visitors. The second priority is the reduction of damage that leads to downtime and disruption. The third priority is the reduction of damage and repair costs. To realize these priorities, as a minimum the school should be designed and constructed in accordance with the latest edition of a current model building code such as the IBC (unless the local building code has more conservative wind-related provisions, in which case the local building code should be used as the basis for design). In addition, the school should be adequately maintained and repaired.

For schools that will be used for emergency response after a storm and/or those schools that will be used for hurricane shelters, measures beyond those required by the IBC should be given high priority (see Section 6.15).

For schools in coastal Alaska and other areas that experience frequent high-wind events (such as parts of Colorado), measures beyond those required by the IBC should be given high priority. Several of the recommendations for schools in hurricane-prone

regions (Section 6.15) are also applicable to these schools, with the exception of the wind-borne debris recommendations. (Limited amounts of wind-borne debris are generated in storms other than hurricanes and tornadoes.)

For schools located in tornado-prone regions, priority should be given to the incorporation of specially designed occupant shelters within the school (see Section 6.16). The decision to incorporate occupant shelters should be based on the assessment of risk (see Section 6.7.1).

For schools located in areas where the basic wind speed is greater than 90 mph, priority should be given to incorporation of design, construction, and maintenance enhancements. The degree of pri-

ority given to these enhancements increases as the basic wind speed increases (see Sections 6.8.3 to 6.8.5 and 6.9 to 6.14 for enhancement examples).

The benefit/cost ratio of incorporating specially designed tornado shelters within schools can be assessed using software that accompanies FEMA 361.⁴ Tornado shelters have been constructed in several schools in Kansas and Oklahoma. An architect involved with several of the Kansas schools reports that the additional cost to incorporate a shelter ranges from \$30 to \$38 per square foot of shelter space (year 2002 costs). FEMA 361 recommends using a minimum of 5 square feet per person for sheltering; therefore, the \$30 to \$38 psf equates to \$150 to \$190 per student and staff for “near absolute protection” (i.e., protection from injury or death) from a violent tornado. Tornado shelters are discussed in Section 6.16.

6.5.2 Cost, Budgeting, and Benefits

The cost for complying with the IBC should be considered as the minimum baseline cost.

For schools that will be used for emergency response after a storm and/or those schools that will be used for hurricane shelters, the additional cost for implementing measures beyond those required by the 2003 edition of the IBC will typically add only a small percentage to the total cost of construction. Sections 6.8 and 6.15 discuss additional measures that should be considered.

For all other schools other than those discussed above, the additional cost for implementing en-

⁴ FEMA 361, *Design and Construction Guidance for Community Shelters*, 2000, is a manual for architects and engineers. It presents detailed guidance concerning the design and construction of shelters that provide “near-absolute protection” from tornadoes. FEMA 361 discusses shelter location, design loads for wind pressure and wind-borne debris, performance criteria, and human factor criteria. It is accompanied by a benefit/cost analysis model.

hancements will typically add only a very small percentage to the total cost of construction. Sections 6.8 to 6.14 discuss additional measures that should be considered.

The yearly cost of periodic maintenance and repair will be greater than the alternative of not expending any funds for periodic maintenance (i.e., deferred maintenance and repair). If, however, the deferred maintenance option is selected, eventually maintenance and repairs will be required, and the extent and cost of the work will typically be much greater than the costs associated with the periodic option. Also, if a windstorm causes damage that would have otherwise been avoided had maintenance or repairs been performed, the resulting costs can be significantly higher. (Note: Maintenance and repair costs are reduced when more durable materials and systems are used; see Section 6.8.2, under “Step 4: Durability.”)

Budgeting. It is important for the school district to give consideration to wind enhancement costs early in the development of a new school project. If enhancements, particularly those associated with schools used as hurricane shelters, emergency response after a storm, and tornado shelters, are not included in the initial project budget, often it is very difficult to find funds later during the design of the project. If the additional funds are not found, the enhancements may be eliminated because of lack of forethought and adequate budgeting.

Benefits. If strong storms do not occur during the life of a school, there is little benefit to spending the money and effort related to wind resistance. However, considering the long life of most schools (hence, the greater probability of them experiencing a design level event) and considering the importance placed on students and the value of the school to the community, clearly it is prudent to invest in adequate wind resistance. By doing so, the potential for loss of life and injuries can be significantly reduced or virtually eliminated. Investing in wind resistance also minimizes future expenditures for repair or replacement of wind-damaged schools and avoids costly interrupted building use.

Figure 6-19

The HVAC unit in the parking lot in the photo's lower right corner blew off the curb during a storm that had wind speeds that were less than the design wind speed. A substantial amount of water entered the building before a temporary covering could be placed over the opening. The blow-off was caused by a load path discontinuity; no provisions had been made to anchor the unit to the curb. The insignificant cost of a few fasteners would have prevented repairs costing several thousand dollars and also prevented interrupted use of a portion of the building.



Fortunately, most of the enhancements pertaining to increased wind resistance are relatively inexpensive compared to the benefit that they provide. In evaluating what enhancements are prudent for a specific school, an enhancement that provides greater performance reliability at little cost is an enhancement worthy of consideration (see Figure 6-19).

Wind resistance enhancements may also result in decreased insurance premiums. The school district's insurer should be consulted to see if premium reductions are available, and to see if special enhancements are required in order to avoid paying a premium for insurance. For those school districts that self-insure, enhanced wind resistance should result in a reduction of future payouts.

6.6 PRIORITIES, COSTS, AND BENEFITS: EXISTING SCHOOLS

Prior to evaluating existing schools for risk from high winds and beginning the risk reduction design process, it is first necessary to consider the priorities, costs, and benefits of potential risk reduction measures. These factors, as discussed below, should be considered within the context of performance-based wind design as discussed in Section 2.12.3.

6.6.1 Priorities

In prioritizing work at existing schools, an assessment should be made on all schools within the district to ascertain which schools are vulnerable to damage and therefore most in need of remedial work. As part of the assessment, the nature of the vulnerability and the needed remedial work should be identified at the various schools. In making the district-wide assessment, all applicable hazards should be assessed and the needs prioritized. For some districts or some schools within a given district, the high priority work may be related to wind, or it may be related to one of the other hazards. In some instances, the same remedial work item can mitigate wind and other hazards. For example, strengthening the roof deck attachment can improve both wind and seismic resistance.

School districts located in following areas are in greatest need of assessing their schools (listed in descending order of priority): hurricane-prone regions and school districts outside of hurricane-prone regions that have schools that will be used for emergency response after a storm; tornado-prone regions; areas where the basic wind speed is in excess of 90 mph (the priority increases as the basic wind speed increases); and areas where the basic wind speed is 90 mph or less.

For school districts in hurricane-prone regions, the first priority needs to be given to those schools that will be used as hurricane shelters. Other priorities are as discussed at the beginning of Section 6.5.1.

For school districts in tornado-prone regions, the first priority needs to be given to occupant protection (see Section 6.16). Other priorities are the same as discussed at the beginning of Section 6.5.1.

For all other school districts, the priorities are the same as discussed at the beginning of Section 6.5.1.

In some instances, perhaps all the funds available for the year for remedial work will be spent at one school. In other instances, perhaps the available funds will be used for remedial work at several different schools.

See Section 6.17 for specific remedial work guidance.

6.6.2 Cost, Budgeting, and Benefits

Wind-resistance improvements would ideally address all elements in the load path from the building envelope to the structural system and into the ground. (Load path is discussed in Section 6.8.2 under “Step 3: Detailed Design”); however, this approach can be very expensive if there are many inadequacies throughout the load path. The maximum return on dollars invested for wind-resistance improvements is typically achieved by performing work related to the building envelope. Obviously if there are serious structural deficiencies that could lead to collapse during strong storms, these types of deficiencies should receive top priority; however, this scenario is infrequent.

Because elements of the building envelope are the building components that are most likely to fail in the more commonly occurring moderate wind speed events, strengthening these elements will avoid damage during those storms. Of course, if a storm approaching a design level event occurs, in this scenario, the building envelope will remain attached to the structure, but a structural element may fail. For example, if the connections between the roof joists and bearing walls are the weak link, the roof covering will remain attached to the roof deck and the deck will remain attached to the joists, but the entire roof structure will blow off because the joists will detach from the wall. Although loss of the entire roof structure is more catastrophic than the loss of just the roof covering, much stronger events are typically required to cause structural damage. Hence, on a school district-wide level, strengthening building envelopes can result in maximum return on funds spent on wind-resistance improvements. Of course, for a specific school, the actual scope of wind-resistance work should

be tailored for that school, commensurate with the findings from the evaluation (as discussed in Section 6.6.1) and the benefit/cost analysis (as discussed in below under “Benefits”).

Costs can be minimized if wind-resistance improvements are executed as part of planned repairs or replacement. For example, if the roof deck is inadequately attached in the perimeter and corners, and the roof covering has another 10 years of remaining service life, it would typically be prudent to hold off performing deck attachment upgrade until it is necessary to replace the roof covering. Then, as part of the reroofing work, the existing roof system could be torn off, the deck reattached, and the new membrane installed.⁵ With this approach, the full service life of the roof membrane (and, hence, its full economic value) is achieved.

Budgeting. As it is with new construction, it is important for the school district to give consideration to wind enhancement costs early in the development of a major repair/renovation project (see discussion in Section 6.5.2).

Benefits. The benefits for spending money and effort related to wind resistance of existing schools are the same as described for new schools in Section 6.5.2.

6.7 EVALUATING SCHOOLS FOR RISK FROM HIGH WINDS

To evaluate risk for wind storms other than tornadoes, the following steps are recommended:

- **Step 1:** Determine the basic wind speed from ASCE 7. As the basic wind speed increases beyond 90 mph, the risk of damage increases and it continues to increase as the speed increases. To compensate for the increased risk of damage, design, construction and maintenance enhancements are recommended (see Section 6.8).

⁵ In some cases, it is economical to reattach the decking from below the deck, but typically this approach is more costly.

As part of Steps 2 and 3, consider availability of other schools or other buildings in the community that could be used for educational purposes (and emergency response if the school is so designated) in the event that the school is damaged. For example, in an isolated community, the school may be the only facility available for education and/or emergency response, in which case loss of school use would be very serious. In this scenario, the enhancements given in Section 6.15 should be even more robust.

- **Step 2:** For schools not located in hurricane-prone regions, determine if the school will be used for emergency response after a storm (e.g., temporary housing, food or clothing distribution, or a place where people can fill out forms for assistance). If so, refer to the design, construction, and maintenance enhancements recommended for schools in hurricane-prone regions (see Section 6.15).
- **Step 3:** For schools in hurricane-prone regions, determine if the school will be used for a hurricane shelter and/or for emergency response after a storm. If so, refer to the design, construction, and maintenance enhancements recommended in Section 6.15.

- **Step 4:** For existing schools, evaluate the wind resistance of the building. The resistance will be a function of its original design and construction, various additions or modifications, and condition of building components (which may have weakened due to deterioration or fatigue).

As a first step, calculate the wind loads on the school using ASCE 7 and compare these loads with the loads that the school was originally designed for. (The original design loads may be noted on the contract drawings. If not, determine what building code or standard was used to develop the original design loads and calculate the loads using that code or standard.) If the original design loads are significantly lower than current loads, upgrading the load resistance of the building envelope and/or structure should be considered (see Section 6.6.2). (Note: An alternative to comparing current loads with original design loads is to evaluate the resistance of the existing school as a function of the current loads to determine what elements are highly overstressed.)

As a second step, perform a field investigation to evaluate the primary building envelope elements and structural system elements to determine if the school was generally constructed as indicated on the original contract drawings. As part of the investigation, the primary elements should be checked for deterioration. Load path continuity should also be checked.

The above evaluations will allow development of a vulnerability assessment that can be used along with the site's wind regime to assess the risk. See Section 6.17 for remedial work recommendations.

6.7.1 Tornadoes

Neither the IBC or ASCE 7 require buildings (including schools) to be designed for tornadoes, nor are occupant shelters required in buildings (including schools) located in tornado-prone regions. Because of the extremely high pressures and missile loads that tornadoes can induce, constructing tornado-resistant schools is extremely expensive. Therefore, when consideration is voluntarily given to tornado design, the emphasis typically is on occupant protection, which is achieved by “hardening” portions of a school for use as safe havens.

In this manual, the term “tornado-prone regions” refers to those areas of the U.S. where the number of recorded F3, F4, and F5 tornadoes per 3,700 square miles is six or greater (see Figure 6-2). However, a school district may decide to use other frequency values (e.g., 1 or greater, 16 or greater, or greater than 25) in defining whether or not the district is in a tornado-prone area. In this manual, tornado shelters are recommended for schools in tornado-prone regions.

FEMA 361, *Design and Construction Guidance for Community Shelters*, includes a comprehensive risk assessment procedure that designers can use to assist school districts in determining whether a tornado shelter should be included as part of a new school. See Section 6.16 for design of tornado shelters.

Where the number of recorded F3, F4, and F5 tornadoes per 3,700 square miles is one or greater, if the school does not have a tornado shelter, the best available refuge areas should be identified as discussed in Section 6.16.

6.7.2 Portable Classrooms

Unless portables are designed and constructed (including anchorage to the ground) to meet the same wind loads as the main school building, students and faculty should be considered at risk during high winds. Therefore, portables should not be occupied when high winds are forecast (even though the forecast speeds are well below design wind conditions for the main building). Also, during winds that are well below design wind conditions, it should be recognized that wind-borne debris from disintegrating portables could impact and damage the main school building and/or nearby residences.

6.8 RISK REDUCTION DESIGN METHODS

The keys to enhanced wind performance are devoting sufficient attention to design, construction contract administration, construction, maintenance, and repair. Of course, it is first necessary for the school district to budget sufficient funds for this effort (see Sections 6.5.2 and 6.6.2). This section provides an overview of these elements:

6.8.1 Siting

Where possible, a school should not be located in Exposure D. Locating the facility on a site in Exposure C or preferably in Exposure B would decrease the wind loads. Also, where possible, avoid locating a school on an escarpment or upper half of a hill. Otherwise, if the school is located on an escarpment or upper half of a hill, the abrupt change in the topography would result in increased wind loads. When siting on an escarpment or upper half of a hill is necessary, the ASCE 7 design procedure accounts for wind speed-up associated with this abrupt change in topography.

Trees in excess of 6 inches in diameter, poles (e.g., light fixture poles, flag poles, power poles), or towers (e.g., electrical transmission and communication towers) should not be placed near the school. Blow-down of large trees, poles, and towers can severely damage a school and injure occupants.

Providing at least two means of site egress is prudent for all schools, but is particularly important for schools used for hurricane shelters and emergency response after a storm. Two means of egress facilitate emergency vehicles that need to reach or leave the site. With multiple site egress roads, if one route becomes blocked by trees or other debris or by floodwaters, another access route should be available.

To the extent possible, site portable classrooms so that, if they disintegrate during a storm that approaches from the prevailing wind direction, debris will avoid impacting the main school building and residences. Debris can travel in excess of 300 feet. Destructive winds from hurricanes and tornadoes can approach from any direction. These storms can also throw debris much farther.

6.8.2 School Design

Good wind performance depends on good design (including detailing and specifying), materials, application, maintenance, and repair. A significant shortcoming of any of these five elements could jeopardize the performance of a school against wind. Design, however, is the key element to achieving good performance of a school against wind. Design inadequacies frequently cannot be compensated for by the other four elements. Good design, however, can compensate for other inadequacies to some extent.

Step 1: Calculate Loads

Calculate loads on the main wind-force resisting system (MWFRS; i.e., the primary structural elements such as beams, columns, shear walls, and diaphragms that provide support and stability for the overall building), the building envelope, and

In the past, architects seldom performed load calculations on the building envelope (i.e., roof and wall coverings, doors, windows, and skylights) and rooftop equipment and neither did structural engineers. In large part, as a result of not determining loads on these elements and not designing them with adequate load resistance, building envelope and rooftop equipment failures have been the leading cause of failure during past wind events. Just as it is with the MWFRS, it is imperative that loads be determined by the architect or engineer for the building envelope and rooftop equipment, and the envelope and rooftop equipment designed to accommodate the design loads.

rooftop equipment in accordance with ASCE 7 or the local building code, whichever procedure results in the highest loads.⁶ The importance factor for most schools will be required to be 1.15. For schools with an occupant load of 250 or less and not intended for use as shelters, a 1.00 importance factor is permitted; however, a value of 1.15 is recommended for all schools.

Uplift loads on roof assemblies can also be determined from Factory Mutual Global (FMG) Data Sheets. In some instances, the loads derived from ASCE 7 or the local code may exceed those derived from FMG, but, in other cases, the FMG loads may be higher. If the school is FMG-insured, and the FMG-derived loads are higher than those derived from ASCE 7 or the building code, the FMG loads should govern; however, if the ASCE 7 or code-derived loads are higher than those from FMG, the ASCE 7 or code-

derived loads should govern (whichever procedure results in the highest loads).

Step 2: Determine Load Resistance

After loads have been determined, it is necessary to determine a reasonable safety factor (when using allowable stress design) or reasonable load factor (when using strength design). For building envelope systems, a minimum safety factor of two is recommended; for anchorage of exterior-mounted mechanical, electrical and communications equipment (such as satellite dishes), a minimum safety factor of three is recommended.

For structural members and many cladding elements, load resistance can be determined by calculations, based on test data. For other elements (such as most types of roof coverings), load resistance is primarily obtained from system testing.

⁶ Criteria for determining loads on rooftop equipment were added to the 2002 edition of ASCE 7.

Load resistance criteria need to be given in contract documents. For structural elements, the designer of record typically accounts for load resistance by indicating the material, size, spacing, and connection of elements. For nonstructural elements, such as roof coverings or windows, the load and safety factor can be specified. In this case, the specifications should require the contractor's submittals to show that the system will meet the load resistance criteria. This performance specification approach is necessary if, at the time of design, it is unknown who will manufacture the system.

Regardless of which approach is used, it is important that the designer of record ensure that it can be demonstrated that the structure, nonstructural building envelope, and exterior-mounted mechanical, electrical, and communications equipment have sufficient strength to resist design wind loads.

Step 3: Detailed Design

Design, detail, and specify the structural system, building envelope, and exterior-mounted mechanical, electrical, and communications equipment to meet the factored design loads (based on appropriate analytical or test methods) and as appropriate to respond to the risk assessment discussed in Section 6.7.

As part of the detailed design effort, load path continuity should be clearly indicated in the contract documents. Load paths need to accommodate design uplift, racking, and overturning loads. Load path continuity obviously applies to MWFRS elements, but it also applies to building envelope elements. Figure 6-19 shows a load path discontinuity between a piece of HVAC equipment and its equipment curb. Figure 6-20 illustrates the load path concept.

Connections: Connections are a key aspect of load path continuity between various structural and nonstructural building elements. For example, consider a window: the glass must be strong enough to resist the applied load and the glass must be adequately anchored to the window frame, the frame adequately anchored to the wall, the wall adequately anchored to the foundation, and the foundation adequately anchored to the ground. As loads increase, greater load capacity must be developed in the connections.

Figure 6-20

This figure illustrates load path continuity of the structural system. Members are sized to accommodate the design loads and connections are designed to transfer uplift loads applied to the roof, and the positive and negative loads applied to the exterior bearing walls down to the foundation and into the ground. The roof covering (and wall covering if there is one) is also part of the load path. To avoid blow-off, the nonstructural elements must also be adequately attached to the structure.

SOURCE: FEMA 342, OKLAHOMA AND KANSAS MIDWEST TORNADOES OF MAY 3, 1999, 1999

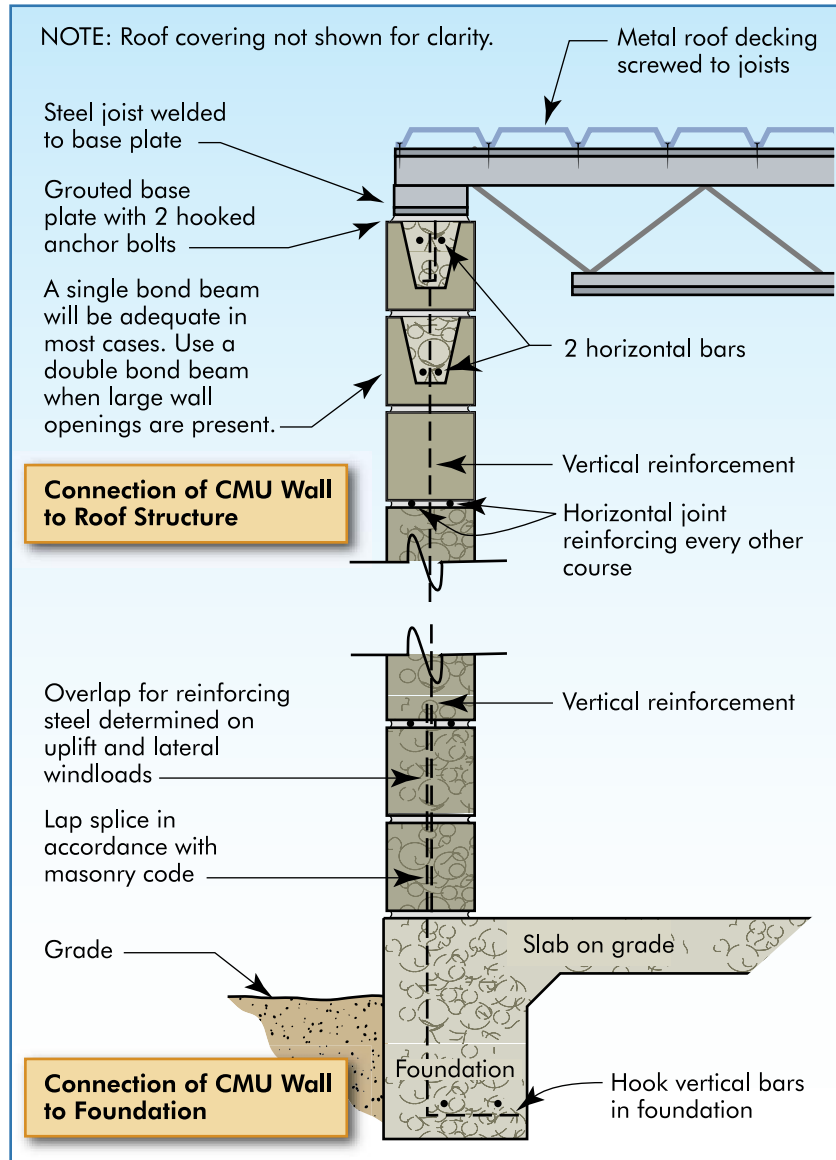

Step 4: Durability

Because some locales have very aggressive atmospheric corrosion (such as schools located near oceans), special attention needs to be given to specification of adequate protection for ferrous metals, or specify alternative metals such as stainless steel. *Corrosion Protection for Metal Connectors in Coastal Areas*, FEMA Technical Bulletin 8-96, August 1996, contains information on corrosion protection. Attention also needs to be given to dry rot avoidance,

for example, by specifying preservative-treated wood. Appendix J of the *Coastal Construction Manual*, FEMA 55, Third Edition, 2000, presents information on wood durability.

Durable materials are particularly important for components that are concealed, which thereby prohibit knowing that the component is in imminent danger of failing.

Special attention also needs to be given to details. For example, details that do not allow water to stand at connections or sills are preferred. Without special attention to material selection and details, the demands on maintenance and repair will be increased, along with the likelihood of failure of components during high winds.

Step 5: Rain Penetration

Although prevention of building collapse and major building damage is the primary goal of wind-resistant design, consideration should also be given to minimizing water damage and subsequent development of mold from penetration of wind-driven rain. To the extent possible, non-load bearing walls and door and window frames should be designed in accordance with rain-screen principles. With this approach, it is assumed that some water infiltration will occur. The water is intercepted in an air-pressure equalized cavity that provides drainage from the cavity to the outer surface of the building. See Sections 6.11.3 and 6.13.3, and Figure 6-47 for further discussion and an example. Further information on the rain-screen principle can be found in *Facts and Fictions of Rain-Screen Walls*, M.Z. Rousseau, Construction Canada, 1990.

In conjunction with the rain-screen principle, it is desirable to avoid using sealant as the first line of defense against water infiltration. When joints are exposed, obtaining long-lasting watertight performance is difficult because of the complexities of sealant joint design and application.

6.8.3 Peer Review

If the design team's wind design expertise and experience is limited, wind design input and/or peer review should be sought from a qualified individual(s). The design input or peer review could be for the entire school or for specific components such as the roof or glazing systems that are critical and/or beyond the design team's expertise.

Regardless of the design team's expertise and experience, peer review should be considered when the school:

- is located in an area where the basic wind speed is greater than 90 mph (peak gust)
- will be used for emergency response after a storm
- will be used for a hurricane shelter
- will incorporate a tornado shelter

6.8.4 Construction Contract Administration

After a suitable design is complete, the design team should ensure the design intent is achieved during construction. The key elements of construction contract administration are submittal reviews and field observations, as discussed below.

Submittals. The specifications need to stipulate the submittal requirements. This includes specifying what systems require submittals (e.g., windows) and test data (where appropriate). Each submittal should demonstrate development of a load path through the system and into its supporting element. For example, a window submittal should show that the glazing has sufficient strength, its attachment to the frame is adequate, and the attachment of the frame to the wall is adequate.

During submittal review, it is important for the designer of record to be diligent in ensuring that all required submittals are submitted and that they include the necessary information. The submittal information needs to be thoroughly checked to ensure

its validity. For example, if a test method used to demonstrate compliance with the design load appears erroneous, the test data should be rejected unless the contractor can demonstrate the test method was suitable.

Field Observations. It is recommended that the design team analyze the design to determine which elements are critical to ensuring high-wind performance. The analysis should include the structural system and exterior-mounted electrical equipment, but it should focus on the building envelope and exterior-mounted mechanical and communications equipment. After determining the list of critical elements to be observed, observation frequency needs to be determined. Observation frequency will depend on the magnitude of the results of the risk assessment described in Section 6.7, complexity of the facility, and the competency of the general contractor, subcontractors, and suppliers.

See Section 6.15.8 for schools located in hurricane-prone regions.

6.8.5 Post-occupancy Inspections, Periodic Maintenance, Repair, and Replacement

The design team should advise the school administration of the importance of periodic inspections, maintenance, and timely repair. It is important for the administration to understand that, over time, a facility's wind-resistance will degrade due to exposure to weather unless it is periodically maintained and repaired.

The building envelope and exterior-mounted equipment should be inspected once a year by persons knowledgeable of the systems/materials they are inspecting. Items that require maintenance, repair, or replacement should be documented and scheduled for work. [Note: The deterioration of glazing is often overlooked. After several years of exposure, scratches and chips can become extensive enough to weaken the glazing.]

The goal is to repair or replace items before they fail in a storm. This approach is less expensive than waiting for failure and then repairing the failed components and consequential damages.

If unusually high winds occur, a special inspection is recommended. The purpose of the inspection is to assess if the strong storm caused damage that needs to be repaired to maintain building strength and integrity. In addition to inspecting for obvious signs of damage, the inspector should determine if cracks or other openings have developed that allow water infiltration, which could lead to corrosion or dry rot of concealed components.

See Section 6.15.9 for schools located in hurricane-prone regions.

6.9 STRUCTURAL SYSTEMS

Based on post-storm damage evaluations, with the exception of tornado events, the structural systems (i.e., MWFRS and structural components such as roof decking) of school buildings have typically performed quite well during design wind events. There have, however, been notable exceptions; in these cases, the most common problem has been blow-off of the roof deck, but instances of collapse have also been documented (Figure 6-15). The structural problems have primarily been due to lack of an adequate load path, with connection failure being a common occurrence. Problems have also been caused by reduced structural capacity due to termites, workmanship errors (commonly associated with steel decks attached by puddle welds), and limited uplift resistance of deck connections in roof perimeters and corners (due to lack of code-required enhancement in older editions of the model codes).

With the exception of tornado events, structural systems designed and constructed in accordance with the IBC should typically offer adequate wind resistance, provided attention is given to load path continuity and to material durability (with respect to corrosion and termites). However, the greatest reliability is offered by cast-in-place concrete. There are no reports

of any cast-in-place concrete buildings experiencing a significant structural problem during wind events, including the strongest hurricanes (Category V) and tornadoes (F5).

The following design parameters are recommended (see Section 6.15.2 for schools located in hurricane-prone regions):

- If a pre-engineered structure is being contemplated, special steps should be taken to ensure the structure has more redundancy than is typically the case with pre-engineered buildings.⁷ Steps should be taken to ensure the structure is not vulnerable to progressive collapse in the event a primary bent is compromised or bracing components fail.
- Exterior load bearing walls of masonry or precast concrete should be designed to have sufficient strength to resist external and internal loading of components and cladding. CMU walls should have vertical and horizontal reinforcing and grout to resist wind loads. The connections of precast concrete wall panels should be designed to have sufficient strength to resist wind loads.
- For roof decks, specify concrete, steel, or wood sheathing (plywood or oriented strand board [OSB]). See Section 6.15.2 for schools located in hurricane-prone regions.
- For steel roof decks, specify screw attachment rather than puddle welds (screws are more reliable and much less susceptible to workmanship problems). See Figures 6-21 and 6-22. The decking shown in Figure 6-21 was attached with puddle welds. However, at most of the welds, there was only superficial bonding of the metal deck to the joist, as illustrated at this weld. Only a small portion of the deck near the center of the weld area (as delineated by the circle) was well fused to the joist. At the weld, shown in Figure 6-22, the deck was well bonded to the joist. When the decking blew off

⁷ Pre-engineered structures are composed of rigid steel frames, secondary members (including roof purlins and wall girts made of Z- or C-shaped members) and bracing.

due to failure of nearby weak welds, at this location the metal decking tore and a portion of it remained attached to the joist. Tearing of the decking, rather than debonding, is the desired failure mode, but deck tearing is rare due to welding reliability problems. Screw attachment is a more reliable attachment method.

Figure 6-21
View of a steel joist after the metal decking blew away

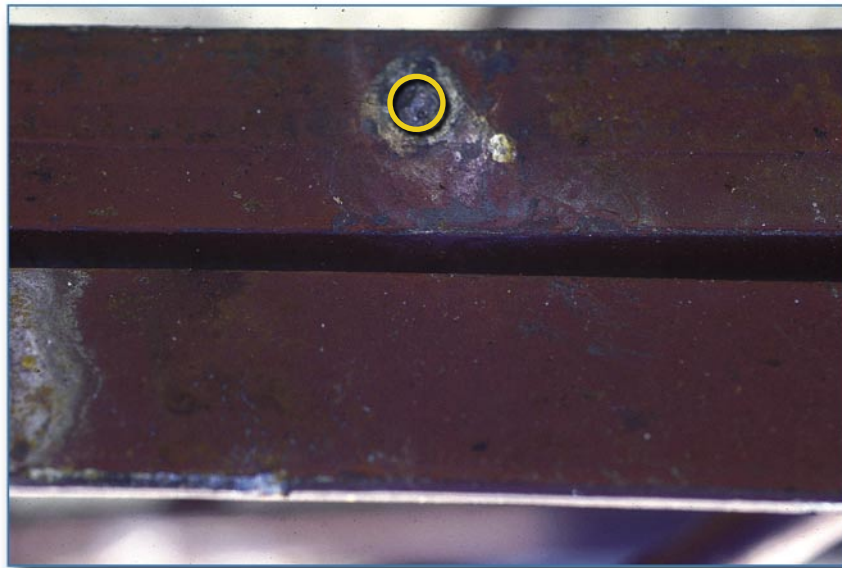

Figure 6-22
View of another weld near the weld shown in Figure 6-21



- For attachment of wood sheathed roof decks, specify screws, or ring-shank or screw-shank nails in the corner regions of the roof. Where the basic wind speed is greater than 90 mph, also specify these types of fasteners for the perimeter regions of the roof.
- For precast concrete decks, design the deck connections to resist the design uplift loads (the dead load of the deck itself is often inadequate to resist the uplift load; see Figure 6-23).



Figure 6-23
Portions of this waffled precast concrete roof deck were blown off. Bolts had been installed to provide uplift resistance; however, anchor plates and nuts had not been installed. Without the anchor plates, the dead load of the deck was inadequate to resist the wind uplift load.



Figure 6-24
Several of the precast twin-Tee roof and wall panels collapsed. The connection between the roof and wall panels provided very little uplift load resistance. This roof panel lifted because of combined effects of wind uplift and pretension.

- For precast Tee decks, design the reinforcing to accommodate the uplift loads in addition to the gravity loads. Otherwise, large uplift forces can cause Tee failure due to the Tee's own prestress forces after the uplift load exceeds the dead load of the Tee (see Figure 6-24).
- For schools that have mechanically attached single-ply or modified bitumen membranes, refer to the decking recommendations presented in the National Research Council of Canada, Institute for Research in Construction, *Wind Design Guide for Mechanically Attached Flexible Membrane Roofs*, B1049, 2004.
- If an FMG-rated roof assembly is specified, the roof deck also needs to comply with the FMG criteria.

6.10 EXTERIOR DOORS

This section addresses primary and secondary egress doors, sectional (garage) doors, and rolling doors. See Section 6.15.3 for schools located in hurricane-prone regions.

6.10.1 Loads and Resistance

The IBC requires that the door assembly (i.e., door, hardware, frame, and frame attachment to the wall) be of sufficient strength to resist the positive and negative design wind pressure. Architects should specify that doors comply with wind load testing in accordance with ASTM E 1233. Architects should also specifically design the attachment of the door frame to the wall (e.g., specify the type, size, and spacing of frame fasteners).

See Section 6.15.3 for schools located in hurricane-prone regions.

6.10.2 Durability

Where corrosion is problematic, anodized aluminum or galvanized doors and frames, and stainless steel frame anchors and hardware are recommended.

6.10.3 Exit Door Hardware

For primary swinging entry/exit doors, exit door hardware is recommended to minimize the possibility of the doors being pulled open by wind suction. Exit hardware with top and bottom rods offers greater securement than exit hardware that latches at the jamb.

6.10.4 Water Infiltration

When heavy rain accompanies high winds (e.g., thunderstorms, tropical storms, and hurricanes), it can cause wind-driven water infiltration problems (the magnitude of the problem increases with the wind speed). Leakage can occur between the door and frame, and frame and wall, and water can be driven between the threshold and door. When the basic wind speed is greater than 120 mph, because of the very high design wind pressures and numerous opportunities for leakage path development, some leakage should be anticipated when design wind speed conditions are approached. To minimize infiltration, the following are recommended:

- **Vestibule.** Designing a vestibule is a method to account for the infiltration problem. With this approach, both the inner and outer doors can be equipped with weatherstripping, and the vestibule itself can be designed to tolerate water. For example, water-resistant finishes (e.g., concrete or tile) can be specified and the floor can be equipped with a drain.
- **Door swing.** With respect to weatherstripping, out-swinging doors offer an advantage compared to in-swinging doors. With out-swinging doors, the weatherstripping is located on the interior side of the door, where it is less susceptible to degradation. Also, some interlocking weatherstripping assemblies are available for out-swinging doors.

Another challenge with doors is successful integration between the door frame and wall. See Section 6.13.3 for discussion of this juncture.

ASTM E 2112 (*Standard Practice for Installation of Exterior Windows, Doors and Skylights*) provides information pertaining to installation of doors, including the use of sill pan flashings with end dams and rear legs (see Figure 6-25). It is recommended that designers use E 2112 as a design resource.

Figure 6-25
Door sill pan flashing with end dams, rear leg, and turned-down front leg

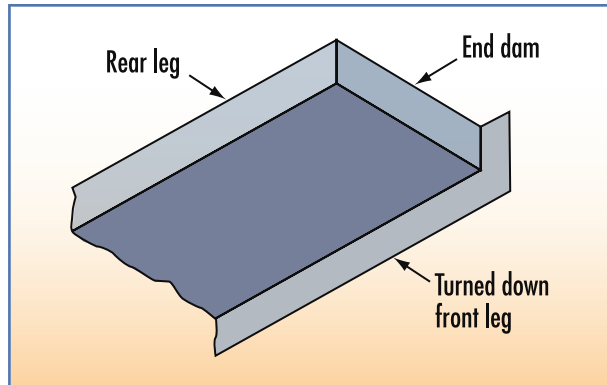

6.10.5 Weatherstripping

A variety of pre-manufactured weatherstripping components are available, including drips, door shoes and bottoms, thresholds, and jamb/head weatherstripping. A few examples of weatherstripping options are:

- **Drip.** These are intended to shed water away from the opening between the frame and door head, and the opening between the door bottom and the threshold (see Figures 6-26 and 6-27). Alternatively, a door sweep can be specified (see Figure 6-28); however, for high-traffic doors, periodic replacement of the neoprene will be necessary.

Figure 6-26
Drip at door head and drip with hook at head

SOURCE: FEMA 55, COASTAL CONSTRUCTION MANUAL, 2000

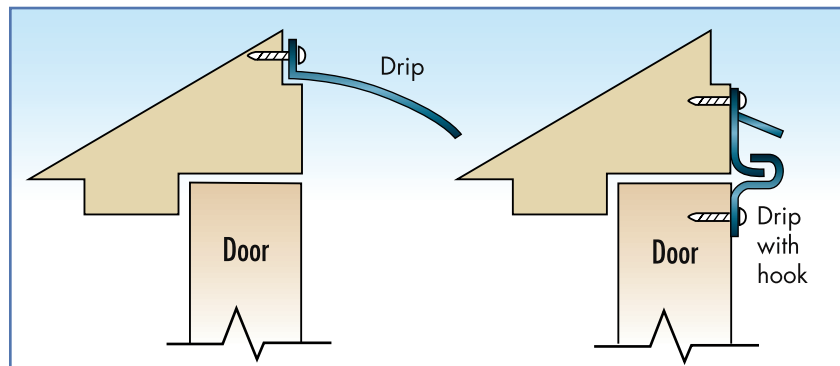

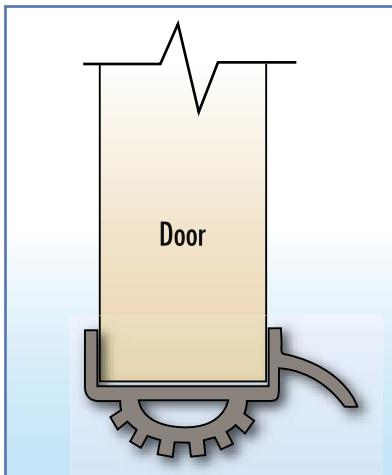

Figure 6-27
Door shoe with drip and vinyl seal
SOURCE: FEMA 55, COASTAL
CONSTRUCTION MANUAL, 2000

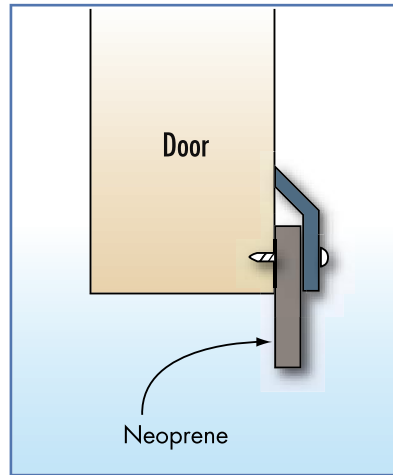

Figure 6-28
Neoprene door bottom sweep
SOURCE: FEMA 55, COASTAL
CONSTRUCTION MANUAL, 2000

- **Door shoes and bottoms.** These are intended to minimize the gap between the door and threshold. Figure 6-27 illustrates a door shoe that incorporates a drip. Figure 6-29 illustrates an automatic door bottom. Door bottoms can be surface-mounted or mortised. For high-traffic doors, periodic replacement of the neoprene will be necessary.

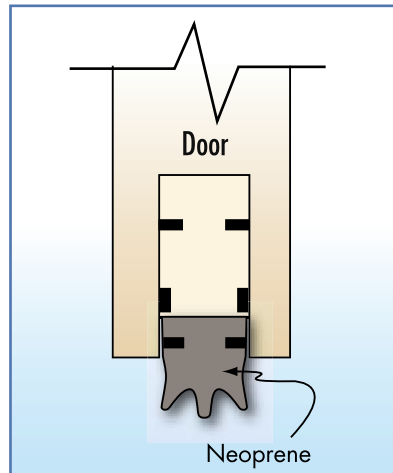

Figure 6-29
Automatic door bottom
SOURCE: FEMA 55, COASTAL
CONSTRUCTION MANUAL, 2000

- **Thresholds.** These are available to suit a variety of conditions. Thresholds with vertical offsets offer enhanced resistance to wind-driven water infiltration. However, where Americans with Disabilities Act (ADA)-compliant thresholds are required, or at high-traffic doors, the offset is limited. However, at other doors, high offsets are preferred.

Thresholds can be interlocked with the door (see Figure 6-30) or thresholds can have a stop and seal (see Figure 6-31). In some instances, the threshold is set directly on the floor. Where this is appropriate, specify setting the threshold in butyl sealant to avoid water infiltration between the threshold and floor. In other instances, the threshold is set on a pan flashing as discussed in Section 6.10.4. If the threshold has weep holes, specify that the weep holes should not be blocked (see Figure 6-30).

Figure 6-30
Interlocking threshold with
drain pan

SOURCE: FEMA 55, COASTAL
CONSTRUCTION MANUAL, 2000

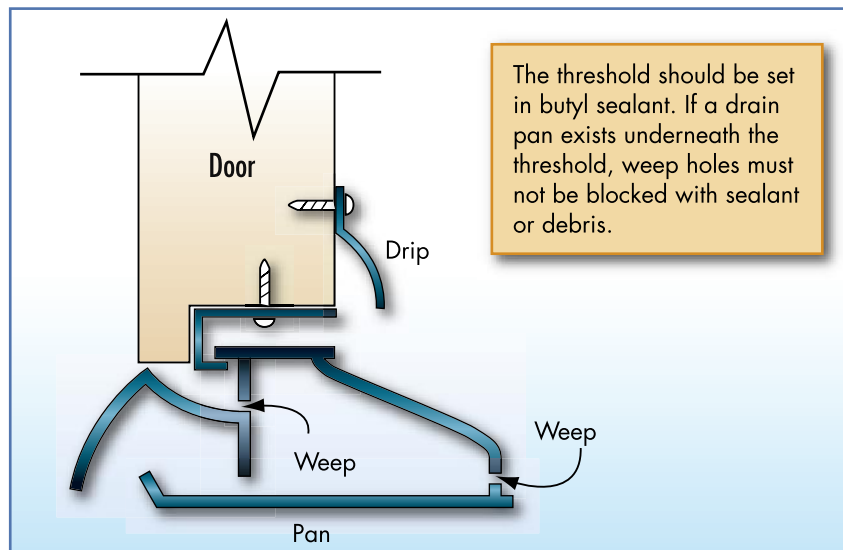
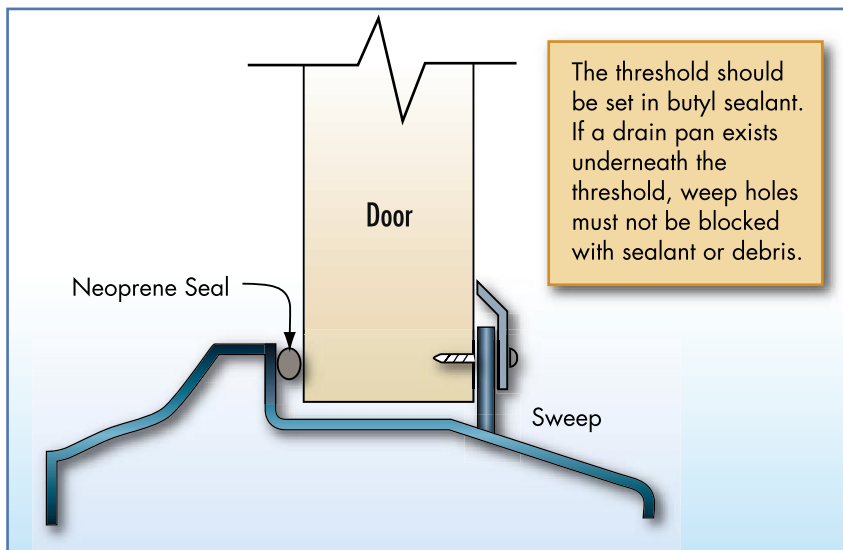

Figure 6-31
Threshold with stop and seal

SOURCE: FEMA 55, COASTAL
CONSTRUCTION MANUAL, 2000



- **Adjustable jamb/head weatherstripping.** This type of jamb/head weatherstripping is recommended because these units have wide sponge neoprene that offers good contact with the door (see Figure 6-32). The adjustment feature also helps ensure good contact, provided the proper adjustment is maintained.
- **Meeting stile.** At the meeting stile of pairs of doors, an overlapping astragal weatherstripping offers greater protection than weatherstripping that does not overlap.

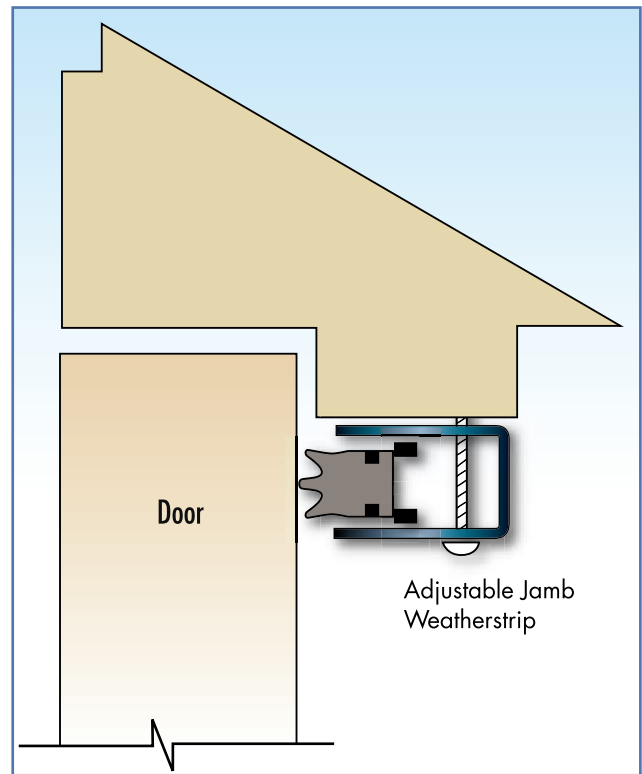

Figure 6-32 Adjustable jamb/head weatherstripping

SOURCE: FEMA 55, COASTAL CONSTRUCTION MANUAL, 2000

6.1.1 NON-LOAD BEARING WALLS, WALL COVERINGS, SOFFITS, AND UNDERSIDE OF ELEVATED FLOORS

This section addresses exterior non-load bearing walls and provides guidance for interior non-load bearing masonry walls. Exterior wall coverings and soffits, as well as the underside of elevated floors, are also discussed.

See Section 6.15.4 for schools located in hurricane-prone regions.

6.1.1.1 Loads and Resistance

The IBC requires that exterior non-load bearing walls, wall coverings, and soffits (see Figure 6-33) have sufficient strength to resist the positive and negative design wind pressure. Architects should specify that wall coverings and soffits comply with wind load testing in accordance with ASTM E 1233.

Depending upon wind direction, soffits can experience either positive or negative pressure. Besides the cost of repairing damaged soffits, wind-borne soffit debris can cause property damage and injuries.

Figure 6-33
This suspended metal soffit was not designed for upward-acting wind pressure.



Particular care should be given to the design and construction of exterior non-load bearing walls constructed of masonry. Although these walls are not intended to carry gravity loads, they must be designed to resist the positive and negative wind loads in order to avoid collapse. Because of their great weight, when these types of walls collapse, they represent a severe risk to life as shown in Figure 6-14.

Special consideration should also be given to interior non-load bearing masonry walls. Although these walls are not required by building codes to be designed to resist wind loads, if glazing is broken, the interior walls could be subjected to significant load as the school rapidly becomes fully pressurized. To avoid occupant injury (see Figure 6-34), it is recommended that interior non-load bearing masonry walls that are adjacent to student areas be designed to accommodate loads exerted by a design wind event, using the partially enclosed pressure coefficient. By doing so, wall collapse may be prevented if the building envelope is breached. This recommen-

dition is applicable to schools in tornado-prone areas that do not have shelter space designed in accordance with FEMA 361, to schools located in areas with a basic wind speed greater than 120 mph, and to schools that will be used for hurricane shelters.



Figure 6-34
The interior walls of this classroom wing were constructed of unreinforced CMU.

SOURCE: FEMA 342, *OKLAHOMA AND KANSAS MIDWEST TORNADOES OF MAY 3, 1999*, 1999

6.11.2 Durability

Where corrosion is problematic, stainless steel fasteners are recommended for wall and soffit systems. For other components (e.g., furring, blocking, struts, and hangars), the following are recommended: nonferrous components (such as wood), stainless steel, or steel with a minimum of G-90 hot-dipped galvanized coating. In addition, if air can freely circulate in a cavity (e.g., above a soffit), access panels are recommended so components within the cavity can be periodically observed for corrosion.

6.11.3 Wall Coverings

There are a variety of exterior wall covering options. Brick veneer, exterior insulation finish systems (EIFS), metal wall panels, and aluminum and vinyl siding have often exhibited poor wind performance. Veneers (such as ceramic tile and stucco) over concrete

and cement-fiber panels and siding have also blown off. Blow-off of wood siding and panels is rare.

Figure 6-35 shows brick veneer that was blown off. The bricks were attached to the back-up wall with corrugated metal ties. All of the following failure modes are commonly found in the vicinity of this type of common failure: 1) The nails pull out of the studs (smooth shank nails are typically used, hence they have limited withdrawal resistance; 2) The ties do not extend far enough into the mortar joint (i.e., the tie is not long enough); 3) Although the ties make contact with the mortar, they are not well-bonded to it; 4) The ties are spaced too far apart; and 5) The ties provide essentially no resistance to compression. Hence, when a great amount of positive pressure is applied to the bricks, the brick joints flex. This flexing weakens the mortar joint. Walls that have not had bricks blown away have been found to be capable of being deflected with hand pressure. Although they look sound, in this condition they are very vulnerable to failure. Good reliable wind performance of brick veneer is very demanding on the designer and applicator.

Figure 6-35
Failure of brick veneer

SOURCE: FEMA 342, OKLAHOMA
AND KANSAS MIDWEST
TORNADOES OF MAY 3, 1999,
1999



Figure 6-36 shows EIFS blow-off. In this case, the expanded polystyrene (EPS) was attached to gypsum board, which was attached to metal studs. The gypsum board detached from the studs, which is a common EIFS failure mode. When the gypsum board on the exterior side of the studs is blown away, it is common for gypsum board on the interior side to also be blown off. This then allows the school to become fully pressurized and allows entrance of wind-driven rain. Other common failure modes include separation of the EPS from its substrate and separation of the synthetic stucco from the EPS. Good reliable wind performance of EIFS is very demanding on the designer and applicator. Maintenance of EIFS and associated sealant joints is also demanding in order to minimize reduction of EIFS' wind resistance due to water infiltration.



Figure 6-36
EIFS blow-off near a wall corner. At one area, the metal fascia was also blown in.

SOURCE: FEMA 342, OKLAHOMA AND KANSAS MIDWEST TORNADOES OF MAY 3, 1999, 1999

Another issue associated with EIFS is the potential for misdiagnosis of the wall system. EIFS is sometimes mistaken to be a concrete wall. If school personnel believed that an EIFS wall covering was a concrete wall and sought shelter from a tornado, instead of being protected by several inches of concrete, only two layers of gypsum board (i.e., one layer on each side of the studs) and a layer of EPS would be between the occupants and wind-borne debris. The debris could easily penetrate such a wall.

EIFS can also be applied over concrete or CMU. In this scenario, the concrete or CMU could provide adequate missile protection provided it was thick enough and adequately reinforced. However, with this wall construction, there is still risk of blow-off of the EIFS. As discussed in Section 6.15.4, if the concrete or CMU is left exposed, there is no covering to be blown off.

Wind performance of metal wall panels is highly variable. Performance depends upon strength of the specified panel (which is a function of material, panel profile, panel width and whether or not the panel is a composite) and the adequacy of the attachment (which can either be by concealed clips or exposed fasteners). A common problem is excessive spacing between clips/fasteners. Clip/fastener spacing should be specified, along with the specific type and size of fastener to be used. Figures 6-13 and 6-43 illustrate metal wall panel problems.

To minimize water infiltration at metal wall panel joints, it is recommended that sealant tape be specified at sidelaps when the basic wind speed is in excess of 90 mph. However, end laps should be left unsealed so that moisture behind the panels can wick out. End laps should be a minimum of 3 inches (4 inches where the basic wind speed is greater than 120 mph) to avoid wind-driven rain infiltration. At the base of the wall, a 3-inch (4-inch) flashing should also be detailed, or the panels should be detailed to over-lap with the slab or other components by a minimum of 3 inches (4 inches).

Vinyl siding blow-off is typically caused by nails spaced too far apart and/or the use of vinyl siding that has inadequate wind-resistance. Vinyl siding is available with enhanced wind resistance features, such as an enhanced nailing hem, greater interlocking area, and greater thickness.

Secondary Protection. Almost all wall coverings permit the passage of some water past the exterior surface of the covering, particularly when rain is wind-driven. Hence, most wall coverings should be considered as water-shedding, rather than as water-

proofing coverings. To avoid moisture related problems, it is recommended that a secondary line of protection with a moisture barrier (such as housewrap or asphalt-saturated felt) and flashings around door and window openings be provided. Designers should specify that horizontal laps of the moisture barrier be installed so that water is allowed to drain from the wall (i.e., the top sheet should lap over the bottom sheet so that water running down the sheets remains on their outer surface). The bottom of the moisture barrier needs to be detailed to allow drainage.

In areas that frequently experience strong winds, enhanced flashing details are recommended. Enhancements include use of flashings that have extra-long flanges, and use of sealant and tapes. Flashing design should recognize that wind-driven water can be pushed vertically. The height to which water can be pushed increases with wind speed. Water can also migrate vertically and horizontally by capillary action between layers of materials (e.g., between a flashing flange and housewrap). It is recommended that designers attempt to determine what type of flashing details have successfully been used in the area where the school will be constructed.

If EIFS is specified, it is strongly recommended that it be designed with a drainage system that allows for dissipation of water leaks.

6.11.4 Underside of Elevated Floors

If sheathing is applied to the underside of joists or trusses elevated on piles (e.g., to protect insulation installed between the joists/trusses), its attachment should be specified in order to avoid blow-off. Stainless steel or hot-dip galvanized nails or screws are recommended. ASCE 7 does not provide guidance for load determination.

6.12 ROOF SYSTEMS

Because roof covering damage has historically been the most frequent and costly type of wind damage, special attention needs to be given to roof system design.

Code Requirements. The IBC requires load resistance of the roof assembly to be evaluated by one of the test methods listed in IBC’s Chapter 15. Architects are cautioned that designs that deviate from the tested assembly (either with material substitutions or change in thickness or arrangement) may adversely affect the wind performance of the assembly. The IBC does not specify a minimum safety factor. However, for the roof system, a safety factor of two is recommended. (To apply the safety factor, divide the test load by two to determine the allowable design load. Conversely, multiply the design load by two to determine the minimum required test resistance.)

For metal panel systems, the IBC requires test methods UL 580 or ASTM E 1592. It is recommended that architects specify use of E 1592 because it is more likely to give a better representation of the system’s uplift performance capability.

Load Resistance. Specifying load resistance is commonly done by specifying a Factory Mutual Research (FMR) rating, such as Factory Mutual (FM) 1-75. The first number (“1”) indicates that the roof assembly passed the FMR tests for a Class 1 fire rating. The second number (“75”) indicates the uplift resistance in psf that the assembly achieved during testing. Applying a safety factor of two to this example, this assembly would be suitable where the design uplift load is 37.5 psf.

As previously discussed, because of building aerodynamics, the highest uplift load occurs at roof corners. The perimeter has a somewhat lower load; the field of the roof has the lowest load. *FMG Data Sheets* are formatted so that a roof assembly can be selected for the field of the roof. That assembly is then adjusted to meet the higher loads in the perimeter and corners by increasing the number of fasteners or decreasing the spacing of adhesive ribbons by a required amount; however, this assumes that the failure is the result of the pulling-out of the fastener from the deck, or that failure is in the vicinity of the fastener plate, which may not be the case. Also, the increased number of fasteners required by FM may not be sufficient to comply with

the perimeter and corner loads derived from the building code. Therefore, if FM resistance data are specified, it is prudent for the architect to separately specify the resistance for the field of the roof (1-75 in the example above), the perimeter (1-130), and the corner (1-190).

Edge Flashings and Copings. Roof membrane blow-off is almost always a result of lifting and peeling of the metal edge flashing or coping, which serves to clamp down the membrane at the roof edge (see Figure 6-37). Therefore, it is important for the architect to carefully consider the design of metal edge flashings, copings, and the nailers to which they are attached. ANSI/SPRI ES-1, *Wind Design Standard for Edge Systems Used in Low Slope Roofing Systems* provides general design guidance, including a methodology for determining the outward-acting load on the vertical flange of the flashing/coping (ASCE 7 does not provide this guidance).



Figure 6-37
The metal edge flashing on this modified bitumen membrane roof was installed underneath the membrane, rather than on top of it and then stripped in. In this location, the edge flashing is unable to clamp the membrane down. At one area, the membrane was not sealed to the flashing (an ink pen was inserted into the opening prior to photographing). Wind can catch the opening and lift and peel the membrane.

A minimum safety factor of three for edge flashings, copings, and nailers is recommended for schools. ANSI/SPRI ES-1 also includes test methods for assessing flashing/coping resistance. For FMG-insured schools, FMR approved flashing should be used and *Data Sheet 1-49* should also be consulted.

The traditional edge flashing/coping attachment method relies on concealed cleats that can deform under wind load and lead to disengagement of the flashing/coping (see Figure 6-38) and subsequent lifting and peeling of the roof membrane (as shown in Figure 6-11). When a vertical flange disengages and lifts up (as shown in Figure 6-38), the edge flashing and membrane are very susceptible to failure. Normally, when a flange lifts such as shown in Figure 6-38, the failure continues to propagate and the metal edge flashing and roof membrane blow off.

Figure 6-38
This metal edge flashing had a continuous cleat, but the flashing disengaged from the cleat and the vertical flange lifted up. However, the horizontal flange of the flashing did not lift.



Storm-damage research has revealed that, in lieu of cleat attachment, use of exposed fasteners to attach the vertical flanges of copings and edge flashings has been found to be a very effective and reliable attachment method (see Figure 6-39).

If cleats are used for attachment, it is recommended that a bar be placed over the roof membrane near the edge flashing/coping as illustrated in Figure 6-40. The purpose of the bar is to provide secondary protection against membrane lifting and peeling in the event that the edge flashing/coping fails. A robust bar specifically made for bar-over mechanically attached single-ply systems is recommended. The bar needs to be very well anchored to the parapet or deck. Depending upon design wind loads, a spacing



Figure 6-39
 This coping was attached with ¼-inch diameter stainless steel concrete spikes at 12 inches on center. When the fastener is placed in wood, #14 stainless steel screws with stainless steel washers are recommended. Also, in the corner areas, the fasteners should be more closely spaced (the spacing will depend upon the design wind loads). ANSI/SPRI ES-1 provides guidance on fastener spacing and thickness of the coping/edge flashing.

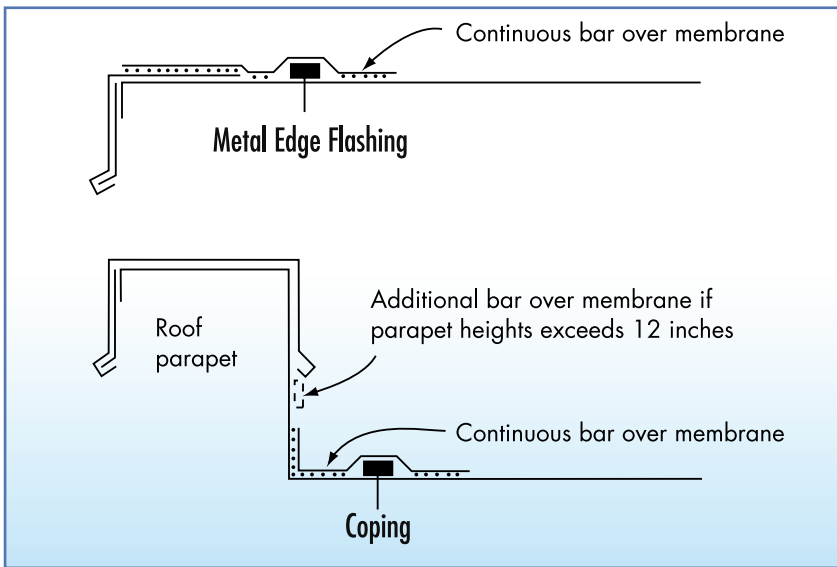

Figure 6-40
 Continuous bar near the edge of edge flashing or coping. If the edge flashing or coping is blown off, the bar may prevent a catastrophic progressive failure.

SOURCE: FEMA 55, COASTAL CONSTRUCTION MANUAL, 2000

between 4 and 12 inches on center is recommended. A gap of a few inches should be left between each bar to allow for water flow across the membrane. After the bar is attached, it is stripped over with a stripping ply.

Gutters. Special design attention needs to be given to uplift attachment of gutters, particularly those in excess of 6 inches wide. Recommendations are provided in “Honing in on hangars,” *Professional Roofing*, Thomas L. Smith, October 2002, pp. 32 (available on-line at www.nrca.net).

Roof System Performance. Storm-damage research has shown that sprayed polyurethane foam and liquid-applied roof systems are very reliable high-wind performers. If the substrate to which the foam or liquid-applied membrane was applied does not lift, it is highly unlikely that the sprayed polyurethane foam (SPF) or the liquid-applied membrane will blow-off. Both systems are also more tolerant of missiles than other systems. Built-up roofs (BURs) and modified bitumen systems have also demonstrated good wind performance provided the edge flashing/coping does not fail (edge flashing/coping failure is common). The exception is aggregate surfacing, which is prone to blow-off (see Figure 6-11). Modified bitumen adhered to a concrete deck has demonstrated excellent resistance to progressive peeling after blow-off of the metal edge flashing. Metal panel performance is highly variable. Some systems are very wind-resistant, while others are quite vulnerable.

Of the single-ply attachment methods, the paver-ballasted and fully adhered methods are the least problematic. Systems with aggregate ballast are prone to blow-off, unless care is taken in the design of the size of aggregate and the parapet height (see Figure 6-8). Performance of protected membrane roofs (PMRs) with factory-applied cementitious coating over insulation boards is highly variable. When these boards are installed over a loose-laid membrane, it is critical that an air retarder be incorporated to prevent the membrane from ballooning and disengaging the boards. ANSI/SPRI RP-4 (which is referenced in the IBC) provides wind guidance for ballasted systems using aggregate, pavers, and cementitious-coated boards.

The National Research Council of Canada, Institute for Research in Construction's *Wind Design Guide for Mechanically*

Attached Flexible Membrane Roofs, B1049 (2004) provides recommendations related to mechanically attached single-ply and modified bituminous systems. B1049 is a very comprehensive wind design guide and includes discussion of air retarders, which can be effective in reducing membrane flutter, in addition to their beneficial use in ballasted single-ply systems. When a mechanically attached system is specified, careful coordination with the structural engineer with respect to selection of deck type and thickness is important. If a steel deck is specified, it is critical to specify that the membrane fastener rows run perpendicular to the steel flanges in order to avoid overstressing attachment of the deck to the deck support structure (see Figures 6-41 and 6-42). In Figure 6-42, the flange with membrane fasteners carries essentially all of the uplift load because of the deck's inability to transfer any significant load to adjacent flanges. Hence, at the joists, the deck fasteners on either side of the flange with the membrane fasteners are the only connections to the joists that are carrying uplift load. Had the membrane fasteners shown in Figure 6-42 been run perpendicular to the deck flanges, each of the fasteners connecting the deck to the joists would have been carrying uplift load.



Figure 6-41
On this school, the fastener rows of the mechanically attached single-ply membrane ran parallel to the top flange of the steel deck. Hence, essentially all of the row's uplift load was transmitted to only two deck fasteners at each joist (as illustrated in Figure 6-42). Because the deck fasteners were overstressed, a portion of the deck blew off and the membrane progressively tore.

Figure 6-42
View of the underside
of a steel deck. The
mechanically attached
single-ply membrane
fastener rows ran parallel
to the top flange of the steel
deck.



Recommendations related to metal panels is provided in “Insights on Metal Roof Performance in High-wind Regions,” *Professional Roofing*, Thomas L. Smith, February 1995, pp. 12 (available on-line at www.nrca.net).

Parapet Base Flashings. Loads on parapet base flashings were first introduced in the 2002 edition of ASCE 7. The loads on base flashings are greater than the loads on the roof covering if the parapet’s exterior side is air-permeable. When base flashing is fully adhered, it has sufficient wind resistance in most cases. However, when base flashing is mechanically fastened, typical fastening patterns may be inadequate, depending upon design wind conditions (see Figure 6-43). Therefore, it is imperative that base flashing loads be calculated and attachments be designed to accommodate the loads. It is also important for designers to recognize and specify different attachment spacings in parapet corner regions versus regions between corners. Further discussion is provided in “Detailing ASCE 7’s changes,” *Professional Roofing*, Thomas L. Smith, July 2003, pp. 26 (available on-line at www.nrca.net).



Figure 6-43
The parapet on this school was sheathed with metal wall panels. The panels were fastened at 2 feet on center along their bottom edge, which was inadequate to resist the wind load.

Lightning Protection Systems. When not adequately integrated into a roof system, a lightning protection system can become detached from the roof during high winds. The detached system can damage the roof covering (see Figure 6-44). In addition, a detached system is no longer capable of providing lightning protection. Most manufacturers of lightning protection systems and most roofing manufacturers provide vague or inadequate details for securing a lightning protection system to a roof.

During prolonged high winds, repeated slashing of the membrane by loose conductors (“cables”) and puncturing by air terminals can result in lifting and peeling of the membrane. It is, therefore, important to adequately design the attachment of the lightning protection system.

Recommendations pertaining to wind-resistant design, and specification and installation of lightning protection systems are provided in “Integrating a Lightning Protection System in a Roof System,” Thomas L. Smith, 12th International Roofing and Waterproofing Conference Proceedings (CD), National Roofing Contractors Association, 2002.

Steep-slope Coverings. For discussion and recommendations pertaining to steep-slope roof coverings, see FEMA 55, *Coastal Construction Manual*, Third Edition, 2000.

Figure 6-44

This air terminal (“lightning rod”) was dislodged and whipped around during a windstorm. The single-ply membrane was punctured by the sharp tip in several locations.

SOURCE: FEMA, *BUILDING TO MINIMUM TYPHOON DAMAGE: DESIGN GUIDELINES FOR BUILDINGS*, JULY 1998



Hurricane-prone Regions. See Section 6.15.5 for schools in hurricane-prone regions.

Tornado-prone Regions. In order to reduce the number of wind-borne missiles, it is recommended that aggregate surfacings, pavers, tile, and slate not be specified on schools in tornado-prone regions (as defined in Section 6.7.1; see Figure 6-8).

6.13 WINDOWS AND SKYLIGHTS

This section addresses exterior windows and skylights. See Section 6.15.6 for schools located in hurricane-prone regions.

6.13.1 Loads and Resistance

The IBC requires the window, curtain wall, or skylight assembly (i.e., the glazing, frame, and frame attachment to the wall or roof) to have sufficient strength to resist the positive and negative design wind pressure (see Figure 6-45). Architects should specify that these assemblies comply with wind load testing in accordance with ASTM E 1233. It is important to specify an adequate load path and to check its continuity during submittal review.



Figure 6-45
Two complete windows, including their frames, blew out. The frames were attached with an inadequate number of fasteners, which were somewhat corroded.

SOURCE: FEMA, *BUILDING TO MINIMUM TYPHOON DAMAGE: DESIGN GUIDELINES FOR BUILDINGS*, JULY 1998

In tornado-prone regions, some school districts may desire to have laminated glazing installed at exterior openings in order to provide wind-borne debris protection during weak tornadoes. Laminated glazing may also offer protection during strong tornadoes, but should not be relied upon for violent tornadoes. Further discussion is provided in Section 6.15.6.

6.13.2 Durability

Where corrosion is problematic, anodized aluminum or stainless steel frames and stainless steel frame anchors are recommended.

6.13.3 Water Infiltration

When heavy rain accompanies high winds (e.g., thunderstorms, tropical storms, and hurricanes), it can cause wind-driven water infiltration problems; the magnitude of the problem increases with the wind speed. Leakage can occur at the glazing/frame interface, at the frame itself, or between the frame and wall. When the basic wind speed is greater than 120 mph, because of the very high design wind pressures and numerous opportunities for leakage path development, some leakage should be anticipated when design wind speed conditions are approached.

The challenge with windows and curtain walls is successful integration between these elements and the walls. To the extent possible, detailing of the interface between the wall and the window or curtain wall units should rely on sealants as the secondary line of defense against water infiltration, rather than making the sealant the primary protection.

When designing joints between walls and windows and curtain wall units, consider the shape of the sealant joint (i.e., a square joint is typically preferred) and the type of sealant to be specified. The sealant joint should be detailed so the sealant is able to bond on only two opposing surfaces (i.e., a backer rod or bond-breaker tape should be specified). For concealed sealants, butyl is recommended. For exposed sealants, polyurethane is recommended. During installation, cleanliness of the sealant substrate is important (particularly if polyurethane or silicone sealants are specified), as well as tooling of the sealant. ASTM E 2112 provides guidance on design of sealant joints, as well other information pertaining to installation of windows, including the use of sill pan flashings with end dams and rear legs (see Figure 6-46). It is recommended that designers use ASTM E 2112 as a design resource.

Figure 6-46
View of a typical window
sill pan flashing with
end dams and rear legs.
Windows that do not have
nailing flanges should
typically be installed over a
pan flashing.

SOURCE: ASTM E2112

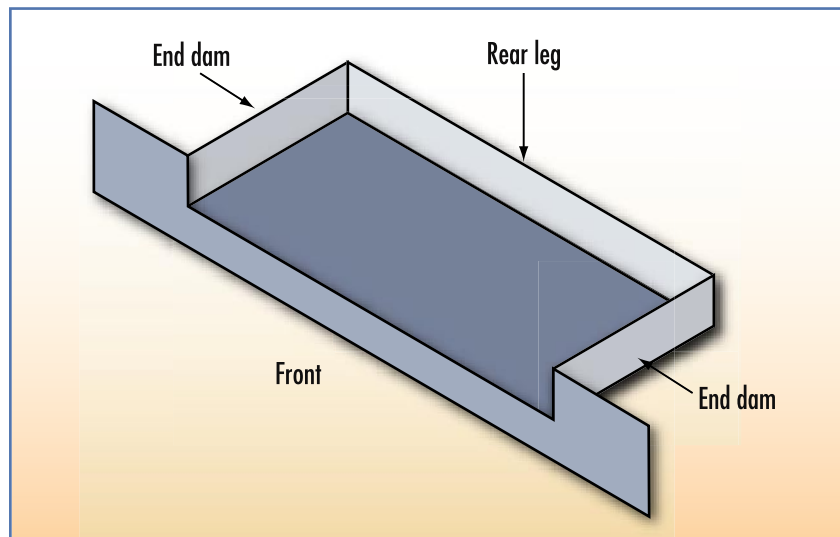

Sealant joints can be protected with a removable stop as illustrated in Figure 6-47. The stop protects the sealant from direct exposure to the weather and reduces the wind-driven rain demand on the sealant.

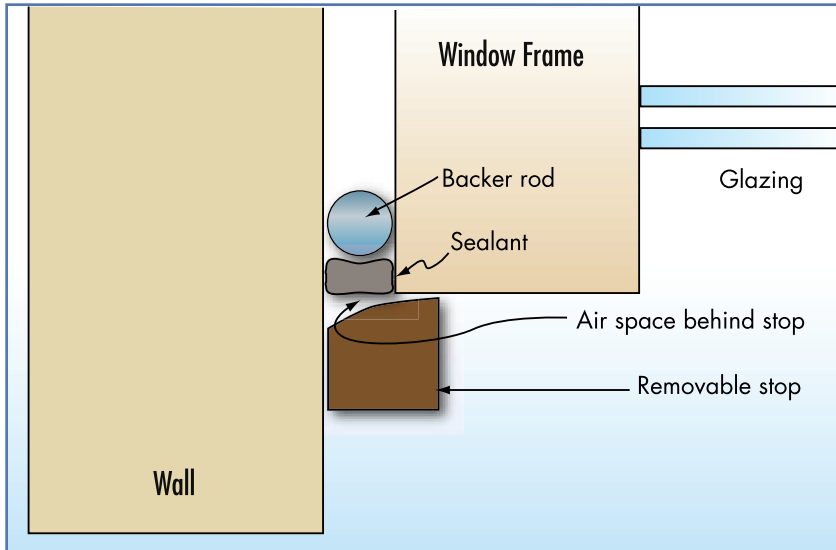

Figure 6-47
Protection of sealant with a stop. The stop retards weathering of the sealant and reduces the wind-driven rain demand on the sealant.

SOURCE: FEMA 55, COASTAL CONSTRUCTION MANUAL, 2000

Where water infiltration protection is particularly demanding and important, it is recommended that on-site water infiltration testing in accordance with ASTM E 1105 be specified.

6.14 EXTERIOR-MOUNTED MECHANICAL, ELECTRICAL, AND COMMUNICATIONS EQUIPMENT

Exterior-mounted mechanical (e.g., exhaust fans, HVAC units, relief air hoods, boiler stacks), electrical, and communications equipment (e.g., light fixtures, antennae, satellite dishes) are often damaged during high winds. Damaged equipment can impair the use of the school, the equipment can become missiles, and water can enter the facility where equipment was displaced (see Figures 6-19 and 6-48).

Problems typically relate to inadequate equipment anchorage, inadequate strength of the equipment itself, and corrosion.

Figure 6-48

The rooftop mechanical equipment on this school was blown over. The displaced equipment can puncture the roof membrane and, as in this case, rain can enter the school through the large opening that is no longer protected by the equipment.



6.14.1 Loads and Attachment

Rooftop Equipment. Criteria for determining loads on rooftop equipment were added to the 2002 edition of ASCE 7. A minimum safety factor of three is recommended for the design of equipment anchorage.

To anchor membrane fans, small HVAC units, and relief air hoods, the following minimum prescriptive attachment schedule is recommended:

- For curb-mounted units, specify #14 screws with gasketed washers.
- For curbs with sides less than 12 inches, specify one screw at each side of the curb.
- For curbs between 12 inches and 24 inches, specify two screws per side.
- For curbs between 24 inches and 36 inches, specify three screws per side.
- For units that have flanges attached directly to the roof, attachment with #14 pan-head screws is recommended. A minimum of two screws per side, with a maximum spacing of 12 inches on center is recommended.

Figure 6-49 illustrates the use of supplemental securement straps to anchor equipment. The supplemental attachment was marginal; the straps were too light and the fasteners used to secure them were corroded. This illustrates the validity of the supplemental securement, and it also illustrates the need to execute the securement with attention to detail. In lieu of one screw at each end of the strap, two side-by-side screws offer a stronger and more reliable connection (this of course requires a slightly wider strap).



Figure 6-49
This HVAC equipment had two supplemental securement straps. Both straps are still on this unit, but some of the other units on the roof had broken straps.

SOURCE: FEMA, *BUILDING TO MINIMUM TYPHOON DAMAGE: DESIGN GUIDELINES FOR BUILDINGS*, JULY 1998

Electrical and Communications Equipment. Damage to exterior-mounted electrical equipment is infrequent, in large part, because of the small size of most equipment (e.g., disconnect switches). Exceptions are communication masts (see Figure 6-50), surveillance cameras, service masts, and satellite dishes. These failures are typically caused by failure to perform wind load calculations and anchorage design. Service mast failure is typically caused by collapse of overhead power lines; this can be avoided by underground service. Where overhead service is provided, it is recommended that the service mast not penetrate the roof. Otherwise, a downed service line could pull the mast and rupture the roof membrane.

Figure 6-50

The communications mast on this school was pulled out of the deck, resulting in a progressive peeling failure of the fully adhered single-ply membrane. There are several exhaust fans in the background that were blown off their curbs, but were retained on the roof by the parapet.

SOURCE: FEMA, *BUILDING TO MINIMUM TYPHOON DAMAGE: DESIGN GUIDELINES FOR BUILDINGS*, JULY 1998



ASCE 7 provides load calculation criteria for trussed towers. The ASCE 7 criteria are consistent with ANSI/EIA/TIA-222-E. The ASCE 7 approach is a simplified procedure. The IBC allows use of either approach. ASCE 7 does not provide guidance for on-site power distribution poles nor for light fixture poles. However, the National Electrical Safety Code, ANSI/C2 provides guidance for determining wind loads on power poles. The AASHTO *Standard Specification for Structural Support for Highway Signs, Luminaries and Traffic Signals* provides guidance for determining wind loads on light fixture poles.

See Section 6.8.1 regarding siting of light fixture poles, power poles, and electrical and communications towers.

6.14.2 Equipment Strength

It is common for equipment components such as fan cowlings and access panels to be blown off during storms. Design of these elements is the responsibility of the equipment manufacturer. Although poor equipment performance has been documented, manufacturers have not offered enhanced equipment for high-wind regions. Therefore, it is incumbent upon the architect/engineer to give special design attention to equipment strength.

Damage investigations have revealed that cable tie-downs have been effective in securing fan cowlings when a sufficiently strong cable and anchor details were used (see Figure 6-51). For fan cowlings less than 4 feet in diameter, 1/8-inch diameter stainless steel cables are recommended. For larger cowlings, use 3/16-inch diameter cables. When the basic wind speed is 120 mph or less, specify two cables. Where the basic wind speed is greater than 120 mph, specify four cables. (As an alternative to cables, heavy stainless steel straps could be screwed to the cowling and curb.) To minimize leakage potential at the anchor point, it is recommended that the cables be anchored to the equipment curb (rather than anchored to the roof deck). The attachment of the curb itself also needs to be designed and specified.



Figure 6-51
To overcome blow-off of the fan cowling, which is a common problem, this cowling was attached to the curb with cables. The curb needs to be adequately attached to carry the wind load exerted on the fan.

SOURCE: FEMA, *BUILDING TO MINIMUM TYPHOON DAMAGE: DESIGN GUIDELINES FOR BUILDINGS*, JULY 1998

To minimize blow-off of equipment access panels, job-site modification will typically be necessary (such as the attachment of hasps and locking devices such as a carabineer). The modification details will need to be tailored for the equipment, which may necessitate detail design after the equipment has been delivered to the job site. Alternatively, factored loads on the equipment could be specified, along with the requirement for the manufacturer to demonstrate compliance with the load requirement.

6.14.3 Durability

To avoid corrosion-induced blow-off, it is recommended that exterior-mounted mechanical, electrical, and communications equipment be nonferrous, stainless steel, or steel with minimum G-90 hot-dip galvanized coating for the equipment itself, equipment stands, anchors, and fasteners. When equipment with enhanced corrosion protection is not available, the designer should advise the school district that periodic equipment maintenance and inspection is particularly important to avoid advanced corrosion and subsequent equipment damage during a windstorm.

The recommendations given in Sections 6.8 through 6.14 are summarized in Table 6-1.

Table 6-1: Summation of Risk Reduction Design Methods

Site	See Section 6.8.1.
Exposure	Locate in Exposure B if possible. Avoid escarpments and upper half of hills.
Are there trees or poles?	Locate to avoid blow-down on school.
Site access	Minimum of two roads.
Are there, or will there eventually be portables?	Locate downwind of school.
General design issues	See Section 6.8.2
Calculate loads on MWFRS, building envelope and rooftop equipment	Use ASCE 7 or local building code, whichever procedure results in highest loads.
Determine load resistance via calculations and/or test data	Give load resistance criteria in contract documents, and clearly indicate load path continuity.
Durability	Give special attention to material selection and detailing to avoid problems due to corrosion, wood decay, and termite attack.
Rain penetration	Detail to minimize wind-driven rain penetration into the building envelope.

Table 6-1: Summation of Risk Reduction Design Methods (continued)

Structural Systems (MWFRS)	
See Section 6.9.	
Is it a pre-engineered structural system?	Take special steps to ensure structure is not vulnerable to progressive collapse.
Are there exterior bearing walls?	Design as MWFRS and Components and Cladding. Reinforce CMU. Sufficiently connect precast concrete panels.
Roof decks	Concrete, steel, or wood sheathing is recommended. Attach steel decks with screws. Use special fasteners for wood sheathing. Anchor precast concrete to resist uplift load. For precast Tees, design reinforcing to resist uplift. If FMG-rated assembly, deck must comply with FMG criteria. If mechanically attached roof membrane, refer to recommendations in National Research Council of Canada, <i>Institute for Research in Construction, Wind Design Guide for Mechanically Attached Flexible Membrane Roofs</i> , B1049, 2004.
Exterior Doors and Non-Load Bearing Exterior Walls	
See Section 6.10 and 6.11.	
Door, frame and frame fasteners	Resist positive and negative design load, verified by ASTM E 1233 testing. Specify type, size, and spacing of frame fasteners.
Water infiltration	Consider vestibules, door swing, weatherstripping. Refer to ASTM E 2112 for design guidance.
Are there exterior non-load bearing walls, wall coverings, soffits, or elevated floors?	See Section 6.11.
Load resistance	Resist positive and negative design load, verified by ASTM E 1233 testing. Design as Components and Cladding.
Secondary protection	Provide moisture barrier underneath wall coverings that are water-shedding.
Roof Systems	
See Section 6.12.	
Testing	Avoid designs that deviate from a tested assembly. If deviation is evident, perform rational analysis. For metal panel systems, test per ASTM E 1592.
Edge flashings and copings	Follow ANSI/SPRI ES-1. Use a safety factor of three. Consider face-fasteners (Figure 6-39). Consider continuous bars (Figure 6-40).
System selection	Select systems that offer high reliability, commensurate with the wind-regime where the school is located.
Are there parapet base flashings?	Calculate loads and resistance. This is particularly important if base flashing is mechanically attached.
Is there a lightning protection system?	Design and specify anchorage to the roof.
Is there a steep-slope roof system?	See <i>Coastal Construction Manual</i> , Third Edition, FEMA 55, 2000.

Table 6-1: Summation of Risk Reduction Design Methods (continued)

Windows and Skylights		See Section 6.13.
Glazing, frame, and frame fasteners	Resist positive and negative design load, verified by ASTM E 1233 testing. Specify type, size, and spacing of frame fasteners.	
Water infiltration	Carefully design juncture between walls and windows/curtain walls. Avoid relying on sealant as the first line of defense. Refer to ASTM E 2112 for design guidance. Where infiltration is demanding, consider on-site water infiltration testing per ASTM E 1105.	
Exterior-mounted Mechanical, Electrical, and Communications Equipment		See Section 6.14.
Load resistance	Specify anchorage of all rooftop and wall-mounted equipment. Use a safety factor of three for rooftop equipment anchorage.	
Equipment strength	Specify cable tie-downs for fan cowlings. Specify hasps and locking devices for equipment access panels.	
Electrical service mast	Avoid penetration through the roof.	
After Completion of Contract Documents		
Peer review	Consider peer review. See Section 6.8.3.	
Submittals	Ensure required submittals are submitted and that they include the necessary information. Verify that each submittal demonstrates development of a load path through the system and into its supporting element. See Section 6.8.4.	
Field observations	Analyze design to determine which elements are critical to ensuring high-wind performance. Determine observation frequency of critical elements. See Section 6.8.4.	
Post-occupancy inspections, maintenance, and repair	Advise the school administration of the importance of periodic inspections, special inspections after unusually high winds, maintenance, and timely repair. See Section 6.8.5.	

6.15 SCHOOLS LOCATED IN HURRICANE-PRONE REGIONS

The IBC, through ASCE 7, prescribes that exterior glazing in schools in wind-borne debris regions be provided with wind-borne debris protection (either by use of laminated glass or shutters, as discussed in Section 6.15.6). Schools in hurricane-prone regions also have to be designed for a 100-year mean recurrence interval wind event if they are to be used as shelters. These are the only hurricane-related requirements currently in the IBC. These requirements do not provide adequate protection to occupants in a school during a hurricane, because the missile requirements only pertain to glazing. Hence, a code-compliant school can be designed, yet still allow the entrance of missiles through the roof or walls. To account for this deficiency, recommendations are given below regarding missile penetration through exterior walls and the roof. For a more conservative hurricane shelter, refer to FEMA 361.

Publication 4496 by the American Red Cross (ARC) provides information regarding assessing existing buildings for use as hurricane shelters. Unless a school has been specifically designed for use as a shelter, it should only be used as a last resort and only if the school meets the criteria given in ARC 4496.

Schools located in hurricane-prone regions should receive special design attention because of the unique characteristics of this type of windstorm. In addition to being capable of delivering very high winds, hurricanes can cause strong winds for many hours, which can eventually lead to fatigue failure. The direction of the wind can also change, thereby increasing the probability that the wind will approach the school at the most critical angle. Hurricanes also typically generate a large amount of missiles, which can be very damaging to schools and cause injury or death.

For schools in hurricane-prone regions that will be used for a hurricane shelter and/or for emergency response after a storm, the following design parameters are recommended (these

recommendations are in addition to the recommendations previously given in Sections 6.8 through 6.14):

1. During the design phase, the architect should determine from the school district whether or not the school will be designated or used as a shelter or emergency response facility. The school should only be used for a shelter if it was designed for that purpose.
2. For schools in coastal Alaska and other areas that experience frequent high wind events (such as parts of Colorado), several of the following recommendations are also applicable to these schools, with the exception of the wind-borne debris recommendations.

6.15.1 Design Loads

For the importance factor, use a value of 1.15.

6.15.2 Structural Systems

Because of the exceptionally good wind performance that reinforced cast-in-place concrete structures offer, a reinforced concrete roof deck and reinforced concrete and/or reinforced and fully grouted CMU exterior walls are recommended.

In order to achieve enhanced missile resistance, the following roof decks are recommended, in descending order of preference: cast-in-place concrete, precast concrete, and concrete topping over steel decking. For exterior walls, the following are recommended: 6-inch (minimum) thick concrete reinforced with #4 rebars at 12 inches on center each way, or 8-inch (minimum) thick fully grouted CMU reinforced with #4 rebars in each cell.

6.15.3 Exterior Doors

For glazing in doors, see the recommendations in Section 6.15.6.

Although the ASCE-7 wind-borne debris provisions only apply to glazing within a portion of hurricane-prone regions, it is recommended that all schools that will be used for evacuation shelters within the entire hurricane-prone region comply with the following recommendation: To minimize the potential of missiles penetrating exterior doors and striking people within the school, it is recommended that doors without glazing and the unglazed portions of doors with glazing be designed to resist the missile loads specified in ASTM E 1996 and that they be tested in accordance with ASTM E 1886. The test assembly should include the door, door frame and hardware. Further information on missile resistance of doors is found in FEMA 361, *Design and Construction Guidance for Community Shelters*.

6.15.4 Non-load Bearing Walls, Wall Coverings, and Soffits

In order to achieve enhanced missile resistance, the following types of exterior walls are recommended: reinforced cast-in-place concrete, or reinforced and fully grouted CMU.

To minimize long-term problems with non-load bearing walls, wall coverings, and soffits, it is recommended that non-load bearing exterior walls, wall coverings, and soffits be avoided to the extent possible. Reinforced concrete or CMU offers greater reliability (i.e., they have no coverings that can be blown off).

6.15.5 Roof Systems

The following types of roof systems are recommended on schools in hurricane-prone regions because they are more likely to avoid water infiltration if the roof is hit by wind-borne debris. Also, the following systems are less likely to become sources of wind-borne debris:

- In tropical climates where insulation is not needed above the roof deck: 1) liquid-applied membrane over cast-in-place concrete deck, or 2) modified bitumen membrane torched directly to cast-in-place concrete deck.

- Install a secondary membrane over a concrete deck (if another type of deck is specified, a cover board may be needed over the deck). Seal the secondary membrane at perimeters and penetrations. Specify a minimum 2-inch thick rigid insulation and a layer of 5/8-inch thick glass mat gypsum roof board over the secondary membrane to absorb missile energy. If the primary membrane is punctured during a storm, the secondary membrane should provide watertight protection unless the roof is hit with missiles of very high energy. A modified bitumen membrane is recommended for the primary membrane because of its enhanced resistance to puncture by small missiles.
- For an SPF roof system over a concrete deck, specify that the foam be a minimum of 3 inches thick to avoid missile penetration through the entire layer of foam.
- For a PMR, it is recommended that pavers weighing a minimum of 22 psf be specified. In addition, base flashings should be protected with metal. Parapets are recommended at roof edges. The parapet should be at least 3 feet high or higher if so indicated by ANSI/SPRI RP-4. Note: If the basic wind speed exceeds 130 mph, a PMR is not recommended on schools in hurricane-prone regions.
- For structural metal roof panels with concealed clips, it is recommended that mechanically seamed ribs spaced at 12 inches on center over a concrete deck be specified. If a steel deck is specified, specify a self-adhering modified bitumen membrane and 3-inch thick rigid insulation, followed by the metal panels installed on wood nailers. At the self-adhering membrane laps, specify metal strips over the deck where the laps do not occur over the deck ribs, or specify a suitable cover board between the deck and self-adhering membrane. If the metal panels are punctured during a storm, the secondary membrane should provide watertight protection unless the roof is hit with missiles of very high energy. Note: Architectural metal panels are not recommended on schools in hurricane-prone regions.

In order to avoid the possibility of roofing debris blowing off and striking people arriving at the school during the storm, the following types of roof coverings are not recommended: aggregate surfacings (either on BUR [shown in Figure 6-11], single-ply [shown in Figure 6-8] or SPF), lightweight concrete pavers, cementitious-coated insulation boards, slate, and tile (see Figure 6-52). Wind-borne debris from heavy roof coverings such as tiles have great potential to cause serious injury to people arriving at a school during a hurricane or other high wind event.



Figure 6-52
These wire-tied tiles were installed over a concrete deck. They were attached with stainless steel clips at the perimeter rows and all of the tiles had tail hooks. Adhesive was also used between the tail and head of the tiles.

SOURCE: FEMA, *BUILDING TO MINIMUM TYPHOON DAMAGE: DESIGN GUIDELINES FOR BUILDINGS*, JULY 1998

Because mechanically attached and air-pressure equalized single-ply membrane systems are susceptible to massive progressive failure after missile impact (see Figure 6-53), these systems are not recommended on schools in hurricane-prone regions. Fully adhered single-ply membranes are also very vulnerable to missiles (see Figure 6-54); therefore, they also are not recommended unless they are ballasted with pavers.

Figure 6-53

At this school, a missile struck the fully adhered low-sloped roof (see arrow) and slid into the steep-sloped reinforced mechanically attached single-ply membrane. A large area of the mechanically attached membrane was blown away due to progressive membrane tearing.



Figure 6-54

This fully adhered single-ply membrane was struck by a large number of missiles during a hurricane.



6.15.6 Windows and Skylights

ASCE 7 requires the use of impact-resistant glazing (i.e., laminated glass) or shutters in wind-borne debris regions. ASCE 7 refers to ASTM E 1996 for missile loads and to ASTM E 1886 for the test method to be used to demonstrate compliance with the E

1996 load criteria. In addition to testing for impact resistance, the window unit is subjected to pressure cycling after missile impact to evaluate whether or not the window can still resist wind loads.

If wind-borne debris glazing protection is provided by shutters, the glazing is still required by ASCE 7 to meet the positive and negative design air pressures.

For those schools that desire to provide blast-resistant glazing, the windows and glazed doors can be designed to accommodate wind pressure, missile loads, and blast pressure. However, the window and door units need to be tested for missile loads and cyclic air pressure, as well as for blast. A unit that meets blast criteria will not necessarily meet the E 1996 and E 1886 criteria, and vice versa.

With the advent of building codes requiring glazing protection in wind-borne debris regions, a variety of shutter designs have entered the market. Figure 6-55 illustrates an effective shutter. A metal track was permanently mounted to the wall above and below the window frame. Upon notification of an approaching hurricane, the metal shutter panels were inserted into the frame and locked into position with wing nuts.



Figure 6-55
View of a metal shutter
designed to provide missile
protection for windows

Shutters typically have a lower initial cost than laminated glass. However, unless the shutter is permanently anchored to the school (e.g., an accordion shutter), space will be needed to store the shutters. Also, when a hurricane is forecast, costs will also be incurred each time shutters are installed and removed afterward. To avoid the difficulty of installing shutters on upper-level glazing, motorized shutters could be specified, although laminated glass may be more economical in these locations.

6.15.7 Emergency Power

Schools intended for use as shelters and/or emergency response after a storm should be equipped with an emergency generator.

6.15.8 Construction Contract Administration

It is important for the school district to obtain the services of a professional contractor who will execute the work described in the contract documents in a diligent and technically proficient manner.

The frequency of field observations and extent of special inspections and testing should be greater than those employed on schools that are not designated as shelters.

6.15.9 Periodic Inspections, Maintenance, and Repair

The recommendations previously given for periodic and post-storm inspections, maintenance, and repair are critically important for schools used as shelters and emergency response after a storm because, if failure occurs, the risk of injury or death to occupants is great, and the needed continued operation of the school would be jeopardized.

The recommendations given in Section 6.15 are summarized in Table 6-2. These recommendations are in addition to those given in Sections 6.8 to 6.14, as summarized in Table 6-1.

Table 6-2: Summation of Design of Schools Used for Hurricane Shelters and/or for Emergency Response After a Storm

For wind-load calculations	Use an importance factor of 1.15.
Structural system	Reinforced cast-in-place concrete is recommended. If roof deck is not cast-in-place, pre-cast concrete or concrete topping over steel decking is recommended.
Exterior walls	Reinforced concrete or fully grouted and reinforced CMU is recommended, without wall coverings other than paint.
Exterior doors	Designed and tested to resist missiles.
Roof covering	Avoid aggregate surfacings, lightweight concrete pavers, cementitious-coated insulation boards, slate and tile. Avoid single-ply membranes unless ballasted with heavy pavers. Design a roof covering that can accommodate missiles – see Section 6.15.5.
Exterior windows and skylights	Laminated glass or shutters designed and tested to resist missiles. If equipped with shutters, glazing is still required to resist wind pressure loads.
Emergency power	School equipped with an emergency generator.
Construction contract administration	Construction executed by professional contractor and subcontractors. More frequent field observations, special inspections and testing.
Periodic inspections, maintenance, and repair	After construction, diligent periodic inspections and special inspections after storms. Diligent maintenance and prompt execution of needed repairs.
Is enhanced occupant protection sheltering desired?	For a more conservative hurricane shelter, refer to FEMA 361, <i>Design and Construction Guidance for Community Shelters</i> .

6.16 DESIGN FOR TORNADO SHELTERS

Terrorist threat: If it is desired to incorporate a tornado shelter, and if it is also desired for the shelter to provide protection from terrorism, refer to FEMA 428 and 453 for additional shelter enhancements.

Tornado risk assessment and tornado-prone regions were discussed in Section 6.7 and the cost of tornado shelters was discussed in Section 6.5.2. Following up on those discussions, strong and violent tornadoes produce wind speeds that are substantially greater than those delivered by the strongest hurricanes; hence, the wind pressures that these tornadoes exert on buildings is tremendous and far exceed the minimum pressures required by building codes. In addition, strong and violent tornadoes can generate very powerful missiles (see Figure 6-56), including vehicles. The missile sticking out of the roof in the foreground of Figure 6-56 is a double 2-inch by 6-inch. The portion sticking out of the roof is 13 feet long. It penetrated a ballasted ethylene propylene diene monomer (EPDM) membrane and approximately 3 inches of polyisocyanurate roof insulation and the steel roof deck. The missile laying on the roof just beyond is 2 inches by 10 inches by 16 feet long.

Missile loads that are used for the design of tornado shelters are significantly greater than the missile loads used for the design of glazing protection in wind-borne debris regions of hurricane-prone regions.

Figure 6-56

A violent tornado passed by this high school and showered the roof with missiles.

SOURCE: FEMA 342, OKLAHOMA AND KANSAS MIDWEST TORNADOES OF MAY 3, 1999, 1999



As discussed in Section 6.5.2, FEMA 361, *Design and Construction Guidance for Community Shelters*, includes software for assessing the benefit/cost ratio of incorporating specially designed tornado shelters within schools. In addition, it includes comprehensive information regarding the design of shelters. If shelter design is contemplated, use of FEMA 361 is recommended.

Existing Schools without Tornado Shelters. Where the number of recorded F3, F4, and F5 tornadoes per 3,700 square miles is one or greater (see Figure 6-2), if the school does not have a tornado shelter, the best available refuge areas should be identified. FEMA 431, *Tornado Protection, Selecting Refuge Areas in Buildings* provides useful information for school administrators, and for architects and engineers who perform evaluations of existing schools.

To minimize deaths and injuries of students, faculty, and other occupants, it is critically important that the best available refuge areas be pre-identified by a qualified architect/engineer.⁸ Once identified, those areas need to be clearly marked so that occupants can quickly seek refuge. Don't wait for the arrival of a tornado on the school grounds to try to find the best available refuge areas; by that time, it is too late. If refuge areas have not been pre-identified, occupants can easily take cover in areas that can become death traps (see Figure 6-57).

When a true shelter is desired for a school that does not have one, retrofitting a shelter within the school can be very expensive. An economical alternative is an addition to the existing school that can function as a shelter as well as serve another purpose. This approach works well for smaller schools, but, for a very large school, construction of two or more shelter additions should be considered in order to reduce the time it takes to reach the shelter (often there is ample warning time, but sometimes an approaching tornado is not noticed until a couple of minutes before it strikes).

⁸ It should be realized that, unless the refuge area was specifically designed as a tornado shelter, occupants in a "best available refuge area" are vulnerable to injury or death.

Figure 6-57

View of an elementary school corridor after passage of a violent tornado. Although corridors sometimes offer protection, they can be death traps as illustrated in this figure (fortunately the school was not occupied when it was struck).

SOURCE: FEMA 342, OKLAHOMA AND KANSAS MIDWEST TORNADOES OF MAY 3, 1999, 1999



Portable Classrooms. Portable classrooms should not be occupied during times when a tornado watch has been issued by the National Weather Service (a watch means that conditions are favorable for tornado development). Do not wait for issuance of a tornado warning (i.e., a tornado has been spotted) by the National Weather Service to seek refuge in the main school building. If a tornado is nearby, students could be caught outdoors.

The recommendations given in Section 6.16 are summarized in Table 6-3 .

Table 6-3: Summation of Design for Tornado Shelters

Proposed New School	
1. Is proposed school in a tornado-prone region: yes or no? If yes, go to step 2.	See Section 6.7.1 for decision analysis.
2. If yes, perform benefit/cost analysis to assist in deciding whether or not to incorporate a shelter(s) within the school.	See FEMA 361, <i>Design and Construction Guidance for Community Shelters</i> , benefit/cost analysis.
3. Perform steps 1 and 2 prior to setting project budget.	If sheltering is not considered until after setting the budget, funds may not be available.
4. It is decided to incorporate a shelter(s).	Refer to FEMA 361, <i>Design and Construction Guidance for Community Shelters</i> , for design guidance.

Table 6-3: Summation of Design for Tornado Shelters (continued)

Existing schools without specifically designed tornado shelters	
1. If 1 or more F3-F5 tornadoes per 3,700 square miles, pre-identify best available refuge areas.	See Figure 6-2 for history frequency and FEMA 431, <i>Tornado Protection, Selecting Refuge Areas in Buildings</i> for identification guidance.
2. If 1 or more F3-F5 tornadoes per 3,700 square miles, consider incorporating a shelter(s) within a new building addition(s).	See FEMA 361, <i>Design and Construction Guidance for Community Shelters</i> , for benefit/cost analysis and design guidance.

6.17 REMEDIAL WORK ON EXISTING SCHOOLS

Section 6.6.1 discussed prioritizing and Section 6.6.2 discussed cost. Following up on those discussions, many existing schools need building envelope component strengthening or structural strengthening. The need for this work is due either to deterioration over time and/or inadequate facility strength at the time the school was built.

It is prudent for school districts to have their existing facilities evaluated. This also applies to recently constructed schools that are located in an area where the basic wind speed is greater than 90 mph (peak gust), and those schools that will be used for emergency response after a storm and schools that will be used for a hurricane shelter.

For new schools, areas of concern would typically be the building envelope and exterior-mounted mechanical, electrical, and communications equipment. By identifying weaknesses and prioritizing and executing the work, many failures can be averted. A proactive approach can save significant sums of money and decrease the number of instances when schools are impaired or immobilized after a storm.

For roofs with weak metal edge flashing or coping attachment, face-attachment of the edge flashing/coping (as shown in Figure 6-39) is a cost-effective approach to greatly improve wind-resistance of the roof system. Fastening rooftop equip-

ment to curbs is a cost-effective approach to avoid the type of problems shown in Figure 6-19.

During planned roof covering replacement, by tearing off the existing roof covering rather than re-covering, there is the opportunity to evaluate the structural integrity of the deck and deck attachment and upgrade its attachment if necessary. Many older decks are poorly attached (Figure 6-58); hence, if their attachment is not upgraded, blow-off of the deck and the new roof covering could occur. The two deck panels shown in Figure 6-58 blew away because their attachment to the roof structure was inadequate. An SPF roof covering was over the deck panels that blew away because of the characteristics of this type of covering, membrane propagation failure did not occur, as would have been the case with built-up, modified bitumen, or single-ply roof membranes. Cementitious wood-fiber decks were commonly used on schools built in the 1950s and 1960s. Decks constructed during that era typically had very limited uplift resistance due to weak connections to the support structure.

Design guidance pertaining to existing decks is presented in “*Uplift Resistance of Existing Roof Decks: Recommendations for Enhanced Attachment During Reroofing Work*,” RCI Interface, Thomas L. Smith, January 2003, pp. 14.

Figure 6-58
This school had a cementitious wood-fiber deck (commonly referred to by the proprietary name “Tectum”).



Weak non-load bearing masonry walls, poorly connected precast concrete panels, long-span structures (e.g., at gyms) with limited uplift resistance, and weak glass curtain walls are common problems with many older schools. Although the technical solutions to these problems are not difficult, the cost of the remedial work is normally quite expensive. If remediation funds are not available, it is important to minimize the risk of injury and death by evacuating areas that have this type of construction when winds above 60 mph are forecast.

For schools located in wind-borne debris regions, if the exterior glazing is not missile-resistant, equipping the openings with shutters is a cost-effective approach to provide protection.

The recommendations given in Section 6.17 are summarized in Table 6-4.

Table 6-4: Summation of Remedial Work on Existing Schools

Perform district-wide assessment of all schools	Evaluate all hazards. Prioritize the various schools and the work items at each school. Life-safety items are first priority; property damage and school interruption are second priority. See Section 6.6.1.
Are there weak non-load bearing masonry walls, weak curtain walls, poorly connected precast concrete panels, or weak long-span roof structures?	If strength is inadequate to resist winds that are likely to occur while the school is occupied (such as strong thunderstorms), implement remedial work.
Are edge flashings or copings inadequately attached?	Face-attach the vertical flanges. See Figure 6-39.
Are rooftop equipment units unanchored or poorly anchored?	Add screws or bolts to anchor equipment to curbs. Add cables to secure fan cowlings. Add latches to secure equipment access panels. See Section 6.14.
Are roof deck or roof structure connections weak?	During planned roof covering replacement, remove roof covering and strengthen attachment of deck and/or roof structure. See Section 6.12.
If the school is in a wind-borne debris region, does exterior glazing have protection (via laminated glass or shutters)?	Even if the school will not be used as a shelter, equip with shutters to avoid interior wind and water damage. For more conservative protection, consider the wind-borne debris region to include areas where the basic wind speed is equal to or greater to 110 mph (100 mph if the school is located within 1 mile of the coast).
Will the school be used as a hurricane evacuation shelter and/or for emergency response after a storm?	To the extent reasonably possible, upgrade the school so that it complies with the provisions in Section 6.15.
Is the school located in a tornado-prone area?	See Section 6.16.

6.18 REFERENCES AND SOURCES OF ADDITIONAL INFORMATION

American Institute of Architects, *Buildings at Risk: Wind Design Basics for Practicing Architects*, 1997.

Federal Emergency Management Agency, *Building Performance: Hurricane Andrew in Florida*, FEMA FIA-22, Washington, DC, December 1992.

Federal Emergency Management Agency, *Building Performance: Hurricane Iniki in Hawaii*, FEMA FIA-23, Washington, DC, January 1993.

Federal Emergency Management Agency, *Corrosion Protection for Metal Connectors in Coastal Areas*, FEMA Technical Bulletin 8-96, Washington, DC, August 1996.

Federal Emergency Management Agency, *Typhoon Paka: Observations and Recommendations on Building Performance and Electrical Power Distribution System*, Guam, U.S.A., FEMA-1193-DR-GU, Washington, DC, March 1998.

Federal Emergency Management Agency, *Hurricane Georges in Puerto Rico*, FEMA 339, Washington, DC, March 1999.

Federal Emergency Management Agency, *Oklahoma and Kansas Midwest Tornadoes of May 3, 1999*, FEMA 342, Washington, DC, October 1999.

Federal Emergency Management Agency, *Coastal Construction Manual*, Third Edition, FEMA 55, Washington, DC, 2000.

Federal Emergency Management Agency, *Design and Construction Guidance for Community Shelters*, FEMA 361, Washington, DC, July 2000.

Federal Emergency Management Agency, *Primer to Design Safe School Projects in Case of Terrorist Attacks*, FEMA 428, Washington, DC, October 2003.

Federal Emergency Management Agency, *Tornado Protection, Selecting Safe Areas in Buildings*, FEMA 431, Washington, DC, October 2003.

National Research Council of Canada, Institute for Research in Construction, *Wind Design Guide for Mechanically Attached Flexible Membrane Roofs*, B1049, 2004.

Rousseau, M.Z., *Facts and Fictions of Rain-Screen Walls*, Construction Canada, 1990, pp. 40.

Smith, Thomas L., "Insights on Metal Roof Performance in High-wind Regions," *Professional Roofing*, February 1995, pp. 12 (available on-line at www.nrca.net).

Smith, Thomas L., "Integrating a Lightning Protection System in a Roof System," 12th International Roofing and Waterproofing Conference Proceedings (CD), National Roofing Contractors Association, 2002.

Smith, Thomas L., "Honing in on hangars," *Professional Roofing*, October 2002, pp. 32 (available on-line at www.nrca.net).

Smith, Thomas L., "Uplift Resistance of Existing Roof Decks: Recommendations for Enhanced Attachment During Reroofing Work," *RCI Interface*, January 2003, pp. 14.

Smith, Thomas L., "Detailing ASCE 7's changes," *Professional Roofing*, July 2003, pp. 26 (available on-line at www.nrca.net).

6.19 GLOSSARY OF WIND TERMS

Basic wind speed. A 3-second gust speed at 33 feet above the ground in Exposure C. (Exposure C is flat open terrain with scattered obstructions having heights generally less than 30 feet.) Note: Since 1995, ASCE 7 has used a 3-second peak gust measuring time. A 3-second peak gust is the maximum instantaneous speed with a duration of approximately 3 seconds. A 3-second peak gust speed could be associated with a given windstorm (e.g., a particular storm could have a 40-mile per hour peak gust speed), or a 3-second peak gust speed could be associated with a design-level event (e.g., the basic wind speed prescribed in ASCE 7).

Building, enclosed. A building that does not comply with the requirements for open or partially enclosed buildings.

Building, open. A building having each wall at least 80 percent open. This condition is expressed by an equation in ASCE 7.

Building, partially enclosed. A building that complies with both of the following conditions:

1. The total area of openings in a wall that receives positive external pressure exceeds the sum of the areas of openings in the balance of the building envelope (walls and roof) by more than 10 percent, and
2. The total area of openings in a wall that receives positive external pressure exceeds 4 square feet or 1 percent of the area of that wall, whichever is smaller, and the percentage of openings in the balance of the building envelope does not exceed 20 percent.

These conditions are expressed by equations in ASCE 7.

Building, regular shaped. A building having no unusual geometrical irregularity in spatial form.

Building, simple diaphragm. An enclosed or partially enclosed building in which wind loads are transmitted through floor and roof diaphragms to the vertical main wind-force resisting system.

Components and cladding. Elements of the building envelope that do not qualify as part of the main wind-force resisting system.

Escarpment. Also known as a scarp, with respect to topographic effects, a cliff or steep slope generally separating two levels or gently sloping areas.

Exposure. The characteristics of the ground roughness and surface irregularities in the vicinity of a building. ASCE 7 defines three exposure categories - Exposures B, C, and D.

Glazing. Glass or transparent or translucent plastic sheet used in windows, doors, and skylights.

Glazing, impact-resistant. Glazing that has been shown by an approved test method to withstand the impact of wind-borne missiles likely to be generated in wind-borne debris regions during design winds.

Hill. With respect to topographic effects, a land surface characterized by strong relief in any horizontal direction.

Hurricane-prone regions. Areas vulnerable to hurricanes; in the U.S. and its territories defined as:

1. The U.S. Atlantic Ocean and Gulf of Mexico coasts where the basic wind speed is greater than 90 miles per hour, and
2. Hawaii, Puerto Rico, Guam, U.S. Virgin Islands, and American Samoa.

Impact-resistant covering. A covering designed to protect glazing, which has been shown by an approved test method to withstand the impact of wind-borne missiles likely to be generated in wind-borne debris regions during design winds.

Importance factor, I. A factor that accounts for the degree of hazard to human life and damage to property. The importance factor adjusts the mean recurrence interval. Importance factors are given in ASCE 7.

Main wind-force resisting system. An assemblage of structural elements assigned to provide support and stability for the overall structure. The system generally receives wind loading from more than one surface.

Mean roof height, h. The average of the roof eave height and the height to the highest point on the roof surface, except that, for roof angles of less than or equal to 10 degrees, the mean roof height shall be the roof eave height.

Missiles. Debris that became or could become ingested into the wind stream.

Openings. Apertures or holes in the building envelope that allow air to flow through the building envelope and that are designed as “open” during design winds. A door that is intended to be in the closed position during a windstorm would not be considered an opening. Glazed openings are also not typically considered an opening. However, if the building is located in a wind-borne debris region and the glazing is not impact-resistant or protected with an impact-resistant covering, the glazing is considered an opening.

Ridge. With respect to topographic effects, an elongated crest of a hill characterized by strong relief in two directions.

Wind-borne debris regions. Areas within hurricane-prone regions located:

1. Within 1 mile of the coastal mean high water line where the basic wind speed is equal to or greater than 110 mph and in Hawaii; or
2. In areas where the basic wind speed is equal to or greater than 120 mph.

A

AASHTO	American Association of State Highway and Transportation Officials
ACSA	Association of Collegiate Schools of Architecture
ADA	Americans with Disabilities Act
AHJ	Authority Having Jurisdiction
AIA	American Institute of Architects
AK	Alaska
AL	Alabama
ANSI	American National Standards Institute
ARC	American Red Cross
ASCE	American Society of Civil Engineers
ASTM	American Society for Testing and Materials
ATC	Applied Technology Council

B

BFE	base flood elevation
BOCA	Building Officials and Code Administrators International
BSSC	Building Seismic Safety Council
BUR	built-up roof

C

CA	California
CBR	chemical, biological, or radiological
CMU	concrete masonry unit

D

DE	Delaware
DFE	design flood elevation

E

EIFS	exterior insulation finish system
ELF	Equivalent Lateral Force
EPDM	ethylene propylene diene monomer
EPS	expanded polystyrene system

F

FEA	finite element analysis
FEMA	Federal Emergency Management Agency
FIRM	Flood Insurance Rate Map
FIS	Flood Insurance Study
FL	Florida
FM	Factory Mutual
FMG	Factory Mutual Global
FMR	Factory Mutual Research



GIS Geographic Information System
gpm gallons per minute



HazMat hazardous materials
HAZUS Hazards U.S.
HAZUS-MH Hazards U.S. - Multihazards
HID high intensity
HVAC heating, ventilating, and air conditioning



IBC International Building Code
ICBO International Conference of Building Officials
ICC International Code Council
ID identification
IL Illinois
IT Information Technology



K-12 kindergarten to grade 12
km kilometer



LA	Louisiana
LCD	liquid crystal display



MA	Massachusetts
MD	Maryland
M/E/P	Mechanical/Electrical/Plumbing
mph	miles per hour
MT	Montana
MWFRS	main wind-force resisting system



NBC	National Building Code
NC	North Carolina
NEHRP	National Earthquake Hazards Reduction Program
NFIP	National Flood Insurance Program
NFPA	National Fire Protection Association
NIBS	National Institute of Building Sciences



O&M	operations and maintenance
OH	Ohio
OSB	oriented strand board

P

PA	Pennsylvania
PMR	protected membrane roof
psf	pounds per square foot

R

RC	reinforced concrete
RSP	Rapid Screening Procedure

S

SBC	Standard Building Code
SBCCI	Southern Building Code Congress International
SC	South Carolina
SEACO	Structural Engineers Association of California
SFPE	Society of Fire Protection Engineers
SPF	sprayed polyurethane foam
SUG	Seismic Use Group

T

TN	Tennessee
tv	television
TX	Texas

U

UBC	Uniform Building Code
URM	unreinforced masonry
U.S.	United States
USACE	U.S. Army Corps of Engineers
USFA	United States Fire Administration
USGS	United States Geological Survey
UT	Utah

V

VA	Virginia
-----------	----------

W

W	Washington
----------	------------