



**UNIVERSITY OF
CAMBRIDGE**
Faculty of Education

**THOUGHT EXPERIMENTS
IN PHYSICS PROBLEM-SOLVING:
ON INTUITION AND IMAGISTIC SIMULATION**

ANDREAS GEORGIU
Supervised by DR KEITH S. TABER

Thesis Presented for the degree of
Master of Philosophy
in Educational Research

Submitted July 2005

University Statement of Originality

In accordance with Regulation 8 of the General Regulations for the MPhil Degree (one-year course) I declare that this thesis is substantially my own work. Where reference is made to the works of others the extent to which that work has been used is indicated and duly acknowledged in the text and bibliography.

Word count: 20000

Acknowledgements

I wish to address my gratitude to my supervisor Dr Keith S. Taber for his advice and guidance. Several of my colleagues at the Faculty of Education and Homerton College have earned my gratitude for their advice and encouragement. Among them Valesca Valentina Grau and Alejandra Garciafranco, and Olivier Wantz who was my advanced physics hotline. Prof. Peter Lipton who filled in assorted gaps in the philosophical literature on thought experiments. Prof. Nicos Valanides, an exemplary teacher and mentor at the University of Cyprus; for his advice, support and encouragement, and because he changed forever the way I thought about learning physics I will always be profoundly grateful.

The people who deserve special mention are my father and mother; at the end of the day I owe this thirst for knowledge to them.

For my nephew
Kyriacos

Contents

List of tables and figures	vi
Abstract.....	vii
1 Introduction.....	1
2 Conceptual Framework	4
2.1 PREAMBLE.....	4
2.2 THAT WHICH HAS BEEN NAMED TES.....	5
2.3 THE TRIPARTITE STRUCTURE	6
2.4 THE TWO PARADOXES OF TES	8
2.4.1 The debate so far	8
2.4.2 The first paradox: the from-conceivability-to-possibility	9
2.4.2.1 The role of intuition: phenomenological-primitive premises in TEs.....	11
2.4.2.2 TEs as limiting cases of real experiments.....	14
2.4.3 The second paradox: the a priori informativeness	15
2.4.3.1 The role of imagistic simulation: the quasi-sensory hypothesis	16
2.5 SYNTHESIS	19
3 Methodology	20
3.1 PREAMBLE AND RESEARCH QUESTIONS	20
3.2 THE NATURALISTIC TURN AND A CONSTRUCTIVIST ACCOUNT OF TEATION.....	21
3.3 RESEARCH DESIGN.....	24
3.3.1 The choice for case study	24
3.3.1.1 Bounding the case	26
3.3.2 The choice for think-aloud	29
3.3.2.1 Procedure	31
3.3.2.2 Designing successful tasks	33
3.4 ANALYSIS OVERVIEW	33
3.5 DESIGN CHECKS	37
3.6 SYNTHESIS	40
4 Analysis.....	41

4.1	PREAMBLE.....	41
4.2	ABSOLUTE MOTION.....	42
4.2.1	The ‘telescope TE’	42
4.2.2	Verificationist epistemological commitments: Basic TEs as a feedback mechanism	45
4.2.3	The spinning passenger	49
4.3	PHYSICS IN A SPACESHIP	53
4.3.1	Non-agentive causation	54
4.3.2	A note on gesticulation as evidence for imagery	55
4.3.3	Shuttling from non-agentive to agentive causation	58
4.4	WHY DO THINGS FALL.....	61
4.4.1	One more basic TE: The ‘spring-scale TE’	61
4.4.2	Basic TEs and the ‘Transfer of Runnability’ hypothesis	64
4.4.3	The ‘separation TE’: the role of insight in (some) TEs.	67
5	Interpretive synthesis	73
5.1	PREAMBLE.....	73
5.2	THEORETICAL CLAIMS.....	73
5.2.1	Main theoretical claim: the emergence hypothesis	73
5.2.2	Salient characteristics of TEs in the protocol	79
5.3	IMPLICATIONS FOR FUTURE DOCTORAL RESEARCH	81
5.4	CONCLUSION	83
6	Bibliographies	87
6.1	BIBLIOGRAPHY ON THOUGHT EXPERIMENTS (MAINLY IN THE NATURAL SCIENCES)	87
6.1.1	Mainly philosophical studies	87
6.1.2	Mainly studies in the qualitative physics tradition and science education	91
6.2	BIBLIOGRAPHY OF WORKS CITED	93
	Appendices	103
APPENDIX A	PARADIGMATIC CASES OF TES.....	103
APPENDIX B	THE TASKS.....	108
B.1	Tasks designed for session 1	108
B.2	Tasks designed for session 2	114
APPENDIX C	TRANSCRIPTS	117
APPENDIX D	LETTER REQUESTING ACCESS.....	127

List of tables and figures

Figure 3.1: Analysis overview	35
Figure 3.2: Research design overview	36
Figure 3.3: Fieldwork and analysis timetable	36
Figure 4.1: Task ‘Absolute motion’	42
Figure 4.2: The positive feedback mechanism in the telescope TE	48
Figure 4.3: The positive feedback mechanism in the pseudo-forces TE	51
Figure 4.4: Task ‘Physics in a spaceship’	54
Figure 4.5: Shuttling from non-agentive to agentive causation in task ‘Physics in a spaceship’	61
Figure 4.6: Task ‘Why do things fall’	61
Figure 4.7: The <i>accurate</i> kinematical behaviour of the spring scale and the object after its release.....	66
Figure 4.8: Similar gesticulation as evidence for transferability of runnability during model construction and application (Clement & Steinberg, 2002)	67
Figure 4.9: Schematic representation of the separation TE	68
Figure 4.10: Task given to examine the exploratory processes of the separation TE.....	69
Figure 5.1: The feedback mechanism in the case of a physical experiment	78
Figure 5.2: Why the physical and the imaginary worlds overlap	79
Figure 5.3: Proposed research design for future study	83
Table 5.A: List of basic TEs in the protocol.....	84
Table 5.B: List of other TEs in the protocol	85

Abstract

This study is part of a larger research agenda, which includes future doctoral study, aiming to investigate the psychological processes of thought experiments. How do thought-experimenters establish relations between their imaginary worlds and the physical one? How does a technique devoid of new sensory input result to new empirical knowledge? In this study I investigate the following claims as possible answers: that intuition grounds the behaviour of an imaginary scenario in the experienced world; and that imagistic simulation provides the thought-experimenter with a quasi-perceptual analogue to direct perception through which they acquire novel empirical knowledge. Case methodology was adopted, the case being a pair of final year A-level physics students. Data was collected through non-participant observation over two sessions of collaborative problem-solving. The tasks drew upon Newtonian mechanics. A certain type of thought-experimental reasoning prevailed in the observation protocol. These thought experiments do not aim to induce unexpected results but to make intuitions about a situation experiencable in a concrete (imaginary) scenario. I interpret thought experiments of this type as a mental analogue to inductive discovery through physical experiment. A critical question for future research is whether all thought-experimental reasoning in general emulates physical experimentation, as the answer will potentially provide insights for exploring thought experimenting as an *educable skill*.

Keywords: thought experimentation, intuition, mental simulation, science education

CHAPTER I

1 Introduction

Secundum imaginationem

(‘according to imagination’ – William of Heytesbury)

Today Maria left her office and took the eight o’ clock bus to her place. At nine o’ clock she was meant to meet a friend at the cafeteria in the corner. And whilst everything looked promising for a relaxing night out, Maria could not find her keys to lock the house on her way out. The frightening thought came to her mind that she may have lost them in the bus. ‘But wait!’ thought Maria. ‘If I had lost them in the bus, then I wouldn’t be able to get into the house in the first place - well, at least not through the door! This is absurd, the keys have to be somewhere in the house.’

This is a thought experiment. Unlike the thought experiments I will deal with in this study, it does not address a scientific problem. Nevertheless it shares most of the characteristics I will attribute to scientific thought experiments. First of all, it posits a hypothetical scenario: ‘If I had lost my keys in the bus...’ It has a runnable content which involves elements of personal participation: ‘if I had lost them in the taxi, then I wouldn’t be able to open the door in the first place!’ It results into new knowledge: ‘the keys have to be somewhere in the house.’ Somewhere in this reasoning, I will argue, there are intuitions which ground this imaginary scenario in the real world: we know for certain that normally one cannot open a locked door without a key. Somehow in this reasoning, I will also argue, these intuitions are accessed through an imagistic simulation of the situation, and this brings Maria to a reconfiguration of her cognitive apparatus.

The term *Gedankenexperiment* was coined at the end of the last century by Ernst Mach (1886/1897) to describe a specific method of enquiry used by professional scientists as a mental analogue to physical experimentation. In the century that followed *Gedankenexperiments*, in their English translation

Thought Experiments (hereafter TEs), appeared sporadically in the literature of the philosophy of science most notably in Popper's (1968) *On the Use and Misuse of Imaginary Experiments, Especially in Quantum Theory* and Kuhn's (1977) *A function for Thought Experiments*. After the 1980s when TEs had been recognised as a technique in analytic philosophy, philosophical scrutiny was directed upon them. Heeding Mach's recognition that 'thought experiments are important not only in physics, but in every field' (Mach, 1905/1976, p.144), an outburst in philosophical interest in thought experimentation (TEation) in various disciplines inspired the publication of several books and articles in journals, some of which relate TEation with science education.

Today it is indisputable even by the unsympathetic critics of TEation, that TEs are a common reasoning device in the context of both formal argumentation and in everyday life (finding Maria's keys is an example of the latter). Nevertheless science education has yet to acknowledge the pedagogical benefits of TEation: for example, the DfES/QCA (DfES, 2002) scheme of work for science and the renditions of science underlying the UK National Curriculum by and large recognise the role of physical experimentation whilst TEation does not appear in commonly used textbooks, for example in tasks of the kind 'frame a TE to show that...'. After all, students spend much more time in the privacy of their own 'mental laboratories' than in their schools' laboratories. The driving force behind this work is the conviction that in order to realise the educational value of thought-experimental inquiry we firstly need to reach a sort of ontological agreement about what thought-experimental reasoning in science is, and secondly understand the psychological processes that underpin it.

The purpose of my research, then including my future doctoral project, is to establish a conceptual framework for the psychological workings of scientific TEation, to ultimately inform pedagogy. Toward this direction the purpose of this study is first to establish a methodology for the investigation of the psychological processes in TEs secondly to generate hypotheses grounded in process data about the role of intuition and imagistic simulation in TEation.

The plan for this thesis is as follows:

In Chapter 1 I lay down the rough outlines of a provisional conceptual framework motivated by the philosophical study of TEation and empirical research in the qualitative physics tradition and research in mental simulation.

In Chapter 2 I advocate a constructivist turn in the study of TEation based on the situated character of thought-experimental reasoning. Subsequently I describe the design for this research.

In Chapter 4, following the analysis of the data in Chapter 3, I interpret the findings in a set of theoretical ideas about the role of intuition and imagistic simulation in TEation, propose a set of questions that could orientate future research, and discuss how the methodology can be improved for my future doctoral project.

CHAPTER II

2 Conceptual Framework

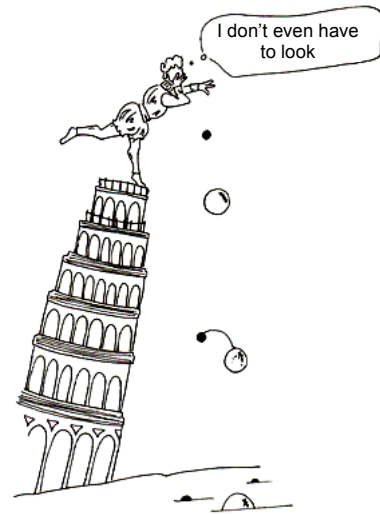

Blindfold physics?
(illustration in Brown, 2004b, p.24)

2.1 PREAMBLE

If we are to settle issues of TEation it is imperative that we explicitly debate what has and has not been done and what needs to be done. Reflection will help us avoid reinventing the wheel every time there is need for travel, as this will only deprive us from precious travel time in probing deeper in TEation. In this chapter I deconstruct the largely philosophical and historical literature on TEation and identify two key questions, namely the *from-conceivability-to-possibility* and the *a priori informativeness* paradoxes. The former questions how an imaginary hypothetical scenario can be relevant to, and informative about, the physical world. The latter questions how a process devoid of new empirical input can produce new empirical knowledge (one does not expect to become richer by handing over money from the left hand to the right). Philosophers of science, so the argument goes, in the empiricist and rationalist paradigms have focused their inquiries only on one of these questions each, based on what each tradition found more puzzling. The result of their debate is largely incommensurable vistas that give a limited range of

vision for understanding the actual transformations that occur in the learners and that may promote instructional situations related to TEation.

In what follows I describe the most salient features of TEs and I suggest a conceptual framework accountable for both puzzles which I will use to approach TEs in this study. The framework is based on the idea of mental models, and more specifically, the role that intuition and imagistic simulation may play in mental models. The conceptual framework is based on two standards, namely *theoretical* and *empirical accountability*: In principle, a claimed-to-be well rationalised explanatory construct should distinguish at a minimum between TEs and non-TEs. It should provide provisions for a clear specification of the epistemological resources of TEs, and should maintain a technically well-developed and intersubjective terminology. As for empirical accountability, the need to go beyond philosophical discourse is to go beyond anecdotal and introspective evidence. Claims pertaining to the explanatory constructs should include wide empirical evidence so as to allow for analytical scrutiny at a variety of depths: the benefit is a theoretical account that takes into consideration *process data*, not only narratives of TEs. The assumptions and hypotheses underlying this conceptual framework will guide the design of the methodology, and the analysis and interpretation of the data.

2.2 THAT WHICH HAS BEEN NAMED TES

How does one know a TE when one sees one? TEs, unlike real experiments, have never had a *prescriptive* methodology to systematise the thought-experimental work in a discipline. Based on instances of reasoning which we recognise as TEs on the basis of early paradigmatic uses of the term, it is possible that a *descriptive* methodology of TEation is formulated.

After Mach coined the term a wide variety of instances of reasoning were recorded as TEs. Additionally, later editions interpolate the term where it was not originally used (Gendler, 2003) so expanding the definition to include new cases between cases previously covered.¹ There is such a variety of uses of the

¹ For example, many credit Einstein to have been one of the first to have used the term *Gedankenexperiment*, however, Einstein despite his extensive readings of Mach appears not to have used the expression in his own writings (Gendler, 2003). After the publication of

term both across fields and within fields that the worry is that an excessively strict definition might disqualify as non-thought-experimental many instances that have been historically known as such. To avoid this, authors in the field provide a more reflexive account. According to Anapolitanos (1991), what one would consider as specific examples of TEs in the discipline, should be gathered and labelled as such on a tentative basis based on a minimal and not necessarily very precise idea of the patterns that all TEs follow. Brown's (1991a, p.122) account is an example of such a definition:

Thought experiments are performed in the laboratory of the mind. Beyond that bit of metaphor it's hard to say just what they are. We recognize them when we see them: they are visualizable; they involve mental manipulations; they are not the mere consequence of a theory-based calculation; they are often (but not always) impossible to implement as real experiments...

These considerations teach that discriminating akin reasoning techniques involving imagination is a difficult task. 'As a matter of sociological fact, however, the expression [TEation] tends to be reserved for cases involving a certain degree of visualisation, complexity, or novelty' (Gendler, 2003, p.389). So, for instance, even though a physics book might be giving problems involving imaginary scenarios and other 'what if...' situations, and despite what these problems' intentions are in terms of new knowledge, the exercises *per se* are rarely considered material for TEs (even when their solution on behalf of the students entails TEation). Helm, Gilbert and Watts (1985) also alert that a problem arises in distinguishing TEs from any other mental activities that seem to have similar intentions to those of TEs, for example, any questions of the kind 'suppose that...'

2.3 THE TRIPARTITE STRUCTURE

Instead of giving *one* definition of TEs I will give a list of conditions that philosophers of science generally accept as salient features that capture something important about their fundamental structure and make it reasonable to credit TEs as a mode of reasoning. Such an open-ended

Mach's (1886/1897) essay the term seems to have taken about four decades to become widespread in scientific circles.

description has a priority over a definition, firstly because a definition couldn't be complete until these conditions are scrutinised, and secondly because these conditions will guide the selection of TEs from the history of science which I will be using as examples and counterexamples in my arguments.²

Even though trivial, it is important to make the basic distinction between the activity of *self-generating* a TE, and the activity of *interpreting* the narrative of a TE that *others* have constructed. Since this study is concerned with the former, the tripartite structure that follows refers to the self-generation of TEs. It has been adopted from Gendler (2000, p.21):³

(i) *An imaginary scenario is described*

TEs' thought-like character is due to the fact that they posit hypothetical or counterfactual states of affairs. In the thought-experimental mode of inquiry it is basic that one is '*constructing* a situation in imagination and then observing it in order to determine "what would be the case"' (Horowitz & Massey, 1991, p.99; my emphasis).

(ii) *The evaluation of the imagined scenario is then taken to reveal something about cases beyond the scenario*

The general function of a TE is to provide a context of justification 'within which sense can be made of previously incomprehensible conceptual distinctions'(Gendler, 1998, p.413). This element is the necessary condition that differentiates a TE from other acts involving the contemplation of a picturesque scenario, such as mere 'thought simulations'. Thought simulations, as defined in this study, are the mental reproductions of a real experiment or states of affairs that only give an accurate description of how things are *known* to be, without however having any repercussions for the original background conceptual framework(Irvine, 1991).⁴

² All classical TEs referred to in this study are described in APPENDIX A.

³ The basic difference between Gendler's (2000) tripartite structure and mine is that she presents the elements in the order (i), (iii), (ii). Since, however, my emphasis is on the *process* of thought-experimenting and specifically the process of *self-generating* a TE (in contrast to merely *interpreting* the narrative of one), it seems more sensible that the narrative is the last stage of the process.

⁴ A thought simulation would be the recall of the mental image of a ball rolling on the soccer field (assuming that one has already had the experience).

- (iii) *A narrative is constructed to describe the setting and sequence in order to communicate the experiment to others*

An argument is offered that attempts to establish the correct evaluation of the scenario by others (Gendler, 2000). Although for the one who generated the TE this element has dim epistemological significance in the production of new knowledge in comparison to elements (i) and (ii), it ‘plays a central role in communicating a thought experiment within a community of scientists’ (Nersessian, 1993, p.292).

In congruence with Nersessian (1992, 1993) my working hypothesis is that the processes in (i) and (ii) lead to the production of (iii), but are not comprised in (iii); that is, by the time a TE becomes public as a narrative, its readers rely on *internal* mental mechanisms that construct a mental analog of what is being described in the narrative (and not on the linguistic propositions *per se* (cf. Johnson-Laird, 1983)). Since the primary role of this study is to provide an explicit account of the cognitive processes and structures that contribute to thought-experimental thinking and discovery, the conceptual framework I propose in the next sections only addresses how people achieve elements (i) and (ii) (even though an important area for future research could address the way people interpret the narratives of TEs).

2.4 THE TWO PARADOXES OF TES

2.4.1 The debate so far

I hereby address two paradoxes of TEs, namely the *from-conceivability-to-possibility* paradox and the *aprioristic informativeness* paradox. The answers given to these puzzles so far by the philosophers of science have been largely paradigmatic, that is, they are guided by distinct theoretical matrices in the Kuhnian sense that are widely established and rather incommensurable mind-sets. Traditionally, the philosophical debate about TEs touches the debate between rationalists and empiricists. However, neither the pure deliverances of our senses (an empiricist account), nor purely explicit argumentation (a rationalist account) seem to provide sufficient answers to both paradoxes. On

the one hand, empiricism, by asserting that what we know about the world comes from experience, cannot explain how the production of *a priori synthetic* propositions (as opposed to *analytic* ones, which are true solely by virtue of the definition of their terms i.e. of the kind ‘bachelors are unmarried males’) in TEs works (Sorensen, 1992a). Empiricists’ difficulties are with the second paradox, the aprioristic informativeness. On the other hand, a rationalist viewpoint where logic has precedence over experience cannot dictate how TEs’ results can reflect something about the physical world. Their difficulty is mostly with the first paradox, the from-conceivability-to-possibility.^{5, 6}

In the next sections I describe the two paradoxes in more detail and attempt to provide *one* answer based on research in mental models.

2.4.2 The first paradox: the from-conceivability-to-possibility

TEs’ hypothetical character is illustrated in Brown’s (1991a, p.93; my emphasis) phrase:

There are no frictionless planes in *our* world, so let ‘s just consider a possible world in which there are and then see how Stevin’s chain [cf. APPENDIX A] device behaves. No one here can run at the speed of light, so let’s consider a possible world in which people can, then ask what they see.

TEs aim to yield conclusions about how things *would be* based on some hypothetical premises. This however raises a number of ‘unimaginability’ objections based on what at first glance seems to be a striking asymmetry between the hypothetical situation and our physical world (e.g. ‘the scenario we are being asked to consider is just too far-fetched’ (Gendler, 2000, p.23)): just how can an imaginary scenario yield results relevant to the experienced

⁵ Sorensen illustrates the rationalist-empiricist debate on TEation in the following passage (1992a, p.27):

[T]he phrase ‘thought experiments’ runs afoul of the contrast between conceptual and empirical inquiry... Experiments are designed to answer questions by actions that produce empirical data; but thought experiments cannot deliver empirical data. In short, the objection alleges that ‘thought experiments’ is a contradiction in terms and should be grouped with oxymorons [sic] such as ‘tiny giant’ and ‘married bachelor’.

⁶ For concise reviews of the debate see Gendler (1994) and Lipton (1993).

physical world? The first paradox, restated, questions the thought-experimenter's ability to imagine a scenario that is relevant, and delivers results relevant, to our physical world. A classic example of unimagability objection is Mach and Berkeley's disagreement with Newton's bucket TE (cf. APPENDIX A) through which Newton (1686/1999) postulates the existence of 'absolute space'. Mach and Berkeley dismissed the explanation offered of the thought-experimental phenomenon described by Newton by arguing that one cannot know whether in a universe without other material bodies the water would climb up the sides of the bucket. Indeed, how could Newton ever be certain that the phenomenon he describes in his TE would occur in such a hypothetical universe?

The unimagability objection can be reduced to a demand for 'lawfulness' in the imaginary scenario according to these two general standards:

- (i) *Internal coherence*: Internal coherence establishes the *replicability* and the *intersubjectivity* of an experiment-in-thought. These two constraints demand that the world-in-imagination behaves in a certain manner and causes an intended insight when the TE is run by other thought-experimenters. Thus, what would happen in a TE becomes less a matter of guesswork or pontification (Horowitz & Massey, 1991). This standard aims to render benign the idiosyncrasy of the thought-experimenter by calling for a collective decisive outcome. The problem and objection that the results of TE might turn to be idiosyncratic is an expression of the legitimate concern 'that our beliefs, desires, and concepts are deeply tied to our views about which alternate possibilities are salient, so that the imagined disruptions of such patterns of saliency will leave us with too little to base our judgments on' (Gendler, 2000, p.23).
- (ii) *External coherence* establishes the relevancy of the world-in-thought with the physical world. Indeed, 'science is about the real world, not fictional ones' (Sorensen, 1992a, p.48).⁷

⁷ One can guess the vague outlines of a taxonomy of acts of imagination, building the distinction on degrees of internal coherence: for example, dream experiences, like

There are cases of classical TEs that fail because they are faulty in their design, failing to evoke a *collective* decision on their outcomes, i.e. they lack internal coherence and specifically, intersubjectivity. A classical example of the case is Newton's (1686/1999) bucket, and Einstein's (1916/1997) spheroid TEs (cf. APPENDIX A). Both these TEs essentially describe the same situation, yet they reach diametrically opposed conclusions (Peijnenburg & Atkinson, 2003).⁸

According to these two constraints, the construction of the ontology of an imaginary world entails *active decisions* about the properties that will govern the behaviour of imaginary entities. Additionally, if the TE is to have any relevancy to the physical world, one cannot be entirely agnostic about the properties of the world-in-thought.

2.4.2.1 The role of intuition: phenomenological-primitive premises in TEs

Winchester (1991) provides the outlines of an answer to the puzzle. He follows the line of argument offered by Moore's (1925) *A Defense of Common Sense* and Wittgenstein's (1969) *On Certainty* and argues that TEs are grounded in our everyday certainties about the world in which we live. These certainties cannot be justified as true except through our recurrent experience; any attempt to explain their truthfulness through other causal relationships leads to cyclical reasoning, and eventually we have no choice but to accept that this fact *is such because it is such!* Winchester's everyday certainties are properly called *intuitive knowledge* in this sense: they present us with a *prima facie* modal truth about what is permissible, impermissible, possible, or necessary in a TE and their strength is determined by us rather than by appeal to authority; intuitive knowledge is self-evaluated. Like Winchester (1991), but

hallucinations, are unpredictable, outside the bounds of reality, and lack intersubjective agreement. Although they may fit the commonsense notion of imagination, of course they are excluded from my definition of TEation because they lack internal and external coherence.

⁸ For a detailed discussion on thought-experimental failures of this kind see Peijnenburg and Atkinson (2003). Also see Coleman (2000) and Janis (1991) for more cases in which TEs can fail.

in much more detail, Gendler (1998, 2000) identified everyday certainties in Galileo's free-fall TE.⁹

This account suggests that intuition plays a special role in grounding the predictions of the behaviour of an imaginary system in the physical world. In the rest of this section I investigate this idea more closely from the perspective of research in intuitive physics. The diversity of empirical claims in the literature relating to intuitive physics is impressive. The 'children's science' movement initiated by Gilbert, Osborne and Fensham (1982) showed that people are not passive learners; instead, their interpretation of their network of everyday experiences leads to the acquisition of intuitive knowledge. There is, however, lack of ontological agreement on the form of knowledge that intuitive knowledge represent and debate regarding its role in learning physics. For example, intuitive knowledge is described as a *theory* in which non-experts possess a coherent but alternative theory of the world (e.g. McCloskey, 1983; Vosniadou & Brewer, 1992; and later work by Vosniadou, 1994), or a series of isolated misconceptions (Clement, 1984). Intuitive knowledge can be treated as getting in the way of building expertise and therefore making necessary its replacement by formal physics knowledge (McCloskey, 1983). Smith, DiSessa and Roschelle (1993), on the contrary, argue that such a deficit perspective overemphasises the differences and undervalues the similarities between novices and experts, thereby misinterpreting the role that intuitive knowledge has to play in building expertise. The work of Clement, Brown and Ziesman (1989) is illustrative to these ends because it provides empirical evidence that people build knowledge on fragments of intuitive knowledge, thus learning physics does not necessarily require the replacement of pre-theoretical beliefs which, instead can be usable anchoring conceptions.

The hypothesis that follows from Clement *et al's* (1989) work in relation to the role of intuition in TEation is that, one of intuition's purposes is

⁹ Some intuitive premises identified by Winchester in classical TEs are that *volume is conserved* (underpinning Harvey's TE on the circulatory system), and that *the rigidity of a body is maintained under any state of motion* (underpinning Leibniz's maximum speed TE – cf. APPENDIX A). Gendler (1998, 2000) identified two certainties in Galileo's free fall TE: that *speed and weight are physically determined* ('for any body that one might encounter, there is a determinate fact concerning its weight and natural speed' (*ibid.*, p.406)) and the second that *the weights of two objects tied together are added*.

to reveal the physical causality involved in an imaginary scenario but is unavailable in the form of propositional knowledge such as a global or local rule (see for example de Kleer & Brown, 1983): one being in possession of these commonplace truths, one can employ TEs for arguing about hypothetical scenarios for which one holds no ready (e.g. proposition-like) conceptual schemata about the possible outcome of the scenario. This is not to imply that intuition reveals inexperienced classes of phenomena such as those examined by many counterfactual TEs. What it suggests is that, in at least some TEs, thought-experimenters may be situating parts of the imaginary causality within experienced causality, available as lower-level knowledge. An increasing body of literature in the philosophy of science argues that TEs are designed to activate these intuitions (Winchester, 1991; Nersessian, 1992; Gendler, 2000; Peijnenburg & Atkinson, 2003; Gendler, forthcoming). The idea seems plausible, since it is not new for psychological research in learning science: an original motivation behind mental model theory was to provide a plausible explanation how reasoning about novel descriptions is possible when the cognizer does not readily possess a pre-existing script or schema (e.g. Black & Bower, 1980).

My judgement is that, before any empirical agreement can be fashioned about the role that intuition may play in TEs, there is need for ontological agreement on the form of knowledge that intuition represents. Dictionary definitions of intuition don't come close to the level of specificity we need. DiSessa's (1993) p-prims theory will be used as the main model of learning. It provides a (tentative) framework for theorizing the role of intuition in TEation by employing technically well-developed explanatory constructs (DiSessa in Kaufman, Vosniadou, DiSessa, & Thagard, 2000). The p-prim theory is representative of a research tradition that attempts to formalise the continuum from common events, known to happen in specific circumstances, to more fundamental explanations supposed to explain more than the particular events. It is a theory of how pre-theoretical beliefs account for commonsense predictions and expectations in physics reasoning. The elemental knowledge structure in this theory is called a *phenomenological primitive* (p-prim: *phenomenological* because it is supposed to develop directly out of one's experience of the physical world, and *primitive* because it

forms the base level of one's intuitive explanations of physical phenomena; an explanation goes precisely as deep as a p-prim and no deeper.) In this sense, p-prim are assumed to constitute the building blocks of meaning-making of physical situations which then integrate into a systematised network of p-prim (DiSessa & Sherin, 1998; see also Sherin, in press).

Two broad types of physical intuition will be addressed in this study: (i) *agentive intuitions*: these are intuitive attributes having to do with kinaesthetic agency, that is, abstracted over a broad range of competent sensorimotor schemata (DiSessa, 1993). They involve sense of personal agency in the form of 'I act – it reacts' or 'it acts – I feel' causal patterns. (ii) *non-agentive intuitions*: they involve no sense of personal agency. The distinction between personal and non-personal agency can be demonstrated in this example: tossing a ball invokes kinaesthetic agency as long as the ball is still in one's hand. DiSessa (1993) suggests that there is an intuitive element (called the *force-as-a-mover* p-prim) which explains the situation of tossing. As soon as the ball detaches from the hand, the situation becomes problematic because one possesses no agentive intuitions to explain the observed trajectory of the ball. At this point, the phenomenology invokes non-agentive intuitions and specifically the notion of 'impetus', as the mediating agent that produces the anticipated result (DiSessa, 1988).

2.4.2.2 TEs as limiting cases of real experiments

In this section I make a note on the relation between TEs and real experiments. I will elaborate the idea further in the discussion on the second paradox of TEs.

The concern is that an account based on intuition may not provide a full-blown framework for the from-conceivability-to-possibility paradox: a strikingly puzzling property of TEs is that they provide us with a context for reasoning about highly idealised hypothetical scenarios which have no obvious relevance with the everyday phenomenology. Laymon (1991) and Sorensen (1992a, 1992b) provide an answer looking at scientific TEation as analogous to physical experimentation. This primarily originates in the realisation that, like in physical experiments, the knowledge gained at the end

of the process of thought-experimenting is also empirical. Laymon (1991) examines the imaginary entities in a TE as a highly idealised description which may have possible negative effects on the internal and external coherence of the TE; the initial premises being highly idealised, may also be unsound. This is ‘a fairly major problem with the argumentation typically given to justify conclusions drawn from thought experiments’ and also ‘goes some way towards explaining our general discomfort with thought experiments’ (*ibid.*, p.170). A thought-experimenter’s role, according to Laymon, is to develop natural transformations of the idealised premises so that what results from the TE is an acceptable demonstration of the hypothetical scenario.¹⁰ He suggests that idealisations are rendered benign by thinking whether, if we were to perform a real experiment version of the TE, we could refine the real experiment so as to asymptotically approach to the possible existence of the ideal limit. For example, eliminating friction of surfaces in a real experiment is to asymptotically approach the ideal limit of zero friction. This makes totally frictionless surfaces in TEs conceivable.¹¹ Indeed, the inferential leap between everyday observations and the idealised states of affairs in some TEs seems less mystical if we suppose a continuum of increasing abstraction between (some) TEs and real experiments, with the former being ‘limiting cases of [real] experiment just as circles are limiting cases of ellipses’ (Sorensen, 1992a, p.186).

2.4.3 The second paradox: the *a priori* informativeness

¹⁰ According to Laymon (1991), heavy idealisation in a thought experiment is both a strength and a weakness. The strength comes from the ‘freedom it provides to eliminate complicating features, thus rendering the argumentation more explicit, precise and complete than it would be otherwise’ (p.171-172). Similarly Nowak (1994) argues that idealised models differ from their sensory prototypes in that they present hidden relationships which could not be grasped with the aid of mere experience. ‘But because the assertion of the existence of such situations is strictly false, the argumentation will be either false or unsound... What is required is some procedure that will render the falsity of the idealisations benign’. (Laymon, 1991, p.171-172)

¹¹ For example, our experience of the large distances between some celestial bodies increases our confidence about the possibility of an imaginary universe in which all material bodies are infinitely far away from each other. Thus, Newton’s reasoning in his bucket TE is underpinned by the assumption that the thought-experimental situation is in a natural continuum with our everyday experience (perhaps a metaphysical primitive). Also, in Leibniz’s maximum speed TE (cf. APPENDIX A) we assume that the laws we extracted from the experienced phenomenology must hold in situations we have not yet experienced).

The second condition of the tripartite structure of TEs requires that the evaluation of the imagined scenario reveals something beyond what was known before engaging with the TE. The paradox questions how non-perceptual capacity can lead to new knowledge about non-stipulated features of reality. This paradox is attributed to Kuhn's (1977) seminal paper *A function for thought experiments*. Kuhn poses the paradox concisely as: "How... relying exclusively upon familiar data, can a thought experiment lead to new knowledge or to a new understanding of nature?" (Kuhn, 1977, p.241)

Some necessary clarifications are due at this point. Learning through TEation and learning through the mediation of the physical environment (and physical experiment) do not share the same epistemological resources: unlike physical experiments, TEs do not include actual intervention within the physical environment, because they are generated and conducted on the basis of a pre-existing conceptual context. If there is one uncontroversial characteristic of TEs, this is the fact that they are devoid of any new experiential input, a criterion I refer to as the *extra-experiential independence*. The notion denotes the purely technical fact that TEs are 'air-proof' from new input via the senses.

The assumption underpinning the p-prims model is that learning occurs through the adaptation of the intuition networks to new phenomenology. This entails a substantial revision in the p-prims network that eventually leads to packaging p-prims into a bundle of propositional and formulae-like rules. Assuming that the p-prims model can provide a sufficient description of the role of intuition in TEation, the second paradox can be restated as such: TEs are by definition devoid from new phenomenology; then what causes the reconfiguration of the thought-experimenter's intuition networks?

2.4.3.1 The role of imagistic simulation: the quasi-sensory hypothesis

One of the oldest and most comprehensible views of the nature and function of TEs is that of Ernst Mach (1883/1960b, 1886/1897, 1905/1976). To explain the aprioristic informativeness paradox Mach maintained that although TEs do not directly appeal to observation and experiment (and so seem *a priori*) they are indirectly based on mental observation and mental experiment.

Mach's escape door from the second paradox was to postulate TEs on a kind of internal observation, thus maintaining that a thought-experimenter's new knowledge is a 'relative' *a posteriori*.¹² In other words, on Mach's account TEs rely on a sort of *quasi-observation*. Mach (*ibid.*), like Sorensen (1992a, 1992b) and Laymon (1991) (cf. 2.4.2.2), held that TEs are on a continuum with real experiments in that they too provide empirical data. That at least some knowledge accessed by TEation is non-propositional, and that contemplation of imaginary cases gives access to that knowledge in a way that argument alone cannot, has been argued extensively by the followers of Mach (Brown, 1991a, 1991b; Gendler, 1998; Arthur, 1999; Gendler, 2000; Brown, 2004a; Gendler, forthcoming). Nersessian (1992, 1993) also suggested that the inferences thought-experimenters make are derived from constructing and manipulating a mental model of the situation at hand through a sort of quasi-perception.

In what follows, through an examination of the literature in mental simulation, I argue that there is convergent evidence that (some) TEs are indeed a kind of experiment-in-thought that shares the same cognitive mechanisms as learning through direct perception and physical experimentation. I will argue that it is misleading to suggest that thought-experimenters 'see' their mental experiments as visual images, but instead that they 'do' them, through imaginary *actions*.

The little empirical research on TEation (e.g. Reiner, 1998; e.g. Gilbert & Reiner, 2000; Reiner & Gilbert, 2000; Clement, 2002; Reiner & Gilbert, in press) supports Mach's hypothesis about the quasi-sensory character of TEs. Their findings indicate that thought-experimental reasoning is often accompanied with indicators of the use of quasi-proprioceptive and quasi-spatial mental images, suggesting that thought-experimenters (at least sometimes) engage in mental simulation. The question is: assuming that a sort of quasi-perception is involved in TEation, then of what modality (e.g. visual, proprioceptive, spatial) is it?

Recent research has provided evidence for mental simulation as a strategy in physical and mechanical reasoning. There is experimental evidence

¹² For an extensive discussion of Mach's account of TEs, see Chapter 3: *Mach and Inner Cognitive Africa* in Sorensen (1992a)

that mental simulation is time responsive, i.e. one running a mental simulation responds to real-time temporal changes of imagined situation (Schwartz, 1999). For example, people's mental simulations of the behaviour of complex mechanical or physical systems are piecemeal rather than holistic, involving sequentially propagating the effects of local interactions between components, (Hegarty, 1992; Hegarty, Kriz, & Cate, 2003; Hegarty, 2004).¹³ This suggests that mental simulation is not a process of inspecting a holistic mental image of the physical situation because this would require that all parts in the imaginary system would be moving at once. Also, neurophysiological studies have made distinction between spatial (i.e. representing locations in space, movement) and visual imagery (i.e. limited to representations of visual modality, such as colour), which correspond to neural activity in different parts of the brain (Ungerleider & Mishkin, 1982; cited in Hegarty, 2004).

Further evidence in the literature suggests that imagery transformations are not coordinated by purely visual-geometric information but also incorporate non-visible entities and properties such as torque, force and density. This suggests that mental simulation is better described as dependent on *rate-based* representations of physical properties like friction, elasticity, and balance, instead of *vision-based* ones (Schwartz & Black, 1996a; Schwartz, 1999).

Based on the kind of information that people use when mental simulating the behaviour of a system, the tendency today is to take mental simulation as a simulated *doing* rather than a simulated '*seeing*' (Schwartz, 1999) and that people generally simulate actions where they have no direct predictions about the behaviour of a system and would want to observe the natural world.

The above suggest that the traditional metaphor that TEation requires introspective access to visual information through the mind's eye is misleading on the basis that it places the focus on the wrong resource: *vision*. Suggesting that the epistemological resources of mental simulation in TEation are bodily or spatial imagery (Reiner & Gilbert, 2000; but see also Gilbert &

¹³ For example, when asked to predict the behaviour of a certain component of a complex pulley system, people took more time to infer the movement of a pulley than was closest to the end of the chain than the one that was closest to the beginning (Hegarty *et al.*, 2003).

Reiner, 2000; Reiner, 1998; Reiner & Gilbert, in press) does not portray the whole image: if quasi-perception is indeed involved, then our capacity to think about the distal and absent through quasi-perception seems grounded in the use of emulation-based strategies, namely *simulated doing* and not *simulated seeing*. In support of this consider anecdotal evidence from great thought-experimenters such as Bohr who claimed not to be able to visualise well (cf. Nersessian, 1993). The simulated seeing approach is misleading in that it places the analytical focus on the manifest consequences of simulated actions rather than the actions themselves (Scaife & Rogers, 1996).

Assuming that quasi-perception is involved in TEation, then, according to the above, it is time to reconsider our awe about the ‘mystical’ properties of TEation: learning through imagistic actions in TEation and learning via the mediation of the physical environment through real actions in real experiments might be different only because TEation is independent from new sensory input; not because the mediating cognitive mechanism is different. If TEs indeed emulate real perception, this would explain why and how TEs result into new empirical knowledge.

2.5 SYNTHESIS

This conceptual framework makes it reasonable to suggest (i) that lower-order knowledge (intuition) may be the psychological reason for the relevance of imaginary worlds with the experienced everyday phenomenology, and (ii) that mental simulation in TEs plays the role of a mental analogue to physical action, and as such, it provides the thought-experimenter with a quasi-perceptual correlate of direct perception, and new empirical knowledge. In this study I will examine these two claims, and will investigate how intuition and mental simulation relate to each other.

CHAPTER III

3 Methodology

ALICE: **There 's no use trying, one *can't* believe impossible things.**

WHITE QUEEN: **I daresay you haven't had much practice. When I was your age, I always did it for half-an-hour a day. Why, sometimes I 've believed as many as six impossible things before breakfast.**

(Lewis Carrol, *Through the looking Glass*)

3.1 PREAMBLE AND RESEARCH QUESTIONS

This research is a pilot study for a future doctoral research project. Firstly it aims to identify and establish a methodology apt for the study of the psychological processes of scientific TEation. This involves the development of observation concepts that allow the researcher to recognise intuitive premises and the use of imagery in the observation protocol. Secondly, it aims to generate hypotheses and empirical questions that will orientate future doctoral research in TEation.

Based on the findings of previous empirical research (Reiner, 1998; Reiner & Gilbert, 2000; Clement, 2002) I assume that intuition and imagistic simulation have a role in at least some thought-experimental reasoning. These two broad research questions are addressed:

- (i) What is the role of intuition and imagistic simulation in the generation and exploration of TEs in the protocol?
(What role do intuition and imagistic simulation play in generating new knowledge? How does the use of agentive and non-agentive intuitions relate to the use of imagistic simulation?)
- (ii) What are the salient characteristics of the TEs in the protocol in terms of the role of intuition and imagistic simulation?

But first it is necessary to make the focus of this study finer by distinguishing between the *physical outcome* of a TE (what would happen in the scenario) and the *creative possibilities* that arise from the interpretation of that physical outcome (how should we interpret the physical outcome in the context of a larger theory?). Of course physical outcomes and creative possibilities are intertwined and indistinguishable in some TEs: for example in Galileo's freefall TE, the physical outcome that the combined objects fall slower than the heavy object naturally leads to the creative possibility that there is an inconsistency in the Aristotelian theory. This research only explores the mechanism through which thought-experimenters realise the physical outcomes of their TEs. How and to which extent both novice and expert learners realise creative possibilities could be an important area for future research in science education.

In what follows, I lay down the design for the empirical enquiry. I advocate a naturalistic turn, guided by constructivist assumptions that take TEation as an *in situ* cognitive activity. I discuss the appropriateness of case study methodology and explicate the methodological considerations underlying the selection of participants, the age-group, the design of the tasks and the decision for collaborative problem-solving and think-aloud. Finally, I refer to the concern for credibility and transferability.

3.2 THE NATURALISTIC TURN AND A CONSTRUCTIVIST ACCOUNT OF TEation

From the standpoint of cognitive sciences, the account of mainstream philosophy of science on TEation suffers from the linearity that it imposes upon *all* reasoning, as a result of the fact that it is too dependent upon the textual reconstruction of TEs' narratives:

The new naturalism in science studies recognises that people learn by active intervention in a world of objects and other people. Philosophy of science lacks resources to deal with new notions of reasoning and empirical access implied by the new image of scientific practise (Gooding, 1992, p.45).

A naturalistic account for the study of TEs should make a clear-cut distinction between TEation as a dynamic process of performing a TE and a TE as the

static, crystallised product derivative therefrom (Gooding, 1992). The *narrative* of a TE must not be uncritically taken as equivalent of the *process* that produced the TE for these reasons:

- (i) This would assume that the process of thought-experimenting follows, in an unproblematic manner, a neat and *sequential* process. The real-time thought-experimental process however is most likely to be a vicious back and forth (involving recycling, reinterpretations, recants, repetitions) rather than a one-pass enterprise. A linear view of discovery conceals the importance of human agency in reticular reasoning, in which goals and solutions are separated by multiple pathways (Gooding, 1992), and also undervalues the creative possibilities opened up by uncertainty (Gooding, 1989).
- (ii) TEation should not and cannot be investigated detached from its whole psychological context, which involves the individuality of each participant, the possible 'uneasiness' caused by the participants' awareness of being observed, the problem tasks, the problem-solving group as a whole, etc. Textual analysis suppresses the broad psychological context (Nersessian, 1993).

A naturalistic interpretation of TEation puts the emphasis on the interdependence of *fact*, *theory*, *value* and *interpretation*. Eschewing the assumption that there is sharp line between theory on one hand and raw data on the other, the position introduces an element of *constructivism*. This suggests that learning through TEs derives from the reconfiguration of conceptual commitments on the part of the thought-experimenter which enables her to see old phenomena in a new way.

The term 'constructivism' is often used (or misused) to mean different things (Geelan, 1997). For the sake of convenience, constructivism can be divided into three traditions, namely educational, philosophical and sociological (Matthews, 1998). The second tradition approaches constructivism as an alternative to realism, and the third examines the sociological aspects of scientific knowledge. They mainly interest the

philosophers of science. The constructivism referred to in this paper is the educational one. It necessarily involves considerations of the philosophical and sociological traditions, but it has its own roots and autonomy (*ibid.*). A second working distinction, also adopted from Matthews, is between those who concentrate on constructivist practice (e.g. anything that is pupil-centred, engaging, questioning, etc.) but consider the epistemological claims behind their actions peripheral, and those, amongst whom I place myself, who pay attention to epistemological claims so as to guide pedagogy on the basis that a decent learning theory must be grounded on sound epistemological considerations. Therefore (my) constructivism goes beyond the psychological question of how beliefs develop, to the epistemological question of what makes beliefs true and what counts as scientific knowledge. The question of what sort of standards we should apply in the practical criticism of argumentation becomes highly relevant.

The key claim of educational constructivism is the view that all learning involves the interpretation of experienced phenomena, situations, and events, including classroom instruction, problem-solving and everyday life experiences, through the perspective of the learner's existing knowledge (Smith *et al.*, 1993). Reasons as evidence and reasoning about evidence play a central role in science, and consequently in physics education (Nola, 1997), and since this research deals with a tool of scientific reasoning, an account of knowledge that is focused on justification is the most informative and reflexive.

One acquires knowledge by having a tethering reason (justification, evidence) for the truthfulness of a belief (Nola, 1997).¹⁴ But not just *any* reason will do the trick, as Nola (1997, p.60) points out: 'some versions of

¹⁴ This standard account of knowledge requires that the satisfaction of its belief condition is adequately related to the truth condition through adequate indication (justification) for its truthfulness (Audi, 1996): Where *A* is some person (or group of persons) and *p* the content of a belief held by *A*, then, according to the standard analysis:

A knows that *p* if:

- (1) *A* believes that *p* (belief condition); and
- (2) *p* is true (from *A*'s point of view) (truth condition); and
- (3) *A* has reason (justification, evidence) that *p* (justification condition). (Adopted from Nola, 1997)

For example, scientists *know* that electrons are negatively charged because they have *good reasons* to *believe* that this is *true*, at least in the range of their current experience (they might prove to be wrong in the future).

constructivism carry the implication that any kind of construction by a pupil can be permitted' thus posing difficulties in the epistemic role of justification. In his words, there are 'objective constraints of reasons and reasoning upon knowledge that anyone who hopes to know some science (or anything else) can and must come to grasp...[T]he ability to reason and recognise reasons for and against our belief is ... something that can be taught' (*loc. cit.*). Scientific logic therefore sets maxims to remind thinkers how they should think, in the sense of tips for sound argumentation (Toulmin, 1958). The norms for scientific reasoning whereby we obtain scientific knowledge are assumed to have been negotiated and established (Nola, 1997), an idealist ontological account that perceives 'reality' as the result of the interplay between individual and social consciousness. Then, of central importance in constructivist physics teaching is the enculturation of students in the customary forms of scientific argumentation (Gilbert & Reiner, 2000). As for intuitive knowledge, by definition this does not require other reasons for its truthfulness but the fact that 'it is such because it is such'; it is *self-justifiable* (Nola, 1997).¹⁵

3.3 RESEARCH DESIGN

3.3.1 The choice for case study

Several arguments can be advanced in favour of the appropriateness of case study methodology in this research:

- Case study is inherently superior to other alternatives such as surveys when data to be collected is not only verbal or textual (Bailey, 1978; cited in Cohen & Manion, 1989). Indeed, the non-propositional character of intuitive knowledge (DiSessa, 1993; Nersessian, 1993; Reiner, 1998) makes verbal behaviour a poor indicator of the role that TEs may play in physics problem-solving.
- Unlike the experimentalist who can demand evidence on research questions from the data, the case study observer adapts her thinking to

¹⁵ For a comprehensive discussion on the self-justifiable nature of intuition see Chisholm (1987).

what the observer happens to be doing, and this makes the data highly sensitive and adaptive to the context (Adelman, Kemmis, & Jenkins, 1980; Lincoln & Guba, 1985; Stenhouse, 1988; Cohen & Manion, 1989). There are three reasons that make context crucial in the study: firstly, the assumption that the act of observation affects the phenomenon itself makes contextual values inseparable from the findings; secondly, the assumption that the phenomenon is not shaped by a simple linear causation but in a much more complex manner suggests that the whole-phenomenon-in-context is studied in its full-scale influence field. The psychological context is assumed to shape the non-linearity of TEation, making TEs a highly unpredictable and idiographic (dependent on the local characteristics of the individuals, their interchanges, the tasks, and the whole context in general) psychological phenomenon. It is hard to predict whether and what TEs will be generated. Especially this point makes a strict experimental design an unsuitable strategy; and thirdly, describing the context is important in making decisions about whether or not the findings may have any meaning in other contexts (Lincoln & Guba, 1985).

- The nature of the study is to uncover plausible structures and mechanisms, not to prove the existence of any particular one or to accumulate reliable statistics. This is beyond what non-ideographic methodologies can offer, as the multitude of factors involved in social phenomena does not permit conclusions in the form of law-like propositions that can be replicated again and again with the same results (Grix, 2004).
- Case study is in epistemological harmony with the basic tenets of educational constructivism, as it recognises the complexity of the case in its own right and the 'embeddedness' of social truths. Furthermore, it promotes multiple interpretations of the study by the readers (Adelman *et al.*, 1980; Simons, 1996) as its 'language and the form of the presentation is hopefully less esoteric and less dependent on specialised interpretation than conventional research reports... At its best, [it allows] the reader to judge the implications of a study for himself [sic]' (Adelman *et al.*, 1980, p.60).

- Case study is apt for advancing further research because it provides a broad corpus of data, an archive that can be potentially subjected to subsequent critical interpretation by other researchers working to these ends (Stenhouse, 1988; Stake, 1995; Bassey, 2000).

3.3.1.1 *Bounding the case*

Collaborative learning

A collaborative problem-solving setting was thought a good technique so as to promote the externalisation of internal processes. Previous research indicates that the need for thought-experimenters to find channels of communication in a collaborative problem-solving setting promotes the externalisation of their mental worlds (Reiner, 1998).

There is need, however, to justify whether and how the *intra-individual* processes of TEation work *within individuals*, and if those processes observed in a collaborative setting and seem to have the characteristics of a TE as put forward in the tripartite structure of TEs, can be identified as a TE. Indeed, TEs have been traditionally constructed by individual scientists in the privacy of their minds.

The crucial question here is ‘what is the nature of the dyad, triad, etc in collaborative learning?’ In other words, which entities are the explanatory foci of the investigation (the units of analysis) (Burnstein, 1997)? The nature of the group can be viewed as comprising two or more relatively independent cognitive agents which exchange messages, or can be viewed as a single cognitive system with its own properties. The former approach’s focus is on the individual and the research aims to understand how the individual is transformed by messages transmitted by the others. The latter approach’s challenge is to understand how individual cognitive agents merge to produce a shared TE.

The theoretical ideas of situated cognition, according to which emergent phenomena are analysed as a group product (Dillenbourg, Baker, Blaye, & O'Malley, 1996) informs the general decision-making in this research and legitimises the investigation of TEs on the inter-personal plane. Since ‘the

causality of social and cognitive processes is, at the very least, circular and is perhaps even more complex' (Perret-clermont, Perret, & Bell, 1991, p.50), the situated cognition approach recognises that clear distinctions between what is social and what cognitive will have an inherent weakness. In a collaborative setting what is being looked at is the phenomenon of TEation as this is formed by a cognitive system and not an individual. An individual is constantly subjected to new empirical data from the other members of the group and this is in contrast to the fact that TEs are by definition devoid of new empirical input. The idea that a group forms a single cognitive system may appear too metaphorical, nevertheless, the granularity of a distributed system, i.e. the size of each agent, is, according to Dillenbourg *et al.* (*ibid.*) a designer's choice.¹⁶ Indeed, the designer can tune this variable to grasp phenomena invisible or not applicable at another scale: for if we insist on the extra-experiential-independence criterion of TEs (cf. 2.4.3) then the choice of the group as a cognitive system bound within its own actions, is a matter of methodological necessity, because the TEs produced in a multi-agent system (collaborating group) will not be derivable or representable solely on the basis of the cognitive processes of the individual component agents, i.e. the individual participant (Gasser, 1991). Indeed, as Reiner (1998, p.1055) contents, TEs can be 'constructed in collaborative settings where the sum of students' contributions can lead to complete thought experiments, even if each narrative was not intended as a part'.

There is a debate on whether the p-prims theory can be interpreted from the distributed cognition tradition (for a review see Karlgren & Ramberg, 1995). My theoretical stance is that interpreting TEs as a social construct is in agreement (or at least not in contrast) with the basic assumptions of the p-prims theory. A p-prim can be both intra and inter-individual: the same p-prim can be abstracted from a diverse phenomenology, thus different people with different prior experiences share many of the same intuitions (DiSessa, 1993). As Ueno contents, communicating shared p-prims can be taken as the communication of lower-level knowledge structures of which the truthfulness is taken for granted and thus doesn't need to be expressed explicitly. In this

¹⁶ The concept of agent is very vague; it may sometimes represent a single neurone, a functional unit, an individual or even the world (Dillenbourg *et al.*, 1996), depending on the phenomenon under investigation and the researcher's centre of attention.

sense, p-prims are social *non-representations*. A p-prim can be based on *individual* experiences as DiSessa (1993) contents, but explanations and descriptions of p-prims are also social, elements of our language system (Ueno, 1993). To conclude, despite their inarticulate elements, TEs can be communicable and intersubjective when they are based on mutually shared intuitions, and thus can be researched as the social constructions of a cognitive system.

Participants

Purposive sampling is generally encouraged in interpretive research because it increases the range of data exposed (unlike random and representative sampling which suppresses deviant cases) (Lincoln & Guba, 1985; Stenhouse, 1988; Stake, 1995; Schmuttermaier & Schmitt, 2001). Hence purposive sampling was used to maximize what can be learned in a limited amount of time, by controlling the theoretical relevance of the data and counterbalancing the methodological restrictions discussed before.

A-level physics students (ages 16-19) were thought to be ‘methodologically easy’ for the exploratory purposes of the study: according to the Qualifications and Curriculum Authority (QCA) the A-level specifications in physics build on skills set out in the National Curriculum Key Stage 4 programme of study for Double Science (QCA, 2004). Therefore there were good reasons to hope that A-level physics students would be familiar with the rhetoric of scientific argumentation (e.g. expressing ideas clearly and methodically, using appropriate vocabulary and generally being competent in thinking aloud) and scientific inquiry (e.g. bringing together principles and concepts from different areas of physics, selecting appropriate information on which to construct arguments with which to solve problems and possessing an extended repertoire of problem-solving strategies).

After the choice for the participants’ age-group was made, a second factor to be dealt with was the availability of access: two sixth form colleges in the town of Cambridge were contacted on the basis of being within the geographical region of the Faculty of Education, since it was initially planned to conduct the sessions there. Letters requesting access, a brief description of

the research and an information leaflet for the students were sent to the Principals of the two colleges (cf. APPENDIX D). Of the two colleges one answered affirmatively. Sessions were arranged for the free periods. Subsequently, all students taking the A-level course in physics in the college were contacted via email by the Director of physics of the college who gave them general information about the research project and the requirements of participation. Twelve students declared interest but only two showed up in the first session. The two students were in their final year of A-levels, did well in their physics course and were competent in thinking aloud according to the Director of physics. Both participants are males. The first, to whom I will refer as 'J' took maths and physics and had applied to study architecture at the university. The second ('P') took physics, chemistry and double maths and had applied to study theoretical physics at the university.

3.3.2 The choice for think-aloud

Choosing appropriate methods was chiefly driven by the attempt to heed external representations that characterise both the situated nature of preverbal mental activity and the unpremeditated parts of discovery processes in TEs.

Think-aloud is now widely used as method for studying cognitive processes because of early findings suggesting that verbal protocols, when properly collected, are both valid and non-reactive with inner cognitive processes, corresponding closely to the contents of inner speech (Vygotsky, 1934/1989, 1978; Ericsson & Simon, 1980, 1984). Specifically, Ericsson and Simon (1980, 1984) suggested that when people are explicitly directed to verbalise information that is not normally heeded, verbalisation may only have weak side-effects such as slowing the performance. Some recent studies re-examined the claim and suggest that problem-solving that involves a considerable amount of *non-reportable* processing may be disrupted by verbalisation, even if subjects are given concurrent, non-directive, think-aloud instructions (Schooler, Ohlsson, & Brooks, 1993). Generally, any cognitive activity that relies primarily on non-reportable processes, including creativity (Finke, 1990) and perceptual reorganisation (Ohlsson, 1990), may be

vulnerable to verbalisation. Also, when automatic processes (e.g. insight processes) are involved, they may be impaired when attention is directed towards them (Erriksen, Webb, & Fournier, 1990; Schooler *et al.*, 1993).¹⁷ Today it is generally thought that reportable processes elicited by verbalisation may overshadow other critical non-reportable processes. Given the nonverbal characteristics of mental simulation, it seems quite possible that verbalisation may disrupt these processes as well. Verbalisation may also impede the role that intuition may play, because processes at this low level control of reasoning mechanisms are likely to be unconscious and up to an extent automatic (diSessa, 1983, 1988, 1993).

Despite the limitations of language in externalising some internal processes, think-aloud was adopted as the general method for this study because, unlike experiments and surveys, it does not suppress the natural unfolding of reasoning. It was thought that as long as some basic guidelines were followed, the overshadowing effect of language would be rendered benign and the reasoning observed would be a valid source of information about inner processes:

- (i) *Think-aloud should be non-directive*: The challenge was to keep the think-aloud natural and non-directive, by designing tasks that collect relevant data without direct interrogation of non-reportable processes. For example, the participants should not be asked questions of the kind ‘what were you imagining when you said ...?’

¹⁷ Also consider the anecdotal reports of scientists and other creative individuals who report experiencing their discoveries in wordless thoughts. In this excerpt Einstein (1945/1952, p.32-33) describes his creative processes to the mathematician Jacques Hadamard:

The words or the language, as they are written or spoken, do not seem to play any role in my mechanism of thought. The psychical entities which seem to serve as elements in thought are certain signs and more or less clear images which can be ‘voluntarily’ reproduced and combined. ...There is, of course, a certain connection between those elements and relevant logical concepts. It is also clear that the desire to arrive finally at logically connected concepts is the emotional basis of this rather vague play with the above mentioned elements. But taken from a psychological viewpoint, this combinatory play seems to be the essential feature in productive thought - before there is any connection with logical construction in words or other kinds of sign, which can be communicated to others. The above mentioned elements are, in my case, of visual and some of muscular type. Conventional words or other signs have to be sought for laboriously only in a secondary stage, when the mentioned associative play is sufficiently established and can be reproduced at will.

‘What muscular sensations did you feel when ...’ ‘What do you see in your imagination?’ etc. It was thought that as long as the participants verbalised processes that they would naturally verbalise as part of their natural communication with each other, then the overshadowing effect of verbal over nonverbal processes would be kept at a minimum level. The researcher should not prompt the participants to verbalise beyond this point so as to avoid further overshadowing effects, and also to avoid collecting distorted data. Metcalfe (1986) for example suggested that shifting the attention of people to non-reportable processes in insight tasks engages them in a ‘gradual rationalisation process’ (p.623) that focuses them on a reportable, yet inaccurate account of their thinking.

- (ii) *Data of various modalities should be collected*, especially other than verbal, such as diagrams produced during the sessions, body language and gestural movements (which, as I will discuss soon after, are often externalisations of mental animations). For this reason, the sessions were videotaped to capture both verbal and visual data. As Heath (1997, p.195) notes, video recordings ‘allow for the possibility of capturing aspects of the audible and visual elements of *in situ* human conduct as it arises within its natural habitat’, providing us with access to actions that would be otherwise suppressed in the transcript.

3.3.2.1 Procedure

J and P participated in two sessions: session 1 took place at the sixth form college and was an 80 minutes non-participant observation. Session 2 took place at the Faculty of Education and was an 80 minutes non-participant observation *cum* follow-up interview (Figure 3.2 and Figure 3.3 illustrate the research design and timetable). Both sessions were videotaped.

Session 1: non-participant observation

For the first session two problem sets were prepared. ‘Problem set A’ consisted of seven tasks and ‘Problem set B’ of six tasks (cf. APPENDIX B.1). The twelve participants initially expected would be grouped into four groups and the problem sets would be divided amongst them. Eventually only problem set B was used. The subject matter domain of the problem tasks drew upon Newtonian Mechanics.

Session 2: non-participant observation cum follow-up interview

A second session was scheduled three weeks after the first. By that time the protocol of session 1 was analysed and some questions and further tasks were prepared. As mentioned earlier, effort was made to collect relevant data without directly interrogating about non-reportable processes, thus the main method here was again non-participant observation. A number of additional tasks (cf. APPENDIX B.2) were used in order to encourage the participants to investigate more closely an idea or a TE that was produced in session 1 and potentially generate new TEs too.

The second method used was follow-up interview. In qualitative research, interviews are generally semi-structured at most, meaning that the interviewer has a set of questions or topics prepared beforehand, but is prepared to deviate from that set (McQueen & Knussen, 2002). Since the creative possibilities evoked by thought-experimental reasoning are situated in a very complex psychological context, they can be assumed impulsive and unpredictable; thus a semi-structured/follow-up approach was adopted. Questions were made sporadically only in occasions where some reasoning in session 1 was incomprehensible and so clarifications were sought (e.g. questions of the kind ‘can you explain a bit further what you meant by...’), and in other occasions to encourage, in an as much as possible non-directive manner, the participants to investigate more closely an idea or a TE they had produced.

During the interview the participants were shown extracts from the video of session 1, so as to bring them right to that point in the problem-solving that a question or a task was referring.

3.3.2.2 *Designing successful tasks*

Little is known at present about the characteristics of tasks that may invoke TEs (although this is clearly an important area for further theory and research). If TEs are in close relation with intuition, as proposed in the conceptual framework, then it seems reasonable to assume that the content of the tasks should be such that the participants are ‘working at the frontier of [their] own personal knowledge on an unfamiliar problem’ (Clement, 2003, p.258). Thus the tasks should at least make an effort to make mathematical solutions the less straightforward option since such solutions are less likely to entail scientific TEation. To accomplish this some rough standards for designing successful tasks were defined: tasks should describe a scenario that involves concrete entities so as to encourage personal participation; avoid extensive references to exact numerical values so as not to mislead the problem solvers to seek for a mathematical treatment; tasks likely to have been already treated mathematically (e.g. at school) should be avoided.¹⁸

3.4 ANALYSIS OVERVIEW

The analysis of the observation protocol incorporated both inductive (data-driven) and deductive (theory-driven) methods (cf. Figure 3.1), as these were proposed by Boyatzis (1998). Below I describe these two modes in more detail:

(i) *Deductive mode:*

This involves the generation of a broad pre-defined thematic code for identifying TEs in the protocol. According to Strauss and Corbin (1990), the value of the coding scheme is highly dependent on the theoretical sensitivity of the researcher, that is, the ability of the researcher to recognise what is important, give it meaning, and conceptualise the observations. A good thematic code is one that captures the qualitative richness of the phenomenon

¹⁸ To ensure that the tasks would invoke some TEs, one informal observation was conducted before session 1 with a postgraduate theoretical physics student thinking aloud through the tasks.

(Diesing, 1972; Strauss & Corbin, 1990; Boyatzis, 1998). The fact that the tripartite structure provides a broad enough description of TEation that caters for possible deviant cases of TEation made it an apt scheme for identifying TEs in the protocol. Specifically, the first two elements of the tripartite structure were used as the code, according to which possible TEs must satisfy these conditions: (i) like a physical experiment, a TE must take place within the context of a reasonably well-developed prediction (a hypothetical scenario). The tasks only set the foundations for the self-generation of novel elements in the imaginary world and thus the generation of a TE. The novel scenario can either be completely new or an enriched (with new entities) version of the one given in the task, and (ii) a prediction of the behaviour of the new scenario must be made.

(ii) *Inductive mode:*

As Tesch (1990) points out, some topical categories relating to a conceptual framework may already exist before the analysis, but for the most part the data should be interrogated with regard to the data itself. The rationale that underpins qualitative research is that substantive theory emerges from the data in a principally inductive manner (e.g. Strauss & Corbin, 1990; e.g. Schmuttermaier & Schmitt, 2001) and that the researcher should remain sensitive and adaptable to the raw data (Strauss & Corbin, 1990). This also relates to the distinction between manifest-content analysis and latent-content analysis proposed by Boyatzis (1998). The former is the analysis of the visible or apparent content of the phenomenon under investigation whilst the former is looking at the underlying aspects of the phenomenon, and is more interpretive than manifest-content analysis. The manifest level of analysis is a seductively easy way to obtain observations and feel a sense of control over the raw information when more latent themes are elusive, but leaves much of the richness of the raw material out of the analysis (*ibid.*). To answer the research questions which require deep-level understanding of the micro-processes involved in TEation, it was thought necessary to turn to latent-content analysis and use a more inductive mode of analysis. Thus after the raw data was analysed through the deductive mode, patterns of similarities were looked for in the identified TEs. Several cycles of analysis of

the observation protocols led to revisions of the coding scheme and some new TEs were identified, based on the salient behaviours that were found to generally accompany thought-experimental reasoning. In some cases the narratives of some classical TEs were used as a supplementary source of information to triangulate the emergence of structure from process data. Note however that the emergence of structure was primarily studied from process, for the reasons already discussed in section 3.2. Classical TEs were only used as a *secondary* source.

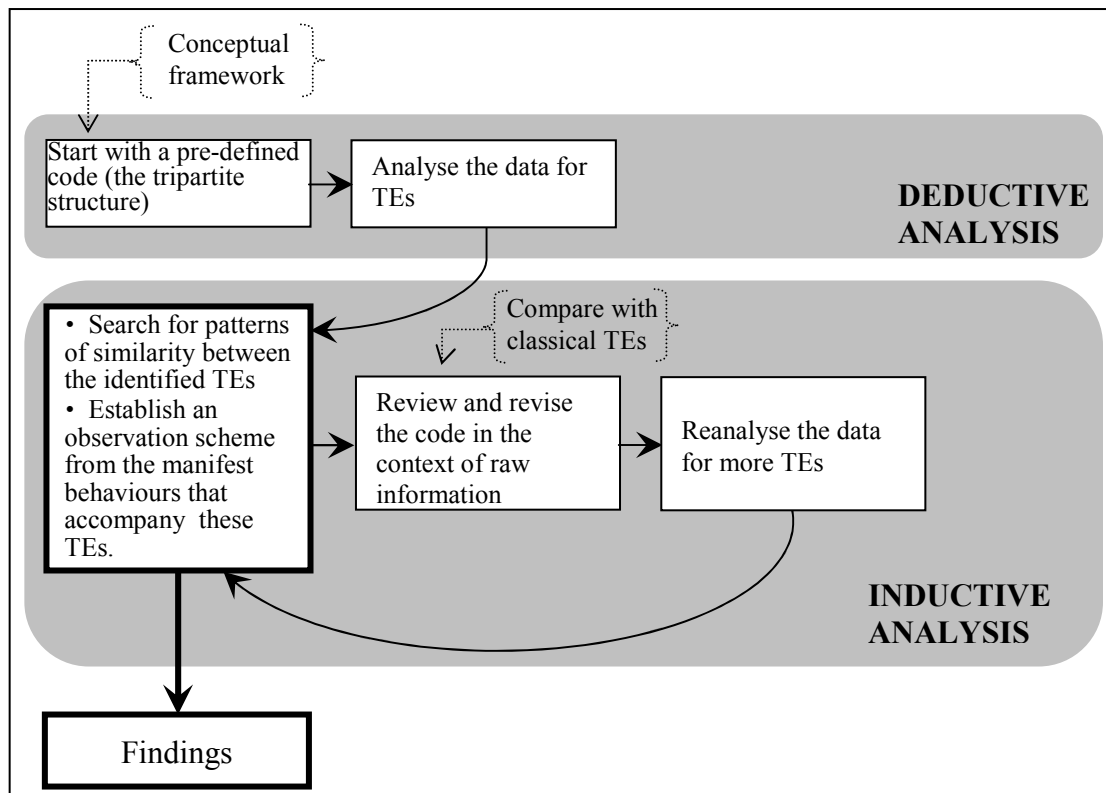

Figure 3.1: Analysis overview

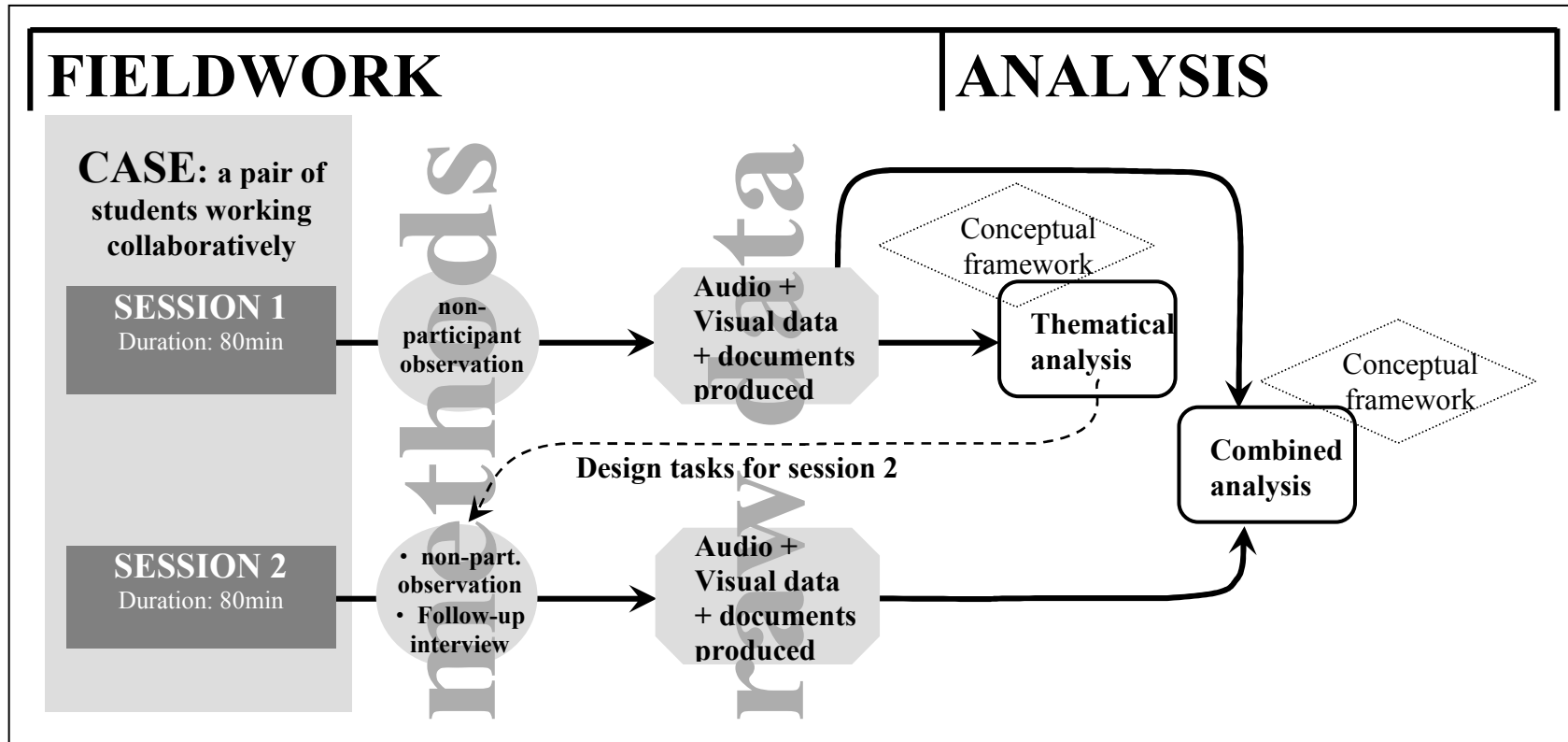

Figure 3.2: Research design overview

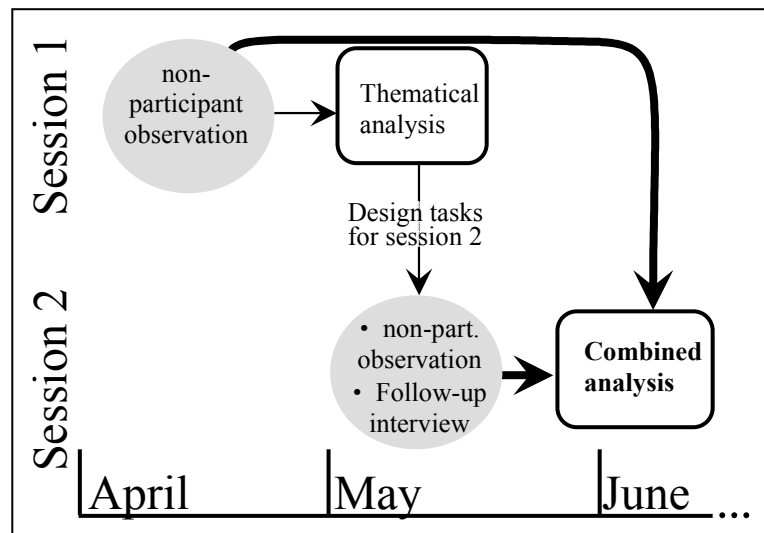

Figure 3.3: Fieldwork and analysis timetable

3.5 DESIGN CHECKS

Conventional criteria of trustworthiness (internal and external validity, reliability and objectivity) are inconsistent with case study methodology and the interpretive paradigm in general. As Lincoln and Guba (1985) point out in their analysis of trustworthiness in the *Naturalistic inquiry*, internal validity fails because it implies one single reality represented by the case study's results, external validity because it requires nomothetic generalisability, reliability because absolute stability and replicability are impossible for a research based on an emergent design, and objectivity because of the accredited value-ladenness of the observer in the interpretive paradigm. Any research project in the interpretive paradigm, however, should be at least as concerned with trustworthiness as research in the positivist paradigm.

I draw this chapter to a close by examining how some strategies were followed to establish *credibility* and *transferability* (the analogues of internal and external validity respectively) as these terms have been described by Lincoln and Guba (1985). Three techniques have been proposed by Lincoln and Guba for increasing the probability that credible findings will be produced: *prolonged engagement*, *persistent observation*, and *triangulation*.

Prolonged engagement draws upon the assumption that it is not possible to understand any phenomenon without reference to the context in which it is embedded, including a more thorough appreciation of local characteristics like participants' personal interests that might enhance thought-experimental skills. It requires 'that the investigator be involved with the context sufficiently long to detect and take account of distortions that might otherwise creep into the data' (*ibid.*, p.302). Due to the small duration that the problem-solving activities had for practical reasons, however, prolonged engagement was not possible to apply in this study. Other techniques had to be used to provide scope in the contextual factors of the phenomenon.

Persistent observation aims to provide depth, by making the observer able to recognise what is and what is not important (Lincoln & Guba, 1985). The inquirer is engaged in constant tentative labelling of the salient features in a non-superficial manner. This mostly pertains to the analysis of data:

- Both deductive and inductive modes of analysis were used
- The pre-defined code used for identifying TEs caters for possible deviant cases of TEs

Triangulation is the third technique proposed by Lincoln and Guba (1985). Two different modes of triangulation were used: the use of multiple and different *sources* and *methods*.

The first relates with the notion of *contextual validation* (Diesing, 1972) and was the technique mostly practised in this study. According to this technique, the source itself is called into question, on the basis of the presumption that by having multiple sources of data collection the researcher is in a position to correct distortions established through only one source. Since the data collected was vulnerable to distortions because of overshadowing effects during think-aloud (cf. section 3.3.2), this mode of triangulation was thought imperative. Thus both verbal and visual process data (gestures, body language, and diagrams) were used as the main source, so that potential imperfections of one could be cancelled out by the strengths of the other. Analysis of classical TEs' narratives was used as a secondary source to triangulate the emergence of structure from process data.

Additionally, given the intention of qualitative research to make sense of a phenomenon and investigate its inherent variety and richness in a setting, it was thought appropriate to expose the participants to and to examine as much variation as possible. As Tesch (1990) contends, the main intellectual tool of data analysis is comparison, because a main goal of data analysis is to discern and refine categories. For comparison of interpretation over time and events (Boyiatzis, 1998) data was collected over two problem-solving sessions and as many tasks as possible were used within the time limitations and the availability of participants. But also the fact that the characteristics of tasks that may provoke TEs are not known yet added to the need to use multiple tasks.

The use of multiple methods was the second triangulation technique employed. The idea in this study was to supplement the non-participant observations with follow-up interviews as a secondary method. Nevertheless, given the inadequacy of interviewing to elicit nonverbal processes without

distorting them, interview was mostly used as a means for prompting the participants to engage in problem-solving and thus enrich the collection of data through non-participant observation. Concept mapping was considered as a supplementary method. The literature that refers to concept mapping in science education is impressive. Nevertheless, in none of these studies was concept mapping used to depict *processes* of a *non-propositional* character.¹⁹ Process data can be collected by observing the participants whilst concept-mapping. The limitation of concept mapping that did not allow its use in the study is that the need to correspond reasoning patterns with node-concept patterns may impose linearity to reasoning, and the need to elucidate non-propositional processes as explicit concepts may cause overshadowing effects. The risk of using concept mapping was the possibility of collecting distorted data.²⁰

With regards to generalisation, what is at stake here is a judgement whether the findings of this study are representative of all thought-experimental reasoning. Stenhouse (1988) saw generalisation as ‘... a matter of judgement rather than calculation... [T]he task of case study is to produce ordered reports of experience which invite judgement and offer evidence to which judgement can appeal’. Stake (1995) sees transferability as ‘analytical generalisation’ which involves a judgement of the extent to which the findings of the study may occur in another context, by assisting the reader to experience vicariously what the researcher herself experienced. This kind of generalisation is left to the reader to perform and, from this perspective, case study methodology is in epistemological harmony with the reader’s experience. It is a matter of ‘value resonance’ - as Lincoln and Guba (1985) call the coherence of metaphysical assumptions - not to assume different models of behaviour for the researcher, the respondents and the research’s readership. Guba and Lincoln (2000, p.109) also assert that ‘it is not the

¹⁹ For example concept mapping has been used as an assessment tool (Ruiz-Primo & Shavelson, 1996) and as a research tool to illustrate patterns of conceptual development (Kitchin, Hay, & Adams, 2000; Pearson & Somekh, 2000; Novak, 2004), for example to unearth mental models about chemical equilibrium equations (Screiber & Abegg, 1991), understanding of atoms (Novak, 2004; Zele, Lanaerts, & Wieme, 2004) and plant reproduction (Kitchin *et al.*, 2000).

²⁰ Of course this does not preclude the use of concept mapping as a potent tool in future studies; its usefulness in explicating mental models is acknowledged. But first, both the nature of a concept map and the techniques for its analysis would have to be revised to cater for lower-level knowledge structures and imagery-based models.

researchers' task to provide an index of transferability'. However, to allow for meaningful comparisons by the reader and facilitate decisions on whether the findings are transferable to other settings, the context of this study is generally portrayed thoroughly. For example, the general characteristics of the participants are described, the procedure of collecting data is explicated step-by-step, pictures of episodes supplement textual descriptions of the problem-solving, and the full transcripts are appended at the end of the study.

3.6 SYNTHESIS

I argued for the appropriateness of case study methodology on the basis of constructivist assumptions about the nature of TEation as a situated activity. The case was a pair of final year A-level male students at a sixth form college in Cambridge, collaborating towards the solution of a set of tasks on Newtonian mechanics. I discussed why TEs can be thought of as social constructs from the stance of distributed cognition, and presented collaborative problem-solving as a methodological necessity based of the conviction that it would promote the externalisation of the participants' mental worlds. The need to collect relevant data without directly interrogating about nonverbal processes guided the decision for non-participant observation as the main method. Follow-up interview was used as a secondary method. The participants took part in two 80-minute-long sessions, which were videotaped to collect data of various modalities. Subsequently I discussed how the data was analysed, at a first level by identifying TEs using the tripartite structure as a pre-defined code, and at a second level through inductive thematic analysis. Finally I addressed the concern for trustworthiness in the study.

CHAPTER IV

4 Analysis

**‘I do my best,’ the Messenger said in a sullen tone. ‘I’m sure
nobody walks much faster than I do!’
 ‘He can’t do that,’ said the King, ‘or else he’d have been here
 first’.**
 (a Thought Experiment by Lewis Carroll, *Through the Looking Glass*)

4.1 PREAMBLE

The chapter is structured in three parts:

In 4.2 I draw a theoretical sketch about the workings of a certain type of TEs in the protocols which I call *basic* because they seem to be underpinned by only one elemental intuitive premise. As such, I use them as a methodological springboard to address issues mainly related to the role of intuition.

In 4.3 I analyse and discuss an episode that suggests a special role for the sense-of agentive causality in the participants’ thought-experimental reasoning.

In 4.4 I make connections with Clement’s (1994) work on runnable models and discuss the role of imagistic simulation in some episodes of thought-experimental reasoning. I also address the role of insight in the generation of a certain TE.

Each of these three parts does not make a unique point in itself but rather in combination with the others; the next chapter provides an interpretive synthesis of the analysis.

Because the psychological context within which TEation takes place is acknowledged as crucial so as to make sense of TEs as a reasoning technique, it was thought important to analyse and present TEs as part of the whole problem-solving of the task. The solution of all six tasks involved thought-experimental reasoning, but since presenting all of them would be out of place

because of space limitations, only the analysis of the three tasks that were most rich in TEs will be presented here.

4.2 ABSOLUTE MOTION

TASK: ABSOLUTE MOTION

A scientist is completely isolated inside a smoothly-moving opaque box that travels along a straight line through space, and another scientist is completely isolated in another opaque box that is spinning smoothly in space. Each scientist may have all the scientific goodies she likes in her box for the purpose of detecting her motion in space. The scientist in the

- box that travels a straight-line can detect her motion
- box that spins can detect her motion
- ... both can detect their motions
- ... neither can detect their motions

And what if the boxes were transparent?

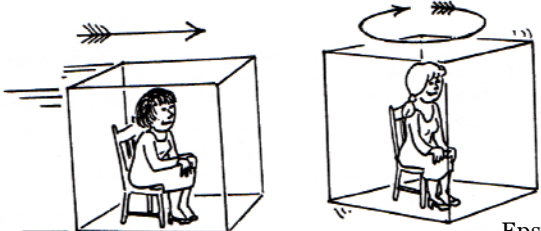

(adapted from
Epstein, 1989, p.104)

Figure 4.1: Task ‘Absolute motion’

The rationale behind the task was to give the basis for the exploration of the notion of (Galilean) relativity, that is, that there is no observation by which one can distinguish between inertial frames of reference.

4.2.1 The ‘telescope TE’

Consider this first excerpt:²¹

²¹ *Ellipses* in the excerpts have been used to denote pauses; *double diagonal lines* indicate interruption of speech by the other participant; *remarks in square brackets* have been added to clarify context; *italic square-bracketed remarks* describe gestural behaviour; *empty square brackets* denote that text from the protocol has been omitted. (text was omitted to increase the clarity of an argument, where the text was thought too long and irrelevant to the analysis, or was incomprehensible. Text was omitted with care so as not to distort the line of reasoning.) ‘J’ and ‘P’ denote the two participants, and ‘A’ the researcher.

To allow the reader to follow the line of reasoning, the line number where each extract can be found in the full transcript (cf. APPENDIX C) is quoted.

Extract 1 (session 1)

(Line 29 in the transcript)

P: ... If it was transparent. Well both [the uniformly-moving and the spinning passengers] should be able to tell if it was transparent. I mean, even if the box was miles away, miles, from any star, she could take readings using a telescope, and then see that the stars change as she goes along.

J: Yes, she could work it out, if she can see something

This reasoning fulfils the first condition of the tripartite structure (cf. 2.3): P has introduced *new* phenomenology, a new imaginary setting away from the stars and equips the passenger with a telescope. At least for the sake of argument I will examine this reasoning as a self-generated TE (let us refer to it as the ‘telescope TE’): The TE provides evidence that an observation outside the box can detect its movement: an observer in a static box would observe ‘the stars change as she goes along’ in the same way that a passenger on a ship sees the ground ‘move’ away. Nevertheless, unless J and P define a *static* reference point for the observations, the passenger of the uniformly moving box cannot possibly reach a decisive conclusion on whether it is the box that is moving or the surroundings of the box. J and P seem to tacitly presuppose the stars to be the static reference ground. Ueno (1993) recognises this predisposition as a phenomenological primitive (a p-prim), and argues that it could be an abstraction from everyday situations in which the ground is taken to be the fixed point of reference, such as for example, travelling in a ship (we detect the movement of a ship because it appears to us that the beach ‘moves’ and because simultaneously we tacitly presuppose that the beach is naturally at rest; so despite the appearances we infer that it is the ship that moves, not the beach). The commitment that motion observed from the ground (in the previous example the ground was the beach, in this case it is the distant stars) is *real motion*, whilst motion observed from another system such as a ship or our moving box is a *mere appearance*, is the telescope TE’s phenomenological-primitive premise (Ueno, Arimoto, & Fujita, 1990; Ueno, 1993; Ueno & Arimoto, 1993). I will be referring to this predisposition as the ‘static-ground intuition’. It seems to play an implicit role in J and P’s reasoning and is considered natural to such an extent that it needs no communication and justification. The failure to examine the scenario beyond

this ready intuition suggests that the participants are deeply involved in its ‘truthfulness’.²²

If this reasoning is really a TE, it should also fulfil the second condition of the tripartite structure. The striking thing about this reasoning is that J and P have known that the transparent room would allow the passenger to detect her movement *before* engaging with the telescope TE. Consider the following excerpt (note that it preceded Extract 1):

Extract 2 (session 1)

(Line 4 in the transcript)

P: ... because [the box] is opaque, provided that nothing can get through the doors, there is no way she would see *what’s going on outside*.

Here P argues that the passenger in the opaque box cannot detect her motion. He seems to have known, before constructing the telescope TE, that if the passenger can see ‘what’s going on outside’ then she can detect her motion. It is tempting to reify the conclusion that the telescope TE is epistemologically redundant: if the particulars of the thought-experimental scenario are just the localised effects of the TE’s premise, then it is unclear how it can fulfil the second condition, i.e. that a TE results into *new* knowledge. To rephrase the paradox: since they knew this prior to engaging with the TE, why did they generate the TE in the first place? Was it simply to make a picturesque representation of what was already known, an enthymetic version of a deductive argument? On Norton’s (1991, 1996) analysis of TEs, the difference between a TE in its unreformed state and a TE reconstructed as a mere argument is similar to the difference between a high-level algorithm and its computation, which requires that all its parameters are supplied with particular values so that they can be evaluated (Gooding, 1994). The tripartite structure, however, requires real repercussions to J and P’s knowledge, i.e. a role beyond mere communication. Then, is the ‘TE’ just ornamental, mistakenly called as such in the first place?

²² This intuition has been previously identified as an ‘ontological commitment’ by Resnick (1988). Ueno (1993) convincingly argues that Resnick’s (1988) analysis of intuitive physics is relevant to DiSessa’s definition of p-prims, since they both argue for tacit presuppositions of which the truthfulness is taken for granted.

4.2.2 Verificationist epistemological commitments: Basic TEs as a feedback mechanism

I will attempt to build up an answer through examples from the protocol, based on one key notion, a hypothetical theoretical construct I call *verificationist epistemological commitments*. In this section I start by presenting the notion very roughly, and in the following analysis I attempt a more elaborate theoretical sketch.

To facilitate the discussion, I start by making a rough distinction between two classes of TEs, in terms of the circumstances of their generation. Even though there may be more classes, these two accommodate all the TEs generated in this protocol:

(i) *First class (classical example: Galileo's free fall TE):*

What would happen in the imaginary scenario is not known to the thought-experimenter unless she runs her TE. The TE is designed to *explore* what would happen in the imaginary scenario.

'Exploration' denotes finding something new, like when you look around in a room you visit for the first time to see what is there: e.g. you explore the music room and discover that there are a piano and a lute.²³

(ii) *Second class (classical example: Galileo's ship TE):*

What would happen in the imaginary scenario is *tacitly known* by the thought-experimenter before engaging with the TE. The TE is designed so as to *make observable* a tacitly known causal relationship within the imaginary world. 'Making observable' is like switching on the lights on your way into the music room: you *believe* (in the sense of suspecting) that there is a piano in that

²³ I assume that a classical TE of this class would be Galileo's free fall TE: presumably, Galileo did not know what the acceleration of the two balls would be when combined until he run the scenario in his mind. Of course we lack process data supporting this; on the other hand it is not evident how else he could have known what would happen prior to running the TE, because this experiment is counterfactual – against our direct intuitions about the situation (and ultimately against the laws of nature); thus how could he know what would happen unless he ran the TE?

room, then you switch on the lights, and *know* that there is piano in the room.²⁴

I put forward the notion of *verificationist epistemological commitments* to explain why the thought-experimenters in the protocol feel the need to make a causal relationship observable and produce TEs of the second class. The fact that J and P felt the need to include a method of observation -a telescope- in their imaginary world could be because, in satisfaction of verificationist epistemological commitments, they attempt to ensure that the relation between cause and effect is subjected to *verification by observable facts* of (thought-experimental) experience (and not in order to explore what would happen. This was already known - or, to use the term 'know' consistently, this was already *believed*). From this perspective, the telescope TE is epistemologically akin to Galileo's ship TE (cf. APPENDIX A):²⁵

- (i) They are both underpinned by a single intuitive premise: in the case of Galileo's TE the intuition is that in a ship that is still or moves uniformly there is no muscular sensation that may inform on the kinematical state of the ship. In the case of the telescope TE, the premise is the static-ground intuition.
- (ii) Both TEs seem to have been designed to allow for observations to be conducted within the imaginary world. For example, in Galileo's ship, the particulars involved (some friends tossing a ball around, fish swimming, birds flying, etc) are merely a picturesque representation of the premise: if one's muscular sensations cannot betray one's kinematical state, then neither should the fish and the bird in the same ship feel anything different; they should fly and swim as if in the open sky and open sea; all the mechanical phenomena are the same as if the ship were anchored at the

²⁴ Note that this vision-based analogy, no matter how informative, may end up misleading: 'observation' is not a process necessarily entailing vision; instead it involves a larger span of apparatuses (embodied, like muscular sensations, or external, like a speedometer) that transcend a causal relationship to an experientiable aspect of the environment.

²⁵ Surprisingly Galileo's ship TE, even though often admitted as paradigmatic, has escaped philosophical scrutiny.

harbour. In the telescope TE, watching the celestial map change is a concrete application of the static-ground intuition.

- (iii) In both TEs, the conclusion is the same as the premise itself.

I will be referring to TEs with the above characteristics as *basic* to denote the basic simplicity of their design and aims.

How do basic TEs satisfy the second condition of the tripartite structure? Through the following theoretical sketch I attempt an answer using the theoretical construct of *reliability priority* put forward by DiSessa (1983, 1993):²⁶ the thought-experimenter's verificationist commitments are a result of low confidence to the underlying elemental intuition; through the application of the intuition in concrete situations a *positive feedback mechanism* (the telescope) increases the thought-experimenter's confidence in the premise; it would be expected that transition to an active state in future encounters of a similar context will not require a feedback mechanism because the TE would have already increased the thought-experimenters' confidence in the premise, and will have induced a rule-like prediction (Figure 4.2 depicts the hypothesised processes). What I mean by a 'rule' is a parsimonious explanatory scheme based on a symbolic (arithmetic or linguistic) system. For example, Galileo's ship TE takes the tacit intuitive premise that there is no muscular sensation in a uniformly moving ship, and results into explicit knowledge, which can be put into words as 'there is no possible internal observation decisive for the kinematical state of a non-accelerating ship'. The telescope TE is less spectacular, epistemologically speaking, but works in a very similar way: it starts with the static-ground intuition; through the feedback mechanism, the intuitive premise, from tacit knowledge obtains a more explicit character which can be articulated as 'when an observer can see

²⁶ *Cueing* and *reliability priorities* are very general control constructs, but they seem particularly well adapted to explain control of reasoning *to* and *away from* an explanatory scheme, such as a p-prim. The former is called *cueing priority* and has to do with how likely is an idea to be profitable in a context. Once an explanatory scheme is cued, the resistance to abandonment is a second kind of priority called *reliability priority*. This second kind of priority is closer to being a proper technical sense of the notion of 'more fundamental'. This means that the specifics of a situation are relevant to deciding the priority of the use of an idea (i.e. priorities are context dependent): for example, in a context where energy is an applicable notion for providing an explanation, the high reliability priority of conversation of energy makes it an apt explanatory scheme (a more 'fundamental' idea) to draw conclusions on. Conclusions drawn on the basis of another explanatory notion might be ignored in favour of the higher reliability priority perspective (diSessa, 1983).

outside her frame of reference, then she can also detect her motion'. There is no clear evidential support for the induction of a rule through basic TEs, so the feedback mechanism remains just a hypothesis (well-grounded in data, nevertheless). The question should be addressed through a set of tasks specifically designed to collect process data about the induction of rules. I defer this to future doctoral research.²⁷

According to this sketch basic TEs may fulfil the second condition of the tripartite structure by giving access to all that phenomenology of agency that is encapsulated, but not directly accessible, in intuition, and therefore make *tacit knowledge into explicit*. The idea is not new, it has been proposed for example by Reiner and Gilbert (2000), and previously by philosophers such as Mach (1905/1976). A mechanism for it however has never been proposed.

TEs of the basic type are the prevalent mode of reasoning in the protocol; I will attach a number of supportive (and some better) examples to the mechanism and refine this theoretical sketch throughout the analysis. In an exploratory clinical study, accounting for multiple instances helps constrain a theoretical construct to explain a number of various episodes throughout the protocol (and expectantly other protocols too, if the hypotheses set are well-informed by existing well-established theory).

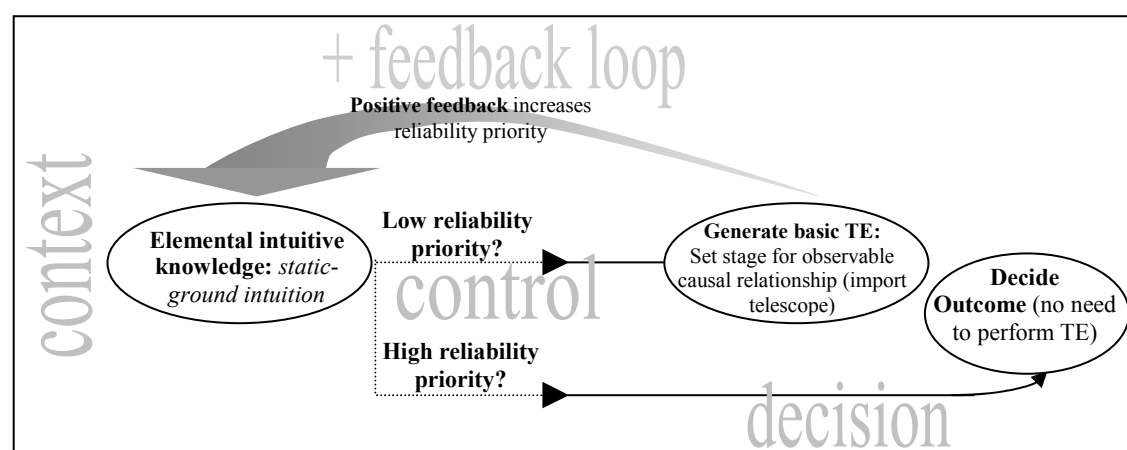

Figure 4.2: The positive feedback mechanism in the telescope TE

²⁷ The language used in the description of the feedback mechanism (e.g. 'have low confidence in the premise' and 'increases their confidence') suggest an elaborate reasoning process on the part of the thought-experimenters. In reality however, according to DiSessa (1983), processes described at this low level control of reasoning mechanisms are likely to be unconscious and too quick and simple to be dignified by such high level terms. Subsequently, we are short of a proper vocabulary to describe them and instead rely on the metaphoric use of higher level terms (diSessa, 1983).

The context of the task cues the specific intuition. The processing initiated by the activation of the underpinning p-prim (or small cluster of p-prim) in a concrete thought-experimental situation increases the p-prim's *reliability priority* (*positive feedback loop*). This subsequently affects that element's transition to an active state in future encounters of a similar situation (*flow control mechanism*). It is likely that in subsequent encounters the solution will be based on a rule-based description of the system's behaviour and that no TE will be generated to reach to a decisive outcome. The rule-like description would be that 'a passenger can detect her motion if she can observe outside of her room' (of course this omits the necessary precondition that the observer must be certain that the reference point is static).

4.2.3 The spinning passenger

In sections 4.2.3 and 4.4.1 I attach to the feedback mechanism hypothesis four more basic TEs.

In the case of the rotating box, P reasons that the passenger would be able to detect her movement by observing the centrifugal movement of an object let free in the box:

Extract 3 (session 1)

(Line 15 in the transcript)

P: She [the spinning passenger] should be able to tell just by dropping something and it will go out towards the side [away from] the centre of spinning. [*meanwhile P is illustrating the movement of the rock using his hand (cf. Picture 4.1)*].

In the interview, however, he attributes his knowledge about the centrifugal movement of the object to the sensation of heaviness that makes one's body parts feel 'pushed':

Extract 4 (session 2)

(Line 35 in the transcript – Interviewer refers to Extract 3)

A: How do you know that the object will move away from the centre?

J: you experience the force but//

P: You feel heavy. You are just being pushed like this [*his left palm pushing the right towards his right (cf. Picture 4.2)*]



Picture 4.1: ‘She should be able to tell just by dropping something and it will go out towards the side [away from] the centre of spinning.’ (Extract 3)



Picture 4.2: ‘You feel heavy. You are just being pushed like this’ (Extract 4). His left palm pushes his right towards his right.

I will be referring to the sensation of ‘heaviness’ mentioned by P as the *pseudo-force intuition*. The pseudo-force intuition is likely an abstraction over sensorimotor schemata experienced in curvilinear motion, like the characteristic muscular sensation one has when one takes a sharp turn in the car. It is a fictitious force in that it is not caused by another object like all real forces. I will be referring to the TE in Extract 4 as the *pseudo-force TE*.

But since P already possessed the necessary intuition, why didn’t he directly infer that the passenger will detect her movement? Why did he construct an imaginary world in which an object is dropped and observed? Like in the case of the telescope TE, it seems that this new element is imported in satisfaction of verificationist commitments: the movement of the box is established as the cause to an *observable* effect in the imaginary world (cf. Figure 4.3). The reasoning provided by J and P constitutes a TE of the same class as the telescope TE. Both TEs are underpinned by a single phenomenological-primitive premise which is made observable as a local interaction between particulars of the imaginary scenario.

Basic TEs seem to be the simplest form of TEation. They transcend intuitive knowledge in the observable world through the use of apparatuses that enable observation. In a sense the skill of thought-experimenters to improvise in this manner indicates their creative ingenuity.

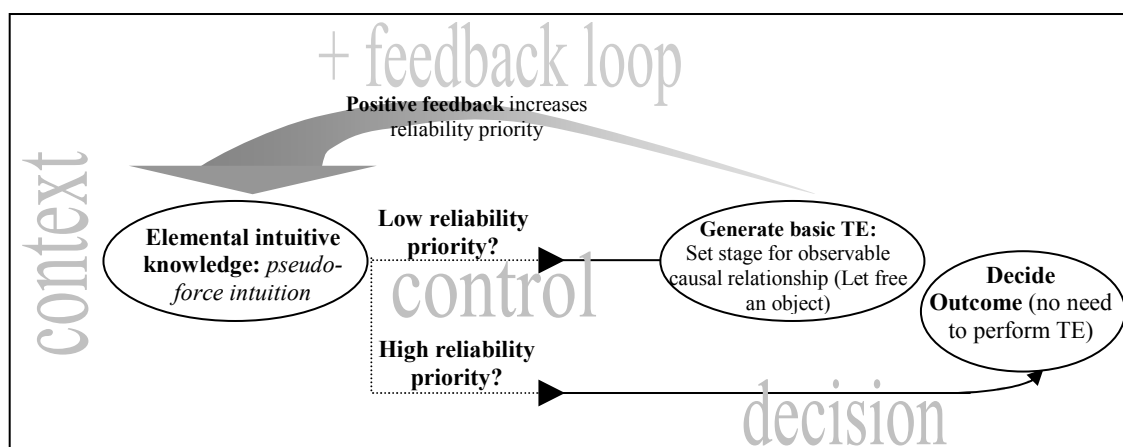

Figure 4.3: The positive feedback mechanism in the pseudo-forces TE

In the two excerpts that follow, a new intuitive element makes its appearance in J and P's reasoning:

Extract 5 (session 1)

(Line 19 in the transcript)

J: []What if she stood in one corner of the box?

P: Well she'd be always feeling a force. How, I mean it's not//

J: She feels... Acceleration would be... Would it be greater if she is outside... further out?

P: Yeah it would.

Extract 6 (session 2)

(Line 44 in the transcript – Interviewer refers to Extract 5)

J: Did I suggest that if she maybe walked in the centre of the box she'd feel greater acceleration?

A: I was going to ask you about this. How do you this?

J: See, if she's sitting in the middle and her weight is evenly distributed, she would all be pulled [*makes a movement with his palms open, as if there is something in between his palms that is expanding*]. But because she's got irregular shape...

The new intuitive premise provides a qualitative relationship among differentials in the radius of rotation and the amount of pseudo-force on the agent. This is enough primitive to require that J increases its reliability priority through a new basic TE: J imports in the imaginary world a passenger whose weight is evenly distributed and is rotating around her axis. The TE can be rephrased as such: 'If she is sitting right at the centre and her weight is evenly distributed, she would be equally "pulled" to all directions and so would be in equilibrium' (note that J takes the passenger to sit in the centre, as shown in the figure accompanying the task). Indeed, if the passenger were evenly distributed, she would be able to sit on her chair comfortably without having to hold anywhere to remain on her seat.

P then continues with the construction of another basic TE:

Extract 7 (session 2)

(Line 51 in the Transcript – Extract continues from Extract 6)

P: If she was in one point [*joins his palms and arms upwards as if to represent an axis, perhaps an object as thin as an axis (cf. Picture 4.3)*] then she actually wouldn't feel her motion, but because she actually has got volume, she may be feeling one arm being pulled [*makes an outwards movement with his right arm (cf. Picture 4.4)*] in one way and the other arm in another [*repeats the movement with his other hand*].



Picture 4.3: 'If she was in one point [*joins his palms and arms upwards as if they are an axle*] then she actually wouldn't feel her motion...'



Picture 4.4: '...but because she actually has got volume, she may be feeling one arm being pulled in one way and the other arm in another.' (Extract 7)

Or, the passenger could be thought of as a volume-less object (a point) placed on the axis of rotation and she will still remain comfortably on her seat despite her rotation!

Finally, when I asked J once again to explain how he came up with the relationship between radius and pseudo-force (because it was thought that he had not given an answer when he was firstly asked in Extract 6), he returned to the intuitive premise, mentioning some everyday experiences as the source of his intuitions:

Extract 8 (session 2)

(Line 67 in the transcript – Interviewer refers to Extract 5)

A: What made you ask 'would it be greater if you sat outside?' You asked this before having an answer. Put differently, how did you think about this question?

J: I guess... when you are in the corner of the car, or something, and you [*makes movement with his arm from left to right*]... oh, I don't know... So, it's something like from experience. When you are travelling around the corner faster, then you experience greater force because you lean [*leans rapidly to his left (cf. Picture 4.5)*]. So it's something from experience. You feel the further up, you are going faster than when you are closer the centre [*His eyes fixed at the diagram of the box, whilst*

making a circular movement around the box with his finger (cf. Picture 4.6)].



Picture 4.5: ‘When you are travelling around the corner faster, then you experience greater force because you lean’ (Extract 8). J leans rapidly to his left.

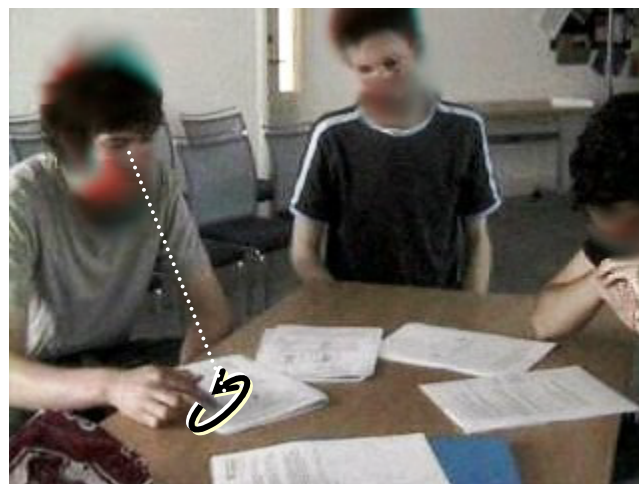

Picture 4.6: Projection of imagery onto a diagram. J’s eyes fixed at the diagram of the box whilst making a circular movement around the box with his finger and says ‘You feel the further up, you are going faster than when you are closer the centre’ (Extract 8).

The interesting point in this extract is the fact that the causal relationship seems not be directly between pseudo-force and radius of rotation, but between pseudo-force and velocity (‘When you are travelling around the corner faster, then you experience greater force because you lean’ (Extract 8)). It seems that the radius-force relationship is established through what DiSessa (1993) calls a *phenomenological syllogism* (like in predicate logic a phenomenological syllogism follows the pattern ‘if A is B and B is C, then A is C’, where A, B, and C are parameters in intuitive causal relations): the further from the centre, the larger the velocity; the larger the velocity, the more intense the pseudo-force; therefore the pseudo-force increases with the radius of rotation.²⁸

4.3 PHYSICS IN A SPACESHIP

²⁸ It is not surprising that the causation is between velocity (rather than radius) and pseudo-force: in everyday life situations (i.e. driving a car or a bicycle) the directly manipulable parameter is the speed rather than the radius of a curve.

TASK: PHYSICS IN A SPACESHIP

Suppose a huge space ship of a doughnut-like shape is projected far into space where there are no nearby planets (thus no gravitational effects). The spaceship is spinning rapidly about its central axis perpendicular to the ring.

(a) Sketch a passenger standing the 'right way up' as he feels it -on his feet- inside the ring, near A; and another passenger near B and another at C.

(b) Suppose a passenger holds an apple and releases it. Where will the apple fall?

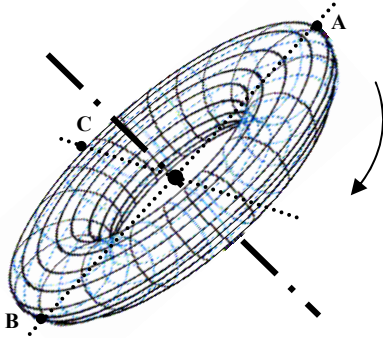

(adapted from
Rogers, 1960, p.764)

Figure 4.4: Task 'Physics in a spaceship'

4.3.1 Non-agentive causation

The phenomena examined until now by J and P invoked intuitive attributes having to do with kinaesthetic agency. In task *Physics in a spaceship-question b*, however, the phenomenological causality is extended to deal with situations that do not invoke agentive causation. *Physics in a spaceship-question a* involves agentive causality and was posed so as to facilitate the solution of *question b*. The task was given in session 2, following Extract 7. The following excerpt refers to *question b* of the task.

Reasoning is now based on *geometrical manipulations* rather than *personal participation*:

Extract 9 (session 2)

(Line 112 in the transcript)

A: Will it [the apple] drop at his feet, or will it drop behind his feet?

P: I think it will drop at his feet [*forms a curve with his palm, as if it is the curvilinear wall of the spaceship. He moves a finger of his other hand as if to simulate the trajectory of the apple*]

J: I think it will fall behind it.

P: It is moving tangentially to the right [(note that the spaceship is rotating clockwise according to the diagram in the task)] but he is moving right as well once he's let it go.

J: But if he 's going that way, it will go that way and will miss it [*With the movements of his hands 'draws' the trajectories of the apple and the passenger - Picture 4.7*]

P: It goes like that [*'draws' a curvilinear trajectory with his finger on the desk*], the apple goes like that [*'draws' a linear trajectory with his other hand's finger on the desk - Picture 4.8*] so it might be that they intersect.

J: I don't get that. [*repeats the same diagram as in Picture 4.7 with his fingers*]. The

apple will drop behind him.



Picture 4.7: According to J, the apple will miss the passenger of the spaceship.

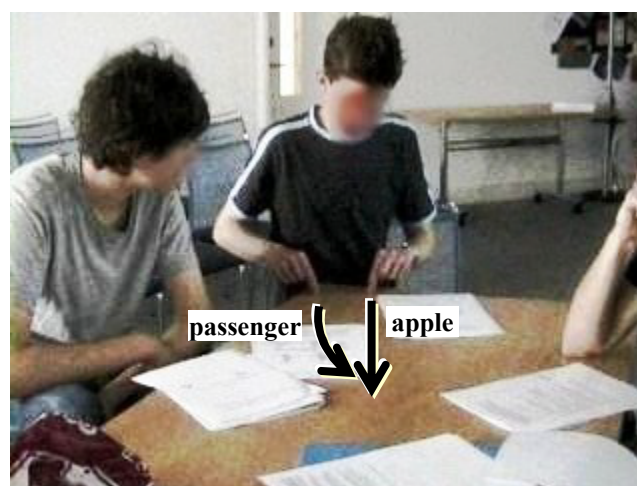

Picture 4.8: According to P, the apple meets the passenger's feet.

4.3.2 A note on gesticulation as evidence for imagery

I will use the episode above as a springboard to make a methodological note on gesticulation as behavioural evidence for mental simulation. Note however that the episode is not taken to be a TE, as it does not involve hypothetical elements.

Consider this excerpt:

Extract 10 (session 2)

(Line 128 in the transcript - Extract continuing from Extract 9)

P: But, I was thinking, as she is in the spaceship, to her it would look as if the apple is going down, whilst for someone outside it would look that the apple is going on the tangent; because she is moving around *[draws a segment of a circle by moving counter-clockwise his arm]* as the as the apple falls. Or, she sees the apple fall diagonally *[draws a diagonal trajectory to his right, which he interrupts after about 2 seconds and draws a new diagonal trajectory to his left (cf. Picture 4.9 and Picture 4.10)]*



Picture 4.9: Gesticulation during the articulation of the phrase 'Or, she sees the apple fall diagonally'. He first draws a diagonal trajectory to his right, which he interrupts after about 2 seconds and draws a new diagonal trajectory to his left (cf. Picture 4.10).



Picture 4.10: New gesticulation during the articulation of the phrase 'Or, she sees the apple fall diagonally'. P draws a new diagonal trajectory.

P starts 'drawing' in the air a diagonal trajectory with direction to his right (cf. Picture 4.9). Briefly afterwards, he interrupts and draws a new trajectory with direction to his left (cf. Picture 4.10). How can this obscure behaviour be explained?

Going back to the discussion in Extract 9, J argued that the apple will fall behind the passenger's feet. It could be that P accommodates this in his model and draws the supposed diagonal trajectory. But if the apple fell behind the passenger's feet, then the diagonal should be towards his left because the spinning of the spaceship is counter-clockwise (according to P's previous gestures, the spaceship is spinning counter-clockwise (cf. Extract 10)). Therefore P rapidly switches the direction of the diagonal to make it consistent with the direction of spinning. This adds to previous research on imagery that assigns gesticulation a role as an expression of core meanings or reasoning strategies and not simply translations of speech. This interpretation suggests that this specific gestural behaviour had more than a mere communicative purpose; instead, it seems to correlate to P's imagistic model as an extension of his thinking and as a window to his 'deeper layer' of representation (Schwartz & Black, 1996b). These gestures represent their referents deliberately and directly (McNeil, 1987). Hand gestures that take the form of their referents have also been elsewhere shown to influence semantic

sensibility judgements (Klatzky, Pellegrino, McCloskey, & Doherty, 1989). Hegarty (2002) points out that visualisations can exist both externally, as in a drawing or gestures, or internally and that there can be various relations between them.

None of these observations are infallible indicators on their own. I will generally take gestures as evidence for imagery following an increasing variety of studies of depictive gestures. In the episode above gestures appear to serve as an important type of externalisation of imagery that is amenable to initial analysis. In addition to the externalisation of imagery as hand motions, there are a number of other indicators for use of imagery in the participants' discourse without accompanying gesticulation. In accordance to Clement (1994; and summarised in Clement 2002, 2004, 2005) there are several hypotheses grounded in protocol analyses, about indicators of the use of imagery:

- (i) *Personal action projections*: spontaneously re-describing a system action in terms of human action, consistent with the use of 'simulated doing': this is manifested in all the basic TEs in this protocol in the form of observable-experienceable agentic causation.
- (ii) *Imagery reports*: these are manifested in the protocol as references to an imagistic model e.g. 'You are just being pushed like this' (Extract 4) and such spontaneous expressions as 'imagining', 'seeing', 'feeling' throughout the whole protocol.
- (iii) *Depictive hand motions* manifested throughout the protocol. A special case of gesticulation is related to *projections of imagery onto drawings* (e.g. Trickett & Trafton, 2002) during which eyes are fixed on a diagram and hand motions denote imaginary movements or other manipulations (such as shape deformation) of the diagram (e.g. in Extract 8, J, with his eyes fixed to the diagram of the spaceship rotates his finger in front of the diagram and says 'You feel the further up, you are going faster than when you are closer the centre' (cf. Picture 4.8)). Eye-tracking experiments generally treat

visual attention shifts on a diagram-stimulus as an indication for the use of imagery.²⁹

4.3.3 Shuttling from non-agentive to agentive causation

In the following episode, J and P make a new discovery about the kinematics of the apple as observed by the passenger:

Extract 11 (session 2)

(Line 139 in the transcript)

A: Would the passenger observe the apple fall in uniform speed or with acceleration?

P: [*P is silently 'drawing' a diagram on the desk with his finger*] Because she is curving around, like that, I mean the apple is going on a straight line whilst the passenger is curving, I think it would appear to her as if the apple is coming towards her faster all the time. I think it will appear to her as if it is accelerating, even though there are no forces acting on it. She is accelerating relative to it because she is going inwards.

Through geometrical manipulations P infers that the apple will appear to the passenger as if it is accelerating, despite the fact that there are no forces acting on it that might cause that acceleration. In the following excerpt J and P make the crucial discovery that rotation creates (artificial) gravity in the spaceship:

Extract 12 (session 2)

(Line 149 in the transcript)

A: To summarise, the passenger is standing as you showed me, and there is a force on him which holds him on the wall. Presumably he can also walk on the wall?

J: Yes, it is effectively like on Earth, like a gravitational field. It is not the same way, because it is forcing him towards the outside, but it is something pressing her against the walls.

A: So is it a gravitational field?

J: No it is not a gravitational field, but it has the effect of keeping her against the floor.

A: Can you make connections with the apple?

P: So it would be like the apple is falling in a gravitational field.

It seems that a coherence is discovered among accumulated problem-relevant pieces of information (i.e. that the passenger is pressed against the wall-floor of the spaceship; that she sees an apple fall in acceleration and land on her feet - or a bit behind them). This information provided meaningful and useful clues for realising that the passenger experiences artificial gravity.

²⁹ For a review see Yoon and Narayanan (2004).

J and P's previous findings, that prescribe direct connections between certain intuitions (manifested as geometrical manipulations) and resulting motions, are channelled into a single, complex notion; gravity. According to the p-prims theory, we can expect that the explanatory priority of intuitions that guide geometrical manipulations will diminish, with the notion of gravity becoming the predominant explanatory scheme (the most 'fundamental' idea):

Extract 13 (session 2)

(Line 158 in the transcript - Extract continuing from Extract 12)

A: Can you make connections with the apple?

P: So it would be like the apple is falling in a gravitational field.

From now on J and P do not base their reasoning on geometrical manipulations but channel their explanations through their *agentive* sense-of gravity: what is it like for the passenger herself to move around in the spaceship? If she jumped, would she ever come down? And would she land at the same point? Having realised that the passenger experiences gravity-like phenomena triggered their curiosity to explore the imaginary scenario through personal participation:

Extract 14 (session 2)

(Line 160 in the transcript – Extract continuing from Extract 13)

J: []If she jumped off the surface, then would she come back? Because she's got a velocity she will eventually come down like the apple. But is it at the same point?

P: Yeah I think. If it wasn't then she would be pulled a bit backwards every time she made a step forward... in the direction of rotation. And would feel a force pulling her to the opposite direction of the rotation when she is still.

P generates an elegant TE which works as a *reductio ad absurdum* (since it is the only TE of this kind produced, let us call it the *reductio TE*): if, when the passenger jumped perpendicularly to the surface of the spaceship, she landed a bit behind the initial point, then, at every step she made she would also cover a bit less distance than a full step. There must be a mysterious force pulling her backwards, which the passenger would also sense when she stands still in the spaceship. This however is in conflict with the strong belief that the passenger feels the pseudo-force at a 90 degrees angle with the floor of the spaceship. From this *absurdum* P concludes that the passenger lands at the

same point she jumped from (assuming that she jumped perpendicularly to the floor).

This reasoning satisfies the first two conditions of the tripartite structure of TEs:

- (iv) *The TE posits a hypothetical scenario:* what if it was the case that the passenger landed behind the point she jumped from?
- (v) *The evaluation of the imagined scenario results into new knowledge.* I take this to be unproblematic, since the TE gave a full-blown solution to the problem that J and P were struggling with for about twenty minutes. As for how this TE works, I restrict myself to a minimal answer: it seems that personal participation activated P's gravity-related intuitions about how it feels to jump and walk in gravity, thus activating his strong beliefs about the situation.³⁰ Shuttling from non-agentive to agentive causation in the episode is illustrated in Figure 4.5. This interpretation adds to the discussion on the role of agentive causation illustrated in basic TEs, suggesting that agency comprises a fundamental set of attributes at the generic roots of these two novice physicists' thought-experimental reasoning.³¹

³⁰ A more detailed, although still very rough and speculative mechanism of how this TE works is this: it could be that it works in a somehow reverse manner than basic TEs: basic TEs start with the intuitive premise, the imaginary scenario being a consequence of the premise. This TE might have started with the imaginary-hypothetical scenario, and then the thought-experimenter pinpointed the premise that would satisfy the hypothesised scenario (i.e. that the forces sensed by the observer in the hypothetical scenario cannot be at a 90 degree angle with the projectile). Subsequently, the premise was contrasted with what is factually *known-to-be* (i.e. that a passenger feels force vertically to the floor of the spaceship – the pseudo-force intuition). This mechanism should not give the impression that the generation and exploration of the TE occurred in an entirely conscious, or linear, manner. Instead, the TE was generated in a sudden flash of insight right after J and P realised that rotation creates effects similar to gravity.

Anything more elaborate would be overly speculative in the light of this limited evidence. Unfortunately no other TEs of this *reductio ad absurdum* type were generated by the participants, whilst similar classical *reductiones ad absurdum* such as Galileo's free fall TE and Stevin's chain, are not useful as supplementary data, as they do not provide us with any process data.

³¹ Indeed agentive causation, according to DiSessa (1993), is generally thought to comprise a fundamental set of explanation often manifested through animistic and anthropomorphic explanations which transcend causation to an 'I act-it reacts' or 'it acts-I feel' pattern. This explains why they are so popular among children and naïve physicists, sometimes orienting thinking long into university level physics (DiSessa, 1993).

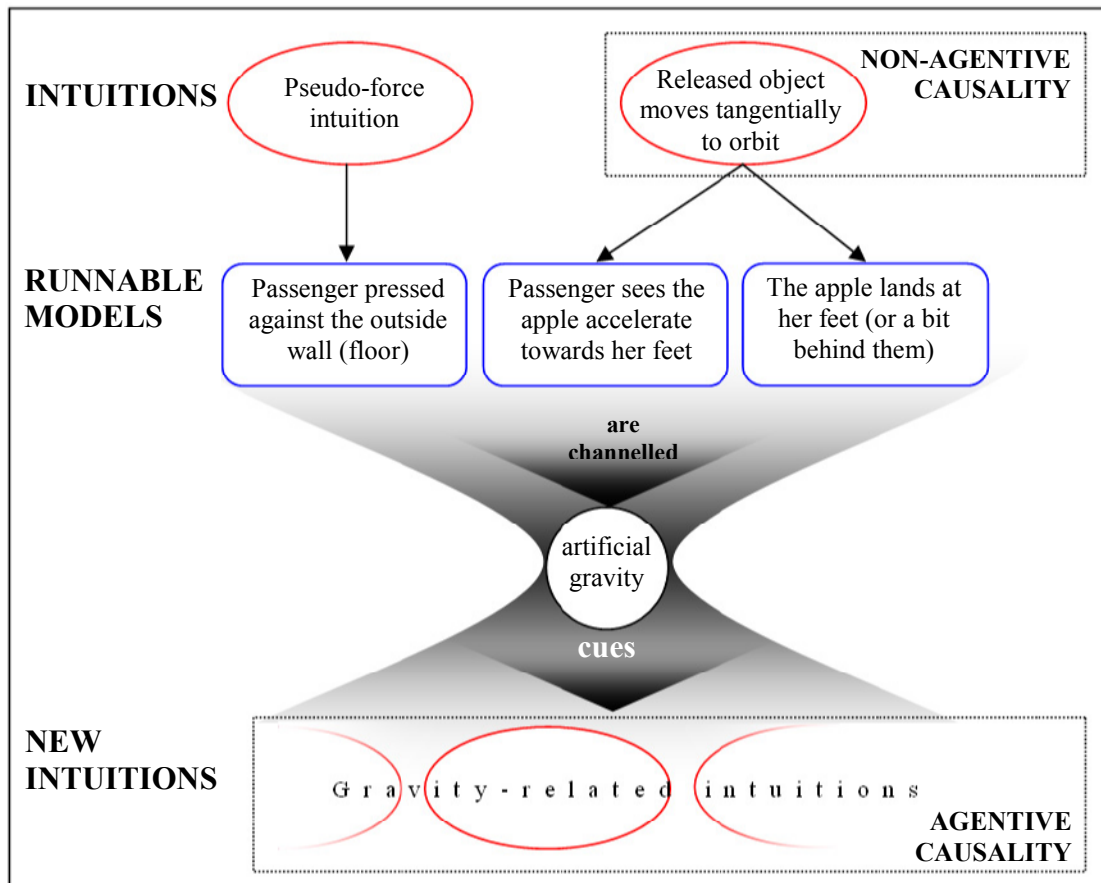

Figure 4.5: Shuttling from non-agentive to agentive causation in task ‘Physics in a spaceship’

The hypothesised internal processes is that independent runnable models (mostly relying on non-agentive causality) were channelled into one notion, gravity, which then cued gravity-related intuitions. Sense of agency seems to have been the crucial element that generated the TE.

4.4 WHY DO THINGS FALL

TASK: WHY DO THINGS FALL
 You are in a freefalling falling room. Is it possible that you demonstrate that ‘Earth is pulling an object’ by weighing it whilst it is falling and you are falling with it?

Figure 4.6: Task ‘Why do things fall’

This task aimed to provide the context for the exploration of the effects of free fall on the ‘sense’ of gravity.

4.4.1 One more basic TE: The ‘spring-scale TE’

Extract 15 (session 1)

(Line 196 in the transcript)

J: In a room that is falling. So it would appear to you as if it is... [] That 's hard because you should fall with the same rate. So in this room and this thing is falling [points at a marker on the desk] how can we measure it [its weight]?

P: Well I don't think you could. Because if you are in a room you can't see yourself accelerating, even if you could calculate the mass somehow.

J: What if in your room you have an object and you have some scales. You measure the forces.

Extract 16 (session 2)

(Line 240 in the transcript - Interviewer refers to Extract 15)

A: Can you write an answer to teach somebody who doesn't understand Newtonian mechanics why you think that you cannot measure the weight of the object?

J: You 'd probably say that you cannot experience something that is experiencing force, you need to see how it moves in relation to something else. You could sit on the outside and see it as it's falling it is getting faster and faster. Whereas if you are falling with it at the same speed then//

The option of measuring the acceleration and the mass and then calculate the weight is quickly rejected: one cannot see something accelerate if one is falling with it. They then explore the option of using a balance to examine how freefall influences the gravity in the room:

Extract 17 (session 1)

(Line 205 in the transcript - Extract continues from Extract 15)

P: []If it [the object] was on the scales just before your room was left in the gap then, ignoring air resistance, everything drops at the same acceleration so everything stays in the room relatively to each other at the same positions they were before.

J: So if it was on a set of scales when you let [the room] go then it [the measurement on the balance] should stay the same.

P: Well, no. If they are 'springy' scales, the downwards force on the object will stop as soon as you start accelerating [*Uses his left palm as a platform on which his right palm rests on, apparently simulating a weight resting on a balance. This system is initially static but then he 'lets go' and both palms fall downwards. During this fall, his right hand palm, perhaps representing the weight, and his left hand palm, representing the balance, come apart (cf. Picture 4.11)*].

A spring scale is introduced in the imaginary world and a new TE is generated. Causation between acceleration and gravity in the room is thus made observable.

It is not evident how P could have reached this conclusion either through the geometrical manipulations he reports (entailing the relative positioning of the objects) or through purely deductive reasoning from the premises. Indeed, the bug in the justification he reported is that geometrical manipulations do not explain why the downwards force will stop acting on the balance as soon

as the room starts accelerating; they can only take the problem-solvers up to the conclusion that the objects in the room will maintain their relative positions. J's comment that the balance should measure the same downwards force as before the room started its free fall is a logical (and correct) consequence of P's (seemingly) geometrical-manipulations-based argument.

A second striking characteristic in P's reasoning is that it omits any intuitions about springs: in reality, right after the box starts its freefall, the compressed spring will decompress and then extend, and the spring will oscillate up and down, whilst the object will be pushed upwards relative to the box as the spring decompresses (cf. Figure 4.7). If the spring scale was involved in imagistic simulation and geometrical simulation, then intuitions attached to springs would be expected to be cued thus causing oscillation to occur at least as a weak expectancy about the kinematical behaviour of the system.

For the two reasons above, I am inclined to reject that geometrical manipulation are the resource of this TE. Thus, a question that needs to be addressed is, if the spring scale was not involved in the reasoning, then why was it introduced in the first place? Examining the protocol further, we can identify a primitive premise underpinning P's reasoning. Consider the following excerpt, in which, as debriefing, J and P were asked to teach a non-expert about the reasoning reported in Extract 17:

Extract 18 (session 2)

(Line 247 in the transcript - Extract continues from Extract 16)

P: You might talk about things that fall and how people feel when they are falling such as in a lift that goes down really fast you feel lighter. You just have a feeling that you are lighter. If you are in a lift and it is going really fast, if it is falling on the free fall *[meanwhile his palms touch each other and move downwards, apparently the one being the floor of the lift, the other one the object (cf. Picture 4.12)]//*

J: The faster the lift is falling the less interaction you get from the base to feel your own weight. If you imagine the lift is your scales and the object is you as you fall and you are measuring your weight then you can measure your weight according to the interaction you have with the base.



Picture 4.11: ‘If they are ‘springy’ scales, the downwards force on the object will stop as soon as you start accelerating’ (Extract 17). P’s right hand palm (representing the weight?) and his left hand palm (representing the balance?) come apart as they fall.



Picture 4.12: ‘You have a feeling that you are lighter. If you are in a lift and it is going really fast, if it is falling on the free fall...’ (Extract 18). P’s palms touch each other and move downwards, apparently the one being the floor of the lift, the other one the object.

A primitive premise is revealed in the reasoning above. This is a sensation of lightness (let us call it the *lightness* primitive) experienced during accelerated fall, probably abstracted over everyday situations involving sensorimotor schemata such as travelling in elevators, or jumping down from a high wall, and possibly many other everyday experiences such as feeling the weight of a heavy grocery bag decrease when letting it fall whilst still holding it. This intuition, entailing agentic causation, could be responsible for the inference that objects are weightless during freefall.

4.4.2 Basic TEs and the ‘Transfer of Runnability’ hypothesis

Clement and Steinberg (2002; summarised in Clement, 2003, 2005) put forward the hypothesis that a model constructed using runnable (i.e. carrying information that can be used in mental simulation) source schemas can inherit the runnability of those schemas. He called this, *transfer of runnability* from a runnable schema (source) to a more complex model (target). For example, Clement and Steinberg (2002) analyzed video tapes of a student being tutored in an electricity curriculum that used analogies to construct models of voltage and current by anchoring them in the student’s intuitions about air pressure and air flow. Evidence from the student’s

spontaneous use of similar depictive hand motions during the air analogue, and during the electric potential model indicated that she was using similar imagery in both cases. The authors hypothesized a *transfer of runnability* from the analogue to the target model (cf. Figure 4.8). According to Clement (2003, p.260):

Such a simulation may draw our implicit knowledge in the schema that the subject has not attended to before – e.g. in this case the simulation may draw out knowledge embedded in analog tuning parameters of a motor schema.

Clement extends this to conjecture several possible sources of *new information* and *conviction* in TEation, such as:

perceptual motor schemas that are general enough to generate and run imagistic simulations with conviction in a variety of situations within their domain of application; the flexible extended application of such a schema to a case outside of its normal domain of application; or the tapping of implicit knowledge in the schema. (p.261)

Agentive intuitive attributes can be thought to be a primitive runnable schema. They carry information about the behaviour of a system as patterns ‘I act-it reacts’, or ‘it acts-I feel’ and are manifested through personal participation in a concrete imaginary scenario in basic TEs. Such a transfer of imagery seems to have occurred in the spring-scale TE, the source being an imagistic instance involving the lightness intuition (i.e. travelling in the elevator) and the target being a situation set up so as to measure the weight of an object in a falling room. Indeed, the source is a runnable agentive intuition (the lightness intuition), in contrast to the target (weighing the object) which doesn’t seem to invoke any intuitions to J and P. This hypothesis is supported by evidence of spontaneous *identical* gesticulation in Extract 16 and Extract 17 (cf. Picture 4.11 and Picture 4.12 respectively) which suggests that P is relying on the same runnable schema (the lightness primitive) in both cases.

In the same line of argument, Galileo’s ship TE seems to work through the transfer of runnability of the intuition (runnable schema) that a passenger’s muscular sensations are the same whether the ship is static or uniformly moving, to a non-agentive situation (non-runnable schema: are there any mechanical experiments in the ship that can betray its kinematical state?). The transfer goes like this:

Runnable schema (source): muscular sensations during non-accelerated motion cannot betray one's kinematical state

Non-runnable schema: the observable behaviour of the various living beings and mechanical devices in the cabin

Transfer of runnability (target): if our muscular sensations cannot betray the kinematical state of the ship, then the same sensations should be felt by all the living beings on board, thus they should behave no differently than if the ship were still. This conclusion can be extrapolated to all mechanical experiments on board. It is no accident that Galileo chose to include living beings in his ship, since the runnability of kinaesthetic intuitions is naturally transferable to them.

Following the discussion above there are good reasons to hypothesise that the spring-scale TE did not aim for *exploration* through geometrical manipulations, but to *make observable* the already available lightness intuition. Consequently the reading on the balance changes so as to do justice to this intuition, hence the spring-scale TE is of the basic kind. We can expect that the reinforcement of the primitive's reliability will induce a rule about the situation at hand.

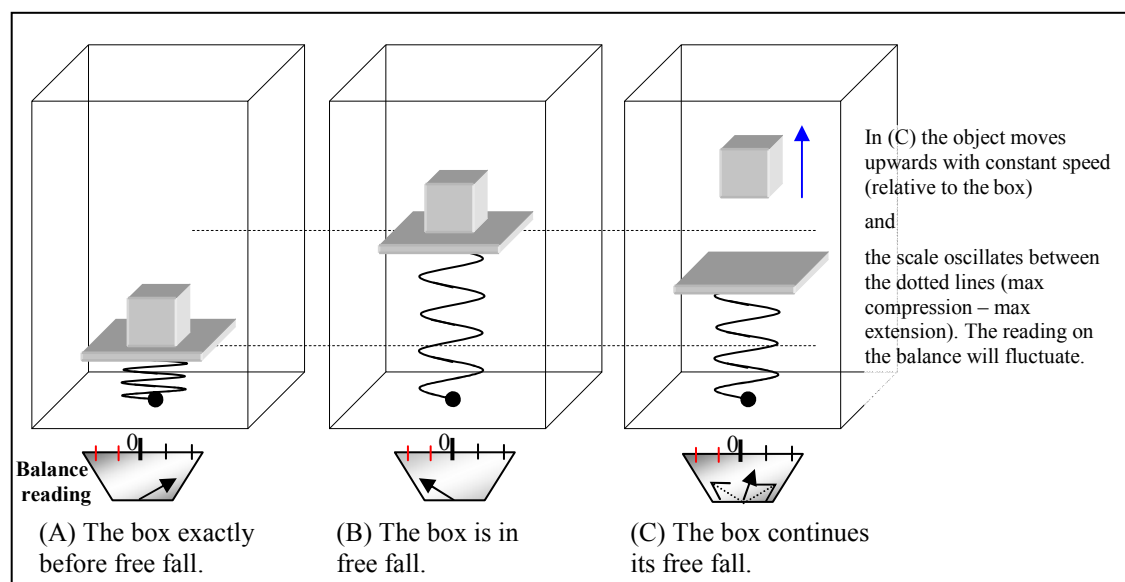

Figure 4.7: The accurate kinematical behaviour of the spring scale and the object after its release.

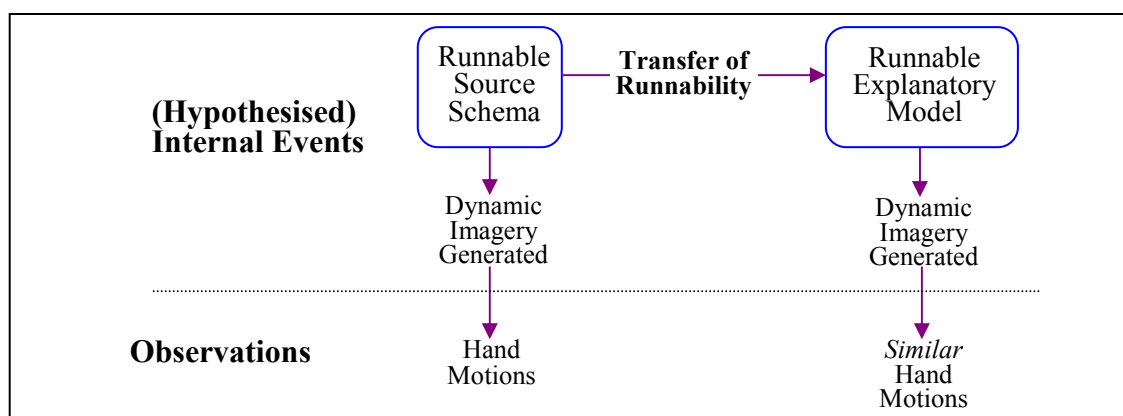

Figure 4.8: Similar gesticulation as evidence for transferability of runnability during model construction and application (Clement & Steinberg, 2002)

4.4.3 The ‘separation TE’: the role of insight in (some) TEs

The following extract is taken from the discussion on *Why things fall* and it followed Extract 17. Prior to this, J and P had mentioned that gravitational acceleration decreases with distance from the Earth.

Extract 19 (session 1)

(Line 218 in the transcript)

J: A! How about if you create a separation between the thing you measure and the object, a very big separation, because of the thing with Earth that [gravity] further away [from Earth] gets less the object should fall slower, then you ‘d see it change. [cf. Figure 4.9]

It is a new TE (the *separation TE*): it introduces new hypothetical states of affairs which are a pivot-like balance in which the two weights are separated as shown in Figure 4.9 (note that J was shown this diagram during the interview and agreed that it illustrated his TE). The gravitational field is non-uniform. J reasons that the balance will turn towards the weight that is closest to the Earth.

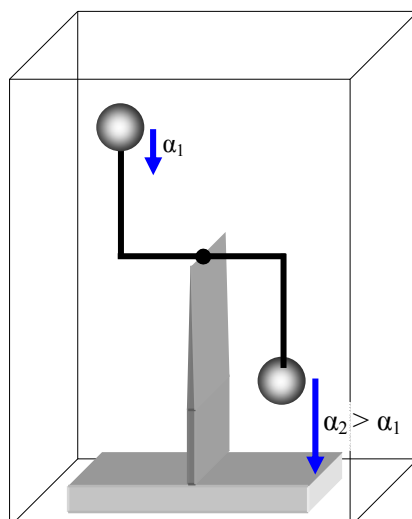

Figure 4.9: Schematic representation of the separation TE

The objects on each end of the balance are identical. The 'arms' are rigid. Gravity decreases with distance from Earth.

Judging from the context, J presumably aimed to illustrate that the influences of gravity do not always cease in free fall. J however did not take his TE further to infer that through non-local experiments (such as the balance described in the separation TE) we can calculate the weight of free falling objects. That is, J realised the *physical* outcome of his separation TE but left the *creative possibilities* unexplored. Unfortunately I did not urge the participants to explore this TE further during the interview.

How did J come up with this graceful TE? Was it generated based on a rule, or an imagistic model? Rule-based solutions are relatively fast, in contrast to the rather sluggish imagistic ones which can only model a limited number of simultaneous events (Hegarty & Sims, 1994). Also, rule-based solutions do not involve gestural behaviour (Schwartz & Black, 1996b) and other indicators of imagery, like those mentioned in 4.3.2 *A note on gesticulation as evidence for imagery*. There is evidence that no imagistic inferences took place in Extract 19. There are three alternative interpretations for this: (i) It could be that no imagistic simulation took place in the separation TE and this would be *negative* evidence against one of the very basic assumptions that underpin the naturalistic study of TEs: that the success of scientific TEs relies in the personal participation of the thought-experimenter and that the persuasiveness of a TE does not depend on pure deduction. This interpretation would mean that the TE was *deduced* through

rule-based reasoning. Where are the *simulated worlds* that Kuhn (1977), Gooding (e.g., 1992, 1993), Gendler (e.g., 1998, 2000) and Nersessian (1993), amongst others, necessitate as an indispensable psychological element of TEation? (ii) Alternatively, it could be that we can draw a line between the generative and the explorative processes of this TE: it could be that imagistic simulation is not invoked in the generative phase of this specific TE, but could be involved in the exploratory phase; only J did not explore the TE. Thus if he is urged to explore the TE, he imagistic simulation may be invoked. (iii) Or it could be that imagistic simulation was involved in the reasoning in Extract 19 but was *hidden* (non-externalised).

To explore these possibilities I constructed the following task to urge the participants to explore the scenario of the separation TE.

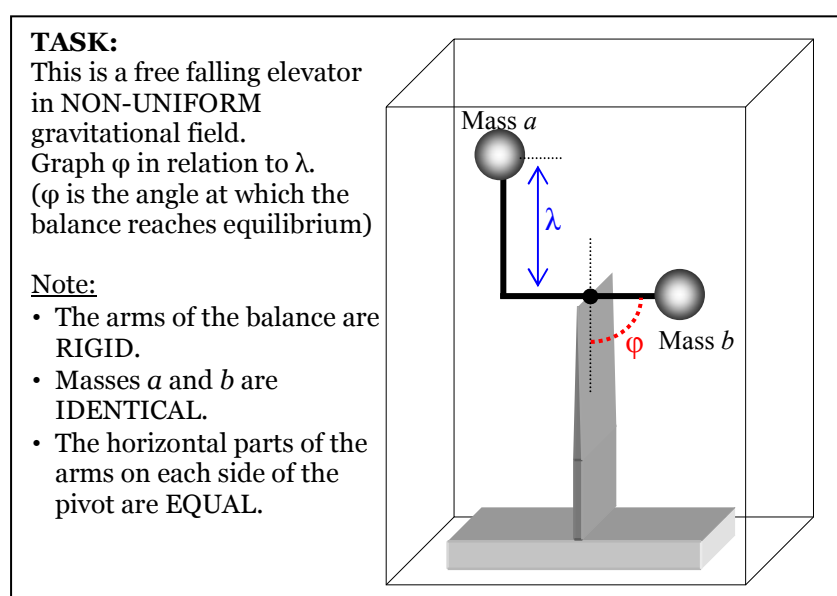

Figure 4.10: Task given to examine the exploratory processes of the separation TE

The task was designed in such a way so that a rule-based solution and a mental-animation-based one would deliver different conclusions:

- (i) *Possible rule-based solution:* If J and P are engaged in purely deductive reasoning from the rule that ‘a mass experiences more gravitational force when it is further away from the Earth’, then they would infer that for every λ bigger than 0, φ will be 0 too, i.e. the

balance would go all the way down.³² Of course this, in its own, would not be an infallible indicator that mental imagery is definitely not involved, and in fact it may be that the participants will not reach the anticipated conclusion because of misjudged inferences. However, a full flip of the balance in combination with lack of behavioural evidence of mental simulation would be a strong indicator in favour of deductive reasoning and the absence of imagistic reasoning.

- (ii) *Possible imagistic solution:* If J and P are engaged in imagistic simulation then they will at least recognise that the balance cannot go all the way down (Imagine that the balance rotates clockwise. Mass b cannot possibly go all the way down, because in such case mass a would have to go over the pivot. With both masses on the right side, equilibrium would be impossible). Such a prediction involves a mental animation of the system.

Now consider J and P's attempt to solve the task:

Extract 20 (session 2)

(Line 346 in the transcript)

J: So the greater the value of λ the less the acceleration on this object [points to mass a on the diagram] and the less force, therefore the moment on this is going to be less and less than this one [mass b] because this is constant so therefore as λ increases the angle will decrease.

P: If λ is zero then that's [points at the angle] 90 degrees. If it is a little bit more than zero then the force on that [mass b] is greater than the force on that [mass a] and the moment is greater. Will it turn all the way around?

J: I see, it is the same argument that once they are unbalanced it will fall all the way?

No gestures took place and furthermore J and P reasoned that the balance will turn all the way down. Therefore I am inclined to hypothesise that no imagistic simulation took place. Instead, it seems that this TE was generated in a sudden flash of creative inference. My hypothesis is that cumulative information critical to the inference made in the TE may have received activation from related material and through an 'Aha!' incident gave rise to

³² Note that if the mechanism of the balance were such that the perpendicular part of the left arm (i.e. the part that holds the weight) remained perpendicular during the rotation, then this inference would be correct.

this TE. Insights may occur when novel properties emerge unexpectedly when a coherence or systematic reclassification is discovered among pieces of information retrieved from memory (Finke, Ward, & Smith, 1992). Essentially this hypothesis reinterprets the generative processes of the *reductio* TE too, as an accumulation of critical information in the psychological context that provided the basis for generating interesting possibilities and exploring their implications.

But as the problem-solving proceeds, a gradual transition to imagistic reasoning seems to take place:

Extract 21 (session 2)

(Line 355 in the transcript - Extract continues from Extract 20)

J: As soon as it starts turning then this [points to mass a] is going to get higher and this [points to mass b] is going to get lower so the turning moment will be increasing as it turns because that [mass b] will experience bigger and bigger force than that [points to mass a]. So, once you get it into motion it will turn more and more [*With his eyes fixed on the diagram, J makes rotates his palms in front of the diagram (cf. Picture 4.13)*]. But because that [points at the arms of the balance] is fixed...

P: To make this [mass b] go straight down, that [mass a] must get to the point in which that mass [mass a] goes over the pivot. And then the balance will keep rotating.



Picture 4.13: An incident of imagery projection onto a diagram. J: 'So, once you get it into motion it will turn more and more' (Extract 21). With his eyes fixed on the diagram, J makes rotates his palms in front of the diagram.

Imagistic simulation is externalised as a projection of imagery onto the drawing of the balance (cf. Picture 4.13). Then J recognises that the arm is rigid ('But because that [points at the arms of the balance] is fixed...') and P, follows this line of reasoning and argues that the balance cannot go all the way

down, because if it did, there would be no equilibrium ('And then the balance will keep rotating').

How can this transition to imagistic simulation be explained? We can pose this set of hypotheses as a possible answer:

- (i) We may assume that Extract 20 essentially reflects the initial generative processes that gave rise to the TE in the first place: generated as a *hunch* about a system's behaviour, an insight based on cumulative relevant critical information.
- (ii) When J initially *generated* the separation TE, he did not explore it. Extract 20 reflects those explorative processes that did not take place when J generated the TE in the first place. J and P relied on a step-by-step runnable model to explore the TE.

Obviously the way this TE's generative and exploratory processes took place is not representative of all TEs: for example it does not reflect the generative and exploratory processes of basic TEs, which appear to be indistinguishable, that is, occurring in an one-shot cycle of simultaneous generation and exploration.

CHAPTER V

5 Interpretive synthesis

You see things; and you say, 'Why?'
But I dream things that never were; and I say, 'Why not?'
(George Bernard Shaw)

5.1 PREAMBLE

In the remainder of this work, section 5.2 summarises the analysis into a set of theoretical ideas about the role of intuition and imagistic simulation in TEs, and section 5.3 focuses on how the methodology can be improved for future doctoral research.

5.2 THEORETICAL CLAIMS

5.2.1 Main theoretical claim: the emergence hypothesis

In this section I attempt an answer to the first research question (cf. 3.1). What is the role of intuition and imagistic simulation in generating and exploring self-generated TEs in this protocol?

The most prevalent form of TEation in the protocol was what I called *basic*, so I start with hypotheses mainly grounded in the analysis of basic TEs. There are two working assumptions underpinning my interpretation of the workings of basic TEs:

- (i) That some lower-order knowledge has runnable content which prescribes what would happen in some imagined action.
- (ii) That the runnable content encapsulated in some lower-order structures is inaccessible unless applied in a concrete situation in which the prescribed action actually occurs.

Work on imagery is at an early stage, because we do not yet have a stable set of observation concepts and theoretical concepts relevant to the use of imagery that have any grounding in clinical studies (Clement, 2003). For both assumptions there is only sporadic empirical support from previous research.

With reference to the first assumption, Clement (1994, 2003, 2005) hypothesised that imagistic simulation in model construction involves the activation of a somewhat *general and permanent perceptual schema* that carries the information for an action. These schemes may transfer their runnability to a more complex schema. This suggests that some ideas that have content that is expressed imagistically (i.e. a *runnable* content) play the role of ‘axioms’ or ‘grounding primitives’ in another model-target which inherits the runnability of those axioms. Concrete entities are implemented into the model-target and the model is run. Finally, an expectation about the results of the action is generated. According to Clement, the last two subcomponents allow the schema to run as an imagistic simulation and be predictive.³³

With regards to the second assumption, some research in cognitive psychology suggests a complex dialectic between the beliefs system and simulated action. Schwartz and Black (1996a) argued for the inaccessibility of some beliefs unless they are involved in simulated action: for example, in Schwartz and Black’s (1996a) ‘glass tilting problem’ the participants were shown two glasses of different radiuses, and were asked which of the glasses would require a larger angle of tilt for the water to pour out. When participants just looked at the glasses and made qualitative judgements, their predictions were generally inaccurate. However, when they were asked to close their eyes and imagine tilting each glass until the imagined water started to pour, they correctly tilted the narrower glass further. The success of the mental simulation strategy motivates that the lower-level knowledge that underpins the imagined tilting of the glasses may be accessible only when it is used in a concrete application (Schwartz & Black, 1996b).

In the protocol I have identified an epistemological commitment in J and P’s thought-experimental reasoning. I refer to it as *verificationist* because it

³³ Early precedents of this idea are Schmidt’s (1982) motor control theory, and Gooding’s (1992) discussion on Faraday’s experimental thought and TEation.

describes an (most likely unconscious) attempt on behalf of the participants to generate imagined actions in which a phenomenological-primitive causal relationship is transcended to an *observable* (measurable, countable) aspect of the imaginary environment; instead of engaging in purely deductive reasoning directly from the causal relation.

I take this behaviour to be a result of the second assumption, and hypothesise a set of background processes underpinning basic TEs:

- (i) A relatively primitive intuitive element is cued. In all cases of basic TEs examined in the protocol the premise invoked the thought-experimenters' sense of kinaesthetic agency, e.g. the static ground intuition, the lightness intuition and the pseudo-force intuition (cf. Table 5.A).
- (ii) Then in satisfaction of verificationist commitments, new entities are introduced in the scenario and the causal relation is *made observable*.
- (iii) Empirical claims in basic TEs are not meant to induce unexpected results but only confirm intuitions. I mentioned before that 'to make observable' is like switching on the lights when entering a room: in the case of basic TEs, what the thought-experimenter 'sees' is what was already *believed* (but not *known*) to be: J and P believe (suspect) that rotation is detectable due to their pseudo-force intuition, and then they construct a concrete situation, the pseudo-force TE, and *know* that rotation is detectable.

I suggested that a possible mechanism for the transition from (ii) to (iii) could be a positive feedback loop that increases the reliability priority of the underpinning intuitive premise. According to this interpretation, basic TEs provide the mechanism for moving from intuition as a pre-symbolic schema to a pattern of actions and then rule-like expectations and descriptions. This hypothesis is grounded on a larger theoretical framework, that is, on the well-elaborated empirical claims of DiSessa's work on intuitive physics. My working assumption has been that learning physics involves structural changes in the learner's priority network (cf. fn. 26) and the generation of

sufficiently reliable networks of knowledge (an idea referred to as *systematicity* in the p-prims theory). Ultimately it would be expected that a basic TE induces a rule-like description of the system's behaviour that provides a parsimonious solution to similar situations. Therefore in subsequent encounters of tasks similar to those that invoked the generation of the basic TE, one would rely on the induced explicit knowledge rather than generate a basic TE again. In future studies there is need to design a methodology specifically aiming to investigate the claim that basic TEs induce such rule-like descriptions. Even though this study did not provide evidence that basic TEs induce rule-based descriptions, the proposed framework at least provides a plausible interpretation for a class of reasoning that is hard to explain in another way without dismissing akin instances that have been historically known as exemplary TEs, such as Galileo's ship TE.

In this analysis I have taken 'perceptual schemas' in their most fundamental form to be p-prims or relatively small clusters of p-prims. Even though DiSessa (1993) doesn't explore the issue of runnability of p-prims, his general description of p-prims is that they are *proposals* about some change (that is, they encapsulate information about it) but not the action itself because they have an arbitrary relation to real time. No research has been done yet to determine the runnable content of p-prims, thus there is no intention to suggest that *all* p-prims are runnable in terms of imagery. In the protocol one specific class of p-prims appears to have runnable properties: intuitions related to agentic causality, that is, abstracted over sensorimotor schemata. Knowledge encapsulated in them is manifested in thought-experimental situations involving quasi-perceptual experiences similar to those on which they were initially abstracted. The strongest evidence for the runnable content of agentic p-prims came with the analysis of the spring-scale TE (cf. 4.4.1 and 4.4.2) where there were indications for transfer of runnability from everyday life instances of 'feeling lighter' such as travelling in a lift (cf. Extract 18) to a situation in which the participants took the reading of a freefalling balance (Extract 17). The spontaneous use of similar depictive hand motions indicates that the participants were relying on the runnable content of the lightness-intuition in both cases.

Are basic TEs simulated actions?

The short answer to the first research question is that at least basic TEs are not (so) different from directly perceivable doing after all. Basic TEation resembles to a great extent inductive reasoning as this occurs through directly perceivable action, in which people would want to observe the world to confirm a hunch about a system's behaviour (cf. Figure 5.1). Like in directly perceivable doing, basic TEs are provide the thought-experimenters with novel phenomenology through quasi-perception. The idea is not new; more than a century ago, Mach (1893/1960, p.36) expressed a surprisingly similar view, attributing the workings of TEs to a process that triggers what he called *instinctive knowledge* to generate scientific principles:

Everything which we observe in nature imprints itself uncomprehended and unanalysed in our percepts and ideas... In these accumulated experiences we possess a treasure-store which is ever close at hand and of which only the smallest portion is embodied in clear articulate thought.

Of course, Mach was referring to instinctive knowledge as a sort of innate beliefs hard-wired into our brains, casting this kind of knowledge to an evolutionary framework, 'a biological necessity of conforming thought to environment' (Sorensen, 1992a, p.51). This is not the character I attribute to intuitive knowledge in this study, which is thought to derive (mostly) from experience. Beyond this disagreement, some TEs seem to harness knowledge that is directly inaccessible to the belief system, whether this knowledge is hard-wired or experientially abstracted. This stored knowledge is a basis for the events in an imaginary world in which 'experiments' take place.

Basic TEs seem to serve as surrogates for perceptual evidence that, if it were possible, would be collected through directly perceivable actions. The extent to which these actions deliver an accurate inference is presumably determined by the extent to which the same action would deliver an accurate inference if it were performed in the physical world. For example, through the telescope TE J and P inferred that the passenger of a uniformly moving box can detect her kinematical state if the walls are transparent; it is reasonable to assume that they would reach the same inaccurate conclusion through a similar *physical* experiment. The most significant difference between learning

through imagistic reasoning in basic TEs and learning via the mediation of the physical environment is the fact that basic TEation is independent from new sensory input. What gives basic TEs a seamless place with direct perception, and suggests a significant pedagogical application that deserves further investigation, is that the new phenomenology in a basic TE is the product of coming to understand what was *already* there in the belief system but in a lethargic state.

An imperative measure for the success of a theoretical interpretation of the role of intuition and mental simulation in TEation in this study was if some kind of coherent relations were found between intuition and mental simulation. Figure 5.2 summarises the hypothesised integrated workings of intuition and mental simulation in basic TEs. Basic TEs take advantage of the problem-solvers' reservoirs of tacit knowledge to deliver *internally* and *externally* coherent (cf. 2.4.2) predictions of a system's behaviour. The imaginary world emulates features of the physical world. But the imaginary world is not just an *imitation* but rather an *extension* of the physical because it provides the problem-solver with new phenomenology; this changes the thought-experimenter's descriptive apparatus to focus on different features and configurations of the world (but which world? the physical or the imaginary one? a clear-cut distinction between them seems rather vague and meaningless now).

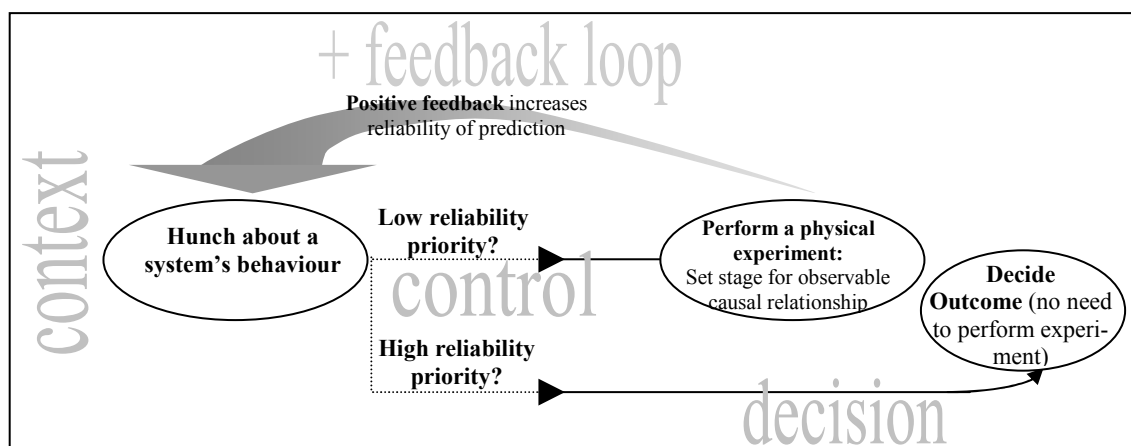

Figure 5.1: The feedback mechanism in the case of a physical experiment

In the case of a physical experiment (in its very basic form) one has a hunch and tests it through an appropriate procedure; if the hunch is verified then it ceases being 'just a hunch': the experiment will have induced a rule-like description of the system's behaviour and will not need to conduct an experiment in similar situations in the future. The hypothesised feedback mechanism for basic TEs is the mental analogue of the mechanism of such basic physical experiments and inductive reasoning.

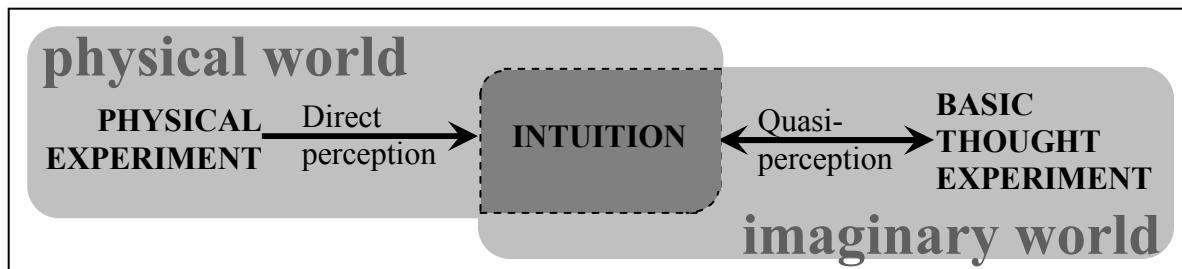

Figure 5.2: Why the physical and the imaginary worlds overlap

Intuition is the critical link between them: the phenomenology of the physical world is abstracted into intuition and intuition is used to prescribe the phenomenology of the imaginary world. Thus, experiments conducted in the physical or the imaginary worlds are on a continuum. The double arrow between intuition and the basic TE denotes the fact that the phenomenology of a basic TE is the result of intuition, and at the same time the basic TE ‘tunes’ the thought experimenter’s physical intuition. This way basic TEs are grounded in the physical world (giving an answer to the first paradox), and also deliver new knowledge (the second paradox).

In what follows I discuss the role of agentic causation in J and P’s thought-experimental reasoning, and finally discuss what was common amongst all TEs in the protocol.

5.2.2 Salient characteristics of TEs in the protocol

I hereby address the second research question. What are the salient characteristics of the TEs in the protocol in terms of the role of intuition and imagistic simulation?

Two broad types of self-generated TEs were identified in this protocol (cf. Table 5.A and Table 5.B): the *first class* includes the separation TE and the *reductio* TE. What would happen in the imaginary scenario is not known to the thought-experimenter unless she runs her TE. The TE is designed to *explore* what would happen in the imaginary scenario. The *second class* includes all the basic TEs produced. What would happen in the imaginary scenario is already known (as a weak expectancy - or better to say suspected) by the thought-experimenter before engaging with the TE. The TE is designed so as to *make observable-experientable* a tacitly known causal relationship.

These appear to be the common elements in *all* thought-experimental reasoning in *this* protocol:

(i) *Prevalence of agentive intuition:*

There are convergent lines of evidence suggesting that J and P's sense of agentive causality played a crucial role in *all* the TEs generated in the protocol: for example, the transfer of runnability from the lightness intuition (which is agentive) to a situation for which J and P have no direct intuitions (presumably they never actually measured the weight of a falling body), suggests that agentive intuition is transferred to non-agentive situations. Basic TEs in the protocol have a design which accommodates the sense of agentive causation of the problem solvers. But agency appears to have played a role in J and P's thought-experimental reasoning beyond basic TEs: for example, the crucial element that gave rise to the *reductio* TE (cf. 4.3.3) were gravity-related agentive intuitions. It could be that agentive intuitions provide the psychological context for intimate engagement and personal participation. The fact that basic TEs stand in a privileged relationship to the participants' sense of agency could be the key reason why they are such a prevalent type of TEation in the protocol. Further research should elaborate the role that agentive intuition plays in thought-experimental at various levels of expertise.

(ii) *The role of insight:*

All TEs in the protocol appear to have been generated in a flash of insight. For example, basic TEs occurred rapidly and automatically (e.g. similarly to the way people recognise the creative implications of a metaphor). TEs of the first class were generated through a rapid and sudden reconfiguration of the psychological context. In none of the TEs in the protocol were there repeated cycles of generations and explorations.

(iii) *The role of mental simulation:*

All TEs involved mental simulation. All basic TEs involved personal participation which invoked the thought-experimenters' sense-of agency (experienced through both spatial and proprioceptive quasi-perception). Amongst the two TEs of the second class, the separation TE provided the most interesting evidence about the psychological role of imagery. This TE was generated in a sudden flash of insight. Gradually there was an increasing amount and variety of imagery indicators, such as depictive gestures and

projection of imagery on the diagram of the task. My interpretation of the transition from non-imagery-based to imagery-based reasoning was that the first part, which was free of evidences of imagery, represents the generation part of the TE, whilst the second part where there were indications of imagery, represents the exploration part of the TE. Apparently during the generation phase the information about the behaviour of the balance that was encapsulated in the premises was accessed without the mediation of imagistic simulation. The behaviour of the system seems to have been predicted as 'just a hunch' (at such a low level of processing, we probably shouldn't call it 'deduction'). It seems reasonable to assume that the imagistic simulation in this specific TE was an indispensable part without which the prediction would remain 'just a hunch'. The reader will remember the discussion on Norton (1991, 1996) according to whom the simulated worlds of TEs are just ornamental as aids to comprehension. My interpretation raises objections to Norton's. It suggests that without a mentally simulated world the separation TE would remain 'just a hunch'. In other words, we do not perform an argument, but we *need* to perform a (thought) experiment (Gooding, 1998).

5.3 IMPLICATIONS FOR FUTURE DOCTORAL RESEARCH

The research design was generally successful in delivering relevant data: the tasks provided the context for the generation of a large number and variety of TEs. Collaborative learning proved apt in provoking the externalisation of mental worlds. Non-directive think-aloud allowed for the collection of data about nonverbal processes without directly interrogating the participants about these processes. The idea to have a second session so as to probe deeper into the TEs produced in the first session proved a very powerful technique for investigating TEation with no loss of contextual sensitivity. It can be improved by using more than two observation sessions as shown in Figure 5.3. This will potentially invoke richer data and will allow for more detailed analysis. The way forward in a future doctoral study is to look at participants from a variety of levels of expertise. Questions to be addressed could be, amongst others:

- (i) Basic TEation was shown to be the most prevalent type of TEation in the protocol. Is basic TEation a prevalent mode of thought-experimenting at various levels of expertise?
- (ii) Agentive intuition was shown to be prevalent in this protocol. Is its role prevalent in thought-experimental reasoning produced at various levels of expertise?
- (iii) To what extent do people realise the creative possibilities of their TEs at various levels of expertise?
- (iv) It is imperative that future research investigates the hypothesis that basic TEs induce rule-based descriptions and expectations. It seems to me important to pursue a better understanding of basic TEs in general: unlike more complex classes of TEs, basic TEs appear to involve only pre-symbolic modes of reasoning, thus they may provide a context for understanding the micro-level workings of intuition and mental simulation that are often difficult to discern in more complex forms of TEation.
- (v) Are insight and mental simulation *intrinsic* psychological properties of scientific thought-experimental reasoning? i.e. Does thought-experimenting in general require exploration through mental simulation? Are there types of scientific TEs that are not generated through insight but in a step-wise manner?

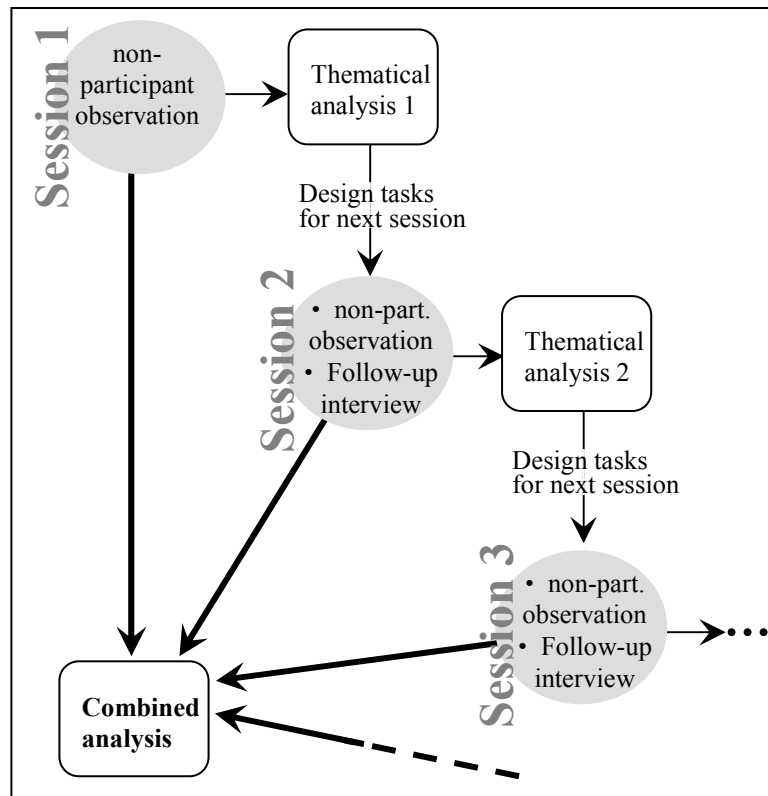



Figure 5.3: Proposed research design for future study

5.4 CONCLUSION

I proposed an interpretation for the way basic TEs deliver new empirical knowledge. This interpretation suggests that imaginary actions in basic TEs are on a continuum with directly perceivable actions. The crucial question that stems from the interpretation is: can we extend it to explain more complex forms of TEs? Can we suggest that all TEation is on a continuum with physical experimentation? There is evidence in this protocol that imagistic simulation is psychologically necessary in some more complex forms of TEation, which motivates that an affirmative answer is plausible; but we are a long way from making such a claim with confidence. If this is substantiated by future larger-scale research, then it would naturally lead us to pedagogy: if we can teach somebody to design and conduct physical experiments, and TEs are a mental analogue of physical experimentation, then, in principle, there is no reason why thought-experimenting cannot be taught as an educable skill.

Table 5.A: List of basic TEs in the protocol

Quotation	Premise	Evidence for imagistic simulation
<p><u>The telescope TE</u> P: ...if it [the uniformly moving box] was transparent. Well both [the uniformly-moving and the spinning passengers] should be able to tell if it was transparent. I mean, even if the box was miles away, miles, from any star, she could take readings using a telescope, and then see that the stars change as she goes along.</p>	<p><u>Static-ground intuition</u></p> <ul style="list-style-type: none"> • Schematisation: Motion observed from the ground is real motion, whilst motion observed from another system (e.g. a ship) is an appearance (Ueno, 1993; Ueno & Arimoto, 1993). • Comments: a point is thought to be static, and the impression of its movement indicates movement of the observer rather than of the reference point. 	<p>Reference to an imagistic model: ‘...see that the stars change as she goes along.’</p>
<p><u>The pseudo-force TE</u> P: She [the spinning passenger] should be able to tell just by dropping something and it will go out towards the side [away from] the centre of spinning.</p>	<p><u>Pseudo-force intuition:</u></p> <ul style="list-style-type: none"> • Schematisation: Rotation causes off-centre ‘push’. 	 <p>P moves his hand to illustrate the movement of the rock.</p>
<p>P: If she was in one point then she actually wouldn’t feel her motion, but because she actually has got volume, she may be feeling one arm being pulled in one way and the other arm in another.</p>	<p><u>A phenomenological syllogism based on these two premises:</u></p> <p>(a) <u>An intuition that relates velocity to pseudo-force intuition:</u></p> <ul style="list-style-type: none"> • Schematisation: During rotation, pseudo-force (off-centre ‘push’) increases with velocity • Comments: It is not surprising that pseudo-force is related to velocity, rather than the radius of rotation. In everyday life situations (i.e. driving a car or a bicycle) the directly manipulable parameter is the velocity rather than the radius of a curve. <p>(b) <u>Velocity is greater further from the centre</u> (assuming constant angular velocity).</p> <p>→ <u>From the phenomenological syllogism:</u> the more off-centre the rotation, the bigger the pseudo-force.</p>	 <p>Left: ‘If she was in one point then she actually wouldn’t feel her motion ...’ P joins his palms and arms upwards as if to represent an axis, perhaps an object as thin as an axis.</p> <p>Right: ‘...but because she actually has got volume, she may be feeling one arm being pulled in one way and the</p>



		 <p>other arm in another.’ Left: Projection of imagery onto the diagram of the task suggests that the relation ‘velocity is greater further from the centre of rotation’ was somehow established through imagistic simulation.</p>
J:[] If she [the passenger of the rotating box]’s sitting in the middle [of the rotating box] and her weight is evenly distributed, she would all be pulled.	Same as in the previous.	J makes a movement with his palms open, as if there is something in between his palms that is expanding.
<p>The spring-scale TE P: [] If [the object in the freefalling room is placed on] ‘springy’ scales, the downwards force on the object will stop as soon as you start accelerating.</p>	<p>Lightness intuition: • Schematisation: Falling objects ‘feel’ lighter.</p>	 <p>P rests his right palm on his left, apparently simulating a weight resting on a balance. This system is initially static but then he ‘lets go’ and both palms fall downwards. During this fall, his right hand palm, perhaps representing the weight, and his left hand palm, representing the balance, come apart.</p>

Table 5.B: List of other TEs in the protocol

Quotation	TE (reconstructed quotation)	Evidence for imagistic simulation
<p>The <i>reductio</i> TE J: ...[I]f [the passenger of the spaceship in ‘Physics in a spaceship’] jumped off the surface, then would she come back? Because she’s got a velocity she will eventually come down like the apple. But is it at the same point? P: Yeah I think. If it wasn’t then she would be pulled a bit backwards every time she made a</p>	<p>If, when the passenger in the rotating spaceship jumped perpendicularly to the floor of the spaceship, she landed a bit behind the initial point, then, at every step she made she would also cover a bit less distance than a full step. Thus there must be a mysterious force pulling her backwards, which the passenger would also sense when she stands still in the spaceship. This however is in conflict with the strong belief that the passenger feels</p>	<p>Beyond the fact that it seems to involve elements of personal participation, the use of imagistic simulation, if any, is unclear.</p>

<p>step forward... in the direction of rotation. And would feel a force pulling her to the opposite direction of the rotation when she is still.</p>	<p>the pseudo-force at a 90 degrees angle with the floor of the spaceship. Thus the passenger lands at the same point she jumped from (assuming that she jumped perpendicularly to the floor).</p>	
<p><u>The separation TE</u> J: A! How about if you create a separation between the thing you measure and the object, a very big separation, because of the thing with Earth that [gravity] further away [from Earth] gets less the object should fall slower, then you 'd see it change.</p>	<p>When the gravitational field is non-uniform, then the mechanical balance of the diagram will turn towards the weight that is closest to the Earth. J does not explicitly say what he aimed to show through this TE; judging from the context it could have been generated to contradict P's previous inferences that when free-falling a balance cannot measure any gravitational influences.</p> 	<p>Evidence for transition from non-imagery-based to imagery-based reasoning, the former being the generation part of the TE, the latter being the exploration part of the TE. During the exploration phase there were indicators of imagery such as imagery projection onto a diagram.</p> 

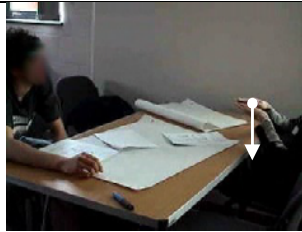
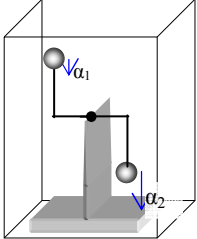
6 Bibliographies

6.1 BIBLIOGRAPHY ON THOUGHT EXPERIMENTS (MAINLY IN THE NATURAL SCIENCES)

Note: 6.4.1 includes studies that explore TEation from a philosophical lens. 6.4.2 includes studies that address topics related to TEation and pedagogy, or explore TEs from a psychological perspective. Where a clear distinction was not possible, the studies are included in both 6.4.1 and 6.4.2.

6.1.1 Mainly philosophical studies

- Arthur, R. T. W. (1999). On Thought Experiments as a Priori Science. *International Studies in the Philosophy of Science*, 13(3), 215-229.
- Bishop, M. A. (1998). An Epistemological Role for Thought Experiments. In N. Shanks (Ed.), *Idealization in Contemporary Physics (Poznan Studies in the Philosophy of the Sciences and the Humanities)* (Vol. 63, pp. 19-33). Atlanta, GA: Rodopi.
- Bishop, M. A. (1999). Why Thought Experiments Are Not Arguments? *Philosophy of science*, 66, 534-541.
- Bokulich, A. (2001). Rethinking Thought Experiments. *Perspectives on Science*, 9(3), 285-307.
- Brendel, E. (2004). Intuition Pumps and the Proper Use of Thought Experiments. *Dialectica*, 58(1), 89-108.
- Brown, J. R. (1986). Thought Experiments since the Scientific Revolution. *International Studies in the Philosophy of Science*, 1, 1-15.
- Brown, J. R. (1991). *The Laboratory of the Mind. Thought Experiments in the Natural Sciences*. London: Routledge.
- Brown, J. R. (1993). Why Empiricism Won't Work. In D. Hull, M. Forbes & K. Okruhlik (Eds.), *Proceedings of the 1992 Biennial Meeting of the Philosophy of Science Association* (Vol. 2, pp. 271-279). East Lansing, MI: PSA.
- Brown, J. R. (2004a). Peeking into Plato's Heaven. *Philosophy of science*, 71, 1126-1138.
- Brown, J. R. (2004b). Why Thought Experiments Transcend Empiricism. In C. Hitchcock (Ed.), *Contemporary Debates in Philosophy of Science* (pp. 23-43). Oxford: Blackwell.

Bibliographies

- Bunzl, M. (1996). The Logic of Thought Experiments. *Synthese*, 106(2), 227-240.
- Cohen, M. (2004). *Wittgenstein's Beetle and Other Classic Thought Experiments*. Oxford: Blackwell.
- Coleman, S. (2000). Thought Experiments and Personal Identity. *Philosophical Studies*, 98, 53-69.
- Einstein, A. (1945/1952). Letter to Jacques Hadamard. In B. Ghiselin (Ed.), *The Creative Process, a Symposium* (pp. 32-33). Berkeley, CA: University of California Press.
- Gendler, T. S. (1994). Tools of the Trade: Thought Experiments Examined. *The Harvard Review of Philosophy*, IV, 81-85.
- Gendler, T. S. (1998). Galileo and the Indispensability of Scientific Thought Experiment. *British Journal of Philosophy of Science*, 49, 395-424.
- Gendler, T. S. (2000). *Thought Experiment. On the Powers and Limits of Imaginary Cases*. New York: Garland Publishing.
- Gendler, T. S. (2003). Thought Experiments. In L. Nadel (Ed.), *Encyclopedia of Cognitive Science* (Vol. 4, pp. 388-394). London: Nature Publishing Group.
- Gendler, T. S. (forthcoming). Thought Experiments Rethought and Reperceived. *Philosophy of science*.
- Gooding, D. (1990). *Experiment and the Making of Meaning: Human Agency in Scientific Observation and Experiment*. Dordrecht: Kluwer Academic.
- Gooding, D. (1992). The Procedural Turn; or Why Do Thought Experiments Work? In R. N. Giere (Ed.), *Cognitive Models of Science*. MN, Minneapolis: University of Minnesota Press.
- Gooding, D. (1993). What Is Experimental About Thought Experiments? In D. Hull, M. Forbes & K. Okruhlik (Eds.), *Proceedings of the 1992 Biennial Meeting of the Philosophy of Science Association* (Vol. 2, pp. 280-290). East Lansing, MI: PSA.
- Gooding, D. (1994). Imaginary Science. *British Journal for the Philosophy of Science*, 45, 1029-1045.
- Gooding, D. (1998). Thought Experiment. In E. Craig (Ed.), *Routledge Encyclopedia of Philosophy* (Vol. 9, pp. 392-397). London: Routledge.
- Hacking, I. (1993). Do Thought Experiments Have a Life of Their Own? In D. Hull, M. Forbes & K. Okruhlik (Eds.), *Proceedings of the 1992 Biennial Meeting of the Philosophy of Science Association* (Vol. 2, pp. 302-310). East Lansing, MI: PSA.
- Horowitz, T., & Massey, G. J. (Eds.). (1991). *Thought Experiments in Science and Philosophy*. Maryland: Rowman & Littlefield Publishers.
- Ireson, G. P. (2005). Einstein and the Nature of Thought Experiments. *School Science Review*, 86(317), 47-53.

Bibliographies

- Kuhn, T. S. (1977a). *The Essential Tension*. Chicago: The University of Chicago Press.
- Kuhn, T. S. (1977b). A Function for Thought Experiments. In *The Essential Tension* (pp. 240-265). Chicago: The University of Chicago Press.
- Lipton, P. (1993). Review of Horowitz and Massey, Eds. *Thought Experiments in Science and Philosophy* (1991). *Ratio*, VI(1), 82-86.
- Mach, E. (1893/1960). The Principle of the Inclined Plane (T. McCormack, Trans.). In *The Science of Mechanics* (sixth ed., pp. 39-44). La Salle, IL: Open Court Publishers.
- Mach, E. (1905/1976). On Thought Experiment (T. J. McCormack & P. Foulkes, Trans.). In *Knowledge and Error* (pp. 134-147). Dordrecht: D. Reidel.
- Maidens, A. (1998). Idealization, Heuristics and the Principle of Equivalence. In N. Shanks (Ed.), *Idealization in Contemporary Physics (Poznan Studies in the Philosophy of the Sciences and the Humanities)* (Vol. 63). Atlanta, GA: Rodopi.
- McAllister, J. (1996). The Evidential Significance of Thought Experiments in Science. *Studies in the History and Philosophy of Science*, 27, 233-250.
- McAllister, J. W. (1993). Review of Sorensen *Thought Experiments* (1992). *Mind*, 102, 686-689.
- Miller, A. I. (1996a). Common Sense and Scientific Intuition. In *Insights of Genius: Imagery and Creativity in Science and Art* (pp. 1-36). New York: Springer-Verlag.
- Miller, A. I. (1996b). *Insights of Genius: Imagery and Creativity in Science and Art*. New York: Springer-Verlag.
- Nersessian, N. J. (1993). In the Theoretician's Laboratory: Thought Experimenting as Mental Modelling. In D. Hull, M. Forbes & K. Okruhlik (Eds.), *Proceedings of the 1992 Biennial Meeting of the Philosophy of Science Association* (Vol. 2, pp. 291-301). East Lansing, MI: PSA.
- Norton, J. D. (1996). Are Thought Experiments Just What You Thought? *Canadian Journal of Philosophy*, 26, 333-366.
- Norton, J. D. (2004). Why Thought Experiments Do Not Transcend Empiricism. In C. Hitchcock (Ed.), *Contemporary Debates in Philosophy of Science* (pp. 44-66). Oxford: Blackwell.
- Page, R. (Ed.). (In press). *Interpunct: Thought Experiments in Real Space*. Carcanet Press.
- Paggini, J. (2005). *The Pig That Wants to Be Eaten and Ninety Nine Other Thought Experiments*. London: Granta Books.
- Peijnenburg, J., & Atkinson, D. (2003). When Are Thought Experiments Poor Ones? *Journal for General Philosophy of Science*, 34, 305-322.
- Popper, K. R. (1968). On the Use and Misuse of Imaginary Experiments, Especially in Quantum Theory. In *The Logic of Scientific Discovery* (4th (revised) ed., pp. 442-456). London: Hutchinson.

Bibliographies

- Schrenk, M. (2004). Galileo Versus Aristotle on Free Falling Bodies. *Logical Analysis and History of Philosophy: History of the Philosophy of Nature*, 7.
- Sorensen, R. (1992a). *Thought Experiments*. Oxford: Oxford University Press.
- Sorensen, R. (1992b). Thought Experiments and the Epistemology of Laws. *Canadian Journal of Philosophy*, 22(1), 15-44.
- Winchester, I. (1991). Thought Experiments and Conceptual Revision. In M. R. Matthews (Ed.), *History, Philosophy and Science Teaching: Selected Readings*. Toronto: OISE Toronto Press.

6.1.2 Mainly studies in the qualitative physics tradition and science education

- Clement, J. J. (1984). A Conceptual Model Discussed by Galileo and Used Intuitively by Physics Students. In D. Gentner & A. L. Stevens (Eds.), *Mental Models* (pp. 325-329). Hillsdale, NJ: Erlbaum.
- Clement, J. J. (2002). *Protocol Evidence on Thought Experiments Used by Experts*. Paper presented at the Twenty-Fourth Annual Conference of the Cognitive Science Society, Mahwah, NJ.
- Gilbert, J. K., & Reiner, M. (2000). Thought Experiments in Science Education: Potential and Current Realisation. *International Journal of Science Education*, 22(3), 265-283.
- Gooding, D. (1990). *Experiment and the Making of Meaning: Human Agency in Scientific Observation and Experiment*. Dordrecht: Kluwer Academic.
- Gooding, D. (1992). The Procedural Turn; or Why Do Thought Experiments Work? In R. N. Giere (Ed.), *Cognitive Models of Science*. MN, Minneapolis: University of Minnesota Press.
- Gooding, D. (1993). What Is Experimental About Thought Experiments? In D. Hull, M. Forbes & K. Okruhlik (Eds.), *Proceedings of the 1992 Biennial Meeting of the Philosophy of Science Association* (Vol. 2, pp. 280-290). East Lansing, MI: PSA.
- Helm, H., & Gilbert, J. K. (1985). Thought Experiments and Physics Education-Part 1. *Physics Education*, 20, 124-131.
- Helm, H., Gilbert, J. K., & Watts, D. M. (1985). Thought Experiments and Physics Education-Part 2. *Physics Education*, 20, 211-217.
- Lattery, M. J. (2001). Thought Experiments in Physics Education. *Science & Education*, 10, 485-492.
- Miller, A. I. (1996a). *Insights of Genius: Imagery and Creativity in Science and Art*. New York: Springer-Verlag.
- Miller, A. I. (1996b). Visual Imagery in Scientific Thought. In *Insights of Genius: Imagery and Creativity in Science and Art* (pp. 325-378). New York: Springer-Verlag.
- Nersessian, N. J. (1993). In the Theoretician's Laboratory: Thought Experimenting as Mental Modelling. In D. Hull, M. Forbes & K. Okruhlik (Eds.), *Proceedings of the 1992 Biennial Meeting of the Philosophy of Science Association* (Vol. 2, pp. 291-301). East Lansing, MI: PSA.

Bibliographies

- Park, J., Kim, I., Kwon, S., & Song, J. (2001). An Analysis of Thought Experiments in the History of Physics and Implication for Physics Learning. In R. Pinto & S. Surinach (Eds.), *Physics Teacher Education Beyond 2000* (pp. 347-351). Paris: Elsevier.
- Reiner, M. (1998). Thought Experiments and Collaborative Learning in Physics. *International Journal of Science Education*, 20(9), 1043-1058.
- Reiner, M., & Gilbert, J. K. (2000). Epistemological Resources for Thought Experimentation in Science Learning. *International Journal of Science Education*, 22(5), 489-506.
- Reiner, M., & Gilbert, J. K. (2004). The Symbiotic Roles of Empirical Experimentation and Thought Experimentation in the Learning of Physics. *International Journal of Science Education*, 26(15), 1819-1834.

6.2 BIBLIOGRAPHY OF WORKS CITED

- Adelman, C., Kemmis, S., & Jenkins, D. (1980). Rethinking Case Study: Notes from the Second Cambridge Conference. In *Towards a Science of the Singular* (pp. 45-61). Norwich: Center for Applied Research in Education, University of East Anglia.
- Anapolitanos, D. A. (1991). Thought Experiments and Conceivability Conditions in Mathematics. In T. Horowitz & G. J. Massey (Eds.), *Thought Experiments in Science and Philosophy* (pp. 149-165). Maryland: Rowman & Littlefield Publishers.
- Arthur, R. T. W. (1999). On Thought Experiments as a Priori Science. *International Studies in the Philosophy of Science*, 13(3), 215-229.
- Audi, R. (Ed.). (1996). *The Cambridge Dictionary of Philosophy* (2nd ed.). New York: Cambridge University Press.
- Bailey, K. D. (1978). *Methods of Social Research*. London: Collier-Macmillan.
- Bassey, M. (2000). *Case-Study Research in Educational Settings*. Great Britain: Open University Press.
- Black, J. B., & Bower, G. H. (1980). Story Understanding as Problem Solving. *Poetics*, 0, 223-250.
- Boyatziis, R. E. (1998). *Transforming Qualitative Information: Thematic Analysis and Code Development*. Thousand Oaks, CA: Sage.
- Brown, J. R. (1991a). *The Laboratory of the Mind. Thought Experiments in the Natural Sciences*. London: Routledge.
- Brown, J. R. (1991b). Thought Experiments: A Platonic Account. In T. Horowitz & G. J. Massey (Eds.), *Thought Experiments in Science and Philosophy* (pp. 119-128). Maryland: Rowman & Littlefield Publishers.
- Brown, J. R. (2004a). Peeking into Plato's Heaven. *Philosophy of science*, 71, 1126-1138.
- Brown, J. R. (2004b). Why Thought Experiments Transcend Empiricism. In C. Hitchcock (Ed.), *Contemporary Debates in Philosophy of Science* (pp. 23-43). Oxford: Blackwell.
- Burnstein, L. (1997). Units of Analysis. In J. P. Keeves (Ed.), (2nd ed., pp. 775-781). Oxford, UK: Pergamon.
- Chisholm, R. M. (1987). The Truths of Reason. In P. K. Moser (Ed.), *A Priori Knowledge* (pp. 112-144). Oxford: Oxford University press.
- Clement, J. (1984). A Conceptual Model Discussed by Galileo and Used Intuitively by Physics Students. In D. Gentner & A. Stevens (Eds.), *Mental Models* (pp. 325-329). Hillsdale, NJ: Erlbaum.

Bibliographies

- Clement, J., Brown, D., & Zietsman, J. (1989). Not All Preconceptions Are Misconceptions: Finding 'Anchoring' Conceptions for Grounding Instructions on Students' Intuitions. *International Journal of Science Education*, 11, 554-565.
- Clement, J., J. (2003). Imagistic Simulation in Scientific Model Construction, *25th Annual Meeting of the Cognitive Science Society*. Cambridge, MA.
- Clement, J. J. (1994). Use of Physical Intuition and Imagistic Simulation in Expert Problem Solving. In D. Tirosh (Ed.), *Implicit and Explicit Knowledge*. Norwood, NJ: Ablex Publishing Corp.
- Clement, J. J. (2002). *Protocol Evidence on Thought Experiments Used by Experts*. Paper presented at the Twenty-Fourth Annual Conference of the Cognitive Science Society, Mahwah, NJ.
- Clement, J. J. (2005). Transfer of Imagery and Runnability from Analogies to Models in Experts, *AERA*. Montreal.
- Clement, J. J., & Steinberg, M. (2002). Step-Wise Evolution of Models of Electric Circuits: A 'Learning Aloud' Case Study. *Journal of the Learning Sciences*, 11, 389-452.
- Cohen, L., & Manion, L. (1989). *Research Methods in Education* (3rd ed.). London: Routledge.
- Coleman, S. (2000). Thought Experiments and Personal Identity. *Philosophical Studies*, 98, 53-69.
- de Kleer, J., & Brown, J. S. (1983). Assumptions and Ambiguities in Mechanistic Mental Models. In D. Gentner & A. L. Stevens (Eds.), *Mental Models*. Hillsdale, NJ: Erlbaum.
- DfES. (2002). *Key Stage 3 national Strategy. Framework for Teaching Science*. Retrieved January 5, 2005, from http://www.standards.dfes.gov.uk/keystage3/downloads/sc_fwkd1_10.pdf
- Diesing, P. (1972). *Patterns of Discovery in the Social Sciences*. London: Routledge & Kegan Paul.
- Dillenbourg, P., Baker, M., Blaye, A., & O'Malley, C. (1996). The Evolution of Research on Collaborative Learning. In E. Spada & P. Reiman (Eds.), *Learning in Humans and Machine: Towards an Interdisciplinary Learning Science* (pp. 189-211). Oxford, UK: Elsevier.
- diSessa, A. A. (1983). Phenomenology and the Evolution of Intuition. In D. Gentner & A. L. Stevens (Eds.), *Mental Models* (pp. 15-33). Hillsdale, NJ: Lawrence Erlbaum Associates.

Bibliographies

- DiSessa, A. A. (1988). Knowledge in Pieces. In G. Forman & P. Pufall (Eds.), *Constructivism in the Computer Age* (pp. 49-70). Hillsdale, NJ: Lawrence Erlbaum Associates.
- DiSessa, A. A. (1993). Towards an Epistemology of Physics. *Cognition and Instruction*, 10(2&3), 165-255.
- DiSessa, A. A., & Sherin, B. L. (1998). What Changes in Conceptual Change? *International Journal of Science Education*, 20(10), 1155-1191.
- Einstein, A. (1916/1997). The Foundation of the General Theory of Relativity. In A. J. Kox, M. J. Klein & R. Schulmann (Eds.), *The Berlin Years: Writings, 1914-1917* (Vol. 6). Princeton University Press.
- Einstein, A. (1945/1952). Letter to Jacques Hadamard. In B. Ghiselin (Ed.), *The Creative Process, a Symposium* (pp. 32-33). Berkeley, CA: University of California Press.
- Epstein, L. C. (1989). *Thinking Physics Is Gedanken Physics* (2nd ed.). San Francisco, CA: Insight Press.
- Ericsson, K. A., & Simon, H. A. (1980). Verbal Reports as Data. *Psychological Review*, 87, 215-251.
- Ericsson, K. A., & Simon, H. A. (1984). *Protocol Analysis*. Cambridge, MA: MIT Press.
- Erriksen, C. W., Webb, J. B., & Fournier, L. R. (1990). How Much Processing Do Nonattended Stimuli Receive? Apparently Very Little, But. *Perception and Psychophysics*, 47, 477-488.
- Finke, R. A. (1990). *Creative Imagery: Discoveries and Inventions in Visualisation*. Hillsdale, NJ: Erlbaum.
- Finke, R. A., Ward, T. B., & Smith, S. M. (1992). *Creative Cognition. Theory, Research, and Applications*. Cambridge, MA: MIT Press.
- Galilei, G. (1632/1953). *Dialogue Concerning the Two Chief World Systems* (S. Drake, Trans.). Berkeley, CA: University of California Press.
- Galilei, G. (1632/1954). *Dialogues Concerning Two New Sciences* (H. Crew & A. De Salvio, Trans.). New York: Dover Publications.
- Gasser, L. (1991). Social Conceptions of Knowledge and Action: Dai Foundations and Open Systems Semantics. *Artificial Intelligence*, 47, 107-138.
- Geelan, D. (1997). Epistemological Anarchy and the Many Forms of Constructivism. *Science & Education*, 6, 15-28.
- Gendler, T. S. (1994). Tools of the Trade: Thought Experiments Examined. *The Harvard Review of Philosophy*, IV, 81-85.

Bibliographies

- Gendler, T. S. (1998). Galileo and the Indispensability of Scientific Thought Experiment. *British Journal of Philosophy of Science*, 49, 395-424.
- Gendler, T. S. (2000). *Thought Experiment. On the Powers and Limits of Imaginary Cases*. New York: Garland Publishing.
- Gendler, T. S. (2003). Thought Experiments. In L. Nadel (Ed.), *Encyclopedia of Cognitive Science* (Vol. 4, pp. 388-394). London, UK: Nature Publishing Group.
- Gendler, T. S. (forthcoming). Thought Experiments Rethought and Reperceived. *Philosophy of science*.
- Gilbert, J. K., Osborne, R. J., & Fensham, P. (1982). Children's Science and Its Implications for Teaching. *Science Education*, 625-633.
- Gilbert, J. K., & Reiner, M. (2000). Thought Experiments in Science Education: Potential and Current Realisation. *International Journal of Science Education*, 22(3), 265-283.
- Gooding, D. (1989). Thought in Action: Making Sense of Uncertainty in the Laboratory. In M. Shortland & A. Warwick (Eds.), *Teaching the History of Science* (pp. 126-141). Oxford: Blackwells/BSHS.
- Gooding, D. (1992). The Procedural Turn; or Why Do Thought Experiments Work? In R. N. Giere (Ed.), *Cognitive Models of Science*. MN, Minneapolis: University of Minnesota Press.
- Gooding, D. (1993). What Is Experimental About Thought Experiments? In D. Hull, M. Forbes & K. Okruhlik (Eds.), *Proceedings of the 1992 Biennial Meeting of the Philosophy of Science Association* (Vol. 2, pp. 280-290). East Lansing, MI: PSA.
- Gooding, D. (1994). Imaginary Science. *British Journal for the Philosophy of Science*, 45, 1029-1045.
- Gooding, D. (1998). Thought Experiment. In E. Craig (Ed.), *Routledge Encyclopedia of Philosophy* (Vol. 9, pp. 392-397). London: Routledge.
- Grix, J. (2004). *The Foundations of Research*. London: Palgrave macmillan.
- Guba, E. G., & Lincoln, Y. S. (2000). In L. Cohen, L. Manion & K. Morrison (Eds.), *Research Methods in Education* (5th ed.). London: Routledge Falmer.
- Heath, C. (1997). The Analysis of Activities in Face to Face Interaction in Using Video. In D. Silverman (Ed.), *Qualitative Research: Theory, Method and Practice*. London: Sage.
- Hegarty, M. (1992). Mental Animation: Inferring Motion from Static Diagrams of Mechanical Systems. *Journal of Experimental Psychology. Learning, Memory and Cognition*, 18, 1084-1102.

Bibliographies

- Hegarty, M. (2002). *Mental Visualisations and External Visualisations*. Paper presented at the Twenty-Fourth Annual Conference of the Cognitive Science Society, Mahwah, NJ.
- Hegarty, M. (2004). Mechanical Reasoning by Mental Simulation. *Trends in Cognitive Sciences*, 8(6), 280-285.
- Hegarty, M., Kriz, S., & Cate, C. (2003). The Roles of Mental Animations and External Animations in Understanding Mechanical Systems. *Cognition and Instruction*, 21(4), 325-360.
- Hegarty, M., & Sims, V. K. (1994). Individual Differences in Mental Animation During Mechanical Reasoning. *Memory & Cognition*, 22, 411-430.
- Helm, H., Gilbert, J. K., & Watts, D. M. (1985). Thought Experiments and Physics Education-Part 2. *Physics Education*, 20, 211-217.
- Horowitz, T., & Massey, G. J. (Eds.). (1991). *Thought Experiments in Science and Philosophy*. Maryland: Rowman & Littlefield Publishers.
- Irvine, A. D. (1991). Thought Experiments in Scientific Reasoning. In T. Horowitz & G. J. Massey (Eds.), (pp. 149-165). Maryland: Rowman & Littlefield Publishers.
- Janis, A. I. (1991). Can Thought Experiments Fail? In T. Horowitz & G. J. Massey (Eds.), *Thought Experiments in Science and Philosophy* (pp. 149-165). Maryland: Rowman & Littlefield Publishers.
- Johnson-Laird, P. N. (1983). *Mental Models*. Cambridge, MA: Harvard University Press.
- Karlgren, K., & Ramberg, R. (1995). *Conceptual Change & Language Use in Learning*. Paper presented at the Workshop on Situated Cognition, Stockholm.
- Kaufman, D. R., Vosniadou, S., DiSessa, A. A., & Thagard, P. (2000). Scientific Explanation, Systematicity, and Conceptual Change. In L. Gleitman & A. K. Joshi (Eds.), *Proceedings of the Twenty-First Annual Meeting of the Cognitive Science Society*. Mahwah, NJ: Lawrence Erlbaum Associates.
- Kitchin, I. M., Hay, D. B., & Adams, A. (2000). How a Qualitative Approach to Concept Map Analysis Can Be Used to Aid Learning by Illustrating Patterns of Conceptual Development. *Educational Research*, 42(1), 43-57.
- Klatzky, R. L., Pellegrino, J. W., McCloskey, B. P., & Doherty, S. (1989). Can You Squeeze a Tomato? The Role of Motor Representations in Semantic Sensibility Judgements. *Journal of Memory and language*, 15, 56-77.

Bibliographies

- Kuhn, T. S. (1977). A Function for Thought Experiments. In *The Essential Tension* (pp. 240-265). Chicago: The University of Chicago Press.
- Laymon, R. (1991). Thought Experiments by Stevin, Mach and Gouy: Thought Experiments as Ideal Limits and as Semantic Domains. In T. Horowitz & G. J. Massey (Eds.), *Thought Experiments in Science and Philosophy* (pp. 149-165). Maryland: Rowman & Littlefield Publishers.
- Lincoln, Y. S., & Guba, E. G. (1985). *Naturalistic Enquiry*. Newbury Park, CA: Sage.
- Lipton, P. (1993). Review of Horowitz and Massey, Eds. Thought Experiments in Science and Philosophy (1991). *Ratio*, VI(1), 82-86.
- Mach, E. (1883/1960a). (T. McCormack, Trans.). In *The Science of Mechanics* (sixth ed.). La Salle, IL: Open Court Publishers.
- Mach, E. (1883/1960b). The Principle of the Inclined Plane (T. McCormack, Trans.). In *The Science of Mechanics* (sixth ed., pp. 39-44). La Salle, IL: Open Court Publishers.
- Mach, E. (1886/1897). *Contributions to the Analysis of the Sensations* (C. M. Williams, Trans.). Chicago: Open Court Publishing Company.
- Mach, E. (1893/1960). The Principle of the Inclined Plane (T. McCormack, Trans.). In *The Science of Mechanics* (sixth ed., pp. 39-44). La Salle, IL: Open Court Publishers.
- Mach, E. (1905/1976). On Thought Experiment (T. J. McCormack & P. Foulkes, Trans.). In *Knowledge and Error* (pp. 134-147). Dordrecht: D. Reidel.
- Matthews, M. R. (1998). Introductory Comments on Philosophy and Constructivism in Science Education. In M. R. Matthews (Ed.), *Constructivism in Science Education: A Philosophical Examination* (pp. 1-30). Dordrecht, London: Kluwer.
- McCloskey, M. (1983). Intuitive Physics. *Scientific American*, 248(4), 122-130.
- McNeil, D. (1987). *Psycholinguistics: A New Approach*. New York: Harper and Row Publishers.
- McQueen, R., & Knussen, C. (2002). *Research Methods for Social Sciences: An Introduction*. Essex: Pearson Education.
- Metcalf, J. (1986). Premonitions of Insight Predict Impending Error. *Journal of Experimental Psychology: Learning, Memory and Cognition*, 12, 623-634.
- Moore, G. E. (1925). A Defence of Common Sense. In J. H. Muirhead (Ed.), *Contemporary British Philosophy: Personal Statements. 2d Series* (pp. 193-223). London, UK: Allen & Unwin.

Bibliographies

- Nersessian, N. J. (1992). Constructing and Instructing: The Role of 'Abstraction Techniques' in Creating and Learning Physics. In R. Duschl & R. Hamilton (Eds.), *Philosophy of Science, Cognitive Psychology and Educational Theory and Practice* (pp. 48-68). New York: State University of New York.
- Nersessian, N. J. (1993). In the Theoretician's Laboratory: Thought Experimenting as Mental Modelling. In D. Hull, M. Forbes & K. Okruhlik (Eds.), *Proceedings of the 1992 Biennial Meeting of the Philosophy of Science Association* (Vol. 2, pp. 291-301). East Lansing, MI: PSA.
- Newton, I. (1686/1999). *The Principia: Mathematical Principles of Natural Philosophy* (I. B. Cohen & A. M. Whitman, Trans.). Berkeley: University of California Press.
- Nola, R. (1997). Constructivism in Science and Science Education: A Philosophical Critique. *Science & Education*, 6, 55-83.
- Norton, J. D. (1991). Thought Experiments in Einstein's Work. In T. Horowitz & G. J. Massey (Eds.), *Thought Experiments in Science and Philosophy* (pp. 129-148). Maryland: Rowman & Littlefield Publishers.
- Norton, J. D. (1996). Are Thought Experiments Just What You Thought? *Canadian Journal of Philosophy*, 26, 333-366.
- Novak, J. D. (2004). *A Science Education Research Program That Led to the Development of the Concept Mapping Tool and a New Model for Education*. Paper presented at the First International Conference on Concept Mapping, Pamplona.
- Nowak, L. (1994). Remarks on the Nature of Galileo's Methodological Revolution. In M. Kuokkanen (Ed.), *Idealisation Vii: Structuralism, Idealisation and Approximation: Poznan Studies in the Philosophy of Science and the Humanities 42* (pp. 111-126). Amsterdam: Rodopi.
- Ohlsson, S. (1990). The Mechanism of Restructuring Geometry. In *Proceedings of the 12th Annual Conference of the Cognitive Science Society* (pp. 237-244). Cambridge, MA: MIT Press.
- Pearson, M., & Somekh, B. (2000). *Concept Mapping as a Research Tool: A Study of Primary Children's Representations of Information and Communication Technologies (Ict)*. Paper presented at the British Educational Research Association Conference, Cardiff.
- Peijnenburg, J., & Atkinson, D. (2003). When Are Thought Experiments Poor Ones? *Journal for General Philosophy of Science*, 34, 305-322.
- Perret-clermont, A. N., Perret, F.-F., & Bell, N. (1991). The Social Construction of Meaning and Cognitive Activity in Elementary School Children. In L. Resnick, J. Levine & S. Teasley (Eds.), *Perspectives on Socially Shared Cognition*. Hyattsville, MD: American Psychological Association.

Bibliographies

- Popper, K. R. (1968). On the Use and Misuse of Imaginary Experiments, Especially in Quantum Theory. In *The Logic of Scientific Discovery* (4th (revised) ed., pp. 442-456). London: Hutchinson.
- QCA. *GCE Advanced Subsidiary (AS) and Advanced (A) Level Specifications. Subject Criteria for Physics*. Retrieved December 20, 2004, from <http://www.qca.org.uk/10371.html>
- Reiner, M. (1998). Thought Experiments and Collaborative Learning in Physics. *International Journal of Science Education*, 20(9), 1043-1058.
- Reiner, M., & Gilbert, J. K. (2000). Epistemological Resources for Thought Experimentation in Science Learning. *International Journal of Science Education*, 22(5), 489-506.
- Reiner, M., & Gilbert, J. K. (in press). The Symbiotic Roles of Empirical Experimentation and Thought Experimentation in the Learning of Physics.
- Resnick, L. B. (1988). *Ontological Commitments in Learning Physics*. Paper presented at the Meeting of Colloque International, CIRADE, Montreal.
- Rogers, E. M. (1960). *Physics for the Inquiring Mind: The Methods, Nature, and Philosophy of Physical Science*. London: Oxford University Press.
- Ruiz-Primo, M. A., & Shavelson, R. J. (1996). Problems and Issues in the Use of Concept Maps in Science Education. *Journal of Research in Science Teaching*, 33(6), 569-600.
- Scaife, M., & Rogers, Y. (1996). External Cognition: How Do Graphical Representations Work. *International Journal of Human-Computer Studies*, 45, 185-213.
- Schmidt, R. A. (1982). *Motor Control and Learning*. Champaign, IL: Human Kinetics Publishers.
- Schmuttermaier, J. R., & Schmitt, D. (2001). Smoke and Mirrors: Modernist Illusions in the Qualitative Versus Qualitative Research Debate. *Sociological Research Online*, 6(2). Retrieved November 15, 2004, from <http://www.socresonline.org.uk/6/2/schmuttermaier.html>
- Schooler, J. W., Ohlsson, S., & Brooks, K. (1993). Thoughts Beyond Words: When Language Overshadows Insight. *Journal of Experimental Psychology: General*, 122(2), 166-183.
- Schrödinger, E. (1935). *The Present Situation in Quantum Mechanics*. Retrieved June 1, 2005, from <http://www.tu-harburg.de/rzt/rzt/it/QM/cat.html>
- Schwartz, D. L. (1999). Physical Imagery: Kinematic Versus Dynamic Models. *Cognitive Psychology*, 38, 433-464.

Bibliographies

- Schwartz, D. L., & Black, J. B. (1996a). Analog Imagery in Mental Model Reasoning: Depictive Models. *Cognitive Psychology*, 30, 154-219.
- Schwartz, D. L., & Black, J. B. (1996b). Shuttling between Depictive Models and Abstract Rules: Induction and Fallback. *Cognitive Science*, 20, 457-497.
- Screiber, D. A., & Abegg, G. L. (1991). *Scoring Student-Generated Concept Maps in Introductory College Chemistry*. Paper presented at the Annual Meeting of the of the National Association for the Research in Science Teaching, Lake Geneva, WI.
- Sherin, B. L. (in press). Common Sense Clarified: Intuitive Knowledge and Its Role in Physics Expertise. *Journal of Research in Science Teaching*.
- Simons, H. (1996). The Paradox of Case Study. *Cambridge Journal of Education*, 26(2), 229-240.
- Smith, J. P., DiSessa, A. A., & Roschelle, J. (1993). Misconceptions Reconceived: A Constructivist Analysis of Knowledge in Transition. *Journal of the Learning Sciences*, 3(2), 115-163.
- Sorensen, R. (1992a). *Thought Experiments*. Oxford, UK: Oxford University Press.
- Sorensen, R. (1992b). Thought Experiments and the Epistemology of Laws. *Canadian Journal of Philosophy*, 22(1), 15-44.
- Stake, R. E. (1995). *The Art of Case Study Research*. London: Sage.
- Stenhouse, L. (1988). Case Study Methods. In J. Keeves, P. (Ed.), *Educational Research, Methodology, and Measurement. An International Handbook*. Oxford: Pergamon Press.
- Stevin, S. (1955). *The Principal Works of Simon Stevin* (Vol. 1: General Introduction and Mechanics). Amsterdam: C. W. Swets and Zeitlinger.
- Strauss, A., & Corbin, J. (1990). *Basics of Qualitative Research: Grounded Theory Procedures and Techniques*. Newbury Park, CA: Sage.
- Tesch, R. (1990). *Qualitative Research: Analysis Types and Software Tools*. London: Falmer Press.
- Toulmin, S. E. (1958). *The Uses of Argument*. Cambridge, UK: Cambridge University Press.
- Trickett, S., & Trafton, J. G. (2002). *The Instantiation and Use of Conceptual Simulations in Evaluating Hypotheses: Movies-in-the-Mind in Scientific Reasoning*. Paper presented at the Twenty-Fourth Annual Conference of the Cognitive Science Society, Mahwah, NJ.

Bibliographies

- Ueno, N. (1993). Reconsidering P-Prims Theory from the Viewpoint of Situated Cognition. *Cognition and Instruction*, 10(2&3), 239-248.
- Ueno, N., & Arimoto, N. (1993). Learning Physics by Expanding the Metacontext of Phenomenon. *The Quarterly Newsletter of the Laboratory of Comparative Human Cognition*, 15(2), 16-27.
- Ueno, N., Arimoto, N., & Fujita, G. (1990). *Conceptual Models and Point of View*. Paper presented at the Annual Meeting of the American Educational Research Association, Boston.
- Ungerleider, L. G., & Mishkin, M. (1982). Two Cortical Visual Systems. In D. J. Ingle, M. Goodale & R. Mansfield (Eds.), *Analysis of Visual Behaviour* (pp. 549-586). Cambridge, MA: MIT Press.
- Vosniadou, S. (1994). Capturing and Modelling the Process of Conceptual Change. *Learning and instruction*, 4, 45-69.
- Vosniadou, S., & Brewer, W. F. (1992). Mental Models of the Earth: A Study of Conceptual Change in Childhood. *Cognitive Psychology*, 24(535-585).
- Vygotsky, L. S. (1934/1989). *Thought and Language* (A. Kozulin, Trans.). Cambridge, MA: MIT Press.
- Vygotsky, L. S. (1978). *Mind in Society: The Development of Higher Psychological Processes*. Cambridge, UK: Cambridge University Press.
- Winchester, I. (1991). Thought Experiments and Conceptual Revision. In M. R. Matthews (Ed.), *History, Philosophy and Science Teaching: Selected Readings*. Toronto: OISE Toronto Press.
- Wittgenstein, L. (1969). *On Certainty* (D. Paul & G. E. M. Anscombe, Trans.). Oxford, UK: Basil Blackwell.
- Yoon, D., & Narayanan, N. H. (2004). *Mental Imagery in Problem Solving: An Eye Tracking Study*. Paper presented at the Eye Tracking Research and Applications (ETRA) Symposium, San Antonio, TX.
- Zelev, E. V., Lanaerts, J., & Wieme, W. (2004). Improving the Usefulness of Concept Maps as a Research Tool for Science Education. *International Journal of Science Education*, 26(9), 1043-1064.

Appendices

APPENDIX A PARADIGMATIC CASES OF TES

This Appendix includes classical TEs I consider as paradigmatic cases. All classical TEs referred to in the text are described here.

Stevinus' chain

Stevinus' question is how much force would be necessary to prevent a ball from sliding down an inclined plane. He asks us to imagine a triangular prism on the surface of which is a closed chain of 14 balls (all moving parts are free of friction). Stevinus concludes that the chain is in equilibrium, for otherwise the chain would move perpetually clockwise or counter-clockwise with an increasing speed, which is, from everyday experience, impossible. He next asks us to cut the string at the two lower corners of the prism. Since the chain was in equilibrium before the cut, it will remain in equilibrium after it because the dynamics of the system remain unchanged. From this, we conclude that the force required to hold one ball in place along an inclined plane is inversely proportional to the length of the plane (cf. Stevin, (1955); also in Mach (1883/1960b)).

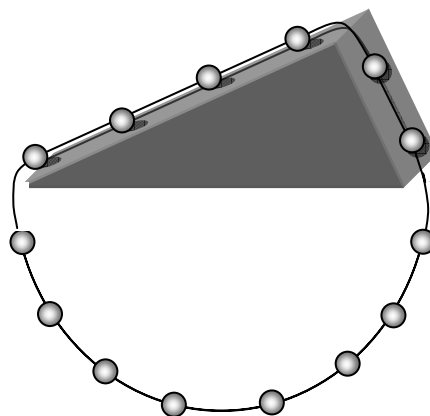

Galileo's free fall TE

Aristotelian physics assumed heavier bodies to fall faster than light ones. Galileo asks us to imagine that a heavy cannon ball is attached to a light musket ball. What would happen if they were released together? The Aristotelian law leads to an absurd conclusion: the light ball acting as a kind of a drag, will slow down the heavy one, so the speed of the combined system would be slower than the speed of the heavy ball falling alone. But this is absurd, because the combined system is heavier than the heavy ball alone, so it should fall faster than the heavy ball. How can the canon ball be both faster and slower than the even heavier combined system? The paradox is resolved by making the two speeds of the heavy ball and the combined system equal. For, if the speeds are equal, then the combined objects do not act on each others' motion when freefalling:

SALVIATI: ... One always feels the pressure upon his shoulders which prevents the motion of a load resting upon him, but if one descends just as rapidly as the load would fall, how can it gravitate or press upon him?... during free and natural fall, the small stone does not press upon the larger and consequently does not increase its weight as it does when at rest. (Galilei, 1632/1954, p.64)

Leibniz's maximum speed TE

In this TE Leibniz argues that there cannot be such a thing as a maximum speed in the universe: He asks us to suppose a rotating wheel, with each point of its rim moving at the hypothetical 'maximum possible speed' c . Then he asks to imagine a rod extending beyond the rim. Any point on the rod which extends beyond the rim is travelling at larger speed than the 'maximum possible speed' c , thus showing – in terms of the physics of Leibniz's days - that the notion of maximum speed is self-contradictory (cf. Winchester, 1991).

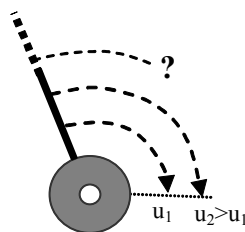

Galileo's ship TE

This TE is an illustration of classical principle of relativity. According to this principle, as formulated by later physicists, there is no internal observation by which one can distinguish between a system that is moving in a straight line at constant speed and one that is at rest. Says *Salviati* in the *Dialogues*

Concerning Two New Sciences:

Shut yourself up with some friend in the main cabin below decks on some large ship, and have with you some flies, butterflies and other small flying animals. Have a large bowl of water with some fish in it; hang up a bottle that empties drop by drop into a wide vessel beneath it. With the ship standing still, observe carefully how the little animals fly with equal speed to all sides of the cabin. The fish swim indifferently in all directions; the drops fall into the vessel beneath; and, in throwing something to your friend, you need throw it no more strongly in one direction than another, the distances being equal; jumping with your feet together, you pass equal spaces in every direction. When you have observed all these things carefully (though there is no doubt that when the ship is standing still everything must happen in this way), have the ship proceed with any speed that you like, so long as the motion is uniform and not fluctuating this way and that. You will discover not the least change in all the effects named, nor could you tell from any of them whether the ship was moving or standing still. (Galilei, 1632/1953, p.187)

Newton's bucket TE

Newton imagines a world where there are no planets and other objects in the universe except a bucket filled with water. At the initial state the water and the bucket are in relative rest in respect to each other. Probably extrapolating from his experience from the known physical world, Newton imagines that when the imaginary bucket starts rotating in the imaginary universe, then the water and the bucket will be in relative motion with respect to each other, the surface of the water being level. Afterwards, the water and the bucket will be in relative motion, and after some time, the water and the bucket will be rotating together (thus in relative rest) but the surface of the water will become concave, an indication that their kinetic state is not the same as it was in the initial state, even though their relative motion is the same. Newton's explanation of the imagined phenomenon is that in the last, but not in the initial state, the bucket and water are rotating with respect to what he calls

absolute space, therefore postulating the notion of ‘absolute motion’ (cf. Newton, 1686/1999).

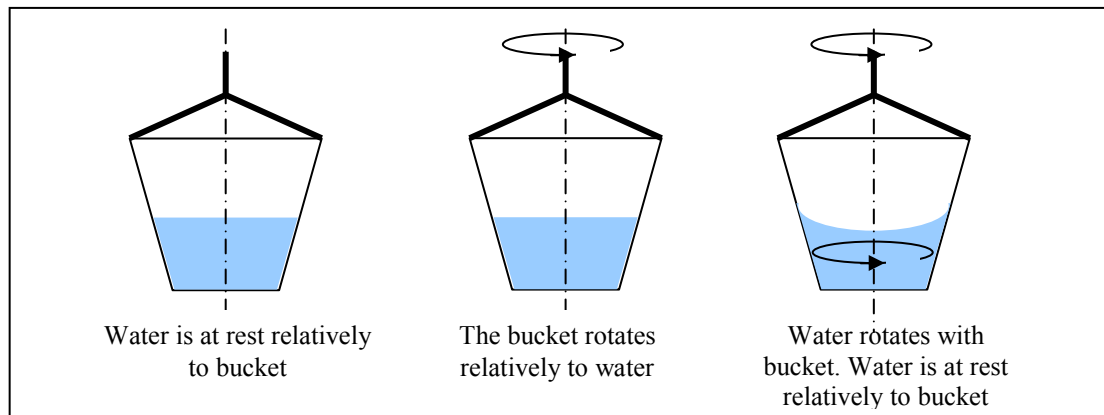

Einstein's spheroid TE

Einstein uses this TE to castigate Newton's ‘absolute space’ (which Newton postulated to explain the obscure behaviour of the bucket in his TE) on the grounds that it invokes a ‘merely *factitious* cause’ (Einstein, 1916/1997, p.149). Einstein described the TE as follows:

Two fluid bodies of the same size and nature hover freely in space at so great a distance from each other and from all other masses that only those gravitational forces need be taken into account which arise from the interaction of different parts of the same body. Let the distance between the two bodies be invariable, and in neither of the bodies let there be any relative movements of the parts with respect to one another. But let either mass, as judged by an observer at rest relatively to the other mass, rotate with constant angular velocity about the line joining the masses. This is a verifiable relative motion of the two bodies. Now let us imagine that each of the bodies has been surveyed by means of measuring instruments at rest relatively to itself, and let the surface of S1 prove to be a sphere, and that of S2 an ellipsoid of revolution. Thereupon we put the question — What is the reason for this difference in the two bodies? (Einstein, 1916/1997, p.148)

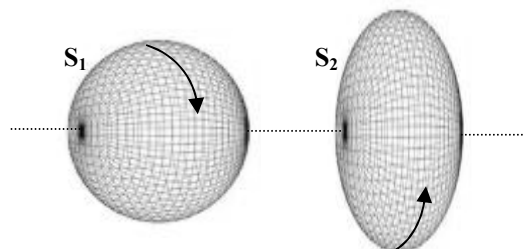

As to what causes the difference between S1 and S2, Einstein makes an epistemological prescription that ‘no answer can be admitted as epistemologically satisfactory, unless the reason given is an *observable fact of*

existence. ... Newtonian mechanics does not give a satisfactory answer to this question.' (Einstein, 1916/1997, p.149). According to Einstein, the behaviour of the spheroid and bucket TEs must be explained through an observable fact of experience, and absolute space is not such an observable fact. So Einstein argues that the difference between S_1 and S_2 (and similarly the difference between the flat and the concave water surface in the bucket TE) is caused by the influence of matter in the rest of the universe:

We have to take it that the general laws of motion, which in particular determine the shapes of S_1 and S_2 , must be such that the mechanical behaviour of S_1 and S_2 is partly conditioned in quite essential respects, by distant masses which we have not included in the system under consideration. These distant masses and their motions relative to S_1 and S_2 must then be regarded as the seat of the causes (which must be susceptible to observation) of the different behaviour of our two bodies S_1 and S_2 . They take over the role of the fictitious cause R_1 . (Einstein, 1916/1997, p.149)

Schrödinger's cat TE

Schrödinger in this TE attempts to undermine the uncertainty principle. He takes the indeterminacy, which is already strange in the micro-world, and magnifies its bizarreness into the macro-world:

One can even set up quite ridiculous cases. A cat is penned up in a steel chamber, along with the following diabolical device (which must be secured against direct interference by the cat): in a Geiger counter there is a tiny bit of radioactive substance, *so small*, that *perhaps* in the course of one hour one of the atoms decays, but also, with equal probability, perhaps none; if it happens, the counter tube discharges and through a relay releases a hammer which shatters a small flask of hydrocyanic acid. If one has left the entire system to itself for an hour, one would say that the cat still lives *if* meanwhile no atom has decayed. The first atomic decay would have poisoned it. The ψ -function of the entire system would express this by having in it the living and the dead cat (pardon the expression) mixed or smeared out in equal parts.

It is typical of these cases that an indeterminacy originally restricted to the atomic domain becomes transformed into macroscopic indeterminacy, which can then be *resolved* by direct observation. That prevents us from so naively accepting as valid a "blurred model" for representing reality. (Schrödinger, 1935)

On the Copenhagen interpretation the cat would be in a state of superposition, a mixture of living and dead, until someone opened the box and looked so the cat would pop into one of the two possible eigenstates.

APPENDIX B THE TASKS

B.1 **Tasks designed for session 1**

This Appendix includes the two problem sets designed for session 1, plus the accompanying cover page. Only 'Problem set B' was eventually used in the study.

Faculty of Education

184 Hills Road, Cambridge CB2 2PQ, UK



UNIVERSITY OF
CAMBRIDGE

Andreas Georgiou

Tel: 07910 284372 Email: ag427@cam.ac.uk

<http://www.georgiou.netfirms.com>

I have recently read a physics book with many exciting exercises in it. In fact, many of the problems set here draw upon this excellent book. In the preface, the author summarises what I am trying to achieve through my research, in just one paragraph:

You must guard your against letting the quantitative superstructure of physics obscure its qualitative foundation. It has been said by more than one wise old physicists that you really understand a problem when you can intuitively guess the answer before you do the calculation. How can you do that? By developing your physical intuition. How can you do THAT? The same way you develop your physical body – by exercising it. (Epstein, 1989, preface)

In this session, I will observe how you revise ideas about the physical world using something much more powerful than traditional problem solving: YOUR IMAGINATION and what some philosophers of science have called ‘everyday certainties about the world’. Indeed, many of the problems set here haunted some of the greatest minds of science; their solution needed more than one portion of what one could call *playful imagination!* So, that is what I call you to do today: *use your imagination:* in other words, control the problems, don’t let them control you!

Let these problems be your mental push-ups!

Note I will publish (my) solutions to these problems at www.cus.cam.ac.uk/~ag427/solutions/ as soon as possible, for your information.

Thank you for your kind participation!

Andreas Georgiou
ag427@cam.ac.uk
07910 284372

PROBLEM SET A

RE-ENTRY

Sputnik I, the first artificial satellite, fell back to earth because friction with the outer part of the earth's atmosphere slowed it down. As Sputnik spiralled closer and closer to the earth its speed was observed to

- (a) decrease
- (b) increase
- (c) remain the same

SCIENCE FICTION

As you move away from the earth its gravity gets weaker. But suppose it did not? Suppose it got stronger? If that fictitious law were so, would it be possible for things, like the moon, to orbit the earth?

- a) Yes, just as they presently do
- b) Yes, but unlike they presently do
- c) No, orbital motion could not occur

MAGNET CAR

Will hanging a magnet in front of an iron car, as shown, make the car go?

- a) Yes, it will go
- b) it will move if there is no friction
- c) it will not go

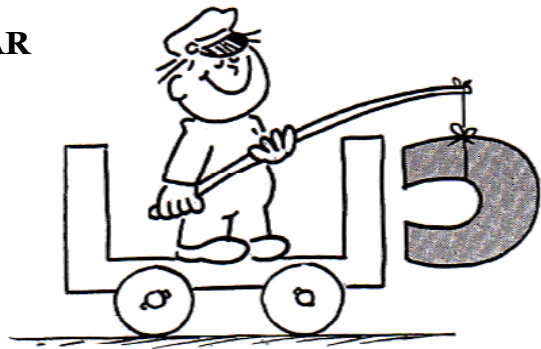

PHYSICS IN A SPACE SHIP

Think hard for this one: it is quite a stumper! Suppose a huge space ship (the form of a doughnut ring tube) is projected far into space where there are no nearby planets (thus no gravitational effects). The spaceship is spinning rapidly about its central axis perpendicular to the ring.

- (a) sketch a passenger standing the 'right way up' as he feels it –on his feet- inside the ring, near A; and another passenger near B and another at C.
- (b) Suppose a passenger releases an apple outside the ship. Which path will he observe?
- (c) Suppose a passenger at B pushes an apple 'upwards' through a trapdoor on the ceiling, to another passenger at A. Describe the kinematics of the apple according to passenger B, and according to an outside observer.

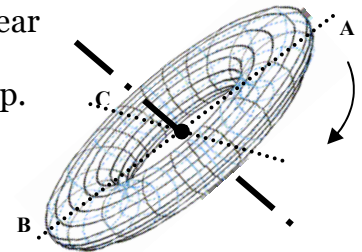

JAR OF FLIES

A bunch of flies are in a capped jar. You place the jar on a scale. The scale will register most weight when the flies are:

- a) sitting on the bottom of the jar

- b) flying around inside the jar
- c) ... weight of the jar is the same in both cases

According to book in which the problem appears, the answer is:

ANSWER: JAR OF FLIES

The answer is: c. When the flies take off or land there might be a slight change in the weight of the jar, but if they just fly around inside a capped jar the weight of the jar is identical to the weight it would have if they sat on the bottom. The weight depends on the mass in the jar and that does not change. But how is a fly's weight transmitted to the bottom of the jar? By air currents, specifically, the downdraft generated by the fly's wings. But that downdraft of air must also come up again. Does the air current not exert the same force on the top of the capped jar as on the bottom? No. The air exerts more force on the bottom because it is going faster when it hits the bottom. What slows the air down before it hits the top? Friction. Without air friction the fly could not fly.

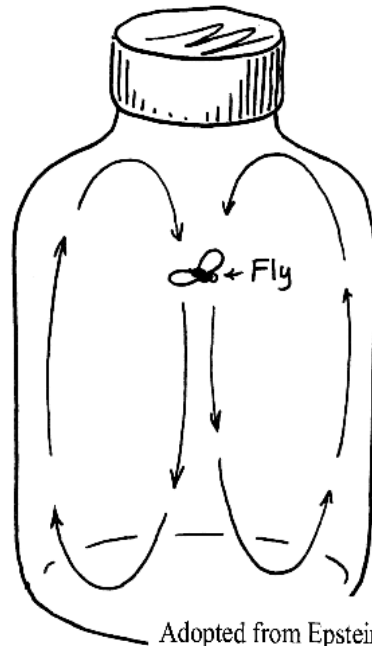

Adopted from Epstein(1998, p.31)

This argumentation does not convince me personally that (c) is the correct answer. Either persuade me that the author got it right, or persuade the author that he got it wrong!

PULL

How much is the tension of the rope (assuming that there is no friction)?

- (a) 10N
- (b) more than 10N
- (c) less than 10N



Notes:

All exercises and illustrations except 'Physics in a spaceship' and 'Pull' were adopted from Epstein L. C. (1989) *Thinking Physics is Gedanken Physics* (2nd ed.). San Fransisco, CA: Insight Press.

'Physics in a spaceship' was adopted from Rogers, E. M. (1960) *Physics for the Inquiring mind*. London: Oxford University Press.

PROBLEM SET B

ABSOLUTE MOTION

A scientist is completely isolated inside a smoothly-moving **opaque** box that travels a straight-line path through space, and another scientist is completely isolated in another **opaque** box that is spinning smoothly in space. Each scientist may have all the scientific goodies she likes in her box for the purpose of detecting her motion in space. The scientist in the

- box that travels a straight-line can detect her motion
- box that spins can detect her motion
- ... both can detect their motions
- ... none can detect their motions

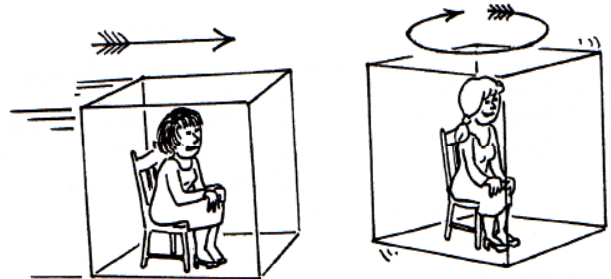

And what if the boxes were transparent?

STRONGMAN

When the strongman holds the rope like in the first picture, the tension in each strand of rope is equal to half the weight of the rope. So, if the rope is 10N, then the tension on each strand is 5N. If the strongman wished to stretch the rope into a horizontal position as shown, the tension of the rope would be

- zero
- about 5N
- 10N
- 20N
- more than a million N

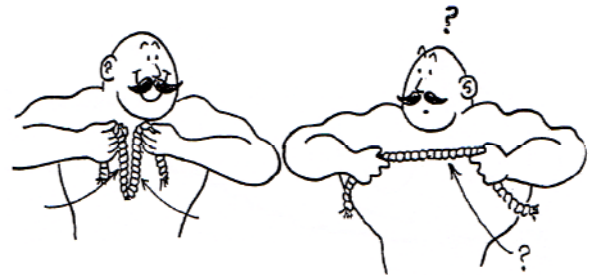

WHY DO THINGS FALL

You are in a freefalling falling room. Is it possible that you demonstrate that 'Earth is pulling an object' by weighing it whilst it is falling and you are falling with it?

ANTI-GALILEAN COSMOS

Time for a stumper!

Before Galileo, scientists thought that smaller weight bodies fall with smaller speeds than bigger weight bodies. Today we know that the acceleration of free-falling bodies is independent of their weight (of course, many students nowadays keep having pre-Galilean beliefs, which is unfortunate).

Suppose that we live in Cosmos X in which the laws of nature are different than in our Cosmos. In Cosmos X, light bodies fall with smaller acceleration than heavier ones.

Suppose now that you have moved to Cosmos X, where you conduct this experiment: You get a light stone and a heavier one, and you tie them together with a weightless string. What is the weight of the system now (i.e. the two stones together?)

JAR OF FLIES

A bunch of flies are in a capped jar. You place the jar on a scale. The scale will register most weight when the flies are:

- d) sitting on the bottom of the jar
- e) flying around inside the jar
- f) ... weight of the jar is the same in both cases

According to book in which the problem appears, the answer is:

ANSWER: JAR OF FLIES

The answer is: c. When the flies take off or land there might be a slight change in the weight of the jar, but if they just fly around inside a capped jar the weight of the jar is identical to the weight it would have if they sat on the bottom. The weight depends on the mass in the jar and that does not change. But how is a fly's weight transmitted to the bottom of the jar? By air currents, specifically, the downdraft generated by the fly's wings. But that downdraft of air must also come up again. Does the air current not exert the same force on the top of the capped jar as on the bottom? No. The air exerts more force on the bottom because it is going faster when it hits the bottom. What slows the air down before it hits the top? Friction. Without air friction the fly could not fly.

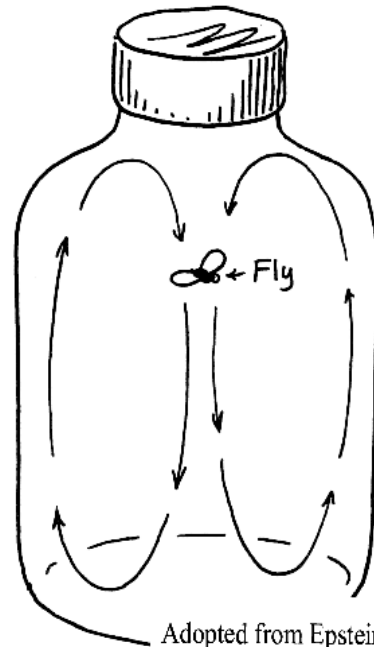

Adopted from Epstein(1998, p.31)

This argumentation does not convince me personally that (c) is the correct answer. Either persuade me that the author got it right, or persuade the author that he got it wrong!

PULL

How much is the tension of the rope (assuming that there is no friction)?

- (d) 10N
- (e) more than 10N
- (f) less than 10N



Notes:

All exercises and illustrations except 'Anti-Galilean Cosmos', 'Why do things fall' and 'Pull' were adopted from Epstein L. C. (1989) *Thinking Physics is Gedanken Physics* (2nd ed.). San Fransisco, CA: Insight Press.

B.2 Tasks designed for session 2

This Appendix includes some of the tasks designed for session 2.

(Because session 2's tasks were designed based on session 1's reasoning, only tasks related to the reasoning that is presented in this study are included in this appendix, i.e. only tasks that refer to session 1's 'Absolute Motion' and 'Why do things fall').

Only some of the tasks in this appendix are presented in the analysis chapter.

TASK ON 'ABSOLUTE MOTION'

A.

TASK: PHYSICS IN A SPACESHIP

Suppose a huge space ship of a doughnut-like shape is projected far into space where there are no nearby planets (thus no gravitational effects). The spaceship is spinning rapidly about its central axis perpendicular to the ring.

- (c) Sketch a passenger standing the 'right way up' as he feels it -on his feet- inside the ring, near A; and another passenger near B and another at C.
- (d) Suppose a passenger holds an apple and releases it. Where will the apple fall?

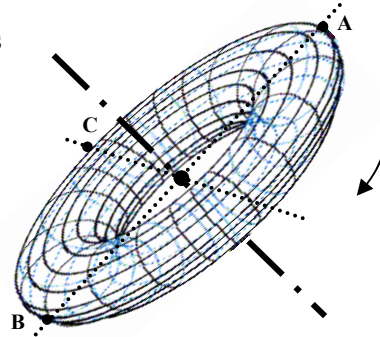

(adapted from Rogers, 1960, p.764)

TASKS ON 'WHY DO THINGS FALL?'

B.

(A) In a freefalling room there is a balance like the one in the figure (horizontal bar is rigid; dotted vertical lines are strings). Will the balance

- a. stay still
- b. move to the left
- c. move to the right?

(B) Now the room is falling in conditions with air resistance. We can vary the area of the elevator's floor and so change the acceleration α of the elevator in the medium (consider that acceleration α remains constant). What is φ going to be when the area of the floor is infinite?

Graph the relation between angle φ and acceleration γ .

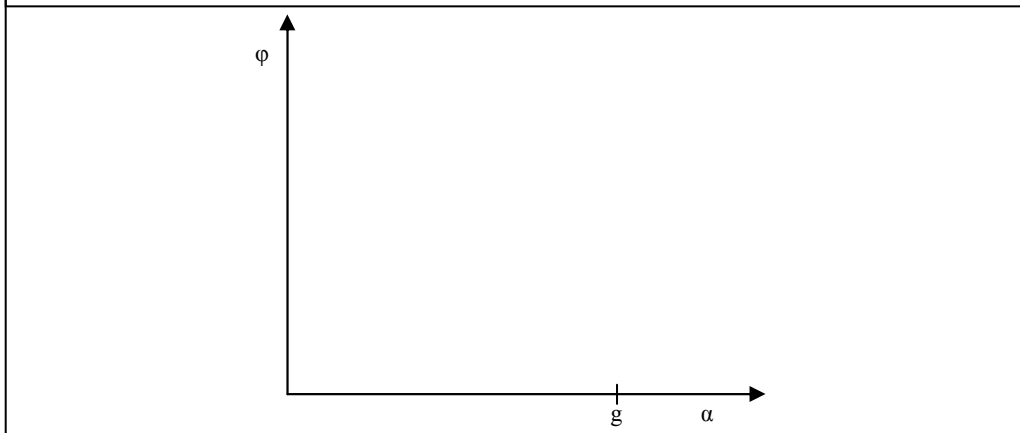
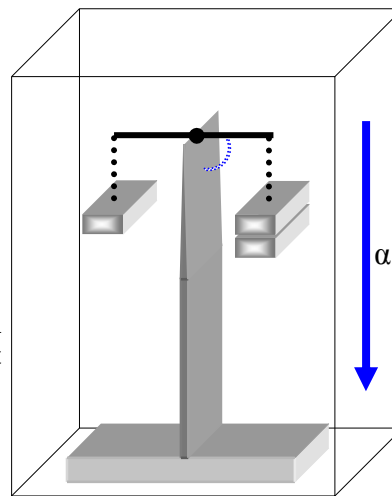

C.

These are balances in free-falling elevators. Will the balance move to the left, right, or stay still?

Notes:

- Take into consideration the fact that gravity gets less as we move further from the earth.
- Squares are objects of equal mass.
- Distance between successive dots is 1 unit of length.

1

2

3

D.

TASK: Graph φ in relation to λ .

- The gravitational field is **NON-UNIFORM**.
- The arms of the balance are **RIGID**.
- Masses a and b are **IDENTICAL**.
- The distances of the masses from the pivot are **EQUAL**.

APPENDIX C TRANSCRIPTS

This Appendix includes the transcripts for:

- *Parts of session 1 that refer to the solution of tasks ‘Absolute motion’ and ‘Why do things fall’.*
- *Parts of session 2 that are related to ‘Absolute motion’ and ‘Why do things fall’.*
Transcripts for all tasks in Appendix B.2 are included whether they are presented in the Analysis chapter or not.

The line numbers in the transcripts correspond to the extracts’ line numbers in the Analysis chapter.

TRANSCRIPTS FOR SESSIONS 1 AND 2

SESSION 1: Task ‘ABSOLUTE MOTION’

- J: A straight line means it is moving smoothly that is she is not accelerating, you see, so she would ... forces are being eliminated so she should feel the same things as... experience the same things as if she is completely still.
- 5 P: And because it [the box] is opaque, provided that nothing can get through the doors, there is no way she would see *what’s going on outside*.
- J: That is right, if she is going constant speed, she won’t.
- P: Yeah. There is no force.
- J: smooth yeah
- [pause]
- 10 P: Because she is completely isolated from the outside.
- J: Whereas the spinning lady, isn’t that ...
- P: There is an acceleration...
- J: towards the... centre... well each point of her is feeling an acceleration towards the centre.
- 15 P: She [the spinning passenger] should be able to tell just by dropping something and it will go out towards the side [away from] the centre of spinning. [*meanwhile P is illustrating the movement of the rock using his hand (cf. Picture 4.1)*].
- J: ... That kind of makes sense. What if she stood in one corner of the box?
- 20 P: Well she’d be always feeling a force. How, I mean it’s not//
- J: She feels... Acceleration would be... Would it be greater if she is outside... further out?
- P: Yeah it would.
- J: That’s not the question. So do you reckon that the lady who is spinning is
- 25 the one who can detect the motion?
- P: I think she can.
- J: Yeah
- P: Yeah it’s just cause to the fact that she’s spinning.
- P: ...If it was transparent. Well both [the uniformly-moving and the spinning
- 30 passengers] should be able to tell if it was transparent. I mean, even if the box was miles away, miles, from any star, she could take readings using a telescope, and then see that the stars change as she goes along.
- J: Yes, she could work it out, if she can see something.
- J: Cool

SESSION 2: Interview and further tasks on ‘ABSOLUTE MOTION’

- 35 A: How do you know that the object will move away from the centre?
- J: you experience the force but//
- P: You feel heavy. You are just being pushed like this [*his left palm pushing the right towards his right (cf. Picture 4.2)*]
- A: So, are there any points the lady sitting in the box//
- 40 P: Oh yeah.

- J: If she 's sitting in the middle she wont... we are talking about the rotating room... in the centre there wont be any acceleration because it is staying at one point.
- 45 J: Did I suggest that if she maybe walked in the centre of the box she'd feel greater acceleration?
- A: I was going to ask you about this. How do you this?
- J: See, if she's sitting in the middle and her weight is evenly distributed, she would all be pulled [*makes a movement with his palms open, as if there is something in between his palms that is expanding*]. But because she's got
- 50 irregular shape...
- P: If she was in one point [*joins his palms and arms upwards as if to represent an axis, perhaps an object as thin as an axis (cf. Picture 4.3)*] then she actually wouldn't feel her motion, but because she actually has got volume, she may be feeling one arm being pulled [*makes an outwards*
- 55 *movement with his right arm (cf. Picture 4.4)*] in one way and the other arm in another [*repeats the movement with his other hand*].
- P: If she was evenly distributed she might..... I don't know ,she might not... she would probably be feeling a force...
- A: How do you know that when you are sitting in the corner of the box you 'd
- 60 be feeling more acceleration than in the centre?
- J: Well, your velocity is changing at a greater rate, cause... no wait I haven't said that right. You are still travelling with the same angular velocity but your velocity around the outside is faster. You require a greater force to bring you into the centre.
- 65 A: What do you mean 'to bring you into the centre?'
- J: To maintain circular motion.
- A: What made you ask 'would it be greater if you sat outside?' You asked this before having an answer. Put differently, how did you think about this question?
- 70 J: I guess... when you are in the corner of the car, or something, and you [*makes movement with his arm from left to right*]... oh, I don't know... So, it's something like from experience. When you are travelling around the corner faster, then you experience greater force because you lean [*leans rapidly to his left (cf. Picture 4.5)*]. So it's something from experience. You
- 75 feel the further up, you are going faster than when you are closer the centre [*His eyes fixed at the diagram of the box, whilst making a circular movement around the box with his finger (cf. Picture 4.6)*].
- A: Now that you have seen the video, can you explain to someone who hasn't studied Newtonian mechanics why you answered the way you did to the
- 80 problem?
- J: you can say that if you are in the first box you will not experience anything different than when you were stationary.
- P: So if you are in a car and you travel//
- J: So, to someone who doesn't know mechanics you explain it through
- 85 experiences they can.
- A: And what if you were to give an explanation to a colleague?
- J: Probably you can discuss that for the first lady there is no resultant force so she doesn't experience anything different than when she stationary. For the second you talk about motion towards the centre of the circle.
- 90 P: And that to keep her travelling there is a force from somewhere that is acting inwards.

SESSION 2: Interviewer gives task ‘PHYSICS IN A SPACESHIP’

P: They are all going to have their feet on the outside wall wont they?

J: [long pause. Reluctantly answers ‘Yeah’]

95 P: Cause they will feel a force [*looks at the drawing and moves his finger outwards the spaceship*]. No there has to be a force acting on them inwards to keep them in a circular motion [*his eyes fixed on the diagram. Moves finger in a circular motion in front of the diagram (projection of imagery onto the diagram)*] so in order for that force to happen there will be a force on them from the outside wall [*moves his one palm towards his other, which is stationary, as if the stationary is the spaceship’s wall and the moving one is the person who tends to move outwards*]. And that would be a bit like a weight... gravity.

A: Now suppose that you have a passenger who holds an apple in the ship. Where will the apple fall when she releases the apple?

105 J: Initially the apple will have velocity in the direction that the guy is holding in the instance that the guy lets it go.

[Shakes his head in agreement]

It will maintain that direction. So it won’t have any acceleration towards the centre after he lets go of it. So it will go straight. Oh yes, it will hit the wall.

110 Did you get that? It will have the instantaneous velocity when he lets the apple go.

A: Will it drop at his feet, or will it drop behind his feet?

115 P: I think it will drop at his feet [*forms a curve with his palm, as if it is the curvilinear wall of the spaceship. He moves a finger of his other hand as if to simulate the trajectory of the apple*]

J: I think it will fall behind it.

P: It is moving tangentially to the right [(note that the spaceship is rotating clockwise according to the diagram in the task)] but he is moving right as well once he’s let it go.

120 J: But if he ‘s going that way, it will go that way and will miss it [*With the movements of his hands ‘draws’ the trajectories of the apple and the passenger - Picture 4.7*]

125 P: It goes like that [*‘draws’ a curvilinear trajectory with his finger on the desk*], the apple goes like that [*‘draws’ a linear trajectory with his other hand’s finger on the desk - Picture 4.8*] so it might be that they intersect.

J: I don’t get that. [*repeats the same diagram as in Picture 4.7 with his fingers*]. The apple will drop behind him.

130 P: But, I was thinking, as she is in the spaceship, to her it would look as if the apple is going down, whilst for someone outside it would look that the apple is going on the tangent; because she is moving around [*draws a segment of a circle by moving counter-clockwise his arm*] as the as the apple falls. Or, she sees the apple fall diagonally [*draws a diagonal trajectory to his right, which he interrupts after about 2 seconds and draws a new diagonal trajectory to his left (cf. Picture 4.9 and Picture 4.10)*].

135 J: I forgot there is no gravity.

P: Well there is no force acting when he lets the apple go.

J: So it wont necessarily fall, it will just go around.

P: It cannot go around. It will just go in a straight line.

140 A: Would the passenger observe the apple fall in uniform speed or with acceleration?

P: [*P is silently 'drawing' a diagram on the desk with his finger*] Because she is curving around, like that, I mean the apple is going on a straight line whilst the passenger is curving, I think it would appear to her as if the apple is coming towards her faster all the time. I think it will appear to her as if it is accelerating, even though there are no forces acting on it. She is accelerating relative to it because she is going inwards.

A: So, does the passenger experience force because of his rotation?

J: He must be, to keep him moving in that motion.

150 A: To summarise, the passenger is standing as you showed me, and there is a force on him which holds him on the wall. Presumably he can also walk on the wall?

J: Yes, it is effectively like on Earth, like a gravitational field. It is not the same way, because it is forcing him towards the outside, but it is something pressing her against the walls.

155 A: So is it a gravitational field?

J: No it is not a gravitational field, but it has the effect of keeping her against the floor.

A: Can you make connections with the apple?

P: So it would be like the apple is falling in a gravitational field.

160 J: I see what you mean. If she jumped off the surface, then would she come back? Because she's got a velocity she will eventually come down like the apple. But is it at the same point?

P: Yeah I think. If it wasn't then she would be pulled a bit backwards every time she made a step forward... in the direction of rotation. And would feel a force pulling her to the opposite direction of the rotation when she is still.

SESSION 1: Task 'WHY DO THINGS FALL'

P: I would say you can't measure its weight whilst it's falling.

J: If you could weight it could you show that as you fell the force of gravity became less on the object. But then that wouldn't necessarily prove that it's gravity. It would just show that the force it's pulling it down is getting less and less. You know when we talked about the inverse square the force gets stronger as you come closer to the earth.

P: I am not sure you could actually weigh something that was falling as it was falling. If something is falling//

J: It would have to be in freefall otherwise...

175 P: If you assume it is in freefall...

J: That means it is accelerating towards the Earth. Well it depends on how far from Earth you are.

P: Anyway it is accelerating towards the Earth.

J: If you fix them somehow... If you have a lot of objects falling and you measure the weight of the small object in relation to ... but you wouldn't be able to see the difference because the acceleration doesn't have anything to do with the//

P: Well, the weight is the force...

- 185 J: Why don't we say that it is the average that is pulling a body whilst is falling? We can do that by eliminating other things.
- P: Well the main question is whether you can measure the weight whilst is falling. But apart from that, what is the weight? It's a force that is acting towards [*points downwards with finger*].
- [long pause]
- 190 J: Could you weigh it by measuring the acceleration towards the Earth? You could know its mass, because you can measure that, can't you? ...but then you'd know the weight too.
- P: I was trying to think how you can measure the mass of the object.
- [Interviewer makes an intervention and clarifies that we measure the weight as we fall with the object.]
- 195 J: In a room that is falling. So it would appear to you as if it is...
- P: Well yeah, it just appears.
- J: Oh that makes sense... [pause]. That 's hard because you should fall with the same rate. So in this room and this thing is falling [*points at a marker on the desk*] how can we measure it [*its weight*]?
- 200 P: Well I don't think you could. Because if you are in a room you can't see yourself accelerating, even if you could calculate the mass somehow.
- J: What if in your room you have an object and you have some scales. You measure the forces.
- 205 P: Well it depends. Because if it [*the object*] was on the scales just before your room was left in the gap then, ignoring air resistance, everything drops at the same acceleration so everything stays in the room relatively to each other at the same positions they were before.
- J: So if it was on a set of scales when you let [*the room*] go then it [*the measurement on the balance*] should stay the same.
- 210 P: Well, no. If they are 'springy' scales, the downwards force on the object will stop as soon as you start accelerating [*Uses his left palm as a platform on which his right palm rests on, apparently simulating a weight resting on a balance. This system is initially static but then he 'lets go' and both palms fall downwards. During this fall, his right hand palm, perhaps representing the weight, and his left hand palm, representing the balance, come apart (cf. Picture 4.11)*].
- 215 J: A! How about if you create a separation between the thing you measure and the object, a very big separation, because of the thing with Earth that
- 220 [*gravity*] further away [*from Earth*] gets less the object should fall slower, then you 'd see it change. [*cf. Figure 4.9*]
- J: Because the change is small, you probably could.
- P: That's probably too much.
- 225 A: If there was air resistance. What if the falling room was falling in air?
- P: It would reach an amount of velocity
- A: No assuming that it is still accelerating
- J: Oh it is still accelerating. That means that the room would be travelling... the objects inside wouldn't be experiencing air resistance, would be free
- 230 falling, so therefore//
- P: If you had just your spring scale you would get some read [*meanwhile he repeats the same gestural model as before, but now his right hand (presumably representing the object) is moving much faster than his left*

235 hand (presumably representing the balance) – cf. picture below] because...
hang on... Yeah you would, because the room would be accelerating slower.

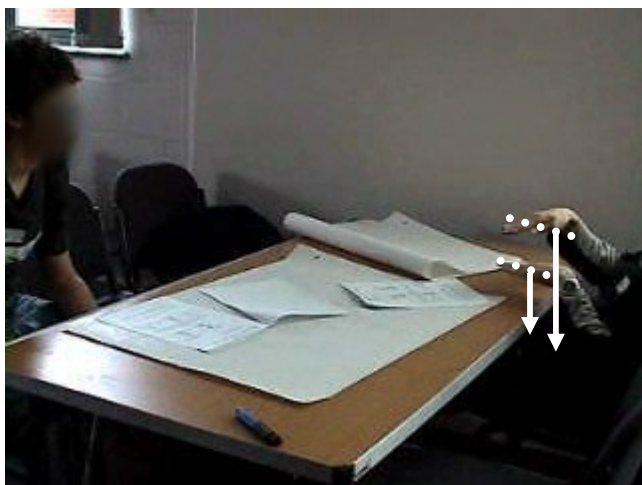

J: Yeah...Well no, it'd have the same [pause]

P: [mumbles] It'd have a lower acceleration because of the resisting force.

J: Yeah they 'd have the same pull. Yeah that's cool.

SESSION 2: Interview and further tasks on 'WHY DO THINGS FALL'

240 A: Can you write an answer to teach somebody who doesn't understand
Newtonian mechanics why you think that you cannot measure the weight of
the object?

J: You 'd probably say that you cannot experience something that is
experiencing force, you need to see how it moves in relation to something else.
245 You could sit on the outside and see it as it's falling it is getting faster and
faster. Whereas if you are falling with it at the same speed then//

P: You might talk about things that fall and how people feel when they are
falling such as in a lift that goes down really fast you feel lighter. You just have
a feeling that you are lighter. If you are in a lift and it is going really fast, if it is
250 falling on the free fall [*meanwhile his palms touch each other and move
downwards, apparently the one being the floor of the lift, the other one the
object (cf. Picture 4.12)]//*

J: The faster the lift is falling the less interaction you get from the base to feel
your own weight. If you imagine the lift is your scales and the object is you as
255 you fall and you are measuring your weight then you can measure your weight
according to the interaction you have with the base.

J: The faster the lift is falling the less interaction you get from the base to feel
your own weight. If you imagine the lift is your scales and the object is you as
you fall and you are measuring your weight then you can measure your weight
260 according to the interaction you have with the base.

A: If you are in the freefalling room and you hold a ball in your palms and you
let it go what happens to the ball?

J: It will fall at the same speed as you and//

P: When you let it go it falls at the same speed as you and then it falls with the
265 same acceleration as you and the room so it should stay at the same position.

A: If there is air resistance, I mean the room is still falling with acceleration but less than g , and you once again drop the ball, what will happen to the ball?

P: There is still air resistance on the ball.

270 J: Yes but if you have a room falling it is going to be experiencing more resistance than the ball. The ball's speed relatively to the air is really small because you might think that it is stationary when you drop it.

P: If you made the room really narrow and pointy, and you somehow made the air resistance on the room bigger than that on the ball, which is going to be incredibly difficult, then the ball would go upwards. A feather maybe would go
275 upwards because it has lots of air resistance considering its mass, so it might fall half the way than the room.

A: If you were born in such a room and the room is falling in conditions of air resistance, but you don't know that you are falling and you have never experienced the Earth conditions, what would the gravity of the room be the
280 passenger?

P: It would be less but it's still be there.

A: If there was no resistance?

P: She would feel no gravity.

SESSION 2: Interviewer gives Exercise B. (cf. Appendix B.2)

285 A: In a freefalling room you have this balance (shows diagram Q3). Will the balance stay still, move to the left or to the right?

P: If there is no air resistance it is going to stay where it is. If there is air resistance, then//

J: Then the room will accelerate faster than...

290 J: With the more air resistance you get... is air resistance proportional to speed?

P: In the case of zero acceleration, which is like being on Earth then that would tip all the way around.

J: Infinite air resistance is experienced by the room, but also everything that is in it, isn't that right?

295 P: Yeah if there is infinite air resistance in the room, then this wouldn't move down.

A: Suppose that there is no air resistance in the room.

P: Well, if acceleration is zero, then... Oh the air resistance will just stop the room.

300 J: I think as the amount of air resistance increases, the angle will get smaller.

A: Can you make this graph?

P: With infinite air resistance, it is like the ground. The weight will just go down. If there is some air resistance it is going to fall all the way down anyway. Because there is less angular momentum at the other side of the balance.

305 When there is any acceleration less than g , that [masses on the right side] is going to have a greater resultant force than the box, so that [masses on the right side] is going to accelerate down relative to the box *[meanwhile points on the diagram and makes downwards movements with his fingers]*. So it is just going to fall down. The graph will be a straight line [the angle being at

310 zero degrees], except at air resistance zero, when the angle will be at 90 degrees.

SESSION 2: Interviewer shows the video extract for the separation TE. Then shows the schematic representation he prepared for the separation TE (cf. Figure 4.9)

A: Is this how you meant your balance you talked about in the video?

J: That 's actually very good. Yeah that's it. It just needs to have a big separation between the two arms.

315 A: Explain what you mean.

J: The acceleration is greater the closer you are to the Earth. If you are low, you will be accelerating faster than the one that is further away, so your speed should increase would increase at a greater rate, so the separation should increase.

SESSION 2: Interviewer gives Exercise C. (cf. Appendix B.2)

320 J: The masses on both sides are the same, right?

P: Yes, but on this one the masses are further away from the Earth, so the weight is less.

A: How did you find this?

325 P: [Takes pen] These bits balance [scratches weights which are at the same height], so the only two that are left are these two. That one is further away from the Earth, so the gravitational force acting on it will be less.

J: Sorry, if it was still, the force on each site would be equal, right?

P: Well, no, the force on one side is still less.

330 J: I mean in a uniform gravitational field, because it would be the same weight and the same distance.

P: Yes, in a uniform gravitational field, then it would be equal.

A: Let's go to the second one.

335 J: It's going to go counter-clockwise. This [a] is further away so this will be accelerating less, but as it is greater distance away, the turning force is greater around the pivot. This one [d] is experiencing greater gravitational force but as it is closer to the pivot it causes less turning force. So they will probably cancel up.

340 P: No, the way I think, these two are the same distance [b and c], right? This one [c] is closer and experiences greater force. Considering these two, it will turn that way [clockwise]. Applying the same thinking to these two [a and d], it will turn the same direction. So when you combine them it will go that way around [clockwise].

A: Let's go the third.

345 P: It will go counter-clockwise. It is closer to the Earth, so it will experience greater acceleration, but it is also at greater distance from the pivot.

SESSION 2: Interviewer gives Exercise D. (cf. Appendix B.2)

J: So the greater the value of λ the less the acceleration on this object [points to mass a on the diagram] and the less force, therefore the moment on this is going to be less and less than this one [mass b] because this is constant so therefore as λ increases the angle will decrease.

350 P: If λ is zero then that's [points at the angle] 90 degrees. If it is a little bit more than zero then the force on that [mass b] is greater than the force on that [mass a] and the moment is greater. Will it turn all the way around?

J: I see, it is the same argument that once they are unbalanced it will fall all the way?

355 J: As soon as it starts turning then this [points to mass a] is going to get higher and this [points to mass b] is going to get lower so the turning moment will be increasing as it turns because that [mass b] will experience bigger and bigger force than that [points to mass a]. So, once you get it into motion it will turn more and more [*with his eyes fixed on the diagram, he makes a turn with his fingers in front of the diagram in his sheets (cf. Picture 4.13)*].
360 But because that [points at the arms of the balance] is fixed...

P: To make this [mass b] go straight down, that [mass a] must get to the point in which that mass [mass a] goes over the pivot. And then the balance will keep rotating.

APPENDIX D LETTER REQUESTING ACCESS



08 February 2005

THOUGHT EXPERIMENTATION IN PHYSICS

Dear [Principal of XXXX Sixth Form College]

I wish to inform you about a research project I am currently conducting and request your kind support in the fieldwork involved.

The project investigates the potential role that Thought Experimentation might play in physics Education. It is one of the very first to be conducted in this area, and is part of a larger research agenda which hopes to inform educational judgments on how Thought Experimentation may be included in the teaching of physics. The current project is part of the requirements of the degree Master of Philosophy at the University of Cambridge, Faculty of Education and aims to provide deep-level understanding of how self-generated Thought Experiments may provide an intellectual context in collaborative problem-solving.

Having considered the performance of your physics students in the 2004 A-level examinations, as well as the outstanding overall judgement of your Science program in the 2001/2 OFSTED inspection, students of XXXX Sixth Form College are expected to be suitable participants for the aims of this project.

I would appreciate it if you would give me your permission to inform A-level physics students at XXXX Sixth Form College about potential participation in this project. Copies of an information leaflet will be sent for distribution at the College, should you give your permission. I should be grateful if you could distribute the leaflet to interested A-level physics students. A short form will be attached to the leaflet and should be completed by the students who wish to participate, and then, should you agree, be collected by one of the teachers of the College. All subsequent arrangements for meetings with participants will be managed by the researcher. Sessions will be held *after school hours* at the new building of the Faculty of Education in Hills Road. Please find a copy of this information leaflet and form enclosed in this letter.

Benefits for students

It is hoped that the participants' involvement will bring benefits exceeding the commitments sought, as it will induct them in some interesting concepts of Newtonian mechanics and modern physics. The workshop and problem-solving sessions will be a helpful and positive enrichment activity for those who will participate.

Participation

The project hopes to enter the fieldwork stage beginnings of April 2005. This will involve observation of two groups of 4 A-level physics students each (thus 8 students in total).

Potential participants should have a vivid interest in physics and must commit to participate in two problem-solving meeting of 2 hours each, in which the participants will be expected to work collaboratively in a group of 4. The meetings will be observed by the researcher who will also keep a video record of the students work.

Dates and times of sessions can be arranged in collaboration with the College, so as to be as more convenient for the participants as possible. It is hoped that there will not be any need for extra demands from the participants.

Ethical declaration

I assure you that precautions for the anonymity of both the participants and the College will be strictly enforced. In no case will XXXX Sixth Form College be referred to with its name nor will it be described in a way that might make its identification possible. This applies both for this thesis and any subsequent publication of this research. Precautions for the confidentiality of participants will be strictly enforced, as they will be assigned pseudonyms known only to them and the researcher. All measures will be followed so as no information that could reveal their identity will be included. I also wish to assure the participants and the College that the project has non-judgemental and unobtrusive intentions. Particularly, it has no intention whatsoever to assess the students, and *in no circumstances will information be used in this or any future projects to assess the College.* Both the College and the participants are entitled to read the final thesis and verify that these assurances have been enforced as described.

Please find enclosed an outline of the research proposal and the ‘project information’ leaflet. You may also find an online edition of my CV at <http://georgiou.netfirms.com/CV.htm>.

For further arrangements I can be contacted by email at ag427@cam.ac.uk or by phone at 07910 284372.

Yours truly,

Andreas Georgiou

- Encl.**
- ‘Project information’ leaflet for students
 - Research proposal



Project information leaflet

Dear physics Student,

I wish to request your valuable contribution in a research project which I conduct at the University of Cambridge. The project involves notions of Newtonian mechanics and contemporary physics, and hopes to induct you in the strikingly odd ways the world can behave. It will be an overall helpful and positive experience, especially if you have a keen interest in physics.

Participation

You should be A-level physics students at XXXX Sixth Form College with a vivid interest in physics. You will be required to participate in **two problem-solving meeting of 2 hours (with intermission for snacks and drinks)**, in which you will be expected to work collaboratively in a group of 3 or 4. The meeting will be video recorded by the researcher.

PLEASE MAKE SURE THAT YOU CAN ATTEND BOTH PROBLEM-SOLVING MEETINGS.

If you are keenly interested in participating but the dates and times of the problem-solving meetings are inconvenient, do not hesitate to contact me at ag427@cam.ac.uk, as it may be possible to reschedule the meetings so as to allow more students to participate.

Ethical declaration

- No information that might reveal your identity will be included in the research report. You will be assigned pseudonyms known only to you and the researcher;
- The project has no intention whatsoever to assess you;
- You are entitled to read the final research report and verify that the assurances above have been enforced as described.

If you wish to participate, please complete the form below and return it to [Director of physics at XXXX Sixth Form College] **by the 4th of March.** Do not hesitate to contact me to discuss concerns and further questions. My email is ag427@cam.ac.uk.

Many thanks,
Andreas Georgiou
University of Cambridge, Faculty of Education



I would like to participate in the project. I can attend both problem sessions.

Name:

Email*: Mobile phone*:

*you might be contacted in case of date/time changes

	Date	Time	Venue
Problem-solving meeting A	<i>TBC with College</i>	<i>TBC with College</i>	Faculty of Education, 184 Hills Road
Problem-solving meeting B	<i>TBC with College</i>	<i>TBC with College</i>	Faculty of Education, 184 Hills Road

Please return to [Director of physics at XXXX Sixth Form College] by Friday 4th of March