

The 28th International Conference  
Of the  
International Group for the Psychology of  
Mathematics Education  
Volume 4  
14–18 July 2004  
Bergen, Norway

Table of Content

Research Reports – Full-Text

- p01-08      Situated or Abstract: The Effect of Combining Context and Structure on Constructing an Additive (Part-Part-Whole) Schema  
(Irit Peled; Ruth Meron)
- p09-16      Using Graphical Profiles to Study the Learning and Teaching of Mathematics  
(Dvora Peretz)
- p17-24      The Role of Number in Proportional Reasoning: A Prospective Teacher's Understanding  
(Axelle C. Person; Sarah B. Berenson; Paula J. Greenspon)
- p25-32      Learning to Use CAS: Voices from a Classroom  
(Robyn Pierce; Kaye Stacey)
- p33-40      Technical School Students' Conceptions of Tangent Lines  
(Márcia Maria Fusaro Pinto; Valéria Guimarães Moreira)
- p41-48      Elementary School Students' Mental Representations of Fractions  
(Demetra Pitta-Pantazi; Eddie M. Gray; Constantinos Christou)
- p49-56      A Structural Model for Problem Posing  
(Pittalis, M.; Christou, C.; Mousoulides, N.; Pitta-Pantazi, D.)
- p57-64      Some Undergraduates' Experiences of Learning Mathematics  
(Hilary Povey; Corinne Angier)
- p65-72      Normalising Geometrical Constructions: A Context for the Generation of Meanings for Ratio and Proportion  
(Psycharis, Georgos; Kynigos, Chronis)
- p73-80      The Sensual and the Conceptual: Artefact-Mediated Kinesthetic Actions and Semiotic Activity  
(Luis Radford; Serge Demers; José Guzmán; Michele Cerulli)
- P81-88      A Sociocultural Account of Students' Collective Mathematical Understanding of Polynomial Inequalities in Instrumented Activity  
(Ferdinand Rivera; Joanne Rossi Becker)
- p89-96      Infinity as a Multi-Faceted Concept in History and in the Mathematics Classroom  
(Ornella Robutti; Ferdinando Arzarello; Maria G. Bartolini Bussi)
- p97-104      Successful Undergraduate Mathematicians: A Study of Students in Two Universities  
(Melissa Rodd; Margaret Brown)

The 28th International Conference of the International Group for the Psychology of Mathematics Education, Volume 4, Bergen, Norway 14–18 July 2004

Research Reports - Full-Text

- p105-112 Bilingual Lessons and Mathematical World Views – A German Perspective  
(Katrin Rolka)
- p113-120 The Use of Models in Teaching Proof by Mathematical Induction  
(Gila Ron; Tommy Dreyfus)
- p121-128 Reflecting on Prospective Elementary Teachers' Mathematics Content Knowledge:  
The Case of Laura  
(Tim Rowland; Peter Huckstep; Anne Thwaites)
- p129-136 The Competent Use of the Analytic Method in the Solution of Algebraic Word  
Problems. A Didactical Model Based on a Numerical Approach with Junior High  
Students  
(Guillermo Rubio; Rafael Del Valle)
- p137-144 Language and Concept Development in Geometry  
(Frode Rønning)
- p145-152 The Role of Gestures in Conceptualisation: An Exploratory Study on the Integral  
Function  
(Cristina Sabena)
- p153-160 Psychological Aspects of Genetic Approach to Teaching Mathematics  
(Ildar S. Safuanov)
- p161-168 Routines in Non-Routine Problem Solving Processes  
(Wolfgang Schloeglmann)
- p169-176 Teacher Guidance of Knowledge Construction  
(Baruch Schwarz; Tommy Dreyfus; Nurit Hadas; Rina Hershkowitz)
- p177-184 Types of Student Reasoning on Sampling Tasks  
(J. Michael Shaughnessy; Matt Ciancetta; Dan Canada)
- p185-192 Didactic Model – Bridging a Concept with Phenomena  
(Beba Shternberg; Michal Yerushalmy)
- p193-200 Elaborating the Teacher's Role – Towards a Professional Language  
(Dianne Siemon; Jo Virgona; Maria Lasso; Vanessa Parsons; Juli Cathcart)
- P201-208 Making the Connection: Procedural and Conceptual Students' Use of Linking Words  
in Solving Problems  
(Adrian Simpson; Nora Zakaria)
- p209-216 Children's Conceptual Understanding of Counting  
(Slovin, Hannah; Dougherty, Barbara J.)
- p217-224 Adding Fractions Using 'Half' as an Anchor for Reasoning  
(Alina Galvão Spinillo; Maria Soraia Silva Cruz)

The 28th International Conference of the International Group for the Psychology of Mathematics Education, Volume 4, Bergen, Norway 14–18 July 2004

Research Reports - Full-Text

- p225-232 Persistence of Decimal Misconceptions and Readiness to Move to Expertise  
(Vicki Steinle; Kaye Stacey)
- p233-240 Molly and Equations in A2: A Case Study of Apprehending Structure  
(Nada Stehliková; Adrian Simpson)
- p241-248 Image - Metaphor - Diagram: Visualisation in Learning Mathematics  
(Rudolf Sträßer; Gert Kadunz)
- p249-256 Images of Fractions As Processes and Images of Fractions *In* Processes  
(Marek Sulista; Jan Herman; Lucia Ilucova; Veronika Kremsova; Jiri Pribyl;  
Janka Ruppeldtova; Adrian Simpson; Nada Stehlikova; Michaela Ulrychova)
- p257-264 Describing Elements of Mathematics Lessons that Accommodate Diversity in  
Student Background  
(Peter Sullivan; Judy Mousley; Robyn Zevenbergen)
- p265-272 Orchestrating Mathematical Proof Through the Use of Digital Tools  
(Rosamund Sutherland; Federica Olivero; Marnie Weeden)
- p273-280 School-Based Community of Teachers and Outcomes for Students  
(Paola Sztajn; Martha Alexsaht-Snider; Dorothy Y. White; Amy Hackenberg)
- p281-288 Thinking Through Three Worlds of Mathematics  
(David Tall)
- p289-296 The Effect of Students' Roles on the Establishment of Shared Meanings During  
Problem Solving  
(Konstantinos Tatsis; Eugenia Koleza)
- p297-304 Integrating CAS Calculators Into Mathematics Learning: Partnership Issues  
(Michael O. J. Thomas; Ye Yoon Hong)
- p305-312 The Development of Structure in the Number System  
(Noel Thomas)
- p313-320 Orientations to Numeracy: Teachers' Confidence and Disposition to Use  
Mathematics Across the Curriculum  
(Steve Thornton; John Hogan)
- p321-328 Efficiency and Adaptiveness of Multiple School-Taught Strategies in the Domain of  
Simple Addition  
(Joke Torbeyns; Lieven Verschaffel; Pol Ghesquière)
- p329-336 Supporting Teachers on Developing Teaching Norms Based on Children's Learning  
Mathematics  
(Wen-Huan Tsai)
- p337-344 Prospective Teachers' Images and Definitions: The Case of Inflection Points  
(Pessia Tsamir; Regina Ovodenko)
- p345-352 Fostering Mathematical Meaning Via Scientific Inquiry: A Case Study  
(Ron Tzur; Rita A. Hagevik; Mary E. Watson)

The 28th International Conference of the International Group for the Psychology of Mathematics Education, Volume 4, Bergen, Norway 14–18 July 2004

Research Reports - Full-Text

- p353-360 Students Building Isomorphisms  
(Elizabeth B. Uptegrove; Carolyn A. Maher)
- p361-368 How Do High School Students Interpret Parameters in Algebra?  
(Sonia Ursini; María Trigueros)
- p369-376 Causes Underlying Pre-Service Teachers' Negative Beliefs and Anxieties About Mathematics  
(Liisa Uusimaki; Rod Nason)
- p377-384 Fractions in Adult's Elementary School: The Case of Lucina  
(Marta Elena Valdemoros- Alvarez)
- p385-392 Students' Overreliance on Proportionality: Evidence from Primary School Pupils Solving Arithmetic Word Problems  
(Wim Van Dooren; Dirk De Bock; An Hessels; Dirk Janssens; Lieven Verschaffel)
- p393-400 From Functions to Equations: Introduction of Algebraic Thinking to 13 Year-Old Students  
(Petros Verikios; Vasiliki Farmaki; Nikos Klaoudatos)
- P401-408 Critical Awareness of Voice in Mathematics Classroom Discourse: Learning the Steps in the 'Dance of Agency'  
(David Wagner)
- p409-416 Metaphors and Cultural Models Afford Communication Repairs of Breakdowns Between Mathematical Discourses  
(G.D. Wake; J.S. Williams)
- p417-424 Generalising Arithmetic: Supporting the Process in the Early Years  
(Elizabeth Warren)
- p425-432 A Framework for Describing the Processes that Undergraduates Use to Construct Proofs  
(Weber, Keith)
- p433-440 The Nature of Spontaneity in High Quality Mathematics Learning Experiences  
(Gaye Williams)
- p441-448 Spreadsheet Generalising and Paper and Pencil Generalising  
(Wilson, Kirsty; Ainley, Janet; Bills, Liz)
- p449-456 A Comparison of a Visual-Spatial Approach and a Verbal Approach to Teaching Mathematics  
(Woolner, Pamela)
- p457-464 Differentiation of Students' Reasoning on Linear and Quadratic Geometric Number Patterns  
(Kai-Lin Yang; Fou-Lai Lin)
- p465-472 Map Construction as a Context for Studying the Notion of Variable Scale  
(Nikoleta Yiannoutsou; Chronis Kynigos)

The 28th International Conference of the International Group for the Psychology of Mathematics Education, Volume 4, Bergen, Norway 14–18 July 2004

Research Reports - Full-Text

- p473-480 Understanding How the Concept of Fractions Develops: A Vygotskian Perspective  
(Kaori Yoshida)
- p481-488 Secondary Mathematics Teachers' Knowledge Concerning the Concept of Limit and Continuity  
(Zachariades, T.; Mastorides, E.)
- p489-496 Characteristics of Mathematical Problem Solving Tutoring in an Informal Setting  
(Orit Zaslavsky; Iris Zodik)
- p497-504 Making Sense of Irrational Numbers: Focusing on Representation  
(Rina Zazkis; Natasa Sirotic)
- p505-512 Numeracy Practices of Young Workers  
(Robyn Zevenbergen; Kelly Zevenbergen)

# SITUATED OR ABSTRACT: THE EFFECT OF COMBINING CONTEXT AND STRUCTURE ON CONSTRUCTING AN ADDITIVE (PART-PART-WHOLE) SCHEMA

Ruth Meron and Irit Peled

University of Haifa, Israel

*This study investigated the development of an additive schema from the perspective of the schema's flexibility in coping with new context and unfamiliar semantic structure. It followed 27 first graders who learned addition and subtraction using an experimental curriculum. The instruction involved a didactical model combining the context of two stories with a structured part-part-whole schema. In addition to collecting data from the whole class, eight children were individually interviewed. The development of their additive structure was examined by comparing the distance between the original stories and the range of transfer problems they could analyze. The findings show that a rich additive structure was constructed, although some difficulties involving dependency on the instructional model were observed.*

Many elementary schools in Israel use a curriculum that is based on introducing mathematical concepts by using structured instructional models that are isomorphic to the mathematical structures. The rationale of this approach is that mathematical concepts are abstract and therefore should be represented by something children can communicate about in natural language (Nesher, 1989). Although there is no argument against this rationale, there are claims that in using such models, for example, teaching addition and subtraction by using Cuisenaire Rods, an expert model is explicitly imposed upon the child (Cobb, Yackel & Wood, 1992).

These structured instructional models together with their rules of operation constitute a Learning System (LS), as termed and described by Nesher (1989). An ideal LS uses an instructional model to define the targeted mathematical objects and mathematical relations and later facilitates a gradual shift from talking about the objects of the model to talking about the mathematical objects they represent.

The instructional model used in the LS is usually a sterile model, i.e. it uses concrete objects such as Cuisenaire Rods (for addition and subtraction), Dienes Blocks (for place value), etc. This model does not usually involve any context. Context and situations that can be mathematized, i.e. mathematically modeled by using the taught mathematical concept, appear later as applications of the LS.

In alternative instructional approaches situations and context come first. Some programs use a problem based curriculum that starts by introducing real world problems or authentic (relevant rather than real) problems. These approaches differ from each other in the amount of structure imposed on the solvers. In some cases

children are expected to suggest a variety of solutions using their existing schemas, in others they are given tools to be used in coping with the authentic situations. The Dutch curriculum encourages children to reinvent mathematical models by analyzing situations with the help of tools such as the empty number line. Their theory is described by Gravemeijer and Stephan (2002) terming the stage of analyzing and realizing the structure of the situation as building a model *of* that specific situation, and further on abstracting this structure to a model *for* reasoning mathematically that can be used in mathematizing new situations.

An approach that introduces a mathematical concept with the use of situations risks leading children to a wide range of ideas that might not include the targeted mathematical structures. Even if the right structures are created children might construct a situated model and remain in the *model of* level. On the other hand, a sterile approach might create a sterile structure without meaningful connections resulting with difficulties in identifying the relevancy of the mathematical concept to its potential applications.

Through the years we have tried different combinations of structure and context in an effort to create meaningful structures. Peled and Resnick (1987) used structure and context in designing a train-word, a microword involving zones where carts were added or taken off trains in a way that corresponded simultaneously to mathematical definitions of addition and subtraction and to different semantic categories of word problems. Similarly, in the design of software for kindergarten (Peled, Meron & Hershkovitz, 2000) the designers introduced addition and subtraction using a context that involved the exchange of presents between some characters. The situation created an intrinsic need to act on objects in a way that could be mathematized as addition or subtraction. Although the situations in these examples help children make sense of the structure and learn it more meaningfully, the targeted structure is explicitly imposed.

In this study we introduced addition and subtraction in first grade using stories that lend themselves to an additive mathematization. That is, a representation of the story corresponded naturally to two parts and a whole, and included a rationale for putting the parts together. Thus, the operations were not presented as a sterile model prior to meeting any situations, but were expected to emerge through the children's operations within the situations. In this sense the expected schema development was similar in nature to Gravemeijer's (1997, 1997b) terms of *model of* and *model for* mentioned earlier and also discussed later in more details.

The special role of these contexts or source stories raised the question whether the constructed schema would be limited, enabling applications to problems that are similar in context to the two source stories. That is, whether children's knowledge would be situated. Based on research on analogical thinking (Gick & Holyoak, 1983), we assumed that having two stories would help facilitate schema abstraction. These theories also predicted that problems differ in degree of difficulty to be mapped to the source problem (Gentner & Toupin, 1986). This study investigates the nature of



schema children construct in this experimental instruction, and the degree of difficulty of transfer problems.

## METHOD

The study was conducted in first grade in a school with population of an average to slightly less than average socio-economical status. The class was taught by its regular teacher using an experimental curriculum. Of the 27 children undergoing this instruction, 8 children were chosen to be individually interviewed three times through the whole unit of instruction on addition and subtraction. The 8 children included 4 average children, 2 above average and 2 below average, assigned by the teacher according to the interviewer's specifications.

The study consisted of three instruction and evaluation parts. Each part included an instructional unit followed by a whole class questionnaire and by individual interviews with the 8 chosen children.

Each instructional unit began with the teacher telling a story. The story involved a situation of putting parts together and a situation of separating into two parts or taking a part away from the whole. The first story was about a grandfather who has two grandchildren. In some of the situations grandfather sent presents to the children and in others the two children sent presents to him. The second story was about children who live on two islands and travel by boats to school. In some situations the children were going from the two islands to school, and in others they went from school back home.

With the first story the children were asked to model the story (engage in *direct modeling* in Carpenter and Moser's (1984) terms) by moving concrete objects (unit cubes) on a drawn part-part-whole schema, the *Presents' Board*, as depicted in figure 1. For the second story the children had another (similar) board on which they could use unit objects or Cuisenaire Rods.

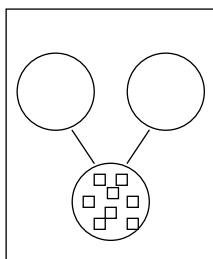


Figure 1: The part-part-whole Presents' Board.

Following the instructional part the whole class worked on a questionnaire that included the completion of part-part-whole schemas involving familiar and unfamiliar situations in the same context (grandfather or boats). The last (third) questionnaire included computational problems as well. In the interviews children

were given problems that were similar to the source stories and problems that were different from these stories on the following dimensions: context and roles of characters, semantic structure, and logical structure.

On the basis of an analysis of these three dimensions we built a hypothesized measure of problem difficulty. Our assumption was that problem difficulty would increase when the context changed or when the characters were used in a different role. We assumed that problems with semantic structure that is known to be more difficult (Nesher, Greeno & Riley, 1982) would indeed be more difficult and that problems with an unknown part would be more difficult than problems where the whole is unknown. As we found later, there were cases where the results did not fit with our predictions, some problems with a low difficulty measure were found to be more difficult than expected and vice versa.

An answer was considered as an indication that the student understood the problem structure, if the student solved the problem correctly, retold the problem in a way that made sense, represented it correctly using a number schema (writing the 3 numbers on a part-part-whole template as seen in the example represented in Figure 3) and later also mapped it to a computational expression.

The research purpose was to investigate whether this instructional approach could produce a rich additive schema. The criterion for determining the quality of the schema was the extent of the schema's flexibility as observed by looking at the range of the problems children could understand.

## RESULTS

In order to test the effect of instruction 19 problems of different difficulty measures were given to the 8 children in each of the three interviews. In this paper we focus on the changes that were observed in problem solving throughout the three interviews.

Figure 2 depicts the changes in problem understanding for student #1. The problems were arranged by growing degree of difficulty as determined by the three factors mentioned earlier.

The student's answers were coded according to his understanding. As it turned out, there were some problems that were immediately solved (marked in light gray) other problems took some time to analyze, and in some cases the student constructed a schema and then realized it could not be right and changed it. These solutions were termed "not spontaneous" (marked in medium gray).

As can be seen in figure 2, the more difficult problems were mostly those that were predicted to be difficult using the three factors criterion. In the second interview more problems were spontaneously solved and eventually almost all problems were solved. In the third interview all problems were eventually solved and there were more problems that were spontaneously solved.

Problem	Difficulty	Interview		
		1	2	3
1	1			
2	1			
3	2			
4	2	■	■	
5	3	■	■	
6	3			
7	4			
8	4	■	■	
9	4	■	■	
10	5	■	■	■
11	5	■	■	■
12	5	■	■	■
13	6			
14	6	■	■	■
15	6	■	■	■
16	7	■	■	■
17	7	■	■	■
18	8	■	■	■
19	8	■	■	■

spontaneously
  not spontaneously
  not understood

Figure 2: Problem understanding of student #1 through the 3 interviews.

Problem #14 is an example of a problem that was considered to have a degree of difficulty 6, and turned out to be more difficult than expected (it was difficult for the other children as well). The following description shows how student #1 coped with this problem.

The problem: There were 8 red and yellow flowers in the vase. 3 of the flowers in the vase were red. How many yellow flowers were in the vase?

First interview: The student uses the presents' board. He picks up 8 unit cubes and puts them in the place intended to represent a part while saying *8 reds*. Then he puts 3 unit cubes on the other part saying *3 yellows*. He counts them all, makes a counting mistake getting a 10. He then writes a number schema using 3 and 8 as parts and 10 as the whole (as seen in Figure 3). He tells the story: *I had in my vase 8 red flowers and 3 yellow flowers*. The interviewer asks about the 10 and he says: *That's all there is in the vase*. Now he tells the story again: *There are 10 flowers in the vase, 8 reds and 3 yellows*.

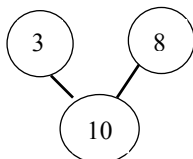


Figure 3: A part-part-whole (incorrect) number schema.

Second interview: The student uses Cuisenaire rods. He takes a rod representing 8 and then puts a rod representing 3 next to it. He gets a rod representing 11 that fits the given length and writes a number schema with 8 and 3 as parts and 11 as the whole. Suddenly he says: *This is wrong*. He changes the numbers in the number schema so that 8 will be the whole and 3 and 5 are the parts. He tells the story: *There were 8 flowers in the vase, 3 reds and then also 5 yellows*. The interviewer asks: *I don't understand. There were 8 flowers and then they put 3 reds and also 5 yellows?* The student answers: *No. There were 3 red flowers and also 5 yellow flowers and together they are 8*.

Third interview: The student puts 8 and 3 rods as parts. He does not complete the rod schema but instead asks to hear the problem again. He then looks at what he constructed and moves the 8 rod to represent the whole. Again he asks to hear the problem and then says: *Ah, the whole is 8*. He completes the rods' schema and then writes a correct number schema.

Similar figures (to figure 2) were drawn for each of the students. Other representations looked at performance over all the children within each interview.

To determine the effect of each of the three factors that were used in predicting difficulty, the average number of problematic solutions was calculated in each interview as a function of the degree of difficulty predicted by that factor. The findings show that the semantic category and the place of unknown predicted correctly the degree of difficulty. The distance in context including change in roles between characters in the stories was not as crucial as expected and the predictions based on it resulted in some incorrectly estimated difficulty rank.

In general, most of the students (7 out of the 8 interviewed students) improved from one interview to the next, and managed to understand most of the problems in the third interview. A large part of the problems was spontaneously understood in the third interview. An interesting observation concerned the spontaneous answers. In looking at the stories that children were asked to compose and sorting them by their spontaneity and structure, it turned out that all spontaneous answers involved a correct additive structure.

## DISCUSSION

Although the part-part-whole schema was introduced in this experimental curriculum in the context of two specific stories, our findings show that the schema constructed by children was not situated. This conclusion is based on observing transfer to more difficult and more distant new problems and interpreting this fact as an indication of the existence of a flexible schema.

Three factors, including context, were used in determining the difficulty of a new problem. The results show that the semantic structure of the problem and the identity of the unknown predicted the degree of problem difficulty better than the problem's distance in context from the source stories. These results have several possible

interpretations. We might say that the instructional combination of structure and context resulted in a stronger effect of structure over context. Children were able to focus on the problem's deep structure and were less affected by surface structure (context and roles in the story). However, this interpretation does some injustice to the role of the stories as observed through the study.

In an example from the Dutch curriculum addition and subtraction were taught using a story-context of a Double Decker bus with people getting on and off it. This context was accompanied by an arithmetic rack with two lines of ten beads on which the people (and actions) on the bus could be represented. Gravemeijer et al. (2000) use this example to discuss children's shift from working within the situation, using the beads at first to represent people on the bus to working with the beads on a more abstract level later using the beads to represent the quantitative structure. In their terms, children are involved in an organizing activity and thus the beads' rack changes roles from being a model *of* the situation to becoming a model *for* reasoning that can be used for reasoning about the mathematical relations, a tool for mathematizing other situations.

In our study children used the part-part-whole template in a similar way to the use of the arithmetic rack. During class instruction they used unit cubes on the template to represent the presents that were given by grandfather to his grandchildren. Later they used Cuisenaire Rods to represent the boats that were carrying children from their school. While viewing the cubes and rods as characters in the story they were still engaged in organizing these situations. Further on during their instruction children were asked to map between mathematical expressions and stories in the given context. This stage facilitated the abstraction of the quantitative problem structure.

When word problems with unfamiliar context and new semantic structure were introduced during the interviews, it was possible to observe that some of the children had already shifted to a model *for*. Children who could spontaneously use the number template to represent the quantitative structure of the new problem had probably shifted to thinking about the schema as representing a mathematical structure. Children who took more time to cope with the problems seemed to be using the template as a place for acting first on the objects of the new situation before being able to relate to the mathematical structure. Some children still needed "a period of organization" but this period was becoming shorter in later interviews. The change from one interview to another showed that more problems were solved by more children spontaneously, indicating their shift to a more abstract schema.

We conclude by suggesting that the use of this instructional approach combining context and structure helped children construct an abstracted additive schema. The use of two stories rather than one seemed to facilitate this abstraction, although the shift in performance from the first interview to the next could also be attributed to more instruction. It should be noted that this article reports only on children's problem solving. In the study we also observed how children solved numerical

equations and how they understood them. Some of the children exhibited a need to use objects (cubes or rods) and in some cases relate to the stories in order to solve them.

## References

- Carpenter, T. P. & Moser, J. M. (1984). The acquisition of addition and subtraction concepts in grades one through three. *Journal for Research in Mathematics Education*, 15, 179-202.
- Cobb, P., Yackel, E., Wood, T. (1992). A constructivist alternative to the representational view of mind in mathematics education. *Journal for Research in Mathematics Education*, 23, 1., 2-33.
- Gentner, D. & Toupin, C. (1986). Systematicity and surface similarity in the development of analogy. *Cognitive Science*, 10, 277-300.
- Gick, M.L. & Holyoak, K.J. (1983). Schema induction and analogical transfer. *Cognitive Psychology*, 15, 1-38.
- Gravemeijer, K. (1997). Mediating between concrete and abstract. In T. Nunes & P. Bryant (Eds.) *Learning and Teaching Mathematics: An International perspective* (pp. 315-345). Hove: Psychology Press.
- Gravemeijer, K. (1997b). Commentary on solving word problems: A case study of modeling? *Learning and Instruction*, Vol. 7 No. 4 (pp.389-397).
- Gravemeijer, K., Cobb, P., Howers, J., & Whitenack, J. (2000). Symbolizing, modeling and instructional design. In P. Cobb, E. Yackel & K. McClain (Eds.), *Symbolizing and Communicating in Mathematics Classrooms: Perspectives on Discourse, Tools, and Instructional Design*, (pp. 225-273). Hillsdale, NJ: Lawrence Erlbaum Associates.
- Gravemeijer, K., & Stephan, M. (2002). Emergent models as an instructional design heuristic. In K. Gravemeijer, R. Lehrer, B. van Oers, L. Verschaffel (Eds.), *Symbolizing, Modeling, and Tool Use in Mathematics Education*. (pp.145 – 169). Dordrecht, The Netherlands: Kluwer.
- Nesher, P. (1989). Microworlds in mathematical education: A pedagogical realism. In L.B. Resnick (Ed.), *Knowing Learning and Instruction*. (pp. 187-215). Hillsdale, NJ: Lawrence Erlbaum Associates.
- Nesher, P., Greeno, J. G., & Riley, M.S. (1982). The developmental of semantic categories for addition and subtraction. *Educational Studies in Mathematics*, 13, 373– 394.
- Peled, I. & Resnick, L. B. (1987). Building semantic computer models for teaching number systems and word problems. *Proceedings of the 11<sup>th</sup> International Conference for the Psychology of Mathematics Education*, 2, 184-190.
- Peled, I., Meron, R. & Hershkovitz, S. (2000). Math buds: early mathematical concepts. An educational software for ages 4-7. Centre for Educational Technology, Ramat Aviv.

# USING GRAPHICAL PROFILES TO STUDY THE LEARNING AND TEACHING OF MATHEMATICS

Dvora Peretz

Ben Gurion University, Beer-Sheva, Israel

*We propose a methodology for studying the processes of learning and teaching mathematics. We will argue that this methodology carries many of the advantages of qualitative approaches while still keeping the main advantage of quantitative research methodology, which is the potential to produce findings that could be generalized. At the heart of this methodology is a research tool that quantifies learning processes and enables visualization of the learning paths. This is achieved by means of a comprehensive graphical profile of the processes. This graphical profile of an individual learner lends itself to detailed analysis and offers new kinds of insights into the learning/teaching processes. It is unique in the kind of conclusions it suggests and in the scope of the conclusions it allows one to make*

## INTRODUCTION

The wish to understand how students construct mathematical concepts led us to develop a methodology that focuses on processes rather than on their outcomes. Since the essence of Mathematics is abstractions and abstract concepts, we tested this methodology in an exploratory research study of abstraction processes that are involved in the learning of a piece of abstract mathematics. We present this methodology vis-à-vis our exploratory study.

We begin our presentation with an overview of our research and then we get into a more detailed description of: a) The subjects; b) What concept we used in the learning experiment and why; c) What processes we observed and how we initiated them; d) How we conveyed the learning text and why; e) The assessment attribute of our tool or, How we monitored the processes; f) The products of our tool - The individuals learning profiles; and, g) The analytical attributes of the method - Our research conclusions.

The main purpose of this paper is to present our methodology, rather than to present the outcomes of our study. As our study was of an explorative nature, we do not claim validity for our findings, rather we consider them as conjectures to be studied further.

## CONCEPTUAL FRAMEWORK

Here we look briefly at a part of the clinical context of our study. A laboratory experiment seems a reasonable choice given that the goal of the study is to understand the basic learning mechanisms themselves, and that “learning takes place inside the learner and only inside the learner” (Simon, 2001, p.210). It might be said that this stands in opposition to the contemporary view of learning as a social

process; however, Simon's (2001) perspective of the social aspect of learning suggests otherwise: "... 'Social' means more than 'having people around'. ... Perhaps the most important social influence on learning are ... forms of written communication ... Putting learning in books does not desocialize it." (p. 207). Elaborating on this line of thought, we assert that laboratories do indeed incorporate the social values and beliefs of the 'social construct' that built it. Thus, conducting research on learning in a lab environment does not in itself oppose the current social trend in the educational milieu; rather, it offers another level of observation.

Some might argue that from a pedagogical point of view, a 'clinical' context for a learning experiment is not appropriate, as their main interest is in learning as a social activity (usually in a classroom context). Atkinson et al (2000, p.185), however, argue for the transferability of lab experiments to the classroom context and are strongly in favor of labs as a context of research on learning.

One-way to partly control the effect of the teaching method on the learning process is to present the concepts to be learned only by examples of the concept. Atkinson et al (2000) present a comprehensive literature review of the Learning-From-Examples (LFE) research paradigm. They refer to learning from 'worked' examples, which provide an expert problem-solving model for the learner to study and emulate (p.181). In most research on problem-solving, the LFE serves as the focus or as the target of the research, and not as its context. This kind of research aims at gaining insight into the LFE as a (preferred) mode of teaching or of learning, and the subject matter serves as the context. However, researchers of concepts-formations (1950-1970) used LFE in their experiments in a different way; they used examples as instances of a concept. Atkinson et al (2000) put it thus: "A typical study ... measured students' ability to identify a member of a target concept after viewing numerous instances and non-instances of it, to ... derive the underlying concept common to the examples". (p.182). In concept-formation research the LFE paradigm serves only as a tool to convey the concept to be learned. As such, the LFE is part of the context of the research, rather than its focus.

## **OVERVIEW OF THE RESEARCH**

We closely observed two abstraction processes that we had identified theoretically: Abstraction Process (AP) and Reversed Abstraction Process (RAP). For the purposes of this paper we define the two learning processes by the mode of their instigation. One is instigated by learning from a text which is presented in an order of increasing abstractness level (AP - group U in the experiment – ten ninth-grade subjects), while the other is instigated by learning from a text which is presented in an order of decreasing abstractness level (RAP - Group D in the experiment - ten ninth-grade subjects). Computerized learning modules presented the learning texts, which were identical in both modules except for the order in which the chapters appeared in each of them.

The subjects were twenty 'regular' students in an Israeli suburban high school, in the



last month of their ninth grade school year. They were all volunteers and joined the experiment on a first come basis. There was no randomizing in the procedure of assigning the volunteers to one of the two groups of subjects, U and D. The experiment took place at school, in a room especially assigned for the experiment. We took each of the subjects out of class for an individual learning session of approximately three hours.

The module kept track of all the time periods that the subjects spent at each point (assignment) as well as of their answers. At the same time, it created a personal file for each of the subjects, which was later used to assess the learning process of the individual. Moreover, the module enabled the researcher to assess each of the answers (to about 204 short questions), according to approximately forty different indices. Subsequently, the module created a file of numerical vectors for each subject as a product of the evaluation stage, where each of the vectors represented the progression of the learning process according to one of the indices. These vectors were readable by the computer algebra system, *Mathematica*, which we used for constructing a graphical profile for each subject. The final analysis of the findings of our experiment was based primarily on these graphical profiles.

## THE RESEARCH METHODOLOGY

Students were given the Mathematical Relation (MR) concept to learn because it is both highly abstract and difficult to learn. This corresponds with Bereiter's (1990) recommendation to use difficult concepts in order to explore learning processes. The MR generalizes many of the concepts that students learn in school: intuitive relations, functions, linear transformations, mathematical operations, etc. The learning of the MR concept in the experiment enabled us to investigate the abstraction capabilities of the participants as they tried to relate the new MR concept to more basic concepts they already knew. Since our main goal was to concentrate on a thorough, in-depth analysis of a short learning episode, we limited the learning to the definition<sup>1</sup> of the MR concept. However, in order to avoid having to teach the students such concepts as the Cartesian product of two sets, sub-sets etc., we used a simplified version<sup>2</sup> of the formal mathematical definition of the MR.

Since our interest lies in the learning processes of individuals, we strove to limit the impact of the teacher and of other external factors on the learning process. Consequently, we used a computerized learning module to convey the learning text to the participants. We presented the concept using examples, rather than explanations, and presented these examples in a 'neat', 'facts-only' format without any elaboration. This was followed by fixed repeated reasoning assignments to force the learner to 'think aloud'.

---

<sup>1</sup> R is a MR from a set A to a set B if R is subset of the Cartesian product  $A \times B$ .

<sup>2</sup> R is a MR from a set A to a set B if R is a set of ordered pairs of the form (a,b) where a is an element of A and b is an element of B.

Basically, our research tool was a computerized module with four functions: instigating (a learning module); monitoring (interactive features); quantifying (assessment features) and externalizing (graphical profiling) the target processes.

**The Learning Module.** In this paper we use the structure of the text as an operational definition for the processes studied. Hence, the learning process initiated by a text that presents the subject to be learned in an order of increasing abstractness will be referred to as an Abstraction Process (AP), while the ‘inverse’ process that is initiated by a text that presents the learning subject in an order of decreasing abstractness will be referred to as a Reversed Abstraction Process (RAP)<sup>3</sup>. The abstractness level of a specific example of the MR was determined by an abstractness scale we devised according to the mathematical abstractness level of its different components and its different characteristics in widening circles of mathematical abstraction (see also Mitchelmore & White, 1995).

Our learning modules presented fifteen levels of abstraction, which we theoretically defined before the experiment. However, in our final analysis we referred only to three main levels (low, intermediate and high level of abstractness) and each of these levels was again divided into two sub-levels (low and high).

Each of the fifteen chapters contained positive and negative examples of MR, all of approximately the same level of abstractness. In the bottom-up module (group U - AP) the chapters are presented in an order of increasing abstractness and in the top-down module (group D - RAP) they are in an order of decreasing abstractness. It is worth noting that the two modules are identical except for the order in which the chapters appear.

**The Monitoring Device.** When designing the assignments we aimed towards a maximal exposure of the participants' thoughts. Thus, following each of the examples, the module presented several kinds of assignments: a) Reasoning assignments; b) Construction of examples assignments; c) Counting elements assignments; and d) Identification assignments. At the end of each of the fifteen chapters the learners were asked to: (a) Describe their feelings, (b) Define a MR verbally, and (c) Construct an example of a MR.

**The Assessment Device.** Assessment of the learning processes was performed by means of thirty-nine indices that were designed to evaluate and record the progression of the conception of ten different aspects of the MR and of the three general aspects of the learning process (time, affective and fixation aspects). These indices were used to evaluate and grade the efforts of individual subjects in each point (point=assignment, 204 points in total) of the learning process in an accumulated manner, and were normalized to values between -1 and +1 for purposes

---

<sup>3</sup> Though interesting, yet, the theoretical attributes and significance of the AP and the RAP as abstraction processes lie outside of the scope of this paper and therefore will not be discuss it here

of comparison. To illustrate: if the value of the positive index that measured the conception of the Set aspect of the MR had an accumulated value of 0.5 by a certain point, this would mean that by this point the student had gained half of what we considered to be the ‘full’ positive conception (understanding) of the MR as a Set.

The assessment was done manually according to the different scales and was then typed up. For the most part, there were three indices associated with each of the aspects. One measured only the progression in a positive direction (i.e. mathematically correct statements and doings, or positive feelings), the second measured only the progression in a negative direction (i.e. mathematically incorrect statements or doings and negative feelings). The third measured the total progression of the conception of the specific aspect – i.e. the sum of both the positive and the negative indices. The fixation aspect of the learning process was assessed only by a negative index, while the time aspect was assessed by two indices, both positive. One measured the time spent at each point and the other measured the elapsed time from the beginning of the learning process to a specific point. Three summation indices, positive, negative and total, assessed the participants’ total positive, total negative and total conception of the MR concept.

The grading at each point was done in a positive manner; i.e. grades were assigned only to the participants’ statements. There was no negative grading for a missing statement, or erroneous statements. To illustrate, if a participant neglected to write ‘ordered pairs’ in his answer regarding an example of MR, it was not documented in either the negative or positive indices. On the other hand, if he did have pairs in his example, but with curly parentheses rather than round, it was documented in both the positive and the negative indices. The positive index was scored for the kind of elements (i.e. pairs) and for the existence of parentheses, but not for their shape. At the same time, the negative index was scored for the shape of the parentheses.

The grading was done in an accumulated manner; in the above example, a new occurrence of an ordered pair with round parentheses would change the grading of the negative index that assessed the conception of the kind-of-elements aspect by taking away the points that were assigned previously to the wrong shape of parentheses, and at the same time the positive index would be scored for the correct shape of parentheses.

**Graphical Profiling.** The progression of the indices’ values was graphed on three axes: the Process Progression Axis - Point  $x$  on this axis marked the  $x^{\text{th}}$  assignment to be handled (one of 204); the Location Axis - shows the location of the point in the bottom-up module; the Time Axis - shows the elapsed time from the start. Note that a specific point on each of the axes has a different history with regards to the two observed processes. The graphs were processed by the Computer Algebra *Mathematica*, based on a file of numerical vectors (204- dimensional) that the modules produced for each of the individual subjects.

The learning processes of each of the twenty individual subjects, ten in each group, U

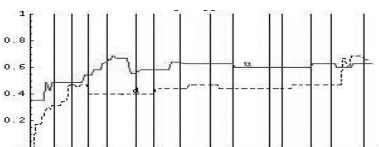
and D, were presented as an individual profile consisting of approximately sixty graphs (most of them continuous; few discrete) and a non-graphic set of data. The ‘average process’ of each of the two groups of learner was also presented via such a profile.

## RESEARCH CONCLUSIONS

We derived dozens of ‘local’ conclusions about the conception of each of the ten aspects of the MR and about each of the three general aspects of the learning (time, affective and fixation), as well as more ‘global’ conclusions about the whole conception process. There were also conclusions concerning the effects of examples of a specific level of abstraction on the learning process.

In the following graphs the dotted line represents the process in group D - the RAP, while the continuous line represents the process in group U – the AP. The vertical lines represent the different chapters (each chapter presents examples of different levels of abstractness) of the bottom-up module. In total the x-axis shows 204 points; each represents a short assignment. The y-axis represents the measure of effectiveness.

**Figure 1 Conception of the set aspect**



**Figure 2 Total conception**

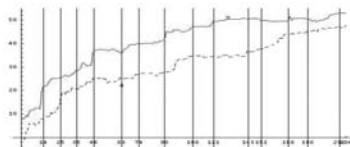


Figure 1 shows the average progression of the positive conception of the Set aspect of the MR concept in both groups of student, U and D. We can see that the average achievements of the students in group D were slightly higher than those in group U at the end of the learning process, even though along most of the learning process axis, group U students did better. This is seen also in the progression of the total conception of the Set aspect. This demonstrates the accumulative dominance of the one process over the other, and leads to the conclusion that *The RAP is more dominant than the AP in respect to the conception of the Set aspect of the MR.*

Figure 2 shows the progression of the total conception of the MR concept in both groups of student. We can clearly see that along the learning process axis, the achievements of the students in group U (bottom-up), were higher than those in group D (taking into account the negative conception as well). This leads to the conclusion that *the AP is more effective in respect to the total conception (positive minus the negative) of the MR concept.* This is effectiveness in the sense that at any given moment in the learning process, the students in group U gained a greater part of what was considered to be the full conception of the MR concept.

Figure 3 presents the progression of the average negative conception of the Size

aspect of MR in both groups of learners, U and D. Here we can clearly see that the graph of group D (top-down) is higher than the graph of group U. This leads to the conclusion that on average, students in group D made fewer errors. This in turn implies that *the RAP is better at leading the conception towards the positive direction*. We find it intriguing that this is seen in the graphs that depict the progression of the conception of most of the aspects of the MR, as well as in the one depicting the total conception of the MR concept.

Figure 3 Negative conception

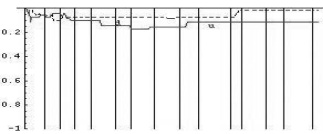


Figure 4 The Affective aspect

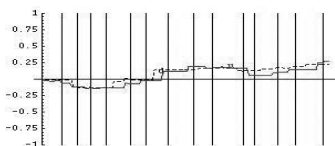
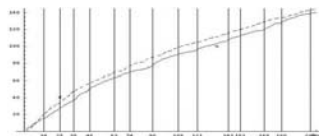


Figure 5 The Time aspect



Figures 4 and 5 present the progression of the Affective and the Time aspects of the learning process in both groups. From here we can see that *there are no significant differences between the two processes, AP and RAP, in respect to the Elapsed Time aspect nor in respect to the Affective aspect of the learning process*. This is especially interesting in light of the prevalent view that considers the deductive approach among the causes of affective and cognitive difficulties in learning mathematics.

## DISCUSSION

We argue that our (almost) continuous probing does indeed offer an outline of the progression of learning processes. We do, however, make a cautious comment regarding the sensitivity of the scales we used to assess each aspect of the monitored process, at each point. As we see it from our exploratory study, the scales are the weakest link. We nevertheless believe that continual studies, on larger and less biased samples, will eventually yield an accurate depiction of learning processes.

Our study encompasses other weaknesses too: it focuses on a very short learning episode (about three hours), while meaningful learning could take much longer (even years). It monitors the conception of a very small ‘piece’ of a whole concept (MRs could be the subject of years of study) and ‘flattens’ the complex research setting (putting a rich learning process into a graphical profile, even if it does contain dozens of graphs); it ‘extrapolates’ without sufficient justification (when stretching a line between the conception in two adjacent points to achieve the continuousness of the process); and it also attempts to derive general conclusions based on a non-statistical sample (small and non-random).

But at the same time, the short learning episode allows us to concentrate on deep and detailed observation, and the ‘flat’ graphical portrayal enables us to conduct a precise

analysis of the findings. While the design of the modules could have affected the processes that we observed, they also facilitated a close monitoring of the learning process. And lastly, the simultaneous nature of the tool that allowed us to observe the process from as many angles as we desired and had the resources for, gives this kind of research enormous potential.

One of the concerns that prompted the qualitative reform was the segmented nature of research on learning up until this point. Qualitative scholars argue quite rightly that one needs to see the 'whole' learner, which for some includes also the learner's social envelope, in order to study complex learning processes. The tools that qualitative scholars advocate are indeed comprehensive and thorough. Yet at the same time they fail to make irrefutable general claims about their research findings (Schoenfeld, 1999). The question is: do we have anything to gain by quantifying a qualitative situation? We believe that we do. Moreover, we believe that our methodology, while not qualitative, does indeed encompass the essence of qualitative methodologies. We believe it offers a holistic, comprehensive and thorough description of the learner - all of which are considered qualitative qualities and yet, at the same, also offers the means to make irrefutable general claims about the learning process.

The method we used, in which we probed every minute or so, may be compared to the kinds of observation made by qualitative researchers when they closely observe a subject. The kinds of question that the learners answered in our research are in many ways similar to those asked by qualitative researchers. Taking into account simultaneously all the aspects involved in the learning situation is in fact a kind of holistic approach. The methodology used could also monitor the physical aspects of learning (by incorporating medical devices), the social aspects (by video recording), and the motivational aspects (by incorporating psychological tools). Moreover, if one argues that the absence of the human perspective might affect the description, we can suggest numerous ways in which that perspective might be incorporated as a further monitoring device.

## References

- Atkinson, R.K., Derry, S.J., Remkl, A., and Wortham, D.W. (2000). Learning from Examples: Instructional Principles from the Worked Examples Research, *Review of Educational Research*, 70 (2), 181-214.
- Bereiter, C. (1990). Aspects of an Educational Learning Theory, *Review of Educational Research*, 60(4), 603-624.
- Mitchelmore, M.C. and White, P. (1995). Abstraction in Mathematics: Conflict, Resolution and Application, *Mathematics Education Research Journal*, 7(1), 50-68.
- Schoenfeld, A.H. (1999). Looking Toward the 21st Century: Challenges of Educational Theory and Practice, *Educational Researcher*, 28 (7), 4-14.
- Simon, H.A. (2001). Learning to Research about Learning, in S.M Carver and D. Klahr (eds), *Cognition and Instruction*, Twenty-Five Years of Progress. Lawrence Erlbaum Ass., Mahwah, New Jersey, London.

# THE ROLE OF NUMBER IN PROPORTIONAL REASONING: A PROSPECTIVE TEACHER'S UNDERSTANDING

Axelle C. Person, Sarah B. Berenson, Paula J. Greenspon  
North Carolina State University

*We examine a prospective high school teacher's instructional representations of rate of change and right triangle trigonometry to investigate his interpretation and understanding in relation to the development of proportional reasoning. Despite a constant effort by the subject to resort to "real life" examples in order to give meaning to his teaching, as well as a fairly good understanding of how to connect the topic of instruction with the use of proportional reasoning, it occurs to us that the map of his conceptual moves is from ratio, to comparisons, to fractions. Once he enters the abstract world of fractional expressions and quotients, he often displays difficulties in re-connecting his ideas back to ratio.*

## INTRODUCTION AND FOCUS

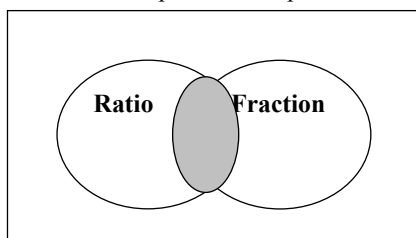
Emphasis has recently been put on the importance of proportional reasoning in understanding topics across the high school curriculum. Also, it is necessary for middle grade students to make connections between ratios and fractions and then to use these connections appropriately to solve problems in other proportional reasoning topics (Carraher, 1996; Sowder, Armstrong, et al., 1998). Research shows that not only is proportional reasoning at the core of the mathematics curriculum, but also it is a good indicator of higher mathematical achievement. Although a lot of research has been conducted on students' understanding of proportional reasoning, very few publications actually focus on teachers' conceptual understanding of ratios and proportions, especially at a high school level. However our belief that quality teaching is directly related to subject matter knowledge (Ball, Lubienski, & Mewborn, 2001) strongly justifies the need for studying and enhancing the growth of understanding of proportional reasoning topics among teachers.

In this article we take a look at a prospective teacher's lesson plans on rate of change and right triangle trigonometry in the light of his beliefs of ratios and fractions. We focus on his ability to connect these topics to proportional reasoning (PR) concepts and argue that the mapping of his growth of understanding of ratio and ratio-related topics within the linking model developed by Clark, Berenson and Cavey for evaluating PR (Clark, Berenson, & Cavey, 2003) reflects on his instructional representations. Our initial interest generally focused on a prospective teacher's understanding of proportional reasoning topics and to find patterns in his thinking about teaching PR related topics.

## CONCEPTUAL FRAMEWORK

For this research we rely heavily on the Linking Model of Ratio and Fraction proposed by Clark, Berenson, and Cavey (2003) that we summarize here for the

purpose of this paper. The intent of building this model was to understand how people, in particular teachers and middle school students, connect ratios and fractions. During their studies the researchers encountered several models of thinking about the relationship between ratios and fractions. Some people saw all ratios as being fractions, hence consider ratios as a subset of the fraction world; others see all fractions as ratios, inverting the previous conclusion. Others see fractions and ratios as two completely different concepts with no relationship, while there are others who consider they are the same. However none of these four models seemed to explain the complexity of the relationship between ratios and fractions, hence the researchers came up with a fifth model, called the Linking Model of Ratio and Fraction, a representation of which is given below (fig.1). The idea is that not all ratios are fractions and not all fractions are ratios, but the two concepts do share an intersection where ratios and fractions can be treated the same. In the ratio-only sub-construct one would find any ratios and rates in a non-fractional form, as well as expressions such as “1 cup sugar : 2 cups flour”. The same example would be expressed “1 cup sugar/3 cups ingredients” in the intersection sub-construct, and “1/3 cup sugar” in the fraction-only region. In the intersection one also finds probabilities and comparisons part-part, part-whole, while the fraction-only region includes percentages and decimal expressions as well as operations or points on the number line.



*Figure 1.* Linking Model of Ratio and Fraction (Clark, Berenson, Cavey, 2003)

## **METHODOLOGY**

The material available for this study are archived videotapes and transcripts collected during a first methods course offered for pre-service teachers in their sophomore year. The purpose of the course was to increase pre-service teachers’ subject matter knowledge and understanding of proportional reasoning topics through teaching and lesson planning. The subject Brian, a former chemical engineer student with a GPA above 2.5, was interviewed twice early in the semester in order to get an idea of his beliefs and understanding concerning the PR topics. Then the student planned a lesson with the help of textbooks, trying to relate the topic of



instruction to ratio and proportion. Finally he explained the lesson to the interviewer. Six weeks after the initial interview and after some group work with other peers on the same topics, Brian was also asked to plan two other lessons for his final grade on both rate of change and right triangle trigonometry. For this article we worked with one specific student's transcripts and followed Maher's methodology suggestions for analyzing videotape data (Powell, Francisco, & Maher, 2003). The main attempt at using this method expressed itself in coding the appearances of numerical representations in Brian's talking and lesson planning. More specifically we focused on where to locate Brian's thinking within the Linking Model of Ratio and Fraction, be it on the right hand side of the model (coded RHS), in the ratio-only sub-construct, on the left hand side of the model (coded LHS), i.e. the fraction-only sub-construct, or in the intersection region of the model (coded IR). The parts of material that had been coded RHS were also studied carefully to emphasize the nature of the numerical representation used, be it a chart, a decimal expression, a number operation, a fractional expression or other representation. Furthermore we looked for critical events in Brian's transcripts, places where he seemed to come to a higher understanding or suddenly make or clarify a connection that appeared to be missing before.

## ANALYSIS/RESULTS

Each interview focused on three different points of view: *What do you remember about being taught and the time you were learning this concept?* This question helped us understand how much of the preceding instruction received by the teacher was affecting his own teaching and understanding. *What does this concept mean to you?* We focused on Brian's own interpretation and representations of each concept, a place where personal beliefs and emotional engagement can affect the understanding. *How would you teach this concept?* This question is actually composed of two parts; first Brian was asked how he would teach it to a peer, and then how he would introduce it in a middle grade classroom.

The first interview we consider is rate of change. Before specifically asking questions about rate of change the interviewer tries to reveal Brian's ideas on ratio and proportion. When asked to describe the term ratio in his own terms Brian (B) chooses to define it as "how one quantity is related to another".

B Well, lets keep it simple, so say we're just throwing out a fraction, two-thirds describing roughly sixty-six percent of one. Two-thirds of something. Now at the same time we can take four-sixths. Now they have two different numbers, two and four are obviously different. Three and six are obviously different. But the relationship between two and three is... two over three, we'll just divide that out to see what we get. Three will go into twenty, what's that, about six times? We'll say eighteen, twenty, six feet. Let's come over here. Six will go into forty, four, nine. That's six feet also. Even though these numbers are different we can consider this point six repeating to be the ratios, and match those, they are exactly the same. So different numbers, different sizes, same ratio.

Interpretation: The choice of a fraction for illustrating the concept of ratio belongs to the right hand side of the model we chose for our conceptual framework, and the dexterity with which Brian plays with the fractions indicates a possible comfort zone in this abstract representation of ratio where well trodden techniques give the right results, especially the instant need to divide and find a decimal value for the corresponding fractions. The latter also illustrates the power of equalities in mathematics and the comfort they provide to a problem solver. A closer look at the videotape and of Brian's engagement in the calculations suggests that he feels extremely comfortable with these manipulations. After this first introduction of ratio with two similar fractions, Brian underlines the importance of introducing real life examples for a better understanding of mathematical concepts. Among these examples he chooses to focus on dimensions, be it dimensions of similar triangles, dimensions of a table, another evidence of his familiarity with the right hand side of the Linking Model where measurements belong.

B We're going to have to maintain this three to two ratio with the base and the height. In order to do that we're like, OK, we want to keep a similar triangle and we want it to have a height of fifteen. We'll draw this, not to scale, and we know we want it to be fifteen high. How big of a base do we need? Taking it out to the real world, how much concrete do you need? So let's look at this ratio here, it's a three to two ratio. Let me show you a trick. Going back to this two-thirds and four-sixths, you can take, lets' bring it down here, well let's work left to right, you can factor out two out of both sides. If you notice right here, you have the exact same thing, which is six. Just factor this down to two-thirds and two-thirds. Bring it out on this side, and we've got three over two over here, and then we've got fifteen over something over here.

I What are you going to call the something?

B Let's call it x. We'll label this other triangle x. Fifteen, can we make that, we can take a three out of there. So let's take a three out, and we've got five. Now, since we took three out of five... we'll let's do this, this will still be x down here. Wait a minute, just like on this side we factored a common thing out and we ended up with the same thing as this. Let's come back over here, factor the five out of here, and since we did that, this isn't going to be an x anymore. We'll call it a y. Five times y equal x. Factor the two out, two-thirds over here. Factor the five out; we're going to have three-halves right here, just like we did on the other side. So now we know y equals two. Now we know five y equals x, which is the base of our triangle. Let's say five time y, which is five time two, ten. So now we know the base of this triangle is ten. Now we've got similar triangles, completely different sizes, but the ratio is the same.

Interpretation: Once the problem is set about what needs to be done (namely finding the dimension of a similar triangle with a specific height), Brian is very prompt in moving to numerical manipulations again. He shows excitement about giving the interviewer a "trick" to solve and simplify the problem, reducing it to merely finding a common factor for the numerator and denominator, barely mentions the existence of units in the action of measuring, and resorts to the symbolic variables x and y,

making the problem more abstract than it was in the first place. Obviously the visual aspect of proportions in this example is lost through the solution given by Brian. Similarly, when asked how to introduce the concept of ratio to middle school students, Brian's first intuition about answering the question is to resort to operations (he mentions division) and numbers without getting into giving a sense of proportions outside of a purely mathematical world. This triggered the final question from the interviewer concerning Brian's beliefs about the connections between ratios and fractions:

I Okay. How about the relationship between ratio and fraction? How would you describe that?

B Well, I guess I would describe fractions as a useful tool to work with ratios. You know, even if you have so many monkeys will fit into so many barrels, you can put it in fraction form. It's going to be so many monkeys over so many barrels. [...] I'd just use it as a good tool.

I As a tool. Okay. Well do you see them the same, or do you see them differently?

B Fractions and ratios?

I Uh-huh. If you don't see them differently that's okay.

B Yeah. Well you can put basically anything in a fraction form. Like when you think of fractions, two-thirds is not the same as ten monkeys in two barrels, but we use the same thing, which basically is just a line with one thing over it and one thing under it. When you think of fraction, the name itself implies a fraction of something, a part of something, where as a ratio doesn't have to be like that.

Interpretation: It becomes clear here that Brian's model for thinking about the relationship between ratios and fractions is one where all fractions are ratios. Fractions being a tool, he naturally resorts to them any time he has to deal with ratios, and to a further extent with proportions. Within the "workshop" where he handles fractions, he also has access to a collection of tricks and techniques that he will mention on several occasions throughout the interview, usually becoming very verbal during these occurrences and sometimes expressing the pleasure he gets out of performing these manipulations.

Now that we have an idea of how Brian might perceive proportions, ratios, fractions, and how these concepts relate with each other, let us focus on Brian's understanding of teaching the concept of rate of change. To him rate of change represents "the amount something changes in a given time", or "something per something" such as miles per hour. When asked to show a graph representing velocity he decides to assign speed to the y-axis and does not use the graph to determine which distance he would have gone had he been driving fifty miles per hour for two hours. Instead he goes back to the following numerical manipulation:

B Let's just do this; we'll put our velocity over here, n miles per hour. You can be going ten, twenty, thirty, forty fifty, two billion sixty. We'll call this one hour, and two hours.

Now if we're going fifty miles per hour, steadily as if you have the cruise on going to the beach. Since you have the cruise on, all the time down here that you're driving is fifty miles per hour. So our one, and our half, and hour and a half, you're always going fifty. So constant speed is represented fifty going across here. Now if you want to, say how far have I gone after two hours? Two hours is right here and we've been going fifty... now watch this, velocity on this side and time over here, miles per hours and hours over here. So we know, using a little dimensional analysis, miles per hour and you're going to times that by hours. Your hours are going to cancel out and you're left with miles. So how far have I gone after traveling two hours at fifty miles per hour? Let's say fifty miles per hour times two hours, remember hours cancel out, we'll get a hundred miles.

Interpretation: In this sequence Brian is not completely located in the right hand side of the model. Instead he pays attention to keeping in mind the goal of his calculations and in particular the units to help him solve his problem. The interviewer then asks to see the graph of distance over time and this triggers in Brian a sudden reaction where one sees him make the connection between rate of change and ratio and proportion, what we would call a critical event. Once Brian starts playing with the graph and actually looking at its shape, the visual representation of ratio and similarity helps him connect the notion of a linear graph, in other words constant rate of change, to the notion of similar triangles and constant ratio between distance and time. We noted how the visual allowed the occurrence of this critical event in Brian's understanding when he appeared to be fairly enclosed in his numerical manipulations earlier on and lacked the overview needed for him to see an obvious connection between different mathematical concepts. This confirms the idea that using several representations that call for different sensory perceptions helps the understanding of a concept, as well as the intertwining of different concepts within one field. We selected a few critical events related to our own understanding of Brian's thinking this time in the preliminary interview on right triangle trigonometry. Again the interview was following the interviewer's desire to understand what Brian learned about the subject, how he perceived it from his personal belief, and how he would then teach it. From what Brian remembers being taught we find a strong association with the numerical representation of a table of values for the trigonometric functions, with little association to the unit circle or the triangle ratio formulas. However his first association with trigonometry is the unit circle:

- B Is the biggest thing that comes to my mind. I remember not really understanding the unit circle. Well, I think I may have. It's hard to remember what I did and what I didn't understand at certain points. It's like we'd have a circle and we'd talk about going, like a point going around the circle, and then you could lay the circle out along the x-axis, say it's wound up a whole bunch.
- I Oh, okay. You could take the entire circle and sort of stretch it out along the x-axis.
- B Of course it repeats, if you have a big chord of it. Now that I'm actually... I don't know.

- I Was that an association that helped you put it all together, the unit circle, or was it a source of confusion at that point?
- B I'm not sure it helped much. I eventually did understand. The thing that helped me the most was a chart. We had a chart that I memorized easily. On this side we had the degree, well actually degrees on this side, the most left, then radians, and then like thirty, sixty, ninety. Then we'd have radians and everything that corresponded to it. I had this chart memorized and I think that eventually helped me place things on the unit circle. Like I could see thirty degrees, forty-five, and then know that it keeps on going. Like for ninety, thirty is going to be the same, then in certain areas, and graph like with the sine for instance.
- I So once you learned the numbers in the table, sort of by memory, that helped you to understand the concepts that the unit circle was getting at.
- I How did you commit all this to memory, that's a lot of numbers, and a lot of things that are close?
- B Well it's an easy pattern. Once you get to figuring out that... this is you know radians. I can't really remember radians, the measures (Ahah), but once you figure out that like for sine thirty is going to be the sine of one fifty, and understanding things and what they actually meant.

Interpretation: What seems striking here is that the unit circle is remembered as being stretched out on the real number axis, hence losing its geometrical properties of symmetry, which ties into Brian's inability to remember radians. His approach to trigonometric measures and formulas remains in the counting world and is very sequenced and based on repetition, as opposed to the splitting world that one can associate with the parting of the circle into radians. It then makes sense that mastering the table of values enabled him to get a better picture of the unit circle. Furthermore trigonometric functions are certainly not understood within the context of ratio through this approach, but instead are seen as a list of values, another very different way to represent functions. Brian's entrapment in a number world and the counting scheme is definitely clear here. Our analysis of his entrapment into a purely numerical world where sense disappear to leave place to techniques and tools might account for this lack of understanding and visual representation.

## **CONCLUSION**

The comfort zone of number, which Brian seems to heavily rely on, suggests that techniques and number operations are given higher priority than concept clarity. It may also throw students in an abstract and technical world where connections between concepts are harder to make but where the correct answer is found. Brian finds himself resorting to number operations, charts or formulae. He admits seeing fractions as a useful tool to work with ratio hence belongs to model two from Berenson, Clark and Cavey (Clark, Berenson, Cavey, 2003). What is interesting to us is that once he enters the right side of the diagram where fractions belong, he seems trapped there and it

becomes very hard for him to step out again. There is the perpetual need for the use of different representations to achieve full understanding of a concept. In our lesson plan context for Rate of Change and Right Triangle Trigonometry the visual representations of graphs or of similar triangles and extended discussion on these seemed to facilitate the learning of a concept more than number-based formulas.

## References

- Ball, D.L., Lubienski, S.T., & Mewborn, D.S. (2001). Research on teaching mathematics mathematics: The unsolved problem of teachers' mathematical knowledge. In V. Richardson, (Ed.), *HandBook of research on teaching*, 4<sup>th</sup> Edition, (pp. 433-456). Washington, DC: AERA.
- Confrey, J. (1994) Splitting, Similarity, and rate of change: A new approach to multiplication and exponential functions. In J. Confrey, & G. Harel (Eds), *The development of multiplicative reasoning in the learning of mathematics* (pp. 293-330). Albany, NY: State University of New York Press.
- Clark, M.R., Berenson, S.B., & Cavey, L.O. (2003). A comparison of ratios and fractions and their roles as tools in proportional reasoning. *Journal of Mathematical Behavior*.
- Powell, A., Francisco, J., Maher, C. (In press). An analytical model for studying the development of learners' mathematical ideas and reasoning using videotape data. *Journal of Mathematical Behavior*.
- Sowder, J., Armstrong, B., Lamon, S., Simon, M., Sowder, L., & Thompson, A. (1998). Educating teachers to teach multiplicative structures in the middle grades. *Journal of Mathematics Teacher Education*, 1, 127-155.

# LEARNING TO USE CAS: VOICES FROM A CLASSROOM

Robyn Pierce

University of Ballarat

Kaye Stacey

University of Melbourne

*This paper reports on the experiences of students who were learning mathematics with CAS for a second consecutive school year. Evidence presented shows that nearly all students managed the challenging task of mastering the technical aspects of using CAS well. It also shows that the level of technical difficulty and the degree to which it presents an obstacle to mathematical learning is not predictable from conventional mathematical ability. There is a complex interaction between cognitive and affective factors. Planning appropriate teaching for developing the effective use of CAS will require awareness and understanding of these individual differences.*

## INTRODUCTION

In many mathematics courses around the world Computer Algebra Systems (CAS) now take their place among the smorgasbord of tools available for doing, teaching and learning mathematics. CAS is arguably the most complex tool that any students are expected to use at school or elsewhere, and so it is important to know whether mastery is realistically within the capabilities of students and teachers. The work reported in this paper is also motivated by the need, when CAS is used in teaching, to monitor students' progress and plan teaching across a continuum of knowledge and skills from machine utility, through technical facility, to mathematical facts and concepts. In particular, this paper focuses on the technical difficulty that is experienced when student, machine and mathematics connect.

The data was collected throughout 2002 from a class participating in the trial (CAS-CAT project: website <http://www.edfac.unimelb.edu.au/DSME/CAS-CAT>) of a new tertiary-preparation mathematics subject where CAS calculators were available at all times, including for examinations. The students had used CAS throughout 2001, and were preparing in 2002 for their final year examinations. The experienced and highly motivated teacher was as new to CAS use as the students. She taught relevant CAS features, actions and strategies by demonstrating through a view screen. Students were also encouraged to suggest efficient syntax or command sequences. This paper presents the results and views of students in their second year of using CAS.

The paper shows that, regardless of mathematical ability and with good teaching, effective CAS use is within the capability of students who are willing to overcome the initial hurdles. The findings that most students developed good technical facility also emphasise the individual nature of students' response to CAS and the need for monitoring, to inform teaching, if students are to develop automated technical skills with CAS.



## **LEARNING TO MAKE EFFECTIVE USE OF CAS**

In mathematics courses for which the use of CAS has been accepted, students need to learn to operate the technology effectively and to integrate it with their repertoire of techniques for doing and learning mathematics. That this is not a simple process has been acknowledged. For example, Guin and Trouche (1999) outline a complex process which they call ‘instrumental genesis’. They claim this process is required to turn the CAS machine into a ‘mathematical instrument’ that a student can use skillfully. Lagrange (1999) points out that learning to use the technology of a CAS presents new, additional challenges for students. In his study, many students who felt that they were competent CAS users actually had difficulty using basic home screen commands. Drijvers (2000) also describes key obstacles, including technical difficulties that impede students’ use of CAS. Guin and Trouche (1999) comment that the syntactic requirements of CAS can be demanding and have to be memorised. Technical difficulties and the distraction of correcting syntax errors should not complicate students’ focus on conceptual learning. Students’ use of the technical facilities of CAS needs to become automated, especially when CAS is used for learning mathematics. It is important that these difficulties are recognised and addressed by teaching.

Students’ effective use of CAS will not be determined only by these cognitive issues. Affective factors (Pierce and Stacey, in press) will determine the purposes for which students use CAS (e.g. strictly functional use to get answers, or including pedagogical use to explore) as well as the effort they make to overcome the many initial obstacles. Affective factors may determine the effort which students put into the process of learning to use CAS correctly, efficiently, even automatically and, in particular, the degree to which their own mathematical habits and learning strategies are changed as a result of the new possibilities afforded by the availability of CAS.

To expedite the process of instrumental genesis external guidance is necessary. Trouche (2003) argues that this necessity is rarely taken into account. He explains the need for carefully planned teaching episodes that consider a number of dimensions in what he terms ‘orchestrated instrumentations’. Designing suitable learning experiences requires an understanding of the mathematics, the CAS, the students and impediments to their positive interaction. The reactions and interactions at the interface between students, mathematics and CAS add a new dimension to mathematics classrooms, which are studied in this paper.

## **NUMERIC DATA COLLECTION AND RESULTS**

The data reported in this paper was collected from 30 students during their second year of working with CAS. A survey instrument was administered on four occasions: February (the beginning of the school year), May, August and October (shortly before final examinations); a ‘Basic CAS Skills’ test was conducted in October; and the experienced classroom teacher was interviewed. The ‘Use of CAS Questionnaire’ consisted of the same 36 Likert scale items each time plus up to 6 open questions.



Students were asked to reflect on their experience during the previous week. The open questions always offered the students the opportunity to note any technical difficulties they were experiencing and anything else they would like us (or future students) to know about their experience of doing and learning mathematics with CAS available. The closed items were separated into two sections. The first 16, included below as Table 1, identified CAS features or actions along with 5 response options scaled from ‘Very Hard’ (scored as 1) to ‘Very Easy’ (scored as 5) plus the possibility ‘Not Used’ (omitted from averages).

CAS feature or action	
1. Using CAS symbols like / for division and ^ for ‘raise to power’	9. Changing between symbols and tables
2. Bracketing expressions as required	10. Viewing the important parts of my graphs
3. Remembering what names like TRNS mean.	11. Setting table start and increments
4. Using CAS syntax eg. Substitute(3x,x=4)	12. Finding all of my answers on the screen
5. Working with letters other than x	13. Scrolling through my working steps
6. Defining or using functions	14. Obtaining exact, approximate, surd or decimal solutions
7. Finding my way through the menus.	15. Copying graphs from the screen
8. Changing between symbols and graphs	16. Interpreting CAS symbols as ordinary maths

Table 1: Survey items relating to the technical aspect of CAS use

Boxplots of the average class results for the technical issues section of the survey data are included below as Figure 1. These graphs indicate that, by the end of their second year of working with CAS, most students were confident and half of the students felt that using CAS was either easy or very easy. However, no item was indicated as Very Easy or Easy by every student. Students were most confident about item 1, but some other items had up to 13 percent of students who found them to be Hard or Very Hard. Students indicated least confidence in items 2, 6, 8, 10 and 16. For example, almost half the students indicated that they found item 8 (*Changing between symbols and graphs*) to be Hard or OK (score 2 or 3). The data shows some improvement on average over the year, but new challenges arose at every stage.

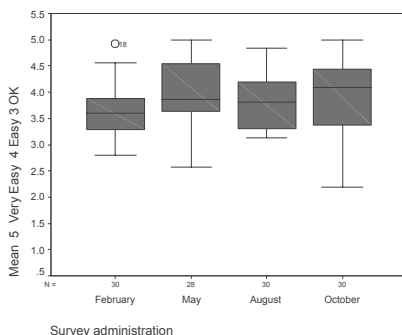


Figure 1: Students’ average rating of their technical facility throughout the year.

The ‘Basic CAS Skills’ test in October required students to use their CAS to perform 16 mathematical tasks such as entering expressions with algebraic fractions and parameters, evaluating integrals and finding the solutions of simultaneous equations. These items covered the essential tasks that students needed for their imminent, high-stakes, final examinations. Students recorded the number of attempts required before achieving ‘no syntax errors and a correct result’. This task was undertaken as a formative revision ‘test’ in class with immediate feed back from the teacher via the view screen. We recorded the number of tasks which students completed using correct syntax on their first attempt. These results, illustrated in Figure 2, show that most students had few problems with CAS syntax on familiar tasks, with all students performing the majority tasks correctly at first attempt. It is not surprising that most students made one or two slips when lengthy or composite syntax was required.

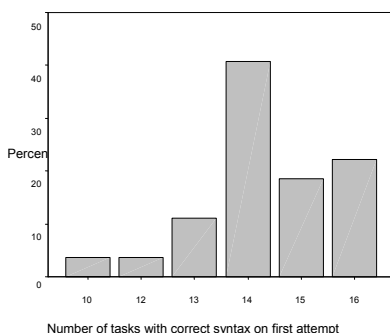


Figure 2: Number of tasks correct on first attempt (max 16).

## SIX STUDENTS’ EXPERIENCES

The issue of difficulties with the technical aspect of effective use of CAS is not simple. A broad grouping on students as being of ‘high’, ‘middle’ or ‘low’ year 12 mathematics achievement was based on the judgement of the class teacher. In this study the teacher, who had at least 10 years experience of teaching the equivalent course without CAS available, was well qualified to make this assessment. Figure 3 below illustrates details of 6 students (pseudonyms used) chosen because they provide clear evidence that level of technical facility is *not* only explained by mathematical ability. Technical facility in Figure 3 is reported in three loose groupings, related to inputting information, using commands and interpreting results.

The second set of closed items on the ‘Use of CAS Questionnaire’ included 20 statements describing personal approaches to using CAS. This included statements such as ‘I use CAS to try out ideas’, ‘I like using CAS’ and ‘I can do harder maths with CAS’. Students were asked to indicate, on a 3-point scale, how often each description applied to them in the previous week. This information was used to

classify students' attitude towards CAS and how they used it. Using CAS in a limited manner only, to do some questions faster, or when the teacher directed, but not to initiate exploration was classified as 'low usage'. High use included exploring ideas.

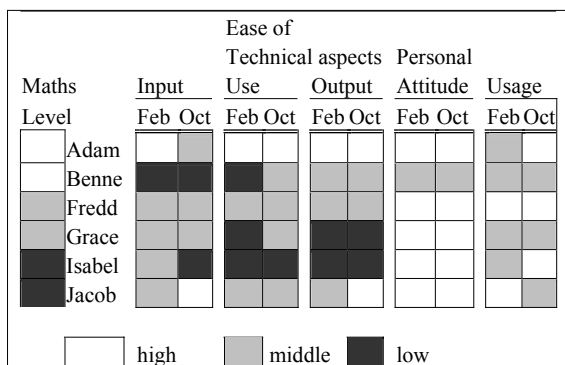


Figure 3: Mathematical, Technical and Personal aspect levels for six students

Adam, a very high achieving mathematics student, was also strong in each aspect of Effective use of CAS. The class teacher described his use of CAS as elegant. He began the year with confidence, writing in February: “Easy, feel confident, interested. It’s [CAS] a very good machine, making maths a lot quicker and easier to understand.” Following an important test in May, he indicated that he had had no difficulties but rather found CAS to be “lots of help” throughout the task. At the end of the year his advice to future students was: “Don’t be confused by the syntax. Try to remember what each function does and use it to your advantage”.

In contrast Benne, who was also a very strong mathematics student, did not like using CAS and, despite the evidence of the Basic CAS Skills test, when he completed each task correctly at his first attempt, never said that he found CAS easy. In February he indicated that CAS did not make any area of mathematics easier nor did it help him in his understanding. He preferred to use pen and paper. By August he indicated that he did make some use of CAS: “I make sure that I know how to do the problem by hand before using CAS and use CAS to check the answer.” The limited value that he placed on CAS is clear. He did not use CAS to explore maths or try out ideas: “Not enough time to...actually can’t be bothered.” Benne’s mildly sarcastic comment to future students indicates a reluctant acceptance of the technology. “It’s good. Make sure you can do stuff by hand as well but know how to use all features of CAS- know how to turn it on/ take off the cover.”

Fredd, a middle ability mathematics student, felt strongly positive towards about the role of CAS in learning and made strategic use of its facilities. This was despite continued technical difficulties. In February he wrote: “I like CAS because it is easier.” During the May test he experienced difficulty “when putting functions into the graph menu, [format] often has to be varied.” In August, he also commented that

he had difficulty “ensuring that brackets [parentheses] are right in long equations in CAS menu.” This did not discourage Fredd. He wrote: “I use CAS for ‘hard’ questions to often check answers with it as a safe guard. It is a waste of time for easier questions. ... We use CAS to explore broader ideas, not just the single or specific questions.” In October his advice to future students emphasised the tension between needing mathematical knowledge to use CAS effectively and the role of CAS in expanding mathematical understanding. Fredd’s technical difficulties don’t seem to be important to him. “Go for it, if you are not strong in by-hand skills. Good if you understand what you use it [CAS] for. If not it isn’t useful for you. It can dramatically expand your understanding. If you are not strong in maths the CAS program is not as beneficial.”

Grace, another middle band mathematics student, experienced technical difficulty but retained a positive attitude. In February she wrote: “I have found that for some topics CAS has been really helpful.” In August she still found “using brackets in appropriate places frustrating” but “I will try to do the question both by hand and then on CAS and this helps me to understand the answer I got.” Grace’s advice to future students indicates an awareness of her technical difficulties along with thoughtful reflection on the role of CAS. “Always plan what you are going to do first in your head and not just key in anything - understand what you are doing. Keep practising your by-hand skills - this is one disadvantage of the CAS because I find factorising etc. difficult now because I have forgotten how to do a lot of simple maths. Persist with the CAS, it becomes easier with time.”

Isabel, a low ability mathematics student, also experienced considerable difficulty managing the technical aspects of CAS. Against these odds she remained positive about both mathematics and the use of CAS. With a positive start to the year, in February, Isabel wrote that she used CAS “for lots of things” and that “differentiating is made easier with CAS”. In the important May test Isabel had trouble with syntax errors: “It is annoying how when you get errors and then it doesn’t actually tell you where you have gone wrong” and setting an appropriate graph window: “It is annoying if you can’t see the graph and can’t find it then you have to search for ages.” She also found CAS unhelpful when she needed to “use lots of letters.” In August, Isabel still found working with “letters other than  $x$  a nuisance” but, despite such fundamental technical difficulties, she still valued the facility of CAS to explore mathematics. “I find it easier just to put an eq[uation] into the CAS and then play around till I find an answer that looks right. Most times I get it. Also long questions and diff[erentiation]/ antidiff[erentiation] are so good on CAS.” She wrote “The CAS is good [be]cause it makes maths easy.” Isabel’s positive advice to future students acknowledges that using CAS is not trivial :” DO IT! It’s really good - but it can be confusing and kind of hard as well. Find the shortcuts on the different menus of the CAS before you do anything else - they are the best things. Do by hand as well.”

Jacob was a low ability mathematics student who, according to the class teacher, would not have tackled the equivalent mathematics subject without CAS. He felt

empowered by CAS. In February, his cautiously optimistic comment reflects the technical difficulties he has experienced: “Often frustrated, occasionally it's a good thing.” After the important May test he wrote that he had found CAS helpful for most tasks. He continued, “Without CAS, I would be lost; it helps me understand maths in general. With CAS, I can do maths confidently!” His reflection in August outlines the degree to which he has come to value CAS. “I've never been good in the maths department, especially the ‘hard’ questions. Using CAS enables me to understand maths and have a ‘crack’ at questions I would usually leave!!! Without CAS I struggle ... so I use it for everything. It's incredibly helpful and a great learning tool. I can do harder maths with CAS. I can now do maths with confidence and an understanding of what I'm trying to do.” Jacob's advice to future students was: “Learn to do problems both ways, by hand and by CAS; that way you can check your answers and fully understand what's going on.”

## DISCUSSION

These students serve to remind us of the individual variation in students' mastery of this technology. Adam's combination of positives, for every aspect of his CAS use, certainly allowed him to employ it to the advantage of both his doing and his learning of mathematics. Benne, who preferred to work by hand, did not automate the technical aspect sufficiently for it to become easy and free him to focus on the mathematic, as he did without CAS. Fredd did not allow his technical difficulties to affect his attitude or constrain the scope of his CAS use. Grace, who was cautiously positive about the role of CAS, saw technical mastery as requiring persistent effort. She was concerned about the effect of reliance on CAS and therefore perhaps did not ‘practise’ CAS skills on ‘simple’ mathematics. Isabel, who had only low mathematics ability, continued to experience fundamental technical difficulties but, despite this, felt empowered by CAS in both doing and learning mathematics. It seems that Jacob, although a low ability mathematics student, succeeded in overcoming his early technical difficulties. From his comments, it seems likely that he made a great deal of use of CAS and that, because he saw it as an essential partner in his mathematics progress, he was prepared to make the effort to become a competent user.

The nature of the common difficulties reported, in particular the use of brackets, are similar to those described by Drijvers (2001) and Lagrange (1999). Students, in their initial use of CAS, often report frustration at both the need to correctly use brackets and to efficiently move between representations. Within a generally positive climate, it was interesting to see that, for some students, fundamental difficulties persist well into their second year of CAS use, even for skills that are likely to improve with practice. The resistance of some able students to mastering these actions is especially interesting, in this context, because this well motivated class, preparing for high stakes examinations, was taught by a teacher who was excited by the opportunities afforded by CAS. Kendal and Stacey (2001) report the impact of teachers' underlying beliefs and values with respect to mathematics on what they privilege in their teaching of mathematics in a CAS active environment. In this study we see the

influence of students' attitudes, based on their beliefs about how they learn mathematics, on their adoption of CAS as an instrument for doing or learning mathematics. These results are consistent with those of the authors' previous study undertaken with first year undergraduate students (Pierce and Stacey, in press), where we also observed able students who used CAS effectively, able students who did not want to use CAS, along with previously weak mathematics students who became able exploiters of the facility of CAS. In this study, the Effective Use of CAS framework (Pierce and Stacey 2002) proved sufficient for highlighting the technical and personal aspects of students' thinking that impacted on each student's use of CAS.

## CONCLUSION

The evidence presented in this paper emphasises the importance of giving due consideration to the extra layer of complexity which developing effective use of CAS can add to the mathematics classroom. Both the teachers' and the students' attitudes have an effect. Although obstacles were encountered, students generally were well able to master the required technical aspects of CAS whilst they learned a demanding mathematics subject. The level of technical difficulty that students may have in using CAS and the degree to which this may present an obstacle to their mathematical learning is not predictable on the basis of their 'conventional' mathematical ability. To plan appropriate teaching for the effective use of CAS it is therefore important to undertake some monitoring of this dimension of students' progress.

## References

- Drijvers, P. (2000). Students encountering obstacles using CAS. *International Journal of Computers for Mathematical Learning*, 5, 189-209
- Guin D. & Trouche, L. (1999). The complex process of converting tools into mathematical instruments: The case of calculators. *International Journal of Computers for Mathematical Learning*, 3, 195-227.
- Kendal, M., & Stacey, K. (2001). The impact of teacher privileging on learning differentiation with technology. *International Journal of Computers for Mathematical Learning*, 6, 143-165.
- Lagrange, J.-B. (1999b). Complex calculators in the classroom: theoretical and practical reflections on teaching pre-calculus. *International Journal of Computers for Mathematical Learning*, 4, 51-81.
- Pierce R. & Stacey, K. (2002). Monitoring Effective Use of Computer Algebra Systems in B. Barton, K. Irwin, M. Pfannkuch & M. Thomas (Eds.) *Mathematics Education in the South Pacific* (Proceedings of the 25th Annual conference of the Mathematics Education Research Groups of Australasia, Auckland, Vol 2 pp 575 -582.) (Refereed paper)
- Pierce, R. & Stacey, K. (in press). A framework for monitoring progress and planning teaching towards effective use of computer algebra systems. *International Journal of Computers for Mathematical Learning*.
- Trouche, L. (2003). Managing the complexity of human/machine interaction in a computer based learning environment(CBLE): Guiding student's process command through instrumental orchestrations. Paper presented at 2003 Symposium on Computer Algebra in Mathematics Education, France. Retrieved January 11, 2004, from: <http://itsn.mathstore.ac.uk/came>.

# TECHNICAL SCHOOL STUDENTS' CONCEPTIONS OF TANGENT LINES

Valéria Guimarães Moreira, Márcia Maria Fusaro Pinto

Universidade Federal de Minas Gerais. Brazil.

*This paper reports ongoing research investigating how students' experiences with the notion of tangent line in different lecture courses at a technical school are being integrated to the related mathematical concept. Focusing on a technical course case study, we examine how aspects of the notion of tangent line are related to features of the context in which they are being produced. In addition, we discuss whether it is appropriate, from the perspective of situated learning, to account for practices of school mathematics in the various lecture courses in the curricula as distinct school mathematics practices, or, distinct communities of practices of (school) mathematics.*

## INTRODUCTION

Our study investigates aspects of the mathematical notion of tangent line which emerge from practices in vocational classes at a technical school. Research questions emerge during the development of a two years research project involving four mathematics undergraduate students as researchers<sup>1</sup>. Supported by Vinner (1991) and Tall and Vinner (1981), we partially reproduce research already conducted by those authors, though referring to students in their first course on Calculus in our own country. The notions of *concept image* as the whole cognitive structure associated to a mathematical notion and *concept definition* as the form of words used to designate a mathematical concept oriented our data collection and analysis. From our results, we became specially interested in those related with the notion of tangent line. Having attended a Calculus lecture where the lecturer presented the mathematical notion as the limit position of secants to a curve at a point, interviewees were invited to draw a tangent line to a curve. The students responded giving explanations involving movement that had occurred in their physics lectures. Their procedures included 'adjusting a circular arc at the point', instead of perceiving the curve locally straight as we generally suggest in our Calculus course. In addition, they spoke freely about the 'centre of a curve at a point' when referring to the centre of the adjusted circular arc.

---

<sup>1</sup> This research project was supported by CNPq. We would like to thank David Tall in sharing ideas with us and revising this paper.

These evoked images remind us of mathematical notions which are met, but only, later in advanced mathematics, which we never took into account when teaching the first year Calculus course.

Being aware of students' technical school backgrounds and examining some of their technical design papers, we conjectured that those students' earlier images related to curves and tangent lines may not have been made explicit by their teachers or by any instructional material. Similar responses occurred in many students, suggest that they could have been shared in a technical design activity. It appears for us that an investigation of students' evoked concept image and learning should account for students' practices and a learned curriculum other than to be restricted to the one taught by the teachers or explicit in instructional materials. In addition, the shared images also highlight a social dimension in their practices. Concerned with students' learning in those terms, we refer to Lave and Wenger's theoretical framework in situated learning and suggested by it, we discuss the practices of school mathematics.

Our interest in this study is twofold. On the one hand, we become acquainted with aspects of students' notion of tangent line we are not aware of, and which we in general leave untouched in our mathematics lectures. On the other hand, we reflect on our current educational reform-based curriculum for technical schools, examining if it has improved in supporting the role of school mathematics in the vital part of the curriculum – the specific technical courses.

The research as a whole is concerned with school mathematics practices (as we are perceiving them) in regular secondary school courses such as mathematics, physics and technical design, and in specific technical courses in Mechanics, Electronics and Highway Systems, when directly or implicitly approaching the concept of tangent line during the development of the course.

In this paper, we attempt to clarify what we understand as diversity in school mathematics practices. We also present partial results from data analysis, collected through classroom observations and interviews with groups of students from a Highway System technical course case study. Results indicate that students seems to reaffirm their prospective professional culture through school mathematics practices which are close to those already observed and described in workplaces.

## **RESEARCH FRAMEWORK**

Lave and Wenger developed their theory focusing on practices out-of-school. They see learning as developing in practices and as part of a process where people's identities are developed in participating in communities of practice (Lave and Wenger, 1991). Researchers do not consider as unproblematic a



recontextualization of such a theory in formal institutions. With such aim, Wimbourne and Watson (1998) characterize communities of practices expressing their beliefs that many of their features could be re-signified in schools. These refer to developing an identity, supported by a social structure of the practice, with a common purpose and shared ways of behaving, language, habits, values, and tool-use. They consider less obvious that in school classrooms the participants will constitute the practice, given that in most mathematics lessons 'the teacher is not engaged in learning mathematics' (p.94) and also that all participants would see themselves engaged in the same activity, 'because pupils' participation is often passive' (p.94). Adler (1998) expresses her view that the learning of mathematics at school is a specific practice; that mathematics is learned through the language in use in classroom, and also the learning of mathematics would include acquiring, recognizing and developing specific ways of using language. We agreed to guide our investigation into school mathematics practices in different courses on the following features: lecture course goals in approaching mathematics; classroom practices, including the role played by the teacher and students during the activities; didactical materials, from which students may incorporate aspects from the concepts even if they are not made explicit by the teacher and students during the lessons; the mathematical language in use, meaning the mathematical symbolic language and representations evoked by students and the teacher. In general, these are built during the activity and highlight behaviour, language, habits, values and shared tools, which we understand as part of developing an identity.

## **METHODOLOGY**

The whole study is a qualitative research taking place at a technical (secondary) school from March to August, 2003. Methods of data collection are non-participant observation of eight regular course classrooms, analysis of students' written responses to a questionnaire handed by the researcher at the end of each course classroom observation, and semi-structured interviews with eight groups of six students from each regular course, selected on basis of their responses to the questionnaire.

The eight regular course classrooms were previously selected and field notes were taken when activities referred to the notion of tangent line. Some activities were recorded in video. Our questionnaire partially reproduced a previous research instrument (Vinner, 1991) and results are interesting but will not be detailed in this paper. We interviewed groups of students as an attempt to account for students' shared images and to relate them with the context where they were apparently being produced.

The case study we report in this paper focuses on a 4 hours a week course classroom Project, at the beginning of the second year of the Highway System course. 19 students are attending the course. All of them are in their final year of secondary school or had just graduated. Video recording and field notes were taken during 4 weeks observation.

## **THE HIGHWAY SYSTEM CASE STUDY**

The Project course syllabus consists of the development of an activity of plotting roads on topographic maps. Plotting procedures were learned in previous courses. In this same academic term, students are also implementing a project in placement and locating a proper road. In order to discuss school mathematics learning and practices in the Project course, data analysis presentation is organised by relating our observations to *classroom practices*, *didactical materials*, *mathematical language in use*. *Goals in approaching mathematics* in this context are left for a last section in the paper.

### **Classroom practices**

The course activities run in a special class, with individual work desks for students, facing the blackboard and the teacher's desk. The teacher conducts the activity giving initial instructions and discussing procedures he believes as necessary to implement the activity. He does not stay in classroom during the activities, which does not interfere in the students' performance as a whole. When in doubt, students consult each other, constantly discussing the task, which could be nearly described as a collaborative work. They often meet in small groups around some student's work desk, looking for an agreement, or for explanations from those who had already concluded the activity, or part of it. Mathematics mainly refers to calculations of coordinates to locate the cambers on the road. Checking results may involve the whole class in a discussion. In general, they attempt to get a common result, adjusting their calculations within an admissible error.

### **Didactical materials**

A topographic map, pencil, rule, compass, scientific calculator, no text book or other written instructions; a table with data and specific measurements for plotting the cambers, constructed as course work in a previous course.

### **The mathematical language in use**

The teacher explains the procedures to plot the road on the blackboard, paying special attention to the cambers of the roads. At the beginning of his speech, he takes for granted students' awareness of the notion of tangent line. Interrupting his own explanation, he addresses the whole class as follows:

You all know what a tangent line is, don't you? We have a circle [he draws a circle on the blackboard while speaking], or, it doesn't really matter if it's a circle or another circular picture, okay? Any curved picture. It could be a circle, it could be a spiral, it could be any curved picture, she would know better how to speak what a curved picture is [he refers to the researcher, facing her], it could be an ellipse. If you have a line which touches this picture [he draws a tangent line to the circle he had drawn on the blackboard] at a single point, only a single point, we say this line is tangential to the curved picture, isn't it? And in case of roads, what we are going to do is to take these lines and *adjust them with* a curved picture, in this case a circle, or an arc of a circle ...

Notice that images evoked by the teacher relates the notion of tangent line to the notion of tangent line to a circle. He also emphasizes the idea of a tangent line as a line which 'touches the picture at a single point'. He makes an attempt to discuss the concept generically when observing that 'it doesn't really matter if it's a circle'; though turning it back specific, when referring to a curve as any 'circular picture'. We may also suggest his unawareness of the mathematical discourse when referring to 'circular pictures or curved pictures'. He definitely contextualizes his discourse and his definition within his own practice when naming the procedure of plotting the tangents by using a technical jargon such as 'adjusting them [the tangent line] with' the curve.

Students' evoked images are observed during the interview. Victor, Carla, Laura, Linda, Daniel and Hilton were handed the questionnaire they had previously responded. They were invited to comment on its first question, which asks

Write down what a tangent line is.

Follows the conversation:

Victor: Mine [tangent line or definition of tangent line] are straight lines that once stretched crosses at a single point.

Interviewer: Sorry?

Victor: They are stretched straight lines, umm, that crosses at a single point, making an angle which will be used to define the kinds of cambers which will be plotted in a project.

Notice that Victor is not intimidated by the interviewer's implicit comment on his answer nor by the interviewer's mathematical background he knows as a mathematician. He continues, supporting his concept definition on procedures arising from his technical practice. In respect, devising tangents before defining the curve could be thought as an interesting aspect of his evoked images, reminding us of other mathematical notions such as integral curves.

Victor continues his explanation responding to the interviewer, who insists that he clarify his thoughts. Asking for other students' help, Victor is assisted by Carla and Laura

Carla: Oh, like this. I believe like this, in the context of, like, geometry, in actual mathematics, it is just the one [the straight line] which touches a single point at a curve, at a circle and everything. In the case of plotting roads they would be, like, it is straight lines, it is, it is like it is not in the field, it is like imaginaries. They would be the procedures you develop, they cross each other and they are also called tangents these procedures that you carry out referring to, in topography, when plotting roads, we use them as tangents.

Laura: Yes, then you go there and plot the points, carry out the procedures and then they cross each other and they are considered tangent, for us, you know, in the case of our course.

Both Carla and Laura suggest a distinction between the 'actual mathematics' learned in mathematics classroom and the mathematics reconstructed with their practices, referred to by Laura as (the mathematics) 'in the case of our course'. Carla also suggests a distinction between the 'actual mathematics' and her technical practice observing that, in practice, tangents are 'imaginaries'. We conjecture that, for her, this is not the case in geometry or in 'actual mathematics'. This could suggest a distinction between practising mathematics and using mathematics in another practice that poses a mathematical instrument as imaginary (or abstract?) when dealing with applications, but not when practising the actual mathematics. Linda joins the conversation, being assertive about her mathematical meaning for the word tangent.

Linda: What I'd learnt about this term in my seventh grade is that it [the tangent] touches at a unique point of the circle, isn't it? This is what I'd learnt there, since mine ...

Victor: Yes, tangent is that.

Victor had no choice other than agreeing with Linda's mathematical notion. The interviewers' intervention provokes a collective construction of a *concept definition* of tangent, situated in the students' practice of locating highways

Interviewer: Is that the same tangent, when you are plotting highways?

Linda: In the case of, of...

Victor: ... plotting ...

Carla: ...cambers, in the case of whom would be the tangents ...

All interviewees at once: ...the external tangents ...

Daniel: ...tangent in such different way would be, as I say, a straight line, isn't it?

Linda: Yes, they would be straight lines, isn't it? Straight lines which crosses each other.

In turn, Linda had no choice other than accounting for the notion of tangent line as reconstructed by the group.

## DISCUSSION

The episode presented above and students' comments on curves and tangent lines suggested our research questions share common aspects. Other than making explicit well-known images, such as a *tangent touches a curve at a unique point*, they indicate that a context of technical design practices may reinforces such ideas, supported by the notion of tangent to a circle as a special case. Or, rephrasing, it seems that such images naturally emerge from procedures of students' technical design practices, through identifying (arcs of) curves and arcs of circle. In our case study, this fact is already implicit in students' and teacher's speech. Ideas may not be matching with ours, Calculus teachers, when we present curves to students as intuitively locally straight (and we might be aware of it); but the mentioned procedures naturally bring to bear other mathematical notions, such as centre of curvature or 'given the tangents, determine the curve', that may enrich discussions in our classrooms.

From our analysis of classroom practices we argue that both teacher and student voices appear as legitimated during the whole process. In fact, a correct procedure is bounded by general agreements among the students, in a similar fashion as described by researchers examining the use of mathematics in work place (see Magajna, 1998). Both students and the teacher are constituting the practice, all of them engaged in the same activity, suggesting that classroom practices could attend to those features of communities of practice considered by Wimbourne and Watson (1998) as less obvious in school institutions. In this case, supported by the researchers' comments, these aspects certainly distinguish the school mathematics practices in the Project course from many other practices in mathematics classrooms.

Language used in the classroom gives clear indication that both students and teacher re-signify mathematical meaning with their practice, modifying the mathematical discourse. From Adler (1998), observation of a distinction between the learning of a language and acquisition of a language, we suggest that our students are acquiring language, in the structure of their practice. In fact, they seem to be 'borrowing' a concept name from the mathematics practice and collectively transforming its meaning to indicate its use in a technical procedure. Therefore, goals in approaching mathematics in this

technical classroom seems very different from those in our mathematics classrooms. In this sense, we may think of a diversity of school mathematics practices in school, in particular, in a technical school.

And why does it matter at all? We may well assume a perspective, as students and workers seems to do, that there is an actual mathematics practice which is different from their practice, meaning that what they practice, is not mathematics practice. Sometimes, they apply some mathematics, learned at school. But if we simulate thinking on their practice as re-structuring school mathematics practice, or, as a distinct community of practice of mathematics, we may rethink our vocational and services courses and perceive them as much more complex than a simple context for modeling or applying mathematics. Maybe we are far from understanding what happens with the implementation of our mathematics in other practices.

### References:

- Adler, J. (1998). Lights and Limits: recontextualising Lave and Wenger to theorise knowledge of teaching and of learning school mathematics. In: Watson, A. (ed) *Situated Cognition and the Learning of Mathematics*. Oxford. 161-177.
- Lave, J. and Wenger, E. (1991). *Situated Learning. Legitimate Peripheral Participation*. Cambridge University Press.
- Magajna, Z. (1999). Making sense of informally learnt advanced mathematical concepts. Proceedings of 23 Conference of the International Group for the Psychology of Mathematics Education. 3, 249-256.
- Magajna, Z. (1998). Formal and informal mathematical methods in working settings. In Watson, A.(ed). *Situated Cognition and the Learning of Mathematics*. Oxford: Centre for Mathematics Education. 59-70.
- Tall, D. & Vinner, S. (1981). Concept image and concept definition in mathematics with particular reference to limits and continuity. *Educational Studies in Mathematics*, 12 (1), 151-169.
- Vinner, S. (1991). The role of definition in teaching and learning mathematics. In Tall, D. (ed.) *Advanced Mathematical Thinking*, Dordrecht: Kluwer. 65-81.
- Wimbourne, P. and Watson, A. (1998). Participating in learning mathematics through shared local practices in classrooms. In Watson, A. (ed). *Situated Cognition and the Learning of Mathematics*. Oxford: Centre for Mathematics Education Research, University of Oxford Department of Educational Studies. 94.

# ELEMENTARY SCHOOL STUDENTS' MENTAL REPRESENTATIONS OF FRACTIONS

Demetra Pitta-Pantazi\*, Eddie M. Gray\*\* & Constantinos Christou\*

\*Department of Education, University of Cyprus

\*\* University of Warwick

*Based on psychological approaches that evoke mental representations through verbal and visual cues, this paper investigates the different kinds of mental representations projected by 8 to 11 year old children of identified arithmetical achievement when responding to verbal and visual stimuli associated with fractions. It examines how the visual and verbal cues may affect the kind of mental representations the students' project. The paper traces the way these mental representations may change from an immediate "first" response to a "30 seconds" response. The study reveals that different formats of the stimuli and the elapse of time not only evoke different kinds of mental representation but that these different kinds may be strongly associated with the level of mathematical achievement.*

## INTRODUCTION

Students' understanding of fractions is an area of research within the field of mathematics education that has received considerable attention in the recent years. This interest has produced a wealth of information associated with students' operations and representations of fractions, the complexity of the concept, student difficulties and advice on the way fractions may be approached in the classroom (Behr, Harel, Post, & Lesh, 1992). In addition, research has also provided a wealth of information associated with the abstraction that denotes the cognitive shift implicit in doing mathematics and knowing mathematics (Beth & Piaget, 1966; Dreyfus, Hershkovitz & Schwartz, 1997).

It is students' difficulties in making these abstractions in the context of fractions that is the rationale for this paper. Both research findings as well as school experience, indicate that students provide a variety of responses when asked "what is a fraction?" (Pitta, 1995). Some students tend to see it as "something very small", "a circle cut into pieces" or "a shape with a lot of lines". Other students may tend to see the more intrinsic qualities of the mathematical symbolism and think of fractions as "the relationship between a numerator and a denominator, quotient and decimals". From such findings we may discern that there are differences in the quality of students' thinking about fractions and the mental representations they associate with the notion.

Our efforts to gain insight into why these differences occur, have consciously taken a route that considers cognitive development and more specifically mental representations. Whilst acknowledging that there is a wide spectrum of inherent, social and educational influences on this development, our interest focuses on

seeking answers to the kind of mental representations students' form. The underlying assumption is that the qualitative differences in thinking may arise because students form different kinds of mental representations.

The paper reports part of a larger study investigating the way in which different kinds of mental representations may be associated with students' achievement in elementary arithmetic. However, when we refer to different kinds of mental representations we do not intend to discuss differences in format associated with visual or non-visual characteristics. Irrespective of these formats, our guiding principle is that there are other aspects of mental representations that require further discussion. We believe these are important in understanding what it is children select to form in their mind and how they may relate to mathematical concept development.

Starting from De Beni's and Pazzaglia's (1995) classification of different kinds of mental representations, we broaden this debate to illustrate how these different kinds of mental representations may be related to different levels of arithmetical achievement. We also investigate whether mental representations are affected by the presentation of visual and verbal forms of stimulus and whether they change from an immediate or "first" response to a lengthier, "30 seconds", response.

## **THEORETICAL BACKGROUND**

A number of mathematics education researchers have considered different kinds of images and mental representations. Pirie and Kieran (1994) indicate that the development of a learner's understanding can be seriously influenced by strong attachments to initial particular images. Thomas, Mulligan and Goldin (2002) have suggested that children's internal systems of representation of numbers go through a series of changes, from a semiotic one, in which meaning is established through previously constructed representations, to an autonomous stage in which a new system of representation functions independently of its precursor. Brown and Presmeg (1993) suggested a distinction between concrete, pictorial, memory and pattern imagery. The first two appeared to be dominant amongst instrumental thinkers and the later amongst relational thinkers. In elementary arithmetic such differences may emerge because those who mainly use procedures display less inclination to filter information. Relational thinkers appear to reject, temporarily ignore or select information which is more relevant to the task (Gray & Pitta, 1999).

Within the field of cognitive psychology De Beni and Pazzaglia (1995) have identified different kinds of mental representations which seem to share the view that mental representations may have different contexts and different levels of abstraction. They identified several kinds of mental representation: general, specific, contextual and autobiographical which were seminal to our work and to this study.

Although within the fields of mathematics education and cognitive psychology there are various classifications of mental representations, research seems to converge at least on one basic principle: individuals construct different kinds of mental representations from any learning (or daily life) activity. This observation has crucial



implications for the development of the fraction concept, the initial development of which usually involves activities with concrete objects and geometric shapes. From these activities learners are expected to abstract the concept of fraction and, eventually, the associated subconstructs of part-whole, number, quotient, operator, and ratio. The issue for this paper is the relationship between abstraction and mental representations.

The abstraction of mathematical constructs from concrete situations is considered to be an important outcome of mathematical learning activity. However, the individual needs to identify the same concepts, structures and relationships from many different but structurally similar tasks (Dreyfus, HersHKovitz & Schwartz, 1997; Charles & Nason, 2003). The absence of such identification may lead to the mere completion of the task and superficial memorization of the procedure or the activity (Bereiter, 1994).

Mental representations may be seen to be the product of a suitable form of abstraction. Beth and Piaget (1966) have identified three kinds of abstraction, each of which contributed to qualitative different levels of thought. Whilst “empirical abstraction” derives its knowledge from the properties of objects “pseudo-empirical abstraction” teases out properties from the actions. A third kind, “reflective abstraction”, teases out properties that the actions of the subjects introduce into the objects. These three kinds of abstraction have special connotations for this study since they are concerned with the focus for the abstraction: the object, the action or the common properties that the actions have introduced into the objects, and the level of specificity or generality of these abstractions.

## **AIMS OF THE STUDY**


The aim of this study is threefold. First, to identify what it is that 8 to 11 year old students at different levels of achievement have selected to abstract and keep as mental representations of fractions. Second, to investigate what is the “first”, immediate mental representation that comes to mind when students are presented with different fraction items and examine how this mental representation may change and expand during a 30 seconds period of clarification. Through the two part questioning process, the “first” response and a “30 seconds” response, it was believed that respondents would have an opportunity to create a “first” mental representation that had the potential to be enriched with detail resulted from a network of other relationships (Drake, 1996). The third aim of the study was to investigate whether visual and verbal stimuli caused different kinds of responses.

## **METHOD**



One cannot of course observe students’ mental representations. Spoken words and written representations are used to make inferences about these mental representations. Thus the data gathering technique was the semi-structural clinical interview (Ginsburg, Kossan, Schwartz & Swanson ,1983). Students were

interviewed over two separate occasions approximately 8 weeks apart. All interviews were video-recorded, linked to field notes and transcribed.

The research was conducted in a “typical” primary school in the English Midlands. The participants were sixteen children aged 8 to 11 years old, representing the extremes of numerical achievement in each of the four years of schooling. Thus there were two children at the each extreme of achievement within each of four years. The students’ arithmetical ability was measured by criterion based test results available in the school and a numerical component which formed part of the larger study of which this paper is part. The underlying assumption was that the analysis of responses provided by students at the extremes of arithmetical achievement would demonstrate a clear distinction between the different kinds of mental representation they project and these in turn would demonstrate a relationship with arithmetical achievement.

A modified version of the defining feature approach (see for example, Roth & Bruce, 1995) was used to gain a sense of what students feel is important to communicate when faced with visual and verbal stimuli. Within this paper we report on the outcomes of children’s responses to three verbal cues: fraction, half, three quarters, and three visual cues: the symbols  $1/2$  and  $3/4$  and the representation .

Each verbal and visual cue was presented with the following instructions:

- 1<sup>st</sup>: What is the first thing that comes to mind when you hear the word (fraction, half, three quarters) (or see  $1/2$ ,  $3/4$ , )?
- 30 seconds: Talk for 30 seconds about what comes in your mind when you hear the word... (fraction, half, three quarters)
- 30 seconds: Look at this, ( $1/2$ ,  $3/4$ , ) when I tell you close your eyes and put this in your mind. Talk to me for 30 seconds. Do it now.”

## RESULTS

### Classifying Responses

The classification of responses is mainly based on those identified by De Beni and Pazzaglia (1995). However, after a first analysis of the data collected we felt that some modification of these classifications was necessary in order to make them more appropriate to mathematics education. One of the most important modifications made was the replacement of the classification “contextual” with three separate components, “episodic”, “generic” and “proceptual” (Gray & Pitta, 1999). In order to provide a more comprehensive description of the way in which students’ responses were classified for this paper, examples of the different kinds of mental representations projected by the students for the item “fraction” are presented below.

General: the representation of a concept without any reference to a particular example: “*Part of*”.

Specific: De Beni’s and Pazzaglia’s reference to one well-defined example of the concept was extended to allow for representations that included multiple examples that were qualitatively similar: “*Lots of different fractions for example  $1/8$ ,  $1/7$* ”.

Episodic: representations associated with a scene or sequence of scenes that was most often narrated: *"It's like doing maths and being taught how to do fractions"*.

Autobiographic-episodic: representations, which allowed for the "occurrence of a single episode in the subject's life connected to the concept: *"My friend wasn't good at fractions and last week she had to take extra work home"*.

Generic: these representations originated from the same general concept that served as the basis for explicit relational connections. They were collections of statements that seemed to have the potential to produce new ideas. Though these representations had a 'general' quality, the statements diverged to produce different ideas: *"Shapes, part of shapes, cutting, cut shapes, sharing"*.

Proceptual: these representations were identified from those that possessed a proceptual nature (procedural and conceptual): *"Half, shaded shape, decimal, percentage, part whole... it is all of these together"*.

### **Analysis of Results**

Tables 1 and 2 display the results related to students' "first" and "30 seconds" responses when presented with the verbal and visual cues. During their "first" response, students provided one kind of mental representation whereas during the 30 seconds it was possible for a child to start from one kind of mental representation and expand to other kinds. This is why whereas in Tables 1 and 2, only 16 responses are recorded for each item in the "first" response, in the "30 seconds" there are more responses and not of an equal number between the two groups of students. It was important to record all the responses, that were provided during the 30 seconds, in order to illustrate the way in which access to one part of the representation prompted the retrieval of other kinds of representations contained in the students' mind.

From Table 1, one can detect that high achievers' "first" response tended to be mainly general (33%) and in a lower extent specific (25%) and generic (21%), while low achievers projected mostly specific (25%) "first" responses. During the "30 seconds" both high and low achievers' general responses dropped dramatically; for the high achievers from 33% to 12% and for the low achievers from 17% to 0%. High achievers appeared to shift mainly towards proceptual (30%) or generic responses (24%). Low achievers, on the other hand, changed to more specific (41%) and episodic (19%) ones. It can be argued that high achievers' "first" responses, whether general or specific, acted as a trigger which was used to search and retrieve actions and objects related to the items in question. This resulted in generic and proceptual mental representations. Indicative of this behavior are the responses provided by a Year 4 high achiever for the word "half":

First response: *"Fraction"*

30 sec. response.: *"2/4, 1/2 of a whole, 1/4 less than 3/4, a part of something"*

After their "first" specific mental representation, low achievers continued by offering more specific examples of similar quality or by including the item in an episode. A

Year 4 low achiever gave the following responses for “half”:

First response: *“Half an apple”*

30 sec. response: *“Cut things in half. You can have half of a broken heart. Cut play dough in half, cut with scissors in half, cut a paper.”*

		Not know		General		Specific		Episodic		Aut. Epis.		Generic		Procept	
		H	L	H	L	H	L	H	L	H	L	H	L	H	L
1 <sup>st</sup>	Fraction	0	5	4	2	3	1	0	0	0	0	1	0	0	0
	Half	0	0	3	1	3	4	0	0	0	1	1	1	1	1
	3/4	1	2	1	1	0	1	0	2	0	0	3	1	3	1
		1%	29%	13%	17%	25%	25%	1%	8%	1%	4%	11%	8%	17%	8%
30 sec.	Fraction	1	4	1	0	2	2	2	2	0	0	2	1	3	1
	Half	1	0	1	0	0	5	0	1	1	1	1	0	4	2
	3/4	0	2	2	0	2	4	0	2	2	0	5	0	3	0
		5%	22%	2%	0%	12%	41%	5%	19%	1%	4%	14%	4%	30%	11%

**Table 1: Students’ “first” and “30 seconds” responses for the verbal cues**

Table 2 displays students’ responses to the visual stimuli. The results obtained show that more than half (54%) of the “first” responses provided by high achievers were general, whereas the same percent (54%) of “first” responses provided by low achievers were specific. This is important since it illustrates that once presented with the visual cue high achievers were more inclined to give a general mental representation, which often was the name of the item. For example, seven high achievers when looking at 1/2 said:

*“Half” (Year 3, high achiever)*

On the contrary low achievers tended to look at the specific example and concentrate on its surface characteristics:

*“Black writing. Number 1 with a line underneath and a black 2. It’s on a green card”*  
*(Year 5, low achiever).*

*“A one and a two”.*  
*(Year 6, low achiever)*


The results also illustrate that 21% of high achievers’ “first” responses were proceptual whereas 25% of the low achievers’ “first” responses were episodic.



Given the 30 seconds high achievers’ general responses dropped radically (54% to 23%). This drastic change was not observed in the low achievers’ specific responses (54% to 46%). This suggests that some low achievers started off by projecting a specific example or defined surface characteristics of the object and when more time was given they continued to do the same. The small shift however that seems to have occurred was mainly from specific to episodic. For example:

First response: *“It is 2 numbers like 1 and 2.”*

30 sec. response: *“I don’t know why that line is there but it just is. If you put the 2*

*and 1 together is 12, if you put the 2 there and the 1 there it is 21”  
(Half, Year 4, low achiever)*

The item that caused the highest proportion (16%) of specific responses to high achievers was , since they often attempted to describe it. Still, four of them projected the general response “half”. Low achievers mainly produced specific and episodic mental representations since they attempted to describe it or place it in a real life context. What was very interesting was the fact that five of the low achievers suggested that it was “a window” or a “tennis court”. It appears that these students had embellished it with more surface characteristics and turned it into an item of real life. The remaining three, simply talked about its surface characteristics.

		Not know		General		Specific		Episodic		Aut. Epis.		Generic		Procept	
		H	L	H	L	H	L	H	L	H	L	H	L	H	L
1 <sup>st</sup>		0	1	0	0	1	3	3	4	0	0	0	0	4	0
	1/2	0	0	7	4	0	4	0	0	0	0	0	0	1	0
	3/4	1	0	6	0	0	6	1	2	0	0	0	0	0	0
		4%	4%	14%	17%	4%	54%	17%	25%	0%	0%	0%	0%	11%	0%
30 sec.		0	0	0	0	6	4	3	5	1	0	0	0	3	0
	1/2	1	1	4	2	3	6	0	4	0	0	1	0	3	0
	3/4	0	0	5	3	4	6	2	3	0	0	2	1	2	0
		3%	3%	13%	14%	13%	46%	13%	34%	3%	0%	8%	3%	10%	0%

**Table 2: Students’ “first” and “30 seconds” responses for the visual cues**

By comparing the results in Tables 1 and 2, it appears that for both visual and verbal stimuli, high achievers’ “first” responses tend to be general and low achievers’ specific. This phenomenon seems to be exaggerated for the visual cues. For both groups, visual stimuli tend to cause an increase in specific and episodic responses and a decrease in generic responses. It can be argued that the visual stimuli facilitate the generation of specific and episodic representations while the verbal stimuli facilitate the search and retrieval of other objects, action and relationships.

## DISCUSSION

This study supports the belief that different kinds of mental representations may be identified amongst high and low achievers. Both groups of children provide specific and episodic mental representations. However, while it is a tendency for low achievers to dominantly provide these, high achievers have the tendency to give generic and proceptual responses. What is intrinsic in the results is the diversity in the way these representations appear to evolve. The “first” response of high achievers tends to be general but when allowed to expand their comments, they can provide a network of relationships with other objects. It can be argued that the general comment needs to occur before the search and retrieval of generic and proceptual qualities is carried out. In contrast, low achievers seem to start from a specific mental representation and given more time they provide more qualitatively similar examples,

concentrate or embellish the items with surface characteristics or place them in an episode. It is also clear that the different format of the stimuli may cause different kinds of mental representations. This may have some serious consequences in teaching practice and especially in relation to the use of teaching aids.

The results appear to have important implications for our understanding of students' abstraction of the fraction concept. It appears that different groups of students concentrate on different qualities of the items and filter out information in a variety of ways. High achievers tend to synthesize aspects of pseudo-empirical and reflective abstraction – they identify the qualities that actions bring to objects and are able to disregard superficial external and contextual characteristics. Low achievers seem to concentrate more on empirical abstractions which appear to cause a disposition towards more specific and episodic representations.

## References

- Behr, M.J., Harel, G., Post, Th.R., & Lesh R. (1992). Rational number, ratio and proportion. In D. A. Grouws (ed.), *Handbook of research in mathematical concepts and processes*. Academic Press, New York/London, pp.91-126.
- Bereiter, C. (1994). Constructivism, socioculturalism, and Popper's World 3. *Educational Researcher*, 23(7), 21-23.
- Beth, E. W., & Piaget, J. (1966). *Mathematical epistemology and psychology*, (W. Mays, trans.). Dordrecht: Reidel.
- Charles, K., & Nason, R. (2000). Young children's partitioning strategies. *Educational Studies in Mathematics*, 43, 191-221.
- De Beni, R., & Pazzaglia, F. (1995). Memory for different kinds of mental images: Role of contextual and autobiographic variables. *Neuropsychologia*, 33,11, 1359–1371.
- Drake, S.M. (1996). Guided imagery and education: theory, practice and experience. *Journal of Mental Imagery*, 20, 1–58.
- Dreyfus, T., Hershkowitz, R., & Schwartz, B. (1997). *Consolidation of mathematical abstractions in a situation based functions curriculum*, (ERIC Document Reproduction Service No. ED407 228)
- Ginsburg, H., Kossan, N., Swartz, R., & Swanson, D. (1983). Protocol methods in research on mathematics thinking. In H.P. Ginsburg (ed.), *The Development of Mathematical Thinking*, Academic Press, New York, pp.7-47.
- Goldin, G.A. (1998). Representational systems, learning and problem solving in mathematics. *Journal of Mathematical Behavior*, 17(2), 137-165.
- Pirie, S., & Kieran, T. (1994). Growth in mathematical understanding: How can we characterise it and how can we represent it? *Educational Studies in Mathematics*, 26, 165–190.
- Pitta, D. (1995). 'Spatial and whole number characteristics in the context of fractions'. In M. Hejny and J. Novotná (Eds.), *Proceedings of the Third International Symposium Elementary Math Teaching*, 141-144. Prague: Czech Republic,
- Pitta, D., & Gray, E.M. (1999). Images and their frames of reference: A perspective on cognitive development in elementary arithmetic. In O. Zaslavsky, (Ed.) *Proceedings of 23<sup>rd</sup> International Conference for the PME (Vol.3, pp. 49-56)*.
- Roth, I., & Bruce, V. (1995). *Perception and representation: Current Issues*. (2<sup>nd</sup> Ed.), Open University Press with association with the Open University.
- Steencken E.P., & Maher, C.A. (2003). Tracing fourth graders' learning of fractions: early episodes from a year-long teaching experiment. *Journal of Mathematical Behavior*, 22, 113-132
- Thomas, N., Mulligan, J., & Goldin, G.A. (2002). Children's representation and structural development of the counting sequence 1-100. *Journal of Mathematical Behavior*, 17(2), 167-181.

# A STRUCTURAL MODEL FOR PROBLEM POSING

Pittalis, M., Christou, C., Mousoulides, N., & Pitta-Pantazi, D.

University of Cyprus, Department of Education

*Based on a synthesis of the literature, a model for problem posing cognitive processes was formulated, and validated. The major constructs incorporated in this framework were the situations in which problem posing occurs. For each situation, four cognitive processes were established: the editing of problems based on iconic or symbolic stimuli, the filtering of important and critical information, the comprehending of the structural relations in quantitative information, and the translating on the quantitative information from one mode to another. The data suggested that all four cognitive processes contributed to problem posing abilities with the filtering and editing having a heavier role than the comprehending and translating processes.*

## INTRODUCTION

Problem posing and problem solving have been identified to be central themes in mathematics education. Problem posing involves the generation of new problems about a situation or the reformulation of a given problem (English, 1997a; Silver & Cai, 1996). Recent recommendations for reform in mathematics education suggest the inclusion in instruction of activities in which students generate their own problems in addition to solving pre-formulated problems (NCTM, 2000).

Most of our knowledge about the development of students' cognitive skills involves studies of students engaged in cognitive tasks in which they are provided with problems that are well defined. With the exception of a few studies (English, 1997a; Silver, 1994), problem posing remained unexplored as a tool for studying cognitive processes in the domain of mathematics education. Because problem posing is intellectually a more demanding task than solving problems (Mestre, 2002), in the present study we investigate students' cognitive processes in problem posing by proposing a model that encompasses most of the previous research in the area. This article begins by reviewing two strands of research that have a bearing on this study, and then discusses a theoretical model of the cognitive processes of problem posing.

## THEORETICAL CONSIDERATIONS

In this section we describe two kinds of research studies on problem posing in mathematics instruction. The first strand of research describes the development of students' problem posing abilities, and the second strand discusses the classification of problem posing tasks.

### **The problem posing abilities**

Research studies provided evidence that problem posing has a positive influence on students' ability to solve word problems (Leung & Silver, 1997), and provides the opportunity for teachers to get an insight of students' understanding of mathematical

concepts and processes (English, 1997a). It was also found that students' experience with problem posing enhances their perception of the subject, and produces excitement and motivation (English, 1998; Silver, 1994). Specifically, English (1997a; 1997b; 1998) asserted that problem posing improves students' thinking, problem solving skills, attitudes and confidence in mathematics and mathematical problem solving, and contributes to a broader understanding of mathematical concepts.

English (1997a, 1997b, 1998) investigated students' abilities in generating problems in three studies with third, fifth and seventh graders, respectively. In the first of these studies, third graders revealed significant difficulties in posing problems both in informal and formal contexts. They were only able to create several change/part-part-whole problems by altering the contexts of the original problems and by focusing on the operational and not the semantic structure of the problems (English, 1998). In the second study, English (1997a) organized a problem posing program through which fifth graders improved their abilities to model a new problem on an existing structure and to diversify the story context of the problem. In contrast to the previous study, fifth graders developed their abilities to perceive the problem structure as independent of a particular context, providing them with greater flexibility in their problem creations. In the third study, English (1997b) proposed a theoretical framework for tracing seventh graders' abilities in problem posing across a range of mathematical situations. This framework encompassed abilities that referred to the knowledge and reasoning of students in problem posing as well as abilities for assessing students' metacognitive processes. In this study, the students who participated in the program exhibited greater facility in creating solvable problems than their counterparts that did not participate. Most of the students in the program created quite sophisticated problems using semantic relations in their problems.

Silver and Cai (1996) conducted a study in which a large number of sixth and seventh grade students were asked to pose questions to given story problems and classified them in terms of mathematical solvability, linguistic and mathematical complexity. Most students in Silver and Cai's study were able to pose appropriate mathematical questions when presented with a story situation as a stimulus for question generation. In addition students were able to generate syntactically and semantically complex mathematical problems.

### **Classification of problem posing tasks**

The second strand of research discusses the classification of problem posing tasks. Stoyanova (2000) identified three categories of problem posing experiences that can increase students' awareness of different situations to generate and solve mathematical problems: (a) free situations, (b) semi-structured situations, and (c) structured problem-posing situations. In the free situations students pose problems without any restriction. An example of the free problem posing situation are the tasks where students are encouraged to write problems for friends to solve or write



problems for mathematical Olympiads. Semi-structured problem posing situations refer to situations where students are asked to write problems, which are similar to given problems or to write problems based on specific pictures and diagrams. Structured problem posing situations refer to situations where students pose problems by reformulating already solved problems or by varying the conditions or questions of given problems.

Silver (1994) classified problem posing according to whether it takes place before (presolution), during (within-solution) or after problem solving (post-solution). He argued that problem posing could occur (a) prior to problem solving when problems are being generated from particular presented stimulus such as a story, a picture, a diagram, a representation, etc., (b) during problem solving when students intentionally change the goals and conditions of problems, (c) after solving a problem when experiences from the problem solving context are applied to new situations.

Stoyanova (2000) and Silver (1994) classified problem posing tasks in terms of the situations and experiences which provide opportunities for students to engage in mathematical activity. Both classifications involve five categories of problem posing tasks, which were used throughout the studies so far: Tasks that merely require students to pose (a) a problem in general (free situations), (b) a problem with a given answer, (c) a problem that contains certain information, (d) questions for a problem situation, and (e) a problem that fits a given calculation.

It is acknowledged that there are a variety of ways to analyze problem posing tasks and each may give a different understanding of the process. However, there is a need for a framework that can be used on responses from a wide range of tasks and from different age groups so that inter-task study and development of problem posing behavior can be investigated. The model proposed in the present study synthesizes most of the ideas articulated in previous studies, including a classification scheme of cognitive processes. The focus of the proposed model is on students' ability to pose their own two-step addition and subtraction problems, but the model can be applied to many other areas of mathematics.

## **THE PROPOSED MODEL AND THE PURPOSE OF THE STUDY**

Notwithstanding the extent of research into students' thinking in problem posing, recent research has not investigated systematically the quantitative information of the problem posing tasks in combination with the cognitive processes used in each task. Accordingly, the literature does not provide the kind of coherent picture of students' problem posing thinking that is desirable for current approaches to instruction. In this paper, we propose a model, which may enable young students' problem posing thinking to be described across four cognitive processes. As it is highlighted in Figure 1, the cognitive processes that are postulated to occur when a person engages in problem posing refer to filtering quantitative information, translating quantitative information from one form to another, comprehending and organizing quantitative

information by giving it meaning or creating relations between provided information, and editing quantitative information from given stimulus.

We speculate that the cognitive processes correspond to specific problem solving tasks presented in iconic, tabular or symbolic forms. It is possible for a cognitive process to correspond to more than one task, but for clarity and simplicity purposes, we incorporate in the model the most prominent cognitive process for each task. It is also hypothesized that each cognitive process emerges and develops in a way that incorporates the continuing development of cognitive processes. Editing quantitative information is mostly associated with tasks that require students to pose a problem without any restriction from provided information, stories or prompts (Mamona-Downs, 1993). Filtering quantitative information is associated with tasks that require students to pose problems or questions, which are appropriate to specific, given answers. The given answer functions as a restriction, making filtering a more demanding process than editing. Comprehending quantitative information refers to tasks that students pose problems from given mathematical equations or calculations. Comprehending problem posing tasks require the understanding of the structural context of problems and the relations between the provided information. Translating quantitative information requires students to pose appropriate problems or questions from graphs, diagrams or tables.

In order to capture the nature of problem posing, our model (Figure 1) incorporates forms of semi-structured and structured situations (Stoyanova, 2000) in which students are asked to generate problems from a presented stimulus (presolution phase). The stimulus situations involve quantitative information, which contain representations either in the iconic or in the symbolic form. For example, students posing problems based on a picture are handling information in iconic form. Similarly, students are handling quantitative information in iconic form if they are given graphs and diagrams. Students posing problems based on words or phrases or calculations are handling quantitative information in symbolic form. Examples of the tasks that correspond to each cognitive process are shown in Table 1.

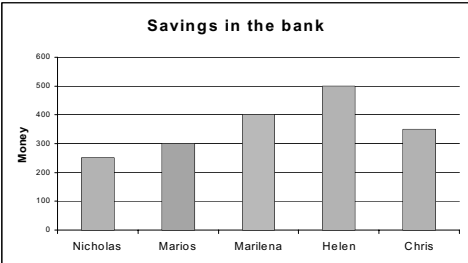
The purpose of the present study was twofold: First, to validate the proposed model, i.e., to confirm that problem posing consists of the proposed cognitive processes, and second to search for a possible developmental trend in students' abilities to pose problems based on the editing, filtering, comprehending, and translating cognitive processes and to find out meaningful differences in students' thinking in generating problems. However, in this paper, due to space limitations, we present the results of the first aim of the study.

## **METHOD**

### **Subjects**

The sample for this study consisted of 143 Grade 6 students from six classes at elementary schools in an urban district in Cyprus. Seventy-nine students were males and sixty-four females. The school sample is representative of a broad spectrum of

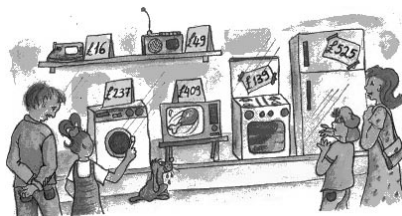
socioeconomic backgrounds. Prior to the start of this study, none of the children had been exposed to problem posing instruction.

Cognitive Process	Tasks
Filtering	Write a question to the story so that the answer is “285 stamps”. “Chris has 135 stamps while Helen has 15 stamps more than Chris”
Translating	Write a problem based on the following diagram: 

Comprehending Write an appropriate problem for  $(1300+2100)-790=n$

Write a problem based on the following picture:

Editing



**Table 1: Tasks examples corresponding to each cognitive process**

### Instruments

Each student completed four problem posing tests, which contained situations that help students to perceive mathematical context in diverse ways. Test 1 consisted of three tasks in which students were required to complete the problems with the missing question as to correspond to the provided answer. Test 2 involved three tasks, which required from students to write problems that fit to given equations. Test 3 consisted of four tasks, which presented pictures, and diagrams with mathematical information. Students were asked to use information from the pictures and diagrams to write problems whose solutions would require or not specific operations, i.e., two additions or one addition and one subtraction. In Test 4, which involved three tasks,

students had to pose problems based on interesting stories. For these 13 tasks, students were required not only to pose questions or problems but also to justify their answers by writing the mathematical solutions of the constructed problems or the mathematical equation, which corresponded to their own problems.

The tests were administered to the students by the researchers in five 20-minute sessions. Prior to the administration of the test, which lasted ten working days, one researcher visited the classes involved in the project and worked with the students on problem solving for approximately 40 minutes.

### **Data Analysis**

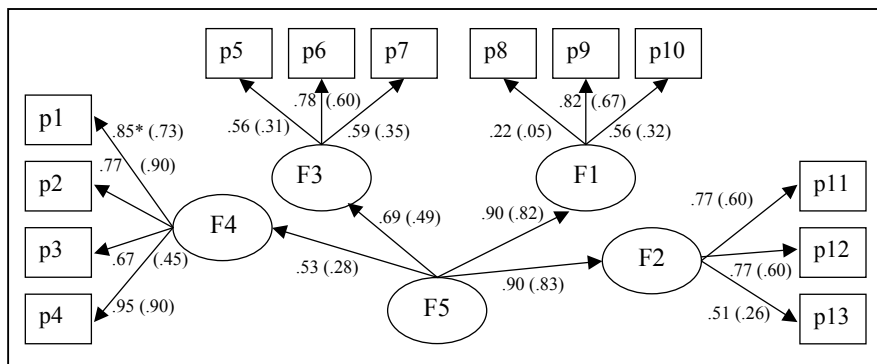
The goal of the analysis was to estimate the relative strength of the proposed model. Because we proposed a theoretically driven model about the components of problem posing cognitive processes, our first interest was in the assessment of fit of the hypothesized a priori model to the data. The assessment of the proposed model was based on confirmatory factor analysis, which is part of a more general class of approaches called structural equation modeling. One of the most widely used structural equation modeling computer programs, MPLUS, was used to test for model fitting. In order to evaluate model fit, three fit indices were computed: The chi-square to its degrees of freedom ratio ( $\chi^2/df$ ), the comparative fit index (CFI), and the root mean-square error of approximation (RMSEA). These three indices recognized that the following needed to hold true in order to support model fit (Marcoulides & Schumacker, 1996): The observed values for  $\chi^2/df$  should be less than 2, the values for CFI should be higher than .9, and the RMSEA values should be lower than .08.

### **RESULTS**

In this section, we refer to the results of the analysis, establishing the validity of the latent factors and the viability of the structure of the hypothesized latent factors. In this study, we posited an a-priori structure of the proposed model and tested the ability of a solution based on this structure to fit the data.

The proposed model consists of four first-order factors and one second-order factor. The first-order factors represent the cognitive processes: the editing (F1), the filtering (F2), the comprehending (F3), and the translating (F4). The editing, the filtering and the comprehending factors were measured by three tasks each, while translating was measured by four tasks. F1, F2, F3, and F4 were hypothesized to construct a second order factor “problem posing abilities”, which was hypothesized to account for any correlation or covariance between the first order factors. Figure 1 makes easy the conceptualization of how the various components of problem posing cognitive processes relate to each other. The descriptive-fit measures indicated support for the hypothesized first and second order latent factors ( $\chi^2/df=1.45$ , CFI=.965, and RMSEA=.056). The parameter estimates were reasonable in that all factor loadings were large and statistically significant (see Figure 1). The r-squares (shown in the parentheses in Figure 1) also illustrate that modest to large amounts of variance are accounted for all tasks corresponding to each cognitive process and suggest that

editing and filtering explained the shared variance of their corresponding tasks much better than did translating, and comprehending.



**Figure 1: A structural model of problem posing cognitive processes**

Note: F1=Editing, F2=Filtering, F3=Comprehending, F4=Translating and F5=Problem posing abilities, p1-p13 refer to the problems assigned to students.

\* The first number indicates factor loading and the number in parenthesis indicates the corresponding  $r^2$ .

The main focus in this study was to address the fact that the cognitive processes of editing, filtering, comprehending and translating constitute the students' problem posing abilities. In the context of good model fit, the effects of each cognitive process on the problem posing abilities of students were investigated. The structure of the proposed model also addresses the differential predictions of the four cognitive processes for the problem posing abilities. Considering the effects among the cognitive processes reveals that the filtering and the editing cognitive processes were the primary source explaining students' abilities to generate problems ( $r^2=.83$  and  $r^2=.82$ , respectively). The translating cognitive process had a small significant effect ( $r^2=.28$ ), while comprehending had moderate effects on students' abilities to pose problems ( $r^2=.49$ ).

## DISCUSSION

Problem posing is currently discussed as a function of complex and concomitant growth in a knowledge base, strategies, motivation, and metacognition (English, 1998). It was argued in this study that few models exist to help educators explain how problem posing actually develops. Hence, the goal of this study was to articulate and empirically test a theoretical model to help educators build new understandings about the cognitive processes required by students in generating problems. The model integrated most of the abilities and tasks from existing problem posing research (Silver & Cai, 1996; English, 1997a) and extended the literature in a way that cognitive processes are recognized as important components of developing problem

posing abilities. The model proved to be consistent with the data leading to the conclusion that the four cognitive processes (filtering, editing, comprehending, and translating) mediate the ability to pose problems. Specifically, it was found that the four cognitive processes contribute to the students' abilities to pose problems with the filtering and editing cognitive processes being more important than comprehending and translating in generating problems. This particular finding suggests that students' abilities to filter and edit problems are highly related to pose problems.

The model used in this study offers teachers and researchers a means to examine the complexity and sophistication of problem posing. From the perspective of teachers, the model may be used in order to include in their instruction the development of the four cognitive processes. From the prospective of researchers, it is likely that the model could be useful as a prototype for further analyses of the cognitive processes of problem posing.

## References

- English, L. D. (1997a). The development of fifth-grade children's problem-posing abilities. *Educational Studies in Mathematics*, 34, 183-217.
- English, L. D. (1997b). Development of seventh-grade students' problem posing. In E. Pehkonen (Eds.), *21st Conference of the International Group for the Psychology of Mathematics Education*, (Volume 2, pp. 241-248). Lahti, Finland.
- English, L. D. (1998). Children's problem posing within formal and informal contexts. *Journal for Research in Mathematics Education*, 29(1), 83-106.
- Leung S. K., & Silver, E. A. (1997). The role of task format, mathematics knowledge, and creative thinking on the arithmetic problem posing of prospective elementary school teachers. *Mathematics Education Research Journal*, 9(1), 5-24.
- Mamona-Downs, J. (1993). On analyzing problem posing. In I. Hirabayashi, N. Nohada, K. Shigematsu, F.L. Lin (Eds.), *Proceedings of the 17th International Conference for the Psychology of Mathematics Education*, (Volume 3, 41-47). Tsukuba, Japan.
- Marcoulides, G.A., & Schumacker, R.E. (Eds.) (1996). *Advanced structural equation modeling: Issues and techniques*. Mahwah, NJ: Lawrence Erlbaum Publishing.
- Mestre, P. J. (2002). Probing adults' conceptual understanding and transfer of learning via problem posing, *Applied Developmental Psychology*, 23, 9-50.
- National Council of Teachers of Mathematics (2000). *Principles and Standards for School Mathematics*. Reston: Va, NCTM.
- Silver, E. A. (1994). On mathematical problem posing. *For the Learning of Mathematics*, 14(1), 19-28.
- Silver, E. A., & Cai, J. (1996). An analysis of arithmetic problem posing by middle school students. *Journal for Research in Mathematics Education*, 27(5), 521-539.
- Stoyanova, E. (2000). Empowering students' problem solving via problem posing: The art of framing "Good" questions. *Australian-Mathematics-Teacher*. 56(1), 33-37.

# SOME UNDERGRADUATES' EXPERIENCES OF LEARNING MATHEMATICS

Hilary Povey and Corinne Angier  
Sheffield Hallam University

*One theme of current research about higher education students of mathematics concerns those who fail. At our institution, some of the entrants are students who have previously failed in mathematics; others come to us with a comparatively weak mathematical background. Most of these students go on to become confident and effective mathematicians, some even achieving first class honours. We believe that understanding something of their perceptions of this experience may contribute to the current debate about who succeeds and who fails in higher education mathematics study and why.*

## INTRODUCTION

This paper contributes to the body of research into the teaching of mathematics undergraduates (for example, Jaworski, 2001) and specifically relates to that concerned with success and failure in learning mathematics in higher education (for example, Leder *et al*, 1998); our particular concern is with previously failing students who become successful. Our interest in researching this topic was prompted by recent research into students' experience of undergraduate mathematics at two traditional English university – ‘Marmion’ and ‘Waverley’ - universities which are among the elite institutions in England for undergraduate mathematics (see, for example, Rodd, 2002; Macrae, Brown, Bartholomew and Rodd, 2003).

Attending a seminar reporting aspects of the research and particularly hearing some of the tales of failure of individual students discussed, we were struck by how little the characterization of the teaching and learning of mathematics at these institutions matched our characterization of our own. On some of our courses, many of the students come to us with weak mathematical backgrounds<sup>1</sup> - either through non-traditional routes or an experience of previous failure in higher education or both - but most of them go on to become confident, engaged and successful mathematicians. We believed that hearing the voices of some of these students talking about themselves as mathematicians and their thoughts and feelings about learning mathematics would provide a useful contribution to the current debate about who fails mathematics in higher education and why. Thus, our research questions were: what is the student experience of learning mathematics in our institution? how is it likely to be different from that at ‘Marmion’ and ‘Waverley’? and what ways of

---

<sup>1</sup> For those familiar with the system of qualifications in England, entry might be perhaps through an Access Course, perhaps through a Foundation Course, occasionally perhaps with only a grade E at Advance Level.

understanding themselves as mathematicians, what mathematical identities, are available to and claimed by our students (but not, perhaps, those failing students at ‘Marmion’ and ‘Waverley’)?

## **CONTEXT OF THE STUDY AND DATA COLLECTION AND ANALYSIS**

The cohort of students involved in this piece of research is following one of the longer routes into secondary mathematics teaching. For this cohort, a pattern of a weak entry profile followed by success in mathematics was clearly evident. On their course, they study undergraduate mathematics for two years within the context of a Mathematics Education Centre rather than in a university mathematics department; (this is followed by a professional year). Their mathematical studies comprise the equivalent of three quarters of a first year of undergraduate mathematics followed by the equivalent of half a second year and half a third year; there almost no options. (The remainder of their studies relates to the teaching of mathematics and other educational and professional studies.) In other words, they study mathematics to honours degree level but within a narrower range than would a single honours mathematics student.

We interviewed seven of the students, sometimes alone and sometimes in pairs. The interviews were relatively open and unstructured with just a few prompts. We encouraged them to talk about

- whether or not and in what way(s) they thought their relationship with mathematics had changed and developed during their current studies;
- whether or not they thought they had changed as mathematicians;
- and whether what they thought about mathematics itself had changed.

Each interview lasted between an hour and an hour and a half. We taped and transcribed the interviews (with occasional editing for clarity) and then began working with these texts in a familiar way. We each read and re-read the transcripts, immersing ourselves in the data and searching for themes. Separately, we each derived some themes from the data and coded the transcripts accordingly. Next we met to discuss our themes and our coding and to re-work the analysis, subsequently returning repeatedly to the transcripts to check out and evidence our developing ideas, seeking to keep them grounded in the data.

Elsewhere, we have presented much fuller portraits of individual students (Povey and Angier, 2003; Angier and Povey, 2004). Here we adopt a more conventional style, closer to a thematic analysis. We have some methodological difficulties with this approach and are sceptical about the sense of certainty of representation it may generate. We share Margaret Walshaw’s doubts about ‘the possibility of true and accurate research findings and, moreover, about the very possibility of knowing others and telling their stories’ (2002: 349). We do not claim that these are the only or true accounts about the students’ experiences of learning mathematics with us, nor that the interviews represent the students unproblematically ‘telling it like it is’



(Hollway and Jefferson 2000: 10). We came to regard the transcripts as, in part, stories through which the students were able to construct - for us and for themselves - an account of themselves as mathematicians. The interviews were places where they did ‘identity work<sup>2</sup>’ (Mendick, 2002: 336), where they spoke into being mathematical identities. So, in the rest of the paper, we first draw on the students’ descriptions of their experience of learning mathematics with us, contrasting this very briefly with what they might have encountered elsewhere, and then connect these with the mathematical identities which these experiences and the available discursive frameworks allowed them to produce.

## LEARNING UNDERGRADUATE MATHEMATICS

We start with what seems to us to be an accurate picture of what most undergraduate mathematics is like. It is a description provided by Melissa Rodd in the context of writing about ‘Marmion’ and ‘Waverley’.

[B]eginning university mathematics is invariably presented as an abstract subject, *without fuzziness or debateable results*, which is *assessed through individuals’ timed exam performance*. Such assessment arrangements are personal and adrenalin-producing yet *the assessment’s mathematics does not express any personal view*. There is nothing to hide behind in mathematics: *no experiment, no interpretation of evidence, no comparison of criticisms*. The students are relatively *more exposed* – intellectually and emotionally – than in other subjects. (Rodd, 2002: 2; our emphasis)

Much of this description, however, is contrary to our own ‘common sense’ about the nature of mathematics itself; and consequently about what is entailed in the learning and teaching of the subject at undergraduate level. We define ourselves as mathematics educators at least as much as mathematicians. Our understandings place us firmly in the now well-established alternative tradition of ‘inquiry mathematics’ (Cobb *et al.*, 1992) where learning is co-constructed; classroom practice is ‘discussion orientated’ (Boaler, 2002: 116); and an agentic and authoritative epistemology supports coming to know (Povey, 1995). We draw on such earlier theoretical frameworks in the analysis which follows. Unsurprisingly, our students evoke a very different picture of undergraduate mathematics from that given above. We argue that these different experiences enable them to construct their identities as mathematicians and therefore to succeed. Below we cluster the things they said around four interconnected themes. The first three - mathematics is negotiable, a subject to explore; assessment in mathematics can be personal; and learning is social, supported, collaborative – offer a clear contrast to the description of undergraduate

---

<sup>2</sup> ‘Identities are unstable, contradictory and multiple. Identities are the way we have of talking about ourselves, and are constantly being produced in our actions and our interactions with others; identities are always in process and never attained. However, the word “identity” suggests coherence and completeness so I have decided instead to use the phrase “identity work”.’ (Mendick, 2002: 336)

mathematics at traditional universities given above. The fourth relates to their authoritative and agentic identities as makers of mathematics.

### **Mathematics is negotiable, a subject to explore**

We hear these students describing mathematics as a subject to explore, which is negotiable, where there is productive space for difference, where there is room for fuzziness and debate, for experiment and interpretation.

You go through your entire A levels and you have got very set ways of doing things, you're kind of trained to do things by the book and then suddenly here... being forced to think quite laterally and actually solving problems again meant that you were stretched... We've been introduced to different ways of approaching things as well, not just here's a method of doing this which we used to get... you have to think sort of sideways... And of course when you discuss with other people and you see that they have done in a different way to you, you don't think "Oh I've done it wrong because they are obviously getting further than me" you think "They've done it a different way to me". (Myra<sup>3</sup>)

If I was approached with a problem now I'd know a whole host of different ways to try and tackle it because we've seen them all and I've tried looking laterally at things that aren't necessarily set problems. I think when you first come to university you're used to working through questions at school and you'd either get them right or wrong... [Here you say] "Have I got the right answer?" and the person at the front goes "Well but there isn't actually an answer" or "There are some other things which – " and you think well, how could I achieve that? I think now we are able to just like not be too worried about getting the correct answer at the end of the day. (Michael)

I've got my work from previous degrees where a big NO written in the margin all over the place and you can't be wrong. Whereas here you can be wrong or you can explore and it's taken as that's part and parcel of the whole thing... All the things that are supposedly proved and are correct mathematically all came from dead ends and so on. All the great mathematicians made mistakes and said well "That didn't work." You don't see it any more because it's all been polished up into the thing that is correct but there are so many mistakes that are quite valid and certainly things come from them sometimes. (Geoff)

That's what it is like here, that the way that we have been encouraged to think about maths is so different from what I have done before and it makes it more interesting because there is room to think about it and to kind of look at different possibilities... the fact that maths isn't right or wrong, I think that is probably the biggest difference, that there's not always a right answer. (Anna)

It is interesting how frequently the issue of 'right and wrong' came up during the interviews. It is a commonplace that, unlike other subjects, 'maths is right or wrong'; yet this truism seems to mis-describe both mathematics and, by implication, other subjects too. Clearly, in some sense it is very much possible to be right and to be wrong in mathematics (and history and French and...). So what are the students claiming by using this alternative discourse? A number of different things: amongst

---

<sup>3</sup> Pseudonyms are used throughout.

others, that employing different methods can provide different productive insights; that looking at things from different angles uncovers new aspects of a problem; that mistakes can be productive; and that both history and personal experience show that mathematical progress is a messy business. Crucially, however, we believe they are claiming a relationship of author/ity (Povey 1995) with the subject. We can hear this in the way in which they describe the work they produce for formal assessment.

### **Assessment in mathematics can be personal**

Most of the assessments that the students chose to talk about were by coursework rather than by examination. (This also reflects the pattern of assessment on the course.) There is a strong sense of the personal, of authorship and of a claim to constructing knowledge. For the coursework tasks they are asked to complete, a broader range of assessment criteria is used than would be encountered in a more traditional course. For example, mathematical imagination, originality and creativity are prized and mathematical communication and mathematical thinking are valued.

The fact that you are doing coursework and can investigate – it's not about getting the right answer a lot of the time so that the whole work we've been asked to do it's just so completely different, I can't really relate it [to my previous degree course] at all. You're taught, you do an exam and you either pass or fail whereas here it's like you go and find out something or you work something out for yourself. We have done a couple of assignments where you start without looking at any reference material at all, it's just your own, you're given a starting point and go off and work it out for yourself. (Geoff)

The work what we've been given, sort of a topic or a title, you just go and find things out about it and just do it your own way instead of having structured work like "First do this, then that, follow on to that, as long as you put this you are okay". You can start with something and by going through some kind of procedure and doing something completely different, it's because you've actually looked into it so well and you've thought about it and you've involved so much mathematical things, it sort of spurs me on to do, to keep going at it. I can never - like when I'm doing an assignment in maths - I can never say "Right, that's it. I'm going to end it here". 'Cos I think "Well, what if, instead of when I were doing that, but instead of going that way I did that way" and I end up doing another so many pages about that thing because I can't stop thinking about it, that kind of task... for me I like these kind of assignments where you're given "This is the unit, this is what we've talked about, find something interesting about it and work on it and see where you get or where you don't get and what you find out". (Naomi)

You had to work through it, you had to think, you had to draw things together, you had to understand why certain equations worked and how they worked and be able to put them into another context to get some more results, do a little bit more and you know it was just this ongoing thing and I found that really enjoyable... being able to do your own thing and work through it and nothing was wrong or right and I think that's a very good of working. You don't start off with "You should know this before you do this". (Joanne)

[An assignment that requires reflection] helps me concentrate what I think because it means that I am thinking about - like instead of just thinking in a big jumble I have to sit

there and untangle what I am thinking, and say "Well I think this about this because - " and things like that, more than just things going round and round in my head. (Anna)

It seems, then, that these assessments do allow the presentation of a personal view and that this is a real source of pleasure and affirmation of the self for these students.

### **Learning is social, supported, collaborative**

From the beginning, the creation of a collaborative classroom is prioritised and unhelpful habits of competitiveness are challenged. Great emphasis is placed on the social and intellectual ground rules of the classroom and discussion is a central pedagogical device. This, coupled with a reconstruction of the learners' relationship to knowledge, has reduced the risk of intellectual and emotional exposure.

It's probably to do with how I learn maths, I like to be able to bounce things off people. I like to, if I find something interesting, it's nice to be able to find somebody to talk to about it, whereas in a big lecture approach you don't, you go to a lecture, you go home, you write up the lecture and that's it really. So the fact that both in the sessions and outside the sessions you can talk to people in a small group, people that you know well and that helps me I think... talking to other people on the course, they're able to put links in for you and you are able to put links in for them you know they might not have noticed. (Geoff)

We were bouncing off each other like one of us would have a good idea and the other would try and implement it because we had different strengths that we could bring in to what we were doing as well and I think that's important... I think it's been good being able to discuss things and then go away and do your own work... talking about it and then going away - I think talking about it, it gives you more ideas that you can then go away and develop on your own and then you come back and you talk a bit more and I think that's how it develops. (Myra)

Sometimes I need some space and some time for it to sink in... and I suppose in the way that I work better on my own than with other people just so I can sort out what I am thinking... But like often... what would happen is that the people that want to work together and want to discuss ideas they'll do that and I can just stay sitting in my corner thinking about it. And that's fine and, you know, I can listen to their ideas and, if I've got something to say, say it. (Anna)

If you're stuck, I can easily go and speak to somebody and they can point out little things what will trigger something and you suddenly understand it. And the other way round as well. There are other people what you can help... Now it's more like trying to get peers to help the others in the class. (Naomi)

These comments are in contrast to the discourse of undergraduate mathematics, reported from another elite university, as ' "a kind of competition that you train for"' (Mann, 2003: 19) with 'a "performance" route' (Mann, 2003: 20) to success.

### **Makers of mathematics**

We do not claim that *all* our students are successful. Some fail; and some pass but without ever gaining a real sense of themselves as successful creators of

mathematics. Ray, for example, has grown tremendously as a mathematician and is set to gain a lower classed honours degree; but he has never felt confident about his learning or his mathematics – although it can sometimes be a challenge to be enjoyed, it is still something external to be forced in from the outside.

First day I come, me first day I can remember [the tutor] sticking something on board and having no idea right from the first minute I got in that classroom and I started panicking then and to a point I don't think really I've been in a lesson where I've not, not so much dreaded but felt confident that I know where - everything is supposedly there to challenge us and there is always maybe something - but I've never been able to go in and think I'm sure I am going to understand everything in this lesson, even if it get hammered into me one way or another I'm going to come out and I'm going to know what I've done and I've never been confident of that and I've never done that I don't think. (Ray)

Nevertheless, offering a different pedagogy, one that values agency and authorship, one that places the learning community as central (Boaler and Greeno, 2000), has enabled some failing and some initially weak students to construct authoritative mathematical identities: we argue that these in turn have been instrumental in producing their success.

I like to explore things. Never before have I sat down in my spare time and just started doodling triangles or something like that, you know proving things which have been proved many times before but I'm just doing it for my own sake, I've never done that before but I am now. (Geoff)

If you find out something interesting... you can actually discuss it; and you can get ideas off your peers and even the tutor. You can go to them and talk, talk to them about something, even if it's something you don't cover in class but they're interested and then you get sort of nice discussions going on with them about whatever you've found out. (Naomi)

I think it's mostly confidence to put your own ideas on the table ... to realise that what you say might be worth listening to, that every little thing that gets chuck in this pot in the middle can contribute to finding an answer... you were allowed to develop it, isn't it. There were no sort right and wrong answers, you were allowed to put your own input into it and your own direction. (Joanne)

These students have constructed a positive and active 'disciplinary relationship' (Boaler, 2002: 113) which allows them to identify as mathematicians and which is productive of increased capability. They have found opportunities to 'engage in a disciplinary dance' (Boaler, 2002: 119)': that is, their own agency and the agency of the discipline have worked together effectively. The mathematical community of practice thus produced is one to which they can belong, with which identification is possible: they have found a way of making mathematics which is authoritative and self-affirming and also successful in enabling them to come to know. We believe that what they have to say helps us re-envision the undergraduate experience of learning mathematics and has a useful contribution to make to the current debate about who succeeds, who fails and why.

## References

- Angier, Corinne and Povey, Hilary (2004) ‘“I can do it but it’ll be a battle”: finding her place as an undergraduate mathematician’ paper submitted to IOWME at the 10th ICME Conference, Copenhagen
- Boaler, Jo (2002) ‘The development of disciplinary relationships: knowledge, practice, and identity in mathematics classrooms’ in the Proceedings of the 26<sup>th</sup> PME Conference, Norwich, 2002, (2), 113-120
- Boaler, Jo and Greeno, James (2000) ‘Identity, agency and knowing in mathematical worlds’ in Boaler, Jo (ed) *Multiple Perspectives on Mathematics learning and Teaching*, Westport, CT: Ablex Publishing
- Cobb, Paul, Wood, Terry, Yackel, Erna and McNeal, Betsy (1992) ‘Characteristics of classroom mathematics traditions: an interactional analysis’ in *American Educational Research Journal*, (29), 3, 573-604
- Hollway, Wendy and Jefferson, Tony (2000) *Doing Qualitative Research Differently: free association, narrative and the interview method*, London: Sage
- Jaworski, Barbara (2001) ‘University mathematics teaching – where is the challenge?’ in the Proceedings of the 25<sup>th</sup> PME Conference, Utrecht, 2001, (3), 193-200
- Leder, Gilah, Forgasz, Helen and Brew Christine (1998) ‘Who persists with mathematics at the tertiary level: a new reality?’ in the Proceedings of the 22nd PME Conference, Stellenbosch, 1998, (3), 183-190
- Macrae, Sheila, Brown, Margaret, Bartholomew, Hannah and Rodd, Melissa (2003) ‘The tale of the tail: an investigation of failing single honours mathematics students in one university’ in Proceedings of the BSRLM Day Conference, Oxford, June 2003, pp. 55- 60
- Mann, Christine (2003) Indicators of Academic Performance, retrieved in December, 2003 from <http://www.admin.cam.ac.uk/reporter/2003-03/weekly/5913/6.html>
- Mendick, Heather (2002) ‘“Why are we doing this?” A case study of motivational practices in mathematics classrooms’ in the Proceedings of the 26<sup>th</sup> PME Conference, Norwich, 2002, (3), 329-336
- Povey, Hilary (1995) ‘Ways of knowing of student and beginning mathematics teachers and their relevance to becoming a teacher working for change’, unpublished PhD thesis, University of Birmingham
- Povey, Hilary and Angier, Corinne (2003) ‘Some undergraduates’ experiences of learning mathematics: (how) can narrative form enable us to create knowledge?’ in the Proceedings of the BSRLM Day Conference, Birmingham, November, 2003
- Rodd, Melissa (2002) ‘Hot and abstract: emotion and learning mathematics’ in the Proceedings of the second International Conference on the Teaching of Mathematics at Undergraduate Level, Crete: John Wiley and the University of Crete
- Walshaw, Margaret (2002) ‘Telling other people’s stories: knowledge production and representation lessons’ in the Proceedings of the 26<sup>th</sup> PME Conference, Norwich, 2002, (4), 345-352

# NORMALISING GEOMETRICAL CONSTRUCTIONS: A CONTEXT FOR THE GENERATION OF MEANINGS FOR RATIO AND PROPORTION

Georgos Psycharis and Chronis Kynigos

Educational Technology Lab, University of Athens, School of Philosophy.

**Abstract:** *This paper describes aspects of 13 year-olds' activity in mathematics as emerged during the implementation of proportional geometric tasks in the classroom. Pupils were working in pairs using a piece of software specially designed for multiple representation (symbolic and graphical) of the variation in parametric procedures with dynamic manipulation of variable. In this paper we discuss children's use of normalising, an activity in which children 'correct' the geometrical figures while developing meanings for ratio and proportion. We discuss the potential of normalising for the construction of mathematical meanings in relation to particular aspects of the pedagogical setting including pupil's interaction within the computational environment as well as task design.*

## THEORETICAL FRAMEWORK

In this paper we report research aiming to explore 13 year-olds' mathematical meanings constructed during activity involving ratio and proportion tasks in their classroom. The students worked in collaborative groups of two using 'Turtleworlds', a piece of geometrical construction software which combines symbolic notation through a programming language with dynamic manipulation of variable procedure values (Kynigos, 2002). They were engaged in a project to build figural models of capital letters of varying sizes in proportion by using only one variable to express the relationships within each geometrical figure. We were interested to study the ways in which the students interacted with the provided computational tools and the ways in which the emergent meanings were structured by the tools (Noss & Hoyles, 1996).

We adopted a broadly constructionist framework (Harel and Papert, 1991) for our work taking also into account the situated cognitionist view about the complex ways by which knowledge is shaped within a particular setting (Lave, 1988). In this paper we discuss children's *normalizing* activity characterized by engagement with 'corrections' of distortions to figural representations (similar to the sense of Ainley et al. 2001). This kind of activity emerged as a coherent part of pupil's reflections on the graphical feedback resulting from the symbolic code and it was characterized by their gradual focus on relationships or dependencies between objects and representations and the emergence of mathematical meanings of ratio and proportion.

Proportional reasoning has been the object of many research studies (Hart, 1981, 1984, Tourniaire & Pulos, 1985, Hoyles & Noss, 1989, Harel et al., 1991). The

results of most of these studies have revealed that children view ratio and proportion tasks as requiring addition and not multiplication and thus chose an ‘additive strategy’ for solving them. More specifically, it has been reported that geometrical enlargement settings provoke more addition strategies than any other one while students have great difficulty in identifying a ratio relationship regardless of context and numerical content (Kuchemann, 1989). Some explanations of these poor levels of performance have highlighted two areas of difficulties: (a) sometimes enlarging the sides of the original figure by addition still produces the same kind of figure (e.g. rectangle) (b) most pupils ignore that the resulting enlargement should be the same shape as the original because of being so “engrossed in the method to be used” and the arithmetic calculations (Hart, 1981). However, there have also been reported the benefits of the use of computational tools in children’s proportion strategies derived from interacting within specially designed microworld settings that facilitate linkages between visual, numerical and symbolic representations of geometrical objects (Hoyles and Noss, 1989, Hoyles et al., 1989). Hoyles and Noss (1989). Discussing ‘the qualitatively different kinds of work’ facilitated within such a computer environment, they focus on the child-tools interaction which “directed the child’s attention to key points in her problem solving and served to clarify the proportional relationship involved, p. 66”. According to their analysis this interaction “is built on the synthesis between the child’s need to formalize the relationship algebraically (i.e. to type a program) and to receive confirmation of intuitions (i.e. to perceive the intended geometrical effect on the screen, p. 65)”.

In this report, we thus build on prior computer-based geometrical enlargement tasks with the aim to exploit kinesthetic control *as a process*. Our focus was on students’ dynamic manipulations of the geometrical objects *during* the ongoing experimentation through actions with symbolic notations and representations (Kynigos & Psycharis, 2003). This kind of manipulation of the graphical outcome is also related to the following considerations: (c) In proportional tasks of that kind graphical representation of objects is tightly related to the use of algebraic relations and thus joint symbolic and visual control may have important potential for the construction of mathematical meanings of ratio and proportion. (d) According to the task pupils are asked to manipulate geometrical figures in a meaningful way i.e. to construct models of capital letters of different sizes that will not “distort” under size changes which keeps up with the functionality of any font both in and off the computer.

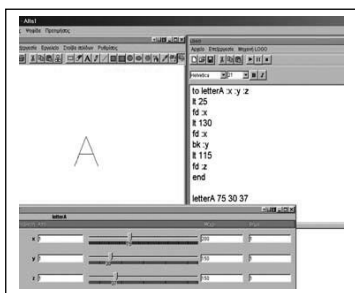
## RESEARCH SETTING AND TASKS

In our research perspective we attribute emphasis on two aspects of the pedagogical setting that are likely to foster mathematical learning: the choice of the computer environment and the task design. As far as the microworld artefact the pedagogical design of the software involved an integrated use of both formal mathematical notation and dynamic manipulation of variable values. In Turtleworlds, what is



manipulated is not the figure itself but the value of the variable of a procedure. Dragging thus affects both the graphics and the symbolic expression through which it has been defined, combining in that sense these two kinds of representations which appear rather static in most of the enlarging geometrical settings. The second factor taken into consideration is the task design as offering a research framework to investigate *purposeful* ways that allow children to appreciate the *utility* of mathematical ideas (Ainley & Pratt, 2002).

The work reported here is part of an ongoing study on the generation of meanings of proportionality by groups of pupils working with ‘Turtleworld’ microworlds in the classroom setting. The research took place in a secondary school with two classes of 26 pupils aged 13 years old and two mathematics teachers. During the activity, which lasted for 32 hours in total over 9 weeks, each of the two classes had two 45-minute project work sessions per week with the participant teachers. Each class had the task to construct all the capital letters of the alphabet called ‘*The Dynamic Alphabet of your own class*’. The letters would be used in a following classroom activity by the pupils to construct ‘dynamic posters’ in which particular words or phrases can change size in the same way. During the classroom activity, the students were engaged in building models of capital letters of variable sizes, having initially been told that the aim was for each letter procedure to have one variable corresponding to the height of the respective letter. According to the task, each group of pupils was assigned to construct two letters while in a subsequent stage groups were asked to interchange their constructions so as to check and correct other pupil’s work. Problems stemming from the use of different variables by different groups were left as a point of interaction



**Fig. 1: Constructing ‘A’ with three variables**

among students and teachers. At the time of the study, the students had already had experience with traditional Logo constructions including variable procedures. During the study they were introduced to the dynamic manipulation feature of the software called ‘variation tool’. After a variable procedure is defined and executed with a specific value, clicking the mouse on the turtle trace activates the tool, which provides a slider for each variable. Dragging a slider has the effect of the figure dynamically changing as the value of the variable changes sequentially. The graphics, the tool and the Logo editor are all

available on the screen at all times. In spite of the task requiring a procedure with one variable for each letter, most of the groups initially experimented by choosing different variables for the segments of their constructions until they built their final one with one variable. For example, in the procedure of Figure 1 for letter “A” the first variable (:x) changes the length of the “slanty” sides, the second (:y) the length on the “slanty” sides from the base to the edges of the horizontal side and the third

(:z) the horizontal side. The procedure for drawing the final model of a letter can be derived through the functional relation of the only variable to the ratios of the sides of a fixed model of the letter. Our general aim thus was to utilize the functionalities of the computer environment and the feedback it can provide so as to provoke children: (e) to construct relationships and figures according to proportional rules (not initially explicit to pupils); (f) to come up against visual conflict with common initial strategies e.g. the inclusion of an additive relationship in a procedure would result to a “distorted” figure for some numeric values on the variation tool; and (g) to engage in the dynamic manipulation of the enlarging process. Our objective was to gain insight into (h) the nature of the meanings of ratio and proportion constructed by pupils during their explorations and (i) the ways in which meaning generation interacted with the use of the available tools.

## **METHOD**

During the activity, we took the role of participant observers and focused on one group of students in each class (focus groups), recording their talk and actions and on the classroom as a whole recording the teacher’s voice and the classroom activity. In our analysis we used a generative (Goetz and LeCompte, 1984) stance, i.e. allowing for the data to shape the structure of the results and the clarification of the research issues. Here we use data from the focus group in one of the classrooms. A team of two researchers participated in each data collection session as participant observers. We used two video-cameras and two microphones. One camera and one wired microphone were on the groups of students who were our focus (1 in each class). One researcher was occasionally moving the second camera to capture the overall classroom activity as well as other significant details in student’s work as they occurred. A second wireless microphone was attached to the teachers, capturing all their interactions with all groups of students. Background data was also collected (i.e. observational notes, students written works). Verbatim transcriptions of all audio-recordings were made.

## **VISUAL MANIPULATION OF THE INTERDEPENDENCE OF VARIABLES**

In the following episodes we present different kinds of normalizing activity according to the criterion or motive of pupils’ normative actions interrelated to the simultaneous emergence of mathematical meanings. In the first example, normalising is associated with the interdependence of the lengths of the construction. The focus group students made a model of the letter “A” using three variables as shown in Figure 1. Early in their work they had constructed the displayed figure – which we refer to as the *original pattern* of “A” – without using any variables. On the next stages of their exploration, pupils would try to change it proportionally. The three sliders were set in the values of the original pattern as displayed at the bottom of the screen:  $x=75$ ,  $y=30$  and  $z=37$  when S1 started to move the slider of (:x) for the first time. S2 proposed to assign to it the value of 150.

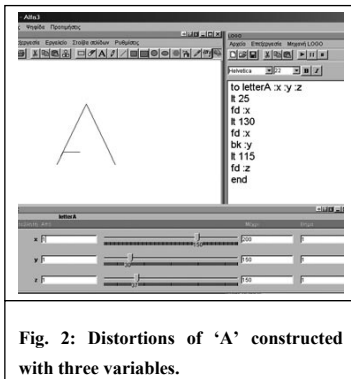
S2: [To S1] Change it to 150.

S1: [The figure is distorted] But, I have to increase this one [i.e. the (:y)].

R: [To S1 who is dragging the slider of (:z)] What are you changing now with (:z)?

S1: With (:z) I was changing this [ i.e. the horizontal side].

R: Ok, but in your “a”, this little line is now too low.



[S1 drags the variation tool of (:y) to a higher value, thus pulling up the horizontal line]. In this case the normative process started after the ‘distortion’ of the figure when moving one of the sliders (Figure 2). S1 continued normalising by the appropriate change of the length of the horizontal length of “A”, so as to join up the side sections. However, those modifications had also changed the starting point for drawing the horizontal part, expressed by the variable (:y), as the researcher pointed out. Thus, S1’s normalizing action was to move the third slider of the variation tool to a higher value. Although

S1’s suggestion of 150 being twice as much as the initial value of (:x) may be an indication of a proportional prediction for the values of the other variables, S2 did not change them proportionally. However, we may observe that pupils apparently connected at an intuitive level the articulation of the figure and the interdependence of the involved magnitudes. In this phase pupils seemed to give priority to complete the shape instructed by the visual outcome on the screen and not paying attention to some kind of relationship between the selected values. The next episode shows how this kind of experience was exploited in further exploring the construction.

## GRAPHICAL AND NUMERIC CONTROL OF THE SIMILARITY RATIO

For some time pupils seemed to move the sliders of the variation tool at random observing the visual feedback of the continuing changes in the variables. Gradually their dragging moved from this mode to become more systematic and focused in their attempt to discover some rule or invariant property so that they could create the original letter “A” in different sizes. S1, who used the keyboard, while trying to normalise an incomplete form of a figure had the idea to double and half the initial values of the original pattern. In the following excerpt, S1 set as initial value for each slider the half of the correspondent value in the original pattern and as the end value, its’ double.

R: [To S1] What are you changing now?

S1: I set it to the smallest.

S2: [After a while] Therefore, we have to study the relation to find what's right.

R: Which relation?

S2: That of the three numbers. To find a relation, if possible, in order not to think of it each time.

S1, by setting the specific limits on the sliders and dragging them at both ends, achieves to construct similar figures and take control of the similarity ratio equal to the values  $\frac{1}{2}$  and 2. S1's manipulation of the variation reflects the purposeful way in which the computational setting provided a web of structures which pupils could exploit in shaping the available resources to satisfy the emerging proportional rule (Noss and Hoyles, 1996). This time the exploration process became more 'focused' as if dragging had found its path to provide a form against with the normality of the shape was judged. However, when S2 speaks about relation, he refers to the correlation of each set of three numbers so as to solve the construction problem for all subsequent attempts. In his words, the emergent meaning is related to the functional interdependence between the construction magnitudes which is a necessary step for the completion of the final construction with one variable. This process is completed in the next episode through the use of appropriate function operators for the expression of the internal relationships built into the figure.

## GRAPHICAL DISCONTINUITY OF THE COVARIANT MAGNITUDES

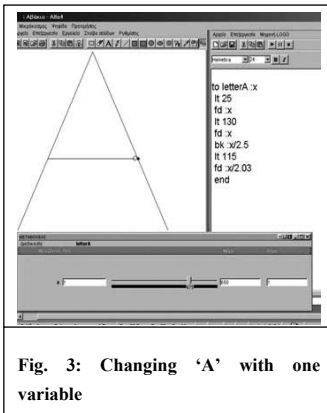


Fig. 3: Changing 'A' with one variable

Children have constructed the changing "A" based on the (:x) variable (Figure 3). For the expressions of the changing lengths corresponding to the variables (:y) and (:z), they have divided the variable (:x) by the numbers resulting from the division of the original pattern's lengths:  $75:30=2,5$  and  $75:37=2,03$  respectively. The students rounded off the second quotient, since its exact value is the periodic decimal  $2,027027\dots$  As S1 moves the only slider of variable (:x) to gradually bigger values, the researcher points out a gap between the horizontal and slanted segments.

S1: Yes. Because 2,03 has been rounded off ... It should have been 2,27.

S2: We have to make a more accurate ... division.

They repeat the division and then they change the denominator from 2,03 to 2,027.

S2: However, it's better now. Before, the difference was bigger.

S1: Let's do it better.

S2: [By adding another 027 to the denominator] Another zero two seven.

As regards the mathematical content, the field where normalising takes place is the dynamic covariance of the sides of similar geometrical figures. The term 'better' used by S2 seems to refer to both the approximation of the function operator implying the use of more digits and to the best possible accuracy on the figure. The relationship between the figures' side and horizontal segments (interior vertex angle of  $50^\circ$ ), is an irrational number and therefore, the figure will inevitably present a slight difference for high values of  $(:x)$ . What is particularly noticeable in the excerpt is the emerging connection between symbolic and graphical representation and the way it is used to elaborate the internal relationships in the general procedure: pupils triggered by a little abnormality on the graphical outcome formed a utility in which symbolic notation helped them to extend the normative process. At the same time the episode is indicative of the dynamic nature of normalising in pupil's manipulation of relationships by exploring the dependencies between different objects and representations. As normalising develops the use of the variation tool in particular shifts to being an analytic tool connecting the various representations of the internal proportional relationships built into the figure and the experimental process to the results of the constructions themselves.

## DISCUSSION

These episodes illustrate the dialectic relationship between the evolution of normalising and pupil's progressive focusing on relations and dependencies underlying the current geometrical constructions and its representations. The key difference amongst the episodes is that in the evolution of the activity the appreciation of the feedback was much more closely bound into the articulation of the proportional relationships involved. We had hoped that children could see the construction problems in relation to symbolic changes each time – but this turned out not always to be the case. In the first episode an icon-driven interpretation of the task to build a bigger letter in proportion with the original pattern bypassed altogether the internal relationships of its structure and it was not related to any kind of proportionality. In the second episode children seemed to gain control of the normative process adopting intuitively the scalar proportional strategy of doubling and halving by the use of the symbolic interface of the variation tool. In the third episode pupil's previous experience with the computational tools had been moving in the direction of manipulating the graphical object and its symbolic relations as a source to bring new meanings to the questions arose by the current construction task. Indeed, the approximation of the horizontal segment in the last episode highlights the dynamic nature of normalising as a corrective activity since for high values of the only variable another corrective field could be introduced for further normalising actions likely to follow. What we took from these situations was not so much student responses to proportionality tasks, but rather, their progressive recognition and expression of relationships between the elements of the problem by playing with representations and relationships as well. The use of symbolic and graphical notation

in conjunction with the dynamic manipulation of the way the figures evolved as variable values changed, played an important part in the generation of these ideas which was interwoven with the activity and the use of the tools.

## REFERENCES

- Ainley, J., Pratt, D. & Nardi, E. (2001) Normalising: Children's activity to construct meanings for trend, *Educational Studies in Mathematics*, 45: 131-146.
- Ainley, J. & Pratt, D. (2002) Purpose and utility in pedagogic task design, *Proceedings of the 26<sup>th</sup> PME Conference*, Norwich, England, Vol. 2., pp. 17-24.
- Goetz, J. P. and LeCompte, M. D. (1984) *Ethnography and Qualitative Design in Educational Research*, Academic Press, London.
- Harel, I. and Papert, S. (eds) (1991) *Constructionism: Research Reports and Essays*, Ablex Publishing Corporation, Norwood, New Jersey.
- Harel, G., Post, T. & Lesh, R. (1991) Variables affecting proportionality, *Proceedings of the 15<sup>th</sup> PME Conference*, Assisi, Italy, Vol. 2., pp. 125-132.
- Hart, K. (Ed.) (1981) *Children's Understanding of Mathematics*, J. Murray, London.
- Hart, K. M. (1984) *Ratio: Children's Strategies and Errors*. Windsor: NFER-Nelson.
- Hoyles, C. & Noss, R. (1989) The computer as a catalyst in children's proportion strategies, *Journal of Mathematical Behavior*, 8, 53-75.
- Hoyles, C., Noss, R. & Sutherland, R. (1989) A Logo-based microworld for ratio and proportion, *Proceedings of the 13<sup>th</sup> PME Conference*, Paris, Vol. 2., pp. 115-122.
- Kuchemann, D. (1989) The effect of setting and numerical content on the difficulty of ratio tasks, *Proceedings of the 15<sup>th</sup> PME Conference*, Paris, Vol. II, pp. 180-186.
- Kynigos C. (2002). Generating Cultures for Mathematical Microworld Development in a Multi-Organisational Context. *Journal of Educational Computing Research*, Baywood Publishing Co. Inc. (1 and 2), 183-209.
- Kynigos, C. & Psycharis, G. (2003) 13 year-olds' meanings around intrinsic curves with a medium for symbolic expression and dynamic manipulation, *27<sup>th</sup> PME Conference*, Honolulu, U.S.A. Hawaii, Vol. 3, pp. 165-172.
- Lave, J. (1988) *Cognition in Practice*, Cambridge: CUP.
- Noss, R. & Hoyles, C. (1996) *Windows on Mathematical Meanings*, Kluwer.
- Tourniaire, F. & Pulos, S. (1985) Proportional reasoning: A review of the literature, *Educational Studies in Mathematics*, 16, 181-204.

# THE SENSUAL AND THE CONCEPTUAL: ARTEFACT-MEDIATED KINESTHETIC ACTIONS AND SEMIOTIC ACTIVITY

Luis Radford<sup>(1)</sup>, Serge Demers<sup>(1)</sup>, José Guzmán<sup>(2)</sup> and Michele Cerulli<sup>(3)</sup>

<sup>(1)</sup> Université Laurentienne, Canada. <sup>(2)</sup> Cinvestav, Mexico. <sup>(3)</sup> I.T.D. of Genova, Italy.

*In this paper we deal with the problem of the genetic relationship between the sensual and the conceptual in knowledge formation. Transcript and videotape analyses of two small groups of a regular Grade 11 mathematics class shed some light on the dialectics between semiotic activity and artefact-mediated kinesthetic actions. The analyses point to a dialectical embedding of the sensual and the conceptual through perceptual activity, gestures, mediated action, speech, and signs.*

## INTRODUCTION

Although 20<sup>th</sup> century psychology acknowledged the role of language and kinesthetic activity in knowledge formation, and even though elementary mathematical concepts were seen as being bound to them (as in Piaget's influential epistemology), bodily movement, the use of artefacts, and linguistic activity, in contrast, were not seen as *direct* sources of abstract and complex mathematical conceptualizations.

Nevertheless, recent research has stressed the decisive and prominent role of bodily actions, gestures, language and the use of technological artefacts in students' elaboration of elementary, as well as abstract mathematical knowledge (Arzarello and Robutti 2001, Robutti 2003, Nemirovsky 2003, Núñez 2000). In this context, there are a number of important research questions that must be addressed. One of them relates to our understanding of the relationship between body movement and actions carried out through artefacts (objects, technological tools, etc.) with linguistic and symbolic activity. Research on the relationship between these two chief sources of knowledge formation (i.e. artefact-mediated kinesthetic actions and semiotic activity) is of vital importance for a better understanding of human cognition in general, and of mathematical thinking in particular. As current research suggests, highly complex mathematical symbolism cannot incorporate students' kinesthetic experience in a direct manner. The severe limitations of a direct translation of actions into symbols require the students to undergo a dynamic process of imagining, interpreting and reinterpreting.

The goal of this paper is to contribute to our understanding of the dialectical process between (concrete or imagined) actions, signs and meanings underpinning students' elaboration of mathematical conceptualizations. In order to do so, we continue and deepen our analysis of a classroom activity where Grade 11 students were asked to investigate the relationship between the distance traveled and the time spent by a cylinder moving up and down an inclined plane (Radford et al. 2003). In this paper,

we focus on the students' difficulties in interpreting a graph involving negative distances.

### **THEORETICAL FRAMEWORK**

In our theoretical framework, the interplay between semiosis and artefact-mediated kinesthetic actions is located in the individual's reflective, cognitive activity, out of which certain conceptual objects are grasped or produced. The semiotic-cultural perspective that we are advocating stresses the fact that the production of knowledge of individuals results from goal-oriented activities, encompassed by social processes of meaning making. In the course of such processes, stable forms of awareness are achieved and subjective intentions are made apparent. In this context, awareness and intentions as subjective constructs are consubstantial with the variety of culturally embedded actions carried out through a dynamic interaction of semiotic systems (e.g. gestures, speech, written language, mathematical symbolism), perceptual activity, and tool use. These culturally embedded actions underlining the individual's elaboration of mathematical knowledge are part of complex social processes of *knowledge objectification* (Radford 2002, 2003).

Knowledge objectification nevertheless requires the possibility of detaching oneself from the particularities of personal experiential perspectives. As Piaget remarked, actions on objects provide the individual with a vantage viewpoint on the object of knowledge, a vantage viewpoint that, ontogenetically, has later to undergo a process of detachment (or "*décentration*", to use Piaget's word). The same is true of perceptual activity and of natural language too. With its arsenal of deictics, (e.g. "I" "here", "there", "now") natural language indeed anchors the individual's talk at a particular spatial-temporal point. It is from this point that reference to objects of discourse is made. This point accounts for distinctions between e.g. "here" and "there". Its spatial-temporal nature becomes apparent when we notice that if we move this point, "right" may become "left", "close" may become "far", and so on.

As a result of the contextual nature of actions and of the aspectual view deriving from language, gesture and perceptual activity, a spatial-temporal relationship is created between the individual and the conceptual object leading to what can be termed an *embodied meaning*. This embodied meaning has to become somehow *disembodied* in order to endow the scientific conceptual object with its cultural, interpersonal value.

Within the sketched semiotic-cultural framework, the relationship between semiotic activity and artefact-mediated kinesthetic actions can be seen as a dialectical relationship in which external cultural conceptual objects are transformed into objects of self-awareness through an integrated movement unfolding between the worlds of the sensual and the conceptual (i.e. between the manifold of sensual experience and the world of conceptual idealities). To better understand this dialectic, in this paper we discuss some steps in the students' process of knowledge objectification as knowledge becomes objectified in the physical, cultural environment of body and artefacts –an environment that we propose to view as a semiotic system, i.e. as a system of signs and significations. We shall return to this point later.



## METHODOLOGY

**Data Collection:** Our experimental data comes from an ongoing longitudinal classroom-based research program whose classroom activities (elaborated by a team of teachers, researchers and research assistants) are part of the regular school teaching lessons, as framed by the provincial Curriculum of Mathematics. In these activities, designed as layered *zones of proximal development* (Vygotsky), the students spend a substantial part of the activity working together in small groups of 3 or 4. At some points, the teacher conducts a general discussion allowing the students to expose, confront and discuss their different solutions. In addition to collecting written material, tests and activity sheets, we have three or four video-cameras each filming one group of students. Subsequently, transcriptions of the video-tapes are produced. These transcriptions allow us to identify salient short passages that are then analyzed in terms of the students' use of semiotic resources and tool use.

**The Teaching Sequence:** The data reported here comes from the second day of a two-day mathematical activity based on a hands-on investigation of motion along an inclined plane. The first day, the students were asked to make a graph of the relationship between the time spent and the distance traveled by a cylinder propelled from the bottom of a ramp. Then the students carried out the experiment using a TI 83+ calculator connected to a Calculator Based Ranger (CBR) placed on top of the ramp. The students were asked to compare their graph to the one produced by the calculator and to discuss the differences between the two. One of the questions asked to the students on the second day was the following: "A group of students drew the following curve to represent the relationship between time and space when a cylinder is propelled upwards [from the bottom] on an inclined plane [see Fig. 1]. This group placed the distance origin around the center of the inclined plane. Is this curve correct? Explain in detail your answer." Transcript and videotape analysis of one of the small groups suggested that some students' difficulties are linked to the distinction between the mathematical origin and the origin of the cylinder motion (Radford et al. 2003, pp. 60-61). In this paper, we will focus exclusively on this question. We want to deepen our analysis of this cognitive problem in order to shed some light on the more general problem of the dialectics between semiotic activity and artefact-mediated kinesthetic actions underpinning the students' processes of knowledge objectification.

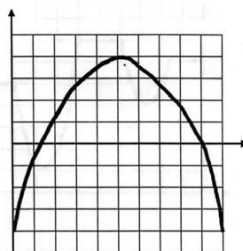


Figure 1. The graph accompanying the question.

## RESULTS AND DISCUSSION

The classroom mathematical activity required the students to coordinate two different semiotic systems: on one hand, the semiotic system of body and artefacts where a concrete experiment was performed, on the other, the Cartesian coordinate semiotic system. Each of them is governed by its own semiotic structure. In the first case, the semiotic structure derives from the particulars of the experiment, e.g. the position of

the CBR, the place where the cylinder was propelled, the moment in which the cylinder started moving, the place where the cylinder was stopped, etc. (see Figure 2)



Figure 2. The picture shows the physical environment of body and artefacts as a semiotic system of signs and significations. It includes the ramp, the cylinder, and noteworthy points such as the CBR position, the beginning and the end of the cylinder motion, body position, etc. The cylinder was propelled upwards from the bottom of the ramp. The picture captures a moment of the cylinder motion after release.

In the second case, the semiotic structure obeys mathematical conventions (e.g. a division of the domain along two perpendicular axes, one for registering distances from their origin and the other for registering the elapsed time). The mathematical origin of the Cartesian system is of course an important point in the sense that the relationship between variables is referred to it. The contextual nature of the experiment endows a structure to the physical semiotic system of body and artefacts, where other significant points can be identified. They are defined by their mutual relationship and by the role they play in the actual course of the experiment. One of the most noteworthy points is the reference point of the students' spatial-temporal mathematical experience –the point from where an embodied meaning is bestowed on signs. Following Bühler's linguistic concept (Bühler, 1979), we want to term this point the *origo*.

In what follows we present excerpts from two small groups (these groups belong to the same classroom of the group mentioned in Radford et al. 2003). As will be seen in the course of the analysis which follows, the first group had problems distinguishing between the mathematical origin (0,0) of the Cartesian coordinate system and the *origo*. The second group, in contrast, managed to establish a suitable distinction. In asking the students to critically judge whether a given graph was correct or not, knowing that the mathematical origin corresponded to a point near the middle of the ramp, negative distances come into play offering us an interesting terrain in which to investigate our research question, that is, the dialectics between the sensual and the conceptual.

In the following excerpt the students were studying the graph shown in Figure 1.

1. Tammy: I think it doesn't make any sense ... you can't just go down to the negatives like that ... (*she point with her pen to the lower part of the graph*)
2. Amanda: Why would it go down into the negatives? (*Pointing to the ramp, which is on the right of the students, she says*) it goes down into the negatives ... if the ball falls (*i.e. if the cylinder goes off the ramp*) (see Table 1 Picture 1 from left to right).

3. Jess: Unless they threw it up from the floor (*as she utters the word up she makes a gesture with her right hand moving it up, see Picture 2*) and it fell backwards.
4. Amanda : Ok well we can just say that for us it doesn't make any sense because when you begin to throw the ball your minimum point is at zero (*with her right hand she makes a gesture indicating a point on her desk; see Picture 3*) and it can't be in the negatives, it's at zero (*she moves now the hand back to mean below the origin; see Picture 4*) [...] the minimum point of the ramp is zero [...] zero signifies the end of the ramp.
5. Jess : ... if anything, it should be like this [...] it would be straight here and straight there (*she adds two segments to the graph where it cuts the horizontal axis; see Picture 5*).



Table 1. Pictures 1 to 4 (from left to right) show parts of the dialectical process between imagined actions, meaning and the interpretation of the sign-graph (shown in picture 5), as encompassed by physical experiments carried out on the first day.

In these lines, the students display an attempt at making sense of the given graph. Tammy starts making a general statement. In line 2 Amanda elaborates further and offers a first explanation that links the conceptual category of negative numbers and the physicality of the experiment in a decisive way. As her utterance reveals, the conceptual realm remains subjected to the sensual experience by the metaphor that the cylinder “goes down” into the negatives. This metaphor rests on two key elements:

- (1) The physical aspect of the phenomenon where one actually *sees* the cylinder *moving down* in the last part of its trajectory (a part that is stressed by Amanda's gesture shown in Picture 1), and
- (2) The central idea that the bottom of the ramp is taken as “zero”.

Within this conceptual space, the only way negative values could be obtained, as Amanda says, is if the cylinder goes off the ramp. The confusion between the physical “zero” (i.e. the *origo*, defined by the spatial coincidence of body and cylinder motion) and the mathematical origin impedes a suitable understanding. In keeping with this view, Jess suggests the unlikely possibility that the cylinder was thrown up from the floor. Pictures 3 and 4 in Table 1 show Amanda producing a gesture (a “moving down” gesture) that simulates the imagined motion of the cylinder going below the bottom of the ramp. The “moving down” gesture serves the purpose of knowledge objectification. An alternative is proposed by Jess in Line 5, where the graph is emended in a coherent way within the students' working conceptual space: no part of the graph can go below the horizontal axis, so little horizontal segments are added in each part where the graph cuts the axis.

As we see, the students did not succeed in suitably objectifying knowledge. Knowledge remained confined to the embodiment of mediated actions. Kinesthetic,

mediated actions were governing both the realm of sensual experience and of mathematical conceptual descriptions, leading to a superimposition of the mathematical origin and the *origo*.

Let us now turn to the second group of students. In the beginning, this group also had problems relating negative numbers to the cylinder motion:

1. Sandra : But a value can't be negative, it can't be negative ... minus 2 meters.
2. Nelly : Negative 2 meters, even if she walks backward it can't be negative [...]
3. Sandra : Ok, (*she proposes an imaginary situation*) Albert goes for a walk and one measures his distance.
4. Albert : So I go then I come back, the instant that you move, it isn't minus meters.
5. Nelly : Yeah ... If you walk one meter behind you'll say, yoh man! I walked a negative mile!
6. Sandra : Or if you take a ball and you dig a hole in the ground, the ground has a value of zero ... whatever.
7. Nelly : Still the ball wasn't in the negative meter ... it went down ...
8. Albert : But it will come back to 2 meters, even though ... I don't know...

In this part, in an attempt to make sense of the graph, the students had recourse to two experiential situations: a walk and the position of a ball, each of them referring to their own *origo*. The inclusion of the conceptual category of negative numbers in the students' discussion about practical (imagined) situations shows the interplay between the sensual and the conceptual. But again, the predominance of the physical *origo* over the conceptual mathematical origin impedes the coordination between semiotic systems. After some more discussions, the students continue as follows:

9. Sandra : Let's say that this is zero (*she points to a point on the ramp; see Table 2, Picture 1*), we'll say that this is zero ...
10. Nelly : (*Interrupting*) there it goes (*she makes an indexical gesture with her right hand that physically touches a point on the ramp. Then she takes the cylinder with her left hand and puts it right beside the point indicated by her index finger on the ramp and says*) but do they start counting here?
11. Sandra : (*Disagreeing with the fact that Nelly put the cylinder beside her index finger, says*) Yeah but they begin to count ...
12. Nelly : **If** they count that as point zero! Then it's like ... (*she moves the cylinder to the bottom of the ramp; see Picture 2*)
13. Sandra : (*Interrupting*) Well yeah it's negative variable...
14. Nelly : (*At this moment, Nelly starts a long gesture: she moves slowly her left hand while saying*) So negative one,... zero (*she stops for a very short moment; see Picture 3*)
15. Albert : (*When Nelly reaches the point of zero, he says, at the same time as Nelly*) Zero...
16. Nelly (*Continuing to move the cylinder up says*), one, two (*she reaches the maximum point –see Picture 4*) and when moving the cylinder back to the bottom (*says*) blah, blah, blah ... (*see Picture 5; then, turning to her group-mates, says*) I guess that could go

In this excerpt, Sandra starts working on a hypothetical situation derived from the problem data, namely, that the distance origin was placed around the center of the

surface where the cylinder can move. She makes an indexical gesture (Table 2, Picture 1) that is elaborated in a more precise way by a second gesture performed by Nelly. Indeed, Nelly turns to the ramp (which was behind her) and positions her index finger to indicate in a precise way the point on the ramp that corresponds to the mathematical zero of the distance axis. Thus far, things are not yet completely clear, as is shown by her putting the cylinder close to her right index. Next, Sandra makes her understand that the cylinder did not start there. As she is still not fully convinced, Nelly uses the conditional “if,” which she stresses by a clear intonation. Within the hypothetical situation thus defined, with her left hand she places the cylinder on the bottom of the ramp, which corresponds to the physical origin or *origo*. In so doing, the *origo* and the zero of the distance axis are perceptually distinguished in an unequivocal manner. It still remains to be seen if there is agreement between the two semiotic systems –the one of body and artefacts and the Cartesian graph. The enactment of the cylinder motion follows. The coordination between the two semiotic systems is accomplished by perceptual activity and by another semiotic system: *speech*. While she moves the cylinder up, she says “negative one” “zero” “one”, “two”. A suitable understanding seems to have been reached, and the second part of the cylinder motion is now merely schematized with gestures and words. Indeed, the words “blah, blah, blah ...” now indicate a few points on the ramp that do not require further specification.



Table 2. Indexical gestures indicate the point on the concrete semiotic system of body and artefacts that corresponds to the mathematical origin of the distance variable. The enactment of the cylinder motion, encompassed by mediated actions and conceptual categories, leads to the objectification of knowledge.

But knowledge objectification is not something that usually happens once and for all. Thus, the students’ dialogue continues with a reflection on the meaning of zero. Replying to Nelly’s last utterance (Line 16), Sandra says:

17. Sandra : Since the origin isn’t at zero-zero I guess it could go...
18. Albert : (*Looking at Sandra he says with a subtle and Machiavellian smile*) What is zero-zero...?
19. Sandra : Mmm ... Well ... that would be like the bottom of the ramp (*she points to the bottom of the ramp with her pen*).
20. Albert : (*interrupting*) Zero-zero is there where you put it ... when we had the CBR (*referring to the experiments carried out the day before*) we had zero at the CBR, so it depends on where you want to put the origin ... so technically it’s true (*Sandra and Nelly think for a while about what Albert has just said*) (...)
21. Sandra : But really because it’s from the bottom ... but there isn’t really a CBR so we don’t know (...)
22. Albert : It’s where you want to put the origin... it makes sense! It’s where you want to put the origin!

While on Line 8 Albert was still unsure about the difference between the origin and the *origo*, we now see that the difference has become well established. Through a complex interplay of conceptual categories, gestures, perceptual activity, and mediated imagined and concrete actions, the dialectics between the sensual and the conceptual ensured a culturally correct interpretation of the graph.

### CONCLUDING REMARKS:

As the previous analysis suggested, one important difference between the two groups of students mentioned in this paper is the possibility to accomplish a detachment of body and actions. Such a detachment is underpinned by the disembodiment of a meaning generated by artefact-mediated kinesthetic actions. The disembodiment of meaning is not related to the exclusion of the body or the austerity of the action. Rather, the disembodiment of meaning is related to the possibility of dialectically embedding the sensual and the conceptual. This dialectic embedding is most revealing in the “semiotic node” (Radford et al. 2003) of perceptual activity, gesture, mediated action and speech displayed in lines 4 to 8 (see also Table 2). Nelly’s indexical gesture indicating the origin of the distance variable opens up the possibility to re-cognize the domain of scrutiny where the iconic gesture comes to enact the motion of the cylinder. The iconic gesture is accompanied by words that highlight spots to be perceptually attended, leading to the attainment of a stable form of awareness. Gestures, mediated actions and words mark altogether, out of the continuum of the ramp, particular points that are simultaneously sensual and conceptual. Naturally, the short examples discussed in this paper do not exhaust the difficult problem of the epistemic relationship between the sensual and the conceptual. Our examples merely suggest that our understanding of students’ objectifying processes of historically and culturally constituted bodies of knowledge require a better understanding of the dialectics in which the sensual and the conceptual become subsumed into each other. They point to some of the aspects of the general problem and thereby call for further theoretical and practical research.

**Acknowledgment:** This paper is a result of a research program funded by the Social Sciences and Humanities Research Council of Canada (SSHRC/CRSH).

### References:

- Arzarello, F. & Robutti, O. (2001). From Body Motion to Algebra through Graphing. In *Proceedings of the 12th ICMI Study Conference*, Vol. 1, 33-40.
- Bühler, K. (1979). *Teoría del lenguaje*. Madrid: Alianza Editorial.
- Nemirovsky, R. (2003). Three Conjectures Concerning the Relationship between body activity and Understanding Mathematics. *Proceedings of the PME27 Conference*, Hawaii, 1, pp. 105-109.
- Núñez, R. (2000). Mathematical Idea Analysis. *Proceedings of the PME24 Conf.*, Japan, 1, 3-22.
- Radford, L. (2002). The seen, the spoken and the written. A semiotic approach to the problem of objectification of mathematical knowledge. *For the Learning of Mathematics*, 22(2), 14-23.
- Radford, L. (2003). Gestures, speech and the sprouting of signs, *Mathematical Thinking and Learning*, 5(1), 37-70
- Radford, L., Demers, S., Guzmán, J. and Cerulli, M. (2003) Calculators, graphs, gestures, and the production meaning, *Proceedings of the PME27 Conference*, 4, pp. 55-62.
- Robutti, O. & Arzarello, F. (2003). Approaching algebra through motion experiences, *Proceedings of the PME27 Conference*, 1, pp. 111-115.

# A Sociocultural Account of Students' Collective Mathematical Understanding of Polynomial Inequalities in Instrumented Activity

Ferdinand Rivera and Joanne Rossi Becker  
San José State University, USA

*In this report, we give a sociocultural account of the mediating functions handheld graphing calculators and social interaction play in students' mathematical understanding. We discuss the evolution of students' abilities to symbolize, model, and develop collective mathematical practices about polynomial inequalities in instrumented activity. In our sociocultural model we foreground the social nature of technological tools and the social transactions that take place in a classroom context which assist students as a collective to establish viable shared practices and collective representations. Graphing calculators as psychological tools are characterized as providing intentional, transcendental, and social mediation.*

## BACKGROUND AND RESEARCH PROBLEM

While a number of psychologically-driven research investigations consider competence in the use of mathematical tools such as notations and representations as a primary goal in the development of students' mathematical understanding (see, for e.g., Thompson 1992 and Kaput 1991), in this report we give a qualitative account of the mediating functions handheld graphing technologies and social activity play in this development. In particular, we discuss the evolution of students' abilities to symbolize, model, and develop collective mathematical practices about polynomial inequalities based on their actions with the TI-89, a handheld graphic calculator, as well as their interaction with other learners. Cobb and colleagues (Cobb 1999; Cobb & Yackel 1996; Cobb, Wood, & Yackel 1992) have clearly demonstrated the independent, but mutually reflexive and determining, roles played by social and psychological factors in mathematical learning. Since their research investigations attempt to account for both collective and individual mathematical development, they focus on social (i.e., classroom norms, sociomathematical norms, and classroom practices) and individual (i.e., personal and mathematical beliefs, nature of mathematical activity, interpretations, and reasoning) mechanisms that contribute to learning acquisition and appropriation. Our overall concern in this investigation is to provide a sociocultural basis for the meaning objectification of mathematical concepts and processes - that is, by surfacing both the social nature of technological tools and the social transactions that take place in classroom activity which assist students as a collective to establish viable shared practices and collective representations (Durkheim 1915).

One basic task in secondary school algebra in the US involves solving inequalities. The algebra and precalculus components of high school mathematics target the solutions of linear, quadratic, polynomial, rational, absolute value, and

radical inequalities. Noncalculator-based mathematical analysis texts oftentimes favor a table-of-signs method to solving polynomial inequalities (see Table 1) which is a novel improvement compared to the very cumbersome manner in which they were solved in the 1970s (see Table 2). In this research report, we provide a socio-cultural account of how students collectively developed a graphical approach to solving polynomial inequalities. Such an account considers how learners produce truths based on taken-as-shared practices of symbolizing and modeling.

Solve: $(x - 1)(x + 1) < 0$ .					
$x - 1$	-		-	0	+
$x + 1$	-	0	+		+
$(x-1)(x+1)$	+	-1	-	1	+
Therefore, $(x - 1)(x + 1) < 0$ provided $-1 < x < 1$ .					

**Table 1. Example of a Quadratic Inequality Solution by the Table-of-Signs Method**

Solve: $(x - 1)(x + 1) < 0$ .	
<p>Case 1. <math>x - 1 &lt; 0</math> and <math>x + 1 &gt; 0</math></p> <p style="margin-left: 40px;"><math>x &lt; 1</math> and <math>x &gt; -1</math></p> <p style="margin-left: 40px;">Therefore, <math>-1 &lt; x &lt; 1</math>.</p>	$\begin{array}{c} <-----> \\ (-----> \\ \hline -1 \qquad 1 \end{array}$
OR:	
<p>Case 2. <math>x - 1 &gt; 0</math> and <math>x + 1 &lt; 0</math></p> <p style="margin-left: 40px;"><math>x &gt; 1</math> and <math>x &lt; -1</math></p> <p style="margin-left: 40px;">There is no solution.</p>	$\begin{array}{c} <-----> \qquad (-----> \\ \hline -1 \qquad 1 \end{array}$
Final Solution Set: $(-1, 1) \cup \emptyset = (-1, 1)$ (i.e., $-1 < x < 1$ ).	

**Table 2. Example of a Solution of a Quadratic Inequality by the Case Method**

### THEORETICAL FRAMEWORK

Recent sociocultural investigations in school mathematics concerning ways in which individuals acquire concepts provide strong evidence that learning takes place through experiences that are oftentimes mediated by physical or material and symbolic tools and with assistance drawn from other (competent) individuals (Gravemeijer, Lehrer, van Oers, & Verschaffel 2002; Cobb, Yackel, & McClain 2000). Such tools are capable of influencing learners' thinking about concepts and processes, and they also assist learners to exercise "control" over mental functions that affect their thinking. Following Vygotsky (1978), those devices such as graphing technologies mediate as "psychological tools" between the mind and the required sociocultural acts of mathematizing (Kozulin 1998). Graphing calculators, in particular, provide a convenient virtual environment that enable learners to acquire mathematical processes and concepts. Further, as learners become



competent in using them, they begin to implicitly reconstruct and appropriate conventional practices.

Within a sociocultural context, knowledge is seen as arising out of collective representations that are (historically) rooted in a community (Durkheim 1915). For instance, a classroom community consists of learners who participate with other learners in an effort to construct shared knowledge among themselves. In mathematical settings, knowledge evolves as a common representation for all; it is shared by all members in a community and, hence, is a form of social relation. A collective representational view of mathematical knowledge enables individual and groups of learners to construct universal understandings; for any meaningful mathematical knowledge constructed does not inhere entirely on the individual learner but from the communities in which the learner transacts with and which determine the manner in which the knowledge is constructed (Cobb, Stephan, McClain, & Gravemeijer 2002; Gravemeijer, Lehrer, van Oers, & Verschaffel 2002).

Mathematical learners in social activity develop understanding by means of participation, cooperation, co-construction, negotiation or transaction, and, ultimately, intersubjective agreement among learners. These social performances enable them to form a “conscience collective,” and this form of solidarity of social consciousness or shared understanding appears to be distinct from the individual consciousness or understanding of members in the community (Durkheim 1915). In other words, within a conscience collective, since mathematical knowledge is an established social fact, it resists individual interpretations of learners whose understanding appears different from what it has taken to be its “true” nature. Individual understandings are, thus, forced to reconcile with understandings that are allowed in the conscience collective. This is not to say that individuals could not negotiate. They could, certainly, but they are not allowed to establish freely on their own because mathematical knowledge as a social fact has the power to sanction or to constrain the manner in which individual learners develop their understanding of it.

Collective mathematical practices emerge from learners in social activity behaving as a conscience collective. Such practices are “perceptions of the acts and artifacts as manifestations of culture (as an analytic construct), and of the social relationships, which exist in the field of collectively held representations” (Bohannon 1960 p. 94). The symbolizing nature of collective mathematical practices is, thus, inherently social – that is, they possess social attributes whereby the meanings and practices associated with them have not been drawn from the objects of knowledge, at least not entirely, but more so in the manner in which the practices have become for the conscience collective their collective representation.

## METHODS

Thirteen males and seventeen females of mixed mathematical abilities comprise this class of juniors and seniors (mean age: 16.63; 26 Asians and Asian Americans, 4 Hispanic-Americans). The first author taught the class while the resident

teacher observed and took down notes throughout the investigation. Twenty-one sessions each lasting 55 minutes were needed to accomplish the goal of the entire teaching experiment. In each session, students would usually work in pairs first and then would later regroup for a whole-classroom discussion. The basic design of the classroom teaching experiment focused on initially providing the participants in the study with an experientially real context for thinking about a way to solve a polynomial inequality, and a TI-89 could facilitate the construction of such a context. Thus, instead of simply telling the students how polynomial inequalities were solved using the standard methods such as those in Tables 1 and 2 above, we wanted them to construct a model that would make much more sense to them based on their collective mathematical experiences and with assistance from a TI-89.

## RESULTS

**Developing a Model of Solving Inequalities Graphically Using Linear and Quadratic Functions.** The class took ten 55-minute sessions exploring ways to solve linear and quadratic inequalities graphically. The sequence of activities implemented at this stage was meant to help students obtain a relatively simple structure for solving inequalities. In solving linear and quadratic inequalities, the students performed the following activities: (1) they investigated the general behavior of the graphs of linear and quadratic functions; (2) they investigated situations in which  $y = ax + b$  and  $y = ax^2 + bx + c < 0, > 0, \leq 0, \geq 0$  graphically. Due to limitations in space, we discuss only linear inequalities. From the graphs shown in the TI-89, Pair 1 interpreted the inequality  $y < ax + b$  as “getting the values of  $x$  where  $y$  is negative.” They suggested “imagine shading” portions of the graph where  $y = ax + b$  was below the  $x$ -axis and then determining the range of values of  $x$  where the regions applied. This proved to be difficult to accept by other pairs since they could not make a connection between the two variables (“we are graphing the  $y$ -values but we are solving for  $x$ ?”; “isn’t the inequality expressed as  $y$ ? ... So why not get all the  $y$ -values instead of  $x$ ?”). Pair 2 then suggested to the class to “think of interval notations as boundaries where the graph lies below the  $x$ -axis.” The “graphic action” enabled the class to conclude that linear inequalities involved determining intervals for  $x$  in which  $y$  was below the  $x$ -axis. Pair 3 made another suggestion, that is, to examine the table generated in the TI-89 to determine the range of values of  $x$  wherein  $y$  was negative. But this suggestion proved to be impractical and was eventually abandoned. Later, the students’ attempts to write the correct solution had them discussing the significance of knowing the  $x$ -intercepts because the solution intervals relied on them.

Thus, the students’ model of solving linear and quadratic inequalities consists of the following: transforming a given inequality into its standard form in which one side would contain the algebraic expression while the other side is set to 0; obtaining the graph of the inequality in standard form and calculating the zeros of the corresponding function either algebraically or graphically; determining the

appropriate domain that satisfies the inequality, and; expressing the final answer in interval notation form.

**Developing a Model For Solving Polynomial Inequalities.** The class needed eleven 55-minute sessions to accomplish this task. The model they developed for solving polynomial inequalities graphically could be broken down into three stages below using different types of tools and in which the TI-89 served as the primary tool for the progressive evolution of the two later tools.

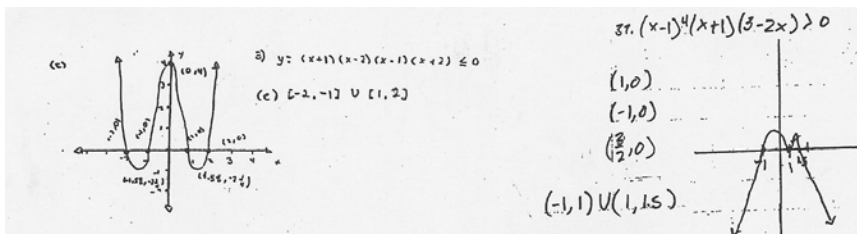
I Using the TI-89 as a tool for investigating the following: (1) graphs of even- and odd-powered polynomial functions in factored form; (2) graphs of polynomial functions in factored form that contained odd and even multiplicities; (3) graphs of polynomial functions in factored form that contained imaginary zeros; (4) solving polynomial inequalities in factored form graphically.

II Using a constructed Cartesian plane on paper as a tool for solving polynomial inequalities in factored form graphically.

III Using a number line as a tool for solving polynomial inequalities in factored form graphically (and the same tool was used later in the case of polynomial inequalities expressed in the general (non-factored) form.

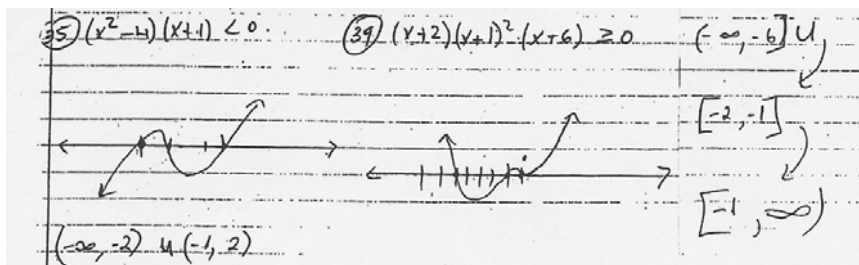
Initially, the students relied on the TI-89 to obtain generalizations about the graphs of polynomial functions subject to certain restrictions (see (I) above). They also used it to solve inequalities and to see the significance of knowing how the  $x$ -intercepts played out in the solution process. The TI-89 enabled them to develop their initial ability to describe and to reason perceptually about graphs of polynomial functions and their relationship to solving polynomial inequalities that were all initially expressed in factored form. In establishing a model for solving inequalities graphically, two additional shifts took place, and both shifts were unaided by the graphing tool. When the students were prompted to solve a polynomial inequality independent of a TI-89, Pair 3 suggested for the class to draw a Cartesian plane, plot the real  $x$ -intercepts, and use what they initially learned about the graph of the corresponding polynomial function to draw a sketch of its graph, and then to write down the intervals in which the inequality made sense. It took students some time to accomplish this because they had to calculate specific points on the graph. A number of them obtained values for  $y$  by beginning with  $x = 0, 1, 2, 3$ , and so on, which did not make sense in many cases of polynomial functions and, hence, did not gain much support from the class. One collective practice that emerged from a whole-group discussion came from Pair 4 who suggested obtaining points that lie between  $x$ -intercepts that the class immediately accepted. A second collective practice came from Pair 5 who suggested that to solve a polynomial inequality graphically, a rough sketch of its corresponding graph together with all the  $x$ -intercepts was all that were needed and that none of the other points mattered. See Figure 1 for a sample of two students' work based on these two collective practices.

As a homework assignment, the students were asked to solve a number of polynomial inequalities of varying difficulty without the use of the TI-89. During the next day's whole-class discussion, Tran raised the viability of solving a polynomial inequality by simply using a number line and not the Cartesian plane as a solution tool (see Figure 2). Tran did not see the significance of constructing a y-axis since the solution of any polynomial inequality depended primarily on the x-intercepts.



**Figure 1. (a) #5: Solution With x-intercepts and Other Points**  
**Figure 1. (b) #37: Solution With x-intercepts Only**

Further, consistent with earlier practices, Tran interpreted interval notations as consisting of x-intercepts in which portions of the corresponding polynomial graph satisfied the indicated inequality. What his classmates obtained from his argument became the third collective practice for the entire class. This practice, which was perceptual in origin, is metaphorically equivalent to the table-of-signs method (see Table 1) that was conceptual and algebraic.



**Figure 2. Solution Using the Number Line Method**

### DISCUSSION

While the initial model for solving polynomial inequalities graphically was mediated by the use of a TI-89, it was the simultaneous negotiation and participation

that took place among the students that enabled the development of other models leading to a formal process. Such a process was not something that has been merely foisted upon them as an external reality; it evolved out of their actions with other learners and the TI-89. Formal thought emerging from informal activity in this manner is seen as the “creation of a new mathematical reality” (Gravemeijer & Stephan 2002).

The students capitalized on those shared understandings that they developed amongst themselves in the public space of the classroom. The TI-89 made learning less problematic for them because they used it mainly to draw sketches of several graphs all at once within some limited time. Hence, a shift of focus took place from being able to draw the graphs to being able to collectively make sense of the graphs as they pertained to inequality solving. Both the TI-89 and other learners mediated in ways that made it difficult to analyze the influence of one apart from the other, which is but an effect of instrumented activity (Rivera forthcoming).

Another effect of instrumented activity is seen on students’ developing representational fluency. Based on my analysis of the students’ written work, about 70% could easily switch from graphic to algebraic and vice-versa. The students could use the trace function to obtain approximate roots, or press one of the math keys to solve for the roots of the corresponding equations, or apply the appropriate algebraic forms to determine exact values. A sociocultural account for finding exact values is worth discussing briefly. When Nestor asked for the best way to obtain correct zeros on the TI-89, he received different approximations for the same root from others (even though they all used the math function “intersection” in the TI-89 to obtain it). Duong suggested that the class agree on how to round numbers, while Salvador insisted on identifying the appropriate upper and lower bounds so as to minimize errors. When the class was nowhere near an agreement, Nestor insisted that they obtain exact answers instead (for e.g., using the quadratic formula for irrational roots). In this situation, their understanding was shaped by the negotiation that occurred as a result of a calculator constraint which nobody was able to resolve. Thus, representational fluency was not forced on the students to achieve; the need to be fluent arose from a social conflict that needed to be settled.

Isolating the role played by the TI-89 in instrumented activity leads to several insights. First, because the various commands and functions in the TI-89 reflect mainstream mathematical processes, students are implicitly provided with an “intentional experience” (Kozulin 1998 p. 65). For example, my students did not have to create the graphs themselves since the calculator did it for them. They did not haphazardly construct their own graphs because the TI-89 has been program-med in such a way that the graphs reflect standard and correct features and characteristics (subject to the appropriate windows, of course). The experience of interpreting is intentionally directed in a way that reflects prevailing conventions. Second, the TI-89 functions as a “transcendent mediation” (*ibid.* p. 66). This was evident among my students when their thinking transitioned from a model of solving inequalities using linear and quadratic functions to a model for solving any polynomial inequality. How

they developed the “model of” phase became the basis for constructing the “model for” phase. Students initially obtained solutions of linear and quadratic inequalities by imitating and copying the graphs they saw in the TI-89. In the final stage of their understanding, the essential elements they acquired from the TI-89 were used later as they shifted to more general models for solving inequalities involving the Cartesian plane and the number line. Third, the mathematical functions in the TI-89 will fail to mediate if learners fail to invest them with the correct meanings. While the TI-89 displays the symbols and objects that reflect our cultural inheritance, they are not embodied productions – that is, meaning does not reside in them. However, acting on them individually and in social activity is tantamount to loading them with value and purpose. The students found it significant to use the TI-89 because of the collective meanings that they developed amongst themselves which proved to be especially meaningful in the more formal stages.

### REFERENCES

- Cobb, P. (1999). Individual and collective mathematical development: The case of statistical data analysis. *Mathematical thinking and learning*, 1, 5-44.
- Cobb, P., Stephan, M., McClain, K., & Gravemeijer, K. (2002). Participating in classroom mathematical practices. *Journal of the learning sciences*, 10, 113-164.
- Cobb, P., Yackel, E., & McClain, K. (2000). *Symbolizing and Communicating Mathematics Classrooms: Perspectives on Discourse, Tools, and Instructional Design*. Mahwah, NJ: Lawrence Erlbaum Associates.
- Cobb, P. & Yackel, E. (1996). Constructivist, emergent, and sociocultural perspectives in the context of developmental research. *Educational psychologist*, 31, 175-190.
- Cobb, P., Wood, T., & Yackel, E. (1992). Learning and interaction in classroom situations. *Educational studies in mathematics*, 23, 99-122.
- Durkheim, E. (1915). *The Elementary Forms of the Religious Life*. New York: Free Press.
- Gravemeijer, K., Lehrer, R., van Oers, B., & Verschaffel, L. (2002). *Symbolizing, Modeling, and Tool Use in Mathematics Education*. Dordrecht, Netherlands: Kluwer.
- Gravemeijer, K. & Stephan, M. (2002). Emergent models as an instructional design heuristic. In K. Gravemeijer, R. Lehrer, B. van Oers, & L. Verschaffel (Eds.), *Symbolizing, Modeling, and Tool Use in Mathematics Education* (pp. 145-170). Dordrecht, Netherlands: Kluwer.
- Kaput, J. (1991). Notations and representations as mediators of constructive processes. In E. von Glasersfeld (Ed.), *Constructivism in Mathematics Education* (pp. 53-74). Dordrecht, Netherlands: Kluwer.
- Kozulin, A. (1998). *Psychological Tools*. Cambridge, MA: Harvard University Press.
- Rivera, F. (forthcoming). An anthropological account of the emergence of mathematical proof and related processes in technology-based environments. To appear in W. Masalski (Ed.), *Technology-Supported Mathematics Learning Environments: 2005 NCTM Yearbook*.
- Thompson, P. (1992). Notations, principles, and constraints: Contributions to the effective use of concrete manipulatives in elementary mathematics. *Journal for research in mathematics education*, 23, 123-47.
- Vygotsky, L. (1978). *Mind in Society*. Cambridge, MA: Harvard University Press.

# INFINITY AS A MULTI-FACETED CONCEPT IN HISTORY AND IN THE MATHEMATICS CLASSROOM

Ferdinando Arzarello(\*), Maria G. Bartolini Bussi (\*\*), Ornella Robutti (\*)

(\*) Dipartimento di Matematica, Università di Torino

(\*\*) Dipartimento di Matematica, Università di Modena e Reggio Emilia

*This paper presents the conceptualisation of infinity as a multi-faceted concept, discussing two examples. The first is from history and illustrates the work of Euler, when using infinity in an algebraic context. The second sketches an activity in a school context, namely students who approach the definite integral with symbolic-graphic calculators. Analysing the similarities between the examples, the authors widen the embodied cognition approach to infinity, based on the so called Basic Metaphor of Infinity of Lakoff and Núñez. In fact, they consider also the manipulation of symbols, the use of virtual and real artefacts (in one case, the algebraic machine, in the other, the calculator) and their interpretation as instruments.*

## INFINITY

Infinity in the class is a very intriguing guest, which fascinates and challenges pupils and teachers. The existing research (see Boero *et al.*, 2003 for some references) underlines the complexity of its conceptualisation, pointing out its multi-faceted sides. For example, it reveals sensible to textual and contextual aspects (Monaghan, 2001), to classroom social interaction situations, to the cultural environment lived by pupils (Boero *et al.*, *ibid.*). Also from the epistemological side the infinite reveals intriguing features: many mathematical concepts have been generated speculating on infinite processes and with big jumps between the current ideas in the culture of the time and the new ones (see Jahnke, 2001). Examples of this kind are: the discovery of irrationals in the Greek culture, the creation of the points at infinity in geometry (from XVII c.), the birth and development of infinitesimal calculus (from XVII c.) and of set theory (XIX c.). Roughly speaking, both the cognitive and the epistemological analysis show a persisting conflict between two main approaches to infinity, namely the *potential* and the *actual* one. According to the former, infinite is as an ongoing process that never terminates (e.g. a sequence of decimal approximation of  $\pi$  or  $\sqrt{2}$ ). According to the latter, infinity is conceptualised as a given object (e.g., the number  $\pi$  or  $\sqrt{2}$  *per se*).

The history shows moments where the relationships between the two approaches live together in the ideas of the time and moments where the conflict is more apparent within mathematics or between (some parts of) mathematics and other disciplines (e.g. philosophy). We find an example of the first type in the origin of infinitesimal calculus by Leibniz and Newton (since 1670's), while examples of the second type are given by the critique of Bishop Berkeley to infinitesimal methods in 1734 (mainly

from the philosophical view) or by the rigour program by Weierstrass and his school in the 1870's (within mathematics).

### THEORETICAL FRAMEWORK

Some research has pointed out more or less specific cognitive mechanisms, like analogies and metaphors, which seem to support the relationships between the two approaches and help the transition from one to the other. For important examples, see the pioneer book by Polya (1954, especially Ch. 2), the work by Fischbein (1987, especially Ch. 12) and the recent book by Lakoff and Núñez (2000, Ch. 8).

Lakoff and Núñez have introduced the so-called Basic Metaphor of Infinity (BMI), which arises when one conceptualises actual infinity as the result of an iterative process (Lakoff & Núñez, 2000, p. 159). The two domains (source and target) of the metaphor are characterised by an ordinary iterative process with an indefinite number of iterations, each of which has an initial state and a resultant state. The crucial effect of the metaphor is to add to the target domain the completion of the process and its resultant state as a unique final state. This metaphor allows to conceptualise infinity in terms of the unique and final result of a process (Lakoff and Núñez, 2000, p.160):

Via the BMI, infinity is converted from an open-ended process to a specific, unique entity.

Lakoff and Núñez point out some important general features in the conceptualisation of the infinity. But their analysis should be refined further, for example adding: “the very idiosyncratic nature of students’ individual conceptions” (Sinclair & Schiralli, 2003); the interactions between students and artefacts in a mathematical activity and the cultural environment in which the activity takes place (Rabardel, 1995); the subject’s activity, which may be “*learning, doing or using mathematics*” (Sinclair & Schiralli, 2003). Moreover, not only conceptualisation changes, but also the very nature of the mathematical concept of infinity varies substantially with respect to the context. The infinity of integers, that of the continuum, the infinite limit of a real function, the point at infinity in projective geometry have been generated by very different processes, whose nature can be lost, if one considers only the BMI. Infinity possibly is not a single concept, but a network of concepts: the word itself collects a lot of meanings, each with a different story, and the use of the singular word has a risk, namely to hide its pluralities of meanings.

Our aim is to present infinity as a multi-faceted concept, describing two examples: one from history, namely Euler’s work about infinity, the other from a teaching experiment at school, aimed at constructing the concept of definite integral, through approximate area measurements. In the end a comparison between the two examples is sketched, discussing the possible integration of the embodied approach within other theoretical elements, namely the analysis of symbols and artefacts: in fact, both can usefully support the conceptualisation of infinity.



## AN EXAMPLE FROM THE HISTORY

This example comes from Euler fascinating book, *Introductio in Analysin Infinitorum* (Euler, 1748), whose title (*Introduction to Analysis of Infinities*) underlines that there are many infinities; in fact, Euler analyses three possible situation in which infinite occurs: infinite series, infinite products and continued fractions. The algebraic context where Euler develops his computations features infinite numbers in a very specific way. Their ultimate meaning is acquired through two levels of performing abstract calculation:

(i) Letters for variables (“which can take any value”, *ibid.*, #2) are introduced at the level of the mathematical language to represent all possible numbers, infinite ones included; they can be manipulated according to the usual machinery of algebra. Through letters the basic concept of function is introduced, as “an analytic expression composed in any way whatsoever of the variable quantity and numbers or constant quantities” (*ibid.*, #5): namely a function is given through its form, which can vary through suitable transformations (Ch. II).

(ii) The very concept of infinity is introduced at the meta-level to manipulate the forms of the functions through the algebraic laws; so one can add or multiply infinite terms. For example (#156), one can add the infinitely small quantity  $x/j$  ( $x$  finite,  $j$  infinite)  $j/2$  times and get the finite term  $x/2$ . Or one can express the rational function  $a/(\alpha+\beta z)$  as the infinite series that results “by a continuing division procedure” (*ibid.*, #60), which gives the value of the function. “Even the nature of transcendental functions seems to be better understood when it is expressed in this form [an infinite series of powers], even though it is an infinite expression” (*ibid.*, #59).

It is the interplay between the two levels (i) and (ii) which allows Euler to develop his analysis of infinity, as a study of the different forms of functions. For example, in Chapter VII to express Exponentials and Logarithms through series he writes:

114. Since  $a^0 = 1, \dots$  it follows that if the exponent is infinitely small and positive, then the power also exceeds 1 by an infinitely small number. Let  $\omega$  be an infinitely small number, or a fraction so small that, although not equal to zero, still  $a^\omega = 1 + \psi$ , where  $\psi$  is also an infinitely small number. From the preceding chapter we know that that unless  $\psi$  were infinitely small, then neither  $\omega$  would be infinitely small. It follows that  $\psi = \omega$ , or  $\psi > \omega$ , or  $\psi < \omega$ . ...so let  $\psi = k\omega$ . Then we have  $a^\omega = 1 + k\omega$ , and ...we have  $\omega = \log(1+k\omega)$ .

115. ...we have  $a^{j\omega} = (1+k\omega)^j$ , whatever value we assign to  $j$ . It follows that  $a^{j\omega} = 1 + j/1 k\omega + j(j-1)/1 \cdot 2 k^2 \omega^2 + j(j-1)(j-2)/1 \cdot 2 \cdot 3 k^3 \omega^3 + \dots$  If now we let  $j = z/\omega$ , where  $z$  denote any finite number, since  $\omega$  is infinitely small, then  $j$  is infinitely large....When we substitute  $z/j$  for then  $a^z = 1 + 1/1 kz + 1(j-1)/1 \cdot 2j k^2 z^2 + 1(j-1)(j-2)/1 \cdot 2j \cdot 3j k^3 z^3 + \dots$

This equation is true provided an infinitely large number is substituted for  $j$ , but then  $k$  is a finite number depending on  $a$ , as we have just seen.

And later to sum infinite series he writes in Chapter X:

165. If  $1 + Az + Bz^2 + Cz^3 + Dz^4 + \dots = (1+\alpha z)(1+\beta z)(1+\gamma z)(1+\delta z)\dots$ , then these factors, whether they be finite or infinite in number, must produce the expression, when they are actually multiplied. It follows that the coefficient A is equal to the sum  $\alpha + \beta + \gamma + \delta + \varepsilon + \dots$ . The coefficient B is equal to the sum of the products taken two at a time. Hence  $B = \alpha\beta + \alpha\gamma + \alpha\delta + \beta\gamma + \beta\delta + \gamma\delta + \dots$ . All of this is clear from ordinary algebra.

As it is well known, Euler uses this type of arguments to prove that:  $\pi^2/6 = 1 + 1/4 + 1/9 + 1/16 + \dots$  (*ibid.*, #167). The excerpts clearly show that the possibility of managing the new entities within a suitable symbolic register allows Euler to acquire new mathematical results in the field of transcendental functions and new operative insights in the concept of infinity. The symbolic register is the machinery of algebra, used to make infinite sums and products (the infinite is at the meta-level previously described). Euler is particularly attentive to make only finite local computations: it is at the level of a global insight that he uses infinite to make general considerations, which allow him to introduce the new result within the old frame.

This analysis goes a step beyond the usual comments (Polya, 1954; Steiner, 1975; Fischbein, 1987), which underline the analogy that Euler puts forward between the finite and the infinite, extending an algebraic rule “from equations of finite degrees to an equation of an infinite degree” (Fischbein, p. 132). However, the extension of the law is built up controlling its meaningfulness with respect to the algebraic manipulations of the formulas, and not because of abstract ‘transfer’ principles. Lakoff & Núñez (2000) underline that “Infinite Sums Are Limits of Infinite Sequences of Partial Sums” (p. 197). This aspect of approximation is present in Euler more times, but he is seeking for understanding the infinite by the algebraic exactness (Euler, Preface):

Although Analysis does not require an exhaustive knowledge of algebra, even of all the algebraic techniques so far discovered, still there are topics whose consideration prepares a student for deeper understanding” and can allow people avoiding the “strange ideas [that they entertain] about the concept of infinity.

### AN EXAMPLE FROM THE CLASSROOM

We describe now an example from the classroom, aimed at showing the conceptualisation of definite integral; it has been carried out through various activities based on approximate measures of areas under curves in the Cartesian plane, using before paper and pencil, then a technological artefact, namely the calculator TI89 (Robutti, 2003). The students, at the 12<sup>th</sup> grade of a scientific-oriented Italian school, are used to work in small groups, then to share the results in a class discussion led by the teacher.

In the example described here, the students are working to evaluate the area under the graph of a given function. The task consists in the determination of the work made by a perfect gas during an isothermal transformation, represented by a hyperbola on the Cartesian plane (p,V) [1]. From the discussion about different procedures (obtained

by the students in the groups) to determine the work (the area under the hyperbola), the need of an algorithmic formula arose. A formula has an advantage respect to other non-algorithmic methods: it can be implemented in a program on the calculator. The teacher guides the various students' interventions to converge on the method of rectangles under and over the function to approximate the area. After that, the students use the program (Figure 1) based on this calculation, in a group activity, to evaluate the area under the graph with different numbers of rectangles [2].

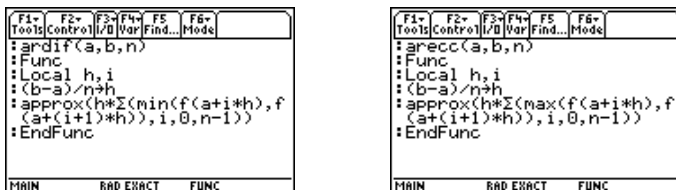


Figure 1

The discussion following this activity was aimed to reflect on the degree of approximation with respect to the number of rectangles.

Teacher: "Which was the best we said?"

Andrea: "The last!"

Teacher: "Why?"

Andrea: "Because it has more intervals and then ..."

Stella: "Because it gets nearer to the area"

Teacher: "But why is it so precise, if there are more intervals?"

Andrea: "Because ... with more intervals ... it is possible to give a better approximation of the curve with a line going to a more ... microscopic, and then ... nearer"

The last phrase is interesting, because it reveals a passage from the global to the local properties of functions, as if Andrea could notice the local properties of a graph, after having observed the global ones, thanks to the sub-division of the interval on the  $x$ -axis. The student has the intuition that the more the intervals, the better is the approximation of a curve with segments, which are closer to the curve. This intuition marks a first step in the conceptualisation of definite integral. The word "microscopic" reminds to the local approximation of curves with lines, that is the theoretical base of Calculus. The discussion continues with the next excerpts:

Teacher: "The last is more precise: what does it mean saying more precise?"

Andrea: "That it gets nearer to the average value"

Students: "That it gets nearer to the real value". "That it gets closer to the real value"

The students come to a second step in the conceptualisation process: the idea that the last result of the program, which approximates the area, is more precise than all the

previous results, because “it gets nearer to the real value”. This step is characterised by the consciousness that there exists a “real value” for the area, even if they do not have it, at the moment, because they have seen a succession of values approximating the area, but not ‘the end of the story’.

In the collective discussion after the group activity, the students are guided by the teacher toward connecting the approximate evaluation of the area with a theoretical content, which was developed in the previous year (the concept of real number as a pair of contiguous classes).

Teacher: “What do we remember thinking back to this situation?”

Stella: “The square root of 2”

Teacher: “The square root of 2. That is, when did we construct what?”

Francesco: “The contiguous classes”

In the process of evaluating the area of the rectangles, the students recognise the construction of a real number, namely  $\sqrt{2}$ , and this is the third step in the conceptualisation. But it is not sufficient, because, if they understand the analogy between the approximate measure of the area and a real number, they are unable to bridge the gap between the approximation process of evaluation and the exact value of the area, namely between finite and infinite.

The students need to extend the possibilities of the real calculator in order to reach infinity, because at a certain moment Francesco says, substituting  $n$  with the symbol  $\infty$  in the program of rectangles on the real calculator:

Francesco: “I put infinite instead of a number  $n$ , and the calculator answers *undef*” [3]).

And when the response of the calculator is *undef*, because it is unable to produce this number, Francesco shares his surprise with his mates.

In order to help students to pass to infinity, the teacher introduces an ideal calculator:

Teacher: “Now I am in an ideal calculator, which doesn’t exist of course, and I imagine doing the calculation”

Francesco: “At the end we will have a root”

Teacher: “A root?”

Francesco: “No, a number ... What is the name of those numbers?”

Teacher: “Real”

Through the ideal calculator, conceived as an instrument (Rabardel, 1995) that does the same calculation as those done by the real calculator, but without limitations, neither in quantities, nor in the number of operations, it is possible to bridge the gap between finite and infinite. This is the fourth step in the conceptualisation: to recognise the analogy between the exact measure of the area and the concept of real number.

## DISCUSSION

The conceptualisation process described above reveals the Basic Metaphor of Infinity, in the particular case: Infinite Sums Are Limits of Infinite Sequences of Partial Sums (Lakoff & Núñez, 2000; p. 197). But the BMI is not sufficient. We have shown that in both Euler's and students other ingredients are essential to understand the process. The core of Euler's process is the use of infinite sums and products, in which the coefficients must be equal, in that they represent different forms of the same function. More specifically, Euler did not use an identity principle in infinite formulas, but the necessity that the calculations produce the same results, showing in that a semiotic need, more than a structural one. And in doing this, he found his famous outcome about the powers of  $\pi$  as infinite sums of the inverses of powers of naturals (Euler, 1748, #168). The students, in the process of approximation, can use different values in the number of rectangles. In this way, they use the letter  $n$  in the program as a symbol for a variable (see in Figure 1, where *arecc* and *ardif* are programs depending on the endpoints of the interval,  $a$  and  $b$ , and on the number  $n$  of subdivision of the interval). They use different numbers, bigger and bigger, to reach a better approximation for the area, till Francesco tries to substitute  $\infty$ . And his attempt to insert  $\infty$  in the calculation process corresponds to a need of algebraic exactness, as in Euler's process. The second element is the *ideal calculator*, which leads the students towards the measure of the area, thought of as a real number. The students already know  $\sqrt{2}$  as a real number, and they are constructing a calculation process with the areas of rectangles, to approximate the area under a graph. The link between the two objects (the exact area and the real number), which represent the same concept, is 'embodied' by the ideal calculator, introduced by the teacher. A kind of ideal calculator exists also in Euler's process, when he uses infinite algebraic computations as if they were finite. Euler's ideal calculator is constituted by the algebraic computations extended to infinity, together with the use of infinity at the meta-level, as pointed out by him several times. Both the protagonists of the two examples (Euler and the classroom) had at disposal artefacts: in the former case, it was the set of algorithms of algebraic computation; in the latter it was the TI89. During the process the artefacts went through the process of instrumentation (Rabardel 1995) that transformed them into instruments. The role of the artefacts is essential: they work at the meta-level, and help the subjects to "manipulate" or "conceive" infinity as well. The cases we have presented in this paper have been chosen in a list of examples that concern the parallel analysis of historical processes and of didactical processes concerning infinity. The artefacts that lead the manipulation and the conception of infinity may be different when different meanings of infinity are into play. Hence a local analysis is needed that adds the needed elements to the Basic Metaphor of Infinity (for examples see the case of perspectograph in Bartolini *et al.*, in press; the case of abacus in Bartolini & Boni, 2003).

## Endnotes

[+] Research funded by the MIUR and the Università di Torino and the Università di Modena e Reggio Emilia (COFIN03 n. 2003011072).

[1]  $p$  and  $V$  mean pressure and volume of a gas respectively.

[2] *ardif* indicates the area of the rectangles under the graph (defect approximation), while *arecc* refers to the rectangles over the graph (excess approximation).

[3] The response *undef* means *undefined*, in the sense that the calculator has no possibility to produce an answer.

## References

- Bartolini Bussi M. G. & Boni M. (2003). Instruments for semiotic mediation in primary school classrooms, *For the Learning of Mathematics*, 23 (2), 12-19.
- Bartolini Bussi M. G., Mariotti M. A. & Ferri F. (to appear). Semiotic mediation in primary school: Durer's glass in Hoffmann H., Lenhard J. & Seeger F. (eds.) *Activity and Sign – Grounding Mathematics Education*, Kluwer Academic Publishers.
- Boero, P., Douek, N. & Garuti, R. (2003). Children's Conceptions Of Infinity Of Numbers In A Fifth Grade Classroom Discussion Context, *Proceedings of the 27<sup>th</sup> PME Conference*, Honolulu, Hawaii, vol. 2, 121-128.
- Euler, L. (1748). *Introductio in Analysin Infinitorum*, Lausanne. (English translation by J.D. Blanton: *Introduction to Analysis of the Infinite*, Springer, Berlin, 1988).
- Fischbein, E. (1987). *Intuition in Science and Mathematics*, Reidel, Dordrecht.
- Jahnke, H. N. (2001). 'Cantor's cardinal and ordinal infinity', *Educational Studies in Mathematics*, 48 (2-3) 175-197.
- Lakoff, G. & Núñez, R. (2000). *Where Mathematics comes from*, Basic Books, New York.
- Monaghan, J. (2001). Young people's ideas of infinity, *Educational Studies in Mathematics*, 48 (2-3) 239-257.
- Polya, G. (1954). *Induction and analogy in mathematics*, Princeton University Press, Princeton, NJ.
- Rabardel, P. (1995). *Les hommes & les technologies. Approche cognitive des instruments contemporains*. Arman Colin Éditeur, Paris.
- Robutti, O. (2003). Real and virtual calculator: from measurement to definite integral. *CERME 3*, [http://www.dm.unipi.it/~didattica/CERME3/draft/proceedings\\_draft/](http://www.dm.unipi.it/~didattica/CERME3/draft/proceedings_draft/).
- Sinclair, N. & Schiralli, M. (2003). A constructive response to 'Where mathematics comes from', *Educational Studies in Mathematics*, 52(1), 79-91.
- Steiner, M. (1975). *Mathematical Knowledge*, Cornell University Press, London.

# SUCCESSFUL UNDERGRADUATE MATHEMATICANS: A STUDY OF STUDENTS IN TWO UNIVERSITIES

Margaret Brown & Melissa Rodd

King's College, London & University of Leeds

*As part of an ESRC-funded longitudinal study, 'Student Experiences of University Mathematics' [1], we followed a cohort of undergraduate mathematics students at two traditional universities with high ratings for research and teaching. This report centres on interpretations of successful students' engagement with their course as gleaned from in-depth interviews, statistical data and questionnaires. We report that these first class' students participate in their undergraduate mathematics community in many different ways and their views about mathematics are diverse. Nevertheless, these students have, in Aristotle's terms, 'flourished' and we point to factors which we hypothesise contributed to 'first class' students' success.*

## INTRODUCTION

Success at university is multi-faceted. Making friends and having taken extra-curricular opportunities are important, whatever a student's academic profile. Nevertheless, while it is difficult to gauge the success of friendships, the degree classification at the end of the course serves as a standard measure of academic success. In this paper we consider students who have achieved a first class degree at the end of three years of undergraduate study. Data for this paper come from the 'Students' Experiences of Undergraduate Mathematics' (SEUM) project. In this three year, Economic and Social Research Council (ESRC) funded project we focused on one cohort of single honours, undergraduate mathematics students from two, traditional, city based English universities, 'Waverley' and 'Marmion'. We have collected a variety of data: in-depth interviews, questionnaires, statistics, observations of lectures and tutorials.

## Statistics

Distributions of degree classifications was as shown in this table:

University	1	2.1	2.2	3	ord.	y/a	fail	total
Waverley	29	38	30	13	4	9	3	126
Marmion	14	9	8	3	-	-	3	37
Total	43	47	38	26	4	9	6	163

Table 1: numbers in each degree class ('y/a' stands for 'year abroad')

As this table shows, a significant proportion (26%) of the students who saw the course through to the third year did gain a first class degree (or its equivalent, for those continuing to a fourth year and M.Math, or equivalent, degree). We have

substantial interview data from 25 of the 43 students with firsts and will draw on representatives of these in this paper. Furthermore, we have data on these students' background from 35 out of the 43, primarily from our questionnaires. From these data we found that 29 out of the 35 had at least one parent who was a graduate. The issue of cultural capital, after their first year, was discussed in (Macrae & Maguire, 2002).

In this paper, firstly, we introduce a set of 'telling cases' who illustrate some extent of the variety in successful experience. Then we aim to explain why these five succeeded by positioning them in terms of participation in the *Community of Practice* (Wenger, 1998) of undergraduate mathematics students at their university. As this theory of social learning of Wenger's did not seem to be sufficiently explanatory, a more general and more ancient notion of human flourishing (Aristotle, *Nichomachean Ethics*) is then mooted as a common feature of these students' experience.

### **Charlie (graduated 2003)**

“it was everything I expected and some more”

Charlie chose to do mathematics at university because it was something he was confident that he could do well in, it was a degree “that showed I could think and learn and had a logical mind and would be employable” and indeed, as he says in his final year, it was “a means to an end”; Charlie has secured himself a good job in a prestigious company in the City of London. His life has been “going well on so many fronts” and he can see himself working in London for “five or ten years... get what I want from London and then move out”.

Charlie does seem to know what he wants and can self-regulate successfully in order to achieve his goals. He is both short-sighted and diabetic, so he has tended to sit in the front of lectures and to drink little alcohol. He was determined not to be “undersold”, and has managed to “distinguish [himself] from the rest of the crowd”. Charlie knows what is important in terms of relationships, is not shy about asking lecturers about maths problems, has participated enthusiastically in the basketball team and will have “very, very good memories” of Waverley which he assesses to have been “very, very good for me”. He disdains students that “let themselves” get behind, his advice being “catch up and shut up or stop going to the lectures”. He says that mathematics was a degree choice rather than a “particular passion”. He does not feel that his view of maths has changed over the three years: “it is a very kind of straight square subject by the nature of it” and it “still has room to evolve”.

Charlie is a socially-focused person. In the first year he speaks about “really, really enjoying ... working together, discussing things, getting going with ideas”. He reckons, speaking of Oliver, neither of them would have done better than “a medium 2.1 without each other”. In the third year he says “I think working on your own is just loveless and a lonely kind of task so you've obviously gotta have some course mates,..., you've gotta have the right ones”. Charlie has picked the right ones, picked the right girlfriend, picked the right job; he has had social and academic success.



### **Oliver (graduated 2003)**

“I’ve enjoyed the course as much as I’ve, I’ve got out as much as I’ve put in basically. The more I’ve worked on things the more I’ve enjoyed it, that’s the bottom line, but all the maths is really, really interesting.”

Oliver is one of the big personalities on the maths course at Waverley. He started his undergraduate career at the age of 22 having redone maths A level at night school. He always sits at the front of a lecture and is unhesitant in engaging the lecturer in mathematical discussion during a lecture or around the maths department. He has joined many clubs, for example, juggling, basketball, climbing, yoga and meditation society. He comes from a graduate family where his father and step-mother are teachers and, despite having eschewed teaching at the beginning of his course, he has now enrolled to do a secondary mathematics PGCE as he’s “got into all this meditation and yoga and stuff and become like less career orientated” and “I really enjoy explaining stuff to people and I actually think I’m quite good at it”.

Oliver does see himself as a mathematician “a bit” because he’s going to be teaching maths and he’s “really sort of passionate about the subject”. He considers that he’s “got quite a bit in common with the lecturers in that way. I know I’m older, I don’t see them as like separate things, d’you know what I mean, I just see them as part of the Maths Department.” Indeed he is on first name terms with the younger lecturers and is often to be seen arguing a mathematical point or pursuing a deeper explanation with lecturers, “looking at why they’re doing things and thinking about it rather than just trying to pass the exam.” Oliver does not consider that his view of mathematics has changed fundamentally: “I know, I do understand though there’s something kind of certain about maths, but when you come to apply it really, it’s not, it’s not certain at all, it’s just continuing taking a situation and adjusting it. And even Pure Maths is kind of a bit like that really. Em, it’s just that once you’ve done something it’s kind of fixed.” (On statistics, he “just found it all so boring that [he] didn’t do any of it”). Mathematics is considered a creative subject and Oliver considers the teaching “very good”, “even the not very good ones [lecturers] still have the enthusiasm.”

Oliver has been sharing a house with Charlie for the past two years and they chose the same modules as they can help each other effectively “there’s one module that he’s gonna teach me, and I’m gonna teach him the other three when we revise”. Oliver is “kind of regrettin’ a little bit that I’m not doing a Masters now though. I’m not blaming Charlie, but ... he’s got carried away with [the investment banking idea] and I’ve gone off it completely.” Oliver has had a rich experience overall. Although he is consistently “passionate” about mathematics, he has had his ups and downs socially, and indeed in terms of results (1% in one statistics exam!). He reckons that a Maths degree has taught him “about organisation and stuff” as well as maths, but he’s “learned more from the whole university experience really”. He has changed from a rather ambitious career-orientated youth to someone who is “continually trying to become a better person, which is really important to me.” He attributes this to his yoga and meditation practice, rather than maths, which has changed him “off the

scale”.

### **Chloe (on four year course)**

“I love being a student...I like, I just like this life. There’s no real pressure and it’s just so nice.”

Chloe comes from a small supportive family, she still refers often to her mother, to whom she has continued to be close, and took her father’s advice in staying on for the four year course as “most people have degrees these days”. However, she also says “I don’t want to leave” and “wouldn’t like it” if this, her third year, was her last. Her father has introduced her to some part-time jobs, and she seems to have managed her finances comfortably with the help of some “maturing investments”.

Chloe was one of a small group of students (most of whom seem to be heading for first class degrees) who have gone each year to the departmental weekend at a nearby residential centre for a few days of extra-curricula mathematics lectures. “I’ve been every year. I love it.” She is also involved a departmental scheme “to integrate the first years”. So I go to that party every year, which is good, cos you make a few friends through that”. In the first year she felt she’d “opened up” when she came to university, despite having a self-conception as “shy”. Her grades from school were excellent, and she found “the first year was quite easy... because everything that we covered in Further Maths [advanced high school maths] they went through here really quickly” adding “I was relieved that I knew what they were talking about.”

While Chloe likes to socialise, and did sometimes work in a group of high attaining students in college in her first year, in her third year she says that she is “quite independent”, and she does not generally ask lecturers if she has a problem, because she’d rather “try and work things out for herself”. She also remarked that some lecturers are “quite rude” when you “don’t know what they’re talking about” as they are “just here for research”. It has “never occurred to her to think beyond what is being offered”, but her interests are clearly towards theoretical physics which she speaks about spontaneously and enthusiastically. In the first year she tells the interviewer that her Cambridge-educated engineer father had said to make sure to go to tutorials and “not to worry about those lectures” as “he hardly went to any of the lectures”, in her final year she said, with pride, that she was attending all her lectures.

And she sees herself as a mathematician, despite her reports of being demotivated at various junctures over the three years. A mathematician is some one who has a “special quality” in their “way of thinking” and for whom mathematics is “more a part of them”. As a mathematician “you think outside what you might think is practically possible. An engineer’d just dismiss things if he didn’t think they were practical, but a mathematician can think outside that”. As an undergraduate, Chloe has become an insider, she has accepted the constraints of her environment without perceiving them as restrictions; she is hard-working, socially well-integrated and compliant.

### **Robert (graduated 2003)**

“I’m just passive and as you say just regurgitating everything I’ve been taught”

Interviewed after the first semester of his course, Robert was quite disheartened. He only decided to stay on because his mother pointed out that he didn’t have anything else to do. When asked him where he sat on various spectrums all his answers were “towards the middle”. He is “possibly” doing an MSc, also at Waverley “I’ve got to apply and see whether there’s a place”, having missed the deadline to get on the 4 year undergraduate course. His reasoning is that the MSc will “help me to get a job” which is the same reason he gave in the first year for doing a maths degree. Robert says he’s a “regurgitator”. When asked what he’s got out of a maths degree, he first says that he’s “forgotten a lot of the maths”. However, after floundering a little considers that “time management” has been a new skill for him because

I was useless when I first came to university cos obviously in school the teachers manage everything for you, and I don’t know, er, you know, that’s just the main thing, time management and learning to accept that you’ve got to sit down and do the work and that sort of thing.

Something that has developed since his first year is his notions of memorisation and understanding, he now values the latter, perhaps because he sees it as a means to improved grades: “I’m making sure I understand everything, and, as well as memorising them, and my grades have improved, so, that’s, I don’t know.” When asked about his change in attitude to maths, he interprets this as a question about how much work he now does, rather than a question about his philosophical take on mathematics. However, he does indicate a preference for applied mathematics as it involves “real problems”. In fact, Robert would have rather done a physics degree. He gives a glimpse of his tacit view of maths when he explains “that’s just what maths is, it’s the workings of things, it’s never going to be that interesting to trawl through the last little detail”.

What seemed to keep him going was the fact that he felt a first class degree was within his reach. This was a considerable motivation to Robert, who seems to correlate enjoyment with success very closely. When asked to talk about the modules he’s taken, his response is couched in terms of difficulty and the results he got. His social life revolves around going to the pub with people he shares a house with, and though he says he plays five-a-side football with some maths students, he also reports that he doesn’t “really speak to anyone else in my year”.

### **Florence (graduated 2003)**

“I certainly think that my degree or the majority of the content of my degree will never be useful for anything, and it will just get sort of forgotten within six months of finishing and then never asked for again, which is fine”

Florence, from a graduate family, started her university career by working on her maths each evening and spending each weekend with a boyfriend in a city 50 miles from her university. She felt maths was “the only part of university that’s remained

fairly constant". Mathematics is satisfying to Florence: "real Analysis 2 in the last semester was just a fantastic course because it pulled together Maths". She reports that "95%" of the work she does on her own. Although in the first year Florence complained about lectures being boring, she has no complaints about the teaching in the third year, even though there are lecturers she "dreads" as they try and get participation in tutorials. She sees herself as someone with a maths degree, rather than as a mathematician. She would like a job that is '9 to 5'.

Florence invested early in study before she integrated socially into the city-university life, she speaks to other people when something is hard but has no interest in speaking in tutorial. Her principal orientations are through her boyfriends and she seems to have little emotional contact with her parents. She has good control over the maths and to keep that advantage, she shares a house with three successful male maths students, two of whom she's been out with. Her plan after graduation is to move to the town where her current boyfriend will be living, there to be "reconciled to either doing accounts, chartered accountancy training or something like that".

### MATHEMATICS UNDERGRADUATES' COMMUNITIES OF PRACTICE

Wenger's 'social theory of learning and becoming' is an explanation of how learning involves both *practice* and *identity* (1998:14). That is, knowledge develops for an individual as they engage with the world in a particular fashion: they participate in a *practice*. As they participate, they become part of the community of practice, taking as real (reifying) the tokens of that group and this beginning to belong helps fashion their *identity*, (ibid.:151). The experiences of attending mathematics lectures and sitting exams, giving pet names for modules or courses and being familiar with staff, contribute to a way of being and constitute participation in the community of mathematics undergraduates. In this community, objects of mathematics as well as the mathematics department's curriculum, exams and assessment procedures are reified.

Participation, is experienced in quite different ways by even this 'first class' group of students and, as Wenger's theory of learning explains, this different participation contributes to their identity: **Robert and Florence** both appear to be on the periphery of the undergraduate mathematics community. Robert has participated by focussing on definite goals and taking a narrow, manageable, view of mathematics as dealing with details. Florence has participated by producing good results and having some social engagement with other students, particularly males, who might be useful for help. Florence communicates a deep satisfaction with mathematics; it is a refuge for her. It seems that Robert needs the structures of mathematics (or physics) to hold him to a viable path: the requirements of being a mathematics student are understood and he has found that he can regulate himself to achieve the well-understood goal of exam-passing. Florence is the opposite – where maths for Robert gives him external structure in the form of exams, for Florence, maths is an internal regulator. For Florence the structures of maths and her capacity to work with them give her an inner security and satisfaction despite her attachment to relationships which do not seem to

enhance her ‘flourishing’.

**Chloe and Oliver** are both central within their respective undergraduate mathematics community. While Oliver participates by standing out in his behaviours and appearance and uninhibitedly talking mathematics whenever he has an opportunity, Chloe has participated by gaining respect from her efforts in her work and contributing to the social environment of the department. The nature of their respective participation is highly gendered, for what is more, Chloe has the role of a ‘big sister’ to newer students while Oliver associates with the almost entirely male lecturers and will dominate any lecture when he has a point he wants to make or idea he wants to pursue. Chloe does not tend to expose her lack of understanding to lecturers, but Oliver has moved to participation *as a mathematician* where playful delight in all mathematical problems, including those which might be considered elementary, is an aspect of participation in the community of *mathematicians*.

Charlie has participated in order to maximise his advantage in his future, rather than to learn mathematics for its own end or to pass exams. He seems to be able to understand the requirements of the community, and to seek the status of a first class degree, without handing over his heart, as Oliver has done. While Charlie has gained pleasure from doing mathematics, the chances are that he’d have also found the satisfying side to studying economics or chemistry.

## **FLOURISHING**

While Wenger’s theory gives us a way of interpreting the relationship between practice and identity, it does not give us insight into what facilitates these successful undergraduates getting ‘on track’. A theory that fits the observation that these students have ‘done-well-for-them’ is that of Aristotelian ‘human flourishing’ – an aspect of ‘virtuous character’ (Sherman, 1989). This flourishing is not to be understood just in conventional terms, which is exemplified in Chloe’s story: showing round first years, loving the life, being enthusiastic about a particular branch of mathematics and being justifiably critical about a few aspects of provision. Even Robert, whose story was presented as a foil to the enthusiasts, has developed: he has made friends that he lives with, is able to focus on his work well enough to achieve satisfying results and to please his parents, and he has learnt to value understanding in his learning.

The Aristotelian concept of ‘human flourishing’ (*eudaimonia*, Aristotle, *Nicomachean Ethics* from Sherman, *op. cit.*:77-8), seems to pertain to the process of becoming within a social setting, which is also Wenger’s interest. From the extensive data we find that the students gaining a first all did communicate spontaneously some aspect of pleasure to do with doing maths, which contributed to their well-being and their sense of well-being. Another common feature was that they all communicated that they valued understanding, even though their notions of understanding varied from being able to answer exam questions to an engagement with ideas irrespective of the exams. From what we have found out about the students, these first class

students all engaged with their studies, for most of the time at least. Such virtuous activity is integral to flourishing, despite their patterns of engagement being very different and their motivations varying hugely. These commonalities contrast with their views of the subject which were wide ranging: from mathematics as a meaningless game which is fun to do, maths as a source of the processes of following through tedious details, maths as a practical subject/ a beautiful subject, or even, considered on a meta-level, as a high status subject that is character and mind-developing.

This sense of satisfaction, happiness, or ‘human flourishing’ can be contrasted with the frustration, anger and despair of some other students who have not done so well. We have less data from failing students since they have not been as willing to be interviewed, they often miss appointments or avoid the interviewer.

## CONCLUSION

The major differences between very successful and failing students, reported in Macrae, Brown, Bartholomew and Rodd (2003), seemed to be greater focus and self-discipline, perseverance and determination, including the determination to sort out a solution when things started to go wrong, and less inclination to self-delusion. Several of these factors can be classified in Entwistle’s terms of managing effort, having a deep or surface approach to learning organising or monitoring their studying (Entwistle, 2003:2). Finally, it has to be said that, the successful students all had social backgrounds which considered a university education normal or prestigious, so the challenge to achieve inclusivity remains.

## NOTES

1. The project’s ESRC reference number is R000238564. Dr Sheila Macrae, King’s College, London, was the principal research officer and Dr Hannah Bartholomew, Auckland University, also contributed to the project. We are most grateful to the staff in the mathematics departments for their support and interest.

## References:

- Entwistle, N. (2003) ‘Concepts and conceptual frameworks underpinning the ELT project’ *Enhancing Teaching-Learning Environments in Undergraduate Courses Project* Edinburgh: School of Education University of Edinburgh.
- Macrae, S. & Maguire, M. (2002) ‘Getting in and choosing the best’ in A. Hayton & A. Paczuska (eds.) *Access, Participation and Higher Education: policy and practice* London: Kogan Page, 24-37.
- Macrae, S., Brown, M., Bartholomew, H. & Rodd, M. (2003) ‘An examination of one group of failing single honours students in one university’ *MSOR Connections*, Vol. 3 no. 3, 17-21.
- Sherman, N. (1989) *The Fabric of Character: Aristotle’s theory of virtue* Oxford: Oxford University Press.
- Wenger, E. (1998) *Communities of Practice* Cambridge: Cambridge University Press.

# BILINGUAL LESSONS AND MATHEMATICAL WORLD VIEWS – A GERMAN PERSPECTIVE

Katrin Rolka

University of Duisburg

*With the globalization of human activities, profound foreign language skills are of increasing importance. Bilingual lessons are a promising opportunity to enable pupils to acquire greater foreign language competence within the school context. In Germany, however, a foreign language is rarely used as a learning and working language in mathematics lessons. This paper presents the results of research on subjective convictions of teachers about mathematics as a bilingual subject which underline the central role of mathematical world views in this context.*

## MOTIVATION

Even though any discussion on mathematics lessons cannot really ignore the socio-cultural context of this school subject, this is even more the case for bilingual mathematics lessons. In the book “The Two Cultures” from Charles Percy Snow, published 1959, the core thesis is propagated that the intellectual world is split into two polar groups. At one pole, there are the literary intellectuals, at the other the scientists, and „between the two a gulf of mutual incomprehension, [...a] lack of understanding” (p. 4). This view is still today – more than forty years later – commonly expressed. Schwanitz (1999) patronizingly remarks in his recently published book “Bildung” (Humanistic Education) on the theme mathematical-scientific knowledge that one may confidently display it but that it is neither a part of humanistic education nor does it represent a part of our cultural heritage. This view sparked off an open, widely-recognized debate in Germany, which also motivated a book by Fischer (2001) called “Die andere Bildung” (The Other Education). The internationally acclaimed Germanist Enzensberger also stresses cultural deficits of mathematics, as expressed in the title of his lecture: “Drawbridge Up: Mathematics – A Cultural Anathema” (1999) on the occasion of the 50th International Congress of Mathematicians in Berlin in 1998. Furinghetti (1993) also points in a similar direction.

This polarization is increased by the common belief that people are either mathematical-scientifically or linguistically interested or talented. Such beliefs generally have a massive effect on the implementation of bilingual lessons, which is the concrete motivation for this paper. First, general features of bilingual lessons are presented, followed by particular aspects of bilingual mathematics lessons. A short excursion on my approach to world views is presented to enable the presentation and interpretation of the data of the interviewed teachers. Finally a concise conclusion is reached as to which degree mathematics and a foreign language can be combined in

mathematics lessons with the objective of changing world views as expressed, amongst others, by Snow.

## **BILINGUAL LESSONS**

### **International context**

In the last years bilingual teaching and learning programs have more or less established themselves in school education in many countries. Depending on the particularities of the various countries, there exist different forms of realization of bilingual teaching. If one takes a look at the Canadian context, for example, then the conditions in that country are quite different to those of most European countries in the sense that Canada is a bilingual country and that bilingual lessons mean lessons in the two official languages of this nation, denoted in the literature under the term “Immersion Programs” (Swain, 1998).

Besides official bilingual and multilingual conditions, we are as a matter of fact living in multicultural societies worldwide in which more than one language coexist. The desire for integration has led to a multitude of bilingual programs (Ellerton & Clarkson, 1996) – this will however not be dealt with in this paper.

Beyond this, there are in monolingual classrooms other approaches towards the implementation of a foreign language in mathematics lessons (Hofmannová, 2003; Moschkovich, 1996; 2002) – what will be discussed in this paper.

### **German context**

In the following I restrict my elaborations on this theme to Germany, which is officially monolingual but in reality features a number of multilingual characteristics. The discussion of bilingual lessons in Germany is last but not least conducted on the background of an ever faster changing Europe under the so-called “growing-together” of Europe and of a “Europe without borders”. Thus foreign language skills are evidently of increasing importance. In the Federal Republic of Germany bilingual lessons are viewed as a promising chance – not only in academic and professional circles, but also in the public in general – to more effectively increase foreign language learning within the school context.

### **Features of bilingual lessons**

In Germany there exist various didactic approaches to bilingual lessons featuring differing objectives. Without going into details about various objectives, the definition of bilingual lessons employed here is of the utilization of *two* learning and working languages in a non-language subject – in this instance mathematics. In this case one learning and working language is German – the native language of the majority of the pupils – and the other one a foreign language: in Germany overtly English or French. Even though in bilingual lessons the native language is occasionally referred to – for example for comprehension checks or to allow pupils to express affective or emotional moments – the increasing use of the foreign language



is a central objective of bilingual lessons to enable the pupils to acquire greater foreign language competence.

The terminology “Fremdsprache als Arbeitssprache” (foreign languages as working languages) – an expansion of the concept “Englisch als Arbeitssprache” (English as a working language) developed in Austria (Abuja, 1999) – entails a fitting metaphor. Through this approach of using a foreign language one stresses it as a tool – for example for conveying information. In contrast to conventional foreign language lessons the foreign language itself is insofar not the prime topic of lessons here but serves as a medium of communication for the various non-language subjects. Therefore, grammar plays a more minor role in this kind of bilingual lesson.

Eventually the goal is mediation of cultural knowledge and intercultural aspects of the countries and nations in which the foreign language in question is dominant.

### **Foreign languages in mathematics lessons**

Traditionally, in most Federal German States (“*Bundesländer*”) the subjects geography, history, political and social studies are taught in bilingual lessons. In the last years one can note a trend to implement bilingual didactics in mathematics lessons, which is only being executed reservedly on the school level. One must hereby concede, however, that the use of a foreign language is temporally quite limited and usually realized within the framework of small lesson modules or projects.

When realistically viewing the use of a foreign language in mathematics lessons one automatically faces the problem of finding teachers qualified to teach both mathematics *and* a foreign language. Here is where Germany is at an advantage in comparison to some other countries, as in this country you have to be qualified in two school subjects to be employed as a secondary school teacher, which means that the combination of mathematics with a foreign language is principally possible. Regretfully, this subject combination is quite rare in Germany.

This however leads in my opinion to a fundamental question: Even if there were enough teachers with a mathematics-foreign language subject combination – should according to the interviewed teachers these two subjects be extensively combined in mathematics lessons? The attitudes of the interviewed teachers on this will be presented in the following. Concerning opinions of pupils, I refer to Hofmannová, Novotná & Hadj-Mousová (2003) where pupils treat this theme of foreign language in mathematics lessons uninhibitedly and stress the practical use of a foreign language in this kind of lesson: „Instruction in a foreign language will definitely make me use the language in practice.“ (p. 72)

The reserved acceptance concerning the use of a foreign language in mathematics lessons seems to be rooted in the subjective convictions (world views) of teachers – for this reason I will briefly explain the term “mathematical world views”.

## **MATHEMATICAL WORLD VIEWS**

Subjective views on mathematics are generally called “mathematical beliefs” (compare the extensive discussion in Leder, Pehkonen & Törner, 2001). If the case is a comprehensive system of beliefs – for example on mathematics as a school subject on the whole – then it appears to me that the term world views employed by Schoenfeld (1985) expresses metaphorically more content. I therefore give preference to this term in the following. In accordance to Schoenfeld I understand under world views subjective beliefs and personal theories related to a context that can on the one hand be a single (isolated) terminological object, or on the other hand can also encompass a whole field of mathematics.

As substantiated by a number of research projects already in the 1980s (Köller, Baumert & Neubrand, 2000; Leder, Pehkonen & Törner, 2001), mathematics is typically viewed in the traditional static mode as mechanical calculation and as a field in which numbers and formulae as well as memorization of formulae and results are of central relevance. It is not surprising that such a world view of mathematics allocates language only a marginal role. Bauersfeld (1995) employed the term “language games” to underline to which residual level the role of language can degenerate in the context of specific subject matter. In contrast, a process-oriented understanding of mathematics viewing language as a tool for description, presentation, elaboration, explanation, argumentation, communication and discussion allocates great relevance to language in mathematics. This view is also central when learning is understood in the constructivistic sense and oriented towards this approach.

## **EMPIRICAL RESULTS**

Within the framework of a research project conducted in and around Duisburg, ten teachers were interviewed on their views concerning the use of a foreign language in mathematics lessons. Four teachers conducting bilingual lessons (not mathematics but another non-language subject) and a further six mathematics teachers, of which two teach at a bilingual school, were interviewed. These interviews were video-recorded and transcribed. For the sake of brevity I limit myself in the following to the presentation of the three major argumentation lines of the interviewed teachers without naming their personal identities. This paper is not the place to go into detail on theories of language in mathematics; for this general discussion I refer to Brown (1997); Durkin & Shire (1991); Maier & Schweiger (1999); Niederrenk-Felgner (2000). However, more than one of the interviewed teachers repeatedly mentioned the relevant arguments.

### **The role of language in mathematics**

Our interviewees teaching in a bilingual context describe certain subjects as suitable for bilingual lessons in which pupils and teachers discuss and debate issues offering numerous opportunities for verbal communication. In relation to mathematics lessons, however, one teacher expresses the following: “*In the case of mathematics*

lessons we are confronted with reduced language processes. This subject is about numbers, formulae and calculation. Language hardly plays a role.” Language in mathematics lessons is thus allocated a marginal role, as discussion and debate can hardly occur within this understanding and practice of mathematics. Another teacher sharpens this view by stating that there is only true or false in mathematics; one can implicitly infer here that this teacher may feel he is in possession of the truth – thus discussion and debate are superfluous. A further teacher states the following concerning the role of language in mathematics lessons: *“When I think of traditional mathematics lessons with their countless exercise parcels for silent seat work or homework – you really don’t need language for that!”* A further facet of mathematics is implied here that goes beyond the aspect of being calculation, namely of mathematics as a solitary occupation rendering communication between individuals simply unnecessary.

In opposition to this, a mathematics teacher working at a bilingual school views reduced language processes as an asset by pointing out that in mathematics lessons a high level of language competence is not necessary; thus grammar plays a subordinate role in bilingual lessons: *“One does not need good grammar knowledge in mathematics lessons and therefore pupils can start relatively early with bilingual lessons, possibly already in the 5<sup>th</sup> class (10-11 year-olds).”* Both argumentations embody reductionistic views on the role of language in mathematics lessons and lead to differing consequences for the suitability of mathematics as a bilingual subject.

A positive exception is a mathematics teacher who teaches German as a second subject and intentionally promotes language activities of her pupils, e.g. in the form of journals.

### **Possibilities for culture mediation**

Teachers working in bilingual schools underline that intercultural learning is practised in bilingual lessons, i.e. that cultural content related to those countries in which the foreign language is dominant plays an important role. In relation to mathematics one bilingual teaching interviewee pointed out: *“I can hardly imagine intercultural learning occurring in mathematics lessons. Mathematics is an internationally neutral science.”* Another mathematics teacher also takes up this aspect and emphasizes: *“This is not possible in mathematics lessons.”*

### **Effects for mathematics lessons**

Eight of the interviewed teachers cannot imagine that the effort involved in incorporating a foreign language into mathematics lessons will lead to worthwhile results. They cannot see anything being gained by bilingual lessons. Without having the space to discuss the advantages of utilizing a foreign language in particular in mathematics lessons in detail here, the two teachers will nonetheless be quoted here who – in particular in view of Snow’s core thesis mentioned at the beginning of this paper – offer arguments for the use of a foreign language in mathematics lessons. One mathematics teacher in a bilingual school presents his pupils with tasks in

English justified as follows: “*I’d like to keep my pupils from pigeon hole thinking that English is only important in English lessons and not in mathematics. At university all academic and scientific texts are in English anyway, so what I do is a good preparation.*” One teacher added as a motivation for the use of a foreign language in mathematics lessons the following: “*Maybe the pupils will develop another approach to mathematics. Maybe pupils can be reached who are not so interested in mathematics.*”

## CONCLUSION

For both mathematicians and non-mathematicians interviewed in this paper the fundamentally expressed world view on the role of language in mathematics lessons is equally the decisive argument against (or in one case for) the use of a foreign language in mathematics lessons. Behind these statements one finds various reductionistic world views towards mathematics. The academic discussion on the role of language in mathematics lessons also does not seem to have reached school reality in Germany yet (Brown, 1997; Durkin & Shire, 1991; Maier & Schweiger, 1999; Niederdenk-Felgner, 2000).

In relation to the second presented argument – the possibilities of culture mediation in mathematics lessons – one can state that all interviewed teachers do not see any implementation possibilities in these lessons. This points to deficits concerning world views on mathematics in society, science and technology. There are however fields involving mathematics which can certainly be interculturally represented, for example when one considers the overtly disapproving position of Germany in the atomic energy debate on the one hand, and the overtly approving position of France on the other hand. To a certain degree such themes can be explored mathematically, thus initiating discussion and debate, also illuminating intercultural aspects of mathematics lessons. Only at a first glance is mathematics culture-free. In another context Presmeg (1998) explicitly points out that mathematics lessons simply cannot be culture-free.

Altering world views of individuals is a difficult task, last but not least also when the theme is mathematics and mathematics lessons. Bilingual lessons entail potential for this urgently needed venture – yet one encounters a vicious circle here: in particular the aforementioned world views stand massively in the way of incorporating foreign languages into mathematics lessons.

## References

- Abuja, G. (1999). Die Verwendung einer Fremdsprache als Arbeitssprache: Charakteristika bilingualen Lernens in Österreich. *Zeitschrift für Interkulturellen Fremdsprachenunterricht*, <http://www.ualberta.ca/~german/ejournal/ejournal.html>.
- Bauersfeld, H. (1995). 'Language Games' in the Mathematics Classroom: Their Function and Their Effects. In P. Cobb & H. Bauersfeld (Eds.), *The Emergence of Mathematical Meaning: Interaction in Classroom Cultures* (pp. 271-291). Hillsdale, NJ: Lawrence Erlbaum.

- Brown, T. (1997). *Mathematics Education and Language: Interpreting Hermeneutics and Post-Structuralism*. Dordrecht, The Netherlands: Kluwer Academic Publishers.
- Durkin, K., & Shire, B. (Eds.) (1991). *Language in mathematics education – Research and practice*. Milton Keynes, England: Open University Press.
- Ellerton, N. F., & Clarkson, P. C. (1996). Language Factors in Mathematics Teaching and Learning. In A. J. Bishop, K. Clements, C. Keitel, J. Kilpatrick & C. Laborde (Eds.), *International Handbook of Mathematics Education* (pp. 987-1033). Dordrecht, The Netherlands: Kluwer Academic Publishers.
- Enzensberger, H. M. (1999). *Drawbridge Up: Mathematics – A Cultural Anathema*. Natick, MA: A K Peters, LTD.
- Fischer, E. P. (2001). *Die andere Bildung*. München: Econ Ullstein List Verlag GmbH & Co. Kg.
- Furinghetti, F. (1993). Images of Mathematics Outside the Community of Mathematicians: Evidence and Explanations. *For the learning of Mathematics*, 13(2), 33-38.
- Hofmannová, M., Novotná, J., & Hadj-Moussová, Z. (2003). Attitudes of Mathematics and Language Teachers towards New Educational Trends. In N. A. Pateman, B. J. Dougherty & J. Zilliox (Eds.), *Proceedings of the 2003 Joint Meeting of PME and PME-NA of the International Group for the Psychology of Mathematics Education* (Vol. 3, pp. 71-77). Honolulu, Hawaii, USA.
- Köller, O., Baumert, J., & Neubrand, J. (2000). Epistemologische Überzeugungen und Fachverständnis im Mathematik- und Physikunterricht. In J. Baumert, W. Bos & R. Lehmann (Eds.), *TIMSS/III: Dritte Internationale Mathematik- und Naturwissenschaftsstudie – Mathematische und naturwissenschaftliche Bildung am Ende der Schullaufbahn, Band 2: Mathematische und physikalische Kompetenzen am Ende der gymnasialen Oberstufe* (pp. 229-269). Opladen: Leske + Budrich.
- Leder, G., Pehkonen, E., & Törner, G. (Eds.) (2002). *Beliefs: A Hidden Variable in Mathematics Education?* Dordrecht, The Netherlands: Kluwer Academic Publishers.
- Maier, H., & Schweiger, F. (1999), *Mathematik und Sprache: Zum Verstehen und Verwenden von Fachsprache im Unterricht*. Wien: öbv & hpt Verlagsgesellschaft mbH. & Co. KG.
- Moschkovich, J. (1996). Learning Math in Two Languages. In L. Puig & A. Gutiérrez. (Eds.), *Proceedings of the 20th Conference of the International Group for the Psychology of Mathematics Education* (Vol. 4, pp. 27-34). Valencia, Spain.
- Moschkovich, J. (2002). A Situated and Sociocultural Perspective on Bilingual Mathematics Learners. *Mathematical Thinking and Learning*, 4(2), 189-212.
- Niederdrenk-Felgner, C. (2000). Themenheft “Mathematik und Sprache”. *Mathematik lehren*, Heft 99.
- Presmeg, N. C. (1998). Ethnomathematics in Teacher Education. *Journal of Mathematics Teacher Education*, 1, 317-339.
- Schoenfeld, A. H. (1985). *Mathematical Problem Solving*. Orlando, FL: Academic Press.

Schwanitz, D. (1999). *Bildung*. Frankfurt am Main: Eichborn Verlag.

Snow, C. P. (1959). *The two cultures*. Cambridge: University Press.

Swain, M. (1998). French immersion in Canada. In J. Cummins (Ed.), *Bilingual education*, Volume 5 of The encyclopedia of language and education. Dordrecht, The Netherlands: Kluwer Academic Publishers.

# THE USE OF MODELS IN TEACHING PROOF BY MATHEMATICAL INDUCTION

Gila Ron and Tommy Dreyfus  
Tel Aviv University, Israel

*Abstract: Proof by mathematical induction is known to be conceptually difficult for high school students. This paper presents results from interviews with six experienced high school teachers, concerning the use of models in teaching mathematical induction. Along with creative and adequate use of models, we found explanations, models and examples that distort the underlying mathematical ideas and show teachers' conceptual difficulties.*

## INTRODUCTION

The Israeli high school curriculum includes proof by mathematical induction for high and intermediate level classes. Usually in grade 11, students are taught to prove algebraic relationships such as equations, inequalities and divisibility properties by mathematical induction.

Proof by mathematical induction is a method to prove statements that are true for every natural number. In order to prove by mathematical induction that a statement is true for every natural number  $n$ , one has to establish the validity of two conditions:

That the statement is true for  $n=1$ ;

That if a statement is true for any natural number  $k$ , then it is also true for its successor  $k+1$ .

In this paper the validation of the first condition will sometimes be called the induction basis and the validation of the second condition will sometimes be called the induction step. Moreover, the assumption used in the second condition, namely that the statement is true for  $k$ , will be called the induction hypothesis.

The research literature shows that high school students and prospective teachers are facing difficulties in understanding the idea of mathematical induction in depth. For example, Fischbein & Engel (1989) showed that for many students it is difficult to build the induction step on the basis of a statement that has not been proven, namely the induction hypothesis. As a consequence, many students adopt wrong attitudes like "The validity of the induction basis confirms the induction hypothesis", "the validity of the induction step confirms the induction hypothesis" or "the validity of the induction hypothesis is limited and should be considered true unless the contrary has been proved".

Avital and Libeskind (1978) also relate to students' difficulty to understand the implication in the induction step. They recommend to hold preparatory discussions about the nature of implications and to give students opportunities to explore and formulate their conjectures. They also recommend to give students the opportunity to

gain confidence in the induction step by introducing a naive approach to mathematical induction, namely to show how the truth of the statement for  $n=2$  follows from its truth for  $n=1$ , the truth for  $n=3$  from the truth for  $n=2$ , and so on.

Movshovitz-Hadar (1993a) showed that many prospective teachers lack conceptual understanding of proof by mathematical induction and it is therefore easy to put them in situations of cognitive conflict and thus to shake their confidence that proof by mathematical induction works. She also suggests (Movshovitz-Hadar, 1993b) holding discussions about conceptual aspects of mathematical induction with students, and proposes tasks that can be used as trigger for such discussions.

In summary, the research literature shows that meaningful understanding of proof by mathematical induction requires complex knowledge. In this paper, we shall refer to three aspects of that complex knowledge:

Understanding the structure of proof by mathematical induction, namely

that the two conditions are independent of each other and that both of them are necessary;

how these two conditions are integrated to result in the overall proof.

Understanding the stage of the induction basis, namely

that checking the validity of the initial case is an integral part of the proof – not a preliminary activity that is intended to shed light on the statement or to give confidence that the statement to be proved is true;

that one has to check only for  $n=1$  and that other checking activities, if conducted, are not necessary parts of the proof. (We disregard here more complicated cases such as induction steps from  $k$  to  $k+2$ .)

Understanding the stage of the induction step, namely

that this is a separate statement and proof, nested in the overall proof;

that the induction hypothesis is different from the overall statement, and what the essence of the difference is;

that the variable  $k$  used at this stage can take any natural value.

## **THE USE OF MODELS FOR MATHEMATICAL INDUCTION**

In this paper, we shall deal with some aspects of the use of models for teaching mathematical induction. Hereby, we use the notion of model in a wide sense, not necessarily limited to physical models.

A role for models can be to demonstrate, illustrate and interpret the method of proof by mathematical induction, and thus to support understanding by use of pictorial language that might be more accessible to learners than the formal language commonly used in teaching mathematical induction. According to Fischbein (1987), if the original and the model belong to different systems, the model provides an



analogy. On the other hand, if the original is a certain category of objects and the model is provided by an example in this category, then the model is paradigmatic.

The most common model for mathematical induction appears to be the domino model: Domino tiles are standing in a row. The dominoes are arranged in such a way that if we push the first one it falls and causes a chain reaction - every domino tile knocks down the next one and as a consequence all the dominos in the row fall. In Table 1 (see next page), we present our analysis of how elements of proof by mathematical induction can be represented by the domino model, and how teachers can potentially use the model's language in their explanations.

Another model that teachers sometimes use for illustrating mathematical induction is presented by the story of the Hanoi towers (see Figure 1)

**THE STORY OF THE HANOI TOWERS**

In the temple of Brahma in Benares there are three diamond needles. At the creation, 64 golden rings of different sizes formed a tower on one of the needles, the largest at the basis, the others stacked upon it according to decreasing size. The priests in the temple transfer rings between the needles, day and night, according to Brahma's two rules: (1) Only one ring can be carried at a time, (2) No ring may be placed on top of a smaller one. They believe that when the 64 rings will form the same tower on another needle the world will vanish.

Is there a reason for panic?

**Figure 1:** The story of the Hanoi towers

There are several ways to demonstrate the idea of proof by mathematical induction using the story of the Hanoi towers. One possibility is to concentrate on the proof that it is possible to transfer any number of rings according to the rules: It is trivial to transfer one ring; and if we know how to transfer  $k$  rings from one needle to another, then we can transfer  $k$  rings to the third needle, put the  $k+1^{\text{st}}$  ring at the bottom of the target needle and transfer the  $k$  rings on top of it using the same method as before. Another possibility is to concentrate on the proof that the number of single ring transfers needed to transfer a stack of  $n$  rings is  $2^n - 1$ .

A table similar to table 1 can be built for demonstrating the use of the Hanoi towers in teaching mathematical induction. For example, the legitimacy of the induction hypothesis, or the similarity between the statement to be proved and the induction hypothesis, can be dealt with by reference to the local scope of the hypothesis. In the language of the model, one can say: The hypothesis is that we can transfer  $k$  rings from one needle to another; on this basis we only prove that we can transfer  $k+1$  rings from one needle to another. We are not talking about the whole tower now. That we shall do later...".

THE POTENTIAL CONTRIBUTION OF THE DOMINO MODEL TO UNDERSTANDING PROOF BY MATHEMATICAL INDUCTION	ELEMENTS OF PROOF BY MATHEMATICAL INDUCTION AND KNOWLEDGE RELATED TO PROOF BY MATHEMATICAL INDUCTION	
The pushing of the first domino tile so that it falls represents the basis stage.	The <b>representation</b> of the induction basis	The induction basis
In order to stress the necessity of this stage the teacher can demonstrate that no tile falls if the first one doesn't, even though the tiles are arranged in a row such that every tile would knock down the next one, if it were to fall.	The <b>necessity</b> of the induction basis	
Any falling tile knocks down the next one.	The representation of the induction step	The induction step
If a tile falls then it knocks down the next one.	<b>What</b> do we prove in the induction step?	
Any one of the domino tiles falls.	The representation of the induction hypothesis	
Questions about the <b>legitimacy</b> of the induction hypothesis, or about the similarity between the statement to be proved and the induction hypothesis, can be dealt with by reference to the model, and specifically to the local scope of the hypothesis. The teacher can say, for example: "On the basis of the hypothesis we only prove that the statement is true for $k+1$ . It is like saying that if the tile $k$ falls, then the tile $k+1$ also falls. We don't talk about the all the tiles but only about <b>one tile and its successor.</b> "	The induction hypothesis is a <b>part of the induction step</b> What is the <b>role</b> of the induction hypothesis? Why is it <b>legitimate</b> to use the hypothesis? What is the <b>difference</b> between the hypothesis and the original statement?	
<b>Every</b> tile knocks down the next one.	The <b>generality</b> of the variable $k$ that is used in the induction hypothesis.	
A domino row with a sufficiently big distance somewhere	Situations, where the induction step cannot be applied at some place	

## **THE STUDY**

### **Aim**

Our aim in the present study was to learn about teachers' use of models for the teaching of proof by mathematical induction. What are the models that teachers use? What do they intend to clarify by means of the models, and how? In particular, we wanted to know whether the teachers' use of models is adequate in the sense that it suits the mathematical ideas they want to represent, demonstrate or illustrate.

In this paper we shall present findings concerning the use of models for the induction basis, specifically checking for  $n=1$ , and findings concerning the use of models for the induction step, specifically the use of the induction hypothesis in the proof.

### **Population**

Six experienced high school mathematics teachers were interviewed for 30 - 60 minutes each. Teachers were considered experienced if they had at least 10 years of teaching experience. Two of the teachers have a Master's degree in mathematics education, and three are presently studying toward such a degree. One teacher (T6) is a graduate in economics and statistics who has taken a long-term course in order to become a mathematics teacher. This teacher also participated in three-year professional development program for mathematics teachers. All the teachers taught proof by mathematical induction at least twice, of which at least once during the two years immediately prior to the interviews. The interviews were semi-structured. The teachers were not informed that our main interest was the use of models. The interviewer referred to the use of models only if the teachers didn't bring up the issue by themselves in the course of the natural flow of the interview.

### **Use of models**

Five out of the six interviewed teachers do use models when teaching proof by mathematical induction. All five use the domino model when they introduce the concept. Usually they arrange a set of domino tiles (or wafers) in an appropriate row and ask the students about the conditions that ensure that all the tiles in the row will fall. Three of the teachers said that they go back to the model later in the instruction, when students forget to check for  $n=1$ , or when they fail to show that the induction step is valid for all  $k$ .

Two of the teachers also use the Hanoi towers in the introductory stage of teaching mathematical induction. T2 always introduces the subject in an exploratory lesson, in which the students are asked to work out the number of steps needed for transferring  $n$  rings from one needle to another. Usually, some of her students discover a recursive law and most of the others discover the explicit formula. They are then asked to show that the two solutions are equivalent. This leads them to construct proofs by mathematical induction, without being explicitly aware of this. Her teaching design includes conducting the induction step for particular examples before generalizing it, following the naive approach as proposed by Avital and Libeskind (1978).

“...and then I say: let’s assume that one of the students went home and checked that it [the equivalence of the two laws] is valid for all the particular cases until the up to  $n=10$ . Can we show now that it is also true for  $n=11$ ? ... and then, during exercising they discover the depth of proving by induction. That someone checked until a certain place and we can prove it for the next place”.

We shall refer to this quote again in another context.

The explanations of two teachers, T1 and T3, always reflected the mathematical idea properly. However their use of the models was limited to stressing the necessity of the two conditions and their combined role. The explanations of the other teachers included occasional misuse of models.

### **Misuse of models for the induction basis**

When talking about checking for  $n=1$ , T4 related:

“We want to prove something so we start by checking case by case an example or two or three, and then we are convinced that it starts to work. And then I give them an example of an electric tool. I tell them that I want to buy a used tool. Before I bargain about the price, I plug it in to see if it’s worth bargaining.”

In another place, when relating to checking, she said:

“If someone wants to get into the water, let’s say to a lake. Then, before a normal person jumps into the water, she decides to check the water temperature.”

Already the first sentence by T4 quoted above raises the suspicion that she presents the action of checking as a motivation for the proof rather than as a first step of the proof. This suspicion is then more than confirmed: Buying an electrical tool or getting into the water cannot possibly reflect the idea of checking as a part of a proof by mathematical induction because of two reasons. The first reason is that in these two examples the claim to be proved does not have the structure that makes proof by mathematical induction feasible: These claims do not include a natural variable, i.e. a variable that takes the natural numbers as values. The second reason is that the examples don’t stress the unique role of the checking as an integral part of the proof.

### **Misuse of models for the induction step**

During the interviews the teachers related to the induction step, to the legitimacy of using a hypothesis and to the pertinent explanations that they give to their students. However, none of them mentioned that the assumption is a part of the induction step, and that at this stage there is no need to know whether the assumption is true or not. Nor did they mention that in the induction step we don’t prove that the statement is true for any “ $k+1$ ”, but we prove that if the statement is true for a particular  $k$  then it is also true for it’s successor.

Three of the teachers, T2, T4, and T6, stated that the hypothesis is based on the induction basis. When T2 explained the legitimacy of the use of the hypothesis she referred to the Hanoi towers:

“Just a moment, do we have a problem with that one student went home and checked all the cases up to 10 rings and basing on this we succeeded to prove that it is true also for 11 rings?”

T2 used the story of the Hanoi towers in a creative way to explain the induction step. However, her explanation is problematic: When she stresses the fact that someone went home and checked all the cases up to  $n=10$ , she does *not* present this as an analogy to relying on a hypothesis. One of the main difficulties of the reasoning process of the induction step is that we rely on the hypothesis without knowing whether it is true or not. To stress that point a teacher might say to her students: “None of you checked for  $n=20$ . Can we nevertheless prove that *if a tower of  $k=20$  rings can be transferred, then a tower of  $k=21$  can also be transferred?*”

T4 tried to exemplify the induction step with an example that does not include a natural variable. She continued her earlier example of buying an electric tool:

“Yes, yes. The checking stage is clear. Now we go to the hypothesis. OK. If it works why do we have to assume that it works up to  $k$ ? Because I say, if I see that it works then I assume that it will work until a certain stage. But I can’t assume that it will work forever because it can stop working like all the electric tools do. I assume that it works. My task is to prove that it will also work in the next stage”.

Two of the teachers, T2 and T6 didn’t distinguish between the induction hypothesis and other features of the problem situation. T2, for example, said:

“What is the assumption that it is true up to the  $k^{\text{th}}$  place - a certain natural  $k$ ? The assumption is that all the dominoes are with equal distances, if they are close enough to each other, of course.”

The distance between the domino tiles represents features of the statement to be proved, while the induction hypothesis would be represented by a falling tile.

One teacher, T5, who expressed some anxiety about using a hypothesis in the proof referred in her explanation to the use of axioms in geometry and to assumptions that people make in everyday life:

“... so sometimes I look for help from geometry and I say that in geometry we also use hypotheses and base all the theory on these hypotheses.”

T5 also attributed the anxiety about using a hypothesis to the mathematical language:

“One thing that mathematics reflects is language, and this language is not complete and not always precise, but it clarifies things.”

Later on, T5 stated explicitly that even though she knows that the use of a hypothesis is correct, she does not know what to answer when her students ask her why they may use a hypothesis.

## SUMMARY

Teaching proof by mathematical induction meaningfully requires teachers' awareness of the difficulties that student may encounter with respect to proof by mathematical induction as well as complex mathematical knowledge.

The interviewed teachers are aware of the complexity of the proof process and of some students' difficulties. Consequently they make efforts to overcome the difficulties, including the use of models during instruction. Alongside some adequate and sometimes creative use of models, we found models that don't reflect the mathematical idea properly.

Concerning the induction hypothesis we found several wrong explanations: Looking at the hypothesis as based on the checking; considering the hypothesis as an axiom that can be true or false (also after completion of the proof process); confusing between the induction hypothesis and other conditions of the problem situation; attribution of the difficulty in using a hypothesis to the mathematical language, and even declaration of anxiety with using a hypothesis.

Concerning the induction basis we found a teacher who considers the induction basis as an action that justifies the proving effort and not as an integral part of the proof. This teacher also used examples that don't contain a natural variable.

Where teachers' explanations reflected the mathematical ideas properly, their use of the models was limited to stressing the necessity of the two conditions and their combination in the overall proof.

Considering the potential contribution of models to explaining proof by mathematical induction, we have shown that teachers could make more profound use of the models, in particular with respect to delicate points concerning the induction hypothesis. We suggest models should be used in teacher education, and that student teachers should be asked to explicitly and in detail establish the connections between model and abstract idea of mathematical induction.

## References

- Avital, S. & Libeskind, S. (1978): Mathematical induction in the classroom: Didactical and mathematical issues. *Educational Studies in Mathematics* 9, 429-438.
- Fischbein E. (1987): *Intuition in science and mathematics*. D. Reidel publishing company.
- Fischbein E., and Engel, I. (1989): Psychological difficulties in understanding the principle of mathematical induction", in G Vergnaud, J. Rogalski & M. Artigue (Eds.): *Proceedings of the 13<sup>th</sup> international conference for the Psychology of Mathematics Education*, Vol I (pp. 276-282). Paris, France: CNRS.
- Movshovitz-Hadar, N. (1993a): The false coin problem, mathematical induction and knowledge fragility. *Journal of Mathematical Behavior* 12, 253-268.
- Movshovitz-Hadar, N. (1993b): Mathematical induction: A focus on conceptual framework. *School Science and Mathematics* 8, 408-417.

# REFLECTING ON PROSPECTIVE ELEMENTARY TEACHERS' MATHEMATICS CONTENT KNOWLEDGE: THE CASE OF LAURA

Tim Rowland, Peter Huckstep and Anne Thwaites  
University of Cambridge

*In this paper we describe a framework for the identification and discussion of prospective elementary school teachers' mathematics content knowledge as evidenced in their teaching. This framework - 'the knowledge quartet' - emerged from intensive scrutiny of 24 videotaped lessons. Application of the 'quartet' in lesson observation is illustrated with reference to a particular lesson taught by one trainee teacher.*

## INTRODUCTION

It is now widely agreed that a vital component of the complex knowledge base for teaching is the transformation of subject matter knowledge (SMK) into a form that might enable others to learn it. The term 'pedagogical content knowledge' (PCK) was first employed by Shulman (1986) to depict "the particular form of content knowledge that embodies the aspects of content most germane to its teachability" (p. 9). Questions about the adequacy of teachers' SMK have been voiced for more than a decade in the US (e.g. Kennedy, 1990) and the UK (e.g. Alexander, Rose and Woodhead, 1992). Specific concerns about elementary teachers' SMK and PCK have been a recurrent theme in reports by the government inspection agency, the Office for Standards in Education (Ofsted 1994, 2000, 2003). Similar concerns in Israel have led to a recent recommendation that, from Grade 1, mathematics be taught by mathematics specialists. This has resulted in a three-year national in-service programme to train specialist elementary mathematics teachers (Tsamir and Tirosh, 2003). A number of recent PME papers have considered aspects of elementary teachers' SMK, such as place value (McClain and Bowers, 2000), reasoning and proof (Rowland, Martyn, Barber and Heal, 2001) and division (Lamb and Booker, 2003) with comment on the relevance of SMK to the professional role of their participants. In this paper we describe a research-based framework which facilitates the discussion of mathematics SMK and PCK between prospective teachers, their mentors and teacher educators.

## PURPOSE OF THE RESEARCH

In the UK, most trainee teachers follow a one-year, postgraduate course leading to a Postgraduate Certificate in Education (PGCE) in a university education department. All primary (elementary) trainees are trained to be generalist teachers of the whole primary curriculum. About half of the PGCE year is spent working in schools under the guidance of a school-based mentor. Our immediate focus in this paper is on an approach to supporting the development of prospective elementary generalist teachers' mathematics teaching during these school-based, clinical placements.

Placement lesson observation is normally followed by a review meeting between a school-based teacher-mentor and the student-teacher ('trainee', in the terminology of

recent official UK documentation). On occasion, a university-based tutor will participate in the observation and the review. Research shows that such meetings typically focus heavily on organisational features of the lesson, with very little attention to mathematical aspects of mathematics lessons (Brown, McNamara, Jones and Hanley, 1999). The purpose of the research reported in this paper was to develop an empirically-based conceptual framework for the discussion of the role of trainees' mathematics SMK and PCK, in the context of lessons taught on the school-based placements. Such a framework would need to capture a number of important ideas and factors about content knowledge within a small number of conceptual categories, with a set of easily-remembered labels for those categories.

## **METHOD**

This study took place in the context of a one-year PGCE course, in which 149 trainees followed a route focusing either on the 'lower primary' years (LP, ages 3-8) or the 'upper primary' (UP, ages 7-11). Six trainees from each of these groups were chosen for observation during their final school placement. Two mathematics lessons taught by each of these trainees were observed and videotaped, i.e. 24 lessons in total. Following the lesson, the observer/researcher wrote a brief (400-500 words) descriptive synopsis of the lesson. From that point, we took a grounded approach to the data for the purpose of generating theory (Glaser and Strauss, 1967). In particular, we identified aspects of trainees' actions in the classroom that seemed to be significant in the limited sense that it could be construed to be informed by their mathematics SMK or PCK. These were grounded in particular moments or episodes in the tapes. This inductive process generated a set of 18 codes. Next, we revisited each lesson in turn and, after intensive study of the tapes, elaborated each descriptive synopsis into an 'analytical account' of the lesson. In these accounts, significant moments and episodes were identified and coded, with appropriate justification and analysis concerning the role of the trainee's content knowledge in the identified passages, with links to relevant literature.

Our catalogue of 18 codes presented us with the following problem. We intended to offer our findings to colleagues for their use, as a framework for reviewing trainees' mathematics content knowledge from evidence gained from classroom observations of teaching. We anticipate, however, that 18 codes is too many to be useful for a one-off observation. Our resolution of this dilemma was to group them into four broad, super-ordinate categories, or 'units', which we term 'the knowledge quartet'.

## **FINDINGS**

We have named the four units of the knowledge quartet as follows: foundation; transformation; connection; contingency. Each unit is composed of a small number of cognate subcategories. For example, the third of these, *connection*, is a synthesis of four of the original 18 codes, namely: *making connections*; *decisions about sequencing*; *anticipation of complexity*, and *recognition of conceptual appropriateness*. Our scrutiny of the data suggests that the quartet is comprehensive as a tool for thinking about the ways that subject knowledge comes into play in the classroom. However, it will become



apparent that many moments or episodes within a lesson can be understood in terms of two or more of the four units; for example, a **contingent** response to a pupil's suggestion might helpfully **connect** with ideas considered earlier. Furthermore, it could be argued that the application of subject knowledge in the classroom *always* rests on **foundational** knowledge. Drawing on the extensive range of data from the 24 lessons, we offer here a brief conceptualisation of each unit of the knowledge quartet.

The first category, *foundation*, consists of trainees' knowledge, beliefs and understanding acquired 'in the academy', in preparation (intentionally or otherwise) for their role in the classroom. The key components of this theoretical background are: knowledge and understanding of mathematics *per se* and knowledge of significant tracts of the literature on the teaching and learning of mathematics, together with beliefs concerning the nature of mathematical knowledge, the purposes of mathematics education, and the conditions under which pupils will best learn mathematics. The second category, *transformation*, concerns knowledge-in-action as demonstrated both in planning to teach and in the act of teaching itself. As Shulman indicates, the presentation of ideas to learners entails their re-presentation (our hyphen) in the form of analogies, illustrations, examples, explanations and demonstrations (Shulman, 1986, p. 9). Of particular importance is the trainees' choice and use of examples presented to pupils to assist their concept formation, language acquisition and to demonstrate procedures. The third category, *connection*, binds together certain choices and decisions that are made for the more or less discrete parts of mathematical content. In her discussion of 'profound understanding of fundamental mathematics', Liping Ma cites Duckworth's observation that intellectual 'depth' and 'breadth' "is a matter of making connections" (Ma, 1999, p. 121). Our conception of this coherence includes the sequencing of material for instruction, and an awareness of the relative cognitive demands of different topics and tasks. Our final category, *contingency*, is witnessed in classroom events that are almost impossible to plan for. In commonplace language it is the ability to 'think on one's feet'. In particular, the readiness to respond to children's ideas and a consequent preparedness, when appropriate, to deviate from an agenda set out when the lesson was prepared.

## **LAURA'S LESSON AND THE KNOWLEDGE QUARTET**

We now proceed to show how this theoretical construct, the knowledge quartet, might be applied, by detailed reference to just one of the 24 videotaped lessons. The trainee in question, Laura, was teaching a Year 5 (pupil age 9-10) class about written multiplication methods. By focusing on just one lesson we aim to maximise the possibility of the reader's achieving some familiarity with Laura and the children in her class, as well as the structure and the flow of her lesson.

Conforming to National Numeracy Strategy guidance (DfEE, 1999), Laura segments the lesson into three distinctive and readily-identifiable phases: the *mental and oral starter*; the *main activity* (an *introduction* by the teacher, followed by *group work*, with tasks differentiated by pupil ability); and the concluding *plenary*. The key focus of this lesson is on teaching column multiplication of whole numbers, specifically multiplying a two-digit number by a single digit number. After Laura has settled the class on the carpet in

front of her, the lesson begins with a three-minute *mental and oral starter*, in which the children rehearse recall of multiplication bonds. There follows a 15-minute *introduction* to the *main activity*. Laura reminds the class that they have recently been working on multiplication using the ‘grid’ method. She speaks about the tens and units being “partitioned off”. Simon is invited to the whiteboard to demonstrate the method for  $9 \times 37$ . He writes:

x	30	7		
9	270	63	=	333

Laura then says that they are going to learn another way. She proceeds to write the calculation for  $9 \times 37$  on the whiteboard in a conventional but elaborated column format, explaining as she goes along:

	37
	x 9
30x9	270
7x9	63
	333
	1

Laura performs the sum  $270+63$  by column addition *from the right*, ‘carrying’ the 1 (from  $7+6=13$ ) from the tens into the hundreds column. She writes the headings h, t, u above the three columns.

Next, Laura shows how to “set out”  $49 \times 8$  in the new format, followed by the first question ( $19 \times 4$ ) of the exercises to follow. The class proceeds to 24 minutes’ work on exercises that Laura has displayed on the wall. Laura moves from one child to another to see how they are getting on. She emphasises the importance of lining up the hundreds, tens and units columns carefully, and reminds them to estimate first.

Eventually, she calls them together on the carpet for an eight-minute *plenary*. She asks one boy, Sean, to demonstrate the new method with the example  $27 \times 9$ . Sean gets into difficulty; he is corrected by other pupils and by Laura herself. As the lesson concludes, Laura tells the children that they should complete the set of exercises for homework.

We now select from Laura’s lesson a number of moments, episodes and issues to show how they might be perceived through the lens of ‘the knowledge quartet’. It is in this sense that we offer Laura’s lesson as a ‘case’ - it is typical of the way that the quartet can be used to identify for discussion matters that arise from the lesson observation, and to structure reflection on the lesson. Some possibilities for discussion with the trainee, and for subsequent reflection, are flagged below thus: **Discussion point**. We emphasise that the process of *selection* in the commentary which follows has been extreme.

Nevertheless, we raise more issues relating to content knowledge than would normally be considered in a post-lesson review meeting.

### Foundation

First, Laura’s professional knowledge underpins her recognition that there is more than one possible written algorithm for whole number multiplication. We conceptualise this within the domain of fundamental knowledge, being the *foundation* that supports and

significantly determines her intentions or actions. Laura's learning objective seems to be taken from the National Numeracy Strategy (NNS) *Framework* (DfEE, 1999) teaching programme for Year 4:

Approximate first. Use *informal* pencil and paper methods to support, record or *explain* multiplication. *Develop* and *refine* written methods for TUxU (p. 3/18, emphasis added)

These objectives are clarified by examples later in the *Framework*; these contrast (A) *informal* written methods - the grid, as demonstrated by Simon - with (B) *standard* written methods - the column layout, as demonstrated by Laura in her introduction. In both cases (A and B), an 'approximation' precedes the calculation of a worked example in the *Framework*. Laura seems to have assimilated the NNS guidance and planned her teaching accordingly. It is perhaps not surprising that she does not *question* the necessity to teach the standard column format to pupils who already have an effective, meaningful algorithm at their disposal. The NNS distinguishes between 'effective' and 'efficient' methods and favours the latter. The suggestion in this case is that the 'standard' method B is efficient whereas the 'informal' grid method is effective i.e. it merely *works*. On the other hand, a best-selling handbook for trainee primary teachers, written by a respected teacher educator, explains why the standard algorithm works, but forcibly advocates the adequacy and pedagogical preference of grid-type methods with primary pupils (Haylock, 200, pp. 91-94).

**Discussion point:** where does Laura stand on this debate, and how did this contribute to her approach in this lesson?

Another issue related to Laura's fundamental knowledge is her approach to computational estimation. When she asks the children to estimate  $49 \times 8$ , one child proposes 400, saying that  $8 \times 50$  is 400. Laura, however, suggests that she could make this "even more accurate" by taking away two lots of 50. She explains, "Because you know two times five is ten and two times fifty is a hundred, you could take a hundred away". Perhaps she had  $10 \times 50$  in mind herself as an estimate, or perhaps she confused something like subtracting 8 from the child's estimate. She recognises her error and says "Sorry, I was getting confused, getting my head in a spin". The notions of *how* to estimate and *why* it might be desirable to do so are not adequately discussed or explored with the class.

**Discussion point:** what did Laura have in mind in this episode, and is there some way she can be more systematic in her approach to computational estimation?

At this stage of her career in teaching, Laura gives the impression that she is passing on her own practices and her own forms of knowledge. Her main resource seems to be her own experience (of using this algorithm), and it seems that she does not yet have a view of mathematics didactics as a *scientific* enterprise.

## Transformation

Laura's own ability to perform column multiplication is secure, but her pedagogical challenge is to *transform* what she knows for herself into a form that can be accessed and appropriated by the children. Laura's choice of demonstration examples in her

introduction to column multiplication merits some consideration and comment. Her first example is  $37 \times 9$ ; she then goes on to work through  $49 \times 8$  and  $19 \times 4$ . Now, the NNS emphasises the importance of *mental* methods, where possible, and also the importance of choosing the most suitable strategy for any particular calculation.  $49 \times 8$  and  $19 \times 4$  can all be more efficiently performed by rounding up, multiplication and compensation e.g.  $49 \times 8 = (50 \times 8) - 8$ . Perhaps Laura had this in mind in her abortive effort to make the estimate of 400 “even more accurate”.

Her choice of exercises - the practice examples - also invites some comment. The sequence is:  $19 \times 4$ ,  $27 \times 9$ ,  $42 \times 4$ ,  $23 \times 6$ ,  $37 \times 5$ ,  $54 \times 4$ ,  $63 \times 7$ ,  $93 \times 6$ , with  $99 \times 9$ ,  $88 \times 3$ ,  $76 \times 8$ ,  $62 \times 43$ ,  $55 \times 92$ ,  $42 \times 15$  as ‘extension’ exercises (although no child actually attempts these in the lesson). Our earlier remark about the suitability of the column algorithm relative to alternative mental strategies applies to several of these,  $99 \times 9$  being a notable example.

But suppose for the moment that it is understood and accepted by the pupils that they are to put aside consideration of such alternative strategies - that these exercises are there merely as a vehicle for them to gain fluency with the algorithm. In that case, the *sequence* of exercises might be expected to be designed to present the pupils with increasing challenge as they progress through them. This challenge would be of two kinds. First, the partial products (e.g.  $10 \times 4$  and  $9 \times 4$ ) make demands on their recall of products, but consideration of this dimension is not apparent in the sequence. Secondly, the necessity of ‘carrying’ when summing the tens digits of the partial products would add to the complexity of an exercise. This is a factor only in the second of the first eight exercises,  $27 \times 9$ , and in the third of the extension items,  $76 \times 8$ .

**Discussion point:** on what grounds did Laura choose these particular examples and exercises? What considerations might contribute to the choice?

### Connection

Perhaps the most important connection to be established in this lesson is that between the grid method and the column algorithm. Laura seems to have this connection in mind as she introduces the main activity. She reminds them that they have used the grid method, and says that she will show them a “slightly different way of writing it down”, although after the first example is completed Laura says that they are learning a “different way to work it out”. She says that the answer would be the same whichever way they did it “because it’s the same sum”. Of course, that presupposes that both methods are valid, but does not clarify the connection between them: that the same processes and principles - partition, distributivity and addition - are present in both methods. The fact that Laura includes demonstrations of  $37 \times 9$  by both methods does help to establish the connection, but the effort to sustain the connection is not maintained, and no reference to the grid method is made in her second demonstration example,  $49 \times 8$ . Her presentation of this example now homes in on procedural aspects - the need to “partition the number down”, “adding a zero” to  $8 \times 4$ , getting the columns lined up, adding the partial products from the right. The fact that the connection is tenuous for at least one pupil is apparent in the plenary. Sean actually volunteers to

calculate  $27 \times 9$  on the whiteboard. He writes 27 and  $\times 9$  in the first two rows as expected, but then writes  $20 \times 7$  and  $2 \times 9$  to the left in the rows below.

**Discussion point:** Laura is clearly trying to make a connection between the grid method and the column method. What reasons did she have in mind for doing so? To what extent did she think she was successful?

### Contingency

Sean's faulty attempt (mentioned above) to calculate  $27 \times 9$  on the whiteboard appears to have caught Laura 'on the hop'. Laura does not notice Sean's error immediately - it seems that she fully expected him to apply the algorithm faultlessly, and that his actual response really was unanticipated. In the event, there are several 'bugs' in his application of the procedure. The partition of 27 into 20 and 2 is faulty, and the multiplicand is first 9, then 7. This would seem to be a case where Sean might be encouraged to reconsider what he has written by asking him some well-chosen questions. One such question might ask how he would do it by the grid method. Or simply why he wrote those particular numbers where he did. Laura avoids correcting Sean herself, although her response indirectly suggests that all is not well. She asks the class? "Is that the way to do it? Would everyone do it that way?". Leroy demonstrates the algorithm correctly, but there is no diagnosis of where Sean went wrong, or why.

**Discussion point:** what might be the reason for Sean's error? In what ways could this have been addressed in the lesson, or subsequently?

### FINAL COMMENTS AND CAVEATS

In this paper, we have introduced 'the knowledge quartet' and shown its relevance and usefulness in our analysis of Laura's lesson on written methods of multiplication with a Year 5 class. We have a manageable framework within which to discuss actual, observed teaching sessions with trainees and their mentors. These groups of participants in initial teacher preparation, as well as our university-based school colleagues, will need to be acquainted with (and convinced of the value of) the quartet, and to become familiar with some details of its conceptualisation, as described in this paper. Steps towards this familiarisation are already in place in the context of our own university's initial teacher education programme.

It is all too easy for an observer to criticise a novice teacher for what they omitted or committed in the high-stakes environment of a school placement, and we would emphasise that the quartet is intended as a tool to *support* teacher development, with a sharp and structured focus on the impact of their SMK and PCK on teaching. Indications of how this might work are explicit in our analysis of Laura's lesson. We have emphasised that our analysis has been *selective*: we raised for attention some issues, but there were others which, not least out of space considerations, we chose not to mention. The same would be likely to be true of the review meeting - in that case due to *time* constraints, but also to avoid overloading the trainee with action points. Each such meeting might well focus on only one or two dimensions of the knowledge quartet for similar reasons.

Any tendency to descend into deficit discourse is also tempered by consideration of the wider context of the student teacher's experience in school. In the novice teacher we see the very beginnings of a process of reconciliation of pre-existing beliefs, new 'theoretical' knowledge, 'practical' advice received from various quarters, in the context of highly-pressured, high-stakes school-based placements. There is also good evidence (e.g. Hollingsworth, 1988; Brown *et al.*, 1999) that trainees' concern for pupil learning is often eclipsed by their anxieties about timing, class management and pupil behaviour.

## References

- Alexander R., Rose J., and Woodhead C. (1992) *Curriculum Organisation and Classroom Practice in Primary Schools*. London: Department for Education and Science.
- Brown, T., Mcnamara, O., Jones, L. and Hanley, U. (1999) 'Primary student teachers' understanding of mathematics and its teaching.' *British Education Research Journal*, 25(3), pp. 299-322.
- DfEE (1999) *The National Numeracy Strategy: framework for teaching mathematics from Reception to Year 6*. Sudbury: DfEE Publications.
- Glaser, B. G. and Strauss, A. L. (1967) *The Discovery of Grounded Theory: Strategies for Qualitative Research*. New York: Aldine de Gruyter.
- Haylock, D. (2001) *Mathematics Explained for Primary Teachers*. London: Paul Chapman.
- Hollingsworth, S. (1989) 'Prior beliefs and cognitive change in learning to teach.' *American Educational Research Journal* 26, pp. 160-189.
- Kennedy, M. (1990) 'A survey of recent literature on teachers' subject matter knowledge.' Issue Paper IP 90-3. Michigan State University: National Center for Research on Teacher Learning
- Lamb, J. and Booker, G. (2003) 'The impact of teachers' understanding of division on students' division knowledge'. In A Pateman, D. Dougherty and J. Zilliox (Eds.) *Proceedings of PME27*. Vol. 1, p. 207. Honolulu: University of Hawaii.
- Ma, L. (1999) *Knowing and teaching mathematics: teachers understanding of fundamental mathematics in China and the United States*. Mahwah, NJ: Lawrence Erlbaum.
- MacClain K. and Bowers, J. (2000) 'Supporting pre-service teachers' understanding of place value'. In Nakahara, T. and Koyama, M. (Eds.) *Proceedings of PME24*. Vol. 4, pp. 279-286. Hiroshima: University of Hiroshima.
- Ofsted (1994) *Science and Mathematics in schools: a review*. London: HMSO.
- Ofsted (2000) *The National Numeracy Strategy: the first year: a report from HM Chief Inspector of Schools*. London: HMSO
- Ofsted (2003) *The National Literacy and Numeracy Strategies and The Primary Curriculum*. London: Office for Standards in Education.
- Rowland, T., Martyn, S., Barber, P. and Heal, C. (2001) 'Investigating the mathematics subject matter knowledge of pre-service elementary school teachers'. In M. van den Heuvel-Panhuizen (ed.) *Proceedings of the PME25*, Vol. 4, pp. 121-128. Utrecht, Freudenthal Institute. Utrecht University
- Shulman, L. (1986) 'Those who understand: knowledge growth in teaching'. *Educational Researcher* 15(2), pp 4-14.

# THE COMPETENT USE OF THE ANALYTIC METHOD IN THE SOLUTION OF ALGEBRAIC WORD PROBLEMS. A didactical model based on a numerical approach with junior high students

Guillermo Rubio

Rafael del Valle

Universidad Nacional Autónoma de México. CCH Sur

*The study proves that a didactical model based in a method to solve word problems of increasing complexity which uses a numerical approach was essential to develop the analytical ability and the competent use of the algebraic language with students from three different performance levels in elementary algebra. It is shown that before using the analysis (“numerical analysis”) comprised in the method, a “preparatory analysis” is required. It was observed that when the use of this analytical process is given sense, the student advances in his/her ability to establish the relationships between the elements of the problem, which central aspect is the numerical equivalence between two quantities that mean the same in the problem. The study also revealed some of the obstacles that obstruct the analytic development.*

## INTRODUCTION

In the previous works [see, e.g., Filloy, Rubio, 1993; Rubio, 2002], it has been proven that the use of a didactical model based in the analytical method of numerical exploration makes possible the unleash of analytical processes that allow the student to symbolize arithmetic-algebraic word problems with one equation, where the numerical approach plays a mediating role between the arithmetic and algebraic methods. The evidences presented hereby are linked to the performance of 14-15 year-old in tests, clinic interviews and their work in the classroom by using the analytical method of numerical exploration, but having now as central objective to clarify the relationship between the development of the analytical ability of junior high students to solve new algebraic word problems of increasing complexity [see, e.g. Bednarz, Dufour-Janvier, 1994, Bednarz, 2001] and the evolution they acquire in the competent use of the algebraic language.

The empirical research shows that the use of the analysis (“numerical analysis”) contained in the phases 2 and 3 of the analytical method of numerical exploration fosters the development of the student’s ability to establish and produce meanings for: a) the numerical relationships between the unknowns; b) the relationships between them and the data; and; c) the comparison between two quantities which represent the same in the problem, that is, that they are equivalent regarding their meaning. The study shows that such numerical comparison is essential for the student to transit not only towards the symbolization of the problem with one equation, but also to be able to give sense to the equivalence between the two algebraic expressions comprising it which will be essential for the student to detach from the concrete

model and, at the same time, to build the meanings that will allow him/her to give sense to the algebraic method to solve problems. Finally, the research revealed obstacles (cognitive tendencies, Filloy, 1991) that obstruct the student to start or continue with the analytical process to solve some families of problems never tackled before.

## REFERENTIAL AND THEORETICAL FRAMEWORK

In [Rubio, 2002], it was said that the analytical method of numerical exploration has as an historical paradigm the method of the false position (*Regula Falsi*), which can be found in the Babilonians and in the Medieval treatises [Radford, 1996], as well as in text books of the 19<sup>th</sup> and 20<sup>th</sup> Centuries [Rubio, 2002]. The most important matter we have taken from this antique method to solve problems is the analytical intention its first steps have, where the use of the analysis is comprised, that is, the “assumption that the problem is solved” [Chabornneau, 1996]), but instead of using a literal as a solution of the problem, as it is used in the Cartesian Method, a hypothetical numerical quantity is designated to one of the unknowns of the problem. Both methods try to facilitate the analysis of the problems and to treat all of them in a similar way, as if they were the same problem (different from the arithmetic method where each problem is analyzed case by case). However, both proposals finally separate from each other because they have different projects to solve a problem; in the case of the (*Regula Falsi*), through one proportion and in the Cartesian Method with an equation.

The analytical method of numerical exploration used in the study tried to pick up in its Phases the use of the analysis included in both projects, but using their “numerical” aspect to obtain the equation that symbolizes the problem and to give sense to the use of the algebraic expressions comprising the same. The numerical approach is also framed within the historical perspective of the algebra development where the analysis is considered as a central process to solve problems algebraically where the hypothesis is its nucleus [Chabornneau, 1996]. Finally, it must be said that in the construction of the analytical method of numerical exploration the stages established by Piaget (1979) were also taken into account in relation to the assimilation process of the real facts to the mathematical-logical structures in the development of theories constructed from the physical experiences verified by such theories [see, e.g. Rubio, 1994].

## METHODOLOGY

In this stage of our research, videotaped clinical interviews were carried out to six 14 to 15 year-old junior high students who had received teaching in elementary algebra topics in their previous courses. These students were chosen out of 45 students through a classification in the classrooms based on their performance with two diagnostic tests on arithmetical-algebraic problems and the solution of equations. The



investigation used as a driving factor the scheme proposed in [Fillooy, Rojano, Solares, 2002] to implement a controlled teaching system, within which the population to be studied is chosen.

### **THE EMPIRICAL STUDY: Development of the Analytical Ability**

Due to the lack of space, we will show in this document that using of the numerical exploration method were the didactical proposal is based in, only with Berenice's case, which was the lowest level performance case. Through some episodes of three out of the nine videotaped interviews carried out to this case we will show the development of the analytical ability to solve new arithmetic-algebraic word problems of increasing complexity, the progressive creation of meanings for the algebraic expressions contained in the equations symbolizing such problems and some of the obstacles obstructing the solution of a problem. It was evidenced that it is only when such obstacles are eliminated that it is possible to continue with the production of meanings for algebraic expressions, making possible to advance in the competent use of the algebraic language.

**The Analytic Method of Numerical Exploration** [see, e.g. Rubio, 2002]. The method consists in seven phases, with which it is tried to: i) Clarify the unknowns of the problem (writing them separately) and the relationship between them (Phase 1); ii) Assume the problem as solved by designating a numerical hypothetical quantity to one of the unknowns, obtaining as of it, the numerical quantity of the other unknowns (from both the main and the secondary) (Phase 2); iii) To compare two numerical quantities meaning the same in the context of the problem (Phase 3), which is a essential background so the student can build the sense of use of the equivalence between two algebraic expressions of the equation symbolizing a problem (Phases 4 and 5). The Phases 6 and 7 of the analytical method of numerical exploration are linked to the syntactical part of the didactical model which is yet unpublished [Rubio, 1995], where a method to solve families of progressive complexity equations is used.

**I. The Preparatory Analysis.** The 1<sup>st</sup> interview shows us that the use of the “numerical analysis” included in the numerical approach, Phases 2 and 3, requires a previous analytical process, which we will call “preparatory analysis”. Here the student must write the unknowns separately (make the unknowns explicit) and understand what is the relationship between them. The following episode shows that student Berenice can use the analysis (“numerical analysis”) successively and be able to symbolize the problem with one equation until she is able to establish clearly the relationship between the unknowns. The interview begins when Berenice is posed with the problem of the belt which says: *“For \$4.80 a belt and its buckle was bought. If the belt costs \$4 more than the buckle, how much does each thing cost separately?”*. The student reads the problem and writes the unknowns down as a list: price of the belt and price of the buckle (Phase 1). Then, she goes to Phase 2, which she does not obey since she does not designate an arbitrary numerical amount to one of the

unknowns, but she wrongly establishes that the price of the belt is 4 dollars. Let us see:

Interviewer: ...Why do you write the price of the belt there... which is four?

Berenice: Because it says here that it costs 4 dollars... [Later, she is told:

Interviewer: ...Then, why do they ask you how much does the belt and the buckle cost?  
...Where does it say... the belt cost this much?

Berenice: The belt costs four dollars more than the buckle. [Berenice realizes that there is a comparison relationship between the unknowns]

Interviewer: If, for example, your shirt costs \$4 more than my sock...? Have explained myself?

Berenice: Then it will be how much does each thing cost!

This evidences that it is only until Berenice realizes that there is a comparison relationships between the unknowns of the problem that she can carry out the “preparatory analysis” and pass to the use of the “numerical analysis” (Phases 2 and 3) and finally symbolize the problem with the equation (Phases 4 and 5):  $w+w+4=4.80$ , where  $w$  is the value of the buckle.

**II. Progressive Construction of Meanings for Algebraic Expressions.** In the 2<sup>nd</sup> interview, Berenice was posed two problems of the same type, but of greater complexity. It could be seen that she advanced in her analytical development since she carried out a correct “preparatory analysis” and used the analysis (“numerical analysis”) properly. However, once she symbolized the following problem (Phases 4 and 5): “*21400 will be distributed among three persons in such a way that the first person has half of the second and the third what the other two have together. How much does every person received?*” with the equation:  $x+x/2+x+x/2=21,400$ , where “ $x$ ” is what the 2<sup>nd</sup> person has, she had problems expressing which was the meaning of the algebraic expression  $x/2$ . Let us see:

Interviewer:... What does the  $x/2$  is?

Berenice: Half of the  $x$  value

Interviewer: And in the problem, what does it represent?

Berenice: The money of the second person is half of the first one [she is only translating]

Interviewer: Then, what does  $x/2$  is? ... the numbers can help and tell you what it is..

Berenice: ...the money of the first person.

Once Berenice gives the meaning of  $x/2$ , she says that:  $x+x/2$  is the money of the 3<sup>rd</sup> person and that “ $x+x/2+x+x/2$ ” is the total of the money distributed.

**III. The Analytical Development in a New but Simple Problem.** In the 3<sup>rd</sup> interview, Berenice was presented with the problem: “There are chickens and rabbits

in a stock-yard, the heads are counted and are 460; the feet are counted and are 1492. How many chickens and how many rabbits are there in the stock-yard?" which has a different scheme from the others she has faced until now. She shows her analytical development by using the "preparatory analysis" (Phase 1) and the "numerical analysis" (Phases 2 and 3) achieving the symbolization with one equation (Phases 4 and 5):  $2(460-X) + 4X = 1492$ . She is able to identify the meaning of each term of the equation and what is the most relevant for her algebraic development is that she gives a sense of algebraic use to the equal sign when she says that:  $2(460-X) + 4X$  is equivalent to 1492 because both represent the total number of feet.

**IV. A New Problem Where an Obstacle Arises and Which Impedes to Continue with the Analytical Development.** In another part of the interview, Berenice faced the *Problem of the guided tour*: *One group of students has to do a collection to pay a guided tour. If each one of them gave \$62, they would be lacking \$200. If each one gave \$82, then they will have \$1000 in excess. How many students are there in the group?*, which is totally new for her since at until this moment of the interview she had only faced problems symbolized with one equation, where in one of its sides is a number and this problem is symbolized with an algebraic equation (of the type  $ax + b = cx + b$ ). This and other similar problems served to evidence the presence of an obstacle of semantic order (linked to the construction of meanings for the equivalence of two "quantities" that represent the same in the context of the problem) which impedes Berenice to continue with the analysis and symbolization of the problem using an equation and stopping her analytical development and algebraic. The above makes us think that problems of this kind will comprise a "didactical cut" (Fillo, Rojano, 1989) of semantic order, since it is created before the student had obtained the equation.

**A) The Analytical Process Before the Obstacle Arises.** Berenice follows Phases 1, 2 and 3 of the analytical method of numerical exploration to solve the "problem of the guided visit" carrying out the "preparatory analysis", where she makes the unknown "number of students" explicit. Once this is done, she uses the "numerical analysis" (assuming that 80 students is the solution) to obtain the relationships of the problem, establishing the comparison between two numerical quantities that mean the same in the problem (the total of the money paid), which is written as follows:  $\$5160 = \$5560$ ? Although Berenice manages to obtain this comparison, she is not able to give sense to its use yet. It must be said that the latter is not only the culminant aspect of the analytical process, but also what allows the advancement in the analytical and algebraic development, since as of such comparison the equation symbolizing the problem can be obtained, as well as to give sense to the equivalence of two different algebraic expressions.

**B) The Interruption of the Analytical Process When a Obstacle Arises.** The following episode shows that a obstacle arises in Phase 4 (which specifies to work backwards as of the comparison, in this case:  $\$5160 = \$5560$ ?, recovering the operations made to obtain the quantities comprising the comparison). Berenice writes

under 5160 the addition:  $4960+200$ , but when writing the operation where the 5560 came from, she erases what she just wrote. This indicates the presence of an obstacle, linked with negative cognitive tendencies [Fillooy, 1991], that impede her to continue with the recovery process of operations in both sides of the comparison. Let us see:

Interviewer: Why did you erase?

Berenice: Because for me ... I believe ... the comparison of these two results are different and I don not know exactly if this [she points out the amount of 5560 pesos which is at the right side of the comparison] ...well, this is not the correct one ... and it is what I was going to write as the result.

It can be observed that the obstacle is connected to the cognitive tension she still has between the arithmetic and equivalence uses (algebraic) of the equal sign being noticed that the first one prevails in spite that moments before she had used this notion in Phase 3 by comparing two numerical “quantities” ( $5160 = 5560?$ ), which mean the same in the problem’s context. She interprets the numerical quantities of such comparison as two different and isolated results, where the 5560 is considered as the result of what is in the left side. This represents a problem for Berenice since she knows it is not correct due that 5560 was obtained from numerical operations different to those in the left side of the equal sign. She solves the question incorrectly by saying that 5560 is not the correct value and erasing all what she had done.

The obstacle also impeded Berenice to resume the Phases of the analytical method of numerical exploration and give sense to the comparison and recover the operations:

Interviewer: ...What have you written in the comparison?

Berenice: The total of money of... [she points out to the amounts 5160 and 5560]

Interviewer: ...And, is not it what you want?

Berenice: No...

Interviewer: Don’t you want to compare the total of money?

Berenice: No.

In order to overcome the obstacles that have arose, Berenice is reminded that the sense of phase 3 is to compare two quantities that mean the same in the problem and when recovering operations she has to forget about the meanings of the operations, which she can resume later when solving the problem. Then she says with a smile:

Berenice: Yes, but because Phase 4 says that we have to recover the operations, then I have to recover the two operations I made.

Finally, the student can detach from the obstacles giving sense to the comparison:  $5160 = 5560?$  and to the recovery of operations of both numerical quantities. As of this, she achieves giving sense to the equivalence between the two algebraic expressions of the equation  $62X+200=80X-1000$  that she obtained by following Phases 4 and 5 of the numerical exploration method. Let us see:

Interviewer: What is all this? [Pointing out to 62X+200]

Berenice: is all they collect to go to the guided tour

Interviewer: What is all this? [Pointing out to 82X – 1000]

Berenice: The money they needed to go to the guided visit

Interviewer: What are we going to find upon the solution of the equation?

Berenice: The number...of students.

## CONCLUSIONS

As it can be observed in the episodes of Berenice's interviews, the use of the numerical exploration method to solve algebraic-arithmetic word problems was determining to develop the analytical ability of the student. The empirical evidences obtained in the experimental work (more than 20 hours of videotaped interviews with six students from three stratum of knowledge are kept) show that such development was fundamental so the students of the study were able to progress in the symbolization of new problems of progressive complexity and in the creation of meanings for algebraic expressions contained in the equations that represent the problems. The study also revealed two different and complementary analytical moments in the symbolization process of a problem: i) the "preliminary analysis", which is the moment when the unknowns must be made explicit and the relationships between them (if there is more than one unknown) must be understood, and ii) the use of the analysis ("numerical analysis") which begins with the assumption that the problem is solved and has its culminant point when the comparison between two quantities having the same meaning in the context of the problem is established and that it ends when acquiring the equation symbolizing such problem.

The investigation also evidenced that when using the analysis ("Analysis is at the Heart of Algebra", Chabornneau, 1996) within a stratum language more concrete than the algebraic one, as the one comprised in the analytic method of numerical exploration, allows the student to produce meanings with which he/she can give sense, first, to the equivalence of two "quantities" that represent the same in the problem and, as of this, to the equivalence between the two algebraic expressions contained in the equation symbolizing the problem. It was observed that the development of these skills resulted as fundamental to symbolize and solve an arithmetic-algebraic word problem and to advance in the competent use of the algebraic language. Finally, the empirical research allowed to prove the presence of obstacles that obstruct the continuation of the analytical process in order to symbolize a problem. An obstacle of this kind, linked to the tension between the arithmetic use and the equivalence use of the equal sign [Kieran, 1981] arise when the students are presented for the first time a problem that is symbolized with an algebraic equation. It is thought that this obstacle presents a "didactical cut", of semantic order, in the transit of the arithmetic thought to the algebraic one.

We thank the observations made by Dr. Aurora Gallardo on this document.

## References:

- Bednarz, N., Dufour-Janvier, B. (1994). The emergence and development of algebra in a problem solving context: a problem analysis. In J. da Ponte, J. Matos (Eds). *Proceedings of the 18<sup>th</sup> international conference of PME*. Lisbonne, Portugal, vol 1, p. 64-71.
- Bednarz, N., (2001). A problem solving approach to álgebra: Accounting for reasonings and notations developed by students. In H. Chick, K. Stacey, J. Vincent, J. Vincent (Eds) *Proceedings of the 12<sup>th</sup> ICMI Study Conference: The Future of the Teaching and Learning of Algebra*, vol 1, pp 69-78. The University of Melbourne.
- Charbonneau, L. (1996). From Euclid to Descartes: Algebra and its relation to Geometry. In Bednarz, N., Kieran C., Lee L. (Eds) *Approaches To Algebra. Perspectives for Research and Teaching*. Dordrech, Kluwer Academic Publishers, pp. 15- 38.
- Filloy, E. (1991). Cognitive tendencies and abstraction processes in algebra learning, in Furinghetti (ed), *Proceedings of the 15<sup>th</sup> International Conference for the Psychology of Mathematics Education*, vol 2, pp.48-56. Assisi, Italy.
- Filloy, E., & Rojano, T. (1989). Solving Equations: The Transition from Arithmetic to Algebra. *For the Learning of Mathematics*, vol 9, no 2.
- Filloy, E. & Rubio, G. (1993). Didactic Models, Cognition and Competence in the Solutions of Arithmetic & Algebra Word Problems, in Hirabayashi, I. et al. (eds). *Proceedings of the 17<sup>th</sup> International Conference for the Psychology of Mathematics Education*, vol I, pp. 154-161. University of Tsukuba, Japan.
- Filloy, E., Rojano, T., & Solares, A.. (2002). Cognitive tendencies and abstraction processes in algebra learning. A.Cockburn & E.Nardi (eds), *Proceedings of the 26<sup>th</sup> Conference for the PME*. Vol 4, pp 145-152. Norwich, UK.
- Kieran, C. (1981). Concepts associated with the equality symbol. *Educational Studies in Mathematics*, 12, 317-326.
- Piaget, J. (1979). “Los problemas principales de la epistemología de la matemática”. *Tratado de lógica y conocimiento científico*. Ed. Paidos , 170-182. Buenos Aires, 1979. (Original version: *Logique et connaissance scientifique*. Gallimard, Paris).
- Radford, L. (1996). “The roles of geometry and arithmetic in the development of algebra: Historical remarks from a didactic perspective”. In N. Bednarz, C. Kieran and L. Lee (Eds.) *Approaches To Algebra. Perspectives for Research and Teaching*. Dordrech, Kluwer Academic Publishers, pp. 39-54.
- Rubio G. (1994). *Modelos Didácticos para Resolver Problemas Verbales Aritmético-Algebraicos*. Tesis Teóricas y Observación Empírica. (Doctoral dissertation. Departamento de Matemática Educativa del CINVESTAV, México).
- Rubio, G. (1995). *Un método evolutivo para resolver familias de ecuaciones de complejidad progresiva*. unpublised.
- Rubio, G. (2002). Solution of Word Problems Through a Numerical Approach. Evidences on the detachment of the arithmetical use of the unknown and the construction of its algebraic sense by pre-university students, in A.Cockburn & E.Nardi (eds), *Proceedings of the 26<sup>th</sup> Conference for the PME*. Vol 4, pp 145-152. Norwich, UK.

# LANGUAGE AND CONCEPT DEVELOPMENT IN GEOMETRY

Frode Rønning

Sør-Trøndelag University College, Trondheim, Norway

*The object of this paper is to present and analyze some observations of the language children in 1<sup>st</sup> grade (6-7 years old) use when they talk about geometrical objects. The observations are made during a number of encounters with the pupils during one year. The work is part of an ongoing collaboration project between a university college and a primary school. The work can be described as empirical research centered around teaching units where the researcher partly has been a passive observer and partly an active participant in the process. The analysis is based on constructivistic theory and theory about levels of development.*

The pupils in this study started in 1<sup>st</sup> grade in August, and the episodes that are described took place in the period from October to February. I want to investigate how these children develop their language and concepts about geometrical objects in various surroundings, using various artefacts and being subject to varying degree of interaction from me. More precisely I want to get information about what properties of the geometrical objects they seem to notice, how they describe these properties, and how they construct names for geometrical objects for which they have not already learnt a name. The main purpose of obtaining such information is to improve the possibilities for the teacher to meet the pupil on his/her level and with an appropriate language in order to initiate better learning. In the teaching units (episodes) that I will describe, I sometimes use the Norwegian words for mathematical concepts. In these cases the word is marked with (NO), and I also give the literal translation (lit.) from Norwegian to English, which sometimes differ from the usual English word.

## **THEORETICAL FRAMEWORK**

One important theoretical basis for the study is social constructivism. Steffe and Tzur (1994) discuss the relation between social interaction and radical constructivism. Many authors interpret constructivistic learning as a process that takes place in solitude, where the learner constructs his/her knowledge in the absence of social interaction. As Jaworski (1994) points out part of the reason why constructivistic learning has been viewed as an individual and lonely process is due to Piaget whose view of the learner is more that of an individual than that of a social participant. Steffe and Tzur (1994, p. 9) view learning as “the capability of an individual to change his or her conceptual structures in response to perturbation.” In the episodes that I will describe I will discuss how concepts and language may have developed in different ways due to the degree of interaction with me (degree of perturbation).



Steffe and Tzur (ibid., p. 24) further state that

“Children cannot construct our knowledge, because our knowledge is essentially inaccessible to them. The best they can do is to modify their own knowledge as a result of interacting with us and with each other.”

Similarly the children’s knowledge is also inaccessible to us. In order to learn as much as possible about their mathematical knowledge I will argue that it is valuable to observe and interact with the children in as many different situations as possible. By doing this we can better adjust our actions in order to modify the children’s knowledge in the direction that we want it to develop. This is in accordance with Steffe and Tzur (ibid., p. 12) when they state the following:

”The mathematics of children is not independent of our mathematical concepts and operations because it is constructed partially through their interactions with our goals, intentions, language and actions.”

The process of constructing permanent objects is discussed by von Glasersfeld (1995) where he refers to a fundamental work by Piaget (1937). A crucial point in this discussion is the difference between *recognition* and *re-presentation*. Recognition has to do with our ability to recognize an object from some, possibly partial, presentation in our perceptual field. On the other hand, re-presentation has to do with the ability to construct to oneself an image of an object without being exposed to a presentation of it. The difference between these concepts will play a crucial role in some of the examples that will be presented later. When a pupil is able to re-present a concept, I consider the concept to be developed to a higher level than if only the ability of recognition is present.

Another important theoretical basis for my study is the van Hiele theory (levels) of geometrical thinking. In the literature the number of levels varies from three to five (or even six). I shall be concerned only with the first two levels, here in the formulation of Schoenfeld (1986, p. 251).

*First level:* Gestalt recognition of figures. Students recognize entities such as squares and triangles, but they recognize them as wholes; they do not identify properties or determining characteristics of those figures.

*Second level:* Analysis of individual figures. Students are capable of determining objects by their properties.

Going from the first to the second level, the students move from a visual recognition of the objects to a more descriptive and analytic recognition. The next levels are of a more abstract/relational nature. Nickson (2000) discusses a reconceptualization of the van Hiele level 1, presented by Clements *et.al.* (1997):

“Their results suggest that on this level children are not merely interpreting shapes visually, but they are thinking in a more syncretic way and bringing together visual responses with some recognition of the components and properties of shape.” (Nickson 2000, p. 62).



I will later refer to this as level 1+.

## METHOD

Methodologically the study resembles what Wittmann (1998) describes as “empirical research centered around teaching units”. Data have been collected in different ways depending on my role in the various teaching units. In cases where I have been an active participant the content of the important episodes has been written down right after they took place. When I have played the role of a passive observer, I have taken notes of conversations during the process and pictures of the scenes. All pupils involved came from the same class, but I am not working with a fixed group of pupils throughout the study.

## DESCRIPTION AND ANALYSIS OF THE EPISODES

The first episodes take place in a cathedral. I accompanied the pupils during an excursion to the cathedral, and we looked for geometrical shapes and discussed what names to give to them. Here I was taking an active part in the dialogues. In the cathedral geometrical objects can be met in somewhat different surroundings than in



Figure 1

everyday life, and we also have the opportunity to see objects that are not so often seen elsewhere. An example of this is that in the cathedral the children became very aware of the concept of the octagon, various eightfold symmetries and other occurrences of the number eight. The high altar of the cathedral is surrounded by walls, and the floor inside of these walls is shaped like a large octagon (Figure 1).

There are actually only seven walls, because there is an opening facing the choir of the church (to the right in Figure 1). The pupils and I looked at the shape of the floor and I asked if they could see what kind of geometrical figure this floor was shaped like. It should be mentioned that before the excursion to the cathedral the children had worked with geometrical shapes, and they were familiar with certain triangles and quadrilaterals. They even knew names like square and rectangle. No suggestions for the shape of the floor came up, so I introduced an interaction by suggesting that we should try to find out how many edges and corners the surrounding walls had. I told the children to walk along the walls and count up every time they passed a corner. When we reached the start of ‘the missing wall’ they had counted to seven. One pupil said: “If there had been a wall from here to where we started, it would have been eight, so it must be an *åttekant*” (NO: *Åttekant* = octagon, lit.: eight-edge). I interpret this in the following way: Based on the concept that this pupil has of triangles (NO: *Trekant*, lit.: three-edge) and quadrilaterals (NO: *Firkant*, lit.: four-edge) as figures with three, respectively four edges, she is able to generalize to the concept ‘*åttekant*’ because there were eight edges (NO: *kanter*).

Shortly after this little episode the pupils discovered that some of the columns in the church were also shaped like an octagon. Although the perimeter of the columns was

much shorter than the perimeter of the octagon around the altar, and the columns actually were solid octagonal cylinders, the pupils could apply the concept by focusing on the property of having eight edges. What they actually did also with the columns was to walk around them, counting the edges. Some of the columns have a different shape, not so easy to describe with simple mathematical terms, and they also investigated these columns and discussed what name to give to the shape based on the properties they observed.

My understanding of the pupils' level of understanding here agrees with the van Hiele level 1+ , as they seem to focus on *some* properties of the octagon (eight edges) and not on a holistic recognition of the figure. There is, however, no evidence in this observation that they have identified other properties of the octagon, other than the eight edges.

The cathedral's main appearance is that of a gothic cathedral, but the oldest parts of it have roman arches, both as openings and as decorations on the walls. The children observed some of these arches and their first interest was to count them. On one of the walls there were 11. Afterwards I asked the children what names they would give to these arches. What did the arches look like? They answered that they looked like circles, but they were not complete (NO: hele, lit.: whole). So I asked how much of a circle they were. They said one half and suggested that we should call them half circles (NO: halvsirkel). The class teacher could confirm that they had worked with the concept 'circle' before, but not 'half circle'. In this case I propose that the children themselves constructed a new word based on their previous experience with the concept 'half' and the concept 'circle'.



Figure 2

The next episode takes place in the classroom where I did some paper folding activities together with the children. I wanted them to make an eight-pointed star. The activity involved folding eight pieces of paper, and then gluing these pieces together to a star with eight arms. Each piece has the shape shown in Figure 2. I asked what name they would give to this object. At first I did not get any suggestion, and I did not give any clues. Although they were familiar with quadrilaterals like

squares and rectangles, they did not seem to recognize this object as a quadrilateral.

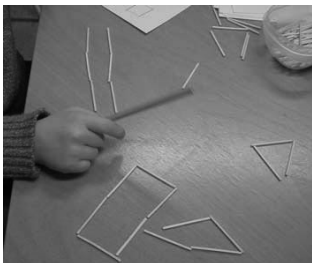
After a while one pupil suggested that we should call it a 'to-trekant' (lit.: two-three-edge). I interpret this suggestion to mean that the pupil sees two triangles (NO: to trekant) put together, and hence gives to it a name that for him is natural, namely a 'to-trekant'.

I did not pursue this at the time because we were too busy making the star, but I see that if we had been able to agree that the object also could be called a quadrilateral, we would have had the opportunity to discover the property that *a quadrilateral can be divided into two triangles*. The point to make here is that the children's naming can be a good starting point for discovering further properties of the objects.

The episodes with the ‘half circles’ and the ‘two triangle’ are two episodes where a child is naming an object from looking at the object, and observing some properties of the object that he/she is familiar with. In one episode, with the half circle, this led to the concept which is generally used for that type of object, in the other episode it did not. It is possible that the outcome of the first episode was influenced by my leading questions. If given more time without my influence, the children might have come up with other suggestions. In the second episode the name (to-trekant = two-triangle) came up without any leading questions, although there was interaction on my part just by drawing attention to the figure. These two episodes seem to fit with the ideas of Steffe and Tzur (1994) that the children’s concepts and language is developed and modified as a result of interaction, and in different ways depending of the nature of the interaction.

In the next two episodes the pupils work with given tasks without much interference from others. A student teacher is leading the work, and I am a passive observer. I take notes of the dialogues and pictures of the objects that are produced. The children communicate with the student teacher and with each other. My main interest here is to analyze the level of development of the concepts that are being handled.

The first episode consists of two tasks. The first task is to sort and categorize geometrical objects. The pupils were shown various geometrical objects made of colored plastic, and with a very distinct shape such as regular triangles, other simple polygons and circles. They were asked to name the objects, and this they could do



without hesitating. Most often they would use mathematical terms like rectangle and circle. One of the objects they were shown was a regular hexagon, and they answered that ‘this is a sekskant’ (NO: sekskant = hexagon, lit: six-edge). The next task was to construct polygons with sticks of equal length given the name of the polygon. When they were asked to make a hexagon out of the sticks, two of the suggestions that came up can be seen to the left in Figure 3.

Figure 3

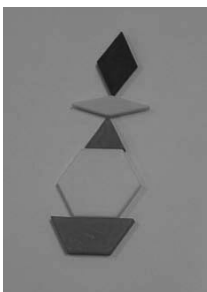
In both attempts they have grasped the idea that a hexagon should consist of six sticks, but also in both cases the idea of six vertices is missing. In the proposed hexagon on top left the edges are not even connected. These are the same pupils that give the name ‘sekskant’ to the regularly shaped plastic piece that they are shown, but when asked to make a ‘sekskant’ they do not copy the plastic piece, but construct an object that has some of the properties that the plastic piece has. Also here I see a situation where *some* properties of the objects are used to construct the figures. The two tasks differ, from the viewpoint of the observing teacher, in the sense that the second task contains more possibilities to obtain information about the level of development. The experiment with the plastic hexagon indicates that only a gestalt

recognition is taking place, whereas the experiment with the sticks suggests that the property of being composed of six sticks is identified, and at the same time the idea of six vertices is missing.

In view of the language of von Glasersfeld (1995) my interpretation of this incident is that the children were able to *recognize* the hexagon, but they were not able to *re-present* it. Or better, they were able to re-present some of the properties of a hexagon, but not all, which again fits with van Hiele level 1+. The two tasks also show the characteristics of *synthetic* and *analytic* tasks, as these terms often are used in arithmetic to describe the difference between a task like “ $4 + 2 =$ ” (synthetic) and “how can you partition these six elements:  $\blacklozenge\blacklozenge\blacklozenge\blacklozenge\blacklozenge\blacklozenge$ ?” (analytic) (Olsson 2000).

In the last episode the setting is that two pupils are sitting back to back, with access to the same geometrical objects (plastic pieces). One is making a figure out of these pieces without the other seeing it, and the task is to describe the figure so that the other can copy it. In the first task the figure is shown in Figure 4.

We enter the conversation when the rhombus, second piece from the top, shall be put in its place. Pupil 1 is going to describe what piece to pick and how to place it.



Protocol I

P1: “Long, white, kind of quadrilateral, really long, thickest in the middle, thinnest on the tips.”

P2 (immediately choosing the right piece): “What way?”

P1: “The lower tip on top of the triangle.”

P2 (not understanding): “What lower tip?”

P1: “Both of the longest sides outwards.”

P2 puts the piece down correctly.

Figure 4

P1 does not have a precise word for this type of object, a rhombus, but still he is able to describe it very well: It is a quadrilateral, although only ‘kind of’, because for children of this age quadrilateral (NO: firkant) is very often used only for the square. It seems that this boy is starting to develop a more general concept of a quadrilateral by allowing the rhombus to be ‘kind of quadrilateral’. When P2 does not understand which way he shall place the figure, P1 is able to use one more characteristic property of this rhombus, namely that the diagonals are not equally long. He expresses this by saying that the sides are not equally long, which they of course are, but it is clear what he means, and it immediately makes P2 choose the correct piece. In fact P1 uses the property with the non-equal diagonals already in his description in the beginning when he says that the figure is ‘thickest in the middle, thinnest on the tips’. Again I propose that the level of development fits with van Hiele level 2 or 1+.

In the next task we see in Figure 5 the original object to the right and the copy to the left. Here is the conversation:

Protocol II

P1: “First a round piece. Thick. Then a rectangle.”

P2: “On top?”

P1: “Yes.”

P2: “What way?”

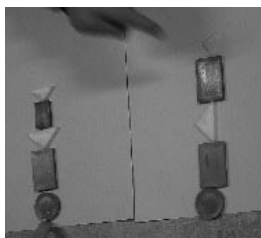
P1: “Not like outwards, but upwards. Then almost a triangle, but not quite. Slightly longer.”

P2: “What way?”

P1: “The tip at the bottom.”

P2: “What tip? The upper or the lower?”

P1: “The longest side downwards. Then a red, thick rectangle placed like the blue one.”



The main confusion here is about placing the triangle. When P2 does not understand how to place the tip, P1 changes his strategy and starts to talk about the direction of the longest side. Still, it does not give the desired result. We notice also that the last rectangle is not correct because P1 failed to say that it should be a red, thick, *big* rectangle.

Figure 5

The most interesting in the last conversation, I find, is the way the triangle is described. P1 says that it is ‘almost a triangle, but not quite’. This is the same boy that in the previous task described a rhombus as being ‘kind of quadrilateral’. When talking to the boy afterwards he emphasized his opinion by saying that “it has three edges (NO: tre kanter), but it is not a triangle (NO: trekant)”. I did not get a clear statement about what it takes to be a triangle, but I assume that he meant a regular triangle. If so this is the first time I have heard the word triangle reserved for regular triangles, whereas the corresponding phenomenon with quadrilaterals is very common.

## CONCLUSION

From the observations made in this study I find that the pupils at an early stage start to identify properties of geometrical objects, although they are not able to see all properties of the object, let alone define the object. Sometimes they are also not able to describe the properties correctly, as in the case with the rhombus whose position was described as ‘having both the longest sides outwards’ (Protocol I). Hence, my findings support the revised van Hiele level 1 as suggested by Clements *et al.* (1997).

To get insight into the pupils' level of development I argue that it is important to perform tasks of both synthetic and analytic nature. In the example with the hexagon the second task gave more specific information about the pupils' level of development than the first one, information that is valuable for the teacher's further work. The study also suggests that the language that the pupils develop may be sensible to the interaction of the teacher. If the language can be developed in a relatively free manner, it might give the teacher valuable information to take into consideration when designing further teaching for the pupils.

## References:

- Clements, D.D., Sarama, J. and Swaminathan, S. (1997). Young children's concept of shape. *Proceedings of the 21<sup>st</sup> Conference of the International Group for Mathematics Education*. 2, 161-168.
- Glaserfeld, E. von (1995). *Radical Constructivism: A Way of Knowing and Learning*, London: Routledge/Falmer.
- Jaworski, B. (1994). *Investigating Mathematics Teaching*, London: Routledge/Falmer.
- Nickson, M. (2000). *Teaching and Learning Mathematics*, London: Continuum.
- Olsson, I. (2000). Att skapa möjligheter att förstå. In: Wallby, K. et al (Eds.) *Nämnamnaren – TEMA: Matematik från början*, Göteborg: Institutionen för ämnesdidaktik, Göteborgs universitet.
- Piaget, J. (1937). *La construction du réel chez l'enfant* (The construction of reality in the child, Translation, M. Cook, New York, Basic Books, 1971), Neuchâtel: Delachaux et Niestlé.
- Schoenfeld, A.H. (1986). On Having and Using Geometric Knowledge. In: Hiebert, J. (Ed.) *Conceptual and Procedural Knowledge: The Case of Mathematics*, Hillsdale NJ: Lawrence Erlbaum.
- Steffe, L.P. and Tzur, R. (1994). Interaction and Children's Mathematics. In: Ernest, P. (Ed.) *Constructing Mathematical Knowledge: Epistemology and Mathematical Education*, London: Routledge/Falmer.
- Wittmann, E. Ch. (1998). Mathematics Education as a 'Design Science'. In Sierpiska, A. and Kilpatrick, J. *Mathematics Education as a Research Domain*. Dordrecht: Kluwer Academic Publishers.

# THE ROLE OF GESTURES IN CONCEPTUALISATION: AN EXPLORATORY STUDY ON THE INTEGRAL FUNCTION

Cristina Sabena

Dipartimento di Matematica, Università di Torino

*The paper reports on a case study from a teaching experiment on the construction of meaning of integral at secondary school level, starting from the cognitive root of area. In the considered activity, students are faced with some graphs of functions and are asked to work in group to trace the corresponding integral functions. The analysis considers the gesture-speech relationship and is carried out integrating cognitive and semiotic perspectives. The aim is to study how gestures enter in the process of conceptualisation, in a context of social construction of knowledge.*

## INTRODUCTION AND THEORETICAL FRAMEWORK

Despite their simple appearance, graphs of functions are very complex mathematical objects. Far from being transparent with respect to their meaning, they carry in a holistic and compressed way a big amount of information. To cope with graphs and effectively use them to interpret, model, or build new relations involves making use (often in an unconscious way) of different resources, among which language and gestures play important roles. The focus of this paper is to analyse how gestures intervene in the construction of meaning for the integral function, as a case of conceptualisation process in a functional context.

The relation between gestures, language and conceptual processing is still debated. Different hypothesis have emerged in psycholinguistics, among which the Lexical Retrieval Hypothesis and the Information Packaging Hypothesis (Kita, 2000). Whereas the former restricts the role of gesture in giving lexical access to generate sentences, the latter recognizes it as having an essential role not only in the process of *speaking*, but also in that of *thinking*: it states that “gesture is involved in the *conceptual planning* of the message to be verbalised, in that it helps speakers to “package” spatial information into units appropriate for verbalisation” (Alibali et al., 2000, italics in the original). Studying the relationships between gesture and speech, some researchers have identified the *gesture-speech match*, when a gesture expresses the same information conveyed by the verbal utterance, and the *gesture-speech mismatch*, when a gesture contains information not expressed in the uttered speech (Alibali et al., 2000; Goldin-Meadow, 2000). Kita (2000) argues: “[gesture-speech] discordance appears because spatio-motoric thinking explores organizing of information that analytic thinking cannot readily reach”. *Spatio-motoric thinking* and *analytic thinking* constitute two different yet complementary modes of thinking: the former “organizes information with action schemas and their modulation according to the features of the environment” (ibid.), whereas the latter “organizes information by hierarchically structuring decontextualized conceptual templates” (ibid.). McNeill

(1992), on a different position, maintains that for the speaker gesture and speech form complementary yet intricately interwoven parts of a *single integrated system*, and that they together allow constructing multiple representations of a single task.

The link between gesture and language seems to have neural basis, thus lying in the very nature of human body. Rizzolatti and his colleagues in their neurophysiological studies on monkeys have found the existence of some single neurons, dubbed as *mirror neurons*, that are active both when the subject makes particular gestures of reaching and when it watches a person making the same gesture (Rizzolatti & Arbib, 1998). By representing the observed action in terms of internal motor encoding, the mirror neurons construct a link between self-actions and observed actions, thus providing a mechanism for the sharing of meaning. These cells are in an area (homologous to Broca's area in the human brain) that is critically involved in the programming of human speech. According to Rizzolatti, this supports the hypothesis of a gestural origin of language in human evolution: the impulse to imitate the chains of actions performed by our fellows would have brought about, through the inhibition of the physical action, the transfer of the imitation to a symbolic level.

In science education, the role of gesture has been taken into account for instance by Roth (2002). Analysing videotaped science classes of all levels, he has found that independently of the age, individuals draw a lot in gesture, especially when, in laboratory context, they have to explain facts and things they are not yet familiar with. In his perspective, "gestures are not only a co-expression of meaning in a different modality but also constitute an important stepping stone in the evolution of discourse" (ibid.).

With respect to mathematics, recent studies have begun to analyse the gesture component in the learning context, as a means of gaining information about the cognitive processes of a subject (see Edwards, 2003; Arzarello & Robutti, in print). Developing from the work of McNeill (1992), a classification of different kinds of gestures has been pointed out, identifying: *deictic* gestures (pointing to an object), *metaphoric* gestures (the content represents an abstract idea that has no physical form), and *iconic* gestures (bearing a relation of resemblance to the semantic content). The iconic gesture has been further analysed: Edwards (2003) refers to *iconic-physical* gesture in the case of concrete or physical referent, and to *iconic-symbolic* gesture if it relates to "written symbolic or graphical inscriptions, and/or to the procedures associated with these inscriptions"; Arzarello and Robutti (in print) speak of *iconic-representational* gesture when it refers specifically to graphs or other graphic representations of mathematical concepts.

In a semiotic-cultural perspective, Radford considers gestures as a type of signs. He has called *semiotic nodes* those "pieces of the students' semiotic activity, where action, gesture, and word work together to achieve knowledge objectification" (Radford et al., 2003). Conceptualising is seen in terms of objectifying knowledge, that is making things and relations apparent in the universe of discourse (ibid.).



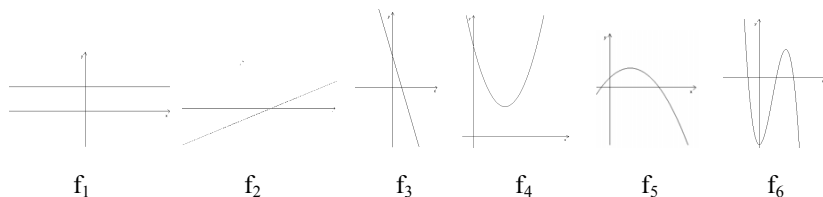
In this report, the relations between gestures, language and the process of conceptualisation are looked at through two interpretative lenses: the cognitive one, which considers how gestures enter in the thinking processes of individuals, and the semiotic one, to study how they work as body signs that join the individual to the social practice of mathematics (Radford et al., 2003).

## TEACHING EXPERIMENT

The research is based on a teaching experiment aimed at studying the concept of integral starting from the cognitive root of area under a function (Tall, 2002). It was set up in a secondary school class (from an Italian “Liceo Scientifico”, a scientifically oriented high school) during grades 11, 12 and 13. In grades 11 and 12, before facing calculus, students were involved in activities on area and length measurements and with approximation problems on areas under given functions, using both paper and pencil and symbolic-graphic calculators (Robutti, 2003). The notion of definite integral was thus conceptualised as the area (with sign) under a curve, whereas the traditional approach starts from indefinite integral as inverse of derivative. In the 13<sup>th</sup> grade, the class in calculus course was introduced to limits and derivative, and their meanings with respect to the graph. The integral function was then approached as the function that measures the area (with sign) under a function between two values: one fixed and the other one variable ( $x$ ). The activity presented below focuses on the graphical representation of the integral function and its generation from a given graph. During the whole experiment, students were involved in small group works and in class discussions conducted by the teacher. Both group works and class discussions were video-recorded, thus providing the data for the research.

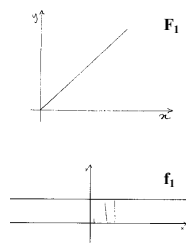
## PROTOCOL ANALYSIS

Groups are given a series of worksheets, with the following task: “Work on the graph from a qualitative point of view: for each of the following functions  $f$ , determine and sketch the corresponding integral function  $F$ ”. At the bottom of each page, the graph of a function is given, and the top of the page is left blank for the drawing of the corresponding integral function. Here are the six functions  $f$ :



One girl and two boys compose the observed group: Erika, Francesco and Fabio. They are brilliant students, with different attitudes towards mathematics: Erika is precise and schematic in her study, Francesco and Fabio are more intuitive.

The group quickly solve the case  $f_1$ , tracing the integral function  $F_1$  as a straight line (the figure is on the right). Then, to cope with case  $f_2$ , whose negative values raise some problems, the students come back to the previous case  $f_1$  and reason on it:





59. Fabio: *Here you have to know* [he is putting his left forefinger on the origin of the Cartesian plane containing  $f_1$ , and with his right one is pointing to the upper straight line  $F_1$ . Then he places his right forefinger on the intersection point between the function  $f_1$  and the  $y$ -axis] *as  $x$  increases...* [he has moved simultaneously both his forefingers from the  $y$ -axis rightwards: the left one on the  $x$ -axis, the right one pointing  $f_1$  and covering the area under it] *how much the area increases* [keeping the left hand in the same position, he is placing his right forefinger on the straight line  $F_1$ ].
60. Erika, overlapping: *How much the area is.*
61. Fabio continues: *How much the area is* [while speaking, he has repeated the previous gesture moving both his forefingers on the same Cartesian plane, and then he has set the right one to the upper straight line  $F_1$ ].
62. Erika and Francesco: *Yes.*
63. Fabio moves simultaneously his forefingers on the sheet: the left one on the  $x$ -axis of the lower Cartesian plane (with  $f_1$ ), from the origin rightwards, and the right one in the corresponding upper Cartesian plane, moving along the function  $F_1$  from left to right. Concluding the movement, he says: *And here it increases more and more... because the more I go ahead, and the more the area increases.*

Using both his hands, Fabio (#59) performs a gesture made of three parts: first he points to the origin of the lower Cartesian plane (containing the given function) and simultaneously to the upper one (containing the traced integral function); then he moves both his fingers on the lower Cartesian plane, depicting the increasing of the abscissa and the resulting behaviour of  $f_1$ ; finally he comes back to the function  $F_1$ . This complex gesture is co-ordinated with a single sentence, forming with it a unique integrated system by which the student carries out several tasks: he copes with the function  $f$ , he links  $f$  with the variation of the subtended area, and conceives it as a new function. The functions (both the given  $f$  and the integral function) are thought in terms of a *covariance view*, that is observing one variable changing respect to another (Slavit, 1997): the simultaneous movement of the forefingers on the Cartesian plane expresses very effectively the two variations and their relation, as a whole phenomenon. To give an account of the situation, the speech, that has an intrinsic linear-ordered structure, has to split it into two consecutive parts (#59: *as  $x$  increases... how much the area increases*). The gesture is not redundant with respect to the speech, since it conveys information left implicit by words, as the starting point for the area variation (that has been fixed at zero by the teacher in introducing the activity) and the positive direction of the increments. It is an *iconic-representational* gesture that, referring to the *metaphoric* structure of the Cartesian plane, represents

the abstract idea of increasing of the variable  $x$ . In line #61 Fabio repeats the same gesture-word schema, and in line #63 he goes further: maintaining the established co-ordination between the two hands, he moves his finger along the graph of the integral function, by successfully correlating it with the given function  $f$ . Differently from the previous ones, the utterance is now partly self-based (#63: *the more I go head*), that is the student takes the point of view of the variable  $x$ . Roth (2002) suggests that the subject-centered perspective, requiring a lower cognitive effort, provides cognitive advantages over abstract perspective and that for this reason is often taken by pupils in early stages of conceptualisation processes. Here the self-based perspective combines with verbs of motion (#63: *I go head...it increases more and more*), describing  $F$  in dynamic terms. The conceptualisation of a curve (a static object) as a dynamic process is very frequent in mathematics and in everyday situations: the cognitive mechanism that allows it has been called *fictive motion* and consists in thinking a line as the motion of a traveller tracing that line (Núñez et al., 1999). In the present case, Fabio has to cope with two variations (the given  $f$  and the varying area under it) expressed in a single graph. By taking the point of view of the variable  $x$  (that refers to  $f$ ), he can concentrate on the behaviour of the function  $F$ , that is the focus of the conceptualisation process. The integral function rises here from the student's co-ordination between gestures and words, in a piece of the semiotic activity that can be recognizes, in Radford's terms, as a *semiotic node*.

The following excerpt regards the group tackling the case  $f_4$ :

128. Erika: *It is this area here* [with her pencil, she is pointing to the area under  $f_4$ , going from the  $y$ -axis rightwards].
129. Fabio: *Yes, yes*.
130. Francesco, reasoning by himself: *It does...* [with a single movement with his forefinger, he sketches on the desk a graph, tracing firstly quickly a vertical line segment, from the top downward, then slowing down the arc of a curve increasing rightwards from the bottom of the segment. The complete figure is represented at this side]. Fabio and Erika are not paying attention to their mate. 
131. Erika traces a Cartesian plane in the upper part of the page.
136. Fabio: *It starts from zero* [he is pointing his pencil at the origin of the Cartesian plane that Erika has just finished tracing].
137. Francesco: *Yes* [with his forefinger he traces in the air in front of himself an arc of a curve similar to that represented at this side, from left to right]. 
138. Fabio goes on, overlapping Francesco: *Like this* [while saying *like this*, with his pencil he is miming (without writing), starting from the origin in the Cartesian plane, an arc similar to that just done by Francesco].

139. Erika: *Here* [she is covering the area under the parabola, from the y-axis to the vertex] *it does like this* [she sketches with her finger on the Cartesian plane, starting from the origin, an arc similar to those of her schoolmates].
140. Fabio: *It increases* [he is repeating his gesture of tracing an arc, as in line #138].
141. Erika: *Up to here* [she is pointing to the vertex of the parabola], *wait...*
142. Fabio: *Up to there.*

After Erika's *deictic gesture* (#128), drawing attention to the area to be represented, Francesco (#130) performs a gesture that can be identified as *iconic-representational*. Unlike the preceding iconic-representational gestures, which refer to graphs already traced on paper, the present one has not any written reference. In a semiotic perspective, it can be interpreted as a sign starting from which the graph (another sign) will later come to life, as a sort of iconic crystallized form of the gestures. It is worth observing that the student begins his representation with a vertical straight movement, which can be interpreted as tracing the *y*-axis: in fact he, rather than using the worksheet, is gesturing on the desk, where he has no reference to relate to. In line 141, Erika's words (#141: *here*) refer to the integral function, whereas her *deictic gesture* points to the given graph *f*: the *gesture-speech mismatch* allows the connection between the two functions.

As it develops, the protocol becomes richer and richer in gestures, which tend to overlap each other and which are accompanied by simple utterances, often deictics that draw group mates' attention to concurrent action (#128, #139, #141, #142). The students neither refer to the integral function with its name, nor giving it any name, rather through the generic pronoun "it" (#63, #130, #136, #139, #140): it is the gesturing that clarifies any ambiguity to the referent, by making perceptually available what is required for sense making. In spite of this gestural abundance, the only descriptive word referring to the integral function is the verb "increases" uttered by Fabio (#140; see also #59, #63, and below, #179).

Let's look at what happens when the students face function  $f_5$ :

172. Erika traces the Cartesian reference in which the integral function is to be sketched.
173. Fabio points his pencil at the origin of the new Cartesian plane and immediately Erika points her pencil towards the Cartesian reference containing the function  $f_5$ .
174. While Fabio keeps his pencil pointed, Erika slowly moves her pencil rightwards along the parabola, up to the vertex.
175. Fabio: *It increases...*
178. Erika: *Here it does like this* [in the new Cartesian reference, she is tracing an arc similar to that represented at this side].
179. Fabio: *It increases...*
180. Erika: *Up to here* [she is pointing to the vertex of the parabola  $f_5$ ].



Without speaking, Erika and Fabio co-ordinate their actions on the worksheet (#172-174). Fabio refers to the origin of the upper Cartesian plane, a “starting point” for the integral function, a sort of “eye” through which he looks at the graph of  $f$  and “sees” how the function  $F$  originates from it (see also #135, #138). The girl focuses attention on the behaviour of the function  $f$ . The resulting *iconic-representational* gesture can be compared with that previously performed by Fabio to analyse the case 1 (#63): in both cases it supports in covariational terms the link between the given graph and the new rising function. It is a sign that, put on the scene by a student, enhances reasoning not only in the subject, but in the whole group. Its features, implicitly established by the social practice, allow its use in a sort of co-operation between the students. In fact, they do not need to explain to each other what they are doing: the scene opens silently and shows very few utterances. Fabio’s and Erika’s words (#175-180) refer to the forthcoming integral function, describing it with in successful connection with gestures. In line #180 the girl performs a *gesture-speech mismatch*, similar to that of line #141, previously discussed.

## CONCLUSIONS

The mathematical context of graphs of functions and the given task have fostered the flourishing of iconic-representational gestures. This kind of gesture appears to be performed not only with reference to represented graphs, already traced on paper (as discussed in Arzarello & Robutti, in print), but also as describers of new functional relations (i.e. the integral functions). They are expressed in graphs that come to exist only after some gestural explorations, as sort of crystallized forms of the preceding gestures. Coping with the given graphs, the students construct the integral function using a covariational view. It is supported in an effective way by the holistic character of gesturing and therefore properly described by language: in McNeill’s terms, gesture can be appointed a mediating role between internal, subjective, “global-synthetic” imagery and shared, conventional, “linear-segmented linguistic structure” (McNeill, 1992).

But gesture’s role goes beyond a cognitive dimension, purely internal to the subject. It is also endowed with an external dimension, coming from its semiotic nature in the social practice of mathematics. Internal and external dimensions of gestures are interwoven and mutual-affecting. Their interplay enhances individuals’ thinking processes and develops a shared semiotic system in which other signs, such as graphic or symbolic representations, can emerge. In such a complex, multi-faced semiotic context, the construction of a mathematical meaning can finally be reached.

The picture portrays the scene leaving in the background two important and pervasive elements: cultural and institutional dimension. Further research is to be undertaken to widen the scope of analysis and to study how student’s culture (in a broad sense) and the teaching practice affect students’ gestures in the context of mathematical conceptualisation. The relationship between the cultural-social contribution and the biological-neural human basis, which is taken into account by recent research in

neurology (Rizzolatti & Gallese, 1997), constitutes an intriguing issue that is still to be clarified.

### **Acknowledgment**

Research funded by the MIUR and the Università di Torino and the Università di Modena e Reggio Emilia (COFIN03 n. 2003011072).

### **References**

- Alibali, M.W., Kita, S. & Young, A.J. (2000). Gesture and the process of speech production: We think, therefore we gesture. *Language and cognitive processes*, 15 (6), 593-613.
- Arzarello, F. & Robutti, O. (in print). Approaching Functions through Motion Experiments. *Educational Studies in Mathematics*.
- Edwards, L.D. (2003). A Natural History of Mathematical Gesture. *American Educational Research Association Annual Conference*, Chicago, April 2003.
- Goldin-Meadow, S. (2000). Beyond Words: The Importance of Gestures to Researchers and Learners. *Child Development*, January/February, vol 71, n° 1, 231-239.
- Kita, S. (2000). How representational gestures help speaking. In: D. McNeill (ed.), *Language and Gesture Window into thought and action*, pp. 162-185. Cambridge, UK: Cambridge University Press.
- McNeill, D. (1992). *Hand and mind: What gestures reveal about thought*. Chicago: University of Chicago Press.
- Núñez, R.E., Edwards, L.D. & Matos, J.F. (1999). Embodied cognition as grounding for situatedness and context in mathematics education. *Educational Studies in Mathematics*, 39, 45-65.
- Radford, L., Demers, S., Guzmán, J. & Cerulli, M. (2003). Calculators, graphs, gestures and the production of meaning. *Proceedings of the 27<sup>th</sup> PME Conference*, Hawaii, vol. 4, 55-62.
- Rizzolatti, G. & Arbib, M.A. (1998). Language within our grasp. *Trends in neuroscience*, 21, 188-194.
- Rizzolatti, G. & Gallese, V. (1997). From action to meaning. In: J.-L. Petit (ed.), *Les neurosciences et la philosophie de l'action*. J. Vrin Paris, 217-229.
- Robutti, O. (2003). Real and virtual calculator: from measurement to definite integral. *CERME 3*, [http://www.dm.unipi.it/~didattica/CERME3/draft/proceedings\\_draft/](http://www.dm.unipi.it/~didattica/CERME3/draft/proceedings_draft/).
- Roth, W-M. (2002). From Action to Discourse: The Bridging Function of Gestures. *Journal of Cognitive Systems Research*, 3, 535-554.
- Slavit, D. (1997). An alternate route to the reification of function. *Educational Studies in Mathematics*, 33, 259-281.
- Tall, D. (2002). Using Technology to Support an Embodied Approach to Learning Concepts in Mathematics. *First Coloquio do Historia e Tecnologia no Ensino de Matemática at Universidade do Estrado do Rio de Janeiro*, February 2002.

# PSYCHOLOGICAL ASPECTS OF GENETIC APPROACH TO TEACHING MATHEMATICS

Ildar S. Safuanov,

Pedagogical Institute of Naberezhnye Chelny

*In this theoretical essay the psychological aspects of genetic approach to teaching mathematics (mainly at universities) are discussed. Analysis of the history and modern state of genetic teaching shows that its psychological aspects may be explained using both Vygotskian and Piagetian frameworks. Experience of practice of mathematical education has been important for the development of genetic approach as well. Furthermore, genetic teaching should be enhanced by stylistic and emotional elements developing students' motivation and interest.*

## PRINCIPLE OF GENETIC APPROACH

The principle of genetic approach in teaching mathematics requires that the method of teaching a subject should be based, as far as possible, on natural ways and methods of knowledge inherent in the science. The teaching should follow ways of the development of knowledge. That is why we say: “genetic principle”, “genetic method”.

Probably, the first who used the expression “genetic teaching” was prominent German educator F.W.A. Diesterweg (1790-1866) in his published in 1835 “Guide to the education of German teachers”: “...The formal purpose requires genetic teaching of all subjects that admit such teaching because that is the way they have arisen or have entered the consciousness of the human ... Though a pupil covers in several years a road that took milleniums for the mankind to travel. However, it is necessary to lead him/her to the target not sightless but sharp-eyed: he/she must perceive truth not as a ready result but discover it...” (Diesterweg, 1962).

Certainly, ideas of genetic principle had been expressed prior to Diesterweg, too. For example, much earlier G.W. Leibnitz (1686) expressed a similar idea: “I tried to write in such way that a learner could always see the inner foundation of things studied, that he could find the source of the discovery and, consequently, understand everything as if he invented that by himself”.

In history and modern state of genetic approach a significant variety of interpretations of the terms “genetic principle”, “genetic method”, “genetic approach to teaching mathematics” is observed... It is clear that today, as noted by Wittenberg (1968, p.127), nobody understands genetic approach as historical, and more appropriate is idea that genetic approach is connected to relevance, which here should be understood as conformity of a method of teaching (and learning) to the most expedient and natural ways of cognition inherent in the given subject (or topic).



Wittenberg is certainly right also in that genetic approach is connected to epistemology, psychology and logic.

Analyzing various interpretations of genetic approach to teaching mathematics in theory and history of mathematics education and taking into account today's experience of teaching undergraduate mathematics and latest achievements of psychology and methods of teaching mathematics, we can reveal the contents and features of genetic approach to teaching mathematical courses in universities.

We will call the teaching of a mathematical discipline *genetic* if it follows natural ways of the origination and application of the mathematical theory. Genetic teaching gives the answer to a question: how the development of the contents of the mathematical theory can be explained?

Genetic teaching of mathematics at universities should have the following properties:

Genetic teaching is based on students' previously acquired knowledge, experience and level of thinking;

For the study of new themes and concepts the problem situations and wide contexts (matching the experience of students) of non-mathematical or mathematical contents are used;

In teaching, various problems and naturally arising questions are widely used, which should be answered by students independently with minimal necessary effective help of the teacher;

Strict and abstract reasonings should be preceded by intuitive or heuristic considerations; construction of theories and concepts of a high level of abstraction can be properly carried out only after accumulation of sufficient (determined by thorough analysis) supply of examples, facts and statements at a lower level of abstraction;

The stimulation of mental and cognitive activity of students should be performed, they should be constantly motivated;

The gradual enrichment of studied mathematical objects by interrelations with other objects, consideration of the studied objects and results from new angles, in new contexts should be carried out.

## **PSYCHOLOGY OF TEACHING AND GENETIC APPROACH**

One of major aspects of genetic approach to teaching mathematics is psychological aspect. As indicated by E.Ch.Wittmann (1992, p. 278), genetic principle should use results of both genetic epistemology of J. Piaget and Soviet psychology based on the concept of activity. Synthesizing not contradicting each other results of two theories concerning construction and development of concepts in the learning process, it is possible to take as a psychological basis of genetic approach to teaching mathematics the following principles of psychology of education:



1) *Principle of problem-oriented teaching*. S.L.Rubinshtein (1989, p. 369) wrote: “The thinking usually starts from a problem or question, from surprise or bewilderment, from a contradiction”. It is similar to Piagetian phenomenon of the violation of balance between assimilation and accommodation. L.S.Vygotsky (1996, p. 168) indicated in 1926 that it is necessary to establish obstacles and difficulties in teaching, at the same time providing students with ways and means for the solution of the tasks posed.

2) *Principle of motivation and development of interest*. L.S.Vygotsky (1996) in “Pedagogical psychology” indicated to the importance of interest and emotional issues in teaching.

3) *Principle of continuity and visual representations*: introducing new contents, it is necessary to maximally use previously generated cognitive structures and visual representations of pupils, familiar contexts. This principle is connected to the Vygotsky's theory of development of scientific concepts (see, e.g., Vygotsky, 1996, p. 86 and 146), and also with his concept of “zone of proximal development”.

4) *Principle of integrity and system approach*: the teaching should aim at the accumulation of integral systems of cognitive structures by the pupil (Itelson, 1972, p. 132). This principle also follows both from the activity approach (Vygotsky, 1996, p. 178-179 and 270; Davydov, 2000, p. 327-328, 400) and from the theory of operator structures of J.Piaget (1994, p. 89-91).

5) *Principle of “enrichment”*: “Accumulation and differentiation of experience of operating by an introduced concept, expansion of possible aspects of understanding of its contents (by inclusion of its various interpretations, increase of number of variables of different degree of essentiality, expanding interconceptual connections, use of alternative contexts of its analysis etc.)” (Kholodnaya, 1996, p. 332). This principle was in various forms repeatedly proposed by psychologists (Rubinshtein, 1958; p. 98-99; Davydov, 2000, p. 429).

6) *Principle of “transformation”*: for revealing essential properties of an object, its essence, “genetically initial general relation” (Davydov, 2000), it is necessary to subject this object to mental transformations, to perform mental experiments, asking questions of the type: “What will happen with the object if? ...”

According to the theory of A.N.Leontyev (1977, p. 208-212), “any substantial activity answers a need materialized in a motive; its main generators are the purposes and corresponding actions... The task is just a purpose given in certain conditions... By operations we mean ways of realization of actions... Actions... are correlated to purposes and operation to conditions... the genesis of an action lays in the exchange of activities and derives from the intrapsychologization of them. Every operation is a result of transformation of an action occurring as a result of its inclusion in another action and its subsequent “mechanization” ...Actions are processes subordinate to the conscious purposes... the operations... directly depend on conditions of achievement of a concrete purpose”.

A. N. Leontyev (1981) argued that actions on learning concepts, as well as any actions, consist of operations, which are almost unconscious or completely unconscious. These operations are essentially “contracted” actions with the concepts of the previous level of abstraction. As M. A. Kholodnaya (1997) noted, “a contraction is immediate reorganization of the complete set of all available... knowledge about the given concept and transformation of that set into a generalized cognitive structure”.

Close to the Soviet conceptions of actions and operations as contracted actions in mathematics teaching are the APOS theory of E. Dubinsky (1991), “reification theory” of A. Sfard (1991) and idea of “procept” of Gray and Tall (1994).

Soviet psychologists, basing on the conceptions of L.S.Vygotsky and A.N.Leontyev, have developed the activity approach to teaching. The most important for development of theoretical thinking is the theory of educational activity of V.V.Davydov (1996) who wrote: “The substantial contents of a concept can be revealed only by finding out the conditions of its origination”.

We see that the process of teaching in the theory of V.V.Davydov ultimately uses genetic approach. This theory has shown its efficiency for learning theoretical concepts at the level of elementary school. Here we are discussing the use of genetic approach in teaching mathematics at undergraduate level.

The main difficulty of investigating educational activity during study of mathematical disciplines at universities consists in multilevelness of abstraction, especially in such sections as the theory of algebraic systems, functional analysis etc.

For example, A. A. Stolyar (1986, p. 58-60) has revealed 5 levels of thinking in the field of algebra and has noted, that “the traditional school teaching of algebra does not rise above the third level, and in the logical ordering of properties of operations even this level is not reached completely”. The following is the description of the third, fourth and fifth levels according to A. A. Stolyar (*ibid.*, p. 59):

“On the 3-d level the passage from concrete numbers expressed in digits, to abstract symbolic expressions designating concrete numbers only in determined interpretations of the symbols is carried out. At this level the logical ordering of properties is carried out “locally”.

On the 4-th level the possibility of a deductive construction of the entire algebra in the given concrete interpretation becomes clear. Here the letters designating mathematical objects are used as variable names for numbers from some given set (natural, integer, rational or real numbers), and the operations have a usual sense.

At last, on the 5-th level distraction from the concrete nature of mathematical objects, from the concrete meaning of operations takes place. Algebra is being built as an abstract deductive system independent of any interpretations. At this level, the passage from known concrete models to the abstract theory and further to other

models is carried out, the possibility of existence of various algebras derived formally by properties of operations is accomplished”.

Thus, to the 5-th level the deductive study of groups, rings, linearly ordered sets etc. corresponds. The highest degree of abstraction here is the study of general algebraic systems with various many-placed operations.

To the 4-th level corresponds, for example, a systematic and deductive study of the sets of natural numbers or integers. Therefore, taking into account that in school teaching even on the 3-rd level is not completely reached, it would be certainly a big mistake to omit in universities the 4-th level (systematic study of an elementary number theory) and immediately pass to the deductive study of groups, rings and even of general universal algebras (as is done in a text-book by L. Ya. Kulikov, 1979). Therefore, systematic study of the elementary number theory can serve as a good sample of the construction of a deductive theory for preparation for the further construction of the axiomatic theories.

A. A. Stolyar built his classification of levels from the point of view of teaching school algebra. In our view, development of algebra as a science in the last decades (after the World War II, under the influence of works of S. Eilenberg and S. MacLane, 1945, and A. I. Maltsev, 1973) allows to distinguish one more higher, the 6-th level of algebraic thinking - we will name it the *level of algebraic categories*. At this level the entire classes of algebraic systems together with homomorphisms of these systems - varieties of universal algebras, categories of algebraic and other structures (for example, topological spaces, sets and other objects) are considered. Thus, the abstraction from concrete operations in these structures and from the nature of homomorphisms and generally of mappings takes place; morphisms between objects of categories are considered simply as arrows subordinate to axioms of categories – e.g., to the associativity law for the composition. Moreover, the functors between categories – certain mappings compatible with the laws of the composition of morphisms, and natural transformations of functors are considered.

Note that J. Piaget in the last years of his life was interested in the theory of categories as the highest level of abstraction in the development of algebra (Piaget and Garcia, 1989).

Essential in teaching algebra and number theory in universities are the 4-th and 5-th levels in the classification of A. A. Stolyar. First of all, the 4-th level (which is already beyond the school curricula) should be reached. Therefore, during the first introduction of the definition of a group in the beginning of the algebra course, one should not immediately begin the full deductive treatment of the axiomatic theory of groups. Only after the experience of the study at the 4-th level of thinking in the field of algebra, namely of the study of the elements of number theory, it is possible to consider a deductive system of the most simple constructions and statements of the group theory, and the systematic account of complicated sections of the theory should

be postponed to a later time, after studying at the 4-th level such themes as complex numbers and arithmetical vector spaces.

J. Piaget who developed the classification of levels for thinking in the fields of geometry and algebra (“intra”, “inter” and “trans”), noted that it is possible to distinguish sublevels inside each level (Piaget and Garcia, 1989).

## **DEVELOPMENT OF MOTIVATION OF LEARNING WITH THE HELP OF STYLE AND EMOTIONAL ELEMENTS**

The great significance for the development of motivation of learning belongs to the individual style of a lecturer or author of the textbook.

Many prominent educators seriously recognized the importance of the individual style in teaching. Diesterweg demanded to make learning interesting by means of 1) diversity, 2) liveliness of the teacher 3) by the whole personality of the teacher.

E.Wittmann (1997, p. 175-178) devoted a special epilogue in his fundamental guidebook to the human (i.e. emotional) factor in teaching mathematics.

The style and psychological effect on students (including readers of textbooks) play the extremely important role in teaching. In our view, it is possible to use many elements of artistic technique (from the areas of theatre, literature and music). Fruitful for refreshing the attention of students are the stylistic elements causing the violation of inertia of perception, e.g. elements making the different levels of the discourse conflict with each other, making the discourse strange. For example, one can very thoroughly and meticulously speak about elementary things, and, on the other hand, soften the discussion of very difficult, complicated and abstract things by humor, unexpected comparisons (as it did such classics of a science as D. Hilbert and A. Einstein). It is possible to study the skill to soften serious and hard things from the playwrights W. Shakespeare and A. Chekhov. Requires additional study the role in teaching of such aesthetic category, as catharsis (see Vygotsky, 1987).

Consider in more detail such important means of emotional influence on an audience as unexpectedness.

In our view, awakening and maintaining interest of students in a mathematical discipline should be carried out through various channels of perception. It is natural to take advantage of the experience of art.

N.N.Luzin (1948, p. 5) in the foreword to his textbook mentions with gratitude his teacher B.K.Mlodzeevsky who "always put forward the strong requirements to the artistic side of scientific discourse".

Certainly, mathematics has something in common with art. Both in mathematics and in art the important criterion of value is the economy of efforts: in science it is economy of thought, as indicated by E.Mach and A. Poincare (1990, p. 383), in art it is economy of art means (Masel, 1991, p. 182). Such economy gives also grace and ease of perception both to scientific results and to works of art.

Poincare especially noted that the grace is reached "by unexpectedness of rapprochement of such things that we have not used to pull together ... Important is not a pattern in general but a pattern unexpected " (Poincare, 1908).

It is discovered by art researchers that the element of a paradoxical contradictoriness is inherent to the nature of art (Masel, 1991, p. 223). Therefore, those using means of art in teaching should also use elements of surprise.

The elements of surprise can be used in different aspects of teaching - both in the contents and in the form, and also at different levels of the discourse (in a lecture or a textbook).

As well as in art, the surprises are more effective when they are well prepared. Any concept intended to be considered in a new, unexpected context, should be in anticipation imprinted on the minds of the students, so that they really could recall it in a new situation. Lecturers might imitate authors of detective stories: the keys to the disclosure of a crime or mystery usually are distributed in different parts of a story, so that the reader, even after overlooking these moments, at once recollects them in a final scene. In mathematics it means that the lecturer, introducing any concept, should make it unusual, connect it with an interesting example, method or application.

### References

- Davydov, V.V. (1996) *Theory of developing instruction*. ДАВЫДОВ, В.В. *Теория развивающего обучения*. М.: ИНТОР.
- Davydov, V.V. (2000). *Types of generalization in teaching*. В.В.ДАВЫДОВ. *Виды обобщения в обучении*. М.: Педагогическое общество России.
- Dистервег, F.A.W. (1962). *Wegweiser zur Bildung fuer deutsche Lehrer und andere didactische Schriften*. Berlin.
- Dubinsky, E. (1991). Reflective abstraction in advanced mathematical thinking. – In D. Tall (Ed.). *Advanced mathematical thinking*. Dordrecht, the Netherlands: Kluwer Academic Publishers, pp. 95-123.
- Eilenberg, S. and MacLane, S. (1945). General theory of natural equivalences. – *Transactions of American Mathematical Society*, v. 58, No. 2, pp. 231-294.
- Grey, E.M., & Tall (1994), D.O. Duality, ambiguity and flexibility: A proceptual view of simple arithmetic. *Journal for Research in Mathematics Education*, 25, 2, pp. 115-141.
- Ительсон, Л.Б. (1972). *Lectures on modern problems of psychology*. Ительсон, Л. Б. *Лекции по современным проблемам психологии обучения*. Владимир.
- Kholodnaya, M. A. (1996). *The Psychology of the Intelligence: Paradoxes of the Research*. Холодная, М. А. *Психология интеллекта: парадоксы исследования*. М.: Барс.
- Kulikov, L. Ya. (1979). *Algebra and Number Theory*. Куликов, Л. Я. *Алгебра и теория чисел*. М.: Высш. школа.
- Leibnitz, G.W. (1880). *Mathematische Schriften*. Berlin.

- Leontyev, A.N. (1977). General concept of activity. Леонтьев, А. Н. Общее понятие о деятельности // Мироненко, В. В. (сост.). *Хрестоматия по психологии*. М.: Просвещение, с. 206-214.
- Leontyev, A. N. (1981). *Problems of the development of mind*. Леонтьев, А. Н. *Проблемы развития психики*. М.: Изд-во Московского университета.
- Luzin, N.N. (1948). *Theory of functions of real variable*. Лузин, Н. Н. (1948). *Теория функций действительного переменного*. М.: Учпедгиз.
- Maltsev, A. I. (1973). *Algebraic systems*. Berlin – N. Y. – Heidelberg: Springer.
- Masel, L.A. (1991). *Problems of analysis of music*. Мазель, Л.А.. *Вопросы анализа музыки*. М: Советский композитор.
- Piaget, Jean, & Garcia, Rolando. (1989). *Psychogenesis and the history of science*. N. Y.: Columbia University Press.
- Poincare, H. (1908). The future of mathematics. *Revue generale des sciences pures et appliquees. Vol. 19*. Paris.
- Polya, G. *Mathematical discovery, v.2*. New York - London: Wiley, 1965.
- Rubinshtein, S. L. (1958). *On thinking and ways of its research*. Рубинштейн, С. Л. *О мышлении и путях его исследования*. М.: Изд-во АН СССР.
- Rubinshtein, S. L. (1989). *Fundamentals of general psychology, v. 1,2*. Рубинштейн, С.Л. *Основы общей психологии, т. 1,2*. М.: Педагогика
- Safuanov, I. (1999). On some under-estimated principles of teaching undergraduate mathematics. – In O. Zaslavsky (Ed.): *Proceedings of the 23<sup>rd</sup> Conference of the International Group for the Psychology of Mathematics Education, v. 3*. Haifa, Israel: Technion, pp. 153-160.
- Sfard, A. On the dual nature of mathematical conceptions: reflections on processes and objects as different sides of the same coin. *Educational Studies in Mathematics, 22*, pp. 1-36.
- Stolyar, A. A. (1986). *Pedagogy of Mathematics*. Столяр, А. А. *Педагогика математики*. Минск: Вышэйшая школа.
- Vygotsky, L.S. (1987). *Psychology of art*. Выготский, Л. С. *Психология искусства*. М.: Педагогика.
- Vygotsky, L.S. (1996). *Pedagogical psychology*. Выготский, Л.С. *Педагогическая психология*. М.: Педагогика-Пресс.
- Wittenberg, A.I. (1968). *The prime imperatives*. Toronto, Vancouver: Clarke, Irwin & Co.
- Wittmann, E.Ch. (1992). The mathematical training of teachers from the point of view of education. *Zentralblatt fuer Didaktik der Mathematik*, No. 7, 274-279.
- Wittmann, E.Ch. (1997). *Grundfragen des Mathematikunterrichts*. 6., neu bearbeitete Auflage. Braunschweig; Wiesbaden: Wieweg.

# ROUTINES IN NON-ROUTINE PROBLEM SOLVING PROCESSES

Wolfgang Schloeglmann

Johannes Kepler University Linz, Austria

*Nonroutine problem-solving, too, involves elements of routine. Often, elementary routines such as solving for a variable are not carried out without error. In this paper, we use new findings from neuroscientific research to explain why even excellent students make mistakes in elementary routines.*

## 1. INTRODUCTION

Mogens Niss, in his paper, "Aspects of the nature and state of research in mathematics education", wrote:

"It is important to realise a peculiar but essential aspect of the didactics of mathematics: *its dual nature*. As is the case with any academic field the didactics of mathematics addresses, not surprisingly, what we call *descriptive/explanatory* issues in which the generic questions are 'what is (the case)?' (aiming at description) and 'why is this so?' (aiming at explanation)." (Niss, 1999; 5)

In this paper, I begin with descriptive issues, in Niss's sense. While correcting maths exams at university, I noticed something very surprising. To pass an exam, students had to complete complex nonroutine tasks that required sophisticated mathematical ideas in the solution process. The student often solved the nonroutine part of a task excellently, while in the routine parts made simple mistakes such as

$$\frac{ax+b}{cx+d} = \frac{a+b}{c+d}$$

or, for instance,

$$\sqrt{a^2+b^2} = a+b.$$

When the students saw their papers after they'd been marked, they couldn't understand how they could make such simple mistakes. In a first analysis of the problem, I found that all nonroutine problem-solving processes utilise routines as important constituents; therefore I had to understand the role of routines in nonroutine problem-solving processes. Many such routines — often called skills, they include tasks such as solving for a variable in an equation — are essential in any problem-solving process. One ought therefore understand the aspects specific to such skills or routines.

## 2. SKILLS

In the course of their education in mathematics, students learn algorithms and rules to calculate numbers, and later, to solve for variables. These algorithms and rules are so

important and are used in so many cases that the student should implement them automatically, meaning that when a student sees certain signs or expressions (i.e. stimuli), the steps of the algorithm are engaged automatically without further thought as to which step comes next or which rule is necessary now. This automatic implementation of algorithms and rules in mathematics is a consequence of a special acquisition process. With practice, knowledge of, for instance, a problem type is converted into procedural form, and is then applied directly without interference from other interpretative procedures. The gradual process by which knowledge is converted from declarative to procedural form is called *knowledge compilation* (Anderson, 1982; 370).

Anderson stresses that the distinction between procedural and declarative knowledge is fundamental. "Procedural knowledge is represented as production, whereas declarative knowledge is represented as a proposition network." (Anderson, 1982; 370)

The distinction between two kinds of knowledge suggests different systems at work in the long-term memory. Most memory researchers classify memory into two basic types: (1) the declarative or explicit memory; and, (2) the procedural or implicit memory (Roth, 2001; 151). Each basic memory type can, in turn, be classified into a number of subcategories. For example, the explicit, or declarative, memory can be viewed as being composed of the episodic memory, which stores remembrances from our personal past, and the semantic memory, which contains associations and concepts, i.e. our general world knowledge.

Skills memory is part of implicit or procedural memory. This type of memory contains the many functions that help us handle everyday problems in life (Schacter, 1999; 222). Skill memory is situated in the cerebellum. Although neuroscientific researchers had long held the view that skills were a motor function, like playing piano or cycling, in recent years, the cerebellum, too, has come to be seen as being important for cognitive skills:

"Research over the last ten years has shown that the cerebellum is active not only during purely motor tasks, but also [when the brain is performing] tasks that are unambiguously cognitive." (Roth, 2001; 396, translating by W.S.)

Nevertheless, researchers are not implying that the cerebellum is itself responsible for the whole cognitive process:

"As Ivory and Fiesz write, as with the purely motor tasks, it is rather difficult to find cognitive tasks in which the cerebellum is not active. However, neuroscience has at present no consistent idea of the extent to which the cerebellum participates in the cognitive activity." (Roth, 2001; 396)

For the problem we are considering here, it is important to know aspects that are specific to automated processes, particularly the ways in which they contrast with non-automated thinking and acting. Roth described the situation in the following



way:

"Automated, or implicit, processes:

- 1) are independent of the limitations of cognitive resources;
- 2) are not – or are only weakly – voluntary acts;
- 3) do not require attentiveness and awareness – indeed, these can be an interference;
- 4) proceed quickly and effortlessly;
- 5) are usually unimodal;
- 6) have a low susceptibility to error;
- 7) can be improved through training, and are difficult to change after having been acquired or consolidated;
- 8) cannot be described in detail in any natural language."

(Roth, 2001;229.)

To understand the function of skills – and automated – processes for our acting and thinking, we must consider the implications of our use of conscious – and controlled – processes as opposed to skills:

"In contrast, controlled, or explicit, processes

- 1) depend strongly on the provision of cognitive resources (a good example being the notoriously limited working memory);
- 2) require attentiveness and conscious awareness;
- 3) proceed slowly – i.e. in seconds or minutes – and are frequently arduous;
- 4) require intensive access to long-term memory;
- 5) are very susceptible to interference;
- 6) show limited response to training; they are, nevertheless,
- 7) quickly alterable; and
- 8) can be described in detail in a natural language."

(Roth, 2001; 229–230.)

Putting the contrast in a nutshell, we may say that skills and automated processes are very important in coping on an intuitive level with tasks encountered in everyday life.

Automation of functions is achieved through training processes (Anderson, 1982; Ciompi, 1999; Roth, 2001; Schacter, 1999). To understand how skills are learned, it is important to note that people with amnesia of the explicit memory are also able to learn skills (Schacter, 1999; 291-292). In most cases, skill learning begins with learning the effects of an action – the result of doing something is stored in the explicit or declarative memory – and the process of training transforms this knowledge into procedural form (Anderson, 1982; 370; Roth, 2001; 151-154). During the training process, we lose conscious awareness of this knowledge, together with the ability to describe the skill. Roth writes that

"In the light of this theory, the explicit, declarative system of consciousness is a *special tool of the brain*. This tool is implemented by the brain when faced with a new problem, of either motor or cognitive type, that is difficult or significant." (Roth, 2001; 231).

For the brain, conscious awareness is energetically expensive, and automation reduces energy consumption. Use of skills and routines in problem-solving significantly extends one's capabilities. Focussing on mathematics in particular, we may assert that solution of complex problems is only possible if we are able to store complex knowledge as a compact unit, and this is achieved through making effective use of the imagination, routines and skills.

While learning mathematics, students acquire basic "building blocks" that can be used in complex situations. In my view, all cognitive processes dealing with new, complex situations place a great demand on cognitive skills, routines and the imagination. These reduce the perceived complexity of a problem and allow the brain to overcome its limitations (e.g. a limited working memory) in solving it. However, cognitive routines used in mathematics – such as algorithms, rules etc. – do not work perfectly in all cases. This fact warrants further investigation.

### **3. ATTENTIVENESS AND ROUTINE PROCESSES**

We have seen that one goal of the creation of routines is the reduction of conscious awareness of the routine. Also, implementation of routines is necessary to reduce attentiveness. Indeed,

"...nothing is more closely tied to conscious awareness than attentiveness."  
(Roth, 2001, 224.)

Implementation of routines is also accompanied by a lowering of emotionality. Ciompi describes this reduction of emotionality (that occurs as a result of routinisation of a thinking process), which results from frequent repetition, as being a prerequisite for all routinisation processes:

"...in this way, the affective components that were originally present during rational thought – the 'affective components of logic' – enter ever more smoothly that giant pool of apparently affect-neutral 'self-evident things'...". (Compi, 1999; 111.)

We may assert that the importance of routinisation lies in the low level of attentiveness and conscious awareness that is necessary to run a routine.

We may define "normal cases" to be those in which routine processes usually run smoothly with a low level of error. Thus the level of error depends on the circumstances. Let us consider a simple example. We are all able to walk. We acquired this skill at an early stage. We are usually able to walk without thinking much about it (i.e. without being attentive to the details of the process). Even when the ground we are walking on is somewhat uneven, we are able to think about any number of other things while we're walking (a maths problem, for instance). But if the ground is very uneven, we need to concentrate on the act of walking, otherwise we'll stumble.

This foregoing example illustrates the existence of "normal cases". Circumstances strongly influence the level of attentiveness necessary to guarantee error-free implementation of routines.

A set of applications exists where a routine runs smoothly and error-free, but outside this set, we must increase our level of attentiveness, otherwise the number of mistakes we commit increases. In situations that demand higher cognitive skills, it seems that a certain level of attentiveness is always necessary if errors are to be avoided. (At work or in everyday life, it is often difficult to hold the required level of attentiveness to routine processes. One therefore speaks of a "duty of care" to indicate that attentiveness is necessary to avoid errors)

All researchers in the field of attentiveness emphasize the importance of the emotions. For example, Matthews and Wells write,

"Emotion and attentiveness are intimately linked."  
(Matthews and Wells, 1999; 171.)

and LeDoux writes,

"Arousal is important in all mental functions. It contributes significantly to attentiveness, perception, memory, emotion and problem-solving. Without arousal, we fail to notice what is going on – we don't attend to the details. But too much arousal is not good either. If you are overaroused you become tense and anxious and unproductive. You need to have just the right level of activation to perform optimally. Emotional reactions are typically accompanied by intense cortical arousal." (LeDoux, 1998; 289.)

If emotion, arousal and attentiveness – the key elements we are considering in this paper – are so strongly linked, we have to consider their role in the relationship between affect and cognition.

On the neuronal level we must distinguish between two processes: namely,

"the affective-emotional, relatively details-poor registration of a situation at hand, together with comparison with the emotional memory; [and] the more or less unemotional, detailed registration of the situation with the help of the cortico-hippocampale system, which leads to a 'rational' weighing up of the particular situation and all the consequences stemming from it." (Roth, 2001; 322.)

The central function of this process is to appraise the meaning of a situation, person or thing:

"Both these systems have assigned to them the attentiveness faculty, which directs our gaze – consciously or not – onto whatever seems conspicuous or important to the brain. This control of attentiveness is an important part of our appraisal system." (Roth, 2001; 322.)

An important point is that the appraisal process is self-regulated:

"Self-regulation focuses attentiveness onto the self, and [enables] appraisal of the personal significance of external stimuli, somatic stimuli and internal cognitions." (Matthews and Wells, 1999; 183.)

This sheds light onto the question we are considering in this paper – namely, understanding why errors occur when routines are invoked in non-routine problem-solving processes. The appraisal system operates on stimuli that are noticeable, new or challenging. But problems requiring non-routine strategies have new, challenging as well as routine parts. Goldin (2000) analysed the affective pathways, together with their representation, in mathematical problem-solving by characterizing the crucial stages of the problem-solving process. The non-routine parts are the ones that are challenging and new, and these are identified by the appraisal system. Therefore, the problem-solver's attentiveness is focused very strongly on this part of a task.

Conversely, when faced with the routine parts of a task, the emotional appraisal system identifies routines as well known, and appraises them as being connected to a well-known, complete solution to the problem. The emotional system is not activated, consequently no special attentiveness is directed towards this part of the task.

We therefore have a situation in which full attention is directed towards some parts of a task but not others: the cognition system is activated for the challenging part, the entire working memory is utilised to handle the non-routine situation. We may suppose that all systems are activated in order to solve the crucial parts of the task, but hardly any resources are available to handle the routine parts of the task.

We know that in "normal circumstances", routines only need a low level of attentiveness to operate error-free. However, it seems that cognitive routines such as mathematical algorithms require more attentiveness to operate error-free. Particularly when manipulating unknowns in an equation, "super-rules" exist that can lead to over-interpretation of the required rule, and hence to an unconscious tendency towards error (Malle, 1993). Lack of attentiveness in non-routine problem-solving processes that are free of routine processes can also lead to error, even if the student could have dealt with the problem had he been more attentive.

The entire picture is made much more difficult if a student has had negative experiences in mathematics learning. Non-routine problems are then often linked to fear of failure. Researchers speak of "impairment effects associated with a reduced quality of efficiency of performance" (Matthews and Wells, 1999; 171). Some ideas for understanding this may be found in Schloeglmann (2002, 2003).

## REFERENCES

- Anderson, J. R. (1982). Acquisition of Cognitive Skill. *Psychological Review* 89, 369 – 406.
- Ciampi, L. (1999). *Die emotionalen Grundlagen des Denkens*. Göttingen: Vandenhoeck & Ruprecht

Goldin, G.A. (2000). Affective Pathways and Representations in Mathematical Problem Solving. *Mathematical Thinking and Learning*, 17(2), 209-219.

LeDoux, J. (1998). *The Emotional Brain*. Phoenix, Orion Books Ltd.

Malle, G. (1993). *Didaktische Probleme der elementaren Algebra*. Braunschweig/Wiesbaden, Vieweg.

Matthews, G. & Wells, A. (1999). The cognitive science of attention and emotion, In: Dalglish T. & Power M.J. (Eds.): *Handbook of Cognition and Emotion*. Chichester, John Wiley & Sons Ltd., 171 – 192.

Niss, M. (1999). Aspects of the nature and state of research in mathematics education. *Educational Studies in Mathematics*, 40, 1 – 24.

Roth, G. (2001). *Fühlen, Denken, Handeln*. Frankfurt/Main, Suhrkamp.

Schacter, D. L. (1999). *Wir sind Erinnerung. Gedächtnis und Persönlichkeit*. Reinbeck bei Hamburg, Rowohlt Verlag.

Schlöglmann, W. (2002). Affect and mathematics learning, In: Cockburn A. D. & Nardi E. (Eds.): *Proceedings of the 26th Conference of the International Group for the Psychology of Mathematics Education, University of East Anglia, Norwich 2002/4*, 185 – 192.

Schlöglmann, W. (2003). Can neuroscience help us better understand affective reactions in mathematics learning? In: *Proceedings of CERME 3*.



# TEACHER GUIDANCE OF KNOWLEDGE CONSTRUCTION \*

Baruch Schwarz  
Hebrew University

Tommy Dreyfus  
Tel Aviv University

Nurit Hadas Rina Hershkowitz  
Weizmann Institute of Science

*This paper focuses on how teachers guide construction of knowledge in classrooms. We suggest that guidance hinges on the kind of dialogue teachers choose to engage students in. We propose several classroom dialogue types relevant for the construction of knowledge and suggest that critical dialogue is particularly effective for knowledge construction. We describe a lesson on probability conducted in a Grade 8 classroom in order to illustrate how a teacher chooses dialogue types, and to what extent she attends during dialogue to epistemic actions, which are constitutive of knowledge construction.*

## INTRODUCTION

This paper is about the role of teachers in the construction of knowledge. It continues an effort we initiated in the study of the construction of knowledge in different social settings (Hershkowitz, Schwarz, & Dreyfus, 2001; Dreyfus, Hershkowitz, & Schwarz, 2001 – henceforth referred to as HSD and DHS, respectively). In HSD, we studied one student constructing knowledge while solving a problem about functions. In DHS, we studied two dyads constructing knowledge while solving a problem in algebra. These studies helped us to elaborate a model of construction of knowledge, the dynamically nested RBC model, based on three basic epistemic actions, *Recognizing*, *Building-with*, and *Constructing*. Recognizing means that the learner identifies the result of a past activity as relevant. Building-with designates the use of past actions to satisfy a given goal. Constructing means assembling knowledge artefacts resulting in a vertical reorganization of knowledge. The model is nested since constructing usually incorporates recognizing, building-with and other constructing actions. Epistemic actions then have a “historical” dimension. They also have a social dimension: in DHS we showed how epistemic actions were distributed among peers. The present paper is a first step in the direction of incorporating into the RBC model the role of the teacher in the construction of knowledge in classrooms.

Given learning goals that include constructing in the above sense, two crucial teacher tasks are to set appropriate activities and to initiate and manage dialogues about them. Accordingly, our study of the construction of knowledge in HSD and DHS relied mainly on the analysis of the talk while students were carrying out activities set by the teacher or researcher. In classrooms, the teacher’s role during activities tends to be indirect. During dialogue phases, however, the teacher’s role is often direct and thus easily observable. Therefore, dialogue phases are suitable for observing the teacher’s guidance of students’ construction of knowledge. The teacher’s input into

---

\* Research partially supported by THE ISRAEL SCIENCE FOUNDATION (grant No. 973/02-1)

the dialogue, what she says, how she says it, her actions, and the ensuing dialogue types are components of guidance to the construction of knowledge that the teacher provides. In this paper we concentrate mainly on dialogue types.

## **BACKGROUND AND THEORETICAL FRAMEWORK**

Specialists in the structure and the norms of dialogue have identified the fundamental concept of *commitment*. When people engage in talk together, they are committed in different ways (Walton & Krabbe, 1995) and their commitment influences the dialogue. For example, *critical dialogue* has structural and formal properties that characterize a commitment to understanding and accommodation of divergent viewpoints whereas *disputational dialogue* conveys the commitment of the participants to win. Commitment induces implicit dialogue rules that interact with the cognitive processes of the participants. The identification of kinds of classroom dialogues therefore constitutes a step in the study of the construction of knowledge in classrooms.

Researchers in cognition and instruction have attempted to analyze talk in classrooms by identifying episodes initiated and controlled by the teacher (Leinhardt & Greeno, 1986; Leinhardt, 1989; Leinhardt & Schwarz, 1997). They found that teachers are very skillful at initiating and controlling presentation, discussion, and summary episodes, and that students are generally receptive and adapt their talk to the teacher's goal. However, these studies focus on the skills of the teacher and are therefore only partially relevant here. Mercer's (1995; 1996) approach to identifying different kinds of talk in classrooms, on the other hand, combines a dialogical description of reasoning with a version of Vygotsky's account of individual development: Reasoning is a social process in which personal development results from social practices. It therefore fits the RBC model of construction of knowledge. Inspired by Mercer's talk categories, we propose the following distinct kinds of classroom dialogues, each referring to a different commitment:

*Grounding dialogue*: Participants are committed to share common knowledge. The teacher presents a topic, often a new one and checks that students are acquainted with the subject to be treated and have the background knowledge needed to achieve the learning goals such as solving a task to be assigned and constructing new knowledge.

*Prospective dialogue*: The commitment here is to prepare to learning. The teacher clarifies the problem at stake and the goals to be attained and encourages the students to participate and state an initial point of view. Interventions are not elaborated.

*Critical dialogue*: Participants are committed to understand and accommodate divergent viewpoints. They elaborate and develop new ideas, raise reasoned arguments, challenge and counterchallenge each other's views. The teacher encourages all students to participate.

*Reflective dialogue*: The participants are committed to integrate and generalized accepted arguments. They recapitulate actions and draw lessons from their experiences. Talk is often about the process rather than about the results obtained.



*Lesson delivery dialogue:* Participants are committed to transmission of knowledge. The teacher presents a prepared lesson with ready-made explanations. Lesson delivery can vary from lecturing through reading from the textbook to presenting a “didactic” lesson in which the teacher asks prepared questions.

This list is not exhaustive. It is limited to dialogue types that are potentially relevant to the construction of knowledge. Table 1 shows how the above types of dialogue differ according to commitments, goals and methods. The table also gives a summary description of the dialogue types. A more detailed description of would include the specific methods used for conducting each dialogue.

<b>Dialogue type</b>	<b>Commitment</b>	<b>Methods</b>	<b>Teacher’s goals</b>	<b>Students’ goals</b>
<i>Grounding</i>	Triggering interest	Describing	Anchor knowledge	Orientation
<i>Prospective</i>	Preparation to learning	Brainstorming Conjecturing	Engage students	Express position
<i>Critical</i>	Understanding Accommodation of divergent viewpoints	Hypothesis testing Elaborating Arguing	Support argumentation and knowledge construction	Share opinions, Persuade
<i>Reflective</i>	Integration Generalization	Recapitulating Evaluating	Elicit conclusions	Draw conclusions
<i>Lesson delivery</i>	Transmission of knowledge	Lecturing Clarifying	Convey content	Grasp content

Table 1: Characteristics of main classroom dialogues

Since this paper is about the role of teachers in knowledge construction, we elaborate a little on the methods of the teacher in critical dialogues. The teacher may first request explanations and conjectures, and then their elaboration by argumentative process. Methods to support the argumentative process are most challenging to implement. They include *Sourcing*, *Eliciting argumentation*, and *Mediating argumentation*. Sourcing means adding necessary information for triggering discussion. Eliciting argumentation consists of encouraging participants to express opinions and to engage in the discussion. Mediating argumentation is similar to eliciting argumentation, but the teacher attempts to ask for reasoned arguments and to connect/contrast specific arguments in order to activate discussion. These argumentative methods are very difficult to implement. Thus teachers usually precede critical dialogue by *grounding* and *prospective* dialogue. Moreover, they need to be active during the argumentation, and to help students reflect on their actions during the *reflective* dialogue in order to abstract the knowledge previously constructed in critical dialogue (Hershkowitz & Schwarz, 1999). In other words, the teacher plays at least two central roles in dialogical guidance for knowledge

construction, namely choosing (a) how to arrange types of dialogues during the lesson, and (b) how to implement specific methods during dialogues (and crucially argumentative ones during critical dialogues).

So far, our considerations are theoretical. They need to be illustrated. In the empirical part of this paper, we will analyze a classroom episode with the aim of showing how the teacher manages the discussion so as to determine the kinds of dialogue, in which the students will engage, in accordance with her goals, and some of the salient methods she implemented.

## A CLASSROOM DISCUSSION

The classroom discussion to be considered occurred during a 10-lesson unit on probability, which includes five activities organized in tasks for small group collaborative work. The activities were designed by the researchers so as to create opportunities for the construction of knowledge. One set of tasks during the second activity was designed to introduce students to the issues related to repeated events, by asking them to locate the probability of various repeated events on a chance bar. To the best of our knowledge, no student had solved similar tasks in the past. The task under discussion is presented in Figure 1.

You spin a Chanuka dreidel 100 times (the letters that appear are **N**, **G**, **H**, **P**). Mark approximately, on the chance bar, the letter that designates each event, and explain:

A: The outcome was **N** all 100 times.

B: The outcome was never **N**.

C: The outcome was **N** between 80 and 90 times.

D: The outcome was **N** between 20 and 30 times.

E: The outcome was **N** exactly 25 times.

F: The outcome was **N** exactly 26 times.

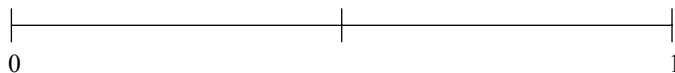


Figure 1: Chance bar and task 5 of the second activity

The following transcript displays part of the protocol of the classroom discussion about tasks 5A and 5B. The researchers independently segmentized the protocol according to dialogue types. On a scale of several utterances, there was full agreement between the classifications of all researchers. Minor disagreements concerning the precise locations where one dialogue type ended and another begins were settled by discussion until mutual agreement was reached. The resulting classification is:

1-32 Grounding dialogue

33-38 Prospective dialogue

39-55 Critical dialogue

56-58 Prospective dialogue

## 59-69 Critical dialogue

The teacher draws a chance bar on the whiteboard and begins the following dialogue. In the transcript, the speakers' names are abbreviated as follows: Teacher – T, Ian – I, Mike – M, Guy – G, Eve – E, Dan – D, Ann – A, Yvonne – Y. Other students – S.

- T33 In the second booklet you have, look at task 5. You weren't supposed to do it. [Reads:] "You spin a Chanukah dreidel." You know what that's about? ... Guy, are you with us? "Mark, approximately, on the chance bar, the event 'The dreidel falls 100 times on the letter N'."
- T34 You understand what's the event A? You spin the dreidel 100 times, and all 100 times it falls on the letter N. [To Ian:] You mark, and we will relate to it. [Ian marks the letter A close to 1/4.]
- T35 What do you think? Would you have marked at the same place? Elsewhere?
- I36 That's supposed to be impossible.
- T37 Wait, you marked, now sit. Let's see what others think about this.
- M38 There is a chance that this happens. It's closer to zero.
- T39 Because ...
- M40 Because there is a smaller chance that it happens.
- T41 [To Ian:] Look at this situation: You have a dreidel, you spin it 100 times, and *all 100 times* the dreidel falls on the letter N? You marked that this is about a quarter of the cases.
- I42 Right, but compared to the letter N, there are four letters ...
- T43 Right!
- I44 And N, out of these, is one letter!
- T45 What do you reply to this? There are four letters, N is only one letter. Guy, what do you reply to him?
- G46 There are, like, each time you spin, there are four letters on which it can fall. Thus, each time the chance divides again by 4, and the chance gets smaller. The more times I throw, there are fewer possibilities that it will again fall on N. Each time it divides by 4. It gets smaller each time you spin.
- T47 So you support him?! You say that the mark is correct?
- G48 No, it needs to be made smaller.
- T49 Because?
- G50 Because each time there is a much smaller probability that you spin twice and it will fall on the same letter. Thus the probability becomes smaller.
- T51 [To Ian:] Do you understand the point? We did not mark what's the chance that if there are four letters it will fall on the letter N. We marked, once more I describe the event, the dreidel will fall *all 100 times* on the letter N. Do you all see the difference between these two things?
- T52 Is the event A clear to you? [Dan expresses doubts.]
- T53 Where would you mark the letter N? Here, does it suit you? [Marks close to 0.]
- D54 But still, one cannot be certain!
- T55 Right, we say what's the chance. We do not say anything in a definite manner.

- T56 Event B says: The outcome was never N ... Again we spin the dreidel 100 times, we look, and not even a single time it fell on N. [Mike makes a mark on the chance bar between 0 and A.]
- T57 Mike marked [B] between A and 0. What do you think? Would you change it? Not change it? Do you agree? Do you disagree?
- E58 I think, wrong!
- T59 Wrong because ...?
- E60 At least for some students it will fall on N: It doesn't make sense that it should never fall on N; at least a few times the outcome should be N.
- T61 And what did we mark right now? What did Mike mark? Mike said, claimed, that it is very unexpected, it's almost zero, that if we turn a dreidel 100 times that zero times it will fall on the letter N.
- E62 I think that it will be more toward the end. [Proposes a mark close to 1.]
- T63 What do you say? We have a tendency to the beginning and a tendency to the end. That's a very big difference ... [Points with her hand to an imaginary chance bar in the air, and to its two ends.]
- Y64 It needs to be a little after A, because the probability for no N at all as compared to 100 times N.
- T65 What do you think? Ann, what do you propose?
- A66 [Inaudible; based on researcher notes.] B is a little higher than A because it means that the other three letters came up every time.
- T67 What do you think about Ann's reasoning?
- S68 We support her ... [Many students raise their hands.]
- T69 In both cases, the chance is very low, but we want to compare between event A, which says that all 100 times N came up and no other letter came up, and between the event that all 100 times the other three letters came up and never N. We are trying to compare these two events, and there is a claim that B is a little higher than A.

## CLASSROOM DIALOGUE AND KNOWLEDGE CONSTRUCTION

In this section we analyze how the teacher's interventions in the above classroom discussion have influenced dialogue types and knowledge construction. This analysis necessarily remains tentative since the data about the students are not sufficiently dense to allow definite conclusions about knowledge construction. The methods adopted by the teacher within each of the dialogue types are italicized.

After some grounding dialogue about the chance bar, about impossible and certain events, and about the placement on the chance bar of the event "the outcome of the throw of a die is 2" (lines 1-32, not reported), the teacher *repeats* (T33) and *rephrases* (T34, T41) event A, *asks* a student to mark a *conjecture* on the chance bar (T34), and *elicits argumentation* by soliciting reactions and new ideas (T35) thus giving the dialogue a prospective character. However, she soon begins *mediating argumentation* by asking the students more and more penetratingly to provide

reasons for their claims (T39, T45, T47, T49) and thus causes the dialogue to become more and more critical.

Let us observe how the teacher actions we just described relate to students' epistemic actions. Ian's contributions express the tension between the single outcome probability (I34, I42, I44) and the repeated outcome probability (I36). This repeated outcome probability is assessed at first intuitively (I36, M38, M40), by Ian and Mike and later more analytically (G46, G48, G50) by Guy. This more analytic way of responding corresponds dialogically to the teacher's demand for reasons and thus, critical dialogue. Nevertheless, it is remarkable that the teacher's requests for reasons are content free – she appears to ignore not only the intuitive but also the first two analytic contributions, in spite of the fact that in G46 Guy provides a complete and detailed reasoning. Only in T51 does the teacher finally relate to the complete idea and *rephrase the conclusion*. She then links it to the initial problem, emphasizing the difference between a single outcome and same outcomes in repeated experiments (a *sourcing method*). While the data do not allow us to assess to what extent any specific student constructed this knowledge, the class as a whole, represented by the three participating boys, did (see DHS for a more detailed discussion on distributed construction of knowledge), and it did so during the critical dialogue engendered by the teacher, while seemingly ignoring the students' contributions to the dialogue.

Event B being a variant of event A, the teacher now moves more quickly through the prospective phase (T56-E58) into the critical phase (T59-T69). We note that while some of her demands for reasons are still general (T59, T65, T67) others are now specific and include detailed reactions to Eve's reasoning (T61, T63) (all these methods *mediate argumentation*). As before, the class as represented now by the three girls who took part in the dialogue about event B appears to have constructed, at least intuitively, not only the low probability of event B but also the fact that this probability is higher than that of A. This is an indication that (at least partial) knowledge about event A was constructed by a subset of the class that includes at least the girls active in the discussion of event B, in addition to the boys active in the discussion of event A. Indeed, it is notable that Yvonne (E64) not only relates to Eve's conjecture (E62) and the teacher's question about it (E63) but in addition places event B in relation to event A, and that Ann (E66) then provides a reasoning supporting Yvonne's claim. It seems then that in event A as well as in event B, the teacher did not attend to the specific epistemic actions shared by students. The teacher could and did elicit or mediate argumentation without attending in detail to the epistemic actions developed by the students. Of course, this observation does not necessarily lead to hasty generalizations: we believe that in numerous cases, the teacher needs to be deeply engaged and attend to the students' epistemic actions. But sometimes, this is not necessary, in particular if the teacher is skilled in applying argumentative methods of guidance. We also believe that sometimes a teacher's explicit attendance to students' epistemic actions may impair construction of knowledge since the teacher risks to impose her view and thus spoil the argumentative process.

## CONCLUDING REMARKS

We saw that the teacher used types of dialogue to guide classroom interaction by shifting in good time from Grounding to Prospective and Critical dialogue. In the discussion of event A, she did not share the ideas developed by Ian, Mike and Guy until the very end; instead, her critical dialogue skills and her almost routine demands to support and explain claims gave the reasoning process opportunities to be phrased and developed in spite of her lack of attention to the boys' reasoning. In discussing event B, we observed more explicit attention to students' reasoning. We presume that in many cases attendance by the teacher to students' epistemic actions is necessary to help in construction of knowledge. Of course, the problem is that although attendance to students' epistemic actions is sometimes necessary, it is often very difficult to undertake. We don't know whether in the case we discussed, the non-attendance of the teacher was due to her limitations to track "on-line" the arguments developed during the lesson, or rather to a strategic choice. At any rate, we can conclude that guidance in construction of knowledge relies on how the teacher designs dialogue types, which teaching methods she implements in these dialogues, and to what extent she attends to students' epistemic actions in the classroom. The study of these three aspects of teaching and their relations to construction of knowledge is a complex endeavor. It constitutes a program of research to which we are currently committed.

## References

- Dreyfus, T., Hershkowitz, R., & Schwarz, B. B. (2001). Abstraction in context: the case of peer interaction. *Cognitive Science Quarterly*, 1, 307-358.
- Hershkowitz, R. & Schwarz, B. B. (1999). Reflective Processes in a Technology-Based Mathematical Classroom. *Cognition and Instruction*, 17, 66-91.
- Hershkowitz, R., Schwarz, B. B., & Dreyfus, T. (2001). Abstraction in context: epistemic actions. *Journal for Research in Mathematics Education*, 22, 195-222.
- Leinhardt, G. (1989). Math Lessons: A contrast of novice and expert competence. *Journal for Research in Mathematics Education*, 20, 52-75.
- Leinhardt, G., & Greeno, J. G. (1986). The cognitive skill of teaching. *Journal of Educational Psychology*, 78, 75-95.
- Leinhardt, G. & Schwarz, B. B. (1997). Seeing the problem: an explanation from Pólya. *Cognition and Instruction*, 15, 395-434.
- Mercer, N. (1995). *The guided construction of knowledge. Talk amongst teachers and learners*. Clevedon, UK: Multilingual matters.
- Mercer, N. (1996). The quality of talk in children's collaborative activity in the classroom. *Learning and Instruction*, 6(4), 359-377.
- Walton, D., & Krabbe, E. (1995). *Commitment in dialogue: Basic concepts of interpersonal reasoning*. Albany, NY, USA: State University of New York Press.

# Types of Student Reasoning on Sampling Tasks

J. Michael Shaughnessy, Matt Ciancetta, & Dan Canada  
Portland State University

*As part of a research project on students' understanding of variability in statistics, 272 students, (84 middle school and 188 secondary school, grades 6 – 12) were surveyed on a series of tasks involving repeated sampling. Students' reasoning on the tasks predominantly fell into three types: additive, proportional, or distributional, depending on whether their explanations were driven by frequencies, by relative frequencies, or by both expected proportions and spreads. A high percentage of students' predominant form of reasoning was additive on these tasks. When secondary students were presented with a second series of sampling tasks involving a larger mixture and a larger sample size, they were more likely to predict extreme values than for the smaller mixture and sample size. In order for students to develop their intuition for what to expect in dichotomous sampling experiments, teachers and curriculum developers need to draw explicit attention to the power of proportional reasoning in sampling tasks. Likewise, in order for students to develop their sense of expected variation in a sampling experiment, they need a lot of experience in predicting outcomes, and then comparing their predictions to actual data.*

This study builds on previous research on middle school students' understanding of variability in a repeated sampling environment conducted by Shaughnessy et al (2003), Watson et al (2003), Toruk and Watson (2000), and Reading & Shaughnessy (2000). The study adds to previous research by including a large number of subjects from grades 6 to 12, by suggesting a possible conceptual analysis of types of students' reasoning in repeated samples tasks, and by including tasks with several population sizes and sample sizes. This work is part of an ongoing research project to investigate students' conceptions of variability in a variety of contexts.

## Subjects & Procedures

A series of questions involving a sampling context was administered in survey form to 272 middle school (N = 84) and secondary school (N = 188) students, mostly from a large metropolitan area in the northwestern part of the United States. The students were in ten classrooms from six schools—two urban, three suburban, and one rural—in two middle schools and four high schools. All six schools are participating in an ongoing research project on students' understanding of variability, with a teacher in each school serving as a consultant and co-researcher on the project. Students in all six schools had some previous experience with graphing data. Three of the four high schools and both middle schools use curriculum materials that include statistics investigations and probability experiments. Students in the other high school had no previous exposure to probability, and little to statistics. This multi year project includes survey tasks, interview tasks, and classroom teaching episodes that involve variability. In this paper we will concentrate mainly on a subset of the survey tasks that were given to all the students at the beginning of the project, prior to the teaching episode work of the project.

All 272 students were surveyed on a series of sampling tasks at the beginning of the project. The first series of tasks involved a mixture of 100 candies, 60 red and 40 yellow, which were thoroughly mixed. Handfuls of ten candies were to be pulled out, the number of

reds would be recorded after each pull, and the candies would be put back in the mixture and remixed for the next pull of 10. The students were asked this series of questions:

- 1) How many reds would you expect to get in a handful (of 10 candies)? Why?
- 2) Would you expect to get that number of reds every time if you did it several times? Why?
- 3) What would surprise you? How many reds would surprise you in a handful of ten? Why would that surprise you?
- 4) What numbers of reds would you predict for six handfuls? (Each time candies replaced and remixed before pulling again) Why did you make those predictions?
- 5) Construct a graph of the results for the numbers of reds for 50 handfuls of ten candies.

A series of similar questions was given only to the secondary students using a mixture of 1000 candies, 600 red, 400 yellow, and sample size 100. Both the population proportion (60% red) and the relative sample size (10% of the population) were constant for the large and small mixtures.

### **Method**

Students' responses to each question were categorized, and then coded on a scale (0, 1, 2, etc) with higher numbers indicating more student use of variation reasoning and/or proportional reasoning. The coding schemes for the items were developed iteratively over several runs by a team of three researchers using the responses from two classes. Subsequently each researcher independently scored every student on each item on the remaining classes. Initial inter-rater agreement percentages were 100%, 82%, 90%, 94%, and 97% for the items presented in this paper. Any disagreements were subsequently discussed and resolved, so that in the end all three researchers agreed on the final coding of each response.

### **Types of Reasoning**

Students' responses and reasoning on these questions fell mainly into three broad categories: additive, proportional, or distributional reasoning. Additive responses tended to rely on absolute numbers or frequencies of reds in the original mixture, e.g. "*because there are more reds.*" Proportional reasons fell into two subgroups. Some students' responses implicitly suggested that they used sample proportions or population proportions, or probabilities, or percents in their thinking, but they had difficulty putting their reasoning into words. ("*Most of them will be around 6, but I just can't explain why*" (implicit proportional reasoners). Other students explicitly mentioned 'ratio of reds', 'percent of reds', 'probability of reds' in their reasoning, and connected it back to the original mixture (explicit proportional reasoners). Distributional reasons integrated both centers, and variation around those centers, into their reasoning on these tasks. A summary of students' responses to the first four questions listed above is presented in Tables 1 – 5, along with codes and code descriptors for each item. The question that asks students to graph the results of 50 samples of 10 will not be discussed in this paper due to space limitations, but we mention it so that readers are aware that students were also asked about larger numbers of repetitions.

### **Results on Sampling Tasks**

1. Suppose you have a container with 100 candies in it. 60 are red, and 40 are yellow. The candies are all mixed up in the container. You pull out a handful of 10 candies.



How many reds do you expect to get? \_\_\_\_\_

Table 1. Responses to number of reds expected in one handful of ten.

Responses	Code	MS (N=84)	HS (N=188)	All (N=272)
Other than 6	0	15	25	40
Six reds	1	64	160	224
A range (i.e. 5-7)	2	5	3	8

**Codes for this item** 0 – Other than around 6  
 1 – Six Red  
 2 – About Six, or a range, e.g. 5–7

Most of the students responded that they'd expect 6 red. Only 8 students out of 272 volunteered a range of possibilities for the number of reds that would be pulled, that is, only 8 spontaneously identified variability as an issue that might arise in this first task. Students focus right in on the expected value, as is oft the case when they are only asked about one trial. It is rather surprising that nearly 15% of the students wrote they expected to get something else than about 6.

2. Suppose you did this several times. Do you think this many reds would come out every time? Why do you think this?

Table 2. Responses to “Would you expect the same number every time?”

Response	Code	MS (N=84)	HS (N=188)	All (N=272)
Yes	0	13	47	60
No- Poor reason or additive reason	1	43	65	108
No - Acknowledged Variation around 6, implicit proportional reasoning	2	27	62	89
No- Explicit proportional reasoning; strong variation reasoning	3	1	13	14
No- Distributional reasoning	4	0	1	1

**Codes for this item** Yes codes: Usually coded 0; occasionally students wrote ‘yes’, but their reasoning indicated they knew things would vary. Such cases were coded according to the *No* code scheme below.

*No* codes: 1—no reason given; vague or nonsense reason; “could be anything” reasoning; additive reasoning such as “there are more reds”

2—Some implicit indication of variation, “around 6”—but no explicit information about the distribution or about proportional reasoning, e.g., “*won't be the same every time.*”; “*probability is not exact every time*”

3—Explicit Reasoning using the ratio, average, percent, or chance of reds (60% reds, 6 : 4 ratio); or reasonable spread. Some clear indication was given of proportional reasoning about the distribution of outcomes.

4—Explicit use of both a reasonable spread, as well as a spread around the expected value—distributional reasoning

25% of the HS students agreed, *yes, it will be the same every time*. This is consistent with findings in previous research (Shaughnessy et al, 1999; Reading & Shaughnessy, 2000; Shaughnessy et. al, 2003). The influence of the probability teaching may interfere with students thinking about variability. “Six reds” is *supposed* to happen, theoretically, in the minds of many students, because that is what probability says. This type of thinking about probability, particularly among the high school students waffled during our extended interviews, as the tension between “the most likely individual outcome”, and a “likely distributions for a set of repeated outcomes”, became more evident when follow-up questions were possible. Only 15 students gave reasons that explicitly used proportions (explicit proportional or distributional reasons). Two-thirds of the students did not reason proportionally at all on this task. Many students relied on additive thinking, such as “there are more red” or on “anything can happen”. This latter response is reminiscent of the outcome approach discussed by Konold et al (1993).

3. How many reds would surprise you? \_\_\_\_\_ Why would that surprise you?

Table 3. Responses to “How many reds would surprise you in a handful of ten?”

Response	Code	MS (N=84)	HS (N=188)	All (N=272)
Any number from 4 to 8	0	11	39	50
0–3, 9, 10; blank, or additive reasoning	1	59	98	157
0–3, 9, 10; proportional or distributional reasoning	2	13	44	57
Mentioned both ends, and used proportional reasoning	3	1	7	8

**Codes for this item** 0– 4, 5, 6, 7, 8

1 – 0,1,2,3, 9, 10 “*because there are more reds*”

2 – Same numbers plus adequate reason (Which means that they attend to proportions or features of the distribution: Average, Ratio, Spread, chance)

(+1) If they mention both ends of the distribution

Students who responded that a number from 4 to 8 reds would be surprising were coded zero on this question, because these outcomes account for most of the cumulative probability distribution, and they really aren’t surprising outcomes. 80% of the students identified at least one surprising outcome, in the sense that it had a low probability of occurring. However, only about 25% could explain why those numbers were surprising by appealing to features of the distribution, such as the proportion of reds, or the spread of outcomes. Most of the responses that were coded 1 were students who just put down one or

two numbers that would surprise them, such as 10 reds, or 1 red. Students tend to believe that the extreme outcomes (0, 1, 9, 10) will occur much more frequently than they actually do in practice, as verified later on by their predictions for repeated samples in the classroom teaching episode where we carried out the sampling with them. There is a long research history dating back to early work in cognitive psychology (Kahneman & Tversky, 1972) which indicates that people lack intuition for the shape of probability distributions in dichotomous sampling tasks. Students' responses on this item bear out that lack of intuition.

4a. Suppose that six of your classmates do this experiment, each of them pulling out 10 candies. (After each pull, the candies are put back and remixed).

What do you think is likely to occur for the numbers of red candies that each classmate would pull out? \_\_\_\_\_, \_\_\_\_\_, \_\_\_\_\_, \_\_\_\_\_, \_\_\_\_\_, \_\_\_\_\_

Why do you think this?

Table 4. Summary of responses for six pulls (of 10) from the 60 – 40 mixture.

Responses	Code	MS (N=84)	HS (N=188)	All (N=272)
Too much or too little variation ( N, W, H, L)	0	24	93	117
Appropriate choices but additive or poor reasoning	1	51	57	108
Centers <i>or</i> Spreads, Proportional reasoning	2	9	32	41
Centers <i>and</i> Spreads, Distributional reasoning	3	0	6	6

**Codes for this item** 0 – Too much or too little variation,

e.g., W(ide)-range  $\geq 8$ , N(arrow)-range  $\leq 1$ ,

H(igh)-all  $\geq 6$ , L(ow)-all  $\leq 6$

1 - Appropriate range of choices, but inappropriate or additive reasoning

e.g., “*there are more reds*”; “*they are all mixed up*”

2-- Using ratio or average or chance or spread—some indication of proportional reasoning

3- Explicitly using variation combined with centers (distributional reasoning)

The main purpose of this item was to gain some insight into what students would predict for the results of repeated samples. Often students are only asked “what would you expect to happen” for one trial in a probability experiment or a sampling situation. Responses such as 3,7,5,6,6,4 or 7,5,6,8,3,6, or 5,6,6,7,6,6 were coded as having a reasonable or appropriate spread or variation, while choices such as 6,6,6,6,6,6 (too narrow, N), 1,7,3,9,10,4 (too wide, W), 1,2,3,4,5,6 (too low, L), or 6, 7, 6, 8, 9, 8 (too high, H) were coded 0, as they had too much or too little spread, or didn't bracket the expected value, 6. Nearly *half* the HS students were coded N, W, H, or L. The HS students did much worse on this task than the middle school students. Table 5 shows the breakdown for the 117 students who received a score of 0 (H, L, W, N) when predicting the results of six repeated samples of size 10 drawn from the 60 – 40 mixture.

Table 5. Breakdown of the 0 codes assigned to the 60 – 40 mixture.

Responses	MS (N=24)	HS (N=93)	All (N=117)
H	4	4	8
L	5	26	31
N	7	24	31
W	4	11	15
N & H	2	5	7
N & L	0	3	3
Other	2	20	22

The HS students who were coded 0 on the repeated sampling task in the 60 – 40 mixture tended to predict low, or narrow. The narrow (N) predictions (e.g., 6,6,6,5,6,6) accounted for 25% of the zero codes and could be an influence of probability instruction, or just lack or exposure to statistics tasks involving variability. Another 25% of the responses were coded 0 because they were Low (L). These students may tend to think of 6 reds as an upper bound for the number of reds that one could get in a handful. Such thinking shows a complete lack of understanding of how sampling results are distributed around a center. Most of the (31) Low responses occurred among 9<sup>th</sup> graders in the school where students had little or no previous exposure to statistics or probability. The large number of low predictions in this sample of students contrasts with previous results where more students predicted high (H) than low (L) (Shaughnessy et al, 1999). That earlier pilot study was conducted with students primarily in grades 4 – 6, while this study was conducted with older students, grades 6 – 12. Perhaps younger students are more likely to be influenced by the “larger number of reds” in the mixture than older students, and thus predict higher. (Note: The “Other” category in Table 5 includes blank responses, or written word responses, such as red, red, . . . , red, written in for the six pulls).

A similar series of questions on a mixture of 1000 candies, 600 red and 400 yellow, was administered only to the 188 secondary students in the study (due to time constraints). The results of students’ predictions for six pulls from this mixture are presented in Table 6.

Table 6. Summary of responses for six pulls (of 100) from the 600 – 400 mixture

Responses	Code	HS (N=188)
Too much or too little variation ( N, W, H, L)	0	123
Appropriate choices but additive or poor reasoning	1	34
Centers <i>or</i> Spreads, Proportional reasoning	2	26
Centers <i>and</i> Spreads, Distributional reasoning	3	5

**Codes for this item** 0 – Too much or too little variation,

& W(ide) range  $\geq 50$ , N(arrow) range  $\leq 3$ , H(igh all  $\geq 60$ , L(ow) all  $\leq 60$

1 - Appropriate range of choices, but inappropriate or additive reasoning, e.g., “*there are more reds*”; “*they are all mixed up*”

2-- Using ratio or average or chance or spread—some indication of proportional reasoning

3- Explicitly using variation combined with centers (distributional reasoning)

Of the 188 secondary students, 65% did not have a good feel for what would be likely to occur in six pulls. The breakdown for the 123 students who received a score of 0 when predicting the results of six pulls from the 600 – 400 mixture was as follows: 30 L; 26 N; 21 W; 4 H; 5 W&L; 3 N&H; 1 N&L; 1 W&H; and 32 Other; (blank or words written in). The population proportion (60% reds) in this larger mixture was the same as for the 60 – 40 mixture, and the relative sample size was maintained at 10% of the population. However, performance was much worse on this task than on the 60 – 40 mixture, with two-thirds of the students making choices for the numbers of reds in their repeated samples that were W, N, H, or L. Students who were coded 0 on this task often predicted low, narrow, or wide. With a much bigger range of numbers, the students were more likely to predict wide for this sampling task than for the smaller mixture. This task provides further evidence of the tendency, also noted in the studies cited above, for students to predict too wide a range of outcomes, or to believe that outcomes with very low probabilities *will* occur.

### Results & Discussion

- Only 8 of our 272 students spontaneously acknowledged the possibility of variation in a sampling situation when there was only one trial (Question 1). This type of question doesn't even raise the role of variability in sampling. Furthermore, it concentrates student thinking on centers, as opposed to spreads. We recommend against using such questions in isolation from other questions on sampling, such as our questions 2 – 5, because they mask variability.
- When asked if they will get the same result every time they sample, surprisingly 25% of our students said yes, they will. However, based on our experience with interviewing students using similar tasks, we believe that many of these students would qualify there thinking under further questioning, and say things like “that’s what theory predicts, but you might not get that if you actually did it, even though your supposed to.” There may be interference from past experiences with probability that distract from variability.
- Many of our students did not have a good sense for the results of a repeated sampling situation, particularly when a large sample size is drawn. Some students believe that a very wide range of possible outcomes will always occur in a dichotomous sampling task. Others predict a very narrow band of outcomes, while still others predict a range (too high or too low) that does not even bracket the population proportion (60% in this case).
- Our students tended to believe that extreme outcomes *will* occur. Many students wrote that only the most extreme outcomes (0 or 10; 0 or 100) would surprise them. Only 8 of 272 students spontaneously identified surprising outcomes in both tails of the distribution. Again, during probing in interviews, we have found that students will mention extreme outcomes at both ends as surprising, but only when specifically asked.
- Our students tended *not* to use the potential power of proportional reasoning in their explanations for their responses. They relied more on additive or frequency types of arguments than on proportions or relative frequencies in their responses. The percentage of students who used proportional (or distributional) reasoning on questions 2, 3, 4a, and 4b, were respectively 38%, 24%, 17%, and 16%, This

suggests that students do not evoke the connections that proportions have to sampling situations, or that they are weak proportional reasoners in general.

We believe that our students are not very different than your students, since our students come from a variety of school settings, a variety of socio-economic situations, and a variety of teaching and curriculum situations. Proportional reasoning is the cornerstone of statistical inference. In order for students to develop their intuition for what to expect in dichotomous sampling situations, we strongly recommend that teachers and curriculum developers provide many more opportunities to enhance students' proportional reasoning skills when working in a sampling environment. Furthermore, to improve students' feel for the expected variability in a sampling situation, students need considerable hands-on experience in first predicting the results of samples, and then drawing actual samples, graphing the results, comparing their predictions to the actual data, and discussing observed variability in the distribution. A forthcoming article (Shaughnessy & Watson, in press) provides several such opportunities for teachers to enhance students' proportional reasoning skills in statistical settings. The power of proportional reasoning in statistical situations needs to be identified much more explicitly in order for our students to evoke the connections of proportional thinking to statistical settings.

## References

- Kahneman, D., & Tversky, A. (1972). Subjective probability: A judgment of representativeness. *Cognitive Psychology*, 3, 430-454.
- Konold, C., Pollatsek, A., Well, A., Lohmeier, J. & Lipson, A. (1993). Inconsistencies in students' reasoning about probability. *Journal for Research in Mathematics Education*, 24, 392-414.
- Reading, C. & Shaughnessy, J. M. (2000) Student perceptions of variation in a sampling situation. In T. Hakahar & M. Koyama (Eds.), *Proceedings of the 24<sup>th</sup> Conference of the International Group for the Psychology of Mathematics Education* (vol. 4, pp. 89 – 96) Hiroshima, Japan.
- Shaughnessy, J. M., Canada, D., & Ciancetta, M. (2003). Middle School Students' Thinking About Variability in Repeated Trials: A Cross -Task Comparison. In N. Pateman, B. Dougherty, & J. Zillox, (Eds.), *Proceedings of 27<sup>th</sup> Conference of the International Group for the Psychology of Mathematics Education* (vol. 4, pp. 159 - 166) Honolulu, USA.
- Shaughnessy, J. M., Watson, J., Moritz, J., & Reading, C. (1999). School mathematics students' Acknowledgement of statistical variation. NCTM Research Pre-session Symposium: *There's More to Life than Centers*. Paper Presented at the 77<sup>th</sup> Annual NCTM Conference, S. F., CA.
- Torok, R. & Watson, J. M. (2000). Development of the concept of statistical variation: An exploratory study. *Mathematics Education Research Journal*, 12, 147-169.
- Watson, J.M., Kelly, B.A., Callingham, R.A., & Shaughnessy, J.M. (2003). The measurement of school students' understanding of statistical variation. *International Journal of Mathematical Education in Science and Technology*, 34, 1 – 29.
- Watson, J. & Shaughnessy, J. M. (in press). Proportional Reasoning: Lessons from Research in Data and Chance. *Mathematics Teaching in the Middle School*.

## DIDACTIC MODEL – BRIDGING A CONCEPT WITH PHENOMENA

Beba Shternberg,

Center for Educational Technology, Israel

Michal Yerushalmy

University of Haifa, Israel

*The article focuses on a specific method of constructing the concept of function. The core of this method is a didactic model that plays two roles together– on the one hand a role of a model of the concept of function and on the other hand a role of a model of physical phenomena that functions can represent. This synergy of modeling situations and constructing mathematical language to describe them is an initial issue in a Learning System.*

### DIDACTIC MODEL AS A COMPONENT IN A LEARNING SYSTEM

A didactic model is a means for learning a new mathematical concept. It consists of objects familiar to the learner with well-defined operations on them. The operations performed on the objects are rigorously defined and are fully and uniquely mapped onto the formal mathematical operations and syntax of this yet unknown mathematical concept. These operations support the construction of an understanding of more formal reasoning about mathematical concepts and about their essential properties. An example of such model is the Cuisenaire Rods for supporting the foundation for learning the concept of number (described by Neshet 1989).

An attempt to use the didactic models of mathematical concepts -- to address the complexity of establishing a meaningful formal language is described by Neshet (ibid.). At the heart of Neshet's Learning System mathematical models are a major means toward understanding the properties of formal mathematical language. As in traditional approaches, the physical world enters the sequence only after the formal language has been meaningfully understood. Thus, while the didactic modeling offers a significant way to grasp the properties of the concept of number (e.g., comparison of quantities as objects, group of binary operation) and connect them to formal language, the link between the physical field and the mathematical concept is not firmly established.

The Realistic Mathematics Education (RME) approach suggests that students investigate real contexts on their own (Gravemeijer & Doorman 1999). Within their perspective, the model and the situation modeled co-evolve and are constituted mutually within the course of the modeling activity.

Our approach to function based algebra learning by “guided inquiry”, combines elements of the “guided reinvention” environment (RME approach) and of the Learning System approach. Like the RME developers, we studied the students' ability to re-invent and construct mathematical notations and mathematical concepts (Yerushalmy, 1997). Like the Learning System developers, we take responsibility for

the design of mathematical didactic models that are the core of the conceptual knowledge to be acquired.

Elsewhere we describe in details the rationale for a function approach to algebra that starts with qualitative modeling (Yerushalmy & Shternberg 2001). Here we will describe the design of the didactic models –DM - that promote and enable learning in this approach. About each component of the DM we will make clear to which mathematical object and action it corresponds.

The offered DM has two parts according to two directions for analyzing functions and their changes: from a function to its change and from a change to appropriated functions.

The first part - from a function to its change - consists of a set of seven graphical icons; each icon is a line with a different behavior of change. The other part of DM allows defining function by using another set of icons, which determines discrete “changes” and presents the function as accumulation of these changes. The DM is in fact a piece of software, and as such it is naturally dynamic. For example, each line can be stretched as far as it preserves the behavior of the change (for instance, it remains ascending with a descending change), or the parameters of each change can be altered manually and the function is adjusted accordingly.

Figure 1 presents briefly the main components of the first part of the DM that is relevant to the study concerning in this paper.

Learning with the DM the students have a chance to begin constructing basic mathematical concepts of calculus at their first steps in high school algebra. The meaning of function grows in parallel with the meaning of phenomena this function could model. Far away from being familiarly with symbolical presentation of function, students get mathematical tools for inquiring meaningful mathematics and phenomena.

The different components: icons, verbs, and stairs are eventually adopted as manipulable objects that support students in constructing complex mathematical models. The learning system is designed to map the terrain of the concept of function in a simplified and abstract way. It provides mathematical terminology and an overview of the possible behavior of processes. The icons, that are models of functions and are used for reasoning about functions, are also mathematical models of situations, and together with the stairs model are used for reasoning about phenomena. Thus, the same model serves as the DM of the concept of function and as the mathematical model of a physical situation. While mathematical modeling cannot be fully accomplished by this qualitative sign system, the issue for this study is to identify essential contributions of modeling using didactic models.



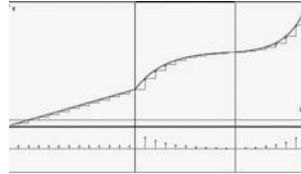
### A Context

During the summer cows produce small quantities of milk. As winter nears, **the quantity of milk increases** to the point where the cows reach peak production. In midwinter there is a decrease in the quantity of milk. **The pace of the decline speeds up until the following summer.** Describe how the pace of milk production depends on the time that elapsed from one summer to the next.

### The DM:

*A model for the concept of function and functional change*

The objects of the DM:  
seven graphic icons;  
each icon is a line representing different behaviors of change  
Action on the objects (lines):  
constructing different graphs from the lines and  
constructing stairs to create a model of a concept of change



and

*A model of acting within the contexts that a function could model*

Above the lines are the properties of functions in terms of the situation (e.g.: the pace of milk production is increasing). Placing points on the properties (or the domains), one gets the appropriate segment in the context.

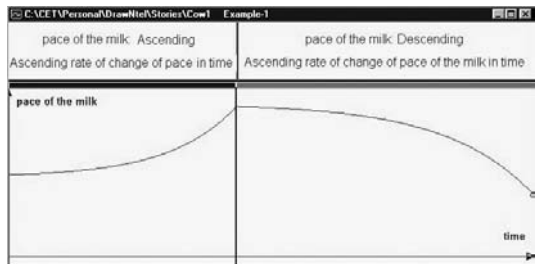


Figure 1: The main components of the DM

Applying the didactic model enables one to analyze phenomena, to describe them mathematically and to communicate about the phenomena and about the functions that represent them. As an illustration, we will introduce the case of pre-algebra students who, before studying symbolic expressions, apply the concept model of the concept of the function to describe a phenomenon.

We will argue that a Learning System that combines the concept model of the concept of function with the mathematical model of the physical situation can help students develop a profound understanding of the mathematics of functions and of its role in describing physical situations.

In the following section we will make some distinctions for describing pre-algebra students' modeling attempts.

## REASONING WITH DIDACTIC MODELS: THE CASE OF INSTANTANEOUS SPEED

A group of 34 pre-algebra 7th grade students was interviewed as they were solving seven tasks. The tasks required constructing mathematical models of phenomena characterized by their function or by their changes and distinguished one from the other by the way of presenting the phenomenon and by the aspect of the rate of change that was outlined in the task.

“Motorcycle” was one of the suggested tasks. It presented a continuous kinetic phenomenon by a graph that describes the length of the route of the motorcycle in time (figure 2).

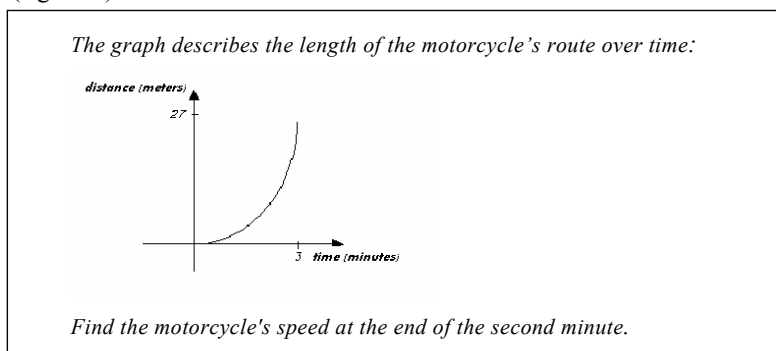


Figure 2: The “Motorcycle” task

It was a new type of problem for the students, because it asked about change at a point (unlike the DM that deals with change over an interval), and because it required a numerical solution (unlike the modeling tasks that ask for graphical and verbal descriptions with which the students were already familiar from their previous class work).

In class, students learned to use the DM to analyze and compare situations, usually in their graphic or verbal forms and with no concern as to their numeric values. “Motorcycle” challenged the students to use the DM in a way that differed from that for which it was designed. In their regular math course, these students had not yet coped with functions in any presentation except the graphic one. A common strategy used by the class, which was also applied to the “Motorcycle” task, was to analyze the behavior of a graph by visually comparing  $\Delta f$  (heights) or  $\Delta f/\Delta x$  (slopes). Although this strategy was inadequate for finding the speed at  $t=2$ , it was obviously very applicative at different steps of the solution process. It was interesting, therefore, to observe whether the didactic model would play any role in the definition of the new concept, its construction, and the process of seeking the solution for the task, i.e. measuring the speed at the second minute.

The examples below demonstrate the use of the DM in defining a new concept about which the students had only some previous intuitive insight.

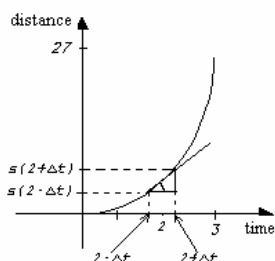
- Defining speed as the distance within the second minute

Tzor: From it (points in the stairs) one can infer the speed. Suddenly I *see* the speed in the graph. The stairs do not continue equally, they are increasing. You can see that at this time (points to a width of a stair) you move this distance (points on the height of the same stair) and from this you derive the speed.

Tzor “sees” speed just as the distance within the whole second minute, as if the speed would be constant during this period.

- Defining speed as the distance within a small unit near  $t=2$

Almost all the students defined speed as the distance within a unit of time. Moreover, most of them improved their definition by dividing the 3 minutes into more than 3 units referring to a small unit near  $t=2$ .

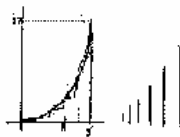


Marina and Rina were first to initiate an explicit discussion about the definition of speed.

Marina: What is speed?

Rina: Speed is the distance traveled in an allocated period of time. In the second minute it means something like this (draws a stair)... In the last minute he traveled almost twice the distance covered in the second minute. Try to make the stairs less wide so that the slope is not too drastic.

Marina: You don't have anything exact between one stair and another. I think that the difference will increase all the time (draws the differences). It comes out that in the second minute he passes something like 5 meters.

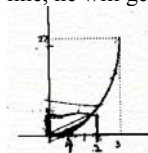


From Marina's drawing we can learn that she divided the 3 minute period into more than 3 stairs and referred to the one that was close to the point of  $t=2$ .

✦ Referring to the average speed

With regard to average speed, none of the 68 students mentioned the misleading possibility of finding the speed at  $t=2$  as the average of the speed during the 3 minutes. All the students indicated that the actual speed, unlike average speed, was not constant.

David: When you ask about the speed in the second minute, do you mean the average in two minutes? But the speed is different each second! If one draws here a straight line, he will get the average speed.



Some of the students went further and tried to define a specific rule for the change of speed, keeping the average as a reference.

Nir: The average for the three minutes is nine.

Shani: But at the beginning he moves a bit slow and then a bit faster. We should therefore add to nine here, and subtract from nine here. You should add and subtract equally.

Nir: No, here the acceleration is fast and you cannot do it equally.

Shani: We check the distance he traveled in the first minute. On average he traveled 9 km in a minute. But the first incline should be a bit less than the average, and then a bit more than average.

Nir: The rise between one and the other cannot be constant. Shani conjectured and I refuted it. He said we should add and subtract equally. It would be 6, 9, 12. It would fit if... it would increase at a constant rate, but the distance does not increase at a constant rate. Actually it cannot be right. If it were a straight line, then the speed would be constant. And here the speed begins slowly and slowly increases.

## DISCUSSION

The stairs component of the DM offers presentations of the average rate of change in an interval, and does not offer any presentation of instantaneous speed, such as a tangent. Although most of the students knew intuitively that in order to determine the speed they needed to divide the distance by time, they realized that this would not work when the speed was not constant.

Unable to discover another way to find the speed, they tried using very small intervals of time, and even then they understood that the division would give them the average speed, not the actual one. Applying the DM of stairs, the students created a mathematical model that uses the concept suitable to the processes in a situation, “saw” the speed, and came up with an operative definition for it. The DM linked the speed to the accumulated distance and created a visual presentation of the speed as the change of the function. Some of the students even tried to define a recursive rule

for the change of the function, attempting to present each height of a stair as a function of the height of the previous stair. A striking impact, which was probably a result of using this strategy, was the absence of 'average' considerations that typically appear when considering linearity. Not one of the 68 students used the linearity argument.

The use of the stairs to find the number value of the speed might result in grasping speed as a constant at each unit of time. This did not happen because the students were used to analyzing the change of function as a continuous smooth magnitude.

In the "Motorcycle" task, the students spontaneously gave the DM new roles: as a model of speed and instantaneous speed, as a tool for definition of new concepts and as a presentation of average speed. Thus, the students used the DM not only to analyze the processes, as they were accustomed, but also to define concepts and to do computations. They really connected between the different presentations of speed and took a step forward from viewing speed as a process to defining it as an object.

Carlson et al (2002) reported on an investigation of high-performing 2nd-semester calculus students, where students appeared to have difficulties in forming images of a continuously changing rate and could not interpret accurately the increasing and decreasing rate of dynamic function situations. The 7th grade students in this study, in contrast to the above mentioned calculus students, demonstrated an ability to figure out co-varying quantities, to represent constant and non-constant changes and to make the link between the graph of accumulated quantity to the graph of change. Turner et al (2000) believe that these abilities play an essential role in understanding the concept of change.

The DM helped the students to develop an understanding of the main properties of the concept of instantaneous speed and to build together the concept of the mathematical signifier – a small stair near the point -- and the signified object in the phenomenon –instantaneous speed. It seems that they took a meaningful step towards understanding some important subjects in calculus, such as the average change of function and instantaneous change and the linkage between them.

The students demonstrated an understanding of the relationship between the graphical presentation of speed and its numerical characteristics and communicated about each of the presentations in terms of the modeled situations. They related to the speed as to a process of accumulating distance in a unit of time and also as an object (defining its properties such as its ability to increase). All this allows us to claim that these students took a step forward towards the profound understanding of important concepts in calculus, such as the average change of function, instantaneous change, and the linkage between them.

## References:

- Carlson, M., Jacobs, S., Coe, E., Larsen, S. & Hsu, E. (2002). Applying Covariational Reasoning While Modeling Dynamic Events: A Framework and a Study. *Journal for Research in Mathematics Education*, 33(5), 352 – 378.
- Gravemeijer, K. & Doorman, M. (1999). Context problems in realistic mathematics education: A calculus course as an example. *Educational Studies in Mathematics*, 39, 111-129.
- Nesher P. (1989) Microworlds in mathematical education: A pedagogical realism. In Resnick, L. B. (Eds.), Essays in Honor Of Robert Glaser (pp. 197-217). Hillsdale, NJ-Hove, London: Lawrence Earlbaum Associates
- Turner, E. E., Wilhelm, J., & Confrey, J. (2000). Exploring Rate of Change through Technology with Elementary Students. Paper presented at AERA New Orleans
- Yerushalmy, M. (1997) Mathematizing Qualitative Verbal Descriptions of Situations: A Language to Support Modeling. *Cognition and Instruction* 15(2), 207-264.
- Yerushalmy, M. & Shternberg, B. (2001). A Visual Course to the Concept of Function. In A. Cuoco & F. Curcio (Eds.), The Roles of Representations in School Mathematics (pp. 251-268). Reston, VA: National Council of Teachers of Mathematics Yearbook

# ELABORATING THE TEACHER'S ROLE – TOWARDS A PROFESSIONAL LANGUAGE

Dianne Siemon, Jo Virgona, Maria Lasso, Vanessa Parsons and Juli Cathcart  
RMIT University, Australia

*As part of a larger project on effective numeracy teaching practice<sup>1</sup> a number of teachers took turns to teach a small group of students in front of their peers who were located on the other side of a one-way window. Observing teachers were asked to comment on what they noticed 'in-the-moment' and suggest labels or metaphors that captured the essence of the teacher's acts to support learning. Twelve scaffolding practices were identified as a result of this activity suggesting that it is a valuable tool for making explicit what teachers know and exercise intuitively in the context of primary mathematics classrooms. Here, we describe the activity and illustrate its potential for building a meaningful, accessible language that teachers can use to actively reflect on their practice.*

## BACKGROUND

The emergence of professional standards to document and celebrate quality mathematics teaching (e.g., National Council of Teachers of Mathematics, 1991; Australian Association of Mathematics Teaching, 2001) has focused attention on the role of the teacher and the need for an accessible professional language to articulate not only what it is that effective teachers *do* but also how they *think about* what they do and *why* they do it (Doerr, 2003). Recent work on the connections between theory and practice (e.g., Evan & Ball, 2003) suggest that this will only be viable if teachers are recognised as co-researchers in the enterprise.

Current interactionist perspectives on the teaching and learning of mathematics (e.g., Voigt, 1995; Lerman, 1998;) point to the need for a deeper understanding of the ways in which teachers contribute to the shaping of classroom cultures and interactions that occur within them. While the notion of a reflexive relationship between classroom culture and the individual construction of meaning views teaching and learning as inherently interrelated, Bauersfeld (1995) acknowledges that the teacher has a special role to play within this environment.

As an agent of the embedding culture, the teacher functions as a peer with a special mission and power in the classroom culture. The teacher, therefore, has to take special care of the richness of the classroom culture – rich in offers, challenges, alternatives, and models, including 'linguaging' (p.283)

---

<sup>1</sup> The *Researching Numeracy Teaching Approaches in Primary Schools Project* was funded by the Department of Education, Science and Training, the Victorian Department of Education, and Training, the Catholic Education Commission of Victoria and the Association of Independent Schools of Victoria.

One of the ways in which the teacher's role has been conceptualized is through the use of the metaphor of scaffolding which according to Anghileri (2002),

was first used by Wood et al (1976) to explore the nature of adult interactions in children's learning, in particular, the support that an adult provides in helping a child to learn how to perform a task that cannot be mastered alone (p.49)

This is consistent with Vygotsky's (1978) notion of the Zone of Proximal Development (ZPD) which suggests an inverse relationship between teacher support and student independence. Different levels of scaffolding have been identified in the situated cognition literature. For instance, Rogoff (1995) identified three qualitatively different 'planes of socio-cultural activity' in an out-of-school setting which she referred to as *apprenticeship*, *guided participation*, and *participatory appropriation*. The different levels trace the development of an individual within a socio-cultural enterprise from dependent novice to independent practitioner. A similar three stage model was proposed by Brown, Collins and Duguid (1989) to describe students' progression from embedded activity to generality.

In her seminal analysis of teachers' scaffolding practices in mathematics, Anghileri (2002) also distinguishes three levels of teacher support. Level 1 scaffolds tend to refer to those environmental prompts and stimuli that serve to support students' mathematics learning. Level 2 scaffolds involve the types of interaction patterns commonly found in 'traditional' classrooms, where the teacher retains control, structures conversations, elaborates, and explains, but it also includes two categories of practices that involve students more directly in reviewing and restructuring. Level 3 scaffolds aim to make connections between students' prior knowledge and experience and the new mathematics to be learned. These include developing representational tools and generating conceptual discourse where,

students are likely to engage in longer, more meaningful discussions and meanings come to be shared as each individual engages in the communal act of making mathematical meaning. (p.56)

In Anghileri's (2002) framework, teacher support appears to be conceptualised in a different way to that evident in the situated cognition literature where learners are much more clearly recognised as inductees into a specific socio-cultural practice (e.g., making cookies, or learning how to become a tent-maker or a problem solver). The practices outlined in Levels 2 and 3 of Anghileri's framework tend to be focused much more directly on qualitatively different interaction patterns. This is perhaps not surprising given the diversity of practices embraced by school mathematics, but it offers another, possibly more useful, way of talking about the nature of the teacher's role in shaping classroom communication and culture.

Wood (1994,1996) has written extensively about the *funnelling* and *focusing* 'patterns of interaction' observed in Year 2 mathematics classrooms. She makes the point that these patterns of interaction are alternatives to the traditional I-R-E interaction. Both operate to enhance rather than constrain student learning and "serve the teacher's



central intention of trying to create learning situations which enable students to construct mathematical meaning for themselves” (Wood, 1994, p.159).

In common with the scaffolding levels described earlier, these interaction patterns can be seen to be representing different levels of teacher support. However, the nature of this support is much more clearly framed in terms of teacher-student interactions and described in ways that teachers can access, contribute to and utilize.

## **The Project**

The *Researching Numeracy Teaching Approaches in Primary Schools Project* was concerned with the identification, description and evaluation of effective numeracy teaching practice. For the purposes of the project, numeracy teaching approaches referred to the communicative acts engaged in by teachers as they sought to scaffold primary students’ numeracy learning. The research question addressed in part by this paper is how can these teaching approaches in numeracy best be described to support teachers to implement them effectively.

The project was conducted in 16 Victorian primary schools including a special school between October 2001 and December 2002. It was essentially set up as an action research study (see Sullivan & Siemon, 2003) where teachers were expected to focus both individually and collectively on the nature of their communicative practice as they supported students making connections in their mathematics learning. An interactionist model developed by Clarke and Peterson (1986) was used to frame the data collection. This involved a range of task-based activities, surveys and interviews, as well as field notes of classroom observations, case-studies of individual teachers and the records of a ‘Behind-the-screen’ (BTS) activity, which involved the structured observation of up to 16 teaching episodes by a group of teachers facilitated by members of the research team. This paper will report on one aspect of this data collection, the BTS activity.

## **DATA COLLECTION**

The Behind-the-Screen activity was adapted from a technique used in Reading Recovery training (see Clay, 1993) to support a much more finely-grained, intensive study of the communicative acts engaged in by teachers. In this case, teachers took turns to engage with a small group of students in front of their peers (who were literally ‘behind’ a screen or one-way viewing window). Observing teachers were introduced to a range of possible approaches at the outset, for example, Wood’s (1994) *funneling* and *focusing* patterns of interaction, but were also encouraged to use their own words, labels or metaphors ‘in-the-moment’ to capture the essence of the observed student/teacher interaction or scaffolding practice. The essential purpose of this technique was to arrive at ways of describing teachers’ communicative acts that resonated with teachers’ experience.

Two clusters of 3 research schools were selected to participate in the BTS activity based on their proximity to one another and access to a suitable venue. This resulted in a metropolitan cluster and a regional cluster. A special school was included in the

regional cluster. Three teachers from each school participated in the BTS sessions. As far as possible, this involved one K-2 teacher, one Year 3-4 teacher, and one Year 5-6 teacher. A relatively remote school was also selected to participate in this activity based on their willingness to explore a video-based adaptation of the BTS activity. In this case, one teacher from each grade level was involved in the BTS group.

Members of the BTS groups met for 3 hours on 8 occasions over 12 months. For the two cluster groups, the BTS sessions occurred in a Reading Recovery facility behind a one-way window. The students, usually 4 students of 'near' or 'mixed ability', were transported to the facility for the duration of the teaching episode. For the 'remote' group, a digital video camera was used to film the teacher in his/her classroom. A 'live' signal was sent through the school's intranet to the library where the remaining teachers observed and discussed the teaching episode on a large monitor.

Observing teachers recorded their labels and/or metaphors on a record sheet together with what they regarded as evidence of the particular act observed. Each teaching session was preceded by a briefing session and followed by a reflective discussion which concluded with the facilitator asking the group to comment on the perceived levels of teacher support and student independence evident in the teaching episode. The written records were collected and summarised by a member of the research team who was also a member of the group. The summary was reviewed by the group the next time it met for clarification and confirmation. At least two research team members attended the cluster group sessions. One research team member worked with the remote group. Audio-tapes of the teaching episodes were collected at the Reading Recovery sites. Digital video-tapes of both the teaching episodes and the related discussion were collected at the remote site.

The summaries from all BTS sessions were collated to provide an emergent list of practices or interaction patterns, supported by a range of exemplars. To be included on the list, a particular practice (or something deemed by the group to be synonymous) had to have been observed and reported by at least two BTS groups on at least three occasions. As the practices emerged they were documented and circulated to all research schools. A *Sorting Task* and *Project Impact Report* completed by all teachers at the end of the project were used to inform the refinement and elaboration of the final list of scaffolding practices.

## **RESULTS FROM 'BEHIND-THE-SCREEN'**

A total of 46 teaching episodes or lessons were observed between March 2002 and March 2003 (16 at the regional centre, 15 at the metropolitan cluster and 15 at the remote rural primary school). The lessons were fairly evenly distributed over Year levels with approximately 30% at Years K-2, 37% at Years 3-4 and 33% at Years 5-6. The majority of the lessons were on Number (51%), but all other curriculum strands were represented with 20% on Measurement, 13% on Chance and Data, 9% on Reasoning and Strategies, and 7% on Space.

Inevitably, the Behind-the-screen activity evolved over the course of the 8 sessions. In part, this was due to the exploratory nature of this approach to researching teachers' practice, but it also evolved as a consequence of the accumulating knowledge, shared language and increasing confidence of the participants. Due to space limitations, it is only possible to include a small extract from the summary of one teaching episode here, but it will serve to illustrate what was noticed, how it was described, and the evidence that was seen to support the observations made.

### **Rhonda**

The teacher and her four, 'near ability' Year K (Prep) students were from a primary school located in a regional centre. The aim of the lesson was to move the students on from using a 'count-all' strategy to using a 'count-on from' strategy for numbers less than 10. In the following excerpt from the summary of Rhonda's lesson, the labels or metaphors assigned by observing teachers are indicated on the left, the evidence offered in support of their claims is included on the right.

- |                                      |   |
|--------------------------------------|---|
| Discussing                           | T: Do you really want to start at 1? Would you like to start at 10?<br>S: OK! [counted from 10 to 28] ...   |
| Reviewing                            | T: Let's count backwards from 10<br>S: 10, 9, 8...1<br>T: What would be here?<br>S: 0<br>[T covered 9 on the 1-100 number chart] T: What number have I covered? Only one number is missing.<br>S: 9   |
| Show me/<br>Convince me/             | T: How do I know that 9 goes here?<br>S: Because there's a straight line of nines...19, 29, 39 and 9 goes on top.   |
| Asking                               | [T repeats this with 5 and 12, asking each time for Ss to justify their response] T: How do you know?   |
| Noticing/<br>Drawing<br>attention to | [T showed numeral or dots cards one at a time ... Ss 'read' each number as it appeared... there is some hesitation when 5 dots are shown]<br>T: How do you know its 5?<br>S: Because its 4 here and a dot there [pointing these out]<br>T: Good, there's a 4 there and a 1 there [ repeating the pointing action].<br>What else can you see? ... K?<br>S: A 3 and a 2<br>T: Good I can see a 3 and a 2 too ... What can you see J?        |
| Modelling                            | [This session continues with the teacher drawing attention to what children see in the dot representations, reinforcing more efficient 'readings', eg a 3 and 3 for 6. When Ss count 8 dots by ones, T says: "I can see a 3, a 3 and a 2 for that one" but continues on, doing this for 7 and 9 as well when they come up. T proceeds to dice activity. A 3 and 5 are thrown, T asks students to say what the numbers are, then covers 3] |

- Focussing      T: Is there a different way we could count? ... How many altogether?  
[S pointed to 3 and covered the 3 with her hand – counting on.]  
T: Is there a different way you could have done that?  
S: 1, 2, 3...  
T: That’s counting all.[The dice are thrown again. A 5 and a 4 result].  
T: How many there now?  
S: 5
- Modelling,  
Making  
explicit      T: How many altogether? [points to both dice covers one die with a card  
that has the numeral 5 on it to encourage counting on].  
T: Say 5 and count on.  
S: 5 ... 6, 7, 8, 9

Observing teachers commented on Rhonda’s reference to explicit strategies, the way she covered smaller than larger numbers to demonstrate the ‘counting on’ strategy (*modelling, noticing*), her use of different activities to demonstrate the ‘counting-on’ idea, and the way she remained focused on the main point of the lesson (*focusing, drawing attention to*). The lesson was seen to involve a fairly high level of teacher support and relatively low level of student independence overall. However, within this, the level of teacher support was also seen to vary according to learning needs.

### **The derivation of scaffolding practices**

At its peak, the list included up to 60 words or phrases that teachers in the BTS sessions had used at some time to characterise an observed interaction pattern or communicative practice. By the end of the project this list was collapsed to twelve discrete categories for which the team felt there was fairly consistent evidence and the patterns of interaction came to be referred to as *scaffolding practices*, that is, practices engaged in by teachers to support student’s mathematics learning that might ultimately be removed when the learner can ‘stand alone’.

In elaborating and exemplifying the list, it is acknowledged that the practices described are not necessarily new. Indeed, they will be recognised widely by many teachers as something they “already do”. However, the list provides the beginnings of a professional language to describe what it is that teachers do and why in a way that is meaningful and accessible to teachers. An example of one of these is given below.

#### **Excavating - *drawing out, digging, uncovering what is known, making it transparent***

The teacher systematically questions to find out what students know or to make the known explicit. The teacher explores children’s current understanding in a systematic and persistent way. For example, in a Year 3-4 lesson on polygons, the teacher systematically investigates what students know about terms such as corners [“where 2 lines meet”], edges, faces etc, building on students responses, “Do we have a mathematical name for that?” [vertex] “How can we remember this? ...”

*Excavating* has something in common with, but is different to another practice, *Reflecting/Reviewing*, which was seen to involve pressing for a generalization or an insight beyond where the students were ‘currently at’.

## DISCUSSION AND IMPLICATIONS

The BTS activity has been shown to be a useful research tool in helping to identify and describe key aspects of teachers' communicative practices. Its value and uniqueness resides in the fact that classroom teachers were actively involved as codifiers of practice in real time. In many studies of classroom communication (for example, Cobb & Bauersfeld, 1995; Clarke, 2001), researchers from similar or differing perspectives work on the analysis of transcript and/or classroom video data to identify and label specific classroom interactions. Inevitably, the sense that is made of these 'after-the-event' analyses reflects the particular perspective of the researcher(s) concerned. While these different interpretations add to the collective understanding of classroom communication, they and the language that frames them are generally removed from the everyday experience of teachers and the language that they use to describe their practice.

The emergence of a common and expanded professional language to describe mathematics teaching was consistently nominated by research school teachers, coordinators and principals as one of the most significant outcomes of the project. This outcome is important as it contributes to the development of a coherent and consistent way of enacting and talking about the complex practice of teaching mathematics in a variety of settings. The advantage of having a language is that it then becomes possible to subject these practices to further scrutiny in order to improve and refine the quality of classroom interactions (see Evan & Ball, 2003).

While the BTS activity clearly has potential as a professional development tool, it is important to recognise the key role of the facilitator in supporting teachers to see for themselves and articulate what it is they see in order to facilitate further professional discussion, planning and reflection. As such we believe the BTS activity has the potential to make public what Hiebert et al (2002) refer to as *practitioner knowledge*, the "kinds of knowledge practitioners generate through active participation and reflection on their own practice" (p.4), that is otherwise largely personal and unshared.

## References

- Anghileri, J. (2002). Scaffolding practices that enhance mathematics learning. In A. Cockburn & E. Nardi (Eds.) *Proceedings of the 26th Annual Conference of the International Group for the Psychology of Mathematics Education* (Vol.2, pp. 49-56). Norwich, UK: UEA
- Australian Association of Mathematics Teachers. (2002). *Standards for excellence in teaching mathematics in Australian schools*. Adelaide: AAMT
- Bauersfeld, H. (1995). 'Language Games' in the mathematics classroom: Their function and their effects. In P. Cobb & H. Bauersfeld (Eds.), *The emergence of mathematical meaning: Interaction in classroom cultures* (pp. 211-292). Hillsdale, NJ: Lawrence Erlbaum
- Brown, J., Collins, A. & Duguid, P. (1989). Situated cognition and the culture of learning. *Educational Researcher*, 41, 32-42.

- Clarke, D.J. (2001). (Ed.), *Perspectives on Practice and Meaning in Mathematics and Science Classrooms*. Dordrecht, The Netherlands: Kluwer Academic Publishers
- Clark, C. M., & Peterson, P. L. (1986). Teachers' thought processes. In M. C. Wittrock (Ed.), *Handbook of research on teaching* (pp. 255–296). New York: Macmillan.
- Clay, M. (1993). *Reading Recovery: A guidebook for teachers in training*. Auckland, NZ: Heinemann Education
- Cobb, P. & Bauersfeld, H. (Eds.), (1995). *The emergence of mathematical meaning: Interaction in classroom cultures*. Hillsdale, NJ: Lawrence Erlbaum
- Doerr, H. (2003). Using students' ways of thinking to re-cast the tasks of teaching about functions. In N. Pateman, B. Dougherty & J. Zilliox (Eds.), *Proceedings of the 2003 Joint Meeting of PME and PMENA* (Vol. 2, pp.333-340). Hawaii: CRDG, College of Education
- Evan, R. & Ball, D. (Guest Eds.), (2003). Connecting research, practice and theory in the development and study of mathematics education. *Educational Studies in Mathematics*, 54 (2-3), 139-313.
- Hiebert, J., Gallimore, R., & Stigler, W. (2002). A knowledge base for the teaching profession: What would it look like and how can we get one? *Educational Researcher*, 31(5), 3-15.
- Lerman, S. (1998). A moment in the zoom of a lens: Towards a discursive psychology of mathematics teaching and learning. In A. Olivier & K. Newstead (Eds.), *Proceedings of the 22nd Conference of the International Group for the Psychology of Mathematics Education* (Vol.1, pp.66–81). Stellenbosch, South Africa: PME.
- National Council of Teachers of Mathematics. (1991). *Professional standards for the teaching of mathematics*. Reston, Virginia: NCTM
- Rogoff, B (1995) Sociocultural activity on three planes: Participatory appropriation, guided participation, and apprenticeship. In J. Wertsch, P. del Rio, & A. Alvarez, (Eds.), *Sociocultural Studies of Mind* (pp.139-164). New York: CUP
- Sullivan, P. & Siemon, D. (2003). Intended and actual approaches to teacher communication in mathematics lessons. In L. Bragg, C. Campbell, G. Herbert & J. Mousley (Eds.), *Proceedings of the 26<sup>th</sup> Annual Conference of the Mathematics Education Research Group of Australasia* (Vol 2, pp. 658-665). Geelong: MERGA
- Voigt, J. (1995). Thematic patterns of interaction and socio-mathematical norms. In P. Cobb & H. Bauersfeld (Eds.), *The emergence of mathematical meaning* (pp.163-203). New Jersey: Lawrence Erlbaum Associates.
- Vygotsky, L. S. (1978). *Mind in society: The development of higher psychological processes*. Cambridge, MA: Harvard University Press.
- Wood, T. (1994). Patterns of interaction and the culture of mathematics classrooms. In S. Lerman (Ed.), *The culture of the mathematics classroom* (pp.149-168). Dordrecht, The Netherlands: Kluwer Academic
- Wood, T. (1996). Events in learning mathematics: Insights from research in classrooms. *Educational Studies in Mathematics*, 30, 85-105.

# MAKING THE CONNECTION: PROCEDURAL AND CONCEPTUAL STUDENTS' USE OF LINKING WORDS IN SOLVING PROBLEMS

Adrian Simpson  
MERC, University of Warwick,  
Coventry, UK

Nora Zakaria  
Universiti Teknologi  
MARA, Malaysia

*The Malaysian educational system tends to take a clear instructionally-focused approach to the teaching of mathematics. This means that many students gain a good procedural command of areas of mathematics. This paper explores one outcome of a teaching experiment in which one area of mathematics (differentiation) was taught in a radically different way which emphasized key concepts rather than procedures. The paper examines how students appear to access their mathematical knowledge in solving problems in a non-mathematical context and demonstrates that there is a strong relationship between an aspect of their language use (transitional words of consequence or contrast) and the form of their mathematical understanding in this area. We discuss the relevance of this finding to the possible structure students' mental spaces.*

## INTRODUCTION

If you teach procedures, they will learn procedures.

The Malaysian educational system tends to focus on ensuring that students have a good command of a wide range of different procedures (Tall and Razali, 1993). Where mathematics is being taught as support for adult students learning another topic, there may again be a tendency for the teachers to focus on the procedures they deem important for the topic they are teaching (Benn, 1997). The environment for this research was a course on differentiation for adult students studying industrial chemistry at Universiti Teknologi MARA (UiTM) in Malaysia.

The study followed 16 students on the industrial chemistry degree, focusing on their participation in a mathematics course and a physical chemistry course. We were particularly interested in examining how the students used their mathematics in solving problems from their chemistry course (in this case, a course covering topics such as rates of reaction, rate laws and half lives, which implicitly require the use of mathematics covered in their differentiation course).

## PROCEDURAL AND CONCEPTUAL DEVELOPMENT

The distinction between being able to apply a relatively well determined set of instructions to a mathematical problem (with varying degrees of fluency) and being able to explain and use links between different structural aspects of mathematics is a common one in the mathematics education literature. Skemp's (1976) distinction between instrumental (knowing how) and relational (knowing how and why) understanding is mirrored in Hiebert and Lefevre's (1986) procedural /conceptual dichotomy

<p><b>Question 1</b></p> <p>Find <math>\frac{dy}{dx}</math> where</p> <p>i) <math>y = e^{-3x} + 2\sin(x + 4)</math></p> <p>ii) <math>y = (\cos(4x))^2</math></p> <p>iii) <math>y = \frac{2x^3 + 8x}{x}</math></p>	<p><b>Question 2</b></p> <p>Differentiate the following equation explicitly, finding <math>y</math> as a function of <math>x</math>:</p> $y^5 + 2y - \ln y = 5x^3 + 1$	<p>Earlier studies had shown that, given the teaching styles they had encountered, we should not expect our population to contain many students with a conceptual understanding of the mathematics. Indeed, a pilot study questionnaire – with students from the preceding year to the main study – using what we felt were relatively simple conceptual questions (such as that described below), found</p>
---	--	--

Figure 1: Example procedural questions

that all of the students appeared to have a very poor conceptual grasp of the topic of differentiation.

It was proposed that we attempt a teaching experiment to examine whether an alternative style of encouraging students to view the material might lead to better results. We adapted some of the ideas of Tall (1991), in particular, using active graphical approaches to working with analytic concepts such as continuity and differentiability. The mathematics module, which covered the same material as the existing course, was a hybrid of traditional teaching of procedures (required by the faculty and requested by the students) and computer-based sessions involving the investigation of particular functions.

At the end of the course, students took two tests: the first was the standard UiTM examination for the module and consisted of 'apply the procedure' questions such as those shown in figure 1.

The second test was an adaptation of the pilot study questionnaire, designed to elicit an indication of students' conceptual understanding of the material. Fundamentally, this consisted of questions of a type the students would not be familiar with and which, in our opinion and the view of two independent, experienced teachers, could not be solved with the direct application of taught procedures or simple recall. For example, the question in figure 2 might rely on students being able to link together symbolism for the



derivative, the sign of the function, the derivative and the second derivate, together with meanings for the derivative and second derivative and their graphical interpretation.

The two tests were scored according to marking schemes drawn up with independent

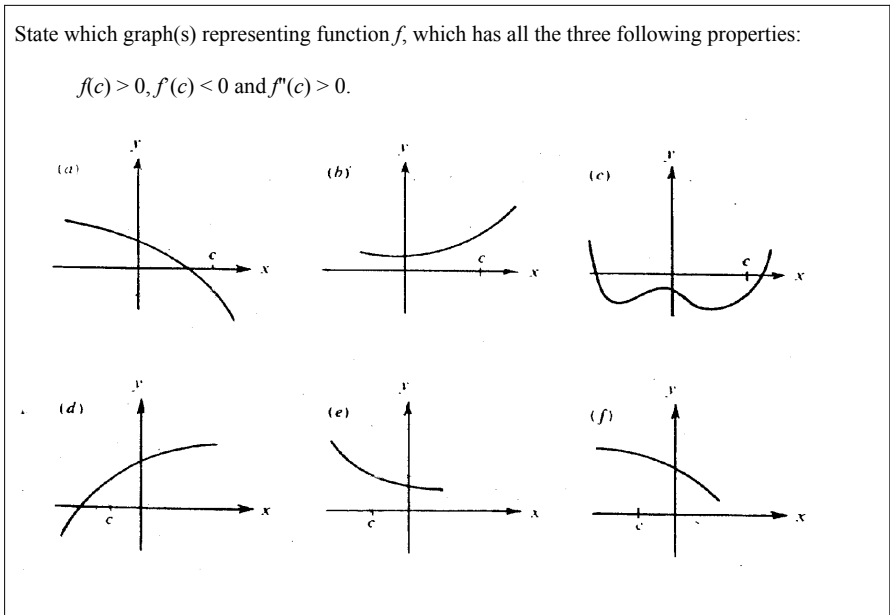


Figure 2: An example conceptual question

colleagues. The results (given as a scatter graph in figure 3) tallied well with our own experience of the students' competence with mathematical procedures and understanding of key underlying concepts.

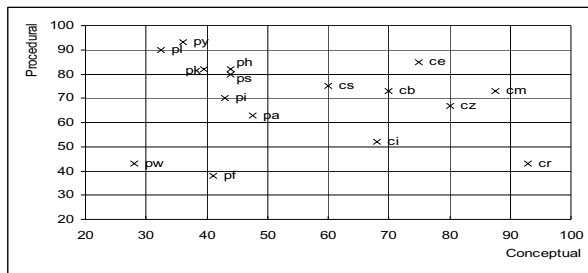


Figure 3: 'Procedural' vs 'conceptual' scores

The results show an even spread of marks across both axes, with low correlation between procedural and conceptual marks ( $r^2 = 0.03$ ) suggesting that procedural and conceptual competence in this sample were relatively independent. Examination of the scatter diagram showed what we felt were two clear groupings based on their conceptual test scores, a cluster scoring quite poorly (marked with names indexed with the prefix P) and a spread of scores above that (marked with names indexed with the prefix C).

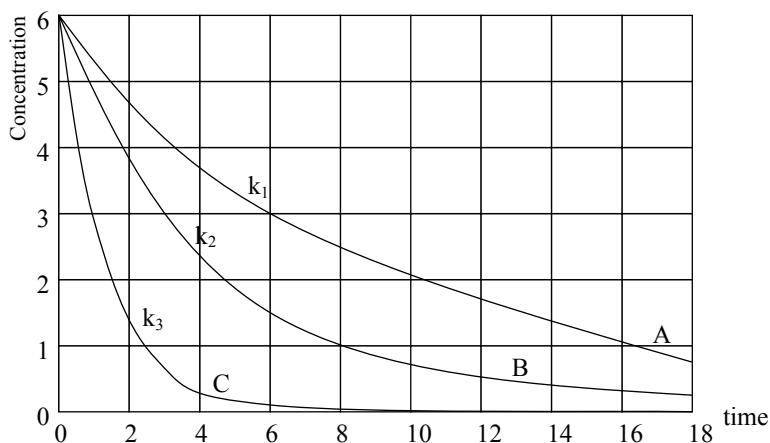
This simplistic split worked relatively well: figure 3 shows that the largest gap between conceptual scores (between candidates PA and CS) is also the point at which we chose to cleave the sample in two. For convenience, those candidates scoring above this gap (marks  $\geq 60$ ) were called conceptual (by which we meant we felt they had access to conceptual understandings of the mathematical material in the course) and those with lower scores ( $\leq 47.5$ ) were called procedural (meaning those who had access only to procedural understanding).

## LANGUAGE AS LINKING CONTEXTS

In addition to the two mathematical tests, the students attended interviews in which they solved questions which had an implicit mathematical content (including aspects of differentiation), but which were presented in a legitimate physical chemistry context. These questions were deemed, by their chemistry lecturer, to be questions appropriate to the chemistry course they were attending alongside the mathematics course (a typical question is shown in figure 4).

The transcripts of the students' attempts to solve these problems were subjected to many different analyses. In this paper, we will concentrate on a simple, yet surprisingly effective one which we came to call linking words analysis. Each transcript was divided into units of meaning (Kruger, 1981) and these units of meaning we sorted into two main categories: statements apparently about mathematics and statements apparently about chemistry. By asking independent raters to repeat this categorization process with a judges' manual (of the form described in Perry, 1970), we showed a good level of reliability in this categorisation. The short extract in figure 5, shows part of one student's response to the question in figure 4, with units of meaning categorized.

The diagram consists of 3 graphs of concentration versus time starting with the same initial concentration but with different rate constant  $k_1$ ,  $k_2$  and  $k_3$ .



Explain what you can about the graphs

Which graph has the highest rate of reaction at time,  $t = 1$  and why?

Which graph has the smallest rate of reaction at  $t = 4$  and why?

What is the order of the reaction for each of the graph?

If each of the graphs is extended, will the graph touch the time-axis and why?

Which graph has the largest rate constant and why?

Which graph has the lowest rate constant and why?

Plot a graph of rate of reaction versus concentration for each of the graph.

Figure 4: A Physical Chemistry Interview Question

In addition to this categorization, however, we noted that many students used explicit linguistic links between their statements, in which transitional words of consequence or contrast (such as 'then', 'but' and 'therefore') apparently indicate that the student is explaining a chemistry idea in terms of a mathematical one, or vice versa. We saw these as explicit indicators of connections in Sweetser's (1990) epistemic domain. In the extract in figure 5, these causal connectives are highlighted in bold.

What became clear from this analysis, however, was that while within both procedural and conceptual groups of students, the ability to solve these chemistry problems varied considerably, there were radically different ways in which they solved them. In

particular, we noticed that those students we had chosen to classify as ‘conceptual’ used many linking words, while those who we had classified as ‘procedural’ used very few (even in the cases of students who performed extremely well on these chemistry tasks).

Chem: These graphs show concentration of 3 different reactants versus time.  $k_1$ ,  $k_2$  and  $k_3$  are the rate constants. Graph A, the reaction is slow.

Math: The slope, if the slope is like this, less steep (shows his hand to indicate the steepness),

Chem: **then** its rate of reaction is slow. Graph C, the reaction is very fast

Math: **because** the slope is more steep (shows his hand to indicate the steepness),

Chem: it is fast to dissolve, it is fast to ...for the reactants to form the products, it is very fast. It means that the rate of reaction is higher.

Figure 5: A coded transcript extract

In figure 6, we consider the relationship between conceptual understanding (as evidenced by the score on the second mathematical test) and the use of linking words (a simple count of number of linking words across all of the chemistry problem questions). From the figure alone is clear that there is a strong correlation between them (in fact,  $r = 0.91$ , significant at the  $p < 0.01$  level) and it seems plausible to suggest that the conceptual understanding the students have allows them to make explicit linguistic links between the two conceptual domains.

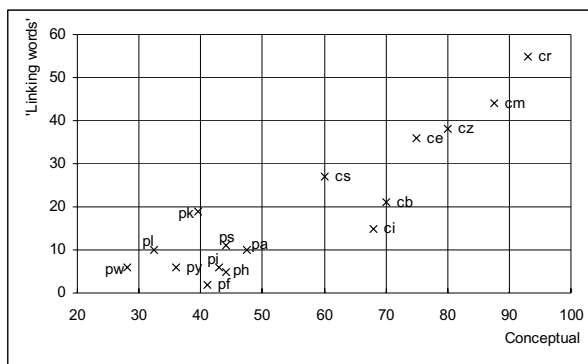


Figure 6: Correlating conceptual scores with linking words

## DISCUSSION

We can consider this strong correlation in terms of Fauconnier’s (1985) notion of a mental space – “partial assemblies constructed as we think and talk, for purposes of local understanding and action.”

Assuming that people's utterances are our entrance into inferring something about the cognitive structure which underpins their thinking processes, the striking level of correlation between the number of linking words and the marks achieved on 'conceptual' problems (that is, ones that appear to require an understanding of relational aspects of the key concepts in differentiation) suggests that the conceptual students are thinking about the problems in quite different ways from the procedural.

Their use of causal connectives suggests that they are explicitly linking the two apparently disparate domains of mathematics and chemistry together. They use their knowledge of mathematics to support their knowledge of chemistry and they use their knowledge of chemistry to contextualize their knowledge of mathematics.

In Fauconnier's terms, this suggests that their sequence of utterances tend to be connected and lie within a single mental space. In contrast, the transcripts of the procedural students, which have remarkably few linking words, indicate they are developing a series of disjoint mental spaces.

The ability to construct conjoined mental spaces would appear to allow the conceptual students access to ideas from chemistry and mathematics flexibly: to use the ideas from one conceptual domain easily and naturally within the other.

## References

- Kruger, D. (1981). *An introduction to phenomenological psychology*. Pittsburgh, PA: Duquesne University Press.
- Skemp, R.R. (1976) "Relational understanding and instrumental understanding." *Mathematics teaching*, 77, 20-26.
- Perry, W.G. (1970) *Forms of intellectual and ethical development*, New York: Holt, Rinehart and Winston
- Sweetser, E. (1990) *From Etymology to Pragmatics: Metaphorical and cultural aspects of semantic structure*, Cambridge: C.U.P
- Tall, D. and Razali, Md. R. (1993), "Diagnosing Students' Difficulties in Learning Mathematics", *International Journal of Mathematics in Education, Science & Technology*, 24, 209– 202.
- Benn, R. (1997) *Adults Count Too*, Leicester : NIACE
- Hiebert, J., & Lefevre, P. (1986), "Conceptual and procedural knowledge in mathematics: an introductory analysis" in J. Hiebert (Ed.), *Conceptual and Procedural Knowledge: The case of mathematics*. Hillsdale, N. Jersey: Lawrence Erlbaum Associates.
- Tall, D., (1991) "Intuition and rigour: the role of visualization in the calculus", in Zimmermann, W. & Cunningham, S. *Visualization in Mathematics*, M.A.A..
- Fauconnier, G. 1985. *Mental Spaces*. Cambridge, Mass.: MIT Press.



# CHILDREN'S CONCEPTUAL UNDERSTANDING OF COUNTING

Hannah Slovin and Barbara J. Dougherty

University of Hawai'i

*This paper describes a design research study with ten second-grade students who are part of the Measure Up (MU) research and development project underway at the University of Hawai'i. Students were asked how they counted in multiple bases, specifically how they knew when to go to a new place value and why it was necessary to do so. All ten students showed skillfulness in counting and representing the numbers, but analysis of their responses showed different levels of generalization of method and explanation of underlying ideas.*

## INTRODUCTION

Educators and the general public continually lament that children are not prepared for the challenge of complex and sophisticated mathematics found in high school mathematics and beyond. To help students attain higher levels of mathematics it is imperative that we reconsider the foundation that children receive in the early grades.

With this in mind, we began a new study called Measure Up (MU) that focuses on establishing a different (and stronger) mathematical foundation from which children can build their understandings in the early grades. One area of early mathematics that students explore from a different perspective is counting.

### Theoretical Foundation of Measure Up and Counting

Children in MU begin their mathematical development from the perspective of measurement and algebraic representations. V. V. Davydov (1975), a Russian psychologist, proposed that some of Piaget's findings (1973) suggested limitations on children's learning that could be overcome if instruction (and the mathematical content associated with it) were changed. Vygotsky's distinction between spontaneous and scientific concepts (1978) provided a means by which children could learn more sophisticated mathematics before we may have thought they were developmentally ready. Spontaneous or empirical concepts are developed when children can abstract properties from concrete experiences or instances. Scientific concepts, on the other hand, develop from formal experiences with properties themselves and progress to identifying those properties in concrete instances. As an example, spontaneous concepts progress from natural numbers to whole, rational, irrational, and finally real numbers, in a very specific sequence. Computations and other ideas are taught within each number system and are often not connected across systems. Scientific concepts reverse this idea and focus on real numbers in the larger sense first, with specific cases found in natural, whole, rational, and irrational numbers at the same time. Davydov (1975) conjectured that a general-to-specific approach in the case of the scientific concept was much more conducive to student

understanding than using the spontaneous concept approach. This idea can be extended to counting even though counting is thought to be a very specific and concrete action.

Drabkina (1962, (cited in Davydov, 1975)) and Minskaya (1975) noted that counting is not a simple act. It involves defining a unit of measure and using it a whole number of times. Thought of in this way, it is clear that a one-to-one correspondence requires that a child ‘see’ the unit and think of it as being iterated multiple times.

In one-to-one correspondence counting, children have to first know what unit they are using to count. Typically, they assume that they are counting ‘one’ thing, but the object(s) being counted could be grouped so that multiple objects constitute a unit. To be competent counters, children also have to understand that objects must be counted with like units. You cannot, for example, count a group of cups and saucers and say 4 when you counted two of them as a cup and saucer set and two as individual cups. A unit has to be carefully defined. This notion of counting is well developed in MU before students move to place value and computations involving multi-digit numbers.

If understanding units is a prerequisite of counting, then what should precede the introduction of number and counting? From the Davydov perspective (1975) instruction should begin by having students identify traits and attributes of objects that can be compared. These comparisons can be described without using numbers—shorter, longer, heavier, lighter, more than, less than, and equal to—and represented with relational statements, like  $G > L$ , that use letters to represent the quantities being compared. Fundamentally, students realize that if  $G > L$ , then it is also the case that  $L < G$ . First-grade students can write these relational statements and understand what they mean, because the statements describe the results of physical actions that the children themselves have performed in the comparison process.

These comparisons, based on Davydov’s proposal, can be used to model equivalence properties, addition, and subtraction. For example, if  $B > T$ , then  $T \neq B$ ,  $B \neq T$ , and  $T < B$ . As one first-grader noted, ‘if it’s an inequality, then you can write four statements. If it’s equal, you can only write two.’ [Justin, 2003] From these comparisons of two unequal amounts, they can be made equal by performing one of two actions—decrease the greater quantity (subtraction) or increase the lesser quantity (addition). The quantity added or subtracted is the difference between the quantities.

All of these ideas are developed before number is introduced in grade 1. Dealing with a problem in which students must find the relationship between two quantities requires identifying a unit and then defining the relationship between the unit and the larger quantity. These experiences establish the need to clearly identify the unit *before* counting because its definition has an impact on the counting process and result. It is only now that number is introduced.

Number introduction is linked to measurement, as a means of representing the relation between a chosen unit and a larger quantity. Children must identify the unit



before a numerical value can be used to represent a quantity. The unit used to measure two or more quantities must be the same if they are to be compared. Children as young as 6 years old can determine the relationship between units of measurement if a quantity is measured first with one unit and then with a different one. For example, if mass  $F$  is measured with mass-unit  $B$  first and then by mass-unit  $E$ , the relationships can be expressed as—

$$\frac{F}{B} = 7 \qquad \frac{F}{E} = 9$$

This indicates to students that mass-unit  $B$  is larger than mass-unit  $E$  because it took fewer of the  $B$  units to measure the quantity.

This idea is then extended to grade 2 where students begin to explore place value. Traditionally, children work with the decimal or base-ten system. Using Davydov's ideas, MU introduces place value instead with measurement units. Students may see proportional measures in a table format that motivate the notion that when you create a quantity of units, at some designated size, the unit is counted differently. For example, in a table format like the following, students combine quantities to create a new quantity. The units ( $K$  and  $N$ ) are defined by columns, the quantities ( $B$ ,  $C$ , and  $T$ ) by rows. Next, students explore the exchanging of units, given that a larger intermediate unit is made up of a specified number of smaller units (see table below). In the case of the second table, it takes 4 of the  $K$  units to make  $A$ , so an exchange can be made.

$K$	$N$	
3	2	$B$
2	2	$C$
		$T$

$A$	$K$	
1	5	$L$
	4	1
	1	
2	1	$L$

This idea is then extended to place value, beginning with bases smaller than 10. Students are given a scenario such as there exists an extraterrestrial group of Ternarians that can only use the digits 0, 1, 2, and 3. How would they count? By exploring the smaller bases first, students create means to exchange units to generate other successively larger ones. For example, if using area-unit  $E$ , in base three, they realize that it takes three of the area-units  $E$  to create a Place II area. Following the generalization they have made, Place III requires three of the Place II areas; Place IV requires three of the Place III areas, and so on. The exchanging of the smaller units for a larger unit helps student develop algorithms for addition and subtraction that involve regrouping, but it also directly links to counting.

## DESCRIPTION OF THE STUDY

The present study is part of the MU research and development project and focuses on second-grade students' ability to count in multiple bases and their understanding of the underpinnings for a place-value counting system. The ten students (six boys and four girls) at the Education Laboratory School (ELS) are representative of the larger student populations in the state. At ELS, for example, student achievement levels range from the 5th to 99th percentile, with students from low to high socio-economic status and ethnicities including, but not limited to, Native Hawaiian, Pacific Islanders, African-American, Asian, Hispanic, and Caucasian. Students at ELS are chosen through a stratified random sampling approach based on achievement, ethnicity, and SES.

The project team has engaged in design research since the fall of 2001. Design research (see *Educational Research, Volume 32, No.1*) in the domain of MU is constituted by a focus on developing a theory about children's learning in elementary mathematics rather than on 'testing' lessons in a write-test-revise cycle. This study used a one-on-one (teacher-experimenter and student) design so that we could study the students' learning in depth and detail (Cobb, Confrey, diSessa, Lehrer, and Schauble, 2003). Specifically, we interviewed the students using a method similar to that used by others for curriculum research and development (Rachlin, Matsumoto, & Wada, 1987). Listening to the student's explanation of his/her thinking allows us to analyze student understandings and helps the project team determine approximations of sophistication and complexity levels of the mathematics that students can handle.

### Description of Questions

Of particular concern in this study was the students' ability to count in multiple bases and how that ability is connected to an understanding of the structure of a place-value number system. Students had engaged in a series of tasks designed to give them experience with place value using multiple bases in the context of measurement. In lessons previous to the study they had created concrete representations of units using length, area, volume, and mass, and had had much experience combining, grouping and exchanging units. In their class work students demonstrated skill in numbering in multiple bases on number lines and on blank paper. This study was conducted at that point in the lessons where we needed to know more about how the students were integrating the tasks that emphasized the conceptual development with those focused more on building skill and fluidity in counting orally and writing numbers.

The following questions were asked individually of each of the ten students:

- 1) When you are writing the numbers in any base, how do you know when you need to go to the next place?
- 2) Explain why you have to go to the next place.

Because our interest is in the conceptual underpinnings of an overt skill, we deliberately made the questions general and open-ended to avoid influencing students' own thinking. [Need more help here]

### Analysis of Response

The responses were analyzed along two dimensions: level of generality and basis of explanation. Within each dimension the responses fell into two categories.

#### Level of Generality

Uses a general rule	Uses specific examples
Generalizes the method to any base. "You can't use the base number." (Dusty) "You can write whatever number before the base; then you change it." (Anthony) "It depends on what base you're in. You can't go to the base number. You can go up to one less." (Justin)	Responds only using particular bases. "You can't go up to six in base 6. When you count six times it means you go to the next place." (Bryson) "Because one, base 3; two, base 3; one-zero, base 3. You can't say 'three' in the [units] place." (Brooke)

#### Basis of Explanation

Uses procedural explanations	Uses conceptual explanations
Explains what you do. Explains when you change places. Uses ease of communication as a rationale. "You have to do it [move to the next place] to count higher." (Anthony) "You might get mixed up. You don't know how much it [referring to the value of the number] is." (Justin) "You can't go past five because it's in base 5." (Laylie)	Refers to the unit of measure. Refers to the structure of the number system. Relates the base to the supplementary measure $E_{II}$ or place II unit. Refers to grouping the main measures to form the supplementary measure. "The base tells you how many times to use the unit." (Michael) "The base tells you how many units to use." (Alicia)

**Table I: Grade 2 Response Categories with Examples**

Responses in which students described a general "rule" for numbering in any base were considered more advanced than those in which students only referred to numbering in specific bases. Similarly, when explaining the basis for representing the numbers, responses that included conceptual reasons were considered more advanced than those that referred only to procedural ones. See Table I above.

## RESULTS

Table II below summarizes how the students' responses in both dimensions fell into the categories. In each domain, responses that contained elements of both categories were counted with the higher category. For example, with level of generality a response that used specific bases and gave a generalized rule to explain how one knows when to move to place II was counted as conceptual.

	Level of Generality: Specific	Level of Generality: General
Basis of Explanation: Procedural	3	3
Basis of Explanation: Conceptual	1	3

**Table II: Second Graders' Responses by Category**

In responding to Question 1, all of the second-grade students knew when they had to go to the next place when counting and writing numbers in a base. Three students had to be prompted after the initial question with a more specific context such as, "Let's say, you were writing the numbers in base 5." The group of responses indicates a progression from responding by counting in a specific base to generalizing a rule for any base with no specific reference to a particular one. Laylie answered question 1 by merely counting in base five, "I had to do one, base 5; two, base 5; three, base 5; four, base 5; one-zero, base 5." Logan, used specific examples, but his response indicates the beginnings of generalization. "If I was in base 2, I do 'one' and then I can't go 'two' because I'm in base 2. But if I'm in base 4, I do..." At this point he asked for a pencil and some paper and correctly wrote the numbers starting from  $1_4$  to  $11_4$ . Justin started by giving a specific example, "In base 3 you can't go up to three, you can only go up to two." He then went on to generalize, "It depends on what base you're in. You can't go to the base number. You can go up to one less." Dusty started his response with a general rule and then gave a specific example, "You can't use the base number. Like in base 5 you can't say 'five-five, base 5.'" Anthony's response indicates that he is able to make a generalization about counting and numbering, "You can write whatever number before the base; then you change it."

Students' responses to question 2 were procedural, conceptual or a combination of both. Six of the ten students answered question 2 using only a procedural explanation. Procedural justifications either indicated an awareness of some patterning of when to start numbering in place II or referred to ease of communication. Laylie said, "You can't go past five because it's in base 5," and

Dusty said, “If you’re in base 6 you go to the five; then you go to the next.” Justin’s response represents a procedural explanation based on ease of communication: “You might get mixed up.” Students who used conceptual reasoning referred to one or more of the following: the main unit, how many units were needed to create the supplementary unit as determined by the base, or the structure of measures that comprise a place-value number system. Erin started her reasoning by saying, “You can’t know which is the number and which is the base,” but added, “it [going to the next place] means you made another amount of four.” As with their ability to generalize writing the numbers in a base, students’ explanations of why one goes to place II showed progressive development toward conceptual justifications.

## **IMPLICATIONS**

The study focused on our interest in students’ counting in multiple bases and their sense making of the ideas underlying counting. Students’ responses were analyzed for degree of generality and the nature of explanation. While all ten students demonstrated skillfulness in their ability to generate and represent counting numbers in multiple bases, they varied in how they described their methods for writing the numbers and in their reasoning of how a place value system works. Students ranged from operating specifically and procedurally to operating generally and conceptually.

The sophistication of the second-grade students’ responses was further verified by asking the same set of questions to fourth-, fifth-, and seventh-grade students at ELS who have not been part of the MU project. Of the 7 fourth and fifth graders and 6 seventh graders only one, a seventh grader, referred to the relationship among the place values. Many fourth and fifth graders responded to the question about how they know when to go to the next place by asking, “What’s place value?” Three seventh graders said they just memorized how to count and didn’t think any more about it.

We note that fewer students answered question 2 using the higher category of response than in question 1. Although the sample is small, we believe these results have several important implications for our work. First, they challenge us to continue to find ways to interweave the concept-development experiences students have with the skill-building ones. Where we once believed that when conceptual understanding was carefully established, students could engage in the type of exercises that promoted automaticity without losing these underpinnings, we now appreciate how much integration of concept and skill development it takes to maintain both. Additionally, this study reminds us that students’ apparent competence may not always be supported by robust conceptual understanding. Implications: the need to interweave the skill but not lose the conceptual understanding.

## **References:**

Cobb, P., Confrey, J., diSessa, A., Lehrer, R., & Schauble, L. (2003). Design experiments in education research. *Educational Researcher*, (32)1, pp. 9-13.

- Davydov, V.V. (1975). Logical and psychological problems of elementary mathematics as an academic subject. In L. P. Steffe, (Ed.), *Children's capacity for learning mathematics. Soviet Studies in the Psychology of Learning and Teaching Mathematics, Vol. VII* (pp. 55–107). Chicago: University of Chicago.
- Minskaya, G. I. (1975). Developing the concept of number by means of the relationship of quantities. In L. P. Steffe (Ed.) *Children's capacity for learning mathematics. Soviet Studies in the Psychology of Learning and Teaching Mathematics, Vol. VII* (pp. 207–261). Chicago: University of Chicago.
- Piaget, J. (1973). Comments on mathematical education. In A. G. Howson, (Ed.), *Developments in Mathematical Education: Proceedings of the Second International Congress on Mathematical Education*. New York: Cambridge University Press.
- Rachlin, S., Matsumoto, A., & Wada, L. (1987). The teaching experiment: A model for the marriage of teachers and researchers. *Focus on Learning Problems in Mathematics*, (9)3, pp. 21–29.
- Vygotsky, L. (1978). *Mind in society: The development of higher psychological processes*. Harvard Press: Cambridge.

# ADDING FRACTIONS USING 'HALF' AS AN ANCHOR FOR REASONING

Alina Galvão Spinillo & Maria Soraia Silva Cruz  
Federal University of Pernambuco, Brazil

*Previous studies stressed the importance of half as an anchor in performing proportion and probability tasks. Thus, it can be supposed that this reference can help children when adding fractions. This possibility is examined in this investigation, contrasting two situations: one in which half is presented as an anchor during the solution of adding fractions; and another in which other fractional units are offered. The results showed that 8-9-year-old children successfully add fractions when half is offered as an anchor during the solution process, helping in the establishment of equivalencies. In utilising half, children also adopt elaborate strategies expressing equivalence schemes that are relevant to the comprehension of adding fractions.*

## INTRODUCTION

The difficulty that children display regarding the concept of fractions has long been recognised, especially in the arithmetical learning of fractions. Many of the difficulties stem from the fact that children apply their knowledge of whole numbers to the arithmetic of fractions (e.g., Behr, Wachsmuth, Post & Lesh, 1984; Gelman & Meck, 1992; Kerslake, 1986; Lamon, 1999; Pitkethly & Hunting, 1996; Sophian, Garyantes & Chang, 1997; Streefland, 1991). Furthermore, traditional teaching tends to value the use of symbols, which can often be an obstacle to the comprehension of logic subjacent to algorithmic actions in operating with fractions (e.g., Bezerra, Magina & Spinillo, 2002).

Despite these limitations, some authors have indicated a number of possibilities regarding the thought process of children (Olive, 2003). Zeman (1991), for instance, points out the capacity of children to operate with fractions when using the reference  $\frac{1}{4}$  and the reference *whole* as anchors for adding fractions. Zunino (1995) illustrates how children in the 3<sup>rd</sup> grade of elementary school successfully work out the adding of fractions in situations that do not require the use of conventional fraction representations (a/b).

It is interesting to note that research studies on complex concepts like proportion and probability have evidenced that 7-year-old children utilise the *half* reference as an anchor to solve tasks involving these concepts (e.g., Spinillo, 1996; 2002; Spinillo & Bryant, 1991, 1999). As verified by Spinillo (1995), children are even capable of learning proportion by way of a specific intervention directed toward the use of estimates and the systematic use of the reference *half*. The intervention offered allows the child to transfer the use of this reference to other analogous, albeit distinct situations; as well as helping to overcome many of the difficulties identified prior to

the intervention. It was concluded that children could be taught to make proportional judgements, with *half* being an important reference in helping to deal with quantities and with relations crucial to proportional reasoning. These studies show that children can successfully perform activities that involve complex mathematical concepts when reference points are offered that serve as anchors for reasoning. The results of these studies find support in the perspective defended by Sowder (1995) that the use of anchors helps children to develop a numerical sense in regards to a variety of mathematical concepts. As Nunes and Bryant (1996) have suggested, the initial comprehension of the concept of *half* also favours the establishment of connections between both extensive and intensive aspects of rational numbers, and can be considered an important reference for children to initiate the quantification of fractions. Recently, Singer-Freeman and Goswami (2001), in investigating children's ability to establish equivalence between continuous and discontinuous quantities, observed a greater success with problems involving the fraction *half* than with those involving the fractions  $\frac{1}{4}$  or  $\frac{3}{4}$ .

Considering the importance of the reference *half* in performing tasks that involve proportion and probability, it can be supposed that this reference is also used on the part of children in performing operations of adding fractions. This possibility is examined in the present investigation, contrasting two situations in the solution of adding fractions: one in which the reference *half* is presented as an anchor during the solution process; and another in which other references are offered. The main objective of this study was to investigate whether children are able to solve problems of adding fractions by way of *half*, seeking to analyse the strategies adopted by them. The hypothesis is that *half* serves as an anchor for reasoning, helping children to successfully perform the addition of fractions, which is something that would not occur in regards to the other references made available during the solution process.

## **METHOD**

### **Participants**

Forty-two middle-class children from the 2<sup>nd</sup> grade (mean age: 8yrs 4m) and 3<sup>rd</sup> grade (mean age: 9yrs 3m) of elementary school in the city of Recife, Brazil. None of the participants had been instructed previously at school in adding fractions.

### **Material**

Four differently coloured circles cut from cards and representing cakes that were sliced in different fashions: the strawberry cake was divided into two equal parts; the lemon cake was divided into three equal parts; the vanilla cake was divided into four equal parts; and the chocolate cake was divided into six equal parts.

Six addition of fractions presented through the slices of cardboard cake so that each slice represented one part of the operation. The additions presented were: (a)  $\frac{1}{4} + \frac{1}{4}$ ; (b)  $\frac{1}{3} + \frac{1}{6}$ ; (c)  $\frac{1}{6} + \frac{1}{6} + \frac{1}{6}$ ; (d)  $\frac{1}{3} + \frac{1}{6} + \frac{1}{4} + \frac{1}{4}$ ; (e)  $\frac{1}{3} + \frac{1}{3} + \frac{1}{3}$ ; e (f)  $\frac{1}{3} + \frac{1}{3} + \frac{1}{3}$ .



Fractional units ( $1/2$ ,  $1/3$ ,  $1/4$  and  $1/6$ ) on cardboard that correspond to the slices of each cake, utilised as anchors in solving the addition problems.

### Procedure

The children were individually asked to solve the same six addition of fractions problems under two conditions: Condition 1 – with the reference *half* ( $1/2$ ); and Condition 2 – without this reference, using other references ( $1/3$ ,  $1/4$  and  $1/6$ ). The examiner provided the following story context:

“Pedro and Arthur (show the figures of the two boys) are brothers and they like cake very much. One day, their mother made a strawberry cake, a chocolate cake, a vanilla cake, and a lemon cake. She sliced each cake in a different way, telling them that if they wanted to eat the cakes, they would have to eat the slices in the sizes that she had cut. The cakes were cut in this way: the strawberry cake was cut in two equal parts; the vanilla cake was cut in four equal parts; the lemon cake was cut in three equal parts; and the chocolate cake was cut in six equal parts (show each cake and how it was sliced). Arthur ate pieces of cake of different flavours at the same time, while Pedro ate only one flavour at a time, but Pedro always wanted to eat the same amount of cake that Arthur ate.”

At each item, the examiner asked the children to solve the addition problem using the reference fraction that was given him/her ( $1/2$ ,  $1/3$ ,  $1/4$  or  $1/6$ ).

Example of *Condition 1* (with the *half* reference), Item:  $1/3 + 1/6$ :

“One day, Arthur ate a slice of lemon cake ( $1/3$ ) and a slice of chocolate cake ( $1/6$ ). Pedro wanted to eat the same amount of cake, but he only wanted to eat strawberry cake ( $1/2$ ). In order to eat the same amount of cake that Arthur ate, how many slices of strawberry cake does Pedro have to eat? Tell me how you solved the problem”.

### RESULTS

The Wilcoxon Test revealed that the performance under Condition 1 (with *half*) was significantly better than that under Condition 2 (without *half*) ( $Z = -4.8982$ ,  $p = .0000$ ), as displayed in Table 1.

Grade	Condition 1 (with half)	Condition 2 (without half)	Total
2 <sup>nd</sup>	74.6	42.8	58.7
3 <sup>rd</sup>	92	52.4	72.2
<b>Total</b>	83.3	47.6	65.5

Table 1: Percentage of correct responses per grade under each condition.

This same pattern of results is observed in relation to each grade (Wilcoxon: 2<sup>nd</sup> grade:  $Z = -3.2900$ ,  $p = .0010$ ; and 3<sup>rd</sup> grade:  $Z = -3.6214$ ,  $p = .0003$ ). However, the performance between grades does not differ under Condition 1 (with half) ( $Z = -1.9505$ ,  $p = .0511$ ) nor under Condition 2 (without half) ( $Z = -1.0345$ ,  $p = .3009$ ). This

occurred because under Condition 1 the children in both grades presented equally good performances, while under Condition 2 the performance was equally low.

### Strategies

From the analysis of the protocols of each child, five types of strategies were identified. They are described and exemplified below:

Strategy I (size comparison): the child compares the size of the slices that constitute the portions of the operation and the reference slice to perform the additions. Examples:

*Item  $1/6 + 1/6 + 1/6$  (chocolate cake) Fractional unit of reference:  $1/4$  (vanilla cake)*

Child: (Place  $1/4$  over  $1/6$ ) Two.

Interviewer: Why?

Child: Because the chocolate slice is smaller than the vanilla one.

Strategy II (absolute number of slices): the child reasons in absolute terms, giving the same number of slices present in the operation as an answer. Examples:

*Item  $1/3 + 1/3 + 1/3$  (lemon cake) Fractional unit of reference:  $1/2$  (strawberry cake)*

Child: Three.

Interviewer: Why?

Child: Because he ate three here ( $1/3 + 1/3 + 1/3$ ) and three more here ( $1/2 + 1/2 + 1/2$ ).

Interviewer: And is that the same amount of cake?

Child: Yes, three and three.

Strategy III (inadequate composition and decomposition): compositions and decompositions based on juxtapositions of the reference slices on the operation slices. The child becomes confused and cannot establish all the necessary equivalencies by way of simple compensations. Examples:

*Item  $1/4 + 1/4 + 1/4 + 1/4$  (vanilla cake) Fractional unit of reference:  $1/3$  (lemon cake)*

Child: (Put together  $1/3 + 1/3$ . Only two. Because this one ( $1/3$ ) is the same as these ( $1/4 + 1/4$ ) and this one (referring to the other  $1/3$  slice) is the same as these ( $1/4 + 1/4$ ).

Strategy IV (global): the child, in a global manner, seeks to determine if the slices present in the operation form either an entire cake or half of a cake. Upon determining this, the child tries to form either an entire cake or half of a cake with the reference slices. Examples:

*Item  $1/3 + 1/6 + 1/4 + 1/4$  (slices from diverse cakes) Fractional unit of reference:  $1/2$  (strawberry cake)*

Child: This would be a whole one (referring to the slices from diverse cakes). It would be two slices of strawberry to make a whole cake too.

Strategy V (adequate composition and decomposition): the child is able to establish the necessary equivalencies, making appropriate compositions and decompositions from groupings of the operation slices and groupings of the reference slices. Examples:

*Item  $1/3 + 1/6 + 1/4 + 1/4$  (slices from diverse cakes) Fractional unit of reference:  $1/2$  (strawberry cake)*

Child: One whole cake. Two slices. (Why?) Because this one (referring to one of these slices of the unit of reference:  $1/2$ ) is the same as two of these (referring to the slices of vanilla cake:  $1/4 + 1/4$ ). Plus this one (referring to the slice of chocolate cake:  $1/6$ ) completes this other one (referring to the  $1/3$  slice, which together with the  $1/6$  slice forms  $1/2$ ).

*Item  $1/3 + 1/6$  (slices of lemon and chocolate cake, respectively) Fractional unit of reference:  $1/4$  (vanilla cake)*

Child: Three. Because this one (referring to the slice of chocolate cake:  $1/6$ ) is the same as this one here (referring to the slice of the unit of reference:  $1/4$ ). And this other one (referring to the slice of lemon cake:  $1/3$ ) needs two.

These strategies express increasing levels of sophistication going from Strategy I to Strategy IV and Strategy V. The distribution of strategies is presented in Table 2.

Strategies	2 <sup>nd</sup> Grade	3 <sup>rd</sup> Grade
<b>I (n=51)</b>	51	49
<b>II (n=50)</b>	100	0
<b>III (n=108)</b>	47.2	52.8
<b>IV (n=117)</b>	42	58
<b>V (178)</b>	42.7	57.3

Table 2: Percentage of strategies per grade.

Strategy I: size comparison; Strategy II: absolute quantity of slices; Strategy III: inadequate attempts at composition and decomposition; Strategy IV: global; Strategy V: adequate composition and decomposition.

The Kolmogorov-Smirnov Test just detected significant differences between grades in relation to the use of Strategy II ( $Z = 1.697$ ,  $p = .006$ ), which was only used by the children in the 3<sup>rd</sup> grade.

The relations between the conditions and the types of strategies adopted were examined by way of the Wilcoxon Test (Table 3).

Strategies	Condition 1 (with half)	Condition 2 (without half)
<b>I (n=51)</b>	39.2	60.8
<b>II (n=50)</b>	38	62
<b>III (n=108)</b>	10.2	89.8
<b>IV (n=117)</b>	65	35

Table 3: Percentage of strategies per condition.

Significant differences were detected in relation to Strategy III ( $Z = -4.7821$ ,  $p = .0000$ ), Strategy IV ( $Z = -3.0239$ ,  $p = .0025$ ) and Strategy V ( $Z = -4.2231$ ,  $p = .0000$ ). These differences occurred because Strategy III was more frequently adopted under Condition 2 (without half) than under Condition 1 (with half), whereas Strategies IV and V were more frequent under Condition 1 than Condition 2.

It was further observed that the distribution of the number of correct responses varied according to the type of strategy (Table 4).

Strategies	Correct response	Incorrect response
I (n=51)	56.9	43.1
II (n=50)	6	94
III (n=108)	18.5	81.5
IV (n=117)	89.7	10.3
V (n=178)	97.2	2.8

Table 4: Percentage of correct and incorrect responses per type of strategy.

The Wilcoxon Test identified significant differences between correct and incorrect responses in relation to all the strategies (with the exception of Strategy 1). It was verified that Strategies II and III were more frequent in items answered incorrectly than in items answered correctly. The opposite was observed in relation to Strategies IV and V, which were more frequent in items answered correctly than incorrectly. It seems that the more elaborate strategies were associated to items that were answered correctly.

## DISCUSSION AND CONCLUSIONS

The data of this study show that children who have not yet been instructed in addition at school successfully add fractions when the reference *half* is offered as an anchor during the solution process, helping in the establishment of equivalencies. In utilising this reference, children not only exhibit better performances, but also adopt more elaborate strategies expressing equivalency schemas that are relevant to the comprehension of adding fractions. These schemas are related to the ability to synthesise units in order to generate a further unit, as for example, identifying that the sum of  $\frac{1}{4} + \frac{1}{4}$  equals half. The compositions and decompositions established (Strategies IV and V) indicate a comprehension, albeit intuitive, concerning adding fractions, with the reference *half* playing an important role in this comprehension.

The main point to be underlined here is that beyond the limits of children's thinking there are possibilities that need to be explored as much in regards to the psychology of cognitive development as in regards to classroom practices. The use of anchors in mathematical reasoning in general, and the comprehension of fraction arithmetic in particular, is an example of this.

The use of the reference *half* seems to play a facilitating role in the comprehension of adding fractions. This result is important in terms of mathematics education on the elementary school level. As such, it would be relevant to conduct an intervention study in which children were encouraged to use the reference *half* in solving problems of adding fractions. Besides exploring the use of this reference, children could be asked to reflect on the different ways to reason and add fractions. An interesting classroom situation would be to ask students to evaluate the inadequacy of their answers and mistakes made when solving addition problems by way of numeric calculations with paper and pencil (adding numerators and adding denominators), contrasting this form of problem solving with that which they adopt when solving the same addition presented in Condition 1 of this study.

The reference *half* opens new possibilities to be considered in terms of what other types of anchors could facilitate children's comprehension of adding fractions. We may suppose the reference *whole* is also a powerful anchor. This possibility should be examined in future research studies.

## REFERENCES

- Behr, M.; Wachsmuth, I.; Post, T. R. & Lesh, R. (1984). Order an equivalence of rational numbers: a clinical teaching experiment. *Journal for Research in Mathematics Education*, 15 (5), 323-341.
- Bezerra, F.; Magina, S. & Spinillo, A. G. (2002). How to promote children's understanding of fractions? An exploratory study. *Proceedings of the 26th International Conference for the Psychology of Mathematics Education (PME)*, vol. 2, pp. 89-96, Norwich, UK, July.
- Gelman, R. & Meck, B. (1992). Early principles aid initial but not later conceptions of number. In J. Bideaud; C. Meljac & J-P. Fischer (Eds.), *Pathways to number: children's developing numerical abilities* (pp.171-190). Hillsdale, NJ: Lawrence Erlbaum.
- Kerslake, D. (1986). *Fractions: children's strategies and errors: a report of the strategies and errors in secondary mathematics project*. Windsor: NFER-Nelson.
- Lamon, S.J. (1999). *Teaching fractions and relations for understanding: essential content knowledge and instructional strategies for children*. Mahwah, NJ.: Lawrence Erlbaum.
- Nunes, T. & Bryant, P. (1996). *Children doing mathematics*. Oxford: Blackwell.
- Olive, J. (2003). Nathan's strategies for simplifying and adding fractions in third grade. *Proceedings of the 27th International Conference for the Psychology of Mathematics Education (PME)*, vol. 3, pp. 421-428. Honolulu, Hawaii, July.
- Pitkethly, A. & Hunting, R. (1996). A review of recent research in the area of initial fraction concepts. *Educational Studies in Mathematics*, 30, 5-38.

- Singer-Freeman, K. E. & Goswami, U. (2001). Does half a pizza equal half a box of chocolates? Proportional matching in an analogy task. *Cognitive Development*, 16, 811-829.
- Sophian, C.; Garyants, D. & Chang, C. (1997). When three is less than two: early developments in children's understanding of fractional quantities. *Developmental Psychology*, 33 (5), 731-744.
- Sowder, J. (1995). A compreensão de número na escola de primeiro grau. *Anais da I Semana de Estudos em Psicologia da Educação Matemática* (pp.19-28). Recife: Copiadora Caxangá.
- Spinillo, A.G. (1995). Can young children learn how to reason proportionally? An intervention study. *Proceedings of the 19th International Conference for the Psychology of Mathematics Education (PME)*, vol. 3, pp. 192-199. Recife, Pernambuco, July.
- Spinillo, A. G. (1996). Developmental perspectives on children's understanding of ratio and proportion and the teaching of mathematics in primary school. In J. Gimenez, R. C. Lins & B. Gómez (Eds.), *Arithmetics and algebra education: searching for the future* (pp. 132-137). Barcelona: Copisteria Asturias.
- Spinillo, A. G. (2002). Children's use of part-part comparisons to estimate probability. *Journal of Mathematical Behavior*, 21, 357-369.
- Spinillo, A. G. & Bryant, P. (1991). Children's proportional judgments: the importance of "half". *Child Development*, 62, 427-440.
- Spinillo, A. G. & Bryant, P. (1999). Proportional reasoning in young children: part-part comparisons about continuous and discontinuous quantity. *Mathematical Cognition*, 5 (2), 181-197.
- Streefland, L. (1991). *Fractions in realistic mathematics education: a paradigm of developmental research*. Dordrecht: Kluwer Academic Publishers.
- Zeman, M. (1991). The part-whole schema in the conceptualization of fractions. *The Journal of Mathematical Behavior*, 10 (3), 251-259.
- Zunino, D. L. (1995). *A matemática na escola: aqui a agora*. Porto Alegre: Artes Médicas.

# PERSISTENCE OF DECIMAL MISCONCEPTIONS AND READINESS TO MOVE TO EXPERTISE

Vicki Steinle and Kaye Stacey

University of Melbourne, Australia

*This paper describes features of a group of misconceptions about decimal notation that lead to students selecting as larger, decimals that look smaller. A longitudinal study identified approximately 900 students from a variety of schools who exhibited these misconceptions and whose subsequent progress could be traced. The data demonstrates that the progress that students makes depends to a certain extent both on the nature of their misconceptions and the grade at which the misconception is held. Such phenomena could be expected to hold for misconceptions in other topics.*

## AIMS

This paper aims to describe some features of several interesting misconceptions about decimal notation. The results are derived from careful analysis of a longitudinal study of students' misconceptions, with data collected in Melbourne, Australia from 1995 to 1999. Over 3000 students, ranging from Grade 4 to Grade 10 (ages about 9 to 16), completed nearly 10000 tests and the responses of individual students have been tracked, in some cases for up to three years. Students were, in principle, tested twice yearly, although with absentees and some delays in testing, the average time interval between consecutive tests by students was 8 months.

This data has enabled us to track how the students' thinking about decimal notation typically evolves with time. In this paper, we discuss what happens to students who hold a group of misconceptions that generally result in a belief that a decimal that *looks* smaller is in fact larger; precise details are given below. These misconceptions are interesting for several reasons. First, the existence of such thinking is very surprising, and is not commonly recognized by teachers. Second, the misconceptions themselves are interesting and variations have recently been uncovered from interview studies that accompany our quantitative analysis. We believe that some of these misconceptions relate deeply to the ways in which mathematical ideas are understood in terms of metaphors – in this case arising from three different mirror metaphors (Stacey, Helme, & Steinle, 2001). Understanding the evolution of the thinking of such students may therefore have wider significance to theories of embodiment and mathematical thinking which has been a theme of PME included in discussion groups in recent years. Third, our early preliminary analysis of the longitudinal data showed that different groups of misconceptions were likely to evolve differently (Stacey & Steinle, 1999). Students generally “grow out of” some misconceptions; they are common in young students but when students leave them, they do not return. In contrast, the group of misconceptions studied in this paper is attractive to students of all ages; Steinle and Stacey (2003a) found that about 1 in 3

students will use one of these ways of thinking at some time during primary school, as do about 1 in 4 secondary students.

Some of the results reported in this paper are qualitatively the same as those that have been reported earlier from the preliminary analyses of the data. However, this analysis is new; it has overcome many technical difficulties of the preliminary analyses (e.g. relating to the composition of the longitudinal sample). Thus numerical results in this paper should be quoted in preference to our earlier publications.

The paper is specifically concerned with two issues: to what extent misconceptions persist in students (so that later tests show exactly the same ideas) and whether it is 'better' to hold one of these misconceptions in preference to others.

## THE TEST AND THE CODES

The data arises from a 30-item Decimal Comparison Test (DCT), which consisted of pair-wise comparison items with the instruction *For each pair of decimal numbers, circle the one which is LARGER*. Two sample items are comparison of 4.8 with 4.63 and comparison of 4.45 with 4.4502. Students' misconceptions are identified by the *pattern* of correct and incorrect choices in the 30 items. Students of interest to this paper will be correct, for example, on the first comparison (63 looks larger than 8, so 4.63 is smaller than 4.8) and incorrect on the second (4502 looks larger than 45, so 4.4502 is smaller than 4.45). More details of the reasoning are given below. Many researchers (e.g. Nesher & Peled, 1986) have used this technique of examining the pattern of correct and incorrect answers to probe students' thinking about decimals and our test builds on this work. Steinle and Stacey (2003a) provided evidence that the majority of errors that students make on the DCT are systematic and predictable, not random. Along with interview evidence (e.g. Swan, 1983), this demonstrates that the technique provides reliable information about common decimal misconceptions.

Four patterns of responses to the DCT are used in this paper and they are coded A2, S1, S3 and *other-S*. The codes are allocated according to strict rules about which items are correct and incorrect. Full details of the rules and the other 9 codes are given in Boneh, Nicholson, Sonenberg, Stacey and Steinle (2003). Whilst the data can only be in terms of the codes, our interest is in the underlying misconceptions, which are inferred from them.

## STUDENTS' THINKING

Each of the codes identifies groups of students who hold particular misconceptions. Steinle and Stacey (2003b) give a comprehensive list of various ways of thinking with explanations. Ideally, one response pattern would correspond to one way of thinking, but as our investigations paralleled the data collection of the longitudinal study, several different variations were found for most codes with this version of the DCT.



### **Thinking that leads to the code S1**

Two ways of thinking lead to students completing tests coded as S1, referred to as *denominator focussed thinking* and *place value number line thinking*. Students with the former will consider 0.73 to be smaller than 0.6 by focussing on the size of the denominators. Knowing that one hundredth is smaller than one tenth is then incorrectly generalized to any number of hundredths is smaller than any number of tenths. These students interpret decimals in terms of place value, but do not reunite. Students with *place value number line thinking* create a false analogy between place value columns and the formal mathematical number line or an informal version of it. Just as all 2-digit whole numbers come after all 1-digit whole numbers and before all 3-digit whole numbers, so they believe that all 2-digit decimals (e.g. 0.43) are smaller than all 1-digit decimals (e.g. 0.4) and larger than all 3-digit decimals (0.432). As a result of the analogy with place value columns, their number lines are often inverted, with larger numbers to the left and smaller numbers (for these students this means longer decimals) to the right. They may have little idea of place value.

### **Thinking that leads to the code S3**

The difference between the codes S1 and S3 shows in responses to equal length decimal comparisons, where S3 students make errors. Two ways of thinking lead to students coded as S3. A student with *reciprocal thinking* makes an analogy with the fact that  $1/73 < 1/6$  and concludes 0.73 is smaller than 0.6, while a student with *negative thinking* makes an analogy with  $-73 < -6$ . These students all effectively treat the decimal portion as a whole number and then choose the smallest whole number as creating the largest decimal. Stacey, Helme and Steinle (2001) explain *reciprocal*, *negative* and *place value number line thinking* in terms of mirror metaphors.

### **Thinking that leads to the other-S**

In this paper, students who generally choose the shorter decimal as the larger, but do not follow the S1 and S3 patterns exactly on items with special features (e.g. zeros) are labeled other-S. Either they do not consistently apply their S1 or S3 thinking, or they have an unidentified misconception, or they use a combination of ideas.

### **Thinking that leads to the code A2**

Students coded as A2 are correct on all types of decimals except one, but they may in fact have very little idea about decimal place value. Students who use *money thinking* believe that 4.4502 is equal to 4.45 (both analogous to \$4.45, maybe with some “round-off error”). These students are effectively rounding or truncating decimals to two decimal places, and treat the 2 digits on the right of the decimal point as a (second) whole number. Steinle and Stacey (2001) explored this thinking by using a variation of a decimal comparison test that allowed students to choose the option of equality and found that, of the students who made errors on these items, about 25% chose this option and about 75% chose  $4.4502 < 4.45$ .

A second group of A2 students compare decimals with the left-to-right digit comparison algorithm, but reach an impasse when they run out of digits to compare. In the example above, they match 4 with 4, 4 with 4, 5 with 5, but then need to compare 0 with a blank, and do not know what to do. If they complete tests coded as A2, it is because they then selected the shorter decimal as the larger. These A2 students are thus like S students. Features of this code are in Steinle and Stacey (2002).

## SAMPLE

For this paper, students who completed tests that were coded as A2, S1 or S3 were tracked to their next test (on average 8 months later). For simplicity, we refer to the unit of analysis as the “student”, but it is actually a pair of tests belonging to a student (many students contribute multiple pairs of consecutive tests over the longitudinal study). Points such as this make good analysis of longitudinal data logically difficult.

Two subsets of the full data are used for this paper. The *full sample* consists of all students (in the codes of interest) who completed another test in the study. The *reduced sample* excludes those whose next test has the same code. For example, 33 students completed A2 tests in Grade 6 and also completed another test in the study. On the next test, 3 students retested as A2 and the other 30 did not. The full sample contains all 33 students and the reduced sample contains the 30 students.

Table 1 shows the number of students in the full and reduced samples in each grade for A2, S1 and S3. Due to small numbers, Grades 4 and 5 will be combined, as will Grades 9 and 10. These students come from 12 different schools and many classes, so their future development is not explained by any particular teaching.

Code	Sample	Grade					Total
		4,5	6	7	8	9,10	
A2	Full	24	33	88	79	56	280
	Reduced	23	30	74	60	40	227
S1	Full	50	57	80	35	23	245
	Reduced	42	49	68	32	22	213
S3	Full	70	59	107	116	33	385
	Reduced	53	43	70	69	23	258

Table 1: Numbers of tests in full and reduced samples by grade

## PERSISTENCE AND READINESS TO MOVE TO EXPERTISE

We first discuss *persistence*, which is plotted on the X-axis in Figure 1. Persistence, the percentage of students who retest the same on the next test, is calculated using the full sample. For the 33 students who completed A2 tests in Grade 6, three retested as A2 on their next test, hence the Grade 6 persistence of A2 is 3/33 or 9%. The overall persistence of A2 is 19%, more than for S1 (13%) but much less than for S3 (33%). These results can be compared to the persistence of 89% for experts (i.e. correct on

all item types) and an average persistence of 25% for all of the non-expert codes. Figure 1(a) shows the grade-related data for students initially in A2. The persistence of A2 increases directly with age (the markers have higher X-axis values with increasing grade). More than a quarter of older A2 students (those in grades 8 to 10) retest in this code on the next test, but less than a tenth of the primary school A2 students retest as A2. Figures 1(b) and (c) provide the same measure of persistence for the codes S1 and S3, respectively. Code S1 is less persistent than A2 and S3 (the maximum X-value is less than 20%) and S1 shows the opposite trend to A2 (persistence decreases with grade). Code S3 is highly persistent, with at least a quarter of all age groups retesting in S3 at the next test. With the exception of the oldest students (Grades 9 and 10), S3 shows a general trend of increasing persistence with grade, like A2.

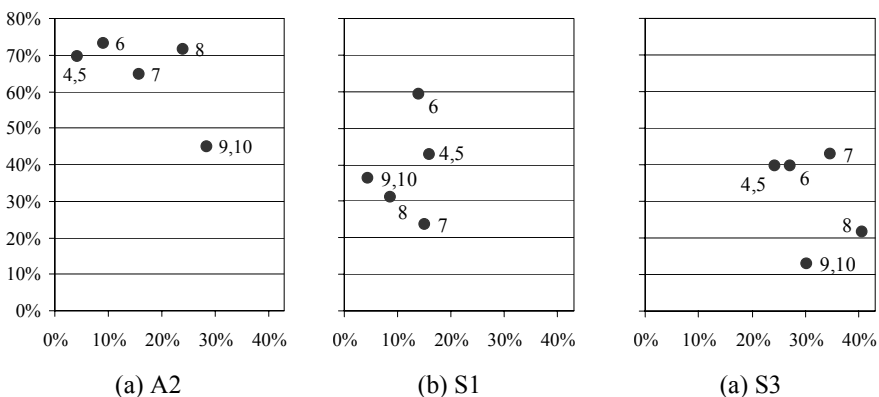


Figure 1: Persistence (on X-axis) against Readiness to move to expertise (on Y-axis) for A2, S1 and S3 by grade.

Next we report the likelihood that a student with a given misconception will become an expert (i.e. complete the test with very few errors). A simple measure shows that in the full sample above, 53% of A2 students are expert at the next test, as are 33% of S1 students and 22% of S3 students. Prospects are better for A2 students than for S1 students, with S3 students least likely to achieve expertise on the next test.

To complete this picture, it is important to examine the likelihood that a student who is looking for new ideas (rather than staying in a previous misconception) becomes an expert. Thus, the proportion of students not retesting in the same code who become experts on the next test is referred to as *readiness to move to expertise*. This is calculated on the reduced sample. Readiness to move to expertise is therefore the conditional probability of a student becoming an expert on the next test, given that they change code. For example, of the 30 Grade 6 A2 students who changed code, 22 moved to A1, hence the readiness to move to expertise is 22/30 (73%). The conditional probability is used for readiness so that it is unaffected by the persistence

of the code; there is no logical relationship between the two variables. Figure 1 displays readiness to move to expertise on the Y-axis for students testing as A2, S1 or S3 at each grade. Hence the two values for A2 students in Grade 6, mentioned above, are graphed in Figure 1(a) as the point (9%, 73%).

Across all grades, the readiness to move to expertise for A2 is a high 65%; while the values for S1 and S3 are much lower (38% and 33%, respectively). Figure 1 shows that students in A2 in Grades 4 to 8 are more likely to become experts (given that they change code) than any other group here, including the oldest A2 students (less than 50% of those who change code). It is important to note that the reason for this decrease with grade level is *not* related to the increase in persistence, as there is no logical relationship between the two measures.

S3 shows a somewhat similar grade pattern to A2, although the readiness to move to expertise is much less in each case. Older S3 students who change code are much less likely to become experts at their next test than younger students (about 20% or less in Grades 8 to 10, compared with about 40% in Grades 4 to 7).

S1 has medium readiness values, but does not show a relationship with grade. Of the students who test as S1 in Grade 6 and change code, 60% move to expertise on their next test, which is relatively high. There is a large drop to less than 30%, however, for the corresponding Grade 7 students. What else do these S1 students do, given that they move from S1, but not to expertise? This will be discussed in the next section.

## MOVEMENT TO S-CODES ON THE NEXT TEST

The previous section established that the readiness to move to expertise was very low for S1 students in Grade 7 and also for S3 students in Grades 8 to 10. These students do not retest in the same code (by definition), and yet do not become experts; so what do they do? There are many ways in which the data can be queried to answer such a question. Here we look only at the extent of movement around the S-codes. Figure 2 contains the proportion of students (based on the full sample) whose next test is one of the S-codes, i.e. S1, S3 or other-S. The earlier measure of persistence can be observed in (b) for S1 (black) and in (c) for S3 (white). Looking at the three graphs, we see that S ideas are particularly attractive to students around Grades 7 and 8.

## DISCUSSION

Since the results above are based on a large amount of data and the students come from many different schools and classes, we can conclude that the nature of the mathematical thinking of students to some extent determines how their thinking progresses. Both the simple rate and the conditional readiness to move to expertise measure show that A2 is the “best” of these misconceptions to have, followed by S1, and then S3. Students testing as A2 on one test have a strong probability of moving to expertise, overall as well as if they change code. This new expertise, however, may be not because of improved understanding but because they resolve the impasse of their failed algorithm differently, in accordance with the bug-migration ideas of

Brown and VanLehn (1982). (Space precludes a full discussion of this point.) The relatively low rates to expertise for S3 can be explained as both ways of thinking behind S3 treat the decimal portion as a whole number, which is more naïve than S1.

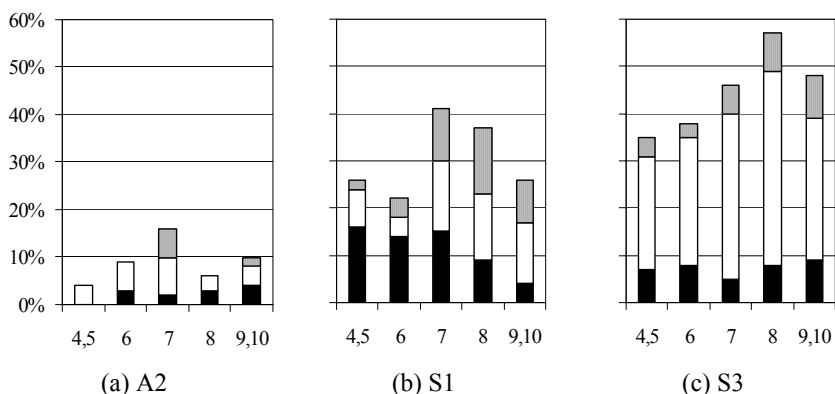


Figure 2: Proportion of A2, S1 and S3 tests, followed by an S test, by grade  
Key: black (S1), white (S3), dotted (other-S)

Persistence data shows that S1 is not “sticky”; students in S1 tend not to stay. Code A2 is “sticky” only for older students as younger students have a high probability of moving out, while S3 is “sticky” for students of all grades. The very high persistence of S3 is unexpected as these students cannot order decimals of equal length (e.g. they think that 0.3 is larger than 0.4) a commonly-met situation in classrooms and hence students would be expected to receive regular feedback on errors.

For both A2 and S3, older students have higher persistence, and when they do change code, they are less likely to move to expertise. We explain these trends by noting that these older students are likely to be low-achievers and have *missed the boat*; the main years for decimal instruction have passed. We are unsure why this does not apply to S1. It may be because most S1 students have reasonable place value knowledge.

There are strong tendencies for students in Grades 7 and 8 to move to S-codes on their next test and we explain this as interference from other learning. Negative numbers are being taught then, which may lead to *negative thinking* and generally support *reciprocal thinking* through the mirror metaphors. Scientific notation is also introduced. As  $0.00007$  can be written as  $7 \times 10^{-5}$  this might also reinforce the association of decimals and negative numbers, as well as long decimals being small.

In summary, this paper has presented a careful analysis of the progress of students who hold an interesting group of misconceptions. Ways of overcoming some of the difficulties of analyzing longitudinal data meaningfully have been indicated. At the most basic level, the results demonstrate that there are significant qualitative and quantitative differences between the progress of students with different misconceptions, as well as grade-related differences. An approach that merges the

groups (often because of insufficient data) will not identify these complexities. This work is in the context of decimal misconceptions, where a well-developed diagnostic test can track the thinking of large numbers of students sufficiently well; it is likely that the same general phenomena will apply to misconceptions in other areas.

## References:

- Boneh, T., Nicholson, A., Sonenberg, E., Stacey, K., & Steinle, V. (2003). Decsys: An intelligent tutoring system for decimal numeration. Technical report 134, School of CSSE, Monash University, Australia.
- Brown, J. S., & VanLehn, K. (1982). Towards a Generative Theory of “Bugs”. In T.P. Carpenter, J.M. Moser & T.A. Romberg (Eds), *Addition and Subtraction: A Cognitive Perspective* (pp117-135). Hillsdale, New Jersey, Lawrence Erlbaum.
- Nesher, P., & Peled, I. (1986). Shifts In Reasoning: The Case of Extending Number Concepts. *Educational Studies In Mathematics*, 17, 67-79.
- Stacey, K., & Steinle, V. (1999). A longitudinal study of children’s thinking about decimals: A preliminary analysis. In O. Zaslavsky (Ed.), *Proceedings of the 23rd Conference of the International Group for the Psychology of Mathematics Education*. (Vol. 4, pp. 233-240). Haifa: PME.
- Stacey, K., Helme, S., & Steinle, V. (2001). Confusions between decimals, fractions and negative numbers: A consequence of the mirror as a conceptual metaphor in three different ways. In M. van den Heuvel-Panhuizen (Ed.), *Proceedings of the 25th Conference of the International Group for the Psychology of Mathematics Education*. (Vol. 4, pp. 217–224). Utrecht: PME.
- Steinle, V., & Stacey, K. (2001). Visible and invisible zeros: Sources of confusion in decimal notation. In J. Bobis, B. Perry, & M. Mitchelmore (Eds.), *Numeracy and Beyond. Proceedings of the 24th Annual Conference of the Mathematics Education Research Group of Australasia*. (Vol. 2, pp. 434-441). Sydney: MERGA.
- Steinle, V., & Stacey, K. (2002). Further evidence of conceptual difficulties with decimal notation. In B. Barton, K.C. Irwin, M. Pfannkuch & M.O.J. Thomas (Eds.) *Mathematics Education in the South Pacific. Proceedings of the 25th Annual Conference of the Mathematics Education Research Group of Australasia*. (Vol. 2, pp. 633-640). Sydney: MERGA
- Steinle, V., & Stacey, K. (2003a). Grade-related trends in the prevalence and persistence of decimal misconceptions. In N.A. Pateman, B.J. Dougherty & J. Zilliox (Eds.), *Proceedings of the 27th Conference of the International Group for the Psychology of Mathematics Education*. (Vol. 4, pp. 259 – 266). Honolulu: PME.
- Steinle, V., & Stacey, K. (2003b). Exploring the right, probing questions to uncover decimal misconceptions. In L. Bragg, C. Campbell, G. Herbert & J. Mousley (Eds.) *Mathematics Education Research: Innovation, Networking, Opportunity. Proceedings of the 26th Annual Conference of the Mathematics Education Research Group of Australasia*. (Vol. 2, pp. 634-641). Sydney: MERGA.
- Swan, M. (1983). *Teaching decimal place value: A comparative study of conflict and positive only approaches*. Nottingham: Shell Centre for Mathematical Education.

# MOLLY AND EQUATIONS IN $A_2$ : A CASE STUDY OF APPREHENDING STRUCTURE

Adrian Simpson,  
MERC, University of Warwick,  
Coventry CV4 7AL, UK.

Nada Stehlíková,  
Charles University,  
Prague, Czech Republic

*This paper explores one student's attempt to apprehend an abstract mathematical structure (similar to  $Z_{99}$ ). We discuss Karmiloff-Smith's theory of representational redescription as a model for the development of structural understanding and contrast this with existing process-object theories. We use two cycles in Molly's movement from an action conception of the teacher-given aspects of the structure, inherent in the definition, to her conscious and expressible personal ownership of aspects of the structure, to explore how the model helps us account for structural understanding.*

## BACKGROUND

There is a well discussed difference between understanding, say, a vector as an action of moving from one location to another and a vector as an object. However, to understand a vector space is, we suggest, a quite different matter. In this paper, we use one girl's work to illustrate the notion of *apprehending structure*: developing a conscious and expressible sense of the relationships within, and properties of, an abstract, defined mathematical structure.

## THEORETICAL FOUNDATIONS

The idea that a learner's conception of a piece of mathematics changes its meaning as the learner develops is hardly new. There is a wide range of literature which explores how actions metamorphose into objects for learners (Sfard, 1991; Dubinsky, 1991; Gray & Tall, 1994) Implicit in much of this literature is the change of internal representation which takes place. In the case of APOS theory:

An *action* is any physical or mental transformation of objects to obtain other objects. It occurs as a reaction to stimuli that the individual perceives as external. ... When the individual reflects on an action, he or she may begin to establish conscious control over it. We would then say that the action is interiorized, and it becomes a process.

A *process* is a transformation of an object (or objects) that has the important characteristic that the individual is in control of the transformation ... As the individual reflects on the act of transforming processes, they begin to become objects. (Cottrill et al., 1996, p 171)

In Sfard's theory:

At the stage of interiorization a learner gets acquainted with the processes which will eventually give rise to a new concept. ... The phase of condensation is a period of

'squeezing' lengthy sequences into more manageable units. ... Only when a person becomes capable of conceiving the notion as a fully fledged object, we shall say that the concept has been reified. *Reification*, therefore, is defined as an ontological shift – a sudden ability to see something familiar in a totally new light

(Sfard, 1991, pp 18–19)

However, in many areas of mathematics the learner's appreciation of mathematics as consisting of particular *objects* does not do sufficient justice to the complexity of the situation. Seeing a vector as (say) both the action of moving and an object that can be added to (or even – in differing senses – multiplied with) other vectors is clearly one level of understanding. Apprehending the structure of a vector space is another. APOS theory acknowledges this difficulty by appending the notion of a *schema* to the original action-process-object theory:

A schema is a coherent collection of actions, processes, objects, and other schemas that are linked in some way and brought to bear on a problem situation. As with processes, an individual can reflect on a schema and transform it. This can result in the schema becoming a new object. (Cottrill et. al., 1996, p 172)

While these theories implicitly acknowledge a structural aspect, they focus on the formation of individual objects. However, switching the figure and ground, to focus on the structure within which these objects lie, enables us to examine different aspects of the learner's development, particularly in abstract, defined mathematics. The process-object duality tends to model better objects described rather than objects defined (Tall et. al., 2000).

Karmiloff-Smith (1992) provides a theory which seems particularly suited to explaining the development of mathematical structure. Moreover, rather than seeing this as the development of an internal representation that matches a given mathematical structure, 'representational redescription' provides a way of explaining how mathematical structure can be the consequence of active mental construction (in the sense of Cobb, Yackel & Wood, 1992) and shows how learners in different phases of redescription can interact with their mathematical environment (and their teachers) differently.

## **REPRESENTATIONAL REDESCRIPTION IN MATHEMATICS**

Representational redescription is a movement from the learner's conception of a set of atomic behaviours which are externally stimulated, to apprehending structure in which the nature and properties of the structure and the relationships within it are consciously available for communication. It is a phase theory in which

1. Initially information about the structure is encoded as separately stored procedures, with no intra- or inter-domain connections. At this phase, the learner might appear to have a set of actions on pre-existing objects (in the sense of Dubinsky, 1991).
2. These actions become internally redescriptioned. This redescription is an act of abstraction which retains only some of the aspects of the full procedures (it is



an internal *description* of the procedure, no longer the procedure itself). At this phase, such a description is unconscious, but may manifest itself in the wise choice of objects in the structure with which to work.

3. The learner is able to consciously access the redescription of the procedures, so that they have an appreciation of the relationships within the structure sufficient to guide them in solving structural problems. However, they may not be able to verbalise or symbolically express these relationships. Learners may, for example, note similarities or relationships between objects in the structure, but might not be able to articulate the nature of the similarity or relationship.
4. The final phase is the ability to communicate directly about the relationships and properties of the structure.

This movement is accompanied by different ways in which the learner can engage with the material and the teacher. At the earliest phases, the focus can only be on whether a procedure is being followed correctly while the later phases enable the learner to talk about the structure in its entirety. A beautiful illustration of such structural development and the nature of the communication about the structure can be seen in Maher and Speiser's (1997) discussion of a learner's development of binomial (and multinomial) structures from its beginnings in investigating building towers from different coloured blocks.

At the earliest phases, there can be no notion of proof, except (perhaps at phases 2 or 3) as generalized calculation. At the last phase, the learner has access to the properties of the apprehended structure, so arguing from those properties is possible. Thus, in terms of Harel and Sowder's proof schemes, there is a movement from empirical to analytic schemes (Harel & Sowder, 1998).

## CONTEXT OF THE RESEARCH

We introduced students to what we called a *restricted arithmetic*: a structure  $A_2 = (\underline{A}_2, \oplus, \otimes)$  where  $\underline{A}_2 = \{1, 2, 3, \dots, 99\}$  and the binary operators  $\oplus, \otimes$  are defined in terms of a *reduction* mapping  $r: \mathbf{N} \rightarrow \mathbf{N}$ ,  $r(n) = n - 99 \cdot [n/99]$ , (where  $[y]$  is the integer part of  $y$ ). This reduction was introduced as an instruction, illustrated by several concrete examples:

For a natural number  $n < 100$ ,  $r(n) = n$ . If  $n \geq 100$ , we split  $n$  into pairs of digits starting from the units digit and add the pairs together. We repeat the procedure until we get an element of  $\underline{A}_2$ . For example,  $r(682) = r(82 + 6) = 88$ ,  $r(7\ 945) = r(45 + 79) = r(124) = r(24 + 1) = 25$ .

Binary operators addition  $\oplus$  and multiplication  $\otimes$  in  $\underline{A}_2$  were defined and illustrated as follows:

$$\forall x, y \in \underline{A}_2, x \oplus y = r(x + y) \text{ and } x \otimes y = r(x \cdot y).$$

For instance,  $72 \oplus 95 = r(167) = 68$ ,  $72 \otimes 95 = r(6\ 840) = 9$ .

Many different problems can be solved in the  $A_2$  system, among them additive and multiplicative equations of the type  $a \oplus x = b$ ,  $c \otimes x = d$ , where elements  $a, b, c, d$  are parameters and  $x$  is the unknown.

Molly, a 20-year-old student training to be a mathematics teacher, along with 11 other students, was introduced to the  $A_2$  structure in the way given above. Unusually, Molly became sufficiently involved in trying to develop her own understanding of  $A_2$  that she quickly developed her own problems in the system and even got to the stage of writing her diploma thesis on the topic (Stehliková, 2002). In this paper, we will examine two cycles in her attempts to apprehend the structure of  $A_2$ . In the first – her work on additive equations – we see a rapid movement through the four phases, while in the second – multiplicative equations – we see the same movement slowed down as she encounters more difficulties and a more intricate structure to apprehend.

Data were collected from numerous sources: transcripts of clinical interviews (in the sense of Ginsburg, 1981), Molly's written work produced both for the interviews and independently, from field notes and from Molly's development of a journal describing  $A_2$ . These data were analysed using methods adapted from grounded theory (Glaser & Strauss, 1967) and, within the area of additive and multiplicative equations, four categories (seen later as phases of apprehending structure) emerged.

### **MOLLY'S APPREHENDING OF EQUATIONS IN $A_2$**

Molly's investigation of additive and multiplication equations was mainly triggered by two experimenter's interventions: first, Molly was presented with a list of several additive and multiplicative equations which she could solve in any order and second, she was asked to classify these equations according to their solubility. As this classification is of a different character and difficulty for additive and multiplicative equations, we will examine them separately.

The investigation of additive equations was apparently straightforward for Molly and the phases below followed on quickly from each another.

*1. An initial procedure.* Molly's first attempts involved treating the elements of  $A_2$  as if they were elements of  $\mathbf{N}$ . This worked well for a small sub-class of problems, such as  $x \oplus 6 = 92$  ( $x = 92 - 6 = 86$ ). However, when she noted this procedure failing, after a short pause, she came up with a strategy (which we call the *strategy of inverse reduction* or *SIR*) based on her procedural understanding of the reduction function:  $61 \oplus x = 4 = r(202) = r(103)$ , hence  $x = 42$

*2. Development of a procedure in  $A_2$ .* The SIR procedure enabled her to solve any additive equation, though she was able to move between the procedure adapted from  $\mathbf{N}$  and using SIR fluently and appropriately.

*3. Properties of  $A_2$ .* It became clear, after a while, that (though she was unable to enunciate it) she was implicitly using the idea that each additive equation has just one root (in  $A_2$ ).

4. *Justifying and communicating structure.* After some time, Molly was able to justify the unique root claim by referring to inverse reductions of  $b$  and their structure and much later when she had defined subtraction in  $A_2$ , she was able to justify her result in these terms.

These same four phases can be seen in more detail in Molly's work on multiplicative equations, which was much more involved and which took more cognitive effort on her part.

1. *An initial procedure.* Again, Molly initially adapted a procedure from her previous experience by treating elements of  $A_2$  as if they were elements of  $\mathbf{N}$  (or  $\mathbf{Q}$ ). As we can see in figure 1, she did this for almost all of the multiplicative equations which she was given, which resulted in some solutions which are incorrect in  $A_2$  (such as  $x \otimes 8 = 92$ , hence  $x = 23/2$ ) and in incomplete solutions (such as  $3 \otimes x = 45$ , hence  $x = 15$ ). However, when she considered the equation  $2 \otimes x = 99$  she did not use this adapted strategy but rather used her knowledge of properties of 99 within the  $A_2$  structure (which she had discovered previously) and concluded that  $x = 99$ .

$\begin{array}{l} 3 \otimes x = 45 \\ x \otimes 8 = 92 \\ 14 \otimes x = 91 \\ 2 \otimes x = 99 \end{array}$	$\begin{array}{l} x = 15 \\ x = \frac{92}{8} = \frac{46}{4} = \frac{23}{2} \\ x = \frac{91}{14} \\ \text{--- } x = 99 \end{array}$	<p>M: So, the first task, so <math>x</math> is 15. Obviously then 2 times <math>x</math> is 99, that will be that 99, that is the case of the zero. Well, now <math>x</math> is 92 eights. It could be cancelled 46 quarters... (pause)...it will go on, that is 23 halves.</p>
--	--	---

Figure 1: Molly's use of procedures from  $\mathbf{N}$

She later appeared to notice the discrepancy between equations which led to elements of  $A_2$  (or  $\mathbf{N}$ ) and those which led to fractions. She used trial-and-error methods, substituting numbers of varying size for  $x$  and exploring how this affected the size of numbers on the right hand side.

In fig. 2, we can see that, after a prompt to consider how she had worked with additive equations, she used the SIR procedure for an equation which previously resulted in a fractional answer and succeeded in finding a root in  $A_2$ . After this, she went back to her previous fractional solutions and re-solved the problems with a solution in  $A_2$ . However, she always stopped after finding the first root, which suggests that her belief that these equations must have at most one root was strong. For instance, when solving the equation  $33 \otimes x = 66$ , she just gave the answer  $x = 2$ .

Again, it was only a prompt ("Is that all?") which motivated Molly to try to use the SIR procedure to demonstrate the uniqueness of roots and which finally led to her discovery that there might be multiple roots. She re-examined the previous equations to see if she had found all the roots.

	<p>E: Consider the way you solved the equation <math>61 \oplus x = 4</math> last time.</p> <p>M: So 92 could be written as 290 ... (short pause) ... so 290 divided by 92, no 8 is ... [used calculator] ... the next one 389 ... also no, 488, it should work, it is 61, which means that the <math>x</math> should be 61.</p>
--	---

Figure 2: Developing a different procedure for  $A_2$

2. *Development of a procedure in  $A_2$ .* At this phase, she was able to solve all the multiplicative equations she worked with and could apparently see that there were equations with zero, one or multiple roots. She made some observations such as multiple roots of an equation make an arithmetic sequence and number 3, 9 and 11 “cause problems” (fig. 3) but at this phase she did not explain more than this.

	<p>M: So 33 times 20, so 20 is the next root...(short pause) ... now 14 ... (laughs) (pause) ... 8 ... (pause) ... 5 ... (pause) ... so it will always differ by 3.</p> <p>It could be calculated using arithmetic sequence.</p>
--	--

Figure 3: Recognising properties of  $A_2$

3. *Properties of  $A_2$ .* As she attempted to classify multiplicative equations, Molly solved many different equations which she posed for herself. While at the beginning she picked them apparently at random, later she decided to explore systematically the equation  $c \otimes x = d$  for  $c$  up to 16. This led to an important discovery which became the basis of a new solving strategy: if  $\sigma$  is a difference between roots and  $p$  is the number of roots, then  $\sigma \cdot p = 99$ .

She noted that this also holds for equations with one root (then  $\sigma = 99, p = 1$ ). She also made some observations such as “We cannot divide the terms of the equations by multiples of 3, 9, 11, 33... by multiples of 3 and 11”. While at the beginning she substituted individual elements of  $A_2$  for  $c$ , later her investigations involved her implicitly working with sets of numbers at once. For example, without expressing it like this, she began to work with the number 3 as if it was the representative of all multiples of 3.

4. *Justifying and communicating structure.* Eventually, Molly felt able to summarise all of her knowledge about multiplicative equations in a table (a part of which is reproduced in fig. 4)

$p$	conditions	example
1	$a \neq 3 \otimes k \wedge a \neq 11 \otimes l$ , where $k, l \in \mathbf{A}_2$	$8 \otimes x = 9$
3	$a = 3 \otimes k \wedge a \neq 9 \otimes l \wedge a \neq 11 \otimes m \wedge b = 3 \otimes n$ , where $k, l, m, n \in \mathbf{A}_2$	$3 \otimes x = 9$
0	$a = 3 \otimes k \wedge a \neq 9 \otimes l \wedge a \neq 11 \otimes m \wedge b \neq 3 \otimes n$ , where $k, l, m, n \in \mathbf{A}_2$	$3 \otimes x = 5$
9	$a = 9 \otimes k \wedge a \neq 11 \otimes l \wedge b = 9 \otimes m$ , where $k, l, m \in \mathbf{A}_2$	$18 \otimes x = 9$

Figure 4: Molly’s knowledge of multiplicative equations in  $\mathbf{A}_2$

She could now articulate the fact that the multiples of 3 and 11 represent, in fact, a set of zero divisors (even though she was not first able to give this set its name, later she called them divisors of 99). She could justify the non-existence of solution by reference to the digit sum (“if  $d$  is not divisible by 3 and 11, neither are its inverse reductions  $d + k99$ ,  $k \in \mathbf{N}$ ”) and the existence of multiple solutions by reference to divisibility tests she had developed for the  $\mathbf{A}_2$  structure.

## DISCUSSION

We can see broad similarities in Molly’s phases of development in working with additive and multiplicative equations. First she works with elements of  $\mathbf{A}_2$  as if they were elements of  $\mathbf{N}$  (using familiar number procedures). She is then able to use her understanding of a fundamental part of the  $\mathbf{A}_2$  structure (inverse reduction – which was itself developing alongside the work discussed here) to solve equations which previously were beyond her. At this phase she begins to get a sense of the structure of these equations – the number and nature of the roots – which manifests itself in the choices she makes in developing problems to investigate. Finally she is able to articulate findings about the system and begin to justify them in terms of the properties of the structure.

Both investigations are accompanied by a ‘U shape’ observable in her fluency in solving these equations. First she seems fluent as she adapts known procedures from  $\mathbf{N}$ , then she realizes that these procedures do not work and becomes much slower as she has to develop the SIR procedure to the situation. As she does so, and as it gives her a sense of the structure of the equations and their roots, she again becomes fluent. However, as Karmiloff-Smith notes, the down-curve of the ‘U-shape’ “is deterioration at the behavioural level, not at the representational level” (Karmiloff-Smith, 1992). Indeed, the loss of fluency seems to accompany her change in perception of the structure.

We do not see the development of her understanding of these aspects of  $\mathbf{A}_2$  as a movement from a process to an object conception – rather, apparently familiar objects (numbers) have taken on new properties and relationships to form a new structure for her. Thus, we suggest that these two example investigations are small scale cycles in representational redescription as Molly moves to apprehending the  $\mathbf{A}_2$  structure. She moves from working with procedures adapted from an old structure, to implicitly recognizing some aspects of the new structure, to having (but being unable

to articulate) a sense of how the equations work, to – finally – being able to express her findings and begin to justify them in terms of properties.

While beyond the scope of this paper, Molly's perseverance with  $A_2$  shows us the same process of apprehending structure writ large: with a change of perspective, her involvement with additive and multiplicative equations become steps to her apprehending  $A_2$  as a new and fascinating mathematical structure of her own.

### Acknowledgements

We are grateful to Milan Hejny for his original development of the  $A_2$  structure. The paper was partially supported by a Czech grant agency GACR No. 406/02/0829.

### References

- Cobb, P., Yackel, E. & Wood, T. (1992). A constructivist alternative to the representational view of mind in mathematics education, *Journal for Research in Mathematics Education*, 23(1), 2–33.
- Cottrill, J., Dubinsky, E., Nichols, D., Schwingendorf, K., Thomas, K. & Vidakovic, D. (1996). Understanding the limit concept: Beginning with a co-ordinated process schema, *Journal of Mathematical Behavior*, 15, 167–192.
- Dubinsky, E., (1991), Reflective abstraction in mathematical thinking, in D. Tall (ed.), *Advanced Mathematical Thinking*, Dordrecht: Kluwer.
- Ginsburg, H. (1981). The clinical interview in psychological research on Mathematical thinking, *For the Learning of Mathematics*, 1, 4–11.
- Glaser, B. & Strauss, A. (1967), *The discovery of grounded theory: Strategies of Qualitative Research*. London: Weidenfeld & Nicolson.
- Gray, E. & Tall, D. (1994). Duality, Ambiguity and Flexibility: A Proceptual View of Simple Arithmetic, *Journal for Research in Mathematics Education*, 26 (2), 115–141.
- Harel, G. & Sowder, L. (1998). Students' proof schemes: Results from exploratory studies, In A. H. Schoenfeld, J. Kaput & E. Dubinsky (Eds.), *Research in collegiate mathematics education III*. Providence, RI: AMS
- Karmiloff-Smith, A. (1992). *Beyond Modularity*, Cambridge, MA: MIT Press.
- Maher, C. A. & Speiser, M., (1997). How Far Can You Go With Block Towers? Stephanie's Development, *Journal of Mathematical Behavior*, 16(2), 125–132,
- Sfard, A. (1991). On the dual nature of mathematical conceptions: reflections on processes and objects as different sides of the same coin, *Educational Studies in Mathematics*, 22, 1–36.
- Stehliková, N. (2002). "A case study of a university student's work analysed at three different levels", A.D. Cockburn & E. Nardi (Eds.), *PME 26 proceedings* (vol. 4, pp 241–248), Norwich, UK: University of East Anglia.
- Tall, D.O., Davis, G., Thomas, M., Gray, E., & Simpson, A. (2000). "What is the object of the encapsulation of a process", *Journal of Mathematical Behavior*, 18, 2, pp 1–19.

# IMAGE - METAPHOR - DIAGRAM: VISUALISATION IN LEARNING MATHEMATICS

Gert Kadunz / Rudolf Sträßer  
Universitaet Klagenfurt - Austria / Luleå tekniska universitet - Sweden

*The paper looks into visualisation in learning mathematics from three perspectives: It starts from a discussion what it takes to make a sign, an inscription on the blackboard, on paper or on a computer screen to an image. Here we will look into the question of 'similarity' and point to the possibility of having different perspectives on the same sign as characteristic for an image. This heuristic will be complemented by looking into inscriptions as diagrams (sensu C.S. Peirce), signs constructed and used respecting certain rules. Our main argument is that learning mathematics can be described as a continuous interplay of images and diagrams. The link between these two ways to use inscriptions is offered by metaphors, which help to structure new, maybe chaotic problem situations by means of old pieces of knowledge.*

## INTRODUCTION: IMAGES AND DIAGRAMS

In Didactics of Mathematics, visualisation seems to be an important issue at present: The data base 'MATHDI' (from FIZ in Karlsruhe/Germany) offers more than 300 entries (mostly in English) - and we will try to build on results from some of these publications (Presmeg, 1992, 1998; Arcavi, 2003; Kadunz, 2003).

We start from taking images as potential representations (i.e.: a not necessarily material means to speak about something), which can - by means of analogy - present a multitude of relations. They are different from symbols, which are taken as signs, which - in a specific context - only represent a single meaning, a single relation. Here, images - as analogous representations - offer the heuristical part of learning, whereas diagrams stand for the algorithmic part of learning. Images are characterised by adjectives like polyvalent and diffuse, while diagrams are should be clear and algorithmic in use. Diagrams even can be treated by machines.

The point in our argument is that these two forms of signs do complement each other in their role for learning mathematics. More specifically, most often it is the decision of the learner if s/he looks upon and uses a representation in an analogous or algorithmic vein, if s/he metaphorically describes or algorithmically transforms a given representation. We want to stress that the changing and mutually controlled use of multi-purpose representations is the most characteristic feature of visualisation in this text.

## IMAGE

We start from the assumption that an image is a special, complex sign - a discussion on characteristics of this sort of signs is a good way to better understand images.

With this approach, being a sign is a major quality of an image and a theory of images is part of a theory of signs, of semiotics.

A sign is an entity, which stands for something else, which points to something else. Insofar, this 'something' is quite arbitrary, the link to its sign seems to be a convention. (in fact, it is NOT the sign, which points to something, but the person looking onto the sign who links it to the object). For being short, we will omit this complication of distinguishing between the sign and its user in the following whenever appropriate). The meaning of a sign is deeply related with its use, but: in the case of an image, this arbitrariness is restricted, because the 'something it stands for' should be recognisable. An image of a landscape is a sign of a special (or a general) landscape (as with the first landscapes in the late medieval pictures before the Renaissance). It is an image of a landscape seen by human beings. An image relates to something, it 'denotes' something (see the concept of 'denotation' by Goodman, 1976). Even if the arbitrariness of denoted objects in the case of an image is restricted because of the necessity of being recognisable, an image may denote more than one object. In addition to that, an image may point to different objects. In addition to the face, a portrait may show a building, a vase or some other everyday object in the background. Apart from the number of objects in an image, the relations between these objects may be denoted, implying an explosion of the numbers of 'objects' denoted. Medieval images of coronation ceremonies show the persons involved in sizes according to their respective importance in the ceremony. Colours and/or objects the persons have in hand offer additional information on these persons - at least to those spectators who are educated and initiated to these symbols. Consequently, the objects denoted by an image should be a restricted, not arbitrary set of objects. Normally, the collection of denoted objects is not restricted to just one object. The 'design' of an image may additionally convey a certain message on the denoted object (like its holiness or diabolic character in medieval images), the initiated spectator may discern a certain style of an image which allows to place it into a certain context (simply compare an impressionist to an expressionist picture). Under very special, 'limit' conditions, a sign may point to exactly one object - like the national flags which only stand for just one nation. For the following, we should stress and retain the ambiguity of an image.

With respect to ambiguity, we want to look into similarity, which may be a criterion to guide the attention of someone using/regarding a sign to detect the relations denoted in the image. There may be relations between parts of the image, which also exist between the objects denoted in the image. Pertinent literature calls this 'structural similarity' (Goodman, 1976, p. 231). Further informations on the concept 'image' can be found in Arnheim, 1969, Panofsky, 1982, Crary, 1992 or Waldenfels, 1994. Comments from a didactical point of view on this can be found in Kadunz (2003). The remark on structural similarity implicitly takes us to the second question of this paper, the question of metaphors, which somehow serve as a bridge to our last issue, namely diagrams. We will come back to metaphors in the final conclusion on



visualisation. With respect to images, we just want to cite W.J.T. Mitchell and his book entitled „Iconology, Image, Text, Ideology“, where a material image ('picture') and its verbal image ('metaphor') are endpoints of an interval (Mitchell 1987, p. 10). For Mitchell, these two extremes are linked by 'similitude', but fall apart in terms of the way they are materialised. The image may be in front of us (on paper, on screen or on the blackboard), while the metaphor is part of the spoken language. What is typical of a metaphor, this distant relative of an image or picture?

## **METAPHOR**

In the first chapter of his book „La métaphore vive“ (transl. to English as "The rule of metaphor", Toronto 1981), Paul Ricoeur (1975) defines the role of rhetoric following Aristotle. Contrary to the now usual definition, rhetoric should not only provide orientation for the construction of a talk, but has a role to play in controlling the validity of arguments used in the oral presentation. This control function was more and more neglected, reducing rhetoric to a means of decoration ('ornatus') of oral presentations. Somehow in contrast to this, the theory of metaphors starts from the assumption that metaphors are everywhere - and paradigms of a theory of metaphors abound. A classical definition is given by Du Marsais (ca. 1730) in his texts on language patterns: The metaphor is a pattern, which transports the meaning of a word into a meaning, which is valid only by means of a mental comparison („*Die Metapher ist eine Figur, durch welche sozusagen die eigentliche Bedeutung eines Wortes auf eine andere Bedeutung übertragen wird, die ihr nur durch die Kraft eines Vergleiches im Geiste zukommt*“; the German citation from Nöth, 2000, p. 342; transl. to English by RS). This idea of a transport is already in the word 'metaphora' (denoting something carried to somewhere else). With a metaphor, we closely link two meanings, some authors even speak of two semantic spheres. The classical theory of metaphors describes the relation between the two meanings as a relation of similarity. Aristotle himself speaks of analogy - and we have already alluded to similarity when discussing images in the section above.

### **Creating meaning**

Describing the use of metaphors, we will concentrate on the creation of meaning and the control and revision of such meanings. Here we will draw on more recent theories of metaphors by I. Richards or M. Black. How to understand the birth and development of a new meaning of a fact when using a metaphor? With respect to this question, Richards and Black point to a special and reciprocal interaction if a context is described in an unusual way. Richard speaks of the context in terms of a *tenor* and of the unusual description in terms of a *vehicle* (Black: 'frame' and 'focus'). The metaphor "a human being is a wolf" takes the human being as the 'tenor', which is described by the metaphorical predicate 'is a wolf'. It immediately comes to mind that there is a direction in the metaphor, it is not symmetrical. Saying "the wolf is a

human being" would ascribe properties to the wolf which - contrary to the usual image - would make him a creature with human (and positive) traits. Nevertheless, a metaphor also transports properties of the tenor to the vehicle. The idea that a human being is a wolf may for instance also emerge because wolves are living in groups, hence as socially organised creatures. At least Richards suggests this when a person using a metaphor takes properties from the tenor (in our example: the human being) to motivate structures in the vehicle (here: the wolf) using similarity. Reciprocally, the tenor is looked upon using properties of the vehicle. Unwanted connotations of the wolf develop into a filter to characterise human beings. Such a theory of interaction of the tenor and the vehicle looks upon the similarity as something deliberately created. Metaphors create similarities where no similarity has been before the metaphor - and this potential of synthesis is exactly how metaphors create semantic innovation, i.e.: new knowledge.

In addition to this recursive relation, there are two features typical of a metaphor: First, they resist to being paraphrased. Giving a paraphrase of a metaphor destroys what is implicitly expressed in a metaphor. The second feature is especially interesting for didacticians of mathematics: metaphors are multi-faceted, allowing a multitude of consequences from the metaphor in question. Such a multi-facetedness immediately creates a need for interpretations or simply the need to reflect on the metaphorical description. This reflection may lead to new meanings (and/or knowledge). It is exactly the confrontation of meanings which are not compatible (human being and wolf), which urge for an interpretation. "What is meant by this statement? How to understand this statement?" To cite Weinrich: "Contrary to what was traditionally thought about metaphors, metaphors do not picture real or imagined commonalities, but newly create analogies. They are the tools of demiurges" (*„dass unsere Metaphern gar nicht, wie die alte Metaphorik wahrhaben wollte, reale oder vorgedachte Gemeinsamkeiten abbilden, sondern dass sie ihre Analogien erst stiften, ihre Korrespondenzen erst schaffen und damit demiurgische Werkzeuge sind“*; Weinrich, 1976, p. 309; transl. RS). Everyday, somehow dead metaphors ('leg of a table', 'bottleneck') do not produce such a motivation, we just lexically use them as words ('arbitrary signs').

Successful new metaphors often provoke a whole bunch of implications with influences in both of the semantic fields linked by the metaphor. Metaphorically (!), one describes this as 'resonance', which induces additional similarities. Black and other authors look upon this creation of similarities as a special cognitive function of human beings (and here we are very cautious in our choice of words), which can lead to the creation of new meaning, perspectives and uses. In this construction, one overrides, maybe even violates 'mathematical logic' and uses a logic of the 'unheard' (according to the German edition of the Ricoeur text, the original French text uses the word 'impertinente', i.e.: the characterisation somehow violates the conventions normally followed). Metaphorical descriptions follow the logic of the unheard because they

- put together things which have been different and consequently never heard together before,
- provoke by being looked upon in conjunction,
- are not understood (completely) when being created or heard.

Our suggestion is that metaphors are not only semantic deviations, but should be taken as produced by us and/or by learners and as productions, which do not follow the usual rules of use. In order to understand and interpret the implications of a metaphor, to create a constructive context for them, we have to use special rules for them. We have to come to grips with the meaning imbedded in these 'unheard' descriptions. In this reflection on the embedded meaning, we need special rules for reflection -taking into account that we do not know about the type of rules we need for this. As a didactician, we assume that a learner makes use of metaphors in situations and configurations, which s/he does not fully understand. Here we are obviously not talking about routine, algorithmic procedures. For supporting the learning of mathematics, it must be helpful to allow for metaphorical descriptions if not actively demanding them. In the course of the learning, these metaphors should be stripped off their metaphorical meaning to covert them into literal descriptions fitting into the usual frame and procedures of mathematics.

In order to test the value of a metaphor, mathematics has a specific test to decide on its validity and pertinence for a solution: We suggest to use the construction and use of appropriate diagrams as a 'litmus test' for metaphors in learning mathematics. The implications of a metaphor have to show their validity when used in a diagram, the validity of metaphors is controlled by using diagrams. To put it differently, from inscriptions used as images we construct metaphors, which are controlled by diagrams, which follow the rules of mathematics.

## **DIAGRAM**

In order to detail the task we ascribed to diagrams, we follow the definition of a diagram from semiotics offered by C.S. Peirce. For Peirce, diagrams are iconic signs, "a Diagram is an Icon of a set of rationally related objects. By rationally related, I mean that there is between them, not merely one of those relations which we know by experience, but know not how to comprehend, but one of those relations which anybody who reasons at all must have an inward acquaintance with. This is not a sufficient definition, but just now I will go no further, except that I will say that the Diagram not only represents the related correlates, but also and much more definitely represents the relations between them, as so many objects of the Icon." (see Peirce, 1906, 'PAP [Prolegomena for an Apology to Pragmatism]', NEM 4:316, c. 1906). This implies, that diagrams are created according to accepted rules of a system of representations and is used according to these rules. For instance, the grammar of a language is such a system controlling the creation of spoken and written language. In a similar way, the constructions of Euclidean geometry are diagrams insofar as they follow the conventions of this geometry (finally decided upon by the persons doing

geometry). Besides other things, especially the axioms and the statements derived from them are the major conventions within geometry.

## CONCLUSION

How to understand the relation of images and diagrams as they are introduced and understood above? For the use of images, we focused on their ambiguity, on the chance of creating and seeing a whole variety of relations in(to) an image. Using inscriptions as images, we concentrate on relations (and less on the things related). Concentrating on relations, we can even apply the imagistic perspective to inscriptions which - in everyday language - may not be taken as images.

To give an example, we could come up with an equation of school algebra built with a number of algebraic expressions ('terms'). In order to transpose the equation, one may bring together some terms and then try to simplify the equation. Algebra offers rules for this simplification, which are to be applied to these inscriptions, to these diagrams of algebra. On the other hand, algebra normally does not tell us which part of the equation is to simplify. The mathematician has to make a choice from (the different parts of) the diagrams in order to use the transposition rules of algebra. In this respect, the equation is looked upon as ambiguous, it is viewed as an image.

More generally, we have to explain how to see a diagram in an image, how to convert a (part of an) image into a diagram. Following Mitchell again, we make use of the opposition of visible images, of images on paper or a computer screen, which are perceived by our senses, to speech images, hence to metaphors as counterparts. From the ambiguity of an image, from a variety of relations may come up descriptions for a state of affairs presently unknown. Think about the well-known example of the "Allisons water level" (see Presmeg 1992): „Another example, which I have described elsewhere (Presmeg, 1992) involved Allison's "water level" metaphor, accompanied by an image of a ship sailing, which reminded her that she was trying to find the key acute angle in trigonometry.“ (Presmeg 1998, p. 28). In this prototypic example, we can see that and how metaphors serve as 'bridges' between images and diagrams to help to cope with a situation.

One has to mention that giving a metaphorical description of a problem is no guarantee for progress in terms of a solution. The relations seen into an image, the metaphorical diagram, which describes the problem in an innovative way, has to be controlled and evaluated if it helps for a solution. Does it offer new ways to transpose the problem? Does it respect the valid rules? Can we find relations to other diagrams?

We would like to refer to a recent paper by Arcavi on „The Role Of Visual Representation“: „Given were: a) the tenth term of an arithmetic sequence ( $a_{10}=20$ ) and the sum of the first ten terms ( $S_{10}=65$ ). The student found the first element and the constant difference mostly relying on a visual element: arcs, which he envisioned as depicting the sum of two symmetrically situated elements in the sequence, and thus having the same value. Five such arcs add up to 65, thus one arc is 13. Therefore, the

first element is  $13-20=-7$ . Then the student looked at another visual element: the ‘jumps’, and said that since there are 9 jumps (in a sequence of 10 elements starting at -7 and ending at 20), each jump must be 3“ (Arcavi 2003, p. 237; see also figure

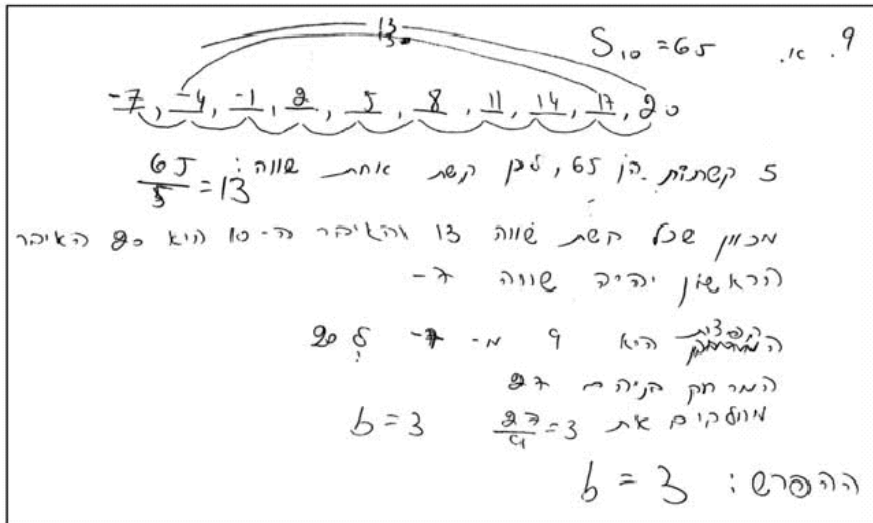


Fig. 1 (from Arcavi, 2003, p. 237)

1).

“Arcs” and “Jumps” are metaphorical means to describe the problem, which generate ideas to solve the problem and are controlled by algebraic rules. In the first step, the student obviously heavily relies on the "arc"-metaphor by linking the symmetrically situated elements, thus creating additional (in the first instance: imagistic) inscriptions (on the invention of new inscriptions see for instance diSessa&Sherin 2000). He then uses the new entities ‘arcs’ as diagrams (having 5 arcs, hence  $65/5 = 13$  as the sum of one ‘arc’). He applies the algebraic transposition. The diagrammatic use of his metaphor allows him to calculate the first element. He then creates the next metaphor, the "jump"-metaphor from his image to go from one element to the next, neighbouring element. This metaphor is used algebraically to find the width of the ‘jumps’. He obviously changes how he makes use of his inscription. First it is an image to generate ideas. Then it becomes a diagram, which is used according to the rules of algebra. Both perspectives luckily complement each other - linked by the heavy use of metaphors.

This is exactly how we look upon visualisation when learning mathematics: Visualisation is understood as linking images and diagrams with the help of metaphors.

## References

- Arcavi, A. (2003). The Role of Visual Representations in the Learning of Mathematics. *Educational Studies in Mathematics*, 52, 215-241.
- Arnheim, R. (1969). *Visual thinking*. University of California Press.
- Black, M. (1962). *Models and metaphors*. New York: Cornell University Press.
- Crary, J. (1992). *Techniques of the observer: on vision and modernity in the nineteenth century*. Cambridge: MIT Press.
- diSessa, A. A., & Sherin, L. B. (2000). Meta-Representation: An Introduction. *The Journal of Mathematical Behavior*, 19(4), 385-398.
- Goodman, N. (1976). *Languages of Art. An Approach to a Theory of Symbols*. Indianapolis: Hackett Publishing Company.
- Kadunz, G. (2003). *Visualisierung: Die Verwendung von Bildern beim Lernen von Mathematik*. Muenchen: Profil Verlag.
- Kadunz, G. & R. Straesser (2000). Visualization in Geometry: multiple linked representations? *25th Conference of the International Group for the Psychology of Mathematics Education (PME 25)*, Utrecht / NL, Freudenthal Institute.
- Mitchell, W. J. T. (1987). *Iconology: image, text, ideology*. Chicago: University of Chicago Press.
- Noeth, W. (2000). *Handbuch der Semiotik*. Stuttgart, Weimar: J.B. Metzler.
- Panofsky, E. (1982). *Meaning in the visual arts*. Chicago: The University of Chicago Press.
- Presmeg, N. C. (1992). Prototypes, Metaphors, Metonomies and Imaginative Rationality in High School Mathematics. *Educational Studies in Mathematics*, 23, 595-610.
- Presmeg, N. (1998). *Metaphoric and Metonymic Signification in Mathematics*. Journal for Mathematical Behaviour 17, 25-32.
- Peirce, C.S. (1976) NEM x:xxx (volume:page number) = *The New Elements of Mathematics*, by Charles S. Peirce. Four volumes in five books. Edited by Carolyn Eisele. The Hague: Mouton Publishers.
- Radford, L. (2000). Signs and meanings in students' emergent algebraic thinking: A semiotic analysis. *Educational Studies in Mathematics*, 42, 237-268.
- Richards, I. A. (1936). *The philosophy of rhetoric*. London: Oxford University Press.
- Ricoeur, P. (1975). *La métaphore vive*. Paris: Editions du Seuil; in English: *The role of metaphor*, Toronto 1981.
- Waldenfels, B. (1994). Ordnungen des Sichtbaren. In G. Boehm (Ed.), *Was ist ein Bild?* (pp. 233-252). Muenchen: Fink.
- Weinrich, H. (1976). *Sprache in Texten*. Stuttgart: Klett.

# IMAGES OF FRACTIONS AS PROCESSES AND IMAGES OF FRACTIONS IN PROCESSES

Jan Herman\*, Lucia Ilucova\*, Veronika Kremsova\*, Jiri Pribyl\*,  
Janka Ruppeldtova\*, Adrian Simpson†, Nada Stehlikova\*,  
Marek Sulista\*, Michaela Ulrychova\*

\*Charles University, Prague, CZ; †University of Warwick, UK.

*Within the large range of potential theoretical perspectives on fractions, this paper considers one particular interpretation: fractions' duality as process and object. By considering the number-fractionbar-number composite symbol as simultaneously representing division and rational, some process-object theories imply that fraction-as-process and fraction-in-process should be highly related. Our research studied the images evoked in these two situations across a wide range of learners and shows that while students attempted post-hoc justifications of their fraction-in-process calculations using their fraction-as-process images, these images were rarely compatible with the process of addition. Thus, we suggest that the routes to seeing the fraction symbol as process and as object may be cognitively separate.*

## INTRODUCTION

There is an impressively wide literature on pupils' interpretation of (and their cognitive roots of) the fraction concept. Much of the literature emphasizes the large range of ways in which symbols, such as  $\frac{3}{4}$  might be interpreted: for example, as part-whole, ratio, quotient, operator and measure (Kieren, 1976) or as quotient function, rational number, vector, and composite function (Ohlson, 1987). In this paper, rather than consider the totality of possible students' interpretations of a fraction, we will consider what happens when students are asked to apparently operate with fractions to examine how they interpret the number-fractionbar-number composite symbol when it is involved in a calculation – specifically addition.

While some researchers have examined the iterative development of a fraction scheme as children pass through multiple representations and operations on those representations which will come to form the scheme (Steffe and Olive, 2002), this paper focuses on just one theoretical interpretation of number-fractionbar-number composite symbol which we view as problematic – its duality as process and object.

## THEORETICAL CONSIDERATIONS

There are three major alternative theories of process-object duality: procept, APOS and structural-operational theories. When considering the duality of fraction, the three theories have much in common. The notion of the 'procept' puts the symbol as central to this duality – the symbol simultaneously stands for both a process and a concept. In the case of the number-fractionbar-number composite symbol, "the symbol  $\frac{3}{4}$  stands for both the process of division and the concept of fraction" (Gray and Tall, 1994). Within the theory of structural-operational duality, rational number

is – structurally – a “pair of integers (a member of a specially defined set of pairs)” and – operationally – “[the result of] division of integers” (Sfard, 1991, p5). While most commonly used in the analysis of mathematical ideas at the university level, “some studies such as that of fractions, show that the APOS Theory ... is also a useful tool in studying students’ understanding of more basic mathematical concepts.” (Dubinsky and MacDonald, 2001)

These three theories differ, however, in their approach to the relationship between the processes and objects. Gray and Tall make no significant claim about how the development of process and concept aspects of a mathematical idea might be connected. APOS and structural-operational theories, however, indicate that the object conception has its genesis in the process conception: as the encapsulation or reification of the process: “This encapsulation is achieved when the individual becomes aware of the totality of the process, realizes that transformations can act on it, and is able to construct such transformations.” (Cottrill et.al., 1996, p171) and “reification is an instantaneous quantum leap: a process solidifies into object, into a static structure” (Sfard, 1991, p20). In contrast to the theory of procepts, these theories thus posit a fixed learning trajectory for fractions and might be termed ‘process-to-object development’ theories.

Our investigation considers the images associated with the fraction concept on both sides of the reification/encapsulation divide, to examine whether we can see the trace of this trajectory.

Sfard notes that reification requires seeing the newly formed object in the context of processes that act upon it: “There is no reason to turn process into object unless we have some higher level processes performed on this simpler process”(Sfard, 1991, p31). Thus, we suggest, the number-fractionbar-number composite symbol should have the power to evoke, differently, process and object conceptions when it is seen ‘as process’ and ‘in process’ – for example  $\frac{3}{4}$  seen in an isolated context and  $\frac{3}{4}$  seen within, say, the context of the addition  $\frac{3}{4} + \frac{2}{5}$ . The test for process-to-object development theories, then, is whether the object conception of fraction has its genesis in the process conception and thus whether the ideas evoked in the two situations are compatible.

## RESEARCH CONTEXT

This research was carried out in the Czech Republic, using a wide range of students to provide us with access to as wide a range of imagery of fraction-as-process and fraction-in-process as possible. This included nine 6<sup>th</sup> grade (7 high and 2 low ability), four 7<sup>th</sup> grade (2 high and 2 low ability), two low ability 8<sup>th</sup> grade and four 9<sup>th</sup> grade (2 high and 2 low ability) school pupils. In addition data was collected from six university students training to be mathematics teachers (two training for lower primary, two for upper primary and two for secondary).



Our methods were adapted from other process-object studies, particularly Pitta and Gray (1996). We gave students two different types of task: one in which they were given different number-fractionbar-number composite symbols individually and one in which they were given these symbols within the context of an addition.

The tasks, presented to the students individually on separate sheets of paper, are shown in figure 1. For each sub-task they were asked three questions

- Tell me what first comes to mind.
- How do you represent\* this?
- Can you tell me a story which might involve this?

Pens were provided and students were informed they could use them if they wished for questions b) and c). After all of the task items had been shown, the interviewer showed the students all of their papers and invited them explicitly to see if they could use their ideas from the task I items to explain the task II items.

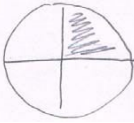
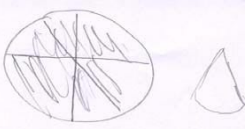
We used semi-structured, clinical, one-to-one interviewing (Ginsburg, 1981) allowing the interviewer to follow the direction set by the students' responses. Each interview was audio taped and transcribed, with the transcripts forming the basis for the classification of the images evoked. The students' responses below are given a code which identifies the student (letter), school grade (number) or 't' for teacher training student, +/- for high or low ability and an indication of the task to which the response relates.

## STUDENT RESPONSES

### Fractions-as-processes

The first task asked students to represent fractions when they were given in isolation. We were expecting to see images which related to fraction-as-process, that is, fractions seen as related to the division of a whole object. Indeed, in all cases we saw this. Most commonly we saw standard images in which appropriate portions of a circle, square or bar was indicated by shading (fig 2a). This sense of the image as an association in some cases was heightened when we saw images, even from stronger students, which did not attend

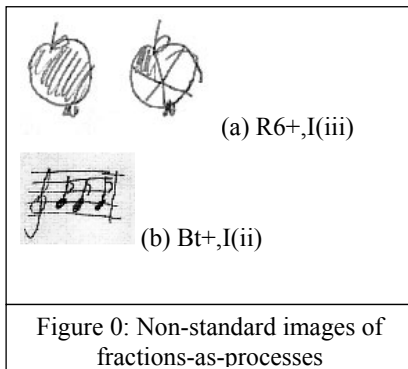
<p>Task I</p> <p style="text-align: center;">i) <math>\frac{1}{4}</math>, ii) <math>\frac{3}{8}</math>, iii) <math>\frac{7}{6}</math></p> <p>Task II</p> <p style="text-align: center;">i) <math>\frac{1}{2} + \frac{1}{4}</math>, ii) <math>\frac{2}{8} + \frac{3}{8}</math>, iii) <math>\frac{32}{45} + \frac{5}{12}</math></p>
Figure 0: Tasks

 <p>(a) M9-,I(i)</p>
 <p>(b) S9+,I(iii)</p>
Figure 0: Standard Images of Fractions-as-processes

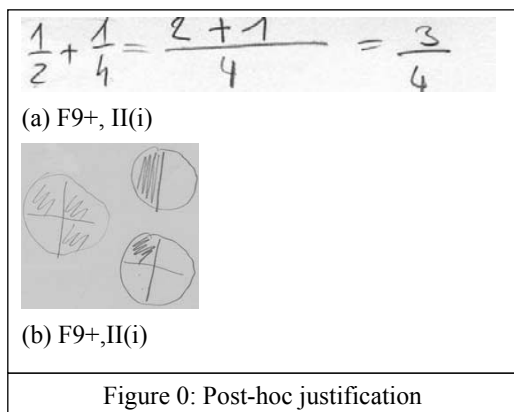
\* In the Czech language the word "zna'zornit" is a rough equivalent of 'represent' which does not imply a representation in any particular medium, but is a commonly used word in school.

to the importance of the equal sizes of the parts (e.g. fig 2b). We do not necessarily see this as a failure to develop a satisfactory part-whole scheme (Behr et. al., 1992) but that, for some students at least, the link between the fraction given as an isolated symbol and the act of dividing was a rapid (and no longer crucial) association.

There were very few other images for these early items, though we did see apples (fig. 3a) and musical notation (fig. 3b) described as “There is a quaver in music. When there are three quavers, so there can be three eighths notes in one time”. One student (Nt+) used the idea of time as an image for fractions: “And then I remembered such a typical one quarter such as a quarter of an hour. Those classical clocks.” and  $7/6$ , “Seven sixths, I realised that it would ... no, it is a stupid thing... well, it would be nicely, say, done on the clock, maybe. The six suggests the sexagesimal system so the seven sixths from an hour could be an hour and ten minutes”.



### Fractions in Processes



It is in task II, however, that we see the most significant issues raised about the problems of the adapting the image of the fraction-as-process to be an image of fractions-in-process. In almost all cases, students faced the problem presented as one of working directly with the symbolism of the number-fractionbar-number composite symbol (fig. 4a). However, when asked to represent or tell a story about the addition, they attempted what we saw as

*post hoc justifications* for their calculations by trying to *adapt their images* from task I (fig. 4b). The imagery which might be well suited to representing the particular fractions is not, we suggest, suitable for representing the *process* of addition.


For example, in task II(ii), we saw many examples of the type reproduced in fig. 5. The circles use shading to appropriately represent each fraction, but it is far from clear whether the process of adding is being represented since the shading for the two addends overlaps. In only one case (fig 5c) did a student explicitly highlight how the two parts fit together in the process of adding. This post-hoc justification based on




the attempt to adapt their images is also highlighted in the language they use to describe their process of fraction addition. In one instance student Z6+ had already completed task II(ii) in symbolic form. In describing how she would represent this she draws two circles (cakes) and says: “We will divide it into eighths. In one I will colour two, in one three, so the result is five eighths” and draws figure 5d. In this she makes no reference to how the act of adding is represented and we again see a representation of the addends, but no representation of the process of adding.

In two further cases, we see the separation of representing the fractions from representing the process on the fractions even more clearly.

In fig 6, a student has acted upon the number-fractionbar-number composite symbol without regard to its composite nature, thus getting an incorrect answer. However, she still represents, in standard imagery, the three fractions from her calculation.


In fig 7, the trainee teacher using the time image (Nt+), first draws a picture appearing to represent a minute hand moving from the hour to half-past, a picture of the hand moving from the hour to quarter-past and, to represent the sum, a picture of the hand moving from the hour to quarter-to.

$\frac{1}{2} + \frac{1}{4} = \frac{3}{6}$ 


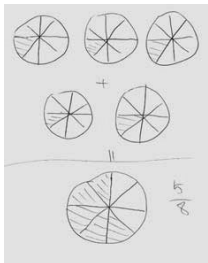

+

=


F7-,II(i)

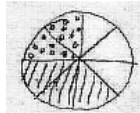
Figure 0: Adapting imagery to incorrect solutions



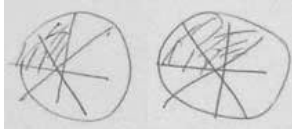
(a) A6+,II(ii)



(b) Vt+,II(ii)



(c) Bt+,II(ii)



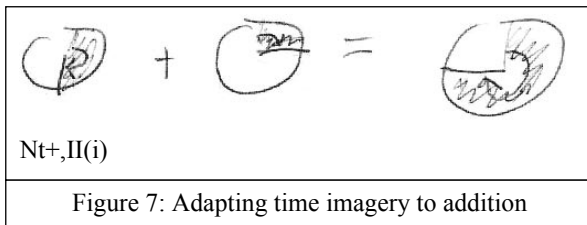
(d) Z6+,II(iii)

Figure 0: Adapting Imagery

The interviewer asked him explicitly to consider the images and he appears to realize that the imagery, as drawn, does not adapt well to the act of adding:

“First the half hour is going on, we will look at the position of the hand, and then the quarter will follow. ... they wouldn’t be able to add it like that”. His image as drawn, has the fractions  $\frac{1}{2}$  and  $\frac{1}{4}$  represented as he had represented them when presented as isolated symbols, but to adapt this successfully to the process of addition, the addends would have to be represented as abutting. His phrase

“they wouldn’t be able to add it like that” suggests he is beginning to recognize the problem of his own imagery here.



The most difficult subtask (II(iii)) proved to be the most problematic for

students’ attempts at adapting the fraction-as-process imagery for a fraction-in-process situation. Many of the students, particularly the higher ability and the trainee teachers, could correctly solve the problem working with the symbolism (fig. 8). When it came to trying to represent it, most again attempted to adapt the imagery from task I to provide a post hoc justification (fig. 9a, 9b). However, in this case, many of the students were able to see the difficulties caused by their fraction-as-

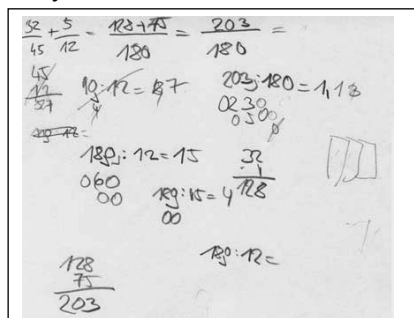


Figure 8: Working Symbolically

process images. In some cases the problems were caused by the nature of the components of the number-fractionbar-number composite symbol. The denominator 45 was seen as “too big”.

In other cases, however, students became explicitly aware that their imagery did not allow them to represent the processes they went through in adding the fractions. Student F9+ was able to correctly work with the symbolism, but when faced with attempting to adapt her imagery said:

from them coloured, and here [pointing under the picture] I would do 12 frames and I would colour 5 of them.

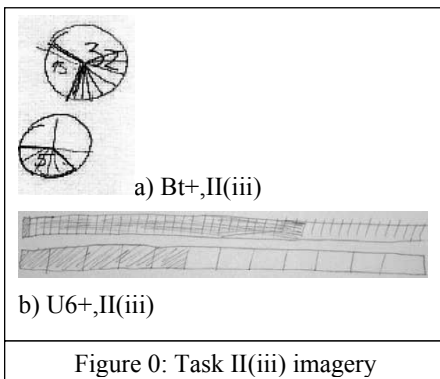
Interviewer: How would you add it?

F: I would have to find the common divisor, I would draw those 180 frames again, and colour 45 of them...[long pause]

Interviewer: And then?

F: [Long pause] ... I don’t know how to represent it. I will take those 180 houses and from them, I don’t know if 32 or 45 of something, I don’t know...[trails off].

F: I would do it for example like that [drawing a rough bar picture], those 45 and 32 [drawing a rough bar picture], those 45 and 32 [drawing a rough bar picture] I would do 12 frames and I



In all three fraction-in-process tasks we saw, across the wide variety of students we worked with, the same features:

- working with the symbols (either correctly or incorrectly)
- attempting a post hoc justification
- adapting fraction-as-process imagery

In most cases, the images used adequately represented the addends and the sum as individual fractions-as-processes (normally the division of a cake, a bar).

However, we suggest that, even though they make significant efforts to adapt this imagery beyond the realms in which it is suitable, even the strongest students were not able to use the imagery they have associated with particular fractions to represent the *process* of addition (which, for those able to perform the process, is a process only on symbolic objects).

## DISCUSSION

The data suggests that even those fluent in acting upon fractions in symbolic form and whose language indicates they are able to think about these as representing elements of the field of rational numbers, are unable to adapt imagery they associate with fractions to fractions-in-processes. This suggests that, for them, the developmental route to fraction as an object which can be acted upon may not be immediately linked to their notions of division.

The data supports the duality of the number-fractionbar-number composite symbol as being able to represent both process and object (upon which processes act) for some of the students in the sample. However, it suggests that the routes to the two parts of this duality may be cognitively separate.

Dubinsky claims that the construction of objects from processes is extremely tricky: “I ... have often stated that one of the most important (and difficult) general mathematical activities consists in encapsulating processes to objects and de-encapsulating objects back to the processes from which they came” (Dubinsky 1997). This difficulty may just be because (in the domain of fractions at least) objects are not the encapsulation or reification of processes at all.

## REFERENCES

- Behr, M. J., Harel, G., Post, T., & Lesh, R. (1992). Rational number, ratio, and proportion. In D. A. Grouws (Ed.), *Handbook of research on mathematics teaching and learning*, New York: Macmillan
- Cottrill, J., Dubinsky, E., Nichols, D., Schwingendorf, K., Thomas, K., & Vidakovic, D. (1996). Understanding the Limit Concept: Beginning with a Coordinated Process Schema. *Journal of Mathematical Behavior*, 15: 167-192.
- Dubinsky, E. (1997). A Reaction to “A Critique of the Selection of ‘Mathematical Objects’ as a Central Metaphor for Advanced Mathematical Thinking” by Confrey and Costa, *International Journal of Computers for Mathematical Learning*, 2, 67-91

- Dubinsky, E. & MacDonald, M. (2001). APOS: A Constructivist Theory of Learning in Undergraduate Mathematics Education Research. In D. Holton et. (Eds.), *The teaching and Learning of Mathematics at University Level: An ICMI Study*, Dordrecht: Kluwer Academic Publishers.
- Ginsburg, H. (1981). The clinical interview in psychological research on mathematical thinking. *For the Learning of Mathematics*, 1, 4-11
- Gray, E. M. & Tall, D. O. (1994). Duality, ambiguity and flexibility: A proceptual view of simple arithmetic. *Journal for Research in Mathematics Education*, 25, 115–141.
- Kieren, T. E. (1976). On the Mathematical, Cognitive, and Instructional Foundations of Rational Numbers. In R. Lesh (Ed.) *Number and Measurement: Papers from a Research Workshop*. Columbus OH: ERIC/SMEAC.
- Ohlsson, S. (1987). Sense and reference in the design of iterative illustrations for rational numbers. In R. W Lawler & M. Yazdani (Eds.), *Artificial intelligence and education*. Norwood, NJ: Ablex.
- Olive, J. & Steffe, L. P. (2002). The construction of an iterative fractional scheme: The case of Joe. *Journal of Mathematical Behavior*, 20, 413-437.
- Pitta, D. & Gray E. (1996). Nouns, Adjectives and Images in Elementary Mathematics. In Puig, L and Guitiérrez, A. (Eds.), *Proceedings of XX International Conference for the Psychology of Mathematics Education*, 3, 35–42.
- Sfard, Anna (1991). On the Dual Nature of Mathematical Conceptions: Reflections on processes and objects as different sides of the same coin, *Educational Studies in Mathematics*, 22, 1-36.

## DESCRIBING ELEMENTS OF MATHEMATICS LESSONS THAT ACCOMMODATE DIVERSITY IN STUDENT BACKGROUND

Peter Sullivan  
La Trobe University

Judy Mousley  
Deakin University

Robyn Zevenbergen  
Griffith University

*We are researching actions that teachers can take to improve mathematics learning for all students. Structural elements of the lessons being trialled include making aspects of pedagogy explicit to seek to overcome differences in familiarity with schooling processes, and sequencing tasks with the potential to engage students. This article reports research on teachers building learning communities by preparing variations to set tasks in order to address differences in students' backgrounds.*

### THREE KEY LESSON ELEMENTS

All lessons are taught to students at different stages of readiness to learn. These differences can be a result of variations in motivation (Middleton, 1995), persistence (Dweck, 2000), perceptions of the value of schooling (Deplit, 1988), social group or cultural factors, or varying degrees of necessary experiences in particular mathematical domains. What is not clear is how teachers can structure lessons to respond to these differences. We agree with Boaler (2003) who argued that:

researchers in mathematics education need to study the practice of classrooms in order to understand relationships between teaching and learning and they need to capture the practices of classrooms in order to cross divides between research and practice. (Boaler, 2003, p. 15)

The following discussion uses an illustrative lesson, structured in a particular way, as data. The general lesson structure is an outcome of our ongoing research into characteristics of lessons that are successful with students from diverse backgrounds. The 3 key elements that contribute to this lesson structure are:

- *explicit pedagogies*, or teacher actions to be articulated or enacted explicitly;
- *a set of mathematical tasks*, with an open-ended “goal task”, sequenced to ensure that all students have the necessary experience to be successful at each stage;
- *the building of a learning community*, evident in the way student products are reviewed and variations offered to students based on their responses to the tasks.

The first two elements are based on the socio-mathematical framework of Cobb and others (e.g., Cobb & McClain, 1999), where two complementary norms of activity are delineated. *Socio-cultural norms* are the practices, organisational routines, and modes of communication that impact on approaches to learning, types of responses valued, views about legitimacy of knowledge produced, and responsibilities of individual learners. *Mathematical norms* are principles, generalisations, processes, and products that form mathematics curriculum and serve as learning tools. This article focuses on the third element, which is a focus of our research. It refers to ways

of catering for differences in background experiences of students. This paper reports on one approach to this challenge: varying the tasks posed to support the participation of all students in order to build a “learning community”.

### **Explicit pedagogies**

Various authors have commented on aspects of schooling that tend to exacerbate the obvious difficulties that some students experience. For instance, Anyon (1981) focused on the ways mathematics learning tasks are posed; Mellin-Olsen (1981) proposed that features of the social context influence learning goals and strategies adopted by pupils; Lerman (1998) attended to SES-related differences between classroom expectations and students’ aspirations; and Zevenbergen and Lerman (2001) argued that the ability to decode contextualised problems corresponds closely with students’ SES backgrounds. Our investigations have identified further areas that are likely to create difficulties for some students, including the use of particular language genres; the use of contexts that proved inappropriate for some groups of students; and lack of explanation of the purposes of different teaching strategies, or contexts, or expectations for student engagement in various types of tasks (Sullivan, Mousley, Zevenbergen, & Turner-Harrison, 2003). We see these as directly connected to the socio-cultural norms, and have shown how it is possible for teachers to address these norms by being more explicit about various aspects of pedagogical practice.

### **A Set of Mathematical Tasks**

It is proposed that student engagement comes from working on sequenced problem-like tasks, rather than following teachers’ step-by-step instructions. There are two reasons for this. The first is recognition that learning and knowing are products of activity that is “individual and personal, and ... based on previously constructed knowledge” (Ernest, 1994, p. 2). The second relates to the role of the teacher in identifying blockages, prompts, supports, challenges and pathways. Cobb and McClain (1999) argued that teachers should form an “instructional sequence ... a conjectured learning trajectory that culminates with the mathematical ideas that constitute our overall instructional intent” (p. 24).

While not essential to the lesson structure being researched, we use open-ended tasks where possible, since they are likely to foster the type of engagement sought while allowing the teacher to plan for student learning. Open-ended tasks are generally more accessible than closed examples, as students who experience difficulty with traditional questions can approach tasks in their own ways (see Sullivan, 1999).

### **The Building of a Learning Community**

Many lessons seem to either ignore the diversity of students’ backgrounds and needs, or address them in ways that exacerbate difference by having alternative goals for particular groups of students. Our intention is that all students engage sufficiently in a



lesson to allow them to participate fully in a whole-class review of their work on the goal task. Students may follow different pathways to the ultimate task, being supported or detoured along the way, but all will feel part of the classroom community. All will know they are expected to master the content, and it is expected that their engagement in discussions will offer substantial educative opportunities.

Sometimes school communities seek to address differences in student achievement by grouping students of like achievement together. It seems that the consensus is that this practice has the effect of reducing opportunities especially for students placed in the lower groups (Boaler, 1997; Zevenbergen, 2003). This can be partly due to self-fulfilling prophecy effects (e.g., Brophy, 1983), and partly due to the effect of teacher self-efficacy which is the extent to which teachers believe they have the capacity to influence student performance (e.g., Tschannen-Moran, Hoy, & Hoy, 1998). Brophy argued that, rather than grouping students by their achievement, teachers should: concentrate on teaching the content to whole class groups rather than worrying too much about individual differences; keep expectations for individuals current by monitoring progress carefully; let progress rates rather than limits adopted in advance determine how far the class can go; prepare to give additional assistance where it is necessary; and challenge and stimulate students rather than protecting them from failure or embarrassment.

One key aspect of this approach relates to the supports offered to students who experience difficulty along the way. It is common, indeed in places recommended, that teachers gather such students together and teach them at an appropriate level (see, for example, Department of Education, Employment and Training, 2001). We suggest that a sense of community is more likely to result from teachers offering prompts to allow students experiencing difficulty to engage in active experiences related to the initial goal task, rather than, for example, requiring such students to listen to additional explanations, or to assume that they will pursue goals substantially different from the rest of the class. Adapting carefully selected core tasks to provide appropriate problem solving opportunities to students experiencing difficulty is evident in the recommendations of Griffin and Case (1997), Ginsburg (1997), and Thornton, Langrall and Jones (1997).

Related to this is ensuring that students who finish tasks quickly, at any stage along the way, are posed supplementary tasks that extend their thinking on that task, rather than proceeding onto the next stage in the lesson. One characteristic of open-ended tasks is that they create opportunities for extension of mathematical thinking, since students can explore a range of options as well as consider forms of generalised response. Unless creative opportunities are provided for the students who have completed the tasks along the way then not only can they be bored, and so create difficulties for the teacher, but also they will not be using their time effectively.

Thus the premise of our notion of learning community is that the class progresses

through to a common goal task of the lesson, developing a set of understandings than can create the context for whole-class discussion, synthesis, and lesson closure, then form a shared basis for following lessons.

### THE LESSON DESCRIPTION: AREA AS COUNTING SQUARES

Lesson descriptions constitute our raw data. The lesson referred to below is an example of lessons that were prepared to incorporate each of the desired planning elements. It was taught, with observers present, on three occasions to upper primary grades (ages 10 to 12): Class A was a small group of Indigenous Australian students; students in Class B were from a predominantly lower SES community in a provincial Australian city; and students in Class C were from a large regional centre with mixed SES backgrounds. In each lesson, an observer completed an instrument adapted from that used by Clarke et al. (2002) which consisted of (a) a naturalistic report using two columns, one for a record of what happened and one for the observers' impressions; (b) a form for overview comments; and (c) a framework to structure observer's post-lesson reporting of their immediate impressions. There were also interviews with the teacher, collection of student products, a short unstructured survey of the students' responses to the lesson, and other naturalistic records of teacher actions. Analysis of these data involved seeking evidence and effects of teachers making pedagogy explicit, task sequence differentiation, and elements of the activities and interactions that seemed to contribute to the building of a learning community.

The intent of the lesson was for students to use squared paper to gain a stronger sense of area-as-covering to lead towards deriving their own rules or formulae for calculating areas of shapes. There was a range of tasks: in the first the students used grid paper to draw letters using 10 square units, aiming to get them to a stage where they could draw triangles of a given area. In later stages, the students undertook more formal, but open-ended, area investigations. Interim tasks for each stage were offered the necessary experiences to allow the students to reach these points.

#### The explicit pedagogies

In the lesson documentation, the teachers were offered suggestions about pedagogies to be made explicit, and did this in their own ways. For example, Teacher B presented some directions on a poster (Figure 1), and read through them, as well as giving additional instructions such as:

... even though we won't be talking during the work ... if you're sitting next to someone and they have got something different, don't be influenced by that, because there are many, many answers to each of the questions.

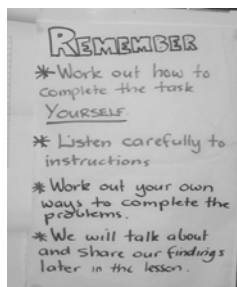


Figure 1: Some explicit pedagogies.

In this project, making aspects of pedagogy explicit has been found to come quite naturally to teachers, has been accommodated into classroom routines readily, and has influenced student actions and learning outcomes (see Sullivan et al., 2003).

### The mathematical norms

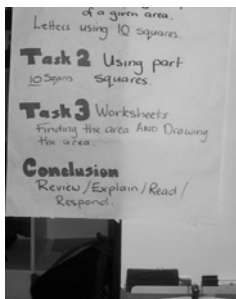


Figure 2: The explicit lesson plan.

The second planning element is the mathematical intent of the lesson. As indicated in the plan prepared by Teacher B (see Figure 2), the lesson was in four parts: Initially students drew letters using 10 square units (see Figure 3), then drew letters of area 10 square units using half squares (see Figure 4 below), then solved conventional area tasks about rectangles and triangles using one set of closed and one of open-ended tasks.



Figure 3: The first task, using squares.

The sequencing of the tasks and awareness of alternative trajectories to meet the ultimate lesson goal was central to the lesson, and is discussed in detail in Mousley, Sullivan, and Zevenbergen (in press). The tasks were structured to be accessible to most students but sufficiently interesting to engage those who quickly grasp the mathematical content. In this case, the possible variations inherent in drawing the letters to the given constraint offered those students who understood the nature of area as counting squares the possibility of creativity as well as some challenge.

### The learning community

The class working more or less together on the tasks, as a community, had three aspects. First, all three teachers conducted short whole class reviews after the students had completed each of the respective tasks. Classes B and C worked through each of the lesson stages together and there were no observation notes to indicate that there were students who were unable to participate in the reviews of any of the lesson stages. Key aspects of these reviews were the diversity of student responses and the variety of insights gained into describing and calculating areas. These reviews allowed the teachers to emphasise key mathematical ideas, including those that layed a foundation for the following activity. Both Teachers B and C encouraged students to look at and comment on each other's work. Teacher A selected the work of particular students and discussed it with the class. Such mid-lesson reviews are already part of the everyday routines of these teachers.

Second, variations to the tasks were proposed to, or prepared by, the teachers. The intent was that if individual students were unable to complete a set task, then a variation could be posed. For example, Teacher A had prepared some sheets of squared paper with one letter of 10 square units already drawn. In the observed

lesson, the initial task was introduced but only a few students were able to commence so Teacher A distributed the additional sheet to the others. Having a model to follow was enough to allow them to commence. Teacher A had also prepared some squares cut from card, to allow students to drop back to a more basic entry point, but these were not needed. Likewise for the second task, drawing letters of 10 square units using some half squares, Teacher A had prepared an additional sheet with an illustrative letter. Again, this sheet was given to the students who could not start, and for most this was enough. This teacher had also prepared some cardboard squares and half squares and gave them to those students who still had not commenced the task. These extra activities allowed all students to reach and succeed in the goal task.

We argue that additional supports such as these should be offered discretely. Both Teachers B and C, when offering the additional prompts, made public statements to the class. For example, Teacher B said to the whole class:

If you are having trouble with the letters, I have some squares here, and you may want to come out and make a letter—and if you still can't get your mind around it, I have some sheets out here that have an example on it, and you can use that if you would like.

Some students did take up the offer as can be seen in Figure 4. Teacher C, however, dealt with the differences by suggesting, “Anybody who is unsure, stay on the floor with me. If at any time you are unsure, come back to me”. Both of these approaches are less satisfactory ways of dealing with difference in that they both draw attention to the students experiencing difficulties (which could affect their willingness to seek the assistance needed) or breed dependence.



*Figure 4: One student's work on the second task.*

However, we noted that it is not easy to be discrete in classrooms, as was evident with Teacher A. When some students were offered the square and half square counters, most other students insisted they be given the pieces. As it happened, about half the students found it easier to solve the task using the squared paper and the other half found it easier to use the counters. Noticing this, Teacher A then challenged all of the students to use the representation other than the one they were using, and the rest of the lesson was spent doing that. Note that the teacher could not have anticipated that particular students would prefer one or other of the representations and would find the other more difficult, so being both observant and willing to adapt the lesson plan was important. This illustrated how acting on to students' responses can be a key strategy in meeting the needs of the individual students.

Third, extensions were prepared and posed for those students who finish tasks quickly. This is perhaps the most important planning element since students who complete the set work have the effect of moving the lesson along, perhaps before some other students are ready, thereby removing the sense of community. Teachers A

and B both posed extensions to students who had completed responses. Interestingly even though Teacher C had posed additional task such as “Choose your most difficult letter and see if you can draw it two different ways”, in the lesson review, she said “It needs more extension work after the first sheet to give me more time to see their work ... I was not able to see who needed help”.

We suspect that implementing these task variations is both unfamiliar to teachers and also quite different from the conventional ways of dealing with differences.

## SUMMARY

Finding ways to address differences in the backgrounds of students is perhaps the most pressing challenge facing mathematics teachers. The challenge should therefore be at the forefront of the minds of researchers. We are investigating lessons in which teachers make otherwise implicit pedagogies explicit, in which there are carefully sequenced tasks that prompt mathematical exploration and activity, and in which the learning communities are fostered by planning variations to particular tasks to ensure that all students can engage productively and successfully at each stage. It seems that teachers are able to accommodate being explicit about pedagogies within their usual routines, that they can implement appropriate sequences of tasks, they can conduct reviews of student products and whole class mathematical discussions, but that there are a number of aspects of implementing variations to the tasks that seem to be quite different from the conventional teaching routines used by these teachers.

## REFERENCES

- Anyon, J. (1981). Social class and school knowledge. *Curriculum Inquiry*, 11(1), 3–44.
- Boaler, J. (1997). *Experiencing school mathematics: Teaching styles, sex and setting*. Buckingham: Open Uni Press.
- Boaler, J. (2003). Studying and capturing the complexity of practice: The case of the dance of agency. In N. A. Pateman, B. J. Dougherty, & J. T. Zilliox, (Eds.), *Proceedings of the 2003 Joint meeting of PME and PMENA* (pp. 3-16). University of Hawai'i: PME.
- Brophy, J. E. (1983). Research on the self-fulfilling prophecy and teacher expectations. *Journal of Educational Psychology*, 75(5), 631–661.
- Clarke, D., Cheeseman, J., Gervasoni, A., Gronn, D., Horne, M., McDonough, A., Montgomery, P., Roche, A. Sullivan, P., Clarke, B., & Rowley, G. (2002). Early Numeracy Research Project report. Melbourne: DET, CEO, AIS.
- Cobb, P., & McClain, K. (1999). Supporting teachers' learning in social and institutional contexts. In Fou-Lai Lin (Ed.), *Proceedings of the 1999 International Conference on Mathematics Teacher Education* (pp. 7–77). Taipei: National Taiwan Normal University.
- Delpit, L. (1988). The silenced dialogue: Power and pedagogy in educating other people's children. *Harvard Educational Review*, 58(3), 280–298.
- DEET (2001). Early years numeracy strategy. Available online January 2004, <http://www.sofweb.vic.edu.au/eys/num/index.htm>
- Dweck, C. S. (2000). *Self theories: Their role in motivation, personality, and development*.

Philadelphia: Psychology Press.

- Ernest, P. (1994). Varieties of constructivism: Their metaphors, epistemologies and pedagogical implications. *Hiroshima Journal of Mathematics Education*, 2, 1–14.
- Ginsburg, H. P. (1997). Mathematical learning disabilities: A view for developmental psychology. *Journal of Learning Disabilities*, 30(1), 20–33.
- Griffin, S., & Case, R. (1997). Re-thinking the primary school with curriculum: An approach based on cognitive science. *Issues in Education*, 3(1), 1–49.
- Lerman, S. (1998). A moment in the zoom of a lens: Towards a discursive psychology of mathematics teaching and learning. In A. Olivier & K. Newstead (Eds.), *Proceedings of the 22nd conference of the International Group for the Psychology of Mathematics Education* (Vol. 1, pp. 66–81). Stellenbosch, South Africa: PME.
- Mellin-Olsen, S. (1981). Instrumentalism as an educational concept. *Educational Studies in Mathematics*, 1, 351–367.
- Middleton, J. A. (1995). A study of intrinsic motivation in the mathematics classroom: A personal construct approach. *Journal for Research in Mathematics Education*, 26(3), 254–279.
- Mousley, J., Sullivan, P., & Zevenbergen, R. (in press). Varying learning trajectories to overcome structural barriers in mathematics learning. *Proceedings of the 22nd Conference of the Mathematics Educational Research Group of Australasia*. Townsville, Qld: MERGA.
- Sullivan, P. (1999). Seeking a rationale for particular classroom tasks and activities in J. M. Truran and K. N. Truran (Eds.), *Making the difference. Proceedings of the 21st Conference of the Mathematics Educational Research Group of Australasia* (pp. 15–29). Adelaide: MERGA.
- Sullivan, P., Mousley, J., Zevenbergen, R., & Turner Harrison, R. (2003). Being explicit about aspects of mathematics pedagogy. In N. A. Pateman, B. J. Dougherty, & J. T. Zilliox (Eds.), *Proceedings of the 2003 Joint meeting of PME and PMENA* (pp. 267-275). University of Hawai'i: PME.
- Thornton, C., Langrall, C., & Jones, G. (1997). Mathematics instruction for elementary students with learning disabilities. *Journal of Learning Disabilities*, 30(2), 142–150.
- Tschannen-Moran, M., Hoy, A., & Hoy, W. (1998). Teaching efficacy: Its meaning and measure. *Review of Educational Research*, 68(2), 202–248.
- Zevenbergen, R., & Lerman, S. (2001). Communicative competence in school mathematics: On being able to do school mathematics. In J. Bobis, B. Perry, & M. Mitchelmore (Eds.), *Numeracy and beyond: Proceedings of the 24<sup>th</sup> Annual Conference of the Mathematics Education Research Group of Australasia*. (pp. 571–578) Sydney: MERGA.

# ORCHESTRATING MATHEMATICAL PROOF THROUGH THE USE OF DIGITAL TOOLS

Rosamund Sutherland\*, Federica Olivero\*, Marnie Weeden\*\*

\*Graduate School of Education, University of Bristol

\*\*The City Academy, Bristol

*This paper explores the role of the teacher in the orchestration of common knowledge and in the interplay between intuitive/empirical and formal aspects within the context of students learning mathematical proof using a dynamic geometry software. The case of a secondary school teacher is discussed through the analysis of her learning initiative which involved the introduction of proof in geometry by using a dynamic geometry software. The analysis shows Marnie's focus on the relationship between construction and mathematical properties and the difference between proof and demonstration, and the way she orchestrates the work of the whole class in the construction of mathematical proofs.*

## INTRODUCTION

The research presented in this paper is framed within a socio-cultural approach, which suggests that mental functioning has its origins in social life and stresses the crucial role which communication through language and other semiotic systems plays in learning (Mercer et al, 1999; Wertsch, 1998). An important aspect of socio-cultural theory is the claim that human action is mediated by 'cognitive tools'. The notion of 'tools' includes a wide range of artefacts and semiotic systems where "cultural artefacts are both material and symbolic; they regulate interactions with one's environment and oneself. In this respect they are 'tools' broadly conceived, and the master tool is language" (Cole & Engestrom, 1993, p. 9).

This theoretical perspective also emphasises the fact that students actively construct knowledge drawing on what they already know and believe (Vygotsky, 1978). From this point of view students bring their implicit theories to any new learning situation and these influence what they pay attention to and thus new knowledge construction. Within this context the teacher has an important role in that "appropriately arranged contrasts can help people notice new features that previously escaped their attention and learn which features are relevant or irrelevant to a new concept" (Bransford et al 1999, p. 48). The teacher also has an important role in opportunistically and contingently drawing students' conversations and actions into increasingly elaborated and sophisticated mathematical domains.

In the context of mathematics, it is now widely accepted that the dynamic and symbolic nature of computer environments can provoke students to make links between their intuitive notions and more formal aspects of mathematical knowledge (Hoyles & Sutherland, 1989; Sutherland, 1998). It is also accepted that mathematical

understandings do not develop spontaneously and that there is a need for a teacher to support students to move between informal mathematical knowing and the virtual world of mathematics (Balacheff & Sutherland, 1994). As discussed in Sutherland & Balacheff (1999) there is often a tension between students' individual and personal intellectual constructions and the collective and common knowledge which the teacher intends to teach.

This paper explores the role of the teacher in the construction of common knowledge and in the interplay between intuitive/empirical and formal aspects within the context of students learning mathematical proof using a dynamic geometry software.

## **PROVING**

Research shows (e.g. Balacheff, 1988; Hoyles, 1997; Olivero, 2002) that the major difficulties of students' construction and understanding of proofs are represented by the coexistence of formal and intuitive aspects, which materialise for example in the transitions from empirical to theoretical practices, from intuition to deduction, etc.

The representations of geometric objects in a dynamic geometry software, as for example The Geometer's Sketchpad (GSP), are a way of bringing together formal and intuitive elements. GSP figures are midway between empirical and generic objects: they can be manipulated as empirical objects and the effect of this manipulation can be seen on the screen as it happens, but at the same time they incorporate geometric properties and as such represent generic mathematical objects. A range of tools is available to manipulate dynamic objects in GSP; dragging and measurements are two of the most commonly used. Within the context of proving in geometry, the possibility of using a measuring tool implies a need for scaffolding a 'good' use of measures, which does not get in the way of the development of formal proofs. Measures can be exploited differently according to different phases of the proving process (Olivero & Robutti, 2002) and the role of the teacher is key in making the students aware of this.

## **THE CASE OF MARNIE**

This paper centres around an analysis of a learning initiative which Marnie Weeden developed through a process of working within the mathematics design team of the InterActive Education Project<sup>1</sup>. Marnie chose to work on geometry and proof with 13-14 year old students who were in the top-set of an inner city multi-ethnic comprehensive school (proof had recently re-entered the English mathematics curriculum). The design of the learning initiative was informed in an iterative way by theories of teaching and learning, research-based evidence on the use of ICT for learning mathematics, teacher's craft knowledge and the research team's expertise. The lessons which constituted Marnie's learning initiative were: 1- Introducing dynamic geometry and the construction process, 2- Proof or demonstration: identifying the difference, 3 & 4 - Proving that the sum of the angles in any triangle



equal 180 degrees, 5 & 6 - Students presenting their proofs to the whole class (Weeden, 2002).

One of the university researchers observed and video recorded each of the lessons. The process of analysis involved viewing the video recordings of each lesson and progressively analysing the video data through the lens of our theoretical perspective.

### **FOCUSING ATTENTION: THE ROLE OF THE TEACHER**

Analysis of the data shows that throughout the learning initiative Marnie continued to emphasise the relationship between construction and mathematical properties and the difference between proof and demonstration. Whereas there is no simple relationship between this focusing of attention and students' activity analysis of the whole teaching and learning initiative shows that across the series of lessons there was a convergence between students' and teacher's perspectives.

#### **Construction and mathematical properties**

The first introduction to a new tool is likely to influence students ongoing use of the tool and research has shown that students often start by drawing mathematical objects within a dynamic geometry environment as opposed to constructing objects from their properties. Marnie was aware of this literature and used the idea of the 'dragging test' (Healy et al, 1994) from the beginning of her work with students.

Marnie [ ] basically this is a session in which you become familiar with the software you are using...[ ] so I am going to show you first of all what the tools do, what you can do [ ]. But we are going to do some construction of a variety of shapes. But using what we know about those shapes. Using their properties. (Lesson 1)

Within the first lesson, as Marnie demonstrated to the students how to use GSP to construct a square (through projecting her portable computer image on a screen at the front of the class) she explicitly modelled her own knowledge construction processes, emphasising that she was explicitly using the properties of a square and that "there's always right angles in it and the construction remains the same. [ ] just different sizes".

After this introductory phase the students worked in pairs on portable computers and tried for themselves to construct a square. Throughout this work as Marnie became aware that not all students were using mathematical properties she intervened again:

Marnie Ok we've had something interesting here. Someone has just found out...they thought they were clever and drew a square, measured it, measured the angles, and guess what it didn't stay. Moved it about and suddenly it was a quadrilateral of all sorts of different dimensions. It has to stay...this one went all over the place because it wasn't constructed. You've got to use what you know are the properties and utilise them in this construction. Otherwise it will break. [ ] Just drawing lines will not work...you need to actually use your

knowledge of shapes in order to construct it. You need to use commands like the perpendicular bisectors, like parallel lines, that's what you need to do. Without actually using commands like that, using the constraints of a circle, circumscribing things, stuff that you know..... (Lesson 1).

This focus on properties continued throughout the whole design initiative. In the third lesson when the students had been asked to construct a rectangle Marnie again focused on mathematical properties:

Marnie And unlike the square you've got less constraints with that...so you know how to construct a pair of parallel lines... so you should be able to produce a proper rectangle...just to remind you because it's been a while....we didn't have the laptops last time (Lesson 3).

This focus on mathematical properties, a crucial part of constructing mathematical objects within GSP was also important when students began to construct their own mathematical proofs and was evident in the final proofs which students presented to the whole class (using PowerPoint) at the end of the learning initiative (see for example fig.1).

### **The difference between proof and demonstration.**

Marnie started the second lesson by emphasising the difference between proof and demonstration.

Marnie If I say proof what do I mean

Rob Gathering evidence ..in order to back.....

Sarah Exploration

Marnie Gathering evidence to support a theory, conjecture? [ ] In science we repeat an experiment loads of times. Is that mathematics proof as we know it? There is a difference between proof and demonstration...are your eyes and the way your brain works enough for you...

Marnie then introduced a proof that the angles of a triangle add up to 180 degrees. She started by constructing a triangle in GSP, measuring the angles, finding they added up to 180 degrees and then asking if this was a proof. After soliciting a range of responses she again emphasised that measurement is not mathematical proof.

Within the third lesson students worked in pairs with GSP to develop their own mathematical proofs that sum of the angles of any triangle is 180 degrees<sup>ii</sup>. Despite Marnie's discussion about what constitutes a mathematical proof the majority of students started to use the measurement tools to construct a proof. This is likely to relate to their previous experiences of measurement in geometry and the types of empirical proofs (Balacheff, 1988) which they are likely to have been introduced to in primary and early secondary school. The following excerpt illustrates how Rachel and Joanna start to explore the possibility of measuring.

- Rachel Is there some way we can calculate what J, K, L and M add up to
- Rachel We'll just have look around (they start to look through the menus).
- Jess Oh...angle bisector....that looks fun
- Rachel So I guess we'll have to highlight an angle.

By experimenting they discovered how to measure an angle. They then discovered the calculator tool and started to sum the angle measures. At this point Marnie, becoming aware of their activity, intervened to the whole class.

- Marnie .....before you go off on a tangent which is where you seem to be going...[ ]  
...you need construction but the other important thing is don't get het up and caught up in the measuring.....measuring is not proof...you've already said that...measuring is not proof...for a start computers can make mistakes...also for the particular computer program it tends to measure to the nearest point. Zero point something...so what you'll end up with is something which doesn't equal 180 degrees....when you've measured it will add up to 181. So you cannot rely on that software. And the reason we are here doing this now is proof...so don't get muddled up with the measuring...measuring is not proof...it is being able to apply what we know about our angle laws to a situation in order to come out with some kind of reasoning, mathematical reasoning as to why that may add up to 180 and I know some of you are nearly there...

Interestingly Marnie had shown the students how to measure lengths and angles within lesson 1, unwittingly drawing attention to the measurement tools. We believe that the use of measurements should not be discouraged because anyway students will use this tool, drawing on their work with paper and pencil. On the contrary we need to find ways of 'enculturating' students in giving the appropriate status to measurements, according to the different phases of the proving process: they cannot be used as a mathematical proof, but they can be very useful in the phase of exploring, conjecturing and validating a conjecture within a dynamic geometry environment. Certainly the need for measures comes from the perceptual level when students have the intuition that, for example, two sides of a figure are equal, or one equals the double of the other and so on; however, when they read measures on the screen, or on paper, they are no longer working at a purely empirical level: he is working at a higher level, because they are looking for an answer to the question *Is my intuition true or false?* Measures work as a tool which can provide an answer: *yes/no*. The quantitative side of the information linked to the use of measures makes students feel safe and certain about a result and can provide a solid starting point for the subsequent construction of a proof.

Analysis of the video data shows that Joanna and Rachel, eventually stopped measuring and started to construct proof statements on the screen.

Angles A, B, C and D are all right angles, they are 90 degrees and are all in rectangle so all the angles in the rectangles add up to 360 degrees

Angles j,k,l and m are an average of 45 degrees each.

Whereas these ‘proof statements’ could be criticised for being empirical and descriptive of the figure the students have on the screen, they seem to have provided an important starting point in terms of supporting these students to enter the world of mathematical proof.

All the students produced their final proofs in PowerPoint and presented them to the whole class. An analysis of the final proof produced by Joanna, Rachel and Rick shows that they have moved from a focus on measurement and tautologies to the production of a proof which contains logical justifications for what they observed on the figure.

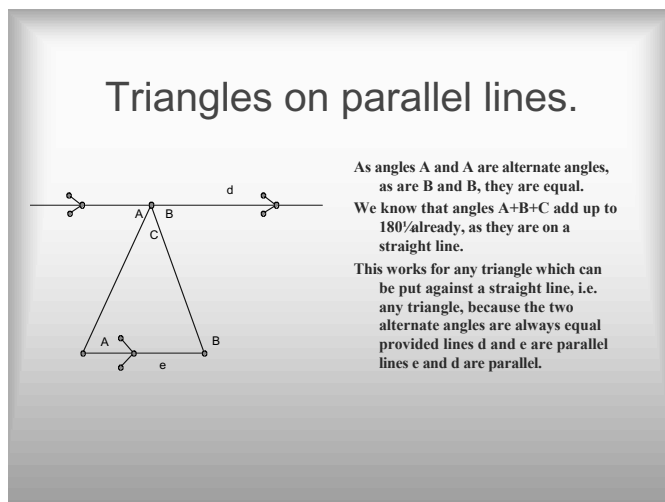


Figure 1. Excerpt from final PowerPoint proof for one group of students

All the students shifted from early uses of measurement to the construction of theoretical proofs and we argue that Marnie’s interventions played a crucial role in this respect. These interventions were based on Marnie’s observations of student activity in the class, her own a-priori analysis of what constitutes mathematical proof and her engagement with the research literature. We also argue that Marnie created a collaborative community which empowered the students to share their ideas and progressively refine their ideas about what constitutes a mathematical proof.

Marnie remember that there is no wrong or right here there is just ideas. There is just us coming together with ideas and that is us learning from each other about what we're doing and this is to do with working collaboratively together. OK learning to work together and come together with our ideas. (Lesson 1).

## SOME CONCLUDING REMARKS

As we have discussed already all the students produced final proofs in PowerPoint and as a digital tool this seems to offer considerable potential in terms of supporting students to focus on the importance of linking together a set of deductive statements to be presented to a 'community' (the classroom in this case). Students imported their geometrical diagrams from GSP. The work with GSP is likely to have supported them to focus on the mathematical properties which became key aspects of their proofs. Each proof presentation was slightly different and some were more mathematically rigorous than others, but all students had started the process of producing mathematical proofs. Students when interviewed explicitly said that they valued the use of ICT tools, which allowed them to progressively develop their mathematical proofs. Within this context writing draft proofs on the screen in GPS enable them to begin to externally represent their proto-proofs which gradually evolved to become more formal and theoretically informed PowerPoint proofs. As Rick explained, constructing and undoing were an important part of this process:

Rick The thing was, much of our project was wrong; it wasn't wrong but large amounts of it were quite bad. So had we been doing it on paper it would have taken us longer to get nowhere, so it meant we could just delete it and start again. We used undo a lot. (final interview)

## References

- Balacheff, N. (1988). Aspects of proof in pupils' practice of school mathematics. In D. Pimm (Ed.), *Mathematics, Teachers and Children* (pp. 216-238). London: Hodder and Soughton.
- Balacheff, N. & Sutherland, R. (1994) Epistemological Domain of Validity of Microworlds: The Case of Logo and Cabri-géomètre, in Lewis R & Mendelsohn P (ed.) *Lessons from Learning*, IFIP Conference TC3WG3.3 North Holland, pp 137-150.
- Bransford, J., Brown, A. & Cocking, R. (1999) *How People Learn, Brain, Mind, Experience, and School*, National Academy press, Washington.
- Cole, M., & Engestrom, Y., (1993) A Cultural-historical approach to distributed cognition, Salomon, G. (ed) *Distributed Cognition*, CUP, Cambridge.
- Healy, L., Hölzl, R., Hoyles, C., & Noss, R. (1994). Messing up. *Micromath*, 10(1), 14-16.

- Hoyles, C. (1997). The Curricular Shaping of Students' Approaches to Proof. *For the Learning of Mathematics*, 17(1), 7-16.
- Hoyles, C. & Sutherland, R. (1989) *Logo Mathematics in the Classroom*, Routledge, London.
- Mercer, N., Wegerif, N. & Dawes, L. (1999) Children's talk and the development of reasoning in the classroom, *British Educational Research Journal*, Vol 25, No 1, 1999.
- Olivero, F. (2002). *The proving process within a dynamic geometry environment*. Unpublished PhD thesis, Bristol: University of Bristol.
- Olivero, F., & Robutti, O. (2002). An exploratory study of students' measurement activity in a dynamic geometry environment, *Proceedings of CERME2* (Vol. 1, pp. 215-226). Marianske Lazne, CZ
- Sutherland, R. (1998) Teachers and Technology: the role of mathematical learning, in D., Tinsley, & D., Johnson, (eds) *Information and Communication Technologies in School Mathematics*, Chapman & Hall, London. pp 151-160
- Sutherland, R. & Balacheff, N. (1999) Didactical Complexity of Computational Environments for the Learning of Mathematics, the *International Journal of Computers for Mathematical Learning*, Vol. 4, pp 1-26
- Vygotsky, L.S. (1978) *Mind in Society: The Development of Higher Psychological Processes*, Harvard University Press, Cambridge, Massachusetts
- Weeden, M. (2002) Proof, proof and more proof, in *Micromath Autumn 2002*, pp.29-32
- Wertsch, J. (1998). *Mind as Action*. New York: Oxford University Press.

---

<sup>i</sup> Interactive Education: Teaching and Learning in the Information Age, project directed by Rosamund Sutherland, Peter John and Susan Robertson ([www.interactiveeducation.ac.uk](http://www.interactiveeducation.ac.uk)) and funded by the ESRC Teaching and Learning Programme (Award No. L139251060). The mathematics team consisted of 11 teachers and 3 university researchers and worked together through a series of meetings of the whole team at the University and meetings of a teacher-researcher pair within the teacher's school. Each teacher chose an area of mathematics which they normally found difficult to teach and for which a particular use of ICT seemed to be a potentially valuable learning tool. The methodology of the project included the use of digital video as a research tool, together with interviews with the teacher and students and collections of the students' digital and non digital work.

<sup>ii</sup> From lesson 1 students had been encouraged to write on the screen and within lesson 3 they were asked to write their proofs on the screen.

# SCHOOL-BASED COMMUNITY OF TEACHERS AND OUTCOMES FOR STUDENTS

Paola Sztajn, Martha Alexsah-Snider, Dorothy Y. White, Amy Hackenberg  
University of Georgia

*This paper describes a school-based professional development project for elementary teachers where all teachers from the school and university mathematics educators regularly met to share and plan mathematics teaching strategies for the school's diverse student body. Analysis of data from focus group interviews with participating teachers revealed that the establishment of a mathematics education community in the school impacted students' motivation for learning mathematics. From the teachers' point of view, their own participation in a mathematics education learning community made their students more interested in learning mathematics. The project underscored the importance of considering school communities as unit of change in mathematics education professional development.*

## PROJECT SIPS

When listing the ten most important principles from research for professional development, Clarke (1994) stated that professional development opportunities should “involve groups of teachers rather than individuals from a number of schools, and enlist the support of the school and district administration, students, parents, and the broader community” (p. 39). Since the early 1990s, educational researchers have highlighted the importance of working with schools as organizations (Fullan, 1990) and considering schools as the unit of change in educational reform (Wideen, 1992). Researchers have also emphasized that successful professional development initiatives involve communities of teachers, privileging teachers' interactions with one another (Wilson & Berne, 1999) and operating within the school organizational structures (Hawley & Valli, 1999).

Teachers working together and sharing their mathematics teaching experiences are the tenets of Project SIPS (Support and Ideas for Planning and Sharing in Mathematics Education), a school-based professional development project to help elementary grades teachers improve the quality of their mathematics instruction by building a mathematics education community within the school. The project emerges from and develops the importance of considering schools as a unit of change in mathematics education.

In fall 2000, classroom teachers, administrators, and mathematics educators met at Adams Elementary Schools (pseudonym) to discuss issues related to mathematics teaching at the school. During the meeting, teachers voiced their frustration with not being able to mathematically reach all their students—especially their low-achieving children. The group discussed professional development ideas to work within the

fabric of the school to improve teachers' mathematical knowledge and to help teachers meet children's needs.

Supported by an Eisenhower Higher Education grant, SIPS began in May 2001 with a needs assessment in which teachers raised mathematics topics and instructional approaches they would like to know more about. In the 2001-2002 school year, schoolteachers and university mathematics educators (two faculty and a graduate research assistant) began to meet regularly to talk about mathematics, children's mathematics learning, and mathematics teaching. All homeroom teachers at the school, some of the school's special education teachers, and a few staff members have been involved in the project since it started, continuing to meet and build the school mathematics education community over three years.

This paper focuses on the first year of SIPS activities and on data from an evaluation interview conducted at the end of that year (2001-2002). In particular, the paper highlights some student outcomes that resulted from the establishment of a mathematics education community at the school.

### **Adams Elementary School**

At Adams Elementary School, 90% of the children qualify for free or reduced lunch. In its school district, Adams has the highest percentage of Hispanic children (29% in 2000 and 39% in 2003), although the school population is mostly African American (57% in 2000 and 51% in 2003). The school enrolled about 400 children in 2001-2002 (the number varied during the year), organized into 2 pre-K, 3 kindergarten, 4 first-grade, 3 second-grade, 2 third-grade, 2 fourth-grade and 2 fifth-grade classrooms. During this year, SIPS worked with 27 teachers at the school: all 18 homeroom teachers and 9 Title I, Special Education, or English Speakers of Other Languages (ESOL) teachers. Two thirds of the teachers were White, six were African American and three were Hispanic. These 27 teachers attended at least 30 hours of SIPS meetings over the year. Other members of the school community such as the school's arts, music, and physical education teachers; staff personnel; administrators; paraprofessionals; and student teachers also attended a few SIPS meetings during the year.

Because Adams serves a low socioeconomic school population, it receives supplementary government money (through Title I) to better serve its students. The school has been pressured to increase its achievement test scores and it has used part of its extra resources to reduce class size (particularly in first grade) and work with ESOL and reading programs.

Mathematics had not been a focus of attention for teachers' professional development at Adams until SIPS started. An initial background questionnaire distributed to participants at the beginning of the project revealed that 20 of the 22 teachers who returned the form (91%) had not completed any in-service activity in the previous five years that discussed research on children's learning of mathematics.



## **First Year Activities of SIPS**

In its first year, SIPS consisted of a variety of mathematics-related activities. These activities included the formation of a Mathematics Leadership Team, monthly worksessions and mathematics faculty meetings. To begin the project, a Mathematics Leadership Team (MLT) was formed with a teacher from each grade level and two special education teachers. The MLT conducted a mathematics needs assessment with all teachers. It then met with school administrators, mathematics educators and the project consultant (a mathematician) to identify topics to be covered in staff development activities throughout the year. For example, second grade teachers wanted help with subtraction and place value, whereas fourth and fifth grade teachers selected fractions and decimals as an important topic to be addressed by SIPS. All grade levels mentioned they needed help with problem solving and mathematics vocabulary.

The project started with a 4-hour mathematics workshop about the Principles and Standards for School Mathematics (NCTM, 2000). All teachers at the school, as well as paraprofessionals and school administrators, participated in this initial activity where mathematics educators talked about new goals for school mathematics, children's mathematical learning, and problem solving. After this workshop, two SIPS activities constituted the heart of the project during its first year: grade-specific professional development worksessions and mathematics faculty meetings.

SIPS worksessions took place at the school, during school hours. Within grade-level groups, teachers worked with the mathematics educators at the school media center. Each group met for a half-day activity every other month. Substitute teachers were hired to allow for teacher participation. Each half-day worksession addressed research on children's learning of mathematics topics selected by the grade-level teachers as important to them and as an area in which they believed they needed help. During the worksessions teachers were introduced to activities and ideas for teaching mathematics, explored their knowledge of and teaching strategies for the highlighted mathematical topics, and planned lessons to implement in their classrooms.

The after-school mathematics faculty meetings were attended by the whole school staff and, whenever possible, by school administrators. These meetings were devoted to building and maintaining a mathematics education community within the school. During these meetings, teachers had the opportunity to share with their colleagues what they were doing in their mathematics teaching. These meetings were also a forum for mathematics problem solving. Teachers worked on solving problems, sharing their solutions and discussing how the problems and concepts discussed could be adapted for use with their students. Teachers had the opportunity to experience mathematics in a way that was based on currently accepted views for mathematics teaching—such as those espoused by NCTM (2000).

Four other activities that were not part of the project's initial plan happened during the first year of SIPS and turned out to be important components of the project. In

November 2001, in-service and pre-service teachers met to learn about bi-lingual mathematics-related resources to use in the classroom. In January 2002, the whole school planned a day of mathematics activities for the 100<sup>th</sup> day of school. In April 2002 the school hosted its math night, a traditional school event that became part of SIPS as teachers used SIPS meeting time to plan. University graduate and undergraduate students joined the schoolteachers in conducting the math night activities. Finally, as SIPS developed, teachers began to voice their interest in and need for further help in the classroom. So, during the second semester of the 2001-2002 school year, the SIPS graduate research assistant devoted part of her project time (6 to 7 hours per week) to visit the school, listening to teachers' needs and helping teachers in classrooms whenever they asked for support.

All activities of SIPS during the project first year were aimed at developing trust among university mathematics educators and school staff. Although impacting mathematics instruction at Adams Elementary School was an important long-term goal of the project, creating and sustaining a mathematics education at the school was the most important objective of the project in its first year. It was expected that, on the long run, this community would impact mathematics instruction and students' achievement at the school. Thus, mathematics educators were not initially looking for students' outcomes from SIPS first year. These outcomes, nonetheless, emerged from the teachers' discourse as they discussed the project.

### **SIPS RESEARCH**

By the end of the first year of SIPS, mathematics educators raised the question of the impact of the project on teachers and the school community. In its research approach, SIPS is an interpretive study that aims at revealing "the complex world of lived experience from the point of view of those who lived it" (Schwandt, 1994, p, 118). Searching for an understanding of how the project was unfolding, how the community was developing, and what teachers' believed they were taking from the project, the mathematics educators developed an interview protocol to begin gaining access to teachers' perception of SIPS and its first year activities. The project external evaluator used this protocol in a series of focus group interviews with all participating teachers. This paper focuses on data from these interviews.

The interviews were designed to be an opportunity for teachers to voice their opinions freely and make suggestions for changes in the project. They also had the role of gathering information for the formative assessment of SIPS. The focus group approach allowed for group discussion, encouraging "participants to talk to one another, asking questions, exchanging anecdotes, and commenting on each others' experiences and points of view" (Kitzinger & Barbour, 1999, p.4). The interviews were conducted with groups of three or four teachers, organized by grade level (seven groups), with the addition of some Title I, special education, and ESOL teachers. These semi-structured interviews lasted approximately 45 minutes and were all

audiotaped and transcribed. Mathematics educators received a transcript of the interviews and a report from the project evaluator.

This paper has participants' language as its main data source since the data analyzed came from teachers' discussions during the focus groups interviews. Through content analysis of the interview transcripts, mathematics educators searched for patterns in the teachers' discussion of SIPS and for recurring words and themes that expressed teachers' perception of the ways in which the SIPS community was developing. We also searched for teachers' comments on how SIPS was (or was not) influencing their work in their classrooms. We looked within interviews and across the seven interviews to bring up issues that were important to teachers, trying to represent an overall view of the teachers instead of particular aspects commented on by only one or two teachers. In particular, we looked for teachers' discussion of their own teaching during the first year of SIPS, changes they perceived in themselves and their students, and ideas from the project that they tried to use in their classrooms.

When considering their own classroom and their learning in SIPS, teachers talked about the way in which their new involvement with mathematics impacted their students' motivation for learning mathematics. This increased motivation was mentioned by most teachers in all grade levels. Teachers also talked about their increased interest in problem solving and mathematics communication in the classrooms, which had implication for students' willingness to work on these areas. These last two ideas were not mentioned as often as motivation, but were very strongly supported by a few teachers. Teachers' comments on students' motivation, problem solving and communication in the classroom are further discussed in the following session.

### **Outcomes for Students**

When asked about the influence of SIPS on their own teaching and their classrooms, teachers mostly mentioned students' improved motivation for learning mathematics. Teachers talked about the importance of having new ideas for teaching mathematics and how beneficial it was for them to be able to carry SIPS activities directly to their own classrooms—components of the project that the mathematics educators considered important for the overall goal of building trust in the newly established mathematics education community. However, what teachers highlighted most often when talking about the impact of SIPS was the students' participation in these activities and the students' increased appreciation and motivation for working in mathematics.

Well, my kids are so in love with math now. They begged me on days that we were doing the [standardized tests] and we were going to take it easy in the afternoon because they worked so hard. They didn't want to take it easy, they wanted to do math. You know, I am good at math but it's not necessarily my favorite subject, but they loved it. So I said, "Well, OK, something we are doing here is coming across . . . the joy of math somehow is coming across

to these kids. And I think it's because, you know, of a lot of the activities and things that I've gotten from the meetings.

First, second, third and fourth grade teachers noted that their own growing enthusiasm for mathematics was reflected in students' more positive attitudes. Teachers shared with students what they learned in the worksessions and faculty meetings, and students seemed to become more engaged with mathematics learning activities.

I think they see their teacher getting more excited about it so they get more excited about it.

I think the children were aware, too, a lot of them, that the teachers were actually going to a math workshop or they were going to a math meeting. I think they knew that we were all working on something.

One teacher remembered a graphing survey done by third-grade students about their favorite subject. Math was highlighted by the majority of students as a favorite subject. Special education teachers also spoke of their students' increased motivation for mathematics and their willingness to stay on task, especially when the teachers used the mathematics children's literature they learned of through SIPS.

Teachers also spoke of their students becoming more effective problem solvers and learning to communicate their ideas about mathematics more clearly. Second grade teachers, for example, reported that students were beginning to get the idea that there are multiple ways to solve the same problem—an idea stressed in many SIPS worksessions. Students, however, were still working on this idea.

It was really hard to get them in the beginning, like you said, they come up with that one way or two ways, and they are finished and they want to hand it to you and there was a lot of moaning and groaning. . . . Like when we got the money, like how many ways can you make a dollar? "Well, I already made it two ways." And it's like, "Well, there's more than [two ways]."

A fifth grade teacher saw that students were more successful with multiplication after he had introduced them to strategies such as using pictures, graph paper and arrays. He also reported that his students were thinking more as they participated in different kinds of problem-solving activities, and that he wanted them to continue to be challenged:

They will meet your expectations. Just the problem solving is good for letting the students' minds work. . . . We spent a whole class on magic numbers. "Let's pair up and find out if magic squares can work with other numbers." It was incredible to watch their minds.

One first grade teacher noticed her students' growing abilities in communicating about mathematics:

I noticed that my kids were more responsive to sharing, speaking about manipulatives, and that helped me a lot to do the activities.

One fifth grade teacher also highlighted communication about mathematical ideas as something that was improving in his classroom:

My kids can talk in terms of math. I whitewashed some of the vocabulary earlier-- I didn't communicate the expectation that they need to be able to talk about the numerator and denominator and understand the process by which you make a fraction and what the numerator means. Now we're doing least common denominator, and it's a breeze--they understand.

To summarize, the most consistent student outcome reported by teachers was increased student motivation for mathematics. The reports of increased student abilities in problem solving and mathematics communicating were anecdotal but were reported across kindergarten, first, second, and fifth grade levels. Some teachers, however, appeared more concerned with basic mathematics skill development than with problem solving and mathematics communication skills.

## **DISCUSSION**

In analyzing research on teaching, Floden (2001) calls for continue study of links between teaching and student achievement—which he calls the effects of teaching. In a similar position, it is important to continue to search for links between professional development activities for teachers and students' achievement in mathematics. These links, however, depend on and are mediated by teachers' learning through professional development activities and teachers' adaptation of what they learned to their own classrooms.

In its first year, the main goal of SIPS was to establish trusting relations within a mathematics education community that was developing at Adams Elementary School. Although impacting mathematics instruction at the school was a long-term goal of the project, it was not the main concern of the mathematics educators as the project began because of the crucial need to build trust. However, the focus groups interviews with participating teachers revealed that the SIPS mathematics education community impacted students as it developed. As teachers tried newly learned ideas in their classrooms there was an overall increase in students' motivation for learning mathematics—across all grade- and ability-levels at the school.

Research in professional development has shown the importance of teachers working in communities for teachers' professional growth (Wilson & Berne, 1999). SIPS adds to this body of literature, showing that teachers' engagement in communities of learners also impacts teachers' perceptions of student engagement with mathematics. Given that learning to value mathematics is an important mathematics education goal for all students (NCTM, 1989), increasing student motivation through teacher participation in professional communities is an important outcome for professional development. Further investigation is needed to continue to examine how teachers' professional development and student learning in mathematics are related. Moreover, research needs to examine the extent to which and what aspects of professional development are directly related to student learning.

## References

- Clarke, D. (1994). Ten key principles from research for the professional development of mathematics teachers. In D. B. Aichele & A. F. Coxford (Eds.), *Professional development for teachers of mathematics* (pp. 37-48). Reston, VA: National Council of Teachers of Mathematics.
- Floden, R. E. (2001). Research on effects of teaching: A continuing model for research on teaching. In V. Richardson (Ed.), *Handbook of research on teaching* (Fourth ed., pp. 3-16). Washington, DC: AERA.
- Fullan, M. (1990). *The new meaning of educational change*. New York: Teachers College Press.
- Hawley, W. D., & Valli, L. (1999). The essentials of effective professional development. In L. Darling-Hammond & G. Sykes (Eds.), *Teaching as a learning profession* (pp. 127-150). San Francisco: Jossey-Bass.
- National Council of Teachers of mathematics (1989). *Curriculum and standards for school mathematics*. Reston, VA: Author.
- National Council of Teachers of Mathematics (2000). *Principles and standards for school mathematics*. Reston, VA: Author.
- Schwandt, T. A. (1994). Constructivist, interpretivist approaches to human inquiry. In N. K. Denzin & Y. S. Lincoln (Eds.), *Handbook of qualitative research* (pp. 118-137). Thousand Oaks, CA: Sage.
- Wideen, M. F. (1992). School-based teacher development. In M. Fullan & A. Hargreaves (Eds.), *Teacher development and educational change* (pp. 123-155). Bristol, PA: Falmer.
- Wilson, S. M., & Berne, J. (1999). Teacher learning and the acquisition of professional knowledge: an examination on contemporary professional development. In A. Iran-Nedjad & P. D. Pearson (Eds.), *Review of Research in Education* (Vol. 24, pp. 173-209). Washington, DC: AERA.

# THINKING THROUGH THREE WORLDS OF MATHEMATICS

David Tall

University of Warwick CV4 7AL, UK

*The major idea in this paper is the formulation of a theory of three distinct but interrelated worlds of mathematical thinking each with its own sequence of development of sophistication, and its own sequence of developing warrants for truth, that in total spans the range of growth from the mathematics of new-born babies to the mathematics of research mathematicians. The title of this paper is a play on words, contrasting the act of 'thinking through' several existing theories of cognitive development, and 'thinking through' the newly formulated theory of three worlds to see how different individuals may develop substantially different paths on their own cognitive journey of personal mathematical growth.*

## INTRODUCTION

The International Group for the Psychology of Mathematics Education is a broad organisation with many 'voices' expressing a wide range of issues in mathematical teaching, learning and thinking. So broad are the views of its members that it moves over the years in ways that may not seem to present an overall universal picture. Yet there are themes that occur which focus on the psychology of cognitive growth of different individuals in mathematics education that begin to recur and link together to build a global framework. In this paper such themes are drawn out to formulate a long-term theory of cognitive development from conception to mature adult that encompasses a wide range of different paths taken by individuals, from discalculic children who make little progress, to research mathematicians who move forward the boundaries of the subject.

## THINKING THROUGH A RANGE OF THEORIES

It is probably difficult for those of us looking at the huge range of current mathematics education research to imagine the state of the theory when the International Group for the Psychology of Mathematics Education was first conceived. Psychology was still in the grips of behaviorism, with the teaching of mathematics largely in the hands of mathematical practitioners and general educators, and just a few major theorists, such as Piaget (1965), Dienes (1960) and Bruner (1966), having something to say that had particular relevance in mathematics. At the time, Piagetian theories held sway, with an emphasis on successive stages of development and a particular focus on the transitions between stages. Underlying Piagetian theory was a tripartite theory of abstraction: *empirical abstraction* focusing on how the child constructs meaning for the properties of objects, *pseudo-empirical abstraction*, focusing on construction of meaning for the properties of actions on objects, and *reflective abstraction* focused on the idea of how 'actions and operations become thematized objects of thought or assimilation' (Piaget, 1985, p. 49). Meanwhile, in a somewhat different direction, Bruner focused on three distinct ways

in which ‘the individual translates experience into a model of the world’, namely, enactive, iconic and symbolic (Bruner 1966, p.10). The foundational symbolic system is language, with two important symbolic systems especially relevant to mathematics: number and logic (ibid. pp. 18, 19).

Our founding President, Efraim Fischbein, with his wide experience of psychology and mathematics, was from the very beginning interested in three distinct aspects of mathematical thinking: fundamental *intuitions* that he saw as being widely shared, the *algorithms* that give us power in computation and symbolic manipulation, and the *formal* aspect of axioms, definitions and formal proof (Fischbein, 1987).

Our second President, Richard Skemp, balanced his professional knowledge of mathematics and psychology with both theory and practice, not only producing his own textbook series for both primary and secondary schools, but also developing a general theory of increasingly sophisticated human learning (Skemp, 1971, 1979). He saw the individual having receptors to receive information from the environment and effectors to act on the environment forming a system he referred to as ‘delta-one’; a higher level system of mental receptors and effectors (delta-two) reflected on the operations of delta-one. This two level system incorporate three distinct types of activity: *perception* (input), *action* (output) and *reflection*, which itself involves higher levels of perception and action.

The emphases in these three-way interpretations of cognitive growth are very different, but there are underlying resonances that appear throughout. First there is a concern about how human beings come to construct and make sense of mathematical ideas. Then there are different ways in which this construction develops, from real-world perception and action, real-world enactive and iconic representations, fundamental intuitions that seem to be shared, via the developing sophistication of language to support more abstract concepts including the symbolism of number (and later developments), the increasing sophistication of description, definition and deduction that culminates in formal axiomatic theories.

In geometry, van Hiele (1959, 1986) has traced cognitive development through increasingly sophisticated succession of levels. His theory begins with young children perceiving objects as whole *gestalts*, noticing various properties that can be described and subsequently used in verbal definitions to give hierarchies of figures, with verbal deductions that designate how, if certain properties hold, then others follow, culminating in more rigorous, formal axiomatic mathematics. In a recent article, van Hiele (2002) asserts differences between his theory and those of others, for instance, denying a change of ‘level’ between arithmetic and algebra, but asserting a change in level from the symbolism of algebra and arithmetic and an axiomatic approach to mathematics. This suggests a significant difference between his theory of development applied in geometry and the cognitive development of arithmetic and algebra, while reasserting a distinction between elementary mathematics (by which I mean school geometry, arithmetic and algebra) and advanced mathematical thinking with its formal presentation of axiomatic theories.



Meanwhile, process-object theories such as Dubinsky's APOS theory (Czarnocha *et al.*, 1999) and the operational-structural theory of Sfard (1991) gave new impetus in the construction of mathematical objects from thematized processes in the manner of Piaget's reflective abstraction. Gray & Tall (1994) brought a new emphasis on the role of symbols, particularly in arithmetic and algebra, that act as a pivot between a do-able process and a think-able concept that is manipulable as a mental object (a *procept*). This, in its turn, amplifies and extends Fischbein's algorithmic mode of thinking, to include not only procedures, but their meanings in an integrated theory.

At the same time, the advanced mathematical thinking group of PME, organised by Gontran Ervynck in the late eighties, surveyed the transition to formal thinking and began to extend cognitive theories to the construction of axiomatic systems.

Two further strands were also emerging, one encouraged by the American Congress declaring 1990-2000 as 'the decade of the brain' in which resources were offered to expand research into brain activity. The other related to a focus on embodiment in cognitive science where the linguist Lakoff worked with colleagues to declare that all thinking processes are embodied in biological activity.

In the first of these, brain imaging techniques were used to determine low grain maps of where brain activities are occurring. Such studies focused mainly on elementary arithmetic activities (eg Dehaene 1997, Butterworth 1999), but others revealed how logical thinking, particularly when the negation of logical statements is involved, causes a shift in brain activity from the visual sensory areas at the back of the brain to the more generalised frontal cortex (Houdé *et al.*, 2000). This reveals a distinct change in brain activity, consistent with a significant shift from sensory information to formal thinking. At the other end of the scale, studies of young babies (Wynn, 1992) revealed a built-in sense of numerosity for distinguishing small configurations of 'twoness' and 'threeness', long before the child had any language. The human brain has visual areas that perceive different colours, shades, changes in shade, edges, outlines and objects, which can be followed dynamically as they move. Implicit in this structure is the ability to recognize small groups of objects (one, two or three), providing the young child with a fundamental intuition for small numbers.

In the second development, Lakoff and colleagues theorized that human embodiment suffused all human thinking, culminating in an analysis of *Where Mathematics Comes From* (Lakoff & Nunez, 2000). Suddenly *all* mathematics is claimed to be embodied. This is a powerful idea on the one hand, but a classification with only one category is not helpful in making distinctions.

If one takes 'embodiment' in its everyday meaning, then it relates more to the use of physical senses and actions and to visuo-spatial ideas in Bruner's two categories of enactive and iconic representations. Following through van Hiele's development, the visual embodiment of physical objects becomes more sophisticated and concepts such as 'straight line' take on a conceptual meaning of being perfectly straight, and having no thickness, in a way that cannot occur in the real world. This development,

from physical embodiment to increasingly sophisticated conceptual embodiments is quite different from the symbolic development encountered in arithmetic where *actions* on objects (such as counting and sharing) are symbolised and the symbols themselves take on a character that allows them to be mentally manipulated at a higher level. The latter may be *functionally* embodied (in that we use our hands to write symbols and think metaphorically about ‘moving symbols around’) but the encapsulation of processes into mental objects is fundamentally different from the reflective sensory focus on objects themselves, sufficient to place it in a different category, analogous to Sfard’s (1991) distinction between operational and structural.

The category focusing on the increasing sophistication of representations of objects includes two of Bruner’s three forms of representation: the enactive and iconic. Meanwhile, symbolic representations include the technical forms of number and logic that resonate with Fischbein’s algorithmic and formal categories.

These re-alignments of categories are usefully seen in relation to the SOLO (Structure of Observed Learning Outcomes) theory of another president of PME, Kevin Collis (Biggs & Collis, 1982). This incorporates a revised stage theory that builds on aspects from both Piaget and Bruner, with successive stages named sensori-motor, ikonic, concrete-symbolic, formal, and post-formal. An essential aspect of this theory is that, once a stage has been constructed, it becomes available *together with previous stages*. Seeing cognitive development in a cumulative light can combine sensori-motor interactions and ikonic visuo-spatial ideas to give an embodied basis for mathematics. This goes in one direction towards geometry through the focus on properties of objects underpinned with language, in another direction, actions on embodied objects build a distinct development operating with symbols in arithmetic and algebra. All these activities grow in sophistication and the study of their properties lead on later to more formal, abstract, logical aspects. Language continues to underpin all of this activity. A visual picture is nothing without meaning being given to what it represents. While embodiment is fundamental to human development, language is essential to give the subtle shades of meaning that arise in human thought.

Taking the lead from Collis in seeing successive developments as cumulative, rather than as the replacement of earlier ways of thinking, we may now see mathematical development beginning before language with an implicit sense of numerosity. By the time the child arrives at school, sensori-motor and ikonic aspects are already working together with language making more subtle conceptions possible. This is the beginning of a van Hiele development in visuo-spatial ideas of figures in particular and other graphical concepts in general. The introduction of arithmetic (concrete-symbolic) brings a distinct mode of operation focusing on the symbolisation of counting processes as number concepts; the properties encountered in the elementary mathematics of arithmetic, algebra, geometry and calculus lead on to a new property-based focus using axiomatic definitions and proof.

### THREE WORLDS OF MATHEMATICS

The foregoing discussion leads to a possible categorisation of cognitive growth into three distinct but interacting developments.

The first grows out of our *perceptions* of the world and consists of our thinking about things that we perceive and sense, not only in the physical world, but in our own mental world of meaning. By reflection and by the use of increasingly sophisticated language, we can focus on aspects of our sensory experience that enable us to envisage conceptions that no longer exist in the world outside, such as a ‘line’ that is ‘perfectly straight’. I now term this world the ‘conceptual-embodied world’ or ‘*embodied world*’ for short. This includes not only our mental perceptions of real-world objects, but also our internal conceptions that involve visuospatial imagery. It applies not only the conceptual development of Euclidean geometry but also other geometries that can be conceptually embodied such as non-Euclidean geometries that can be imagined visuo-spatially on surfaces other than flat Euclidean planes and any other mathematical concept that is conceived in visuo-spatial and other sensory ways.

The second world is the world of symbols we use for calculation and manipulation in arithmetic, algebra, calculus and so on. These begin with *actions* (such as pointing and counting) that are encapsulated as concepts by using symbol that allow us to switch effortlessly from processes to *do* mathematics to concepts to *think* about. This second world I call the ‘proceptual-symbolic world’ or simply the ‘*proceptual world*’. It does not develop in the same way as the van Hiele development of geometry, but by expanding the context of counting to new contexts, sharing, using fractions, allowing debts using negative numbers, decimal representations, repeating and non-repeating decimals, real numbers, complex numbers, vectors in two and three, then  $n$  dimensions, and so on.

The third world is based on *properties*, expressed in terms of formal definitions that are used as axioms to specify mathematical structures (such as ‘group’, ‘field’, ‘vector space’, ‘topological space’ and so on). This is termed the ‘formal-axiomatic world’ or ‘*formal world*’, for short. It turns previous experiences on their heads, working not with familiar objects of experience, but with axioms that are carefully formulated to *define* mathematical structures in terms of specified properties. Other properties are then deduced by formal proof to build a sequence of theorems. Within the axiomatic system, new concepts can be defined and their properties deduced to build a coherent, logically deduced theory.

### JOURNEYS THROUGH THE THREE WORLDS

Different individuals take very different journeys through the three worlds. A few children have such difficulties with numbers that the phenomenon has been given the name ‘dyscalculia’. Most children cope with the action-schema of counting leading to the development of the number concept. However, there are growing differences in the ways children cope with arithmetic. Some remain focused much longer on the procedures of counting, while others are developing more flexible number concepts.

Failure to compress counting procedures into thinkable concepts can lead to the learning of facts by rote. For many (perhaps most) individuals rote-learning can become a way of life. This may give success in a variety of routine contexts, but the longer-term Piagetian vision in which ‘operations become thematized objects of thought’ requires compression of knowledge into thinkable mental entities.

As an individual travels through each world, various obstacles occur on the way that require earlier ideas to be reconsidered and reconstructed, so that the journey is not the same for each traveller. On the contrary, different individuals handle the various obstacles in different ways that lead to a variety of personal developments, some of which allow the individual to progress through increasing sophistication in a meaningful way while others lead to alternative conceptions, or even failure.

For instance, the transition from whole numbers to fractions is highly complex; the embodied representation of a number as a physical collection of counters must be replaced by a sharing of an object or a collection of objects into equal parts and selecting a number of them. In new contexts, old experiences can cause serious conflicts. I call such old experiences ‘met-befores’. In experiencing whole numbers, the child will encounter the idea that each number has a next number and there are none in between. This met-before can cause confusion with fractions wherein there is no ‘next’ fraction, and two fractions always have many others in between. Likewise, in moving from arithmetic to algebra, a typical met-before is the idea that every sum has an answer, for instance,  $2+3$  is 5. But an expression such as  $2+3x$  has no ‘answer’ unless  $x$  is known. So if  $x$  is unknown, the child who regards a sum as an operation to carry out is faced with something that cannot be done. Other met-befores include ideas such as letters stand for codes (for example,  $a=1$ ,  $b=2$ , etc) so  $30-x$  is 6 (because  $x$  is 24), or the idea of place value that interprets 23 as two tens and a 3, so if  $x=3$ , then  $2x$  is 23. It is my belief that such met-befores are a major source of cognitive obstacles in learning mathematics and, when conflict occurs, the safe thing is to stick to routines and learn, at best, in a procedural fashion.

Watson (2001) considers the notion of vector, which is met in school in various guises such as journeys, or forces. These met-befores can give insight in some ways, but can cause serious problems in others. For instance, if a vector is a journey, then one can follow a journey from  $A$  to  $B$  then  $B$  to  $C$  to give the journey from  $A$  to  $C$ , so that  $\overline{AB} + \overline{BC} = \overline{AC}$ . But what is  $\overline{BC} + \overline{AB}$ ? As journeys, one can go from  $B$  to  $C$  to start, but if  $C$  is not the same as  $A$ , then physically, one needs to jump from  $C$  to  $A$  before finishing the journey. At the physical embodied level of a journey, addition of journeys is not commutative, it may not even be defined. In another instance, it is a common mistake for a student to say that the sum of two vectors with the same endpoint as in figure 1 is zero. If the picture evokes a sense of two fingers pushing together, then they cancel out.

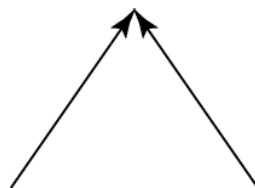


Figure 1

The concept of vector has many meanings. It has several distinct physical manifestations that lay down different met-befores that need to be resolved at more sophisticated levels. The problems just enunciated do not occur once the individual has focused on the concept of *free* vector, which has only magnitude and direction. At this level commutativity occurs for different reasons in each world of mathematics. In the embodied world, the truth of  $\mathbf{u} + \mathbf{v} = \mathbf{v} + \mathbf{u}$  follows from the properties of a parallelogram (figure 2) and meaning is supported by tracing the finger along two sides to realise that the effect is the same, whichever way one goes to the opposite corner of the figure. In the symbolic world of vectors as matrices, addition is commutative because the sum of the components is commutative. At the formal level of defining a vector space, commutativity holds because it is assumed as an axiom.

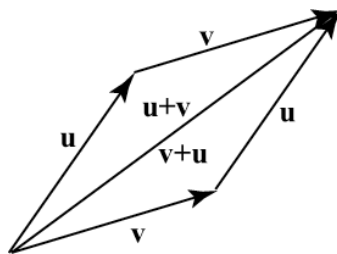


Figure 2:  $\mathbf{u} + \mathbf{v}$  is the same as  $\mathbf{v} + \mathbf{u}$

More generally, each world develops its own ‘warrants for truth’ (in the sense of Rodd, 2000) in different ways. Initially something is ‘true’ in the embodied world because it is *seen* to be true. This is truth in the intuitive sense of Fischbein. Increasing sophistication in geometry leads to Euclidean proof, which is supported by a visual instance and proved by agreed conventions, often based on the idea of ‘congruent triangles’. In arithmetic, something is ‘true’ because it can be calculated; in algebra, because one can carry out an appropriate symbolic manipulation such as

$$(a - b)(a + b) = (a - b)a + (a - b)b = a^2 - ba + ab - b^2 = a^2 - b^2.$$

In the formal world, something is ‘true’ because it is either assumed as an axiom or definition, or because it can be *proved* from them by formal proof.

By becoming aware of the different developments in the different worlds and of the way in which experiences may work at one stage, yet create met-befores that interfere with later development, a broader, more coherent view of cognitive development becomes possible. The theory proposed builds on the fundamental human activities of perception, action and reflection and, by tracing these through the worlds of embodiment and proceptual symbolism to the formal world of mathematical proof, a global vision of mathematical growth emerges. Some make only a small journey before encountering obstacles. Some remain in the initial embodied world of perception and action and cling to procedural thinking, some reflect on embodiments and become fluent in algorithms to encapsulate them into thinkable entities. These achievements may be entirely appropriate for the use of mathematics in a wide range of situations. A few may take matters further into the world of formal mathematical thinking. The purpose of developing such a theory is to gain an overview of the full range of mathematical cognitive development. It is a goal that I suggest is appropriate for the overall study of the Psychology of Mathematics Education.

## References

- Biggs, J. & Collis, K. (1982). *Evaluating the Quality of Learning: the SOLO Taxonomy*, Academic Press, New York.
- Bruner, J. S. (1966). *Towards a Theory of Instruction*, New York: Norton.
- Butterworth, B. (1999). *The Mathematical Brain*, London: MacMillan.
- Dehaene, S. (1997). *The Number Sense*. New York: Oxford University Press.
- Czarnocha, B., Dubinsky, E., Prabhu, V., Vidakovic, D. (1999). One theoretical perspective in undergraduate mathematics education research. *Proceedings of PME 23*, 1, 95–110.
- Dienes, Z. P. (1960). *Building Up Mathematics*. London: Hutchinson.
- Fischbein, E. (1987). *Intuition in science and mathematics: An educational approach*. Dordrecht, Holland: Kluwer.
- Gray, E. M. & Tall, D. O. (1994). Duality, ambiguity and flexibility: A proceptual view of simple arithmetic. *Journal for Research in Mathematics Education*, 25 2, 115–141.
- Houdé *et al.* (2000). Shifting from the perceptual brain to the Logical Brain: The Neural Impact of Cognitive Inhibition Training. *Journal of Cognitive Neuroscience*, 12 4, 712–728.
- Lakoff, G. & Nunez, R. (2000). *Where Mathematics Comes From*. New York: Basic Books.
- Piaget, J., (1965). *The Child's Conception of a Number*. New York: Norton.
- Piaget, J. (1985), *The Equilibration of Cognitive Structures*. Cambridge MA: Harvard.
- Rodd, M. M. (2000). On mathematical warrants, *Mathematical Thinking and Learning*, 2 3, 221–244.
- Sfard, A. (1991). On the Dual Nature of Mathematical Conceptions: Reflections on processes and objects as different sides of the same coin, *Educational Studies in Mathematics*, 22, 1–36.
- Skemp, R. R. (1971), *The Psychology of Learning Mathematics*, London: Penguin.
- Skemp, R. R. (1979), *Intelligence, Learning and Action*, London: Wiley.
- Van Hiele, P. M. (1959), 'La pensée de l'enfant et la géometrie', *Bulletin de l'Association des Professeurs Mathématiques de L'Enseignement Public*, 198.
- Van Hiele, P. M. (1986). *Structure and Insight*. Orlando: Academic Press.
- Van Hiele, P. M. (2002) Similarities and Differences between the Theory of Learning and Teaching of Skemp and the Van Hiele Levels of Thinking. In D. O. Tall & M. O. J. Thomas, *Intelligence, Learning and Understanding: A Tribute to Richard Skemp*.
- Watson, A. (2002). Embodied action, effect, and symbol in mathematical growth. In Anne Cockburn & Elena Nardi (Eds), *Proceedings of the 26<sup>th</sup> Conference of the International Group for the Psychology of Mathematics Education*, 4, 369–376. Norwich: UK.
- Wynn, K. (1992). Addition and subtraction by human infants. *Nature*, 358, 749–750.

# THE EFFECT OF STUDENTS' ROLES ON THE ESTABLISHMENT OF SHARED MEANINGS DURING PROBLEM SOLVING

Konstantinos Tatsis

Eugenia Koleza

Department of Primary Education      Department of Primary Education

University of Ioannina, Greece

University of Ioannina, Greece

*The analysis of interaction among students is becoming very important in mathematics education, especially among the scholars who view knowledge as socially constructed and negotiated. One of the features of human interaction is the roles that people perform while interacting. Using a symbolic interactionist perspective, we analyzed the evolution of students' roles in time and their effect on the establishment of shared meanings.*

## INTRODUCTION

It seems to be a common faith between researchers in mathematics education that interactive mathematical activities provide students with learning possibilities that extend “beyond the realms of memorized procedures” (Wood 1994, p. 149). In other words, a real acquisition of knowledge occurs while the individual engages in a certain discourse<sup>1</sup>. A considerable amount of recent research in mathematics education is dedicated to the analysis of the main factors that comprise discourse: the participants engaged, the language used and the rules that control the interactions<sup>2</sup>. Although there seem to exist many analyses concerning language (Pirie and Schwarzenberger, 1988, Dekker and Elshout-Mohr, 1998, Forrester and Pike, 1998, Stacey and Gooding, 1998, Dreyfus, Hershkowitz and Schwarz, 2001), how it affects the process of interaction (Gómez and Rico, 1995, Ward and Jacobs, 2000) and what rules regulate the interaction (Yackel and Cobb, 1996, Sfard, 2000, Yackel, Rasmussen and King, 2000, Yackel, 2001), little work is done on the acts of the participants themselves, especially on how these acts reflect their wider context or how they affect the interaction or the acquisition of knowledge itself (César, 1998, Carvalho and César, 2001, Rowland, 2002). Our research, having as its

---

<sup>1</sup> “... the word *discourse* has a very broad meaning and refers to the totality of communicative activities, as practiced by a given community” (Sfard, 2000, p. 160).

<sup>2</sup> A recent case study we have conducted (Tatsis and Koleza, 2002) focused on all these factors: we investigated the type of language used, the norms that controlled the interactions and the roles that were adopted by university students while they worked collaboratively.

main focus the participants' acts, their distribution across the interactions and their effect on the creation of shared meanings intended to answer the following questions:

- a) What are the actual roles<sup>3</sup> that students perform while collaborating to solve a mathematical problem?
- b) What is the evolution of these roles in time?
- c) What is the effect of that role playing in the establishment of shared meanings by the students?

## THEORETICAL FRAMEWORK

Symbolic interactionism is a sociological theory introduced by Mead (1934) and Blumer (1969) and elaborated by Goffman (1961, 1971, 1972) among others. Like its name suggests, this theory considers vital the role of symbols for the process of interactions; it is through symbols that people establish shared meanings and define the situation they are involved. Language is the most important symbol, although other non-verbal symbols can sometimes be the object of investigation. The individual is not treated as a passive receiver of society's influences, but as an active participant who takes part in the formulation and negotiation of knowledge during the process of symbolic interaction. This process involves several inter-connected features; a basic one, that may be said to include all the rest, is the individual's *behavior* or *performance*, which is defined as "all the activity of a given participant on a given occasion which serves to influence in any way any of the other participants." (Goffman, 1971, p. 26)

The analysis of performance can be done by the use of role theory, which uses two basic models<sup>4</sup> for its analyses: the dramaturgical model treats the individual as an actor, who presents himself to others and tries to guide and control their impression of him; the game model considers human interactions as a sort of a game which places constraints and rules for participants' behavior, and gives them the chance to employ various strategies in order to achieve their goals. We treat these two models as complementary rather than contradictory, because they both share one of the basic assumptions of symbolic interactionism: people's acts are the product of interpretation of other's acts.

One of the concepts that proved very helpful on our attempt to explain particular characteristics of performances is *face*, which is "the positive social value a person effectively claims for himself by the line others assume he has taken during a particular contact." (Goffman, 1972, p. 5). During each

---

<sup>3</sup> Role is defined as "A behavioral repertoire characteristic of a person or a position" (Thomas and Biddle, 1966, p. 11)

<sup>4</sup> Both models owe their development to Goffman's (1961, 1971, 1972) work.



interaction some *face work* takes place: as soon as the person realizes all the social norms concerning his position, and the possible interpretations of others upon his acts, he employs his face saving strategies.

## METHODOLOGY

Subjects of our research were 40 undergraduate students of the Department of Primary Education of the University of Ioannina in Greece. The students were asked to choose a partner, so 20 pairs were formed. The only instructions given to the students were that they should verbalize every thought they make and that they should try to cooperate to solve the problems posed. All sessions were tape-recorded by the observer, whose interventions were the fewest possible.

Once we got at hand the transcripts, we were engaged in the process of coding the data<sup>5</sup>: firstly, we labeled all the verbal acts of each subject, according to the following labels<sup>6</sup>: a) shows certainty, b) shows uncertainty, c) shows agreement, d) shows disagreement, e) makes suggestion, f) asks for suggestion, g) gives opinion, h) asks for opinion, i) gives information, j) asks for information. We also monitored each student's acts, his partner's *responses* to these acts and the *effect* of these acts in the process. Then we examined the degree of conformity to social and sociomathematical norms that these acts exhibited. All these elements assisted us in the categorization of the mentioned labels. The following categories emerged: a) collaborator (i.e. a person who always asked for her partner's opinion before proceeding) b) contributor (i.e. a person that made many suggestions) c) elaborator (i.e. a person who gave information concerning her suggestions whenever it was possible), d) conciliator (i.e. a person who rarely insisted on a suggestion once it was withdrawn). These categories were dimensionalized in the sense that a person's acts could range from collaborative to non-collaborative, or a person could be indifferent, and so on. The combination of the above categories provided us with enough information to describe each student's role. Finally, in order to study the effect of that role playing on the establishment of shared meanings, we observed the processes by which new meanings were introduced, elaborated and accepted (or abandoned) and then studied how these processes were connected with particular combinations of roles. A brief illustration of our analytic process shall be provided in the sample analysis that follows.

## SAMPLE ANALYSIS

The following excerpt is taken from a "girl-girl" pair's first session, once they were assigned the T-shirt Problem (see Appendix). Next to each student's turn,

---

<sup>5</sup> We mainly followed Strauss and Corbin's (1990) methodology for coding our data.

<sup>6</sup> The labels were adapted from Bales (1966).

lies the label of the act and next to it the degree of this act's conformity to a social or sociomathematical norm.

Verbal acts	Labels	Conformity
1. A. Do you understand what we have to do?	Asks for opinion.	Social norm <sup>7</sup> (high)
2. B. Yes.	Shows agreement.	
3. A. Count the squares and...	Makes suggestion.	
4. B. Number them?	Asks for information.	
5. A. Shall we count them? One side is one two three four and here is one two three four. Let's check if... I believe that these two triangles are equal, because... Because, these two angles, hold on...	a. Asks for opinion. b. Gives information. c., d., e. Makes suggestion and shows uncertainty.	a. Social norm (high) c. Social norm (medium) d. Social norm (low)
6. B. Are these ones angles?	Asks for information.	
7. A. Yes. Vertical angles. So, this side is the same with that, one common side and one angle... What are you thinking? So, this is the circle's center...	a., b., c. Gives information. d. Asks for opinion. e. Makes suggestion.	d. Social norm (medium)
8. B. Hm.	Shows uncertainty.	
(Middle pause)		
9. B. And what are we going to say to him about the drawing of the circle?	Asks for suggestion.	Social norm (medium)

---

<sup>7</sup> The only social norm found in the excerpt is the one that refers to the respect that one has to show for her partner's opinion. High level of conformity was expressed by questions concerning the partner's understanding and/or asking for her opinion. Low level of conformity was expressed by suggestions made in the affirmative and in first person singular. Medium level of conformity was expressed by all verbal acts that contained an element of collaboration (usually the pronoun "we"), but could not be classified at the high level for various reasons.

- |  |   |                            |
|--|---|----------------------------|
| 10. A. Hm. Shall we say that first?  | a. Shows uncertainty.<br>b. Makes suggestion and asks for opinion.                          | Social norm<br>(high)      |
| 11. B. Yes.  | Shows agreement.  |                            |
| 12. A. OK, it's a square with ten small squares in each side. How are we going to write the instructions? The design consists of a circle... | a. Makes suggestion and shows certainty.<br>b. Asks for suggestion.<br>c. Makes suggestion. | b. Social norm<br>(medium) |
| 13. B. And two triangles.  | Makes suggestion.   |                            |
| 14. A. So, we shall begin like this...   | Gives opinion.  | Social norm<br>(medium)    |
| 15. B. Hm.   | Shows uncertainty.  |                            |

A first observation one can make is that student A made most suggestions, sometimes asked for her partner's opinion and always gave sufficient information. She also seemed to show a high level of conformity to the social norm of collaboration<sup>8</sup>; a closer look though, revealed that student A's adherence to that norm was sometimes superficial: in 5, 7 and 12 immediately after posing a question, she proceeded without waiting for her partner to reply. One might say that from the one hand her aim was to maintain her face as a collaborative partner, while on the other hand she wanted to avoid a possible threat to her competitive face<sup>9</sup> by her partner, by eagerly uttering her own suggestion. Student B made almost no suggestions (13 contains a suggestion already made by her partner) and was collaborative in the sense that she listened to her partner's suggestions, expressed her agreement or uncertainty and asked for information. Thus, one cannot conclude that she played a passive role in the episode: her hesitant replies seemed to lead her partner to clarify or elaborate her suggestions.

The first meaning introduced in the excerpt was "numbering the squares" (by student A) which became immediately a shared meaning, since student B accepted it in 4 without showing uncertainty or asking for information. The next meaning, introduced by student A again, was "equal triangles" (5); this time her partner seemed reluctant to accept it: firstly she asked for information (6), then she showed uncertainty (8) and although in 13 she uttered "two triangles" she

---

<sup>8</sup> With the exception of 5 d. student A always used the pronoun "we" in her expressions.

<sup>9</sup> A threat to her competitive face might be consisted of a more effective suggestion, or of a request for information that she could not handle.

did not use the adjective “equal”. This is an example of a meaning that did not become a shared one.

## CONCLUSIONS

The cross-examination of the protocols led us to four basic role categories: “the collaborative initiator”, “the dominant initiator”, “the collaborative evaluator” and “the insecure conciliator”. The collaborative initiator demonstrated the highest level of conformity to social and sociomathematical norms; she made many suggestions, gave information whenever necessary and was ready to withdraw a suggestion in order to maintain the collaboration. The dominant initiator made many suggestions, but rarely asked for her partner’s opinion; she elaborated her proposals, but was reluctant to withdraw a suggestion. The collaborative evaluator made relatively few suggestions, either because she felt uncertain of her skills or because of her partner’s behavior. The insecure conciliator made almost no suggestions; she expressed the lowest level of conformity to most norms, as her remarks usually showed agreement to her partner’s acts, without any sort of evaluation.

The above roles changed very slightly in the course of the three meetings. It seems that once the roles were established, both students tried to maintain them; this may be partially attributed to a face maintaining strategy. Eventually, some roles changed during the three meetings: some insecure conciliators switched to collaborative evaluators; this may be attributed to their partners’ behavior, since all were collaborative initiators. The establishment of shared meanings was also affected by students’ roles; the pairs that consisted of two collaborative initiators produced the most shared meanings; a collaborative initiator with a collaborative evaluator also produced many shared meanings, but not as many as the previous combination. The less shared meanings were established in the pairs consisting two dominant initiators and in all pairs consisting an insecure conciliator.

## References

- Bales, R. F. (1966). Task Roles and Social Roles in Problem-Solving Groups. In B. J. Biddle, E. J. Thomas (Eds.), *Role Theory: Concepts and Research*. New York: John Wiley & Sons, Inc., 254-262.
- Blumer, H. (1969). *Symbolic Interactionism: Perspective and Method*, Englewood Cliffs, NJ: Prentice-Hall.
- Carvalho, C., César, M. (2001). Peer Interactions and Statistics Learning. In M. van den Heuvel-Panhuizen (Ed.), *PME 25 Proceedings*. The Netherlands: Freudenthal Institute, Faculty of Mathematics and Computer Science, Utrecht University, vol. 2, 217-224.
- César, M. (1998). Social Interactions and Mathematics Learning. *MEAS 1 Proceedings*. Nottingham: Nottingham University, 110-119.
- Dekker, R., Elshout-Mohr, M. (1998). A Process Model for Interaction and Mathematical Level raising. *Educational Studies in Mathematics*, 36(3), 303-314.

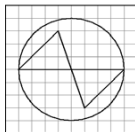
- Dreyfus, T., Hershkowitz, R., Schwarz, B. (2001). The construction of abstract knowledge in interaction. In M. van den Heuvel-Panhuizen (Ed.), *PME 25 Proceedings*. The Netherlands: Freudenthal Institute, Faculty of Mathematics and Computer Science, Utrecht University, vol. 2, 377-384
- Forester, M. A., Pike, C. D. (1998). Learning to Estimate in the Mathematics Classroom: A Conversation-Analytic Approach. *Journal for Research in Mathematics Education*, 29 (3), 334-356.
- Goffman, E. (1961). *Encounters: Two Studies in the Sociology of Interaction*. Indianapolis: Bobbs-Merrill.
- Goffman, E. (1971). *The Presentation of Self in Everyday Life*. Harmondsworth, Middlesex: Penguin University Books.
- Goffman, E. (1972). *Interaction Ritual: Essays on Face-To-Face Behaviour*. Harmondsworth, Middlesex: Penguin University Books.
- Gómez, P., Rico, L. (1995). Social interaction and mathematical discourse in the classroom. In L. Meira, D. Carraher (Eds.), *Proceedings of the 19th PME Conference*. Recife: Universidade Federal de Pernambuco.
- Mead, G. H. (1934). *Mind, Self and Society*. Chicago: University of Chicago Press.
- Pirie, S. E. B., Scharzenberger, R. L. E. (1988). Mathematical discussion and mathematical understanding. *Educational Studies in Mathematics*, 19(4), 459-470.
- Rowland, T. (2002). Pragmatic Perspectives on Mathematics Discourse. In J. Novotná (Ed.), *CERME2: European Research in Mathematics Education II*. Prague: Charles University, 408-419.
- Schiffrin, D. (1994). *Approaches to Discourse*. Oxford: Blackwell.
- Sfard, A. (2000). On reform movement and the limits of mathematical discourse. *Mathematical Thinking and Learning*, 2(3), 157-189.
- Stacey K., Gooding, A. (1998). Communication and Learning in Small-Group Discussions. In H. Steinbring, M. G. Bartolini Bussi, A. Sierpiska (Eds.), *Language and Communication in the Mathematics Classroom*. Reston, VA: National Council of Teachers of Mathematics, 191-205.
- Strauss, A., Corbin, J. (1990). *Basics of Qualitative Research. Grounded Theory Procedures and Techniques*. Newbury Park: Sage Publications.
- Tatsis, K., Koleza, E. (2002). Language as a Communicative and Interpretive Tool in Mathematical Problem Solving. *2<sup>nd</sup> International Conference on the Teaching of Mathematics Proceedings*, <http://www.math.uoc.gr/~ictm2/Proceedings/pap262.pdf>
- Thomas, E. J., Biddle, B. J. (1966). The Nature and History of Role Theory. In B. J. Biddle, E. J. Thomas (Eds.), *Role Theory: Concepts and Research*. New York: John Wiley & Sons, Inc., 3-19.
- Ward, C. S., Jacobs, G. M. (2000). Analyzing Student-Student Interaction from Cooperative Learning and Systemic Functional Perspectives. *Electronic Journal of Science Education*, 4 (4), <http://unr.edu/homepage/crowther/ejse/jacobsetal.html>

- Wood, T. (1994). Patterns of Interaction and the Culture of Mathematics Classrooms. In S. Lerman (Ed.) *Cultural Perspectives on the Mathematics Classroom*. Dordrecht: Kluwer Academic Publishers, 149-168.
- Yackel, E., Cobb, P. (1996). Sociomathematical norms, argumentation, and autonomy in mathematics. *Journal for Research in Mathematics Education*, 27(4), 390-408.
- Yackel, E., Rasmussen, C., King, K. (2000). Social and sociomathematical norms in an advanced undergraduate mathematics course. *Journal of Mathematical Behavior*, 19 (3), 275-287.
- Yackel, E. (2001). Explanation, justification and argumentation in mathematics classrooms. In M. van den Heuvel-Panhuizen (Ed.), *PME 25 Proceedings*. The Netherlands: Freudenthal Institute, Faculty of Mathematics and Computer Science, Utrecht University, vol. 1, 1-9.

## Appendix

### T-shirt Problem

The design below is going to be used on a T-shirt. You accidentally took the original design home, and your friend, Chris, needs it tonight. Chris has no fax machine, but has a 10 by 10 grid just like yours. You must call Chris on the telephone and tell him precisely how to draw the design on his grid. Prepare for the phone call by writing out your directions clearly, ready to read over the telephone.



# INTEGRATING CAS CALCULATORS INTO MATHEMATICS LEARNING: PARTNERSHIP ISSUES

**Michael O. J. Thomas and Ye Yoon Hong**

*The University of Auckland*

*Computer algebra system (CAS) calculators are becoming increasingly common in schools and universities. While they offer quite sophisticated mathematical capability to teachers and students, it is not clear at present how they may best be employed. In particular their integration into students' learning and problem-solving remains an issue. In this paper we address this issue through the lens of a study which considered the introduction of the TI-89 CAS calculator to students about to enter university. We describe a number of different aspects of the partnership they formed with the calculator as they began the process of instrumentation of the CAS in their learning.*

## BACKGROUND

Since Heid's (1988) groundbreaking study, research on the use of computer algebra system (CAS) calculators in the learning of mathematics has tended to concentrate on specific content, such as aspects of algebra or calculus. However, until more recently there has been less emphasis on the processes by which students (and teachers) decide whether to use CAS, and if so, how and when to use it in learning. This is a major area of study since the process of integration of CAS into learning is not a minor consideration but the formation of suitable schemes involves numerous decisions and interactions (Thomas, 2001) with the technology.

A number of studies have described how technological tools may be employed in qualitatively different ways. For example, Doerr and Zangor (2000) have listed property investigation; computational; transformational; data collection and analysis; visualizing; and checking as ways in which technology may be useful. Goos, Galbraith, Renshaw and Geiger (2000) describe a hierarchy of technology interactions, where the student may be subservient to the technology, the technology can be a replacement for pen and paper, can be a partner in explorations, or an extension of self, integrated into mathematical working. A particularly useful approach, based on the ideas of Rabardel (1995), distinguishes between the use of technology as a *tool* and as an *instrument*. Transforming a CAS tool into an instrument involves actions and decisions based on the adapting it to a particular task via a consideration of what it can do and how it might do it. Trouche (2000) and Guin and Trouche (1999) have explained that this instrumentation process and the conceptualisation process are dependent on each other and that for instrumentation to occur classroom activity must be directed at particular conceptions. The study of Drijvers and Herwaarden (2000) concluded that both the technical and conceptual aspects of instrumentation need explicit attention, and that integration of CAS with pen and paper substitution and isolation techniques will lead to improved results.

Theories of instrumentation (e.g., Lagrange, 1999a) stress that each student who uses CAS has to work out its role in their learning. They have to learn to decide what CAS is useful for, and what might be better done by hand, and how to integrate the two (Thomas, Monaghan, & Pierce, in press). When controlling the machine they



have to be aware of possibilities and constraints, of possible differences between mathematical and CAS functioning, of symbolic notations and internal algorithms. Then there is the issue of monitoring the operation of the CAS (e.g., the syntax and semantics of the input/output, the algebraic expectation, etc), and the difficulties of navigating between screens and between menu operations.

These issues have given rise to some problems with CAS use. For example, Monaghan, Sun and Tall (1994) record how, for some students, CAS can become a mere button pushing process that obscured deeper understanding. In turn, Hunter *et al.* (1993) found that not only did CAS not motivate students, but they became dependent on it, performing worse than a control group on factorising and expanding when not using CAS. A similar outcome is recorded by Hong, Thomas and Kiernan (2000) who showed weaker students becoming reliant on CAS as a problem-solving support, resulting in a negative effect on their learning. On the other hand, Drijvers (2000) encourages taking a positive approach to the obstacles that students may encounter during instrumentation, and how these may be overcome. It seems to us that the key lies in the students' ability to engage in instrumentation, to form a partnership with the CAS whereby they are comfortable with integrating it into their learning, problem-solving and mathematical practice. This paper addresses merely the genesis of this process, looking at the ways in which a small group of students begin choosing to use CAS in their mathematical work.

## **METHOD**

A one week workshop was arranged for students taking a standard first year mathematics course at The University of Auckland which uses the TI-89 calculator. Eight students enrolled for the workshop, 5 females and 3 males, aged 18 to 26, with the exception of two older females, who were 51 and 55. None of the 8 students in the study had ever used a CAS calculator before, but all except one had used a scientific calculator. Each student was given their own TI-89 CAS calculator during the workshop which they kept for the whole week. The workshop covered basic functional aspects of the TI-89 along with use of the CAS calculator's more advanced features when solving problems in calculus and linear algebra. There was also discussion on the learning of core mathematical concepts using the calculators.

The second named researcher taught on the workshop for five two-hour sessions, demonstrating some points using a viewscreen while students followed and copied her working onto their own calculator. Afterwards the students spent the rest of the time working on problems and tackling exercises as a group, while the researcher circulated and assisted with any difficulties. The students were given a pre-test prior to the workshop to ascertain their knowledge of calculus and algebra, and four different post-tests during the workshop, one after each two-hour section based on that day's material. The tests (of 5 to 7 questions) comprised procedural and conceptual questions (see the results section for some of the questions).

One of the aspects of the students' work we were particularly interested in, and which forms the focus of this paper, was both the manner and the timing of the



students' CAS calculator use. In order to have some idea of the use they were making of the technology we asked them to mark it by putting a ♦ symbol alongside the point at which they used the TI-89 calculator to help them answer a question, and to give some idea of how or why they used it. The analysis which follows comprises a discussion of these uses.

## RESULTS

Since none of the students had used a CAS calculator before, they were all at the genesis of instrumentation of this particular tool, beginning to form the partnership necessary to integrate its use into their mathematics learning and problem solving. What our analysis of the data revealed was a number of qualitatively different categories of CAS use, each of which is considered below.

### *Direct Use of CAS for Straightforward and Complex Procedures*

As Thomas (2001) has described, interactions with CAS representations can be procedural or conceptual. A number of students chose simply to use the CAS to perform direct procedural calculations (i.e. a single command mapping directly to the mathematical operation) instead of doing them by hand. Sometimes they did so when the calculation was relatively straightforward and probably could have been done by hand, and sometimes when it appeared that the calculation was either too long or too complex for them to do it by hand. In Figure 1 we see examples of the former type for a limit question. These two students did not do the limit question in the pre-test and so may not have been able to do these by hand. In Figure 1 student 8 writes the ♦ symbol alongside her solution to show that she had simply entered the limits, while student 2 shows what she did by re-writing the command entered into the calculator (the F3 is the menu selected and 3 the item in the menu).

♦ (i) $\lim_{x \rightarrow 2} \frac{4x^2 - 9}{2x - 3} = 6$	♦ (ii) $\lim_{x \rightarrow \infty} \frac{8x - 1}{2x + 6} = 4$
Student 8	$\begin{array}{l} \text{F3} = 3 \\ \text{Limit} (8x-1)/(2x+6), x, \infty \\ = 4 \end{array}$
	Student 2

Figure 1. Direct procedural use of the CAS, replacing by-hand working for accessible calculations.

Figure 2 shows an example of direct procedural use of the CAS when the by-hand procedure may be too complex for the student to carry it out. Here student 8 has used the 'Solve' function of the CAS to solve an equation where the variable  $x$  is the index. The lack of intermediate steps, the brackets around the 3s, and the use of the ♦ shows the use of a direct CAS command.

♦ (iii)  $e^{2x} = 3^{2x-4}$  (give the 'exact' solution).  
 $x = \frac{2 \ln(3)}{\ln(3) - 1}$

Figure 2. Direct procedural use of the CAS, replacing by-hand working for complex calculations.

### Using CAS to Check Procedural By-Hand Work

It was expected that our students would use CAS to check pen and paper working. Figure 3 shows such a strategy employed in question 2 from the second post-test, “Find the gradient of the tangent to the graph of  $y = 3x^3 - 5x^2 + 7x - 9$  at  $x=1$ ”. We see student 3’s by-hand working to the left, finding the derivative of  $y$  and substituting  $x = 1$ , giving  $9-10+7$ , or 6. On the right we see where he has checked with the CAS calculator whether the answer is correct. Here again the process can be carried out directly by employing a single command to differentiate the function with respect to  $x$  (using  $d(3x^3-5x^2+7x-9, x)$ ) as well as calculating the value of the derivative at the point where  $x=1$  (using  $|x=1$ ).

$$\begin{array}{l} 9x^2 - 10x + 7 \\ 9 - 10 + 7 \end{array} \quad 6 \quad d(3x^3 - 5x^2 + 7x - 9, x) | x=1$$

Figure 3. Student 3’s direct use of CAS for checking by-hand working.

### Direct CAS Use Within a Mathematical Process

Another category of CAS calculator use at first seemed to be another direct use. However, further consideration showed that students were not simply using the CAS to perform the whole calculation, as seen above, but there was a partnership evolving with CAS assigned a defined role within the overall solution process. In some questions students appeared to reach a point where the mental load required to keep the mathematical concepts in mind along with the overall process appeared to be sufficiently large that they decided to resort to the CAS to handle a procedural aspect, possibly to reduce cognitive load (Sweller, 1994). One example occurred in question 4 of the first post-test:

$$\text{If } f(x) = \sqrt{1-x^2} \text{ and } g(x) = (x+1)^2, \text{ find } f \circ g(x).$$

In order to use CAS for this students first have to undertake some preliminary CAS activity, requiring them to define two functions,  $f$  and  $g$ , and to understand the need to enter  $f(g(x))$  into the calculator for the composite function. Understanding the composite function by-hand working would produce  $\sqrt{1 - ((x+1)^2)^2} = \sqrt{1 - (x+1)^4}$ , but 4 of the 8 students chose CAS use, possibly either because the procedure was too complex, or they feared errors. They obtained answers like those shown in Figure 4a. The extent of their conceptual understanding of the concept of a composite function remains unclear, and we cannot decide from the answers whether or not they used the CAS to avoid cognitive overload. Other students clearly understood the conceptual part of the composite function and produced  $\sqrt{1 - ((x+1)^2)^2}$  by hand. However when student 6 (see Figure 4b) decided to take this further and simplify it she chose the CAS to do so, presenting her working in a way that we can see this. Again she is using CAS within the mathematical process, and decisions on when and how to do so form a significant part of the instrumentation process.

$$\sqrt{-x(x^3 + 4x^2 + 6x + 4)} \quad f(g(x)) = \sqrt{1 - ((x+1)^2)^2} = \sqrt{-x(x^3 + 4x^2 + 6x + 4)}$$

4a 4b

Figure 4. Students 7 and 6's answers to question 4 using CAS commands.

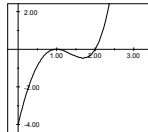
Using CAS to carry out complex procedural calculations can raise difficulties, for example through notation constraints. This is exemplified by the working of student 5 (see Figure 5), who was challenged by the format of the answer provided by the CAS. An observation of the surface structure (Thomas & Hong, 2001) of the function under the square root sign leads him to believe that the function is negative, and hence his comment that there is “No real result”. He is not able to rationalise the root and negative signs with the domain of  $x$  in order to consider whether the function can be positive for some  $x$  values. This demonstrates that the format in which CAS gives answers can lead to problems which challenge understanding.

⇒ Non-real result?  $\sqrt{-x(x^3 + 4x^2 + 6x + 4)}$

Figure 5. Student 5 uses the CAS procedurally and meets a challenge with the answer format.

Question 2 of post-test 3, asked for a sketch of an antiderivative function:

The graph of a function is shown in the figure... Make a rough sketch of an antiderivative function  $F$  alongside, given that  $F(0)=0$ .



In response to this Figure 9 shows the working of student 3. He has first moved from the given graphical representation to an algebraic representation, working by hand to get  $f(x)=a(x-1)^2(x-2)$  and then using  $f(0)=-4$  to find the value of  $a$ . At this point in the solution process he resorted to the CAS to integrate and find an antiderivative function. He then moved back to the graph mode, sketching the graph of this function by hand (it appears), rather than using CAS and copying the graph. Again it appears that complex interplay between known algebraic schemes, cognitive load, and ability to perform procedures are driving decisions about CAS use.

$$\begin{aligned}
 f(0) &= a(0-1)^2(0-2) \\
 f(0) &= -4 \quad \dots f(0) = -2a(x-1)^2(x-2) \\
 \int f(x) dx &= \frac{a(3x^3 - 16x^2 + 20x - 24)}{6}
 \end{aligned}$$

Figure 6. Student 3 uses the CAS procedurally within a mathematical solution.

### Using CAS to Investigate Conceptual Ideas

All of the above have involved direct use of CAS, a single procedural command calculating or evaluating some function or expression, which forms the answer. However, in some of the questions there was more interaction with mathematical concepts. For example, question 3 of the first post-test asked:

If  $f(x) = \begin{cases} x^2 + 2 & \text{for } x < 1 \\ x & \text{for } x \geq 1 \end{cases}$ , then using properties of limits, find out whether or not  $f(x)$  is continuous at  $x = 1$ .

Rather than simply asking for a result this question was assessing the concept of continuity. Students 2 and 4 (see Figure 7), and others, integrated the CAS into their approach, deciding to use it to find the left and right limits of  $f(x)$  at  $x=1$ . While the CAS performs a procedure each time, to embark on this method they needed to know that these limits were relevant and fundamental to the definition of continuity. Student 2 found that CAS would not give the limit at  $x=1$  directly (undefined), but then only found the right-hand limit. Student 4 has answered the question completely (CAS use again shown by the  $\diamond$ ), combining conceptual knowledge with CAS procedural results.

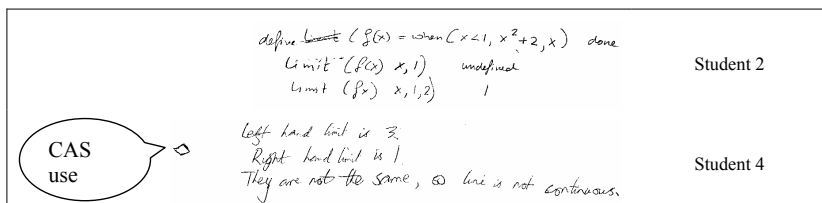


Figure 7. Use of CAS procedures within a test of the definition of continuity.

Another question where integrating the CAS into conceptual thinking seems to have been useful to students was question 6 of post-test 1. It asked:

Let  $f(x) = \frac{x^2 - 6x + 8}{x - 4}$ . Sketch the graph of  $f(x)$ . Can you explain why the graph has this form?

There were several approaches possible here using the CAS. Some students chose to use the CAS immediately to draw the graph of the function. In Figure 8 we see that student 5 indicates that he used the CAS to draw the graph. While the discontinuity at  $x=4$  is not shown on the CAS screen, he is able to combine the graph with his understanding of the function to state that “At  $x=4$ ,  $y$  is undefined.”



Figure 8. Combining CAS with understanding to answer a question.

In contrast, student 6 (see Figure 9a), appears to have chosen to simplify the rational function by hand and then use the CAS to draw the graph, even though it

reduced to a linear function (she shows the by-hand working and explicitly states the use of CAS ‘to draw [the] graph’). Having obtained the graph she then was able to combine her understanding of rational functions to show the ‘missing’ point at  $x=4$  and to say that the function was “not continuous  $x \neq 4$ .” Unfortunately the line at  $x = 4$  is on the wrong side of the  $x$ -intercept, giving  $y$  as  $-2$  instead of  $+2$ . This, along with student 4’s answer in Figure 9b, illustrates that since the CAS graphs do not show the scale values on the axes, one of the necessities of successful integration is care when transferring attention from CAS mode to by-hand working.

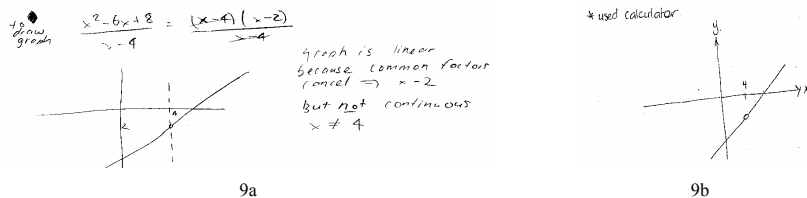


Figure 9. Integrating CAS into a conceptual approach to a question.

This difficulty could have been surmounted by recourse to the table mode of the CAS, but it appears that, at this early stage, none of the students had a sufficiently developed instrumentation of the CAS to consider this.

## CONCLUSION

In this paper we have considered the instrumentation of the CAS calculator as students begin to use it in solving mathematics problems. The results are consistent with the view that such instrumentation is not a short, easy process, but rather its development takes time. Students have to form the techniques and utilisation schemes (Lagrange, 1999b) required. Our research showed that the students were more likely at first to learn the use of buttons and menus for entering direct single procedures into the CAS, often to check their by-hand working. The process of making decisions about when and how to use the CAS in longer or more difficult mathematical problem solving raises obstacles that come later (Drijvers, 2000). This process may begin with procedural use within a question and then later proceed to cases where the CAS is used to explore conceptual ideas, using several procedures and representations.

The specific categories of CAS use that we have identified are:

- Performing a direct, straightforward procedure,
- Checking of procedural by-hand work,
- Performing a direct complex procedure, for ease of use, or because the procedure is too difficult by hand,
- Performing a procedure within a more complex process, possibly to reduce cognitive load,
- Investigating a conceptual idea.

Of course we have simply made a start in analysing types of usage when CAS is integrated into mathematical work. The final category above is where much of the

value of instrumentation lies, and it will no doubt yield a number of subcategories of its own. In future research we intend to provide the students with richer problem solving activities in order to investigate the nature of the thinking elicited, and the decisions which lead to integration of CAS. It is in these kinds of situations that we believe a real partnership with CAS will emerge.

## REFERENCES

- Doerr, H. M., & Zangor, R. (2000). Creating meaning for and with the graphing calculator. *Educational Studies in Mathematics*, 41, 143-163.
- Drijvers, P. (2000). Students encountering obstacles using a CAS, *International Journal of Computers for Mathematical Learning*, 5, 189-209.
- Drijvers, P. & van Herwaarden, O. (2000). Instrumentation of ICT tools: The case of algebra in a computer algebra environment, *The International Journal of Computer Algebra in Mathematics Education*, 7(4), 255-275.
- Goos, M., Galbraith, P., Renshaw, P., & Geiger, V. (2000). Reshaping teacher and student roles in technology-enriched classrooms, *Mathematics Education Research Journal*, 12(3), 303-320.
- Guin, D. & Trouche, L. (1999). The complex process of converting tools into mathematical instruments: The case of calculators, *International Journal of Computers for Mathematical Learning*, 3, 195-227.
- Heid, M. K. (1988). Resequencing skills and concepts in applied calculus using the computer as a tool, *Journal for Research in Mathematics Education*, 19, 3-25.
- Hong, Y. Y., Thomas, M. O. J. & Kiernan, C. (2000). Super-calculators and university entrance calculus examinations, In M. Chinnappan & M. O. J. Thomas (Eds.) *Mathematics Education Research Journal Special Issue on Technology in Mathematics Learning and Teaching* (pp. 321-336), 12(3), MERGA.
- Hunter, M., Marshall, P., Monaghan, J., Roper, T., & Wain, G. (1993). Using computer algebra systems with younger students, In J. Monaghan & T. Etchells (Eds.) *Computer algebra systems in the classroom* (pp. 68-82). Leeds: The University of Leeds.
- Lagrange, J.-B. (1999a). Complex calculators in the classroom: Theoretical and practical reflections on teaching pre-calculus, *International Journal of Computers for Mathematical Learning*, 4(1), 51-81.
- Lagrange, J.-B. (1999b). Learning pre-calculus with complex calculators: Mediation and instrumental genesis. *Proceedings of the 23rd Conference of the International Group for the Psychology of Mathematics Education*, 193-200.
- Monaghan, J., Sun, S. & Tall, D. O. (1994). Construction of the limit concept with a computer algebra system, In *Proceedings of the 18th international conference of the International Group for the Psychology of Mathematics Education* (pp. 279-286). University of Lisbon, Portugal.
- Rabardel, P. (1995). *Les hommes et les technologies, approche cognitive des instruments contemporains*. Paris: Armand Colin.
- Sweller, J. (1994). Cognitive load theory, learning difficulty, and instructional design. *Learning and Instruction*, 4, 295-312.
- Thomas, M. O. J. (2001). Building a conceptual algebra curriculum: The role of technological tools, In H. Chick, K. Stacey, J. Vincent, & J. Vincent (Eds.) *International Congress of Mathematical Instruction (ICMI) The Future of the Teaching and Learning of Algebra Proceedings* (pp. 582-589). Melbourne: The University of Melbourne.
- Thomas, M. O. J. & Hong, Y. Y. (2001). Representations as Conceptual Tools: Process and Structural Perspectives, *Proceedings of The 25<sup>th</sup> Conference of the International Group for the Psychology of Mathematics Education*, Utrecht, The Netherlands, 257-264.
- Thomas, M. O. J., Monaghan, J., & Pierce, R. (in press). Computer algebra systems and algebra: Curriculum, assessment, teaching, and learning, In H. Chick, M. Kendal, & K. Stacey (Eds.), *The future of the teaching and learning of algebra*, Dordrecht: Kluwer.
- Trouche, L. (2000). La parabole du gaucher et de la casserole à bec verseur: étude des processus d'apprentissage dans un environnement de calculatrices symboliques, *Educational Studies in Mathematics*, 41(3), 239-264.

# THE DEVELOPMENT OF STRUCTURE IN THE NUMBER SYSTEM

Noel Thomas

Charles Sturt University, Bathurst

*A cross-sectional study of 132 Australian rural children from grades K-6 assessed children's understanding of the number system. Task-based interview data exhibited lack of understanding of the base ten system, with little progress made during Grades 5 and 6. Few Grade 6 children used holistic strategies or generalised the structure of the number system. Grouping strategies were not well linked to formation of multiunits and additive rather than multiplicative relations dominated the interpretation of multidigit numbers.*

Our numeration system is a consistent and infinitely extendable base ten system that facilitates mental and written notational forms of number for both whole number and decimal fractions. The numeration system allows us to allocate words for numbers in a pattern that follows a base ten system where the multiunit conceptual structures used involve the powers of ten. These multiplicative units, ie 1, 10, 100, ... form the basis for conceptualising ever increasing numerical quantities and enable an infinitely extendable number system. The notational number system, known as the Hindu-Arabic system, records these numbers and together with the mental system evolved through centuries of human thought and use.

This paper explores a part of the study on children's understanding of the number system. The focus is on children's understanding of structure. A critical problem is that children do not recognise that the numbers they use are part of a system, and thus they do not have the multiunit structures to understand how the numbers are regrouped in mental and written algorithms. Further, understanding of the use of powers of ten is needed in order to construct the multiunit conceptual structures for multidigit numbers. Understanding the multiplicative nature of the base 10 system is critical to the development of numeration, place value and number sense.

## RESEARCH ON CHILDREN'S CONSTRUCTION OF MULTIUNIT CONCEPTUAL STRUCTURES

From the developing body of research on numeration and place value we know that a child's understanding of the numeration system is complex, is not necessarily lock-step, and develops over many years. There is also a fundamental change in the way a child understands number from the early notion of number as a counting unit, to the construction of composite units (Steffe, 1994) and the reinitialising of units (Confrey,

1994). The process that starts with treating a collection as a whole and then develops as a system that is built on the iteration of grouping collections, requires significant cognitive reorientations.

Research on how children extend their early number understanding and skills to cater for the expanding system of generating number names and symbols has been far less comprehensive than the work on early number. Despite much research on counting and place value in the 1980's, by the 1990's researchers could not assert any firm explanations about why children fail to grasp the structure of the number system. Sinclair, Garin, & Tieche-Christinat (1992) make the crucial point that:

Understanding place value is not a matter of simply 'cracking' an arbitrary written code following adult explanation or some degree of exposure to computation. It is indissolubly linked to understanding the number system itself. Grasping it implies understanding a multiplicative recursive structure. (p. 93)

Children need structural flexibility in counting and grouping in order to operate meaningfully with the number system. The role of visualisation of the counting sequence was examined in view of children's representations of the numeration system (Thomas, Mulligan & Goldin, 2002). Thomas, et al (2002) suggested that the further developed the structure of a child's internal representational system for counting numbers the more coherent and well organised will be the child's externally produced representations and the wider will be his or her range of numerical understandings.

In numeration the notion of multiplicative units is necessary in order to understand the conceptual structure of multiunit quantities (Behr, Harel, Post, & Lesh, 1994). Construction of a unit occurs through internalising repeatable actions. The unitising action of assigning a number word to each object in a collection is the basis of counting. Multiplicative structures are important because the units in the numeration system are multiplicative. Children construct multiunits through the multiplicative relation. An infinite sequence of multiplicative units are created by grouping units with a particular multiplying number, treating the composite as a unit and iterating them to form further units. Units can also be created by splitting existing units in a similar way (Confrey & Smith, 1995).

## **METHOD**

The study was designed as a broad exploratory investigation employing task-based interviews and quantitative and qualitative methods of analysis. A descriptive approach was used to provide evidence of qualitative differences in the way children use their strategies and relate key elements of the numeration system.



Sample: A cross-sectional sample of 132 children from Grades K to 6 was randomly selected from six Government schools in rural Australia. Five of the schools were from three large regional towns and one was the only school in a small rural town. The sample was representative of a wide range of socio-economic backgrounds.

Interview tasks: A total of eighty-nine tasks were incorporated after trialling in a pilot study. The tasks were designed to probe understanding of numeration through: counting; grouping/partitioning; regrouping, place value; structure of numeration and number sense. Many of the tasks were refined from those used by previous researchers (Bednarz & Janvier, 1988; Cobb & Wheatley, 1988; Davydov, 1982; Denvir & Brown, 1986; Mulligan, 1992; Ross, 1990; Steffe & Cobb, 1988; Wright, 1991). The tasks were graded by level of difficulty and different subsets of tasks were given to each grade cohort.

Analysis of Data: Item Response Analysis using Student-Problem curve theory (Harnish, 1983) and the Rasch model (Rasch, 1980) were used initially to obtain some overall measure of student performance in Grades 4 to 6. The main analysis of results involved coding responses for student performance and strategy use (which is reported partially in this paper) across tasks and grades. The coding of responses was trialled in a pilot study which was devised to indicate correct, incorrect or non-response to the tasks. Strategies used for both incorrect and correct responses to tasks were coded in order to classify the range of numeration skills and understandings. Re-coding was conducted by two independent coders for 20% of responses which established a high level of intercoder reliability (0.92).

## **RESULTS**

The structure tasks in the study aimed to assess the children's ability to identify structure in the number sequence, such as using and extending grouping systems (based on tens and other grouping numbers), using arrays to quantify a large number of items, and calculating with powers of ten. There is evident from the results that there was a diverse range of strategy use across tasks but performance generally increased through the grades with some leveling off (and even decline) in the upper primary grades.

### **Recognition of Place Value Structure**

Figure 1 shows children's performance on the various tasks which tested their recognition of place value structure. These tasks simply asked children to recognise or represent a number or to use place value structure in counting. No calculation was involved.

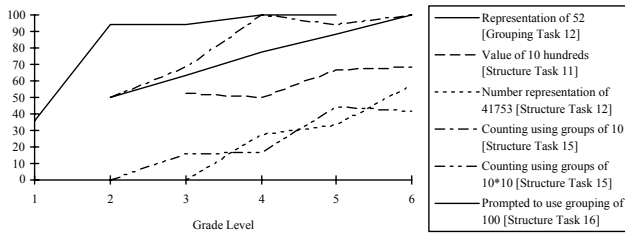


Figure 1. Percentage of sample correctly performing place value recognition tasks

By the end of Grade 2, most children could represent the 52 shells using the pregrouped material [Task 12]. A surprisingly large number (increasing from 50% at Grade 3 to 68% at Grade 6) recognised that a box of lollies (containing 10 bags of 10 rolls of 10 lollies) held 1000 lollies [Task 11]. The number who could recognise the number of lollies in a collection when they were also packed in cases of 10 boxes [Task 12] grew steadily from none in Grade 3 to 58% in Grade 6.

The number of children who recognised and used the fact that the red circle enclosed 100 marks [part of Task 15] was much smaller, and consistently smaller than the number of students who recognised the structure of 1000 [Task 11]. When prompted to consider the red circle [Task 16] the number of children who used the enclosure of 100 marks was consistently below the number of those who used tens groupings in Grouping Task 12 or Structure Task 15. One explanation for these discrepancies is that students have learned to interpret certain concrete materials (bags, blocks, bundles, etc.) representing the number system but have not reached the general level of understanding needed to interpret unfamiliar groupings (circled marks) in the same way.

### Significance of recursive grouping by tens

Several tasks sought to find if children would spontaneously group by tens recursively in order to make counting easier. These tasks are to be distinguished from the tasks discussed so far, where a grouping by tens was given by the interviewer. The results are shown in Figure 2.

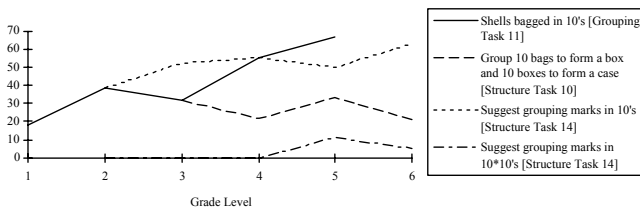


Figure 2. Percentage of sample suggesting grouping by tens

The numbers suggesting grouping by tens for counting shells [Task 11] or marks [Task 14] show a gradual increase from about 20% in Grade 2 to about 60% in Grade 6. A range of grouping numbers were considered appropriate. Most of those who suggested grouping by tens could not offer a reason for their choice. A notable exception was Andrew (Grade 1), who responded, ‘About ten in each ... then we only have to put 10 tens to make 100’. Given the use in schools of a variety of concrete materials to model the place value system - all of which are, of course, based on grouping in tens - this is indeed a surprising result. It suggests that many students are not aware, even at the most basic level, of the purpose or usefulness of our place value system.

The numbers suggesting recursive grouping by tens for packing lollies [Task 14] or counting marks Task 14] was even smaller. It is again surprising that so few students are aware of a further fundamental characteristic of our numeration system.

### Understanding the meaning of multiplication

The action of grouping by tens, so basic to the place value system, is closely associated with the operation of multiplication. Recursive grouping by tens is linked with repeated multiplication or exponentiation. Three tasks related to students’ understanding of multiplication. The results are shown in Figure 3.

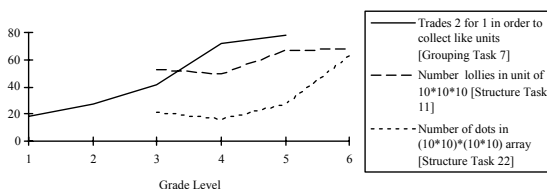


Figure 3. Percentage of sample correctly performing multiplication tasks.

Children showed an increasing success at calculating the result of trading two stickers for one [Task 7] - a multiplicative task with the semantic structure of a ratio (Mulligan, 1992). This task is similar to that of relating the values of successive

places in a numeral, and the shape of the developmental curve resembles that of several of the place value tasks shown in Figures 1 and 2.

The task of calculating the number of lollies in 10 bags of 10 rolls of 10 lollies [Task 11] has already been mentioned (see Figure 1): There is relatively little improvement between Grade 3 and Grade 6. Structure Task 22 involved a further recursion: The pattern could be regarded as made up of 10 rows of 10 groups of 10 rows of 10 dots. Successful students invented several strategies. For example, after they had determined that there were 100 dots in each square, some counting by 100s, 100 times; some counted by 100s to find that there were 1000 in the first row of squares and then counted in 1000s, 10 times; and some determined that there were 100 squares and multiplied 100 by 100. Most of the children in Grades 4 to 6 (89%, 89% and 100% respectively) recognised the pattern of 100s but many (72%, 61% and 37%) could not complete the calculation, that is, they were unable to cope with the recursion. In these three grades, about one third of the successful students used the most sophisticated strategy of multiplying 100 by 100.

Performance on Task 22 vividly illustrates the difficulties children experience relating recursive grouping to repeated multiplication. It may be conjectured that children have little experience with arrays or with repeated multiplication. It is no wonder that they also have increasing difficulties coping with the place value system as the numbers get exponentially larger.

## **DISCUSSION**

It appears from this study that many children in Grades 1-6 are familiar with concrete materials used to represent grouping of numbers, but still rely on unitary counting. They may show good performance on 2-digit calculations, but generally use poor methods and cannot extend their success to numbers with larger numbers of digits. There is in general a weak awareness of structure and, in particular, of the multiplicative nature of this structure. Nevertheless, some children acquire a good understanding of place value and develop their own efficient strategies spontaneously.

The results emphasise the importance of units and multiunits (units of more than one) in understanding the structure of the numeration system. The way that children deal with the units of one and ten influences their understanding of larger numbers (Cobb & Wheatley, 1988; Steffe & Cobb, 1988). A child who uses ten as a singleton unit might be able to recite the decade numbers (i.e., skip count in tens) but makes no sense of the increments of ten. The units of one and ten co-exists but are not coordinated. Only children who can coordinate the units and various multiunits can use these units in mental strategies for operations on larger numbers. There were also

a substantial number of students in Grades 2 and 3 who were not successful in recognising and using groupings of ten to quantify a collection of objects.

Children do not realise that multiunits are related and can be exchanged if they do not understand the abstract properties of quantity (Davidov, 1982), one of the conceptual underpinnings of multiplication. Clark and Kamii (1996) reported that although some children develop multiplicative thinking as early as Grade 2, most children still cannot demonstrate consistent thinking in Grade 5. The present study confirms these results. A substantial minority (about 20%) of the Grade 3 students had developed such an intuitive understanding of powers of ten that they could use the recursive multiplicative structure of the array of 10,000 dots to count the number of dots successfully. But by Grade 6, there were still a significant number who could not count 10 groups of 10 groups of 10.

## CONCLUSIONS

This study showed that understanding of numeration developed slowly over the Kindergarten to Grade 6 period and that very few children were able to generalise the multiplicative structure of the system. Although there was good performance on using grouping in quantifying and building grouped material, there were indications that children did not understand the significance of ten in the number system. This understanding is critical to their further development of understanding and use of the numeration system.

The study highlights the difficulties that primary school children have in understanding the complex nature of the number system. Children did not understand the multiplicative relationships within the system that are the basis of place value structure and the patterns in the counting sequence. Children could count and group in tens but did not relate these processes to a base ten structure.

## REFERENCES

- Bednarz, N., & Janvier, B. (1988). A constructivist approach to numeration in primary school: results of a three year intervention with the same group of children. *Educational Studies in Mathematics*, 19, 299-331.
- Behr, M. J., Harel, G., Post, T., & Lesh, R. (1994). Units of quantity: A conceptual basis common to additive and multiplicative structures. In G. Harel & J. Confrey (Eds.), *The development of multiplicative reasoning in learning mathematics* (pp. 121-176). Albany, NY: State University of New York Press.
- Clark, F. B., & Kamii, C. (1996). Identification of multiplicative thinking in children in grades 1-5. *Journal for Research in Mathematics Education*, 27(1), 41-51.
- Cobb, P., & Wheatley, G. (1988). Children's initial understandings of ten. *Focus on Learning Problems in Mathematics*, 10, 3, 1-28.

- Confrey, J. (1994). Splitting, similarity, and rate of change: A new approach to multiplication and exponential functions. In G. Harel & J. Confrey (Eds.), *The development of multiplicative reasoning in learning mathematics* (pp. 291-330). Albany, NY: State University of New York Press.
- Confrey, J. & Smith, E. (1995). Splitting, covariation, and their role in the development of exponential functions. *Journal for Research in Mathematics Education*, 26, 135-164.
- Davydov, V. V. (1982). The psychological characteristics of the formation of elementary mathematical operations in children. In T. P. Carpenter, J. M. Moser & T. A. Romberg (Eds.), *Addition and subtraction: A cognitive perspective*, (pp. 224-238). Hillsdale, NJ: Lawrence Erlbaum.
- Denvir, B., & Brown, M. (1986). Understanding of number concepts in low attaining 7-9 year olds: Part I. Development of descriptive framework and diagnostic instrument. *Educational Studies in Mathematics*, 17, 15-36.
- Harnisch, D. L. (1983). Item response patterns: Applications for educational practice. *Journal of Educational Measurement*, 20 (2), 191-206.
- Mulligan, J. (1992). Children's solutions to multiplication and division word problems: a longitudinal study. *Mathematical Education Research Journal*, 4(1), 24-42.
- Ross, S. H. (1990). Children's acquisition of place-value numeration concepts: The roles of cognitive development and instruction. *Focus on Learning Problems in Mathematics*, 12 (1), 1-17.
- Rasch, L. (1980). *Probabilistic models for some intelligence and attainment tests*. Chicago, IL: University of Chicago Press.
- Sinclair, A., Garin, A., & Tieche-Christinat, C. (1992). Constructing and understanding of place value in numerical notation. *European Journal of Psychology of Education*, 7(3), 191-207.
- Steffe, L. P. (1994). Children's multiplying schemes. In G. Harel & J. Confrey (Eds.), *The development of multiplicative reasoning in learning mathematics* (pp. 121-176). Albany, NY: State University of New York Press.
- Steffe, L. P., & Cobb, P (1988). *Construction of arithmetical meanings and strategies*. New York: Springer-Verlag.
- Thomas, N., Mulligan, J. T., & Goldin, G. A. (2002). Children's representation and structural development of the counting sequence 1-100. *Journal of Mathematical Behavior*, 21, 117-133.
- Wright, R. J. (1991). The role of counting in children's numerical development. *The Australian Journal of Early Childhood*, 16(2), 43-48.

# ORIENTATIONS TO NUMERACY: TEACHERS' CONFIDENCE AND DISPOSITION TO USE MATHEMATICS ACROSS THE CURRICULUM

Steve Thornton John Hogan

University of Canberra Redgum Consulting

*Numeracy can be defined as “having the competence and disposition to use mathematics to meet the general demands of life at home, in paid work, and for participation in community and civic life” (Willis 1992). An important aspect of developing the capacity to use mathematics in everyday life is, for students at school, to use mathematics to meet the demands of other curriculum areas. Just as literacy has become every teacher’s responsibility, so numeracy needs to be seen as integral to every learning area.*

*This research report describes non-mathematics teachers’ orientations to numeracy, and the development of their sense of identity as mathematicians and as reflective practitioners, as they confront and deal with mathematical problems and opportunities encountered by students across the curriculum.*

## NUMERACY

Numeracy, quantitative literacy and mathematical literacy have become very much “in-vogue” terms in educational circles (Crowther 1959, Cockroft 1982, Gal 1999, Frankenstein 2001, Steen 2001). Coben (2003) gives an extensive review of this literature, emphasizing that numeracy is a contested term rooted in its social, economic, cultural and historical context.

In Australia Willis’ (1992) described numeracy as “at the very least, having the competence and disposition to use mathematics to meet the general demands of life and at home, in paid work, and for participation in community and civic life”. This definition was later picked up by the Australian Association of Mathematics Teachers (AAMT 1998), emphasizing that numeracy is context specific and relative, that all teachers have a role to play in developing students’ numeracy, and that numeracy is underpinned by mathematical concepts. The Commonwealth Department of Employment, Education, Training and Youth Affairs (DEETYA 1997) also adopted Willis’ view of numeracy, and acknowledged that numeracy was “a fundamental component of learning, discourse and critique across all areas of the curriculum”.

Thus there is a long history of thinking about numeracy as contextual and practical, and as more than just arithmetic. Yet even a cursory glance at curriculum documents and statewide assessments in Australian education, such as the numeracy benchmarks (Curriculum Corporation 2000) and Secondary Numeracy Assessment Program (SNAP) assessment in New South Wales, suggests that this distinction has become blurred, and that numeracy is often seen as little more than school mathematics. Both



have a clear emphasis on fundamental mathematical skills, and very little discussion of the use of mathematics to meet the general demands of life at home or in the community.

This focus on the essential aspects of mathematics appears to embody a naïve view of improving student numeracy. It assumes that ‘mathematics can be learned in school, embedded within any learning structures, and then lifted out of school to be applied to any situation in the real world’ (Boaler 1993, p.12). However, the growing literature on the nature of transfer of learning and the evidence suggests that students do not automatically use their mathematical knowledge in other areas. Lave (1988) found that even experience in simulated shopping tasks in the classroom did not transfer to the supermarket. On the other hand, it appears that people use highly effective informal mathematics in specific situations (Carraher, Carraher & Schliemann 1985, Hogan 1996).

It would be easy to attribute this lack of transfer of mathematical skills to other contexts to a deficient mathematics curriculum and poor teaching, but the quite considerable debate about transfer of skills shows that even if mathematics were taught and learned very well people would not necessarily apply it to new situations (Griffin 1995). Researchers in the area of situated cognition argue that cognitive skills and knowledge are not independent of context, and that activities and situations are integral to cognition and learning (Brown, Collins & Duguid 1989; Resnick 1989).

In order to respond to these issues there has been an attempt to contextualize school mathematics using contexts which appear to be relevant to the students (Cohen 2001). It was hoped that this would help students to see the purpose and usefulness of the mathematics they were learning, and that the mathematics would make sense. However, despite teachers’ best efforts many of these ‘real world problems’ appeared contrived rather than real (Willis 1992); required students and teachers to participate in ‘a willful suspension of disbelief about reality and mathematics’ (Williams 1993); and left out factors relevant to the real situation (Boaler 1993). Further, these attempts still had a primary purpose of teaching mathematics rather than developing numeracy. It would seem that if students are to learn to use mathematics outside the mathematics classroom then that is where they need to experience using mathematics.

For children aged between 5 and 16, a significant part of their life is spent at school, most of it studying subjects other than mathematics. For them, the “real world” includes school, and in particular the time in academic pursuits other than mathematics. Hence if students are to see mathematics as connected to the real world or to become “numerate” in the sense described by Willis and others, they need to use mathematics in a range of contexts, including other curriculum areas.

## **RESEARCH METHODOLOGY AND THEORETICAL ORIENTATION**

The Middle Years Numeracy Across the Curriculum Project commissioned by the Australian Capital Territory Department of Education, Youth and Family Services (ACT DEFYS) attempted to address the somewhat naïve concepts of numeracy



outlined above by placing numeracy firmly in context, as the domain of all teachers. The Project involved researchers working with teachers from several ACT schools to identify and document numeracy opportunities, and to design, develop and implement an effective and transferable model that would support ongoing, school-based engagement with numeracy across the curriculum. This model would help teachers identify the numeracy demands of their teaching area(s), support teachers in implementing strategies for improving student numeracy outcomes and learning across the curriculum, and facilitate productive professional discussion on numeracy within and across all curriculum areas in schools;

The research methodology was based on Research Circles (ANSN 1999), in which teachers came together for periods of time to discuss their work, to observe and evaluate classroom incidents, and document these case studies. Initially the focus was on identifying “numeracy moments”, with the focus later moving to school-wide planning for numeracy across the curriculum.

The Research Circles involved nineteen teachers from eight schools. These teachers taught students in years 5 to 10 in a range of settings, including traditional primary schools (up to year 6), high schools (years 7 to 10) and middle schools (years 6 to 9). The primary school teachers all taught every area of the curriculum, the middle school teachers taught a “core” program of three or four subject areas including mathematics, the high school teachers taught predominantly in one subject area, generally not mathematics.

Each teacher was first asked to write down her perception of numeracy and what she hoped to obtain from participating in the project. Teachers were introduced to the Numeracy Framework (Hogan 2000), which describes being numerate as involving a blend of three knowledges:

1. *Mathematical* knowledge – the skills, techniques and concepts necessary to solve quantitative problems encountered in a real context;
2. *Contextual* knowledge – awareness and knowledge of how the context impacted on the mathematics being used; and
3. *Strategic* knowledge – having the confidence, disposition and skills to find out what needs to be known in order to act numerately.

The Framework suggests that being, or becoming, numerate involves being able to, or learning to, take on three roles:

1. *The fluent operator* - Being (becoming) a fluent user of mathematics in familiar settings;
2. *The learner* - Having (developing) a capacity for the deliberate use of mathematics to learn; and
3. *The critical mathematician* - Having (developing) a capacity to be critical of the mathematics chosen and used.

Following this initial discussion and orientation each teacher developed a classroom-based action research project that would enable her to examine students' numeracy in the classroom. The teachers undertook to record, in as much detail as possible, the circumstances in which students encountered mathematical ideas, the problems they had in understanding the mathematics and/or the context, the action taken by the teacher and what the student did next.

Research continued via group sharing and discussion of observations, refinement of the projects, and formal writing up of the results. The discussion provided a rich array of examples of teachers observing student numeracy, and a constructive forum through which others could provide feedback. It became apparent that the teacher-researchers had begun to look more closely at the students' responses to numeracy demands across the curriculum. They had begun to see that a student's numeracy problem might not be simply a matter of not knowing the mathematics, but might relate to the context, or their inability to continue work on the task once they confront something they can't do. When it was seen to be an issue with the mathematics the teachers were more sensitive to what the mathematical problem might be.

## **ORIENTATIONS TO NUMERACY**

The three orientations to numeracy described below represent idealized cases, rather than specific individuals. In reality no one teacher matched perfectly any of the three types, however in examining the implications of various orientations to numeracy for the development of teacher and student identity it is helpful to describe some idealized type examples.

### **The separatist: "It's the mathematics teacher's job"**

The separatist recognizes that mathematical skills are important. The job of teaching these skills resides squarely with the mathematics teacher. Thus when students struggle to understand a mathematical concept that is encountered within another area of the school curriculum, it is because they have not learnt, or perhaps not been taught, the mathematics well enough. Thus mathematics teachers need to teach mathematics better – "It's not my job".

"These students have not learnt how to construct scales on a graph properly. Even if they were taught scales and graphs in math, they didn't learn it properly, because they can't do it now in science." (Participant observation of student learning)

It may be that the separatist sees numeracy as "not their job" because she, herself, has a fear of, or a negative view of mathematics.

"I feel – part fear, especially of failure, avoidance." (Participant feedback after initial discussions of numeracy across the curriculum)

It may also be that her understanding of her own subject area is inadequate, and that she fails to recognize quantitative aspects of it. In one instance a teacher discussed the inadequacies of computer technology for constructing graphs of titrations in Chemistry, believing that because the graph of pH varied wildly, it was not as

accurate as plotting by hand when universal indicator was used. She perhaps overlooked the possibility that wild variations in pH were the result of inadequate mixing, a contextual problem that was not apparent in hand-drawn graphs. It may even be that she does not have the awareness of “knowing to act” in a given situation (Mason 1998).

It is worth noting that in the extensive literature on student identity as mathematicians (Boaler 1997, Wiliam, Boaler and Zevenbergen 2000) the development of this identity is always related back to experiences in the mathematics classroom. While the environment in the mathematics classroom is undoubtedly a major component in the development of students’ identity as mathematicians, it could be argued that the broader school environment, and in particular the way mathematics is seen and used across the curriculum, may also play a key role. Student identity is complex and multi-faceted; it is, perhaps, somewhat naïve to suggest that the development of mathematical identity is the exclusive domain of the mathematics teacher. Perhaps the “community of practice” (secondary school mathematics) described by Wiliam, Boaler and Zevenbergen (2000) should include the practice of mathematics in other areas of the school curriculum. This is an issue worthy of further research.

**The theme-maker: “Mathematics and other learning areas should be integrated.”**

The theme-maker recognizes that mathematics has links to other subjects and the real world. She believes that mathematics should be relevant and interesting to the student, and hence develops units of work that incorporate mathematics and other learning areas in parallel, often based around a theme. Assessment activities often involve relatively open-ended, across curriculum projects such as those espoused in the “rich tasks” movement (Education Queensland ). She believes that students will learn mathematics better because they are interested and engaged.

“Students were given the following scenario – Astronomers have recently detected a pulsating phenomenon in another galaxy.

Your task as an astrophysicist is to determine what this object is and plan an exploratory expedition to investigate this ‘phenomenon’.” (Participant teaching and learning plan)

This teaching and learning plan outlined how science, social science, art, English and mathematics fitted into this theme of exploring the universe. The mathematics included patterns found in nature such as Fibonacci and its connection with the Golden Ratio, and an introduction to scientific notation and exponents in preparation for the large numbers the students were likely to encounter in their reading.

This view of numeracy is very much to the fore in many of the organizational solutions to some of the issues surrounding the disengagement of students in the middle years of schooling. In such solutions the number of teachers who interact directly with any one student in the first two years of secondary school is minimized, and teachers are expected to teach in three or more curriculum areas, such as mathematics, science and physical education, or English, geography and history. It is

expected that the curriculum will thus be developed around coherent themes, and that the distinctions between the different learning areas will become blurred. However, such an approach runs the risk of enacting a simplistic view of mathematics, and minimizing the contribution that the distinctive elements of seeing the world through mathematical eyes can make to our understanding of ourselves and society (Frankenstein 2001)

**The embedder: “Doing mathematics well is essential to learning other learning areas well”**

The embedder recognizes that all learning areas include quantitative elements that students need to understand. These quantitative elements are embedded within the context of other learning areas and cannot be divorced from that context. A mathematical view of the world enriches students’ understanding of every other curriculum area. The embedder believes that every teacher is a teacher of numeracy (that is, of mathematics as it is embedded in their area of expertise), and has a responsibility to vigorously intervene in students’ learning of mathematics in that context.

“In a science lesson students read that the human body contains 6 million red blood cells. When I asked students what this number meant very few could write it down and none could visualize what such a number might look like. We spent some time thinking about what 6 million centimeters or 6 million seconds might be. This added to students’ understanding of the science.”

“The class read ‘Day of the Triffids’. We used this as an opportunity to look at scale drawings and made a model of a triffid that reached up the wall of the classroom. Students were then able to get a much better sense of how people in the story must have felt when they saw a triffid.”

The embedder is confident in her use of mathematics as it applies to her own area of expertise, without necessarily being an expert mathematician. She is curious, not only about her own area of expertise, but of mathematics and how it impacts on that area (Simtt, Davis, Gordon and Towers 2003). She is also aware of students’ knowledge both of the learning area and of the mathematical skills and concepts that are necessary to learn it well. She knows to act in a given situation and, when students are confronted by a problem, decides whether the issues are ones of not having the requisite mathematical skills, ones of not understanding the context or ones of not having the strategic knowledge to act effectively. She recognizes that the methods used by students in a mathematics classroom are not necessarily those used by them in other settings. She encourages students to reflect on the mathematics they have used in doing a task – being critical of the mathematics is something that has to be nurtured.

**Conclusions**

Whose job is to develop students’ numeracy? If the role of school education is, at least in part, to equip the population with the knowledge, skills and strategies to be

thoughtful, productive and critical members of society, then numeracy is everyone's responsibility. Without an awareness of the underpinning role of mathematical ideas in problem solving, in communication and in public debate, it is debatable to what extent an individual can arrive at informed decisions or follow productive strategies. School mathematics alone is unlikely to develop this capacity in our students – it requires conscious effort by all teachers, and a willingness to engage in mathematical thinking in all learning areas. Identifying and capitalizing on numeracy moments not only develops students' capacity to be numerate, it also enriches their learning in other areas of the curriculum.

If learning is to be situated, students need to encounter mathematics not only in their mathematics lessons, nor even in supposedly real-world problems posed during mathematics lessons, but also as it is embedded in the practice of other curriculum areas. They need to be given opportunities to see themselves as learner, critic and fluent numeracy operator within those contexts. Changing teachers' perceptions of numeracy, and helping them to develop the confidence and disposition to embed numeracy in other areas of the curriculum, is critical to developing this community of practice.

## References

- AAMT (1998). *Policy on Numeracy Education in Schools*. Adelaide: AAMT
- Australian National Schools Network (1999). *Research Circles*  
<http://www.nsn.net.au/research/rescircles/index.html>. Accessed 30 June 2003.
- Boaler, J. (1993), The role of contexts in the mathematics classroom: Do they make mathematics more "real"?, *For the Learning of Mathematics*, 13, 2, 12-17.
- Boaler, Jo (1997). *Experiencing School Mathematics: Teaching styles, sex and setting*. Buckingham PA: Open University Press
- Brown, J. S., Collins, A. & Duguid, P. (1989). Situated cognition and the culture of learning. *Educational Researcher*, 18, 1, 32-42.
- Carraher, T., Carraher, D. & Schliemann, A. (1985). Mathematics in the streets and in schools, *British Journal of Developmental Psychology*, 3, 21-29.
- Coben, D. (2003) *Adult numeracy: review of research and related literature*. National Research and Development Centre for Adult Literacy and Numeracy.
- Cockroft, W. (1982). *Mathematics Counts*. Department of Education and Science, London: HMSO
- Crowther Report (1959). 15 to 18: *A report of the Central Advisory Committee for Education*. London: HMSO
- Curriculum Corporation (2000). *Numeracy Benchmarks Years 3, 5 & 7*. Carlton, Vic: Curriculum Corporation
- DEETYA (1997) *Numeracy = Everyone's Business: Report of the Numeracy Education Strategy Development Conference*. Adelaide: AAMT

- Frankenstein (2001). To Read the World: Goals for a Critical Mathematical Literacy. In Lee, B. and Spencer, T. (Eds) *Mathematics: Shaping Australia. Proceedings of the 18<sup>th</sup> Biennial Conference of the Australian Association of Mathematics Teachers*. Adelaide: AAMT
- Gal, I. (1999). A numeracy assessment framework for the international life skills survey. In Zaslavsky, O (Ed) *Proceedings of the 1999 meeting of the International Group for the Psychology of Mathematics Education, Haifa, Israel, July 1999*. 2-353 – 2-360
- Griffin, M. M. (1995). You can't get there from here: Situated learning, transfer and map skills. *Contemporary Educational Psychology*, 20, 65-87.
- Hogan, J. (1996). *Report of the Rich Interpretation of Using Mathematical Ideas and Techniques Project*. Adelaide: AAMT
- Hogan, J. (2000). Numeracy Across the Curriculum. *Australian Mathematics Teacher* 56 (3) 17-20.
- Lave, J. (1988). *Cognition in practice: Mind, mathematics and culture in everyday life*. Cambridge: Cambridge University Press
- Mason, J. (1998). Enabling teachers to be real teachers: Necessary levels of awareness and structure of attention. *Journal of Mathematics Teacher Education* 1: 243-267
- Resnick, L. (1989). Introduction. in L. Resnick (ed), *Knowing, learning and instruction essays in honor of Robert Glase*. Hillsdale, New Jersey: Lawrence Erlbaum Associates.
- Simmt, E., Davis, B., Gordon, L. & Towers, J. (2003). Teachers' mathematics: curious obligations. In Pateman, N., Dougherty, B. & Zilliox, J. (Eds). *Proceedings of the 2003 Joint meeting of the International Group for the Psychology of Mathematics Education PME North America, University of Hawaii July 2003*. 4-175 – 4-182
- Steen, L. (2001). The Case for Quantitative Literacy. In Steen, L (Ed) *Mathematics and Democracy: The Case for Quantitative Literacy pp1-22*. USA: National Council on Education and the Disciplines.
- Wiliam, D., Boaler, J. and Zevenbergen, R. (2000). The construction of identity in secondary mathematics education. In Matos, J. and Matos, M. (Eds). *Proceedings of the Second International Mathematics Education and Society Conference. Universidade de Lisboa*.
- Williams, S. (1993). Mathematics and being in the world: Toward an interpretive framework. *For the Learning of Mathematics*, 13, 2, 2-7.
- Willis, S. (1992). Being numerate: Whose right? Who's left? *Literacy and Numeracy Exchange, Autumn 1992*

### **Acknowledgement**

This project was funded by a grant from the ACT Department of Education, Youth and Family Services, and conducted under the auspices of the Australian National Schools Network

# EFFICIENCY AND ADAPTIVENESS OF MULTIPLE SCHOOL- TAUGHT STRATEGIES IN THE DOMAIN OF SIMPLE ADDITION

Joke Torbeyns<sup>1,2</sup>, Lieven Verschaffel<sup>2</sup>, and Pol Ghesquière<sup>2</sup>

<sup>1</sup> Research Assistant of the Fund for Scientific Research (F.W.O.)--Flanders

<sup>2</sup> University of Leuven, Belgium

*This study investigated the fluency with which first-graders with strong, moderate, or weak mathematical abilities apply the decomposition-to-10 and tie strategy on almost-tie sums with bridge over 10. It also assessed children's memorized knowledge of additions up to 20. Children's strategies were analysed in terms of Lemaire and Siegler's model of strategic change, using the choice/no-choice method. Results showed that the children applied both the decomposition-to-10 and the tie strategy efficiently and adaptively. Furthermore, the first-graders had already memorized the correct answer to more than half of the tie sums. Finally, children with strong mathematical abilities applied the different strategies more efficiently but not more adaptively than their mathematically weaker peers.*

## INTRODUCTION

During the last decade, the goals and content of elementary mathematics education have changed internationally (Kilpatrick, Swafford, & Findell, 2001; Verschaffel & De Corte, 1996). With respect to the goals of elementary mathematics education, the adherents of the reform movement argue that instruction should foster the development of children's "adaptive expertise", i.e. children's ability to solve mathematical problems flexibly and creatively by means of meaningfully acquired strategies (Baroody & Dowker, 2003). This change at the level of instructional goals is reflected in an increased emphasis on new arithmetic procedures and skills, including flexible use of a rich variety of mental calculation strategies. However, the adherents of the reform movement still acknowledge and even stress the importance of older, well-established aims and contents, such as the good mastery of number concepts and mathematical skills in the domain of adding and subtracting up to 20 in the early grades of elementary school (TAL-team, 2001). But these concepts and skills should be taught in a way that supports the development of children's adaptive--instead of routine--expertise. This implies, for instance, that instruction in the domain of additions with bridge over 10 (like  $8+9$ ) should no longer focus on the perfect mastery of one calculation strategy, namely decomposition-to-10 (" $8+9 = \dots$ ;  $10 = 8+2$ ;  $9 = 2+7$ ; so  $8+9 = 8+2+7 = 10+7 = 17$ "). In contrast, instruction should allow and stimulate children to apply a diversity of counting, calculation, and retrieval strategies. As illustrated in detail in Van Eerde, Van den Bergh and Lit (1992), children can apply diverse counting strategies on additions with bridge over 10, like counting all or counting on from the larger addend. Examples of calculation strategies that can be used to solve such additions, are decomposition-to-10, the tie strategy

("8+9 = 8+8+1 = 16+1 = 17"), and the one-less-than-10 strategy ("8+9 = 8+10-1 = 18-1 = 17"). Retrieval involves the (quasi-) automatic activation of the answer to the addition in long-term memory ("8+9 = (immediately) 17"). According to the adherents of the reform movement, instruction should further support children to gradually transform their informal counting strategies into more efficient calculation and retrieval strategies. Moreover, children should be stimulated to solve the additions efficiently, adaptively and mindfully on the basis of their individual strategy knowledge and skills.

Despite the increasing international acceptance of these reform ideas, this change in instructional orientation towards more strategy flexibility raises many, thus far unanswered questions. One of these questions concerns its desirability and feasibility for children of the weakest mathematical ability level (see, a.o., Mercer & Miller, 1992; Miller & Mercer, 1997). Research on the effectiveness of the new instructional approach for children of the weakest mathematical ability level did not yet result in a clear consensus (see, a.o., Woodward, Monroe, & Baxter, 2001). Therefore, we conducted a study to deepen our understanding of the fluency with which children of different mathematical ability level apply diverse school-taught strategies in the domain of simple arithmetic. We aimed to address two issues. First, we wanted to analyse the characteristics of the decomposition-to-10 and tie strategy on almost-tie sums with bridge over 10 for children who had received explicit instruction in both calculation strategies, in terms of Lemaire and Siegler's model of strategic change and with special attention for the strategy performances of mathematically weak children. We explicitly focused on almost-tie sums with bridge over 10, i.e. sums where the difference between the two addends equals only one unit (like 8+7), since (a) both the decomposition-to-10 and the tie strategy can be applied on this type of sums, which is not the case for other sums with bridge over 10, like 7+4, where the difference between the two addends is more than one unit, and the tie strategy is thus much harder to apply, and (b) the authors of textbooks in which multiple calculation strategies are taught (see below) generally assume the tie strategy to be a highly efficient strategy to solve almost-tie sums with bridge over 10. The second aim of the study was to examine children's memorized knowledge of additions up to 20, which is assumed to be enhanced by this type of instruction (Baroody, 1985).

We used Lemaire and Siegler's model of strategic change (1995) to analyse children's strategies. This model distinguishes four parameters of strategy competence. The first parameter, strategy repertoire, refers to the types of strategies children apply to solve a series of additions. The second parameter, strategy distribution, involves the frequency with which each strategy is used. The accuracy and speed of strategy execution belong to the third parameter, strategy efficiency. The fourth parameter, strategy selection, refers to the adaptiveness of individual strategy choices, defined as the selection of the strategy that leads fastest to an accurate answer to the addition.

We examined the efficiency and adaptiveness of strategy execution by means of the choice/no-choice method, which has so far been used rarely in previous studies in the



domain of simple arithmetic (Torbeyns, Verschaffel, & Ghesquière, 2002). The choice/no-choice method requires testing each subject under two types of conditions. In the choice condition, subjects can freely choose which strategy they use to solve each problem. In the no-choice condition(s), the researcher forces them experimentally to solve all problems with one particular strategy. As argued convincingly by Siegler and Lemaire (1997), the efficiency data gathered in the choice condition can be biased by selection effects. In contrast, the forced application of one particular strategy on all items in the no-choice condition(s), makes selective assignments of strategies impossible, and thus yields unbiased data about strategy efficiency. Moreover, comparison of the data about the efficiency of the different strategies in the no-choice conditions with the strategy choices made in the choice condition allows the experimenter to assess the adaptiveness of individual strategy choices accurately: Does the subject solve each item (in the choice condition) with the strategy that leads fastest to an accurate answer to this item, as evidenced by the data obtained in the no-choice conditions?

## **METHOD**

### **Participants**

We selected 97 first-graders who had received instruction in both the decomposition-to-10 and the tie strategy on almost-tie sums with bridge over 10. All children were administered a standardized achievement test (Rekenen Eind Eerste Leerjaar [Arithmetic End First Grade or AE1], Dudal, 2000) to assess their general mathematical abilities. Furthermore, they all solved a series of 10 additions with bridge over 10 in a choice condition. Only those children who were able to solve the additions in the latter condition beyond the level of counting were also tested in the three no-choice conditions, and thus included in our final analyses. Consequently, 14 first-graders who still solved the majority of additions by counting were excluded from the sample.

The remaining 83 first-graders were divided in three groups on the basis of their general mathematical abilities: (a) children with strong mathematical abilities ( $n=31$ ), i.e. children with a score at or above Pc75 on the AE1; (b) children with moderate mathematical abilities ( $n=20$ ), i.e. children with a score between Pc50 and Pc74 on the AE1; (c) children with weak mathematical abilities ( $n=32$ ), i.e. children with a score below Pc50 on the AE1. In line with our criteria, we observed group differences in score on the AE1,  $F(2, 80) = 173.10$ ,  $p < .0001$ . The strong first-graders scored higher on the AE1 than the first-graders with moderate mathematical abilities, who received a higher score on the AE1 than the weak first-graders.

All children were tested in the month of May 2003, i.e. nearly at the end of the first grade. At that moment, they all had been taught additions with bridge over 10 for five to seven weeks. All teachers used the same mathematical textbook to instruct this specific topic to the children. A careful textbook analysis and a structured interview with the teachers revealed that all children first had practiced the tie sums with bridge

over 10 with a view to memorize these answers. Afterwards, children had been taught how to solve additions with bridge over 10 with the decomposition-to-10 strategy. Finally, children had learned to answer almost-tie sums with bridge over 10 with the tie strategy. Special attention was paid to the relation between the different types of additions with bridge over 10, namely (a) tie sums, (b) almost-tie sums and (c) other additions, and the specific type of strategy that--according to the authors of the textbook--is most efficient to solve them, resp. (a) the retrieval, (b) the tie, and (c) the decomposition-to-10 strategy. But none of the teachers forced the children to effectively solve each addition with the strategy that was considered as most efficient on the addition. They rather allowed each child to solve each addition with his or her own preferential strategy.

### Materials

All children solved a series of five experimental items, i.e. five almost-tie sums with bridge over 10 (6+7, 7+6, 7+8, 8+7, 9+8), in four different conditions. To stimulate the children to choose effectively between the decomposition-to-10 and the tie strategy in the choice condition, these five experimental items were mixed with five buffer items, i.e. additions with bridge over 10 that can not be classified as almost-tie or tie sums. To examine children's memorized knowledge of the number combinations up to 20, we added a series of 15 extra retrieval items, i.e. three additional almost-tie sums with bridge over 10, four tie sums with bridge over 10, and eight additions up to 10 (three tie sums up to 10, five non-tie sums up to 10), to the series of five experimental items in the retrieval condition.

### Conditions

All children were tested individually in one choice and three no-choice conditions. In the choice condition, children were asked to solve the experimental items and the buffer items with either the tie or the decomposition-to-10 strategy. Children could choose between the two strategies by means of pictures, which contained a visual representation of the strategies (Figure 1). The identification of the strategies in the choice condition was based on the pictures filled in by the children.

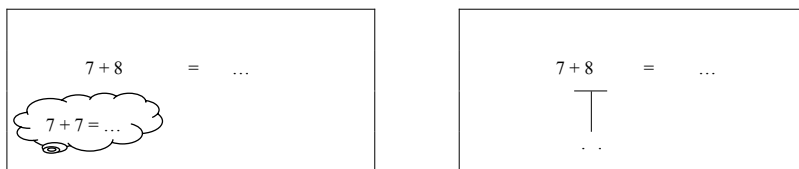


Figure 1: Representation of the tie and decomposition-to-10 strategy

In the decomposition-to-10 and tie condition, children were forced to solve the experimental items with resp. the decomposition-to-10 and the tie strategy by means of the pictures offered. In the retrieval condition, children were forced to retrieve the answer to the experimental items and the extra retrieval items by including a time limit of two seconds. On the first day, all children solved the items in the choice

condition. On the second day, items were offered in the decomposition-to-10 and tie condition. On the third day, all children answered items in the retrieval condition. The experimenter registered the answer and the reaction time per child and per problem in each condition.

## RESULTS

### Characteristics of the Decomposition-to-10 and Tie Strategy

*Strategy repertoire.* The three groups of children applied the decomposition-to-10 and tie strategy at least once to solve the five almost-tie sums in the choice condition. Moreover, the two types of strategies were used at least once on each almost-tie sum. We observed group differences in the repertoire of strategies used,  $\chi^2(4) = 19.8082, p = .0005$ . A larger number of strong and moderate first-graders than of weak first-graders applied both the decomposition-to-10 and tie strategy, whereas the number of strong and moderate first-graders who exclusively relied on decomposition-to-10 was smaller than the number of weak ones. The number of children who solved all sums with the tie strategy did not differ between the three groups.

*Strategy distribution.* The frequency with which the children applied the decomposition-to-10 and tie strategy on the almost-tie sums in the choice condition is presented in Table 1. As shown in Table 1, the children used the tie strategy as frequently as the decomposition-to-10 strategy in the choice condition,  $F(1, 80) = 0.81, p = .3701$ . We observed group differences in the frequency of strategy use,  $F(2, 80) = 8.50, p = .0004$ . The weak first-graders applied decomposition-to-10 more frequently, and the tie strategy less frequently, than the moderate first-graders.

	Decomposition-to-10			Tie		
	Frequency	Accuracy	Speed	Frequency	Accuracy	Speed
Strong	47.74	0.97	10.69	52.26	0.92	07.63
Moderate	32.00	0.96	16.49	68.00	0.95	11.15
Weak	61.88	0.95	16.28	36.88	0.85	13.42
All	49.40	0.96	14.24	50.12	0.90	10.71

*Note.* Frequency = frequency of strategy use in the choice condition, expressed in percentages. Accuracy = accuracy of strategy execution in the decomposition-to-10 and the tie condition, expressed in proportion correct. Speed = speed of strategy execution in the decomposition-to-10 and the tie condition, expressed in seconds.

Table 1: Frequency, accuracy, and speed of the decomposition-to-10 and tie strategy

*Strategy accuracy.* We observed no group differences in the accuracy with which the almost-tie sums were answered in the decomposition-to-10 and tie condition,  $F(2, 744) = 1.20, p = .3010$ . As can be derived from the data in Table 1, children did not perform equally well in the decomposition-to-10 and the tie condition,  $F(1, 744) = 11.73, p = .0006$ . When they were forced to solve all sums with the tie strategy, more

errors were made than when they had to apply decomposition-to-10. Finally, the interaction between the variables group and condition was not statistically significant,  $F(2, 744) = 1.59, p = .2053$ . The weak first-graders solved the sums as accurately as the moderate and strong first-graders in both the decomposition-to-10 and the tie condition.

*Strategy speed.* The strong, moderate, and weak first-graders did not answer the almost-tie sums with the same speed in the decomposition-to-10 and tie condition,  $F(2, 664) = 8.90, p = .0002$ . Overall, the strong first-graders answered the almost-tie sums faster in these two no-choice conditions than the moderate and weak first-graders (resp.,  $M = 09.16s, M = 13.82s,$  and  $M = 14.85s$ ). The speed of responding also differed between the decomposition-to-10 and tie condition,  $F(1, 80) = 12.79, p = .0006$ . As shown in Table 1, children solved the almost-tie sums faster in the tie than in the decomposition-to-10 condition. Finally, the above-mentioned group differences in speed of responding were observed in the decomposition-to-10 as well as in the tie condition,  $F(2, 664) = 0.49, p = .6101$ . The strong first-graders answered the almost-tie sums faster than the moderate and weak first-graders in both the decomposition-to-10 and the tie condition.

*Strategy selection.* In line with Lemaire and Siegler's definition of an adaptive strategy choice as choosing the strategy that leads fastest to an accurate answer to the problem, we scored a strategy choice as adaptive if the child solved the almost-tie sum in the choice condition with the strategy that led fastest to an accurate answer to the same almost-tie sum in the decomposition-to-10 and tie condition. These analyses revealed that the strong as well as the moderate and weak first-graders took into account strategy efficiency characteristics while choosing a strategy: The proportion of adaptive strategy choices exceeded the chance level in the group of strong ( $M = 0.58, p = .0472$ ), moderate ( $M = 0.65, p = .0035$ ), and weak first-graders ( $M = 0.66, p = .0001$ ). Furthermore, we observed no group differences in the adaptiveness of individual strategy choices in the choice condition,  $F(2, 330) = 1.14, p = .3201$ .

### **Accuracy of Task Performance in the Retrieval Condition**

In the retrieval condition, we scored all additions that were answered inaccurately and/or not answered within the time limit of two seconds as incorrect. Subsequent analyses revealed group differences in the accuracy of task performance in the retrieval condition,  $F(2, 1549) = 7.66, p = .0005$ . The strong first-graders answered more additions accurately than their moderate and weak peers (resp.,  $M = 0.41, M = 0.24,$  and  $M = 0.23$ ). Next, children did not answer the different types of additions with the same accuracy in the retrieval condition,  $F(3, 1549) = 141.36, p < .0001$ . Children answered the tie sums up to 10 most accurately ( $M = 0.78$ ). They made less retrieval errors on tie sums with bridge over 10 ( $M = 0.48$ ) than on almost-tie sums with bridge over 10 ( $M = 0.12$ ) and non-tie sums up to 10 ( $M = 0.13$ ). Finally, we observed group differences in the accuracy with which the different types of additions were answered,  $F(6, 1549) = 2.21, p = .0394$ . The strong children answered all types of additions more accurately than the moderate and weak first-graders. The

weak first-graders answered the tie sums with bridge over 10, the tie sums up to 10, and the non-tie sums up to 10 as accurately as the moderate first-graders, but were less accurate than the latter on retrieval of almost-tie sums with bridge over 10.

## DISCUSSION

From a theoretical point of view, our study deepened our insight in children's calculation strategies on additions up to 20. More specifically, it improved our understanding of the quantitative and qualitative characteristics of the tie strategy, which were left largely unexplored in our--and others'--previous work (Torbeys et al., 2001, 2002, in press). The focus on the strategy performances of children of different mathematical ability level further revealed clear differences in the calculation strategies and number fact knowledge of mathematically strong and mathematically weak children, favouring the former, which is in line with the results of earlier work on the strategy characteristics of mathematically weak children in the domain of simple arithmetic (for an overview of studies, see Geary & Hoard, 2003).

From a methodological viewpoint, our study showed the usefulness of the choice/no-choice method to examine young children's calculation strategies in the domain of simple addition. As documented above, the choice/no-choice method was applied successfully to study first-graders' use of the decomposition-to-10 and tie strategy on almost-tie sums with bridge over 10. It allowed us to gather unbiased data about each strategy's efficiency and proved necessary to unravel the level of adaptiveness of children's strategy choices in the choice condition.

From an instructional point of view, our study indicates that children, even the mathematically weak ones, are able to apply multiple school-taught calculation strategies efficiently and adaptively on simple additions. However, it should be noted that these results can not be generalised to children of the weakest mathematical ability level, who were excluded from our sample on the basis of their immature strategy performances in the choice condition. Although our study provided new and important insights in the strategy characteristics of first-graders in the early stage of the formal mathematics curriculum, we think it is very important that future studies try to unravel the developmental changes that are important to become "adaptive experts" by longitudinally assessing children's strategies throughout the entire mathematics curriculum, providing building blocks to optimise our learning and teaching approaches in the mathematical domain.

## References

- Baroody, A. J. (1985). Mastery of basic number combinations: Internalization of relationships or facts? *Journal for Research in Mathematics Education*, 16, 83-98.
- Baroody, A. J., & Dowker, A. (2003). *The development of arithmetic concepts and skills: Constructing adaptive expertise*. Mahwah, N.J.: Lawrence Erlbaum Associates.
- Dudal, P. (2000). *Leerlingvolgsysteem. Rekenen: Toetsen 1-2-3. Basisboek* [System for following pupils. Arithmetic: Tests 1-2-3. Textbook]. Leuven, Belgium: Garant.

- Geary, D. C., & Hoard, M. K. (2003). Learning disabilities in basic mathematics: Deficits in memory and cognition. In J.M. Royer (Ed.), *Mathematical cognition* (pp. 93-115). Greenwich: Information Age Publishing.
- Kilpatrick, J., Swafford, J., & Findell, B. (2001). *Adding it up. Helping children learn mathematics*. Washington, D.C.: National Academy Press.
- Lemaire, P., & Siegler, R. S. (1995). Four aspects of strategic change: Contributions to children's learning of multiplication. *Journal of Experimental Psychology: General*, *124*, 83-97.
- Mercer, C. D., & Miller, S. P. (1992). Teaching students with learning problems in math to acquire, understand, and apply basic math facts. *Remedial and Special Education*, *13*(3), 19-35.
- Miller, S. P., & Mercer, C. D. (1997). Educational aspects of mathematics disabilities. *Journal of Learning Disabilities*, *30*, 47-56.
- Siegler, R. S., & Lemaire, P. (1997). Older and younger adults' strategy choices in multiplication: Testing predictions of ASCM using the choice/no-choice method. *Journal of Experimental Psychology: General*, *126*, 71-92.
- TAL-team (2001). *Children learn mathematics. A learning-teaching trajectory with intermediate attainment targets for calculation with whole numbers in primary school*. Groningen, The Netherlands: Wolters Noordhoff.
- Torbeyns, J., Verschaffel, L., & Ghesquière, P. (2001). Investigating young children's strategy use and task performance in the domain of simple addition, using the "choice/no-choice" method. In M. van den Heuvel-Panhuizen (Ed.), *Proceedings of the 25th Conference of the International Group for the Psychology of Mathematics Education* (Volume 4, pp 273-278). Amersfoort, The Netherlands: Wilco.
- Torbeyns, J., Verschaffel, L., & Ghesquière, P. (2002). Strategic competence: Applying Siegler's theoretical and methodological framework to the domain of simple addition. *European Journal of Psychology of Education*, *17*, 275-291.
- Torbeyns, J., Verschaffel, L., & Ghesquière, P. (in press). Strategy development in children with mathematical disabilities: Insights from the choice/no-choice method and the chronological-age/ability-level-match design. *Journal of Learning Disabilities*.
- Van Eerde, D., Van den Berg, W., & Lit, S. (1992). *Kwantiwijzer voor leerkrachten. Werkboek 4: overbruggen van 10 (optellen)* [Kwantiwijzer for teachers. Workbook 4: The bridge over 10 (addition)]. Tilburg, The Netherlands: Zwijsen.
- Verschaffel, L., & De Corte, E. (1996). Number and arithmetic. In A. Bishop, K. Clements, C. Keitel, & C. Laborde (Eds.), *International handbook of mathematics education. Part I* (pp. 99-138). Dordrecht, The Netherlands: Kluwer.
- Woodward, J., Monroe, K., & Baxter, J. (2001). Enhancing student achievement on performance assessments in mathematics. *Learning Disabilities Quarterly*, *24* (Winter), 33-46.

# SUPPORTING TEACHERS ON DEVELOPING TEACHING NORMS BASED ON CHILDREN'S LEARNING MATHEMATICS

Wen-Huan Tsai

National Hsin-Chu Teachers College, Taiwan

*This study was designed to supporting teachers on developing teaching norms based on classroom-learning community in which students are willing to engage in discourse. A collaborative team consisting of the researcher and four second-grade teachers were set up. The collaborative community intended to generate norms of acceptable or appropriate teaching based on what teachers saw about their students' learning mathematics in classroom. Classroom observations and routine meetings were the major data collected in the study. Three main normative concerns the teachers addressed from classrooms including getting students to participate equally, sequencing students' various solutions to review, and getting students to discourse centered on mathematical aspect were described in the paper.*

## INTRODUCTION

The process of creating mathematical discourse communities dealing with complex and multifaceted undertaking is a challenge for teachers (Cobb & McClain, 1999; Silver, 1996). According to the reform vision, teachers were expected to pose worthwhile mathematical tasks, help students to monitor their own understanding, and help students to question one another's ideas (MET, 2000; NCTM, 2000). Teachers are challenged by the interplay between the reform vision of instruction and their own experience with more traditional pedagogy. Research suggests that teachers need to learn mathematics in a manner is consistent with the way we expect them to teach (Cooney, 1994). Helping teachers toward an instruction rich in discourse is likely to require new experience of learning mathematics in a manner that emphasized discourse and require needed support from collaborative communities of practice (McClain & Cobb, 2001). Therefore, creating a collaborative team is considered to be the way of supporting teachers in encouraging their students to participate in discourse. The intention of the collaborative team was to provide teachers with a new experience of creating a discourse among them as learners. The paper reported here focuses on describing what norms of discourse teachers chose to address and how children evolved mathematical discourse community in classrooms.

## THEORETICAL PERSPECTIVES

The theoretical perspectives for this study rooted in Jaworski's theories of teaching development include social practice theory and constructivists' perspective of learning (Jaworski, 2001). Social practice theory as described by Jaworski is concerned with the socially embedded growth of knowledge within communities of practice. Learning is seen as a process of enculturation where learners as peripheral participants in the community grow into kernel participants who represent the community of practice (Lave & Wenger, 1991). Teachers can be seen as growing into the practice of the community where their teaching is situated in classrooms and



a collaborative learning community. Constructivists' perspective of learning claims that learners construct knowledge through interactions between them and social worlds. Individual knowledge might be seen as a personal construction of the processes of teaching relative to their ongoing experiences in classrooms involving reflection and adaptation (Piaget, 1971). Alternatively, teachers' individual knowledge might be seen to derive from interaction within social settings in which teachers work (Vygotsky, 1978).

The two theoretical perspectives from development and social psychology provide a basis for helping us think about how teachers' knowledge is constructed both individually and socially. Besides, activities were structured to ensure that knowledge was actively developed by teachers, but not imposed by the researcher. The activities participants involved in the collaborative learning community included observing teaching, dialoguing as a group, and reflecting on what they had observed in classroom teaching. The normative aspects of mathematical discourse communities in each classroom was expected to be generated from teachers' negotiation and argumentation based on teaching events. Issues concerning what counts as acceptable or appropriate teaching involve a taken-as-shared sense of when it is appropriate to contribute to a discussion. The normative aspects of teaching referred to the paper are defined as teaching norms. The process of generating teaching norm is similar to the process of generating social norm or sociomathematical norm (Yackel & Cobb, 1996). The difference of teaching norm from social norm is that the teaching norm is generated from the community of teachers' professional development but the social norms or sociomathematical norms is generated from the community of classroom.

The study was designed to help teachers make sense of discourse by discussing the teaching events in which mathematical discourses should be evolved in classroom teaching and to develop teaching norms through discussing and negotiating the pedagogical meanings of teaching events.

## **METHOD**

The study was the second year of a three-year teachers professional development program project that was designed to support teachers in implementing the recommendations of innovative curriculum into their classroom practices (MET, 2000). To achieve this goal, a collaborative team including the researcher and four second-grade teachers at a school was set up. The collaborative team was to help teachers create a community of discourse centering on mathematical ideas based on teaching events derived from their classrooms. The discourse referred to in the study includes the ways of representing, thinking, and talking, and agreeing and disagreeing that teachers and students use to engaging in those tasks (NCTM, 1991,



P. 20). The willingness of teachers to participate in the study was considered when they were recruited. They were selected from the staff of teachers who were teaching in the first grade because they were using the mandate reformed curriculum. Besides, the same mathematical topics they taught lent itself readily as a focus when they discussed in meetings after observing one another teacher's lessons.

The four female teachers were referred to as Ma, Yeh, Shia, and Su, for the sake of confidentiality. The year of teaching for Ma, Yeh, Shia, Su was 2, 2, 1, and 3 respectively. The researcher acted as a partner to the teachers in helping them put the ideas generated in discussion into practice. The researcher was expected to provide teachers with theory-oriented explanations, while they were expected to share more situated classroom experiences.

To provide the teachers with the opportunities of learning from others' concerns, group sharing was scheduled once every other week. The participants were invited to report the concerns relevant with discourse they addressed in the routine meetings after they observed a teaching. The classrooms were observed on every Friday morning and were immediately followed by a routine meeting in the afternoon. All participants observed simultaneously in the same classroom in which the instructor was one of the participants. The lessons of the four teachers were scheduled to be observed in turn. The observers were the collectors for the instructor to collect students' various solutions, because the instructor cannot stay still to collect what her students are doing and how students are thinking. Each participant was asked to choose a group to observe from the beginning to the end in a lesson in order to offer various children's thoughts to the instructor. Likewise, the teachers paid more attentions to understand how they adapted the concerns discussed in the meetings into practice. The influence of the adaptation on students' learning became as the focus of the next meeting. The teachers involved in the study conceptualizing their pedagogical knowledge through the process: formulating the problems generated from classroom events, discussing the problems and framing their pedagogical meaning in the meeting, adapting and putting their pedagogical meaning into next lesson, and reframing their pedagogy. In this generating process, the aspects of teaching norm could be formulated within this community based on the discourse of teaching events.

The routine meetings and classroom observations throughout the entire year were audio- and video- recorded. The audio- and video- tapes were transcribed. On analyzing the data by reading repeatedly the transcriptions of audio and video recordings, the statements each teacher made to the concerns discussed in the routine meeting and the way each teacher evolved discourse in classroom through the interaction among them were the major foci. An event around an issue as a unit was

coded. There were teaching norms emerged.

## RESULTS

It is found that the normative aspects of teaching the teachers encountered in their mathematics classroom were centered on social aspects and then followed by sociomathematical aspects. It is not the concern in this paper. The teaching norms addressed by the teachers included: listening other students' ideas carefully, clarifying their own thinking clearly, getting students to participate equally, and sequencing students' solutions to review and report publicly, getting students to discourse centered on mathematical aspect. Limited space prevents to report each norm. Three norms related to discourse and the way the teachers evolving the norms in their classrooms are described below.

### Norm 1: Getting Students to Participate Equally

At the very early of the study, a challenge the teachers faced in common was building classroom-learning communities in which students are willing to engage in investigation. Su, as an observer, described what she observed in Yeh's classroom in a routine meeting. Su stated that

...After posing the problem [*“Each carton card costs 12 dollars. John bought 2 cards and Joe bought 4 cards. How much do they cost in all?”*], Yeh asked her students to work in groups. The Group 3 I sitting next to, Jing was always authorized as an elitist student by the students in the group. Ming sitting beside Jing starts to move her chair toward Jing for discussing, while the other four students were on and off task back and forth. Ming wrote part of her solution as  $12+12=( )$ ,  $10+10=20$ ,  $20+4=24$ . Immediately, her writing was erased by Jing without reason at all. Ming was upset and became silent at the moment. Jing wrote  $12+12=24$ ,  $24+48=72$  on the board with no discussion with others. She controlled this group and deprived other students' opportunity of participation (Su, Meeting, 10/05/2001).

The issue of unequal participation Sue addressed attracted immediately other teachers in the meeting. Ma shared her same unsuccessful experience that the spokesperson in a group was always the same person, even though Ma paid much attention to encourage students to review their solutions to the class. Yeh, with more research experiences in dealing with social interaction than other participants, also shared her comfortable experience. Yeh said that

...Group work became a common strategy in my instruction. Within a group, each student needed to share ideas. The spokesperson making a presentation to the class was not allowed to stand silently in the front of classroom. In case it happens, the other students' in the same group were obliged to furnish a support to the spokesperson. Reviewing the solution of each group was accomplished unsuccessfully in my classroom until I arranged each group consisting of heterogeneous students. The six students in a group consist of two from above level, two from moderate level, and two from below level. When working in-group, the high achievers have an obligation to teach the others. Conversely, the low

achievers needed to listen carefully and to learn from high achievers. The role of each student takes turns in each lesson, so that each student acted as various roles in classroom. I paid more attentions to emphasize the importance of group work than those of individual work in my teaching (Sue, Meeting, 10/05/2001).

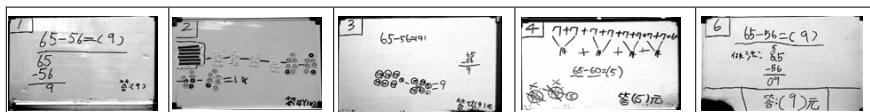
Ma learned the way of Yeh helping students cooperate together and put this idea into her following lessons. The lesson we observed in November, she divided students into six groups. Each students of a group was assigned a job. The coordinator deals with the process of group work. The recorder records and tracks what they had discussed. The monitor takes the responsibility to check if the answer is reasonable. Spokesperson makes a presentation to the whole class. Ma tried to develop the social norm of group work and let students participate equally in discussion. The role of each student within a group takes turns by lesson.

The teaching norm of getting students to participate learning mathematics equally became the to-be-taken-and-shared issue in this community and continually evolved in the following lessons.

### Norm 2: Sequencing Students' Various Solutions to Review

The teachers clearly struggled with the challenge of arranging students' various solutions to make a presentation to the class after solving a problem: in particular, for the beginning teacher, Ms. Shia. As observed, after posing the problem to students, "John brought 65 dollars to bookstore for buying 8 books. Each book costs 7 dollars. How much money did John left?" Shia posted students' group solution written on the board to review in the front of classroom. The solution from Group 5 was blank because the students in the group changed their solution and could not accomplished in time. The other solutions were exhibited in Table 1.

Table 1: Students' Various Solutions



Shia asked spokesperson of Group 2 to explain their solutions. However, the spokesperson of Group 2 merely stated the way they presented the problem rather than explained how they solved the problem. One student asked the spokesperson to explain how they got their answer. The spokesperson hesitated for a long time and finally, he said "the answer 14 was arbitrary because we run out of time".

In the meeting, Ma, one of the teachers asked Shia whether she had some criteria to arrange the order of discussing solutions generated from groups. Shia said "No! I just randomly picked up the various group solutions to discuss". As a result, the arrangement of students' group solutions to be reported became one of the foci in

the routine meeting right after Shia's lesson. The teachers agreed that the sequence of discussing students' various solutions influenced the flexibility of their instructions. The teachers arranged group solutions to report in classroom in different ways. Yeh suggested those who had higher-level thinking to report first, while Ma suggested the students who had erroneous solution to be the first. For Ma, it is impossible to report continually for other groups, as long as the high-level solution was presented. She explained that the student who reported his/her complete solution made an embarrassment to those who gave an erroneous solution.

The norm of sequencing various group solutions within the community was formulated through the teachers' discourses occurred in several teaching events. The norm was established as a good sequence of discussion affected the mathematical meanings in students' learning, so that the simple and incomplete solutions were asked to report first and then the reasonable and higher-level thinking were explained later.

Shia learned the importance of sequencing the discussion of students' various solutions and Yeh was convinced in the discussion. Yeh said:

*I made the arrangement differently from the way in which I did in my previous instructions. I found my students easily understood the mathematical meanings now (Yeh, Meeting, 3/21/2002)*

### **Norm 3: Getting Students to Discourse Centered on Mathematical Aspect**

In the very middle way of the study of the first year, the participants found out that Shia's students were more talkative than the other teachers' students. From observing teachers' teaching, we found out that students conducted the discussion by themselves in Shia's classroom but the discussion of other class were conducted by teachers more often. Although Shia faced a new challenge with arranging students' solutions to make a presentation to the class, she became better to lead to students' increased comfort with presentation and public discussion. The following excerpt was an evidence for document Shia evolving a discourse in her classroom. In Shia's lesson in which enabled students to solve word problems with number sentences, she posed a problem and encouraged students to work and talk with one another in small group. The problem was that "*Ru's parents buy New Year calendar. Each calendar costs 12 dollars. Ru's father buys two and Ru's mother buys four. How much money do Ru's parents need to pay?*" After students accomplished the problem, Shia often asked the reporter of each group to report to the whole class and try not to interrupt. The following episode was the interaction of the students in reviewing Group 4's solution.

[To be continued] (S: The teacher, Shia; All: Whole class response)

S: Ok! Now, Group 4 turns. Who is going to report your way of thinking?

[Jenny was assigned to be the reporter by her group and run to the front of

classroom. She picked up a stick and pointed to her group's solution]

All: Welcome, Jenny! Speak clearly and loudly, Please! [All students say simultaneously]

Jenny: Thanks everyone! Our number sentence is  $12+12+12+12+12+12=72$ . [She used the stick to point the first number sentence and explained]. The first and second 12 stand for the prices of two calendars father bought and the third, fourth, fifth, and sixth 12 stand for the prices of four calendars mother bought. The answer is 72. Now! I will explain how we got this answer. First, we added  $20+40=60$ . 20 came from the prices of two calendars. 40 came from the prices of four calendars. Second, there are 8 dollars left from the prices of four calendars and 4 dollars left from the prices of two calendars. Therefore, we add  $8+4=12$ . Finally, we added 60 and 12, so  $60+12=72$ . We got our group's answerer was 72. Ok! Does anybody have any question?

Been: [raise his hand]

Jenny: Ok! Been

Been: I think your explaining is very clear and wonderful. Another best thing is that you always explain your number sentence based on the problem

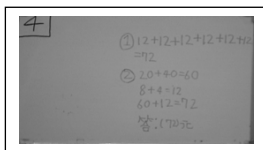
Jenny: Thanks! Any questions now?

All: No!

S: Jenny! You did a good job! Ok! Everybody gives the Group 4 an applause.

All: One, two, three, four, Group 4 wonderful! [Repeat once again]

(Shia, observation, 4/21/2002)



This episode suggests that Jenny shared her group's thinking and justified their ideas orally. The rest of the students listened carefully to her presentation. After her presentation, Jenny invited other students to ask questions in order to clarify her understanding. She offered explanation to monitor her own solution beyond procedural recitation, even though Shia had a little intervention. Been gave a good comment to Jenny to her well explanation. Shia improved the way of creating an atmosphere in which students learned to respect one another's ideas and to participate in discussions relevant with mathematical aspects.

After several discussions, the normative aspect of getting students to discourse became the one of the important concerns within this community. All members of this community agreed that the more you let students to communicate with each other, the better students know how to represent their idea clearly themselves.

## CONCLUSION

The main conclusion of the study was that the teachers were supplied with the support of new experience and needed support of creating learning communities for students from the members of the collaborative learning community. They learned the roles of each member in the collaborative learning community in which the manner is similar to those of creating discourse for students in a classroom. The way of evolving teaching norms in each classroom of the community was parallel, while

the norms generated in each classroom were different.

The acceptable or appropriate teaching norms were to-be-taken-and-shared meanings within this community by investigating, discussing, and negotiating. Moreover, the normative aspects of teaching constructed in individual classroom with different or specific situated meanings were adapted from and were modified by one other classrooms of the community.

Although the teachers evolved discourse centered on mathematics ideas in their classroom, the normative aspects of discourse they encountered in classrooms could be more complex than encountered in more complex settings. The question is how to construct different levels of teaching norms to support or advance students' higher-level cognitive development needed to explore more deeply. Another question that the different levels of the normative aspects of teaching in higher grade are more complex than those of lower grade is a valuable for further investigation.

## REFERENCE

- Cobb, P. & McClain, K. (1999). Supporting teachers' learning in social and instructional context. In F. L. Lin (Ed), *Proceedings of the 1999 International Conference on Mathematics Teacher Education*. (pp. 7-76). Taipei, Taiwan: National Taiwan Normal University.
- Cooney, T. J. (1994). Teacher education as an exercise in adaptation. In D. B. Aichele & A. F. Coxford, (Eds.). *Professional development for teachers of mathematics* (pp.9-22). Reston, VA: The Council.
- Jaworski, B. (2001). Developing mathematics teaching: Teachers, teacher educators, and researchers as co-learners. In F-L. Lin & T. J. Cooney (Eds.). *Making Sense of Mathematics Teacher Education* (pp.295-320). The Netherlands: Kluwer
- Lave J. & Wenger, E. (1991). *Situated learning: Legitimate peripheral participation*. New York: Cambridge University Press.
- McClain, K. & Cobb, P. (2001). Analysis of development of sociomathematical norms in one first-grade classroom. *Journal for Research in Mathematics Education*, 32, 230-266.
- Ministry of Education of Taiwan (2000). *Nine-year curriculum integration for school mathematics in Taiwan*. Taiwan: Taipei.
- National Council of Teachers of Mathematics (1991). *Professional standards for teaching mathematics*. Reston, Va: The Council.
- National Council of Teachers of Mathematics. (2000). *Principles and standards for school mathematics*. Reston, VA: The Council.
- Piaget, J. (1971). *Biology and knowledge*. The University of Chicago Press: Chicago.
- Silver, E. A. (1996). Building discourse communities in mathematics classrooms: A worthwhile but challenging journey. In P.C. Elliott & M. J. Kenney (Eds.) *Communication in Mathematics K-12 and Beyond* (pp. 20-28). 1996 Yearbook. Reston, Va: The Council.
- Vygotsky, L. S. (1978). *Mind in society*. Boston, Harvard University.
- Yackel, E. & Cobb, P. (1996). Sociomathematical norms, argumentation, and autonomy in mathematics. *Journal for Research in Mathematics Education*, 27, 458-477.

## PROSPECTIVE TEACHERS' IMAGES AND DEFINITIONS: THE CASE OF INFLECTION POINTS

Pessia Tsamir

Regina Ovodenko

Tel Aviv University

*This paper describes prospective secondary school mathematics teachers' images and definitions of inflection points. Our data indicate that prospective teachers tended to regard  $f'(x)=0$  and/or the location "where the graph bends" as necessary/sufficient conditions for inflection points. The solutions were based on previous investigations of functions and on daily images associated with driving a car, like "where one has to turn the wheel when driving on a curved track... while still going in the same... general direction". These types of solutions were given even by participants who correctly defined the notion.*

There is wide agreement that teachers should encourage students to present their solutions, raise assumptions, and evaluate each others' suggestions (e.g., Cooney, & Wiegel, 2003; NCTM, 2000). Clearly, teachers conducting such lessons should be able to determine for themselves the validity of students' suggested ideas. Research findings, however, indicate that teachers' and prospective teachers' mathematical knowledge of the topics they teach is not always satisfactory (e.g., Cooney, 1994). There is a call to promote this knowledge (e.g., NCTM, 2000). Any attempt to take this recommendation from theory to practice points to certain prerequisites, such as, familiarity with teachers' common, correct and incorrect solutions, and with possible reasons for their errors as well as with different approaches to promote this knowledge. Here we focus on the first of these prerequisites.

The present study was part of a wider project, designed (a) to extend the existing body of knowledge regarding prospective secondary school mathematics teachers' conceptions of functions, and (b) to examine ways for raising their awareness of their own correct and incorrect ideas. The concept of function was chosen due to its importance in many branches of mathematics and to its central role in the secondary mathematics curriculum in Israel.

We used Tall and Vinnars' (1981) terminology of *concept image* and *concept definition* as a theoretical framework to analyze prospective teachers' conceptions. The term *concept image* is used "to describe the total cognitive structure that is associated with the concept, which includes all the mental pictures and associated properties and processes", while *concept definition* is "a form of words used to specify the concept" (pp. 152). The authors further emphasize that "a *personal* concept definition can differ from a *formal* concept definition, the latter being a concept definition which is accepted by the mathematical community" (ibid., pp. 152). The terms *concept image* and

*concept definition* proved to be useful in analyzing students' conceptions of various mathematical notions and specifically those related to functions (e.g., limits and continuity: Tall & Vinner, 1981; tangent: Vinner, 1982; Tall, 1986).

While much is known about learners' difficulties when dealing with various notions related to functions, we looked at prospective teachers' grasp of less investigated notions such as inflection points and asymptotes. Here we limit ourselves to prospective teachers' *concept images* and *concept definitions* of inflection points.

Publications about students' conceptions of inflection points usually address issues concerning the related tangent, indicating, for example, that students commonly encounter difficulties in determining from a graph whether a given line was a tangent to a given function at an inflection point (e.g., Artigue, 1992).

In this paper we focus on the question: What *concept images* and what *concept definitions* of inflection points can be identified in prospective secondary school mathematics teachers' solutions to verbally and graphically presented tasks? What are possible reasons for these images and definitions?

## METHODOLOGY

### Participants

We investigated 56 prospective mathematics teachers, who participated in the course "Didactical issues of high school mathematics" (DIM), as part of their studies in a teacher education program for secondary school, at Tel Aviv University (one class of 22 and another of 34 prospective teachers). All but two participants had first degree in mathematics, mathematics education or computer science and a number of them were enrolled in M.A./Ph.D. programs. All in all, their mathematical background was solid, as was their motivation.

In Israel, functions usually receive considerable attention, and in the upper grades of high school they are commonly treated in calculus lessons in an algorithmic way. As inflection point is one of the notions addressed in high school, the participants in this study had met this notion in their high school studies and probably also in their more advanced studies at the university.

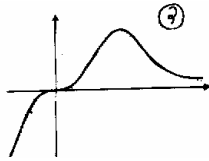
### Tools and Procedure

During the DIM course, the first 15-20 minutes of each 90-minute lesson were dedicated to the prospective teachers' individual work on worksheets which included mathematical tasks and occasionally also didactic dilemmas. When the prospective teachers submitted their completed worksheets, they usually continued working on certain tasks in small groups, and then all were engaged in a concluding whole-class discussion. The worksheets distributed in the first and the second lesson included the following three tasks:

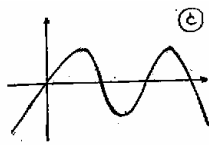
**Task 1: The statement:**  $f:R \rightarrow R$  is a continuous, differentiable function. If  $A(x_0, f(x_0))$  is an inflection point, then  $f'(x_0)=0$  is **correct** / **incorrect** (circle, explain).



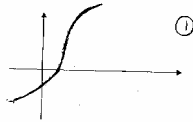
**Task 2:** Given are sketches of graphs. **Mark** on each graph all (possible) inflection points.



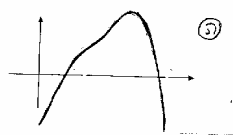
Graph B



Graph A



Graph D



Graph C

**Task 3:** What is an inflection point?

Based on the analysis of their solutions, participants were occasionally invited to individual, follow-up interviews, where they were usually asked by the researchers to elaborate on their written solutions. The interviews took 30-45 minutes, all were audiotaped and transcribed.

## RESULTS

### Prospective Teachers' Reactions to the Statement $f'(x_0) = 0$ (Task 1)

Table 1 indicates that about 40% of the participants correctly answered that the statement is not valid. Most of them incorrectly explained that “the condition should be  $f''(x)=0$ , and not  $f'(x)$ ”. Others, who answered correctly, usually accompanied this judgment with a valid counter-example. One prospective teacher gave  $y=x^3+3$  as an (improper) counter-example.

**Table 1: Prospective teachers' reactions to the statement ( $f'(x)=0$ )**

JUDGEMENT			
	JUSTIFICATION	N=53	%
<b>FALSE*</b>	The condition is... (e.g., $f''=0$ )	20	37.7
	Counter-example	16	30.2
<b>TRUE</b>		4	7.5
		<b>31</b>	<b>58.5</b>
	The definition is... (e.g., $f'(x)=0$ and $f''(x)=0$ )	9	17.0
	That's the definition...	15	28.3
	Algorithmic considerations...	2	3.8
	Irrelevant / No justification	5	9.4
<b>NO ANSWER</b>		2	3.8

\* correct judgment

It seemed that this participant knew that  $f'(x)=0$  is not a necessary condition for an inflection point and that a counter example is needed in order to refute the statement. Still, she was not careful in examining the example she chose.

About 60% of the participants incorrectly claimed that the statement was valid and provided four types of justifications to this judgment: (a) “The definition is...” – providing incorrect definitions, writing, for instance, “ $f'(x)=0$  and  $f''(x)=0$  are the conditions for an inflection point”; or “at an inflection point of  $f$ ,  $f'(x)=0$  and the function either keeps increasing or keeps decreasing”; or “an inflection point is a point where  $f'(x)=0$  and the graph bends”; (b) “That’s the definition” – declaring without actually defining; (c) Algorithmic considerations – addressing the methods in which they used to solve “investigate the function” tasks, where “[we] always found inflection points when looking for extreme points, thus starting this search with  $f'(x)=0$ ”; and (d) Irrelevant or no justifications.

### **Prospective Teachers’ Reactions to the Graphic Representation (Task 2)**

Table 2 indicates that only few participants provided a complete identification of the inflection points in graphs A ( $P_1$  and  $P_2$ ), C ( $P_6$  and  $P_7$ ), and D ( $P_8$ ), and no such solution was given to Graph B. In reaction to Graph A, most prospective teachers identified neither  $P_1$  nor  $P_2$ . That is, most participants identified no inflection points on Graph A. In reaction to Graph B, almost all the prospective teachers identified  $P_3$ , but only few identified  $P_4$  and none identified  $P_5$ . The reactions to Graphs C and D included three types of solutions: (a) correctly identifying all or one of the points; (b) identifying no inflection points, or (c) incorrectly marking the points “where the graph bends” ( $T_6$ ,  $T_7$ ,  $T_8$ ).

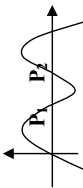
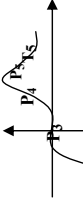
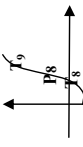
In their interviews, several of the latter participants, who incorrectly marked the points  $T_6$ ,  $T_7$ , or  $T_8$ , explained their solution in terms of “driving on curved tracks”. For example, “I imagine myself driving north, for instance, on a curved road... where I have to turn the wheel... but still go in the same direction... like... keep north... not turn back to the south... the point where I turn the wheel is an inflection point... in the graphical sense...”

A closer look at the data, as summarized in Table 3, shows that  $P_3$ , the inflection point where  $f'(x)=0$ , was identified by most prospective teachers as such,  $P_5$  the inflection point between a Maximum point and a horizontal asymptote was identified by no one (it was either overlooked or misplaced), and almost all prospective teachers misplaced the “vertical inflection point”  $P_8$ .

The points  $P_1$ ,  $P_2$ , (between two extremes) and  $P_4$ , (between an inflection point and a Max point) were correctly identified by a small number of prospective teachers and ignored by others. The points  $P_6$  and  $P_7$  gained a mixture of reactions: correct identifications, incorrect ones and no identification at all.

All in all, when examining the different types of solutions given by the prospective teachers to all the four tasks, two phenomena are evident: (1) the “horizontal inflection point” where  $y'=0$  was easily identified as such, and (2)

Table 2: Prospective teachers' identifications of inflection points (frequencies, %)

								
The Points	N	%	The Points	N	%	The Points	N	%
<b>Complete solution</b>								
$P_1 + P_2$	9	17.3	$P_3 + P_4 + P_5$	-	-	$P_6 + P_7$	4	7.7
$P_3 + P_4$	3	5.8						
$P_3$	43	82.7	$P_6$	5	9.6			
<b>Correct &amp; Incorrect Points</b>								
$P_3 + P_4 + T_5$	2	3.8	$P_7 + T_6$	2	3.8			
$P_3 + T_5$	1	2.0						
$P_4 + T_5$	1	2.0						
<b>Incorrect points</b>								
			$T_6 + T_7$	7	13.5	$T_8 + T_9$	5	9.6
			$T_6$	2	3.8	$T_8$	16	30.8
			$T_7$	10	19.3	$T_9$	4	7.7
<b>No Points</b>								
	43	82.7	2	3.8	22	42.3	18	34.6

$P_i$  - correct identification of a specific point       $T_i$  - incorrect identification of a point      N=52

most prospective teachers, at least once, erroneously regarded the “point where the curve bends” to be an inflection point (see + for  $T_1$ , under the borderline, Table 3).

**Table 3: Summary of Identification of Inflection Points (%)**

THE POINTS:								FREQUENCIES			
P <sub>1</sub>	P <sub>2</sub>	P <sub>3</sub>	P <sub>4</sub>	P <sub>5</sub>	P <sub>6</sub>	P <sub>7</sub>	P <sub>8</sub>	T <sub>5</sub>	T <sub>6</sub> /T <sub>7</sub>	T <sub>8</sub> /T <sub>9</sub>	N=52
-	-	+	-	-	-	-	-	-	-	-	21.0
-	-	+	-	-	+	-	+	-	-	-	5.8
-	-	+	-	-	-	-	+	-	-	-	2.0
+	+	+	-	-	+	+	+	-	-	-	2.0
-	-	+	-	-	-	-	-	-	+	+	19.3
-	-	+	-	-	-	-	-	-	-	+	9.6
-	-	+	-	-	-	-	-	-	+	-	7.8
-	-	+	-	-	-	-	+	-	+	-	5.8
-	-	+	-	-	+	-	-	-	-	+	3.8
+	+	+	+	-	+	+	-	-	-	+	2.0
+	+	+	+	-	+	+	-	+	-	+	2.0
+	+	+	-	-	+	+	-	-	-	+	2.0
+	+	+	+	-	-	+	-	+	+	+	2.0
+	+	+	+	-	-	-	-	-	+	+	2.0
+	+	+	-	-	-	-	-	-	-	-	2.0
+	+	+	-	-	-	-	-	-	-	+	2.0
-	-	+	+	-	-	+	+	-	+	-	2.0
-	-	-	+	-	-	-	-	+	-	-	2.0

+ correct identification    - no identification    Ti erroneous identification

**Prospective Teachers’ Reactions to “What is an inflection point?” (Task 3)**

The explanations of most prospective teachers included necessary and / or sufficient conditions for inflection points (Table 4). About 60% used notions of convex-concave: “a point where the function turns from concave to convex or vice versa”: about 10% of the participants presented tangent / slope ideas: “the point where the slope stops increasing and starts decreasing or the other way around”; and another 8% used  $f'(x)=0$  considerations, which are necessary but insufficient. However, about 15% of the participants expressed the erroneous view that  $f(x)=0$  or slope=0 are necessary conditions for inflection points.

**DISCUSSION**

The discussion addresses the two questions posed in the introduction: What *concept images* and what *concept definitions* can be identified in prospective secondary school mathematics teachers’ solutions to verbally and graphically presented tasks? What are possible reasons for these images and definitions?

***Concept images and concept definitions of inflection points***

Our data indicate that commonly the concept image of inflection points included

two types of points: those that fulfill the requisite of  $f''(x)=0$ , and those that are (mis)placed in the spot where the curve bends. Other points, like  $P_1$  and  $P_2$ ,

**Table 4: Prospective teachers' definitions for inflection points**

DEFINITION	FREQUENCIES	
	N = 52	%
Convex-Concave*	26	50.0
Convex-Concave* & $f'(x)=0^*$ / Increase-Increase	4	7.7
Convex-Concave* & Slope Zero	1	2.0
Tangent* / Slope*	5	9.8
$f''(x)=0^*$ & $f'(x)=0$ & Increase-Increase	1	2.0
$f''(x)=0^*$ & $f'(x)=0$	1	2.0
$f''(x)=0^*$	2	3.8
$f'(x)=0$ / Slope Zero & Increase-Increase	5	9.6
Increase-Increase	3	5.8
No answer	4	7.7

which fulfill neither  $f''(x)=0$ , nor are located in the spot where the curve bends, were frequently overlooked. These conclusions evolved from the prospective teachers' solutions to the graphical tasks and were supported by (a) their tendency to accept the statement: " $f''(x)=0$  in inflection points", and (b) their explanations during the individual interviews. These explanations gave us a clue regarding reasons that might underlie the prospective teachers' concept image of inflection points, so we shall address them in the following section.

In their responses to the question "What is an inflection point?" the participants gave their *personal concept definitions* to specify the concept. We did not explicitly ask for a mathematical definition. Since a description is meant to point to the notion under consideration, enabling to distinguish it from other notions, but not necessarily in the most economic manner. So we expected necessary, sufficient, and possibly some additional, yet relevant conditions. While most participants met this expectation, providing concave-convex plus other considerations, several participants suggested only an insufficient condition ( $f''(x)=0$ ), while others added the redundant condition of  $f'(x)=0$ . None of the participants referred to continuous and differentiable functions.

These data provided us with additional evidence about prospective teachers' tendency to regard  $f''(x)=0$  as a necessary condition for inflection points. It also showed that, like in other topics, the correct ideas presented in the definition (e.g., concave-convex) are not necessarily implemented when solving problems.

### Possible reasons for these images and definitions

We recognized two main sources for the prospective teachers' images of inflection points: one rooted in their previous mathematical studies, and the other in daily life. The unnecessary condition  $f''(x)=0$  may result from extensive algorithmic experience with investigations of functions, where the only

inflection points explicitly addressed were those that were found when " $f'(x)=0$ , but there is no extreme point". Although high school students also encounter inflection points of  $y=\sin(x)$  or  $y=\tan(x)$ , they rarely if ever address these inflection points in class. In this spirit, some prospective teachers explained "sure...  $y'=0$ ... this is how you start looking for inflection points... when looking for max... or min... you know... in the investigation of functions..."

On the other hand, the participants' daily experience with driving on curved roads seemed to underlie the erroneous location of inflection points in the "peak of a curve that keeps its up-up or down-down direction". These participants presented "driving and turning the wheel, while keeping the north", "imagine a turning point of a river", or "it's like the point where a plane changes the slope of its flight during its takeoff" considerations. These participants occasionally added some gestures with their hands to make this explanation more vivid.

Clearly, further research about prospective teachers' teachers' and students' concept images and their concept definitions of inflection points, is needed.

#### REFERENCES

Artigue, M. (1992). The importance and limits of epistemological work in didactics. In W. Geeslin & K. Graham (Eds.), *Proceedings of The 16th Conference of the International Group for the Psychology of Mathematics Education* (Vol. 3, pp. 195-216). Durham, NH: University of New Hampshire.

Cooney, T. J. (1994). Teacher education as an exercise in adaptation. In D. B. Aichele & A. F. Coxford (Eds.), *Professional development for teachers of mathematics* (pp. 9-22). Reston, VA: NCTM.

Cooney, T. J., & Wiegel, H. G. (2003). Examining the mathematics in mathematics teacher education. In A. Bishop, M. A. Clements, C. Keitel, J. Kilpatrick, F. K. S. Leung (Eds.), *Second international handbook of mathematics education*, (pp. 795-828). Dordrecht: Kluwer.

NCTM [National Council of Teachers of Mathematics]. (2000). *Principles and standards for school mathematics*. Reston, Virginia.

Tall, D. (1986). Constructing the concept image of a tangent. *Proceedings of the 11th Conference of the International Group for the Psychology of Mathematics Education* (Vol. III, pp. 69-75). Montreal.

Tall, D., & Vinner, S. (1981). Concept image and concept definition in mathematics, with special reference to limits and continuity. *Educational Studies in Mathematics*, 12, 151-169.

Vinner, S. (1982). Conflicts between definitions and intuitions: The case of tangent. *Proceedings of the 6th Conference of the International Group for the Psychology of Mathematics Education* (pp. 24-28). Antwerp, Belgium.

# FOSTERING MATHEMATICAL MEANING VIA SCIENTIFIC INQUIRY: A CASE STUDY

Ron Tzur, Rita A. Hagevik, Mary E. Watson  
North Carolina State University

*This study addressed the problem of how a prospective mathematics teacher's active engagement in a scientific inquiry can deepen the meaning of her extant mathematical concepts. We used a constructivist framework to analyze a 2-hour interview with a prospective mathematics teacher as she solved an open-ended problem of graphing a 3-D landform. We found two overlapping components in her learning via cycles of action and reflection: interpreting the task and reorganizing extant conceptions to quantify projective, horizontal/vertical distances.*

## INTRODUCTION

We conducted this study in the context of current reform movement in the teaching and learning of mathematics in the United States (NCTM, 2000). This reform emphasizes students' active investigation of their world as a means to construct meaningful and generalized mathematical concepts. This reform stresses the standard of *Connections*, that is, the recommendation to promote connections between mathematics and other disciplines (e.g., science) as well as among mathematical concepts. Because little is known about how such connections are formed, we set out to examine this sound recommendation empirically. In particular, we attempted to articulate the conceptualization process of a content-specific understanding: how a student can deepen her knowledge to meaningfully and flexibly shift between 2-D and 3-D levels.

## CONCEPTUAL FRAMEWORK

This study employed a recent elaboration of the constructivist stance regarding learning as a re-equilibration, or reorganization process (Dewey, 1933; Piaget, 1985; Steffe, 2002; von Glasersfeld, 1995). This elaboration articulates the learning process in a way that provides a teacher with conceptual 'lenses' for analyzing students' extant conceptions and how they might organize those conceptions into desired ones. The core of this elaboration is the mechanism for learning a new conception, namely, reflection on activity-effect relationship (Simon, Tzur, Heinz, & Kinzel, in press; Simon, Tzur, Heinz, Kinzel, & Smith, 1999), which operates as follows.

In a problem situation, a learner sets a goal (e.g., measure projective distances) and executes an activity sequence (e.g., laying a ruler along the contours of a 3-D model) to accomplish that goal. Both the goal and the activity are available through the learner's extant conceptions. While executing the activity sequence the learner may notice that its effects differ from the goal, that is, the learner experiences a perturbation. A common source for such perturbation is the gap between anticipated



and experiential (or perceptual) results. That is, one aspect of the learner's reflection is the type of comparisons the mental system makes between the goal and the effects of the activity, which leads to sorting activity-effect records as successful or unsuccessful. A second, complementary type consists of comparisons among situations in which such activity-effect records are called upon, which leads to abstracting the activity-effect relationship as a regularity (invariant) in the learner's experiential world. This regularity includes a reorganization of the situation that brought forth the activity in the first place.

From this perspective, a *conception* is considered as a dynamic, mental relationship between an activity and its effects. It consists of the learner's anticipation for effects that necessarily follow an activity. That is, an activity is not just a catalyst to the process of abstracting a new conception or a way to motivate learners. Rather, activity both generates and is a constituent of a conception.

This perspective has two complementary implications for teaching. First, one cannot determine the learning process because setting one's goal(s) in a given situation, initiating activities associated with that goal, noticing effects, and relating effect with activity rest within the learner. By the same token, these four rudimentary components of the learning process do not occur in a vacuum. Rather, they are afforded and constrained by learners' interactions in their environment (e.g., with peers, with a teacher) (Steffe & Tzur, 1994). Consequently, teaching includes: (a) engaging learners in solving challenging tasks that might bring forth their extant conceptions and (b) orienting learners' focus of reflection on activity-effect relationships (Simon, 1995).

## **METHOD**

We conducted a case study with Kay, a third-year undergraduate student who was enrolled in a college methods course for high school mathematics teachers. Our data consist of videotapes, audiotapes, and artifacts of Kay's work on an open-ended task: generating a graph that corresponds to a 3-D landform—a thin but sturdy plastic molding with several 'hills' and 'valleys' upon which a few points (A-F) were labeled. Conceptually, generating a graph is more challenging and revealing than interpreting a graph because the learner must make sense of the situation to be quantified instead of recognizing (reading) certain pieces of information from the graph (Roth & McGinn, 1997). Kay solved the task during a 2-hour teaching episode in which the second author served as the leading teacher-researcher (TR). The TR provided Kay with several manipulatives (e.g., straws, a flexible measuring tape with English units (referred to as 'flex tape'), rulers, paper strings, and graphing papers), posed follow-up questions to Kay, and probed for further clarifications.

To make inferences into the conceptualization process, we employed an in-depth, micro-analysis of critical events in Kay's solution process (Powell, Francisco, & Maher, in press). First, we coded segments in the episode that appeared as turning points in Kay's behaviors. Then, we used an reviewed each data segment several



times to make conjectures about plausible explanations for these behaviors. These conjectures consisted of our interpretations of the goals Kay tried to accomplish, the perturbations she might have experienced, and the nature of her anticipation while executing the activities. As we progressed along the segments, we discerned evidence regarding prior conjectures to obtain a coherent, grounded-in-data story line.

## ANALYSIS

Before presenting the task, the TR asked Kay to describe her previous experience with 3-D models. Kay's reaction clearly indicated that: (a) she already encountered such models when using computer simulations in her high school calculus course and (b) she did not like this experience. Kay also shared with the TR that she did not fly in an airplane and had a very limited experience of road trips. An experience of Kay that proved essential in her solution to the problem was that she lives in the foothills.

The TR presented the task by asking Kay to imagine she is driving in the car and looking at the 3-D landscape as it passes by her. The TR asked Kay to construct a graph of this landscape but purposely did not say what type of graph to create. Thus, Kay had to form an anticipation of the graph to be created—what would constitute a sound solution to the task—while considering a 3-D model of a landform that allowed for numerous solutions.

### Transcript 1

- Kay           What kind of graph do you want?
- Teacher       Any kind of graph that you would like to construct.
- Kay           Do you want me to pretend like I am driving *through* (*Touches with her hand some random points on the 3-D model*) ... or just what I see? Or what exactly do you want? [A little later]: Do you want just a line graph? (Receiving no response from the TR, she thinks quietly for about 5 seconds): You can do one of those line graphs. (*Her hands first show a cross-section line in the air, then a two-axis system. A little later she talks to herself while tracing with her finger a path along the contours of the 3-D model.*) Say that you started up here at the top of a mountain and then you went [down] to the bottom and it [the slope] would eventually be zero. That would be your minimum right in that area ... between *C* and *D* ... and then at a steep slope up here along the side of the mountain [where] you are going to put your maximum.

Transcript 1 indicates Kay's formation of her goal. First, she tried to elicit the goal from the TR. Given no indication, Kay detected the 3-D model while calling upon a particular mathematical conception she had available (a line-graph) to resolve the perturbing experience. She reflected on her own notion of a line-graph and explicated, by her hand movements, specific properties of such a graph that would evolve into her set goal: generating on a Cartesian coordinate system a cross-section along a path through some of the red dots. Relative to this goal, she immediately realized that many paths are possible and chose a single one. Kay then grabbed a graphing-paper and used a free-hand motion to trace a line with a minimum and a

maximum similar to the one in her final product (Figure 1). Kay explained to the TR that the path may be thought of as one that goes from her grandma's house up on the hill, down to the valley where her house is, and back to the Blue Ridge mountains. Kay added: "That's how I think about things ... what's the car going to be doing."

We considered this as the first turning point, because, 15 minutes into the interview, Kay had resolved her first perturbation (what graph to produce) by linking her 3-D and 2-D experiences. She had established a goal through calling upon extant conceptions from three different domains: her image of the given 3-D model, her image of landforms near her home, and her mathematical conceptions of 2-D graphs. This coordination was indicated by her anticipatory actions as she combined the free-hand drawing of a line with designating locations on the 3-D model as familiar locations surrounding her home.

The way Kay resolved her perturbation of what graph to create demonstrates two claims. First, Kay anticipated the form of the 2-D graph she wanted to produce and the information she needed—a set of value-pairs for projective vertical and horizontal distances. Second, Kay's extant conceptions did not include a way of generating the anticipated value-pairs. Thus, her attempts to create the value-pairs led to a second perturbation—her inability to accurately measure the desired distances.

Kay took a new sheet of graphing-paper, marked the first point for her new graph ( $A$ ), and tried to measure the distances using a paper string. She laid the string along the contours between two points (e.g.,  $A$ - $B$ ), then, holding the two end points, laid the string next to the flex tape. She indicated her growing perturbation by saying: "Even, if you are doing a 3-D model you want [a] slope. If there was a way to just project the points straight down onto the paper." This utterance and actions indicated Kay's perturbation: she needed to create a slope but did not have a way of projecting points straight down, which she anticipated would have solved the problem.

## Transcript 2

- Kay But, umm ... (*lays the string between A and B but realizes it does not give her a reading of the slope*) ... there's no way to really get that angle that you are going down.
- Teacher Hmm ... I wonder how you could do that?
- Kay Well, you don't have (pauses for 5 seconds) ... You would have to guess what your height was ... You could get your slope by measuring your height here and your distance across.
- Teacher Rise over run?
- Kay Yeah ... and figure out what your slopes ... Actually ... I am not sure that this would be the best way to try. You wanna find out exactly how this [cross-section] goes (*turns the 3-D model upside down, then pauses for about 5 seconds while looking at it.*): Put it right there (*holds the ruler inside the model to measure height. Almost immediately her facial expression indicates "I got something" as her work becomes more purposeful*). Okay. This is experimenting. I'm not sure if this will work.

Transcript 2 consists of a critical event in Kay's learning. The change in her action was the first indication that she resolved her perturbation of how to graph slopes by calling up her mathematical conception of slopes between discrete points. This made Kay aware of the lack of accuracy of her previous method, an awareness that brought about the crucial action of turning the 3-D model upside down. Through reflecting on the effect of her action she realized its usefulness, hence the "AHA" moment she seemed to experience.

Kay's attempted to measure the horizontal distance  $A-B$  with two tools (a piece of folded paper, the flex tape), but both attempts failed. Thus, she picked up a ruler, put it horizontally atop the 3-D model between  $A$  and  $B$  as she said: "This isn't perfect because' ... Umm' I don't have a way of knowing if it's perpendicular." While struggling to hold both the flex tape and the plastic ruler atop the 3-D model, she abruptly turned the 3-D model on its head again. This abrupt action indicated another realization regarding that change of position. We suggest that Kay reflected on her previous action on the upside down model and coordinated it with her specific goal of measuring the vertical distance from  $A$  to  $B$ .

Kay was about to take that measurement with the flex tape underneath the base but then the TR intervened, asking Kay where does the horizontal line goes. After a few seconds of silence, where Kay seemed dissatisfied with the accuracy of her measurements, she explained she was searching for a way to establish a standard reference, a line that is horizontal to the base of the 3-D model. Thus, the TR's interruption proved useful because asking Kay to explain what she tried to accomplish 'sent' Kay into a cycle of reflection and action through which she refined her goal. She began focusing on how to establish a reliable reference. This indicates that Kay's conceptions did not include an anticipation of how to establish such reference. It also indicates the learning that did take place: Kay coordinated her mathematical goal (obtain projective distances) with an evolving scientific understanding—the need to establish a consistent reference. In response to further probing from the TR, Kay identified the reference line with the lowest point on her path, a 'little river' between points  $C$  and  $D$ , and said that her goal was to measure the 6 pairs of coordinates. Kay also clarified that she could choose any point as a reference and that she would need to measure at least one more point (between  $C$  and  $D$ , which she labeled  $C'$ ) to avoid masking a local minimum. In spite of all these theoretical anticipations, at this time (34 minutes into the interview) Kay began producing a 1-D graph that she called "the distance traveled."

Kay's utterances as she produced the new, 1-D graph indicated that she did not consider this to satisfactorily solve the task. For example, she said: "It sounds like we don't get much of a graph." Thus, once she completed the 1-D graph (about 10 minutes), Kay turned back to her original goal of generating a 2-D graph. She had a clear theoretical anticipation of the measurement she needed, but not yet a method to actually measure projective distances. Her perturbation intensified as she moved from an inaccurate measurement of the horizontal distance  $A-F$  to measuring the vertical

boundaries (the range) for her graph. No matter how hard she tried holding the rulers perpendicular or parallel to the desk (even with the TR's help), she was continually obtaining effects of her measuring actions that did not meet her goal. In one of those attempts, however, Kay explicitly talked about her inability to 'drop' a vertical line from the dots on the top of the 3-D model to the desk or to measure vertical distances between points far apart. These two reflections led to a change in her actions—she again turned the 3-D model upside down. In the context of these specific reflections, this time she had available mental images that could be related anew—substituting one measuring action (to the desk as a reference) by another (to the base of the 3-D from beneath). Note that we do not claim that such a relationship was a necessary result of the mental 'items' Kay focused on; only that this focus on her unsuccessful actions allowed for such adjustment of means to ends.

Kay continued by gauging several vertical distances between points. For example, she said she was going to find  $E-F$  'real quick' but this took longer than she planned (over 20 seconds) and was unsatisfactory, as she commented: "This is so unscientific." The TR asked Kay which tools could help and Kay explained she would like to have something that goes through the sturdy plastic. The TR asked Kay how might earth scientists make up a graph without cutting through the landform. She replied, "They set up reference points that are going to be horizontal and vertical to whatever they choose as their [reference]. Then, Kay turned to measure the tiny distances for  $D-C'$  and  $C'-C$  in clear anticipation of the difficulty ahead.

### Transcript 3

Kay            It is going to be almost impossible to ... (*Abruptly, as if having another "AHA" moment, turns the 3-D model upside down, using the flex tape to measure the vertical distance between C and C'*): It's almost like [the height of] C-prime. I know you can't turn the earth upside down (laughs), but I have a model so it's happening.

In response to this action, the TR probed Kay to which horizontal line in the 2-D rough sketch consisting of vertical and horizontal lines through the minimum and maximum points does the ruler held across the base correspond. Kay responded "to any of them," indicating that this was a critical but limited event. It was critical in that for the first time Kay coordinated the turning of the model with a particular measuring action ( $D-C'$ , vertically). It was limited in that, initially, Kay did not generalize it to measuring projective distances for any point. When the TR probed, "Any of them?" Kay thought for a few seconds, then responded that actually it was the horizontal line through  $C'$  in her rough sketch. As Kay reflected on this particular correspondence and on her next action (measuring  $C'-C$ ), she finally related the effect of accurately measuring a projective distance with the action (ruler across the base) that invariably allowed for such measurement. She excitedly said: "I should have done this [technique] the whole way." Thus, Kay grabbed another graphing-paper, systematically measured and recorded all vertical distances, then all horizontal distances, and finally completed a new graph of the cross-section  $A-F$  (see Figure 1).

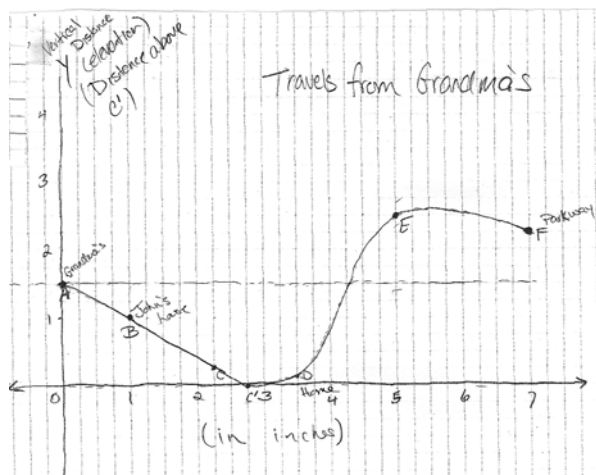


Figure 1. Kay's Final 2-D Cross-Section Graph

## DISCUSSION

This study demonstrated how a problem-based, scientific inquiry of a 3-D model might foster a meaningful conceptualization of 2-D graphs. In particular, it demonstrated the conceptual link that a high school mathematics prospective teacher did not have available in order to shift between the two dimensions. This demonstration is important for two reasons. First, quite often the *Connections* standard (NCTM, 2000) is thought of in terms of introducing new ideas to students. However, the present study indicates that fostering connections can enhance meaningful understandings much later, when a person reorganizes her or his rather limited, textbook-like notions (e.g., 'rise-over-run'). Thus, the present study can contribute to teacher educators' identification of weak areas in teachers' mathematics and of ways to foster a more meaningful understanding via scientific activities.

Second, the present study demonstrates how the mechanism of reflection on activity-effect relationship (Simon et al., in press) helps in analyzing and designing activities that are likely to foster a desired, meaningful understanding. For example, this mechanism provided the conceptual lenses needed to articulate the generative power of two activities that Kay used: turning the 3-D model upside down and laying the ruler across its base. These activities became constituents of a new conception because Kay could notice the effect of both activities, first in a local manner (a reference point for measuring  $D-C'$ ), then in a general, invariant manner (a reference point for measuring any vertical or horizontal distance). Thus, she was able not only to accomplish the complex enough task of generating a graph (Roth & McGinn, 1997), but also to form a quantified image of any chosen path along the contours of a landscape. Having formed this new conception allowed her to meaningfully carry out

the mental and practical back-and-forth shifts between a graphed cross-section and changes of slope in actuality. This kind of understanding is necessary, for example, to make sense of computer simulations because a user does not have access to these back-and-forth shifts as they are carried out by the computer—a plausible reason for Kay's disengaging experience with 3-D simulations.

## References

- Dewey, J. (1933). *How We Think: A Restatement of the Relation of Reflective Thinking to the Educative Process*. Lexington, MA: D.C. Heath.
- NCTM. (2000). *Principles and Standards for School Mathematics*. Reston, VA: Author.
- Piaget, J. (1985). *The Equilibration of Cognitive Structures: The Central Problem of Intellectual Development* (T. Brown & K. J. Thampy, Trans.). Chicago: The University of Chicago.
- Powell, A. B., Francisco, J. M., & Maher, C. A. (in press). An analytical model for studying the development of learners' mathematical ideas and reasoning using videotape data. *Journal of Mathematical Behavior*.
- Roth, W.-M., & McGinn, M. K. (1997). Graphing: Cognitive ability or practice? *Science Education*, 81, 91-106.
- Simon, M. A. (1995). Reconstructing mathematics pedagogy from a constructivist perspective. *Journal for Research in Mathematics Education*, 26(2), 114-145.
- Simon, M. A., Tzur, R., Heinz, K., & Kinzel, M. (in press). Explicating a mechanism for conceptual learning: Elaborating the construct of reflective abstraction. *Journal for Research in Mathematics Education*.
- Simon, M. A., Tzur, R., Heinz, K., Kinzel, M., & Smith, M. S. (1999). On formulating the teacher's role in promoting mathematics learning. In O. Zaslavsky (Ed.), *Proceedings of the 23rd Annual Meeting of the International Group for the Psychology of Mathematics Education* (Vol. 4, pp. 201-208). Haifa, Israel.
- Steffe, L. P. (2002). A new hypothesis concerning children's fractional knowledge. *Journal of Mathematical Behavior*, 20, 1-41.
- Steffe, L. P., & Tzur, R. (1994). Interaction and children's mathematics. *Journal of Research in Childhood and Education*, 8(2), 99-116.
- von Glasersfeld, E. (1995). *Radical Constructivism: A Way of Knowing and Learning*. Washington, D.C.: Falmer.

# STUDENTS BUILDING ISOMORPHISMS

Elizabeth B. Uptegrove and Carolyn A. Maher

Rutgers University Graduate School of Education

*This paper reports on five students' explorations of structural relationships between problem situations that they worked on over several years as participants in a long-term study. In particular, we describe the case of students who recognized isomorphisms between and among two problem situations and who used particular features of the problems to explain Pascal's Identity.*

## INTRODUCTION

According to Greer and Harel (1998), an important component of mathematical cognition is recognizing structural relationships between situations and distinguishing these from surface features. They give as examples the mathematical thinking of Poincaré and a fourth-grade student, Brandon, who spontaneously recognized the mathematical equivalence between two problems he had been exploring. The distinguished mathematician and the fourth grader, they point out, recognized the common structure between two situations that on the surface appear different:

These are two examples of mathematicians – the first a great French genius, the second a fourth grade New Jersey student – experiencing insights about structural identity underlying what, on the surface, appear to be different situations (Greer and Harel, 1998, p. 6)

For further details on Brandon's work, see Maher (1998).

## THEORETICAL FRAMEWORK

According to Davis and Maher (1997), in order to build accurate mental representations for mathematical situations, students need to draw on fundamental basic ideas that they have built and recognize how these ideas are related. This involves a form of reasoning in which learners map corresponding relational structures from one situation to another. Davis indicates that thinking about new ideas involves making connections to ideas that were already present, and in so doing, one often makes use of metaphors in order to communicate these ideas. But Davis points out:

Metaphors are far more important than mere tools of communication – they form a large part of the mental representations by which we think (Davis, 1990, p. I.4).

In describing the importance of metaphors in building new conceptualizations, Davis suggests that having a collection of basic metaphors provides one with a powerful way of looking at new mathematical phenomena. Using the interpretative framework of Davis' work on metaphoric thinking, we trace the mathematical reasoning and the building of isomorphism of six students who did

mathematics together over several years as participants in a long-term longitudinal study. During the course of the study, the students worked on several combinatorics problems as part of a counting strand. Their work led to investigations of various combinatorial theorems, including Pascal's Identity, the addition rule for Pascal's Triangle.

The questions that guide our analysis are: (1) What metaphors did students use in their investigation of Pascal's Triangle? (2) How did they use the metaphors to explain Pascal's Identity? (3) In what ways were the metaphors used to provide a convincing justification for Pascal's Identity?

## PASCAL'S TRIANGLE

Pascal's Triangle shows the number of ways to generate combinations of objects. The number of combinations of  $r$  objects selected from  $n$  objects is given by the  $r^{\text{th}}$  entry of the  $n^{\text{th}}$  row of Pascal's Triangle, often written as  $C(n,r)$ :

$$C(n,r) = \binom{n}{r} = \frac{n!}{r!(n-r)!}.$$

Pascal's Identity is given by the equation  $C(n,r) = C(n-1,r-1) + C(n-1,r)$ .

### Metaphors for Pascal's Triangle

The numbers in Pascal's Triangle are often used to find the coefficients of the binomial expansion:  $C(n,r)$  gives the coefficient of the  $r^{\text{th}}$  term of  $(x+y)^n$ . But these numbers can also be used to investigate some combinatorial problems. The following two problems are isomorphic to each other and to the problem of finding the coefficients of  $(x+y)^n$ . The students investigated versions of these problems, starting in fourth grade and continuing through high school. They form the basis of the metaphors the students used to talk about Pascal's Triangle.

1. **The Pizza Problem:**  $C(n,r)$  gives the number of possible pizzas with exactly  $r$  toppings when there are  $n$  toppings to choose from. The students worked on the 4-topping ( $n=4$ ) and 5-topping ( $n=5$ ) version of this problem in 1993, during fifth grade. They investigated other forms of the problem during high school.
2. **The Towers Problem:**  $C(n,r)$  gives the number of towers (built from Unifix cubes and with two colors to choose from) that are  $n$  cubes tall containing exactly  $r$  cubes of one of the colors. The students first encountered the 4-tall ( $n=4$ ) version of this problem in third grade. They worked on it again in fifth grade and revisited it in high school.

## METHODOLOGY

Data for this analysis is taken from after-school problem-investigation sessions during the students' last three years of high school and from individual follow-up task-based interviews. All sessions were videotaped, usually with two cameras. All



student work was preserved. Summaries were made of all videotaped sessions, and they were coded for critical events related to student use of metaphors and discussion of isomorphic relationships. All critical events were transcribed, and transcripts were reviewed for accuracy.

The five sessions discussed here took place on February 6, 1998, March 1, 1999, May 12, 1999, April 3, 2002, and July 22, 2002.

In the 1998 session, a group of students discussed the pizza and towers problems and the binomial expansion. The students were asked to explain how the 6<sup>th</sup> row of Pascal's Triangle is related to the 6-tall towers problem and the 6-topping pizza problem.

In the March 1999 session, a group of students explored Pascal's Triangle and Pascal's Identity in terms of the towers and pizza problems. They were asked to think about how entries in Pascal's Triangle are related to the towers and pizza problems.

In the May 1999 session, a group of students was asked to discuss the meaning of combinatorial notation and to explain the addition rule in terms of that notation. They were asked to write the general form of Pascal's Identity.

The two sessions in 2002 were individual-student task-based interviews; in both cases, students were asked to explore the meaning of the numbers in Pascal's Triangle and to discuss Pascal's Identity. Michael was interviewed in April, and Romina was interviewed in July.

## RESULTS

Throughout the longitudinal study, the students visited and revisited several problems in combinatorics, including the two listed above. During their high school years, they were encouraged to investigate number patterns that recurred in those problems. In the course of their discussions and with the guidance of researcher questions about how the numbers are related, they made sense of Pascal's Triangle and Pascal's Identity in terms of these isomorphic problems. They made use of metaphors they already knew to extend and generalize their knowledge and build new ideas. We describe here some instances where the students used metaphors in order to explain the numbers in Pascal's Triangle and to give meaning to Pascal's Identity.

### The Case of Ankur

In 1998, Ankur and Jeff were asked to explain how Row 6 of Pascal's Triangle (1 6 15 20 15 6 1) can be connected to the towers and pizza problems:

Ankur: So there's one with no red. There's six with one red. There's 15 with two reds.

Jeff: ...Two reds, 20...

Jeff: ...With 3 reds.

Ankur: 15 with four reds.

Jeff: ...With 4 reds.

Ankur: Six with five reds.

Jeff: And one with no...

Ankur: No, six reds.

Jeff: One with six reds.

Later in that session, the students were asked to explain how the two middle numbers in Row 5 of Pascal's Triangle (10 and 10) are added to produce the middle number in Row 6 of Pascal's Triangle (20). Here, Ankur explained how  $C(6,3)=C(5,2)+C(5,3)$ .

R2: Hm. the first 10 in that row of 5 high has 2 reds and 3 blues. We're counting reds.

Ankur: Yeah.

R2: And the second 10 has...

Ankur: Three reds and two blues.

R2: Three reds and two blues. Now coming down here, the 20 is supposed to count the ones that have...

Ankur: Three reds and three blues.

R2: Right. So how do the two 10s add to give the 20?

Ankur: Because in these 10, when there's three reds and two blues, you want to make it three reds and three blues. So you put a blue on top of each one. ...

R1: ... To preserve the three reds.

### **The Case of Stephanie**

In the March 1999 session, Stephanie was a member of a group of students exploring the pizza problem and its relationship to Pascal's Triangle. Stephanie related the numbers in Row 3 of Pascal's Triangle to pizzas with three toppings to choose from and the numbers in Row 4 to pizzas with four toppings to choose from. She explained two instances of Pascal's Identity, as shown in Figure 1. First she explained how  $1+3=4$  in terms of building one-topping pizzas in Row 4 from zero- and one-topping pizzas in Row 3:

OK, this, to get four pizzas with one topping, you already have three pizzas with one topping. And the plain pizza becomes the pizza with the new topping. ... OK, so this becomes, instead of one plain pizza, this is one pizza with one topping. Cause this one's getting like the pepperoni thrown into it.

Then Stephanie used the metaphor of building two-topping pizzas in Row 4 from one- and two-topping pizzas in Row 3 to explain  $3+3=6$ :

...So then here, um, you have six pizzas with two toppings. Now you already have three pizzas with two toppings. So these three pizzas with one topping get an extra topping added on. ... So these become three pizzas with two toppings. And then three pizzas with two toppings plus three pizzas with two toppings equal six pizzas.

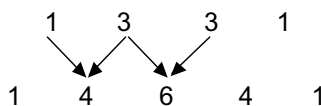


Figure 1: Adding to Create the Next Entry in Pascal's Triangle

### The Case of Jeff

In the May 1999 session, Michael and Jeff explored the same instance of Pascal's Identity that Stephanie had described, also using the metaphor of adding toppings to pizzas.

Michael: So all these 3s would either move up a step onto the next category and, uh, have two toppings or they might stay behind and still only have one if they have the zero. So three, three... [Michael draws lines as shown in Figure 3.] Well, three get a topping, go to this one [Michael points to the 6], and three won't, will stay. [Michael points to the 4.] ... So now this guy's going to have, without toppings. [Michael points to first 1 of 1 3 3 1 row.] You're going to add a topping on to him. That's going to be one topping. These three [points to first 3 of 1 3 3 1 row] with one topping won't get one so, you know, you can put them in the same category as this one.

Jeff: That's their four? Yeah.

Michael: That's four.

Jeff: Those are your four.

Michael: And you know, the three that had two toppings [the second 3 in the 1331 row] won't get any. And you could put them in together with the ones that did get something. [Michael points to the lines going from the two 3s to the 6.] That's why you would add.

Later, Brian joined the group, and Jeff explained the general form of Pascal's Identity to him, which was written in the form shown in Figure 2.

Jeff: We, we were explaining why you add.

Brian: All right, keep going.

Jeff: And why do... because when you add another topping like onto it, this one... Say the toppings were one and zero. [Jeff points to  $N$  choose  $X$ .]

Brian: Uh huh.

Jeff: If it gets a topping, that's why it goes up to the  $X+1$ . [Jeff points to  $N+1$  choose  $X+1$ .] And since it doesn't get anything it'll stay the same. And in this one [Jeff points to  $N$  choose  $X+1$ ], it's staying the same, right? [Jeff looks at Michael.]

Michael: Yeah.

- Jeff: And that's why it's going there. Like saying that's the zero. [Jeff writes a small zero at the bottom of  $N$  choose  $X+1$ .]
- Brian: Okay.
- Jeff: You're going to there. Make sense?
- Brian: Yes. It actually does.
- Jeff: So, so that would be the general addition rule in this case.

$$\binom{N}{X} + \binom{N}{X+1} = \binom{N+1}{X+1}$$

Figure 2: Pascal's Identity in Students' Notation

### The Case of Michael

In the April 2002 interview, Michael was asked to discuss Pascal's Identity. First he explained what the numbers in Pascal's Triangle meant in terms of the pizza metaphor, starting with Row 2 (1 2 1):

If you had no toppings, that would be one pizza. ... If you're having only, using just one topping, you can make two possible pizzas with that. And then if you have all, all the toppings, that's one. Right. And then automatically you, I see that, that relates to this row. [Michael points to his paper, where he has written 1 2 1.] And I'm pretty sure it would go down, this is like a third topping, and a fourth topping. Now I think the way I, um, thought about it is, like, the row on the outside would be your plain pizza. And there's only one way to make a plain pizza. And the next, you know, from then on, the next one over would be how many pizzas you can make, um, using only one topping, and then so on until you get to the last row which is, um, all your toppings. And, once again, you can only make one pizza out of that. ...

Then Michael used the pizza metaphor to explain Pascal's Identity. He equates moving to the left (adding a number to the number on its left) with not adding a topping and moving to the right (adding a number to the number on its right) with adding a topping:

Well, you're starting off with this, you know, this group of pizzas that has no toppings. And this group of pizzas that has one. So when you, when you go up, you have the choice of adding one more. ... to that one that had nothing, you could either not give it that extra topping. ... Or you can. So for those pizzas that you do give that extra topping, it moves to the right. And for the others it moves to the left. And that's kind of why it doubles. The amount doubles each time.

### The Case of Romina

In the July 2002 interview, Romina was shown a diagram of Pascal's Triangle in combinatorial form and asked how the addition rule worked. Romina pointed to Row 1, which contained  $C(1,0)$  and  $C(1,1)$ , and explained the connection between those numbers and the pizza and towers problems. Romina's explanation paralleled Ankur and Jeff's explanation from 1998.

I think this is, how many, how many toppings, like the top number, like the one choose one or one choose zero would be how many toppings. Or I mean if we were talking about towers. ... It would be like how many high and this [pointing to Row 1] would be like with zero reds, with one red. This [pointing to Row 2, containing  $C(2,0)$ ,  $C(2,1)$ , and  $C(2,2)$ ] would be with two high with zero reds, one red, two reds. And it just keeps going like [pointing to Row 3] three high, zero reds, one red, two, then three reds. So it would be like three high and like out of those, you choose how many blocks of each color.

Romina was asked if she could explain the addition rule in terms of towers. She responded with a similar explanation to that offered in 1998 by Ankur:

So...OK, I think, the way it goes, it's like this two [the 2 in the middle of Row 2: 1 2 1], you can take, you could be either direction with it. You're either going to add another, add another red, say, so it goes to two red, or you're going to add another blue, so it stays one red.

Later Romina was asked to explain in terms of pizzas. Her response echoed portions of the discussion from 1999, but she went further and explained the isomorphism between the pizza problem and the towers problem.

R3: Um. Can you look at this in terms of pizzas too? The way Michael does?

Romina: ... if you have two toppings, if you have a possibility of two toppings, in this one [first entry of Row 1 of Pascal's Triangle], you don't have any toppings. And this one [second entry of Row 1], you have one topping.

R3: OK, so you can pick from two toppings, but you don't put any on.

Romina: Yeah, you don't have to necessarily put it. You have two toppings to pick from. And then, what he [Michael] did with this one is either you could...now, you could add a third toppings to your pizza. ... Like you have three options, you could either not add anything to the pizza. Or you could just add one more topping.

R3: All right. So when you said, "add one more topping," or "not add one more topping," how do you... can you relate that to red and blue?

Romina: You either, it's either, like, you add one more red block, or you just keep it consistent and add, just add another blue. ... So blue would be like nothing, like not an ingredient, and red would be an ingredient.

## CONCLUSION AND IMPLICATIONS

These students built connections between some of the problems they worked on throughout their school years (pizza and towers) because they recognized their corresponding structures and their relationships. Using the metaphors and their understanding of the isomorphic relationships as a way of looking at Pascal's Triangle, these students were able to describe and explain Pascal's Identity. They made use of metaphors they already knew to extend and generalize their knowledge and to build new ideas.

Over many sessions students provided lucid explanations of what the numbers in Pascal's Triangle mean. They made use of two isomorphic problems to provide a convincing justification of Pascal's Identity. Their knowledge appears deep and durable. This suggests that giving students rich problems throughout their school career can help them build a collection of basic metaphors that they can later use when building new, more formal, mathematical ideas.

### Note

The research is based on data collected from a longitudinal study, directed by Dr. Carolyn A. Maher, on the development of mathematical reasoning in students funded by the National Science Foundation (#REC-9814846). The collaborators of the research strand for this report are Uptegrove and Maher. Any opinions expressed in this paper are those of the authors and do not necessarily reflect the views of the National Science Foundation.

### References

- Davis, R. B. (1990). The knowledge of cats: Epistemological foundations of mathematics education. In *Proceedings of the Fourteenth Conference of the International Group for the Psychology of Mathematics Education (PME14)* (Vol. 1, pp. PI.1-PI.21). Oaxtepec, México.
- Davis, R. B. & Maher, C. A. (1997). How students think: The role of representations. In English, L. D. (Ed.) *Mathematical Reasoning: Analogies, Metaphors, and Images* (pp. 93-116). Mahwah, New Jersey: Lawrence Erlbaum Associates.
- Greer, B. & Harel, G. (1998). The role of isomorphisms in mathematical cognition. *Journal of Mathematical Behavior* 17(1), 5-24.
- Maher, C. A. (1998). *Can Teachers Help Children Make Convincing Arguments? A Glimpse into the Process*. Rio de Janeiro, Brazil: Universidade Santa Úrsula.
- Maher, C. A. (2002). How students structure their own investigations and educate us: What we have learned from a fourteen year study. In A. D. Cockburn & E. Nardi (Eds.), *Proceedings of the Twenty-sixth Annual Meeting of the International Group for the Psychology of Mathematics Education (PME26)* (Vol. 1, pp. 31-46). Norwich, England: School of Education and Professional Development, University of East Anglia.
- Tarlow, L. D. (2004). *Tracing students' development of ideas in combinatorics and proof*. Unpublished doctoral dissertation, Rutgers University, New Jersey.
- Uptegrove, E. B. (2003). Understanding Pascal's triangle. In Pateman, N. A., Dougherty, B. J., and Zilliox, J. T. (Eds.) *Proceedings of the 2003 Joint Meeting of PME and PMENA* (Vol. 1, p. 261). Honolulu, Hawaii.

# HOW DO HIGH SCHOOL STUDENTS INTERPRET PARAMETERS IN ALGEBRA?

Sonia Ursini

Departamento de Matemática Educativa  
CINVESTAV-IPN, México

María Trigueros

Departamento de Matemáticas  
ITAM, México

## Abstract

*This paper presents an analysis of high school and starting college students' work with algebraic expressions and problems involving parameters. We suggest that parameters should be considered as general numbers that are used to make second order generalizations. The Three Uses of Variable model (3UV model) is then used as the theoretical framework to analyse students' interpretation, symbolisation and manipulation of parameters in different contexts. We found that, in general, students had great difficulties in working with parameters but, when they could assign a clear meaning to them, their difficulties decreased. Our results suggest that parameters are general numbers that acquire a clear algebraic meaning only when a specific referent can be given to them.*

## Introduction

Several studies have investigated students' work with the different uses of variables. The great majority stress students' difficulties and errors when working with unknowns, general numbers or related variables. However, only few studies have paid attention to students' work with parameters (Bloody-Vinner, 1994, 2001; Furinghetti & Paola, 1994). These researchers point out that the difficulties students have when working with parameters are both of semantic and syntactic nature. They stress as well, that in order to work properly with parameters it is necessary to be able to distinguish them from unknowns and variables (meaning by "variables" related variables) and that this distinction depend on the context. Bloody-Vinner (2001) refers to parameters as "another usage of letter" additional to unknowns and related variables; we agree with this affirmation, however it seems to us that parameters should not to be considered only as "another usage of letter" different from an unknown or related variables.

From our perspective parameters are general numbers, but of second order, that is, required when generalising first order general statements. By first order general statements we mean those derived from generalising statements involving only numbers. For example, general numbers of first order are present in the general term of a numeric sequence; the general method for calculating the area of a square; equations with numeric coefficients; etc. Parameters appear when we represent families of first order general statements (families of equations, families of functions, families of open expressions), therefore they can be considered general numbers of second order. When parameters are involved in an algebraic expression their role depends on the context, as it is stressed by Bloody-Vinner (2001) and Furinghetti &

Paola (1994), and this role may change within the same problem, for example, from general number to unknown (e.g. *When does the equation  $3x^2 + px + 7 = 0$  have a unique solution?*); from general number to a variable related to another variable (e.g. *Given the general equation of a straight line  $y = mx + c$  write the equation representing all the straight lines passing through the point (5,6)*).

### **Theoretical framework**

From our perspective parameters are general numbers that assume the role of unknown or of related variable, depending on the context. Therefore, the 3UV model (Trigueros and Ursini, 2003; Ursini and Trigueros, 2001) that considers these three uses of variable and the aspects characterising each one of them, can be extended in scope and be a useful theoretical frame to understand students' work with parameters.

From the 3UV model perspective, in order to understand students' difficulties with parameters it is necessary to focus on their capability to interpret them, to symbolise them and to manipulate them in different contexts. Moreover, when the problem requires shifting between the different roles a parameter can assume (that of general number, unknown or related variable) it is necessary to be able to handle the aspects characterising each one of these specific uses of variable in an appropriate way.

When the parameter is perceived as a general number students need to be able to: relate parameters to patterns' recognition, or to the interpretation of rules and methods; interpret it as representing a general, indeterminate entity that can assume any value; deduce general rules and general methods by distinguishing the invariant aspects from the variable ones in first order general statements; manipulate it; symbolise it for representing second order general statements, rules or methods. When a parameter assumes the role of an unknown it is necessary to: recognise that it represents something unknown that can be determined; interpret it as representing specific values that can be determined by considering the given restrictions; determine its values by performing the required algebraic and/or arithmetic operations; substitute the required values to the parameter in order to make the given condition true. When a parameter assumes the role of a variable related to another one, it is necessary for the student to: recognise the correspondence between the two variables in the analytic expression; determine its values in terms of the value of the related variable or determine the value of the related variable in terms of the value of the parameter; recognise the joint variation of the parameter and the related variable; determine the interval of variation of the parameter or the related variable when the interval of variation of the other one is given. To work successfully with parameters it is therefore necessary to be able to shift between different uses of variable and to master each of them with its own characteristics.

Our purpose in this study was to identify students' interpretations and difficulties when working with parameters. In order to do so, we have used the 3UV model as



theoretical framework to analyse students' interpretation, symbolisation and manipulation of parameters in different contexts.

## **Methodology**

The 3UV model guided the methodology we used in the design of the items of a questionnaire and in their analysis. This methodology was already used in previous work where attention was centred in the analysis of the way students work with the concept of variable in elementary algebra (Trigueros and Ursini, 2003; Ursini and Trigueros, 2001). The way questions are designed using this methodology has shown to be an efficient way to probe students' reasoning on variable. In fact, in previous studies it was found that the results obtained from the analysis of the responses given to a questionnaire and those obtained from the analysis of interviews gave the same results in terms of the analysis of students' reasoning. This methodology allows us to classify the questions into categories related to the interpretation, manipulation and symbolizations of the different uses of variable. It makes also possible to isolate and identify with some precision students' strengths and weaknesses when they work with algebraic expressions.

A 16 items questionnaire was designed (Table 1) which includes items requiring interpretation, symbolisation and manipulation of parameters. The questions can also be distinguished between those in which the parameter has a geometric referent and those in which it has a strictly algebraic one, in order to make it possible to observe if different contexts influenced students' responses.

The questionnaire was piloted and the final version was answered by 112 students: 50 of them were still attending the last year of high school, and 62 were initiating their first mathematics course at college level at a small Mexican university. Students' answers were analysed independently by two researchers and, when differences appeared, they were negotiated for validity.

## **Results**

### *Results related to interpretation of parameters*

Most of the students interpreted a parameter as a general number and, in most cases, they had difficulties in differentiating it from the other variables involved in an expression. This happened both, when questions were posed in a geometric or in a strictly algebraic context. There were students, however, who had less difficulties in differentiating the role of a parameter when they could attribute a geometric referent to it. This happened, for example, when a parameter was involved in an equation of a line (question 2). Students' responses to this question demonstrated their capability to interpret the parameter as the slope of a line. The responses of two students exemplify typical answers to this question: "*a is the value of the slope of the line*"; "*a represents the slope of the line represented by  $y=ax+3$* ". We can conclude, however, that students were using a memorized fact when assigning meaning to the symbol *a* since, when asked to calculate the value of the parameter in a particular case (*which is the line through the point (2,3)*), almost all the students showed

confusion, and they were not able to do it. In the previous example the same two quoted students were not able to calculate the slope using the given information. One of them wrote: “ $y=mx + 3$ ,  $y=-2x+3$ ,  $(3/2)x+y-3=0$  so,  $m=-(3/2)x + 3$ ”.


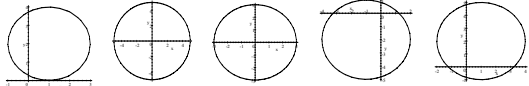
<p>1. Given the family of lines <math>ax + by = c</math> in the plane <math>xy</math>. Where does each line cross the axis <math>X</math>? Where does each line cross the axis <math>Y</math>? What does <math>a</math>, <math>b</math>, <math>c</math>, <math>x</math> and <math>y</math> represent?</p>	<p>9. Give a particular example of the general equation <math>(m + 2)x^2 + 3mx + 6 = m + 2</math>. If <math>x = 0</math>, the expression can still be considered an equation? Explain your answer. If <math>m = -2</math>, the expression can still be considered an equation? Explain your answer.</p>
<p>2. Given the family of lines <math>y = ax + 3</math>, which is the line through the point <math>(2,3)</math>. What does <math>a</math> represent?</p>	<p>10. Use the formula <math>x = \frac{-b \pm \sqrt{b^2 - 4ac}}{2a}</math> to solve the equation <math>2x^2 - 5ax + 8 = 0</math>. What does <math>a</math> represent in the equation? For which values of <math>a</math> the equation has no solution in real numbers?</p>
<p>3. Given the expression <math>x^2 + y^2 = m^2</math> explain what is constant and what varies. What do <math>x</math>, <math>y</math> and <math>m</math> represent?</p>	<p>11. Which of the following lines are represented by <math>y = -3x + C</math>? What does <math>C</math> represent? Which is the value of <math>C</math> in the graphic you chose?</p> 
<p>4. Simplify and solve the equation <math>a^2x - 3a^2 - bx + 3b^2 = 0</math>. What do <math>a</math>, <math>b</math> and <math>x</math> represent?</p>	<p>12. Which of the following circumferences are represented by <math>x^2 + y^2 = K</math>? What does <math>K</math> represent? Which is the value of <math>K</math> in the chosen circumference?</p> 
<p>5. Develop the expression <math>(x^2 - a)(x^2 + b)</math>. What do <math>x</math>, <math>a</math> and <math>b</math> represent?</p>	<p>13. Use symbols to express: The whole numbers that multiplied by 3 produce a multiple of 7. Explain the meaning of the symbols used.</p>
<p>6. Given the equation <math>m(x - 5) = m + 2x</math>, explain the role of <math>m</math> and <math>x</math> in the equation. For which values of <math>x</math> the equation has no solution?</p>	<p>14. Use symbols to express: The real numbers that after being multiplied by a constant are added to 4 and give a multiple of 5. Explain the meaning of the symbols used.</p>
<p>7. Given the equation <math>3x^2 + px + 7 = 0</math>, for which values of <math>p</math> the equation has only one solution? Which are the roles of <math>p</math> and <math>x</math> in this equation?</p>	<p>15. Use symbols to express: The lines with constant slope equal to <math>-2</math>. Explain the meaning of the symbols used.</p>
<p>8. All these equations belong to the same family: <math>3x + 2y = 5</math>; <math>23x + 7y = 5</math>; <math>-8x + 19y = 5</math>. Which is this family? Describe it in your own words and write an algebraic expression to represent it.</p>	<p>16. Write the symbolic expression you would use to solve the following problem but do not solve it: A rectangular land should be circled. There is a fixed longitude for the fence. Which is the area of the circled land in terms of the length of one side? Explain the meaning of the symbols used.</p>

TABLE 1

Usually the letter used for the slope in the general equation is  $m$  so, in order to help himself calculate it, this last student changed the original letter  $a$  to  $m$  and tried to calculate its value. The other one wrote: " $3=2a+3$ " substituting the given values in the equation, but it was observed from his work, that he was not able to continue because he could not accept  $a=0$  as the solution for the slope and  $y=3$  as the equation he was looking for.

Another evidence of students' tendency to use memorized facts to make sense of the role of the parameter is shown in their responses to question 3. The equation does not represent a line, but students who tried to distinguish between the roles of  $x$ ,  $y$  and  $m$  replied " $x$  and  $y$  are variables and  $m$  is constant because  $m$  is the slope". Most of them could not find any referent and they considered that the parameter was just a general number. They replied to this question writing " $x$ ,  $y$  and  $m$  are the variables" or "*all of them,  $x$ ,  $y$  and  $m$  can change*". Only one student referred to the equation of the circle and interpreted  $m$  as the radius.

When the geometrical referent was familiar and was supported with graphic representations (question 11), we observed that college students found a firm support to the interpretation of the parameter as a generalization of the Y intercept of a line in the graphical representation. This, however, was not the case for the majority of high school students, who did not even answer this item. When the geometrical referent was a circle (question 12) students were able, in general, to interpret the parameter as a generalization of something, but were not able to attribute a meaning to it, even when they were able to identify the circle related to the given equation. Only few students recognized the parameter as the radius of the circle.

The tested students have had experience with the equation of a line since the beginning of high school. However, they seem not to have understood it as expected but have only memorized some clue aspects of it. In the case of the circle, all students have had experience with its equation because a course in Analytic Geometry was compulsory for all of them, however, the equation of the circle was something less familiar still to them than the equation of a line. Students' responses show that only a very familiar geometrical context, can give support to the interpretation of the parameter.

When there was not a geometric referent, the structure of the algebraic expression was supposed to provide the referent allowing to differentiate the parameter from the other variables involved. To question 6 most of the students responded " $m$  and  $x$  are variables", " $m$  is an independent variable and  $x$  a dependent variable" or " $x$  is an unknown,  $m$  is a variable". But looking perhaps for a most clear referent, almost 2/3 of the students associated the letter  $m$  to the slope of a line. Nobody could manipulate the expression in order to determine the value of  $x$  for which the equation has no solution. Doing this implies to look at  $x$  and  $m$  as related variables, to express  $m$  as a function of  $x$  ( $m = 2x/(x-6)$ ) and to realise that the value of  $x$  should be other than 6. Students looked for the values that nullified the terms involving  $x$  by direct

inspection, ignoring completely its relation with the parameter, and they considered that the given equation had no solution when  $x = 5$  or  $x = 0$ .

In the case of quadratic equations, less than half of the students could work appropriately with the parameter involved in the expression. In question 7 where the parameter was part of the coefficient of the linear term, students were expected to recognise the algebraic structure of the equation and to recognise the role of the parameter in it. Moreover, they should look at  $p$  as an unknown and find the value of  $p$  that nullified the discriminant of the equation. The great majority of students found it difficult to make sense of this kind of situations. Many of them solved the equation ignoring the parameter. Others responded “*there is no value for  $p$ , since the equation is quadratic, it has to have two different results*”. Some students, however, recognised  $p$  as the unknown but they tried to find its value directly from the given expression and they wrote  $p = (-3x^2 - 7)/x$  and they could not continue.

#### *Results related to manipulation of parameters*

When facing an expression involving parameters, it is necessary to take a decision about the role that each symbol plays in the expression, and then proceed to manipulate the expression according to the requirements of the problem. The great majority of students could not attribute a specific meaning to the parameter and, in consequence, they were not able to manipulate it. Our data suggest that this difficulty is related to the fact that, even when students can differentiate in some way the role that the different letters play in a problem, they are not able to establish clearly their specific role. For example, in question 4, most of the students manipulated the symbols in an appropriate way considering all the letters involved as variables, but they were not able to solve the equation because they were not told explicitly which of the symbols was the unknown. In contrast, when it was clear that  $x$  was the unknown, they could manipulate and solve correctly. When told that the unknown of the equation was another letter than  $x$ , the rate of success decreased a lot.

When facing open expressions (question 5) where all the symbols play the role of general numbers, students were able to think of them that way. Most of them were able to manipulate these kind of expressions. For example, they could develop them when explicitly required and most of them wrote: “ $(x^2-a)(x^2+b) = x^4 + x^2b - ax^2 - ab$ ” and “ $(x^2-a)(x^2+b) = x^2(x^2+b) - a(x^2+b) = x^4 + x^2b - ax^2 - ab$ ”.

#### *Results related to symbolization of parameters*

To symbolise second order generalisations, where parameters should be included, is a very difficult task for students. Most of them ignored the parameter even in the cases where some of them could recognise the pattern leading the first order generalisations involved in the problem. When trying to use parameters, we found that they tended to over-generalise. This clearly appeared in the answers given to question 8. Some of them wrote “ $ax+by=c$ ” over-generalising. A lot of students answered “ $x+y=5$ ”, and many of them showed the contrary tendency, that is, they

gave a particular example such as " $18x+28y=5$ " showing in this way that they had recognised the family but that they were not able to represent it using parameters.

When a geometric referent was provided, for example a family of lines, only few of the students were able to recognize the family, to use a parameter to represent a specific feature of the family, and to show some examples of it, but they were not able to write a general expression to describe it. This is clear in the answers given to question 15. Typical responses to this problem were " $m=-2$ " or something such as " $Ax+By=C$ ", and some students gave an example such as " $y=-2x+3$ ".

When faced to verbal second order generalisations and asked to express it symbolically the great majority of students wrote expressions that did not reflect the meaning of the statement. Those who successfully symbolized the expression, showed lots of difficulty in interpreting the meaning of the different symbols they used to symbolize. This was the case of questions 13 and 14. The following answer shows that this student was able to symbolize the expression, but her understanding of symbols was limited: " $x.3=b$ , with  $b=7a$ , and  $x$  is the integer number we are looking for and  $a$  is the result of  $b$  divided by 7". She identified the symbol  $x$  with an unknown, could interpret  $a$  only in terms of the arithmetical operations required to obtain it, and did not explain the meaning of  $b$  in her own terms. Another student wrote " $x.3=7n$ " and then explained " $x$  is  $x$  and  $n$  is a number".

None of the students of this sample was able to symbolize a very simple problem involving parameters (question 16). They showed a tendency to use a symbol as a label for a given data, but not to use it to symbolize a whole expression. Typical responses to this question were: " $2h \times 2l$ ", " $la \times lb$ ", " $A=l^2$ " or " $A=b \times h$ : formula for the area", but none of the students could symbolize it correctly.

## Conclusions

The interpretation, manipulation and symbolisation of parameters was, in general, difficult for students, even for students who were taking college courses and were registered in programs where advanced mathematics are required. Our data suggest that to be able to differentiate parameters from other variables and to give meaning to them it is necessary for the students to have a clear referent or statement that gives meaning to the second order generalization, otherwise they can only perceive in it its character as general number. The referent can come from a familiar situation, in geometric or algebraic context, but students found it very difficult to assign it by themselves when needed. These results suggest that parameters are general numbers that acquire their algebraic meaning of general numbers of second order only when a specific referent can be given to them. We found that students relied strongly on memorized facts. Although, in general they tried to answer all the questions, they did not have enough resources to solve them and they used only what they could recall immediately. When they were not able to remember something useful in the solution of a problem they did not respond or they made up a quick answer out of context. In general they did not try to make sense of the problem in their own terms, even if they

had studied techniques that could be helpful in making sense of a particular situation. For example, when they solved the question related to the equation of the circle, none of them substituted coordinates in the equation in order to determine the role of the parameter in it. We found as well that manipulation of parameters depends on the possibility of the student to interpret them. When they could assign an appropriate meaning for them in the given expression, the manipulation was less of a problem for them. The use of parameters to symbolise a second order generalization was extremely difficult for students. Even in cases where they were able to write an expression they were not able to explain the different roles the symbols played in it.

Synthesising, our results confirm what Bloedy-Vinner and Furinghetti had signalled, that is, that the role of the parameters is very context dependent and that it is impossible to get away of the consideration of great logical complexity involved in the work with them. Our work shows, however, that the most important consideration about parameters is their role in second order generalizations. When teaching the use of parameters students' conceptions of them as general numbers should be taken as the starting point in order to help them approach second order generalisations and give meaning to parameters. Activities related to the different roles parameters can assume, according to the 3UV model, can help students discriminate between the roles they assume in specific problem situations. The results obtained make us wonder if presently students are really learning algebra at school. Gascón, Bosch and Bolea (2001) had already pointed out this problem. They underlined the fact that in school algebra letters usually play the role of unknowns and that parameters are very frequently absent, thus the formulae do not appear in these courses as the result of an algebraic generalisation and they do not play the role of algebraic models, but only of "rules" to be used in order to perform specific calculations. We consider our results totally agree with this assertion.

## References

- Bloedy- Vinner, H. (2001). Beyond unknown and variables – Parameters and dummy variables in high school algebra, in Sutherland, R., Rojano, T., Bell, A. and Lins, R. (Eds.) *Perspectives on school algebra*. Kluwer Academic Publishers, pp 177-189.
- Furinghetti, F. and Paula, D. (1994). Parameters, unknowns and variables: a little difference?, in *Proceedings of the XVIII International Conference for the Psychology of Mathematics Education*, University of Lisbon, Portugal.
- Gascón, J.; Bosch, M. and Bolea, P. (2001). ¿Cómo se construyen los problemas en didáctica de las matemáticas?, in *Educación Matemática*, 13-3, pp. 22-63.
- Trigueros, M. and Ursini, S. (2003). Starting college students' difficulties in working with different uses of variable, in *Research in Undergraduate Mathematics Education*. American Mathematical Society. Vol. 5.
- Ursini, S. and Trigueros, M. (2001). A model for the uses of variable in elementary algebra, in M. van den Heuvel-Panhuizen (Ed.). *Proceedings of the 25<sup>th</sup> Conference of the International Group for the Psychology of Mathematics Education, PME25*, Vol. 4, Freudenthal Institute. Faculty of Mathematics and Computer Science, Utrecht University, Utrecht, The Netherlands, pp. 4-327 - 4-334.

# CAUSES UNDERLYING PRE-SERVICE TEACHERS' NEGATIVE BELIEFS AND ANXIETIES ABOUT MATHEMATICS

Liisa Uusimaki & Rod Nason

Queensland University of Technology

*This article reports on a study that investigated the causes underlying a sample of eighteen third-year Australian pre-service primary teachers' negative beliefs and anxiety about mathematics. It was found that most of the participants' maths-anxiety could be attributed to their primary school experiences in learning mathematics. Situations such as teaching mathematics or being evaluated in mathematics were noted as particularly stressful and mathematical topics such as algebra, space and number sense were specifically identified to cause maths-anxiety. The paper concludes with a brief discussion about the implications of these findings for an ensuing program whose purpose is to help these pre-service teachers address their negative beliefs and anxieties about mathematics.*

## INTRODUCTION AND BACKGROUND

Teachers' beliefs about mathematics have a powerful impact on the practice of teaching (Charalambos, Philippou & Kyriakides, 2002; Ernest, 2000). It has been suggested that teachers with negative beliefs about mathematics influence a learned helplessness response from students, whereas the students of teachers with positive beliefs about mathematics enjoy successful mathematical experiences that result in them seeing mathematics as a discourse worthwhile of study (Karp, 1991). Thus, what goes on in the mathematics classroom may be directly related to the beliefs teachers hold about mathematics. Hence, it has been argued that teacher beliefs play a major role in their students' achievement and in their formation of beliefs and attitudes towards mathematics (Emenaker, 1996). Addressing the causes of negative beliefs held by pre-service primary teacher education students about mathematics therefore is crucial for improving their teaching skills and the mathematical learning of their students.

Negative beliefs about mathematics are often manifested in the phenomenon known as maths-anxiety. Although early research suggests that the term 'maths-anxiety' was rather an expression of general anxiety and not a distinct phenomenon (Olson & Gillingham, 1980), more recent research into maths-anxiety has recognized it not only to be more complex than general anxiety but also more common than earlier suggested (Ingleton & O'Regan, 1998). Thus, to understand maths-anxiety it must be recognized for its complexity. Maths-anxiety is not a discrete condition but rather it is a "construct with multiple causes and multiple effects interacting in a tangle that defies simple diagnosis and simplistic remedies" (Martinez & Martinez, 1996, p.2; Bessant, 1995). A definition by Smith and Smith (1998) takes into consideration this intricacy by encompassing both the affective and the cognitive domain of learning.

They state that maths-anxiety is a feeling of intense frustration or helplessness about one's ability to do mathematics, and can be described as a learned emotional response to participating in a math class, listening to a lecture, working through problems, and /or discussing mathematics to name but a few examples (Hembree, 1990; Le Moyne College, 1999).

The origins of negative beliefs and anxiety about mathematics can be classified into three categories: a) environmental, b) intellectual, and c) personality factors (Trujillo & Hadfield, 1999). Environmental factors include negative experiences in the classroom, parental pressure, insensitive teachers, mathematics being taught in a traditional manner as rigid sets of rules and non-participatory classrooms (Trujillo & Hadfield, 1999; Stuart, 2000). Intellectual factors include being taught with mismatched learning styles, student attitude and lack of persistence, self-doubt, lack of confidence in mathematical ability and lack of perceived usefulness of mathematics (Trujillo & Hadfield, 1999). Personality factors include unwillingness to ask questions due to shyness, low self-esteem and for females viewing mathematics as a male domain (Trujillo & Hadfield, 1999; Levine, 1996). From this it can then be seen that the origins of negative beliefs and anxiety about mathematics are as diverse as are the individuals experiencing maths-anxiety. For some people maths-anxiety is related to poor teaching, or humiliation and/ or belittlement whilst others may have learnt maths-anxiety from the maths-anxious teachers, parents, siblings or peers, or who may link their anxiety to numbers or only to some operations (Stuart, 2000). Research studies have found that maths-anxiety surfaces most dramatically when the subject either is or is perceived to be under evaluation (Tooke & Lindstrom, 1998).

In the case of many pre-service teachers, negative beliefs and anxiety about mathematics have their origins in prior school experiences such as their experiences as a mathematics student, the influence of prior teachers and of teacher preparation programs, as well as prior teaching experience (Raymond, 1997). For example, many negative beliefs held by teachers can be traced back to the frustration and failure in learning mathematics caused by unsympathetic teachers who incorrectly assumed that computational processes were simple and self-explanatory (Cornell, 1999). Research (e.g., Brown, McNamara, Hanley, & Jones, 1999; Nicol, Gooya & Martin, 2002; Trujillo, & Hadfield, 1999) suggests that a teacher's personal school experiences, especially at secondary level, influence the development of negative beliefs and anxiety about mathematics. This results in a considerable proportion of students entering primary teacher education programs with negative beliefs and attitudes towards mathematics (Carroll, 1998; Levine, 1996).

To help pre-service teachers to overcome their negative beliefs and anxiety about mathematics requires interventions that facilitate fundamental shifts in pre-service teachers' system of beliefs and conceptions about the nature and discourse of mathematics (Levine, 1996). This requires direct conscious action on the part of the



maths-anxious person. It also requires a clear definition of and reflection on the person's part about what particular kinds of mathematics causes negative feelings and anxiety (Martinez & Martinez, 1996). A person who says that he or she 'hates' mathematics may find on further reflection, that he or she 'hates' specific types of mathematics. For instance there may be a strong dislike for algebra whilst mental computation activities are seen as fun and challenging. Teacher educators can do much to facilitate this process by identifying: (a) the origins of pre-service teachers' negative beliefs and anxieties about mathematics, (b) situations causing negative beliefs and anxieties about mathematics, and (c) types of mathematics causing negative beliefs and anxieties about mathematics and then utilizing this information to inform the design of intervention programs that facilitate change in non-threatening ways to the pre-service teachers' beliefs and conceptions about the nature and discourse of mathematics.

Therefore, the aims of the research study were to: 1) identify the causes underlying our sample of pre-service teachers' negative beliefs and anxieties about mathematics, and 2) determine the implications of these causes for the design of an intervention program for these pre-service teachers.

## **METHODOLOGY**

### **Participants**

The eighteen participants in this study came from a cohort of approximately 300 third-year pre-service primary student teachers enrolled in a mathematics education curriculum unit at a major metropolitan university in Eastern Australia. The eighteen participants (17 female and 1 male) were selected from a pool of forty-five self-identified maths-anxious students who volunteered for the study. The criteria for selection were degree of maths-anxiety, access to internet, and availability to attend workshops.

### **Procedure**

The study proceeded in three stages: 1) Development of semi-structured interview, 2) Administration of semi-structured interview, and 3) Analysis of interview data.

#### ***Development of semi-structured interview***

The following four questions were designed for the semi-structured interview: 1) When did you learn to dislike mathematics? 2) Why did you learn to dislike mathematics? 3) What causes your maths-anxiety? and 4) What mathematical concepts cause your maths-anxiety? Questions 1 and 2 focused on the identification of the origins of the participants' maths-anxiety. Question 3 focused on the identification of situations causing maths-anxiety. Question 4 focused on identifying types of mathematics that caused them maths-anxiety. As was noted earlier in this paper, information about the origins of pre-service teachers' negative beliefs and

anxieties towards mathematics, and situations and types of mathematics causing maths-anxiety is needed for the planning of intervention programs aimed at helping pre-service teachers address their negative beliefs and anxieties about mathematics. The design of these questions was informed by the research literature on maths-anxiety (e.g., Martinez and Martinez, 1996; Smith & Smith, 1998), the formation of beliefs and attitudes towards mathematics (e.g., Cornell, 1999; Emenaker, 1996), and means of overcoming maths-anxiety (Carroll, 1999; Raymond, 1997).

### *Administration of semi-structured interview*

The eighteen participants were invited to attend a 20 minute semi-structured interview. Prior to the interview that was conducted by the researcher the purpose of the research study was explained to each participant. During the course of the interview, follow-up questions that enabled the researcher to delve deeper into the thoughts that underlay their responses to questions were administered. The interviews were audio-recorded for later transcription.

### *Analysis of interview data*

After the initial familiarisation reading of the transcripts, the transcripts then were read more closely. From this reading an initial set of emerging themes were identified and listed for each of the three issues being investigated (namely the origins of maths-anxiety, situations causing maths-anxiety, and types of mathematics causing maths-anxiety). The initial themes were then entered into a table. The transcripts were iteratively revisited in order to find data to support or refute the themes. This led to the modifications to the list of themes for each of the issues investigated. The process of analysis was completed by going back to the interview transcripts and ascertaining the number of participants per theme. The totals for each theme were then converted to percentage scores.

## **RESULTS**

### **Issue 1: Origins of negative beliefs and anxiety about mathematics**

The analysis of data revealed that 66% of the participants (n = 12) perceived that their negative beliefs and anxiety towards mathematics emerged in primary school. Linda for example, remembers “exactly” what year in primary school she learnt to dislike mathematics.

When I was in Grade 5 and we started doing division and I was away the very first day they introduced division and I came back the next day and I had no clues what everyone else in the class seemed to know really well. And my teacher never took the time to actually sit down and go through it with me so I was trying to play catch up and I feel like I've been playing catch up every since...

Out of 12 participants who traced their negative beliefs and anxieties back to negative mathematical experiences in primary school, two of the participants identified specific mathematics content, such as learning the multiplication table in grade 2 and abacus, as the cause for their maths-anxiety. One of the participants traced her negative beliefs about mathematics back to her mother. Significantly, the remaining 9 participants specifically identified primary school teachers for their learnt dislike and fear of mathematics. Tina, for example, remembers the time in primary school as a time when,

I used to make lots of mistakes and I was always frightened... I vividly remember, actually in Grade 1, getting into huge trouble because I couldn't fit a puzzle together. I vividly remember that. Just absolutely getting caned by this teacher.

The analysis also revealed that 22% of the participants ( $n = 4$ ) identified secondary school as a time when they learnt to dislike mathematics. Like the 12 participants who identified primary school experiences as where their negative beliefs and anxiety towards mathematics originated, all four of these participants specifically identified secondary school teachers as the major contributing factor for their learnt dislike of mathematics. Petra's comment about one of her secondary school mathematics teachers exemplified the type of comments made by these four participants about some of their secondary mathematics teachers.

I had a teacher called Mr O, a bit of a Hitler looking fellow but I just have visions of him throwing dusters at students you know to get their attentions and he just never explained anything... just wrote it on the board and then you just copied it and then you just had to really go home and try and work it out so I was pretty stressed about that 'cause I kept thinking you need to talk about it, you need to go through it together and ask whether you understand it.

Only 11% of the participants ( $n = 2$ ) identified tertiary education as the time when their negative beliefs and anxieties towards mathematics emerged. An important aspect of the comments made by these two participants was that their negative beliefs about mathematics was not traced back to how mathematics was taught but back to specific content of mathematics.

### **Issue 2: Situations causing most maths-anxiety**

The participants felt most anxious about mathematics when they had to communicate their mathematical knowledge in some way (48%), for example, in test situations or verbal explanations. Also, causing a lot of anxiety was the teaching of mathematics in practicum situations (33%) due to insecure feelings of making mistakes or not being able to solve it correctly. For example, Rose explains that her most anxious moments are:

When I'm being called on to answer questions... and I don't know the right language and I try to answer the question as best I can but you don't really get your meaning across because you don't understand the language and you don't know what language to use.

Testing... Just when somebody tests my knowledge... It does and it makes me feel as if I don't know what I am talking about.

### **Issue 3: Types of mathematics causing maths-anxiety**

Two strands from the Queensland Studies Authority (2003) syllabus caused most anxiety: 'algebra and patterns' (33%) and 'space' (31%). Number operations especially division, was also a concern (21%). The anxiety caused by these strands was well exemplified by Ann's response to Question 4.

Long division! Couldn't ever do that. Dividing. Can't do that. Times tables. You know how they used to learn the times tables. I still can't do them because they sing that song. One, ones are one and all that and I never had a very good memory so I could never learn them. I'm making myself sound really bad... And with addition and subtraction, I still use my fingers to count up things... I used to do it under my desk so the teacher couldn't see 'cos you're supposed to know just what 6 plus 6 is without counting it on your fingers sort of thing.

### **SUMMARY AND CONCLUSIONS**

Most of the findings from this study regarding the causes of negative beliefs and anxieties about mathematics were consistent with the findings reported in the research literature. (e.g., Brown, McNamara, Hanley, & Jones, 1999; Carroll, 1998; Cornell, 1999; Nicol, Gooya, & Martin, 2002; Trujillo, & Hadfield, 1999). For example, this study found that the origin of maths-anxiety in most of these participants could be attributed to prior school experiences (cf., Levine, 1996; Martinez & Martinez, 1996). Whilst the literature suggests that negativity toward mathematics originates predominantly in secondary school (e.g., Brown, McNamara, Hanley, & Jones, 1999; Nicol, Gooya & Martin, 2002), data from this study suggests that negative experiences of the participants in this study most commonly originated in the early and middle primary school. The perceived reasons for these negative experiences are attributed to the teacher, particularly to primary school teachers (72%) rather than to specific mathematical content or to social factors such as family and peers.

Situations which caused most anxiety for the participants included communicating one's mathematical knowledge, whether in a test situation or in the teaching of mathematics such as that required on practicum. This is consistent with findings in the literature that suggests that maths-anxiety surface most dramatically when the subject is seen to be under evaluation (e.g., Tooke & Lindstrom, 1998). Specific

mathematical concepts, such as algebra, followed by space and number sense, caused most concern amongst the participants.

Many of these findings have clear implications for the intervention program to follow this study. For example, the findings that many of the participants' maths-anxiety was teacher-caused indicate the need for the facilitator in the ensuing workshops to be warm, non-intimidating and supportive in nature. The findings also imply that the participants need to be provided with learning environments where they are able to: 1) freely explore and communicate about mathematics in a supportive group environment 2) explore and relearn basic mathematical concepts, and 3), apply this re-learned knowledge in real-life and authentic situations. As evidenced by the latent themes in the participants' responses, it is also clear that isolation and evaluation anxieties will not be allayed via merely arming pre-service teachers with content knowledge. This would act to further problematise the individual and dismiss the fundamental importance of the individual feeling part of an emerging mathematics community in which they perceive themselves to be supported.

### References:

- Bessant, K. (1995). Factors associated with types of mathematics anxiety in college students. *Journal for Research in Mathematics Education*, 20(4), 327-345.
- Brown, T., McNamara, O., Hanley, U., & Jones, L. (1999). Primary student teachers' understanding of mathematics and its teaching. *British Educational Research Journal*, 25(3), 21.
- Carroll, J. (1998). *Understanding professional development through the analysis of the mathematical life histories of primary school teachers*. Retrieved 21 April, 2003, from <http://www.aare.edu.au/98pap/car98138.htm>
- Charalambos, C., Philippou, G., & Kyriakides, L. (2002). *Towards understanding teachers' philosophical beliefs about mathematics*. Paper presented at the International Group for the Psychology of Mathematics Education (PME), Norwich UK.
- Cornell, C. (1999). I hate math! I couldn't learn it, and I can't teach it! In *Childhood education*. Washington, USA: Association for Childhood Education.
- Emenaker, C. (1996). A problem-solving based mathematics course and elementary teachers' beliefs. *School Science and Mathematics*, 96(2), 75-85.
- Ernest, P. (2000). Teaching and learning mathematics. In V.Koshy, P. Ernest, & R. Casey (Ed.), *Mathematics for primary teachers*. London, UK: Routledge.
- Hembree, R. (1990). The nature, effects, and relief of mathematics anxiety. *Journal for Research in Mathematics Education*, 21(1), 33-46
- Ingleton, C., & O'Regan, K. (1998). *Recounting mathematical experiences: Using memory-work to explore the development of confidence in mathematics*. Retrieved 10 June, 2003, from <http://www.aare.edu.au/98pap/ore98260.htm>

- Karp, K. S. (1991). Elementary school teachers' attitudes toward mathematics: The impact on students' autonomous learning skills. *School science and mathematics, 91*(6), 265-270.
- Le Moyne College. (1999). *Study skill guides: Math anxiety*. Retrieved 21 April, 2003, from [http://www.lemoyne.edu/academic\\_support\\_center/mathanx.htm](http://www.lemoyne.edu/academic_support_center/mathanx.htm)
- Levine, G. (1996). *Variability in anxiety for teaching mathematics among pre-service elementary school teachers enrolled in a mathematics course*. Retrieved 12 September, 2003, from <http://gateway.library.qut.edu.au:2127/Webstore/CommonSearchResults.asp?>
- Martinez, J. G. R., & Martinez, N. C. (1996). *Math without fear*. Needham Heights, MA: Allyn and Bacon.
- Nicol, C., Gooya, Z., & Martin, J. (2002). *Learning mathematics for teaching: Developing content knowledge and pedagogy in a mathematics course for intending teachers*. Paper presented at the Proceedings of the 26th Conference of the International Group for the Psychology of Mathematics Education., Norwich, UK.
- Olson, A. T., & Gillingham, D. (1980). Systematic desensitization of mathematics anxiety among preservice elementary teachers. *Alberta Journal of Educational Research., 26*, 120-127.
- Queensland Studies Authority (2003) Mathematics: Core learning outcomes for years 1 to 10. Retrieved 22 August, 2003, from [http://www.qsa.edu.au/yrs1\\_10/kla/matheamtics/overview.html](http://www.qsa.edu.au/yrs1_10/kla/matheamtics/overview.html)
- Raymond, A. M. (1997). Inconsistency between a beginning elementary school teacher's mathematics beliefs and teaching practice. *Journal for Research in Mathematics Education., 28*(5), 550-577.
- Stuart. (2000). Math course or math anxiety? *Teaching children mathematics, 6*(5).
- Smith, B. S., & Smith, W. H. (1998). *Coping with math anxiety*. Retrieved 20 June, 2003, from [http://www.mathacademy.com/platonic\\_realms/mini-text/anxiety.html](http://www.mathacademy.com/platonic_realms/mini-text/anxiety.html)
- Tooke, D. J., & Lindstrom, L. C. (1998). Effectiveness of a mathematics methods course in reducing math anxiety of preservice elementary teachers. *School science and mathematics, 98*(3), 136-140.
- Trujillo, K. M., & Hadfield, O., D. (1999). Tracing the roots of mathematics anxiety through in-depth interviews with preservice elementary teachers. *College Student Journal, 33*(2), 11.

## FRACTIONS IN ADULT'S ELEMENTARY SCHOOL: THE CASE OF LUCINA

Marta Elena Valdemoros Alvarez

Cinvestav – IPN, México

**Abstract.** *The case of Lucina must be placed at a level of a partial advance achieved in the development of an exhaustive qualitative research recently conclude in a night elementary school of Mexico City, an institution that provides young people and adults with academic formation. The research problem herein discussed is the enrichment of semantic and conceptual contents of fractions in relation to the solution of arithmetic problems that allow the reconstruction of previous vital experiences of the subjects. The case of Lucina is analyzed in light of the application of an exploring questionnaire that preceded to realization of two didactical interview applied to a 41-year-old woman attending to sixth grade of elementary school. The didactical interviews were the main source of information in the study reported herein.*

### Introduction

The United Nations (1997) has recognized that one of the most important spaces today is education for adults and the research derived from the same, which have been put aside in the international setting for multiple reasons. In Mexico, more that one million young and adult persons receive elementary instruction in different institutions belonging to the State, which are integrated to the programmed system and to the public open teaching system.

In order to efficiently assist this important field, it is require to investigate the main contents of mathematical education developed in such setting and the learning they propitiate. The use of fractions and the treatment of meanings and concepts herein discussed constitute one of the main milestones of such arithmetical instruction.

### Theoretical Framework

Messina (1993), García Carrasco (1997), Jóia (1997), Mariño (1997), Soto (1997) among other researchers recognize that general knowledge and mathematical knowledge to be acquired in school by young people and adults in an elementary formation process must begin as of the accumulation of experiences and knowledge achieved in different social settings, that its, in the other vital spaces such people evolve. This coincides with what Gimeno and Pérez (2000) have characterized as a “critical reconstruction of reality”, by approaching to the situations proposed through several teaching treatments.

In this way, young people and adults have a symbolic field loaded with sense for global learning and for the specific follow-up of fractions through posing and solving problems which, from the educative institution, reconstruct scenes of real family, work and community life (ratifying what was previously posed in Valdemoros, 2000). Also, as a reference to the last source, it is worth saying that while natural numbers facilitate varied non-school learning within several cultural spaces, fractions are accompanied with a more limited repertoire of “previous knowledge” (we adopt an expression widely spread by researchers as Mariño, 1997).

We consider that semantic contents, notions and concepts referred to fractions present a great diversity in the field of school solution of arithmetic problems. Therefore, the meanings of **measure**, **intuitive quotient** (related to sharing situations), **multiplicative operator** and **ratio** are recovered in this study, according to Kieren (1984, 1985, 1988), who attributes several applications of fraction numbers in a concrete field. The meanings of the **part-whole relationship** and the **unit** notion are also retaken since such researcher considers them as fundamental supports of the semantic contents previously indicated. Regarding the **multiplicative operator**, it has mainly been granted with effect of **fracturing operator** according to the contributions made by Freudenthal (1983) and Streefland (1993), attributing it the role of such fraction that is related to the dynamic partitioning of a whole.

We also recovered from Piaget, Inhelder and Szeminska (1966) the acknowledgement of the **part-whole and part-part relationships**, which constitute the structural bases of the fraction concept, which are, respectively, support for the addition and multiplication of fractions.

### **Research Problem**

Based on the aforesaid, we assume a cognoscible focus that privileges the active role markedly carried out by **young and adult people when constructing meanings, notions and concepts of fraction in the field of arithmetic solution problems that recover relevant experiences of life**, being the latter the **research problem** discussed in this study. After having identified such research problem, we formulated the following **question**:

*What type of arithmetic tasks can favor, in better conditions, the construction of several meanings, notions and concepts of fraction in young and adult people?*

Facing such research question, we explicit the **hypothesis** that it is **in the solution of arithmetic problems where work, community and family experiences are involved by young and adult persons when they are enriched and effectively construct new meanings, notions and concepts related to fractions**.

### **Method**

**Methodological Instruments.** The questionnaire and the “didactical interview” (under the foundations given on the same in Valdemoros, 1998) were included in the study.

**1. Initial Questionnaire.** It was **exploratory** and was submitted to the qualitative analysis of its results. It was applied in order to be able to choose in better conditions the subjects of the case study, as to have general information regarding all the young and adult persons integrating the school groups with whom the research was carried out. The problems or tasks comprised in the questionnaire presented a brief text carefully complemented by certain drawings that allowed as a whole to achieve “a reconstruction of several aspects of their life experiences.”



This instrument was composed by eight tasks, where the **meanings of the fraction as quotient resulting from concrete sharing situations, measure, ratio and multiplicative operator** were involved. The **part-whole relationship** was investigated in more specific way through tasks that required its differentiation from the **part-part relationship**. The **unit** was preferably explored around the discrimination of **continuous and discrete wholes**, as well as through the reconstruction task of a discrete whole from the initial identification of one part. Young and adult persons were asked to complete, translate and interpret different information expressed through several representation channels (texts, arithmetic-technical notations, geometric figures, drawings of different nature); they were also asked to carry out diverse partitioning tasks, the recognition of equivalence relationships and the realization of elementary additions and subtractions of fractions.

**2. Didactical Interviews.** Every subject to be interviewed was chosen for his/her performance in the questionnaire. Two different interviews were carried out to five young and adult persons. These interviews were individual and semi-structured: each of the subjects was submitted to tasks of common design (similar to those included in the questionnaire), so the interview results could be compared to the results obtained in the five cases.

The didactical nature of the interviews was determined by the succession of two moments differentiated in their realization: a) an initial exploring phase, where we tried to determine the advance of each subject by their own means and, b) a final didactical-constructivist phase where the interviewer tried to promote in the interviewed the overcoming of the cognitive difficulties that arose in his/her previous evolution feeding him/her back, but never proposing solutions or obstructing new searches looked for by the subject. The passage from the first to the second moment of the interview was assessed in each situation and depended on having exhausted all the reasonable possibilities of the initial exploration. The interview constituted the main instrument in the development of the case study.

**Subjects.** The students who solved the exploratory questionnaire were 17 young and adult persons incorporated to fourth, fifth and sixth grades of elementary school, with ages between 14 and 70 years old with different working activities (construction workers, domestic workers, housewives, ambulatory marketers, artisans, etc.). From the five cases submitted to study, we only present the case of Lucina, a 41-year-old domestic worker incorporated to sixth grade of night school and who is near to conclude her elementary education. We chose Lucina because she had started her studies when she was a child, leaving it inconcluded since then and recently retaking it and advancing a little more than a half of her elementary studies in the primary school for adults, where she has evidenced a good evolution in the learning of new knowledge and in the update of the previous knowledge.

**The research site.** The investigation was developed in a night public elementary school of Mexico City, located in a peripheral neighborhood inhabited by workers from different rural zones of the country. The school is integrated by small groups of

teenagers and adults who correspond to the six grades established in all educational institutions of this type belonging to the public school teaching system.

**Qualitative Validation Procedures.** Regarding the questionnaire, “cross controls” were applied between two observers since it was an ideal resource for such instrument and did not create resistance in Lucina. In the interviews, in virtue that they were made simultaneously (with the intervention of two researchers and two interviewed adults), it was decided to “triangulate” different processes of solution displayed by the selected woman before analogue arithmetic problems.

### **Analysis of the Results Obtained in Lucina’s Case**

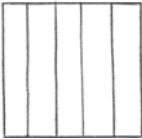
We privileged the follow-up of the representation modes adopted by the chosen woman, as well as the cognitive difficulties detected in the domain of some meanings, the semantic contents that presented a systematic aspect in Lucina and the type of arguments with which she justified the respective processes in problem solving.

#### **• Results Registered in the Initial Exploring Questionnaire**

Globally, in the realization of the **questionnaire** she evidenced a correct use of fractions, appealing to notations expressed in technical language whenever she was asked to give the solution of the corresponding task in such way.

In an analogue way, Lucina exhibited a careful domain of the equal partition in those arithmetic problems where she had to make the sub-division of a collection in sub-collections, or, the sub-division of a figure given in a pre-established number of parts. However, in the partition problem presented in the questionnaire she was able to adequately carry out the equal partition of the continuous whole, but could not correctly identify the fraction she was required, as it is shown in Figure 1.

A father gives to his five sons and daughters a piece of land like the following:



Please mark in the previous drawing how can it be distributed in such a way that each of the five sons and daughters receive the same. Write the corresponding fraction:


**Thus, each son/daughter has 5/5 of the whole piece of land.**

Figure 1. Lucina carried out a careful equal partition, but did not indicated properly the fraction of the whole that corresponded to each of the beneficiaries in the partition of the land.


Regarding the direct recognition of the equivalence relationships between fractions, she evidenced clear difficulties in the management of the same, maybe she made an ambiguous interpretation of the task presented. Figure 2 exemplifies it through the

solution given by Lucina to a simple problem of the initial exploring questionnaire, where she only pointed out one of the subjects involved in the equivalence relationship, but omitted the other subject compromised in such relationship, with which the recognition of the equivalence was not given.


The artisan is covering with red enamel the shadowed parts of these metallic shields:



Shield A



Shield B



Shield C

Use arrows to link the following columns:

Shield A	→	2/4 painted in red
Shield B	→	4/8 painted in red
Shield C	→	3/8 painted in red

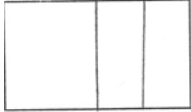
In which shields does the artisan uses the same amount of red paint?  
Shield C

Figure 2. Lucina solved in an incomplete way an elemental problem of equivalence among fractions in the initial exploring questionnaire.

In general, Lucina expressed proper interpretations of the continuous whole and of the discrete whole. It was notorious that in several tasks she showed her need to highlight the global conformation of the whole in the figure included to the problem. Regardless of what we just observe, Lucina was not able to identify the fractions correctly in a recognition task of the part-part relationships as exposed in Figure 3.

Presumably, this took place because the previous learning had excluded that type of elaborations in school work.

Jose has a rectangular piece of land where he planted flowers in  $\frac{1}{2}$  of it. He planted roses in a  $\frac{1}{4}$  of such half.



Indicate in the drawing the part where he planted flowers and the part he dedicated to roses.


What part of all the piece of land did Jose dedicated to roses? 3/4 three quarters

Figure 3. The task of the questionnaire where Lucina was not able to identify properly the part-part relationship.

• **Global Performance of Lucina in the Interviews**

I. During the **first interview** some of the activities of the questionnaire were reconstructed; in order to do so, the interviewer intervene promoting new elaborations and feedbacking the answers as it has been describe in the **Method**. We illustrate the aforesaid with Lucina’s re-questionings regarding the familiar piece of land among five brothers (see Figure 4).

A father gives to his five sons and daughters a piece of land like the following:



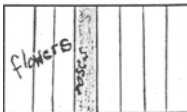
In the previous drawing, how can the piece of land be distributed in order that all five sons and daughters receive the same.  
Write the corresponding fraction:  
**Thus, each son/daughter has  $\frac{1}{5}$  of the whole piece of land.**

Figure 4. In the first interview, Lucina confirmed the equal partition of the initial questionnaire rectifying the fraction related to each beneficiary of the partition.

In the same interview, other activities of the initial questionnaire were reconstructed appealing to simplifications resources of the tasks causing many difficulties. We exemplify this with Lucina’s reconstructions included in Figure 5.

Figure 5 and its contrast to Figure 3 allow the appreciation of the advances that Lucina achieved in the setting of the tasks involving the part-whole and part-part relationship with the subsequent identification of the fraction.

Jose has a rectangular piece of land where he planted flowers in  $\frac{1}{2}$  of it. He planted roses in a  $\frac{1}{4}$  of such half.



Indicate in the drawing the part where he planted flowers and the part he dedicated to roses.  
What part of the piece of land did Jose dedicated to roses?  
 $\frac{1}{4}$


Figure 5. A posteriori of several re-elaboration processes, Lucina re-posed the part-part relationship during the first interview.

Likewise, during the first interview and when reconstructing the task already presented in Figure 2, the interviewed properly recognized the equivalence relationship among the fractions, which is pointed explicitly and in relation to “shields A and C”.

**II.** In the **second interview** new arithmetic problems were introduced, where Lucina showed an efficient management of the **fraction as a measure**.

In those situation involving simple proportional variations, the interviewed woman privileged the use of the **fracturing operators**, of the “**dividing by half**” type, which consideration allowed her to fundament the corresponding solution. Figure 6 shows an example of what we just expressed.

Mrs. Martinez knits cloths with crochet needles. For the following cloth, she needed 4 hanks of thread.



She has been asked to make a cloth which size is half the area of the previous cloth. How many hanks does she need to knit it? 2 hanks of thread.

Explain how did you solve it. Thinking that if for the first cloth she used 4 hanks and is going to make another that measures half of it, then it is two hanks of thread.

Figure 6. The interviewed supported her process in the consideration of the fracturing operator when solving a very simple situation of proportional variation.

Before this situation and paying attention to the circumstance that other adults evidenced similar solution processes, we assume that it will be advisable to introduce the elemental didactical treatment of proportions as of a wide use of fracturing operators as initial tools highly loaded with sense.

### Conclusions

The case presented has allowed to confirm the hypothesis sustained at the beginning of the study, that is, **it is in the resolution of arithmetical problems where working, community and family experiences are re-posed by adults when they are enriched and effectively construct new meanings, notions and concepts related to fractions.**

In the beginning, through the questionnaire, it was confirmed that the domain of basic semantic contents by Lucina was the key to carry out properly the solution process of the arithmetic problems she was presented to, while some of her cognitive difficulties were detected regarding the part-whole and part-part relationship. The “didactical” interviews gave wide and clear evidences of construction and reconstruction of meanings, notions and concepts of fractions when solving problems that favored the mathematical re-elaborations of her life experiences.

## References

- Freudenthal, H. (1983). *Didactical Phenomenological of Mathematical Structures*. Dordrecht, Holland: D. Reidel.
- García Carrasco, J. (1997). *Educación de adultos*. Barcelona: Ariel. 1-22.
- Gimeno, J. & Pérez, a. (2000). *Comprender y transformar la enseñanza*. Madrid: Morata.
- Joya, O. (1997). Cuatro preguntas sobre la educación matemática de jóvenes y adultos (27-30). In: *Conocimiento matemático en a educación de jóvenes y adultos*. Santiago, Chile: UNESCO-SANTIAGO.
- Kieren, T. (1983). Partitioning, equivalence and the construction of rational number ideas. *Proceedings of the Fourth International Congress of Mathematical Education*. 506-508.
- Kieren, T. (1984). Mathematical knowledge building: The mathematics teacher as consulting architect. *Proceedings of the Fifth International Congress of Mathematical Education*. 187-194.
- Kieren, T. (1985). Graphical algorithm in partitioning tasks. *The Journal of Mathematical Behaviour*, 4, 25-36.
- Kieren, T. (1998). Personal knowledge of rational numbers: Its intuitive and formal development 162-181). In: J. Hiebert y M. Behr (Ed.), *Number concepts and operations in the middle grades*, 2. Reston, Virginia: National Council of Teachers of Mathematics.
- Mariño, G. (1997). Los saberes matemáticos previos de jóvenes y adultos: alcances y desafíos (77-100). In: *Conocimiento matemático en la educación de jóvenes y adultos*. Santiago, Chile: UNESCO-SANTIAGO.
- Messina, G. (1993). *La educación básica de adultos: La otra educación*. Santiago, Chile: UNESCO-OREALC. 197-207.
- Piaget, J., Inhelder, B. & Szeminska, A. (1966). *The child's conception of Geometry*. London: Routledge and Keagan Paul.
- Soto, I. (1997). Algunas proposiciones sobre la didáctica para la enseñanza de las matemáticas de jóvenes y adultos (119-130). In: *Conocimiento matemático en la educación de jóvenes y adultos*. Santiago, Chile: UNESCO-SANTIAGO.
- Streefland, L. (1993). The design of a Mathematics course. A theoretical reflection. *Educational Studies in Mathematics*, 25, 109-135.
- United Nations (1997). Plan de acción para el futuro de la educación de adultos. *Fifth International Conference on Adult Education*. Hamburgo, Alemania.
- Valdemoros, M. (1993). *La construcción del lenguaje de las fracciones y de los conceptos involucrados en él*. Doctoral Thesis. Mexico: Cinvestav.
- Valdemoros, M. (1998). La constancia de la unidad en la suma de fracciones: Estudio de caso (465-481). In: F. Hitt (Ed.). *Investigaciones en Matemática Educativa II*. Mexico: Iberoamérica.
- Valdemoros, M. (2000). Los problemas aritméticos elementales resueltos por el alumno. *Resúmenes de la Decimocuarta Reunión Latinoamericana de Matemática Educativa*. 23-24.
- Valdemoros, M. (2001). Las fracciones, sus referencias y los correspondientes significados de unidad: Estudio de casos. *Educación Matemática*, 13, 1. 51-67.

This research project was supported by CONACYT, the Mexican Council for Promotion of the Science and Technology.

# STUDENTS' OVERRELIANCE ON PROPORTIONALITY: EVIDENCE FROM PRIMARY SCHOOL PUPILS SOLVING ARITHMETIC WORD PROBLEMS

Wim Van Dooren<sup>1,2</sup>, Dirk De Bock<sup>2,3</sup>, An Hessels<sup>2</sup>, Dirk Janssens<sup>2</sup>  
and Lieven Verschaffel<sup>2</sup>

<sup>1</sup> Research Assistant of the Fund for Scientific Research (F.W.O.) – Flanders  
<sup>2</sup> University of Leuven and <sup>3</sup> European Institute of Higher Education Brussels; Belgium

*Building on previous research on the tendency in students of diverse ages to overrely on proportionality in different domains of mathematics (e.g., geometry, probability), this study shows that – when confronted with missing-value word problems – Flemish primary school pupils strongly tend to apply proportional solution strategies, also in cases where they are not applicable. The evolution of this tendency is also investigated. It appeared that the overreliance on proportionality already emerges in the 2<sup>nd</sup> grade, but it increases considerably up to the 5<sup>th</sup> grade.*

## THEORETICAL AND EMPIRICAL BACKGROUND

One of the most important goals in nowadays' reform documents and curricula on mathematics education is that students should acquire the ability to develop and use powerful models to make sense of everyday life situations and of the complex systems stemming from modern society (ICMI Study 14 – Discussion Document, 2002). Traditionally, the way of teaching mathematical modelling and applied problem solving in primary school is through the use of word problems. These word problems are assumed to offer an acceptably good substitute for “real” problems that the learners may encounter outside their mathematics lessons (Verschaffel, Greer, & De Corte, 2000).

Nevertheless, during the last 10-15 years, several investigations have shown that – due to the stereotyped diet of the word problems offered to students and to the way in which these problems are handled by teachers – students start to perceive word problem solving as a puzzle-like activity with little or no grounding in the real world, and as something quite far removed from the goal-directed, more authentic activity of mathematical modelling of “real” problems (for an extensive overview, see Verschaffel et al., 2000). Often, students can successfully use very superficial cues to decide which operations are required to solve a particular word problem in a traditional textbook or test. Arguably, such instruction does not lead to the ability to discriminate between cases where a certain arithmetical operation is required and where it is not appropriate, but rather to stereotyped, superficial coping behaviour.

One of the clearest examples of such a “corrupted” modelling process is students' tendency to overgeneralise the range of applicability of the proportional model. Because of its wide applicability in pure and applied mathematics and science, proportional reasoning is a major topic in primary and secondary mathematics education. Therefore,

typically from grade 3 or 4 of primary school on, pupils are frequently confronted with “proportionality problems” such as: “10 eggs cost 2 euro. What is the price of 30 eggs?” There are studies, however, that indicate that at the beginning of secondary education pupils associate such “missing-value problems” (word problems in which three numbers are given and a fourth one is asked for) automatically with the scheme of proportionality, even when it does not appropriately model the problem situation (see, e.g., De Bock, Verschaffel, & Janssens, 1998, 2002). It seems as if these students develop the tendency to assume proportional relationships “anywhere”. For example, several studies (Verschaffel et al., 2000) found that more than 90% of the pupils at the end of primary school answered “170 seconds” to the following “runner” item: “John’s best time to run 100 metres is 17 seconds. How long will it take him to run 1 kilometre?” Another utterance of this excessive adherence to proportionality – observed in numerous studies – can be seen in students making graphs (e.g. drawing a straight line through the origin when representing the relation between the length and age of a person) (Leinhardt, Zaslavsky, & Stein, 1990). But also history provides several cases of unwarranted applications of proportionality (e.g., Aristotle believing that if an object is ten times as heavy as another object, it will reach the ground ten times as fast). The most systematically investigated case of the improper application of proportionality probably stems from geometry. In a series of experimental studies, De Bock and his colleagues have shown that there is a widespread and almost irresistible tendency among secondary school students to believe that if a figure enlarges  $k$  times, the area and volume of that figure are enlarged  $k$  times too (De Bock et al., 1998, 2002). Moreover, students were almost insensible to diverse types of help (drawings, metacognitive support, ...), and systematic remedial teaching had only a limited positive effect (Van Dooren, De Bock, Hessels, Janssens, & Verschaffel, 2003).

Besides continuing the empirical research concerning this “proportionality illusion” in geometry, we recently set up a new line of research to explore the tendency towards unwarranted proportional reasoning in other mathematical domains. The first new domain in which we investigated this tendency is probabilistic reasoning (Van Dooren, De Bock, Depaepe, Janssens, & Verschaffel, 2003). We found that 10<sup>th</sup> and 12<sup>th</sup> graders, and even university students, strongly tend to assume proportional relationships when comparing the probability of two events. For example, many of them believed that if one has 4 trials to roll a die, the probability of getting a six is double as large as if one gets only 2 trials.

## **UBIQUITOUS APPLICATION OF PROPORTIONALITY IN SOLVING ARITHMETIC WORD PROBLEMS**

The remarkably strong tendency towards unwarranted proportional reasoning in secondary school students – as observed in the studies mentioned above –, raises the question when and how the tendency to apply proportionality to missing-value problems actually originates and develops. Therefore we set up a new study with different age groups of primary school children. Because of the young age of the participants, we used rather simple arithmetic word problems (instead of the geometry or probability



problems used in our previous studies). A review of the literature revealed that cases of unwarranted proportional reasoning may occur in reaction to two different kinds of arithmetic word problems: “unsolvable” and “solvable” ones.

First, there are studies in which “unsolvable” problems elicited proportional strategies. We already mentioned the studies reported in Verschaffel et al. (2000), in which proportional answers were observed for several items, e.g. the “runner” item cited above or items like: *“A shop sells 312 Christmas cards in December. About how many do you think it will sell altogether in January, February and March?”* There is, however, a problem with the interpretation of pupils’ proportional answers here. There is no logico-mathematical relation between the givens in these items, so an exact answer cannot be given. Puchalska and Semadeni (1987) call this type of word problems “pseudoproportionality problems”. As Reusser and Stebler (1997) demonstrated, pupils sometimes realise that a proportional model is inappropriate for the problem but give a proportional solution anyhow because they believe or feel it is necessary to give a numerical answer to every word problem.

Besides these “unsolvable” problems, there is a second category of non-proportional arithmetic problems, for which an exact numerical answer can be calculated. Nevertheless, unwarranted proportional answers were also observed for these problems. An example is the “ladder” problem used by Stacey (1989) with 9- to 13-year olds: *“With 8 matches, I can make a ladder with 2 rungs, as the one you see on the drawing. [Figure 1] How many matches do I need to make a ladder with 20 rungs?”* The most frequently

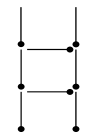


Figure 1

observed erroneous answer was  $10 \times 8 = 80$  matches. (for similar examples, see Linchevski, Olivier, Sasman, & Liebenberg, 1998). Another – even more striking – example comes from Cramer, Post and Currier (1993): 32 out of 33 pre-service elementary teachers answered proportionally to the following problem: *“Sue and Julie were running equally fast around a track. Sue started first. When she had run 9 laps, Julie had run 3 laps. When Julie completed 15 laps, how many laps had Sue run?”* Similar results were recently obtained by Monteiro (2003). Finally, there is also an item used in a study by Van Lieshout, Verdwaald and Van Herk (1997). They found that many children answered the following “biker” item as if proportionality was appropriate: *“Joris and Pim live in the same house. They bike home together on 8 minutes. How many minutes must Joris bike when he bikes home alone?”*

In the study that we will report in the rest of this paper, we only used non-proportional word problems from the second category (i.e. the “solvable” problems). The problems in our study were self-generated, but inspired by the above-mentioned studies.

## RESEARCH QUESTIONS AND HYPOTHESES

The goal of the study was to search for the origins of students’ tendency to apply the proportional model to solve non-proportional problems, and to describe how it evolves with age and educational experience. We hypothesized that – because of the wide applicability and intrinsically simple and intuitive character of the proportional model –

the overgeneralization of the proportional model would already be present at the beginning of primary education, more precisely when children begin to learn how to multiply and to divide and to recognize when to apply these operations in (standard) word problems (in Flanders, this is in grades 2 and 3). We also hypothesized that these errors would reach their peak when proportional relationships are systematically taught in classroom and when textbooks abound with “typical” missing-value proportional problems (i.e., in grades 4 and 5 in Flanders).

## METHOD

729 primary school pupils participated in this study, belonging to three randomly selected Flemish schools. They were more or less equally divided over grades 2 to 6. Pupils from grade 3 to 6 received a paper-and-pencil test containing 10 experimental word problems in random order. The second graders only received the 5 easiest problems, and they were presented to them both in written and oral form. All problems were missing-value problems and were formulated as identical as possible.

The 10 experimental word problems were developed according to the design in Table 1. As can be seen in this table, the 10 word problems belonged to 5 categories. One category consisted of *proportional* problems (i.e. problems for which a proportional strategy leads to the correct answer) and the other 4 categories contained diverse types of *non-proportional* problems (i.e. problems for which another strategy must be applied to find the correct answer). These 4 types referred to different non-proportional mathematical models underlying the problem, i.e., additive, constant, linear (but not proportional), and a pattern. For each of the 5 problem categories an “easy” and a “difficult” version was designed, carefully controlling for the difficulty level within a category (and therefore the difference between the “easy” and “difficult” category) in several ways (number size, calculation complexity, provision of a drawing, verbal complexity).

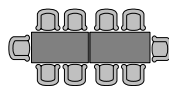
	Easy	Difficult
<b>Proportional</b>	1	6
<b>Non-proportional</b>		
Additive	2	7
Constant	3	8
Linear	4	9
Patterns	5	10

Table 1: Design of experimental items

By strictly controlling the formulation of the problem and manipulating the two experimental factors (category and difficulty level), differences in performance could very likely be attributed to these two experimental factors, rather than to uncontrolled differences in technical reading difficulty or complexity of calculations.

Due to space restrictions, we only give one exemplary item here, namely the (non-proportional) linear item 4. Several other items will be given in the results section.

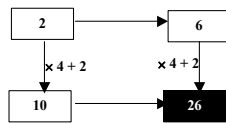
*In the hallway of our school, 2 tables stand in a line. 10 chairs fit around them. Now the teacher puts 6 tables in a line. How many chairs fit around these tables?*



This word problem is non-proportional, since there is no proportional relationship between the number of tables and the number of chairs fitting around. Instead, there is a linear function of the form  $f(x) = ax + b$  (graphically represented by a straight line but

not going through the origin) underlying the problem situation. In Figure 2 the known and unknown elements in the problem – and the relations between them – are represented. The correct reasoning (see Figure 2a) is that there are 4 chairs around each

2a: correct solution



2b: proportional

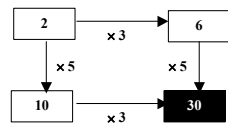


Figure 2 : Representation of the correct (fig 2a)

table plus 2 chairs at both heads of the table line (thus  $(6 \times 4) + 2 = 26$  chairs around 6 tables). Incorrect proportional solutions (see Figure 2b) could consist of reasoning that there are 3 times as many tables (6 instead of 2), so 3 times as many chairs ( $3 \times 10 = 30$ ) fit around (i.e. using the internal ratio), or that there are 10 chairs for 2 tables, meaning 5 chairs per table, so 30 chairs for 6 tables (i.e. applying the “rule of three”). For each of the other non-proportional items, a similar schematic representation was made, distinguishing the correct reasoning for that item from the incorrect proportional one(s).

Pupils’ answers to the problems were classified as either “*correct*” (= the correct answer was given), a “*proportional error*” (= a proportional strategy applied to a non-proportional item) or an “*other error*” (= another solution procedure was followed, or the item was not answered). When a purely technical calculation error was made, the answer was still categorised as either *correct* or *proportional* (depending on the reasoning that was made). Due to space restrictions, we will limit ourselves to the frequency of correct answers (for proportional problems) and the frequency of proportional answers (for non-proportional problems).

## MAIN RESULTS

Table 2 presents the performances for the *proportional items* of each grade. The data clearly show that the ability to solve the proportional problems gradually increased from grade 3 until grade 6, where proportional reasoning was nearly perfectly mastered. The greatest progress was made from grade 3 to 4 and from grade 4 to 5.

Grade→	2	3	4	5	6	Total
Item 1 (easy)	68.2	68.5	83.7	93.9	96.4	82.1
Item 6 (diff)		39.2	63.7	86.7	93.4	73.0
<b>Total</b>		53.9	73.7	90.3	94.9	79.9

Table 2: % correct answers on the proportional problems

Table 3 presents the percentages of proportional answers for the eight *non-proportional items*. For all non-proportional items, 38.5% proportional solution methods were found. Nevertheless, large differences exist between the age groups and between the different types of word problems. Whereas the tendency to apply proportions was already present in the 2<sup>nd</sup> grade, it strongly increased over grades 3, 4 and 5, before slightly decreasing in 6<sup>th</sup> grade. Since there are major differences in the number of proportional answers for

the different categories of non-proportional items (and between the two versions of each category), we will now consider the results for each problem category in detail.

With respect to the *additive* items, there was a sharp difference between the number of proportional answers to the easy and the difficult variant. The easy additive problem (i.e., item 2) (“*Today, Bert becomes 2 years old and Lies becomes 6 years old. When Bert is 12 years old, how old will Lies be?*”) elicited only a small percentage of unwarranted proportional solutions in grades 2, 3 and 4 (1.5%), but remarkably, for this item, proportional reasoning suddenly showed up in more than 10% of the 5<sup>th</sup> and 6<sup>th</sup> graders (e.g. thinking that initially, Lies is 3 times as old as Bert, and that this should also be the case when Bert is 12 years old). A parallel, but much more pronounced evolution was observed for the difficult additive problem (item 7): “*Ellen and Kim are running around a track. They run equally fast but Ellen started later. When Ellen has run 5 rounds, Kim has run 15 rounds. When Ellen has run 30 rounds, how many has Kim run?*” While in 3<sup>rd</sup> grade incorrect proportional solutions were practically absent, this type of error strongly increased with grade, so that by grade 6 more than half of the pupils made the proportional error (e.g. thinking that Kim initially has run 3 times as many rounds as Ellen, and that this ratio also holds at the second moment)!

The largest number of proportional answers was undoubtedly elicited by the most “atypical” word problems, i.e. the *constant* items. Already in 2<sup>nd</sup> grade, 41.7% of the pupils solved the “easy” item 3 (“*Mama put 3 towels on the clothesline. After 12 hours they were dry. The neighbour woman put 6 towels on the clothesline. How long did it take them to dry?*”) proportionally, and the percentage of pupils making this error went up to 82.4% in the 5<sup>th</sup> grade! A parallel evolution was found for the “difficult” item 8 (“*A group of 5 musicians plays a piece of music in 10 minutes. Another group of 35 musicians will play the same piece of music. How long will it take this group to play it?*”): 35.4% of the 3<sup>rd</sup> graders applied a proportional strategy and this raised to 72.1% of the 5<sup>th</sup> graders.

The same increase in the number of proportional answers was observed for the “easy” *linear* item 4 (the “tables” item already cited in the methods section). Whereas already more than one third of the 2<sup>nd</sup> graders solved this item proportionally, this raised to almost two thirds of the 5<sup>th</sup> graders. For the difficult variant (item 9: “*The locomotive of*

Grade→	2	3	4	5	6	Total
<b>Additive</b>						
Item 2 (easy)	1.5	1.5	1.5	11.5	12.6	5.7
Item 7 (diff)		4.6	17.0	35.8	50.3	28.8
<b>Constant</b>						
Item 3 (easy)	41.7	59.2	72.6	82.4	70.1	71.7
Item 8 (diff)		35.4	49.6	72.1	41.3	50.4
<b>Linear</b>						
Item 4 (easy)	37.1	46.1	57.8	64.9	61.1	53.4
Item 9 (diff)		32.3	37.0	39.4	31.7	35.2
<b>Patterns</b>						
Item 5 (easy)	15.9	33.9	34.1	33.3	23.3	28.1
Item 10 (diff)		21.5	36.4	29.1	22.2	25.8
<b>Total</b>	24.1	29.3	37.5	46.1	39.1	38.5

Table 3: % proportional answers on the non-proportional problems

a train is 12 m long. If there are 4 carriages connected to the locomotive, the train is 52 m long. If there would be 8 carriages connected to the locomotive, how long would the train be?") the number of proportional errors was lower, but again, the peak was observed in the 5<sup>th</sup> grade.

The *patterns* problems generally elicited less proportional answers than the other problem categories. Our analysis has shown that pupils made a lot of other errors here, which is not surprising because these problems required a rather complex reasoning. For example, item 10 was: "*Jan participates in a quiz. Each time he wins a round, his points are doubled. After the second round, he has 8 points. When Jan wins all rounds up to round 6, how many points does he have?*" The correct answer to this problem (128 points) was found by only about 15% of the 4<sup>th</sup>, 5<sup>th</sup> and 6<sup>th</sup> graders, whereas more than 60% of them made another error than the proportional one. Nevertheless, the general trend also seems to hold for these "patterns" items: some of the 2<sup>nd</sup> graders already applied proportional solution strategies, and the number of pupils making this error increased up to grade 5 and then slightly decreased in grade 6.

## CONCLUSIONS AND DISCUSSION

This study essentially combined two lines of research. On the one hand, there are the studies showing that when solving word problems, primary school pupils tend to apply very superficial solution strategies, to exclude their real-world knowledge and to believe that all mathematics problems can be solved by applying some simple operations on the given numbers. On the other hand, there are studies revealing that students of diverse ages persistently apply proportionality "anywhere", in different mathematical domains. Our study has shown that primary school pupils strongly tend to apply proportional solution strategies when confronted with non-proportional missing-value word problems. The tendency already emerged in the 2<sup>nd</sup> grade, but it increased considerably up to 5<sup>th</sup> grade. By then, pupils have had increasing training in solving proportionality problems. Despite important differences between the different item categories, this trend seems general. Currently, we are using the same research instrument to collect data with secondary school students (in grades 7 and 8), in order to investigate the further evolution of the tendency to give proportional answers to the diverse non-proportional word problems.

Keeping in mind the goal that students should be able to develop and apply mathematical models to make sense of everyday life situations, the data from our study are quite alarming. Pupils use superficial cues (e.g. linguistic hints in a word problem) to decide upon a solution scheme. In this respect, the proportional model seems to have a special status. Because of its intrinsic simplicity and intuitiveness, and because of the attention it gets in (elementary) mathematics education, the proportional model is prominently present in pupils' minds, and they strongly overrely on it.

Our study stresses the importance of approaching mathematics from a genuine modelling perspective from the very beginning of primary education on. In treating

some basic mathematical concepts (e.g., multiplication, division, direct and inverse proportionality) immediate attention should also be paid at these concepts' capacity of describing, interpreting, predicting and explaining situations, with a strong emphasis on the "fitness" of models for specific situations (Lesh & Lehrer, 2003; Verschaffel et al., 2000). So, instructional moments wherein word problems are used mainly to create strong links between mathematical operations and prototypically "clean" model situations should be alternated with other lessons wherein applied problems are used primarily as exercises in relating real-world situations to mathematical models and in reflecting upon that complex relationship between reality and mathematics.

## References

- Cramer, K., Post, T., & Currier, S. (1993). Learning and teaching ratio and proportion: Research implications. In D. T. Owens (Ed.), *Research ideas for the classroom: Middle grades mathematics* (pp. 159-178). New York: Macmillan.
- De Bock, D., Verschaffel, L., & Janssens, D. (1998). The predominance of the linear model in secondary school students' solutions of word problems involving length and area of similar plane figures. *Educational Studies in Mathematics*, 35, 65-83.
- De Bock, D., Verschaffel, L., & Janssens, D. (2002). The effects of different problem presentations and formulations on the illusion of linearity in secondary school students. *Mathematical Thinking and Learning*, 4(1), 65-89.
- ICMI Study 14 – Discussion document (2002). *Educational Studies in Mathematics*, 5(1), 149-171.
- Leinhardt, G., Zaslavsky, O., & Stein, M. K. (1990). Functions, graphs, and graphing: Tasks, learning, and teaching. *Review of Educational Research*, 60(1), 1-64.
- Lesh, R., & Lehrer, R. (2003). Models and modeling perspectives on the development of students and teachers. *Mathematical Thinking and Learning*, 5(2-3), 109-129.
- Linchevski, L., Olivier, A., Sasman, M. C., & Liebenberg, R. (1998). Moments of conflict and moments of conviction in generalising. In A. Olivier & K. Newstead (Eds.), *Proceedings of the 22<sup>nd</sup> Conference of the International Group for the Psychology of Mathematics education* (Vol. 3, pp. 215-222), Stellenbosch, South Africa.
- Monteiro, C. (2003). Prospective elementary teachers' misunderstandings in solving ratio and proportion problems. In N. A. Pateman, B. J. Dougherty & J. Zilliox (Eds.), *Proceedings of the 27<sup>th</sup> Conference of the International Group for the Psychology of Mathematics Education* (Vol. 3, pp. 317-323), Honolulu, Hawai'i.
- Puchalska, E., & Samadeni, Z. (1987). Children's reactions to verbal arithmetical problems with missing, surplus or contradictory data. *For the Learning of Mathematics*, 7(3), 9-16.
- Reusser, K., & Stebler, R. (1997, August). *Realistic modelling through the solving of performance tasks*. Paper presented at the 7th EARLI Conference, Athens, Greece.
- Stacey, K. (1989). Finding and using patterns in linear generalising problems. *Educational Studies in Mathematics*, 20, 147-164.
- Van Dooren, W., De Bock, D., Depaep, F., Janssens, D., & Verschaffel, L. (2003) The illusion of linearity: Expanding the evidence towards probabilistic reasoning. *Educational Studies in Mathematics*, 53, 113-138.

# FROM FUNCTIONS TO EQUATIONS: INTRODUCTION OF ALGEBRAIC THINKING TO 13 YEAR-OLD STUDENTS

Vasiliki Farmaki, Nikos Klaoudatos, Petros Verikios

Department of Mathematics, University of Athens

*The various difficulties and cognitive obstacles that students face when they are introduced to algebra are well documented and described in the relevant bibliography. If it is possible, in order to avoid these difficulties, we have adopted the functional approach widening the meaning of algebraic thinking. In this paper, which is part of wider research, we concentrate on problems that are modelled by linear equation with the unknown on both sides. We investigate the advantages and disadvantages of the functional approach in the solutions of these kinds of problems. The findings from our research suggest that the functional approach indeed gives the beginners a satisfactory way of answering, while the typical solution by equation demands maturity on the part of the students and could be postponed for a later time.*

## INTRODUCTION

Research in teaching and learning algebra has detected a number of serious cognitive difficulties and obstacles especially to novice students, see for example Tall and Thomas (1991). One of the important themes that research has focused on is the solution of linear equations and problems related to them. Kieran (1997) and Sfard & Linchevsky (1994) have indicated difficulties related with the use and meaning of the symbol of equality, while Kieran (1985) and Kuchemann (1981) found misunderstandings about the use and meaning of letters, to name only a few. In the transition from arithmetic to algebra one of the important steps seems to be the solution of  $ax+b=cx+d$  and its variation  $ax+b=cx$ , Filloy and Rojano (1989), Herscovics and Linchevski (1994). This particular form of equation has been a subject of dispute in bibliography. For example, Filloy and Rojano suggest that this equation demands teacher's intervention 'the didactic cut', while Herscovics and Linchevski locate their argument in the student's cognitive development. We accept the position of Pirie and Martin (1997) that rather than an inherent difficulty in the solution of linear equations, the cognitive obstacle is created by the very method, which purports to provide a logical introduction to equation solution. Our classroom experiences say that, indeed, this kind of equation puts a very heavy burden on the students.

In this paper we adopted the functional approach to algebra which widens the meaning of algebraic thinking. Then, through problems which are expressed by equations of the form  $ax+b=cx+d$  or  $ax+b=cx$ , we examine the students' solution processes by the two approaches, functional and letter-symbolic. Our goal is the



investigation of the advantages and disadvantages of the functional approach in the solutions of problems, which demand the solution of equations of this kind.

## **A CONDENSED THEORETICAL FRAMEWORK**

According to Lins (1992, p.12), to think algebraically is: (1) to think arithmetically, which means modelling in numbers, and (2) to think internally, which means reference only to the operations and equality relations, in other words solutions in the boundaries of the semantic field of numbers and arithmetical operations, and (3) to think analytically, which means what is unknown has to be treated as known. A central notion in this view is the intention to make the shift from the situational context to the mathematical context. Although this view is quite serious, it can be considered as a base of the traditional way of teaching algebra because, in the educational praxis, this approach is prone to well-known manipulation of symbols according to fixed rules.

Recently approaches have been developed in algebra that broaden the meaning of algebraic thinking. One of these approaches is the functional one, see for example Kieran (1996), Kieran et al (1996), (Yerushalmy (2000). A functional approach assumes the function to be a central concept around which school algebra can be meaningfully organized. This means that representations of relationships can be expressed in modes suitable for functions and that the letter-symbolic expressions are one of these modes. Thus, algebraic thinking can be defined as the use of any of a variety of representations in order to handle quantitative situations in a relational way, Kieran (1996, p.275). This approach can be used in two ways, namely as a cognitive support for introducing and sustaining traditional discourse of school algebra and as having its own value. In our approach we use both of them. So the research question of the paper can be reformulated as follows: Does the functional approach sustain a problem solving process in problems modelled by equation with the unknown on both sides? What are the connections between this approach and the letter-symbolic solution processes? What are the advantages and disadvantages of each one?

## **THE RESEARCH DESIGN**

In the Greek curriculum for the second class of 13-year-old students in junior high school, equations precede the functions and in the students' textbook they are found in two different chapters. The solution of equations  $ax+b=c$  and  $ax+b=cx+d$  is presented in a typical way, concentrating on symbol manipulations, while in functions the linear one of the form  $y=ax+b$  is the main subject. We point out that the equation chapter contains, as a final paragraph, simple inequalities. For this reason investigating the solution of inequalities was another goal of our approach, but we will not make any reference to this subject in this paper.



In order to investigate the questions above, we developed a course consisting of 26 lessons of 45 minutes each, four lessons per week. This course replaced the course on equations and the one on functions. The functional orientation enabled us to connect various problem situations to graphs, tables and letter-symbolic representations as well as to connect these representations to the notion of equation. At the beginning of the solution of a problem, attention was paid to the graphic representation of it, where  $x$  was seen as a variable rather than an unknown quantity. In this way the symbols as letters, lines or tables, acquired a meaning from the situational context of the problem. So, problems which traditionally could be answered only by the solution of an equation were now treated in many ways: By trial and error working on a table, by the graphic representation or by an equation. During the course one PC and a video projector were available to the teacher. The PC was used to provide graphs and to develop a class discussion on the qualitative aspects of the tasks. At the end of the course, one and half months later, a post-test was given to the class, considered from then on as the experimental group, as well as to a second class, considered the control group, in which the teaching of equations followed the textbook. Then, a number of interviews were implemented by the third author. Eight students from the experimental group participated in five interviews each, which covered all the subjects of the course. Moreover, two students from the control group participated in the same interviews. The subject of one of these interviews was a break-even task which was modelled by the equation  $ax+b=cx$ . The qualitative elaboration and comparison of the post-test results between the two groups as well as the interviews on the break-even task were the data we used for the present research. In the following we will focus our attention mainly on the break-even task, presenting extracts from two interviews, one from the experimental group and one from the control group.

## **THE BREAK-EVEN TASK**

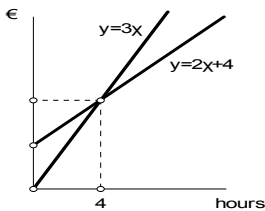
Mr. Georgiou goes by car every work day to the centre of Athens, where his office is located. Nearby there are two car parks. The first demands 4 euros to enter and 2 euros per hour. The second demands only 3 euros per hour. Mr Georgiou does not have a regular timetable. So, his choice about where he parks his car depends on how many hours he will stay at his office. Questions: 1. Express the amount of money as a function of time for both car parks 2. For how many hours can he park his car and pay the same amount of money at each car park?

### **Background to the first interview**

During the course the students developed experience in constructing graphs and solving problems through qualitative understanding of the given situational tasks. The solutions came from the work on graphs, with an accurate coordinate system which was distributed by the teacher, after a class discussion. In general, we used three ways to move from graphs to equations, according to the three ways of representations:

First, giving a specific value of the dependent variable on a table and asking for the associate value of the independent variable  $x$ . Second, from the graph of  $y=ax+b$ , asking for the value of the independent variable  $x$  when  $y$  had a specific value. Third, equating the letter-symbolic representations of two lines, in order to find the coordinates of their point of intersection algebraically. This last case was presented in class through the ‘renting a car’, a problem similar to the break even task. The final part of the course was devoted to the formal solutions of linear equations. In order to achieve the conceptual understanding of the steps to the solution, the teacher persisted in the justification of every step, for example he used the metaphor of balance for moving e.g. a number from one part of the equation to the other, the role of distributive law etc.

First interview, Helen (an average performer in mathematics): After the teacher presented the problem, she constructed tables according to the problem descriptions. From this work she gradually conceived the mechanism through which she developed the functions that represented the money to be paid in the two car parks, which are  $y=2x+4$  and  $y=3x$ . Moreover, by randomly choosing  $x=4$  she found the correct answer, see her tables below. Then the interviewer encouraged her to work in another way. Helen constructed the graphs of the two functions.



1<sup>st</sup> par. 

x	4	10	2	12	1	5
y	12	24	8	28	6	14

 $y = 2x + 4$

2<sup>nd</sup> par. 

x	4	10	2	12	1	5
y	12	30	6	36	3	15

 $y = 3 \cdot x$

Helen: Here...at the point of intersection...well...it does not matter in which car park he will park his car, he will pay the same amount of money.

I (interviewer): How much money?

H: (she constructs perpendicular lines to two axes by hand, then she finds 4 on x axis and 11.5 approximately on y axe): 11.5 hours

I: Are you sure?

H: Yes...wait a minute...what x represents...no, in four hours he will pay 11.5 euros.

I: Are you sure that here it is 11.5?

H: No because I do not have a ruler to construct the line more accurately.

I: Can you find it in a different way?

H: ...precisely...yes to make calculations...if I put y equals three times four to one and y equals two times four plus four (she refers to the formulae, then she finds the correct number, 12 euros).

Up to now Helen was able to solve the problem as she applied what she had learned in the course. She developed, even in a primitive way, abilities for planning, monitoring and, to some extent, executive control. We see that Helen connects the three different representations that model the problem. In other words, she has identified the relationships which connect tables and graphic representations to the letter symbolic system. This means that she has developed meaningful understanding of the problem, which has to do with the relationships that formal configurations of symbols have to other kinds of internal representations. The situation changed rapidly when the interviewer urged her to solve the problem using an equation. In his question ‘Can you solve the problem in another way?’ she was unable to answer. Then the interviewer helped her.

I: Which is the unknown in the second question?

H: The hours

I: If Mr. Georgiou parks his car x hours, how much money will he pay to the first car park?

H: x equals...do we know the y?

I: Why?

H: ...because it says he will pay the same money...can I do it?

I: What?

H:  $y=2x+4$  equals to  $3x$  or  $y=3x$

I: What do you think, can you do it?

H: It has two unknowns

Here the interviewer decided on a second intervention:

I: Can you write it without the y?

H: ...yes...yes I can (She writes  $2x+4=3x$ )...it is an equation

Helen’s difficulty with the problem reformulation in terms of an equation was not the typical case for the other students. For example, Sotiris, a low performer in mathematics, showed considerable facility in formulating the problem by an equation, as the following extract shows:

I: Can you formulate it? (the problem's equation)

S: ...we have  $4+2x=3x$

I: Can you explain it?

S: From the two functions we developed in order to calculate the money he must pay to two car parks.

For most of the experimental group students the difficulties arose when they started solving the equation. In this part we saw all the cognitive difficulties the bibliography has detected in the solution of equations. For example, many students were in a state of embarrassment in cases such as: manipulation of rational numbers, about the terms of an equation, the coefficient of the unknown, the use of terminology, in explaining the steps of their solution, to 'see' the best way of solving the equation, to conceive the zero (0) as an ordinary number.

### **Background to the second interview**

The teaching of equations in the control group followed the students' textbook. Although the chapter uses problems mainly of a 'real' context as a starting point, the course quickly turns to the training of typical solutions of equations. As a result, many students are able to follow the appropriate steps to find the solution, but in most cases they do not make any reference to the problem and to the meaning of the symbols. On the other hand, the cognitive difficulties did not 'disappear' from this kind of course, as we see from the extract below.

Second interview, Sonia (an average performer in mathematics): At first she could not answer the problem. Then the interviewer suggested constructing tables, through which she gradually found the appropriate functions. The interviewer gave her the graphs of the two functions and asked her to answer the second question on her own. Then she formulated the equation  $2x+4=3x$  which she solved correctly. During the solution process she justified her steps by practical rules such as: 'When I change sides in an equation I change the sign' or 'I separate the unknown from known quantities because we cannot add numbers and letters'. When the interviewer asked her if she could solve the problem in another way she was unable to give an answer. Then, the interviewer presented a rectangle whose two-adjacent sides have lengths of 5 and  $x+6$ . He asked Sonia to find an expression of the perimeter. Sonia wrote  $x+6+x+6+5+5$ .

I: Can you write it in a simpler form? (Se writes  $6x^2 + 5^2$ )

I: How much is  $5^2$ ?

S: ...oh... (then she writes  $12x+10$ )

I: When you were trying to solve the equation, in the previous problem, you said that we cannot add letters and numbers, but here what are you doing?

S: ...yes...(she writes correctly  $2x+22$ )

I: Can we write this as  $22+2x$ ? (the interviewer's intention was the distributive law)

S: I think ...yes... (then she writes  $24x$ ).

This extract shows us that teaching the algorithm of solving equations can hardly be considered as a way towards the development of algebraic thinking. On the other hand we do believe that the conceptual understanding of the solution's process of equations is very important and be the final stage of a long term study in introductory algebra.

## DISCUSSION AND CONCLUSIONS

As we see from the very short evidence we have presented, the functional approach gave students a way to answer problems that are expressed by the equation with the unknown on both sides. Moreover, because of the familiarity of the situational context, the students had at their disposal a suitable referential field in which the symbols acquired meaning, see for example Gialamas et al (1999). And this meaning was used in other representations e.g. tables or equations, thus connecting, at a first level, the functional approach to letter-symbolic representation. At the same time we found indications of the development meta-cognitive processes, such as using different representations to find an answer, as Helen did in the case of 12 euros. A cognitive difficulty to this approach emerged during the first interview. We observed that the presence of the two variables  $x$  and  $y$ , can cause difficulties to some students as was the case of Helen who, as she was trying to form the equation of the problem, saw 'two unknowns'  $y=2x+4=y=3x$ . We consider this difficulty as 'natural' for beginners, but attention must be paid in such cases pointing out that  $y$  is a different 'name' for the expression  $2x+4$ . On the other hand, it is clear to us that the solution of the equation is a difficult endeavor for beginners. Even in the case of the control group we cannot speak about conceptual understanding. These findings suggest that solving these problems using equation is not appropriate for beginners. It demands maturity, so it could be postponed for a later time, see also, for example, Yerushalmy. Until then the functional approach can help students answer these problems. On the other hand, the functional approach also has its own value because it enables the students to develop problem solving abilities such as the heuristics 'trial and error', 'draw a diagram' and, for some students, 'solve an equation'. Moreover, it fosters visual thinking, a mathematical mode especially useful today in the advent of new technology.

## References

- Filloy, E. & Rojano, T. (1989). Solving equations: the transition from arithmetic to algebra. *For the Learning of Mathematics*, 9 (2), 19-25.
- Herscovics, N. & Linchevski, L. (1994). A cognitive gap between arithmetic and algebra. *Educational Studies in Mathematics*, 27, 59-78.
- Gialamas V., Karaliopoulou M., Kladoudatos N. & Papastavridis S., (1999). Real problems in school Mathematics, in Zaslavsky, O., (ed), *Proceedings of the 23<sup>rd</sup> conference of PME*, vol. 3, 25-32.
- Kieran, C. (1981). Concepts associated with the equality symbol. *Educational Studies in Mathematics*, 12, 317-326.
- Kieran, C. (1985). Constructing meaning for equations and equation-solving. In A. Bell, B. Low, & J. Kilpatrick (Eds.), *Theory, Research & Practice in Mathematical Education*, 243-248. University of Nottingham, UK: Shell Center for Mathematical Education.
- Kieran, C. (1996). The changing face of school Algebra. In 8<sup>th</sup> international congress on mathematical education selected lectures, 271 – 286. S.A.E.M. ‘THALES’.
- Kieran, C., Boilean, A., & Garancon, M. (1996). Introducing Algebra by means of a Technology- Supported, functional approach, in Bednarz, N., Kieran, C. & Lee, L. (eds). *Approaches to Algebra: Perspectives for research and teaching*. Kluwer A.P.
- Kieran, C. (1997). Mathematical concepts at the secondary school level: The learning of algebra and functions. In Nunes T., Bryant P., (eds), *Learning and Teaching Mathematics: An International Perspective*. Psychology Press, 133-162.
- Kuchemann, D. E. (1981). Algebra. In K. Hart (Ed.), *Children’s Understanding of Mathematics*, 102-119. London: Murray.
- Lins, R.C. (1992). A framework for understanding what algebraic thinking is, *Thesis submitted to the University of Nottingham for the degree of Doctor of Philosophy*.
- Pirie, S. & Martin, L. (1997). One approach to the teaching of linear equations, *Educational Studies in Mathematics* 34, 159–181.
- Sfard, A. & Linchevsky, L. (1994). The gains and the pitfalls of reification. The case of Algebra, *Educational Studies in Mathematics*, 26, 191-228.
- Tall, D., & Thomas, M.. (1991). Encouraging versatile thinking in algebra using the computer, *Educational Studies in Mathematics*, 22, II, 125-147.
- Yerushalmy, M. (2000). Problem solving strategies: A longitudinal view on problem solving in a function based approach to algebra, *Educational Studies in Mathematics* 43, 125–147.

# CRITICAL AWARENESS OF VOICE IN MATHEMATICS CLASSROOM DISCOURSE: LEARNING THE STEPS IN THE 'DANCE OF AGENCY'

David Wagner

University of New Brunswick, Canada

*This account of my extended conversation with a high school mathematics class focuses on voice and agency. I prompted the students daily to become ever more aware of their language practices in class. The tensions in this conversation proved parallel to the tensions in mathematics between individual initiative and convention, a tension that Pickering (1995) calls the 'dance of agency'.*

## BACKGROUND

"You shouldn't use any voice, you should use the general voice. I've termed it the general voice because I'm cool and I can make my own terms." These are the words of Joey, a 17 year old boy, reflecting on his use of the 'I' voice in mathematics class ('Joey' is a pseudonym). This proclamation, together with its context, illustrates some of the possibilities opened up when mathematics students become more aware of their language practice. Joey was part of a high-school mathematics class that I engaged in a semester-long conversation with a view to raising their 'critical language awareness'. In this report, I show how a strand of this extended conversation relates to what Pickering (1995) calls the 'dance of agency'.

Morgan (1998), as a result of her extensive study of secondary school mathematics writing, identifies the need for students to become more aware of their language practice. She laments typical students' mathematical writing, because it tends to be a poor reflection of their mathematics, even their good mathematics. Her work focuses on written language practices in the mathematics classroom. I suggest that similar challenges exist for oral communication. Since Pimm (1987) introduced discourse analysis to mathematics education scholarship, there has been growing interest in the nature and form of mathematics classroom discourse (e.g. Rowland, 1997; Bills, 2002; Wagner, 2003). Discourse analysis has tremendous potential for providing insight into mathematics and its classroom practice. Like Morgan, I want both mathematics students and educators to benefit from increased language awareness.

Linguists Lilie Chouliaraki and Norman Fairclough (1999) have constructed a framework for analyzing discourse for critical purposes. With this framework, they encourage the use of discourse analysis for the identification of "the range of what people can do in given structural conditions" (p. 65). I suggest that this purpose is

well-suited to mathematics students. Though there is much potential for analyzing classroom discourses for other purposes – for example, to say what form these discourses *ought* to take – students have relatively little control over the discursive systems in their mathematics classrooms. I believe they could benefit from exploring various ways of living within the discourse space they encounter daily. They would do well to consider the range of possibilities available for them to participate in this space, to ask: which discursive forms are arbitrary and which are necessary?

## RESEARCH METHOD

Assuming that mathematics classrooms would benefit from increased critical language awareness (see Fairclough, 1992), an important question remains: how can it be brought about effectively? In Wagner (2003), I began to answer this question by analyzing transcripts of interviews in which students responded to audio-taped excerpts of themselves working on pure mathematics investigations. These interviews did not focus on language per se, but the analysis is instructive for applying critical language awareness to the mathematics classroom, especially because the audio excerpts highlighted the students taking initiative in mathematical exploration.

Subsequently, I chose to work closely with one group of mathematics students for an extended period of time. I spent a nineteen-week semester with a grade 11 pure mathematics class, co-teaching the course with the regular teacher and collecting video and audio records of classroom discourse. By directing the students' attention to their own utterances, I tried daily to engage the students in discussion about our language practices in the class. The form of my prompts varied, as I was continually responding to the participants. In addition to our classroom interaction about language, I interviewed participant students and asked them to write accounts of their experiences with language in relation to their mathematics learning.

This research was an investigation of possibility. Skovsmose and Borba's (2000) methodology for critical mathematics education research guided me: "it is by no means a simple truth that research should deal with what *is*. [...] doing *critical research* means (among other things) to research *what is not there* and *what is not actual*" (emphases theirs, p. 5). Following their model, I saw the 'original situation' of the participant class as a situation that I wanted to see transformed. I imagined a situation in which students would notice aspects of their language practice and through this noticing become more aware of the nature of mathematics and of possibilities for them to relate to the mathematics.

My agenda was not the same as the students' agenda for this class. In fact, our agendas, or 'imagined situations' kept changing as we were responding to each other. Therefore, I could not expect the classroom developments to follow my plan. Indeed, I needed to expect disruption, to welcome it. Valero and Vithal (1998) illustrate the importance of disruption in research settings and argue against typical research



methodologies that assume and promote stability. Indeed, just as Valero and Vithal realized from the research they report, I am realizing that the times when I felt most resisted were frequently the most generative times, both for me and the participant students.

## CRITICAL LANGUAGE AWARENESS IN ACTION

Joey's proclamation, with which I began this paper, has its roots in one of these disruptions. I led the students in a conversation about human initiative in mathematics. We looked at voice in their utterances to discuss who has agency in the discourse, who has control over the way the mathematics is done and expressed. In particular, their initial interpretations of their personal pronoun use were very different than mine, but we all learned something through this tension. After I present some highlights from this particular conversation, I will show how the tension in our discussion about their language practice was similar to tensions inherent both in mathematics and in the language used to express mathematics.

The conversation began early in our semester together. As an exercise to develop the students' ability to locate agency in utterances, I read them a newspaper article about a popular singer. I read one sentence at a time and asked the class to identify who, if anyone, was said to be making things happen. Who had 'agency'? After this exercise, I asked them to watch for agency in our mathematics class. At the time they thought agency was not important, because when they looked at their textbook they could not find examples of humans with agency, except in the story part of word problems. Though I considered this absence significant, I did not immediately resist the students' apparent lack of interest.

In this initial conversation about agency, I did not give the students a definition of the word 'agency'. Instead, I wanted their sense of the word to develop from their use of it. However, my simple question, "who is said to be making things happen" was similar to Pickering's (1995) description of agency. He describes choice and discretion as the classic attributes of human agency, and passivity as its antithesis. Nor did I discuss with students how they discerned the agency in each sentence. In the conversations that followed, we focused our attention on the voice of sentences. For example, if the subject of a sentence is 'I', then the speaker is likely to be taking initiative in some way.

A few weeks after our initial discussion about agency, students were given the following question on a written test:

Consider the quadratic function  $f(x) = (x - 1)^2 + 3$ . Explain how you can tell which of the following is its inverse:

$$y = \sqrt{x-1} + 3$$

$$y = \sqrt{x-3} + 1$$

$$y = \pm\sqrt{x-1} + 3$$

$$y = \pm\sqrt{x-3} + 1$$

The next day, I used an overhead projector to show the students some samples of their responses to this question. Without indicating that I wanted to talk about language features in their writing, I showed and described two longer responses. Then I showed the following set of excerpts from four other student responses:

Excerpt 1: "We switch around the $x$ & $y$ (inverse) & do the work." Excerpt 2: "Switch the $y$ and the $x$ and find the value of $y$ ." Excerpt 3: "You switch the $x$ and $y$ and then solve for $y$ which will give you ..." Excerpt 4: "I can tell by switching the $y$ and the $x$ in the original equation & then ..."
---

I asked, "Do you notice anything interesting about these four?" After a long silence, one student noticed that they all contain the word 'switch'. I responded by asking which words were different. After another extended silence, I simply circled the initial word in the first, third and fourth samples – the personal pronouns 'we', 'you' and 'I'. Laughter erupted. (Significantly, laughter was the beginning of a few of the most animated discussions about language in this research.)

I asked which answer was the best. A girl answered, "the second one", giving no reason. A boy said, "the one with 'I'", because that was the one he wrote on the test. Another boy said, "Well, obviously [the test question] asks you to tell how *you* can tell which of the following is its inverse. So you're not saying, 'well, my partner, the guy sitting beside me...'", This student noticed the leading nature of the question's wording: "Explain how *you* can tell ...". He was suggesting that it is natural to answer a 'you'-question with an 'I'-answer.

After hearing these various opinions, I offered an interpretation that I hoped would provoke resistance, but I gave no time for response. I said that the subjects of these sentences were interchangeable. In mathematics it does not matter who does something, because the result should be the same no matter what. I summed up by saying, "In mathematics, people don't matter".

My plans to pursue this conversation about voice and to relate it to issues of agency were foiled by various disruptions. A four-day long weekend and an extra-curricular class engagement intervened. Also, on the first day after our discussion about the various voices, I had planned to prompt a discussion about agency by interrupting the flow of a mathematics conversation when students used pronouns interestingly. I failed to do this because of the difficulty of noticing language use in action and because I did not want to interrupt important mathematics.

Upon reflection, I realized that I myself was experiencing difficulties doing the very thing I wanted the students to do – pay attention to their language practice while using language for mathematics. Because I was concentrating on communication *about* mathematics, language itself was for me at this time a transparent, non-problematic medium. Adler (2001) calls this tension the 'dilemma of transparency', in her account of the dilemmas facing teachers in multilingual mathematics classes.

While it is normal to use language as though it is transparent, at times it is valuable to become aware of language as a mediating resource.

To avoid a repetition of this problem, I began the next day by continuing the conversation. The students immediately engaged in the conversation even though it had been a week since our brief discussion of voice in their writing. I put the same group of four student responses (see above) on the overhead projector, with the initial pronouns still circled. Here is an excerpt from the student response ('DW' refers to my utterances):

DW: I said in mathematics, it shouldn't matter who is doing the work. The subject of any sentence is interchangeable. [...] Is what I said true? And, if not, when is the subject interchangeable and when is it not?

Joey: I think you should, well personally, I think you shouldn't use 'I', 'you', or 'we' or 'me' or whatever because if you say "you switch", that means that somebody else has to do something different. You know what I'm talking about?

DW: To, telling someone what to do.

Joey: No, because if you, like, "you switch" something and if somebody else decides to not switch you're making that one person switch it. It's all wrong. Shambles.

Joey and others articulated a literal interpretation of these personal pronouns. They did not seem to see the possibility of 'you' being used in a general sense. Rowland (2000) has remarked on this form of generalization and Bills (2002) gives evidence that more successful students use 'you' in this way. By contrast, it was clear that the students in my research group did not see this usage as a possibility. I saw an opportunity to help these students become aware of a practice to which they had already been exposed. Indeed, they themselves regularly used 'you' in a general sense without realizing it.

In the next class period, I challenged Joey by quoting the excerpt given above and then quoting from his participation in mathematics discussion later that day. I said:

Joey said, "I think you shouldn't use 'I' or 'you' or 'me' or 'we' or whatever because if you say 'you switch' that means somebody else has to do something different." Then, ten minutes later, he said, "say you are on a test, what would you round this one to?" And he did the exact opposite of what he said.

At the time, we had a rule that no student could participate two consecutive days in discussion about language (to promote wider participation). After the laughter died down and after Joey resigned himself to not speaking, a classmate defended Joey's word choice by describing how he was addressing a particular person: "Joey's just asking you what *you* think with his question." I responded by quoting another more obvious instance of Joey using 'you' in what I considered to be a general sense: "you

know you have degree two ...”. Another classmate described Joey’s language choice this way: “it’s putting pretty much what you did from their perspective”. Other classmates said the same thing, that this ‘you’-voice represented an individual trying to relate his own experiences in such a way as to help others understand his experiences from their own perspectives. I resisted their interpretation and gave invented examples of people using the general ‘you’-voice in everyday life, but I did not call it a ‘general’ voice. And the students likewise resisted my interpretations, giving plausible literal interpretations of the pronoun ‘you’ for every one of my examples.

On reflection, I can see how their interpretations actually described the general sense of the pronoun ‘you’. These students were describing mathematical communication as an attempt to combat diversity of perspectives. They were describing a discourse that promotes a sense of everyone seeing the same things in the same way. This explains the general ‘you’-voice and even the mathematics class ‘we’-voice that Rowland (2000) and Pimm (1987) remark on and discuss. My interpretation of the students’ emerging understanding was supported a week later in an interview with Joey when he made the proclamation I quoted at the beginning of this paper: “You shouldn’t use any voice, ...”.

Joey’s proclamation is significant when it is considered in its context. With this introduction of his own terminology, he demonstrated his individual human agency, his capacity to explore varying ways of participating in mathematics discourse. Furthermore, in his thinking about language, he touched upon important characteristics of mathematical thinking – generalization and abstraction. His move from envisaging particular perspectives in mathematics to envisaging a general, conventional perspective exemplifies a tension that is at the heart of mathematics.

## **THE EXPRESSIVE FORM OF THE DANCE OF AGENCY**

Pickering (1995) identifies this tension in his account of historical scientific and mathematical advances. He identifies different types of agency – human, material and disciplinary – but he does not consider material agency significant in mathematics. Human agency can be resisted by physical reality (material agency) or by conceptual systems (disciplinary agency). When scientists and mathematicians follow the established patterns of their disciplines they surrender to disciplinary agency. It is when they take initiative with open-ended modelling and cross-discipline conversation that they extend present cultural and conceptual practices and, in so doing, demonstrate their human agency. He calls the tension between human and disciplinary agency in such instances a ‘dance of agency’.

Boaler (2003) draws on Pickering’s metaphor to describe good mathematics class discourse. While Pickering is interested in global cultural extension, Boaler is more interested in more local extensions of discourse, particularly in mathematics

classrooms. In her depiction of traditional classrooms, students simply follow the paths set before them. They surrender to the disciplinary agency. By contrast, she promotes classroom discourse that prompts students to take initiative, to demonstrate human agency. Unlike Pickering's interest in scientific, disciplinary advancement, it seems that Boaler is more interested in each individual mathematics student's human advancement. I suggest that the strong presence of the student 'I'-voice in Boaler's exemplar (pp. 9-10) demonstrates the human agency within the classroom disciplinary setting.

The class with which I discussed their language practice would likely be characterized by Boaler as a traditional class. The students mostly followed and practiced mathematical procedures that were given to them. Because of their traditional, passive frame of reference, it was a challenge for me to draw out their 'I'-voices in conversation about language (and about mathematics). However, Joey and some of his classmates were able to overcome the typical patterns of discourse in this class. They expressed their human agency. When they expressed their own voices and resisted the dominant voice of their teacher, they began their 'dance of agency'. I was trying to get them to agree that there is an appropriate use of the 'you'-voice in mathematics, when it is used in a general form, but they resisted my interpretation. This became a generative tension.

With his proclamation about the general voice, Joey displayed his awareness that he can make decisions about how to say things in mathematics class. He showed this awareness by inventing terminology, by saying that he was rejecting the 'I'-voice and the 'you'-voice (even in its general sense) and by adopting a passive voice to reflect mathematical necessity – that utterances should be generally true, independent of the perspectives of particular people.

Ironically, with this display of human agency, Joey seemed to be rejecting human agency in mathematics. He said that he (and others) should not use the 'I'-voice (nor the 'you'-voice and the 'we'-voice). Had he followed his own directive, he would have cut himself off from participating in the dance of agency between his own understanding and the conventional demands of mathematical discourse. However, he did not follow his own directives. Joey, more than any other student in his class, regularly exercised his 'I'-voice. It is conceivable that Joey's growing ability to articulate his linguistic agency strengthened his inclination to engage in the mathematical dance of agency. It is because of this possibility that I think critical language awareness belongs in mathematics classrooms.

## **CONCLUSION**

Dance is about relationship. However, the relationship itself cannot be observed directly. We only see the dance steps. We can see and feel the moves, which tell us something about the relationship. In mathematics, there is a dance of agency between

humans and either conventionality or common necessity. This relationship expresses itself in the language that flows between people doing mathematics. If language is the dance step, then awareness of language allows us to understand the relationships between the actors in our mathematics. Though it is important to participate in the dance when learning it, at times there is value in attending to the steps.

## References:

- Adler, J. (2001). *Teaching Mathematics in Multilingual Classrooms*, Dordrecht: Kluwer.
- Boaler, J. (2003). 'Studying and capturing the complexity of practice – the case of the “dance of agency”' in N. Pateman, B. Dougherty and J. Zilliox (Eds.), *Proceedings of the 27<sup>th</sup> Conference of the International Group for the Psychology of Mathematics Education held jointly with the 25<sup>th</sup> Conference of PME-NA*, Honolulu, Hawaii, vol. IV, 3-16.
- Bills, C. (2002). 'Linguistic pointers in young children's descriptions of mental calculations' in E. Cockburn and E. Nardi (Eds.), *Proceedings of the 26<sup>th</sup> Conference of the International Group for the Psychology of Mathematics Education*, Norwich, UK, vol. II, 97-104.
- Chouliaraki, L. and Fairclough, N. (1999). *Discourse in Late Modernity: Rethinking Critical Discourse Analysis*, Edinburgh, Edinburgh University Press.
- Fairclough (1992). *Critical Language Awareness*, London: Longman.
- Morgan, C. (1998). *Writing Mathematically: the Discourse of Investigation*, London: Falmer.
- Pickering, A. (1995). *The Mangle of Practice: Time, Agency, and Science*, Chicago, University of Chicago Press.
- Pimm, D. (1987). *Speaking Mathematically: Communication in Mathematics Classrooms*, London, Routledge.
- Rowland, T. (1997). 'Fallibilism and the zone of conjectural neutrality' in E. Pehkonen (Ed.), *Proceedings of the 21<sup>st</sup> Conference of the International Group for the Psychology of Mathematics Education*, Helsinki, Finland, 80-87.
- Rowland, T. (2000). *The Pragmatics of Mathematics Education: Vagueness in Mathematical Discourse*, London: Falmer.
- Skovsmose, O. and Borba, M. (2000). *Research Methodology and Critical Mathematics Education*. Roskilde, Denmark: Centre for Research in Learning Mathematics, Roskilde University.
- Valero, P. and Vithal, R. (1998). 'Research methods of the “north” revisited from the “south”' in A. Olivier and K. Newstead (Eds.), *Proceedings of the 22<sup>nd</sup> Conference of the International Group for the Psychology of Mathematics Education*, Stellenbosch, South Africa, vol. IV, 153-160.
- Wagner, D. (2003). 'Students and teachers listening to themselves: language awareness in the mathematics classroom' in N. Pateman, B. Dougherty and J. Zilliox (Eds.), *Proceedings of the 27<sup>th</sup> Conference of the International Group for the Psychology of Mathematics Education held jointly with the 25<sup>th</sup> Conference of PME-NA*, Honolulu, Hawaii, vol. IV, 355-362.

# METAPHORS AND CULTURAL MODELS AFFORD COMMUNICATION REPAIRS OF BREAKDOWNS BETWEEN MATHEMATICAL DISCOURSES

J.S. Williams and G.D. Wake

University of Manchester, UK

*We noticed that when workers try to explain their mathematical practices to inquisitive outsiders, breakdowns in communication arise. We present here an example in which a worker spontaneously uses metaphors and models to facilitate explanation and communication. We analyse these, drawing on Lakoff & Johnson (1999) and Lakoff & Nunez (2000) in substance and theoretical approach. We suggest that metaphors and cultural models ground associations between academic and workplace discourse genres, and point out how sensori-motor groundings of the 'basic' metaphors may afford gesture and image-schema which free discourse from formal mathematical language. In general we see breakdown repairs as being built through cultural models that extend beyond local mathematical genres which situate mathematics within academic or workplace contexts.*

## INTRODUCTION

This paper will provide theoretical development of the role of metaphors and models in repairing breakdowns in communication, regarded as an essential component in learning and problem solving in general, and mathematical modelling in particular. We build on the work of Lakoff, Johnson, Nunez and Sfard with respect to metaphor and communication, and others such as the Freudenthal Institute with respect to modelling. Our work relates particularly to bridging the gaps between mathematical practices and understanding in Colleges and workplaces (e.g. Williams and Wake, 2002 and Williams, 2003).

We argue that the differences between workplace practices and College practices and discourses can be explained by the different structures of their activity systems, and that breakdown moments arise in dialogues between workers and outsiders because of this. We argue that metaphors and models sometimes have a significant role in helping workers to explain their mathematical practices to researchers and students, thus 'bridging the gap' in meanings and understanding that previous researchers have highlighted (e.g. Williams et al, 2001; Pozzi et al, 1998).

Our research involved developing case studies of mathematical practices across a range of workplaces. Data includes detailed transcripts of conversations between

workers, teachers and College students as each tried to make sense of, and explain to each other, their understanding of the mathematical practices of the worker. Our analyses follow a multiple case study methodology (Yin, 2002). We will here touch on the data set from one case, just sufficiently for our main purpose which is to develop our theoretical understanding of modelling and metaphor.

Metaphors such as ‘the computer is a servant’ and associated cultural models (the computer ‘thinks’, stores in memory, recalls, etc) are effective as a means of communication as well as a means of thinking ‘to’ oneself. (Holland & Quinn, 1987; Lakoff & Johnson, 1999; Gee, 1996). In the following example, we will look at a case of breakdown in which such an appeal to a cultural model seemed critical in breakdown repair.

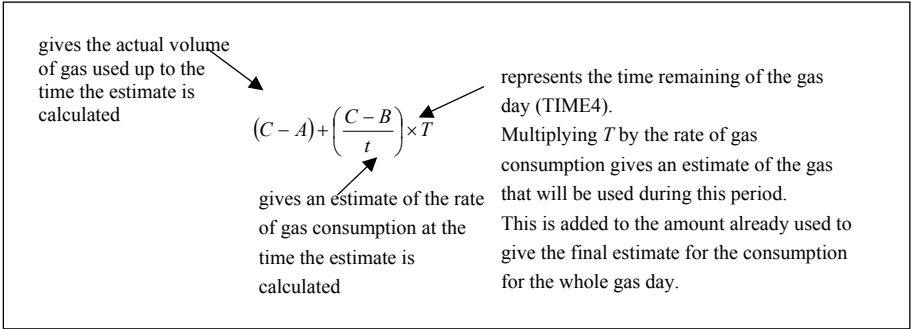
### THE TIME-LINE MODEL FOR ESTIMATING GAS CONSUMPTION

We illustrate the power of grounded metaphorical models by way of an example, in which a mysterious, and rather complex, spreadsheet formula is explained by its author, an engineer in a power plant who is responsible for estimating the plant’s total daily use of gas based on consumption during part of the working day. A breakdown occurs when the researcher fails to follow the explanation of the times and readings involved, particularly the use of T2 and TIME4 in the formula:

$$\{ \{ \{ \{ \{ \text{“2nd INTEGRATING READING”} - \text{“0600 INTEGRATING READING”} \} + \{ \{ \{ \text{“2nd INTEGRATING READING”} \} - \{ \text{“1st INTEGRATING READING”} \} \} / T_2 \} * \text{TIME4} \} \} / 100000 \} / 3.6 * \text{CALCV} * 1000000 / 29.3071 \}$$

The formula uses three meter readings, *A* (0600 INTEGRATING READING) taken at the beginning of the gas day (0600) and the others, *B* (1<sup>st</sup> INTEGRATING READING) and *C* (2<sup>nd</sup> INTEGRATING READING), taken a short interval ( $t=T_2$ ) apart just before the estimate is calculated. These are supplied by technicians who complete a data collection form for the engineer. Below, in Figure 1, we re-present the formula in a mathematical genre which we as ‘academic mathematicians’ possibly feel more comfortable with.

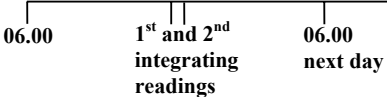




**Fig. 1: Workplace spreadsheet formula re-presented in a mathematical genre.**

During discussion with the researcher, Kate, the worker, Dan, makes the construction of the formula clear by recourse to drawing a timeline, on which he marks the instants during the ‘gas day’ when readings have been taken, and gestures to the intervals between these points on the time-line as time-intervals (e.g.  $T_2$  and TIME4) which are used in the construction of his formula.

	<b><i>Breakdown and inquiry about ‘T2’</i></b>	<b><i>Comments</i></b>
Kate	Yes. Oh so that <i>time</i> that you’ve got there, that...? Is it $T_2$ ?	<i>T<sub>2</sub> refers to time as in ‘interval’ not ‘point’, but Kate is unclear</i>
Dan	Yes, there’s another calculation in there, it gives you $T_2$	<i>Control room workers input the times when readings are taken and a spreadsheet formula calculates the time interval, <math>T_2</math>.</i>
Kate	So $T_2$ : that’s the <i>time</i> ? So is it the time from first to the last, or is it a combined...	<i>inquiry about <math>T_2</math>: still confused</i>
Dan	Because you’ve already got... All I’m interested in, is... Let me draw it out...	<i>Dan is lost for words... draws the following time-line sketch, marking points as he speaks:</i>



Dan	The gas day: 0600... reading 1,... reading 2, ... end of gas day....	<i>'gas day' is 0600 – 0600 next day</i>
Dan	You've got a reading <i>there</i> (1), and you've got a reading <i>there</i> (2)... so subtract one from the other, and you know how much you've used <i>there</i> (3).  Reading 1 and reading 2, subtract one from the other, you know how much you've used <i>there</i> (4);  but you also know the <i>time</i> difference between <i>there</i> and <i>there</i> (4).	<i>Gestures to points and intervals on the line:</i>  (1) <i>i.e. first 06.00 reading</i> (2) <i>i.e. 2<sup>nd</sup> integrating reading</i>  <i>i.e. 'how much gas' used</i> (3) <i>i.e. between first 06.00 reading and 2<sup>nd</sup> integrating reading</i>  (4) <i>i.e. between 1<sup>st</sup> and 2<sup>nd</sup> integrating readings (T<sub>2</sub>)</i>
Kate	Yes.	

In this 'applied version of the number line, we see:

- the number line metaphor (itself a metaphorical blend);
- life, the 'gas day', is a journey, with source-path-goal;
- time is a 'path' along a line through points in space, and
- instants in time and gas readings are 'points', and intervals between the points are both lapses of time and quantities of gas consumed.

Consequently, every point is fused with (i) an instant in time, (ii) a gas reading, and (iii) the (pair of) numbers or algebraic symbols that represent these. The pair of numbers involved suggests the need for a coordinate pair, i.e. a graph rather than a line. This was in fact introduced as an explanatory model by the teacher later on.

Every *line segment* can be blended (in Lakoff's metaphorical term) or fused (in the semiotic terminology of Werner & Kaplan) with (i) a *time-interval*, (ii) a *quantity of gas* and the (iii) *numbers or algebraic symbols* that represent these.

Gestures (pointing to 'points', waving back and forth at 'intervals') and indexical (pointing, waving) pronouns in the discourse (it, here, there, between) associate the concepts with which they are fused, and implicitly index expressions in the spreadsheet formula. Thus the timeline affords a sensori-motor and associated discursive world of engagement, (a) grounded in the space-time image-schema and narrative of passing through time, and (b) with points and intervals on a line

modelling the time and gas consumption involved. This obviates the need to call on formal language such as ‘time interval’ and ‘instant in time’, ‘gas reading’ etc. in favour of pointing gestures which can convey the relevant meanings. Indeed the verbal equivalent of ‘between here (point 1) and there, (point 2)’ might be as complex as “from the time of the first integrating reading to the time of the second integrating reading”, or “the gas consumed between the first and second integrating readings” and indeed the non-verbal gesture may be read in either manner. Thus gestures make communication both easier, more fluent, and perhaps more ambiguous, allowing the interpreter to metaphorically generate meanings initially lacking precision, but affording negotiation and progressive refinement.

Thus, according to Roth (2001) ‘gestures constitute a central feature of human development, knowing and learning across cultures’ (page 365) and he shows how expositions with graphs in a science education context can ‘have both a narrative (iconic gesture) and grounding functions (deictic gestures) connecting the gestural and verbal narratives to the pictorial background’ (p 366).

But Roth’s review suggests the significance of gesture is even deeper than this: there are suggestions in the literature that gestures provide access to another dimension of communication. For instance, when gesture conflicts with the verbal, it usually signifies a transition in meaning or development of understanding, and gesture leads the verbal! In Roth’s own studies, (op cit) the emergence of coherence from ‘muddled’ verbiage in children’s explanations is accompanied by gestural embodiment of relations in advance of their formal, verbal articulation. In sum, gesture can provide a midwife for conception.

If this is the case in the above example, then the number line is surely as important as the midwife’s obstetric instruments. It is a particularly apt tool for the purpose, affording the precision of gesture required to associate the context with the mathematical formula with optimal efficiency.

The number line then we conceptualise as a semiotic, mediating tool through which a formula is associated with a 24-hour time line and the estimation of gas consumption. Its accessibility rests on its status as a ‘cultural model’, widely shared among an educated community which reaches beyond the specialised communities of the workplace, though perhaps only by those sufficiently mathematically prepared to appreciate it. We might call this a mathematical-cultural model. This particular model proves particularly powerful due to its incorporation of metaphorical blendings, within mathematics (space, time, measure and number) and fusions between mathematics (symbols, points, formulae) and the gas day.

## CONCLUSION AND DISCUSSION

We conceive of the ‘bridging of the gaps’ between mathematical practices and discourses (at breakdown moments) as the negotiation of a chain of signs, in the Peircean sense (see also Cobb et al, 2000, and Whitson in Kirschner & Whitson, Eds., 1997). The introduction of new semiotic mediating tools (such as metaphors) can afford ‘new’ links between signs which result in new chains and interpretants, and hence meaning and understanding. Workers, and perhaps informal ‘teachers’ and ‘explainers’ generally, seem to naturally appeal to or reach out to cultural models that can support such semiosis.

At the level of social languages and discourse genres, or Discourses in Gee’s (1996) sense, we picture a landscape consisting of:

- workplace language (e.g. the ‘gas day’);
- workplace (and workplace mathematical) discourse genres (e.g. the spreadsheet formula is written in a ‘spreadsheet genre’);
- formal academic mathematical genres – e.g. mathematical signs, (e.g. their academic uses as in our ‘translation’ of the spreadsheet formula above), and mathematical diagrams (e.g. the number line, points and intervals and labels);
- everyday language including cultural models (e.g. metaphor, cultural models);
- gestures, (e.g. pointing to a symbol in a spreadsheet formula, then to an interval of time on the time-line).

The worker’s and outsider’s discussion helps to constitute a semiotic chain through these domains: a successful conclusion of which may allow the outsider to arrive at an interpretant which is experienced as meaningful to them, (e.g. the formula comes to represent for the researcher a linear extrapolation of gas consumption quantities over time). In such a hypothetical semiotic chain then, a breakdown can occur when the outsider experiences a failure to link: and a missing link may then be supplied by virtue of a mediating chain through a cultural model such as a number-time line.

We hypothesise that such appeals to cultural models may be available to individuals’ internal conversations, on the intramental plane, just as they are in interpersonal conversation, i.e. in the interpersonal plane. In the case described above, for instance, it seems likely that the worker made use of the cited models and metaphors in his own personal work practice before the arrival of the researcher, i.e. when writing programs and when developing the formula for estimating gas consumption. However, once developed the spreadsheet functions adequately each time the engineer inputs the appropriate data values, and there is no longer the need to understand the mathematics that underpins the calculations.

On the other hand, the interpersonal conversations may themselves be generative of new chains and meanings. A metaphor ‘dawns’ in the first instance without one necessarily being fully aware of all its potential for a full-blown analogy. Thus the timeline begins perhaps as a ‘bare’ line, but then it is marked with various indications of instants and intervals, times and readings... the full implications of the metaphoric blend emerge. In general the analogy may subsequently emerge from a generative process (Schon, 1987) of interpersonal or intrapersonal conversation.

We argue that the time line model (or as Lakoff, Johnson and Nunez would prefer: metaphor) served here as a cultural model for repairing the breakdown caused by the outsiders’ lack of familiarity with the particular local discourse genres of the workplace, which combines workplace knowledge and jargon, spreadsheet mathematics and so on in an idiosyncratic way. The outsider, being more familiar with the academic mathematical genre (typified by that of Figure 1), had to ‘build a bridge’ or ‘semiotic chain’ between the spreadsheet formula, the workplace task, and academic mathematics. The dialogue, facilitated by the time line, helped her to negotiate this chain of meanings.

We suggest that repairs of communication breakdowns in general might be built through such cultural models, i.e. those that extend beyond the local mathematical genres which situate and embed mathematics within workplace (or academic) contexts. Let us conceptualise mathematical modelling as the process of using such models in solving problems and communicating, and let us build a ‘modelling’ curriculum around the use of such powerful models in practice.

By studying workplace practices from the perspective of academic mathematics, and especially of the mathematics of College students and teachers, we expose College mathematical practices, and implicitly its curriculum and assessment, to a critical test, or contradiction. We see the research activity then as a potential microcosm of a future, more advanced, mathematical activity and curriculum (Engestrom, 1987). We have therefore begun to see our research into ‘workplace mathematical practices’ in part as just such a curriculum development.

## References

- Cobb et al. (2000). (Eds) *Symbolizing and communicating in mathematics classrooms: perspectives on discourse, tools, and instrumental design*. New Jersey: Lawrence Erlbaum Associates.
- Engestrom, Y. (1987) *Learning by expanding: an activity-theoretical approach to developmental research*, Orienta-Konsultit, Helsinki.
- Gee, J.P. (1996) *Social linguistics and literacies: ideology in discourses*, Taylor & Francis, London.
- Holland, D & Quinn, N. (1987). *Cultural models in language and thought*. CUP
- Lackoff, K. & Johnson, M. (1999). *Philosophy in the Flesh*. Basic Books.
- Lackoff, G. & Nunez, R. (2000) *Where mathematics comes from: how the embodied mind brings mathematics into being*. NY: Basic books.
- Pozzi, S., Noss, R. & Hoyles, C. (1998). Tools in Practice, Mathematics in Use. *Educational Studies in Mathematics* 36, 105-122
- Roth, W-M, (2001) Gestures: their role in teaching and learning, *Review of Educational Research*, 71(3), 365-392
- Schon, D.A. (1987 (2<sup>nd</sup> reprint 1995) Generative metaphor: a perspective on problem setting in social policy, in Ortony, A. (Ed.) *metaphor and thought* (pp.137-163),CUP.
- Werner, H. and Kaplan, B. (1963) *Symbol formation: an organismic-developmental approach to language and the expression of thought*, John Wiley and Sons, New York.
- Whitson, J.A. (1997) Cognition as a semiotic process: from situated mediation to critical reflective transcendence. In Whitson, J.A. and Kirshner, D., (Eds.), *Situated cognition: social, semiotic, and psychological perspectives*, (pp.97-149) Lawrence Erlbaum Associates, Mahwah, N.J.
- Williams, J.S., Wake G.D. & Boreham, N.C. (2001) College mathematics and workplace practice: an activity theory perspective. *Research in Mathematics Education* 3 69-84
- Williams, J.S. & Wake, G.D. (2002). *Understanding workplace practice with College mathematics: a chain of signs mediated by metaphor, discourse genres and models, linking two semiotic practices*. Paper to AERA, New Orleans.
- Williams, J.S. (2003). Metaphors and cultural models bridge the gaps in communication between workers and outsiders. *Proceedings of the British Society for Research in Learning Mathematics*, 22(2) 79-84.
- Yin, R.K.: (2002) 3rd Edition, *Case Study Research: Design and Methods*, SAGE Publications, London

# GENERALISING ARITHMETIC: SUPPORTING THE PROCESS IN THE EARLY YEARS

Elizabeth Warren

Australian Catholic University

*The teaching and learning in algebra has been much debated. Traditionally early algebra has relied heavily on arithmetic. Recently our focus has changed to teaching algebraic thinking with arithmetic thinking. This paper explores the models that assist young students generalise the patterns of arithmetic compensation. A teaching experiment was conducted with two classes of students with an average of eight years and six months. From the results it seems that the use of unmeasured quantity models in conjunction with number models does assist students focus on the underlying generalizations inherent in the models presented.*

## INTRODUCTION

Traditionally early algebra learning has occurred as an extension of arithmetic. Current research continues to indicate that many students experience difficulties in moving from an arithmetic world to an algebraic world, and it seems that many of the difficulties students experience originate from a lack of an appropriate foundation in arithmetic (Carpenter & Franke, 2001; Warren & Cooper, 2001; Warren, 2002; Warren, 2003). The assumption has been that as part of everyday classroom arithmetic experiences using the four operations, students will induce the fundamental structure of arithmetic. But research suggests that they are not. One way of addressing many of these issues, and helping students to *do* algebra, is to involve students in patterns of generalised thinking throughout their education. The focus is away from computation and onto the underlying mathematical structure exemplified by the carefully chosen examples, with an aim of explicitly abstracting arithmetic structure. Malara and Navarra (2003) suggest that a way of distinguishing this difference in the early years is that algebraic thinking is about process whereas arithmetic thinking is about product (reaching the answer). This paper reports on the former, young students generalising arithmetic processes and patterns, and in particular arithmetic compensation.

We are interpreting arithmetic compensation as the idea that if  $A+B = C$ , then  $A-k+B+k=C$ , or  $A+k+B-k=C$ , (e.g.,  $13+34=47$  then  $13-3+34+3=47$ ). In other words, if we increase/decrease one number by a certain amount we must decrease/increase the other number by the *same* amount for the answer to stay the same. Put simply, for Part + Part = Whole, if we keep the Whole constant and change the value of one of the parts, we must compensate for this by changing the other part by the same amount. An extension of this is that for problems such as  $A+B+C+D=E$ , if we increase/decrease one of the numbers then we must decrease/increase some or all the other numbers by an amount that is the *same* for the answer to stay unaltered.

Past research has shown that even in the early years students' prior experiences in number interfere with their ability to generalise patterns and the structure of arithmetic.



This is particularly prevalent in research conducted on their interpretation of the equal sign (Carpenter and Levi, 2001; Warren, 2001) and seems to be related to specific classroom activities and experiences.

In this research, we attempt to use measurement models in conjunction with number patterns to assist students move from arithmetic product to process. The underpinning theory is that number is an abstract concept and represents a quantity that may or may not be obvious. Commonly students begin their learning of number by counting discrete objects (Dougherty and Zillox, 2004). As they move through different number systems, algorithms and routines are commonly changed to deal with the new number set which results, it is conjectured, in students failing to develop a consistent conceptual base that can deal with all numbers as a connected whole.

To bridge this gap, we are following Davydov (1975) in beginning students' experiences on the basic conceptual ideas of mathematics through using unmeasured quantities before moving into number exploration. Daydov claimed that students should begin their mathematics program without number and explore physical attributes such as length, area, and volume, that is, attributes that can be compared. He hypothesised that this allowed young students to more effectively focus on the underlying concepts of mathematics, such as equivalence and non-equivalence without the interference of numbers. We are investigating how such explorations in conjunction with traditional early number experiences can enhance young students understanding of arithmetic processes.

## **BACKGROUND**

The data reported here is part of an Australian Research Council Linkage Grant, a three-year longitudinal multi-tiered teaching experiment. In this study, we are designing and trialling activities and teaching experiences with 8 year olds in five elementary schools. The aims of this large study are to investigate Years 3 to 5 student's abilities to reason algebraically, in particular, to represent, relate and change arithmetical situations in a general manner, to identify key transitions in their development of algebraic reasoning, to construct a model of young student's cognitive development with respect to algebraic reasoning, and to develop instructional strategies effective in facilitating young students' construction of algebraic reasoning.

In this paper, we describe a lesson given to two Year 3 classrooms. The lesson was designed to generalise the addition compensation rule. The specific aims of the lesson were to: (i) investigate models and instruction that begin to assist young students to generalize and formalize their mathematical thinking; and (ii) delineate thinking that supports the development of algebra understanding. The aim of this paper is to document and explain students' generalizations.

## **METHOD**

The lessons were conducted in two Year 3 classrooms from two middle class state elementary school from an inner city suburb of a major city. The sample, therefore, comprised 45 students, two classroom teachers and 2 researchers. These students had

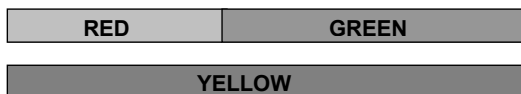


completed classroom experiences involving adding and subtracting two-digit numbers. We worked collaboratively with the teachers to trial teaching ideas and document student learning in relation to teaching actions. The trials of the lesson reported in this paper were those conducted by one of the researchers (teacher/researcher).

The lesson consisted of three phases, integrated so that there was a flow from one phase to the next, and was of approximately one hour duration. During the lesson three types of questions were continuously asked, namely, predicting, justifying, and generalising. The three phases are described below – a more detailed description of the lesson is in Warren & Cooper (2003).

### **Phase 1 – Introducing the addition compensation rule using the length model**

The lesson began with a teacher/researcher led discussion. This initial discussion relied on developing an understanding of addition compensation using unmeasured quantities. In this instance the length model was chosen to represent these ideas.



First students were encouraged to invent names for the three strips of paper and express the relationship between the three strips, for example, (Length) Copt + (Length) Nopt = (Length) Lopt. Then a piece was cut off the **red strip (copt)** and the class was asked: *What would I have to do to the green strip (nopt) so that the length of the green strip plus the length of the red strip (copt) is still the same length as the yellow strip (lopt)? How much would I have to add to the green strip?*

This process was repeated a number of times using new strips each time with a number of students participating in the physical transformations of the length models. In all cases, the first length was reduced. The following discussion ensued,

- Teacher: Can someone tell me what the generalization is.  
Child 1: Cutting a bit of length off and replacing it with another bit of length.  
Teacher: What is special about the other piece of length? What is the word we use?  
Child 2: Equal  
Teacher: What is another word for equal?  
Child 3: Plus  
Teacher: Yes we added something but what is another word for equal? What can you tell me about the two lengths [the one cut off copt and the one added to lopt]  
Child 4: Same.

Students were then asked to write their own 'pattern rule' using their own language.

### **Phase 2 Transferring from the length model to number.**

In this instance the set model acted as a mediator between unmeasured quantities and a symbolic world. For example, for  $6+8$ , we explored what happened to 8 if we decreased 6 by 2, decreased 6 by 4 and so on. The teacher/researcher modelled the process using the set model, moving two counters from one part to the other part and discussing how the parts changed by equal amounts (e.g., 2) but the whole remained the same. Students

were encouraged to model this process using counters. As they worked through these scenarios the students recorded their responses on a worksheet and checked their answers on the calculator. Figure 1 represents the worksheet used

$6 + 8 = 14$				
6	+	8	=	14
4	+		=	14
	+		=	14
	+		=	14
	+		=	14

↓	↑
0	0
-2	

Figure 1 Worksheet for recording answers for the set model activity.

In previous research we have found that students tend to look down the table when searching for patterns, thus finding a vertical pattern (Warren, 1996, 1997). We conjectured that one way of overcoming this was to ensure that the numbers placed in the first column do not conform to a vertical pattern, for example, 6, 3, 4, 5, 2, 1 rather than 6, 5, 4, 3, 2, 1.

### Phase 3 – Moving into a number world

The same process was used for exploring addition number sentences with larger numbers (e.g.,  $12 + 15 = 27$  subtract 3 from 12, and  $26 + 33 = 59$  subtract 11 from 26) and extended to situations where the first number was increased. Some children experienced difficulties in making the transition to larger numbers and used counters to support their explorations. Others simply used the ‘pattern rule’ to reach answers (e.g., add 3 to 12 and take 3 from 15). At the completion of phase 2 and phase 3 students were once again asked to record their own ‘pattern rules’ in their language. The students were finally brought together as a group and asked to explain how the length activity was related to the number activity.

### Data gathering techniques and procedures

The lesson was taught to each class by one of the researchers. The two trials occurred sequentially. During the teaching phases, the other researcher and classroom teacher acted as participant observers. In each instance the other researcher and classroom teacher recorded field notes of significant events including student-teacher/researcher interactions. Both lessons were videotaped using two video cameras, one on the teacher and one on the students, particularly focussing on the students that actively participated in the discussion.

The basis of rigour in participant observation is “the careful and conscious linking of the social process of engagement in the field with the technical aspects of data collection and decisions which that linking involves” (Ball, 1997, p311). Thus both observers acknowledged the interplay between them as classroom participants and their role in the research process.

At the completion of the teaching phase, the researcher and teacher reflected on their field notes, endeavouring to minimise the distortions inherent in this form of data collection, and come to some common perspective of the instruction that occurred and the thinking exhibited by the students participating in the classroom discussions. The video-tapes were transcribed and worksheets collected.

## RESULTS

The two classrooms were different with respect to the students' abilities to complete the lesson, although there were many similarities in students' responses to teaching strategies. The second classroom had more difficulties than the first, particularly with Phase 3 and numbers increasing and decreasing, as the following excerpt shows. IT seems that they did not understand increasing and decreasing in relation to addition.

- Teacher: If I had the number 8 and I want to increase it what number could I make it?  
Child 1: I wouldn't have a clue  
Child 2: 19  
Teacher: How much did I increase it by and how do you work it out?  
Child 2: 7 No  
Child 3: 11 adding on my fingers [demonstrated by counting on from 8]  
Child 4: I don't understand what you mean by increase and decrease

### Students' generalising categories

After phase 1 and phase 3, students were asked to record the generalisations they had discussed as a class in their own words. An examination of the responses indicated that the generalisations expressed by the students fell into six broad categories. Each category represents less sophisticated responses, with the most sophisticated response (Category 1) including a statement about the relationship between the changes made to the parts and how this relationship related to the whole. The following section describes each of the categories with a typical response for each model.

Category 1 – Increase and decrease each part by the same amount and the whole remains the same.

An example of a student's response for the length model was *When you cut copt and put the same amount of nopt it still equals lopt* and for the number model *it is decreased and increased by the same number so it stays the same number.*

Category 2 – Increase and decrease each part by the same amount.

A typical response for the length model was *You increase by the same you decrease*, and for the number model *Increase one number and add the same number that you took away and add it to the other number.*

Category 3 – Increase and decrease the parts so the whole remains the same

A typical response for the length model was *Cut a bit off copt and add a bit to nopt to make it equal to lopt*, and for the number model *You get a new number and the same sum.*

Category 4 – Increase and decrease the parts

An example of a student's response for the length model was *If you cut some from copt*

you have to add more to nopt, and for the number model You take one number down and one number up.

Category 5 – Partial response (e.g., Increase or decrease one of the parts)

Category 6 – No response

The students appeared to be more at ease generalising with respect to length than generalising with number. Table 1 summarises the number of response for each of the categories in each of the models.

**Table 1:**

*Frequency of responses for each category for each model.*

	Category	Length model	Number model
1	<i>(Increase and decrease each part by the same amount and the whole remains the same)</i>	4	1
2	<i>(Increase or decrease each part by the same amount)</i>	10	10
3	<i>(Increase and decrease the parts and the whole remains the same)</i>	6	10
4	<i>(Increase and decrease the parts)</i>	10	9
5	<i>(Increase or decrease one of the parts)</i>	13	5
6	<i>(No response)</i>	2	10

While the trends in the responses appear to be similar, it is worth noting that, for the length model, four students gave the highest level of response and only two students failed to make any response at all. This is particularly pertinent given that the class discussion with regard to the generalization with the length model occurred before discussion about the number model. Also explicit links were made between the two models throughout the lesson and most of the lesson focused on exploring the addition compensation rule with the number model.

At the conclusion of the lesson, students were brought together for a short discussion with regard to how the generalization in the length model was similar to the generalization in the number model. The students' responses appeared to show they understood the similarity between the two models as the following discussion in one classroom shows:

Bernice: As one goes up 5 the other one has to go down by 5.

Teacher: Is that similar to the pieces of paper?

Charles: Yes as one increases the other decreases

Teacher: You have forgotten an important word. What is the important word?

Nick: By the same amount.

Sam: As one goes up the other goes down by the same amount.

## **DISCUSSION AND CONCLUSION**

While the aim of the lesson was to investigate instruction that assists young students recognize the addition compensation rule, it also aimed to investigate how different models assist young students extract the underlying structure of this generalization. We

found that children had difficulty because of language, numbers and understanding of basic mathematics concepts such as equals.

Many children struggled with expressing the generalization in their own words, even when the generalization simply involved lengths of paper. They not only seemed to lack the mathematical vocabulary to hold conversations about mathematical ideas but also appeared unused to participating in these types of conversations. In one classroom, many students held a view of addition and subtraction that did not assist them to explore ideas; they could not see addition and subtraction as a process of change, they could only see it as a process that produced a product, the answer. It seems that not only do young students possess narrow understandings of equals (Warren, 2003) but also of the operations themselves. The impact this has on reaching arithmetic generalizations needs further investigation.

Before the lesson, we had conjectured that young students would have less difficulties in conversing about patterns without number than those with number. The results appear to support this claim. The length model did seem to allow young students to more effectively focus on the underlying concept of arithmetic compensation, thus supporting Davydov's (1975) claim. While we did not strictly follow his belief that we should begin mathematics in a numberless world, initially building up the structure of mathematics using quantitatively different models, the use of his theories in conjunction with the development of number appears to be advantageous. In addition, the representations appeared to influence students' ability to generalize. For example, the random vertical pattern in the tables generated during the lesson certainly assisted in focusing students' attention on looking for patterns across the table rather than down the table. In no instances were there any students who were not looking for the horizontal patterns.

From this preliminary research, it seems that exploring patterns in a number world increases the cognitive load for most students because, as they looked for patterns, they had to continually compute answers, and for some this went beyond their capabilities. This was particularly pertinent as the numbers became larger, with many students failing to participate in these explorations even though they had the use of a calculator to assist them. For some students, the activity had simply gone beyond the model that they commonly used for such activities, their fingers.

This results in a dilemma when exploring mathematical generalizations with numbers: can we focus on small numbers thus reducing the cognitive load or do we need to move into large numbers so that students are forced towards the generalisation in order to reduce the level of computation required? It was only when the lesson moved into large numbers that some students began to use the generalisation to find number combinations (e.g., add 3 to one number and take 3 from the other).

The use of the length model does not have these difficulties. While attempts were made to make explicit links between the underlying generalization in the length model and the number model, the effectiveness of this phase of the lesson needs further exploration. The conversation with one class seemed to support the notion that many students had

effectively made the transfer, but only a few students participated in this conversation. Thus, while the use of quantitative models in conjunction with number models appears to assist the generalization process, more research is needed on the difficulties of transferring between the models and on the instruction and activities that assist with making these links.

## REFERENCES

- Carpenter, T.P., & Franke, M. (2001). Developing algebraic reasoning in the elementary school: Generalisation and proof. In H. Chick, K. Stacey, J. Vincent and J. Vincent (Eds.), *The Future of the Teaching and Learning of Algebra. Proceedings of the 12<sup>th</sup> ICMI study conference* (Vol 1, pp. 155-162). Melbourne: Australia.
- Ball, S. (1997). Participant Observation. In J.P. Keeves (Ed.), *Educational research, methodology, and measurement: An international Handbook*. Flinders University of South Australia, Adelaide: Pergamon.
- Davydov, D. (1975). Logical and psychological problems of elementary mathematics as an academic study. In L.P. Steffe (Ed). *Children's capacity for learning mathematics. Soviet Studies in psychology of learning and teaching mathematics. Vol VII* (pp. 55-107). Chicago: University of Chicago.
- Dougherty B., & Zilliox, J. (2003). Voyaging from theory into practice in teaching and learning: A view from Hawai'i. In N. Pateman, G. Dougherty, J. Zilliox (Eds.), *Proceedings of the 27<sup>th</sup> conference of the international group for the psychology of mathematics education and the 25<sup>th</sup> conference of psychology of mathematics education North America*, 1, 17-30. College of Education: University of Hawaii.
- Malara, N., & Navarra, G. (2003). *ArAl Project: Arithmetic pathways towards favouring pre-algebraic thinking*. Bologana, Italy: Pitagora Editrice.
- Warren E., (1996). *Interactions between instructional approaches, students' reasoning processes and their understanding of elementary algebra*. Unpublished PhD Thesis.
- Warren, E. (1997). Generalising from and transferring between algebraic representation systems: Characteristics that support this process. In F. Biddulph and K. Carr (Eds.), *People in Mathematics Education*. (pp. 560 –567). Mathematics Education Research Group of Australasia.
- Warren, E. (2002). Unknowns, arithmetic to algebra: Two exemplars. In A.Cockburn and E. Nardi (Eds.), *Proceedings of the 26<sup>th</sup> conference of the international group for the psychology of mathematics education*. 4, 361-368. Norwich, United Kingdom.
- Warren, E., (2003). Young children's understanding of equals: A longitudinal study. In N. Pateman, G. Dougherty, J. Zilliox (Eds.), *Proceedings of the 27<sup>th</sup> conference of the international group for the psychology of mathematics education and the 25<sup>th</sup> conference of psychology of mathematics education North America*, 4, 379-387. College of Education: University of Hawaii.
- Warren, E., & Cooper, T. (2001). Theory and practice: Developing an algebra syllabus for P-7. In H. Chick, K. Stacey, J.Vincent and J.Vincent (Eds.), *The Future of the Teaching and Learning of Algebra. Proceedings of the 12<sup>th</sup> ICMI study conference* (Vol 2, pp. 641-648). Melbourne: Australia.
- Warren E., & Cooper T. (2003). Arithmetic pathways towards algebraic thinking: Exploring Arithmetic Compensation in Year 3. *Australia Primary Mathematics Classroom*. 8(4). 10-16.

# A FRAMEWORK FOR DESCRIBING THE PROCESSES THAT UNDERGRADUATES USE TO CONSTRUCT PROOFS

Keith Weber

Rutgers University

*The purpose of this paper is to offer a framework for categorizing and describing the different types of processes that undergraduates use to construct proofs. Based on 176 observations of undergraduates constructing proofs collected over several studies, I describe three qualitatively different ways that undergraduates use to construct proofs. In the concluding section, I describe the learning that is likely to occur by writing proofs in each of these three ways.*

## INTRODUCTION

Mathematicians and mathematics educators both agree on the importance of proof and on the necessity for students to develop the skills needed to construct proofs (Blanton, Stylianou, and David, 2003). However, there is also widespread agreement that students have serious difficulties with constructing proofs. Consequently, there has been a great deal of educational research investigating students' proving abilities. Much of the research on proof has examined both the valid and invalid proofs that students produce. The ratio of valid to invalid proofs has been used to provide a measure of students' proof-writing ability (e.g., Senk, 1985) and the invalid student proofs have been used both to classify common student errors and to glean insight into students' conceptions of proof (e.g., Selden and Selden, 1987; Gholamzad, Liljedahl, and Zazkis, 2003). More recently, some researchers have paid less attention to the proofs that students produce and have focused instead on the processes that students use to create those proofs. For instance, Hart (1994) describes the processes that undergraduates use when they are constructing elementary proofs in abstract algebra and illustrates how these processes are influenced by their conceptual understanding. Weber (2001) delineates the processes that undergraduates and mathematicians use to construct proofs about group homomorphisms and demonstrates that undergraduates' proof strategies are often inadequate. Raman (2003) illustrates several approaches that one can take to prove a theorem from calculus and argues that one should base the proof that they are writing on key ideas that they find to be convincing and intuitively meaningful. The purpose of this paper is to further this work by offering a framework that one can use to categorize and describe the processes that undergraduates can use to successfully construct proofs.

## RESEARCH CONTEXTS

The framework described in this paper was developed using data from several empirical studies in which I observed eight undergraduates in abstract algebra and six undergraduates in real analysis constructing proofs in their respective domains. (See



Weber (2001, 2002, 2003, 2004) for reports on these studies). There were two abstract algebra studies that were conducted to investigate possible deficiencies in undergraduates' proving processes. The real analysis study was a longitudinal one designed to follow the development of undergraduates' concept understanding and proving abilities. In all three studies, undergraduates were asked to "think aloud" as they proved a collection of statements. After their proof attempts, they were asked to describe why they tried to prove the statement in the way that they did. In total, 14 undergraduates were observed constructing a total of 176 proofs (56 from abstract algebra, 120 from real analysis).

## TYPES OF PROOF PRODUCTIONS

### Procedural proof productions

In a *procedural proof production*, one attempts to construct a proof by applying a procedure, i.e., a prescribed set of specific steps, that he or she believes will yield a valid proof. It may be the case that the procedure is meaningful to the prover; that is, the prover understands why the successful implementation of the procedure will yield an argument that logically establishes the veracity of the claim to be proven.

However, in the studies that I conducted, it was more often the case that undergraduates applied procedures that were not meaningful to them. As a result, they would produce valid proofs, but could not explain what their proofs meant (cf., Weber, 2003). There were many cases where the undergraduates' successful proof attempts consisted simply of mimicking the actions of the teacher or applying a set of steps that they had been told will yield a valid proof.

There were two types of procedures executed by the undergraduates in my studies. The procedure may be an *algorithm*, or a list of steps that were highly mechanical and tied to a specific type of problem (cf., Weber, 2003). An example of an algorithm that can prove identities about summations using induction is given below:

To prove statements of the form,  $\sum^{i=n} f(i) = g(n)$ , write:

Proof: [Show  $f(1) = g(1)$  by direct computation], which establishes the basis case.

Assume  $\sum^{i=n} f(i) = g(n)$  as your inductive hypothesis.

Then  $\sum^{i=n+1} f(i) = \sum^{i=n} f(i) + f(n+1)$

Which by the inductive hypothesis is equal to  $g(n) + f(n+1)$ .

[Verify that  $g(n) + f(n+1) = g(n+1)$  using algebraic manipulations].

Hence,  $\sum^{i=n+1} f(i) = g(n+1)$ .

Therefore,  $\sum^{i=n} f(i) = g(n)$  has been proven by mathematical induction.

Many of the students in the real analysis study used an algorithm similar to the one above to prove these types of statements. Note that applying this algorithm requires minimal engagement on the part of the prover; there are few points in the proof



where the prover needs to make decisions or reason mathematically. Also note that the only skills and understanding required to write this type of proof are the abilities to evaluate functions for particular variables and to perform algebraic manipulations; an individual without understanding the logic behind inductive proofs or even knowing the meaning of summation might still be able to apply this algorithm.

As a second illustration of a student proving by applying an algorithm, consider Erica's comments as she proved that the sequence  $\{(n-1)/n\}$  converged to 1.

Erica: I remember doing one like this on our homework. Can I use my notes?

I: Do you think you need to use your notes?

Erica: [laughs] Yeah.

I: OK.

Erica: Yeah, OK I see. You start this proof writing "Let  $\epsilon$  greater than zero be given. Let  $N$  equal". Now he uses scratchwork over here to find the  $N$ . He says, let's see... OK, to show this converges to 1, we... yeah, OK, we start with the absolute value of  $n$  minus 1 over  $n$  minus 1 and we'll re-write this as  $(1 - 1/n - 1)$  which is equal to the absolute value of  $1/n$ ... let's see, then he... oh yes, we drop the absolute value sign and say this is  $1/n$  which is less than  $1$  over big  $N$  which is less than  $\epsilon$ ...

Erica continued her proof by closely relating what she was doing to the proof that the professor had completed in class. She produced what was a fully valid proof. From the proof itself, one could not see a lack of understanding on Erica's part. However, subsequent questions by the interviewer revealed that Erica neither understood why her argument was logically valid nor had an accurate understanding of the meaning of the limit of a sequence.

The procedure may also be a *process*, or a shorter list of global qualitative steps that are not highly specified manipulations but rather involved accomplishing a general goal (cf., Weber, 2003). To illustrate a student applying a process, consider the following undergraduate's proof that  $n! \geq 2^{n-1}$  for all natural numbers  $n$ .

David: Well the basis case just gives .... 1 is equal to 1. To solve the inductive step, I would have to see how  $(n+1)!$  related to  $n!$  and how  $2^{n+1}$  related to  $2^n$ . I think that I would approach it in some way of handling the factorial. If I can expand  $(n+1)!$  in some way, I can see how it relates to  $n$ . If I can see how they are related, I can use my inductive hypothesis.

David went on to construct a valid proof. David's proof by induction involved executing several qualitative steps. For instance, David attempted to write  $(n+1)!$  in terms of  $n!$  without a clear method specifying how this might be done. He was able to construct a valid proof, even though he had not yet proved statements involving factorials. While David showed considerable skill at writing these types of proofs, a comment made after David constructed the proof revealed that he did not understand why inductive proofs are mathematically valid.

David: And I prove something and I look at it, and I thought, well, you know, it's been proved, but I still don't know that I even agree with it [laughs]. I'm not convinced by my own proof!

### Syntactic proof productions

In a *syntactic proof production*, one attempts to write a proof by manipulating correctly stated definitions and other relevant facts in a logically permissible way. In the mathematical community, a syntactic proof production can be colloquially defined as a proof in which all one does is “unpack definitions” and “push symbols”. In the mathematics education literature, this type of proof has also been referred to as a purely formal deduction (Vinner, 1991). Two examples, taken from Weber (2001), are given below. In both examples, the undergraduates were asked to prove the following theorem.

Let  $G$  and  $H$  be groups.  $G$  has order  $pq$ , where  $p$  and  $q$  are prime.  $f$  is surjective homomorphism from  $G$  to  $H$ . Prove that  $G$  is isomorphic to  $H$  or  $H$  is abelian.

Jim: Hm... so what do we have here. We have  $G$  has order  $pq$ ...  $f$  is a surjective homomorphism from  $G$  to  $H$ . So... [long pause]... Well,  $G$  has order  $pq$  so  $G$  has an element of order  $p$ ... by Cauchy's theorem... and likewise  $G$  has an element of order  $q$ ... so since  $f$  is a homomorphism, let  $x$  be an element of order  $p$ , then  $f(x)$  would be an element of order  $p$ ... um, no, an element of order  $p$  or order  $1$ ...

...

So what did we do on the last problem? We looked at the kernel. So, yeah, these problems tend to build on each other, so what is the kernel going to be here. Um the kernel is going to have size  $1$ ,  $p$ , or  $q$ ... oh yeah, or  $pq$ . How does that help us? [pause] Um, okay then  $H$  is going to have size  $pq$ ,  $q$ ,  $p$ , or  $1$ . And if  $H$  has size  $p$  or  $q$ , it is cyclic and abelian. And if it has size  $1$ , it is abelian. And if it has size  $pq$ ? Then it must be isomorphic to  $G$ . Why? Um, oh yeah, by  $f$ .

Steve: Well, injective... if  $G$  and  $H$  have the same cardinality, then we are done. Because  $f$  is injective. And  $f$  is surjective.  $G$  is isomorphic to  $H$  with the isomorphism being  $f$ . OK, so let's suppose their cardinalities are not equal. So we suppose  $f$  is not injective. Show  $H$  is abelian... OK  $f$  is not injective so we can find distinct  $x$  and  $y$  so that  $f(x)$  is equal to  $f(y)$ . OK, to show abelian, let us choose an  $h$  in  $H$ . Then  $f(x)h$  is equal to  $f(y)h$ ...

Steve continued to draw logical deductions, such as the fact that  $f(x)h = f(x)f^{-1}(h) = f(xf^{-1}(h))$  and also that  $xy^{-1}$  would be a member of the kernel of  $f$ , but unlike Jim, was unable to construct a proof. Both Jim and Steve's proof attempts appeared to consist entirely of drawing a sequence of logical deductions. Their deductions either involved stating the definition of a mathematical concept or using facts that they knew about the concepts to construct proofs. At no point did either undergraduate consider the semantic meaning of the statements that he was dealing with; they did not, for instance, use visual representations of the groups in question (perhaps because they did not have such representations in their repertoires) and did not see why this statement would be true by considering particular groups of order  $pq$ .

## Semantic proof production

Mathematical propositions often describe relationships between mathematical objects. In a *semantic proof production*, one first attempts to understand why a statement is true by examining representations (e.g., diagrams) of relevant mathematical objects and then uses this intuitive argument as a basis for constructing a formal proof. In the mathematics education literature, semantic proof productions have also been referred to as proofs following intuitive thought (Vinner, 1991), and are similar to what Raman (2003) calls proofs based on key ideas.

The example below illustrates a semantic proof production in which an undergraduate demonstrates that the sequence  $\{1, 0, 1, 0, 1, 0, \dots\}$  does not converge.

Stacey: [After reading the question] Let me first see what this sequence looks like. [Graphs the sequence on a Cartesian plane]. So this doesn't seem to be converging. [Draws a horizontal band between  $y=0$  and  $y=1$ ]. Yeah, if we make this band thin enough, it's not going to get both of the points... OK, so we'll let epsilon be one-third, which would make the width two-thirds. Then no matter what the limit is, either the 0's will not be in the band or the 1's won't. So no matter what the  $N$  is, I can always find an odd or even number bigger than that and the odd sequence term would be 1 and the even one would be 0.

Stacey then wrote a proof using appropriate mathematical notation that reflected what she had just said. In her proof, Stacey did not begin by stating definitions or drawing inferences. Instead, Stacey first tried to understand the claim being made by sketching a graph. In examining this graph, she realized that any epsilon band having a width of less than one would not contain the points. She then wrote (or translated) her intuitive argument into the language of formal mathematics to produce a proof.

## DISCUSSION

### Learning outcomes of different types of proof productions

Lithner (2003) observes that the way that one solves a problem will affect the nature of what one learns from their problem-solving episode. In this section, I describe how procedural, syntactic, and semantic proof attempts may provide the prover with different levels of conviction and understanding. There are (at least) three important purposes that undergraduates should have when they are constructing proofs in their mathematics courses. Their proof of a statement should convince themselves that the statement is true, promote understanding by explaining why the statement is true, and convince their mathematical community, including their teacher, that the statement is true. In the remainder of the section, I discuss the extent that each type of proof production achieves these three goals.

To most undergraduates, convincing their teacher (and thereby earning satisfactory grades) is typically the most important reason for constructing a proof. Procedural, syntactic, and semantic proof productions can all yield valid proofs; hence all are capable of achieving this goal. Nonetheless, it is worth noting that if undergraduates

rely exclusively on procedural or syntactic proof productions, the scope of statements that they can prove may be rather limited (see Weber (2001, 2002) for empirical support of this assertion).

By “convincing oneself that a statement is true”, I mean to see why the statement is a logical consequence of previously accepted assertions. Syntactic and semantic proof productions both would convince the prover (in a formal mathematical sense) that the statement is true, but procedural proof productions might not. If the procedure that is being applied is not meaningful to the individual applying it, that individual may produce arguments that he or she does not find convincing. This was illustrated in this paper with David, who could prove a statement by induction, but “still not even be sure that he agrees with it”.

Many mathematics educators believe that promoting understanding is the most important reason for introducing proof in the university classroom (e.g., Hanna, 1990; Hersh, 1993). However, both procedural and syntactic proofs may fail to explain to the prover why the statement is true. Many of the undergraduates that I interviewed applied an algorithm similar to that presented early in this paper to verify identities about summations using induction. To apply this algorithm, one does not even need to know the meaning of summation, and certainly does not need to see the identity as establishing an equality between a summation and an equation. Likewise, syntactic proofs may be understood only as symbols obeying logical rules, and not exhibiting relationships between mathematical objects and mathematical structures (cf., Weber, in press). Semantic proofs are based on intuitive representations and will therefore be meaningful to the prover who produces them (Raman, 2003).

This is not to say that undergraduates should not engage in procedural or syntactic proof productions. Having reliable procedures to prove common classes of statements and being able to logically manipulate symbols in a flexible manner are important skills for competent theorem proving, and mathematicians regularly write proofs in this way (Weber, 2001). Further, with reflection, both syntactic and procedural proof productions can serve as the basis for sophisticated learning (c.f., Pinto and Tall, 1999; Weber, 2003). However, there is a danger that if undergraduates *only* write these types of proofs and do not reflect on their proofs or proving processes, then the act of proving may not be effective at promoting understanding.

### **Types of proof productions by the undergraduates in these studies**

Analyzing the proof attempts by the participants in my studies suggests that these undergraduates rarely attempted to construct semantic proofs. Of the 56 proofs attempted by the eight undergraduates in the abstract algebra studies, 46 attempted syntactic proof productions (24 were successful). The other 10 made no progress on the problems and hence could not be categorized. Of the 120 proofs attempted by the six undergraduates in the real analysis course, 48 attempted to produce procedural proofs, 28 syntactic proofs, and only 17 semantic proofs. For the other 27 statements, the undergraduates either engaged in behavior that could not lead to a valid proof

(e.g., checked that a general statement held in several instances and presented this as a proof) or made no progress on the problem. Further, in the longitudinal study in real analysis, I also investigated the participants' learning strategies and found that it was relatively rare for these students to reflect on their mathematical work.

Coupled with the preceding analysis, these results suggest that the act of proving may not have been an effective means for these undergraduates to gain understanding. Of course, one cannot determine whether these results are generalizable. That is, one cannot yet claim that most undergraduates rarely produce semantic proofs. It may have been the case that the undergraduates' behavior was due to the idiosyncrasies of their instructor or, perhaps, their behavior was influenced by the nature of the proofs that they were asked to construct. However, if other undergraduates behave in the same way as the undergraduates in this study, then this is a pedagogical problem that should be addressed. Investigations on whether this would be the case would be useful activities for future research.

### References:

- Blanton, M., Stylianou, D., and David, M. (2003). The nature of scaffolding in undergraduates transition to formal proof. In N. Pateman, B. Daugherty, and J. Zilliox (eds) *Proceedings of the 27<sup>th</sup> Conference of the International Group for the Psychology of Mathematics Education*, 2, 113-120. Honolulu, HI.
- deVilliers, M. D. (1990). The role and function of proof in mathematics. *Pythagoras*, 24, 17-24.
- Gholamazad, S., Liljedahl, P., and Zazkis, R. (2003). One line proof: What can go wrong? In N. Pateman, B. Daugherty, and J. Zilliox (eds) *Proceedings of the 27<sup>th</sup> Conference of the International Group for the Psychology of Mathematics Education*, 2, 437-444. Honolulu, HI.
- Hanna, G. (1990). Some pedagogical aspects of proof. *Interchange*, 21, 6-13.
- Hart, E.W. (1994). A conceptual analysis of proof-writing performance of expert and novice students in elementary group theory. In J.J. Kaput and E. Dubinsky (eds.), *Research Issues in Undergraduate Mathematics Learning: Preliminary Analysis and Results*, Washington, DC: MAA.
- Hersh, R. (1993). Proving is convincing and explaining. *Educational Studies in Mathematics*, 24, 389-399.
- Lithner, J. (2003). Students' mathematical reasoning in university textbook exercises. *Educational Studies in Mathematics*, 52, 29-55.
- Pinto, M. and Tall, D. (1999). Student constructions of formal theory: giving and extracting meaning. In O. Zaslavsky (Ed.), *Proceedings of the 23rd Conference of PME, Haifa, Israel*, 4, 65- 73.
- Raman, M. (2003). Key ideas: What are they and how can they help us understand how people view proof? *Educational Studies in Mathematics*, 52, 319-325.

- Selden, A. and Selden, J. (1987). Errors and misconceptions in college level theorem proving. In *Proceedings of the 2<sup>nd</sup> International Seminar on Misconceptions and Educational Strategies in Science and Mathematics*. Cornell University. Cornell, NY.
- Senk, S. How well do students' write geometry proofs? *Mathematics Teacher*, 78, 448-456.
- Vinner, S. (1991). The role of definitions in the teaching and learning of mathematics. In D.O. Tall (ed.) *Advanced Mathematical Thinking*, Dordrecht: Kluwer.
- Weber, K. (2001). Student difficulty in constructing proofs: The need for strategic knowledge. *Educational Studies in Mathematics*, 48, 101-119.
- Weber, K. (2002) Instrumental and relational understanding of advanced mathematical concepts and their role in constructing proofs about group isomorphisms. In *Proceedings of the 2<sup>nd</sup> International Conference on the Teaching of Mathematics (at the undergraduate level)*. Hersonisoss, Greece.
- Weber, K. (2003). A procedural route toward understanding the concept of proof. In N. Pateman, B. Daugherty, and J. Zilliox (eds) *Proceedings of the 27<sup>th</sup> Conference of the International Group for the Psychology of Mathematics Education*, 4, 395-401. Honolulu, HI.
- Weber, K. (2004). Traditional teaching in advanced mathematics courses: A case study of one professor's lectures and proofs in an introductory real analysis course. To appear in *Journal of Mathematical Behavior*, 23(2).
- Weber, K. (in press). Investigating and teaching the thought processes used to construct proofs. To appear in *Research in Collegiate Mathematics Education*.

# THE NATURE OF SPONTANEITY IN HIGH QUALITY MATHEMATICS LEARNING EXPERIENCES

Gaye Williams

University of Melbourne

*Spontaneity has been linked to high quality learning experiences in mathematics (Csikszentmihalyi & Csikszentmihalyi, 1992; Williams, 2002). This paper shows how spontaneity can be identified by attending to the nature of social elements in the process of abstracting (Dreyfus, Hershkowitz, & Schwarz, 2001). This process is elaborated through an illustrative example—a Year 8 Australian male student who scaffolded his learning by attending to images in the classroom that were intended for other purposes. Leon’s cognitive processing was not ‘observable’ (Dreyfus et al., 2001) in classroom dialogue because Leon ‘thought alone’. Post-lesson video-stimulated reconstructive interviews facilitated study of Leon’s thought processes and extended methodological techniques available to study thinking in classrooms..*

## INTRODUCTION

The case of Leon, a Year 8 male student, whose exploration culminated in a soft exclamation (when everything finally became clear), is used to elaborate the nature of spontaneity and demonstrate a methodological potential. Cognitive activity that was not ‘observable’ in classroom interactions (Dreyfus et al., 2001) ‘became visible’ through post-lesson video-stimulated interviews that were used to probe student reconstruction of thinking.

## THEORETICAL FRAMEWORK

M. Csikszentmihalyi (Csikszentmihalyi & Csikszentmihalyi, 1992) identified activities “chosen spontaneously” as associated with a state of high positive affect and total task involvement (‘flow’). Flow can occur when a person (or group) spontaneously selects their own challenge that can be met by self-directed development of new skills. Flow experiences specific to mathematical problem solving (‘discovering complexity’) occur when complex cognitive challenges are overcome during the creation of novel (to the person) concepts (Williams, 2002). Spontaneous development of novel concepts has been studied across a range of topics and age groups. For example, 5 year olds developed concepts of balance and counterbalance during block building activities (Thornton, 1999); 12 to 15 year olds developed ‘number-theoretic concepts’ during graphical calculator games (Kieran & Guzmán, 2003), and 16 to 18 year olds developed calculus concepts during collaborative exploration of a complex task (Williams, 2002). To identifying the nature of spontaneity that is critical to improving the quality of mathematics learning, the following research question was posed: How can Leon’s case assist in elaborating

the nature of social elements of the process of abstracting that are associated with spontaneity?

## **RESEARCH DESIGN AND ANALYTICAL TOOLS**

This study forms part of a broader study of factors that promote or inhibit autonomous, spontaneous, and creative student thinking associated with high quality cognitive and affective experiences. The study design included three cameras in the classroom simultaneously capturing the actions of the teacher, the whole class, and a pair of focus students over a three-week time interval (see Clarke, 2001 for further detail). A mixed video image with the student pair at center screen and the teacher in the corner was used to stimulate student reconstruction of their thought processes during individual post-lesson interviews. In these interviews, the student controlled the remote, and fast-forwarded through to the parts of the lesson that were important to that student, and talked about what was happening, and what the student thought and felt. The preliminary questions in the interview ‘Did you learn anything new today?’ and ‘What helped you to learn that?’ helped to focus the interviewer’s probes into what the student had been thinking during the lesson. Video-stimulated interviews with the teacher were undertaken once a week in which she discussed the decisions she had made and what had influenced these decisions. These teacher interviews were triangulated with student interview data, and lesson video data, and also used to elaborate classroom activity that had not been captured by the video cameras.

The present paper draws upon data from three consecutive lessons (L11-13) to describe Leon’s thought processes as he abstracted the relationship between rectangles and triangles that enabled him to generalize about areas of triangles. Leon was interviewed after Lesson 12, and briefly again after Lesson 13. The teacher (Mrs Milano) was interviewed after Lesson 13. Some of the interview probes used to stimulate Leon’s elaboration of his thoughts included: ‘How did that happen?’ ‘What helped you to make that decision?’ ‘Can you tell me more about what you were thinking about?’ and ‘Can you explain that a little bit more for me?’ Two video excerpts (less than 3 minute in total) from the last few minutes of Lesson 12 were selected to illustrate how social elements of the process of abstracting (Dreyfus et al., 2001) can be used to identify spontaneity. The six social elements of the process of abstracting (control, explanation, elaboration, query, agreement, and attention) are elaborated when the results are discussed (later). The particular excerpts were selected because they demonstrated that a process of abstracting can sometimes remain spontaneous when visual images in the classroom form part of the stimuli which enabled the student to structure their investigation.

## **CONTEXT**

In Lesson 11, students found areas of irregular shapes by counting squares. Grids and arrays were then used to develop formulae for areas of rectangles and squares. Early in Lesson 12, students dissented about whether a 10 by 10 square was also a



rectangle. As Mrs Milano asked ‘Does a square have four right-angles?’ and ‘Are opposite sides in a square parallel? Does a square have opposite sides equal?’ Leon answered ‘yes’ softly to himself [Video]. He initially thought she had ‘... *no clue* ... a square is a square a rectangle is a rectangle. ...’, then he gradually changed his ideas.

...I thought (pause) ooh well actually a rectangle (pause) is a lot like a square and a square is a lot like a rectangle [Leon’s interview comments about L12, 16:00 Mins]

For the remainder of this paper, ‘Mins’ has been omitted when the time in Lesson 12 is indicated. Task A was presented twenty minutes into Lesson 12 [denoted as 20:00] when students were asked to find the area of the triangle (1, 2, or 3, see Figure 1) allocated to their pair.

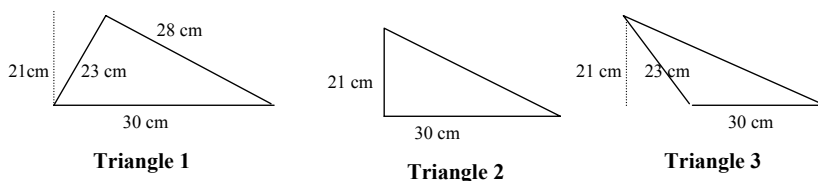


Figure 1. Task A: Colored triangles attached to whiteboard

Most class members (including Leon) lacked prior knowledge of the area of triangle formulae. Leon and Pepe decided to work separately because Leon wanted to think in generalities and Pepe wanted to count squares (in Triangle 1). Leon structured his general exploration by attending simultaneously to the three images on the board. He asked ‘Which triangle is easiest?’ and rapidly ‘recognized’ and ‘built-with ideas’ (Dreyfus et al., 2001):

... all you have got to do is figure out what a rectangle is that has those two um (pause) lengths- length and width and ... then you can just halve it [Interview report of 23:41].

Leon then focused on off-task activity, and intermittently wondered why Pepe was using a compass. At 36:14 he refocused on his exploration of areas of triangles. During two short time intervals in the next three minutes [36:14-36:22 and 38:21-38:57] Leon considered how to find areas of acute-angled triangles. During the intervening time interval he was involved mostly in off-task activity. By the end of the lesson nine seconds later [39:06], he reported recognizing that ‘triangles come in rectangles’ and knew a factor of a half was associated with the right-angled triangle case. During Lesson 13, Leon exclaimed as he recognized the generality of the ‘half’: ‘... sort of just in my head I pulled it apart and put them together ...’. He could have used his right-angled triangle method (applied twice) in developing this insight. He integrated the key attributes of the enclosing rectangles into triangles to find the areas of triangles without explicit reference to rectangles (thereby ‘constructing’) (Dreyfus et al., 2001). Leon’s reflections about Lesson 12 captured the essence of flow experiences in mathematics: ‘... we really didn’t understand ... it was a bit of a challenge ... when I finally did understand it- it really made me feel good about

myself'. He identified the challenge, concept development, and positive affect. The spontaneity associated with such flow experiences is identified below.

## ANALYSIS AND RESULTS

As Leon had identified Lesson 12 as associated with a high quality cognitive and affective experience (above), and that his goal for the lesson had 'changed from *finishing* the work to actually understanding the work', the excerpts used to illustrate spontaneity have been selected to include time just prior to Leon's goal change because it was expected that there would be a rich and diverse nature to the social elements associated with that time. As there was no explicit video evidence of when this goal change occurred, Leon's interview descriptions of this change process were used to identify the relevant video excerpts. Leon reported that preceding the goal change, he '... got different methods in ... [his] head of working it out'. He had also described the types of occasions when such goal changes generally occurred for him.

... when you look around the classroom and see how everyone else is doing it and you are doing a it a completely different way- ... and you think ooh! [soft] maybe my method isn't the best and ... you think about *everyone's* ... and then you think about your own and they all sort of piece together and you just sort of go oh! and it pops into your head.

The above evidence suggested Leon's goal change was preceded by thoughts about at least one inelegant method before a better direction of exploration became apparent. It also suggested that visual images produced by other students formed a part of his synthesis of ideas. An enriched transcript (Table 2) was developed to display the evidence used to identify when Leon's goal change occurred. Each row of the transcript dialogue [Columns 5-7; Leon, Pepe, other participants] displays multi-source data that appeared to relate to the same 'instant' in time [Column 1]. The other columns display Leon's interview comments [Column 2], Leon's images sketched in interview [Column 3], and visual classroom stimuli Leon attended to [Column 4]. Where appropriate, body language was included in the dialogue columns. Due to the richness of data available, decisions were made to include only dialogue associated with identifying Leon's development of ideas, and social elements associated with that process. Dotted horizontal lines in Table 2 indicate omitted intervals of time. All of the dialogue included was associated with small group interactions that were either between: Leon and Mrs Milano [36:14]; the pair on Leon's right, Leon, and Mrs Milano [38:21]; or Leon and Pepe (on Leon's left) [38:56] (see Table 2).

Analysis was undertaken to find when Leon developed his inelegant method. This method was described in Leon's interview as he reported reflecting on Pepe counting squares: '... I thought ... you could do it quicker ... figure out what the area would be fully and then halve it ...' [Table 2, 38:56]. When asked to explain, Leon sketched two juxtaposed acute-angled triangles [See Table 2, Columns 2-3] and stated that the irregular shape in his sketch should have been a parallelogram; that the triangles should have the same 'length' and 'width' (the terms side length and height were confused until 'base' and 'height' were introduced in Lesson 13).




<i>Time in L12</i>	<i>Interview reconstruction: Leon</i>	<i>Interview sketch</i>	<i>Lesson Stimuli</i>	<i>Leon: Dialogue [Body Language]</i>	<i>Pepe</i>	<i>Others</i>
36:14-36:22	... I thought I could just figure out what it would be if it were a parallelogram and then halve it ... figure out what it would be if it was four because you could just trial whatever it was if it was four. ... I understood it- I didn't understand it then I understood it then I didn't understand it.	Asked to explain more, Leon prefaced his sketch with 'Um I ... think it was ... like that ... [drew 2 triangles] should have the same length and width ...' 		Leon: [to T] I think I know. [Nodded] Except if I was doing Triangle 2-2's the easiest one there. [Leon does not respond to Pepe's actions]	Pepe: Bip bip [drove a pen over Leon's arm]	T: [to Leon] Do you?
38:21-38:57	He's [Pepe] drawn up the grid and ... I thought ... you could do it quicker ... figure out what the area would be fully and then halve it [see 36:14 above]. ... people were drawing the actual rectangles around it- I don't know whether they knew they were coming from rectangles ... the way they were drawing it made it look like they did ... made me think about it		Elina's and Serina's  Pepe's page 	Leon: [to T] Aren't they silly? There's so many other shorter ways. [to Pepe] [Laughs] You are doing a great job Pepe.		T: [to Elina and Serina] ... You've resorted to drawing the grid?

Table 2. Enriched transcript identifying intervals in the lesson associated with Leon's goal change

This suggested Leon may have partially developed an analytical argument rather than relied solely on perceptual images to recognize the shape of the figure formed (see Dreyfus (1994)). Leon may have selected this process of juxtaposition and informal consideration of properties of the shape formed because he had used it earlier. Leon's intense interest in rectangle properties just prior to his exploration is consistent with this conjecture.

Leon's reconstruction of his thinking after the parallelogram was formed provided inconclusive evidence about his method (which nevertheless appeared inelegant)

... figure out what it would be if it were a parallelogram and then halve it ... figure out what it would be if it was four because you could just trial whatever it was if it was four

When asked to provide further detail, Leon demonstrated the fragility of his ideas: '... I understood it- I didn't understand it then I understood it then I didn't understand it'. Leon's use of 'four' (above) is not consistent with shifting a triangle to the opposite end in Figure 2 to form a rectangle, but is consistent with cutting the parallelogram into four (see dotted lines in Figure 2) to make four right-angled triangles (and find their areas by repeated use of his right-angled triangle method). He might have used 'trial' as checking empirically, or repeating a process.

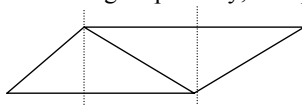


Figure 2. Interpretation of Leon's strategy for finding area of parallelogram

Leon seemed to have been developing this method when he told Mrs Milano he 'knew' and that Triangle 2 was easiest [Table 2, 36:14]. This conjecture is supported in several ways: (a) Leon's method for Triangle 2 is much simpler than the method above; (b) Leon was unaware of the pen Pepe ran over his arm at 36:15 which suggested Leon was involved in his thoughts; (c) Leon participated in off-task activity [36:22-38:21] so was unlikely to have developed the method then; and (d) Leon focused on the grid method for the right-angled triangle [38:21-38:38], then on off-task interactions until 38:56 when we know he was aware of his inelegant method.

As Leon developed his inelegant method first, and did not report being aware that 'triangles come in rectangles' at 38:56, it appears Leon changed direction some time between 38:56 and the end of the lesson (10 seconds later). The fragility of Leon's ideas at 38:56 suggested he could have already had thoughts about more than one approach (that had not yet crystallized). If so, he could already have seen the visual images that contributed to his change in direction. What were these images on student worksheets? And how did they contribute to his change in direction? What was Leon looking at prior to 38:56? During the lesson, Leon had frequently scanned the student activity in the classroom; mainly to find female students within audible range to tease. This activity would also have enabled Leon to see at least five of the worksheets of adjacent pairs, and we know he focused on the worksheets on either

side of him in the minute prior to 38:56. Mathematical explanations appropriate to Leon's exploration were not explicit in the images students produced because pairs were counting squares or finding Triangle 2 using a rectangle [Video, Mrs Milano's Interview]. Leon must have attended to the rectangles students had produced to contain their grids [Table 2, 38:21, Columns 2, 4], and reflected on his right-angled triangle method to recognize that 'triangles come in rectangles'. This provided the impetus for Leon's change in direction, which culminated in his insight in Lesson 13. The spontaneity of Leon's abstracting process during Lesson 12 is now discussed.

## DISCUSSION AND CONCLUSIONS

When indicators of spontaneity occur in the absence of indicators of lack of spontaneity, the abstracting process is seen to be spontaneous. The presence of one or more indicator of lack of spontaneity indicates the process is no longer spontaneous. Social elements are examined to determine their nature; firstly whether Leon responded to social elements associated with an external source or to his own activity (for the purpose of this paper called 'external' and 'internal' social elements respectively). Internal social elements included those observable in video data, and those reconstructed in interview. Internal social elements indicate spontaneity (self-directed activity) if no external social elements associated with lack of spontaneity are also present during the exploration (see below).

### Examining External Social Elements and Internal Social Elements

External social elements can be associated with lack of spontaneity; they can contain mathematical explanations or elaborations, or control of the direction of exploration. External social elements in the video excerpts included only the two queries from Mrs Milano. Mrs Milano's first query 'Did you?' [≈36:16] led to Leon's elaboration of his thinking. This query did not contribute mathematical information but (like the interview probes) encouraged Leon to express ideas. In the second query [38:21], the use of 'resorted' suggested a more appropriate method existed thus providing mathematical information (that Leon already knew). The second query also focused attention on the grid (where mathematical information was not explicit in the image). As none of the external social elements provided mathematical information to Leon, controlled his direction of exploration, confirmed his direction, or its correctness, or the attainment of closure, Leon's process of abstracting appeared to be spontaneous. (Task A did not control Leon's direction because he did not respond to this control but used the stimuli from Task A differently). None of the internal social elements to which Leon responded were traceable to earlier external elements occurring *during* the abstracting process. Leon structured his exploration with his own queries. He used methods, ideas, and strategies he had developed earlier (e.g., right-angled triangle method, juxtaposition of triangles, properties of shapes, and areas of rectangles). Some of these ideas were traceable to external explanation (area of rectangle), and external attention (considering properties of shapes) *prior to* Leon's exploration. For this reason, these external social elements did not indicate a lack of

spontaneity because Leon possessed cognitive artifacts associated with these ideas at the start of his exploration, and recognized their appropriateness for *himself*. Leon's attention to external stimuli was internal focusing of attention on the mathematics implicit in the images.

## Conclusion

Criteria developed to elaborate spontaneity (above) require further refinement and elaboration through their application to other diverse cases where the quality of the learning experience suggests spontaneity might exist. Perhaps, this paper's focus on the benefits of spontaneity might stimulate such further research. Of particular interest is Leon's self-focusing of attention on visual stimuli intended for other purposes. Further research could identify stimuli that can be generated during exploratory activity and used idiosyncratically by students who attend to the mathematics implicit within them. Images identified as inadequate perceptual arguments that require a rigorous mathematical argument to support intuition (Dreyfus, 1994) may stimulate thought about the types of images in which the mathematics is not explicit.

**Acknowledgements:** Analysis of Learners' Perspective data was facilitated by resources at the International Centre for Classroom Research (University of Melbourne).

## References

- Clarke, D. J. (Ed.). (2001). *Perspectives on Practice and Meaning in Mathematics and Science Classrooms*. Dordrecht, The Netherlands: Kluwer Academic Publishers.
- Csikszentmihalyi, M., & Csikszentmihalyi, I. (Eds.). (1992). *Optimal Experience: psychological studies of flow in consciousness*. New York: Cambridge University Press.
- Dreyfus, T. (Ed.). (1994). *Imagery and reasoning in mathematics and mathematics education*. Sante-Foy, Québec, Canada: Les presses de l'université Laval.
- Dreyfus, T., Herschkowitz R., & Schwarz, B., (2001). The construction of abstract knowledge in interaction. In M. van den Heuvel-Panhuizen [Ed.], *Proceedings of the 25<sup>th</sup> Annual Conference for the Psychology of Mathematics Education, Vol. 2* (pp. 377-384), Utrecht, The Netherlands: Freudenthal Institute..
- Kieran, C., & Guzmán, J. (2003). The spontaneous emergence of elementary number-theoretic concepts and techniques in interaction with computer technology. In N. Pateman, B. Dougherty, & J. Zilliox [Eds.], *2003 Joint Meeting of the International Group for the Psychology of Mathematics Education and the Group for the Psychology of Mathematics Education Meeting of North America* (Vol. 3, pp. 141-148). Honolulu: University of Hawai'i.
- Thornton, S. (1999). Creating the conditions for cognitive change: the interaction between task structures and specific strategies. *Child Development*, 70(3), 588-603.
- Williams, G. (2002). Associations between mathematically insightful collaborative behaviour and positive affect. In E. Nardi (Ed.), *Proceedings of the 26th annual conference of International Group for Psychology of Mathematics Education* (Vol. 2, pp. 401-408). Norwich, England: University of East Anglia.

# SPREADSHEET GENERALISING AND PAPER AND PENCIL GENERALISING

Kirsty Wilson, Janet Ainley and Liz Bills

Institute of Education, University of Warwick, UK

*The Purposeful Algebraic Activity Project<sup>1</sup> is a longitudinal study of the development of pupils' algebraic activity in the early years of their secondary schooling. Analysis of data from a spreadsheet-based teaching programme and from semi-structured interviews leads us to identify three features of the spreadsheet environment that appear to shape pupils' generalising: focus on calculations; use of notation; and feedback. We discuss how pupils' experience of generating spreadsheet formulae can potentially support pupils' generalising in a paper and pencil environment.*

## BACKGROUND

Generalising falls within Kieran's (1996) definition of generational activity. Several researchers have reported the difficulties that pupils meet when generating expressions and equations (for example Clement, Lochhead and Monk, 1981). There is some evidence that computer programming environments can support pupils in formalising their generalisations and in developing an understanding of variables (Noss, 1986; Hoyles and Sutherland, 1989; Tall and Thomas, 1991). The improvement in formalising has been attributed to the procedural nature of computer programming and to the use of a symbolic language.

Researchers have suggested that spreadsheets can support pupils in developing an understanding of variables. In a longitudinal study of two groups of 10-11 year old pupils working on traditional problems, Sutherland and Rojano (1993) conclude that 'a spreadsheet helps pupils explore, express and formalise their informal ideas' (p.380), moving from thinking with the specific to symbolising a general rule. Rich examples of pupils exploring, expressing and formalising their ideas offer some insight into how the spreadsheet shapes their activity (Sutherland and Rojano, 1993; Ainley, 1996; Friedlander, 1999).

Ainley (1996) analyses the generational activity of two pupils working on the task, Sheep Pen, which challenges pupils to find how to make a rectangular sheep pen with the largest possible area using 30 metres of fencing set against a wall. The description of the work of the pupils shows how they formalised their generic method of calculating the length of the sheep pen from any width. The pupils made sustained attempts write a spreadsheet formula, and with researcher intervention at the latter stage of their activity, they successfully generated the formula '=30-B11\*2'. Ainley identifies the purposeful nature of the task as central to the success of the pair, who

---

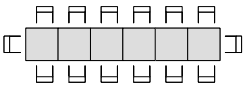
<sup>1</sup> The Purposeful Algebraic Activity Project is funded by the Economic and Social Research Council

had not been introduced to formal algebraic notation. Friedlander (1999) discusses the changes that pupils make to their formulae within a classroom rather than research setting, alongside the reasons for these changes. These are identified as ‘unreasonable computer output, peer discussion or intervention by a neighbour or by the teacher’ (p.339). Friedlander reports that although pupils saw the spreadsheet as a natural tool in moving from the particular to the general, they also experienced cognitive difficulties. For example, pupils frequently generated large quantities of data without questioning whether the data was reasonable.

Sutherland (1995) found that low achieving 14-15 year olds, who had worked on a unit which required them to write an algebraic version of a spreadsheet formula were able to use their knowledge in a paper and pencil test. It is suggested that the ‘the spreadsheet symbol and the algebra symbol came to represent “any number” for the pupils’ (p.285).

The Purposeful Algebraic Activity project aims to explore the potential of spreadsheets as tools in the introduction to algebra and algebraic thinking. To this end we have designed and implemented a spreadsheet-based teaching programme with five classes of pupils in Year 7 (aged 11-12), their first year at secondary school. Pupils across the attainment range were represented in the five classes, set by ability, from two secondary schools. The teaching programme consisted of six tasks, amounting to approximately 12 hours of activity over the course of a year. The pupils’ usual teachers, with whom we have worked throughout the project, taught all of the lessons. We are also conducting regular semi-structured interviews with two cohorts of pupils (those participating in the teaching programme, and those following their usual algebra curriculum). The interviews are designed to cover a number of themes, including generational activity. We have reported our initial findings from analysing pupils’ responses to the ‘tables and chairs’ question (Ainley, Wilson and Bills, 2003).

Tables and chairs are arranged like this in the school dining room:



Can you explain how to work out how many chairs are needed for each long table?  
Can you write it down?

Figure 1: The ‘tables and chairs’ question

We distinguished between pupils generalising the context (‘you need three for the end tables and two for the rest of the tables’) and generalising the calculation (‘you’d double it then add the two on the end’). In drawing out implications for the design and implementation of the teaching programme, we suggested that tasks could signal the need to describe a calculation, and that teachers could encourage pupils to articulate and generalise their calculations. This paper arises from our analysis of how the spreadsheet can shape pupils’ generalising in such tasks.



## DATA COLLECTION

In each of the teaching programme lessons, a range of data was collected. A pair of pupils was video taped whilst working on the task, and screen recording software was used in most lessons. These sources of data were collated into a narrative of the pupils' work. Each narrative includes transcribed dialogue interwoven with details of pupils' non-verbal behaviour and interaction with the computer. In addition, audio recordings were made of teachers' interactions with pupils using a radio microphone; these were semi-transcribed. Field notes were made by the first named author, and examples of written work and spreadsheet files were collected. In our analysis of the data from the teaching programme we have used NVivo software to code examples of pupils engaging in various aspects of generational, transformational and global meta level activity (Kieran, 1996).

We also refer here to data from interviews with pairs of Year 7 pupils prior to and following the teaching programme. The first named author conducted all of the interviews, with each question presented in written form and read aloud. Pupils were encouraged to discuss their responses, and all of the interviews were video and audio taped. Transcripts were annotated to include non-verbal behaviour and any written work. Some interviews were also conducted with high attaining pupils at the beginning of Year 8. These pupils had participated in the teaching programme whilst in Year 7. These interviews were conducted as part of a related study, which aims to identify how pupils mobilise spreadsheet-based knowledge during algebra tasks, and to explore teaching strategies which support this. The interviews followed a similar pattern and included the 'tables and chairs' question, but the pupils were also offered the spreadsheet if they had difficulty formalising their generalisation on paper.

## PAPER AND PENCIL GENERALISING

Prior to the teaching programme, pupils' responses to the 'tables and chairs' question show evidence of algebraic activity, as well as some specific difficulties in generating a symbolic version of the rule. A middle attaining pupil generalised the calculation as 'times it by two and then add two on it,' writing ' $6 \times 2 = 12$ ' and ' $12 + 2 = 14$ .' When asked if she thought that someone would understand what to do for a longer table she explained 'the same like, say if it was ten then ten times two is twenty and then you add two.' When pressed to write something with letters she suggested ' $6t \times 2 = 12$ ' and ' $12 + 2 = 14c$ ', describing the original calculation using letters as objects. We have other examples of pupils using letters in the same way after the teaching programme e.g. ' $10t \times 2 = 20t + 2c$ ' and ' $10t = 22c$ '. These pupils typically understood the calculation, and were able to explain how someone should interpret what they had written. In our interviews with pupils following their usual curriculum we have also seen examples of pupils' written expressions matching their verbal articulation:

'one table equals two chairs and then you'd have to add two chairs to either end'  $1t = 2c + 2$

We have observed that pupils' written generalisations, and any changes they make, tend to reflect their verbal attempts to work with the relationship.

## SPREADSHEET GENERALISING

The following vignette of Jason and Beatrice's response to the 'tables and chairs' question comes from a Year 8 interview. When asked how to tell the caretaker to calculate how many chairs she would need to get out of the store room, Beatrice and Jason both generalised the context, but in different ways:

Beatrice I'd do it by having two per table and then like adding two at the end

Jason ... For every table you need two chairs ... with the exception of the two end ones ... when you add three

Jason and Beatrice knew that sometimes a formula can be written but Jason felt that it was not possible for this question. It appears that he was generalising the context rather than the calculation. The 'two per table' way of looking at the arrangement was revisited, but they were unable to write a symbolic version. In our teaching programme, Jason and Beatrice experienced entering spreadsheet formulae, often to generate data to solve a problem. Although this question focused on formalising the generalisation rather than solving a purposeful problem, there was time at the end of the interview to go back to the question and offer the pupils the spreadsheet below.

	A	B
1	number of tables	number of chairs
2		

Jason and Beatrice were asked to put in a formula that would work out the number of chairs. After initial hesitation, because some time had passed since they had used spreadsheets, Beatrice remembered that they should use A2 because the computer wouldn't understand 't'. Having clarified that they should try and write a formula that would work for any number of tables, Beatrice generalised the calculation:

Beatrice Times two plus two

Jason (pointing to chairs on diagram) Fourteen, six, double it plus two ...

Researcher So now you've got to teach the computer. You know how to do it but you've got to teach the computer how to do it

Jason Try um, number of tables, (in B2 Beatrice types '=A1') um

Beatrice Times two

Jason Times two plus two (...) ~ try it, enter (Beatrice enters '=A1\*2+2' which gives '#VALUE!') (.) No. What have we done wrong? (..)

They decided to 'try it with six,' entering '6' in cell A2 and correcting the formula to '=A2\*2+2.' They pressed enter and both smiled when the number 14 appeared.

They had a clear understanding of the generalised rule:

Researcher What do you understand by A2? If someone said what, what's A2, what does it mean, how would you explain that?

Jason Erm, any number ... but in this case it's "six 'cause it's in that column

Beatrice 'Cause it's in that cell

Using the spreadsheet, Jason and Beatrice formalised the generalisation. In our analysis of the range of data from the teaching programme, we have coded three features of working in a spreadsheet environment which we identify as valuable in supporting pupils' generational activity: focus on calculations; use of notation; and feedback. Reflections on the interplay between the teachers' pedagogic practice and pupils' construction of meaning have also clustered around these three features.

### **Focus on calculations**

Using the spreadsheet, Jason and Beatrice moved from generalising the context ('two per table and then like adding two at the end') to generalising the calculation in natural language ('times two plus two') to formalising that calculation on the spreadsheet ('=A2\*2+2'). In a paper and pencil environment, pupils can 'read' their written generalisations in an idiosyncratic way. But on the spreadsheet, the activity of writing a formula necessitates expressing the calculation in a formalised way.

In our analysis of the teaching programme data, we have coded pupils' use of arithmetic examples to support them in writing a spreadsheet formula. We found that pupils can successfully move from expressing a calculation for a particular number to writing a spreadsheet formula. In the Sheep Pen task (with 39m of fencing), we have seen examples of teachers encouraging pupils to articulate their calculations and then move on to teaching the spreadsheet their method. Whether pupils' responses are specific calculations such as 'take eight away from thirty-nine' or include a sense of variable, such as 'you add on *what(.)ever you need* to make thirty-nine which is thirty-one,' scaffolding questions such as 'What sum have you done?' and 'How did you work that out?' were successfully employed with pupils across the ability range.

### **Use of notation**

Jason and Beatrice understood the use of a symbol to represent a variable. After Jason initially suggested using 't', they used A1 (the label 'number of tables') before remembering the need to use A2. A cell reference such as A2 is clearly not an abbreviation for an object. Beatrice was aware that A2 refers to the contents of the cell. But it also takes on another layer of meaning because if the formula is filled down, using A2 enables calculations to be made in the whole column. Perhaps this is what Jason had understood. Within a spreadsheet, the notation conventions need to be adopted in order to drag the formula down or to change the number in cell A2.

We have many examples from the teaching programme of pupils from across the ability range successfully constructing spreadsheet formulae, and using these formulae in ways that clearly suggest that they are thinking about variables rather than the particular number in the cell. The teachers involved in the research have also reinforced the cell reference as a variable e.g. 'We just say whatever number's in that box.' We have also seen examples of pupils using a single letter rather than a cell reference whilst working in a spreadsheet environment. A pupil tried to write a formula using 'w' for the width of the sheep pen: '39-2w\*='. In Sheep Pen, one pair of pupils started to use 'A,' the name of the column in their formula.

Judith (teacher) Right, why A? A is all of these in this whole column

Pupil Aren't we meant to do loads of sums, that's why, that's why we put

The fact that pupils use letters themselves suggests that it would be useful to explore further the potential of naming cells and columns, a facility offered by a spreadsheet.

### Feedback

The spreadsheet offers immediate numerical feedback, enabling pupils to check their formula. Jason and Beatrice were expecting the number 14 to appear, and when it did they were satisfied that they had written the formula correctly. In the teaching programme, we have coded examples of pupils interpreting feedback from the spreadsheet, often to correct their formula. We have seen a number of pupils achieve success by working through a calculation that gives incorrect feedback. For example, in Sheep Pen, one pair had written the formula '=A8\*2-39' (rather than '=39-A8\*2') for the length of the sheep pen, giving numerical feedback of -19. But whilst they knew it was incorrect it was not until they were encouraged to work through the formula substituting A8 with 10 (their current width) that the pupils corrected the formula by themselves. This activity of interpreting feedback is fleeting by its nature, with pupils inspecting and changing formulae fluently. It does appear that the teacher can play a useful role in encouraging pupils to attend to whether feedback is reasonable, which is something that some pupils tend to overlook (as in Friedlander, 1999), and also to encourage pupils to consider what the spreadsheet has done.

### SPREADSHEETS SUPPORTING PAPER AND PENCIL GENERALISING

The three features of the spreadsheet that we have identified as significant in shaping pupils' generalising are not embedded in a paper and pencil environment. There is no requirement to think in terms of calculations or to use specific notation, and there is no feedback. However, we do have evidence that spreadsheets can support generalising in a paper and pencil environment as indicated by the work of Maria and Jane, high attainers interviewed at the beginning of Year 8. Maria and Jane followed a similar course of action to Jason and Beatrice. Maria initially expressed the relationship in natural language (describing the context):

Maria Would it be like, er, 'cause there's two tables for "each bit of the thing and then there's always gonna be two on each end (pointing throughout)

They then moved directly onto trying to write an equation in standard notation:

Jane You could write um (..) t ... for tables (.) plus (...) ...

Maria Could put like two c equals one t

Jane Yeah, um

Maria Plus two?

$$\begin{array}{l} T = \text{tables} \\ C = \text{chairs} \end{array} \quad t = 2c + 2c$$

When asked what that would look like written down both Maria and Jane wrote ' $t=2c+2$ ' then wrote another 'c' for chairs next to the 2. Without prompting, Jane checked what she had written for one table and two tables, but her activity reflected

her understanding of the context rather than actually substituting the values into the equation that they had written:

Jane            If you had one, “one table then there’d be four chairs which is two plus two  
                  ... If you had two tables there’d be four chairs plus two which equals six

When asked to try to write a spreadsheet formula, Jane wrote ‘=A2+2’, but realised she had made a mistake when she saw the feedback of 3 chairs for 1 table. She referred to what they had written in standard notation.

Jane            No (laughs) I know what I’ve done wrong (..) (deletes formula in B2) Erm equals, equals this number (...) this number, what did we write down here?

Maria           (...) I don’t ↑think this formula’s right (points to ‘t=2c+2c’ written on paper) (..) ‘cause it’s just like (..) ...

Researcher    What makes you think it’s not right Maria?

Maria           Just ‘cause like, that’s just four, it doesn’t seem right like ...I don’t know. ‘Cause you can’t like really (.) get if you wanted to work out like what would it be with ten tables. You can’t really do it for that

Working on the spreadsheet had led to Maria questioning their written generalisation. She quickly generalised the calculation (‘times two plus two’) and they quickly went on to enter the formula ‘=A2\*2+2’. Having entered numbers for the tables and dragged the formula down, Maria and Jane corrected their written equation:

Both            Number of tables (Jane looks at spreadsheet)

Jane            Tables times two plus two equals c (writes)

$$t \times 2 + 2 = c$$

Maria           Yeah (look at what Jane has written)

Jane            t, t times two plus two equals c. Tables times two plus two equals chairs

## DISCUSSION

Our analysis has highlighted three features of the spreadsheet environment which we see as significant in shaping pupils’ generalising. The focus on calculations, use of notation and feedback all act as scaffolds for pupils’ formalising, keeping pupils in touch with arithmetic procedures alongside their verbal attempts to work with the relationships. This supports evidence that computer programming environments can help pupils to formalise their generalisations. Moreover, as illustrated in the interview with Maria and Jane, these features can also support pupils’ generalising in a paper and pencil environment. Working on the spreadsheet was a sufficient scaffold for these high achieving pupils to correct their written generalisation. Their work on the spreadsheet did not involve complex calculations that they would have been unable to carry out mentally. But embedded into their spreadsheet experience was a need to formalise a calculation using a cell reference as a variable. The class had not been taught to replace cell references with standard algebra notation.

Maria and Jane were actually using the spreadsheet in their interview. The extent to which experience of using spreadsheets might influence pupils’ generational activity

when the spreadsheet is not present, is unclear. The interviews that took place with pupils after the teaching programme (at the end of Year 7) were paper and pencil based. We will use these to try to identify subtle influences from the spreadsheet experience on pupils' responses. This will be a major focus of our future analysis across a range of questions and types of algebraic activity.

We have seen in the teaching programme that aspects of teachers' pedagogic practice can usefully advance the three features we have identified here. In terms of mobilising spreadsheet-based knowledge away from the spreadsheet, we suggest that the teacher has a major role to play. Pedagogic strategies could include: asking pupils to think how they would write a formula if they were using a spreadsheet; experience of naming cells/ columns with letters on a spreadsheet; and using substitution to check a formula. The experiences of learners and teachers working with such strategies will be a focus of our further research.

### References:

- Ainley, J. (1996). Purposeful contexts for formal notation in a spreadsheet environment. *Journal of Mathematical Behavior*, 15, 405-422.
- Ainley, J., Wilson, K. & Bills, L. (2003) Generalising the context and generalising the calculation. In N. Pateman, B. Dougherty & J. Zilliox (Eds.), *Proceedings of the 27th conference of the International Group for the Psychology of Mathematics Education held jointly with the 25<sup>th</sup> conference of PME-NA*, Volume 2. (pp. 9-16). Hawai'i.
- Clement, J., Lochhead, J. & Monk, G. (1981) Translation difficulties in learning mathematics. *The American Mathematical Monthly*, 88, 4, 286-290.
- Friedlander, A. (1999). Cognitive processes in a spreadsheet environment. In O. Zaslavsky (Ed.), *Proceedings of the 23rd conference of the International Group for the Psychology of Mathematics Education*, Volume 2. (pp. 337-344). Haifa, Israel.
- Hoyles, C. & Sutherland, R. (1989). *Logo mathematics in the classroom*, London: Routledge.
- Kieran, C. (1996). The changing face of school algebra. In C. Alsina, J. M. Alvares, B. Hodgson, C. Laborde, & A. Pérez (Eds.), *Proceedings of the 8th international congress on mathematics education: selected lectures*. (pp. 271-290). Seville: S.A.E.M. 'Thales'.
- Noss, R. (1986). Constructing a conceptual framework for elementary algebra through Logo programming. *Educational Studies in Mathematics*, 17, 335-357.
- Sutherland, R. (1995). Algebraic thinking: the role of the computer. In L. Burton & B. Jaworski (Eds.), *Technology in mathematics teaching - a bridge between teaching and learning*. (pp. 275-287). Bromley: Chartwell-Bratt.
- Sutherland, R., & Rojano, T. (1993). A spreadsheet approach to solving algebra problems. *Journal of Mathematical Behavior*, 12, 353-383.
- Tall, D., & Thomas, M. (1991). Encouraging versatile thinking in algebra using the computer. *Educational Studies in Mathematics*, 22, 125-147.

# A COMPARISON OF A VISUAL-SPATIAL APPROACH AND A VERBAL APPROACH TO TEACHING MATHEMATICS

Pamela Woolner

School of Education, Communication and Language Sciences

University of Newcastle Upon Tyne

Newcastle Upon Tyne

NE1 7RU

UK

*Despite mathematicians valuing the ability to visualize a problem and psychologists finding positive correlations of visual-spatial ability with success in mathematics, many educationists remain unconvinced about the benefits of visualization for mathematical understanding. This paper describes research that compared a 'visual' to a 'verbal' teaching approach through teaching a range of early secondary school mathematics topics to two classes using one or other approach. The two classes were compared through a post-intervention test of mathematical competency, on which the verbally taught class scored significantly higher. No interactions were found between teaching style and the learner's preferred style although the pupils identified as 'visualizers' did tend to perform more poorly.*

## INTRODUCTION

### Understanding mathematics, visually and verbally

Educators would tend to agree that a major aim of teaching mathematics is for students to develop understanding, even if it can be difficult to conceptualize this understanding fully (Sfard, 1994; Sierpinska, 1994). Taking a broadly constructivist view of knowledge, as teachers are inclined to (Sfard, 1994), suggests the importance of individually constructed understanding. Yet this interpretation still leaves the problem of how teachers interact with learners' constructions and facilitate their building. The challenge of communication can lead beyond a concern with issues of vocabulary and clarity to a tendency to think that verbal descriptions constitute knowledge (Davis, 1984) and that mathematical abstraction is essentially verbal (Anghileri, 1999).

However, the history of the development of mathematical concepts points to the importance within the subject of its visual side (Sfard, 1991). Furthermore, it has been argued that students should be encouraged to develop this aspect within their own understanding (Davis, 1984). It seems necessary to see how a broadly visual approach compares in the classroom to a more verbal approach.



## **Visual-spatial thinking**

In considering how the visual side of mathematics might influence teaching, it seems appropriate to look first at the nature of human visual-spatial cognition. Although there is plenty of debate about this, it is widely agreed that the broad idea of visual-spatial processes as distinct from verbal ones is valid (see Hunt, 1994 for a review).

Other researchers have then moved from this idea of distinctive skills, via observations about individual differences, to the concept of a distinction between people who seem to prefer to use verbal abilities and those who seem to prefer visual processing. Paivio (1971) argued that most information can be encoded visually or verbally and that, along with other factors, the visual/verbal tendency of the subject will affect which mode is used. Other researchers have developed this idea of ‘visualizer’ and ‘verbalizer’ thinking styles.

## **Mathematics and visual spatial thought**

The idea that mathematics involves thought beyond the verbal is supported by the observations of mathematicians, who frequently emphasize the importance of visual reasoning to their thinking (Stylianou, 2002; Sfard 1994). In general, spatial ability predicts success in mathematics (Smith, 1964) and there is evidence that visual-spatial working memory may be important in supporting mathematical performance.

However, all this conviction, mainly in the literatures of mathematics and psychology, appears to be undermined by research in education. Krutetskii (1976), and then Presmeg (1986), found that secondary school students classified as visualizers do not tend to be among the most successful performers in mathematics. At the elementary level, it has been proposed that ‘low achievers’ experience qualitatively different mental representations, where ‘numbers quickly become concrete objects’ (Gray & Pitta, 2000), leading to difficulties with arithmetic.

## **Successful visualization but unsuccessful visualizers**

The apparent contradiction between the positive associations of visual-spatial strength with mathematics and the tendency for ‘visualizers’ to struggle could arise for a number of reasons. An underlying theme is the need to consider individual differences. Firstly, there is the suspicion that visualizers may be failing in school mathematics because of a mismatch between their preferred learning style and the predominance of verbal teaching and assessment. By assessing participants’ habitual learning styles, as visual or verbal, and using two teaching approaches, this research aimed to address this idea.

However, other explanations for the paradox of successful visualizing mathematicians and unsuccessful visualizing pupils suggest attention must be paid to differences between individual visual-spatial approaches, often implying that there are different sorts of visualizer. A major contention is that there is actually a distinction between visual and spatial processes (see e.g. Baddeley, 1997), which has consequences for reasoning (Knauff & Johnson Laird, 2002).



Presmeg (1992) drew attention to different forms of imagery on a 'continuum from specific to more general'. Similarly, in contrast to the concrete images they criticize, Gray and Pitta describe more abstract 'dynamic images of marble or dots'. The concrete type of image, which is found to be less helpful mathematically, can be seen as 'visual' while the abstract style of images seems to demand more 'spatial' skills. This idea has been developed by Kozhevnikov et al (2002), who argue that some visualizers tend to use pictorial images and suffer difficulties, while others succeed through using more abstract spatial representations. Visualizers, according to this theory, have either high or low spatial ability, leading to these distinct approaches.

Alternatively, it has been suggested that the problems of visualizers might arise because of a lack of balance between their visual and verbal understanding. Many writers have pointed out the importance of flexibility in mathematical thought (e.g. Sierpinska, 1994) and it is likely that the visual methods described by mathematicians are balanced and supported by a more verbal understanding (Sfard, 1994). In contrast, the visualizers identified by research into school mathematics are, by definition, unbalanced.

Both these explanations suggest the importance of scrutinizing the visualizers a project identifies, looking at other assessed abilities and observing details of mathematical performance.

## **METHOD**

The aim of this research was to test a broad, visual-spatial based teaching style against teaching with an emphasis on mathematical vocabulary and verbal explanation, while also investigating possible interactions of the teaching styles with the pupils' learning styles. Furthermore, it was anticipated that that assessment and observation would reveal more about the nature of visualizer and verbalizer thinking styles.

It was intended to test the utility of the visual approach in a normal school environment so whole classes were taught by one person (the researcher) with the lesson content ranging over many standard Year 7 (children aged 11 to 12 years) areas, as they arose in the school's scheme of work. The visual ideas were derived from various sources, some of them having been suggested by teachers and researchers. The verbal lessons covered the same content area, using the same questions and investigations, and, where appropriate, identical teaching materials. The intervention lessons were taught once a week, for ten weeks.

The school involved was an 11-18 comprehensive school. Two Year 7 classes, containing children from roughly the lower achieving half of the school population, participated. These two classes were chosen so that the two experimental classes could comprise half from each ordinary class.

## Assessment

The research made use of a number of assessment tools and observations, but only the ones referred to in the results section will be described here.

MidYIS test: This test, administered by the CEM Centre, Durham University, UK produces the scores ‘Vocabulary’, ‘Maths.’ and ‘Non-verbal’.

Mathematics Competency Test (MCT): Vernon, Miller and Izard 1995: This was given to the participants before, and immediately after, the interventions.

Spatial memory test: A test of spatial memory (from the Kaufmann Battery) was administered before the interventions to most of the participants. This involved remembering the positions on a grid of an increasing number of pictorial items.

Recognition test: This was adapted from a procedure described by Richardson (1980) as a feasible method of indicating a person's coding preference, either verbal or visual, when remembering items. Each participant's visual/verbal ratio was calculated and the test-retest reliability of these was 0.478 (N=36; p=0.03).

## RESULTS

### Comparing the two interventions

The children were assigned to the two teaching groups in a broadly random way, but with an attempt being made to balance the distributions of MCT scores in the two groups. Subsequently, the decision was taken to remove from the analysis of MCT gain those individuals who had been absent for half or more of the intervention lessons. The scores of these modified groups did not differ significantly on the MCT or the other measures.

### MCT improvement

After the intervention lessons, MCT scores were higher among the pupils who had received verbal style lessons (see Table 1). Since there was a good correlation ( $r=0.669$ ) between pre and post intervention scores, a regression was completed, predicting post-intervention MCT score from pre-intervention MCT score, with the resulting standardized residuals used as a measure of improvement. Table 2 shows how these compare for the two teaching groups.

Table 1

	Intervention group	N	Mean	Std. Deviation	Sig.(2-tailed)
MCT-pre intervention	Visual	19	13.84	4.50	
	Verbal	17	14.65	4.78	0.606
MCT-post intervention	Visual	17	14.88	4.30	
	Verbal	19	19.32	7.27	0.035

Table 2

	Intervention group	N	Mean	Std. Deviation	Sig.(2-tailed)
MCT gain (residual)	Visual	17	-0.339	0.79	
	Verbal	17	0.339	1.06	0.043

There is a significant difference between the two teaching groups in their post-intervention performance and in individual MCT gain ( $p < 0.05$ ). This produces an effect size of 0.7, a fairly sizable effect due to the verbal style of teaching.

### Nature of the MCT

It seemed worth considering whether the verbal group's superiority on the post-intervention MCT covered all the questions or was limited to a certain style of question. In particular, some of the questions made quite heavy demands on literacy skills. Therefore the test items were classified, according to literacy demands, into three types.

There was no significant difference between the teaching groups on two of the types of question but there was a significant difference in scores on the questions with heavy literacy demands. It is only on these that the verbal group's scores were significantly higher than the visual group's ( $p < 0.05$ ).

### Profiles of MCT improvement in the two classes

The distributions of pre-intervention MCT scores within the two teaching groups were similar, but this was not the case with the post-intervention or the improvement scores. Although the verbal group generally improved, there was variation, with children at the lower end of the range doing little better than those in the other group.

### **Interactions between individuals and interventions**

The correlations of the various measures with the MCT gain did not differ significantly between the two groups. This suggests that the pre-existing abilities and styles of the children were not interacting with the teaching approaches to produce differing patterns of outcome in the two groups.

To clarify whether there were any interactions between the styles of the children and the teaching approaches a series of two-way ANOVAs was conducted. For each measure that related to visual or verbal ability or thinking style the participants were classified as 'high' or 'low'. Two-way ANOVAs were then carried out, considering the influence of each measure together with the intervention group on the MCT improvement. No significant interactions were found between the teaching group and any of the visual-verbal indicators.

This analysis was repeated using the scores on the questions with heavy literacy demands as the dependent variable. Again, there were no significant interactions.

### Individual style and mathematical improvement

Although there was no evidence of systematic interactions of lesson and pupil style, in both classes some children’s MCT gain was much larger than others and it is worth questioning how this gain relates to pre-intervention measures (see Table 3).

Table 3

	MidYIS non- verbal	MidYIS maths.	Spatial memory	Visual/ verbal ratio	MCT gain (residual)
MidYIS vocabulary	.282	.604**	.056	-.123	.478**
MidYIS non-verbal		.437**	.433*	-.127	.354*
MidYIS maths.			.233	.108	.271
Spatial memory				.071	.268
Visual/verbal ratio					-.499**

\*\* Correlation significant at the 0.01 level. \* Correlation significant at the 0.05 level.

It is striking that the measure of visual tendency derived from the recognition test is negatively correlated with the measure of improvement on the MCT: the more ‘visual’ children tended to fail to improve their MCT score. Furthermore, the visual/verbal ratio does not correlate with any of the other assessment scores, which is consistent with previous research findings that verbalizer-verbalizer measures do not correlate with tests of spatial ability (Kozhevnikov et al 2002).

### DISCUSSION

The research produced a wealth of observations on teaching and learning, which can be related to the conclusions possible from the quantitative results reported. A main conclusion is the success of the verbal teaching approach. However, the superiority of the verbally taught class only applied to the verbal style of assessment questions, which is a distinct limitation. Furthermore, the large range of results from the verbal class suggests that the approach only benefited some children, while the correlations with the MidYIS scores imply that these children were the generally more able. The finding that the verbal teaching was better preparation for the verbal assessment does show the importance of style of teaching and assessment, with the visual-verbal distinction appearing valid. However, the lack of any interaction with any measure of verbal style, or ability, might tend to suggest the lack of utility of the visual-verbal distinction, as applied to individuals.

This finding of no straightforward interactions between teaching and learning styles could mean that teaching and learning styles do not interact, or at least not in the simple way proposed. Alternatively, the results could be seen as indicating a failure in the assessment of either the teaching or learning styles. In particular, the visualizer-verbalizer assessment used was not found to be very reliable, although this

could be a symptom of problems with such attempts at global style classifications. As Kozhevnikov et al (2002) point out, there has been long debate about the value of the visualizer-verbalizer distinction.

The visualizers who were identified did have in common their failure to improve their MCT scores, whichever teaching group they were in, and classroom observations suggested that they were struggling. However, there was no evidence of them having particularly low spatial ability, as proposed by Kozhevnikov et al, while the classroom observations and consideration of their various assessment scores failed to indicate any other defining characteristics. There might be a number of reasons why an individual was assessed as a visualizer by the tool used, some of which could be failings of the tool. However, this could also lend support to the idea of different sorts of visualizer. The idea that such differences could result from different reasons for preferring visual thinking is suggested by the finding that some of the visualizers had low MidYIS vocabulary scores; it is clearly different processing visually because of limited verbal ability to preferring visual thinking, given more even abilities.

Yet it should be noted that this idea of there being different sorts of visualizer does not preclude the importance of being cognitively balanced, flexibly using both visual and verbal thinking. Furthermore, this research can be seen as lending support to such an idea, which implies that visualizers defined in this way will tend to have problems. In addition to the observed difficulties of the visualizers identified, the visual teaching highlighted the distinctly visual mathematical thinking of one individual. This child was able to use visual ideas very effectively in class, but was not assessed as a visualizer by the tool used. The implication that his thinking was more balanced between the verbal and the visual was supported by his development of a visual proof, which he used to help him put his, initially visual, reasoning into words.

In conclusion, this project clearly does not support the idea of visual mathematics teaching as a panacea, while the restricted success of the verbal teaching perhaps suggests the limitations of any one style. Although it seems valid to distinguish between visual and verbal strategies, presentations and question styles, it appears more debatable to what extent the distinction can be usefully applied to individuals. If the distinction *is* made, it seems possible to identify varying sorts of visualizers, some with more mathematical problems than others, but also to suggest that lack of balance in visual and verbal thinking might generally be problematic.

## References

- Anghileri, J. (1999). Issues in teaching multiplication and division. In I. Thompson (Ed.) *Issues in teaching numeracy in primary schools*. Philadelphia: Open University Press.
- Baddeley, A.D. (1997). *Human Memory: Theory and Practice (Rev. Ed.)*. Hove, England: Psychology Press.

- Davis, R.B. (1984). *Learning mathematics: the cognitive science approach to mathematics education*. Norwood, NJ: Ablex.
- Gray, E. & Pitta, D. (1996). Number processing: Qualitative differences in thinking and the role of imagery. In L. Puig and A. Guitiérrez (Eds.), *Proceedings of XX International Conference for the Psychology of Mathematics Education, Vol. 4*, 155-162. Valencia: Spain.
- Hunt, E. (1994). Theoretical models for the study of intelligence. In D.K. Detterman (Ed.) *Current Topics in Human Intelligence Vol. 4*. New Jersey: Ablex.
- Knauff, M. & Johnson-Laird, P.N. (2002). Visual Imagery can Impede Reasoning. *Memory and Cognition*, 30, 363-371.
- Kozhevnikov, M., Hegarty, M. & Mayer, R.E. (2002). Revising the Visualizer-Verbalizer Dimension: Evidence for Two Types of Visualizers. *Cognition and Instruction*, 20, 47-77.
- Krutetskii, V.A. (1976) *The Psychology of Mathematical Abilities in Schoolchildren*. J. Kilpatrick and I. Wirszup (Eds.) Chicago: University of Chicago Press.
- Paivio, A. (1971). *Imagery and Verbal Processes*. New York: Holt, Rinehart & Winston.
- Presmeg, N.C. (1986). Visualisation and mathematical giftedness. *Educational Studies in Mathematics*, 17, 297-313.
- Presmeg, N.C. (1992) Prototypes, metaphors, metonymies and imaginative rationality in high school mathematics. *Educational studies in mathematics*, 23, 595-610.
- Richardson, J.T.E. (1980). *Mental Imagery and Human Memory*. London: Macmillan
- Sfard, A. (1991) On the Dual Nature of Mathematical Conceptions: Reflections on processes and objects as different sides of the same coin. *Educational Studies in Mathematics*, 22, 1-36.
- Sfard, A. (1994). Reification as the Birth of Metaphor. *For the Learning of Mathematics*, 14, 44-55.
- Sierpiska, A. (1994) *Understanding in Mathematics*. London: Falmer
- Smith, I. M. (1964). *Spatial Ability*. London: University of London Press.
- Stylianou, D.A. (2002). On the interaction of visualization and analysis: the negotiation of a visual representation in expert problem solving. *Journal of Mathematical Behavior*, 21, 303-317.
- Vernon, P.E., Miller, K.M. and Izard, J.F. (1995) *Mathematics Competency Test*. London: Hodder & Stoughton.

# DIFFERENTIATION OF STUDENTS' REASONING ON LINEAR AND QUADRATIC GEOMETRIC NUMBER PATTERNS

Fou-Lai Lin & Kai-Lin Yang

National Taiwan Normal University

*There are two purposes in this study. One is to compare how 7th and 8th graders reason on linear and quadratic geometric number patterns when they have not learnt this kind of tasks in school. The other is to explore the hierarchical relations among the four components of reasoning on geometric number patterns: understanding, generalizing, symbolizing, and checking, and to differentiate them between linear and quadratic geometric number patterns. From the national survey results, we argue that reasoning on geometric number patterns is a proper initial activity for learning algebraic thinking in Grade 7, and the relations between the checking component and the other components appear to be different between linear and quadratic patterns. Therefore, we propose that checking can play two kinds of role in reasoning on geometric number patterns. One is to induce a strategy for generalizing, and the other is to initiate the development of symbolizing after it is integrated with generalizing.*

## INTRODUCTION

During recent years, more emphasis has shifted from computational skills to effective reasoning about quantitative and qualitative relationships in school mathematics curricula (Thompson & Thompson, 1995; NCTM, 2000). The change in emphasis has contributed to a renewed interest in the teaching and learning of algebra. Pattern generalization is just one principal trend of current research and curriculum development of school algebra. Many studies have also suggested that recognizing, experiencing, expressing, generalizing and symbolizing of functional relationships establish a foundation for algebraic thinking and a precursor to formal algebra (Bednarz, Kieran & Lee, 1996; Orton, 1999).

However, algebra in Taiwan curriculum mainly demonstrated the function of generalized arithmetic and provided a vehicle for solving word problems. Students learnt patterns from number series and the rule of judging whether a number is a given multiple and learnt algebra from solving equations or word problems. Therefore, exploration of geometric patterns does not always stand its own as a curricular topic or activity in Taiwan. Although there is currently a significant mathematics curriculum innovation under way in Taiwan, 'A draft plan of high-year joint mathematics curriculum guidelines (Taiwan Ministry of Education, 2003)' also highlights recognition of regulations, algorithms of number series and symbolic expressions of relationships between patterns. The processes of generalization and symbolization, which incorporate exploring and searching for geometric number patterns, and explaining patterns verbally or diagrammatically still remain neglected.

On the other hand, Bishop had proposed a developmental sequence from the concrete, the recursive, to the functional category; however, the status of proportional

category and reasoning on non-linear geometric patterns still required further research (Bishop, 2000). Taking into account that reasoning strategies may be influenced by different components (generalization or symbolization) and structures (linear or non-linear) which compose of different learning activities, we converted into exploring hierarchical relations among different components of reasoning on geometric number patterns: understanding, generalizing, symbolizing, and checking. These relations may be essential and illuminating when we investigate how to improve and evaluate children's learning in this area.

In summary, there are two purposes in this study. One is to compare how 7th and 8th graders reason on linear and quadratic geometric number patterns when they have not learnt this kind of tasks in school. The other is to explore hierarchical relations among the four components of reasoning on geometric number patterns.

## DESIGN OF THIS STUDY

Ongoing projects on the development of mathematical argumentation in England and in Taiwan are conducted bilaterally. In Taiwan, the instruments were adapted from England and modified based on Taiwanese students' responses. In addition, some new items were included. The six booklets comprised questions in two domains of mathematics — Algebra and Geometry with respect to grade 7, 8 and 9. Not only the coding systems but also some conjectures as to the relations among the four components were formulated from a pilot study. Herein, we mainly report students' reasoning on geometric number patterns in this paper, part in algebra domain, and their reasoning on statements about number patterns will be written in another article.

### Number Pattern Items

Table 1 showed our components of reasoning on number patterns. The patterns are labeled linear or quadratic because their  $n$ th terms can be expressed as  $an+b$  or  $an^2+bn+c$  (Stacey, 1989). When presented with a sequence of configurations of dots or a figural pattern, students were expected to predict the number of dots or a sub-figural pattern for the fifth, twentieth and  $n$ th picture and to check if a given number can represent some term in the sequence or sub-figure.

After identifying the four types of reasoning on number patterns, exemplary items are presented as Fig 1. and Fig 2. Question A1 and A2 are concerned with generalization in a setting (tile patterns) familiar to English students (Kuchemann & Hoyles, 2001) but unfamiliar to Taiwan students. An approach to seeing a pattern is suggested only in quadratic geometric number patterns (e.g. A2-a), and students are required to predict the number of dots for the fourth (e.g. A2-ai) or fifth picture in the understanding task. The approach provides a hint that the relation between the number of terms and the number of dots within each pattern is the focus. It is no doubt that understanding the meaning of the task is necessary before generalizing, symbolizing or checking the sequence of patterns. In particular, we provide the checking items, A1(c) and A2(d), in addition to the items in English study. Students' responses to the generalizing and checking items were respectively coded into 6 categories (Table 2).



The coding system is similar to the English system, but we are interested in whether patterns students *see* or *use* are *improper*, *useful but incomplete*, or *complete*. Therefore, we would be able to find the differences among seeing, recording or using a pattern for students respectively via the generalizing, symbolizing or checking items.

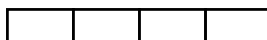
Subject \ Number Pattern	Linear Geometric				Quadratic Geometric			
	U	G	S	C	U	G	S	C
Grade 7	—	A1(a)	—	A1(c)	A2(a)	A2(b)	—	—
Grade 8	—	A1(a)	A1(b)	A1(c)	A2(ai)	A2(aii)	A2(c)	A2(d)

U, G, S and C denote understanding, generalizing, symbolizing and checking respectively.

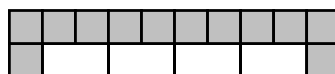
Table 1. Four components of reasoning on number patterns.

(A1) Larry has some white rectangular tiles and some gray square tiles. The white tiles are twice as long as the gray tiles but have the same width.

He makes a row of white tiles, like this:



He then builds a 'U' frame of gray tiles over the white tiles, like this

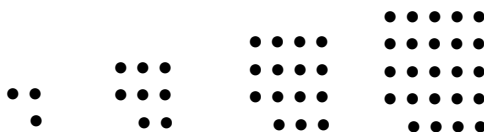


- (a) How many gray tiles does he need to build a 'U' frame over a row of 40 white tiles? Explain your answer.
- (b) Write an expression for the number of gray tiles needed for a row of  $n$  white tiles.
- (c) Can 195 gray tiles be built a 'U' frame over a row of some white tiles?

Fig. 1. Question A1 in Grade 8

(A2) Karen and Josie are looking at these first four patterns in a sequence of dot patterns:

- (a) Karen wants to calculate the number of dots in the 4th and 20th pattern. She says each pattern looks like a square with lacking one corner.



- (i) the 4th pattern
- (ii) the 20th pattern
- (c) Write an expression for the number of dots in the  $n$ th pattern, using
- (i) Karen's way of looking at the pattern.
- (d) Do 9999 dots fit into this pattern?

Question (b) is similar to question (a) but provides another approach which did not present in this paper.

Fig. 2. Question A2 in Grade 8

Code	Key character of response	Exemplary response (Item)
1	Seeing(Using) an improper pattern	$12 \times 10$ (A1-a); $24 \times 5$ (A2-aii); It can be divided by 3(A1-c).
2	Seeing(Using) some useful but incomplete pattern or only with correct result	$40 \times 2$ (A1-a); $20 \times 20 - 1$ (A2-aii); odds numbers are impossible (A1-c).
3	Seeing(Using) a complete pattern only with correct arithmetic or photo-picture(manipulation)	$84$ (A1-a); $21 \times 21 - 1$ (A2-aii); No matter how you arrange, However you arrange, 195 is impossible (A1-c).
4	Seeing(Using) a complete pattern with correct result and verbal explanation	The dot number of length is 1 more than the corresponding term (A2-aii); $191(195-4)$ can not be divided into two equal parts(A1-c).
5	Seeing(Using) a complete pattern towards correct algebraic strategies	$(n+1)^2 - 1$ (A2-aii); $(n+1)^2 - 1 = 9999$ (A2-d)
6	Not showing to see(use) any pattern	$4+20$ (A2-aii); Misunderstand 9999 as the 9999th figure (A2-d); or no response.

Table 2. Response code for the generalizing and the checking tasks.

### Sample and Administration

This survey, which was to be completed in 45 minutes, was administered to 1,181 seventh graders, 1,105 eighth graders and 1,059 ninth graders. The subjects were nationally sampled by means of a two-stage sampling. The first stage was to divide our nation into six regions, and to randomly sample schools from each region. The second stage was to equally distribute these classes of sampled schools into 13 groups. Two of the thirteen groups were used as samples in our project. Half the sampled students in each class answered the booklet in Algebra(A), and the others answered the booklet in Geometry(G) according to their grade.

## RESULTS WITH DISCUSSION

### 7th and 8th Graders' Reasoning on Geometric Number Patterns

We first compare 7th and 8th graders' spontaneous reasoning on geometric number patterns with respect to generalizing and checking, linear and quadratic. Table 3 shows the distribution of their responses to the generalizing items. While *generalizing* the *linear* geometric number patterns, 35.4% of Grade 7 and 52.7% of Grade 8 could answer correctly. But 30.3% of Grade 7 and 14.3% of Grade 8 incorrectly answered with the proportional reasoning strategy as English students did (Kuchemann & Hoyles, 2001). While *generalizing* the *quadratic* geometric number patterns, 36.3% of Grade 7 and 64.3% of Grade 8 could answer correctly. In particular, 8.9% of Grade 7 seeing an improper pattern with focusing on one dimension only, e.g. the number of

rows, columns or diagonal dots and misused partial information. However, reasoning on geometric number patterns is suggested to be the initial activity for learning algebraic thinking in Grade 7 because above one third of the 7th or 8th graders could correctly generalize linear and quadratic geometric number patterns unfamiliar to them. More 7th or 8th graders gave the correct answer while generalizing in quadratic than in linear geometric number pattern. It may result from that we provided an approach in quadratic geometric number pattern or that more students were attracted to the proportional relation between gray and white tiles in linear geometric number pattern.

Generalizing Structure of Geometric Pattern (Percentage)	Grade 7 (N=1181)		Grade 8 (N=1105)	
	Linear	Quadratic	Linear	Quadratic
Seeing an improper pattern	30.3	11.4	14.3	1.4
Seeing some useful but incomplete pattern or only with correct result	7.2	10.3	7.1	13.2
Seeing a complete pattern only with correct arithmetic or photo-picture	34.9	29.8	45.0	50.1
Seeing a complete pattern with correct result and verbal explanation	0.4	6.4	7.1	14.1
Seeing a complete pattern towards correct algebraic strategies	0.1	0.1	0.6	0.1
Not showing to see any pattern	27.0	42.1	26.0	21.1

Table 3. Distribution of students' responses to the generalizing items

Checking Structure of Geometric Pattern (Percentage)	Grade 7 (N=1181)		Grade 8 (N=1105)	
	Linear		Linear	Quadratic
Using an improper pattern	38.4		6.9	1.4
Using some useful but incomplete pattern or only with correct result	11.9		19.3	19.2
Using a complete pattern only with correct arithmetic or photo-picture	15.8		22.9	23.0
Using a complete pattern with correct result and verbal explanation	3.2		1.8	2.1
Using a complete pattern towards correct algebraic strategies	1.4		11.3	11.2
Not showing to use any pattern	29.2		37.9	43.0

Table 4. Distribution of students' responses to the checking items

Table 4 shows the distribution of 7th and 8th graders' responses to the checking items. While *checking* the *linear* geometric number patterns, 32.3% of Grade 7 and 55.3% of Grade 8 could at least use some useful but incomplete pattern to check. But there were 24.6% of Grade 7 and 5.6% of Grade 8 who used an improper pattern with the proportional reasoning strategy (e.g. It can be divided by 3.). While *checking* the *quadratic* geometric number patterns, 36.3% of Grade 8 could answer correctly. Although 8th graders better generalized and checked than 7th graders in general, we draw attention to that the percentage of the response of not showing to see or use any pattern in linear geometric number patterns did not decrease as the grade. Therefore, it is needed to study on whether parts of students do or do not progress after one year, and further on why they do or do not progress.

### Hierarchical Relations among the Four Components

In the following, we further investigated the hierarchical relations among the four components of reasoning on number patterns and differentiated them between linear and quadratic geometric number patterns.

Understanding \ Generalizing	Grade 7		Grade 8	
	Correct	Incorrect	Correct	Incorrect
Correct	33.9%	2.5%	57.9%	0.7%
Incorrect	35.4%	28.3%	12.1%	29.3%

Table 5. Understanding and generalizing the quadratic geometric number patterns

(Grade 8) Symbolizing	Understanding		Generalizing	
	Correct	Incorrect	Correct	Incorrect
Correct	36.2%	1.3%	35.3%	2.2%
Incorrect	33.8%	28.7%	23.3%	39.2%

Table 6. Symbolizing, understanding and generalizing the quadratic geometric number patterns

Symbolizing \ Generalizing	Correct	Incorrect
	Correct	46.5%
Incorrect	6.5%	44.1%

Table 7. Symbolizing and generalizing the linear geometric number pattern

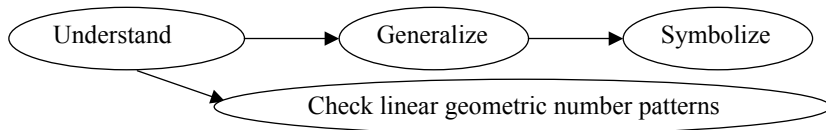
In the *quadratic* geometric number patterns, Table 5 shows that most 7th and 8th graders who correctly generalized this pattern also correctly understood it. Table 6 shows that most 8th graders who correctly symbolized this pattern also correctly understood (or generalized) it. In the *linear* geometric number patterns, Table 7 shows that most 8th graders who correctly symbolized this pattern also correctly generalized

it. The MacNemar's test result ( $\chi^2 = 14.6$ ,  $N=1105$ ,  $p<0.001$ ) suggests that the frequencies of different responses between generalizing and symbolizing linear geometric number patterns (Table 7) are significantly different. The results of Table 5 to Table 7 seem to sustain that a hierarchy proceeds from understanding, generalizing to symbolizing linear or geometric number patterns.

Checking \ Generalizing	Grade 7		Grade 8	
	Correct	Incorrect	Correct	Incorrect
Correct	18.7%	8.4%	38.5%	10.3%
Incorrect	16.5%	56.4%	14.2%	37.0%

Table 8. Checking and generalizing the linear geometric number pattern

In the *linear* geometric number patterns, Table 8 shows that the percentage of students who correctly checked and incorrectly generalized the same pattern was more than 8%. After further analyzing the responses, most of them used a useful but incomplete pattern to get the correct answer, but this strategy is insufficient to generalize correctly. After combining the above results and the result of Table 8, we diagram a hierarchy as follows and conjecture that using a pattern to check may be helpful to inducing a strategy for seeing this pattern.



Symbolizing \ Checking	Correct	Incorrect
	Correct	21.4%
Incorrect	14.8%	47.8%

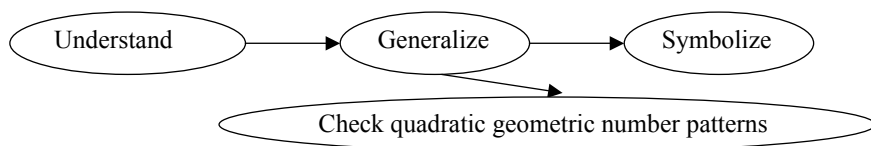
Table 9. Symbolizing and checking the quadratic geometric number pattern

Checking \ Generalizing	Correct	Incorrect
	Correct	30.7%
Incorrect	28.0%	35.8%

Table 10. Checking and generalizing the quadratic geometric number pattern

In the *quadratic* geometric number patterns, Table 9 shows that above 40% (16.0/37.4) of 8th graders who correctly symbolized the pattern were unable to correctly check it. However, Table 10 shows that about 85% (30.7/36.3) of 8th graders who correctly checked the pattern also correctly generalized it. After combining the above results and the results of Table 9 and Table 10, we diagram the

hierarchical relation the four components as follows and conjecture that using a pattern, while integrated with seeing this pattern, may initiate the development of recording it.



## SUMMARY

From the national survey, we argue that reasoning on geometric number patterns is a proper initial activity for learning algebraic thinking in Grade 7. The checking component appears to be different between linear and quadratic patterns. Therefore, we propose that checking can play two kinds of role in reasoning on geometric number patterns. One is to find out a strategy for generalizing, and the other is to initiate the development of symbolizing after it is integrated with generalizing.

Acknowledgements: This work was funded by the National Science Council of Taiwan ( NSC 91-2522-S-003-002 ). We are grateful to the members of the research team, Tam, H. P., Yu Wu, J.Y., Chen, C.Y., Chen, E.R., Lin, C.Z., Hao, S.C, Liang, H.J., and Chang, C.H. who made their contributions on analyzing the protocols and commenting on the draft of this paper. Views and opinions are those of authors and not necessarily those of NSC.

## References:

- Bednarz, N., Kieran, C. & Lee, L. (1996). *Approaches to Algebra*. Dordrecht/Boston/London: Kluwer Academic Publishers.
- Bishop, J. (2000). Linear geometric number patterns: Middle school students' strategies. *Mathematical Education Research journal*, 12(2), 107-126.
- Kuchemann, D. & Hoyles, C. (2001). Investigating factors that influence students' mathematical reasoning. *PME25*, 3, 85-92.
- National Council of Teachers of Mathematics. (2000). *Principles and standards for school mathematics*. Reston, VA: Author.
- Orton, A. (1999). *Pattern in the teaching and learning of mathematics*. London & New York: Cassell Wellington House.
- Stacey, K. (1989). Finding and using patterns in linear generalizing problems, *Educational Studies in Mathematics*, 20, 147-164.
- Taiwan Ministry of Education (2003). *A draft plan of nine-year-joint mathematics curriculum guidelines*. Taiwan: Author. (In Chinese)
- Thompson, A. G. & Thompson, P. W. (1995). A cognitive perspective on the mathematical preparation of teachers: The case of algebra. In C. B. Lacampagne, W. Blair & J. Kaput (Eds.). *The algebra initiative colloquium*, 1, 95-116. Washington, DC: US Department of Education.

# MAP CONSTRUCTION AS A CONTEXT FOR STUDYING THE NOTION OF VARIABLE SCALE

Nikoleta Yiannoutsou and Chronis Kynigos

Educational Technology Lab, University of Athens, School of Philosophy

*We report research on meanings of scale generated by pairs of 14 year-old students engaged in joint map-construction. Characteristics of the learning environment, such as the communicational orchestration, the use of experientially familiar objects in space as starting points for creating figural representations and the interrelated representational registers of tangible objects, graphical and formal symbolic representations were important. The task to create maps allowing for dynamic scale change encouraged students to focus on the proportional aspects of scale in all three phases of the task, while they progressed from a componential to a holistic view of the map.*

## FRAMEWORK

This study aims at exploring the meanings about scale generated by 14 year-olds while constructing a map of their school campus with s/w allowing them to create building contours whose scale can be dynamically changed. Research focusing on concepts of spatial cognition required for cartography and map reading identifies scale as one of the basic elements to understand maps perceiving scale as a facet of proportional reasoning (Liben and Downs 1989 Bausmith et al 1998). Literature on proportional reasoning in mathematics education is of course vast and has provided extensive reports on students' difficulties and misconceptions (see for example Tourniaire & Pulos 1985, Kuchemann, 1991). The research highlights students' difficulty with the concept and their tendency to insist on attaching additive rather than proportional relationships to mathematical entities even in contexts with a didactical design to bring out proportionality. Research on proportional reasoning in spatial cognition tasks, however, is mainly oriented towards geometry curricula, investigating students' thinking in the context of geometric axiomatic systems where, in the end, figures represent instants of classes of 'ideal' figural constructs. When these figures are used to represent tangible objects in educational settings, the mathematization of figural relationships such as proportionality is a non-obvious task for students (Mariotti, 2002). Few exceptions, such as students' constructions with the 'N' tasks and the 'house' task by Noss and Hoyles, 1996, have highlighted how they in fact do generate their own theorems embedding proportional thinking but that at the same time how these are grounded in the specific context at hand and thus characterized as 'situated abstractions' by these authors. The idea that proportionality lies in changing the size of the same figure without 'distorting' its characteristics was, however, researched with a medium restricted to static constructions of instances of a figure, not allowing students to get a kinaesthetic sense of the dynamic evolution of

figure distortion or preservation. The context of cartography, requires the selection of physical objects in space and their graphical representation. There is not much information about how (or even if and under what circumstances) students employ proportional reasoning in order to construct a model of observable objects in real space. Research oriented towards geography education integrates proportional reasoning in map-related tasks where, however, scale is studied solely as a method of establishing correspondence between space and its representations (Leinhardt et al 1998). The focus of these studies is on how students use the calculation formula of scale in map-enlargement or reduction tasks (see for example Bausmith et al 1998). We argue that this view overemphasizes the calculation methods that build a correspondence between space (or the initial model) and its representations placing little emphasis on the functional purpose of scale which is the maintenance of spatial relationships. We designed the cartography activity to bring this issue into the forefront of student activity. The research we report aimed at studying the meanings generated by students negotiating spatial relationships, rather than applying or understanding the scale formula. We wanted to understand weather and how they engaged in proportional reasoning during their attempts to construct the contours of the several buildings of their school site and their respective positions, orientations and relative sizes, so that the figural relationships of these representations would be preserved when dynamically changing the scale. The students worked in a *constructionist* learning environment (Harel and Papert, 1991) including a specially-designed cartography microworld which combines symbolic expression to construct figures with dynamic manipulation of the generated graphical output. A programming language (Logo) functioned as tool for symbolic expression and served a dual purpose: a) provided students with a vocabulary for articulation, reflection, refinement and communication of problem solving strategies (Eisenberg 1995) and with means to focus on how the mechanism underlying scale worked b) provided us with resources to gain insight on how students approached the notion of scale by studying how and what they constructed and edited (Noss et al 1997). Dynamic manipulation of the graphical output offered the students a tangible interface to evaluate and refine the symbolic expression of spatial relationships through the continuous DGS-style evolution of figural constructs.

## CONTEXT

A cartography activity was designed and implemented in four classes of 14 year-old students, 70 students in total. The activity was designed to facilitate inter and intra-group collaboration and to trigger whole class discussions as context for negotiating spatial concepts involved in map construction. Pairs of groups engaged in joint construction of a computerized treasure hunt game per class and designed it so as to take place in their campus. The game involved the use of the cartography microworld, consisting of an electronic map of the area where the treasure hunt was going to take place, of a database with spatial information connected to the map and of clues placed in different locations in the area represented on the map (see fig1).



The de-coding of the clues was facilitated by a Venn diagram representation that was connected to the database and the map.

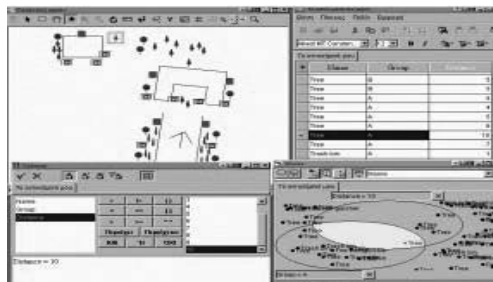


Fig1. An electronic map constructed by a group for the treasure hunt game

The activity involved map construction and use and interweaved navigation in space with work on the representation. Based on Leinhardt's et al (1998) suggestion that students can become more easily acquainted with spatial concepts embodied in maps when they have some knowledge of the place represented on the map, we decided to focus on familiar -for the students- space aiming to support the interplay between representation and referent space. This report is part of a larger study and follows on from a previous study involving seven year olds' spatial orientation (Kynigos and Yiannoutsou, 2002). Here we will focus only on the mathematical facet of the present study that involved construction of the buildings on the map and evolved in two phases. During the first phase students wandered around their school campus and recorded all the information necessary (i.e side lengths of the buildings, distances, type and position of landmarks) for the construction of an accurate map of the area. Accuracy was imposed not only by the task but also by the nature of space. A map of a familiar place is used in a treasure hunt game not to roughly outline space but to offer the necessary information so that a specific symbol on the map (such as a tree or a dust bin) can indicate the exact position of the respective object in space. The space our students represented was bordered by two or three different buildings, and consisted mainly of trees, bushes, dustbins and fire extinguishers. During the second phase, students used a programming language (Logo in this case) to construct a dynamic model of the contours of the buildings based on the measurements they made during the first phase. The idea behind the dynamic model was for the students to express symbolically the spatial relationships so that they could change the scale of their map through direct manipulation with the variation tool (Kynigos, 2002). The variation tool in the microworld can be activated by clicking on a point of the trace of a parametric procedure after it is executed with a specific value for each variable. Dragging the slider which is provided for each variable, causes dynamic change of the figure resulting from the respective 'continuous' change of the value of the variable. An editable step unit allows for change in the effect of continuity. Bundling all these diverse functionalities in one piece of s/w became possible through the use

of E-slate as an authoring system (Kynigos, in press). The students of our research had used one year before, the same programming language to construct a size-changing font. This allowed us to focus on the representation of spatial relationships avoiding any “noise” that could be caused by students’ unfamiliarity with the representational medium or the mathematical concepts involved. In this report, we thus refer only to the basic feature of the cartography microworld that played an important role in studying students’ strategies while expressing spatial relationships symbolically and dynamically manipulating the resulting figural constructs.

## **METHOD**

The study was implemented in four classes of fourteen year-old students and lasted for 19 sessions in each class. We worked in classroom settings aiming to study students’ generation of meanings in a framework with rich social interaction facilitating negotiation and floating of ideas. We employed participant observation and collected our data a) from focusing on two groups in each class and b) from the whole class focusing on different groups for a short while in each session. The selection of our data was related to our decision to combine a detailed account of information regarding the work of two groups along with a general picture of the work in the class. Two researchers acted as participant observers focusing on a) verbal exchanges b) gestures, motion in space and c) data captured on the screen. Observers’ interventions aimed at prompting students to make their thinking explicit as well as challenging students’ actions and explanations. At the end of the activity teachers and the two focus groups from each class were interviewed. Research data consisted of students’ work as well as of transcripts of the video-recorded sessions and of the interviews. We implemented discourse analysis to the transcribed data in the framework described by Yackel & Cobb (1996). Unit of analysis was the thematic episode comprising of a series of verbal exchanges around a specific subject. Change of subject indicated new episode.

## **PERCEIVING OBJECTS AS A SET OF COMPONENTS**

In the context of map understanding research with young children, Lieben and Downs (1989) distinguish between a ‘componential’ and a ‘holistic’ level. The former involves meaningful constituent parts of a map (e.g. a rectangular area representing a tennis court) being at the forefront of student perception and the latter involves students’ ability to make sense of the map by considering the whole of the area represented and the topological relationships between the represented objects. In this sense, all student pairs in the study initially adopted a componential approach, not only by working with the buildings first (we asked them to do this), but by their choice of strategy to measure each segment of a building’s perimeter using a specific unit (amongst the units chosen were a foot, a step, a belt and a meter) and to attach a correspondence between this unit and the turtle step unit of their cartography s/w (typically 1-1, 1-5, 1-10). In this report we analyze the two out of the eight pairs of students, who began by writing a Logo procedure using fixed values for segments

and turns to begin with. They were reminded by their teacher that since they had split the task of constructing the map, they would have to use each other's building procedures and thus needed to construct them so that they would subsequently be able to coordinate building sizes by being able to change them. The two groups proceeded to substitute each value in their procedure with a variable, not thinking about relating a value with another, as shown in fig. 2 (internal continuous graph of perimeter).

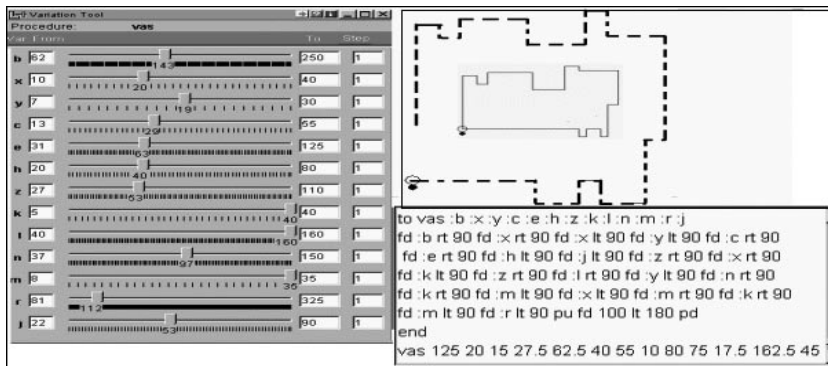


Fig2. Variable scale based on “componential” strategy

When the group tried to enlarge the building using the variation tool sliders they inevitably ended up distorting the building (dotted line contour top right window). It was this problem that brought about dialogue on what change needs to be made to the symbolic code in order for the building to change without distortion, as shown in the following excerpt by one of the groups.

1. S1 We need a lot of variables, because we need a variable here, a variable
2. here [he points on the numbers next to the command forward in the
3. Logo procedure], one here, one here, one here and one here
4. S2 Hold on. Look. Look
5. S1 One, two three four [he counts the numbers in the Logo procedure to
6. decide the number of variables needed]
7. S2 No, this one, and this one will be the same. They have the same
8. value
9. S1 Yeah, right. Ok this is x, this is y, this is z, this is k
10. S2 Hold on, this is, we can
11. S1 Yeah this is the half of it
12. S2 And this is twice as this, this is 3 times this and so on. We can do the
13. whole thing using one variable we don't need all these.

The students' noticing that some sides had the same value seemed to be the departure point for them to attach proportional relationships between line segments (lines 7,11,12). These were expressed by means of giving the procedure one variable and subsequently using a fraction or a product of that variable to express the length of each segment. During this phase, however, the students focused mainly on the line segments constituting the building and had only begun to consider the building as a whole, restricted to the problem of figural distortion.

## PERCEIVING OBJECTS AS ENTITIES

Dynamic change of scale was subsequently used in the context of joining buildings to construct the campus map: pairs of groups exchanged their building procedures and created a map consisting of the buildings both groups had constructed. In the extract below we illustrate how during the process of joining maps one pair of groups (S5, S6 and S7, S8) seemed to reason about the map as a representation of interrelated spatial entities.

14. S7 This is not a correct map. Vasilia (*name of one of the buildings*) has the same size with Benakeio (*name of the other building*) [they use the same variable  $x$  for both buildings]
15. S5 It doesn't have the same size!
16. S8 Maybe but look, when Benakio is ten, Vasilia should be three. Vasilia
17. is three times smaller than Benakio. Now when Benakio is ten Vasilia is 25. It's
18. the opposite.[They execute each procedure separately first Benakio 10 then
19. Vasileia 25]
20. S7 Hold on, if Vasileia is three times smaller we will divide  $x$  by 3

When S7 and S8 attempted to join their map with the map S5 and S6 had constructed they were encountered with two procedures using the same letter ( $x$ ) to denote variable, but with a different correspondence between  $x$  and unit of measurement, as well as different units of measurement. This resulted in the representation of each building being proportionally accurate in itself, but in a distortion between the relative sizes of the two buildings which was obvious to the students right away, since the buildings were part of their everyday reality. The fact that students were representing an experientially familiar space (their campus) seemed to be crucial in the importance they attached to solving the problem of the relative building sizes (lines 15,16,17). Students' efforts seem to focus on coordinating the graphical output not only with the spatial relationships identified in space ("Vasileia is 3 times smaller than Benakeio") but also with the symbolic expression of this relationship ("When Benakeio is 10 Vasileia should be 3"). The next step for the students was the "translation" of the relationship between the sizes of two buildings into a proportional symbolic expression (line 26 "we will divide  $x$  by 3"). At this point students returned to the procedure representing Vassileia and divided all inputs to the FD command by 3. They thus changed from viewing the building as a process of joining segments and

thinking of the relationships between them to considering the building as an entity and then using that perception to go back to the procedural one.

### **SITUATING OBJECTS IN TOPOLOGICAL RELATION TO EACH OTHER**

Apart from relations between buildings and side lengths, spatial relationships also involved distances between buildings. This became problematic when the students realized that dynamic scale changes of maps containing two buildings distorted the distance between the buildings and thus their topological positioning on the map. What had in fact happened was that it had not initially occurred to them to express these distances proportionally to the building sizes and they either gave fixed values of distances between buildings or between the turtle starting point and the first building. S7 initially thought that variable distances would actually cause map distortion.

21. S7: Now, this distance should not have variables, if we increase the map this building, Vasileia, will go out of the screen
22. S8: We have to put variables in this distance, the whole thing should be shrinking if we try to make it smaller
23. S7: Yes, I know the distance between the two buildings will have variables. This is not the same. I am talking about the distance from the center to Vasileia

It was S8, however, who seemed to adopt a holistic view of the map, realizing that topological relations involved both the objects themselves and their relative positions. His referral to 'the whole thing' as proportional ('shrinking') while addressing a series of proportional relationships is within the framework of situated abstractions as proposed by Noss and Hoyles (1996).

### **CONCLUSIONS**

Some features of the learning environment played an important part in providing the students with opportunities to mathematize (in the sense of Sutherland, 2001) a seemingly geographical science-like task. Of these, the communicational orchestration, the use of experientially familiar objects in space as starting points for creating figural representations and the interrelated representational registers of tangible objects, graphical and formal symbolic representations were important. The task to create maps allowing for dynamic scale change encouraged students to focus on the proportional aspects of scale in all three phases of the task, while they progressed from a componential to a holistic view of the map. Situating mathematization and proportional thinking in such contexts may provide students the ground for generating meanings around proportion which previous research seemed to imply were difficult for students to grasp as concepts (e.g. Tournaire and Pulos, 1985). It may however be interesting to study the nature of these meanings (for instance, why did these students not consider additive relationships and how robust was their choice to attach proportional ones) and to investigate ways in which the tasks, the representational media and the interpersonal interactions may generate mathematization out of phenomenological contexts.

## REFERENCES

- Bausmith, J.M., Leinhardt, G. (1998) "Middle-School Students' Map Construction: Understanding Complex Spatial Displays" In *Journal of Geography* 97, 93 – 107. National Council for Geographic Education
- Eisenberg, M. (1995). "Creating software applications for children: Some thoughts about design". In A. diSessa, C. Hoyles and R. Noss with L. Edwards (Eds), *Computers for Exploratory Learning* (175–198). Springer-Verlag.
- Harel, I. and Papert, S. (eds) (1991) *Constructionism: Research Reports and Essays*, Ablex Publishing Corporation, Norwood, New Jersey.
- Kuchemann, D. (1991) The effect of setting and numerical content on the difficulty of ratio tasks, *Proceedings of the 15<sup>th</sup> PME Conference*, II, Paris.
- Kynigos C. (2002). Generating Cultures for Mathematical Microworld Development in a Multi-Organisational Context. *Journal of Educational Computing Research*, Baywood Publishing Co. Inc. (1 and 2), 183-209.
- Kynigos, C. (in press) A "black-and-white box" Approach to User Empowerment with Component Computing. *Interactive Learning Environments*.
- Kynigos, C. and Yiannoutsou, N. (2002). Seven Year Olds Negotiating Spatial Concepts and Representations to Construct a Map. *Proceedings of the 26th PME Conference* (3, 177-184), University of East Anglia, Norwich, UK.
- Leinhardt, G., Stainton C. & Bausmith J.M. (1998) "Constructing Maps Collaboratively" In *Journal of Geography* 97, 19 – 30 National Council for Geographic Education
- Liben, L.S., Downs, R.M., (1989) «Understanding Maps As Symbols: The development of map concepts in children". In Reese H.W. (Ed) *Advances in Child Development and Behavior* Vol 22 pp 145 – 201. Academic Press INC San Diego California
- Mariotti, M. A. (2002) Influence of Technology Advances on Students' Math Learning. In L. English (Ed), *Handbook of International Research in Mathematics Education*, Mahwah, Lawrence Erlbaum.
- Noss, R., Healy, L., Hoyles, C. (1997) "The construction of mathematical meanings: Connecting the visual with the symbolic" In *Educational Studies in Mathematics* 33, 203 –233.
- Noss, R. & Hoyles, C. (1996) *Windows on Mathematical Meanings*, Kluwer.
- Sutherland, R. (2001) Reaction to 'Algorithmic and Meaningful Ways of Joining Together Representatives within the Same Mathematical Activity', M. Heuvel-Panhuizen (Ed.) *Proceedings of the 25<sup>th</sup> PME Conference, Utrecht University, Netherlands*, 1, 108-110.
- Tourniaire, F., Pulos, S., 1985, "Proportional Reasoning: A review of the literature", *Educational Studies in Mathematics*, 16(2), 181-204.
- Yackel, E. & Cobb, P. (1996) Sociomathematical norms, argumentation and autonomy in mathematics, *Journal for Research in Mathematics Education*, 27, 4, 458-477.

# UNDERSTANDING HOW THE CONCEPT OF FRACTIONS DEVELOPS: A VYGOTSKIAN PERSPECTIVE

Kaori Yoshida

Research Fellow of the Japan Society for the Promotion of Science

*Vygotsky posed a variety of meaningful ideas for education in his short life. This paper focuses on everyday concepts and mathematical concepts or scientific concepts from his theory, reorganizing these ideas according to a new idea of sublated concepts. Using a series of interviews from a third grade fraction class in Japan, the paper discusses how everyday and mathematical concepts arise out of discussions among children and a teacher, and how they develop into sublated concepts.*

## DEVELOPMENT OF CONCEPTS ACCORDING TO VYGOTSKY

### “Everyday concepts” and “mathematical concepts”

Vygotsky (1934/1987) thought that concepts consist of two types, i.e. *everyday concepts* and *scientific concepts*, and pointed out that the greatest difference between these two is whether they are based on a system. According to Vygotsky (1933/1975; 1934/1987), everyday concepts are not based on a system; rather they are based in rich daily contexts and, therefore, might be used incorrectly by children. For instance, in series of one-on-one interviews with second graders in Japan, when asked the meaning of a word *half*, a child described that half meant to share something equally among *three* people. This thought was derived from her daily experience of sharing sweets with the other two brothers. For her, therefore, halving always meant dividing something equally among three based on the meaningful daily contexts at home.

On the other hand, scientific concepts are defined according to a system that has developed in human history, and therefore they lack concrete contexts (Vygotsky, 1933/1975; 1934/1987). According to Kozulin (1990), Vygotsky’s scientific concepts are based on “formal, logical, and decontextualized structures” (p.168). Therefore the concepts themselves are independent of any scientific subjects. *Mathematical concepts* are within a system and are characterized by formal and decontextualized structures. For example,  $1/2$  is a number constituting a number system, which consists of rational and irrational numbers. As a result, in this paper mathematical concepts will be used as an example of what Vygotsky called scientific concepts.

According to Vygotsky (1933/1975; 1934/1987) and the other researchers who discussed Vygotsky’s everyday and scientific concepts (Panofsky, John-Steiner, and Blackwell, 1990; Kozulin, 1990; Davydov, 1972/1990; and Schmittau, 1993), everyday and mathematical concepts are defined as follows.

*Everyday concepts* are concepts that originate from children’s daily lives through communication with their family, friends, or community; and thus are closely connected to concrete personal contexts. Children express them through their own



words and use them in their ways of thinking without conscious awareness. As a result, everyday concepts are not systems; rather they are based on the subjectivity.

*Mathematical concepts* are scientific concepts that are connected to mathematics. They are based on a system, and therefore they have logic and objectivity. They are expressed in a mathematical language and introduced to children in a formal, highly organized education. Mathematical concepts make children to develop mathematical thinking and to require conscious awareness and voluntary behavior for concepts. The development of mathematical concepts as children's psychological developments, however, depends on their everyday concepts.

### **The relation between the two concepts: mutual dependence or dichotomy**

As Zack (1999) discussed, the relation between spontaneous and scientific concepts might be regarded as either mutually dependent or dichotomous. On the one hand, the relation could be thought of as dichotomous or mutually exclusive on the surface because of their conflicting characteristics. Yet Vygotsky's words suggest he may have taken another position: "There is a mutually dependence in the relation between the processes of development of children's concepts in daily lives and in school. It enables such relation that the processes of these two concepts pass in the different ways" (Vygotsky, 1933/1975, p.122). The following sections describe in detail the relation between the two kinds of concepts and their development. However, care must be taken when inferring what Vygotsky said about the relation of scientific and everyday concepts, for while mathematical concepts are here equated with scientific concepts, Vygotsky himself did not deal specifically with *mathematical concepts*.

### **The development of concepts in Vygotsky's theory**

Vygotsky (1934/1987) thought of *concepts* as follows:

We know that the concept is ... a "complex and true act of thinking" that cannot be mastered through simple memorization. ... At any stage of its development, the concept is an "act of generalization." The most important finding of all research in this field is that the concept – represented psychologically as word meaning – develops. The essence of the development of the concept lies in the transition from one structure of generalization to another. ... This process is completed with the formation of true concepts (pp.169-170).

Accordingly, a concept is not static or unchangeable, but a complex and dynamic act of thinking and an act of generalization. In addition, psychologically this concept develops from one structure of generalization to another. The process of this concept development could be paraphrased as an identical process to the development of word meaning (Vygotsky, 1934/1987).

It is apparent that this notion of concepts applies to everyday concepts but does not apply to mathematical concepts because mathematical concepts have been developed through history. Thus, the distinction between the two types of mathematical concepts which have developed in human history and which develop based on children's everyday concepts as their psychological development must be made clearer than it is in some of Vygotsky's writing.



### “Sublated concepts”

Once clearly distinguished from one another, we now need to consider the relationship between these two kinds of concepts in mathematics education. In the cognitive development of children, everyday concepts arise from below to above in a certain sense when children learn formal and systematic mathematical concepts in school (Vygotsky, 1933/ 1975; 1934/1987). In other words, everyday concepts are reorganized and raised to a higher level by the appearance of mathematical concepts. However, the everyday concepts that are raised to higher level might not be called everyday concepts after this elevation because they now include elements of more systemic thinking. Likewise, mathematical concepts also change from their proper definition, for after this elevation they now include notions derived from experience in concrete contexts in addition to their systematic characteristics.

Though Vygotsky (1974) did not give detailed accounts of how these two mutually dependent concepts develop in children, he pointed out that the relation between higher and lower forms could be expressed well using the idea of a dialectic, where from the interrelating of everyday and mathematical concepts a new form- the *sublated* concept- gradually develops. Brushlinsky (1968) described this idea as follows:

In his [Vygotsky's] words, any higher stage of developments does not replace [lower stages] but *subordinate* them as their parts. That is, the higher stages contradict the lower. However, they do not eliminate the lower; but the higher stages include the lower as their *sublated* parts. Categories become components within a system, contradicting one another in the system. (L. S. Vygotsky reminds us of the duality of Hegelian meaning of *sublate* – elimination [of original form] together with preservation [of crucial features of the category]) (p.12).

A dictionary in philosophy (Shimonaka, 1971) explains *sublation* as follows:

Sublation is the German word for *aufheben* that has the meaning Hegel defined. It has a sequence of meanings as follows: 1) contradict, 2) lift and 3) preserve. ... This word is used for unifying contradiction, because development is based on contradiction or conflict. ‘Some elements were subordinated by means of an unification’ of a sequence of processes and the results are as follows: some split elements contradict and fight against each other, permeated internally by each other, are unified through such process and as a result highly developed situations are formed (pp.705-6).

Shimonaka (1971) described that *sublated* is used for unifying things that contradict each other. As Vygotsky (1933/1975) recognized, contradictions between everyday and mathematical concepts are factors that promote the intellectual development and bring new possibilities for their development of children. Therefore, it is useful to use the idea *sublated* to explain how the concepts develop. These are defined as follows.

#### Sublated process and sublated concepts:

(1) Mathematical concepts *contradict* a part of the children's everyday concepts; (2-A) The everyday concepts are *lifted* to a higher level, based on a system in mathematics; (2-B) The mathematical concepts are *lifted* to a higher level in which the daily contexts according to children's everyday concepts are accompanied with

them; (3) They are *preserved* as a unified concept, that is, a *sublated concept*. Consequently, sublated concepts are defined as follows: Concepts developed through the sublated process, having both a system in mathematics and rich daily contexts, wherein children are free to move back and forth between the everyday and the mathematical world. Furthermore, children should be able to use the sublated concepts with conscious awareness and voluntary behavior.

## A SERIES OF FRACTION CLASSES

### The outline of a series of fraction classes

A series of seven fraction classes for 40 third graders were observed for five days in Hiroshima, Japan, in March 2001. It was the first time the students had encountered fractions at school. The teacher was a mathematics teacher at the school. Before the classes, he already recognized that children have difficulty dividing equally an object into three, and that they are unconscious of a *unit-whole*, or a *one-whole*. His teaching purpose was to let children overcome these difficulties. Therefore, in the first of five classes he provided situations based on the three elements: (1) multiple meanings of fractions – *partition fractions* and *quantity fractions*; (2) multiple objects for fractions – rectangle and square papers, 1 l measure cup, 1 m and  $\frac{4}{3}$  m tapes; and (3) multiple ways of dividing equally – into three and into four.

### Traditional discussion in Japan: partition vs. quantity

Before describing the classes, it is important to provide a brief history of the discussion on the first class of fractions in Japan. Traditionally, teachers have taken into consideration what kinds of fractions should be introduced to children in the first fractions class: partition fractions OR quantity fractions. When partitioning objects into  $b$  parts equally and picking up  $a$  out of  $b$ , the amount of  $a/b$  is defined as partition fractions. Therefore,  $\frac{1}{2}$  (of a whole pizza) is a type of partition fractions. Moreover, fractions without universal units are called partition fractions nowadays. On the other hand, the prevailing meaning of quantity fractions is defined as fractions that have a universal unit; and traditionally this was led by the particular method according to the Euclidean algorithm (the EA method). As a result, the most remarkable characteristic is the concept of a unique unit-whole, which is independent of any situations. For instance,  $\frac{1}{2}$  m is an example and the unit-whole for this corresponds to 1 m.

When children are introduced to partition fractions before quantity fractions, it is difficult for them to be aware of a unit-whole because the unit-whole is implicit in everyday situations. Therefore, when they subsequently encounter quantity fractions, they may have difficulties. For example, when asked to cut " $\frac{1}{2}$  m" out of 2 m tape, children often cut " $\frac{1}{2}$  of the whole tape." It is difficult for them to recognize 1 m as a unit-whole because the whole tape does not correspond to a unit-whole of the tape, yet in a daily pizza situation the whole pizza is usually identical to a unit-whole. Yet

despite this difficulty, partition fractions are sometimes introduced first for when quantity fractions first children feel no necessity to use the EA method.

### **Three settings consist of a series of seven fraction classes**

The first setting consisted of the first and the second classes in which the following problem were figured out: “How much does each person has when dividing a piece of paper equally (1) among four people, and (2) among three people?” The main discussion was on the possibility of dividing into *three* pieces and on the way of doing that. In the end, the teacher gave children the definition of fractions: Each part of an object divided into four or three parts is called  $1/4$  or  $1/3$ . Secondly, the second setting consisted of the third to the fifth classes. This paper specifically focuses on the episodes in the fifth class. Then, the third setting consisting of the sixth and the seventh classes encouraged children to figure out problems of equivalent fractions.

### **TWO EPISODES IN THE FIFTH CLASS**

In the third class, after each child received a piece of blue tape, they decided the day’s task as to measure the length of the tape by measuring, cutting, or folding, and to express it in (1) integers, and (2) fractions. Then, they reported that the tape was almost 133 *cm* long in integers. Furthermore, a pair of children (YN and TN) presented their own idea on how they expressed the length in fractions, in which they explained by folding the tape in half twice, and then measuring the length of the one part out of the four parts. In the fourth class, after the short discussion about the idea YN and TN gave in the previous class, each child struggled with the problem to express the length of the same blue tape in fractions. Finally, they presented four ideas. In the beginning of the fifth class, the teacher wrote five ideas down on a board that the children had presented in the previous classes:

(1)  $1/4 (m) = 33 \text{ cm}$ ; (2)  $33/25 \text{ cm } (\diamond m)$ ; (3)  $4/4 m \text{ } 33 \text{ cm}$ ; (4)  $4/3 m$ ; (5)  $133 \text{ cm } 4/4$

#### **Episode 1 – The difference between $1/4$ and $1/4 m$**

Because YN objected to the notation  $1/4$  without the unit *m* for # 1, the teacher asked the children, “What is the difference between  $1/4$  and  $1/4 m$ ?” The following is the discussion that took place among them. In the following transcripts, two capitalized letters express a child’s name. In addition, words within parentheses make up meanings, and sentences within brackets means actions. Besides, three dots in a bracket abbreviate several people’s words. The essentials are underlined.

1T (teacher): Well, HS said, “This ( $1/4 m$ ) is 25 *cm*.” Is this right?

2Cs (many children): Yes.

3 T: So, what kind of length  $1/4$  is?

4 Cs: It is  $1/4$  of a whole.

5 T: There are many different meanings for a “whole.” [He shows various lengths with his hands.] This is a whole, or this is also whole and so on. <...>

6 T: So, which is correct, the upper answer ( $1/4 = 33 \text{ cm}$ ) or the lower answer ( $1/4 m = 33 \text{ cm}$ )? <...>

7MM: In the upper answer,  $1/4$ , the unit is unclear, so I thought the lower answer is better.

- 8 T: The  $\frac{1}{4}$  by itself does not tell us how long it is. The measurement of “ $\frac{1}{4}$ ” depends upon the item being measured, right?
- 9 HS: If you need any units, you can say  $\frac{1}{4}$  of “a blue tape.”
- 10 T: Is it good to say  $\frac{1}{4}$  of a blue tape?
- 11TM: ( $\frac{1}{4}$  of) “the blue tape”: in the universe, in the earth, in the world, in Japan, in Hiroshima, in this school, in this room, on the board, where the blue tape is attached. <...>
- 12 T: This is right, isn’t it? But, it’s too long. [He points  $\frac{1}{4} m = 33\text{ cm}$ .] This does not include any redundant information. <...>
- 13 IH: I got it;  $\frac{1}{4}$  of a  $1\text{ m } 33\text{ cm}$  tape is  $33\text{ (cm)}$ .
- Through this discussion, children recognized that the unit-whole for  $\frac{1}{4} m$  is always  $1 m$ , and furthermore the unit-whole for  $\frac{1}{4}$ , in this situation, is  $1\text{ m } 33\text{ cm}$ .

### Episode 2 – Two names for a remainder of a tape: $\frac{1}{4}$ of a whole or $\frac{1}{3} m$

For #4, children discussed what  $\frac{4}{3} m$  meant because many children could not be convinced of the meaning i.e. “four out of three.”

- 21KO: Mr., it means four pieces out of something divided by three pieces, right?
- 22 T: Exactly.
- 23KO: It is impossible.
- 24 T: You mean, this sounds strange as a fraction, right? There are numbers more than numbers divided. Is not it funny? <...>
- 25 T: Let’s figure out this problem. The clue is that I did cut out (from the blue tape) the remainder of the tape. [He points out the  $1\text{ m}$  tape after he cut the blue tape out into  $1\text{ m}$  and  $\frac{1}{3} m$ .] This tape is  $1\text{ m}$  long, so what is the length of the remainder of the tape in fractions?
- 26 C: That is  $\frac{1}{4}$  (of a whole).
- 27 T: This is  $\frac{1}{4}$ . Wait a second. I am going to mark the  $1\text{ m}$  tape with chalk. [He measures the  $1\text{ m}$  tape stuck on the board using the remainder of the tape as a unit of measuring.] (This is the EA method.)
- 28 Cs: It is  $\frac{1}{3}$ !
- 29 T: This part disappeared. [He draws the figure of the remainder of the tape in a dotted line next to the  $1\text{ m}$  tape.] Well, I will ask you once again. Is this (remainder of the tape)  $\frac{1}{4}$  long or  $\frac{1}{3}$  long?
- 30 Cs: It is  $\frac{1}{3}$ ! <...>
- 31TN: [She points out the remainder of the tape.] This  $33\text{ cm}$  tape is  $\frac{1}{4}$  of the whole (tape), right? Then, which expressions of fractions do you need, a fraction for  $1\text{ m}$  (i.e. quantity fractions) or a fraction for the whole (i.e. partition fractions)? ... If you do not decide it, we have two answers. <...>
- 32 T: (NM meant that)  $\frac{1}{3}$  is better (to express the length of the remainder), because the length of  $1\text{ m}$  is clear, therefore the remainder of the tape is  $\frac{1}{3}$  of  $1\text{ m}$ .
- 33YN: That is, [she points at the  $\frac{2}{3}$  width of the  $1\text{ m}$  tape on the board] this longs  $\frac{2}{3}$ , and then  $\frac{3}{3}$  until there. (In the first piece of the blue tape) there are four parts of the lengths of the rest of the tape, so this (whole tape) longs  $\frac{4}{3} m$ .

Through this discussion, children recognized that the remainder of the tape was equal to  $\frac{1}{3} m$  as well as  $\frac{1}{4}$  for the whole through the teacher’s demonstration.

### DISCUSSION

Episodes 1 and 2 express the process how children’s concepts are sublated. In episode 1, line 4 expresses the children’s typical everyday concepts for fractions.

That is, the length of  $1/4$  means  $1/4$  of a whole. Through their everyday experience, they recognize that  $1/4$  means the action of dividing an object equally into four. Therefore, while children focus on the action, they do not pay attention to the unit-whole of the object because the unit-whole is often identical with a whole of the object in their daily life, and accordingly the unit-whole is implicit for them. However, through the discussion on ambiguities of the expression  $1/4$ , they were convinced that they should have a conscious awareness of a unit-whole for the partition fraction as in the lines 11 or 13.

In episode 2, children exposed their everyday concepts in which fractions should be less than 1 in lines 21, 23, and 24. Based on their everyday experience, children are thinking that fractions show actions of dividing or the result of them. Hence, they have no idea that  $4/3 m$  means a quantity. Moreover, teacher's demonstration in line 27 led them to recognize that a unit-whole for a fraction is not necessarily a whole of something given, contrasting with their everyday concepts. The remainder of the blue tape cut off from  $1 m$  can be named  $1/4$  when regarding the whole tape as the unit-whole, and at the same time it can be also named  $1/3 m$  when regarding  $1 m$  as the unit-whole (line 26, 28, and 31). And also, through this new finding, children acquire the concepts of fractions as quantity (line 33). In conclusion, for each episode, everyday, mathematical, and sublated concepts are given in table 1.

Everyday Concepts	Mathematical Concepts	Sublated Concepts
<p>A partition fraction, <math>1/4</math>, expresses the action of dividing an object into four.</p> <p>A unit-whole of fraction always corresponds with the whole implicitly.</p>	<p>The unit-whole for <math>1/4</math> is always 1 or the whole, and for <math>1/4 m</math> it is <math>1 m</math>.</p> <p>The quantity of <math>1/4</math> changes depending on the quantity of the unit-whole.</p>	<p>The length of <math>1/4</math> of <math>1 m</math> <math>33 cm</math> tape is always <math>33 cm</math>, and in this context, the unit-whole is explicitly <math>1 m</math> <math>33 cm</math> or the blue tape stacked on the board.</p>
<p>Fractions must be less than 1 because fractions express actions of dividing or the result of the actions.</p> <p>"<math>1/4</math> of a whole" is only way to express the remainder of the blue tape.</p>	<p>Fractions can express quantity, number etc., and therefore are not necessarily less than 1.</p> <p>A unit-whole does not always correspond to a whole of an object.</p>	<p>When the whole of the blue tape is a unit-whole, the remainder is expressed as <math>1/4</math> of the whole; when <math>1 m</math> is a unit-whole, it is also expressed as <math>1/3 m</math>, and therefore the whole is <math>4/3 m</math></p>

**Table 1: Everyday, mathematical, and sublated concepts in each episode**

As exemplified in these episodes, conflict between the everyday and mathematical concepts leads the development of concepts for fractions in children. That is, children's everyday concepts are exposed in the class and these contradict the system

of the mathematical concepts; and the everyday and mathematical concepts are lifted up to the higher levels; then they are preserved as unified concepts having both system and concrete contexts. Specifically in these episodes, their everyday concepts are finally subordinated to the view in which fractions themselves can express quantities (the importance of quantity) and the view of the conscious awareness that what is a unit-whole for a fraction (the importance of a unit-whole) as well as the view in which fractions correspond to two integers (the part-whole, or partition fraction).

In addition, the intentional settings by the teacher make these concepts develop possible. In other words, because he gave two types of fractions, partition and quantity fractions, at the same time, children could be confronted with problems or contradictions that they have never held in their daily lives.

## References

- Brushlinsky, A.V. (1968), *Kul'turno-istoricheskaiia teoria myshlenia* [Cultural-historical theory of thinking]. Moscow: Vyshaya Shkola Publisher.
- Davydov, V.V. (1990). *Soviet studies in mathematics education: Volume 2 types of generalization in instruction: Logical and psychological problems in the structuring of school curricula* (J. Kilpatrick, Vol. Ed. & J. Teller, Trans.). Reston, VA: National Council of Teachers of Mathematics. (Original work published 1972)
- Kozulin, A. (1990). *Vygotsky's psychology: A biography of ideas*. Harvester Wheatsheaf.
- Panofsky, C. P., John-Steiner, V., & Blackwell, P.J. (1990). The development of scientific concepts and discourse. In L. C. Moll (Ed.), *Vygotsky and education: Instructional implications and applications of sociohistorical psychology* (pp.251-267). Cambridge University Press.
- Schmittau, J. (1993). Vygotskian Scientific Concepts: Implications for Mathematics Education. *Focus on Learning Problems in Mathematics*, 15(2 & 3), 29-39.
- Shimonaka, K. (Ed.) (1971), *Tetsugaku jiten* [Philosophical dictionary]. Japan: Heibonsha.
- Vygotsky, L. S. (1974). *Seishin hattatsu no riron* [Theories on the development of minds] (Y. Shibata Trans.). Tokyo: Meiji Tosho.
- Vygotsky, L. S. (1975). Gakureikini okeru seikatsuteki gainen to kagakuteki gainen no hattatsu [Razvitie zhitseiskikh i nauchnykh ponyatii v shkol'nom vozraste (Developments of everyday and scientific concepts during school age)] (Y. Shibata & S. Morioka, Trans.), *Kodomono chiteki hattatsu to kyoju* (pp.96-123). Tokyo: Meiji Tosho. (Original work showed May 20, 1933 in the stenographic report at a meeting of the Scientific-Methodological Council of the Leningrad Pedological Institute)
- Vygotsky, L. S. (1987). Thinking and speech. In R.W. Rieber & A. S. Carton (Eds.) & N. Minick (Trans.), *The collected works of L.S. Vygotsky: Volume 1 problems of general psychology* (pp.39-285). New York: Plenum Press. (Original work published 1934)
- Zack, V. (1999). Everyday and mathematical language in children's argumentation about proof. *Educational Review*, 51(2), 129-146.

# SECONDARY MATHEMATICS TEACHERS' KNOWLEDGE CONCERNING THE CONCEPT OF LIMIT AND CONTINUITY

Mastorides, E., Zachariades, T.  
University of Athens

*The present study aims to explore the secondary teachers' understanding and reasoning about the concepts of limit and continuity. The findings suggest that teachers have not developed a rich relational understanding of these notions. They exhibited disturbing gaps in their conceptualizations of limit and continuity.*

## INTRODUCTION

The concepts of limit and continuity are of fundamental importance in the learning of Mathematical Analysis and has been the focus of attention for many researchers on mathematics education. Students do not appear to understand these notions easily. They face cognitive difficulties because of the richness and complexity of them. There are a lot of studies dealing with these difficulties and didactical approaches of these concepts (e.g. Artigue, 1997; Cornu, 1981, 1991; Ferrini-Mundy & Graham, 1991; Mamona-Downs, 2001; Schwarzenberger & Tall, 1978; Sierpiska, 1985; Vinner 1991). A common conclusion of these studies is that the majority of the students have deficient understanding of these concepts, even at a more advanced stage of their studies. However, not enough attention has been drawn to the secondary teachers' knowledge of these notions. Since a course of pre-Calculus is contained in the curricula of school mathematics, it is important to explore the teachers' understanding and reasoning of the concepts of limit and continuity. This is the goal of the present study, which is a part of a larger research on the extent and sufficiency of the subject matter knowledge of secondary mathematics teachers.

## THEORETICAL BACKGROUND

There are many studies on the subject matter knowledge of the teachers (Ball, Lubienski & Mewborn, 2001, p.448). The majority of them concerns with the preservice and the elementary teachers. It would appear that very little is known about the extent or the sufficiency of the subject matter knowledge of secondary mathematics teachers. Perhaps the cognitive competence of the secondary mathematics teachers is taken for granted, since they teach the object which they have studied during their undergraduate studies. However research results suggest that this is not always true (e.g. Ball, 1990; 1991; Norman, 1992).

Multiple frameworks exist for thinking about mathematics understanding. Skemp (1976, 1978) distinguished the knowledge in mathematics in instrumental and relational knowledge. The instrumental understanding refers to an algorithmic understanding of a concept or process and the relational understanding comes from an understanding of deeper relationships among the concepts and processes associated with a particular concept or situation. After Skemp's work other classifications of mathematical understanding follow. Hiebert (1986) distinguished in procedural and concep-

tual mathematical understanding, Ball (1988) in knowledge *of* and *about* mathematics and others. Shulman (1986) identified two components of the professional knowledge of teachers: content knowledge and pedagogical content knowledge. For Shulman, content knowledge

refers to the amount and organization of knowledge per se in the mind of the teacher... To think properly about content knowledge requires going beyond knowledge of the facts or concepts of a domain. It requires understanding the structures of the subject matter  
(*ibid*, p. 9)

In pedagogical content knowledge Shulman includes “the most useful forms of representation of those ideas, the most powerful analogies, illustrations, examples, explanations, and demonstrations – in a word, the ways of representing and formulating the subject that make it comprehensible to others” (*ibid*, p. 9).

Shulman (1987, pp. 17-18) emphasizes that lack of content knowledge was the underlying reason for less effective teaching. Other studies have indicated that teachers’ cognition drives their instructional practice (Carpenter, 1989; Fennema, Carpenter, & Peterson, 1989).

In this study we focus on the extent and the sufficiency of the subject matter knowledge of the secondary teachers on the concepts of limit and continuity.

Particularly, we attempt to trace their actual content knowledge and their pedagogical content knowledge as far as the two above mentioned concepts are concerned.

## METHOD

The study is based on 15 secondary mathematics teachers, each one working towards a master degree in mathematics education. All of them had an undergraduate degree in Mathematics. During their undergraduate studies they attended courses about Calculus, based on books like M. Spivak (1967). They all had experience in teaching Mathematical Analysis in secondary school. During their studies for the master degree they attended, among others, a 12 weeks course on the teaching of Calculus. During this course, the concepts and difficulties attached to limit and continuity were extensively discussed. At the end of this course the teachers answered a questionnaire and afterwards we had an interview with each one of them and discussed his/her answers.

## FINDINGS

The teachers were asked the following questions:

- i) Give the definition of limit of a sequence. How would you describe it to a student so that he would understand it?
- ii) Write two student’s misconceptions and explain how you would deal with them.
- iii) Let a sequence  $(a_n)_{n \in \mathbb{N}}$ . Check if the next two statements are equivalent with  $\lim_{n \rightarrow \infty} a_n = 0$ .

**P1:** The sequence  $(a_n)_{n \in \mathbb{N}}$  has terms with absolute value as small as possible.



**P2:** There exists a natural number  $n_0$  such that for every  $\varepsilon > 0$  and for every  $n \geq n_0$  we have  $|\alpha_n| < \varepsilon$ .

iv) Let  $A \subseteq \mathbb{R}$ , and  $f : A \rightarrow \mathbb{R}$ . Give the definitions of continuity of  $f$  at a point  $x_0 \in A$  and on  $A$ . How would you explain these concepts?

v) Write one student's misconception about the continuity and explain how you would deal with it.

Judging by the teachers' answers in the questionnaire and by their interviews, several problems came out concerning the content knowledge and the pedagogical content knowledge of the concepts of limit and continuity. According to the relevant literature, many of these problems had also appeared in the case of students (Cornu, 1991; Sierpiska, 1985; Vinner, 1991 and others). Some of the main problems were:

**a)** Difficulty in understanding the meaning of an inequality in the frame of complex statements such as related to the definition of limit and continuity.

A teacher, answering the question (ii), writes:

Another question that shows misconception on behalf of the students is: "It is a mistake to put  $|\alpha_n - \alpha| \leq \varepsilon$  in the definition of the convergence of a sequence?"

My answer is that of course it is a mistake, since it means that there is the case  $\alpha_n = \alpha$ .

Another teacher answering the question (v) writes:

I draw their attention [about the definition of continuity] to the fact that  $|f(x) - f(x_0)| \leq \varepsilon$  and not  $|f(x) - f(x_0)| < \varepsilon$ , as the definition of the limit, since it can be  $f(x) = f(x_0)$ .

From the above answers we see that these teachers have difficulty to understand the meaning of these inequalities in the frame of the definitions of a limit and continuity. They don't understand that the statements  $\forall \varepsilon > 0 \exists n_0 \in \mathbb{N} : \forall n \geq n_0 |\alpha_n - \alpha| < \varepsilon$  and  $\forall \varepsilon > 0 \exists n_0 \in \mathbb{N} : \forall n \geq n_0 |\alpha_n - \alpha| \leq \varepsilon$  mean exactly the same and of course the difference between the inequalities  $|f(x) - f(x_0)| \leq \varepsilon$  and  $|f(x) - f(x_0)| < \varepsilon$  is not that in the first one it can be  $f(x) = f(x_0)$ .

**b)** From answers, like the ones mentioned above, it came out also that some of them believe that a convergence sequence doesn't reach its limit.

**c)** Difficulties had appeared in the correct understanding of the meaning of the quantifiers. Almost all of the teachers answered in the question (iii) that the statement P2 is equivalent with  $\lim_{n \rightarrow \infty} \alpha_n = 0$ . From the interviews followed that they believed that the change of the order of the quantifiers in the statements

$\forall \varepsilon > 0 \exists n_0 \in \mathbb{N} : \forall n \geq n_0 |\alpha_n - \alpha| < \varepsilon$  and  $\exists n_0 \in \mathbb{N} : \forall \varepsilon > 0 \forall n \geq n_0 |\alpha_n - \alpha| < \varepsilon$  does not change the meaning. For them the above statements are identical.

Many of them also believed, as we observed from the answers to the question (i) and from the interviews that it is a mistake if someone doesn't notice that  $n_0$  depends on  $\varepsilon$ . For them the order of the quantifiers isn't enough.

**d)** From the answers to the question (i), we observed that a great number of them have not understood right the relation between  $\varepsilon$  and  $n_0$  in the definition of the convergence of a sequence. They believe that this relation is a 1-1 function and some of them note that this function is decreasing.

One of them writes:

It has to be clear that  $n_0$  depends on  $\varepsilon$  and for different  $\varepsilon$  there exists different  $n_0$ .

Another one notes:

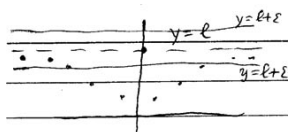
as  $\varepsilon$  decreases then  $n_0$  increases.

**e)** From several answers it follows that some of them haven't understood sufficiently the role of the variables in the definition of the continuity.

Someone writes:

We observe that for every  $x$  close to  $x_0$  we can find an interval of  $f(x_0)$  such that  $f(x)$  to belong in this interval (for a suitable choice of  $\varepsilon$ )

**f)** Some of the teachers, wanting to give graphically the convergence of a sequence, draw wrong graphs, like the following:



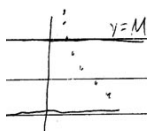
**g)** Difficulties were found out in reading a graph and in giving graphically a statement.

A teacher draws the graph of the function  $f(x) = \frac{1}{x}$ , he explains how we take the graph

of the sequence  $a_n = \frac{1}{n}$ ,  $n=1, 2, \dots$  from it and he continues:

... as  $n$  is increasing, the points of  $a_n = \frac{1}{n}$  approach the line  $y = 0$ .

Another one draws the following graph



and he writes:

I would ask [from the students] to find if there are points of the sequence over the line  $y = M$  for  $M > 0$  as big as I please. My aim is to prepare the students to see the formal definition,  $\lim_{n \rightarrow \infty} a_n = +\infty \Leftrightarrow \forall M > 0 \exists n_0 \in \mathbb{N}$  such that  $a_n > M \forall n \geq n_0$ .

**h)** For the majority of these teachers the definition of the continuity of a function  $f : A \rightarrow \mathbb{N}$  at a point  $x_0 \in A$  is  $\lim_{x \rightarrow x_0} f(x) = f(x_0)$ , without concern if  $x_0$  is an accumulation point of  $A$  or not.

**i)** Another problem which appears is that they don't have complete concept images for some notions. The concept image of the majority for a continuous function is: *It is an interrupted curve*; without taking into consideration if the domain of the function is an interval or not.

Also in their explanations with graphs, they usually use simple pictures of monotonic functions.

**j)** Most of these teachers have difficulty in giving verbally, in a correct way, the formal definitions of limit and continuity.

For example, someone, trying to give verbally the definition of a limit of a sequence, writes:

There exists a term of the sequence after which the difference of the sequence from a constant number became as small as we please.

Another one, giving verbally the concept of the continuity, writes:

As  $x$  approaches to  $x_0$  as close as we please, then  $f(x)$  approaches to  $f(x_0)$ . Namely when the interval of  $x_0$  becomes closer the same it will happen with the corresponding interval of  $f(x_0)$ .

**k)** From the interviews we found out that the majority of the teachers have serious difficulties in giving symbolically the statements P1 and P2.

## CONCLUSIONS

We noted before that there is a considerable body of literature addressing issues on students' understanding of the concepts of limit and continuity. These studies have indicated that they have a weak conception of these notions and usually exhibit purely instrumental understandings. Of course we would expect the secondary mathematics teachers to develop a reasonably rich relational understanding of them. While this study was limited in scope, several observations should be made about the teachers who participated in the study. We note that these teachers, in comparison with their colleagues, would be considered among the more mathematically experienced. Nevertheless, we observed that the majority of the teachers have not developed a rich relational understanding of the notions of limit and continuity. They exhibited disturbing gaps in their conceptualizations of these concepts. Their content knowledge was incomplete and it affected the pedagogical content knowledge. We summarize below some of the more striking observations:

1. Most of them have difficulties in understanding multiquantified statements or fail to comprehend the modification of such statements brought about by changes in the order of the quantifiers.

2. Since their school-teaching is mostly based on specific cases or expressions of general concept, they tend to be believed that all expressions of these general notions are similar to the ones they teach.
3. Some of them cannot read correctly a graph of function and give graphically a symbolic statement.
4. They cannot “translate” correctly from verbal to symbolic and vice versa.
5. They don't always have complete concept images.

The results of this study suggest that the secondary mathematics teachers might not be fully be masters of their mathematical domain. Especially when it comes to understanding the notions of a limit and continuity and articulating their knowledge of them.

## REFERENCES

- Artigue, M. (1997). Teaching and learning Analysis: What we learn from didactical research and curriculum evolution. *Proceedings of the first Mediterranean Conference on Mathematics, Cyprus*, 207-219.
- Ball, D. L. (1988). Unlearning to teach mathematics. *For the Learning of Mathematics*, 8 (1), 40-48.
- Ball, D. L. (1990) Prospective elementary and secondary teachers' understanding of division. *Journal for Research in Mathematics Education*, 21 (2), 132-144.
- Ball, D. L. (1991). Research on teaching mathematics: Making subject matter pan of the equation. In J. Brophy (Ed.), *Advances in research on teaching* (Vol. 2, pp. 1-48). Greenwich, CT: JAI Press.
- Ball, D. L., Lubienski, S. & Mewborn, D. (2001). Research on teaching mathematics: The unsolved problem of teachers' mathematical knowledge. In V. Richardson (Ed.), *Handbook of research on teaching* (4th ed., pp.433-456). New York: Macmillan.
- Carpenter, T. P. (1989). Teaching as problem solving. In R. Charles & E. Silver (Eds.), *The teaching and assessing of mathematical problem solving* (pp. 187–202). Reston, VA: NCTM.
- Cornu, B. (1981) Apprentissage de la notion de limite: modèles spontanés et models propres, *Actes du Cinquième Colloque du Group Internationale PME*, Grenoble, 322-326.
- Cornu, B.(1991). Limits. In Tall, D. (Ed.), *Advanced Mathematical Thinking* (pp. 153-166). Dordrecht / Boston / London: Kluwer Academic Publishers.
- Fennema, E., Carpenter, T.P. & Peterson, P.L. (1989). Teachers' decision making and cognitively guided instruction: A new paradigm for curriculum development. In N.F. Ellerton & M.A. Clements (Eds.), *School mathematics: The challenge to change* (pp. 174–187). Geelong, Victoria, Australia: Deakin University Press.
- Ferrini-Mundy, J. & Graham, K. G. (1991). An overview of the calculus reform effort: issues for learning, teaching, and curriculum development. *American Mathematical Monthly*, 98 (7), 627-635.

- Hiebert, J. (1986). Conceptual and procedural knowledge: The case of mathematics. Hillsdale, NJ: Lawrence Erlbaum.
- Mamona-Downs, J. (2001). Letting the intuitive bear on the formal; A didactical approach for the understanding of the limit of a sequence. *Educational Studies in Mathematics*, 48 (2-3), 259-288.
- Norman, A. (1992). Teachers' mathematical knowledge of the concept of function. In G. Harel & E. Dubinsky (Eds.), *The Concept of Functions. Aspects of Epistemology and pedagogy* (pp.215-232). MAA Notes No.25, Washington, DC: Mathematical Association of America.
- Schwarzenberger, R. L. E. & Tall, D.O. (1978). Conflicts in the learning of real numbers and limits. *Mathematics Teaching*, 82, 44-49.
- Shulman, L. S. (1986). Those who understand: Knowledge growth in teaching. *Educational Researcher*, 15 (2), 4-14.
- Shulman, L. S. (1987). Knowledge and teaching: Foundations of the new reform. *Harvard Educational Review*, 57 (1), 1-22.
- Sierpiska, A. (1985). Obstacles épistémologiques relatifs à la notion de limite. *Recherches en Didactique des Mathématiques*, 6 (1), 5-67.
- Skemp, R. R. (1976). Relational understanding and instrumental understanding. *Mathematics Teaching*, 77, 20-26.
- Skemp, R. R. (1978). Relational understanding and instrumental understanding. *Arithmetic Teacher*, 26 (3), 9-15.
- Spivac, M. (1967). *Calculus*. London: W. A. Benjamin, Inc.
- Vinner, S. (1991). The role of definitions in the teaching and learning of mathematics. In Tall, D. (Ed.), *Advanced Mathematical Thinking* (pp. 65-81). Dordrecht / Boston / London: Kluwer Academic Publishers.



# CHARACTERISTICS OF MATHEMATICAL PROBLEM SOLVING TUTORING IN AN INFORMAL SETTING

Iris Zodik and Orit Zaslavsky

Technion – Israel Institute of Technology

*The study was carried out within the framework of a project that provided after-school mathematics tutorial sessions to 10<sup>th</sup>-12<sup>th</sup> grade students by engineers in an informal setting. The participating students were selected from advanced level mathematics classes according to their need for additional support. The main goal of the study was to characterize the special learning environment that evolved within this project, and to identify distinctive elements that enhanced students learning. In our paper we present three main characteristics associated with the problem solving activities in which the tutor and students engaged, and discuss their contributions to students' learning.*

## BACKGROUND

The study was carried out within the framework of a project the goal of which was to increase the number of high school students who continue to higher education in science and high-tech engineering. In Israel the requirements for acceptance to these fields of higher education include a mathematics matriculation exam at an advanced level. Thus, the project provided opportunities for senior high school students who were conditionally enrolled in advanced level mathematics classes to receive additional support by attending weekly after-school tutorial lessons. For both practical and principled reasons, these lessons were conducted by high-tech engineers, who had a rather sound mathematical background as well as extensive experience in team work. None of the tutors had any formal pedagogical education. Similar to a teacher, the tutor had an overall responsibility for the management of students learning in the tutorial sessions. However, he was not responsible for the content and specific problems on which to focus. These were dictated indirectly by the regular mathematics teacher. Moreover, unlike the task of a teacher, the tutor did not have to evaluate students' performance.

## THEORETICAL PERSPECTIVES

Currently, there is rather scarce literature dealing with informal learning settings in mathematics. Thus, we rely to a certain extent on literature addressing informal learning settings in science. In addition, in order to make sense of the data and characterize our specific learning environment, we also consider literature pertaining to relevant features of learning environments in mathematics in more formal settings. In particular, we draw on some elements of the mathematics classroom that raise concern of mathematics educators.

*The potential contributions of informal learning environments.* We consider any learning environment that is operated outside of school (either in a different location or after school-hours) an informal one. In science education, there is much evidence of the contributing affects of informal environments (e.g., Hofstein & Rosenfeld, 1996). The main contributions attributed to informal environments are: attentiveness to a diversity of learning styles; provision of an extended variety of types of learning experiences (e.g., authentic problem solving, spontaneous collaboration); access to different communities and opportunities to meet and interact with experts. Given the above contributions, one of the main concerns of science educators is how to combine informal and formal settings productively (Hofstein & Rosenfeld, 1996). Thus, we look at the focal informal learning environment as complimenting the ordinary mathematics classroom in school.

*Concerns regarding formal learning settings in mathematics.* Much has been written about formal learning environments in mathematics. From the teacher's perspective, there is often a considerable amount of tension between the desire to be flexible and attentive to students' needs and ideas, and the constraints posed by the school mathematics curriculum (Leikin & Dinur, 2003; Sherin, 2002). Teachers' knowledge - particularly, their subject-matter, pedagogical, and curricular knowledge - has bearing on their practice, in terms of their effectiveness and flexibility (Simon, 1995; Sherin, 2002; Leikin & Dinur, 2003). Teachers' overall practice and choices have impact on students' beliefs about the nature of mathematics (Schoenfeld, 1992; Lampert, 1990). Thus, the common practice leads many students to believe that, for example, a mathematical problem always has one right answer, and one correct or preferable way to solve it (which is usually the procedure most commonly demonstrated by the teacher). "... Changing students' ideas about what it means to know and do mathematics was in part a matter of creating a social situation that worked according to rules different from those that ordinarily pertain in classrooms, and in part respectfully challenging their assumptions about what knowing mathematics entails" (p. 59, Lampert, 1990). One way to deal with the above concerns is by promoting students' meaningful interactions – with one another, with the learning material, and with the teacher (Leikin & Zaslavsky, 1997). In general, classroom norms and social processes are closely related to students' learning (e.g., Yackel & Cobb, 1996; Simon, 1995). Following this approach, our analysis examines the norms and processes that characterized the investigated informal learning environment.

*Teaching and learning mathematical problem solving.* The activity in which students engaged in the after-school tutoring lessons concentrated mostly on mathematical problem solving. Schoenfeld points to one of the limitations and difficulties of teaching problem solving in school:

“Part of the difficulty in teaching mathematical thinking skills is that we’ve gotten so good at them (especially when we teach elementary mathematics) that we don’t have to think about them; we just do them, automatically. We know the right way to approach



most of the problems that will come up in class. But the students don't, and simply showing them the right way doesn't help them avoid all the wrong approaches they might try themselves. For that reason we have to unravel some of our thinking, so that they can follow it." (Schoenfeld, 1983, p. 8).

One of Schoenfeld's suggested ways to deal with the impediment of overly rehearsed teachers' problem solving strategies in the classroom is by creating genuine situations in which a teacher must solve a new problem "on the spot" (ibid). In the context of our study, this kind of situation was an integral part of the tutorial lessons, since the tutor was not an experienced mathematics teacher. His task was to help students solve mathematical problems which they found difficult, mostly without knowing in advance what the specific problems would be. Thus, this created an authentic context for investigation of possible ways of dealing with the need to unravel one's thinking.

## THE STUDY

*Goals:* The main goal of the study was to identify the interplay between a number of distinctive features of our informal classroom learning environment and the nature of the problem solving activities that took place.

*Participants:* The participants in the study consisted of ten highly motivated 10<sup>th</sup> grade students, who were provisionally placed in a class that studied mathematics at the most advanced level. In order to succeed in this top level mathematics class (that consisted of 30 students) they needed some extra support. Therefore, they attended the informal afternoon mathematics lessons. The principal participant was Dan, an engineer, who served as the students' mathematics tutor once a week in the afternoon throughout the school year. Galia was the participating students' regular mathematics teacher in the formal school setting, as well as the school coordinator of the project.

*Data Collection and Analysis:* Our research is an interpretive study of teaching that follows the qualitative research paradigm, based on thorough observational fieldwork, aiming to make sense and create meaning of a specific classroom culture (Erickson, 1986). In particular, we investigated "how the choices and actions of all the members constitute an enacted curriculum - a learning environment" (ibid, p. 129). Thirteen informal mathematics lessons with the above students were carefully observed and detailed protocols were written on-line for each of these lessons. Additionally, written feedback questionnaires were administered to the participating students at the end of the school year, and individual interviews were conducted with each student in the middle of the school year. The interviews focused on eliciting students' views of the characteristics and distinctive elements of the informal learning environment and the contribution they attributed to these elements in enhancing their mathematical knowledge and disposition. Two students were interviewed after the analysis was completed, in order to validate our interpretations. Dan was interviewed twice – once after his first tutorial lesson. We returned to Dan again after completing most of our analysis with a second interview, in order to validate our interpretations.

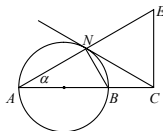
## FINDINGS

Our perspectives developed in an inductive and iterative way. As the evidence and pieces of information accumulated, we began to notice several patterns that recurred, in terms of Dan's teaching style, his interactions with the students, and the classroom norms that developed. In this paper we focus on characteristics of Dan's teaching that were associated with the problem solving activities that constituted the core part of the lessons. Three main characteristics were identified: 1. Dan's ongoing efforts to attend to and understand students' ways of thinking; 2. Dan's readiness to expose himself to solving problems in real time; 3. Dan's tendency to attend to multiple approaches to solving a problem. We turn to a description of above three characteristics, interweaving some citations from observations and interviews with Dan and with his students. In addition, for the first characteristic we elaborate more by providing short excerpts from a lesson with Dan.

Dan continuously encouraged students to think and to express their ideas. When a student raised a suggestion, Dan went along with it, prompting the student to explain his thinking. As Dan gained understanding to the student's ideas, he made them accessible to the other students, by elaborating on the student's reasoning. We illustrate this characteristic in the excerpt below, taken from a lesson dealing with the following (textbook) problem:

AB in the figure is the diameter of the circle; CN is a tangent, and  $AC \perp CE$ . Prove that  $\triangle CEN$  is an isosceles triangle.

Hint: construct the chord NB and mark  $\sphericalangle NAB$  by  $\alpha$ .



After sketching the problem givens (including the chord NB) on the board, Dan turned to Omer who wanted to present his solution (of which he had thought at home). Omer's suggestion was not the simplest one, yet Dan went ahead with it all the way.

Omer: The angle  $\alpha$  is equal to the angle  $\sphericalangle BNC$ , according to the theorem that an angle between a tangent and a chord is equal to the inscribed angle resting on the same arc.

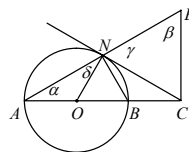
Smadar: Omer invented a new theorem!

Dan addressed Smadar's surprise regarding the theorem that Omer stated by dealing with the theorem separately, reminding the students the theorem's meaning and illustrating it. Then Dan turned back to Omer, who suggested connecting the center of the circle  $O$  with the tangent point  $N$ . At first, Dan did not understand why Omer's construction was necessary, thus, asked Omer to continue his explanation. Even though Omer's approach was more complicated than needed, Dan followed his reasoning attentively, throughout Omer's struggle to refine his approach (by modifying some calculations), until he finally reached a correct proof.

Omer: We got  $180^\circ - 2\alpha$

Dan: How did you get  $2\alpha$ ?

Omer: The radiuses are equal [ $AO=NO$ ], so we get an isosceles triangle [thus in  $\triangle AON$   $\alpha=\delta$ ]. So the adjacent angle [ $\triangle ONB$ ] is  $90^\circ - \alpha$ , not  $180^\circ - \alpha$ . [sketches an auxiliary figure with the relevant part for this stage]



We get ...

[dictates to Dan an expression, while Dan writes it simultaneously on the board].

$$\gamma = 180^\circ - \alpha - (90^\circ - \alpha) - \alpha$$

Dan's attentiveness to students' thinking was a deliberate action he took. He attributed this tendency of his to the experience he had with tutoring his two daughters. He did not believe in disclosing the right answer, nor did he feel the need to "prove" that he knew mathematics. He preferred "to check if they [the students] were going in the right direction, [and if not, check] if it's a technical problem or a conceptual one". As he maintained: "I ask many questions, 'why did you solve it this way?', 'how did you solve it?', 'what did you or did you not understand?' in order to try to follow their thinking as much as possible". He continued: "There were cases in which all the students took part in solving a problem, and sometimes did it in a special way of which I had not thought".

Dan's students appreciated this approach, and brought it as an example of Dan's typical helpful behavior: "Dan lets us think for ourselves and reach a solution on our own or with his help"; "Dan follows our head, even if [we suggest] a long and complicated strategy, he puts himself in our place and when necessary corrects us"; "Thus, we learn to follow and check each others' ways of solving".

The second characteristic of Dan's teaching was exhibited by the way he felt comfortable to solve the mathematical problems in real time together with his students. The students brought to the lesson the problems with which they wanted to deal. These were homework problems with which they had encountered difficulties. When dealing with an unfamiliar and non-trivial problem, Dan made his thinking transparent to his students. He unraveled his thought processes by sharing with them each step, including his doubts and barriers in an apprenticeship like manner. He felt comfortable to turn to them for help when he felt stuck. This in return allowed them to become true contributing participants, leading to the emergence of a community engaging in collaborative problem solving activities.

We noticed that Dan used some key words to express his state when dealing with a challenging unfamiliar problem. The following words and phrases recurred: "I don't know", "wait, we need to think", "I think that this may be a direction", "let's try", "there must be another fact that I can't see here", "I'm beginning to see it", "please help me solve it, it's a tough exercise". In a stimulated recall interview with Dan he was asked to react to two excerpts in which we identified this mode of his. His reaction was: "Yes, that was a difficult problem. I didn't know how to solve it at

first."; "Here I recall that the problem involved hyperbolas, which I did not remember, and they [the students] caught me unprepared. I didn't know I would have to solve with them problems in this topic. So I had to learn on my feet. This happened to me more than once throughout the year"....

In Dan's interview he was also asked to react to the way we analyzed his teaching, and particularly to what we referred to as his transparent problem solving. We also presented him with some excerpts from his tutorial lessons. At one point he said:

"... I tried to be as transparent as I could, because this is a way to learn lots of things, such as, how to decompose a complex question into smaller parts, how to choose the right solution path among various alternative paths, and how to plan the different steps of a solution. Yet, it's impossible to explain exactly how you are thinking.... Overall I tried to convey to them the message that it is ok sometimes not to be able to solve a problem, and that it is perfectly ok to improvise. I have no regrets for acting in this way."

The third characteristic of Dan's teaching was reflected in his tendency to expose his students to multiple solution strategies and approaches to most of the problems with which they dealt. This was done in several ways. One way was to prompt students to think of additional ways, by words such as: "more ideas?", "is there another way?". These prompts encouraged students to suggest numerous directions, which Dan always carried further, even if they were incomplete or led to an impasse. Students felt comfortable to share their thoughts and make suggestions, even when they were not sure about their way. There were also several cases in which Dan suggested on his own an alternative way to solve a problem. This tendency led to discussions that focused on issues such as what is a (relatively) simple or complicated solution as well as preferences regarding aesthetic features of the suggested solutions.

In Dan's interview, he said: "I want to show them [the students] that usually there really is more than one solution and that they shouldn't worry if someone else in the class solved it differently. This doesn't necessarily mean that they are wrong. I want to reinforce their confidence that it is possible to solve in more than one way."

## **CONCLUDING REMARKS**

The findings reported herein point to three typical complimenting and interrelated characteristics of Dan's teaching style with respect to problem solving activities. Interestingly, although Dan did not have any formal pedagogical education, these three characteristics are consistent with current trends in the mathematics education community. The first characteristic has to do with sensitivity to students and openness to their ideas, which is one of the three components of Jaworski's teaching triad (1992). Apparently, Dan developed this sensitivity through his experience with his daughters and colleagues at work. His attentiveness to students' needs was enhanced by his flexible state of mind, allowing the learning environment to evolve "as a result of interaction among the teacher and students as they engage in the mathematical content" (Simon, 1995, p. 133). This characteristic of Dan, together

with the fact that he did not have to assess student's achievement, reduced their anxiety and allowed them to express their ideas more openly. The second characteristic is related to Schoenfeld's (1983) concern that teachers hardly ever unravel their authentic thinking processes. In Dan's case, he intentionally and confidently chose to model transparent problem solving. This often involved situations that experienced teachers would probably consider embarrassing (Leikin & Dinur, 2003). Although the special conditions of the tutorial lessons encouraged his tendency to unravel his thinking, Dan could have avoided such situations by maintaining direct contact with Galia, the students' math teacher, and preparing in advance for each lesson. However, borrowing from his experience at work, Dan was accustomed to facing problems that he could not solve instantly and felt confident enough to face similar problems with his students. Students accepted and respected this position of the tutor, without lessening their appreciation of him. We assume that their expectations of their math teachers would be quite different. Nonetheless, the positive impact of this characteristic on the learning that took place reinforces Schoenfeld's (1983) assertion that teachers should occasionally deliberately exhibit genuine problem solving situations in the classroom. The third characteristic, namely, exposure of students to numerous approaches to problem solving, is significant to developing mathematical competence (Ma, 1999; NCTM, 2000). Dan's students appreciated this opportunity, maintaining that their teachers do not have the "luxury" of devoting so much time to each problem. According to the students, their math teacher has the responsibility to cover the curriculum, and needs to do it "efficiently" within the many constraints she faces. As mentioned above, the three characteristics are interrelated. We believe that by personally encountering difficulties in solving some of the mathematical problems, Dan became more aware and sensitive to students' similar experiences. By thinking on his feet and sharing his difficulties with his students, Dan contributed to the evolving classroom norms that included collaborative efforts, the legitimacy of the students to err, and their mutual responsibility to check their own and each others ideas and (Sfard, 1998; Bransford et al., 2000). Attending to students' diverse ways of thinking naturally lends itself to multiple problem solving perspectives and approaches. The fact that both the tutor and the students thought on the spot and suggested half baked ideas, contributed to the search for alternative solution methods that were simpler, more efficient, or better understood.

Clearly, Dan's lessons complimented the regular math lessons but could not replace them. The different kinds of learning experiences that were fostered in the (informal) tutorial lessons were possible only because of their connection to the learning that took place in the (formal) classroom setting. In this sense, our study provides evidence of the possible fruitful interplay between formal and informal learning environments.

## References

- Bransford, J., Zech, L., Schwarz, D., Barron, B., & Vye, N. (2000). Designs for environments that invite and sustain mathematical thinking. In P. Cobb, E. Yackel, & K. McClain (Eds.), *Symbolizing and Communicating in Mathematics Classrooms* (pp. 275-324). NJ: LEA, Publishers.
- Erickson, F.(1986). Qualitative methods in research on teaching. In M. C. Wittrock (Ed.), *Handbook of Research on Teaching* (3<sup>rd</sup> Ed.) (pp. 119-161). NY: Macmillan.
- Hofstein, A. & Rosenfeld, S. (1996). Bridging the gap between formal and informal science learning. *Studies in Science Education*, 28, 87-112.
- Jaworski B. (1992). Mathematics Teaching: What is it?, *For the Learning of Mathematics*, 12, 8-14.
- Lampert, M. (1990). When the problem is not the question and the solution is not the answer: Mathematical knowing and teaching. *American Educational Research Journal*, 27, 29-63.
- Leikin, R. & Zaslavsky, O. (1997). Facilitating students' interactions in mathematics in a cooperative learning setting. *Journal for Research in Mathematics Education*, 28(3), 331-354.
- Leikin, R. & Dinur, S. (2003, February). Patterns of flexibility: Teachers' behavior in mathematical discussion. Paper presented at CERME 3 - Third Conference of the European Society for Research in Mathematics Education. Bellaria, Italy.
- Ma, L. (1999). *Knowing and Teaching Elementary Mathematics: Teacher's Understanding of Fundamental Mathematics in China and the United States*. Mahwah, NJ: Lawrence Erlbaum Associates.
- National Council of Teachers of Mathematics.(NCTM)(2000). Principles and Standards for School Mathematics. Reston, VA: NCTM.
- Schoenfeld, A. H. (1983). *Problem Solving in the Mathematics Curriculum*. The Mathematical Association of America, Committee on the Undergraduate Program in Mathematics (MAA Notes, No. 1).
- Schoenfeld, A. H. (1992). Learning to think mathematically: Problem solving, metacognition, and sense making in mathematics. In D. Grouws (Ed.), *Handbook of Research on Mathematics Teaching and Learning* (pp. 334-470). NY: MacMillan.
- Sherin (Gamoran) M. (2002) A balancing act: developing a discourse community in a mathematics classroom. *Journal of Mathematics Teacher Education*, 5, 205-233.
- Simon, A. M. (1995). Reconstructing mathematics pedagogy from a constructivist perspective. *Journal for Research in Mathematics Education*, 26(2), 114-145.
- Sfard, A., Neshet, P., Streefland, L., Cobb, P. & Mason, J. (1998). Learning mathematics through conversation: Is it as good as they say? *For the Learning of Mathematics*, 18(1), 41-51.
- Yackel, E. & Cobb, P. (1996). Sociomathematical norms, argumentation, and autonomy in mathematics. *Journal of Research in Mathematics Education*, 27(4), 458-477.

# MAKING SENSE OF IRRATIONAL NUMBERS: FOCUSING ON REPRESENTATION

Rina Zazkis and Natasa Sirotic  
Simon Fraser University

*In our investigation of preservice secondary teachers' understanding of irrational numbers we focus on how different representations influence participants' responses with respect to irrationality. As a theoretical perspective we use the distinction between transparent and opaque representations, that is, representations that "show" some features of numbers while they "hide" others. The results suggest that often participants do not rely on the given transparent representation (i.e.  $53/83$ ) in determining whether a number is rational or irrational. Further, the results indicate participants' tendency to rely on a calculator and a preference towards decimal over the common fraction representation. As a general recommendation for teaching practice we suggest a tighter emphasis on representations and conclusions that can be derived from considering them.*

This report is a part of ongoing research on understanding of irrational numbers. Specifically, we focus here on how irrational numbers can be (or cannot be) represented and how different representations influence participants' responses with respect to irrationality.

## ON REPRESENTATIONS AND IRRATIONAL NUMBERS

There is an extensive body of research on representations in mathematics and their role in mathematical learning (Cuoco, 2001; Goldin & Janvier, 1998, to name just a few recent collections). The role of representations is recognized in manipulating mathematical objects, communicating ideas, and assisting in problem solving.

Researchers draw strong connections between the representations students use and their understanding (Lamon, 2001). Janvier (1987) describes understanding as a "cumulative process mainly based upon the capacity of dealing with an 'ever-enriching' set of representations" (p. 67). Furthermore, representations are considered as a means in the formation of conceptual understanding. The ability to move smoothly between various representations of the same concept is seen as an indication of conceptual understanding and also as a goal for instruction (Lesh, Behr and Post, 1987). Moreover, according to Kaput (1991), possessing an abstract mathematical concept "is better regarded as a notationally rich web of representations and applications" (p. 61). Only a small part of the work on representation addresses

representation of numbers, and it focuses primarily on fractions and *rational* numbers (e.g. Lesh, Behr & Post, 1987; Lamon, 2001).

In contrast, research on irrational numbers is rather slim. Fischbein, Jehiam & Cohen (1994, 1995) are the only research reports we found that treat the issue explicitly. The main objective of these studies was to examine the knowledge of irrational numbers of high school students and preservice teachers. Based on historical and psychological grounds, Fischbein et. al. assumed that the concept of irrational number presented two major obstacles: incommensurability and nondenumerability. Contrary to the expectations, the studies found that these intuitive difficulties did not manifest in participants' reactions. Instead, they found that subjects at all levels were not able to define correctly rational and irrational numbers or place the given numbers as belonging to either of these sets. It has been concluded that the expected obstacles are not of primitive nature – they imply certain mathematical maturity that the subjects in these studies did not possess.

These findings call for a more comprehensive study examining the understanding of irrationality and attending to issues of concern that were identified. Definitions of rational and irrational numbers rely on number representations. There has been no study to date that investigated understanding of irrational numbers from the perspective of representations.

### **THEORETICAL PERSPECTIVE: TRANSPARENT AND OPAQUE**

As a theoretical perspective we use the distinction between transparent and opaque representations, introduced by Lesh, Behr and Post (1987). According to these researchers, a transparent representation has no more and no less meaning than the represented idea(s) or structure(s). An opaque representation emphasizes some aspects of the ideas or structures and de-emphasizes others. Borrowing Lesh's et. al. terminology in drawing the distinction between transparent and opaque representations, Zazkis and Gadowsky (2001) focused on representations of numbers introducing the notion of relative transparency and opaqueness. Namely, they suggested that all representations of numbers are opaque in the sense that they always hide some of the features of a number, although they might reveal other, with respect to which they would be "transparent". For example, representing the number 784 as  $28^2$  emphasizes that it is a perfect square, but de-emphasizes that it is divisible by 98. Representing the same number as  $13 \times 60 + 4$  makes it transparent that the remainder of 784 in division by 13 is 4, but de-emphasizes its property of being a perfect square. In general, we say that a representation is transparent with respect to a certain property, if the property can be "seen" or derived from considering the given representation.

The definition of rational number relies on the existence of certain representation: a rational number is a number that can be represented as  $a/b$ , where  $a$  is an integer and  $b$  is a nonzero integer. When a real number cannot be represented in this way, it is called irrational. Until the exposure to a formal construction of irrational number



using, for instance, Dedekind cuts, this distinguishing representational feature is used as a working definition of irrational number. That is to say, irrational number is a number that cannot be represented as a ratio of integers. An equivalent definition of irrational number refers to the infinite non-repeating decimal representation.

Applying the notions of opaqueness and transparency we suggest that infinite non-repeating decimal representation (such as  $0.010011000111\dots$ , for instance) is a transparent representation of an irrational number (that is, irrationality can be derived from this representation), while representation as a common fraction is a transparent representation of a rational number (that is, rationality is embedded in the representation).

## RESEARCH SETTING

As part of a larger research on understanding of irrational numbers we examined how the availability of certain representations influenced participants' decisions with respect to irrationality. To investigate this we designed the following questions:

1. Consider the following number  $0.12122122212\dots$  (there is an infinite number of digits where the number of 2's between the 1's keeps increasing by one). Is this a rational or irrational number? How do you know?
2. Consider  $53/83$ . Let's call this number  $M$ . In performing this division, the calculator display shows  $0.63855421687$ . Is  $M$  a rational or an irrational number? Explain.

(Note that the numbers in Question 2 are carefully chosen so that the repeating is "opaque" on a calculator display. The length of the period in this case is 41 digits.)

These questions were presented to a group of 46 preservice secondary school mathematics teachers as part of a written questionnaire. These participants were in their final course in the teacher education program and had at least two calculus courses in their background. Upon completion of the questionnaire, 16 volunteers from the group participated in a clinical interview, where they had the opportunity to clarify and extend upon their responses. Participants' responses were analyzed with specific attention to the role that representation of a number played in their decision, and their reliance or non-reliance on the given representation.

## RESULTS AND ANALYSIS

We first present quantitative summary of written responses. We then focus on the detail of one particular interview. Further, we present some common erroneous beliefs of participants and attempt to identify their sources. We conclude this section by summarizing some common trends in participants' approaches to the presented questions.

**Quantification of results for #1 – considering 0.12122122212... (n=46):**

Response category	Number of participants [%]
Correct answer with correct justification	27 [58.7%]
Correct answer with incorrect justification (such as, "this number is irrational because there is an infinite number of digits")	7 [15.2]
Correct answer with no justification	1 [2.2%]
Incorrect answer	6 [13%]
No answer	5 [10.9%]

**Quantification of results for #2 – considering 53/83 (n=46):**

Response category	Number of participants [%]
Correct answer with correct justification	31 [67.4%]
Correct answer with incorrect justification (such as, "this number is rational because the digits terminate")	7 [15.2]
Correct answer with no justification	2 [4.3%]
Incorrect answer	5 [10.9%]
No answer	1 [2.2%]

As shown in these tables, over 40% of the participants did not recognize the non-repeating decimal representation as a representation of an irrational number. Further, over 30% of the participants either failed to recognize a number represented as a common fraction as being rational or provided incorrect justifications for their claim. It is evident that for a significant number of participants the definitions of rational and irrational numbers were not a part of their active repertoire of knowledge. In the next section we consider the responses of one participant, Steve, that shed light on the possible sources of students' errors and misconceptions.

**Focusing on Steve**

Steve: [claiming 0.121221222... is irrational] Um hm, I would say because it's not a common, there's not a **common element** repeating there that it would make it a rational...

Interviewer: How about this one, 0.012222...with 2 repeating endlessly, is this rational of irrational?

Steve: Okay, I would have to say that's irrational real number.

Interviewer: Irrational or rational, I couldn't hear you.

Steve: Irrational. Well oh, the 2 repeats, no but it has to be, then it repeats, even though the 2 repeats, it has to be a **common pattern**, so I would say it's irrational.

Interviewer: Okay, so 0.01222... repeating infinitely is irrational.

Steve: I think so, but I forget if the fact that that, if the 1 there changes, I would have thought it would have to be **012, 012**, ... but if it starts repeating later, yeah I can't remember if it starts repeating later, I'm pretty sure it's irrational, but I could be mistaken.

Interviewer: How about the second question, when you consider 53 divided by 83. . .

Steve: Um hm. . .

Interviewer: And let's call this quotient M, and if you perform this division on the calculator the display shows this number, 0.63855421687.

Steve: And I assume it keeps going, that's just what fits on your calculator. . .

Interviewer: Yeah, that's what the calculator shows, that's right. So is M rational or irrational?

Steve: So this is the **quotient** M, yeah I would say it's **irrational**.

Interviewer: Because?

Steve: Because **we can't see a repeating decimal**.

Interviewer: But maybe later, down the road it starts repeating.

Steve: Well that's true, it's possible. . .

Interviewer: So we can't really determine?

Steve: Well I guess we don't, we **wouldn't know** for sure just **from looking at that number on the calculator, but chances are that if it hasn't repeated that quickly, then it would be irrational**. I haven't seen a lot of examples where they start repeating with 10 digits or more. I'm sure there are some but... .

Interviewer: Okay, and the fact that it comes from dividing 53 by 83, does that not qualify it as rational?

Steve: Oh so that is a fraction, it's 53/83?

Interviewer: Yeah we, that's how we got this number, so we divided 53 by 83 and called this M. . .

Steve: **53/83 as it's written would be rational**, but yeah, I see what you mean, if you took that decimal, yeah, I guess that's a good point. I see what you're, you're saying that fact that it's 53/83 that is A/B, so that is rational, but then when you take, **if you started dividing. . . It would just go on and on and on and on, so that you would think is irrational**. Yeah, I must say I don't know the answer to that.

In the beginning of the interview Steve claims correctly that an infinite non-repeating decimal fraction represents an irrational number. However, his use of the words "common element" prompts an inquiry into his perception of "common". This perception is clarified in Steve's incorrect claim that  $0.0122222\dots$  is also irrational. Steve is looking for a common *pattern*, and the repeating digit of 2 does not seem to fit his perception of a pattern. For the next question Steve is presented with a fraction  $53/83$  and distracted by its display on a calculator. Focusing on the decimal representation rather than the common fraction representation, his first response – this quotient is irrational – presents an oxymoron. It is based on the inability to "see" the repeating pattern. The underlying assumption here is that a repeating pattern, if it exists, has a short and easily detectable repeating cycle. This perception is confronted by the interviewer in directing Steve's attention to the number representation as a fraction,  $53/83$ . From his reply it appears that Steve believes that whether the number is rational or irrational depends on how it is written; that is, a common fraction represents a rational number, but its equivalent decimal representation could be irrational.

In what follows we demonstrate several frequent erroneous beliefs expressed by the participants, some of which have been exemplified in the excerpt from the interview with Steve. There are two, interrelated sources of conflict responsible for these erroneous beliefs: applying incorrect or incomplete definition and not understanding the relationship between fractions and their decimal representations.

### **Applying incorrect or incomplete definition**

- If there is a pattern, then the number is rational. Therefore  $0.12122122212\dots$  is rational, (similarly,  $0.100200300\dots$  is rational, but  $0.745555\dots$  is not, because there is no pattern).
- $53/83$  is irrational because there is no pattern in the decimal  $0.63855421687$ .
- $53/83$  is rational because it terminates (calculator shows  $0.63855421687$ )
- $53/83$  could be rational or irrational – I cannot tell whether digits will repeat because too few digits are shown. They might repeat or they might not.

The first illustration above echoes Steve's reliance on a personal interpretation of "pattern", but is ignoring the required repetition of digits. The other three responses demonstrate participants' dependence on a calculator and preference towards decimal representation, which is misinterpreted as either terminating or having no repeating pattern, or treated as ambiguous.

### **Interrelations of fractions and repeating decimals**

- There is no way of telling if  $53/83$  is rational - unless you actually do the division which could take you forever. Digits might terminate at a millionth place or they might start repeating after a millionth place.

- It is possible that a number is rational and irrational at the same time. For example, there are fractions that have non-repeating non-terminating decimals, yet they can be represented as  $a/b$
- It is easy to turn a fraction into a decimal. But there is no easy, general way of turning a decimal into a fraction. Looking at a decimal, unless it is a terminating decimal, you cannot tell if it is rational or not.
- $0.012222\dots$  is not rational. I cannot think of any two numbers to divide to get that decimal.

These approaches are mostly procedural in their focus on carrying out the operation of division or performing conversion, rather than attending to the structure of the given representation. It is apparent that the connection between fractions and repeating decimals is not recognized.

## SUMMARY AND CONCLUSION

We investigated the understanding of irrational numbers of the group of preservice secondary mathematics teachers. In this report we focused on the role that representations play in concluding rationality or irrationality of a number.

Though the majority of participants provided correct and appropriately justified responses attending to the provided representation, incorrect responses of the minority are troublesome, especially taking into account participants' formal mathematical background. For this significant minority,

- the definitions of irrational, as well as rational, numbers were not in the "active" repertoire of their knowledge;
- there was a tendency to rely on a calculator and participants expressed preference towards decimal representation over the common fraction representation;
- there was a confusion between irrationality and infinite decimal representation, regardless of the structure of this representation
- the idea of "repeating pattern" in decimal representation of numbers was at times overgeneralized to mean any pattern.

From our theoretical perspective, we say that the transparent features of the given representations were either not recognized or not attended to. A possible obstacle to students' understanding is that the equivalence of the two definitions of irrational numbers given in school mathematics – nonexistence of representation as  $a/b$ , where  $a$  is an integer and  $b$  is a nonzero integer and infinite non-repeating decimal representation – is not recognized. We consider this as a *missing link* that is rooted in understanding of rational numbers, that is, the understanding of how and when the division of whole numbers gives rise to repeating decimals, and conversely, that every repeating decimal can be represented as a ratio of two integers.

A general suggestion for teaching practice calls for a tighter emphasis on representations and conclusions that can be derived from considering them. In particular, attending to the connections between decimal (binary, etc.) and other representations (geometric, symbolic, common fraction, and even continued fractions) of a number can be an asset. Simply put, we suggest that by directing explicit attention of students to representations and to mathematical connections that render the two representations equivalent, teachers can help students acquire a more profound understanding of number.

## References

- Cuoco (Ed.). *The roles of representation in school mathematics*. Reston, VA: NCTM.
- Friedlander, A. and Tabach, M. (2001). Promoting multiple representations in algebra. In A. Cuoco (Ed.), *The roles of representation in school mathematics* (pp. 173-184). Reston, VA: NCTM.
- Goldin, G. and Janvier, C. (Eds.) (1998). Representations and the psychology of mathematics education, Parts I and II. Special issue of the *Journal of Mathematical Behavior*, 17(1-2).
- Janvier, C. (1987). Representation and understanding: The notion of function as an example. In C. Janvier (Ed.), *Problems of representation in the teaching and learning mathematics* (pp. 67-72). Hillsdale, NJ: Lawrence Erlbaum Associates.
- Fischbein, E., Jehiam, R., & Cohen, C. (1994). The irrational numbers and the corresponding epistemological obstacles. In da Ponte J.P. & Matos, J.F. (Eds.), *Proceedings of the 18<sup>th</sup> International conference for Psychology of Mathematics Education*, Vol.2 (pp. 352-359). Lisbon, Portugal.
- Fischbein, E., Jehiam, R., & Cohen, C. (1995). The concept of irrational number in high school student and prospective teachers. *Educational Studies in Mathematics*, 29. 29-44.
- Kaput, J. (1991). Notations and representations as mediators of constructive processes. In E. von Glasersfeld (Ed.), *Radical constructivism in mathematics education* (pp. 53-74). Dordrecht, the Netherlands: Kluwer Academic Publishers.
- Lamon, S.J. (2001). Presenting and representing: From fractions to rational numbers. In A. Cuoco (Ed.), *The roles of representation in school mathematics* (pp. 41-52). Reston, VA: NCTM.
- Lesh, R., Behr, M., and Post, M. (1987). Rational number relations and proportions. In C. Janvier (Ed.), *Problems of representation in the teaching and learning mathematics* (pp. 41-58). Hillsdale, NJ: Lawrence Erlbaum Associates.
- Zazkis, R. & Gadowsky, K. (2001). Attending to transparent features of opaque representations of natural numbers. In A. Cuoco (Ed.), *The roles of representation in school mathematics* (pp. 146-165). Reston, VA: NCTM.

# NUMERACY PRACTICES OF YOUNG WORKERS<sup>1</sup>

Robyn Zevenbergen and Kelly Zevenbergen

Griffith University

*This paper presents a summary of the first two years of a large research project investigating the numeracy practices of young people across a range of industries. Drawing on both quantitative and qualitative data, the project aims to identify the ways in which numeracy practices are perceived and enacted by young people (students in part-time employment, employees and job seekers) and their more senior counterparts (teachers, employers, and job placement officers). This paper presents a description of the project to date and provides exemplars of the data collected in order to demonstrate key findings.*

The workplaces that young people enter in the new millennium are substantially different from those of the past. The nature of work is substantially different whereby the workforce has been highly casualized; there has been a decline in unskilled and semi-skilled occupations; and people are expected to demonstrate transportability of labour across sectors (Duffy, Glenday, & Pupo, 1997; Swift, 1997). Furthermore, people are predicted to change occupations a number of times across their working lives; people will create their own jobs; and that the positions that young school entrants will occupy do exist at the time they commence school. Within these changing conditions, other factors are impacting on the nature of work, the most predominant is that of technology. Not only has technology changed the ways in which is undertaken where work has become highly technologised and, by implication, reduced the need for unskilled or semiskilled labour, it has changed the ways in which work and thinking about work have been undertaken. The impact of technology on work and numeracy practices is central to this paper. It is proposed that a better understanding of this phenomenon is important to curriculum theorizing. It is suggested that the nature of work may be substantially different in this post-industrial period from that of the industrial period and that this has ramifications for school mathematics. In the past, part of the rationale for school mathematics has been for the preparation of young people for work and the wider society. But if this society is qualitatively different and has changed needs and demands of young people, then the school curriculum may need to be radically different if it is to prepare young people for this changed world.

## **NUMERACY: IMPLICATIONS OF WORK**

A substantive body of literature exists that documents the numeracy practices of out-of-school practices. These include street sellers (Carraher, 1988); candy sellers (Saxe, 1988); pool builders (Zevenbergen, 2003); carpenters (Millroy, 1992); along with

---

<sup>1</sup> This project “Numeracy, youth and employment” is a three-year project funded by the Australian Research Council. The views in this paper are those of the authors, not of the ARC.

numerous other studies. These studies have been useful in highlighting the different ways in which mathematics is enacted in out-of-school contexts from that expected within school. They have been powerful in alerting educators to the situatedness of activities and the impact on how tasks are undertaken. For example, the plumber may need to know how much lagging (wrapping) is needed to insulate a pipe. In the school situation this would be calculated using the process for finding circumference from either the radius or diameter. However, in the world beyond schools, the plumber will use the diameter since it is the easiest dimension to find. This is found by pulling the metal tape across the pipe and oscillating until the widest dimension is found – this being the diameter. This is then multiplied by 3 (as opposed to pi) and an estimate of the lagging is known. Since error rates are built into the work of the construction – including plumbing – this calculation is more than adequate and much easier than the methods undertaken in school. The precision that is a central element of school mathematics is not a high priority in this situation so more situation-appropriate strategies have been developed by workers.

Within the Australian context, it is recognised that almost 50% of traineeships and/or apprenticeships undertaken by young people are not completed. There are many reasons for such non-completion but one of the most concerning reasons is that young people are unable to cope with the numeracy expectations of the formal study associated with these programs or the numeracy demands of the workplace. The literatures on post-industrial workplaces suggest that the nature of work is changing, in part, due to the significant changes brought about through the use of technology. Little is known of the impact of technology in the workplace and how this may influence the ways of working and of success for young people in today's work. This paper reports briefly on the major findings of the first two years of the study.

## **THE PROJECT - NUMERACY, YOUTH AND EMPLOYMENT**

This is a three-year iterative study. The study is being conducted in a region of Australia (The Gold Coast) which best characterizes the post-industrial workplace. It is highly casualised, has low industrial base, and relies on tourism and other recreational/leisure industries as its main source of employment. The region is bimodal in its population with a significant number of retirees and increasingly a growth in the youth market – that is, young people between the ages of 14-25. A consortium of industry partners<sup>2</sup> work with the project as part of the Linkage Granting scheme. The Industry partners play a key role in guiding the project. The study involves three key phases – 2002 a large-scale survey was conducted across the region – with employers, teachers and employment placement officers representing those groups who worked with the training and placement of young people; along with young workers, students in schools involved in part-time work; and young people seeking work representing the range of young people in the youth labour

---

<sup>2</sup> Industry partners include Gold Coast City Council, Gold Coast Institute of TAFE, SCISCO, Centrelink, Queensland Schools Authority, and Adams Consultancy.



market. The survey sought a range of responses including the importance of a range of literacy, numeracy, ICT and generic skills in contemporary workplaces. Phase 2 was conducted in 2003 and involved workshadowing young people across a range of industries representative of the types of work being undertaken by young people. The workshadowing sought to identify the numeracy practices undertaken by young people in their fields of work. Phase 3, to be implemented in 2004, will involve triangulation of the young people's data from Phase 2 with employers and trainers. This has arisen as the outcomes of Phase 2 indicate discrepancies in expectations of older people of their employees in terms of the numeracy demands. Recommendations will be developed and trialled with employer groups.

Underpinning the project is a hypothesis that the numeracy and literacy demands of contemporary work may be very different from the past. The contemporary literature on literacy demands suggests that new forms of literacy are emerging in post-industrial times, largely due to the impact of technology (Unsworth, 2002). Less is known on how this impacts on numeracy demands of contemporary work. What is known is that technology has the potential to change elements of work (Straesser, 2001), but the impact on work is less known. As such, the project aims to identify if there are different demands of numeracy in the workplace and if there differences, what are they? The Industry partners are central to the project in that they represent the key industry and training groups associated with young people. They have provided insights into the experiences of workplaces for young people in and/or seeking work.

### **Phase 1: The Survey**

In 2002, a survey was constructed with the guidance and input of the industry partners so that all key elements associated with employment of young people were identified. Key sectors, as noted above, were sought. Almost 900 responses were received across the 6 target groups. Aside from the job placement officers (which is a small group relative to the others) the group responses varied from 50 to over 300 thus making analysis considerably reliable. Participants were asked to rate on a Likert scale, the relative importance of various items (e.g. numeracy, statistics) in their current (or last) position. In each case, examples were given for each item. For this paper, the data were combined so that the senior (employers, teachers and job placement officers) and the younger (employees, students and job seekers) formed two cohorts. A step-wise multi-variant analysis showed weighted multiple linear combinations of the predictor variable best distinguished between the two groups. In step-wise order, the following variables were found to be statistically significant at less than  $p \leq 0.001$ :

- 1) Use computers of relatively general purposes (Senior);
- 2) Statistics (Younger);
- 3) Industry-relevant technology (Younger);
- 4) Non-verbal communication (Senior) ;

- 5) Computer technology to support numeracy/ maths (Younger);
- 6) Number (Senior);
- 7) Industry-specific technology (complex) (Senior);
- 8) Volume (Younger); and
- 9) Location (Younger).

These results suggest that aspects of numeracy and computers are key variables in the differences between older and younger people in this study. Five of the nine discriminating items related to numeracy/mathematics (statistics; computer technology to support numeracy/maths; Number; Volume, and location), three related to ICTs (use computers of relatively general purposes; industry-relevant technology; and industry-specific technology; and one to literacy (non-verbal communication).

These data suggest that there are significant differences between younger and senior people's perceptions of the importance of numeracy (and technology) in contemporary workplaces. Open-ended responses in the survey further added that younger people are less concerned about the use of technology in the workplace than senior people; and that younger people are more likely to see applied areas of numeracy (measurement, statistics and location) as being important while senior people are more likely to see number work (i.e. calculations, mental arithmetic) as important. In follow up interviews in a supermarket, young people offered comments such as:

Shop Assistant: I don't need to calculate exactly what the amount is, but I have guess to check that what the register says is likely to be right. Lots of old people come through my aisle and sometimes they get angry if I make a mistake, like as if I am supposed to add up everything. Sure, how can you add up some of the groceries that people buy.

In contrast, supervisors offered comments of the kind:

Register Supervisor: The young ones really don't have much of an idea on how much change to give and that sort of thing. I sometimes think they are a bit lazy and can't be bothered, you know, they let the register do all the hard yakka [work] for them.

These brief comments are indicative of general comments within this initial phase of the project whereby differences suggest that there may be intergenerational differences in how people see numeracy in the workplace, and how technology often is implicated in that numeracy. This outcome aligns with the literatures on post-industrial theorizing whereby younger people have different expectations of and about knowledge than their older peers. As has been argued elsewhere (Zevenbergen & Zevenbergen, 2003), it appears that younger people are more likely to see numeracy in applied settings; older people frame numeracy within 'old basics' – that is, arithmetic; and younger people are more likely to see these basic skills as ones that can be undertaken by technology (such as calculators or cash registers). Indeed as the data suggest, younger people see their role as more holistic (problem solving,

estimation) and that technology is to be used for mundane and routine tasks (such as arithmetic) whereas senior people saw these later skills as foundational to numeracy. These findings have implications for how numeracy is undertaken and assessed within contemporary workplaces. This is particularly relevant when considering the assessment processes for obtaining staff and for formal studies associated with training where many aspects of basic skills are foundational to testing processes. We suggest that many of the numeracy skills being taught as part of apprenticeship training and traineeships may be framed within old or industrial frameworks whereas younger people are not seeing numeracy in these frames of reference. As the survey data suggest, it is possible that senior people who often assume responsibility for assessment of younger people, may perceive the ways of contemporary work very differently from their younger counterparts. This is most evident when considering the role of technology within working mathematically. Senior people were more likely to see core knowledge and attributes as mental calculations whereas younger people saw this work as the task of technology. That is not to say that there is no place for mental computation and accuracy with calculations, only that there are different weightings being applied by the two cohorts.

As survey data can be limited in terms of the responses offered, Phase Two sought to clarify and expand the results of Phase One. In this Phase, case studies have been undertaken of twenty work sites in order to identify the numeracy practices within those sites.

### **Phase Two: Workshadowing**

In Phase Two of the project, we have been investigating the ways in which young people undertake their work, with an emphasis on the numeracy practices. This has been explored through the use of pre- and post interviews, with a period of workshadowing in between the two interviews. Depending on the nature of the work being undertaken, the workshadowing is usually for a period of three days, but this may be longer if needed. The three days enable a reasonable snapshot of the work undertaken. However, in some cases, they may be over a longer period. The field work is undertaken so as to gain a broad snapshot of the work – this may mean consecutive days in some sites, and staggered days in others. We have used stimulated recall (Walker, 1985) as the method for data collection. This entails taking photographs of the worker as he/she goes about work. The post-interview involves the young person talking about what they were doing in the photograph and how they were going about their work, including how they were thinking mathematically about their work. Twenty cases have been undertaken in 2003, across a range of industries including retail, construction, marine, hospitality, and service industries so that a broad range of occupations have been covered. The industries represent key industries that employ young people – both male and female.

Data analysis of these cases has highlighted the different approaches to undertaking numeracy-orientated activities across worksites; the levels of numeracy required for different worksites; and the ways in which young people rely on non-school

mathematics to undertake their work. These broad findings can be exemplified in the following highlights from the case studies of a baker and a boat builder.

### **The Case of a Baker**

The workshadowing of the baker showed very different numeracy practices from those used in school. Prior to commencing the day's baking, the manager prepares a list of products and quantities for each product that needs to be produced. The baker needs to ascertain quantities of flour to make the nominated number of loaves of bread. A 'yield factor' is used to calculate the amount of flour needed for a particular type of bread. For example, if the manager had indicated that 50 white loaves were needed, the baker needs to know how much flour is needed to produce this many loaves. This amount of flour varies for each type of bread. If the yield factor for white bread were 0.4, then the baker needs 20kgs of flour to make the 50 loaves of bread. To obtain the correct amount of flour for a given bake, the baker places the bag of flour on the scales and removes the amount so that the quantity of flour needed is the difference between the start and finish weights. This process is quite different from those used in school settings where the quantity to be used is the amount weighed.

Unlike school recipes where the quantities for each item are expressed as individual quantities, the recipe for bakers is substantially different. Due to confidentiality agreements, the recipes cannot be reproduced so a mock example is provided opposite. The quantities needed are expressed as percentages (rather than amounts). These percentages are in relation to the yield factor that is related to the amount of bread needed for the front end of the shop. Unlike school mathematics where percentages generally are expressed as parts of a whole and usually added together to make 100%, the baker's recipe expresses the individual amounts (such as currants, yeast, etc) as percentages which are then compared to the original amount of flour needed for the bake. This allows for a high

<b>Fruit loaf</b>
Flour 100%
Sultanas 50%
Currants 25%
Mixed peel 7%
Yeast 3%
Salt 2%
Water

degree of flexibility with the baking process since different quantities of bread will be needed on any given day, thus requiring different amounts of constituent ingredients. When calculating the quantities needed for each ingredient, the baker would do the calculation mentally. The apprentice indicated in the interviews that he originally relied on a calculator in the "first few weeks of the job but now can do them in my head... You just get a sense of what is right coz you do it so often."

The case of the baker shows how the numeracy practices of workplaces can be demanding in what is expected to be undertaken. The manager indicated that they had considerable difficulty keeping young people as they were not able to undertake the calculations needed in baking. The case of bakers suggests very different ways in which numeracy practices are represented and undertaken in this context from those used in schools. Most diverse was the recipe genre where quantities are expressed differently from the school (and home) practices. The numeracy embedded within this

genre is very different in terms of how quantities are expressed (as being related to the initial amount of flour); are weighed; the calculation of quantities for each bake (as opposed to a standard quantity); and how percentages are represented.

## **THE CASE OF BOATBUILDING**

There are many aspects of boatbuilding so three cases were developed for this industry. The industry offers apprenticeships across a range of occupations (electrical, boat building, furnishing, upholstery etc). Unlike the industry of the past, current practices are radically different in terms of building products and construction methods. The luxury boat industry (in which this study was conducted) had the boats pre-formed in two parts (hull and deck) which are then joined. The boat builders are responsible for fitting out the hulls and decks. As pre-formed boats, fittings are relatively standard so the apprentice's task is to install and repair since many of the installations are not correct. As part of this work, the apprentice is required to mix an epoxy material (fiberglass) where hardener is added to the base in order to make the resin set. There is a standard ratio that needs to be calculated depending on the type of materials being used. However, the apprentices rarely (if ever) used this method.

Jack: I go by feel, if it looks right and works right, then I can use it. It depends on the size of the job – if it is a big one you don't want the bog to go off too quickly or it might set before you finish so you add a bit less. If is a hot day, you will also add less coz it sets quicker on hot days. You just get to know what is right.

Throughout the boatbuilding workshadowing, informal methods were used often. For example, when needing to align objects – such as a door to be hung – the apprentices used a pencil as this 'looked good' and ensured that they had the same distance at the top and bottom of the door in relation to the fixed wall from which it was hung. Aesthetics were important as products needed to "look right" or "look good" but this was achieved through the use of convenient tools (in this case, pencils) rather than formal measurement. In this industry, despite the manager's suggestion that the apprentices needed considerable mathematics in their work, there was evidence to suggest that the young men tended to rely on estimation, intuition, and aesthetics to perform their work.

## **SUMMARY**

This paper has sought to provide an overall summary of the project in terms of method and outcomes. Exemplars of the data and outcomes have been provided to illustrate the key points that have been found. The survey has identified a number of areas where there are significant differences in perceptions of importance of various aspects of numeracy and ICT between younger and senior people. It was thought that literacy would have featured more significantly but this has not been the case, suggesting that there may be considerable congruence between younger and senior people's perceptions of literacy demands. Interestingly, elements of numeracy featured strongly in the differences in perceptions of importance between younger

people and senior people. To better understand these differences, workshadowing has highlighted numeracy-in-action across twenty worksites. It has been identified that the numeracy demands of most of the worksites are minimal; that the numeracy is highly situational – that is, it is governed by demands and needs that are unique to that context; that the young people appear to be performing the tasks in ways that are substantially different from the approaches advocated in schools (such as the baker example); and that young people have different orientations to approaching their numeracy work than their older peers.

Further qualifications are needed from senior staff to validate or challenge the views of the young people in terms of numeracy demands and this will be the focus of the next phase of the project. The outcomes of the project have implications for how school mathematics is considered in terms of both content and process if young people are to be prepared for the changing work demands. Similarly, senior people need to recognize the impact of technology on working mathematically.

## References

- Carraher, T. N. (1988). Street mathematics and school mathematics. In A. Borbas (Ed.), *Proceeding of the twelfth PME conference* (Vol. 1, pp. 1-23). Veszprem, Hungary: International group for the Psychology of Mathematics Education.
- Duffy, A., Glenday, D., & Pupo, N. (Eds.). (1997). *Good jobs, bad jobs, no jobs: The transformation of work in the 21st century*. Toronto: Harcourt Canada.
- Millroy, W. L. (1992). An ethnographic study of the mathematical ideas of a group of carpenters. *Journal for Research in Mathematics Education, Monograph no 5*.
- Saxe, G. B. (1988). Candy selling and math learning. *Educational Researcher, 17*(6), 14-21.
- Straesser, R. (2001). Cabri-géomètre: Does dynamic geometry software (DGS) change geometry and its teaching and learning? *International Journal of Computers for Mathematical Learning, 6*(3), 319-333.
- Swift, J. (1997). From cars to casinos: From work to workfare. In N. Pupo (Ed.), *Good jobs, bad jobs, no jobs: The transformation of work in the 21st century* (pp. 35-52). Toronto: Harcourt, Canada.
- Unsworth, L. (2002). Changing dimensions of school literacy. *The Australian Journal of Language and Literacy, 25*(1), 11-26.
- Walker, R. and J. Weidel (1985). Using photographs in a discipline of words. *Field methods in the study of education*. R. G. Burgess. Barcombe, Falmer: 1-24.
- Zevenbergen, R., & Zevenbergen, K. (2003). Numeracy in New Times: Implications for youth, work and employment. In L. Bragg, C. Campbell, G. Herbert & J. Mousley (Eds.), *Mathematical education research: Innovation, Networking and Opportunity. Proceedings of the 26th annual conference of the Mathematics Education Research Group of Australasia* (Vol. 2, pp. 799-807). Geelong: MERGA.