

## DOCUMENT RESUME

ED 482 888

FL 801 627

AUTHOR Bohlman, Carolyn; Martin, Laura; Porter, Catherine  
TITLE Community Connections: Education for Involved Communities. A Curriculum for English Literacy/Civics Education.  
INSTITUTION Adult Learning Resource Center, Des Plaines, IL.  
SPONS AGENCY Office of Vocational and Adult Education (ED), Washington, DC.  
PUB DATE 2003-00-00  
NOTE 312p.  
AVAILABLE FROM Curriculum Publications Clearinghouse, Western Illinois University, 1 University Circle, Horrabin Hall 46, Macomb, IL 61455-1396. Tel: 309-298-1917; Tel: 800-322-305 (Toll Free); Fax: 309-298-2869; e-mail: CPC@wiu.edu; Web site: <http://www.wiu.edu/CPC>.  
PUB TYPE Guides - Classroom - Teacher (052)  
EDRS PRICE EDRS Price MF01/PC13 Plus Postage.  
DESCRIPTORS \*Adult Education; \*Civics; Democracy; English (Second Language); Experiential Learning; Housing; Language Proficiency; Public Education; Public Health; Public Libraries; Role Playing; Safety; Second Language Instruction; Vocabulary Development

## ABSTRACT

This reproducible, multilevel curriculum for English Literacy and Civics Education contains six field-tested and illustrated models: (1) The Democratic Process; (2) Community and Home Safety; (3) The Public Library; (4) The U.S. School System; (5) Public Health Services; and (6) Housing. The package includes the following: the Community Connections Curriculum (310 pages of illustrated, multilevel lessons and teaching techniques); a classroom picture set (243 pages of enlarged, cardstock illustrations from the curriculum); and a flashcard picture set (200 cardstock flashcards for individual and group vocabulary practice). The teaching techniques include using pictures for vocabulary development, using pictures for language experience, teaching the reading passages, teaching dialogues and role plays, and experiential activities (planning successful field trips and making the most of guest speakers). Curriculum materials can be integrated into any existing English-as-a-Second-Language curriculum. (Adjunct ERIC Clearinghouse for ESL Literacy Education.) (SM)

Reproductions supplied by EDRS are the best that can be made  
from the original document.

# Community Connections



## Education for Involved Communities

*Community Connections: Education for Involved Communities* is a reproducible, multilevel curriculum for English Literacy and Civics Education (EL/CE). The curriculum materials are easily integrated into any existing ESL curriculum.

### The curriculum contains six field-tested and illustrated modules:

1. The Democratic Process
2. Community and Home Safety
3. The Public Library
4. The U.S. School System
5. Public Health Services
6. Housing

U.S. DEPARTMENT OF EDUCATION  
Office of Educational Research and Improvement  
EDUCATIONAL RESOURCES INFORMATION  
CENTER (ERIC)

This document has been reproduced as received from the person or organization originating it.

Minor changes have been made to improve reproduction quality.

• Points of view or opinions stated in this document do not necessarily represent official OERI position or policy.

PERMISSION TO REPRODUCE AND  
DISSEMINATE THIS MATERIAL HAS  
BEEN GRANTED BY

*Sue Barauski*

TO THE EDUCATIONAL RESOURCES  
INFORMATION CENTER (ERIC)

### Three fully reproducible components are included:

1. Community Connections Curriculum  
310 pages of illustrated, multilevel lessons and teaching techniques
2. Classroom Picture Set  
243 pages of enlarged, cardstock illustrations from the curriculum
3. Flashcard Picture Set  
200 cardstock flashcards for individual and group vocabulary practice

**BEST COPY AVAILABLE**

**CURRICULUM PUBLICATIONS CLEARINGHOUSE**

Western Illinois University • 1 University Circle

Horrabin Hall 46 • Macomb, IL 61455-1396

309/298-1917 • 309/298-2869 fax • CPC@wiu.edu

www.wiu.edu/CPC

**(800) 322-3905**

2



# COMMUNITY CONNECTIONS: EDUCATION FOR INVOLVED COMMUNITIES

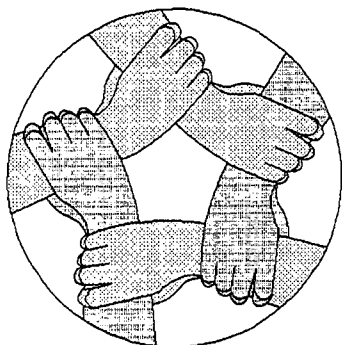

## A Curriculum for English Literacy/ Civics Education

### CURRICULUM DEVELOPERS

Carolyn Bohlman  
Laura Martin  
Catherine Porter

### ILLUSTRATOR

Nan Waterstreet

### PROJECT DIRECTOR

Sue Barauski

For more information about this curriculum  
or training opportunities, contact Sue Barauski:

Adult Learning Resource Center  
1855 Mt. Prospect Road  
Des Plaines, IL 60018  
(847) 803-3535  
[www.thecenterweb.org](http://www.thecenterweb.org)

*Community Connections: Education for Involved Communities*  
©2003 Adult Learning Resource Center

The materials in this curriculum are reproducible for classroom use only.

This curriculum was produced through a grant from the U.S. Department of Education,  
Office of Vocational and Adult Education.

# ACKNOWLEDGEMENTS

The Adult Learning Resource Center wishes to thank the following institutions and individuals for their invaluable contributions to this project:

## GRANT PARTNERS

Governor's Office on Literacy

Illinois State Library/Secretary of State Literacy Office

YWCA of Elgin, Elgin, Illinois

Township High School District 214 Community Education, Arlington Heights, Illinois

Waubonsee Community College, Aurora, Illinois

## WORKING GROUP MEMBERS

Sarah Watson, Governor's Office on Literacy

Cyndy Colletti and Myra Johnson, Illinois Secretary of State Literacy Office

Andrea Fiebig, YWCA of Elgin

Rhonda Serafin, Township High School District 214 Community Education

Daniel Corr and Katharine Grimes, Waubonsee Community College

Sue Barauski and Laura Bercovitz, Adult Learning Resource Center

## PROJECT INSTRUCTORS

Heide Bieser

Deena Borchers

Dawn Brill

Carol Brickley

Ewa Crowe

Marilyn Danegger

Linda Dolan

Susan Dunat

Rocio Fisher

Kathleen Garza

Ronald Katz

Susan Manning

Niurka Mastrapa

Inge Naumann

Lisa Riedl

Nayhibe Reidy

Maureen Ruddy

Maria Silva

Lisa Soron

Susan Thompson

Sarah Tibbott

Jeanne Williams

## PROJECT EVALUATORS

Margo Gottlieb, Illinois Resource Center

Elizabeth Minicz, William Rainey Harper College

*This curriculum is dedicated  
to the memory of  
our colleague and friend,  
Linda Dolan*

COMMUNITY CONNECTIONS:  
EDUCATION FOR INVOLVED COMMUNITIES

◆◆◆ TABLE OF CONTENTS ◆◆◆

	<u>Page</u>
◆ INTRODUCTION	
Project Background .....	v
Curriculum Components.....	vii
Selecting & Customizing Curriculum Activities.....	ix
Learner Outcomes .....	xii
◆ TEACHING TECHNIQUES	
Introduction .....	xiv
Using Pictures for Vocabulary Development .....	xv
Using Pictures for Language Experience.....	xvii
Teaching the Reading Passages.....	xviii
Teaching Dialogues and Role Plays .....	xx
Experiential Activities .....	xxii
Planning Successful Field Trips .....	xxiii
Making the Most of Guest Speakers .....	xxiv
◆ REPRODUCIBLE MODULES	
Module 1: The Democratic Process.....	1
Module 2: Community & Home Safety.....	54
Module 3: The Public Library.....	103
Module 4: The U.S. School System.....	142
Module 5: Public Health Services .....	197
Module 6: Housing .....	241

## PROJECT BACKGROUND

The *Community Connections: Education for Involved Communities* curriculum was developed and field-tested over a two-and-a-half-year period year through a project funded by the U.S. Department of Education, Office of Vocational and Adult Education. The overall goal of the project was:

to build Illinois' capacity to increase statewide the number and quality of English Literacy/Civics Education (EL/CE) programs through the development of innovative, pilot-tested EL/CE programs, related curricula and materials.

For the purpose of this project, the following definitions of English Literacy and Civics Education were adopted:

*English Literacy* programs are English as a second language (ESL) programs providing instruction in listening, speaking, reading, and writing English with instruction appropriate to the adults' English skill levels.

*Civics Education* helps adults enhance their roles as active and informed parents, workers, neighbors, and community participants by assisting them to understand the rights and responsibilities of citizenship, U.S. history and government, the naturalization process, and community participation. This includes being able to successfully access community resources and services (e.g., governmental, educational, workplace-related) as well as contributing back to and positively impacting on the community.

The *Community Connections* project had five objectives:

1. Develop Statewide Partnerships: The Adult Learning Resource Center established a State Advisory Council made up of representatives from governmental, educational, and community service providers. The Advisory Council gave initial input into module content and assisted with marketing and dissemination of the final product.
2. Enhance Local Community Partnerships: The three adult education pilot sites (see #3, below) worked to develop partnerships with social service providers, local libraries, governmental offices, and others in the communities they serve. These community partners provided input into the curriculum content and served as resources for experiential learning activities planned by the field-test classes.
3. Develop and Pilot Innovative, Replicable EL/CE Programs: The *Community Connections* curriculum was piloted in three adult education programs:
  - Waubonsee Community College is located in suburban/semi-rural Aurora, Illinois and serves many Hispanic ESL learners. Its pilot classrooms were in community-based locations such as churches and elementary schools rather than at the college's main campus.

- Consolidated High School District 214 Community Education serves the suburban community of Arlington Heights, Illinois as well as several surrounding suburbs. Its pilot classrooms were at its main campus site as well as community-based sites. The ESL learners served at this program come from many different language groups.
- The YWCA of Elgin, Illinois is a community-based organization that serves ESL learners from a variety of language backgrounds in a fairly urban setting.

Each of the field-test sites integrated the *Community Connections* curriculum into their regular ESL curriculum at all levels of instruction.

4. Develop and Field-Test EL/CE Curricula: As the curriculum modules were developed, they were field-tested by over 20 instructors in the pilot classrooms. The instructors met regularly with project staff to provide feedback on all aspects of the curriculum, including the illustrations and the experiential learning activities. The curriculum was revised extensively to incorporate the suggestions and experiences of the instructors and their students.
5. Provide Professional Development to Support New EL/CE Programs: The Adult Learning Resource Center provided training and support to the field-test instructors throughout the project. Instructors received ongoing training in methodology appropriate for teaching civics as well as a detailed orientation to the project and the curriculum.

In addition to training the pilot instructors through the *Community Connections* project, the Adult Learning Resource Center has provided numerous EL/CE professional development opportunities to adult educators in Illinois and other states. For more information about training opportunities, contact:

Sue Barauski, Director  
Adult Learning Resource Center  
1855 Mt. Prospect Road  
Des Plaines, IL 60018  
sbarauski@thecenterweb.org  
www.thecenterweb.org



# CURRICULUM COMPONENTS

The *Community Connections* curriculum has three components:

- I. SIX REPRODUCIBLE INSTRUCTIONAL MODULES
- II. CLASSROOM PICTURE SET
- III. FLASHCARD PICTURE SET

## I. SIX REPRODUCIBLE INSTRUCTIONAL MODULES

The curriculum contains six modules for classroom instruction. These modules can be used in stand-alone EL/CE classes or integrated into existing ESL curricula at all levels of instruction. Below are the six modules and the learning goals for each:

### MODULE 1: THE DEMOCRATIC PROCESS

1. Define voting.
2. Explain the importance of voting.
3. List the requirements for voting in the United States.
4. Identify the titles of executive leaders of national, state, and local government.
5. Identify the legislative leaders of national, state, and local government.
6. Explain the roles of the school board and the county board.
7. Participate in the decision-making process in their communities.

### MODULE 2: COMMUNITY & HOME SAFETY

1. Call 911 (or other police/fire emergency telephone numbers) to report an emergency.
2. Distinguish between emergency and non-emergency situations.
3. State the laws regarding safe transportation of themselves and their children (e.g., proper use of restraints) in motor vehicles.
4. Develop an emergency escape plan for their house or apartment.
5. Identify safety education programs available in their community for adults and children.
6. Prepare a list of emergency telephone numbers for their community.
7. Participate in community outreach programs to enhance personal and community safety.

### MODULE 3: THE PUBLIC LIBRARY

1. Locate the public library in their community.
2. Complete an application for a library card.
3. Describe the materials and services that the public library provides.
4. Ask for assistance in the library.
5. Find library materials of interest to them to check out or use in the library.

**MODULE 4: THE U.S. SCHOOL SYSTEM**

1. Identify how schools are organized in the United States school system (i.e., from preschool through college).
2. Identify the organization of grades and schools within their local school district.
3. Identify the approximate ages of children who attend the schools within their district.
4. Describe the similarities and differences between the United States school system and the school systems of their native countries.
5. Explain the organization of their local school district and school board.
6. Identify ways in which parents and other adults can participate in schools.

**MODULE 5: PUBLIC HEALTH SERVICES**

1. Explain the differences between private and public health care.
2. Locate public and private health care providers in their community.
3. Identify community resources for wellness programs (including prenatal care, immunizations, and screenings) and crisis services (including domestic violence, child abuse, and substance abuse).
4. Check eligibility requirements for public health care services.
5. Make an appointment for health care services.
6. Complete a patient information/medical history form.

**MODULE 6: HOUSING**

1. Identify the rights and responsibilities of landlords and tenants.
2. Contact their landlords or property associations regarding housing problems.
3. Report a problem with utility service or billing.
4. Obtain information about utility payment plans.
5. Locate resources for building permits or property tax questions.
6. Check a contractor's or solicitor's references or report a complaint against them.

**II. CLASSROOM PICTURE SET**

Each module contains numerous pictures to illustrate relevant concepts and vocabulary. The *Classroom Picture Set* consists of each picture in the curriculum enlarged on heavy cardstock for use in the classroom. Ideas for using the *Classroom Picture Set* are found in "Using Pictures for Vocabulary Development" and "Using Pictures for Language Experience" beginning on page xv.

**III. FLASHCARD PICTURE SET**

The *Flashcard Picture Set* consists of each picture (and its accompanying vocabulary word or phrase) from the curriculum reduced to flashcard size on heavy cardstock. Ideas for using the *Flashcard Picture Set* are found in "Using Pictures for Vocabulary Development" beginning on page xv.

## SELECTING & CUSTOMIZING CURRICULUM ACTIVITIES

The *Community Connections* curriculum contains a wide selection of reproducible classroom activities for EL/CE. Not all of the materials will be appropriate for all learners. Instructors should select only those activities that meet the needs and language levels of their students. The modules do not increase in difficulty and can be used in any order.

The curriculum was field-tested on a wide variety of ESL learners in different classroom settings. It was used successfully with beginning-level learners who lack literacy skills in any language as well as with advanced ESL learners. Adults ranging in age from late teens to early 80's used the curriculum materials with equal success. It was used successfully with new immigrants as well as those who have lived in the U.S. for many years.

The activities found in the curriculum modules are:

- PICTURES FOR VOCABULARY DEVELOPMENT
- PICTURES FOR LANGUAGE EXPERIENCE AND GROUP STORY WRITING
- READING PASSAGES  
(including pre-reading, vocabulary, and comprehension activities)
- DIALOGUES AND ROLE PLAYS
- ACTION RESEARCH ACTIVITIES
- WRITING ACTIVITIES
- HOME ACTIVITIES
- PAIR ACTIVITIES
- CULTURAL COMPARISON ACTIVITIES
- EXPERIENTIAL ACTIVITIES

The curriculum can be thought of as a “menu” from which instructors select activities and materials appropriate for their classes. Each module contains activities at a variety of language levels. The guide below will assist instructors with selecting curriculum activities appropriate for beginning language levels (the left side of the chart) and intermediate/advanced language levels (the right side of the chart).

<p style="text-align: center;"><b>EDUCATIONAL FUNCTIONING LEVELS*</b></p> <p style="text-align: center;">Beginning ESL Literacy Beginning ESL Low Intermediate ESL</p>	<p style="text-align: center;"><b>EDUCATIONAL FUNCTIONING LEVELS</b></p> <p style="text-align: center;">Low Intermediate ESL High Intermediate ESL Low Advanced ESL High Advanced ESL</p>
<ul style="list-style-type: none"> <li>• PICTURES FOR VOCABULARY DEVELOPMENT</li> <li>• PICTURES FOR LANGUAGE EXPERIENCE</li> <li>• DIALOGUES</li> <li>• ACTION RESEARCH ACTIVITIES</li> <li>• WRITING ACTIVITIES</li> <li>• HOME ACTIVITIES</li> <li>• PAIR ACTIVITIES</li> <li>• CULTURAL COMPARISON ACTIVITIES <i>(orally, native language only)</i></li> <li>• EXPERIENTIAL ACTIVITIES</li> </ul>	<ul style="list-style-type: none"> <li>• PICTURES FOR VOCABULARY DEVELOPMENT</li> <li>• PICTURES FOR GROUP STORY WRITING</li> <li>• READING PASSAGES</li> <li>• DIALOGUES/ROLE PLAYING</li> <li>• ACTION RESEARCH ACTIVITIES</li> <li>• WRITING ACTIVITIES</li> <li>• HOME ACTIVITIES</li> <li>• PAIR ACTIVITIES</li> <li>• CULTURAL COMPARISON ACTIVITIES <i>(orally or written)</i></li> <li>• EXPERIENTIAL ACTIVITIES</li> </ul>

\* Educational Functioning Levels are from the National Reporting System for Adult Education (NRS). See [www.nrsweb.org](http://www.nrsweb.org).

## CUSTOMIZING CURRICULUM CONTENT

Although the *Community Connections* curriculum was developed for use in Illinois, instructors will occasionally need to customize the content of the reading passages and related vocabulary to reflect the community in which it is taught. For example, in Module 1 the word “sanitation” is used. However, the terms “waste management” or “garbage service” may be more widely used in particular communities. In cases where particular vocabulary items found in the modules are not those used in the learners’ community, instructors will need to make changes in the reading passage and vocabulary activities before duplicating the module pages for classroom use.

Realia (authentic materials) from the community should also be customized whenever possible. For example, there is a sample library card application in Module 3, *The Public Library*. However, instructors should obtain an *actual* application from their students’ local library for use in class. The “Teacher Notes” for each module include a list of “Possible Authentic Materials” from the community that can be incorporated into instruction.

## ADDITIONAL TOPICS FOR EL/CE

The six modules of the *Community Connections* curriculum are not intended to cover all areas of EL/CE. In working with their students, EL/CE teachers will no doubt discover other important topics, or additional aspects of the topics addressed in the six modules, that are relevant to their students’ lives. These topics may include:

- Employment issues, including worker rights
- Volunteering in the community
- Family issues, including parenting skills or caring for the elderly
- Opportunities for recreation including park district programs and local cultural events

Instructors are encouraged to develop their own materials (including experiential learning activities) to address additional EL/CE areas.

# LEARNER OUTCOMES

A unique aspect of the *Community Connections* curriculum is its emphasis on experiential learning activities that help adult ESL learners bridge the gap between the ESL classroom and their communities. Through field trips, guest speaker presentations, and other experiential activities, students are encouraged to become more active, engaged community members.

Students in the pilot classes reported exciting accomplishments and changes in their lives resulting from information learned through the *Community Connections* curriculum activities, including experiential activities. The instructors collected and documented many of these accomplishments and changes in students' lives. Here are a few examples related to particular modules:

## MODULE 1: THE DEMOCRATIC PROCESS

- Registered to vote and voted for the first time.
- Voted absentee in the presidential election.
- Wrote letters to Illinois legislators requesting a budget increase for adult education. An increase was approved in a fiscal year when many other education dollars were cut.
- Wrote letters to the governor's office requesting a copy of the Illinois "Blue Book," a directory of public officials.
- Brought a local library referendum flyer to class to discuss and share.

## MODULE 2: COMMUNITY & HOME SAFETY

- Planned and practiced emergency escape routes with their families.
- Called the local village hall to find out if there was a Neighborhood Watch program.
- Called 911 when a family member needed emergency help.
- Reported a crime to the police (after meeting a police officer in class).
- Installed home security lights.
- Obtained car seats for their children.
- Called police station to find out what to do/whom to call when carbon monoxide detector beeped.
- Took a CPR class and became certified after seeing a CPR demonstration in class.
- Purchased a smoke alarm for the first time.
- Put a sticker from the fire department in child's bedroom window.

## MODULE 3: THE PUBLIC LIBRARY

- Got a library card and checked out materials.
- Used the Internet to find out the local library hours and services.
- Became a volunteer at the local library.
- Asked a school counselor to find out how to get a library card. (Students lived outside the library service area and could not get free cards.)
- Visited a library for the first time after living in the U.S. for 20 years.
- Registered for a computer ESL program at the library.

**MODULE 4: THE U.S. SCHOOL SYSTEM**

- Attended parent-teacher conferences at child's school.
- Volunteered at child's school.
- Went on a school field trip with child's class.
- Joined the PTA at child's school.
- Requested a copy of son's screening from school principal's office.
- Started a savings plan to save money for college courses.
- Visited the school district office to discuss the availability of gifted services for her child after district was rezoned.
- Applied for a job as a translator with the school district office.
- Shared information on parent-teacher conferences with language-minority friends.
- Wrote a note to child's teacher.
- Set up a meeting with child's teacher to discuss the family's plans to be away for three weeks.

**MODULE 5: PUBLIC HEALTH SERVICES**

- Contacted the township health office to get information on eligibility for a county health insurance program for workers without health insurance.
- Took a pregnant friend to the county health department for pre-natal care and applied for Women, Infants, and Children (WIC) benefits.
- Went for check-ups to a physician, dentist, and eye doctor for the first time. Had dental work done, got contact lenses, and was put on medication for high blood pressure.
- Made a doctor's appointment in English for the first time.
- Called the health department about free immunizations.
- Cut down on salt intake after a dietician's presentation in class.
- Found a yoga class in the community and began attending.

**MODULE 6: HOUSING**

- Contacted the landlord about a leaking toilet.
- Shared information with classmates about free trees available for planting in their neighborhood.
- Began speaking to neighbors and eventually was asked to watch the neighbors' house while they were on vacation. (Before civics classes, this student had never spoken to her American neighbors.)
- Asked landlord for a written lease.
- Discussed a bill for repairs with landlord to determine which charges were actually normal "wear and tear" that shouldn't have been billed to the tenant.
- Called customer service to complain about being disconnected while using a calling card, and received 30 free minutes.
- Went to the village hall to get a building permit.
- Had gas bill converted to the budget payment plan.

# TEACHING TECHNIQUES

This section contains ideas for implementing the following teaching techniques:

- I. USING PICTURES FOR VOCABULARY DEVELOPMENT
- II. USING PICTURES FOR LANGUAGE EXPERIENCE
- III. TEACHING THE READING PASSAGES
- IV. TEACHING DIALOGUES AND ROLE PLAYS
- V. EXPERIENTIAL ACTIVITIES
  - PLANNING SUCCESSFUL FIELD TRIPS
  - MAKING THE MOST OF GUEST SPEAKERS

The ideas presented in this section are suggestions gathered in part from the experiences of instructors and adult learners using the *Community Connections* curriculum materials. Instructors should feel free to adapt the suggestions that follow to their own particular teaching situations.



## I. USING PICTURES FOR VOCABULARY DEVELOPMENT

The *Community Connections* curriculum contains over 200 pictures. Pictures are invaluable tools for helping language teachers convey ideas, teach vocabulary, and generate discussion at all levels of instruction.

Most of the pictures in the modules correspond to words or phrases in the reading passages. For intermediate to advanced students, the pictures can be used to develop vocabulary before or after students read the passages. For beginning students, the pictures can be used in place of the reading passages.

There are many ways to use pictures for vocabulary development--the development of both oral skills and sight reading skills. Following are some suggestions for using pictures in your classes. When teaching beginning students, it is a good practice to begin by presenting the pictures using the method described in *A* below and following up with a variety of practice activities such as those described in *B* through *E*. Feel free to invent your own ways of using pictures.

### A) Introducing New Vocabulary Using Pictures

Using the large pictures from the *Classroom Picture Set*, say the new words/phrases one by one, repeating several times, as you point to the corresponding pictures. Ask comprehension questions as necessary to ensure that students understand the meaning of the words or phrases. Continue with listening comprehension practice, below.

### B) Listening Comprehension Practice

*This teacher-directed activity practices vocabulary that has already been introduced.*

Say the new words/phrases one by one as students point to the corresponding pictures on their papers. When students demonstrate good comprehension, have them practice saying the new words/phrases aloud.

### C) TPR Activities Using the Blackboard

*These teacher-directed activities practice vocabulary that has already been introduced.*

Tape the large pictures from the *Classroom Picture Set* to the board or wall. Have students walk to the board and identify the pictures you name. For additional oral practice, have various students take the role of teacher by naming the pictures for their classmates to identify.

For sight word/TPR practice, pass out flashcards with the words written on them. After you name a picture, the student who has that word walks to the board and puts the sight word on the chalk tray below the appropriate picture.

### D) Flashcard Activities

*These student-directed activities practice vocabulary that has already been introduced.*

The flashcards in the *Flashcard Picture Set* can be used in two ways:

- 1) the pictures and their corresponding words/phrases can be cut apart so that there are separate flashcards for the pictures and the words, or
- 2) the flashcards can be folded and glued together so that there are pictures on one side of the flashcards and the corresponding words/phrases on the other side.

Pairs of students can engage in a variety of practice activities such as matching words with pictures, quizzing each other, or writing sentences about the pictures.

Small groups of students will enjoy playing “Concentration” with the flashcards. In this matching game, the picture cards and their corresponding words/phrases are placed face down on a table. Students take turns turning over two cards, looking for a match of a picture and its corresponding word/phrase. If a student finds a match, he or she keeps those cards and takes another turn. The game is over when all the cards have been matched up, and the student with the most cards is the winner.

**E) Whole Class Match-Up**

*This student-directed activity practices vocabulary that has already been introduced.*

Using the *Flashcard Picture Set*, cut apart the words/phrases from their pictures. Pass out one word/phrase OR one picture to each student. Have the students circulate, using oral language to find their match. Do not allow students to show their pictures or words to each other. (Hint: In classes with mixed literacy abilities, give nonliterate students pictures and literate students words.)

## II. USING PICTURES FOR LANGUAGE EXPERIENCE

The Language Experience Approach (LEA) is appropriate for students with limited literacy skills in the first language. LEA stories are brief passages made up by the learners themselves and transcribed by the teacher. The students then use their familiarity with the content as an aid to reading.

LEA stories are based upon class discussion. The stories may be prompted by the learners' own experiences or by a picture or a series of pictures. Each module in the *Community Connections* curriculum has an LEA story that is told through a series of pictures. Students will often draw on their own experiences when interpreting the pictures.

In addition to using the LEA pictures in the curriculum, teachers can also draw their own pictures or use pictures from current events or class field trips to generate LEA stories.

Here is one way to help students compose LEA stories:

1. Select an LEA picture series from the curriculum (or from another source) that has relevance to your students' lives. Discuss the pictures with the class, prompting with questions such as, *Who are these people? What is happening? How do the people feel? Has this ever happened to you?*
2. Have the learners dictate the story to you as you write the story on the board. Use questions as necessary to prompt the dictation.
3. Transcribe the learners' words exactly; don't worry about correcting grammatical mistakes.
4. Read the story to the class. Make any changes the learners want.
5. Read the story with the class. Point to each word as you read it. Help the class read the story.
6. Follow up with a variety of literacy development activities geared to each learner's literacy level. Some ideas are:
  - Make flash cards of selected vocabulary. (Select 5-10 vocabulary words per story.) Have the students match the vocabulary words on flashcards to words in the story on the board.
  - Have students copy the story, or provide them with a copy. Then have them circle the vocabulary words on their copy of the story.
  - Prepare cloze exercises (in a cloze exercise, the story is written with blanks left for selected vocabulary items). Provide a word bank of vocabulary items for those students who need it.
  - To practice sequencing skills, have the learners sequence pictures that have been cut apart (use the "Pictures for Group Story Writing" without the numbers). Write the story on sentence strips and have the learners put the sentence strips in order. Students can then match the sentences to the appropriate picture.
  - Cut the sentence strips in half and have the students match the beginnings and endings of sentences.

### III. TEACHING THE READING PASSAGES

Each instructional unit in the *Community Connections* curriculum includes one or two reading passages. These reading passages serve two purposes: 1) they provide the instructor with the content information that is to be taught, and 2) they provide low intermediate (and above) learners with the opportunity to increase their reading skills in English while learning about civic participation in the United States.

It is important to note that nonliterate learners (“non-readers”) or beginning-level students will not be able to use the reading passages. Instructors of students at these levels should rely instead upon the pictures (for vocabulary development, language experience, and group stories) included in each unit to convey content information.

#### A NOTE ON THE LENGTH OF THE READING PASSAGES

Most of the reading passages in the curriculum are two pages long; some are a bit shorter and some are a bit longer. Teachers may find it useful to teach the reading passages in two parts, at two separate class meetings, depending on the level of the class. To facilitate teaching the reading passages at two class meetings, the accompanying vocabulary activities are divided into two: Vocabulary Activities 1-A and 1-B correspond to the first part of each reading passage, and Vocabulary Activities 2-A and 2-B correspond to the second part. (One exception is Module 1, which contains two separate reading passages, each with its own vocabulary activities.) The “Teacher Notes” for each module detail exactly where the reading passage may be divided into two parts.

Each reading passage has the following four parts:

1. Pre-Reading Activity
2. Reading Passage
3. Vocabulary Activities
4. Comprehension Check

Here are some suggestions for teaching the reading passages.

#### 1. Pre-Reading Activity

Before having students read a passage, hold a pre-reading class discussion. Each reading passage is preceded by a page of pre-reading questions designed to do three things: engage learners' background knowledge and focus their attention on the topic at hand, elicit/introduce relevant vocabulary, and instill in learners a desire to read. Students can write the answers to the questions before discussing them, if desired. It may be helpful to use pictures from the *Classroom Picture Set* to guide the pre-reading discussion.

#### 2. Reading Passage

After discussing the pre-reading questions, have the students read the passage silently a few times. Encourage them to underline unfamiliar vocabulary. If the students in your class have limited literacy skills, reading the passage aloud to them after they have tried it silently on their own may aid comprehension.

Note, however, that having individual students take turns reading aloud before everyone has tried reading silently is not a recommended procedure. Oral performance in front of the class does not develop reading skills for either the performer or the listeners. Oral performance of a reading passage is a test of English pronunciation skills and does not aid reading comprehension. If students want to read aloud, this should be done after vocabulary and content clarification have taken place.

### 3. Vocabulary Activities

Two sets of vocabulary words and related activities are included in each module. The words and phrases from the passage included in the vocabulary activities are those likely to pose difficulty to low intermediate learners of English. Depending on the level of the learners in your class, it might be necessary to include additional words from the reading passage. These can be written by the students under "Other new words" on the bottom of each vocabulary page.

The pictures in "Pictures for Vocabulary Development" in each module correspond to the words and phrases on the "Vocabulary Activity" pages. These pictures can be of great help in establishing the meaning of new words and concepts. The *Classroom Picture Set* and the *Flashcard Picture Set* may also help convey meaning and provide additional practice with the vocabulary words.

### 4. Comprehension Check

The comprehension check consists of "True-False" statements designed to develop reading skills and to generate class discussion. Learners can work individually or in pairs to complete the "True-False" activities. It is a good practice to encourage learners go back to the reading passage to find the correct answers (when possible) and to correct the false sentences. After this activity has been completed individually or in pairs, the whole class can discuss the answers.

The comprehension check is designed to develop both literal and inferential reading skills. Literal "True-False" statements are those whose answers can be found directly in the text. In the case of inferential statements, however, the answers are not directly found in the text; learners must use critical thinking skills to infer the correct answer.

## IV. TEACHING DIALOGUES AND ROLE PLAYS

The dialogue is a traditional ESL teaching technique. Dialogue practice helps students develop functional listening and speaking skills, as well as vocabulary and pronunciation, in specific real-life contexts.

The dialogues in the *Community Connections* curriculum can be used by all but true beginning (zero level) students. For low-level students, it is important to follow the script exactly and to limit the length of the dialogue. For higher level students, you can be more flexible in adding new information to the dialogue and extending the dialogue as appropriate. Since the dialogues in the curriculum are relatively simple, follow-up discussions with advanced students can focus on grammar, vocabulary, or the function of the exchange.

### HOW TO TEACH A DIALOGUE

Here is one way to teach a dialogue:

#### 1. Set the Scene for the Dialogue

- It is helpful to use pictures and/or to draw stick figures on the board to convey to the students who the speakers are and what the situation is. In many cases pictures from the *Classroom Picture Set* can be used to help establish the context. It may also be helpful to use realia and gestures to help establish meaning.
- After establishing the context of the dialogue, ask the students if they have ever been in a similar situation.

#### 2. Model the Dialogue

- If possible, make a tape of the dialogue with another person before class. (Speak as naturally as possible when making the tape.) Play the tape while the students listen. Point to the picture of each speaker on the board as you play his/her part. This will help students realize who is speaking when.
- If it is not possible to make a tape of the dialogue before class, simply read both parts of the dialogue while the students listen. Point to the picture of each speaker on the board as you read his or her part. Try to be expressive yet natural.
- Play or re-read the dialogue several times. Ask comprehension questions to make sure that students understand the context.

#### 3. Practice the Dialogue

- Have the students repeat each part of the dialogue after you. (Note that the students have not yet seen the written words of the dialogue.)
- Pass out copies of the dialogue, or write it on the board. Play the tape of (or read) the dialogue several times while the students read along silently.  
Note: If the class consists entirely of nonliterate learners, omit this step. If the class has mixed literacy levels (i.e., some students can read and some cannot), do not omit this step; those students who can read will use the written word to help them while those who cannot read will rely on listening skills only.
- Have the whole class recite the dialogue *with* you.
- Take one part of the dialogue; have the whole class take the other part. Practice several times and then reverse roles.

- Divide the class in half. Have each half take one part of the dialogue. Practice several times and then reverse roles.
- Have the students form pairs. While the students practice the dialogue in pairs, circulate around the room to monitor and give help as needed. Have the students reverse roles and continue to practice in pairs while you monitor their progress.

#### 4. Perform the Dialogue

- Ask for volunteers to perform the dialogue for the class.

### EXTENSION ACTIVITIES

#### Substitution Drill

After students are comfortable with the dialogue, have them substitute key words with alternatives. The alternatives can be written on the board or given by you as oral cues.

It is a good practice to have students substitute information that is real to them. For example, if the dialogue is about calling the landlord to report a problem, have them use their landlords' actual names in the dialogue.

#### Role Plays

For intermediate and advanced students, it is good pedagogy to follow dialogue practice with role play practice. Role plays are less structured than dialogues and give the students the opportunity to use the language creatively and to tailor it to their own situations.

Here is one way to do role playing:

1. Have the students work in pairs (or groups of three, if there are three roles in the situation).
2. Assign each partner a role. For example, tell Partner A, "Your son needs immunizations and a check-up before starting kindergarten. Call the immunization clinic to make an appointment." Tell Partner B, "You are the receptionist at the clinic."

Alternatively, you can prepare role cards in advance with the role information written out (see the example on p. 184) and distribute these to the students.

3. Give each pair or group time to prepare their role play. If appropriate, have them write their conversation. (Note: For advanced students, you can omit this step and have them perform their role plays with no preparation time.)
4. Circulate around the room and give assistance to students as necessary while they prepare their role plays.
5. Have each pair or group perform their role play for the class.

## V. EXPERIENTIAL ACTIVITIES

Experiential activities are structured learning activities that help adult language learners bridge the gap between the ESL classroom and their communities. The goal of these activities is to help the students become more active, engaged community members. As such, experiential activities are at the heart of the *Community Connections* curriculum.

There are many kinds of experiential learning activities including:

- Accessing community information by telephone, internet, or mail
- Taking field trips to targeted community locations (see page xxiii)
- Having guest speakers from the community visit the classroom (see page xxiv)

### SELECTING EXPERIENTIAL ACTIVITIES

Each module of the curriculum contains suggestions for numerous experiential activities. You should select or design activities that have relevance to your students' everyday lives and needs. When planning an experiential activity, it is also important to consider these two factors\*:

**Language Level:** What level of ESL ability is necessary to successfully complete the activity?

**Risk:** How much risk-taking is involved? Activities can be low-risk, high risk, or somewhere in between. The more intense and less controllable the contact with unfamiliar people, the higher the element of risk.

For example, using the Internet to access information about a local election requires intermediate-advanced language skills, but it is a *low-risk* activity because it does not involve speaking to unfamiliar people. On the other hand, interviewing a candidate for a local election requires intermediate-advanced language skills but is a *high-risk* activity because the students must interact with someone in the rather uncontrolled context of an interview.

### ORGANIZING EXPERIENTIAL ACTIVITIES

Experiential activities can be organized in a variety of ways including:

- Whole class participating
- Pairs or small groups working together
- Individuals working alone

Select the organization that best suits the needs of your class. For example, if there are mixed language abilities in the class, you may choose to have students work in mixed-ability pairs or small groups. If there are varied interests in the class, students can work individually, in pairs, or in small groups on different topics.

### PLANNING EXPERIENTIAL ACTIVITIES

Effective experiential activities have three phases:

1. In-class preparation: Preparation activities might include discussion, vocabulary development, or practice of questions to be asked during the activity.
2. The activity itself.
3. In-class follow-up: Follow-up activities might include discussion or writing projects based on information learned during the activity.

\*Adapted from *Experiential Language Teaching Techniques, Resource Handbook Number 3, Second Revised Edition* by Michael Jerald and Raymond C. Clark. © 1994 Pro Lingua Associates, Brattleboro, VT [www.prolinguaassociates.com](http://www.prolinguaassociates.com)



## PLANNING EFFECTIVE FIELD TRIPS

Field trips are an ideal way to help bridge the classroom and the community. There are many ideas for field trips in the “Experiential Activities” section of each *Community Connections* module. Depending upon the resources available in your community and on your students’ needs and interests, you will no doubt think of additional places to visit.

If field trips are to be effective, careful planning is essential. Below are some ideas for planning effective field trips.

1. **Plan the Trip**
  - Choose a destination that expands on current lesson work and that the students are interested in.
  - If possible, visit the destination without the class a week or two before the field trip. During this visit, you can identify what concepts and language students will need to benefit most from their visit.
  - Together with the class, decide on the date, time, and transportation.
  
2. **Prepare the Students**
  - Introduce relevant vocabulary and concepts as necessary.
  - Brainstorm and practice possible questions to ask the field trip guide, if applicable.
  - If students will be interacting with people at the field trip site, practice relevant dialogues and role plays.
  
3. **During the Trip**
  - Encourage the students to ask questions of the guide.
  - Assist students with communication as necessary.
  - If possible, take pictures (or have students take pictures) for use after the field trip.
  - Take notes for follow-up activities.
  
4. **After the Trip**
  - Debrief through discussion (same day as trip if possible).
  - Use photos that were taken on the trip to generate discussion and writing activities.
  - Have students write thank you notes as appropriate.

## MAKING THE MOST OF GUEST SPEAKERS

In cases where it is difficult to take a group of students on a field trip, it may be possible to invite a member of the community to come to the class. Many of the experiential activities in this curriculum involve bringing the community into the classroom by inviting members from the community to serve as guest speakers.

Advanced planning is necessary for effective guest speaker presentations. Below are some ideas for making the most of guest speakers.

### 1. Prepare the Speaker

It is essential to prepare the speaker before he or she arrives in the classroom. Ideally, a potential speaker should observe the class a week or two before the scheduled presentation. In this way, speakers who are unfamiliar with adult ESL students will be able to get a sense of the students' language level and the way you communicate with the class. When such a visit is not possible, plan to have a meeting with the speaker (either in person or by telephone) to cover the following points:

- Inform the speaker about the language level of the class.
- Encourage the speaker to use visual aids such as posters, diagrams, slides, or handouts to help convey meaning during the presentation.
- Encourage the speaker to avoid a traditional lecture format and instead give a short presentation followed by time for questions.
- Inform the speaker that you might need to intervene during the presentation or question/answer session if students are having difficulty understanding.

### 2. Prepare the Students

- Introduce relevant vocabulary and concepts as necessary.
- Brainstorm possible questions to ask the guest speaker.
- Practice asking the questions through role play (you can take the role of the guest speaker).
- Practice the language functions of asking questions (e.g., *Could you tell me... Would you happen to know...*) and thanking the speaker.

### 3. Speaker Visits the Classroom

- Introduce the speaker to the class.
- During both the brief formal presentation and the question/answer session that follows, intervene as necessary if students are having difficulty understanding.
- Takes notes for follow-up activities.

### 4. Follow Up

- Debrief through discussion (same day of visit if possible).
- Have students answer (orally or in writing) the questions that they prepared.
- Have students write thank you notes to the guest speaker.

## MODULE 1

# ◆◆◆ THE DEMOCRATIC PROCESS ◆◆◆

## COMPONENTS

	Page
◆ TEACHER NOTES .....	2
◆ <u>SECTION I: VOTING</u>	
◆ PICTURES	
• Pictures for Vocabulary Development .....	5
◆ READING PASSAGE 1	
• Pre-Reading Activity .....	13
• Reading Passage .....	14
• Vocabulary Activity 1-A.....	16
• Vocabulary Activity 1-B.....	17
• Comprehension Check .....	18
◆ <u>SECTION II: PARTICIPATING IN STATE &amp; LOCAL GOVERNMENT</u>	
◆ PICTURES	
• Pictures for Vocabulary Development .....	19
• Pictures for Language Experience .....	31
• Pictures for Group Story Writing .....	36
◆ READING PASSAGE 2	
• Pre-Reading Activity .....	38
• Reading Passage .....	39
• Vocabulary Activity 2-A.....	41
• Vocabulary Activity 2-B.....	42
• Comprehension Check .....	43
◆ EXTENSION ACTIVITIES	
• Dialogue 1: <i>Calling for Alderman's Office Hours</i> .....	44
• Dialogue 2: <i>Calling About a School Board Meeting</i> .....	45
• Dialogue 3: <i>Calling Your Senator</i> .....	46
• Dialogue 4: <i>Calling City Hall</i> .....	47
• Action Research Activity: <i>Elected Leaders Chart</i> .....	48
• Writing Activity: <i>Contacting Your Local Officials</i> .....	49
• Pair Activity: <i>Understanding State &amp; Local Government</i> .....	50
• Cultural Comparison Activity: <i>The Democratic Process</i> .....	51
◆ EXPERIENTIAL ACTIVITIES.....	52

## TEACHER NOTES

Beginning with the democratic process, Module I sets the stage for civic involvement. Some students may be familiar with the experience of voting in their native countries; for others, electing government leaders may be a new concept.

Begin the module with an actual voting experience. Choose something that the class would be interested in, for example, the time or length of the coffee break. Use this opportunity to illustrate majority rule. Then explore with students the venues in everyday life that use voting to elect leaders and make decisions: school boards, labor unions, organizations, school classes, and so on. Cultural comparisons to the students' native countries in the first Pre-Reading Activity will provide a good frame of reference for understanding when and how leaders are elected, various terms of office, and opportunities for re-election. To enhance comprehension of geographical areas of state and local government, you can use maps to show cities, villages, and counties in your state.

Supplemental information about the voting process and local government can be added at your discretion. If the level of the class and student interest warrant more detail, you may expand on the following:

- Local examples of referenda
- Public hearings (and how they are publicized) vs. regular city council meetings
- Non-partisan elections, such as those for school board positions
- Local exceptions to information about community and county government (e.g., library under jurisdiction of the city instead of the county)
- Voting rights withheld from convicted felons or those legally insane

### COMPETENCIES FOR MODULE 1

Students will learn to:

1. Define voting.
2. Explain the importance of voting.
3. List the requirements for voting in the United States.
4. Identify the titles of executive leaders of national, state, and local government.
5. Identify the legislative leaders of national, state, and local government.
6. Explain the roles of the school board and the county board.
7. Participate in the decision-making process in their communities.

### A NOTE ON THE CONTENT AND MATERIALS OF MODULE 1

Module 1, *The Democratic Process*, is the only module in the *Community Connections* curriculum that is a double module. That is, there are two topics related to the democratic process in the module: 1) Voting and 2) Participating in State & Local Government. Each of these topics has its own set of pictures and its own reading passage (with related vocabulary activities and comprehension check). However, there is only one set of Extension Activities and one set of Experiential Activities for the module.

In order to make this module accessible to students, you may need to familiarize yourself with the structure, responsibilities, and services of your county and local governments (city, village, or township). Sources of information are the local offices, web sites, and newsletters of the county and local governments.

## TEACHER NOTES continued

## POSSIBLE AUTHENTIC MATERIALS

- Local newspapers (some newspapers offer free copies to educational institutions)
- Community newsletters
- Voter registration form
- Sample ballot
- Campaign literature
- Voting machines (available from your local election authority, e.g., the county clerk/county board of elections)
- Videotaped TV campaign ads
- Free handbooks on state government available from state agencies
- Web sites of community and state governments

## RESOURCES\*

Print Materials

*Civic Participation and Community Action Sourcebook*, Andy Nash, ed. (1999). Published by the New England Resource Center, Boston, (617) 482-9485, [www.nelrc.org](http://www.nelrc.org). An intermediate/advanced ESL curriculum containing descriptions of actual community participation projects and activity guides for preparing students for community action.

*Handbook of Illinois Government*. Available from the Office of the Secretary of State, 213 State House, Springfield, IL, 62706, (217) 782-2201 or (312) 814-2975, [www.sos.state.il.us](http://www.sos.state.il.us). A concise guide to Illinois state government and the current elected officials.

*Illinois Blue Book*. Available from the Office of the Secretary of State, 213 State House, Springfield, IL 62706, (217) 782-2201 or (312) 814-2975, [www.sos.state.il.us](http://www.sos.state.il.us). A comprehensive guide to Illinois government, state legislators, state departments, and other statistics and information.

*Key to Government in Chicago and Suburban Cook County*, Alfred Saucedo, ed. (2002). Available from Citizens Information Services of Illinois, (312) 939-4636, [www.cisil.org](http://www.cisil.org). General overview of local government system (county, township, and special districts) and a guide to the election system, voting, and taxes.

*New Citizens Vote! An Educational Curriculum About Voting and Civic Engagement*. Published by the Northern California Citizenship Project, (415) 621-4808 or download off the web at [www.ncg.org/difference/citi\\_curr.html](http://www.ncg.org/difference/citi_curr.html). A curriculum designed to provide new and prospective citizens with tools to become involved in civic and electoral activities.

“Illinois Students Vote” teacher’s packet. Published by the League of Women Voters of Illinois Education Fund, 332 South Michigan, Chicago, IL 60604, (312) 939-5935. A set of reproducible classroom activities focused on the election process. Curriculum outline available at [www.illinoisstudentsvote.org](http://www.illinoisstudentsvote.org).

“Making Your Voice Heard” brochure. Published by the League of Women Voters of Illinois Education Fund, 332 South Michigan, Chicago, IL 60604, (312) 939-5935. Provides information about contacting legislators and public officials. (Also available in Spanish.)

**TEACHER NOTES** continuedWeb Sites

State of Illinois

[www.state.il.us](http://www.state.il.us)

Information about state government and living/working in Illinois.

Project Vote Smart

[www.vote-smart.org](http://www.vote-smart.org)

Information about federal and state government officials and their positions and voting records.

Young Voters Program

[www.youngvoters.org](http://www.youngvoters.org)

Information on candidates and their positions on issues and how to contact legislators.

Your Congress

[www.yourcongress.com](http://www.yourcongress.com)

Information on how Congress works and ways to contact legislators.

Video

*Crossroads Café* (1996). Unit 19, “The People’s Choice,” and Unit 20, “Outside Looking In”. A 26-part video series set in a neighborhood restaurant featuring real-world social and cultural issues. Videos and tape scripts available from Intelecom, (800) 576-2988, [www.intelecom.org](http://www.intelecom.org). Textbooks available from Heinle & Heinle, [www.heinle.com](http://www.heinle.com). Videos may be used independently of textbooks.

\* This list of resources is also located at [www.thecenterweb.org](http://www.thecenterweb.org) (click on “The Adult Learning Resource Center”) where it is updated annually.

PICTURES FOR VOCABULARY DEVELOPMENT

REPRESENTATIVE DEMOCRACY

U.S. Constitution

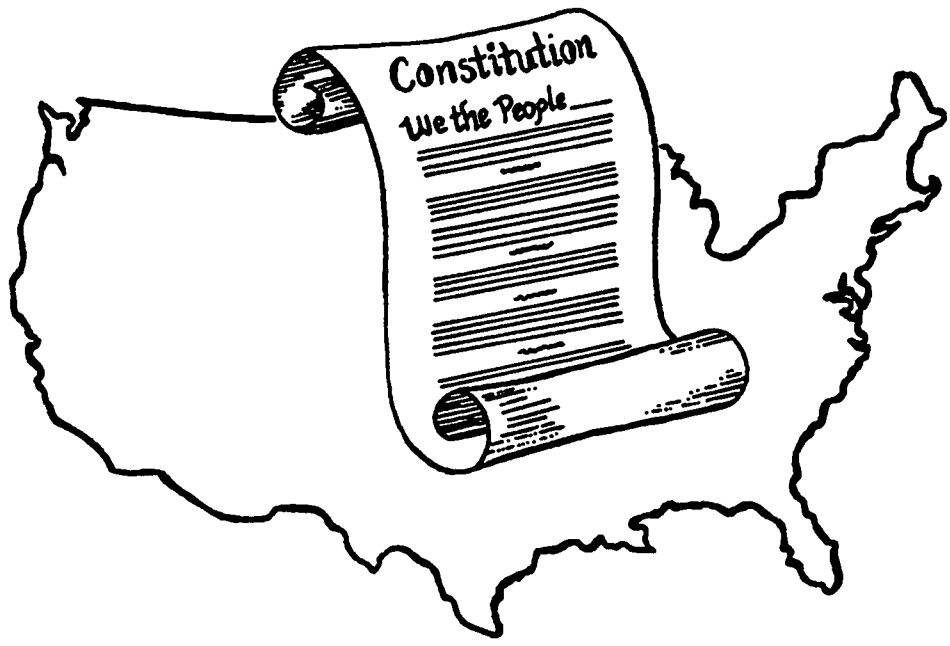

national government

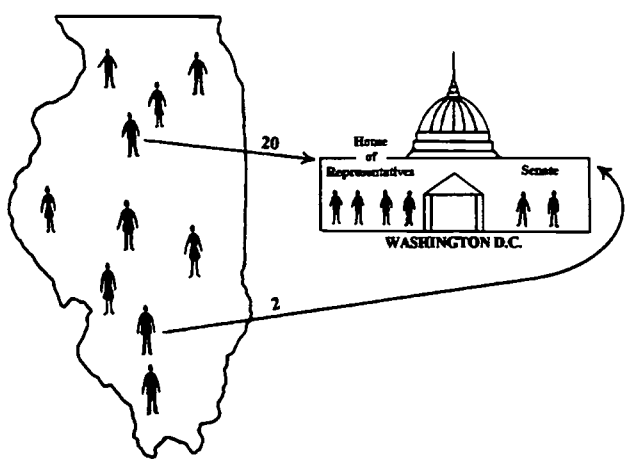

state government

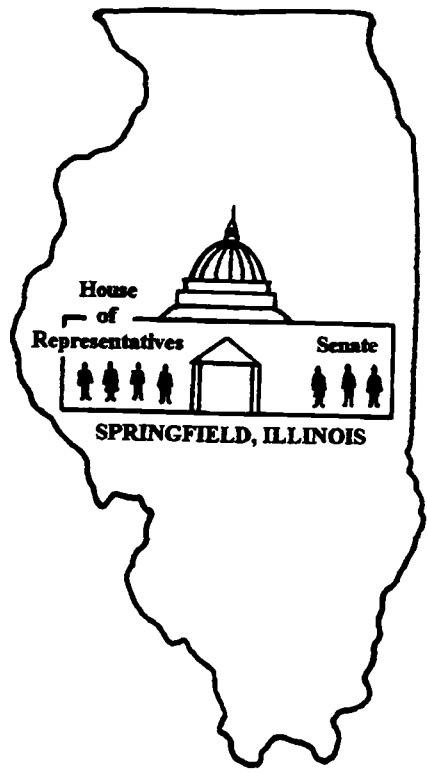

BEST COPY AVAILABLE

PICTURES FOR VOCABULARY DEVELOPMENT continued

President



governor





PICTURES FOR VOCABULARY DEVELOPMENT continued

LEGISLATORS

senator

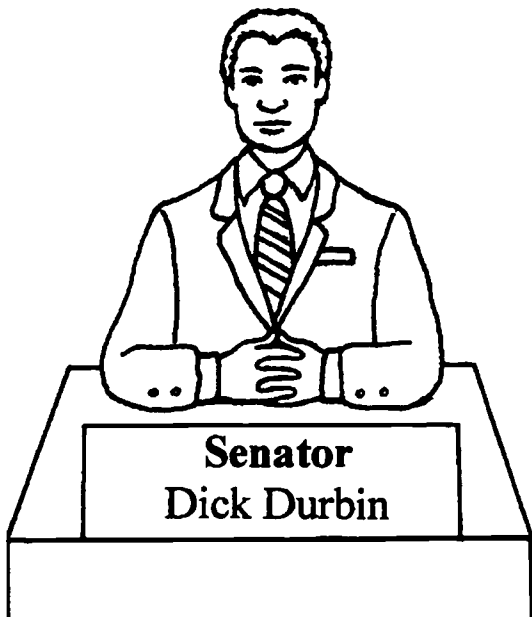

representative



term of office

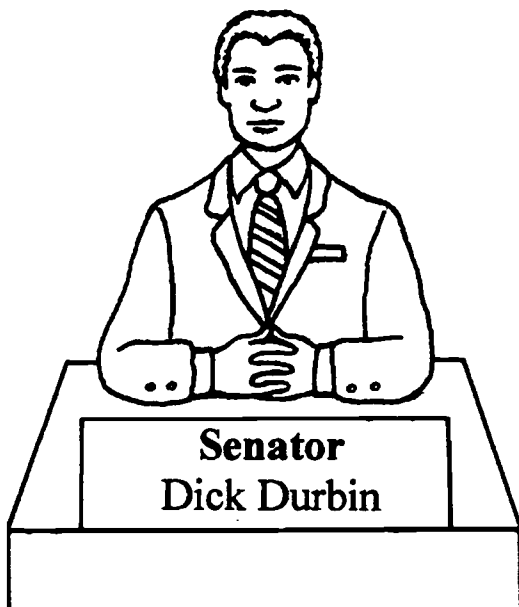

6 YEARS



2 YEARS

PICTURES FOR VOCABULARY DEVELOPMENT continued

POLITICAL PARTIES

Democrat



Republican

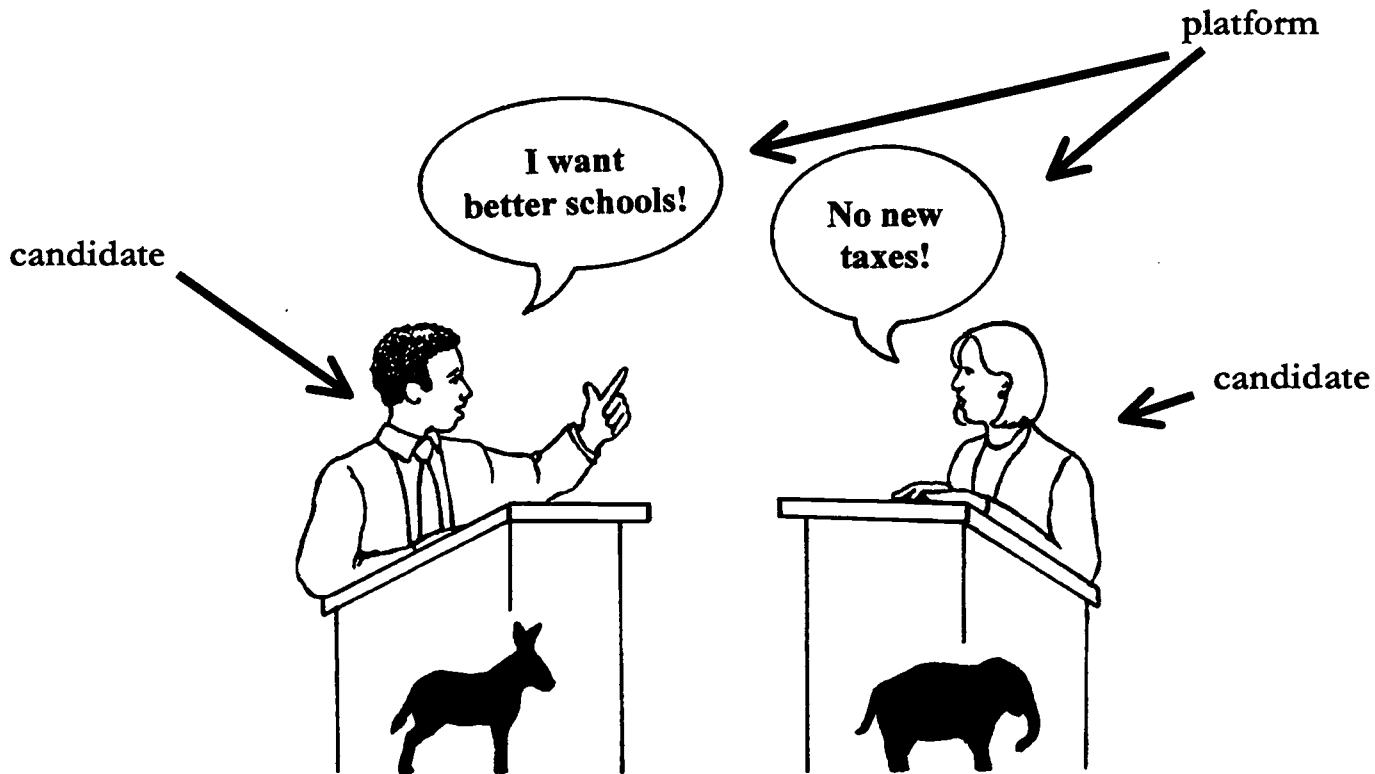

PICTURES FOR VOCABULARY DEVELOPMENT continued

campaign



election/voting



ballot

BALLOT	Punch One
CANDIDATES	
Julia Cuomo	●
Tom Burns	●
Martin Adamski	●
Sheila Rubin	●
Fred Smith	●

majority

BALLOT	
CANDIDATES	
Julia Cuomo	12%
Tom Burns	63%
Martin Adamski	5%
Sheila Rubin	15%
Fred Smith	5%

PICTURES FOR VOCABULARY DEVELOPMENT continued

issues

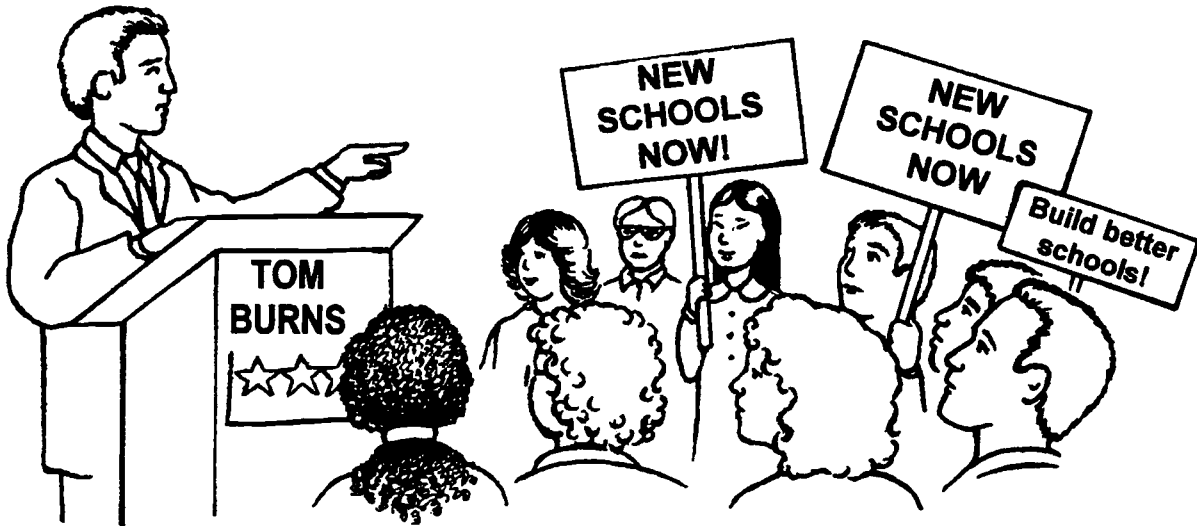

referendum

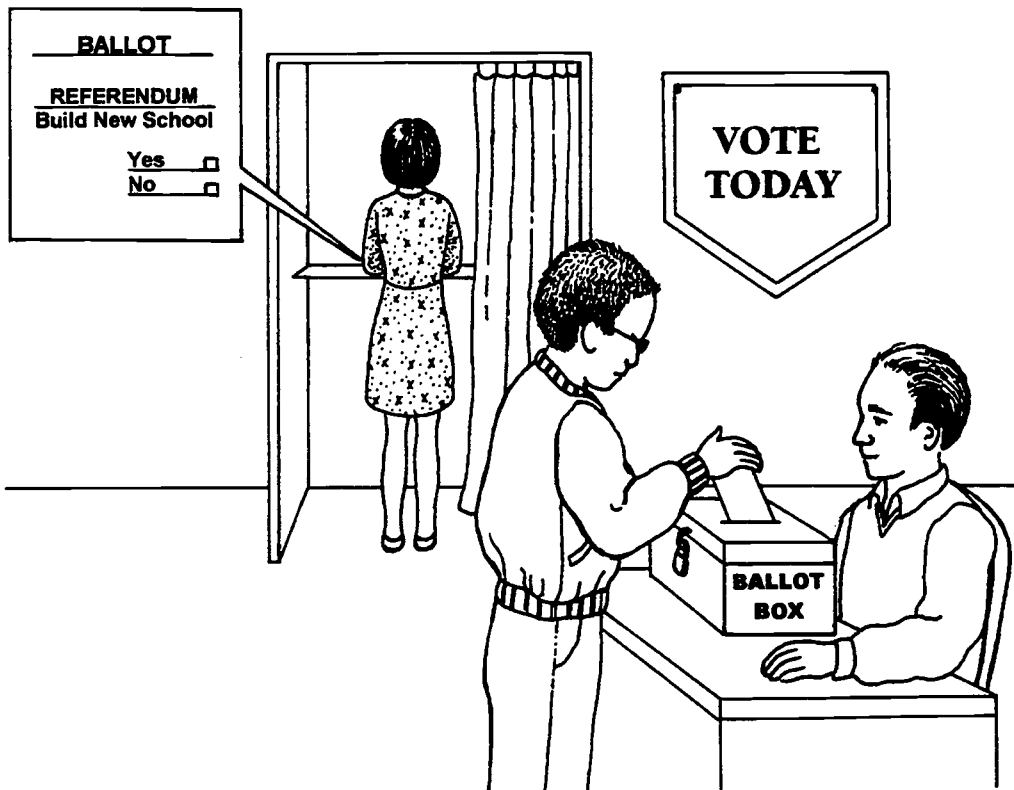

PICTURES FOR VOCABULARY DEVELOPMENT continued

citizen



registered

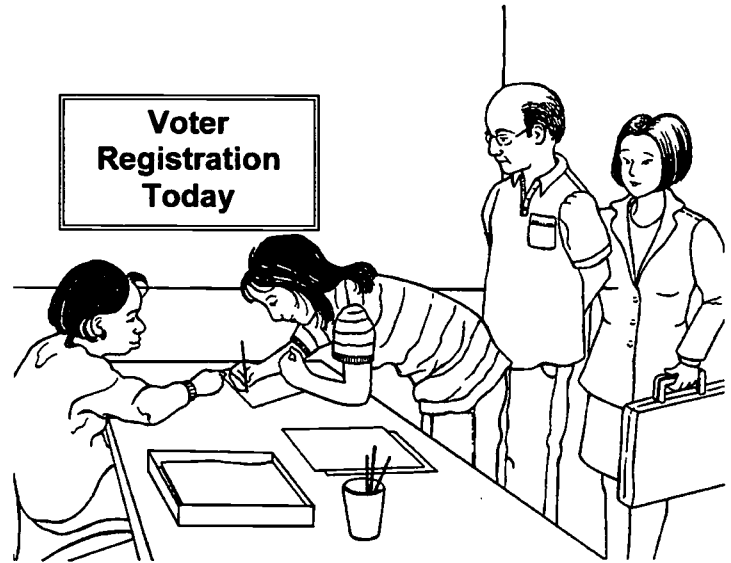

polling place

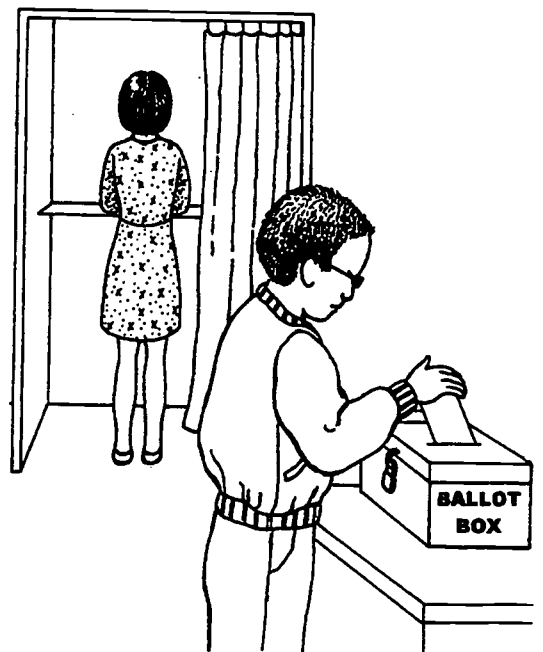
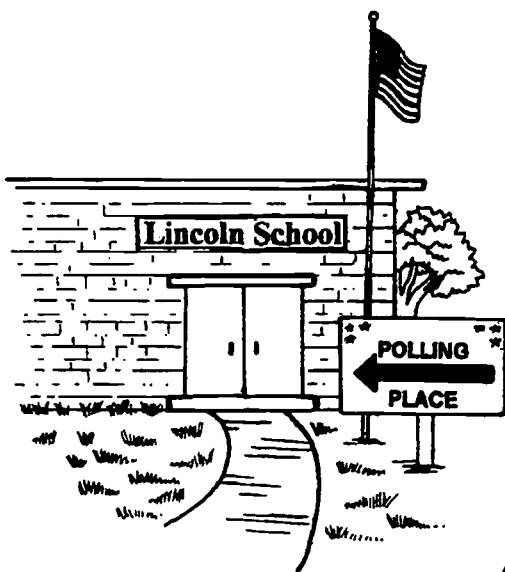

PICTURES FOR VOCABULARY DEVELOPMENT continued

VOTING REQUIREMENTS IN THE UNITED STATES

You must:

be a U. S. citizen

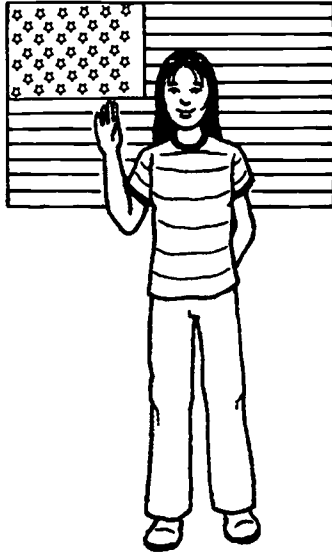

be at least 18 years old



live in your state for a certain amount of time

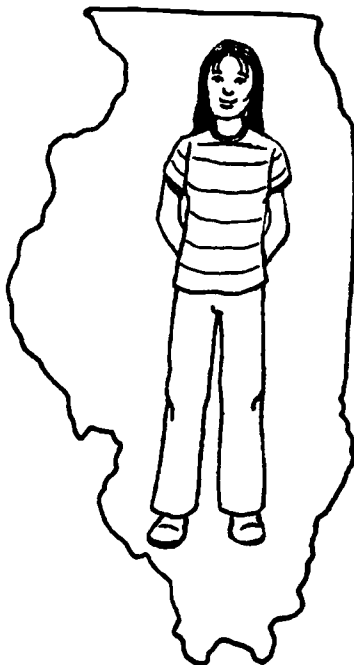

register to vote



---

**READING PASSAGE 1: Pre-Reading Activity**

*Directions:* Think about voting in your native country. Discuss the answers to the questions below with your classmates. (Optional: Write the answers to the questions.)

1. Do you vote for government leaders? If so, what leaders do you vote for?
2. Can all people vote? What are the requirements for voters?
3. Do most people vote in elections? How do they feel about the importance of voting?
4. How are candidates for government office selected?
5. How long do leaders stay in office? Can they be elected again?
6. How do people get information about candidates?

Now talk about this question with your classmates:  
How are elections in the United States different from elections in your native country?

## READING PASSAGE 1

The government of the United States is a representative democracy. The people elect representatives to act for them in daily government work. Government power is divided among national, state and local government.

### THE RIGHT TO VOTE

The power of the government comes from the United States Constitution. The Constitution is the highest law of the land. This document gives citizens the right to vote. When people vote, they make decisions about leaders or issues.

Americans vote for their leaders in national, state, and local elections. They choose a President and Vice-President in the national election. They also vote for their U.S. senators and representatives. Senators and representatives are legislators, people who make laws. In state elections, people elect their governor, state legislators, and other officials. There are also local elections for community leaders and lawmakers.

People also vote on important issues. For example, in state or local elections people sometimes vote on referenda. A referendum is a question on the ballot for people to vote “yes” or “no.” Referenda can be about changes to the state or local government, taxes, or spending money on a special project. For example, voters in a school district may vote on building a new school. People vote “for” or “against” a referendum. If a majority of people votes “for,” the referendum becomes a law.

Not every American can vote. In order to vote, a person must be a citizen, at least 18 years old, and registered to vote. People must live in their state for a certain amount of time before voting. Some states have other requirements, too.

Most citizens think voting is an important right because they can elect their leaders. They vote for leaders who have the same ideas as they have. They want leaders who listen to their problems and work towards solutions. They want government to respond to their needs.

### ELECTIONS

Major elections take place in even-numbered years. Every 4 years there is an election for President of the United States. State and local elections take place every 2 years. Elections usually take place in the fall or spring. People vote at their neighborhood polling place. This is usually a school, church, synagogue, or park building in the community.

Different government jobs have different terms of office. For example, a school board member may serve a 4-year term. State representatives usually serve a 2-year term. U.S. senators are elected for a 6-year term. If elected officials do a good job, voters usually re-elect them.



---

**READING PASSAGE 1 continued**

Before elections, political parties choose their candidates. Political parties are groups of people who share the same ideas about government. The major political parties are Democrat and Republican. There are also many smaller political parties that put candidates on the ballot. The parties help their candidates with campaigns. During campaigns, candidates identify and speak on important issues. They tell what changes they want to make in government. This is their party's platform.

Informed citizens know the candidates and their political parties. They get information about candidates from TV, newspapers, speeches, campaign literature, Internet web sites, and other people. They know the candidates' platforms or positions. Informed citizens know when, where, and how to vote. They also watch to see what leaders do after the election.

---

## READING PASSAGE 1: Vocabulary Activity 1-A

*Directions:* Say these words after your teacher. Discuss the meaning of each word.  
(Optional: Write the meaning next to each word.)

1. representative democracy
2. Constitution
3. election/voting
4. President
5. senator
6. representative
7. governor
8. legislator/lawmaker
9. issues
10. referendum/referenda (*plural*)
11. ballot
12. majority
13. citizen
14. registered
15. polling place
16. term of office
17. political party
18. candidate
19. campaign
20. platform

Other new words:

READING PASSAGE 1: Vocabulary Activity 1-B

*Directions:* Write the correct word or words in each sentence. Use the word bank for help. There are five extra words.

1. Citizens go to a \_\_\_\_\_ to vote.
2. The \_\_\_\_\_ is the chief executive of the state.
3. The major \_\_\_\_\_ are Democrat and Republican.
4. The candidates' names are put on the \_\_\_\_\_ for an election.
5. There is an \_\_\_\_\_ for President every 4 years.
6. The \_\_\_\_\_ is the highest law of the United States.
7. The candidate's \_\_\_\_\_ promised more money for education.
8. In a \_\_\_\_\_ type of government, people vote for their leaders.
9. The \_\_\_\_\_ for President is 4 years.
10. A \_\_\_\_\_ makes laws for the country, state, or community.
11. A citizen must be \_\_\_\_\_ to vote.
12. People vote "for" or "against" an issue on a \_\_\_\_\_.
13. A registered voter must be a \_\_\_\_\_.
14. Government leaders make decisions about important \_\_\_\_\_.
15. A U.S. \_\_\_\_\_ is elected for a 6-year term.

WORD BANK

representative democracy	platform	election	senator
governor	legislator	issues	referendum
ballot	majority	registered	polling place
term of office	political parties	candidate	campaign
representative	Constitution	President	citizen

**READING PASSAGE 1: Comprehension Check**

*Directions:* Take turns reading each sentence below with a partner. Decide if each sentence is TRUE or FALSE. Put an X under TRUE or FALSE.  
(Optional: Correct the false sentences.)

	TRUE	FALSE
1. The power of the government comes from the U.S. Constitution.	_____	_____
2. Americans vote for their leaders in local, state, and national elections.	_____	_____
3. In a referendum, people vote for their favorite candidate.	_____	_____
4. American citizens can vote at the age of 16.	_____	_____
5. Elections usually take place in the summer.	_____	_____
6. There is an election for President of the United States every 2 years.	_____	_____
7. All government jobs have the same terms of office.	_____	_____
8. The 2 major political parties are Democrat and Republican.	_____	_____
9. During campaigns, candidates tell the changes they want to make in government.	_____	_____
10. Citizens learn about candidates' positions from TV, speeches, Internet web sites, newspapers, campaign literature, and other people.	_____	_____

PICTURES FOR VOCABULARY DEVELOPMENT

school district

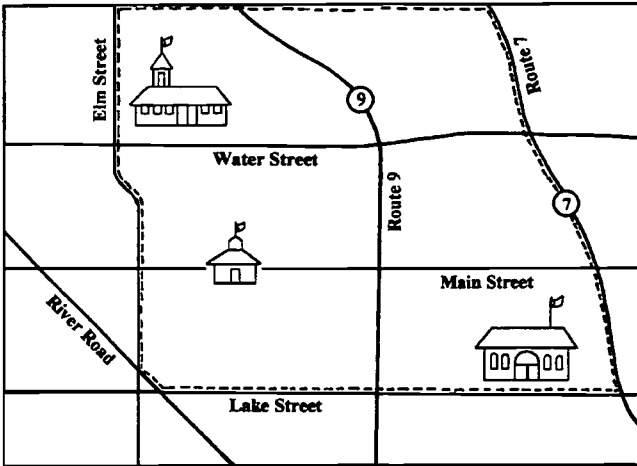

Superintendent

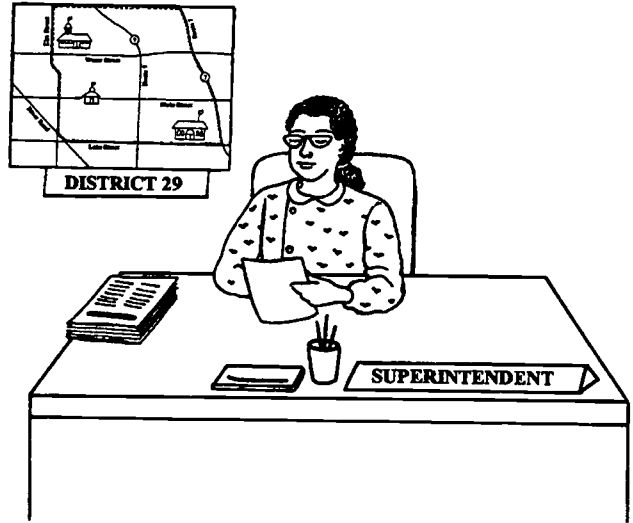

school board



PICTURES FOR VOCABULARY DEVELOPMENT continued

state



county

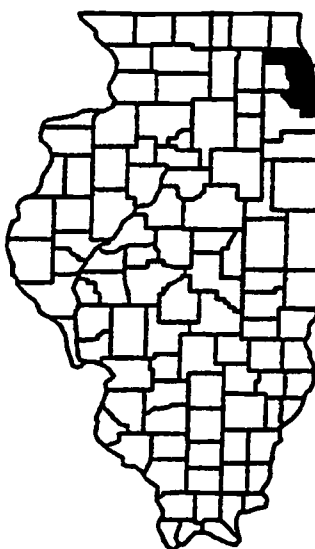

township

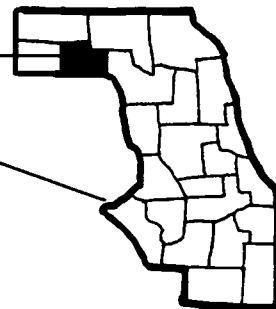

city

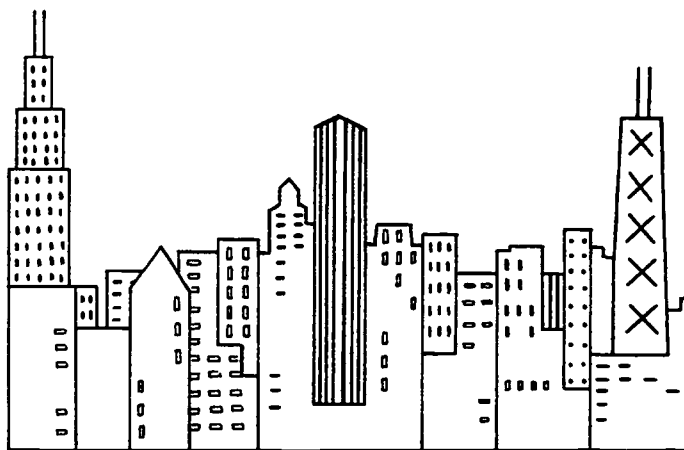

town/village



PICTURES FOR VOCABULARY DEVELOPMENT continued

ELECTED OFFICIALS – CHIEF EXECUTIVES

state



governor



township

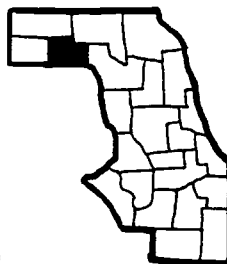

supervisor



city/town/village



mayor/village president



PICTURES FOR VOCABULARY DEVELOPMENT continued

ELECTED OFFICIALS

city council/aldermen/trustees

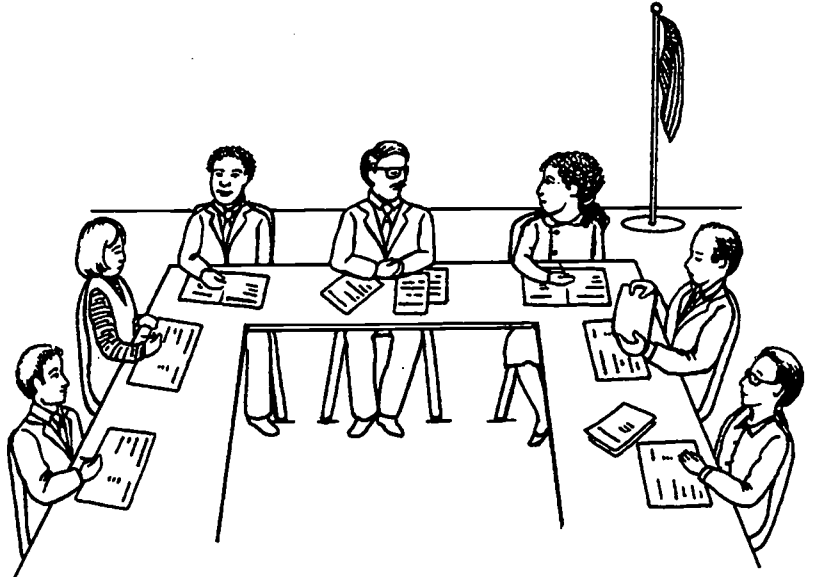
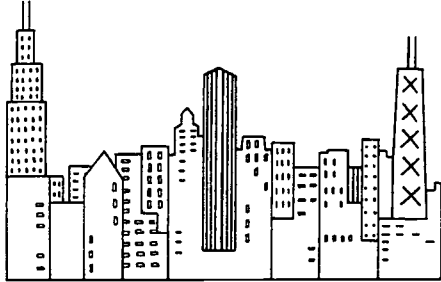

ordinance

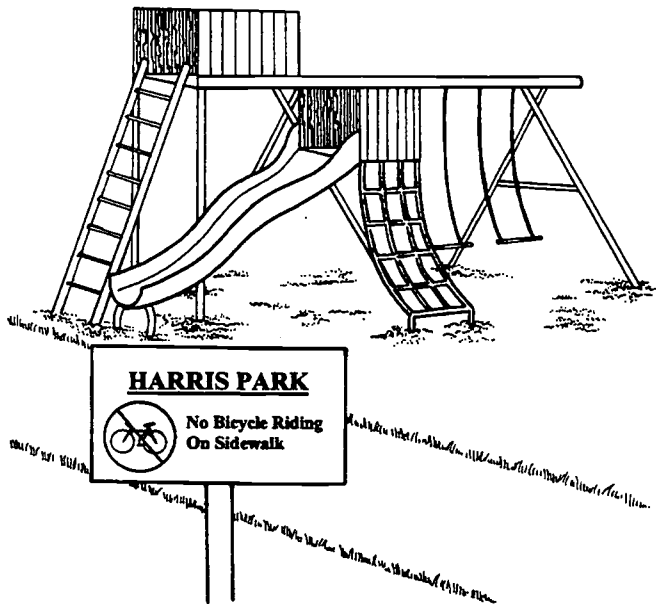

contract

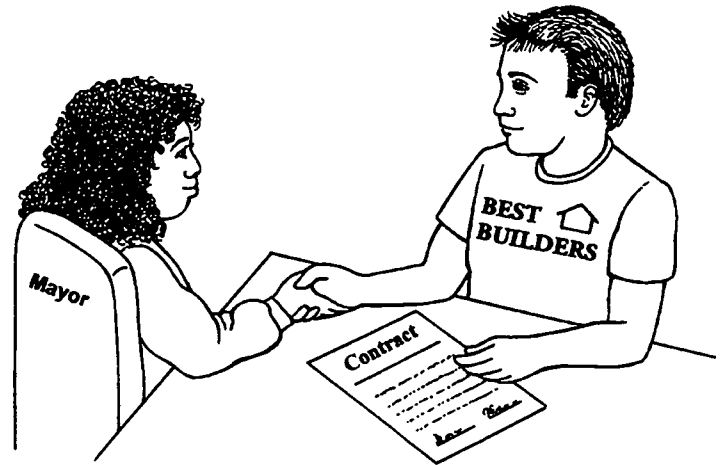



PICTURES FOR VOCABULARY DEVELOPMENT continued

COMMUNITY SERVICES

police

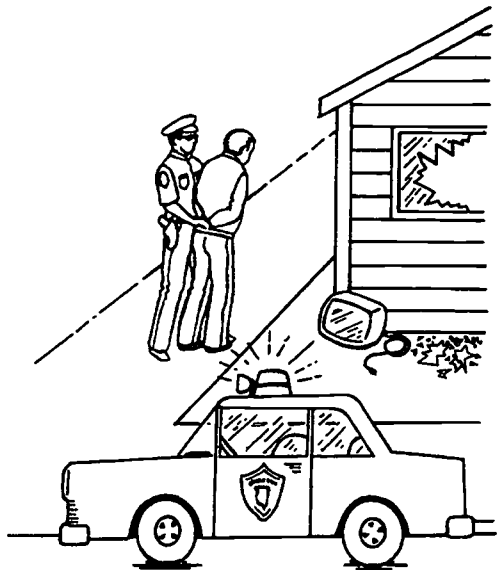

fire

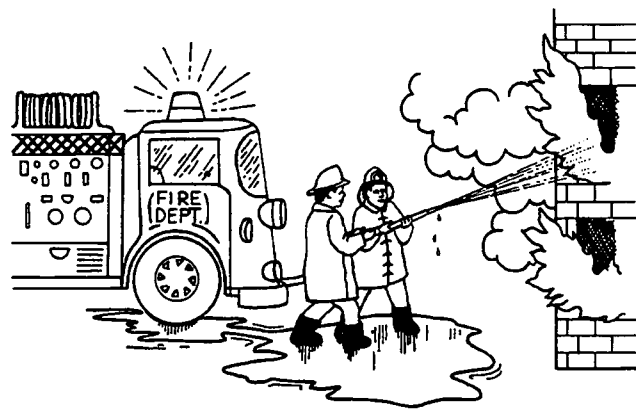

water

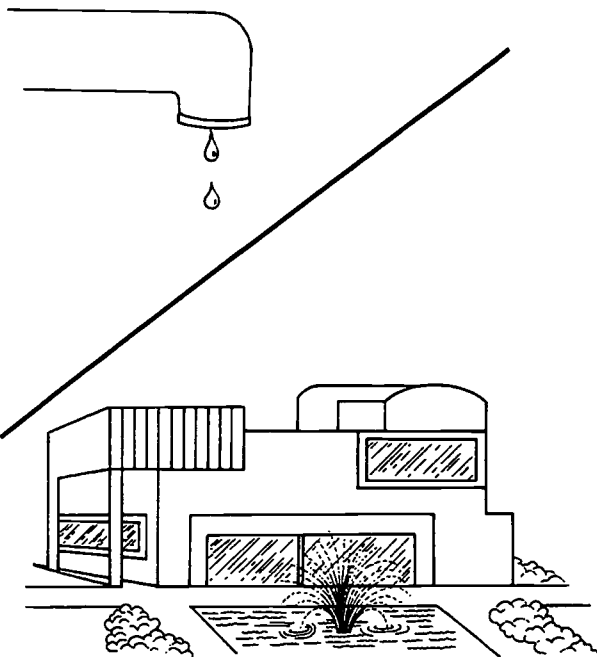

power (gas, electric)

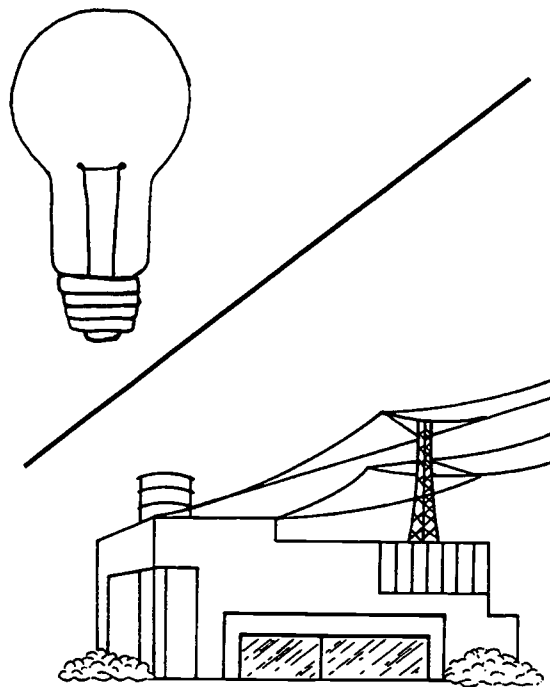

PICTURES FOR VOCABULARY DEVELOPMENT continued

COMMUNITY SERVICES

sanitation

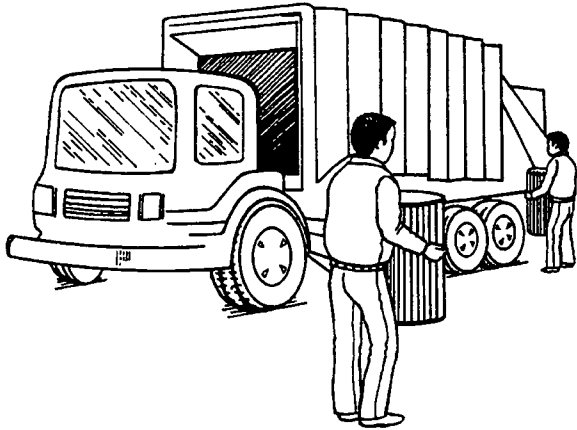

parks

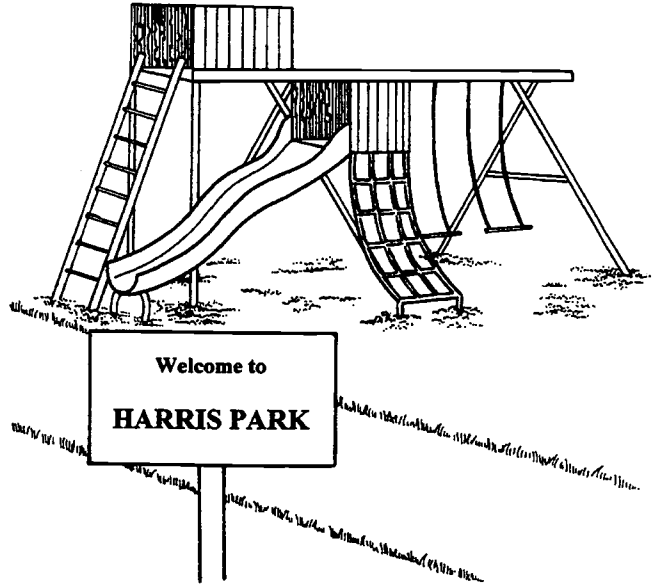

transportation

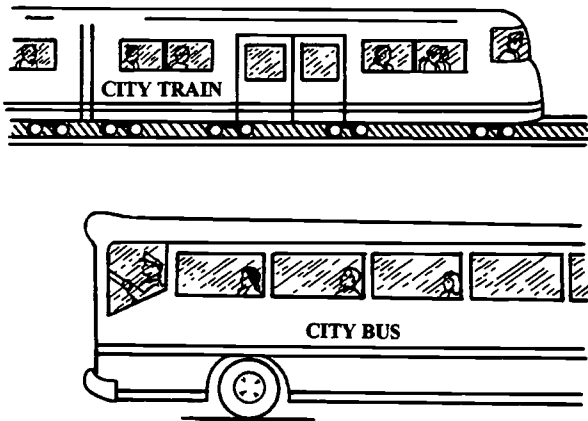

libraries

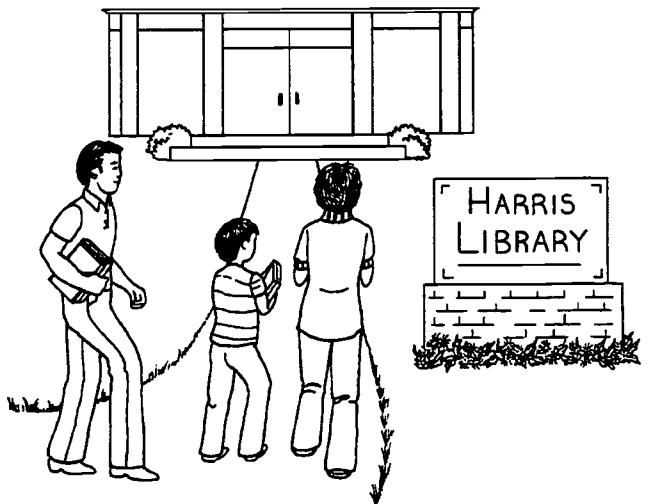

PICTURES FOR VOCABULARY DEVELOPMENT continued

COUNTY SERVICES

county board

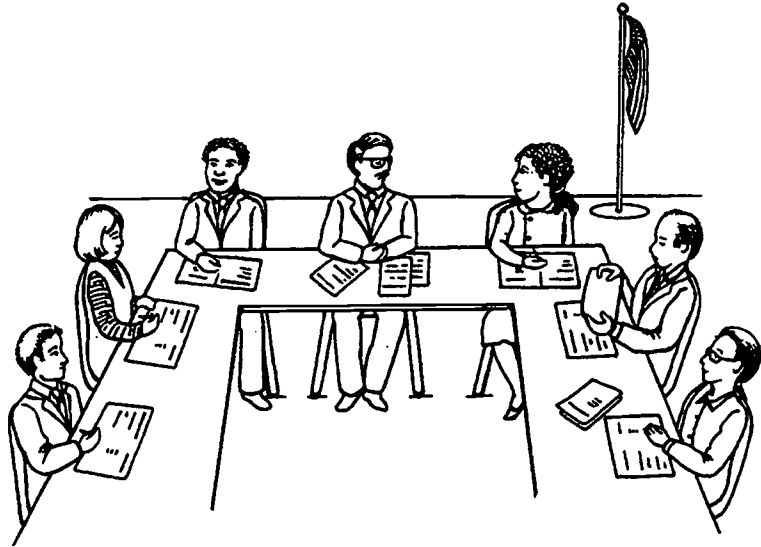
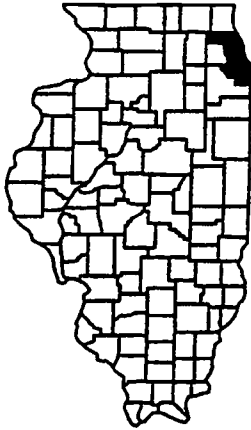

sheriff



PICTURES FOR VOCABULARY DEVELOPMENT continued

COUNTY SERVICES

public health clinics/hospitals

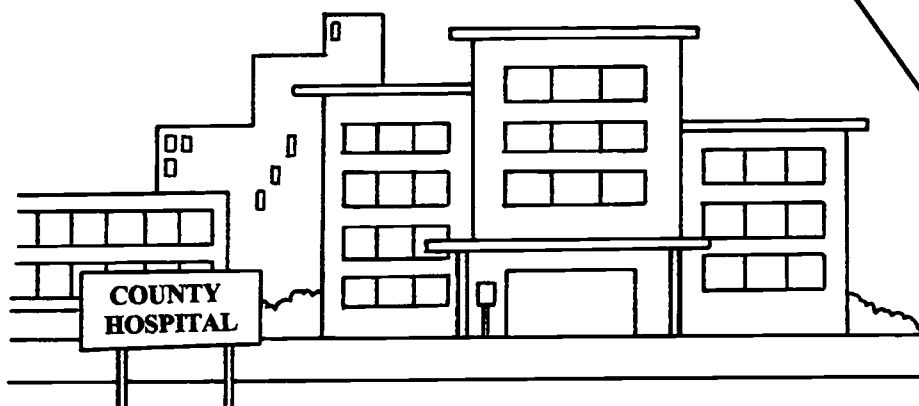

courts

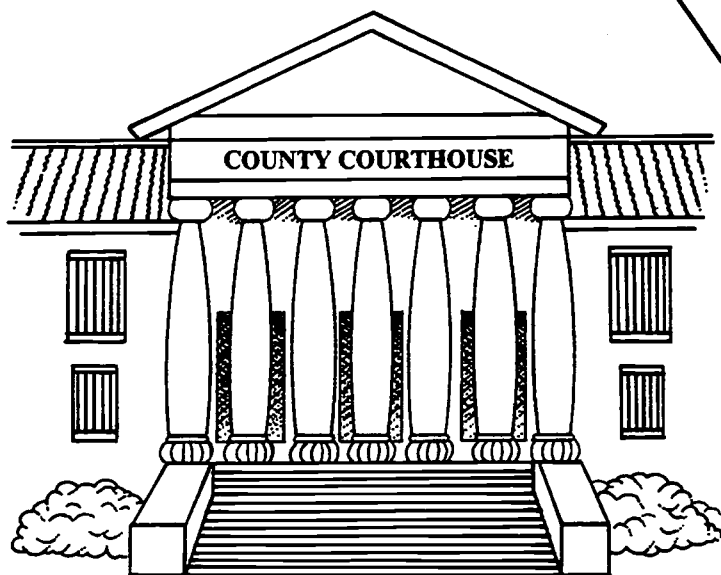

PICTURES FOR VOCABULARY DEVELOPMENT continued

STATE SERVICES

driver's license

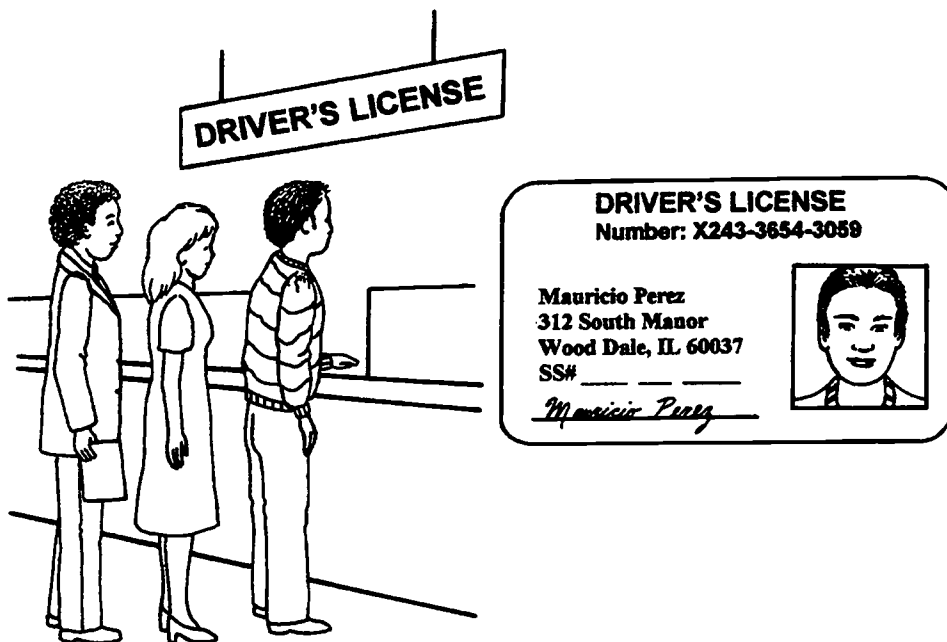

state lottery

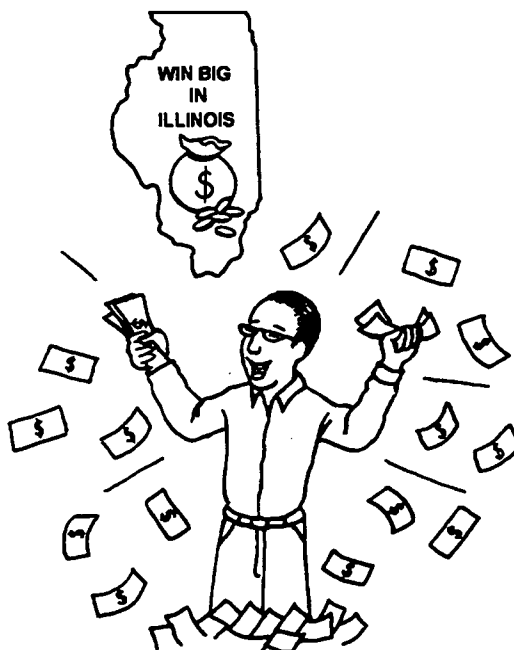

PICTURES FOR VOCABULARY DEVELOPMENT continued

STATE HIGHWAY SERVICES

highway repair

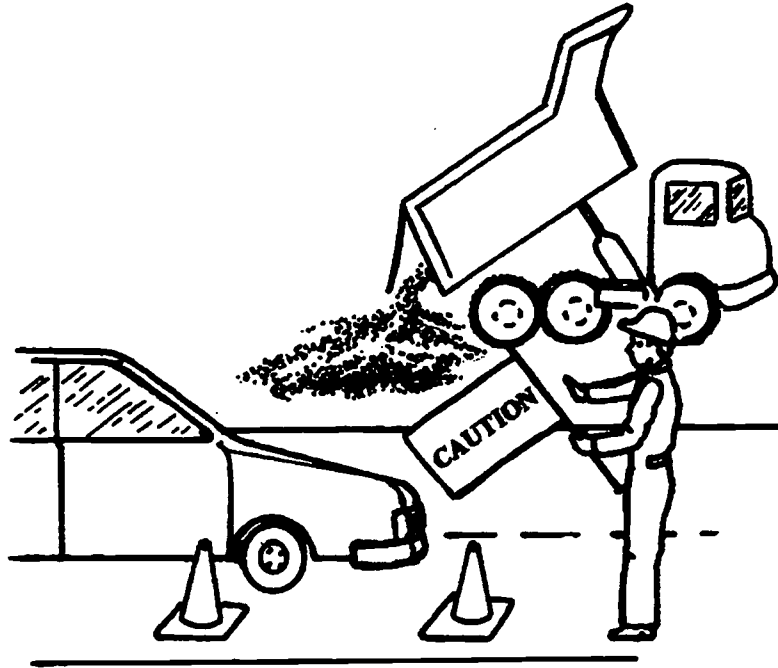

toll road

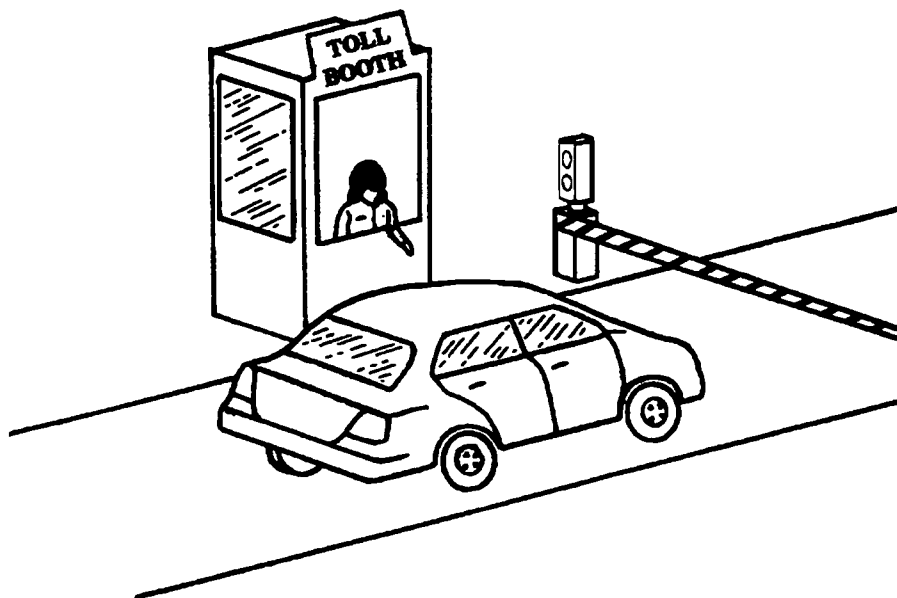

PICTURES FOR VOCABULARY DEVELOPMENT continued

CONTACT YOUR LOCAL OFFICIALS...

by telephone



in person

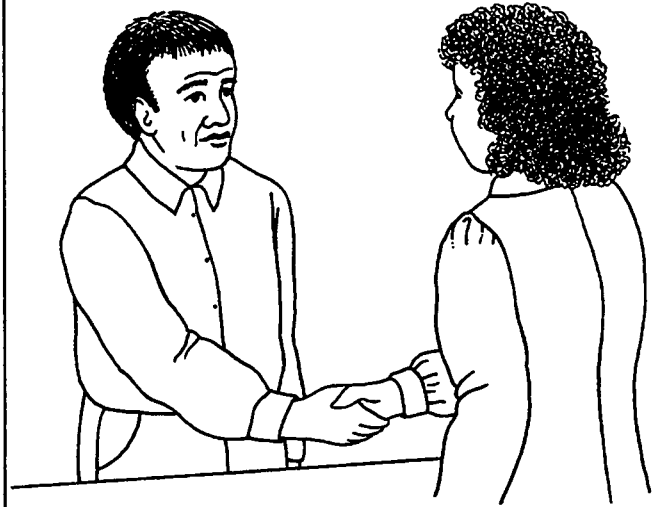

by letter



by email



PICTURES FOR VOCABULARY DEVELOPMENT continued

opinions

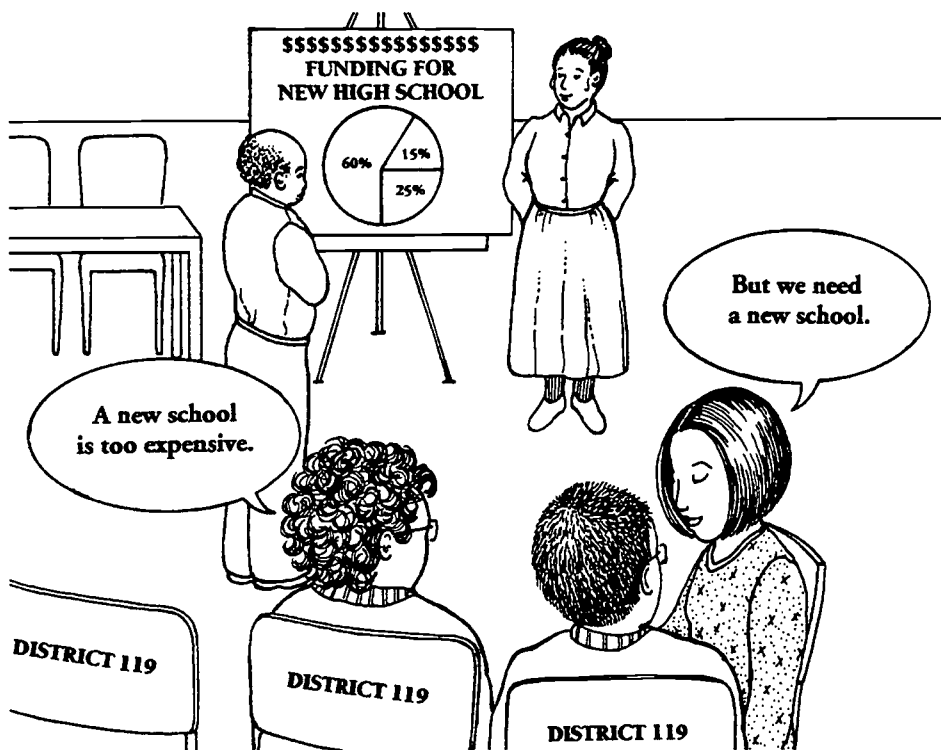

influence

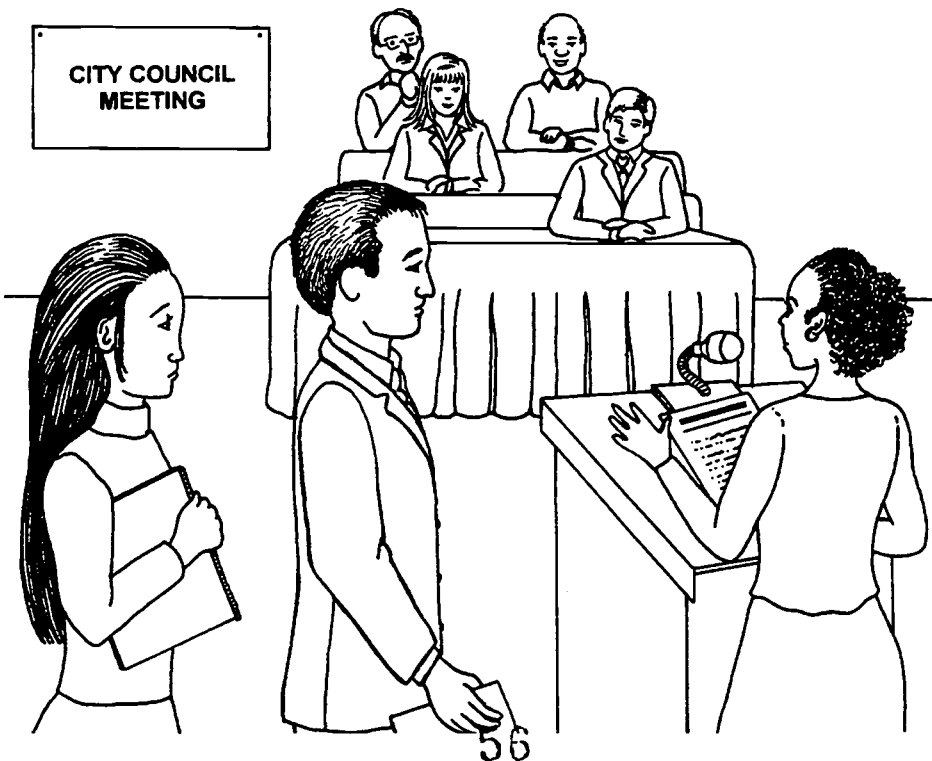



PICTURES FOR LANGUAGE EXPERIENCE

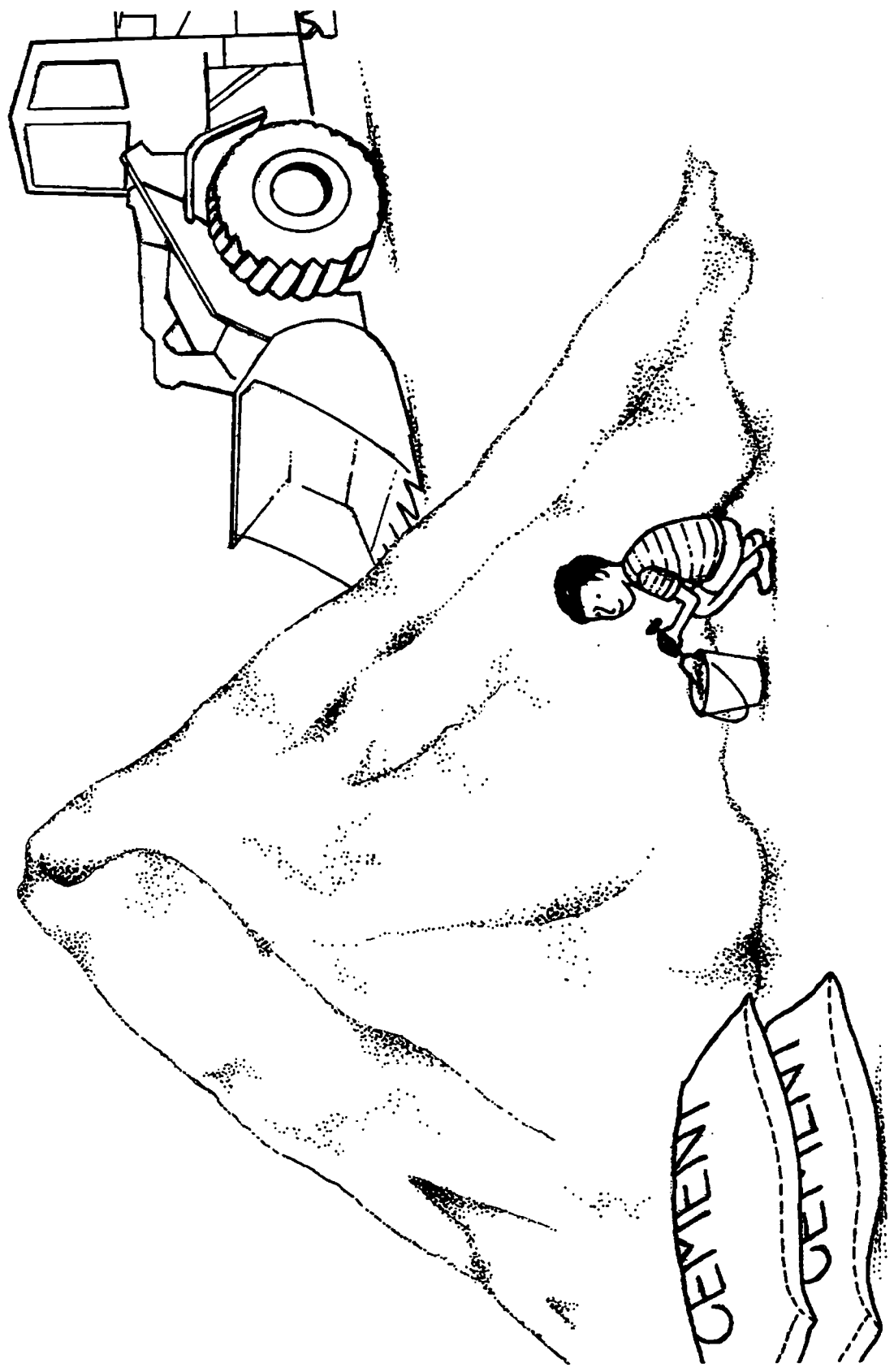

1

BEST COPY AVAILABLE

PICTURES FOR LANGUAGE EXPERIENCE continued

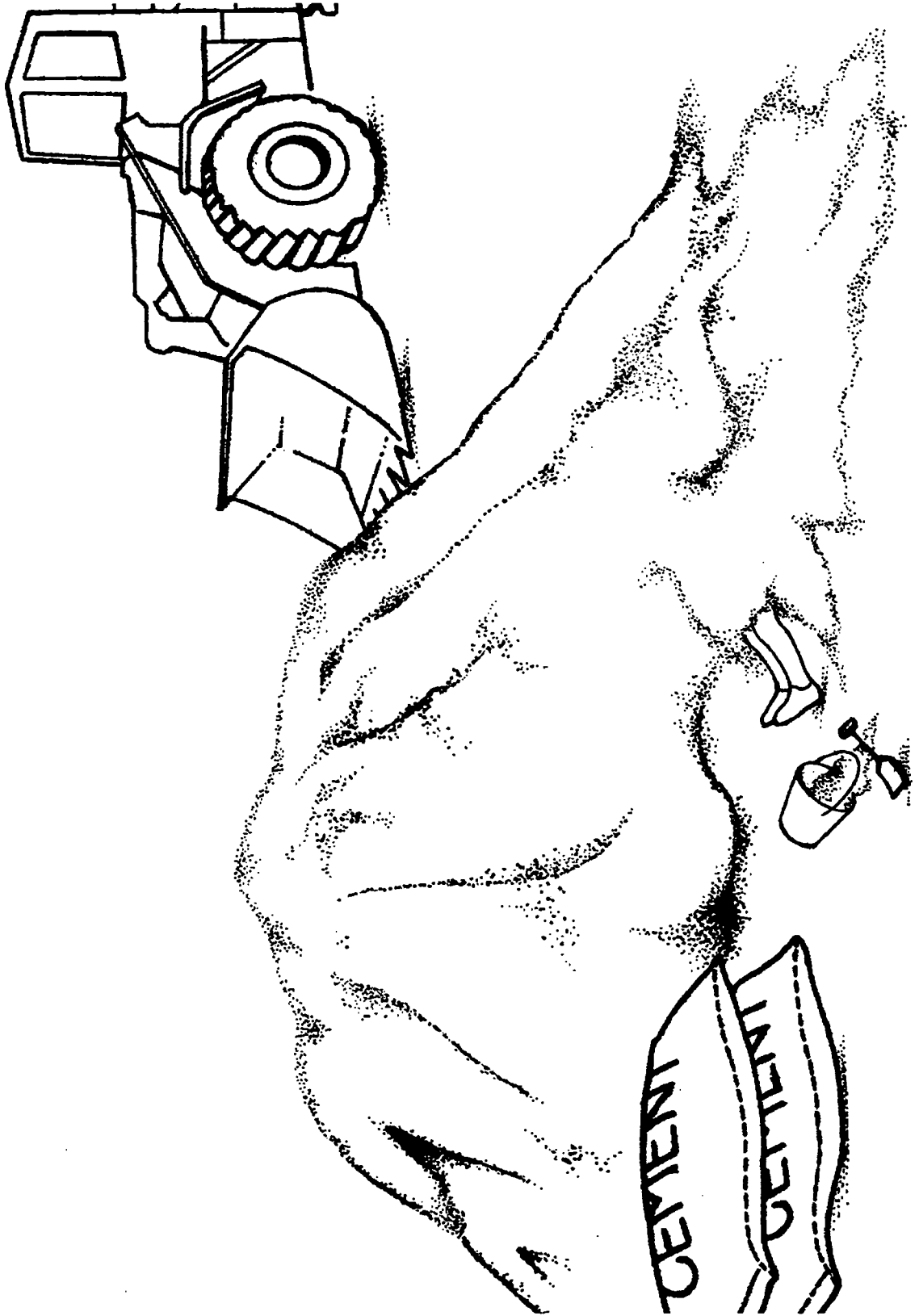

PICTURES FOR LANGUAGE EXPERIENCE continued

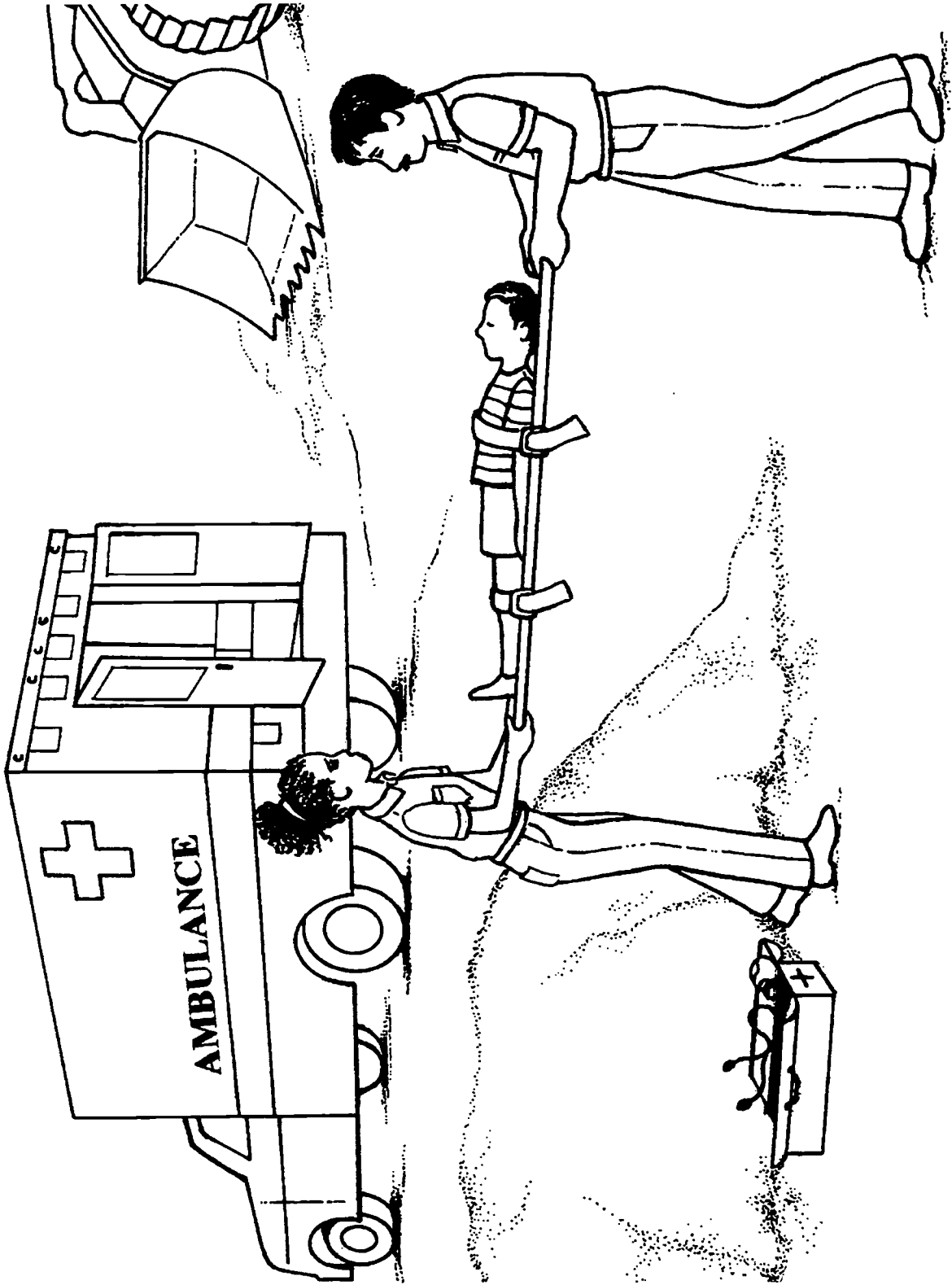

PICTURES FOR LANGUAGE EXPERIENCE continued

CITY COUNCIL MEETING

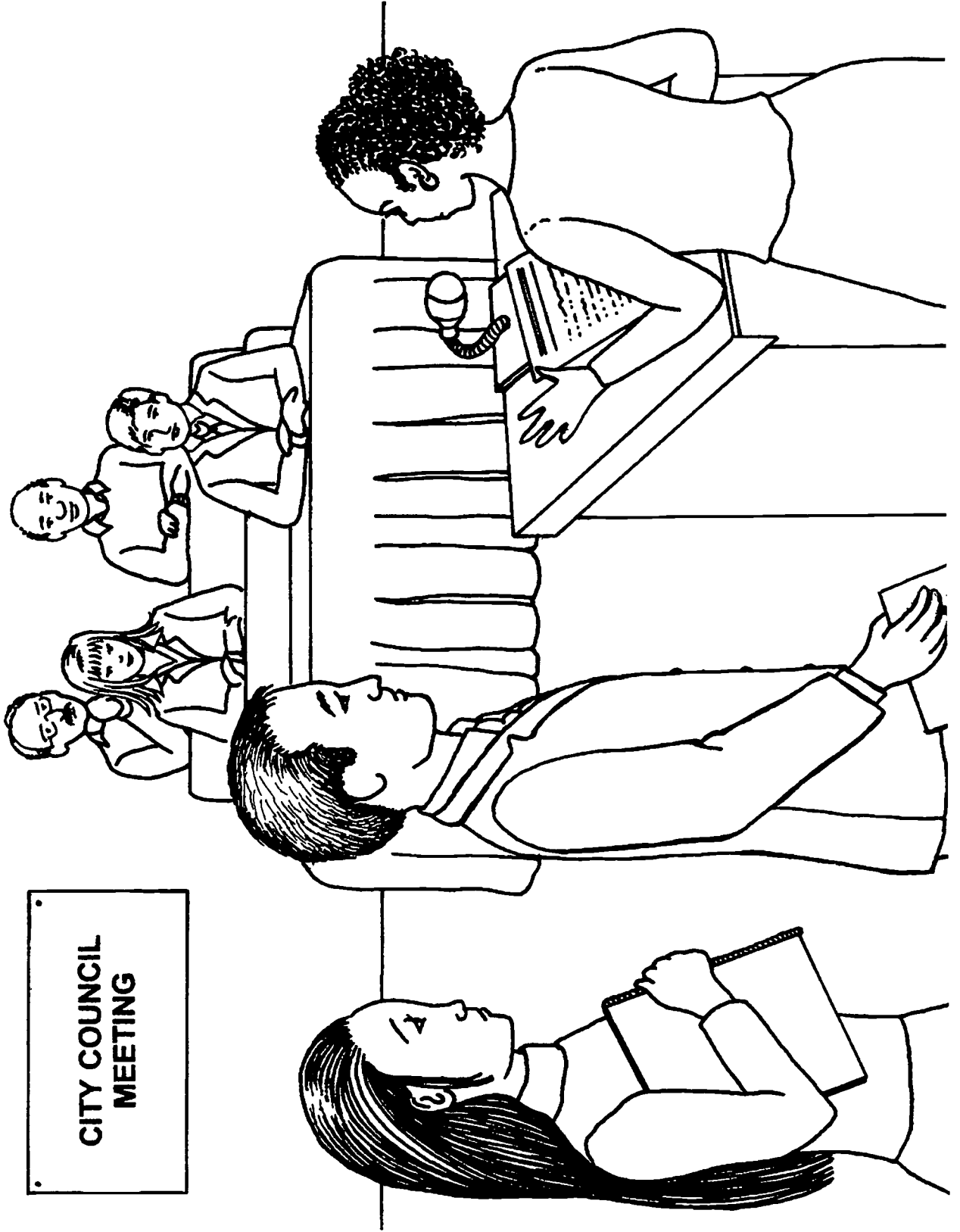

4

PICTURES FOR LANGUAGE EXPERIENCE continued

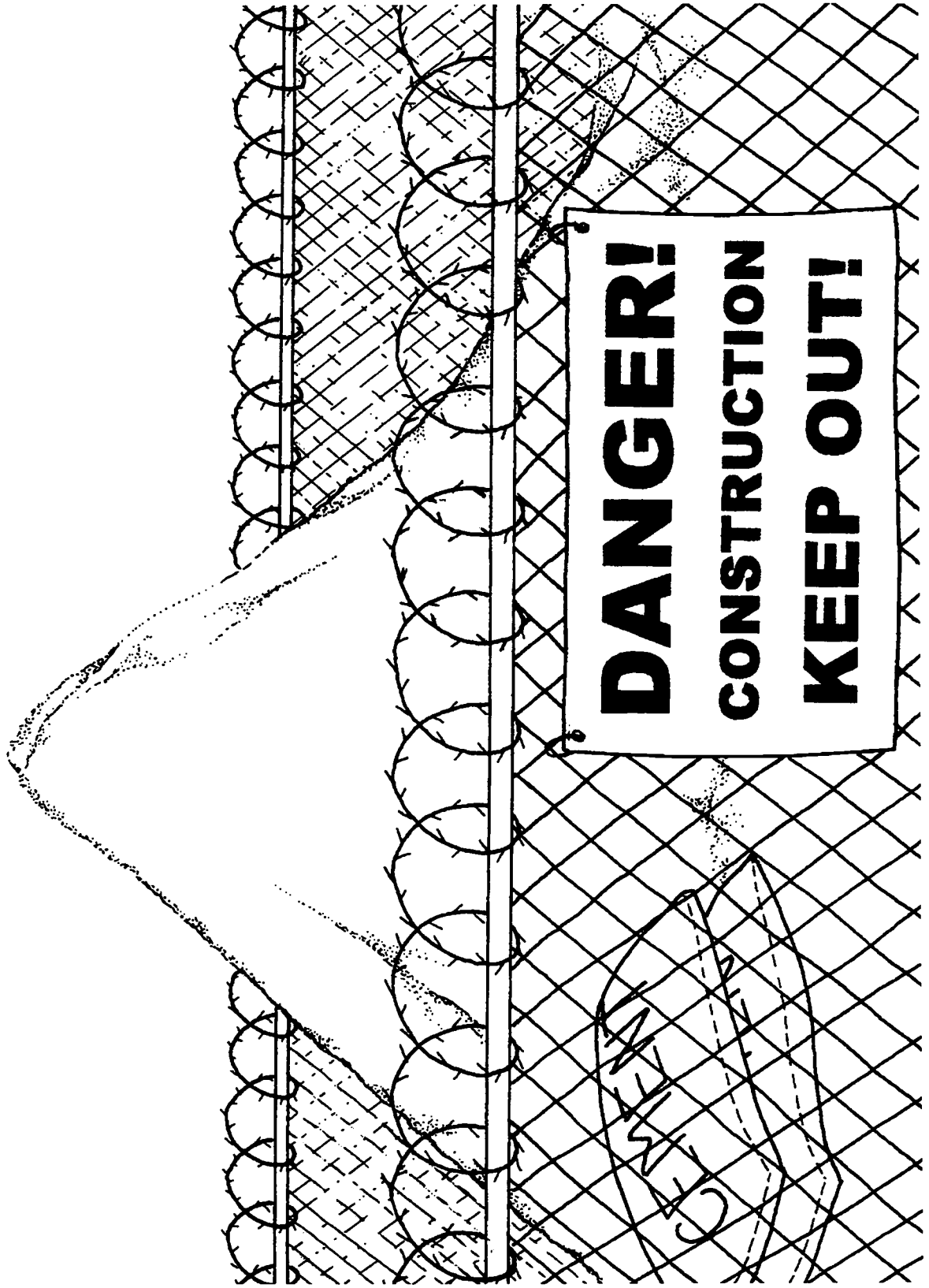

5

## PICTURES FOR GROUP STORY WRITING

*Directions:* Work in groups of three or four. Write a story about the pictures below and on the next page. Write one or more sentences for each picture. Then share your story with the class.

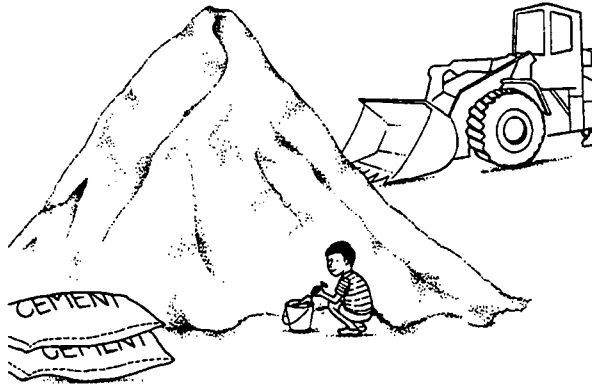

1

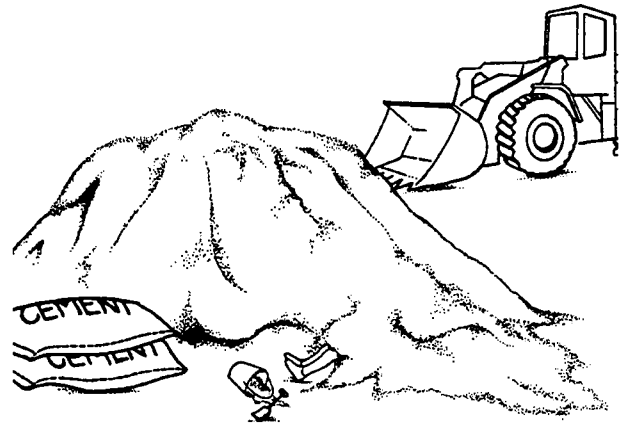

2

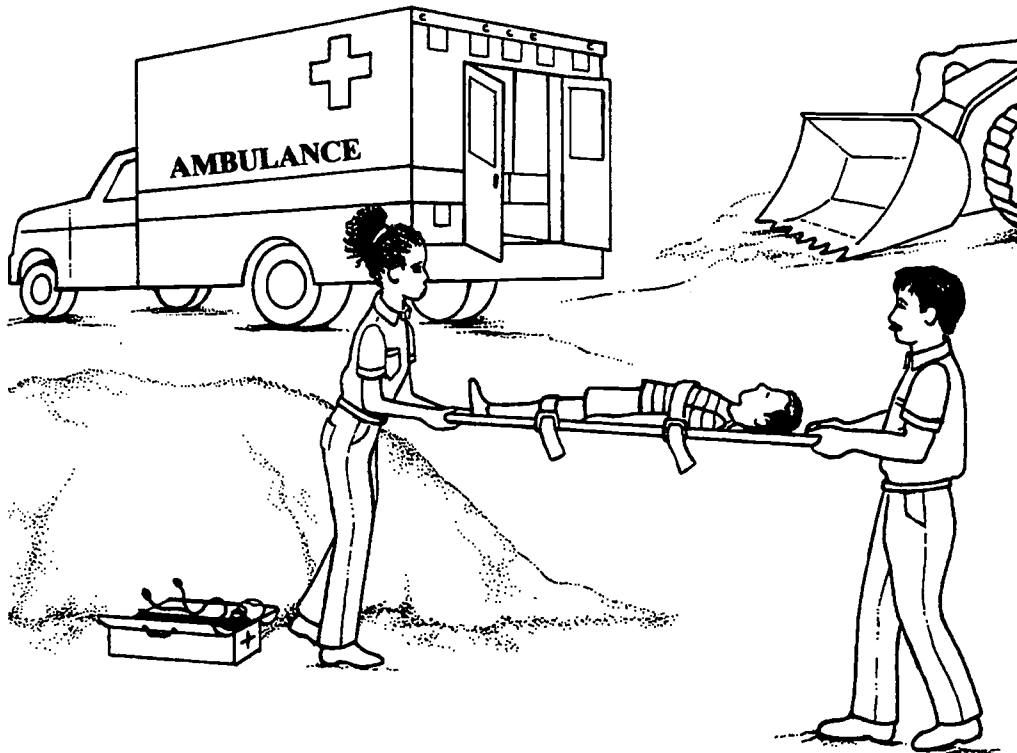

3

PICTURES FOR GROUP STORY WRITING continued

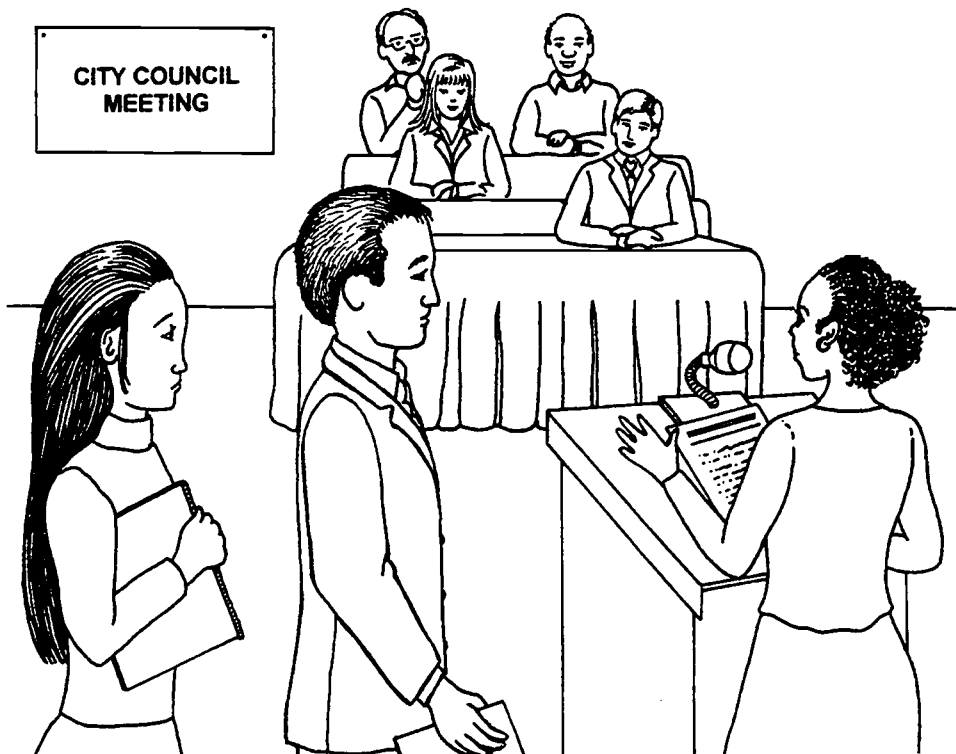

4

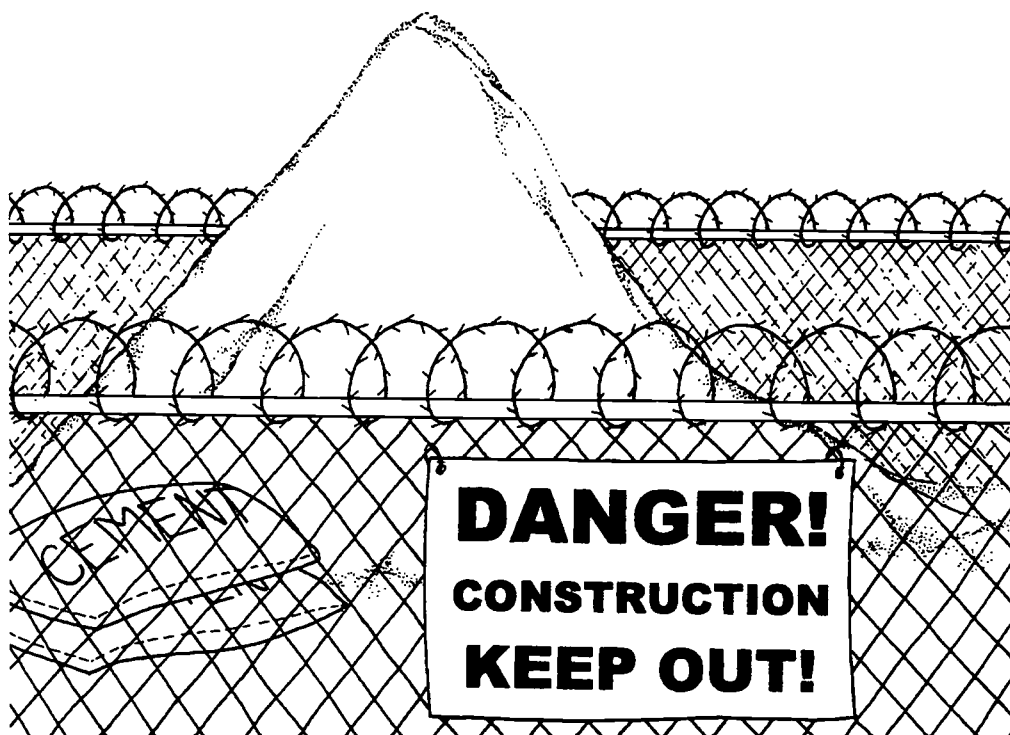

63

5

## READING PASSAGE 2: Pre-Reading Activity

*Directions:* Discuss the answers to the questions below with your classmates.  
(Optional: Write the answers.)

1. Who are the elected leaders

- in your city or village?
- in your county?
- in your state?

What are their jobs?

2. Have you ever contacted a government leader? Why? What happened?

3. How can you become involved in the government of your community?



## READING PASSAGE 2

Each state has smaller areas of local government. Local government areas include the school district, the community, and the county. In each of these areas citizens vote for their leaders. They can also contact these elected representatives with problems or questions.

### SCHOOL DISTRICTS

A school district is an area with one or more schools. The school board is in charge of schools in the district. People in the district vote for the local school board members. The school board makes important decisions for the school district, such as hiring the superintendent. The superintendent is the administrator of the school district. School board meetings are open to the public. Parents can contact board members about problems or with questions about the district or a local school.

### COMMUNITY GOVERNMENT

Communities include cities, villages, towns, and townships. In each of these places, people vote for their local leaders. They elect a mayor, township supervisor, or village president as chief executive. People also elect a city council, a group of aldermen, or a number of trustees. These groups make laws called ordinances and decide important community issues. Sometimes these groups or the chief executive appoint a manager to help run the community.

There are also departments that provide services to people in the community. Some of these services are police, fire, water, power (electric/gas), sanitation, libraries, and parks. In larger cities, there may be other departments such as housing, transportation, and care of children and the elderly. The chief executive of the community usually appoints people to run these departments. But sometimes the chief executive gives contracts to private companies to provide these services. For example, the mayor might hire a company to remove trees in the city.

### COUNTY GOVERNMENT

The county is larger than a city and usually includes many cities. Its governing body is a county board. People elect board members to represent districts or the whole county. County government is responsible for many services such as the county courts, county health clinics and hospitals, and the sheriff's department.

### STATE GOVERNMENT

State government is located in the state capital. The head of state government is the governor. People in the state vote for their governor every 4 years. They also elect members of the state legislature to make laws for the state. People in the districts vote for their own state senators and representatives. These elected officials live and have offices in the district they represent. There are also other elected officials in state government such as secretary of state, attorney general, and state treasurer.

## READING PASSAGE 2 continued

The state government is responsible for drivers' licenses, the state highways, the state lottery, health and education, and many other important services.

### CONTACTING ELECTED OFFICIALS

People elect state and local leaders and lawmakers to represent their community. The leaders' offices are open to the public. There are many ways for people to tell elected officials what they think about an issue. They can contact their officials in person, by telephone, letter, or email. Community members do not have to be citizens or registered voters to contact their leaders.

There are state and local meetings where officials listen to people's opinions. These meetings are open to the public. These government meetings are announced in the newspaper, on web sites, at libraries, and at other places. People go to these meetings to see legislators make laws and decide issues. There is usually an open time during community meetings for people to give their opinions.

### HOW TO BECOME INVOLVED IN LOCAL GOVERNMENT

People can become involved in local government in many ways. They can read the community newsletter to learn about important issues. They can attend city council or school board meetings and speak out on the issues. People can work for candidates during campaigns. They can become citizens and vote in local elections. As citizens, they can also run for political office.

### A TRUE STORY

An accident in an Illinois town shows how citizens can influence their leaders. A young boy was playing at a construction site. A large pile of sand fell on him and hurt him badly. Neighbors were upset and angry. They were also afraid that other children were in danger.

Some people sent email messages to the city council. Others called on the telephone to give their opinions. Many attended the city council meeting a few days after the accident. At the open part of the meeting, community members spoke out. They asked for immediate action by the lawmakers. The city council listened. It passed a new ordinance that said that all construction areas must have a fence around them.

This story shows the political power of community members. To bring change and improve community life, people must be involved.

READING PASSAGE 2: Vocabulary Activity 2-A

*Directions:* Say these words after your teacher. Discuss the meaning of each word.  
(Optional: Write the meaning next to each word.)

1. school district
2. school board
3. superintendent
4. city/village/town
5. mayor/township supervisor/village president
6. chief executive
7. city council members/aldermen/trustees
8. ordinance
9. sanitation
10. contract
11. county
12. county board
13. courts
14. sheriff
15. contact
16. opinion
17. influence

Other new words:

READING PASSAGE 2: Vocabulary Activity 2-B

*Directions:* Write the letter of the definition on the line.

- |   |   |
|---|---|
| ___ 1. influence                          | a. the administrator of the school district                     |
| ___ 2. county                             | b. the elected leader of city government                        |
| ___ 3. school district                    | c. a law made by community government                           |
| ___ 4. contact                            | d. the county's police department                               |
| ___ 5. sanitation                         | e. to change other people's ideas or actions                    |
| ___ 6. city council/aldermen/<br>trustees | f. to communicate with someone by phone, email, or in person    |
| ___ 7. contract                           | g. lawmakers for city government                                |
| ___ 8. chief executive                    | h. an elected group that makes decisions for a school district  |
| ___ 9. ordinance                          | i. a written agreement to do something                          |
| ___ 10. mayor                             | j. garbage collection   |
| ___ 11. village                           | k. an area with one or more schools and a school board          |
| ___ 12. school board                      | l. the highest leader of community, county, or state government |
| ___ 13. superintendent                    | m. a town or small city   |
| ___ 14. county board                      | n. places for trials or law cases                               |
| ___ 15. opinion                           | o. a person's belief or idea about something                    |
| ___ 16. courts                            | p. an elected group of county leaders                           |
| ___ 17. sheriff's department              | q. the largest local governing body of a state                  |

READING PASSAGE 2: Comprehension Check

*Directions:* Take turns reading each sentence with a partner. Decide if each sentence is TRUE or FALSE. Put an X under TRUE or FALSE. (Optional: Correct the false sentences.)

	TRUE	FALSE
1. Local government includes the school district, the community, the county and the state.	_____	_____
2. In the school district, the school board hires the superintendent.	_____	_____
3. The chief executive of the community can be a mayor, village president or township supervisor.	_____	_____
4. Aldermen or trustees can make laws for the community.	_____	_____
5. The sheriff's department and the courts are part of county government.	_____	_____
6. People elect members of the state legislature to make laws for their city.	_____	_____
7. Secretary of state and state treasurer are not elected offices.	_____	_____
8. People can contact their officials only by letter.	_____	_____
9. Only citizens can contact elected state and local leaders.	_____	_____
10. There is no time during community meetings for people to give their opinions.	_____	_____
11. Community members can attend school board meetings to speak out on important issues.	_____	_____
12. Only citizens can run for political office.	_____	_____

**DIALOGUE 1: Calling for Alderman's Office Hours**

*Directions:* Listen to the dialogue. Then practice the dialogue with your teacher and classmates.

Tomás Cintado wants to go to his alderman's office. He calls to find out the office hours.

Secretary: Good morning, Alderman Hansen's office.

Tomás: Good morning. Could you tell me your office hours?

Secretary: We're open Monday through Friday from 9 to 5.

Tomás: Monday through Friday from 9 to 5?

Secretary: Yes.

Tomás: Thank you. Goodbye.

Secretary: You're welcome. Bye.

**DIALOGUE 2: Calling About a School Board Meeting**

*Directions:* Listen to the dialogue. Then practice the dialogue with your teacher and classmates.

Anna Pulaski wants to go to a school board meeting. She calls the school district for information.

Secretary: Hello. This is District 89.

Anna: Good morning. I'm calling for information about the school board meeting.

Secretary: Yes?

Anna: When is the next meeting?

Secretary: Next Tuesday evening, September 5 at 7:30.

Anna: Where will the meeting be?

Secretary: It's at Franklin School in the gym.

Anna: Oh. Where's Franklin School?

Secretary: It's at the corner of Potter and Maple by Woodland Park.

Anna: OK. Thank you for your help.

Secretary: You're welcome. Goodbye.

Anna: Goodbye.

**DIALOGUE 3: Calling Your Senator**

*Directions:* Listen to the dialogue. Then practice the dialogue with your teacher and classmates.

Joon Lee calls his state senator. He wants to influence Senator Hunter's vote on a bill in the senate. He calls the Senator's office to give his opinion.

Receptionist: Good morning, Senator Paul Hunter's office.

Joon: Hi. My name is Joon Lee. I live in Senator Hunter's district.

Receptionist: Yes. How may I help you?

Joon: I am calling to ask Senator Hunter to vote for Senate Bill 550. We need stronger gun control laws.

Receptionist: Okay. I will let the Senator know. Can you give me your address?

Joon: 101 Birch Street in Rockford.

Receptionist: Okay. Goodbye.

Joon: Thank you. Goodbye.



**DIALOGUE 4: Calling City Hall**

*Directions:* Listen to the dialogue. Then practice the dialogue with your teacher and classmates.

A community resident wants to attend a city council meeting. He calls City Hall for information.

Clerk: Good morning. City Hall.

Resident: Hello. My name is \_\_\_\_\_. I'm calling about the city council meeting.

Clerk: Yes. How can I help you?

Resident: Could you tell me \_\_\_\_\_?

Clerk: Sure. \_\_\_\_\_ Is there anything else?

Resident: No. Thanks for your help. Goodbye.

Clerk: Goodbye.

Partner A (Resident)	Partner B (Clerk)
1. when the next city council meeting is	1. Next Monday. The council meets the 1 <sup>st</sup> and 3 <sup>rd</sup> Mondays of each month.
2. what time the city council meets	2. 8:00 p.m.
3. where the city council meets	3. At City Hall on the 2 <sup>nd</sup> floor
4. if there is time during the meeting to speak about a problem	4. Yes. After the agenda items there is an open time for people to speak to the council.



**ACTION RESEARCH ACTIVITY: Elected Leaders Chart**

*Directions:* Write the names of your national, state, and community leaders in the chart below.

NATIONAL LEADERS	STATE LEADERS	COMMUNITY LEADERS
<u>United States</u> Country	_____ State	_____ County
_____ President	_____ Governor	_____ City/Village/Township <i>(circle one)</i>
_____ U.S. Senator	_____ State Senator	_____ Mayor/Village President/Township Supervisor <i>(circle one)</i>
_____ U.S. Senator	_____ State Representative	_____ Alderman/Trustee/City Council Member <i>(circle one)</i>
_____ U.S. Representative		

## WRITING ACTIVITY: Contacting Your Local Officials

*Directions:* Mrs. Ramírez is worried about the safety of her daughter María at school. She writes a letter to the mayor to tell him about the problem. Read this note.

1920 Diversey Avenue  
Hometown, Illinois 63256  
September 15, 2003

Dear Mayor Robertson,

My daughter is a student at Garfield High School. She is a good student and wants to play basketball on the school team. But there is a big problem with gangs. They threaten the students who play sports after school. My daughter is afraid to leave the building after practice.

I think we need more police around the school. They can protect students from the gangs. Policemen will keep the students safe so they can play sports. Please help our community fight the gangs.

Sincerely,  
*Esther Ramirez*

Now write a note to your mayor. Tell about a problem in your community.

\_\_\_\_\_ ,

\_\_\_\_\_

\_\_\_\_\_

\_\_\_\_\_

\_\_\_\_\_

\_\_\_\_\_

\_\_\_\_\_

**PAIR ACTIVITY: Understanding State & Local Government**

*Directions:* With a partner, read each decision below. Decide if it is a state decision or a local decision. Write S or L on each line.

S = a state decision  
L = a local decision

- \_\_\_\_ 1. Put up a stop sign on Washington Street at Greenwood Avenue.
- \_\_\_\_ 2. Change the curfew for teenagers under 18 to 11:30 p.m.
- \_\_\_\_ 3. Put parking meters on Monroe Street.
- \_\_\_\_ 4. Raise state income taxes.
- \_\_\_\_ 5. Hire another bilingual teacher at Emerson School.
- \_\_\_\_ 6. Raise the water rates in the city. (higher water bills)
- \_\_\_\_ 7. Add new playground equipment in the city parks.
- \_\_\_\_ 8. Raise the tolls on the interstate highway.
- \_\_\_\_ 9. Not allow residents to walk their dogs in the park.
- \_\_\_\_ 10. Add a new game to the state lottery.

Discuss each example with your class. Can you add other examples of issues decided by state or local government?

**CULTURAL COMPARISON ACTIVITY: The Democratic Process**

*Directions:* Think about voting and participating in state and local government in your native country and in the United States. Discuss the answers to the questions below with your classmates. (Optional: Write the information in the chart.)

	IN _____ (native country)	IN THE U.S.
1. Do people vote for government leaders? Which ones?		
2. Do candidates campaign for government offices? How do people get information about candidates?		
3. Who makes important decisions about the schools? Are there school districts and school boards?		
4. What services does community government provide?		
5. Can people contact their state and local government leaders? How?		
6. Can people attend legislative meetings and give their opinions?		
7. How can people become involved in community government?		

## EXPERIENTIAL ACTIVITIES

As a class, identify an important issue that affects the group. Some ideas are:

- neighborhood crime
- local gangs
- racial profiling
- an overcrowded school
- a traffic or parking problem
- a safety issue
- insufficient public transportation
- public housing concerns
- re-districting in the school district
- busing students
- community health or welfare issues
- problems with a neighborhood business
- voter registration

Determine the best course of action from the suggestions below or have students generate their own plan of action. Choose an activity requiring a response by a government leader or one of his/her staff. Also select an activity in which students have a vested interest so that they will follow through to a satisfactory conclusion.

1. Attend a school board meeting, village council meeting, or local hearing on a subject of interest to students.  
*risk: low*  
*language level: all*
2. Take a field trip to the precinct office or local polling place. Pick up (or ask for) sample voter registration cards and other materials, if available.  
*risk: low-medium*  
*language level: all*
3. Visit Congressional local offices. Before the trip, have the class do research on bills that have been introduced in this session. At the district office, identify the number of a bill, get a copy and an update on its status, and find out how legislators voted.  
*risk: medium-high*  
*language level: high beginning-advanced*
4. Use a voting “machine” in class. Before practicing, get names of actual candidates, their parties, and their platforms so you can have a mock election.  
*risk: low*  
*language level: all*
5. Write a letter to the editor of the local newspaper or to a school board member on an issue of interest to students.  
*risk: low-medium*  
*language level: intermediate-advanced*
6. Attend a candidate forum. Before going, have the class become familiar with their platforms or positions on important issues.  
*risk: low*  
*language level: all*

---

**EXPERIENTIAL ACTIVITIES continued**

7. Invite a guest speaker to the class. Possibilities include a state representative, an alderman or trustee, or a candidate for local elected office. Have students prepare questions for the speaker before the event.  
*risk: medium-high*  
*language level: high beginning-advanced*
  
8. Have students access the web site for your state government. Find out the names of your elected officials. Get the mail and email addresses for the legislators in students' districts. Have students send messages stating their opinions of the legislator's stand on an issue.  
*risk: low*  
*language level: intermediate-advanced*
  
9. Have students access the web site for your community. Get information regarding elected leaders, the model of your community government, city departments, meetings, etc.  
*risk: low*  
*language level: intermediate-advanced*
  
10. Have students contact a local official by mail or email about a problem in the community and give their opinion on how to solve it.  
*risk: low*  
*language level: intermediate-advanced*

## MODULE 2

# ◆◆◆ COMMUNITY AND HOME SAFETY ◆◆◆

## COMPONENTS

	Page
◆ TEACHER NOTES .....	55
◆ PICTURES	
• Pictures for Vocabulary Development .....	59
• Pictures for Language Experience .....	73
• Pictures for Group Story Writing .....	79
◆ READING PASSAGE	
• Pre-Reading Activity .....	82
• Reading Passage .....	83
• Vocabulary Activity 1-A .....	86
• Vocabulary Activity 1-B .....	87
• Vocabulary Activity 2-A .....	88
• Vocabulary Activity 2-B .....	89
• Comprehension Check .....	90
◆ EXTENSION ACTIVITIES	
• Dialogue 1: <i>Calling 911 to Report a Burglary</i> .....	91
• Dialogue 2: <i>Calling 911 to Report a Fire</i> .....	92
• Dialogue 3: <i>Calling 911 to Report a Medical Emergency</i> .....	93
• Dialogue 4: <i>Calling the Gas Company to Report a Gas Leak</i> .....	94
• Action Research Activity: <i>Important Telephone Numbers</i> .....	95
• Writing Activity: <i>Requesting Safety Information</i> .....	96
• Home Activity 1: <i>Car Safety for Children</i> .....	97
• Home Activity 2: <i>Emergency Escape Plan</i> .....	98
• Pair Activity: <i>Calling for Help</i> .....	99
• Cultural Comparison Activity: <i>Community and Home Safety</i> .....	100
◆ EXPERIENTIAL ACTIVITIES .....	101



## TEACHER NOTES

To introduce the topic of safety, show the vocabulary pictures of common safety equipment referred to in the reading passage (e.g., smoke alarm, first aid kit, seat belt, infant car seat, etc.). Ask students what these things are and why they are important.

After students recognize the theme of the module, ask them where it is important to practice safety. Elicit answers of at home, at work, in the car, on the street, and so on. Explore with them the safety precautions people need to know: first aid, CPR, poison control, transportation safety, and others. As adults they will have concerns about personal safety for themselves and their children as well as public safety in their community.

Supplemental information about community and home safety can be added at your discretion. If the level of the class and student interest warrant more detail, you can include additional information such as:

- Putting together a home first aid kit
- Specific safety requirements for students' jobs
- Finding out the curriculum for the community liaison officer (Officer Friendly) or D.A.R.E. programs for school children

## COMPETENCIES FOR MODULE 2

Students will learn to:

1. Call 911 (or other police/fire emergency telephone numbers) to report an emergency.
2. Distinguish between emergency and non-emergency situations.
3. State the laws regarding safe transportation of themselves and their children (e.g., proper use of restraints) in motor vehicles.
4. Develop an emergency escape plan for their house or apartment.
5. Identify safety education programs available in their community for adults and children.
6. Prepare a list of emergency telephone numbers for their community.
7. Participate in community outreach programs to enhance personal and community safety.

## THE VOCABULARY ACTIVITIES AND THE READING PASSAGE

The Reading Passage contains a large number of vocabulary words that may be unfamiliar to students. To facilitate the teaching of this module, Vocabulary Activities 1-A and 1-B correspond to the first part of the Reading Passage only (through "Transportation Safety"), while Vocabulary Activities 2-A and 2-B correspond to the rest of the Reading Passage ("Home Safety" through the end). You may choose to teach the Reading Passage in two parts, at two different class meetings, depending on the level of your class.

**TEACHER NOTES** continued**THE DIALOGUES**

When preparing to teach the dialogues, please note the following:

- Some communities have the AT & T Language Line to assist with interpreting for 911 calls. When the dispatcher realizes that the caller is limited English proficient, she will ask the caller's native language. The dispatcher then contacts the Language Line for an interpreter to facilitate the call.
- When there is a medical emergency, the dispatcher will ask numerous questions, such as "Is the victim breathing?" "How old is the victim?" "Is the victim male or female?" If the dispatcher feels that CPR is needed, she will ask the caller if he knows how to administer CPR. If the caller doesn't know CPR, the dispatcher will give directions. For more advanced students, you can add this information to the dialogues and role plays.
- For many emergency calls, the dispatcher will tell the caller to remain on the line until told to hang up.

**THE WRITING ACTIVITY**

For the writing activity, students will need actual addresses of agencies, networks and associations that provide free materials on safety issues. A short list is under Resources, below. (You may want to contact the agencies by telephone to be sure that the information is still current.) Additional resources are often suggested in reference books and pamphlets on safety issues.

**POSSIBLE AUTHENTIC MATERIALS**

- Safety brochures from your local police and fire department
- Safety information from the web sites of your police/fire department and city hall or township office
- Newsletters from your local community college, park district, or YMCA which list training opportunities for CPR and first aid

**RESOURCES\***Print Materials

Free brochures on crime prevention and street smarts are available from McGruff, 120 S. Riverside Plaza, Suite 1016, Chicago, IL 60606, (312) 793-8550. Check [www.icjia.state.il.us](http://www.icjia.state.il.us) for a complete list of free brochures.

Information and brochures (some downloadable) on preventing crime are available from The National Crime Prevention Council at [www.ncpc.org](http://www.ncpc.org).

A checklist of tips on traffic safety and other safety issues is available from The National Safe Kids Campaign, 111 Michigan Avenue NW, Washington, D.C. 20010-2970, (202) 939-4993.

**TEACHER NOTES** continued

A complete program on school bus safety is available from the National Safety Council, 444 N. Michigan Avenue, Chicago, IL 60611, (312) 285-1121. (Must be ordered by a teacher or a school.)

Information on hidden hazards in the home is available from the Gas Appliance Manufacturers Association, 4 West Nebraska Street, Frankfort, IL 60423, (800) 426-2811.

Safety-related information is available from the National Safety Council, 1121 Spring Lake Road, Itasca, IL 60143-3201, (800) 621-7619.

Many safety-related publications, services, and links to state and local offices are available from the Red Cross at [www.redcross.org](http://www.redcross.org)

Web Sites

There are many Internet web sites on specific safety issues. Often web sites designed for children are also appropriate for beginning and intermediate adult ESL students because of the graphics and simplified language. Here are a few good web sites to get you started:

Sparky the Fire Dog

[www.sparky.org/](http://www.sparky.org/)

An award-winning web site by the National Fire Prevention Association with games and more about fire safety.

U.S. Fire Administration Kid's Page

[www.usfa.fema.gov/kids/](http://www.usfa.fema.gov/kids/)

Tips, quizzes, and games on fire safety.

Maryland Community Crime Prevention Institute Neighborhood Watch Program

[www.dpscs.state.md.us/pct/ccpi/neighbor.htm](http://www.dpscs.state.md.us/pct/ccpi/neighbor.htm)

Information on how to organize a neighborhood watch program.

National Highway Traffic Safety Administration

[www.nhtsa.dot.gov](http://www.nhtsa.dot.gov)

Information and publications on air bags, child safety seats, school bus safety, and other traffic issues.

National Safe Kids Campaign

[www.safekids.org](http://www.safekids.org)

Information on product recalls, a car seat guide, safety resources (some in Spanish), and a kids' corner with puzzles and games.

National Safety Council

[www.nsc.org](http://www.nsc.org)

Articles, facts sheets, and links on topics such as driving, emergencies, first aid, and safety products.

**TEACHER NOTES** continuedVideos

*Crossroads Café* (1996). Unit 5, "Lost and Found," Unit 9, "Rush to Judgment," and Unit 12, "Turning Points." A 26-part video series set in a neighborhood restaurant featuring real-world social and cultural issues. Videos and tape scripts available from Intelecom, (800) 576-2988 or [www.intelecom.org](http://www.intelecom.org). Textbooks are available from Heinle & Heinle, [www.heinle.com](http://www.heinle.com). Videos may be used independently of textbooks.

*Plan to Get Out Alive*. An excellent fire safety video and an education resource catalog. Available from McDonald's Education Resource Center, 310 Tech Park Drive, LaVergne, TN 37086, (800) 627-7646.

\* This list of resources is also located at [www.thecenterweb.org](http://www.thecenterweb.org) (click on "The Adult Learning Resource Center") where it is updated annually.

PICTURES FOR VOCABULARY DEVELOPMENT

EMERGENCIES

call 911

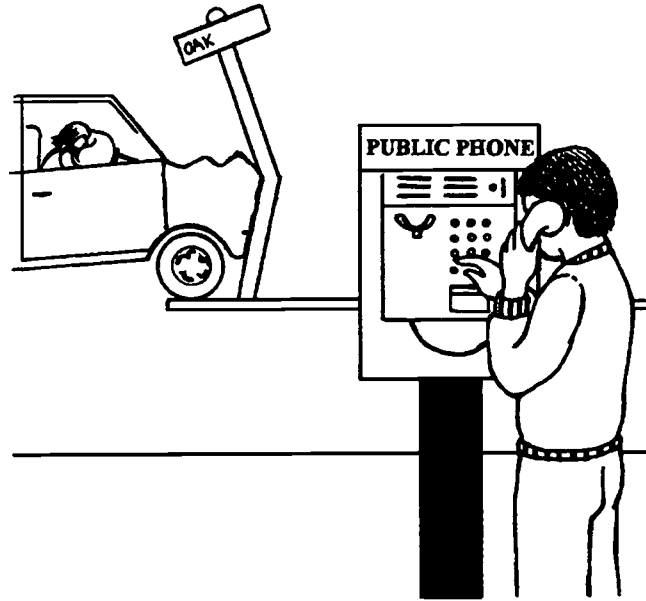

ambulance

injured

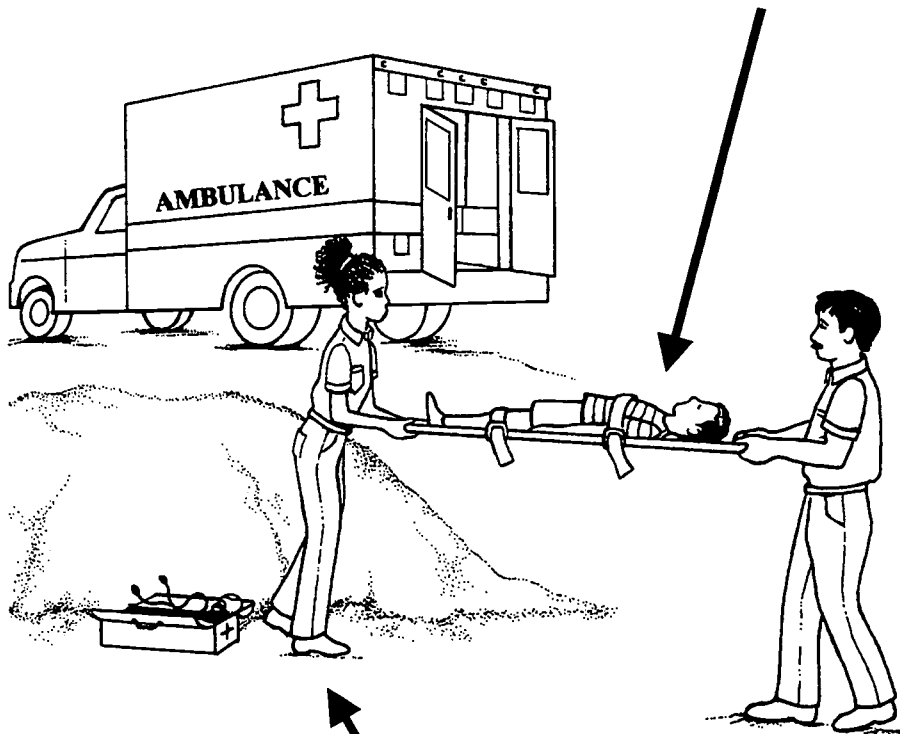

paramedics

PICTURES FOR VOCABULARY DEVELOPMENT continued

EMERGENCIES

police

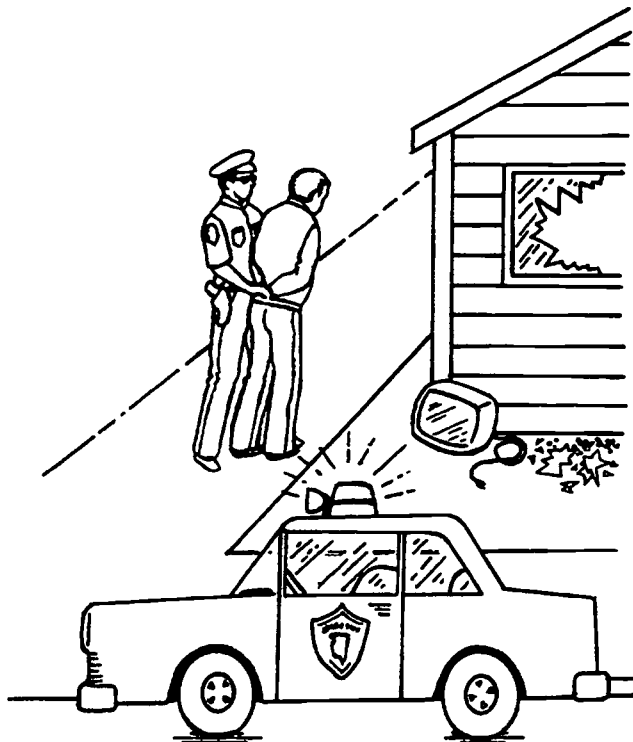

fire



PICTURES FOR VOCABULARY DEVELOPMENT continued

NON-EMERGENCIES

report stolen property

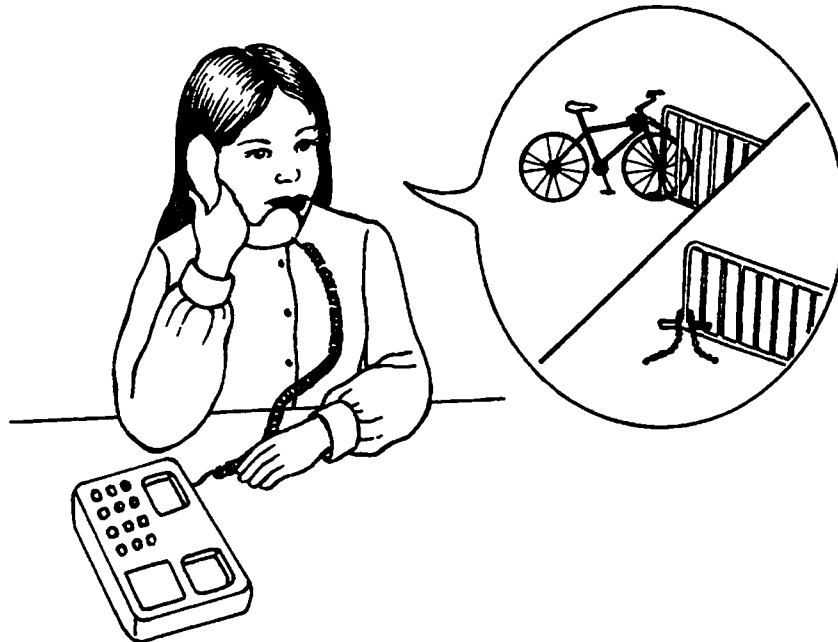

report damaged property



PICTURES FOR VOCABULARY DEVELOPMENT continued

CHILD CAR SEATS

Remember: Always put child car seats in the back seat.  
Do not use car seats that have been in a car accident.

infant car seat

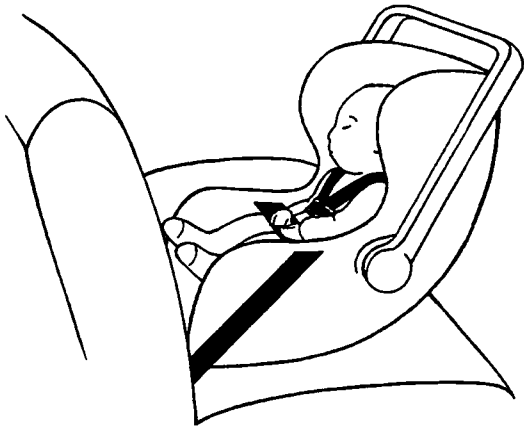

rear facing  
up to 20 pounds

child car seat



convertible  
(rear facing up to 20 pounds,  
forward facing 20 - 40 pounds)

child car seat



20 - 40 pounds

booster seats

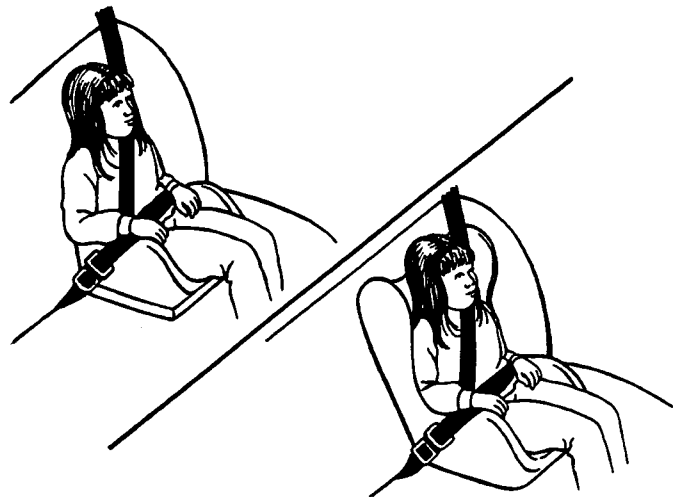

40 - 80 pounds  
up to 4'9" tall



PICTURES FOR VOCABULARY DEVELOPMENT continued

TRANSPORTATION SAFETY

seat belt

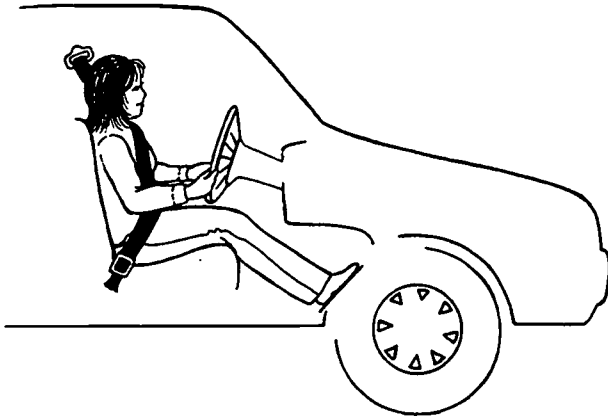

airbag

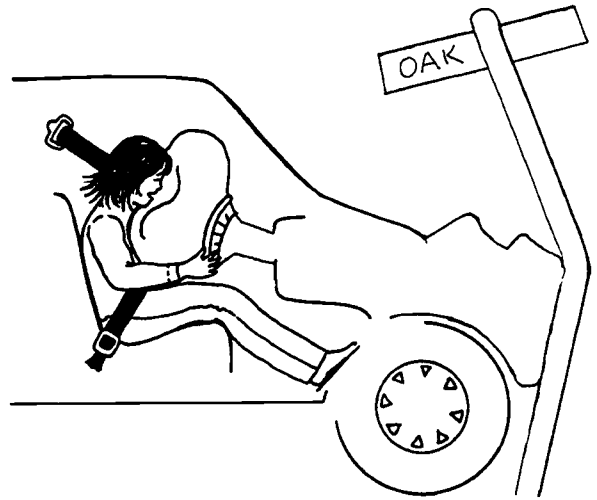

safety ordinance

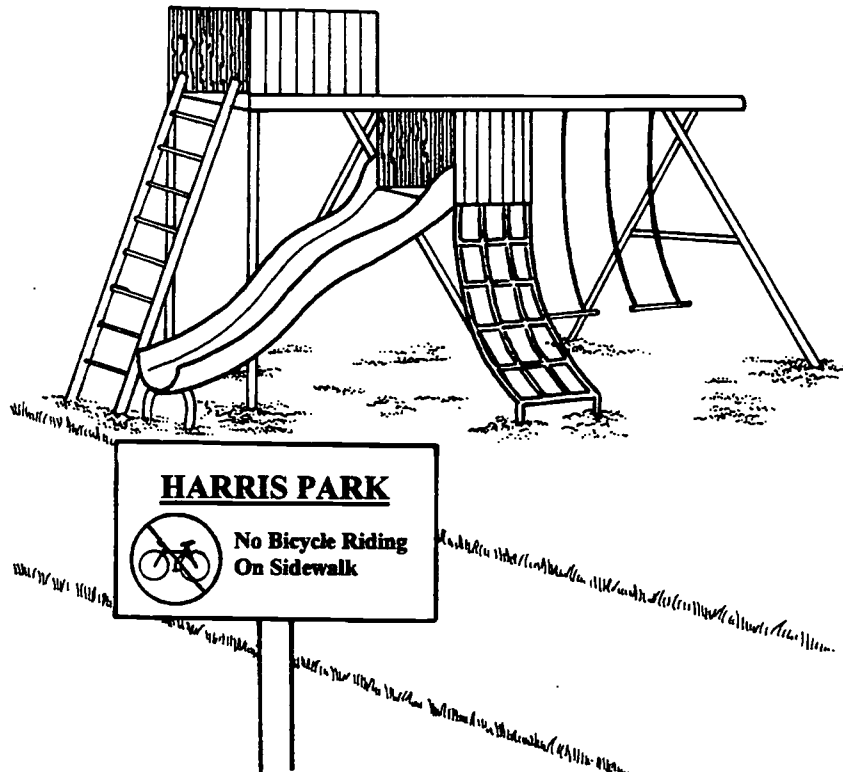

PICTURES FOR VOCABULARY DEVELOPMENT continued

HOME SAFETY

fire escape plan

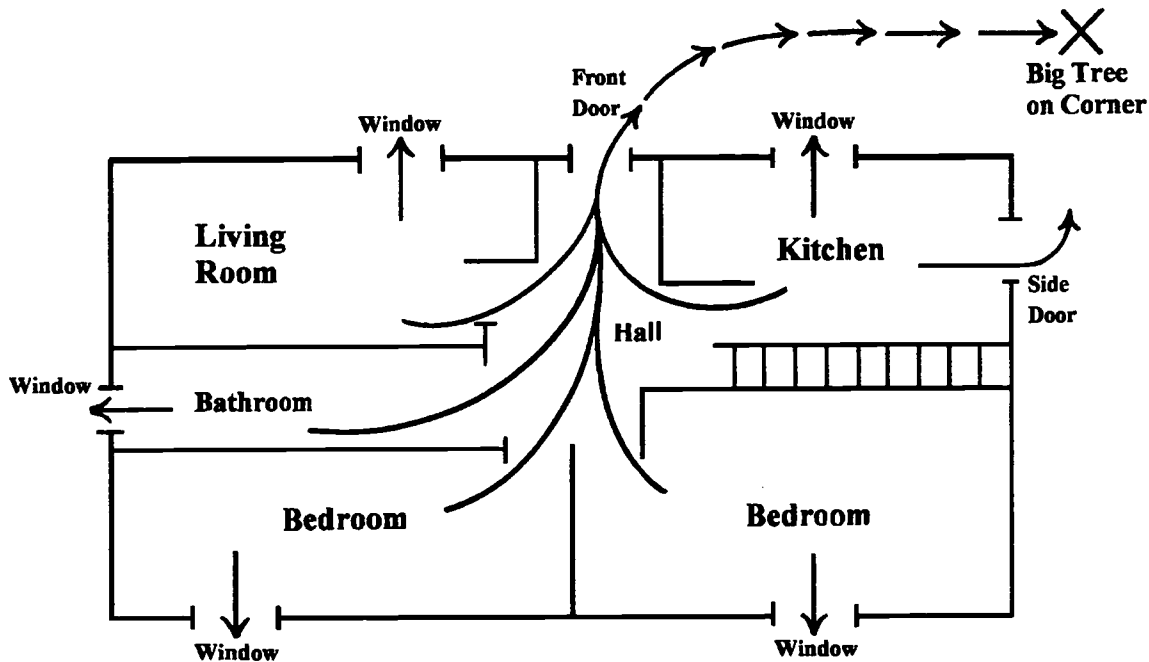

smoke alarm

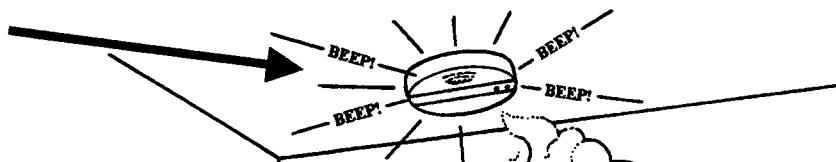

fire extinguisher



PICTURES FOR VOCABULARY DEVELOPMENT continued

HOME SAFETY

space heater

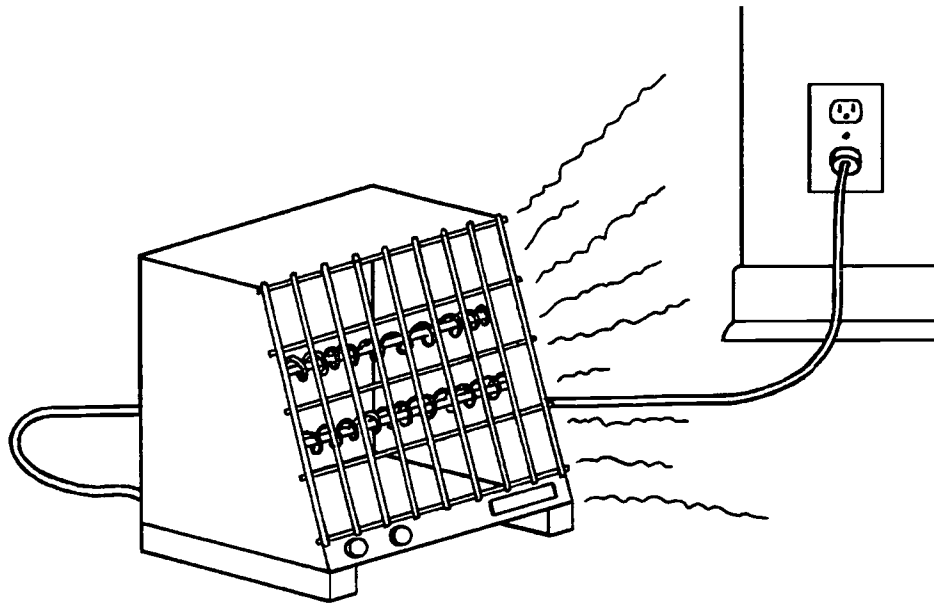

carbon monoxide detector

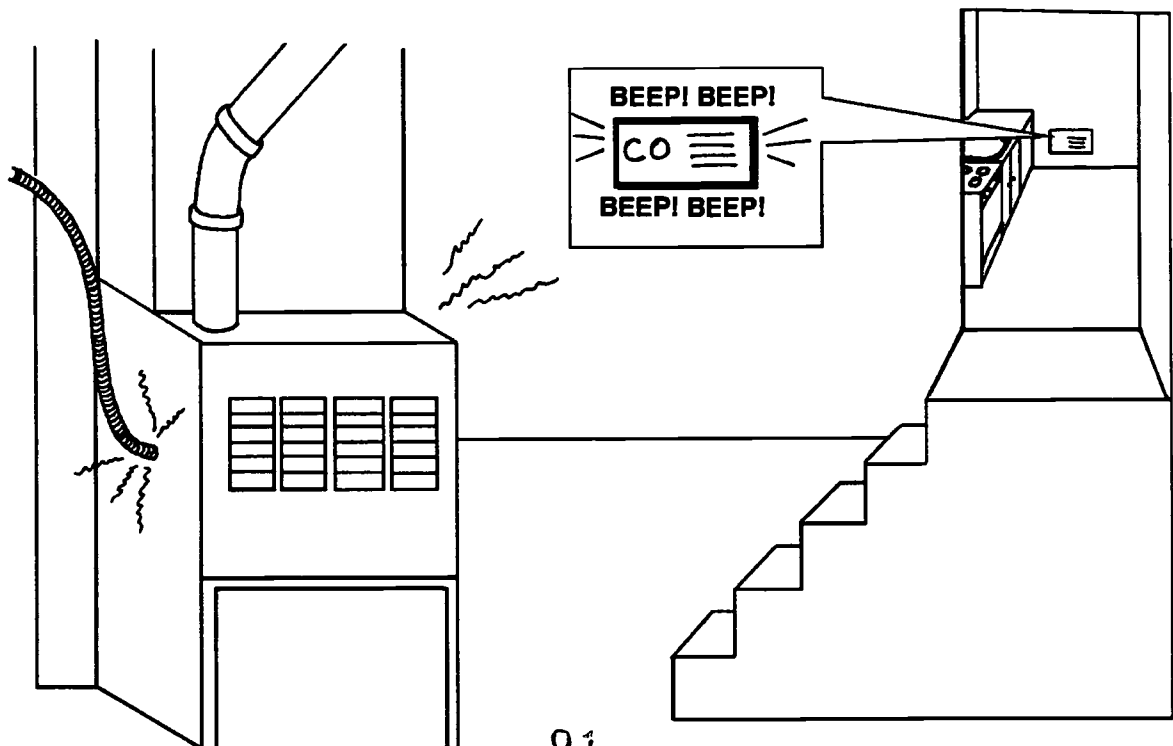

PICTURES FOR VOCABULARY DEVELOPMENT continued

HOME SAFETY

natural gas

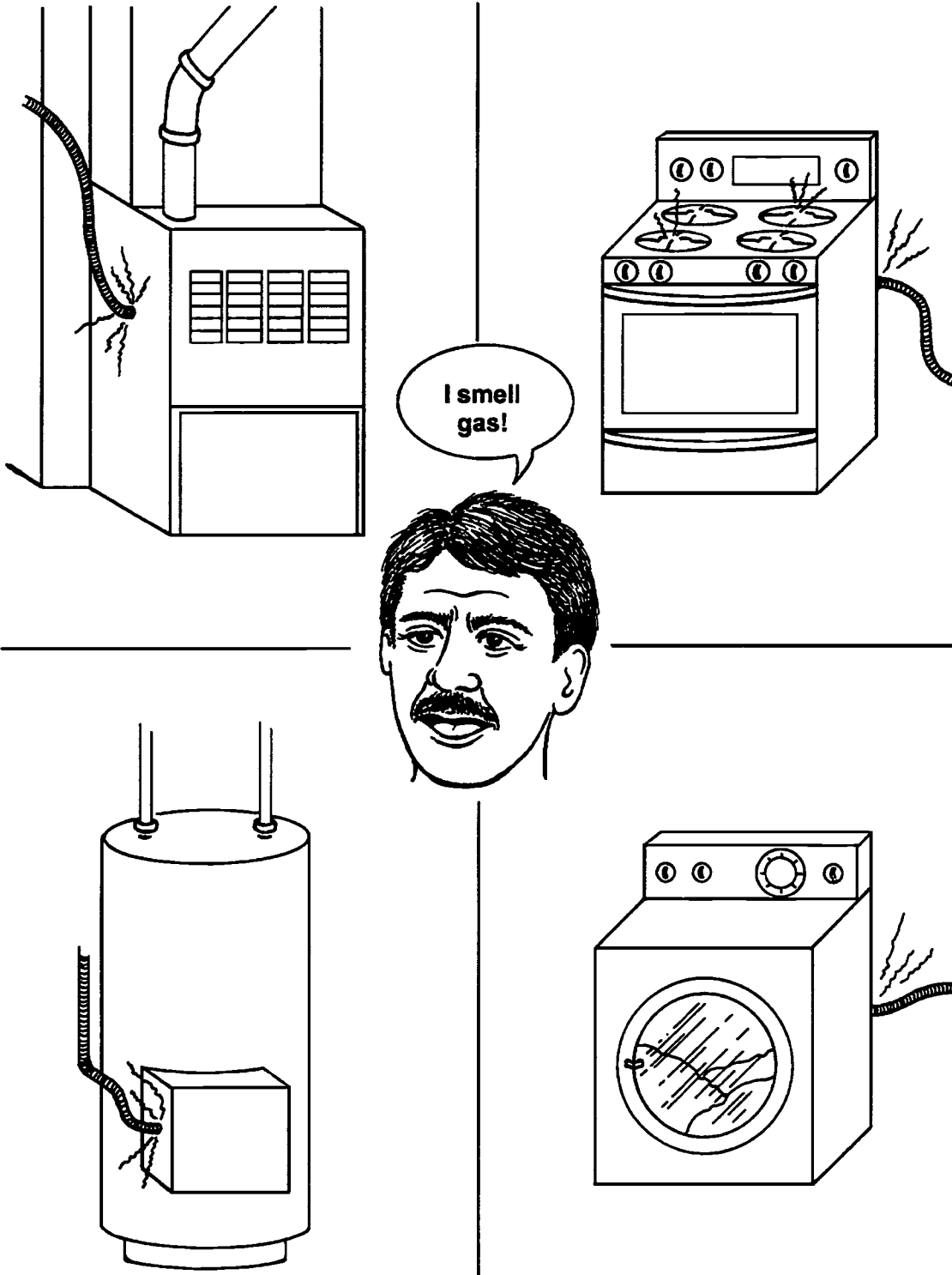

PICTURES FOR VOCABULARY DEVELOPMENT continued

HOME SAFETY

poisons

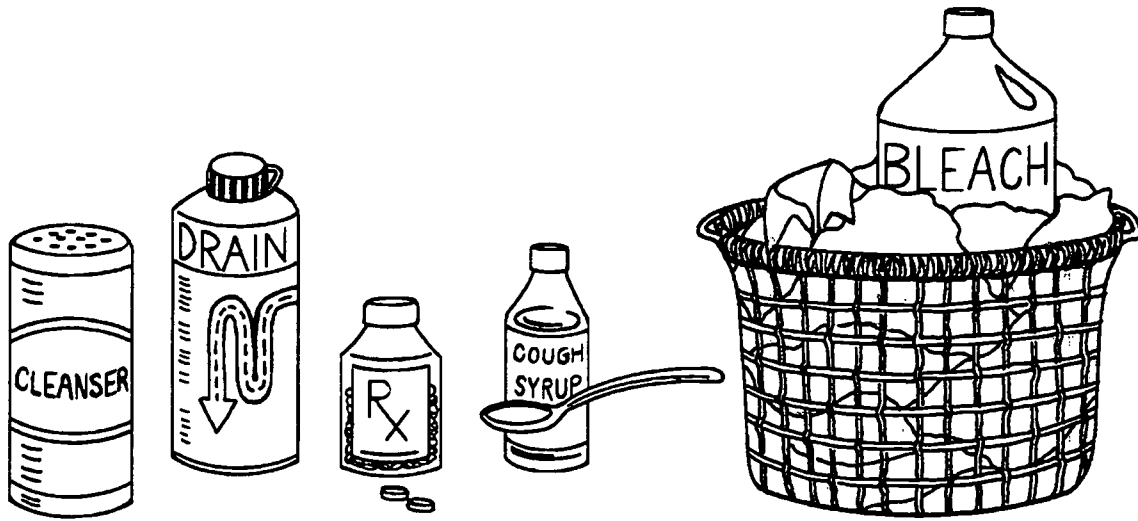

keep away from children

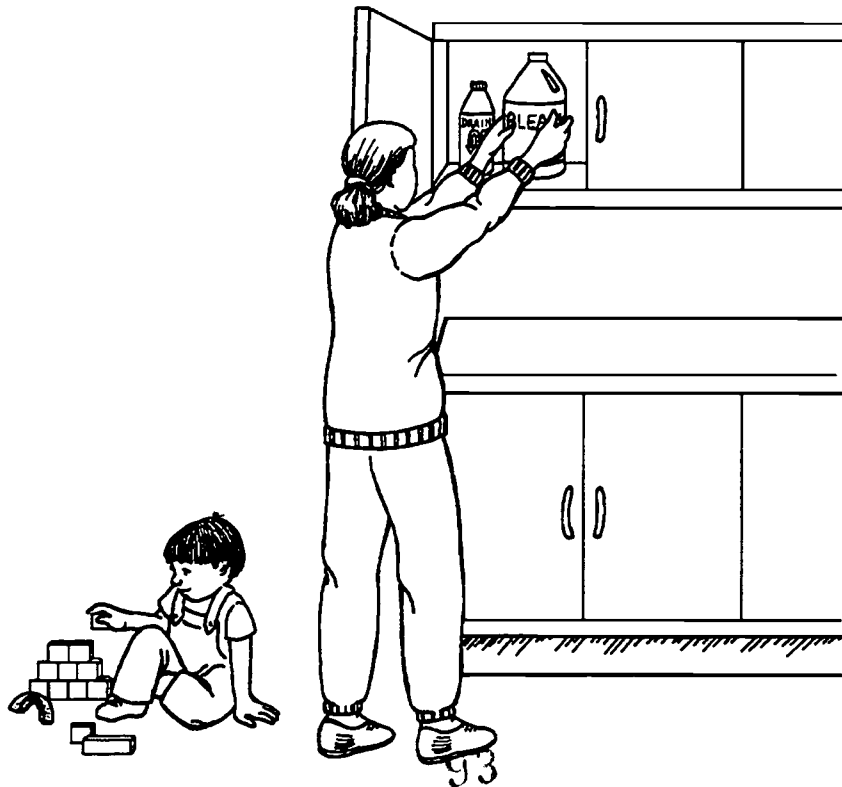

PICTURES FOR VOCABULARY DEVELOPMENT continued

SAFETY EDUCATION

Safety Town

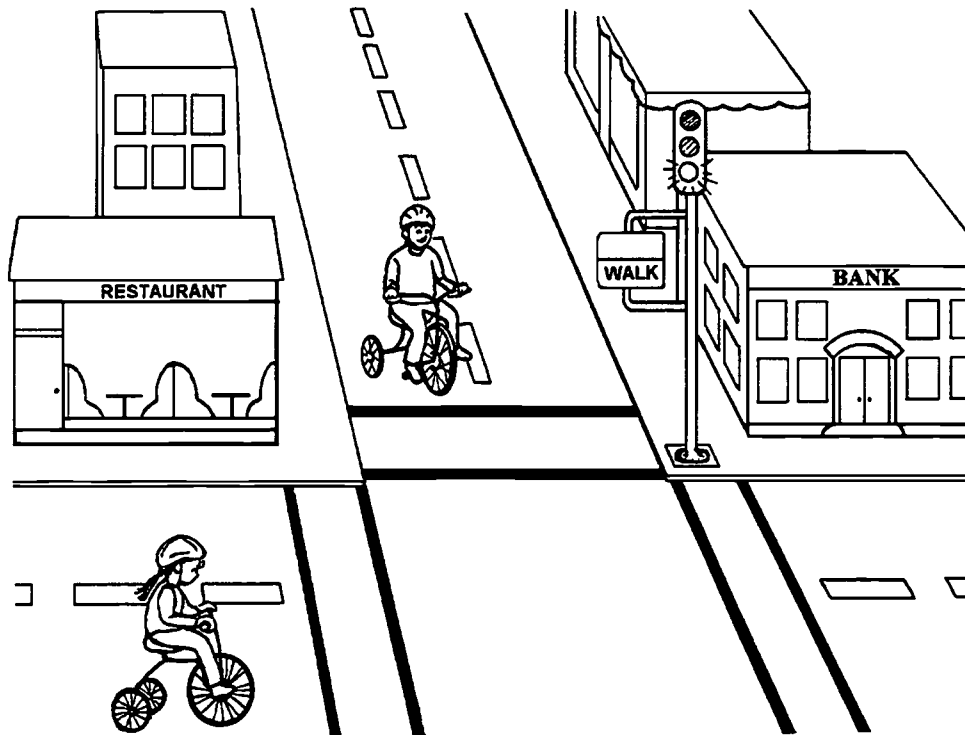

CPR

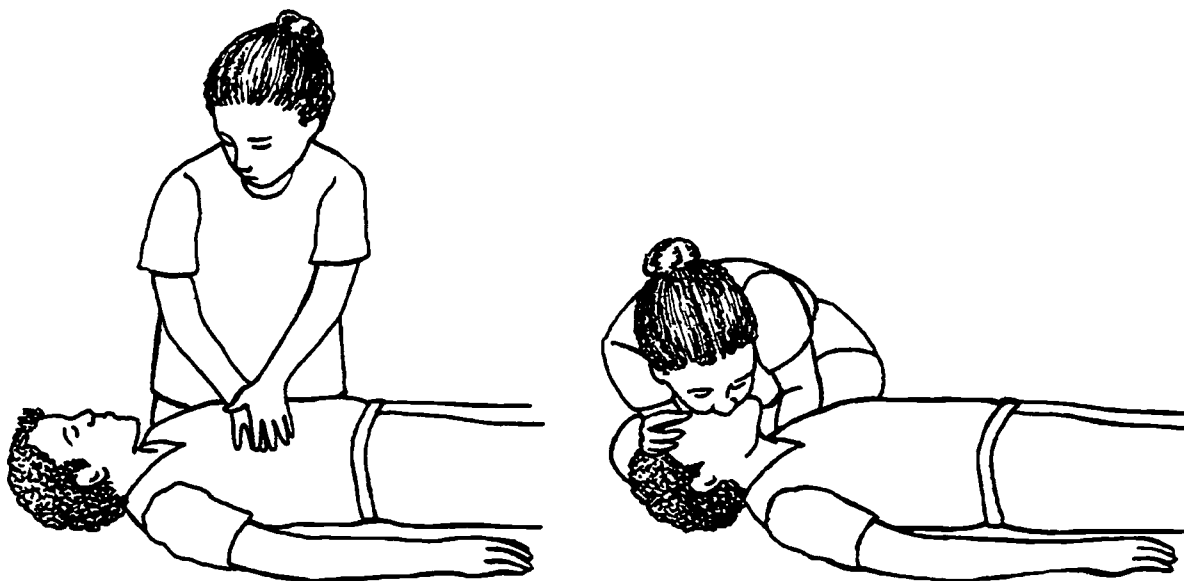

PICTURES FOR VOCABULARY DEVELOPMENT continued

SAFETY EDUCATION

choking/Heimlich maneuver



first aid

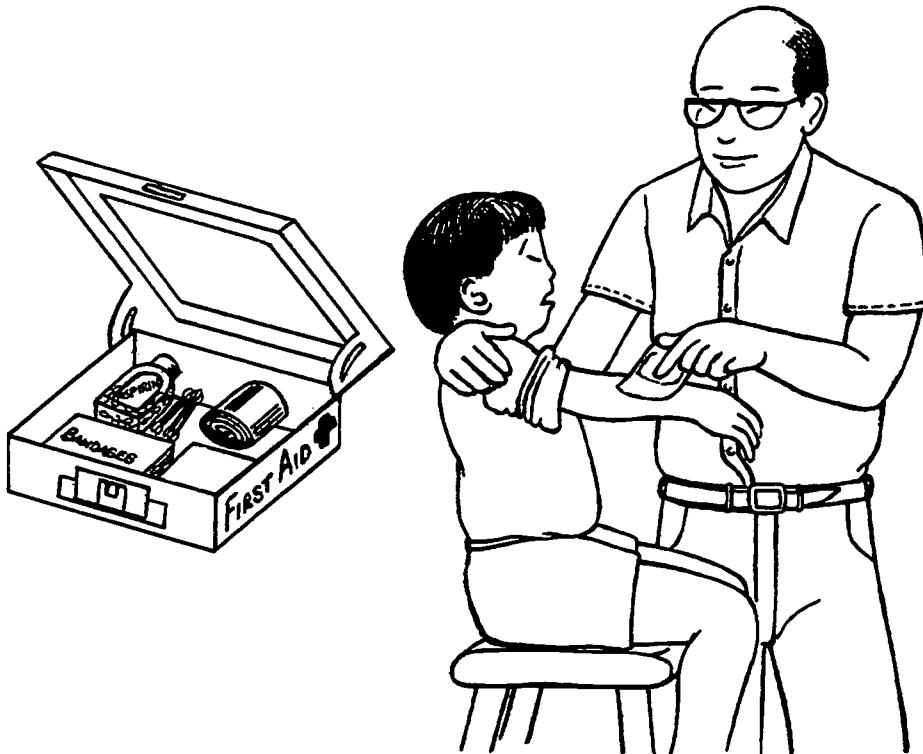

PICTURES FOR VOCABULARY DEVELOPMENT continued

CRIME/CRIMINAL ACTIVITY

mugging/robbery



burglary

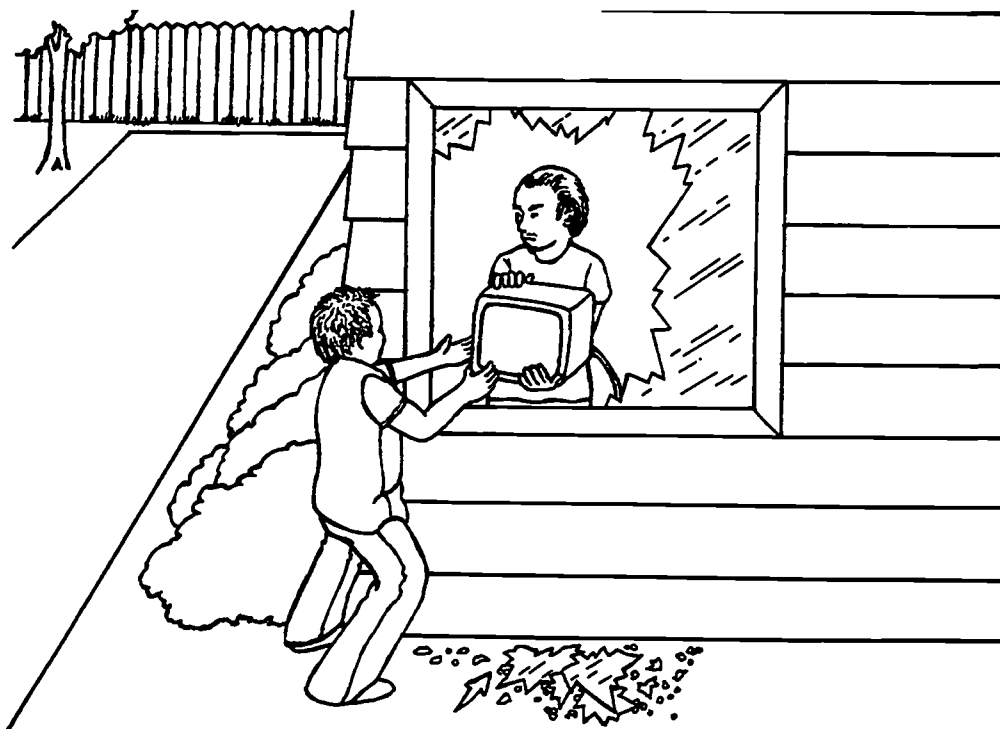



PICTURES FOR VOCABULARY DEVELOPMENT continued

COMMUNITY SAFETY

report suspicious activity

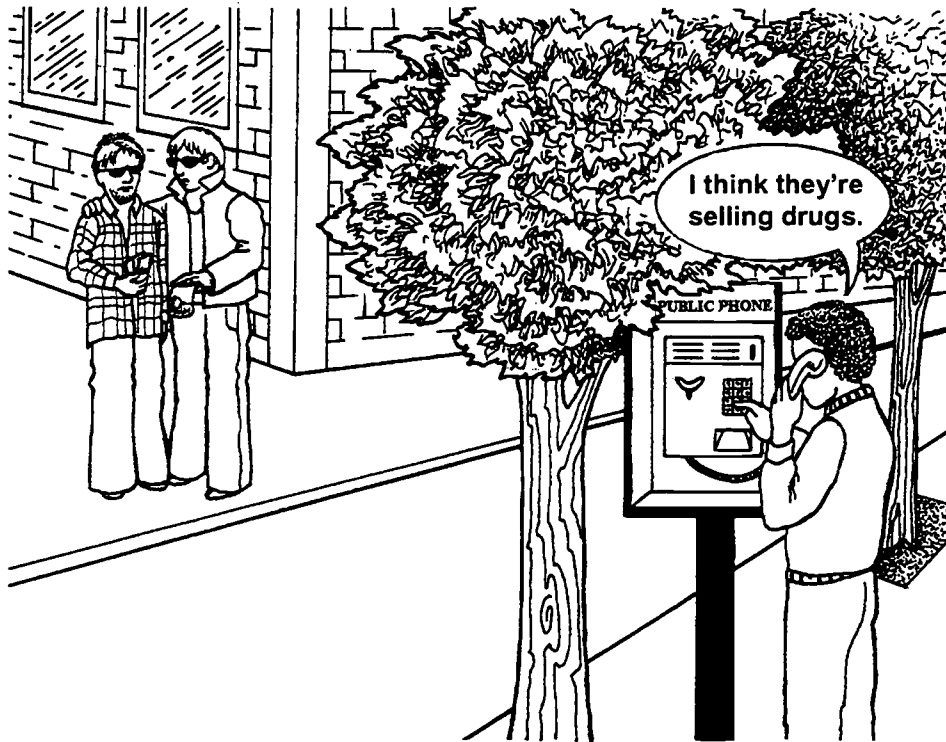

report crimes anonymously

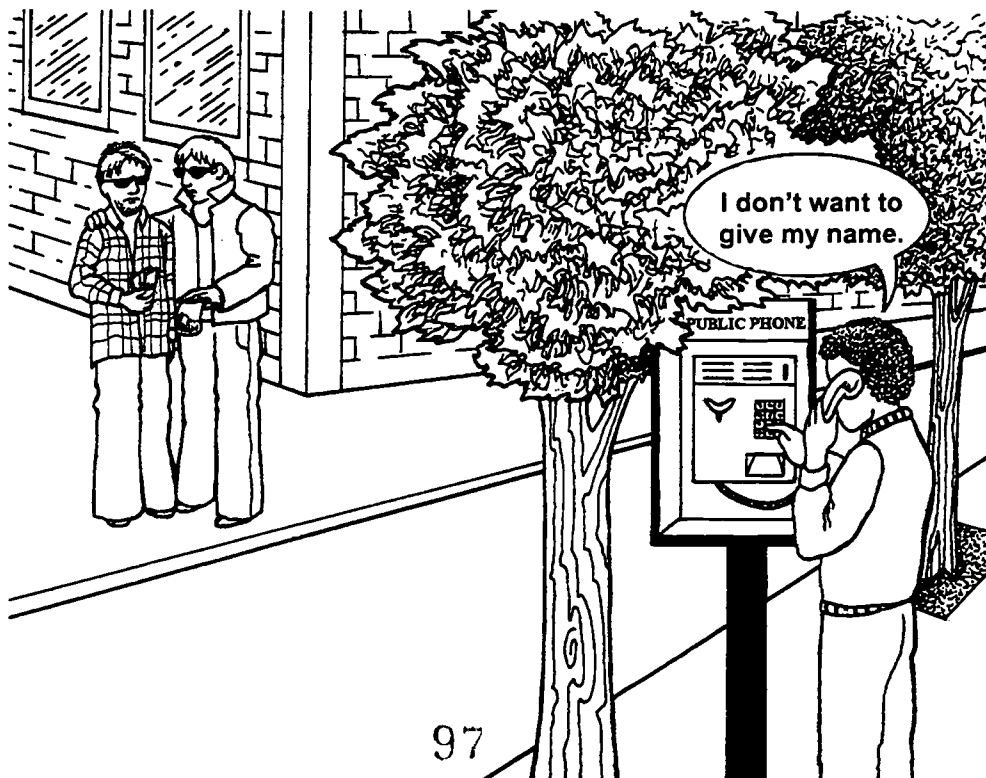

PICTURES FOR VOCABULARY DEVELOPMENT continued

COMMUNITY SAFETY

Neighborhood Watch Program

1:00 pm

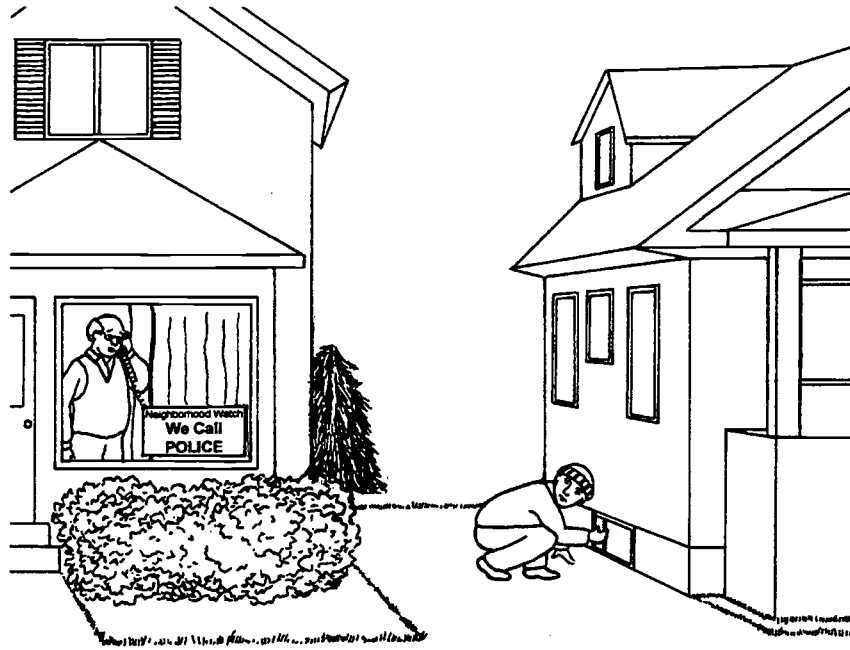

1:10 pm

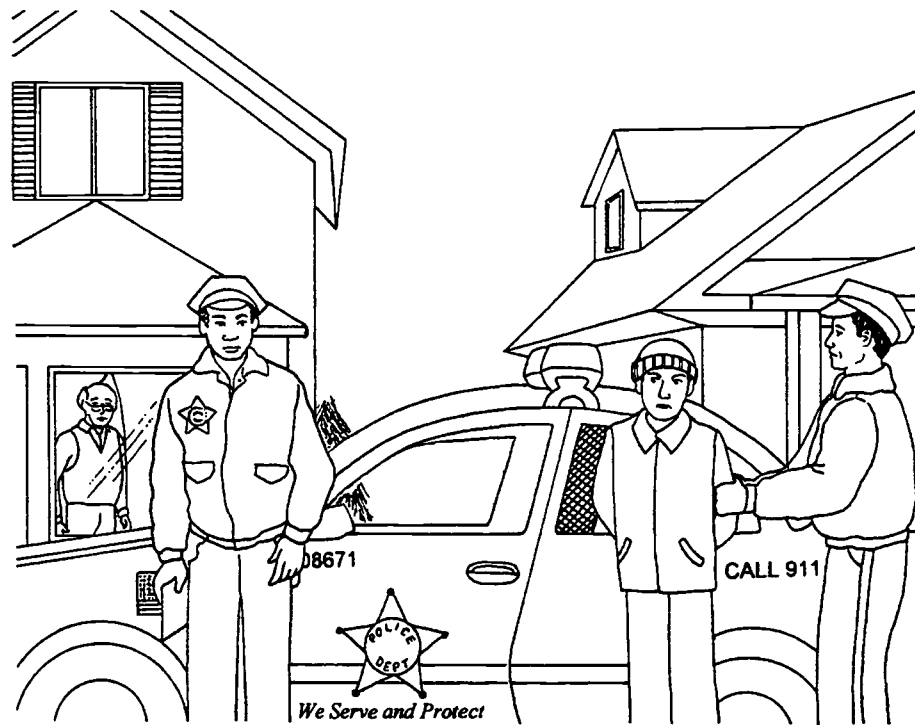

PICTURES FOR LANGUAGE EXPERIENCE

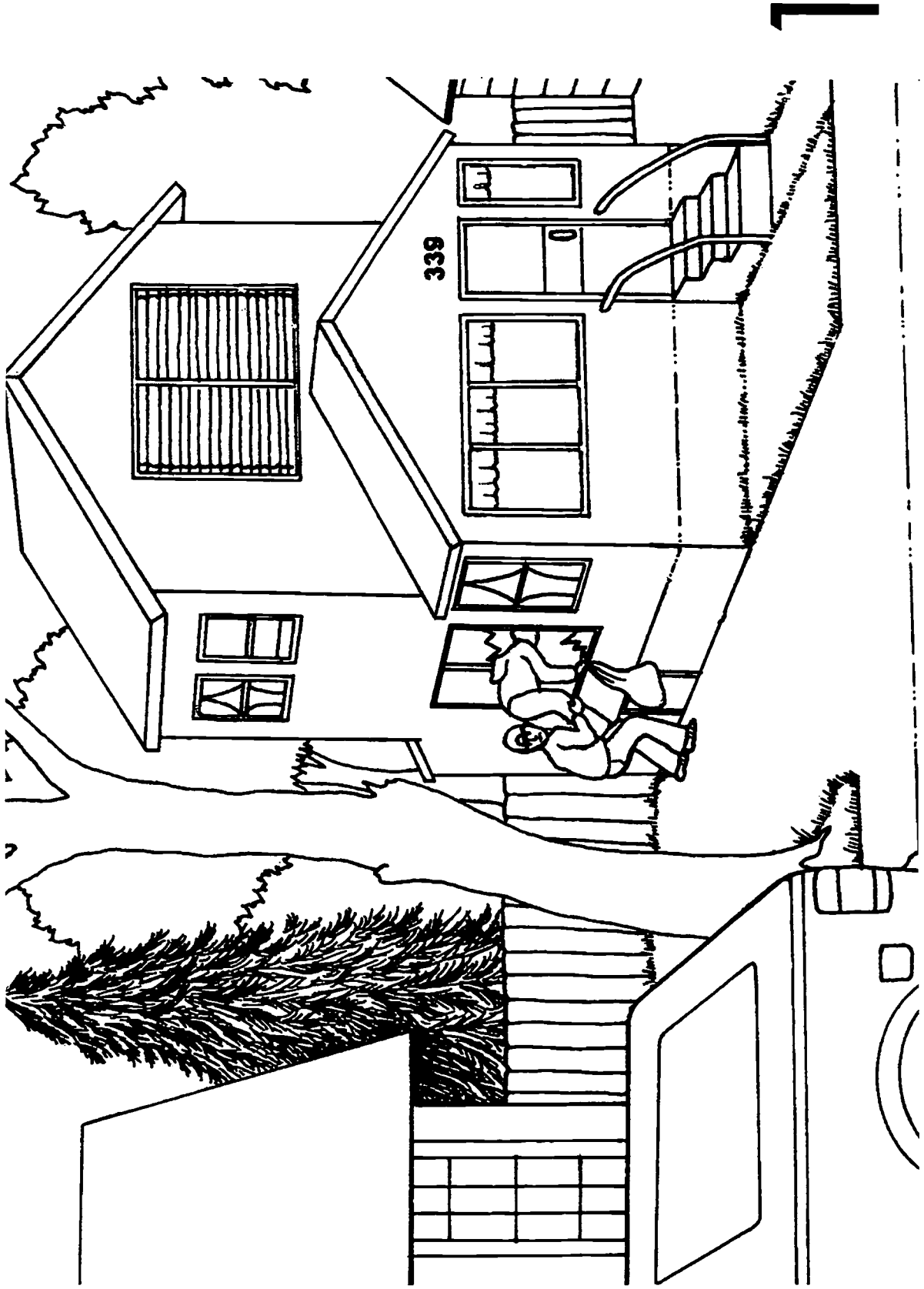

PICTURES FOR LANGUAGE EXPERIENCE continued

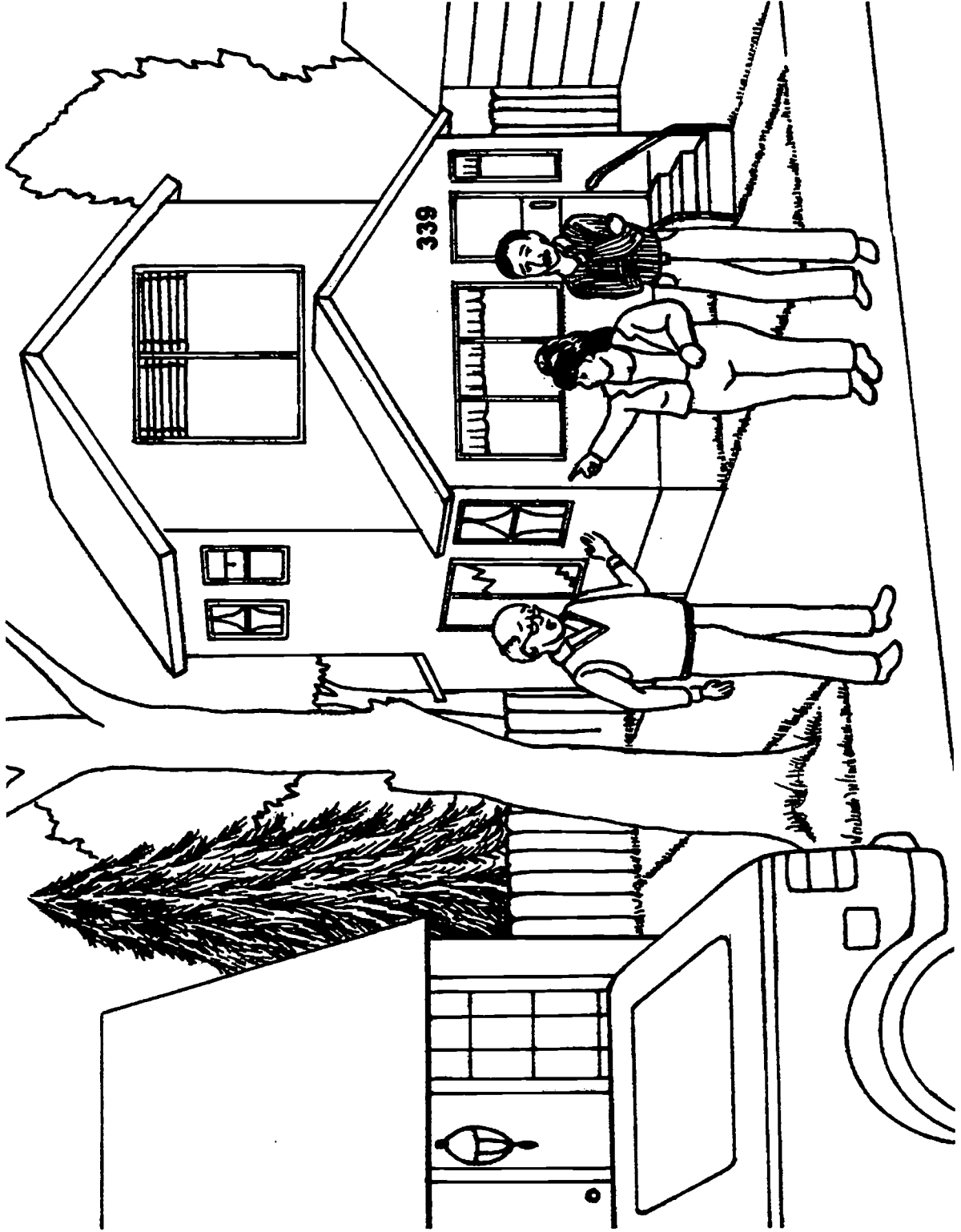

2

PICTURES FOR LANGUAGE EXPERIENCE continued

**5 BURGLARIES  
IN ONE WEEK!  
HELP STOP  
NEIGHBORHOOD  
CRIME!**

**Come to a meeting  
at North Park  
Tuesday  
October 2  
7:30 PM**

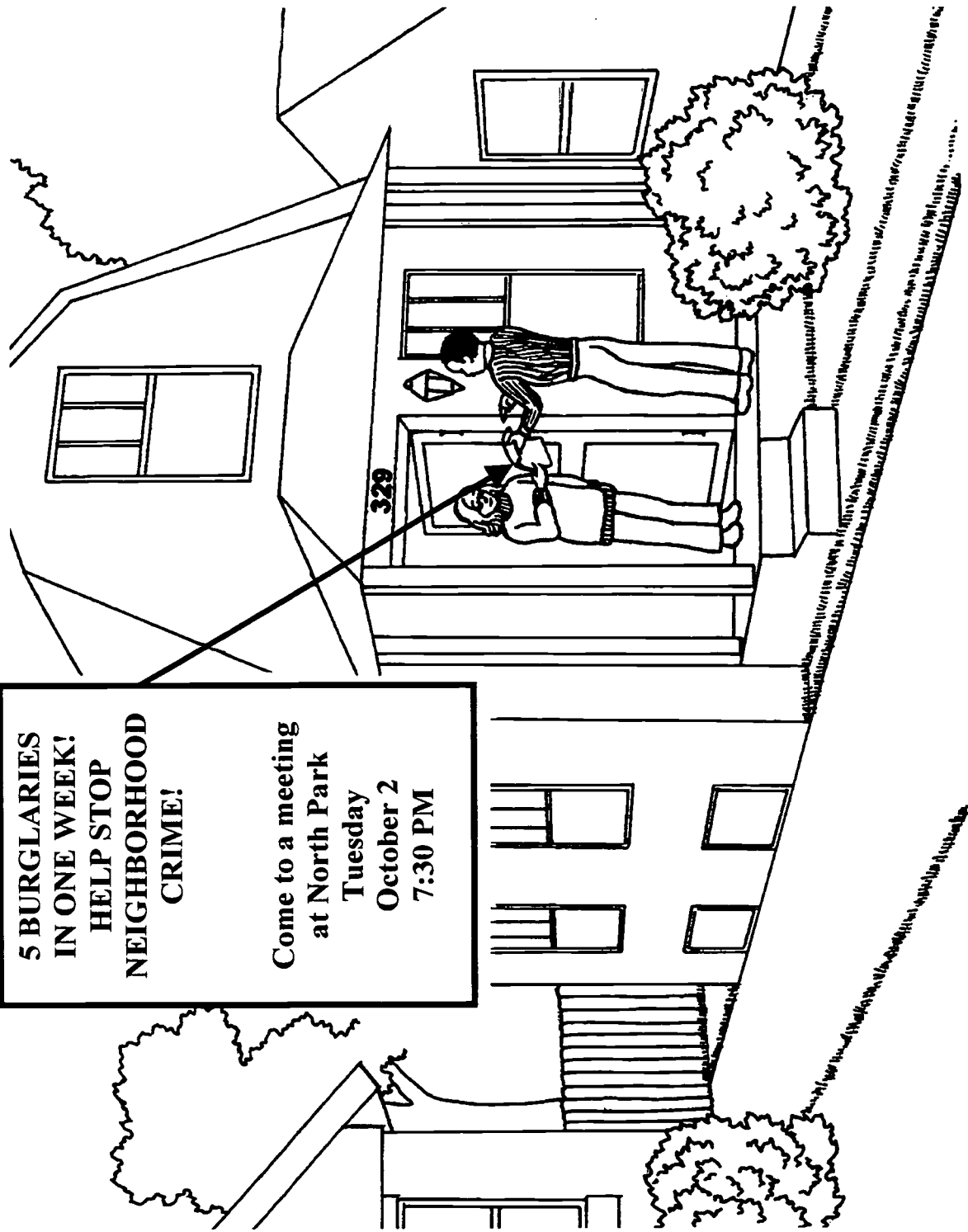

PICTURES FOR LANGUAGE EXPERIENCE continued

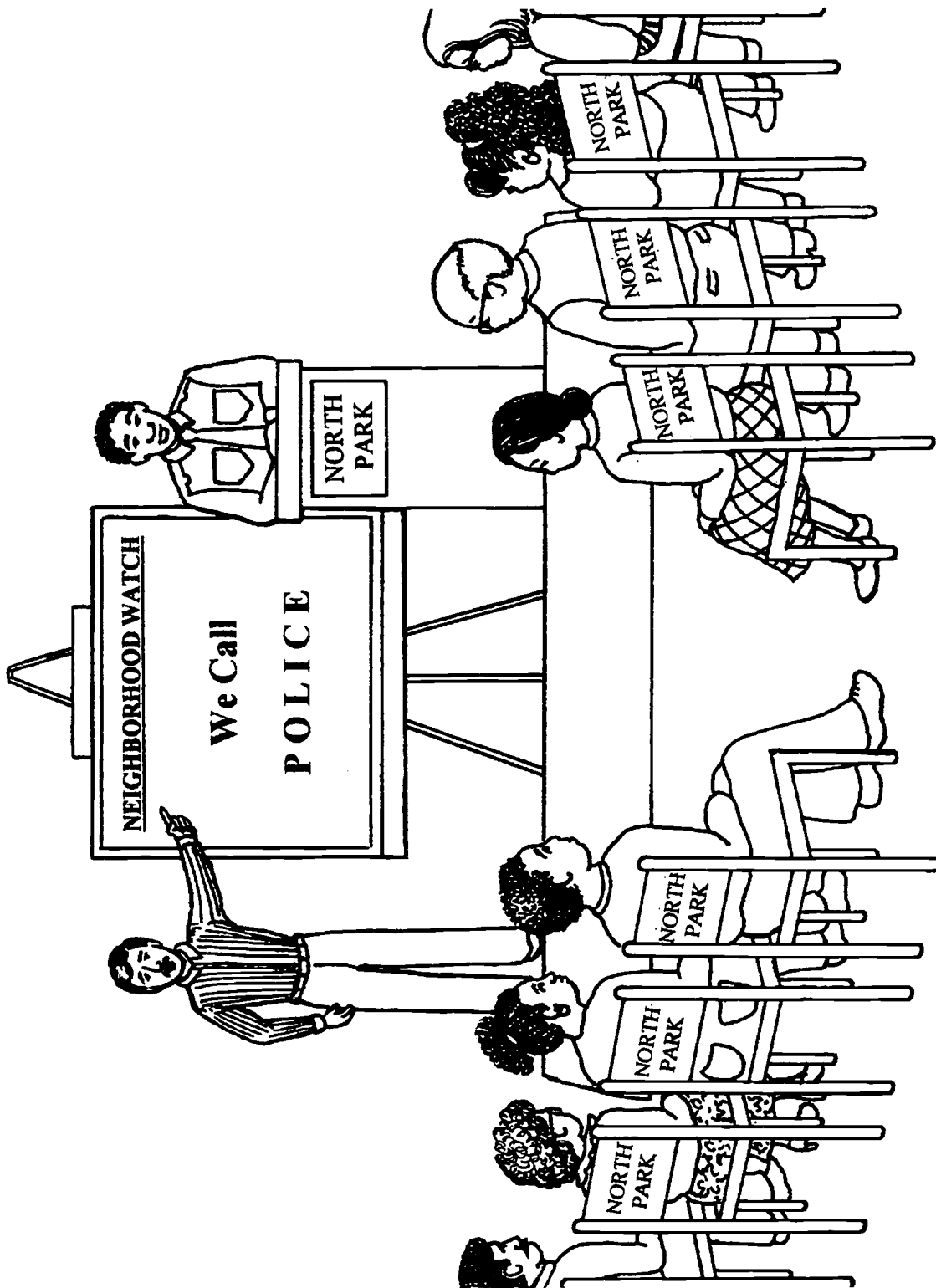

4

PICTURES FOR LANGUAGE EXPERIENCE continued

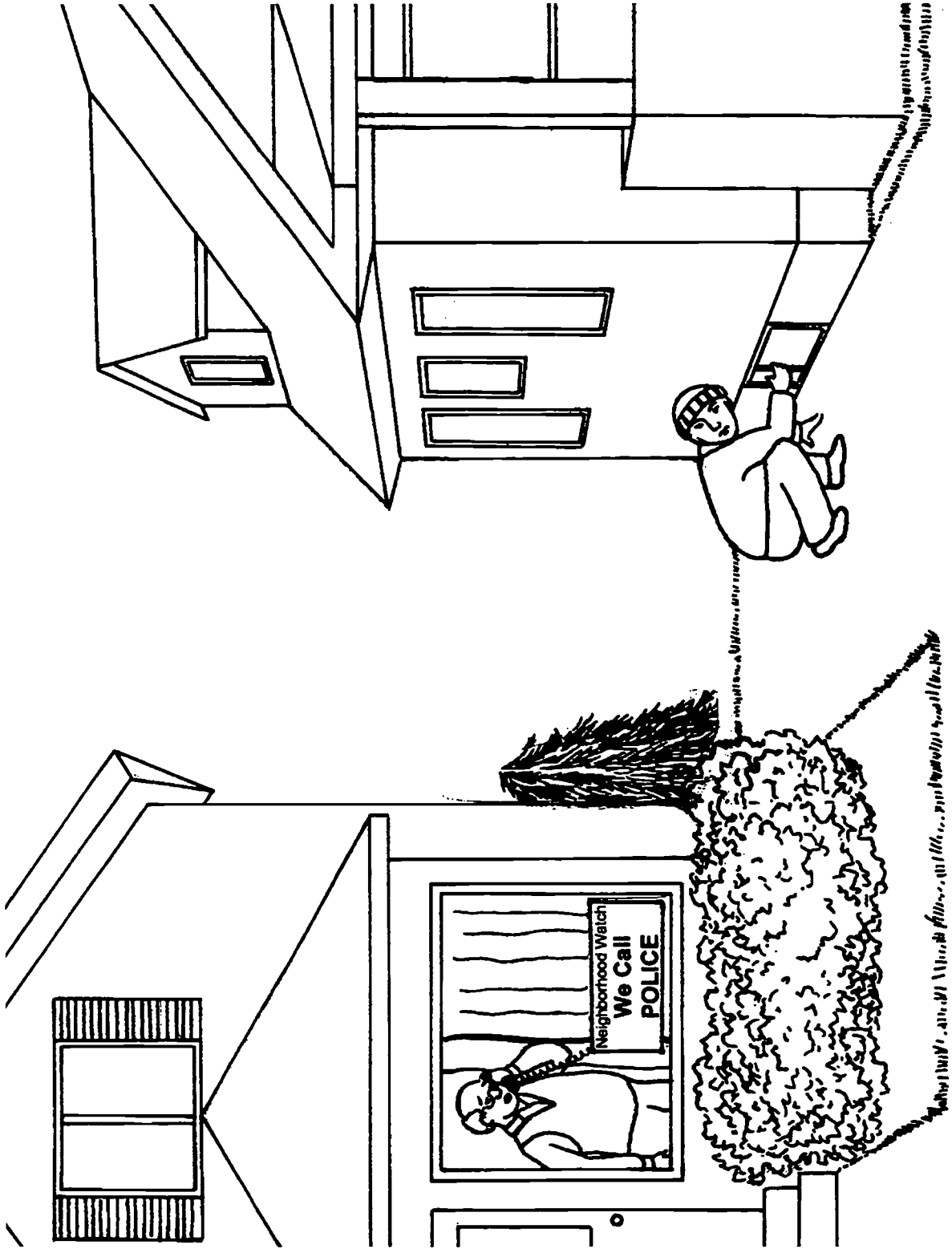

5

PICTURES FOR LANGUAGE EXPERIENCE continued

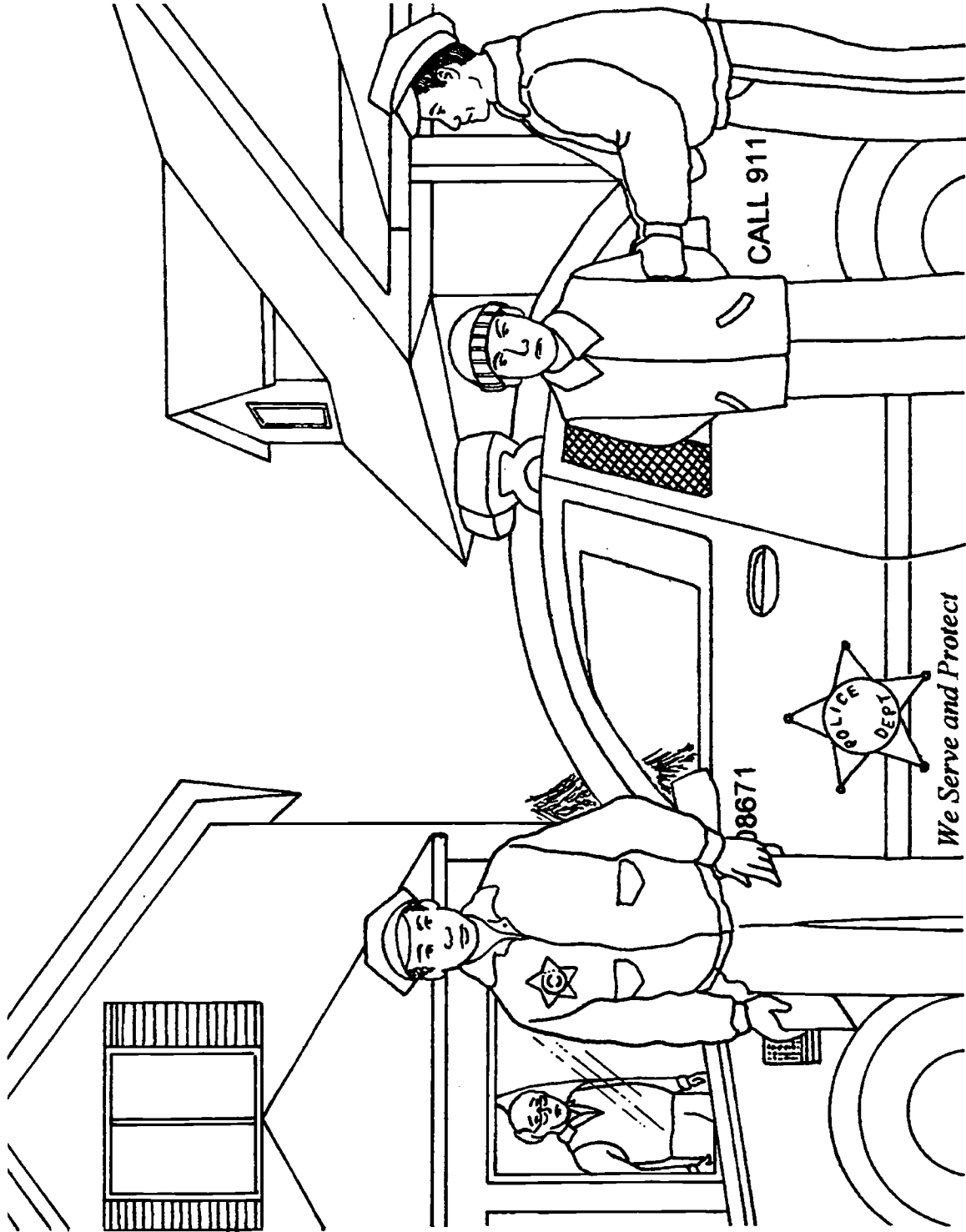

6



PICTURES FOR GROUP STORY WRITING

*Directions:* Work in groups of three or four. Write a story about the pictures below and on the next pages. Write one or more sentences for each picture. Then share your story with the class.

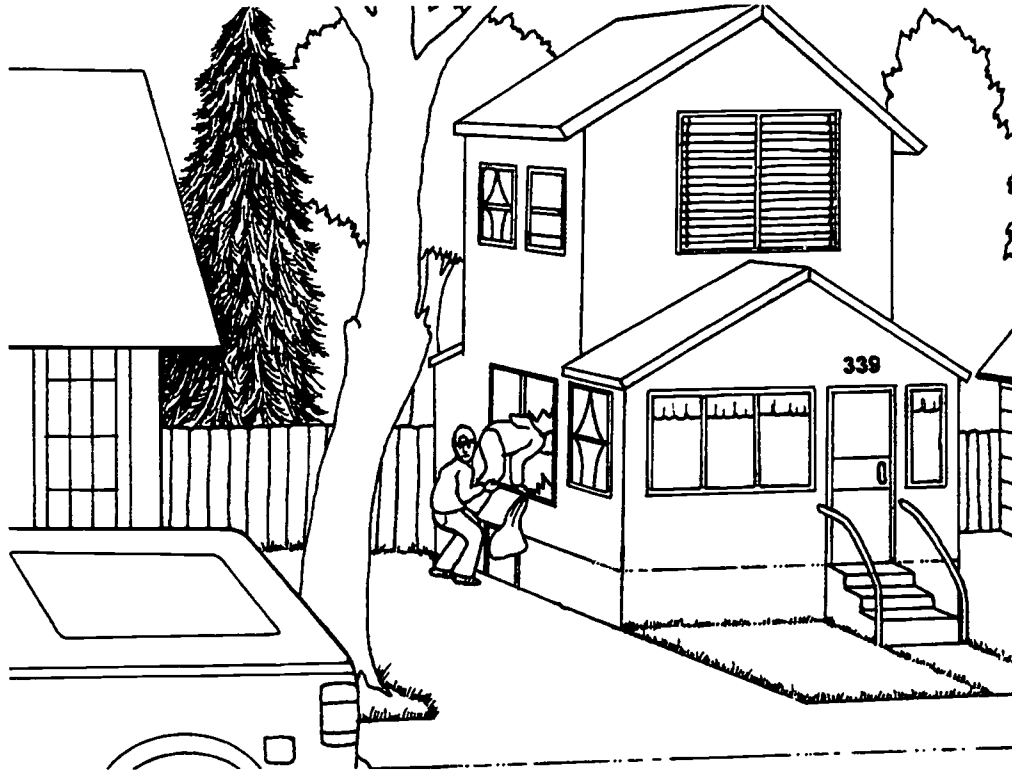

1



2

PICTURES FOR GROUP STORY WRITING continued

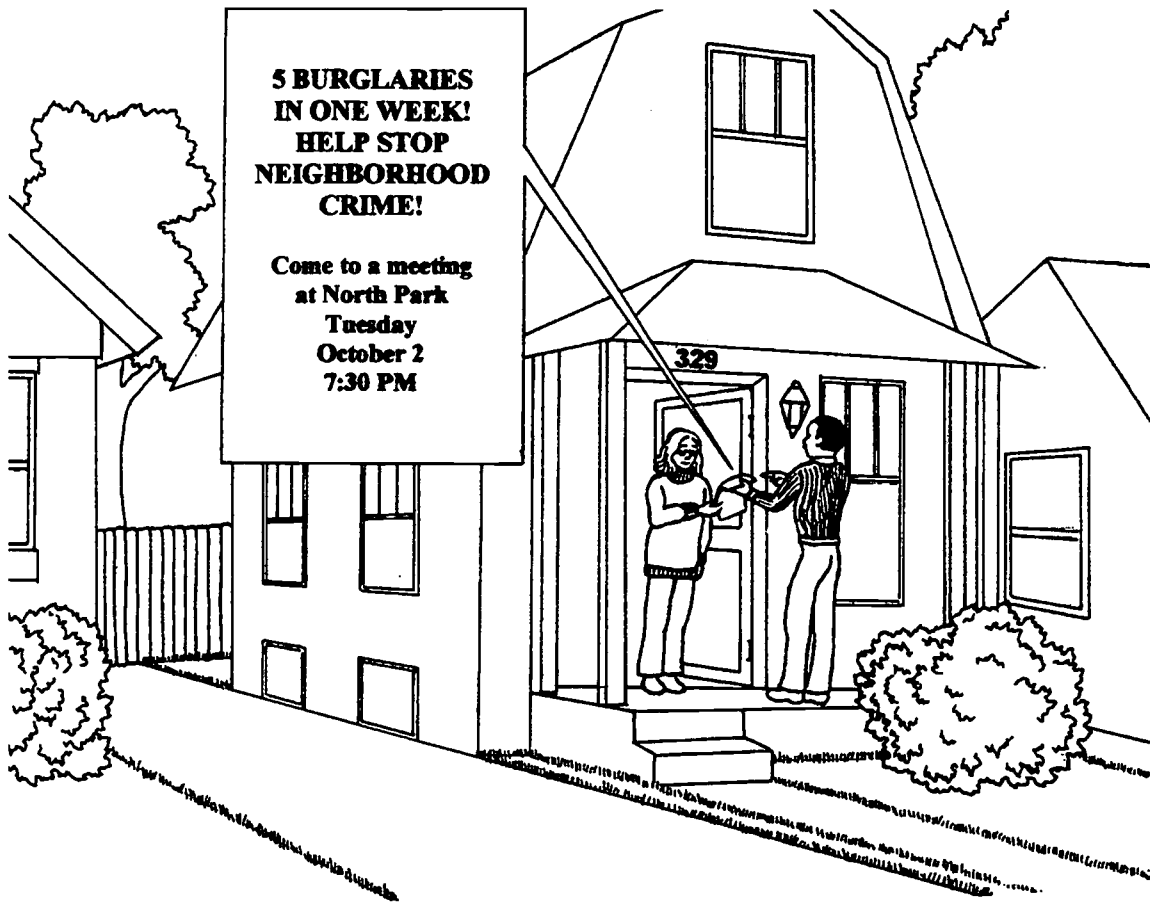

3



4

PICTURES FOR GROUP STORY WRITING continued

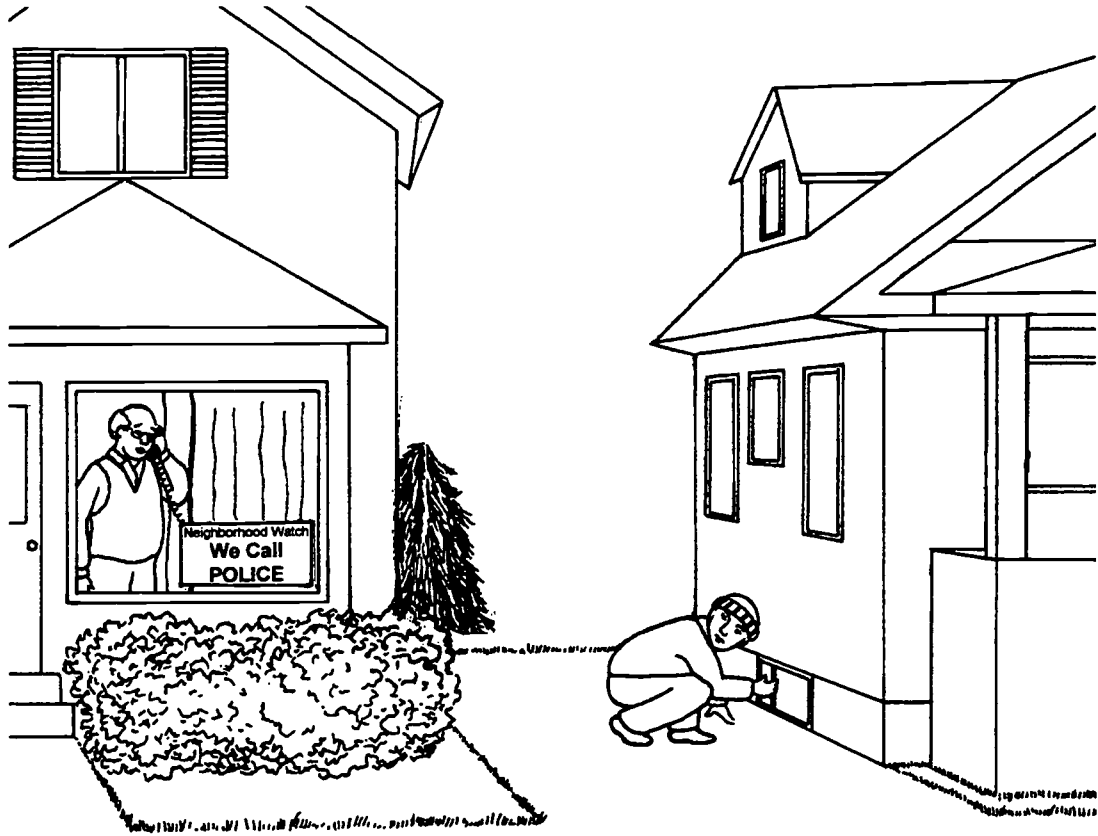

5



6

107

**READING PASSAGE: Pre-Reading Activity**

*Directions:* Think about safety in your community. Discuss the answers to the questions below with your classmates. (Optional: Write the answers to the questions.)

1. Have you ever called the police or fire department? Why? What happened?
  
2. Have you ever been robbed? What happened?
  
3. Do you have any safety equipment in your house or apartment? Do you have smoke alarms, fire extinguishers, or carbon monoxide detectors?
  
4. Do you wear a seat belt when you drive? Do your passengers wear seat belts? Do you have special car seats for your children?
  
5. Do you know how to give CPR or help a choking person?
  
6. Is there crime in your neighborhood? What kind?

## READING PASSAGE

There are many laws and community programs to keep people safe. People must take responsibility to protect themselves and their community.

### EMERGENCIES

An emergency is a serious situation that is often life threatening. There are police, fire, and ambulance services to help people in an emergency. Most communities have the special telephone number 911 for emergencies. But in some communities, people call the police or fire department for emergencies.

Police will come when there is a dangerous situation, a serious car accident, or a crime in progress. The fire department will come for fires in homes, cars, or on property. If someone is seriously sick or injured, paramedics will respond.

To get help quickly you should:

- Call 911 (or your local police/fire emergency number). You can call 911 from any pay phone with no money.
- Give your name and explain the emergency.
- Tell where the emergency is.
- Do not hang up until the operator tells you.

### NON-EMERGENCIES

Sometimes people need to call the police or fire department when it is not an emergency. Non-emergencies require different phone numbers. These numbers are in the telephone book. People can call the non-emergency police department number to report stolen or damaged property. They can call the non-emergency fire department number for information about smoke alarms or to report a broken fire hydrant. It is important to know the difference between an emergency and a non-emergency.

### TRANSPORTATION SAFETY

There are many laws for transportation safety. The driver and front-seat passengers in a car must wear seat belts. Babies and children under 40 pounds must ride in special car seats. Many hospitals provide free or inexpensive infant car seats if parents have no money to buy them. Laws in some states require older children to use special booster seats with the regular seat belts. Car seats must be used in every car that young children ride in.

Most cars have airbags in the front seat. These airbags can hurt or kill young children. Children under 12 should sit in the back seat away from airbags.

Many cities and towns have safety ordinances about motorcycles, bicycles, roller blades, or scooters. In many communities, riders must wear helmets and follow other safety rules.

**READING PASSAGE** continued**HOME SAFETY**

There are many ways to keep houses and apartments safe from fires and poisonous fumes. Houses and apartments need special equipment such as smoke alarms, fire extinguishers, and carbon monoxide detectors. To prevent fires, people should carefully follow directions for space heaters. They should use the kitchen oven only for cooking, not for heating the house. If people smell natural gas, they should immediately call the gas company or fire department.

All families should have an emergency escape plan for their house or apartment. Family members need to know what to do in case of fire. For example, the escape plan might include window exits or fire escapes. There should be a special meeting place outside to see if everyone got out safely. By practicing their escape plan, families can prepare for a real emergency.

Many common household items can be dangerous. Parents must keep medicine and cleaning products away from children. If a child swallows medicine or cleaning products, parents should call a poison control center. They will receive directions about what to do.

**SAFETY EDUCATION PROGRAMS**

There are many safety education programs for children. Safety Town is a summer program for young children. At Safety Town, children learn not to talk to strangers, how to cross streets, and other safety rules. Sometimes the police teach safety education programs in schools. Younger children learn street and bus safety. Older children also learn about drugs. Parents can learn more about these programs from their local police department or children's schools.

Community colleges and community agencies offer safety education programs for adults. In CPR classes, people learn how to help someone having a heart attack. CPR classes also teach the Heimlich maneuver to help choking victims. There are also first aid courses where adults learn emergency care of injuries.

**COMMUNITY SAFETY**

When people keep themselves and their property safe, they keep the community safe. Some community crimes are robbery, burglary, mugging, rape, and gang violence.

Sometimes there are many crimes in the same neighborhood. To stop this problem, some communities start Neighborhood Watch Programs. In a Neighborhood Watch Program, neighbors watch each other's homes. If they see suspicious or criminal activity, they call the police immediately.

Sometimes people don't want to give their names when they report a crime to the police. If you dial \*67 before you dial a phone number, you will block caller ID. If you use a pay phone or a cell phone, you can also report crimes anonymously.

## READING PASSAGE continued

## A TRUE STORY

In a Chicago neighborhood there were many burglaries. Gang members were breaking into many houses in the neighborhood. The neighbors were angry and afraid. They decided to start a Neighborhood Watch Program.

First, neighborhood leaders passed out information to tell residents about the crimes. Then they held meetings where people learned how to keep their property safe. Neighbors watched each other's property and reported suspicious or criminal activity to the police. For example, a man called the police when he saw a burglary happening next door.

After two months, all the burglaries stopped, and the Neighborhood Watch Program was a success. Neighbors got to know each other and worked together to protect their community.

**READING PASSAGE: Vocabulary Activity 1-A**

*Directions:* Say these words after your teacher. Discuss the meaning of each word.  
(Optional: Write the meaning next to each word.)

1. emergency
2. police
3. fire
4. ambulance
5. crime
6. paramedics
7. injured
8. stolen property
9. damaged property
10. seat belts
11. booster seats
12. infant car seats
13. airbags
14. safety ordinance

Other new words:



## READING PASSAGE: Vocabulary Activity 1-B

*Directions:* Write the correct word or words in each sentence. Use the word bank for help. There is one extra word.

1. The 5-year-old child sat in a \_\_\_\_\_ in the back seat of the car.
2. The \_\_\_\_\_ took care of the man who had a heart attack.
3. The driver and front-seat passengers in a car must wear \_\_\_\_\_.
4. The seat belt law is an example of a \_\_\_\_\_.
5. People call the \_\_\_\_\_ when there is a crime.
6. A serious, life-threatening situation is an \_\_\_\_\_.
7. \_\_\_\_\_ in a car can injure children under the age of 12.
8. The man was \_\_\_\_\_ when he fell down the stairs.
9. When a thief stole Maria's purse, she made a police report for \_\_\_\_\_ property.
10. New babies coming home from the hospital must ride in \_\_\_\_\_.
11. People from the \_\_\_\_\_ department often come to schools to teach children about fire safety.
12. The paramedics put the injured man into the \_\_\_\_\_ to take him to the hospital.
13. When a gang member smashed Rosa's window, she called the police to report \_\_\_\_\_ property.
14. Stealing a car is a serious \_\_\_\_\_.

## WORD BANK

airbags	ambulance	booster seat	crime	damaged
emergency	fire	infant car seats	injured	non-emergency
paramedics	police	safety ordinance	seat belts	stolen

**READING PASSAGE: Vocabulary Activity 2-A**

*Directions:* Say these words after your teacher. Discuss the meaning of each word.  
(Optional: Write the meaning next to each word.)

1. smoke alarm
2. fire extinguisher
3. carbon monoxide detector
4. space heater
5. natural gas
6. escape plan
7. poison control center
8. Safety Town
9. CPR
10. Heimlich maneuver
11. choking
12. burglary
13. mugging
14. suspicious
15. anonymously
16. Neighborhood Watch Program

Other new words:

## READING PASSAGE: Vocabulary Activity 2-B

*Directions:* Write the letter of the correct meaning next to each word.

- |                                      |   |
|--------------------------------------|---|
| _____ 1. anonymously                 | a. cardiopulmonary resuscitation (a way to help someone having a heart attack)                  |
| _____ 2. Heimlich maneuver           | b. a small heater for a room  |
| _____ 3. fire extinguisher           | c. fuel for stoves, clothes dryers, and furnaces  |
| _____ 4. burglary                    | d. with no name given   |
| _____ 5. smoke alarm                 | e. a way to help a choking person   |
| _____ 6. CPR                         | f. a program to teach young children about safety   |
| _____ 7. Safety Town                 | g. a way to get out of your house or apartment in an emergency                                  |
| _____ 8. natural gas                 | h. something that looks harmful or criminal   |
| _____ 9. mugging                     | i. a warning device to signal smoke or high heat  |
| _____ 10. choking                    | j. a device for putting out a fire  |
| _____ 11. poison control center      | k. attacking a person to rob him or her   |
| _____ 12. carbon monoxide detector   | l. unable to breathe because of obstructed airway   |
| _____ 13. escape plan                | m. an agency to call if someone is poisoned   |
| _____ 14. space heater               | n. breaking into a house to steal something   |
| _____ 15. suspicious                 | o. a device that detects the poison gas, carbon monoxide  |
| _____ 16. Neighborhood Watch Program | p. a community program where neighbors watch each other's houses and report suspicious activity |

**READING PASSAGE: Comprehension Check**

*Directions:* Take turns reading each sentence with a partner. Decide if each sentence is TRUE or FALSE. Put an X under TRUE or FALSE. (Optional: Correct the false sentences.)

	TRUE	FALSE
1. People should call 911 for an emergency.	_____	_____
2. The paramedics respond to 911 if someone is seriously sick or injured.	_____	_____
3. People can call the non-emergency police telephone number to report stolen property.	_____	_____
4. The driver of a car doesn't have to wear a seat belt.	_____	_____
5. Children under 12 should sit in the front seat of a car.	_____	_____
6. If people smell natural gas, they should call the paramedics.	_____	_____
7. All people should have an escape plan for their house or apartment.	_____	_____
8. Parents should call the poison control center if their child swallows cleaning products.	_____	_____
9. Safety Town teaches children about safety.	_____	_____
10. CPR classes teach how to help people who are choking.	_____	_____
11. In a Neighborhood Watch, neighbors watch each other's homes and report criminal or suspicious activity to the police.	_____	_____
12. People have to give their names when they report crimes to the police.	_____	_____

**DIALOGUE 1: Calling 911 to Report a Burglary**

*Directions:* Listen to the dialogue. Then practice the dialogue with your teacher and classmates.

José Martínez belongs to a Neighborhood Watch program. He sees a burglary happening next door and calls the police.

Operator: This is 911. What is your emergency?

José: I need the police. Someone is breaking into the house next door. My neighbor isn't home.

Operator: OK. What's your name?

José: I'd rather not say.

Operator: OK. What is the address of your neighbor's house?

José: It's 1223 Elm Street.

Operator: OK, we'll send the police right away. Stay on the line and tell me when you see the police car.

José: OK.

**DIALOGUE 2: Calling 911 to Report a Fire**

*Directions:* Listen to the dialogue. Then practice the dialogue with your teacher and classmates.

Mary Lis is at home. She hears her basement smoke alarm beeping and sees smoke. She takes her cordless phone outside and calls 911.

Operator: This is 911. What is your emergency?

Mary: Please help me. My smoke alarm is beeping and there is a lot of smoke in my basement.

Operator: What's your address?

Mary: 939 West Fullerton.

Operator: Is everyone out of the building?

Mary: Yes.

Operator: OK. We will send the fire department right away.

Mary: Thank you.

Operator: Sure. Goodbye.

**DIALOGUE 3: Calling 911 to Report a Medical Emergency**

*Directions:* Listen to the dialogue. Then practice the dialogue with your teacher and classmates.

Bob Miller's mother is having a heart attack. He calls 911 for an ambulance.

Operator: 911. Where is your emergency?

Bob: 1759 Crane Street, Apartment 2B, in Niles.

Operator: What's the problem?

Bob: My mother is having a lot of chest pain. I think she's having a heart attack.

Operator: We'll send the paramedics right away. Stay on the line until they get there.

Bob: OK. Thank you.

**DIALOGUE 4: Calling the Gas Company to Report a Gas Leak**

*Directions:* Listen to the dialogue. Then practice the dialogue with your teacher and classmates.

Reema Patel smells natural gas in the hallway of her apartment building. She calls the landlord but there is no answer. She calls the emergency number for the gas company.

Operator: Hello. Gas Company emergency service.

Reema: Hello. I need help. I smell gas in the hallway of my apartment building.

Operator: There might be a gas leak. We will send someone out to check it. What's your address?

Reema: I'm at 5683 Golf Road, Apartment 3, in Niles.

Operator: Please give me your name.

Reema: Reema Patel. Should I do anything now?

Operator: Yes. Open all of your windows. If the odor is strong, you and your neighbors should leave the building.

Reema: OK. I'll do that. When will somebody be here?

Operator: Within an hour.

Reema: Thank you.

Operator: You're welcome. Goodbye.

Reema: Goodbye.



**ACTION RESEARCH ACTIVITY: Important Telephone Numbers**

*Directions:* Complete this chart with important telephone numbers. Add other telephone numbers that would be useful in an emergency (for example, work, family, neighbor, or friend).

My phone number \_\_\_\_\_

My address \_\_\_\_\_

NAME	TELEPHONE NUMBER
Police Emergency	
Police Non-Emergency	
Fire Department Emergency	
Fire Department Non-Emergency	
Gas Company	
Electric Company	
Poison Control Center	

**WRITING ACTIVITY: Requesting Safety Information**

*Directions:* Helen Gould is worried about safety hazards in her apartment building. She writes to an agency for more information about home safety. Read her letter.

<p>December 13, 2004</p> <p>Gas Appliance Manufacturers Association 4 West Nebraska Street Frankfort, IL 60423</p> <p>Dear Sir or Madam:</p> <p>I would like information on safety hazards in the home. Please send me your free brochure on home safety. Thank you.</p>	<p style="text-align: right;">Helen Gould 1312 Maple Street Chicago, IL 60646</p> <p style="text-align: right; margin-top: 100px;">Sincerely,  <i>Helen Gould</i></p>
--	---

Now write your own letter asking for safety information. Ask for information to be mailed to your home. Share the information with your class when you receive it.

\_\_\_\_\_

\_\_\_\_\_

\_\_\_\_\_

\_\_\_\_\_

\_\_\_\_\_ :

\_\_\_\_\_

\_\_\_\_\_

\_\_\_\_\_

\_\_\_\_\_

\_\_\_\_\_

\_\_\_\_\_

\_\_\_\_\_

**HOME ACTIVITY 1: Car Safety for Children**

*Directions:* Think about safe car transportation for your family. Write down the name and weight of each child in your family. Change kilograms to pounds if necessary. (1 kilogram = 2.2 pounds.) Then write the appropriate type of safety restraint for each child in your family. Choose from:

- infant car seat (rear facing): 0 to 20 pounds
- child car seat (forward facing): 20-40 pounds
- booster seat: 40-80 pounds
- regular seat belt: 4' 9" tall and over 80 pounds

CHILD'S NAME	WEIGHT IN POUNDS	TYPE OF SAFETY RESTRAINT

Note:

A helpful Internet web site for this activity is The National Safe Kids Campaign at <http://www.safekids.org>. Click on the child car seat locator.

## HOME ACTIVITY 2: Emergency Escape Plan

*Directions:* Look at the floor plan below. With a partner, find 2 escape routes from each room in the house. Draw them with arrows.

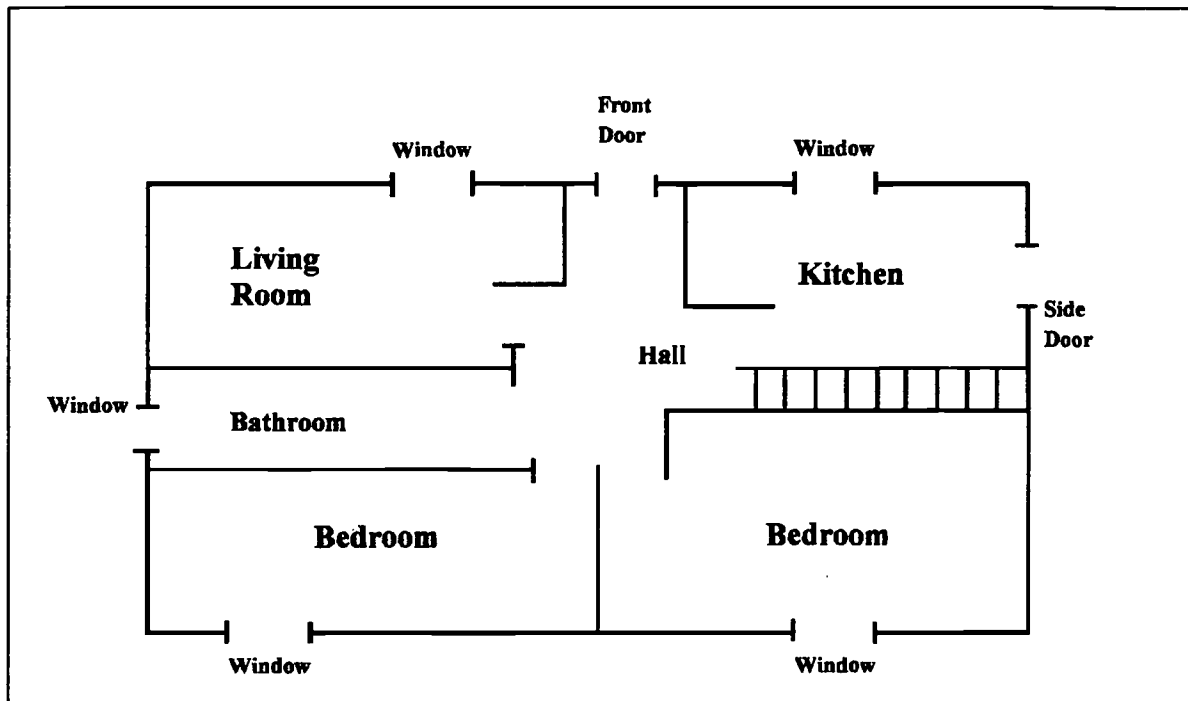

Now draw an escape plan for your house or apartment. First, draw your floor plan. Show all doors, windows, and stairs. With arrows, show 2 ways to get out from each room. Also show where your family would meet outside. (Never use an elevator in your escape plan.)

**PAIR ACTIVITY: Calling For Help**

*Directions:* With a partner, decide who to call for each situation. Write A, B, C, or D. Then explain your answer to the class.

A = 911

B = non-emergency police

C = non-emergency fire department

D = poison control

- \_\_\_\_\_ 1. You see a car accident on the street outside your apartment. The cars are badly damaged and the driver of one car is lying in the street.
- \_\_\_\_\_ 2. Your 3 year-old son just ate a bottle of Tylenol pills. He thought they were candy.
- \_\_\_\_\_ 3. You want advice about where to put smoke alarms in your house.
- \_\_\_\_\_ 4. Your neighbor fell down her front stairs. She can't move one of her legs.
- \_\_\_\_\_ 5. You see some teenage gang members fighting in the street.
- \_\_\_\_\_ 6. You see some kids breaking into your neighbor's garage. One of them is taking a bicycle.
- \_\_\_\_\_ 7. You go to your garage and find that gang members have spray-painted gang signs all over it.
- \_\_\_\_\_ 8. The carbon monoxide detector in your living room is beeping.
- \_\_\_\_\_ 9. After a bad thunderstorm, you notice some electrical wires are down. They are over the fence in your backyard.
- \_\_\_\_\_ 10. You want information about crime prevention in your neighborhood.
- \_\_\_\_\_ 11. You see a leaking fire hydrant on your street.
- \_\_\_\_\_ 12. A strange dog has been around your apartment building for 2 days.

Now role play the telephone call for each situation.

**CULTURAL COMPARISON ACTIVITY: Community and Home Safety**

*Directions:* Think about safety in your native country and in the United States. Discuss the answers to the questions below with your classmates.  
 (Optional: Write the information in the chart.)

	IN _____ (native country)	IN THE U.S.
1. What telephone number do people call for emergencies?		
2. Can people call the police or fire department for non-emergencies? Give some examples.		
3. Do young children ride in safety seats? Is this a law?		
4. Do people make emergency escape plans for their family in case of a fire?		
5. What do people do in case of accidental poisoning?		
6. What kinds of safety programs are available in the community?		
7. How do people keep their homes and communities safe?		

## EXPERIENTIAL ACTIVITIES

As a class, identify an important issue that affects the group. Some ideas are:

- neighborhood crime
- safety hazards in the home
- CPR
- first aid
- infant/child safety
- kitchen/food safety
- safety in the workplace
- safety in the schools
- school bus safety
- traffic safety/car safety
- fire prevention
- personal safety on the street

Determine the best course of action from the suggestions below or have students generate their own plan of action. To maximize the experiential activity, choose one requiring a response from a leader or expert in the community. Also select an activity in which students have a vested interest so that they will follow through to a satisfactory conclusion

1. Invite a guest speaker from the police or fire department to the class. Possibilities from the police department include a community liaison officer, crime prevention officer, Neighborhood Watch expert, or Officer Friendly. Have students prepare questions for the speaker before the event.

*risk: medium-high*

*language level: high beginning-advanced*

2. Take a field trip to the local police or fire station. (Call ahead to make arrangements.) Have students prepare questions beforehand to ask during the visit.

*risk: medium-high*

*language level: all*

3. Have a CPR trainer conduct a hands-on demonstration and training session for the class. Provide bilingual support as necessary.

*risk: low*

*language level: all*

4. Investigate safety education programs for adults and children in the students' community. Consult neighborhood newspapers and newsletters, community college catalogs, brochures from the YMCA, hospital education programs, park district programs, etc. Have students make a poster for classroom display listing such opportunities. Optional: have students select an activity to attend (as a class, in small groups, or individually) and report on afterwards.

*risk: low*

*language level: intermediate-advanced*

---

**EXPERIENTIAL ACTIVITIES** continued

5. Do Internet research on fire prevention. Have students research different web sites and share information with the class.  
*risk: low*  
*language level: intermediate-advanced*
  
6. Do Internet research on Neighborhood Watch programs. Have students find out how to get a program started.  
*risk: low*  
*language level: intermediate-advanced*
  
7. Write a letter to the editor at the local newspaper or to a city council member/village trustee on a safety issue in the community, such as a dangerous intersection, school bus safety, or gang activity in the schools.  
*risk: low*  
*language level: intermediate-advanced*



## MODULE 3

# ◆◆◆ THE PUBLIC LIBRARY ◆◆◆

## COMPONENTS

	Page
◆ TEACHER NOTES.....	104
◆ PICTURES	
• Pictures for Vocabulary Development.....	107
• Pictures for Language Experience.....	117
• Pictures for Group Story Writing.....	122
◆ READING PASSAGE	
• Pre-Reading Activity.....	124
• Reading Passage.....	125
• Vocabulary Activity 1-A.....	127
• Vocabulary Activity 1-B.....	128
• Vocabulary Activity 2-A.....	129
• Vocabulary Activity 2-B.....	130
• Comprehension Check.....	131
◆ EXTENSION ACTIVITIES	
• Dialogue 1: <i>Getting a Library Card</i> .....	132
• Dialogue 2: <i>Reserving a Book by Telephone</i> .....	133
• Dialogue 3: <i>Registering for a Library Program</i> .....	134
• Dialogue 4: <i>Looking for a Book in the Library</i> .....	135
• Action Research Activity: <i>Your Public Library</i> .....	136
• Writing Activity: <i>Applying for a Library Card</i> .....	137
• Pair Activity: <i>Title Sort</i> .....	138
• Cultural Comparison Activity: <i>Public Libraries</i> .....	139
◆ EXPERIENTIAL ACTIVITIES.....	140

## TEACHER NOTES

Before beginning the module, find out which public libraries serve the communities in which your students live. Note that some may live in an area that is served by a district rather than a community library. If your students live in a community that does not have a public library, contact the local library to find out the lending policy and fee for non-residents. Visit the libraries of your students' communities to become familiar with their services and facilities. Collect authentic material (library card applications, newsletters, flyers, etc.) to use or adapt for class activities. Ask if the libraries have a promotional videocassette that highlights library services. If there is one available, ask if you might borrow it for class use.

### COMPETENCIES FOR MODULE 3

Students will learn to:

1. Locate the public library in their community.
2. Complete an application for a library card.
3. Describe the materials and services that the public library provides.
4. Ask for assistance in the library.
5. Find library materials of interest to them to check out or use in the library.

### THE VOCABULARY ACTIVITIES AND THE READING PASSAGE

The Reading Passage contains a large number of vocabulary words that may be unfamiliar to students. To facilitate the teaching of this module, Vocabulary Activities 1-A and 1-B correspond to the first part of the Reading Passage only (through the second paragraph in "Library Services"), while Vocabulary Activities 2-A and 2-B correspond to the rest of the Reading Passage (the third paragraph of "Library Services" through the end). You may choose to teach the Reading Passage in two parts, at two different class meetings, depending on the level of your class.

### EXPANSION IDEAS

#### Computer Catalogues

If the level of the class and student interest warrant it, you may decide to include more classroom instruction on the computer catalog. Additional vocabulary may include:

- Subject
- Author
- Title
- Call number

Use the module pictures and online computer catalog (if you have Internet access) to pre-teach computer catalog information. This can be reinforced and further explained during a field trip to the library.

## TEACHER NOTES continued

Practice with “Borrow” and “Lend”

A grammar focus that you may want to highlight in the context of this module is *borrow vs. lend*. Begin with the vocabulary pictures for these words and present these ideas:

borrow = take

lend = give

Practice these short conversations with students:

Student: What kinds of materials can I **borrow**?

Librarian: **The library lends** books, magazines, DVDs, CDs, audiocassettes, and videos.

Student: Does **the library lend** children’s toys?

Librarian: Yes. You can also **borrow** puzzles and games.

Student: **Can I borrow** this travel book for 3 weeks?

Librarian: No, sorry. **We lend** travel books for only 2 weeks.

Have students complete these sentences with *borrow* or *lend*, or develop your own practice sentences.

1. I want to \_\_\_\_\_ a video on Chicago.
2. The library doesn’t \_\_\_\_\_ reference books to people.
3. People cannot \_\_\_\_\_ this book. It’s part of an encyclopedia set.
4. Can I \_\_\_\_\_ these magazines?

Have students work in pairs to write their own 2-3 line conversations using *borrow* and *lend*.

## POSSIBLE AUTHENTIC MATERIALS

- Library flyers or brochures about services, materials, and policies
- Library card application forms
- Library newsletters
- Web sites of neighborhood libraries

## RESOURCES\*

Print Materials

*Beyond the Library Card: An ESL Curriculum for Effective Library Use*, Elizabeth Minicz (1994). Adult Learning Resource Center, Des Plaines, Illinois. Available from the Curriculum Publications Clearinghouse, (800) 322-3905 or [www.wiu.edu/CPC](http://www.wiu.edu/CPC). A multilevel curriculum designed to increase adult ESL students’ knowledge of public library resources as well as their ability to use the library effectively.

---

**TEACHER NOTES continued**

*Improving Public Library Services to ESL Students: Ready to Use Classroom Lessons for Teachers*, Library Awareness Project of South Bay Cooperative Library System. California (1986). Multilevel ESL curriculum addressing topics such as library resources, borrowing procedures, and the role of the librarian. Ideas for field trips and reproducible visual aids also included. Available to order as a book or microfiche from ERIC, Accession No. ED 3344825. ERIC Document Reproduction Services: [www.edrs.com/Webstore/Express.cfm](http://www.edrs.com/Webstore/Express.cfm).

\* This list of resources is also located at [www.thecenterweb.org](http://www.thecenterweb.org) (click on "The Adult Learning Resource Center") where it is updated annually.

PICTURES FOR VOCABULARY DEVELOPMENT

public library

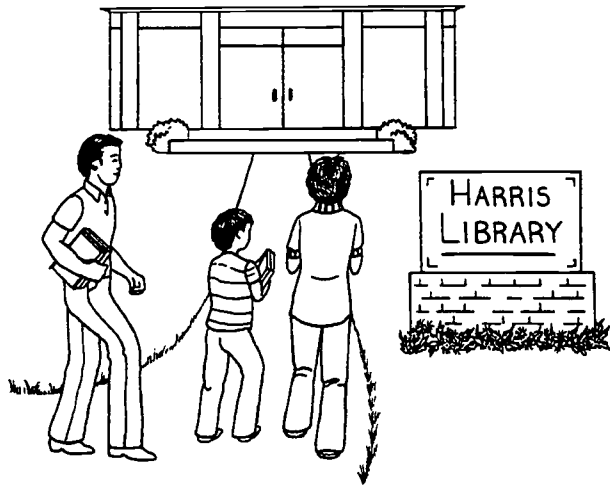

bookmobile

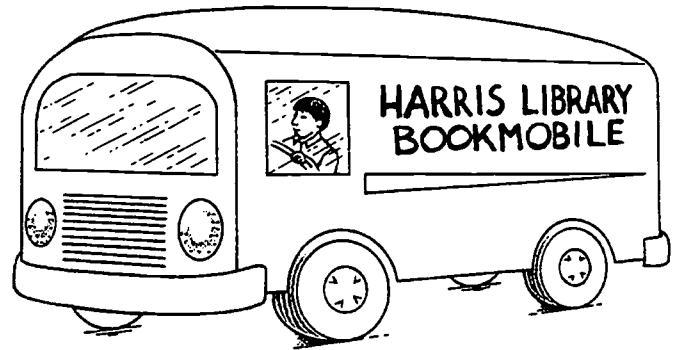

check out

librarian

lend

borrow

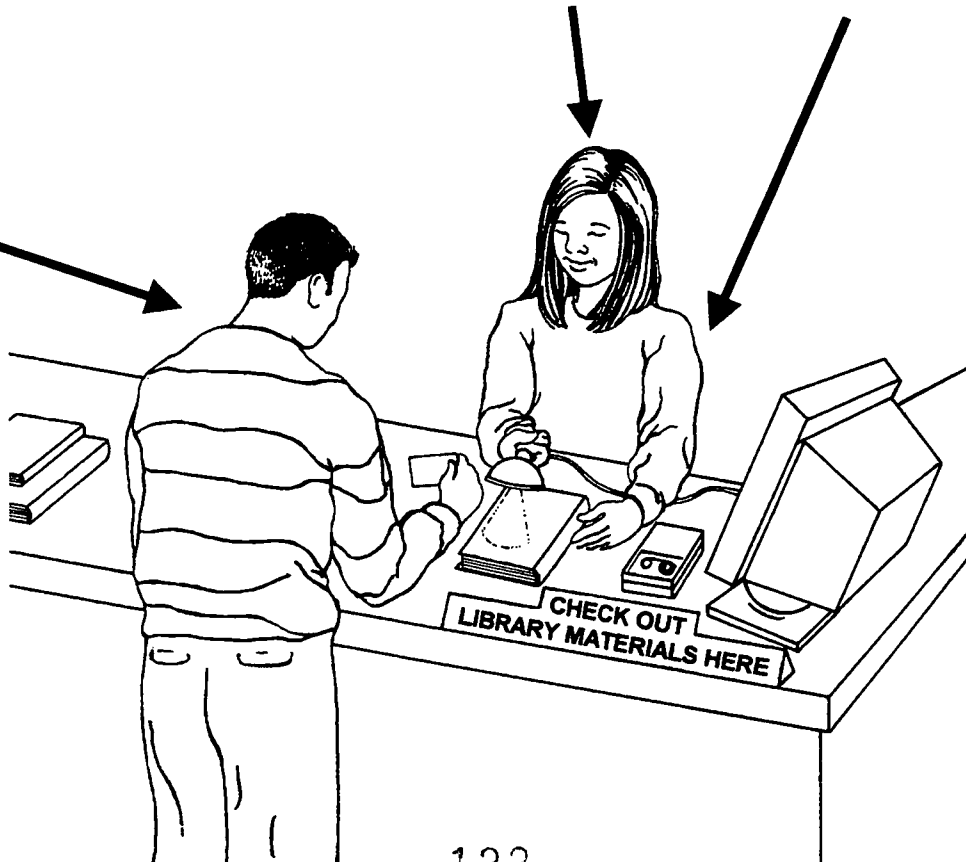

PICTURES FOR VOCABULARY DEVELOPMENT continued

LIBRARY MATERIALS

books



books on tape

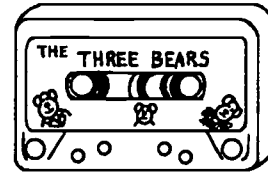

magazines

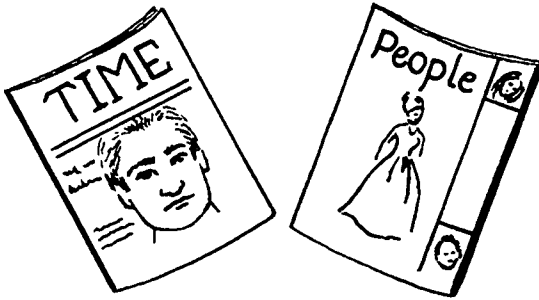

newspapers

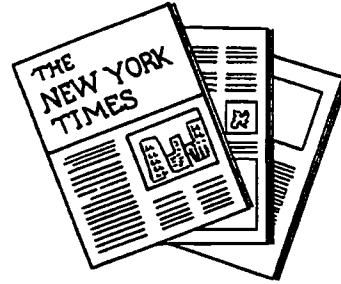

videos/DVDs

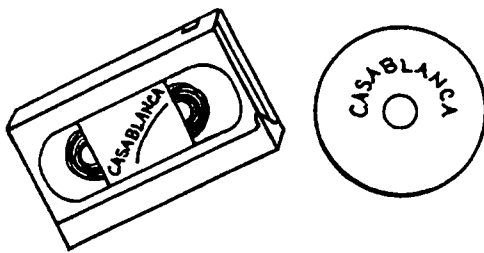

CDs/cassette tapes

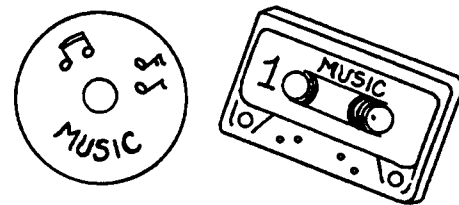

children's games/toys

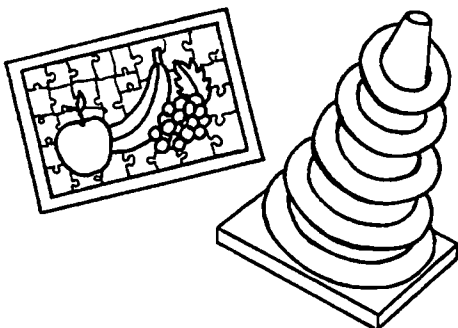

software



PICTURES FOR VOCABULARY DEVELOPMENT continued

COLLECTIONS

fiction/non fiction

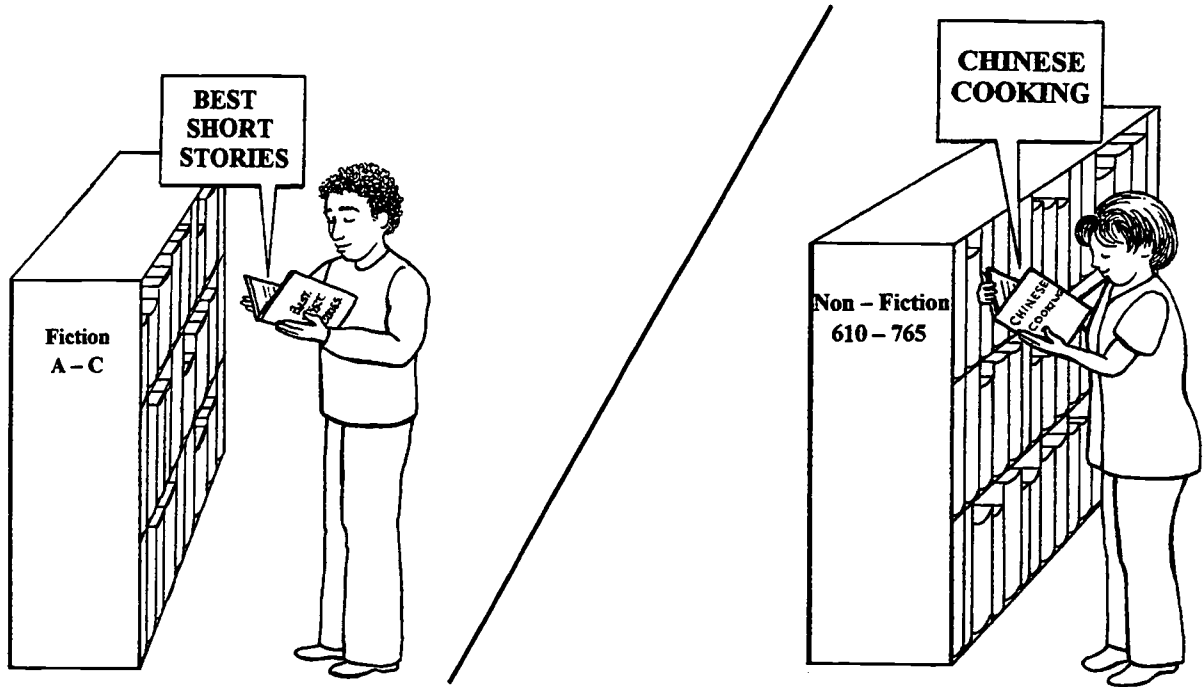

reference

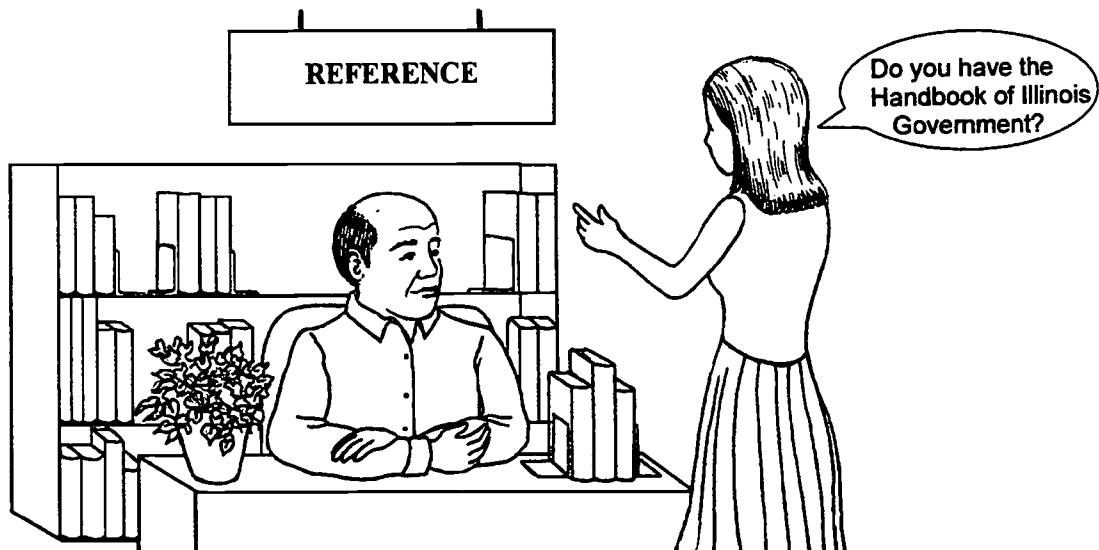

PICTURES FOR VOCABULARY DEVELOPMENT continued

COLLECTIONS

ESL collection

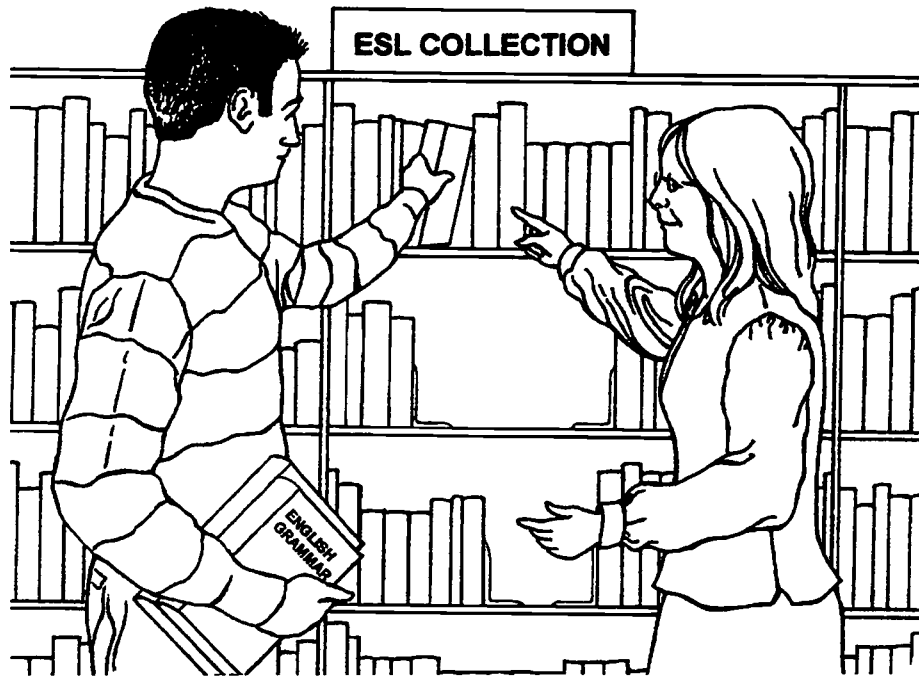

children's section

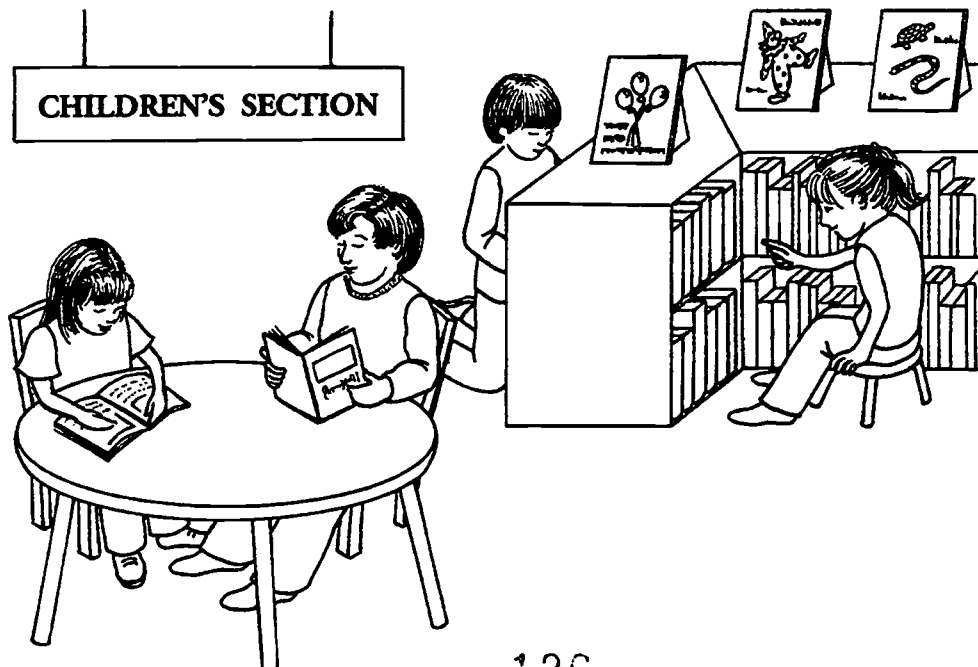



PICTURES FOR VOCABULARY DEVELOPMENT continued

COMMUNITY EVENTS & SERVICES

bulletin board

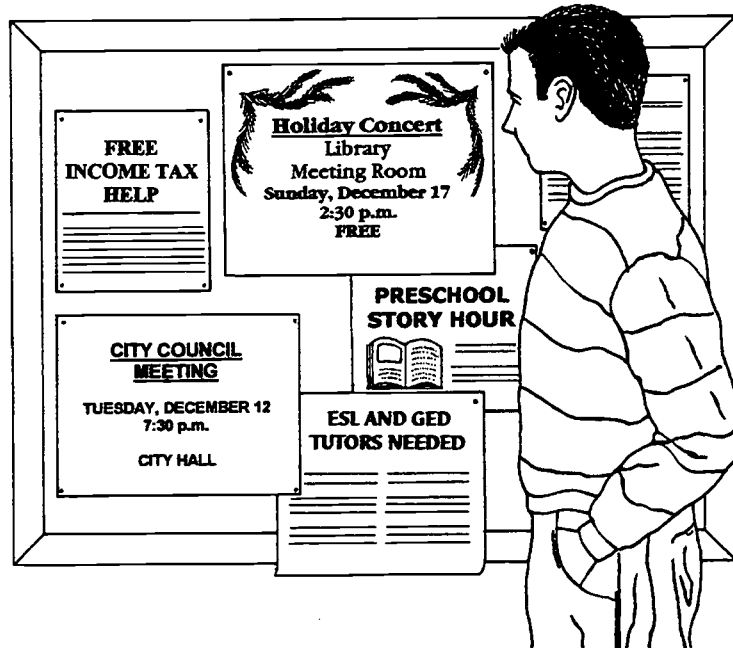

cultural event

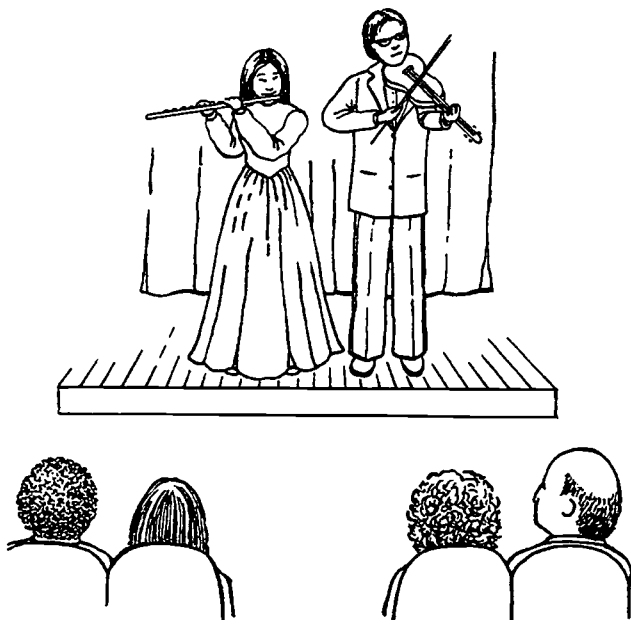

tutor



### MORE LIBRARY SERVICES

reserve



photocopy machine

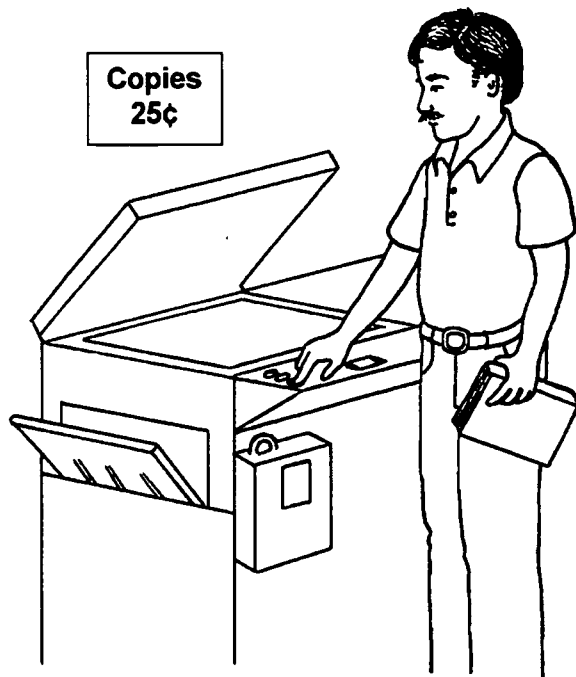

income tax forms

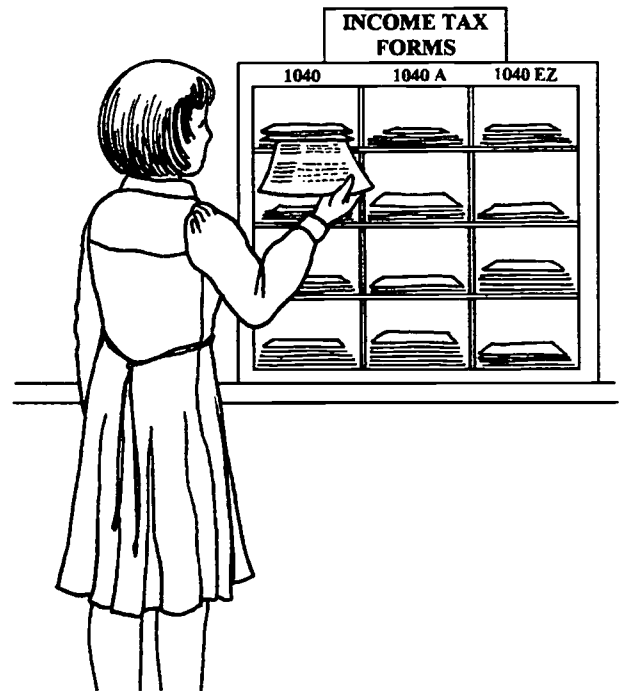

TECHNICAL SERVICES

computer catalog

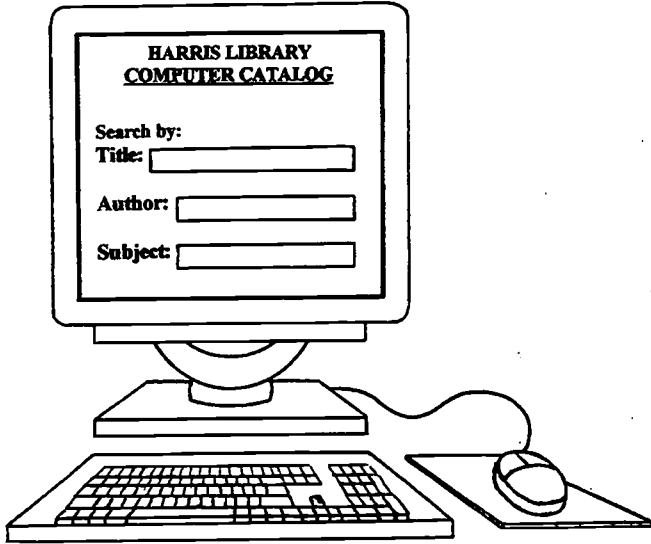

Internet/online

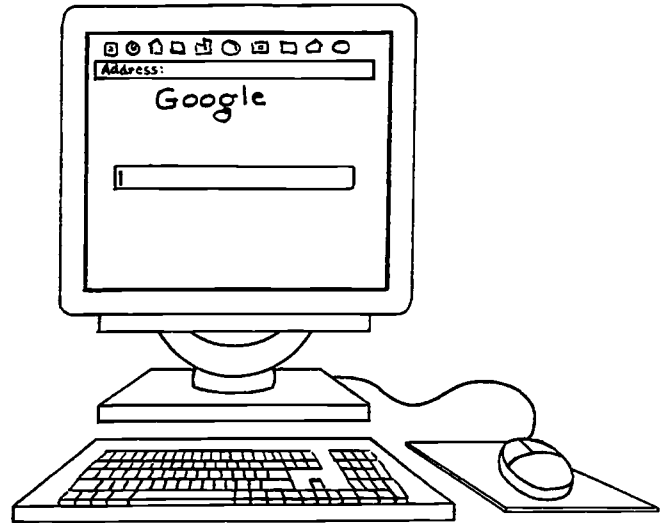

computers



PICTURES FOR VOCABULARY DEVELOPMENT continued

READING PROGRAMS

story hour



book club



summer reading program

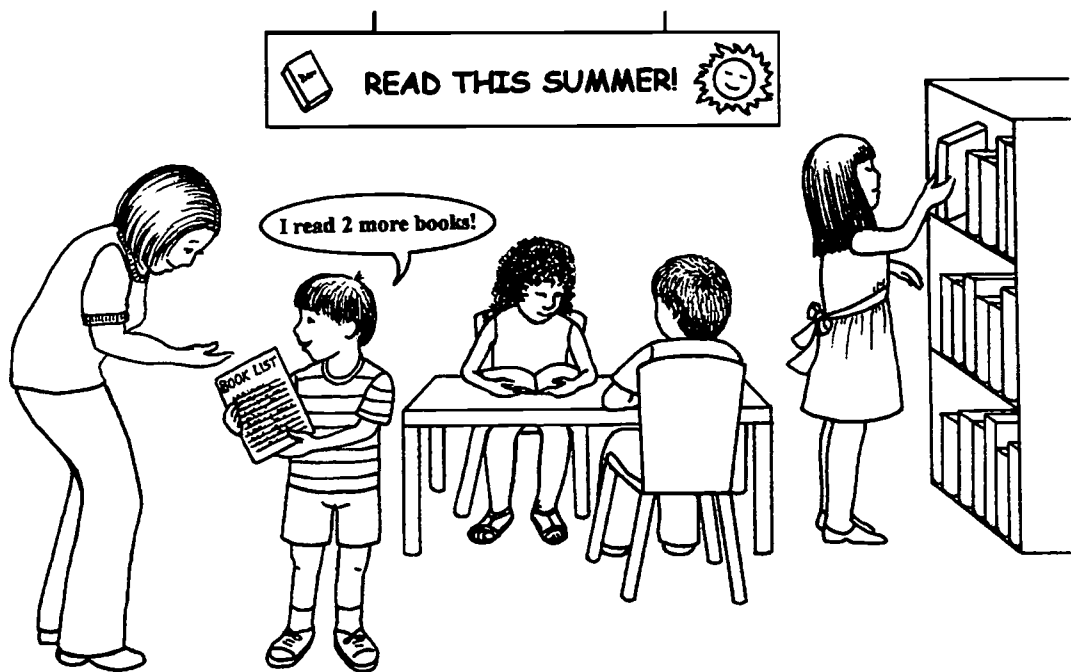

PICTURES FOR VOCABULARY DEVELOPMENT continued

GETTING A LIBRARY CARD

application

**Application for Library Card**

Please fill out and give to librarian with identification showing your name and address.

Name \_\_\_\_\_  
first last

Address \_\_\_\_\_

City \_\_\_\_\_ State \_\_\_\_\_ Zip Code \_\_\_\_\_

Phone \_\_\_\_\_ Birthdate \_\_\_\_\_

proof of address

**Midwest Telephone Company**

**Mauricio Perez**  
**312 South Manor**  
**Harris, Illinois 60037**



---

**Monthly Statement**  
**Account #798-357-897**

**Total Due: \$43.21**

identification

**DRIVER'S LICENSE**  
 Number: X243-3654-3059

Mauricio Perez  
 312 South Manor  
 Harris, IL 60037  
 SS# \_\_\_\_\_



Mauricio Perez

library card

**Harris Public Library**

Mauricio Perez  
 312 S. Manor  
 Harris, IL 60037

P 98 348 9785 98

PICTURES FOR VOCABULARY DEVELOPMENT continued

RETURNING LIBRARY MATERIALS

book drop

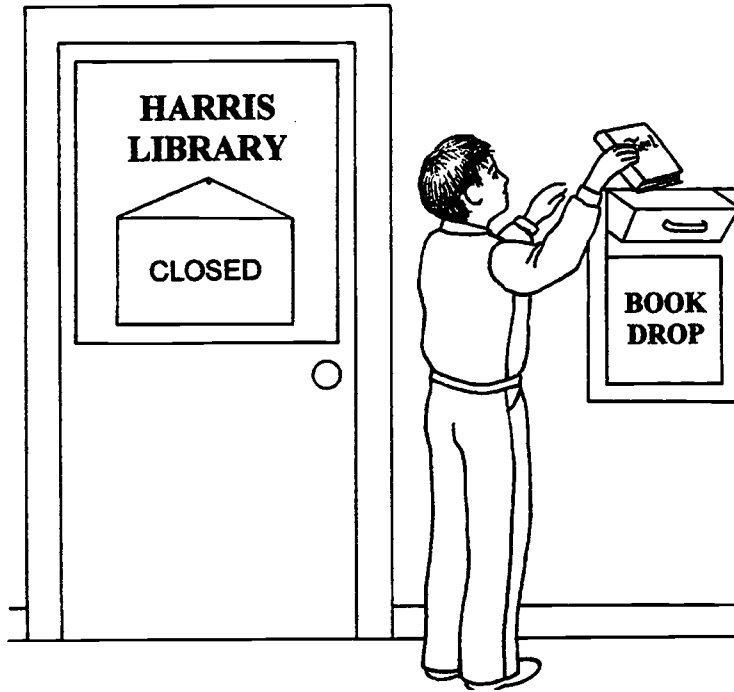

overdue



PICTURES FOR LANGUAGE EXPERIENCE

**LIBRARY CARD APPLICATION**

Print Full Name Mauricio Perez

Address \_\_\_\_\_

City \_\_\_\_\_ Zip Code \_\_\_\_\_

Phone \_\_\_\_\_

Business Address \_\_\_\_\_

Business Phone \_\_\_\_\_

Signature \_\_\_\_\_

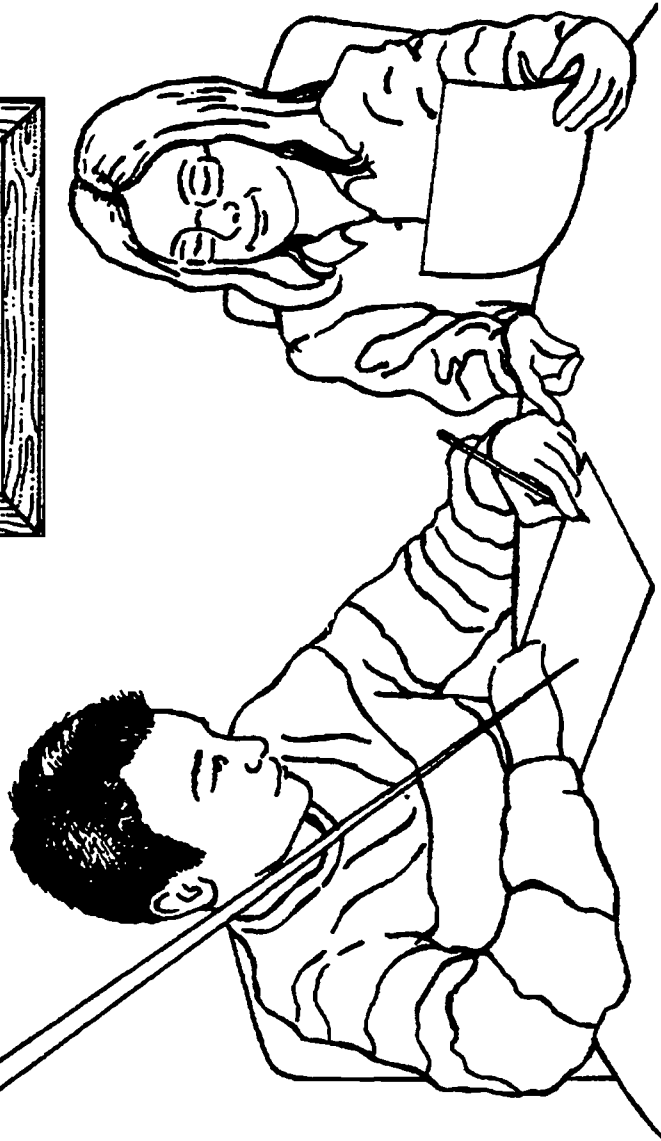
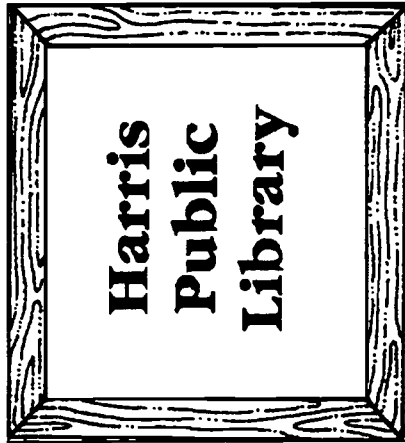

1

PICTURES FOR LANGUAGE EXPERIENCE continued

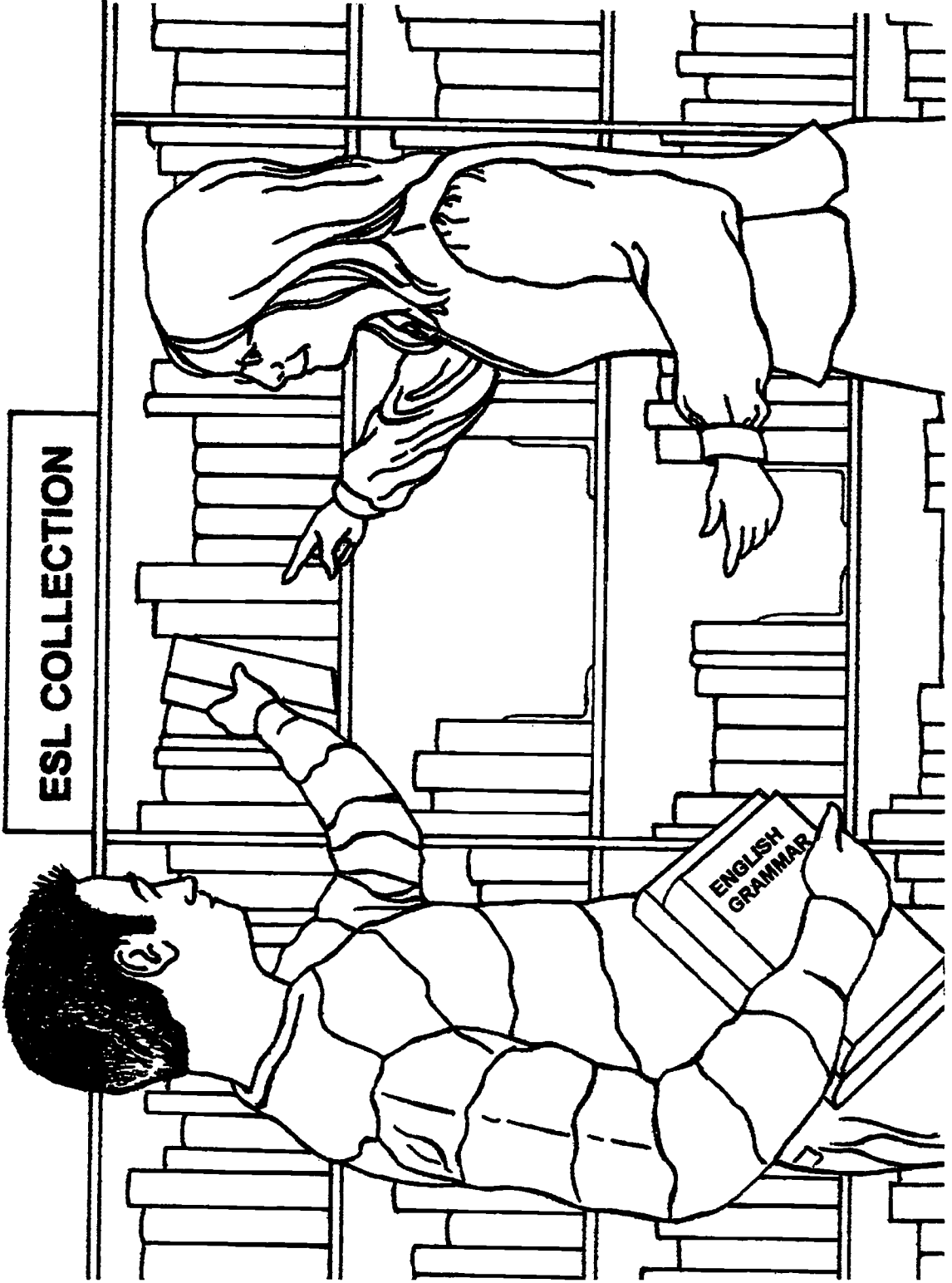



PICTURES FOR LANGUAGE EXPERIENCE continued



3

PICTURES FOR LANGUAGE EXPERIENCE continued

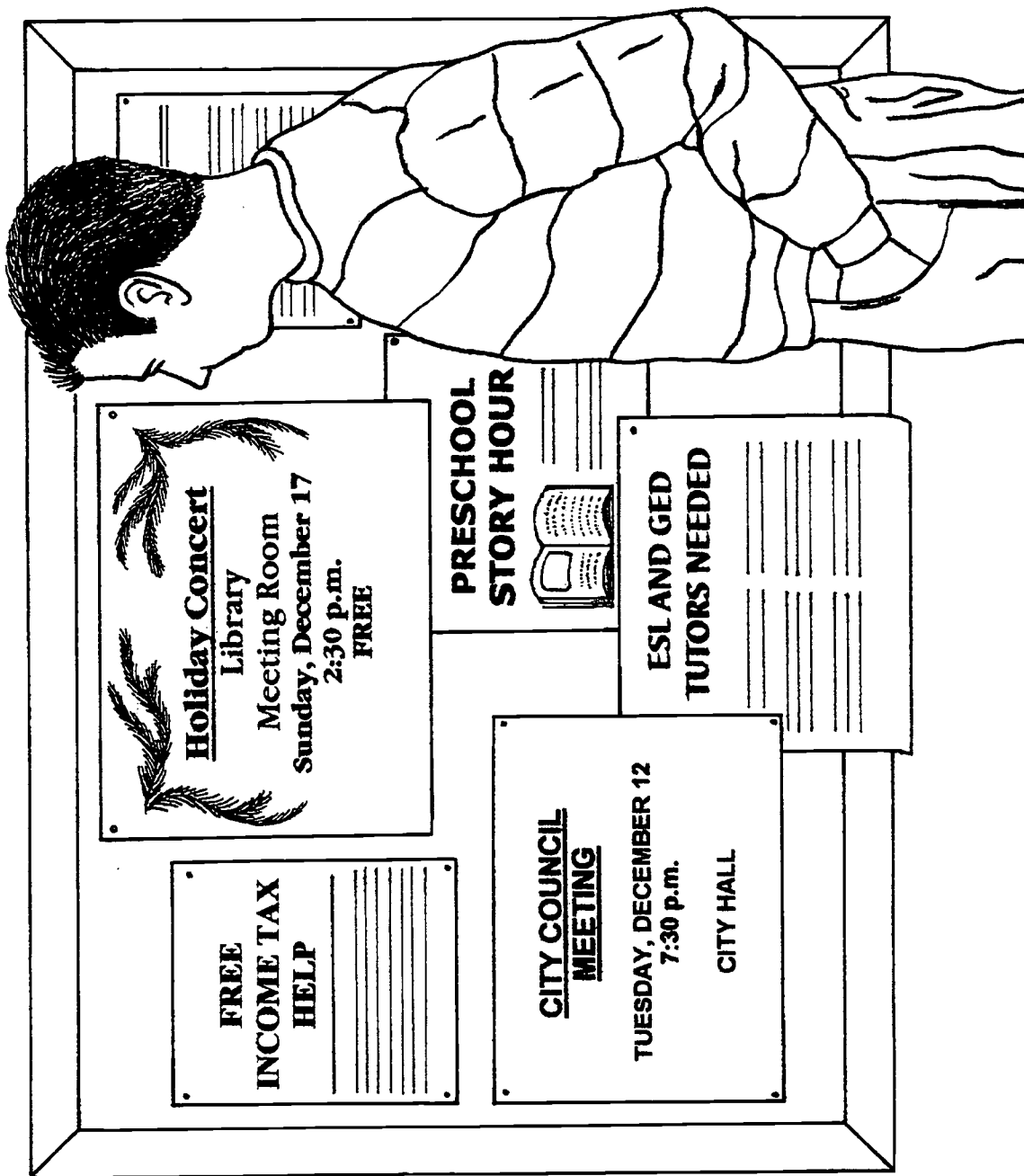

4

PICTURES FOR LANGUAGE EXPERIENCE continued

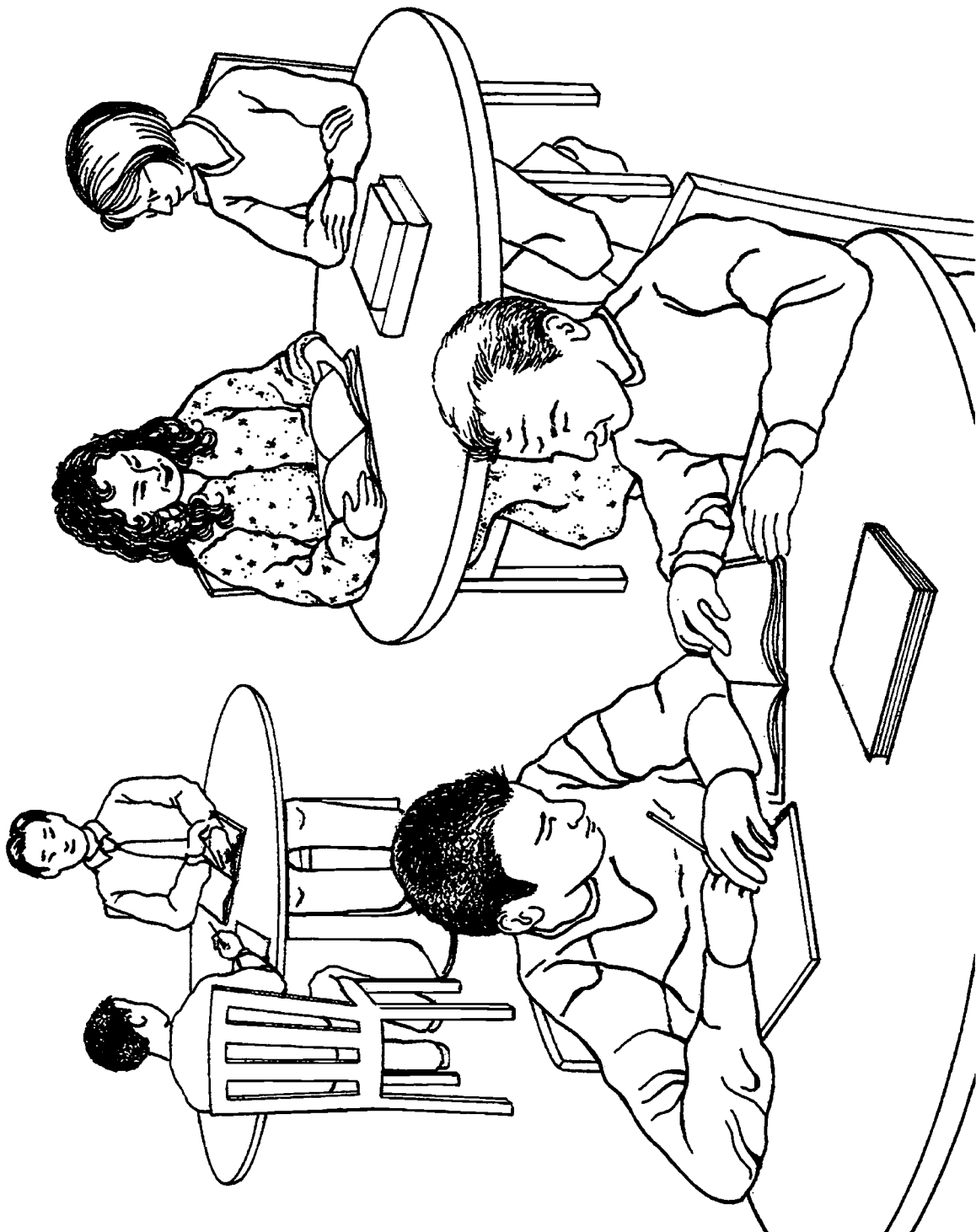

5

PICTURES FOR GROUP STORY WRITING

*Directions:* Work in groups of three or four. Write a story about the pictures below and on the next page. Write one or more sentences for each picture. Then share your story with the class.



1

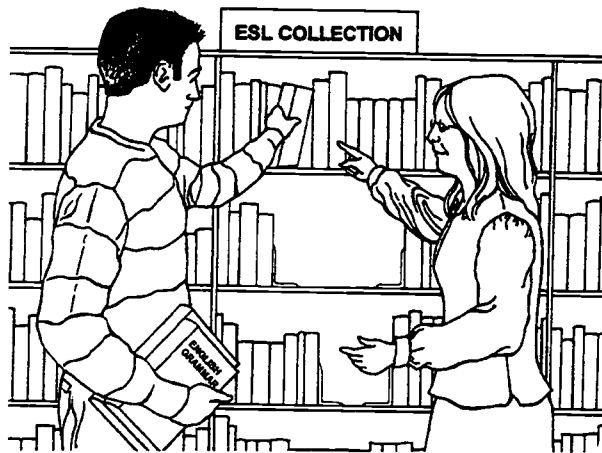

2



3

148

PICTURES FOR GROUP STORY WRITING continued

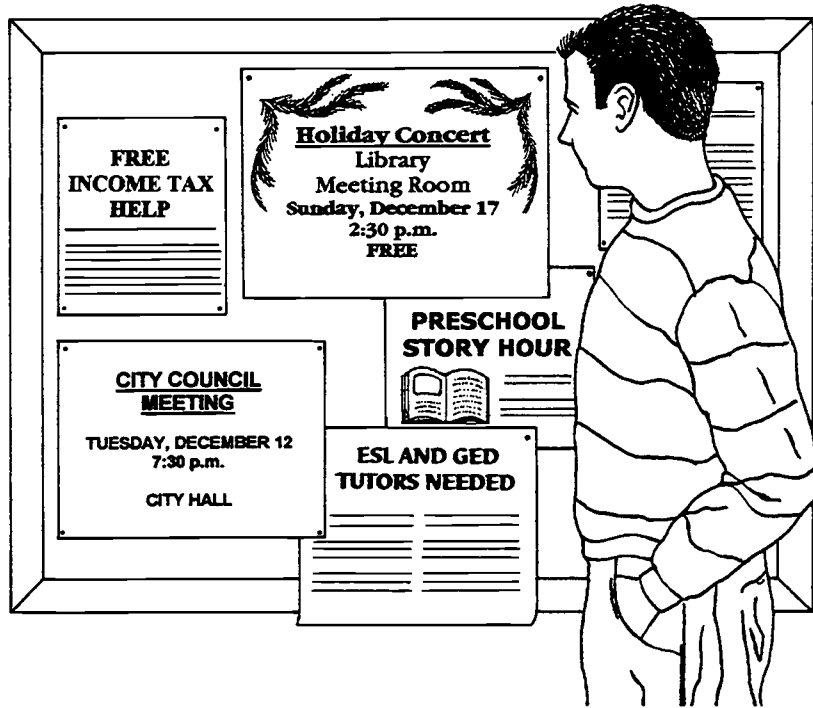

4



5

**READING PASSAGE: Pre-Reading Activity**

*Directions:* Think about the public library. Discuss the answers to the questions below with your classmates. (Optional: Write the answers to the questions.)

1. Have you ever been to your local library? Why did you go?
  
2. What is the name of your local library? Where is it located?
  
3. Do you have a library card? Does anyone in your family have a library card?
  
4. What kinds of materials does the library have? Which ones are you interested in?
  
5. Does your library have ESL materials? Does it have ESL classes or tutoring?
  
6. What activities does your library have for adults? For children?

## READING PASSAGE

The public library is a place for information and recreation. It has materials and services for adults and children. The library is a useful resource in the community.

### COMMUNITY INFORMATION

Many community meetings take place at the library. For example, a community group might hold a meeting about property taxes there. The library also has information about other community events. Bulletin boards tell about cultural events, city council meetings, and community services.

### LIBRARY MATERIALS

People can borrow many different materials from the library. There are books, magazines and newspapers. There may also be books on tape, other cassette tapes, CDs, DVDs, computer software, and videos. Some libraries lend other materials, such as children's games and toys.

Libraries have many different collections of books for adults and children. Books can be fiction, nonfiction, or reference. Fiction books are stories that are not true. Nonfiction books have factual information about topics such as travel, art, cooking, history, and culture. The reference section has books such as dictionaries and encyclopedias. Reference books cannot be checked out. People must use them in the library.

Large libraries often have special collections. There may be ESL books and cassette tapes for learning English as a Second Language. Other collections could be citizenship books or GED (high school equivalency) materials. Often there are literacy materials to help adults learn how to read. Some libraries have books in different languages.

### LIBRARY SERVICES

The library has many reading activities for the whole family. There is a story hour for pre-school children. There are summer reading programs for elementary and high school students. Adults can join books clubs to discuss popular books.

Libraries have many other services. Some libraries show free movies every month. Some have passes to local museums. There are also special events like guest speakers, classes for adults and children, or concerts. All libraries have income tax forms. Some libraries have free ESL classes and tutors to help people learn to read. Often the library has a bookmobile. This traveling library brings books to different parts of the city.

Libraries have technical services too. People can use computers and the Internet in the library. Library web sites inform people about library materials and services. People can use the computer catalog and reserve books online. Most libraries also have photocopy machines for making copies.

**READING PASSAGE** continued**HOW TO USE THE LIBRARY**

People can borrow library materials with a library card. Adults and children age 5 and older can get free library cards. To get a library card, go to the library in your town or city. Ask for an application for a library card. Write your name, address, and phone number on the application. A librarian will ask for some identification and proof of address. Most people show a driver's license and a tax bill or a utility bill. When you sign the application, you are promising to follow the library's rules. Then you get a library card.

When you borrow something from the library, it has a due date. The due date is usually 1 to 3 weeks later. You must return the materials to the library by this date. If you return the materials later, you must pay a fine. For example, many libraries charge 10¢ a day for overdue books and \$2.00 a day for overdue videos. If you want to return books when the library is closed, you can put them in the book drop outside the library.

Some people live in communities where there are no public libraries. These people can go to public libraries in other communities to use most library materials. But if they want to take anything home, they have to pay for a library card. Free library cards are for residents only. Libraries usually have special rules for people who don't live in the library community.

**GETTING HELP IN THE LIBRARY**

Librarians help people in the library. They help children choose books and find information for school projects. They check out books and help people apply for library cards. They reserve books and collect money for overdue books. If the library does not have a book that someone wants, the librarian can order it from another library.

Reference librarians show people how to use the computer catalog and how to find books. They can also help people find information about many different things. For example, people might ask questions such as:

“What is the address of City Hall?”

“Who is the state representative from my district?”

“Which washing machine has the best rating?”

**A TRUE STORY**

Mauricio Pérez had a good experience at his public library. After getting his library card, he asked the librarian for help. He wanted some ESL books and cassette tapes to study English at home. The librarian took him to the special collection. He found books and cassette tapes on English grammar and pronunciation. While he was checking out his books, the librarian told him about free ESL tutoring on Tuesday nights. Mauricio is very happy with the library. He has a library card and good materials. He will come for tutoring next week. Best of all, everything is free!



**READING PASSAGE: Vocabulary Activity 1-A**

*Directions:* Say these words after your teacher. Discuss the meaning of each word.  
(Optional: Write the meaning next to each word.)

1. public library
2. bulletin boards
3. cultural events
4. borrow
5. lend
6. collections
7. fiction
8. nonfiction
9. reference
10. check out
11. story hour
12. summer reading program
13. book club
14. income tax forms
15. tutors
16. bookmobile

Other new words:

## READING PASSAGE: Vocabulary Activity 1-B

*Directions:* Write the letter of the correct meaning next to each word.

- |                                |  |
|--------------------------------|--|
| ___ 1. public library          | a. stories that are not true   |
| ___ 2. bookmobile              | b. people who teach students in small groups or individually                                   |
| ___ 3. tutors                  | c. a traveling library (in a bus or van) that brings books to different parts of the community |
| ___ 4. reference books         | d. art, music, dance, and poetry events  |
| ___ 5. collection              | e. nonfiction books that cannot leave the library  |
| ___ 6. lend                    | f. a wall display with announcements of library and community events                           |
| ___ 7. borrow                  | g. a library program where a librarian reads books to pre-school children                      |
| ___ 8. check out               | h. to borrow materials with a library card   |
| ___ 9. cultural events         | i. books with factual, true information  |
| ___ 10. income tax forms       | j. a group of books on one subject, for example, ESL   |
| ___ 11. book club              | k. a library activity for elementary and high school students who read books during the summer |
| ___ 12. bulletin board         | l. people use these forms to file their income taxes every year by April 15                    |
| ___ 13. fiction                | m. a group of people who meet to discuss a book they have read                                 |
| ___ 14. nonfiction             | n. a community place for information and recreation  |
| ___ 15. summer reading program | o. to take and use something for a short time  |
| ___ 16. story hour             | p. to let someone use something for a short time   |

**READING PASSAGE: Vocabulary Activity 2-A**

*Directions:* Say these words after your teacher. Discuss the meaning of each word.  
(Optional: Write the meaning next to each word.)

1. computers
2. Internet
3. computer catalog
4. online
5. reserve
6. library card
7. application
8. identification
9. proof of address
10. due date
11. fine
12. overdue
13. book drop
14. librarian

Other new words:

## READING PASSAGE: Vocabulary Activity 2-B

*Directions:* Write the correct word or words in each sentence. Use the word bank for help. Each word can be used only once.

1. To borrow library books, you need a \_\_\_\_\_.
2. The \_\_\_\_\_ is a person who helps people in the library.
3. If you return books late, you must pay a \_\_\_\_\_.
4. You must return books on the \_\_\_\_\_.
5. The library can hold or \_\_\_\_\_ a book for you until you can come to check it out.
6. To get a library card, you must fill out an \_\_\_\_\_.
7. A book that was due yesterday is now \_\_\_\_\_.
8. People can type or do research on \_\_\_\_\_ at the library.
9. The \_\_\_\_\_ is a computer network for information.
10. Your driver's license is a type of picture \_\_\_\_\_ and your telephone bill is \_\_\_\_\_.
11. If you are using the Internet, you are \_\_\_\_\_.
12. The \_\_\_\_\_ lists all the materials in the library.
13. Use the \_\_\_\_\_ to return books when the library is closed.

### WORD BANK

application	computers	computer catalog	reserve
due date	fine	identification	book drop
Internet	librarian	proof of address	library card
online		overdue	

## READING PASSAGE: Comprehension Check

*Directions:* Take turns reading each sentence with a partner. Decide if each sentence is TRUE or FALSE. Put an X under TRUE or FALSE. (Optional: Correct the false sentences.)

	TRUE	FALSE
1. The public library has materials and services for children and adults.	_____	_____
2. All libraries lend children's games and toys.	_____	_____
3. People can check out reference books from the library.	_____	_____
4. Some libraries have special collections of ESL or GED books.	_____	_____
5. Story hour for pre-school children is the only reading activity at the library.	_____	_____
6. Libraries have income tax forms.	_____	_____
7. People can buy computers in the library.	_____	_____
8. Only librarians can use the computer catalog.	_____	_____
9. People need to show identification and proof of address to get a library card.	_____	_____
10. If your library books are overdue, you must pay a fine.	_____	_____
11. Free library cards are for community residents only.	_____	_____
12. If your library doesn't have a book you want, you have to go to another library.	_____	_____

**DIALOGUE 1: Getting a Library Card**

*Directions:* Listen to the dialogue. Then practice the dialogue with your teacher and classmates.

Karen Park wants to get a library card. She calls the library for information.

Librarian: Hello. Niles Library.

Karen: Hello. I'd like to get a library card. What do I need to do?

Librarian: Do you live in Niles?

Karen: Yes, I do.

Librarian: You need to bring some identification and a recent utility or tax bill with your address.

Karen: I have my driver's license and an electric bill from this month. Is that okay?

Librarian: Yes. Just bring them in and fill out an application.

Karen: Can I get my card today?

Librarian: Yes. You can use it right away.

Karen: Thank you very much.

Librarian: You're welcome. Bye.

Karen: Goodbye.

**DIALOGUE 2: Reserving a Book by Telephone**

*Directions:* Listen to the dialogue. Then practice the dialogue with your teacher and classmates.

Max Skolnick wants to get a book, *Everyday English*, at the library. He calls the library to see if the book is in.

Librarian: Good Morning. Hillside Library.

Max: Hello. I'm calling to see if you have a book.

Librarian: What is the title?

Max: *Everyday English* by Ann Smith.

Librarian: Let me check the computer catalog. Yes. We have it. It's in.

Max: Good. Can you hold it for me?

Librarian: Sure. What's your name?

Max: Max Skolnick.

Librarian: Can you spell your last name, please?

Max: Yes. S - K - O - L - N - I - C - K.

Librarian: OK, Mr. Skolnick. I'll put it on reserve. You can pick it up at the check out desk. We'll hold it through Friday.

Max: Thank you.

Librarian: You're welcome. Goodbye.

**DIALOGUE 3: Registering for a Library Program**

*Directions:* Listen to the dialogue. Then practice the dialogue with your teacher and classmates.

Lena Tailor has just received her library newsletter in the mail. She reads about the special programs at the library. One special program is a puppet show on May 14<sup>th</sup>. She calls the library to register herself and her 2 children.

Librarian: Hello. This is the Niles Library. May I help you?

Lena: Yes. I'd like to register for the puppet show on May 14th.

Librarian: Sure. May I have your name and telephone number?

Lena: My name is Lena Tailor and my phone number is (847) 555-4321.

Librarian: Can you spell your name, please?

Lena: Yes. Lena, L - E - N - A. Tailor, T - A - I - L - O - R.

Librarian: OK. How many adults and how many children will be coming?

Lena: One adult and two children.

Librarian: Okay. You're registered.

Lena: Thank you. Goodbye.

Librarian: Goodbye.



**DIALOGUE 4: Looking for a Book in the Library**

*Directions:* Listen to the dialogue. Then practice the dialogue with your teacher and classmates.

Alena Zarka is planning a trip to Washington, DC. She goes to the library for a travel book. She asks the librarian for help.

Alena: Hi. Can you help me?

Librarian: Yes. What do you need?

Alena: I'm looking for a book about Washington, DC.

Librarian: Do you mean a travel book with tourist information?

Alena: Yes. My family is going there on vacation.

Librarian: *(Looks in the computer catalogue and then writes a number on a piece of paper.)*

Travel books are in the nonfiction section against the wall. Here's the number.

Alena: Can you show me where to find this number?

Librarian: Sure.

**ACTION RESEARCH ACTIVITY: Your Public Library**

*Directions:* Complete this chart about your library. Use a telephone directory or the Internet for help. Call the library or use the Internet to find out when the library is open.

Your Name: \_\_\_\_\_

Your City or Town: \_\_\_\_\_

Name of Your Library: \_\_\_\_\_

Address of the Library: \_\_\_\_\_

Library Telephone Number: \_\_\_\_\_

Distance From Your Home to the Library: \_\_\_\_\_

When the Library Is Open (Days, Hours): \_\_\_\_\_

Library Web Site Address: \_\_\_\_\_

**WRITING ACTIVITY: Applying for a Library Card**

*Directions:* Look at this application for a library card. Fill in the information about you.

**APPLICATION FOR LIBRARY CARD**

I apply for the right to use the Library and will abide by its rules. I will pay fines or damages charged to me and give prompt notice of any change of address.

Print Full Name \_\_\_\_\_

Address \_\_\_\_\_ Apt. \_\_\_\_\_ Zip \_\_\_\_\_

Phone \_\_\_\_\_ I.D.# \_\_\_\_\_

Employer \_\_\_\_\_

Employer Phone \_\_\_\_\_

Signature \_\_\_\_\_

**PAIR ACTIVITY: Title Sort**

*Directions:* As a class, review the definitions of fiction, nonfiction, and reference. Then look at the book titles below. Work with a partner to write the correct category for each title. Write **fiction**, **nonfiction**, or **reference** on the lines.

**Example:**

nonfiction                      *Photography Made Easy*

1. \_\_\_\_\_                      *The Talking Cat*
2. \_\_\_\_\_                      *Ghost Stories for Halloween*
3. \_\_\_\_\_                      *The Complete Atlas: Maps of all the Countries in the World*
4. \_\_\_\_\_                      *A Vegetarian Cookbook*
5. \_\_\_\_\_                      *Webster's Third International Dictionary of English*
6. \_\_\_\_\_                      *George Washington, Father of Our Country*
7. \_\_\_\_\_                      *How to Care for Your Pet Dog*
8. \_\_\_\_\_                      *Encyclopedia Britannica*
9. \_\_\_\_\_                      *The Old Man and the Sea*
10. \_\_\_\_\_                      *Child Safety*

## CULTURAL COMPARISON ACTIVITY: Public Libraries

*Directions:* Think about public libraries in your native country and in the United States. Discuss the answers to the questions below with your classmates. (Optional: Write the information in the chart.)

	IN _____ (native country)	IN THE U.S.
1. Is there a public library in your community?		
2. Who can use the public library? Is it free?		
3. Can community groups use the public library for meetings?		
4. Does the library have classes or special programs for adults or children? What kind?		
5. What materials can you borrow from the library? What materials can you use in the library but not take out?		
6. Does the library have computers for people to use? What do people use the computers for?		

## EXPERIENTIAL ACTIVITIES

As a class, identify an important issue that affects the group. Some ideas are:

- visiting the library for an orientation
- getting a library card
- learning how to use the computer catalog
- getting income tax forms, a museum pass, or community information
- registering for and attending a library program
- taking children to the library
- finding out the bookmobile schedule
- getting books in other languages
- using reference services
- attending a movie
- requesting a book from another library
- investigating library materials for the disabled
- using the night owl reference service

Determine the best course of action from the suggestions below or have students generate their own plan of action. Choose an activity requiring a response by library personnel. Also select an activity in which students have a vested interest so that they will follow through to a satisfactory conclusion.

### AT THE LIBRARY

1. Arrange a tour of your local library. Have students prepare questions in advance for the librarian about library materials and services.

*risk: medium – high*

*language level: high beginning – advanced*

2. If students live in the library district, have them apply for library cards. Be sure they have the necessary identification and proof of address.

*risk: medium*

*language level: high beginning – advanced*

3. Design a library scavenger hunt to help students become familiar with the library. Provide a worksheet with 5-10 tasks. Include tasks such as:

- Find the copy machine. How much is a single copy?
- Look for the daily newspapers. What is today's headline?
- Does the library have a bookmobile? If so, get a brochure with the schedule.

Students may complete the scavenger hunt individually, in pairs, or in small groups.

*Note: Be sure to let the library staff know about the scavenger hunt activity in advance.*

*risk: low – medium*

*language level: all*

4. Ask the librarian to instruct students on the use of the computer catalog. For practice, have each student find a book by using the call number.

*risk: low*

*language level: intermediate – advanced*

## EXPERIENTIAL ACTIVITIES continued

5. Have students check out or copy pages from a book on their native country or culture. (The Children's Section usually has materials with good illustrations and a lower reading level.) Have students give brief oral reports in class or prepare a poster to share with the class.

*risk: medium – high*

*language level: high beginning – advanced*

6. Have students attend a library program or presentation as a class. After the event discuss and summarize the main points as a whole class activity.

*risk: low – medium*

*language level: intermediate – advanced*

7. Arrange a library tour for students and their families, to be followed by a child or parent-child activity at the library.

*risk: low*

*language level: all*

## IN THE CLASSROOM OR SCHOOL COMPUTER LAB

8. Have students access the community library's web site. Ask individual students to report on information they find.

*risk: low*

*language level: high beginning – advanced*

9. Find out if your local library responds to email questions and how long it takes to get a response. As a whole class, brainstorm a list of possible questions. Ask students to email a question to the local library (Students can do this individually, in pairs, or in small groups). Then have students report the library's answers to the class.

*risk: low*

*language level: high beginning – advanced*

10. Have students telephone or email the library to find out what materials are available in their native language and then report their findings to the class.

*risk: low – medium*

*language level: high beginning – advanced*

11. Invite a librarian to visit the class and do a presentation on library services. Have her demonstrate a child story hour, if appropriate. Have students prepare questions in advance about library materials and services.

*risk: low – medium*

*language level: high beginning – advanced*

◆◆◆ THE U.S. SCHOOL SYSTEM ◆◆◆

COMPONENTS

	Page
◆ TEACHER NOTES.....	143
◆ PICTURES	
• Pictures for Vocabulary Development.....	147
• Pictures for Language Experience.....	162
• Pictures for Group Story Writing.....	166
◆ READING PASSAGE	
• Pre-Reading Activity.....	168
• Reading Passage.....	169
• Vocabulary Activity 1.....	173
• Vocabulary Activity 2-A.....	174
• Vocabulary Activity 2-B.....	175
• Vocabulary Activity 3-A.....	176
• Vocabulary Activity 3-B.....	177
• Comprehension Check.....	178
◆ EXTENSION ACTIVITIES	
• Dialogue 1: <i>Reporting an Absence on the School Answering Machine</i> .....	180
• Dialogue 2: <i>Calling the School to Report a Child's Absence</i> .....	181
• Dialogue 3: <i>Calling the School for Information</i> .....	182
• Dialogue 4: <i>Teacher Calling Parent for Classroom Assistance</i> .....	183
• Role Play Activity: <i>Phone Calls to and from the School</i> .....	184
• Action Research Activity: <i>Children's Schools</i> .....	185
• Pair Activity 1: <i>Children's Schools</i> .....	186
• Pair Activity 2: <i>The School Calendar</i> .....	187
• Writing Activity: <i>Note to the Teacher</i> .....	192
• Cultural Comparison Activity 1: <i>Organization of Schools in Native Country</i> .....	193
• Cultural Comparison Activity 2: <i>Schools and Education</i> .....	194
◆ EXPERIENTIAL ACTIVITIES.....	195



## TEACHER NOTES

This module address the organization of United States schools (from preschool through college), school districts, and opportunities for parental involvement. The pre-reading activity encourages students to share information about the school systems in their native countries. In this way they can move from the familiar (their native countries' school systems) to the less familiar (the United States system). You should be sensitive to the fact that some students may have had limited educational experiences in their native countries.

In this module it is especially important to follow the lead of the class. That is, if there are a lot of parents in the class, then parental involvement issues (for example, parent-teacher conferences) can be explored in detail. Adult learners without children might prefer to investigate other issues, for example, educational opportunities available to them. The experiential activities should be geared to the different interests of students. Dividing the class into two or more groups would allow students to pursue appropriate choices. Each group could give a report on its activity to the rest of the class.

### COMPETENCIES FOR MODULE 4

Students will learn to:

1. Identify how schools are organized in the United States school system (i.e., from preschool through college).
2. Identify the organization of grades and schools within their local school district.
3. Identify the approximate ages of children who attend the schools within their district.
4. Describe the similarities and differences between the United States school system and the school systems of their native countries.
5. Explain the organization of their school district and school board.
6. Identify ways in which parents and other adults can participate in schools.

### A NOTE ON THE READING PASSAGE

The last page of the Reading Passage is a chart titled "Colleges and Universities in the United States". This chart contains information about kinds of U.S. colleges and universities, requirements for admission, and the degrees that can be earned at each. This chart may contain too much detail and vocabulary for beginning-level classes and should be used only if student interest and language level warrant it. Additional degrees (e.g., M.D., J.D., D.D.S., D.V.M.) may be added to the chart.

### THE VOCABULARY ACTIVITIES AND THE READING PASSAGE

The Reading Passage contains a large number of vocabulary words that may be unfamiliar to students. To facilitate the teaching of this module, Vocabulary Activity 1 focuses only on grades and appropriate ages for each grade. Vocabulary Activities 2-A and 2-B correspond to the introduction and first part of the Reading Passage (through "Adult Education"), while Vocabulary Activities 3-A and 3-B correspond to the rest of the Reading Passage ("Special Services" through "Public School Districts"). You may choose to teach the Reading Passage in two parts, at two different class meetings, depending on the level of your class.

**TEACHER NOTES** continued**A NOTE ON DIALOGUE 1**

The goal of Dialogue 1 is to teach learners to report a child's absence on the school answering machine. Many schools use an automated phone system or answering machine to take calls from parents or guardians reporting their child's absence. It is important that learners hear the actual recording from their child's school. You can obtain such a recording from the school office or make your own recording using a telephone or pick-up device (with the school's permission). These devices are available for about \$5 at electronics stores.

**A NOTE ON PAIR ACTIVITY 2: THE SCHOOL CALENDAR**

For this activity, obtain a school calendar from a local school attended by the children of many adult students in your class. You could also use the calendar from your ESL adult school. Provide one copy of the school calendar to each pair of students. (This activity can also be done as a whole class or small group activity instead of pairs.)

**EXPANSION IDEAS**

Active involvement in their children's school may not be part of the native culture of ESL parents. They may therefore be very reluctant to take the initiative in contacting teachers or participating in parent-teacher conferences. If the level of the class and student interest warrant it, you may want to role-play scenarios involving typical communication between parents and teachers. Topics might include:

- Homework expectations and study skills
- Seeking extra help from the teacher or school
- Encouraging children to join clubs and sports
- Appropriate classroom behavior

Adult learners with or without children might benefit from activities designed to explore the local community college catalog. Highlights might include:

- GED information
- Special 2-year career programs and licensing
- Non-credit courses
- Special events (job fairs, concerts, cultural events, etc.)
- Admission and registration procedures

**POSSIBLE AUTHENTIC MATERIALS**

- Local newspapers
- School newsletters (weekly "take-home," principal's newsletter, district or superintendent's newsletter)
- School and district web sites
- School literature (brochures on discipline, attendance policies, parent guides, school calendars, handbooks, etc.)
- Community college catalogs

## TEACHER NOTES continued

## RESOURCES\*

Print Materials

*A Guide to Your Children's Schools: A Parent Handbook*, Adult Learning Resource Center, Des Plaines, IL (2002). Can be downloaded from the ISBE English Language learning web site at [www.isbe.net/bilingual](http://www.isbe.net/bilingual). Information for parents on the U.S. school system, enrolling in school, school procedures and parental involvement. Available in English, Arabic, Bosnian, Russian, Spanish, and Vietnamese.

*Parents as Educational Partners (PEP): A School-Related Curriculum for Language Minority Parents*, Laura Segal Bercovitz and Catherine Porter (1995). Adult Learning Resource Center, Des Plaines, IL, (847) 803-3535, [www.thecenterweb.org](http://www.thecenterweb.org). A reproducible, multilevel curriculum designed to encourage ESL parents to take active roles in their children's education as well as increase their proficiency in English. The curriculum combines instruction about U.S. schools with participatory classroom techniques and includes numerous illustrations.

*Understanding American Schools: The Answers to Newcomers' Most Frequently Asked Questions*, Anne P. Copeland and Georgia Bennett (2001). The Interchange Institute, Brookline, MA, (617) 566-2227, [www.interchangeinstitute.org](http://www.interchangeinstitute.org). A book designed to help non-native parents choose schools and understand the U.S. school system.

New Learning Concepts, Inc., (800) 925-7853, [www.destinationlearn.net](http://www.destinationlearn.net)  
Catalog of parent involvement products including books, videos, and bilingual bookmarks for parents (English and Spanish).

Web Sites

The Center for Law and Education, (202) 462-7688

[www.cleweb.org/catalog.htm](http://www.cleweb.org/catalog.htm)

The School Improvement Catalog has resources such as *Urgent Message for Parents* and *Parents are Powerful* which contain information on topics such as parent rights, advocating for your child, and improving student achievement in English and Spanish.

## ERIC

[www.eric.ed.org/resources/parent/parent.html](http://www.eric.ed.org/resources/parent/parent.html)

Brochures for parents (many in Spanish) available in print or online on topics relating to the education of children.

ERIC.EECE Clearinghouse on Elementary and Early Childhood Education

[www.ericcece.org/pubs/digests.html](http://www.ericcece.org/pubs/digests.html)

Digests (short articles) on topics relating to schools, pre-schools, language learning and other education issues for teachers and parents. Many available in Spanish.

National Parent Information Network

[www.npin.org](http://www.npin.org) (Part of the ERIC system)

Resources include a "Virtual Library" with book summaries and Parent News newsletters as well as "Parents ask ERIC" question-answer service.

**TEACHER NOTES** continued

National PTA Education Resource Libraries

[www.pta.org/programs/edulibr.htm](http://www.pta.org/programs/edulibr.htm)

Numerous short articles (many in Spanish) on parent involvement issues from early childhood education through high school.

Videos

*Crossroads Café* (1996). Unit 2, "Growing Pains," and Unit 21, "Walls and Bridges" (issues concerning high school work-study programs). A 26-part video program available from Intelcom, [www.intelecom.com](http://www.intelecom.com). Textbooks available from Heinle & Heinle, [www.heinle.com](http://www.heinle.com). Videos can be used independently of textbooks.

*Raising Children In Troubled Times*. Set of 15 videos and facilitator guides (in English and Spanish) on general parenting topics and school-related topics including *Studying*, *Homework*, and *School Behavior*. American Guidance Service Publishing, (800) 328-2560, [www.agsnet.com](http://www.agsnet.com)

\* This list of resources is also located at [www.thecenterweb.org](http://www.thecenterweb.org) (click on "The Adult Learning Resource Center") where it is updated annually.

PICTURES FOR VOCABULARY DEVELOPMENT

public schools

property taxes

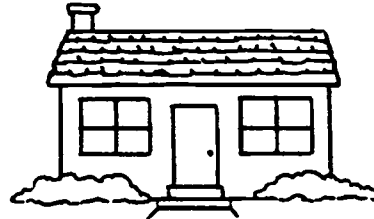
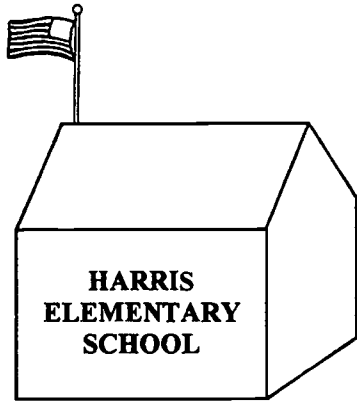

2003  
Property Tax  
Bill

private schools

tuition

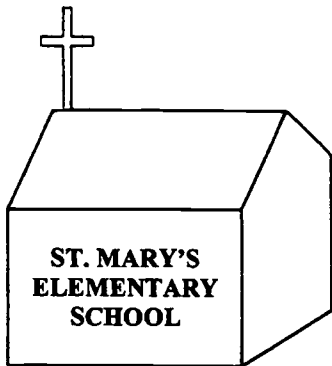

PICTURES FOR VOCABULARY DEVELOPMENT continued

KINDS OF SCHOOLS

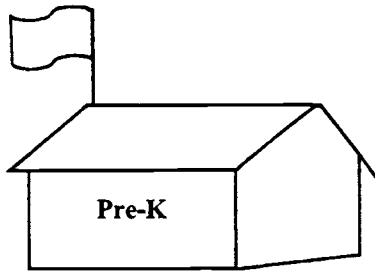

preschool

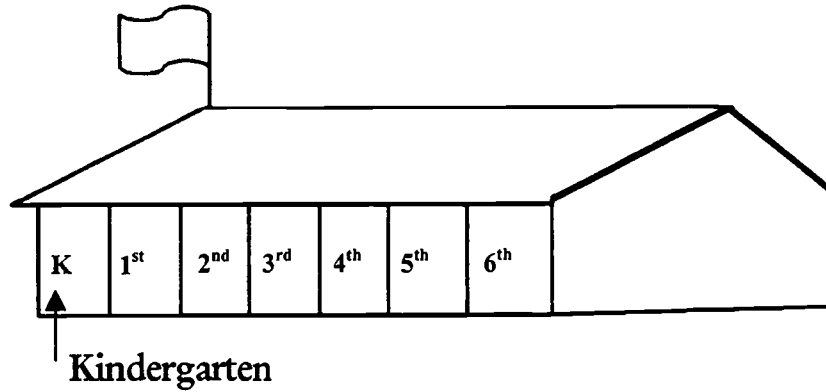

elementary school

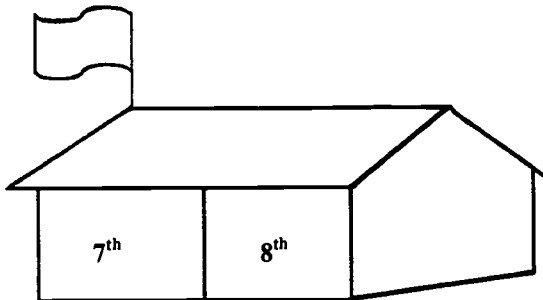

middle school/  
junior high school

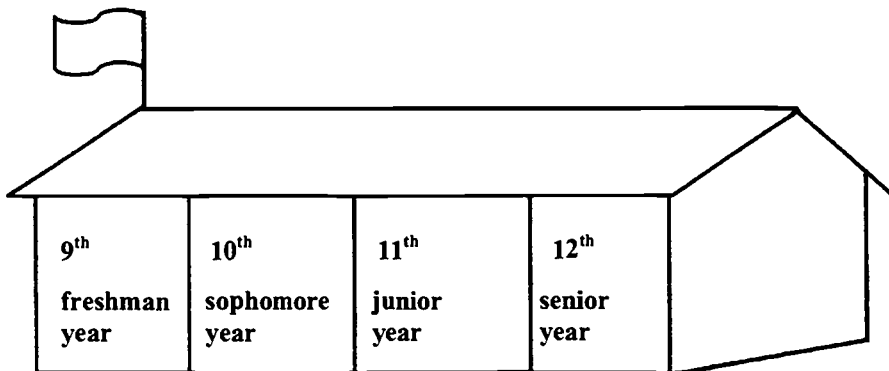

high school

PICTURES FOR VOCABULARY DEVELOPMENT continued

ORGANIZATION OF SCHOOLS IN DISTRICT \_\_\_\_\_  
(your local school district)

*Directions:* How are schools organized in your local school district? Draw pictures like the ones on the preceding page.

PICTURES FOR VOCABULARY DEVELOPMENT continued

graduate

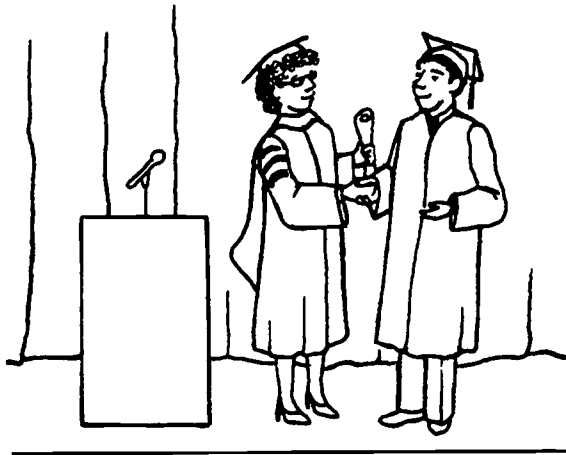

diploma

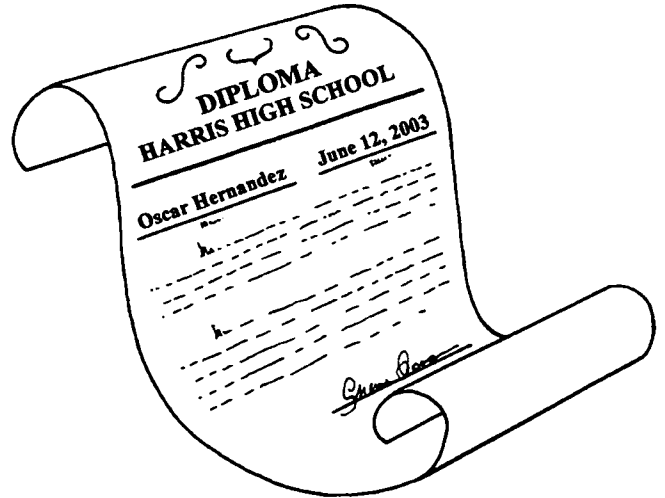

drop out

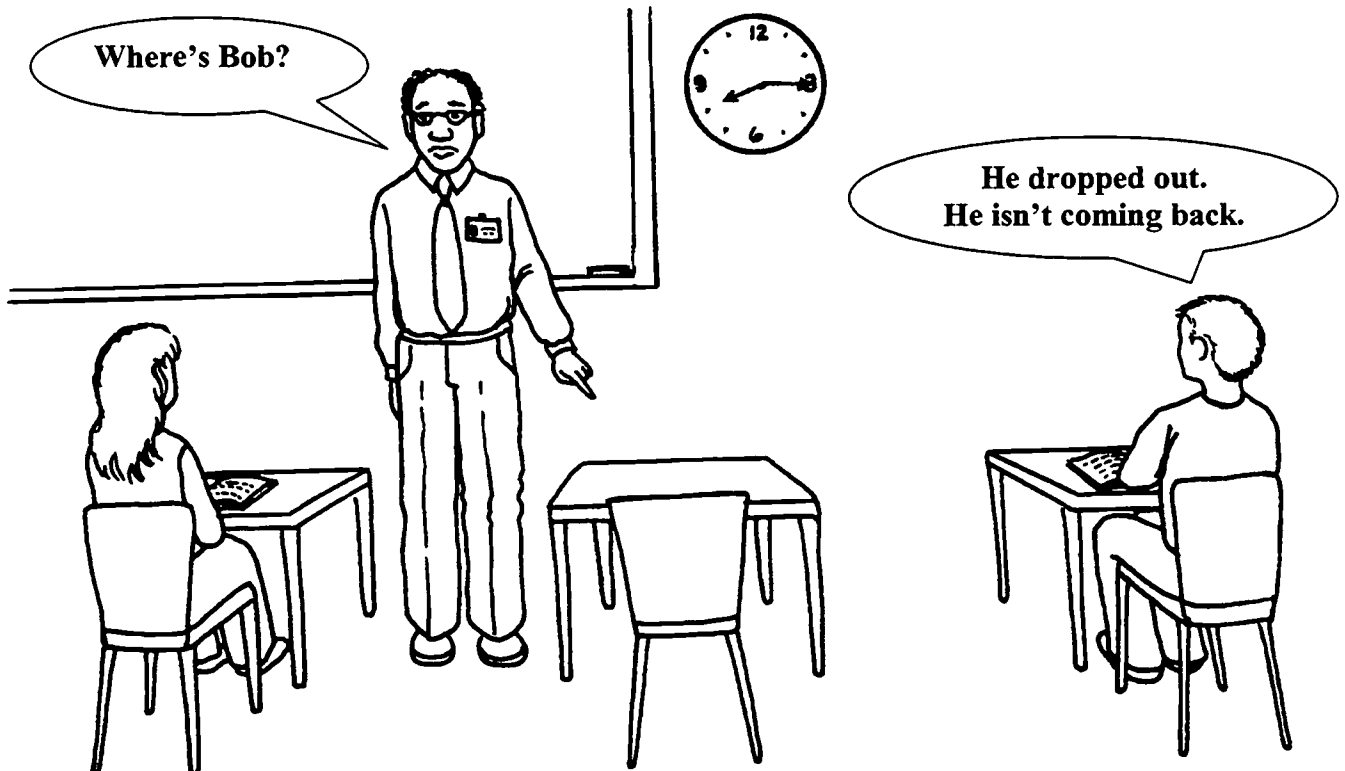



PICTURES FOR VOCABULARY DEVELOPMENT continued

AFTER HIGH SCHOOL

vocational schools

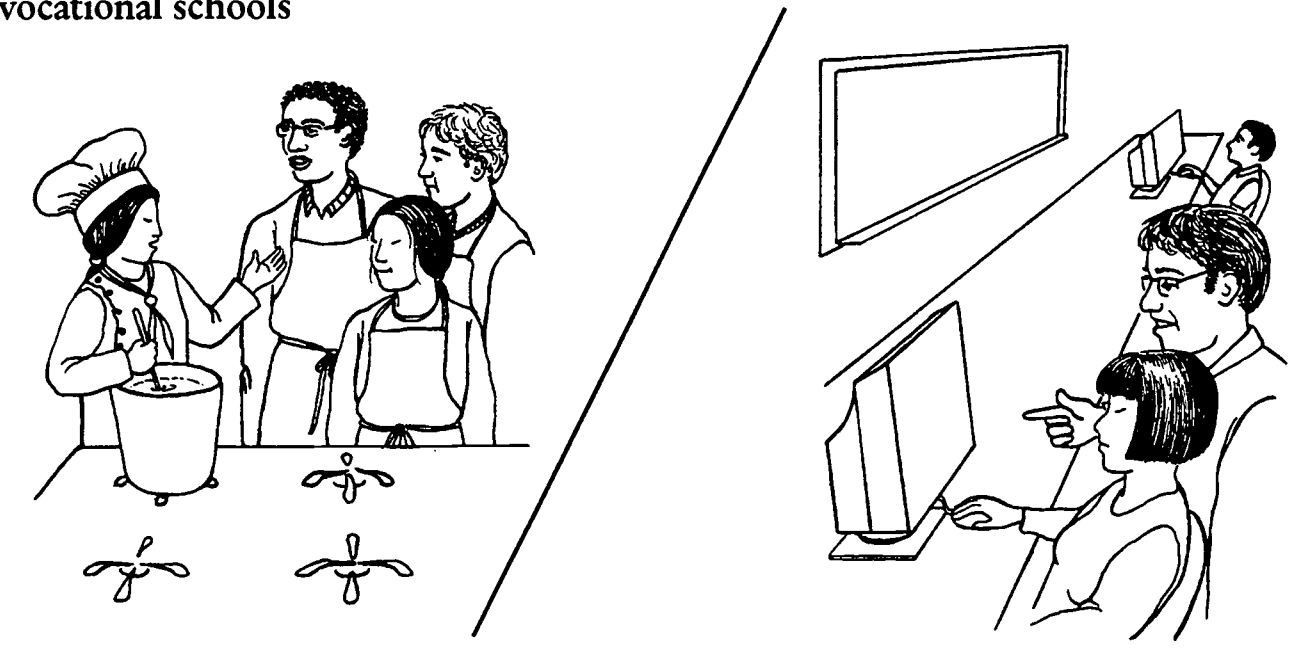

community colleges  
(2 years)

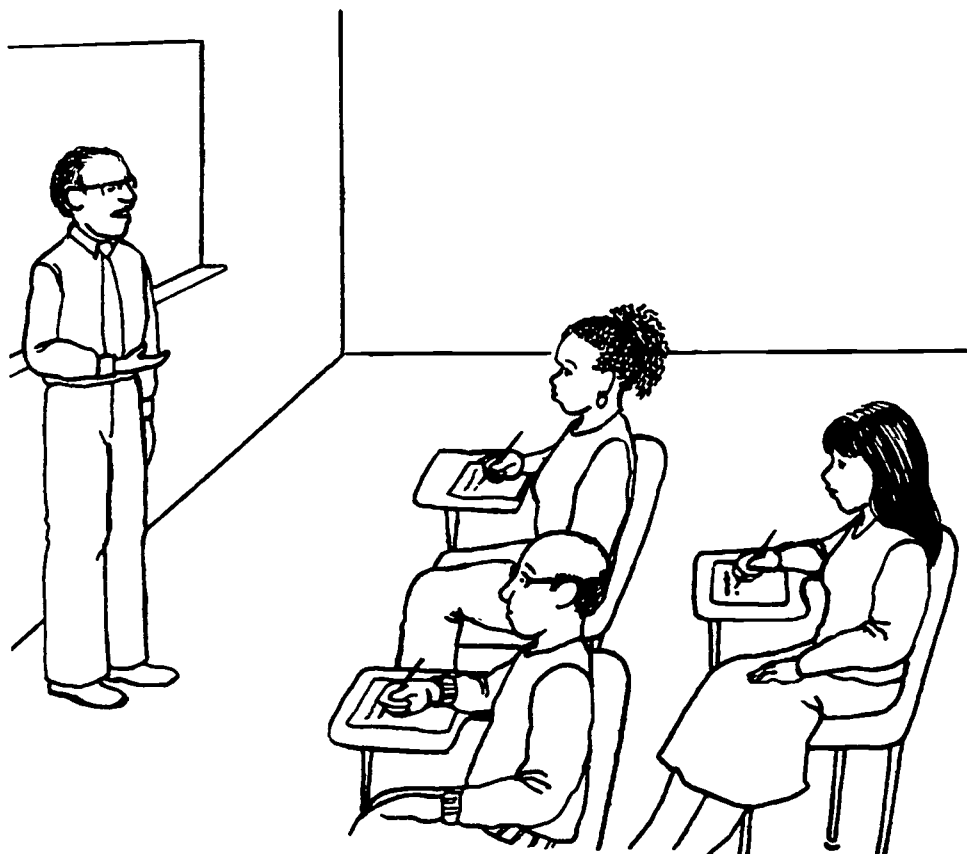

PICTURES FOR VOCABULARY DEVELOPMENT continued

AFTER HIGH SCHOOL

university/college  
(4 years)

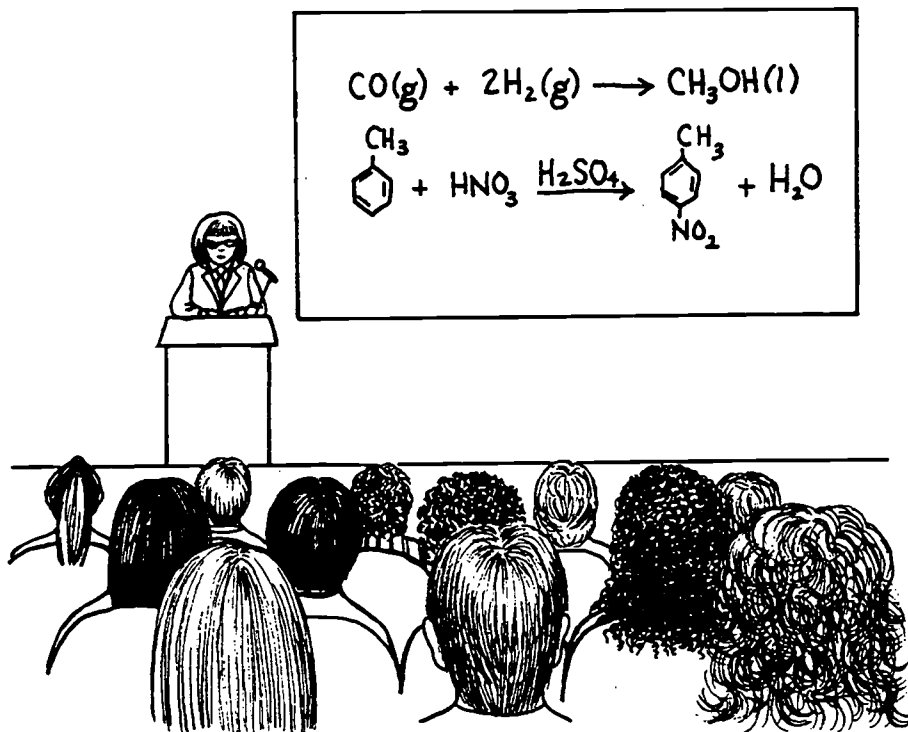

financial aid



## PICTURES FOR VOCABULARY DEVELOPMENT continued

## ADULT EDUCATION

## GED classes

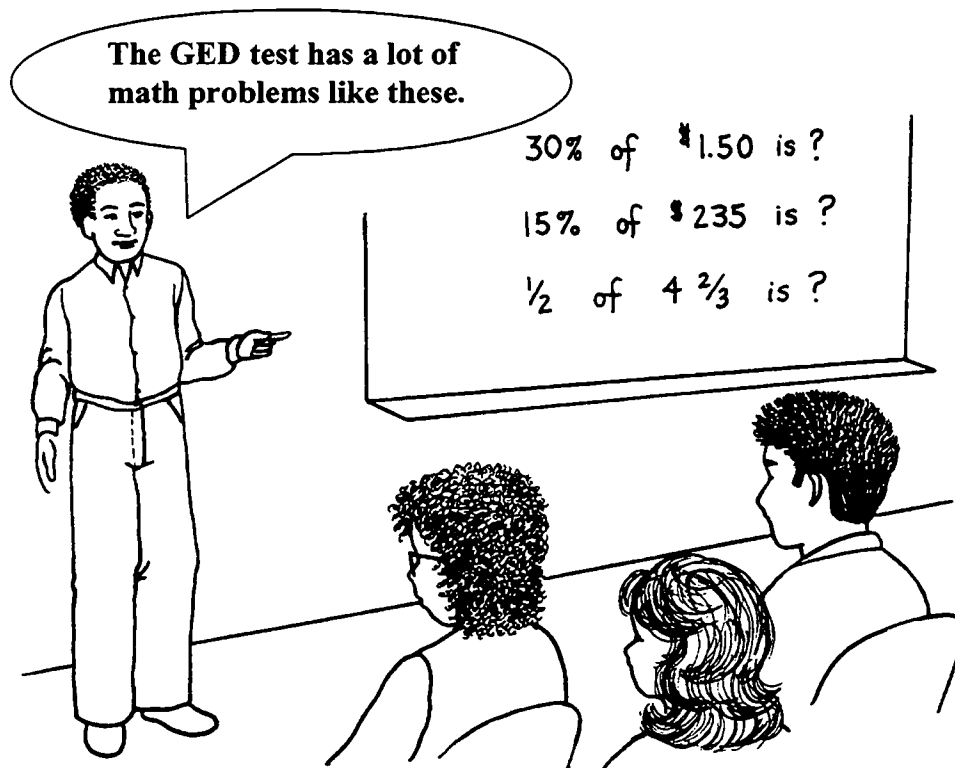

## ESL classes

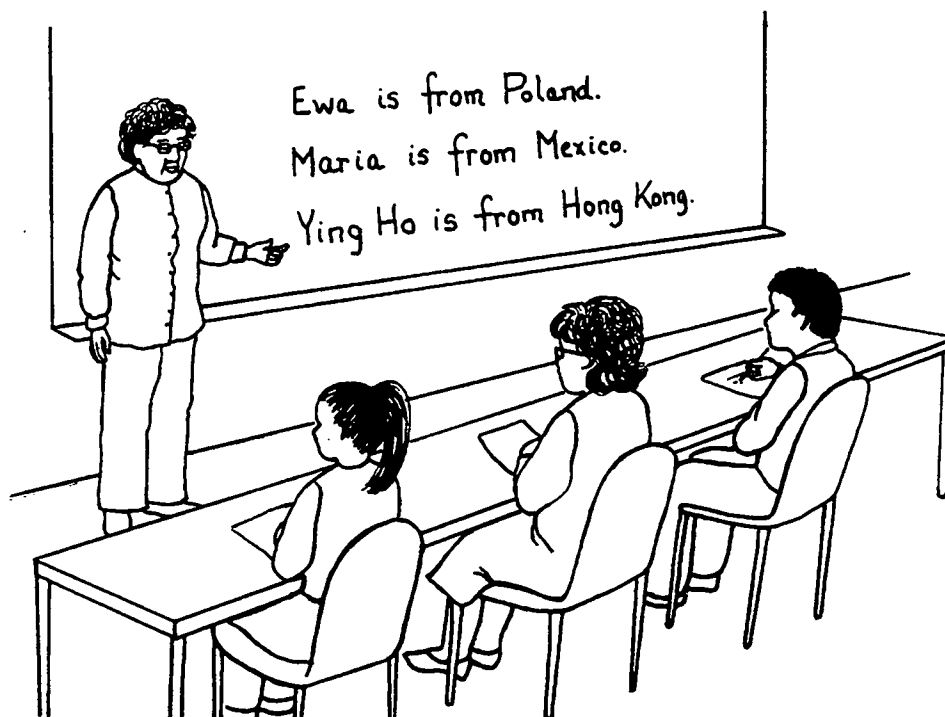

PICTURES FOR VOCABULARY DEVELOPMENT continued

SPECIAL SERVICES

physical differences

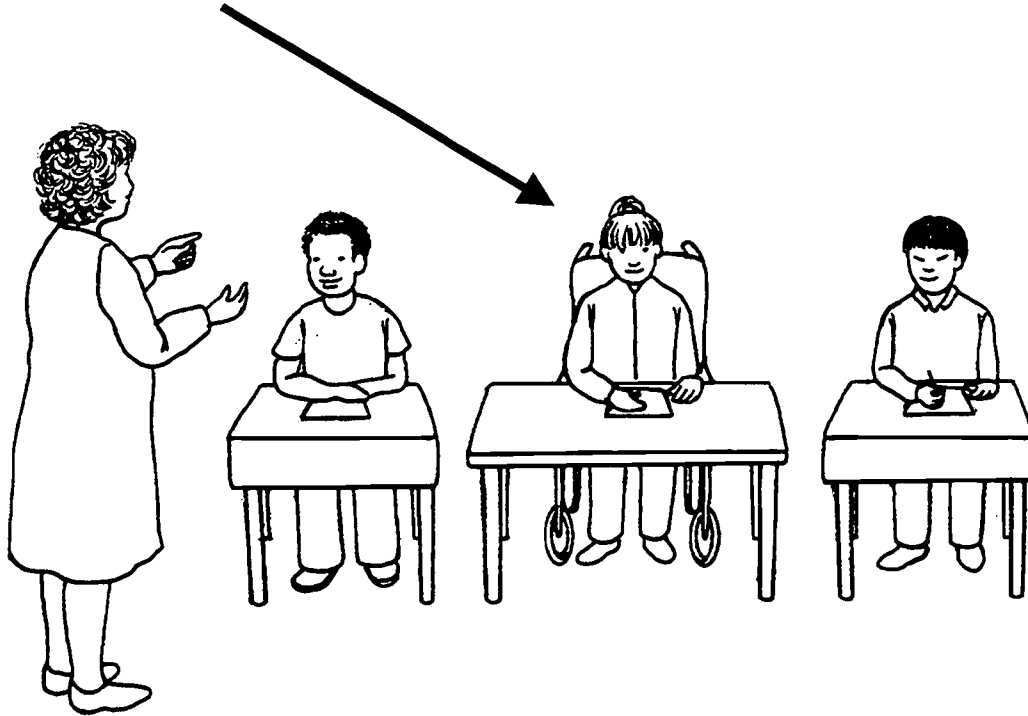

bilingual program

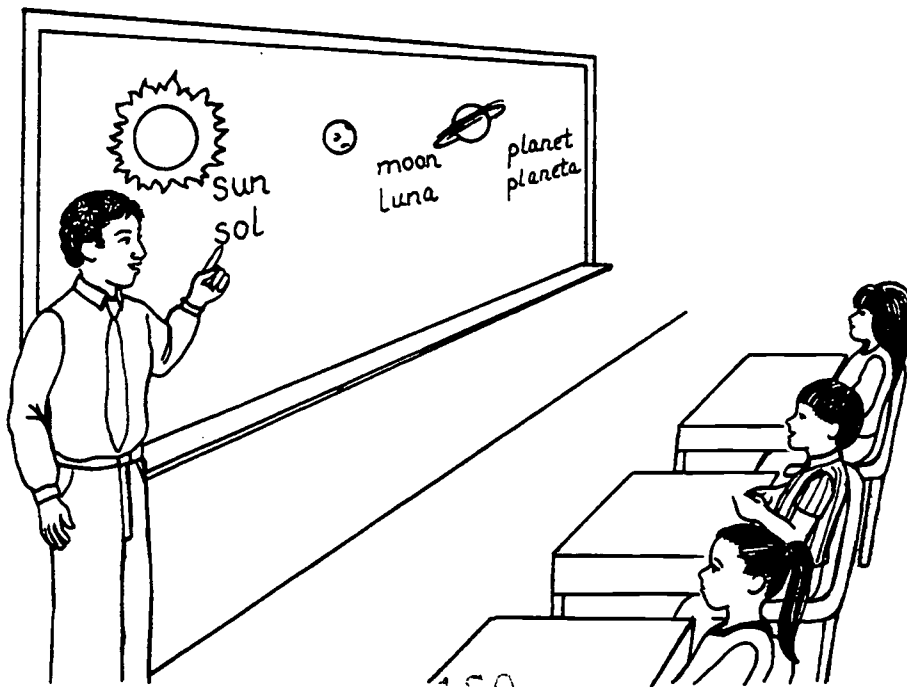

150

PICTURES FOR VOCABULARY DEVELOPMENT continued

SPECIAL SERVICES

gifted program



reading help

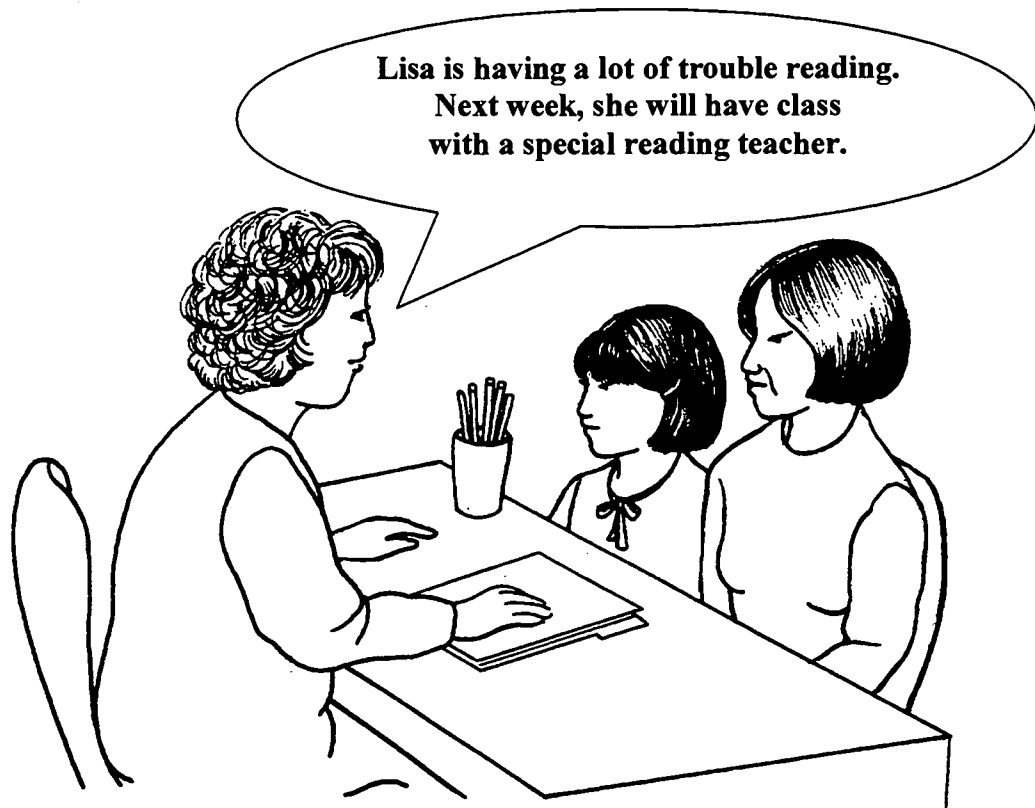

PICTURES FOR VOCABULARY DEVELOPMENT continued

PARENT PARTICIPATION

field trip

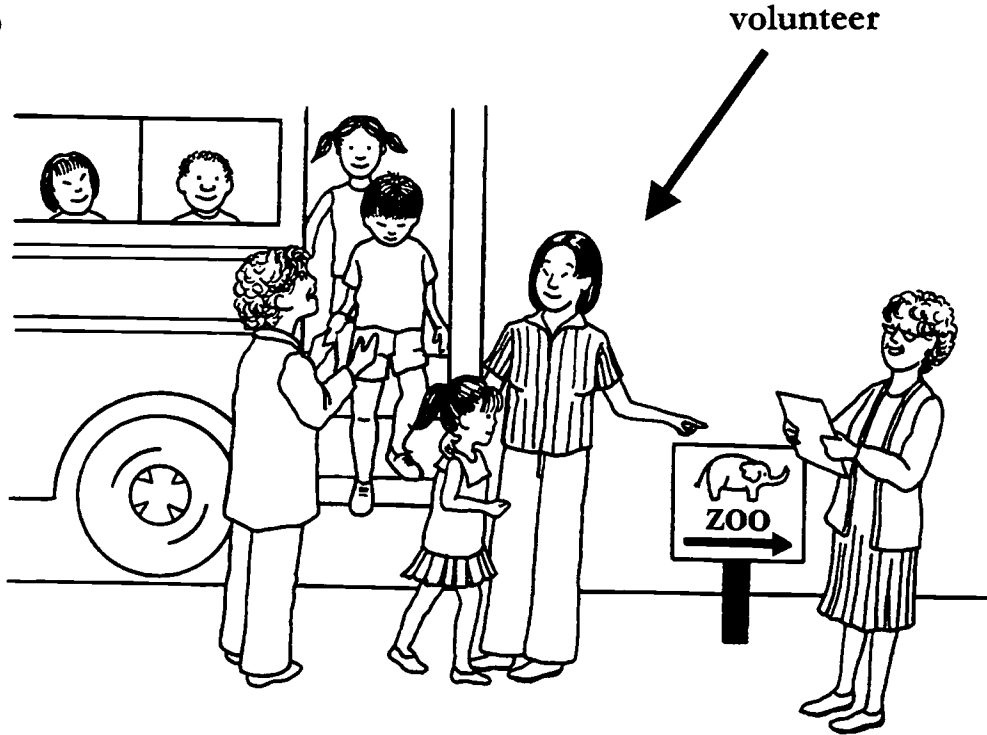

volunteer

parent-teacher organization (PTO/PTA)



PICTURES FOR VOCABULARY DEVELOPMENT continued

PARENT PARTICIPATION

parent-teacher conference

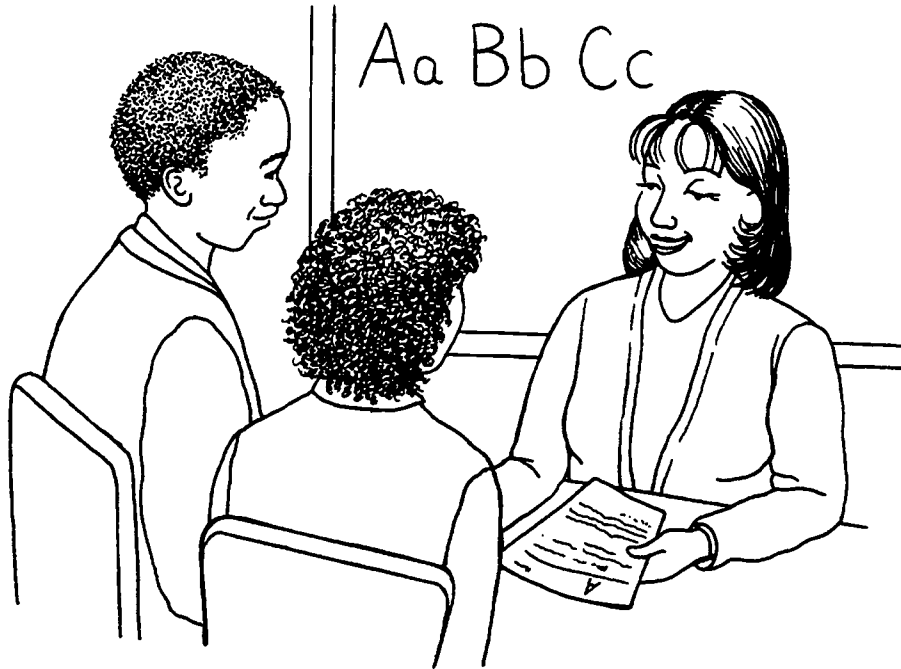

attend activities at the school



PICTURES FOR VOCABULARY DEVELOPMENT continued

PUBLIC SCHOOL DISTRICTS

school district

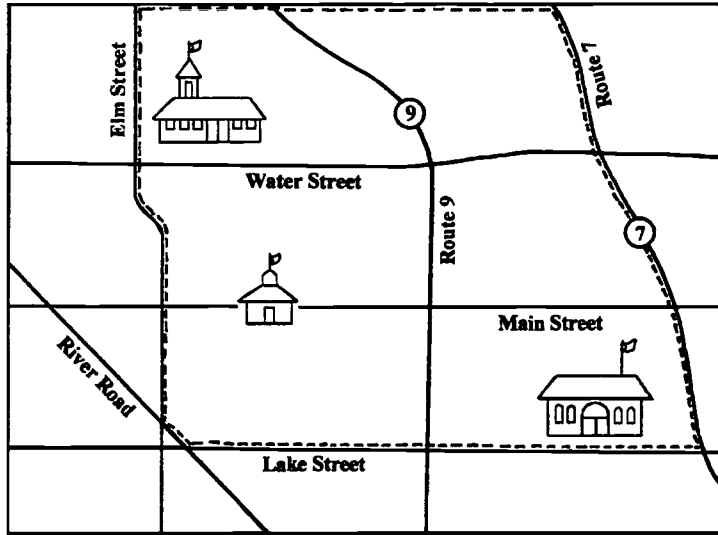

attendance area

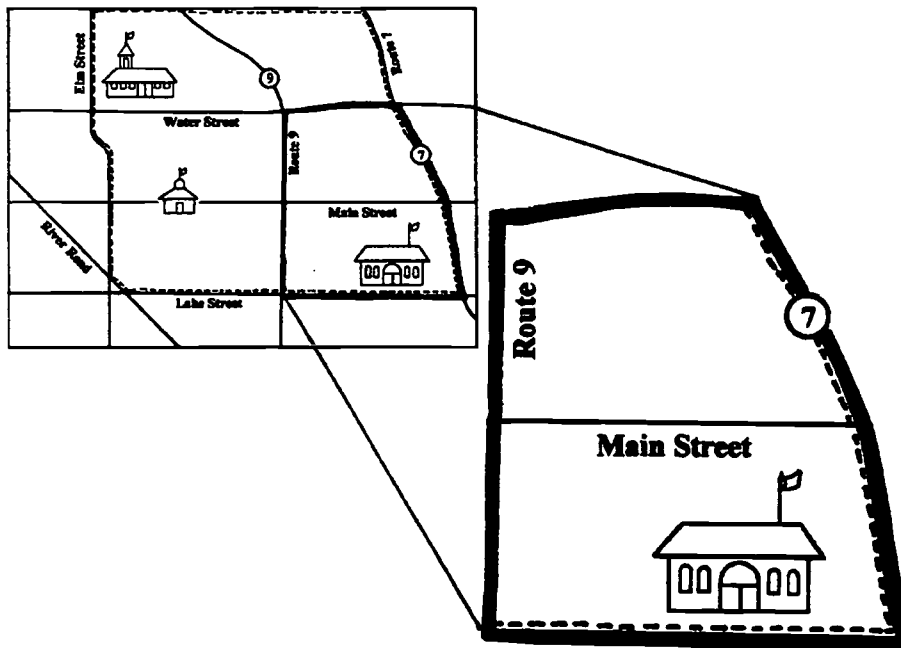



PICTURES FOR VOCABULARY DEVELOPMENT continued

school board/board of education

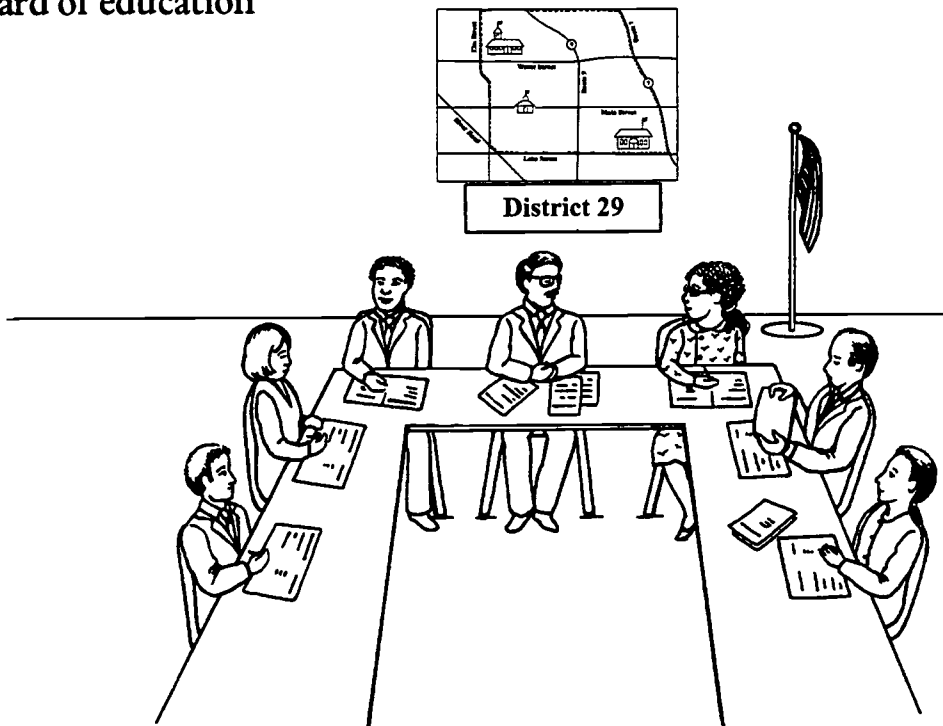

superintendent

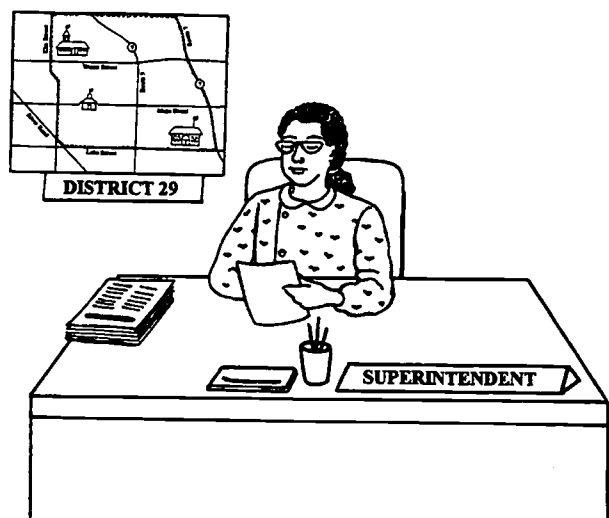

principal

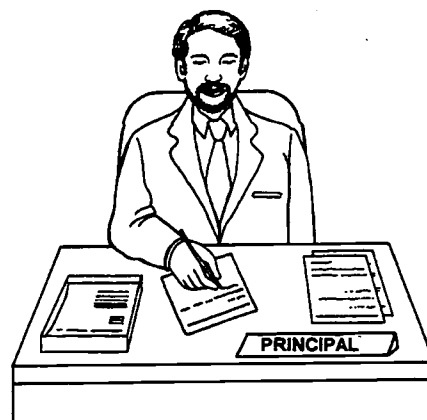

PICTURES FOR VOCABULARY DEVELOPMENT continued

POSSIBLE ORGANIZATION  
OF  
SCHOOL DISTRICT PERSONNEL

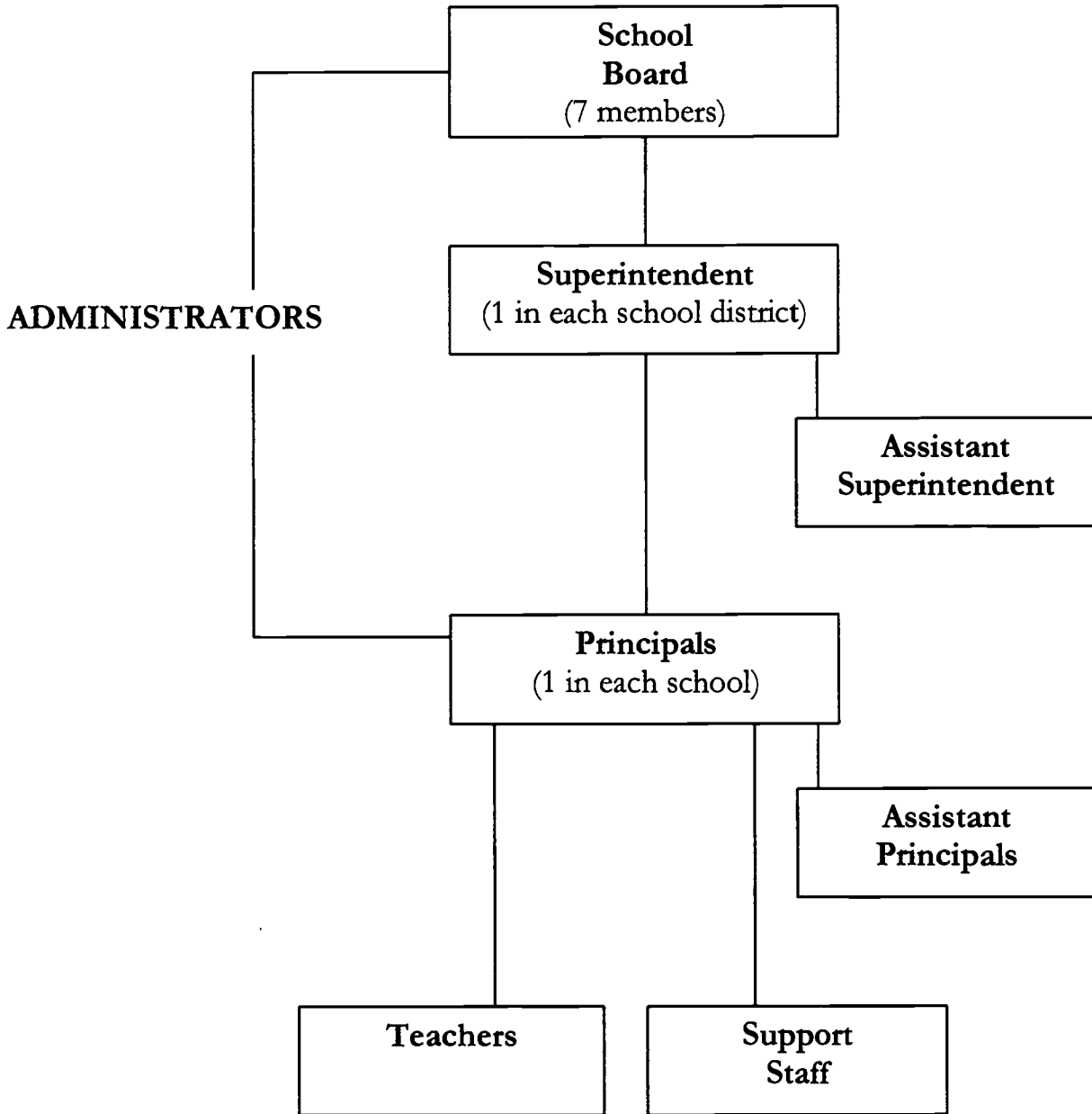

PICTURES FOR VOCABULARY DEVELOPMENT continued

ballot/referendum

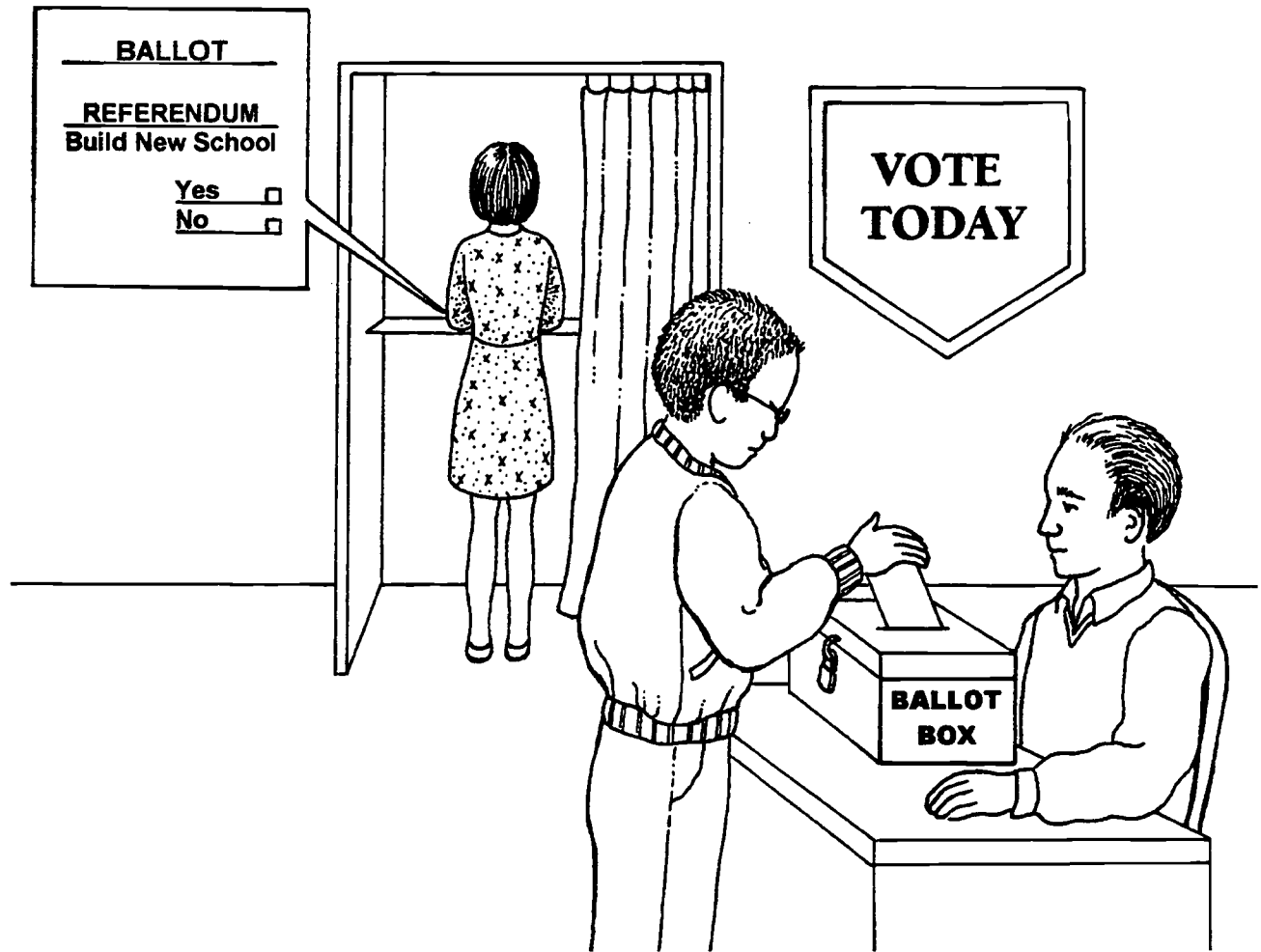

PICTURES FOR LANGUAGE EXPERIENCE

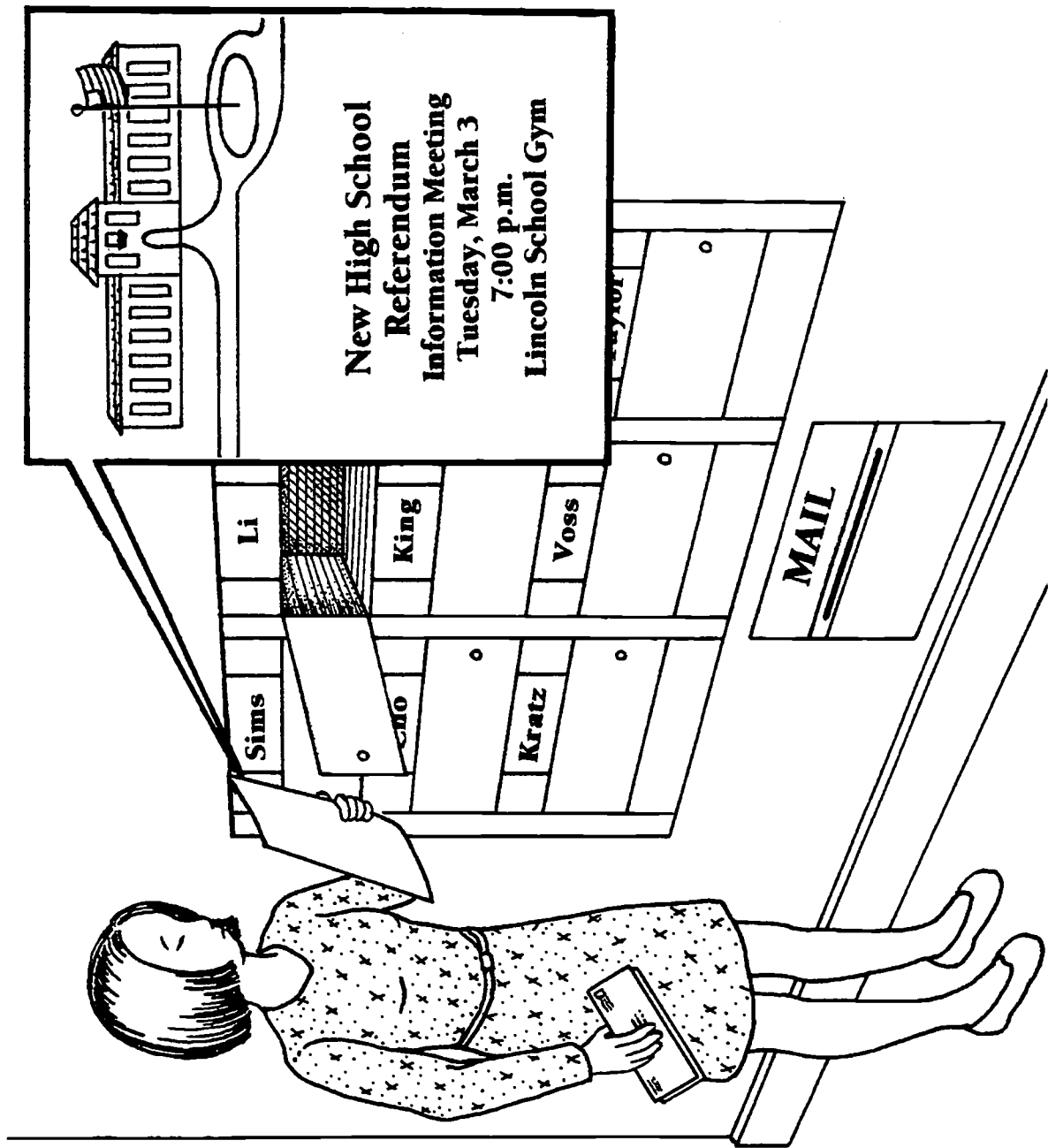

1

PICTURES FOR LANGUAGE EXPERIENCE continued

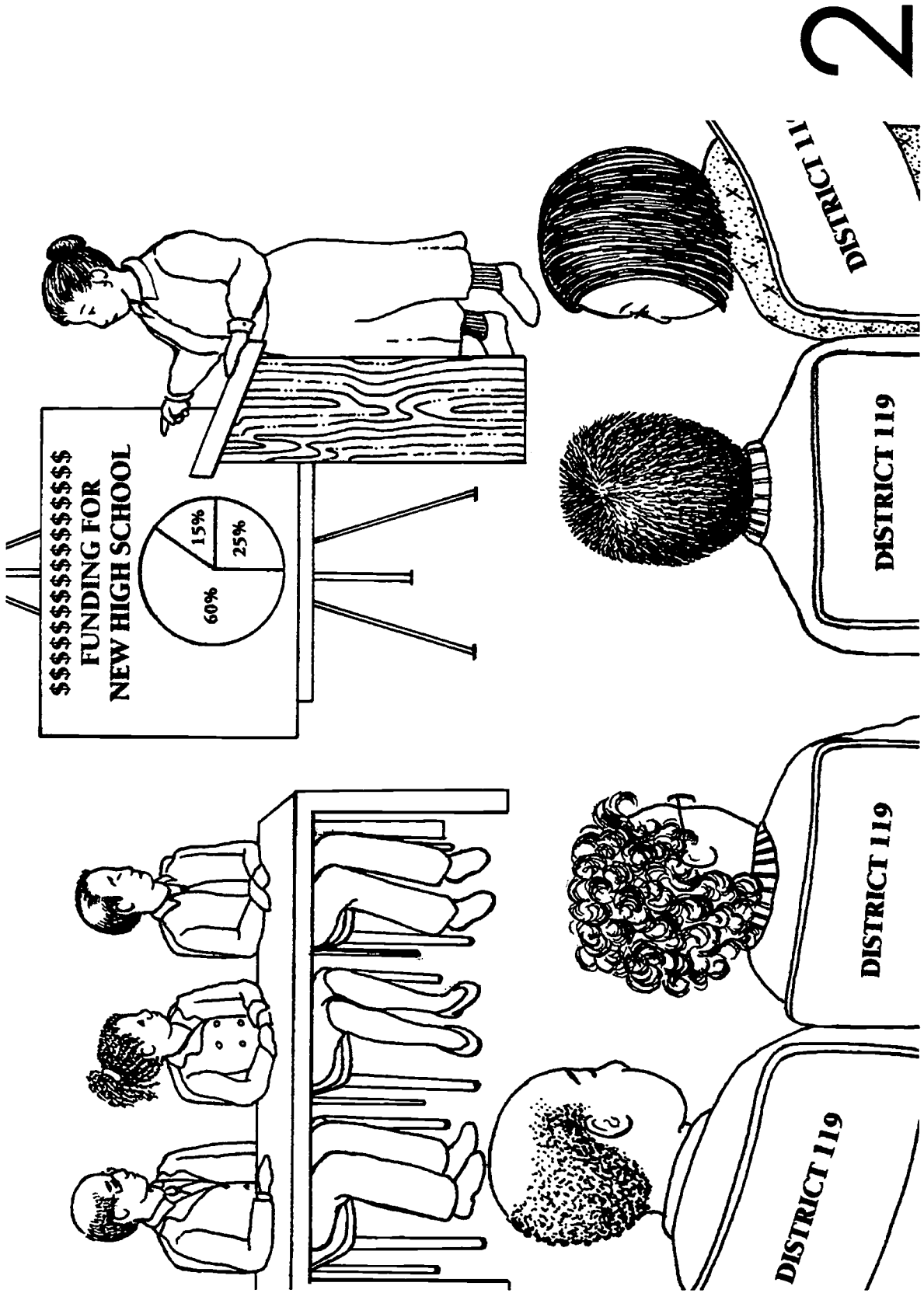

PICTURES FOR LANGUAGE EXPERIENCE continued

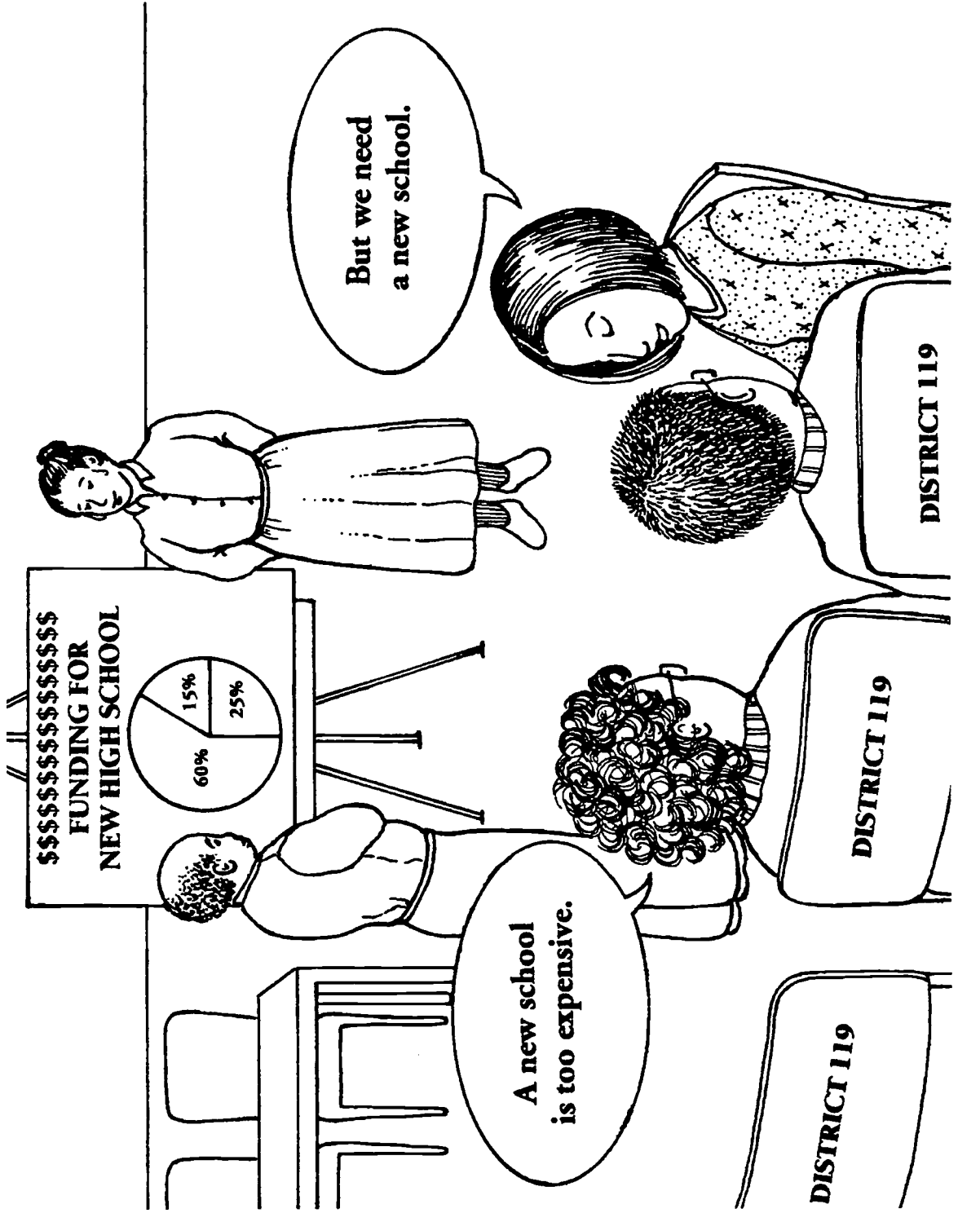

PICTURES FOR LANGUAGE EXPERIENCE continued

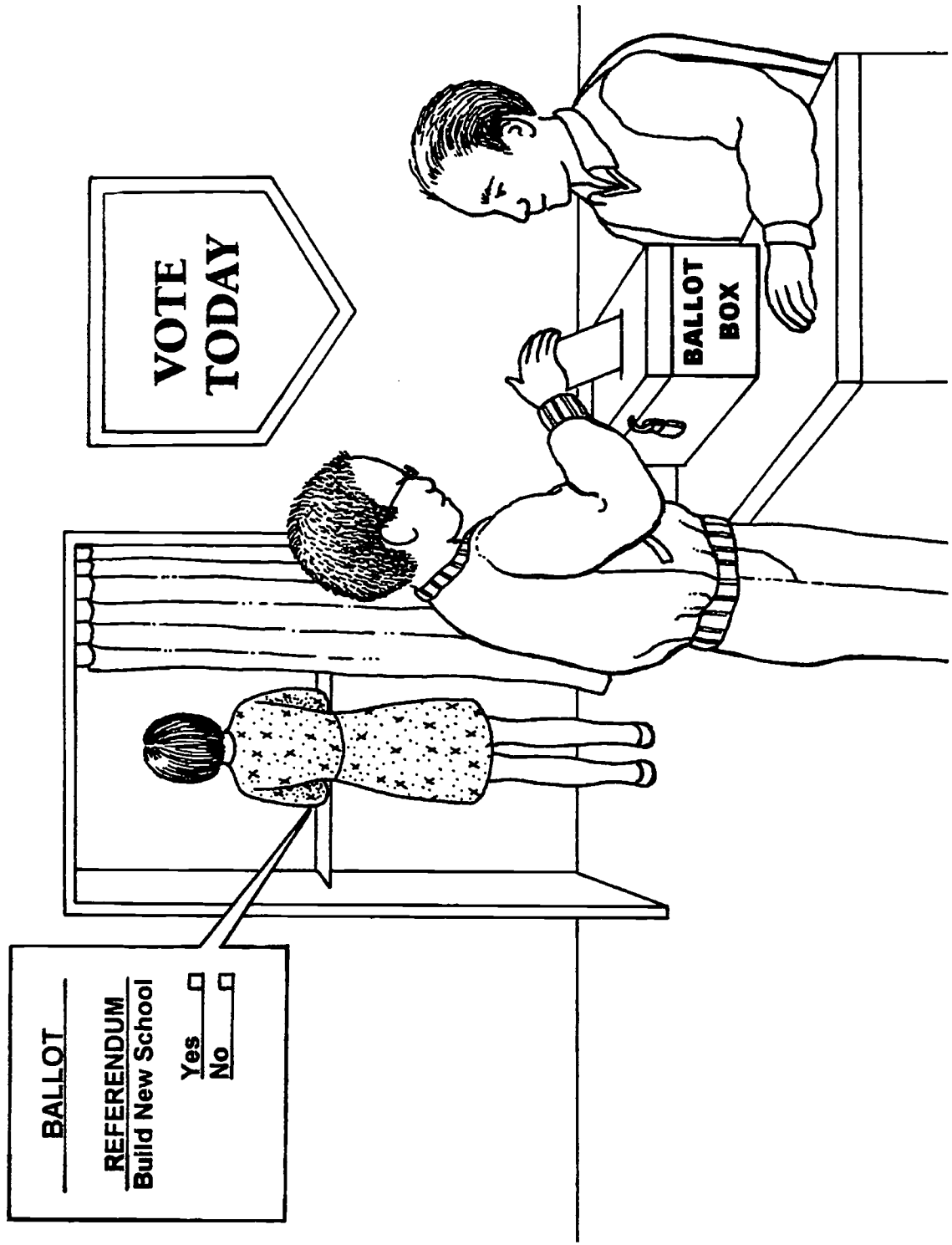

PICTURES FOR GROUP STORY WRITING

*Directions:* Work in groups of three or four. Write a story about the pictures below and on the next page. Write one or more sentences for each picture. Then share your story with the class.

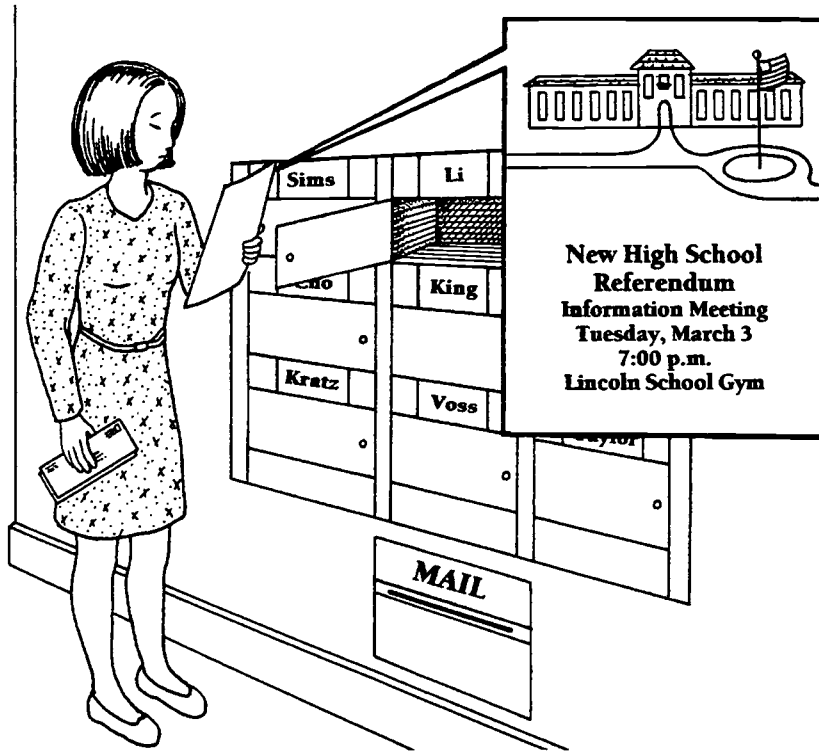

1

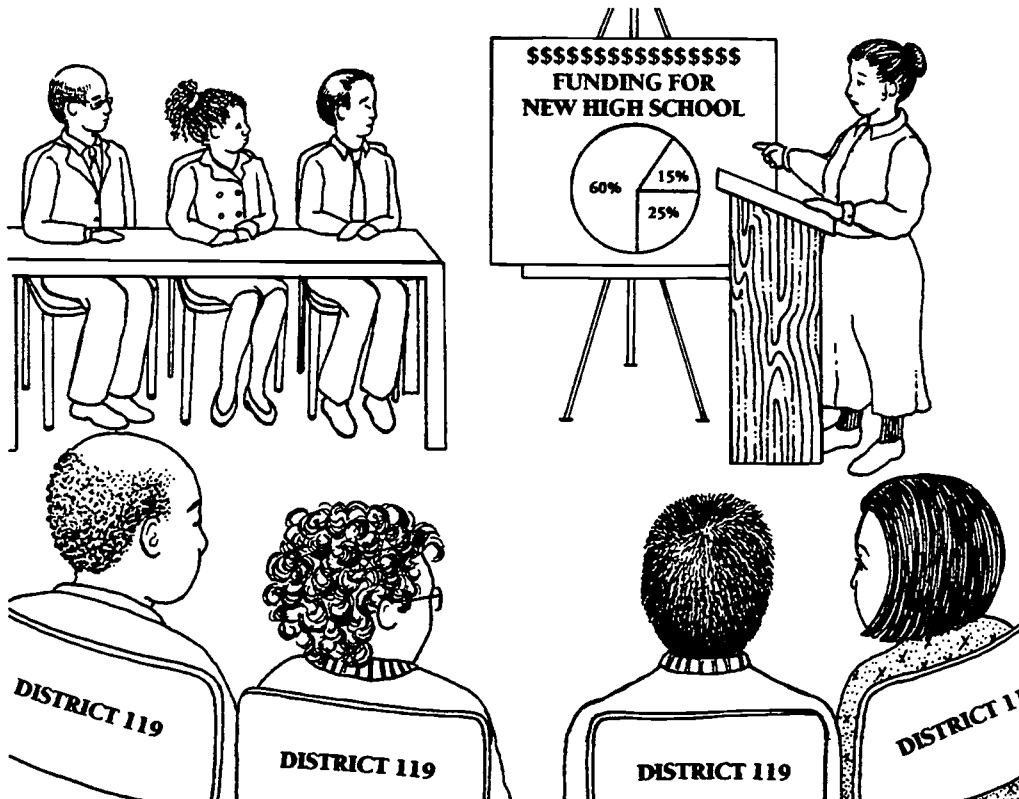

2



PICTURES FOR GROUP STORY WRITING continued

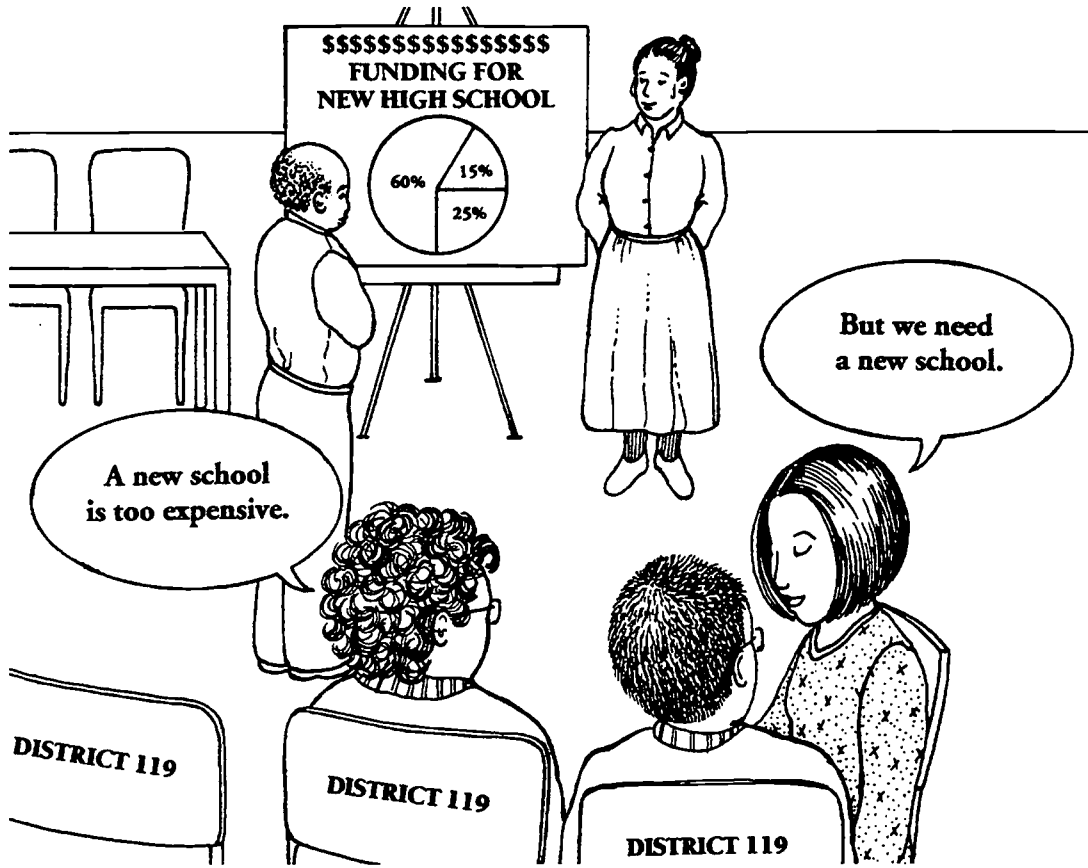

3

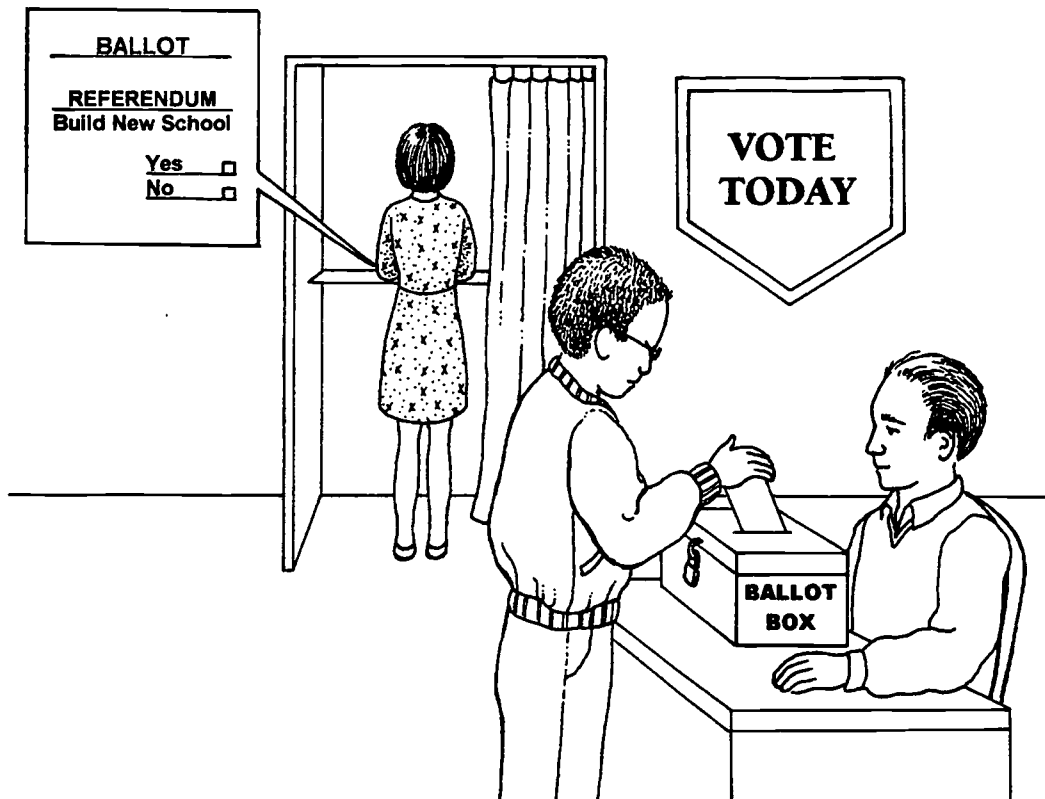

4

**READING PASSAGE: Pre-Reading Activity**

*Directions:* Think about schools in your native country. Discuss the answers to the questions below with your classmates. (Optional: Write the answers to the questions.)

1. Do all children go to school? Is it important for children to attend school every day?
2. Is school free? Do families have to pay for their children to go to school? Where does the money for schools come from?
3. At what age do children usually begin school? For how many years do children usually go to school?
4. How are schools organized? Do children of different ages go to different school buildings?
5. Are parents involved in their children's education? How?
6. Are universities free? Do many children get a university education?
7. Who makes decisions about the schools?

Now talk about this question with your classmates:

How is the United States school system different from the school system in your native country?

## READING PASSAGE

Most communities have schools for children. There are 2 types of schools: public schools and private schools.

Public schools are free. Sometimes parents have to pay for books and supplies, but they don't have to pay tuition. Most of the money to pay for public schools comes from property taxes. If you own a home, you pay property taxes each year. If you rent a house or apartment, your landlord uses part of your rent to pay property taxes. Public schools also get money from the federal and state government, so they have to follow government policies or rules.

Private schools are not free. Parents have to pay tuition for private schools. Private schools decide how much tuition parents have to pay. Because private schools don't get money from the federal or state government, they don't have to follow government policies. Many private schools are affiliated with a religion.

### KINDS OF SCHOOLS

Preschool: Many children begin preschool when they are 3 or 4 years old. Some preschools are public and some are private. In preschool, children play with other children and learn to listen to the teacher.

Kindergarten: Children who are 5 years old on or before September 1 can go to kindergarten. Children do not have to go to kindergarten, but most children do. Most kindergartens are public. Kindergarten classes usually meet for half a day, Monday through Friday. There are some full-day kindergartens, too.

Elementary School: School years in the United States are called grades. Elementary schools usually have kindergarten and grades 1 to 6. All children who are 6 years old must attend grade 1, called first grade.

Middle School/Junior High School: After elementary school, children attend middle school or junior high school. Middle schools and junior high schools usually have grades 7 and 8, but middle schools can have grades 5 or 6 too. Sometimes middle schools or junior high schools are in the same building as elementary schools.

High School: After middle school or junior high school, children begin high school. High schools usually have grades 9 to 12, but some schools have 10 to 12. High schools prepare students for jobs or for study after high school at community colleges, universities, or vocational schools.

When children finish their last year of high school, grade 12, they are usually 18 years old. In the United States, all children must go to school until they are 16 years old. It is important for children to attend school every day. Most children graduate from high school. But sometimes children do not finish high school. Some drop out before they graduate. It is important for all children to finish high school and to receive their high school diplomas.

**READING PASSAGE** continued

After High School: Students who graduate from high school can continue to study at community colleges, vocational schools, or universities. Vocational schools prepare students to work in certain fields, such as cooking or computer programming. Community colleges and universities offer degrees in many fields. There are both public and private 4-year universities and colleges in the United States, and they can be very expensive. Community colleges are 2-year public schools, but they are not free. Many families work hard to help pay for their children to attend community colleges and universities. Students can also apply for financial aid such as scholarships or loans. High schools, colleges, and universities can provide families with information about financial aid.

Adult Education: In the United States, everyone can go to school— even older adults. There are many learning opportunities for adults. Many classes are free, but some charge tuition. Classes are offered during the day, in the evening, and on weekends. Classes for adults are often held at community colleges, schools, libraries, and community centers. Some adult education classes are:

- English as a Second Language (ESL): to learn basic English language skills
- GED and Basic Skills: to learn basic reading and math skills, and to prepare for the GED test (high school completion test)

When adults have good English skills and a high school or GED diploma, they can apply to study at a college or university for a degree.

**SPECIAL SERVICES**

Public schools must provide education to all students, including those with special needs. Some students have physical differences, such as blindness, deafness, or difficulty moving their bodies. Some students have trouble learning and need special help. Schools may have gifted programs for very smart students. Some schools provide bilingual or English as a Second Language (ESL) classes for students who don't speak much English. Parents should talk to the school principal or their child's teacher if their child needs special services.

**PARENT PARTICIPATION**

Schools want parents to participate in their children's education. Parents should:

- Give their children a place and time to do homework.
- Show interest in their children's school work.
- Attend parent-teacher conferences.
- Attend other meetings and activities in the school.

If parents want to know how their children are doing in school, they can talk to the teacher, the principal, or other school staff members. It is a good idea to make an appointment before going to the school.

**READING PASSAGE** continued

Schools need volunteers to help in many ways. Volunteers work without pay. Parents can volunteer to:

- Go on field trips with their children's classes.
- Help with school parties or dances.
- Talk to classes about their jobs or their native countries.

Many schools have a parent-teacher organization. This group of parents and teachers plan programs for the school, its families, and the community. For example, they can organize volunteers to help teachers in their classrooms. Sometimes this group is called the PTO (Parent-Teacher Organization) or the PTA (Parent-Teacher Association).

**PUBLIC SCHOOL DISTRICTS**

Public schools are grouped into school districts. Some school districts include only one city or town, but other districts have more than one city or town. Each school district has 1 or more attendance areas. Children may attend public schools only in the attendance area where they live.

Each school district has a school board or board of education. The members of a school board live in their school district. Registered voters from each school district elect the school board members. To be a member, a person must be at least 18 years old, live in that school district, and be a U.S. citizen. Parents and non-parents can be members of their district's school board.

The school board makes decisions about the schools in the district. For example, the school board hires a superintendent, the administrator of the school district. The school board also hires and fires school principals. They may also decide how money is spent. The school board has to follow policies made by the state and federal government.

Sometimes community members help make decisions about schools. For example, a school-related issue might be on the ballot as a referendum on voting day. A referendum is a question on the ballot for people to vote "Yes" or "No."

**A TRUE STORY**

District 119 wanted to build a new high school. They decided to put a referendum on the ballot on voting day. The school board held a meeting to tell community members about the new school and the referendum.

Susan Li went to the meeting. She learned that the money to build the new school would come from higher property taxes. On voting day, the people in District 119 could vote "Yes" or "No" to have higher property taxes and build a new school. Susan voted on voting day.

## READING PASSAGE continued

**COLLEGES AND UNIVERSITIES  
IN THE UNITED STATES**

Kind of School	Degree Received	Typical Length of Study	Admission Requirements
Community College	A.A. (Associate of Arts) or A.S. (Associate of Science)	2 years	High School Diploma or GED Certificate
4-year College or University	B.A. (Bachelor of Arts) or B.S. (Bachelor of Science)	4 years	High School Diploma or GED Certificate
Graduate School (at a university)	M.A. (Master of Arts) or M.S. (Master of Science)	2 years after B.A./B.S.	Bachelor's Degree
	Ph.D. (Doctor of Philosophy)	3 or more years after M.A./M.S.	Master's Degree

## READING PASSAGE: Vocabulary Activity 1

*Directions:* There are different ways to say the names of the grades in United States schools. Say these words after your teacher. How old are most children when they start these grades? Write the ages on the lines.

GRADE			CHILD'S AGE (approximate)
preschool			_____
kindergarten			_____
grade 1	1 <sup>st</sup> grade	first grade	_____
grade 2	2 <sup>nd</sup> grade	second grade	_____
grade 3	3 <sup>rd</sup> grade	third grade	_____
grade 4	4 <sup>th</sup> grade	fourth grade	_____
grade 5	5 <sup>th</sup> grade	fifth grade	_____
grade 6	6 <sup>th</sup> grade	sixth grade	_____
grade 7	7 <sup>th</sup> grade	seventh grade	_____
grade 8	8 <sup>th</sup> grade	eighth grade	_____
grade 9	9 <sup>th</sup> grade	ninth grade <i>freshman year</i>	_____
grade 10	10 <sup>th</sup> grade	tenth grade <i>sophomore year</i>	_____
grade 11	11 <sup>th</sup> grade	eleventh grade <i>junior year</i>	_____
grade 12	12 <sup>th</sup> grade	twelfth grade <i>senior year</i>	_____

---

**READING PASSAGE: Vocabulary Activity 2-A**

*Directions:* Say these words after your teacher. Discuss the meaning of each word.  
(Optional: Write the meaning next to each word.)

1. public schools
2. property taxes
3. private schools
4. tuition
5. preschool
6. kindergarten
7. elementary school
8. middle school/junior high school
9. high school
10. graduate (*noun or verb*)
11. drop out (*noun or verb*)
12. diploma
13. community colleges
14. vocational schools
15. universities
16. financial aid

Other new words:



## READING PASSAGE: Vocabulary Activity 2-B

*Directions:* Write the letter of the correct meaning next to each word.

- |   |   |
|---|---|
| ___ 1. public school                        | a. a 4-year school for students after high school                 |
| ___ 2. property taxes                       | b. a school for grades 9-12 or 10-12                              |
| ___ 3. private school                       | c. to finish school with a diploma or degree                      |
| ___ 4. tuition                              | d. money that people pay to attend school                         |
| ___ 5. preschool                            | e. money that property owners pay to the county                   |
| ___ 6. kindergarten                         | f. a school where students learn a job or trade after high school |
| ___ 7. elementary school                    | g. a school for children age 3-4                                  |
| ___ 8. middle school/<br>junior high school | h. a certificate or document for students when they finish school |
| ___ 9. high school                          | i. to quit school before graduation                               |
| ___ 10. graduate                            | j. a school that is paid for by private money, not by taxes       |
| ___ 11. drop out                            | k. a school for grades 6-8 or 7-8                                 |
| ___ 12. diploma                             | l. a year of school for children age 5                            |
| ___ 13. community college                   | m. a school for grades 1-6  |
| ___ 14. vocational school                   | n. scholarships or loans to help students pay for school          |
| ___ 15. university                          | o. a school open to the public and supported by taxes             |
| ___ 16. financial aid                       | p. a 2-year school for students after high school                 |

**READING PASSAGE: Vocabulary Activity 3-A**

*Directions:* Say these words after your teacher. Discuss the meaning of each word.  
(Optional: Write the meaning next to each word.)

1. special services
2. participate
3. principal
4. volunteer (*noun or verb*)
5. field trip
6. parent-teacher conference
7. parent-teacher organization (PTO, PTA)
8. school district
9. attendance area
10. school board/board of education
11. superintendent
12. ballot
13. referendum/referenda (*plural*)

Other new words:

**READING PASSAGE: Vocabulary Activity 3-B**

*Directions:* Write the correct word or words in each sentence. Use the word bank for help. Each word can be used only once.

1. A person who works without pay is a \_\_\_\_\_ .
2. The leader of a school is the \_\_\_\_\_ .
3. School children sometimes take \_\_\_\_\_ to museums, theatres, zoos, or other interesting places.
4. At a \_\_\_\_\_ parents can talk with their children's teachers.
5. Ways parents can \_\_\_\_\_ in their children's education are to attend parent-teacher conferences or volunteer in the school.
6. A group of parents and teachers who plan programs for schools, families, and the community is a \_\_\_\_\_ .
7. Each \_\_\_\_\_ has a school board to make decisions about the schools.
8. Juan cannot go to Franklin School because he does not live in the \_\_\_\_\_ .
9. The voters in the school district elect the members of the \_\_\_\_\_ .
10. The administrator of the school district is the \_\_\_\_\_ .
11. In an election, the \_\_\_\_\_ lists the candidates and issues.
12. People vote on school-related issues called \_\_\_\_\_ .
13. Public schools must provide \_\_\_\_\_ to children with special learning needs or physical differences.

**WORD BANK**

attendance area

ballot

parent-teacher conference

principal

field trips

participate

school district

referenda

school board/board of education

special services

superintendent

volunteer

parent-teacher organization  
(PTO, PTA)

## READING PASSAGE: Comprehension Check

*Directions:* The sentences below are about schools in the United States. Take turns reading each sentence with a partner. Decide if each sentence is TRUE or FALSE. Put an X under TRUE or FALSE. (Optional: Correct the false sentences.)

	TRUE	FALSE
1. Property taxes help to pay for public schools.	_____	_____
2. Parents have to pay tuition for public schools.	_____	_____
3. All children go to preschool.	_____	_____
4. Most children who are 5 years old go to kindergarten.	_____	_____
5. Children who are 6 years old must go to school.	_____	_____
6. Elementary schools usually have kindergarten and grades 1 to 12.	_____	_____
7. High schools usually have grades 9 to 12.	_____	_____
8. Children always graduate from high school.	_____	_____
9. All children must go to school from age 6 to age 16.	_____	_____
10. It is important for children to attend school every day.	_____	_____
11. Community colleges and universities are free.	_____	_____
12. Schools want parents to be active in their children's education.	_____	_____
13. It's a good idea for parents to make an appointment before they visit the school.	_____	_____

## READING PASSAGE: Comprehension Check continued

- |   | TRUE  | FALSE |
|---|-------|-------|
| 14. All school districts have a school board to make decisions about the schools. | _____ | _____ |
| 15. The superintendent elects school board members.                               | _____ | _____ |
| 16. The superintendent is the administrator of the school district.               | _____ | _____ |
| 17. Sometimes important school issues are on the ballot as referenda.             | _____ | _____ |

**DIALOGUE 1: Reporting an Absence on the School Answering Machine**

*Directions:* Listen to the dialogue. Then practice the dialogue with your teacher and classmates.

María López is sick and can't go to school today. Her mother calls the school before school starts and leaves a message on the school answering machine.

Answering machine: This is Lincoln School. Please leave a message after the beep.  
(Pause) Beep

Parent: This is Mrs. López. My daughter is sick and can't come to school today. Her name is María López. She is in Mrs. Black's third grade class. Thank you.

**Note to the Teacher.** The goal of Dialogue 1 is to teach learners to report a child's absence on the school answering machine. Many schools use an automated phone system or answering machine to take calls from parents or guardians reporting their child's absence. It is important that learners hear the actual recording from their child's school. You can obtain such a recording from the school office or make your own recording using a telephone pick-up device (with the school's permission). These devices are available for about \$5 at electronic stores.

**DIALOGUE 2: Calling the School to Report a Child's Absence**

*Directions:* Listen to the dialogue. Then practice the dialogue with your teacher and classmates.

María López is sick and can't go to school today. Her mother calls the school in the morning before school starts.

Secretary: Good morning, Lincoln School.

Parent: Hello, this is Mrs. López.

Secretary: How can I help you, Mrs. López?

Parent: My daughter is sick. She has a fever. She can't come to school today.

Secretary: What's her name?

Parent: María López.

Secretary: Who is her teacher?

Parent: Mrs. Black.

Secretary: Okay. I'll tell Mrs. Black. Thank you for calling. Goodbye.

Parent: Thank you. Good bye.

**DIALOGUE 3: Calling the School for Information**

*Directions:* Practice this dialogue with a partner. Use the information in the box at the bottom of the page to complete the dialog.

A parent calls his son's high school to ask a question. He talks to the school clerk.

School Clerk: Good morning. Wilson High School.

Parent: Yes, this is \_\_\_\_\_ . I have a question  
(your name)  
about the \_\_\_\_\_ .  
(event)

School clerk: Yes. What do you want to know?

Parent: When is it?

School clerk: It's on \_\_\_\_\_ .  
(day and date)

Parent: Okay. And what time does it start?

School clerk: It starts at \_\_\_\_\_ .  
(time)

Parent: I see. And where will it be held?

School clerk: In the \_\_\_\_\_ .  
(location)

Parent: Thank you very much. Good bye.

School clerk: You're welcome. Good bye.

Event	Day and Date	Time	Location
New Student Orientation	Saturday, August 30 <sup>th</sup>	10:00 a.m.	student cafeteria
Winter Concert	Friday, January 17 <sup>th</sup>	7:00 p.m.	school gym
School Board Meeting	Monday, November 5 <sup>th</sup>	6:30 p.m.	school auditorium



**DIALOGUE 4: Teacher Calling Parent for Classroom Assistance**

*Directions:* Listen to the dialogue. Then practice the dialogue with your teacher and classmates.

A geography teacher calls a parent to ask a favor. He wants the parent to come to his classroom to talk about the parent's native country, China.

*Phone rings*

Parent: Hello?

Teacher: Hello. Could I please speak to Mr. or Mrs. Chan?

Parent: This is Mrs. Chan.

Teacher: My name is Mr. Garfield. I'm your son's geography teacher.

Parent: Oh, no. Does he have a problem?

Teacher: No, not at all! He's a good student. But I have a favor to ask of you or your husband. We're studying about China. Do you think you or your husband could come and talk about China? And maybe answer some questions?

Parent: What kind of questions?

Teacher: The students will probably ask about the weather and the food, and maybe a little bit about your government. Do you think you can come?

Parent: I'll talk to my husband. I think one of us can come.

Teacher: Thank you. I think you'll enjoy it!

**ROLE PLAY ACTIVITY: Phone Calls to and from the School**

*Directions:* Here are 4 situations. Discuss each situation with your classmate. With a partner, choose 1 of the situations and plan a conversation about it. Then present your conversation to the class. (Optional: Write your conversation.)

<p><b>1-A. You are the school nurse.</b></p> <p>Call Mrs. García and tell her that her son has a fever. Ask her if she can come to school and take him home.</p>	<p><b>1-B. You are Mrs. García.</b></p> <p>The school nurse will call to tell you that your son Ramón has a fever. Tell the nurse that your friend will bring you to school in an hour.</p>
<p><b>2-A. You are Mrs. Wong.</b></p> <p>The school nurse will call you and tell you that Yu Li is hurt. Ask what is wrong and then say that you will pick her up right away.</p>	<p><b>2-B. You are the school nurse.</b></p> <p>Yu Li Wong slipped and has a big bump on her head. You put ice on it, but the child is upset. Call Mrs. Wong and ask her to take Yu Li home.</p>
<p><b>3-A. You are the school secretary.</b></p> <p>Pramod Shah fell in the gym and broke his arm. Call his father at work and tell him that the school is taking Pramod to the hospital.</p>	<p><b>3-B. You are Mr. Shah.</b></p> <p>When the school secretary calls you to tell you about your son's accident, ask if he is all right. Then tell her that you will go to the hospital.</p>
<p><b>4-A. You are Mrs. Polanski.</b></p> <p>Your daughter Anna was sick yesterday and the doctor says she must stay in bed all week. Call the school and tell the secretary that Anna cannot come to school this week. Ask how you can get your daughter's books and assignments.</p>	<p><b>4-B. You are the school secretary.</b></p> <p>Mrs. Polanski will call you to tell you that Anna will not be in school this week. Tell Mrs. Polanski that she can come to school this afternoon at 3:30 to find out about her daughter's assignments.</p>

**ACTION RESEARCH ACTIVITY: Children's Schools**

*Directions:* Complete the chart below about 3 or more children. You can write about:

- your own children
- your nieces or nephews
- your neighbors' children, or
- some other children you know

CHILD'S NAME	AGE	GRADE	NAME OF SCHOOL

**PAIR ACTIVITY 1: Children's Schools**

*Directions:* Work with a partner. Ask your partner the questions below about each of the children in his/her Action Research chart. Then write the information in the chart below.

- What is the child's name? Please spell that.
- How old is the child?
- What grade is the child in?
- What school does the child go to?

CHILD'S NAME	AGE	GRADE	NAME OF SCHOOL

Now tell the class about the children in your partner's chart. (Optional: Write a paragraph about the children in your partner's chart.)

**PAIR ACTIVITY 2: The School Calendar**

*Directions:* Work with a partner. Your teacher will give you a local school calendar to use. Write the information from the calendar on the lines. Then circle the dates on the calendar on the next page.

THE SCHOOL YEAR

The school year starts: \_\_\_\_\_

The school year ends: \_\_\_\_\_

SCHOOL VACATIONS

Winter vacation starts: \_\_\_\_\_

Winter vacation ends: \_\_\_\_\_

Spring vacation starts: \_\_\_\_\_

Spring vacation ends: \_\_\_\_\_

SCHOOL HOLIDAYS

Name of Holiday	Date	Day of Week

Other days the school is closed:

## PAIR ACTIVITY 2 continued

2002

## AUGUST

S	M	T	W	T	F	S
				1	2	3
4	5	6	7	8	9	10
11	12	13	14	15	16	17
18	19	20	21	22	23	24
25	26	27	28	29	30	31

## SEPTEMBER

S	M	T	W	T	F	S
1	2	3	4	5	6	7
8	9	10	11	12	13	14
15	16	17	18	19	20	21
22	23	24	25	26	27	28
29	30					

## OCTOBER

S	M	T	W	T	F	S
		1	2	3	4	5
6	7	8	9	10	11	12
13	14	15	16	17	18	19
20	21	22	23	24	25	26
27	28	29	30	31		

## NOVEMBER

S	M	T	W	T	F	S
					1	2
3	4	5	6	7	8	9
10	11	12	13	14	15	16
17	18	19	20	21	22	23
24	25	26	27	28	29	30

## DECEMBER

S	M	T	W	T	F	S
1	2	3	4	5	6	7
8	9	10	11	12	13	14
15	16	17	18	19	20	21
22	23	24	25	26	27	28
29	30	31				

2003

## JANUARY

S	M	T	W	T	F	S
			1	2	3	4
5	6	7	8	9	10	11
12	13	14	15	16	17	18
19	20	21	22	23	24	25
26	27	28	29	30	31	

## FEBRUARY

S	M	T	W	T	F	S
						1
2	3	4	5	6	7	8
9	10	11	12	13	14	15
16	17	18	19	20	21	22
23	24	25	26	27	28	

## MARCH

S	M	T	W	T	F	S
						1
2	3	4	5	6	7	8
9	10	11	12	13	14	15
16	17	18	19	20	21	22
23	24	25	26	27	28	29
30	31					

## APRIL

S	M	T	W	T	F	S
		1	2	3	4	5
6	7	8	9	10	11	12
13	14	15	16	17	18	19
20	21	22	23	24	25	26
27	28	29	30			

## MAY

S	M	T	W	T	F	S
				1	2	3
4	5	6	7	8	9	10
11	12	13	14	15	16	17
18	19	20	21	22	23	24
25	26	27	28	29	30	31

## JUNE

S	M	T	W	T	F	S
1	2	3	4	5	6	7
8	9	10	11	12	13	14
15	16	17	18	19	20	21
22	23	24	25	26	27	28
29	30					

## PAIR ACTIVITY 2 continued

2003

## AUGUST

S	M	T	W	T	F	S
					1	2
3	4	5	6	7	8	9
10	11	12	13	14	15	16
17	18	19	20	21	22	23
24	25	26	27	28	29	30
31						

## SEPTEMBER

S	M	T	W	T	F	S
	1	2	3	4	5	6
7	8	9	10	11	12	13
14	15	16	17	18	19	20
21	22	23	24	25	26	27
28	29	30				

## OCTOBER

S	M	T	W	T	F	S
			1	2	3	4
5	6	7	8	9	10	11
12	13	14	15	16	17	18
19	20	21	22	23	24	25
26	27	28	29	30	31	

## NOVEMBER

S	M	T	W	T	F	S
						1
2	3	4	5	6	7	8
9	10	11	12	13	14	15
16	17	18	19	20	21	22
23	24	25	26	27	28	29
30						

## DECEMBER

S	M	T	W	T	F	S
	1	2	3	4	5	6
7	8	9	10	11	12	13
14	15	16	17	18	19	20
21	22	23	24	25	26	27
28	29	30	31			

2004

## JANUARY

S	M	T	W	T	F	S
				1	2	3
4	5	6	7	8	9	10
11	12	13	14	15	16	17
18	19	20	21	22	23	24
25	26	27	28	29	30	31

## FEBRUARY

S	M	T	W	T	F	S
1	2	3	4	5	6	7
8	9	10	11	12	13	14
15	16	17	18	19	20	21
22	23	24	25	26	27	28
29						

## MARCH

S	M	T	W	T	F	S
	1	2	3	4	5	6
7	8	9	10	11	12	13
14	15	16	17	18	19	20
21	22	23	24	25	26	27
28	29	30	31			

## APRIL

S	M	T	W	T	F	S
				1	2	3
4	5	6	7	8	9	10
11	12	13	14	15	16	17
18	19	20	21	22	23	24
25	26	27	28	29	30	

## MAY

S	M	T	W	T	F	S
						1
2	3	4	5	6	7	8
9	10	11	12	13	14	15
16	17	18	19	20	21	22
23	24	25	26	27	28	29
30	31					

## JUNE

S	M	T	W	T	F	S
		1	2	3	4	5
6	7	8	9	10	11	12
13	14	15	16	17	18	19
20	21	22	23	24	25	26
27	28	29	30			

## PAIR ACTIVITY 2 continued

2004

## AUGUST

S	M	T	W	T	F	S
1	2	3	4	5	6	7
8	9	10	11	12	13	14
15	16	17	18	19	20	21
22	23	24	25	26	27	28
29	30	31				

## SEPTEMBER

S	M	T	W	T	F	S
			1	2	3	4
5	6	7	8	9	10	11
12	13	14	15	16	17	18
19	20	21	22	23	24	25
26	27	28	29	30		

## OCTOBER

S	M	T	W	T	F	S
					1	2
3	4	5	6	7	8	9
10	11	12	13	14	15	16
17	18	19	20	21	22	23
24	25	26	27	28	29	30
31						

## NOVEMBER

S	M	T	W	T	F	S
	1	2	3	4	5	6
7	8	9	10	11	12	13
14	15	16	17	18	19	20
21	22	23	24	25	26	27
28	29	30				

## DECEMBER

S	M	T	W	T	F	S
			1	2	3	4
5	6	7	8	9	10	11
12	13	14	15	16	17	18
19	20	21	22	23	24	25
26	27	28	29	30	31	

2005

## JANUARY

S	M	T	W	T	F	S
						1
2	3	4	5	6	7	8
9	10	11	12	13	14	15
16	17	18	19	20	21	22
23	24	25	26	27	28	29
30	31					

## FEBRUARY

S	M	T	W	T	F	S
		1	2	3	4	5
6	7	8	9	10	11	12
13	14	15	16	17	18	19
20	21	22	23	24	25	26
27	28					

## MARCH

S	M	T	W	T	F	S
		1	2	3	4	5
6	7	8	9	10	11	12
13	14	15	16	17	18	19
20	21	22	23	24	25	26
27	28	29	30	31		

## APRIL

S	M	T	W	T	F	S
					1	2
3	4	5	6	7	8	9
10	11	12	13	14	15	16
17	18	19	20	21	22	23
24	25	26	27	28	29	30

## MAY

S	M	T	W	T	F	S
1	2	3	4	5	6	7
8	9	10	11	12	13	14
15	16	17	18	19	20	21
22	23	24	25	26	27	28
29	30	31				

## JUNE

S	M	T	W	T	F	S
			1	2	3	4
5	6	7	8	9	10	11
12	13	14	15	16	17	18
19	20	21	22	23	24	25
26	27	28	29	30		



## PAIR ACTIVITY 2 continued

2005

## AUGUST

S	M	T	W	T	F	S
	1	2	3	4	5	6
7	8	9	10	11	12	13
14	15	16	17	18	19	20
21	22	23	24	25	26	27
28	29	30	31			

## SEPTEMBER

S	M	T	W	T	F	S
				1	2	3
4	5	6	7	8	9	10
11	12	13	14	15	16	17
18	19	20	21	22	23	24
25	26	27	28	29	30	

## OCTOBER

S	M	T	W	T	F	S
						1
2	3	4	5	6	7	8
9	10	11	12	13	14	15
16	17	18	19	20	21	22
23	24	25	26	27	28	29
30	31					

## NOVEMBER

S	M	T	W	T	F	S
		1	2	3	4	5
6	7	8	9	10	11	12
13	14	15	16	17	18	19
20	21	22	23	24	25	26
27	28	29	30			

## DECEMBER

S	M	T	W	T	F	S
				1	2	3
4	5	6	7	8	9	10
11	12	13	14	15	16	17
18	19	20	21	22	23	24
25	26	27	28	29	30	31

2006

## JANUARY

S	M	T	W	T	F	S
1	2	3	4	5	6	7
8	9	10	11	12	13	14
15	16	17	18	19	20	21
22	23	24	25	26	27	28
29	30	31				

## FEBRUARY

S	M	T	W	T	F	S
			1	2	3	4
5	6	7	8	9	10	11
12	13	14	15	16	17	18
19	20	21	22	23	24	25
26	27	28				

## MARCH

S	M	T	W	T	F	S
			1	2	3	4
5	6	7	8	9	10	11
12	13	14	15	16	17	18
19	20	21	22	23	24	25
26	27	28	29	30	31	

## APRIL

S	M	T	W	T	F	S
						1
2	3	4	5	6	7	8
9	10	11	12	13	14	15
16	17	18	19	20	21	22
23	24	25	26	27	28	29
30						

## MAY

S	M	T	W	T	F	S
	1	2	3	4	5	6
7	8	9	10	11	12	13
14	15	16	17	18	19	20
21	22	23	24	25	26	27
28	29	30	31			

## JUNE

S	M	T	W	T	F	S
				1	2	3
4	5	6	7	8	9	10
11	12	13	14	15	16	17
18	19	20	21	22	23	24
25	26	27	28	29	30	

**WRITING ACTIVITY: Note to the Teacher**

*Directions:* Mrs. García's son has a dental appointment today at 2:00 P.M. She writes a note to his teacher, Mr. Gordon. Her son will give this note to his teacher this morning. Read the note.

December 20, 2004

Dear Mr. Gordon,

José has a dental appointment today. I will pick him up at 1:30.

Thank you,

*Mrs. García*

Now write a note to your child's teacher.  
Your child has a doctor's appointment tomorrow at 2:00.

Dear \_\_\_\_\_ ,

---



---



---



---



---



---

---

**CULTURAL COMPARISON ACTIVITY 1: Organization of Schools in Native Country****ORGANIZATION OF SCHOOLS IN \_\_\_\_\_**  
(native country)

*Directions:* How are schools organized in your native country? Draw the school system of your native country here. (Note: Students can work in pairs, small groups, or as a whole class. Use “Pictures for Vocabulary Development” on page 148 or 149 as a model.)

Then talk about how the organization of schools in your native country is different from the organization of schools in your local school district in the United States.

## CULTURAL COMPARISON ACTIVITY 2: Schools and Education

*Directions:* Think about schools in your native country and in the United States. Discuss the answers to the questions below with your classmates. (Optional: Write the information in the chart.)

	IN _____ (native country)	IN THE U.S.
1. Do all children go to school? Is it important for children to attend school everyday?		
2. Is school free? Do families have to pay for their children to go to school? Where does the money for schools come from?		
3. At what age do children usually begin school? For how many years do children usually go to school?		
4. How are schools organized? Do children of different ages study in different school buildings?		
5. Are parents involved in their children's education? How?		
6. Are universities free? Do many children get a university education?		
7. Who makes decisions about the schools?		

## EXPERIENTIAL ACTIVITIES

As a class, identify an important issue that affects the group. Some ideas are:

- School board elections
- School funding
- School bilingual/ESL programs
- Special education
- Post-secondary options
- Graduation requirements
- Visiting your child's school
- Parent-teacher conferences
- Registering your child for school
- Volunteering in your child's school
- Communicating with your child's teacher
- Attending a school event
- School services (vision/hearing screening, social services, tutoring, etc.)

Determine the best course of action from the suggestions below or have students generate their own plan of action. Choose an activity requiring a response by a school official or representative. Also select an activity in which students have a vested interest so that they will follow through to a satisfactory conclusion. Some possible activities are:

1. Have students work in small groups and use a community map or telephone directory to locate the public schools in their community. They should find out the ages/grades for each school (by calling the school, if necessary).  
*risk: low – medium*  
*language level: high beginning – intermediate*
2. If students have children in a local elementary or middle school, have them bring the weekly “take home” newsletter to class. Have them share one piece of school news with the other students.  
*risk: low*  
*language level: all*
3. Have students telephone the local schools to find out the date, time, and location of the next school board meetings. Have them report this information to the class.  
*risk: high*  
*language level: high beginning – advanced*
4. As a class, attend a school board meeting. Ask for a copy of the agenda beforehand, if possible. Afterwards, have students discuss the current community school issues.  
*risk: low*  
*language level: intermediate – advanced*
5. Have students access the web site of a local school they want to learn more about. Ask individual students to report on information they learn.  
*risk: low*  
*language level: high beginning – advanced*

**EXPERIENTIAL ACTIVITIES continued**

6. Have students call the local elementary or middle school to find out the ways in which parent volunteers can help in the school.  
*risk: high*  
*language level: intermediate – advanced*
  
7. Have students volunteer to help in a local school. Service can be for one event or an ongoing basis. (For example, students may be able to do a presentation on their native country or culture.)  
*risk: high*  
*language level: intermediate – advanced*
  
8. Invite a school board member, school administrator, counselor, or social worker as a guest speaker. Have students prepare questions in advance. You might have the speaker focus on a specific issue, such as bilingual/ESL services in the school.  
*risk: medium – high*  
*language level: high beginning – advanced*
  
9. As a class, attend a school event – concert, art exhibit, play, sports event, etc. After the event, students can discuss or write about their impressions.  
*risk: low*  
*language level: all*
  
10. In class, have students scan the community newspaper for news about your local schools. Students can then summarize school-related stories orally or in writing and share them with the class.  
*risk: medium*  
*language level: intermediate – advanced*
  
11. Have students find out the date and the name of the candidates for the next school board election. They can then check the community newspaper for information about the candidates.  
*risk: low*  
*language level: high beginning – advanced*

MODULE 5

◆◆◆ PUBLIC HEALTH SERVICES ◆◆◆

COMPONENTS

	Page
◆ TEACHER NOTES.....	198
◆ PICTURES	
• Pictures for Vocabulary Development .....	202
• Pictures for Language Experience .....	213
• Pictures for Group Story Writing .....	218
◆ READING PASSAGE	
• Pre-Reading Activity .....	221
• Reading Passage.....	222
• Vocabulary Activity 1-A.....	225
• Vocabulary Activity 1-B .....	226
• Vocabulary Activity 2-A.....	227
• Vocabulary Activity 2-B .....	228
• Comprehension Check.....	229
◆ EXTENSION ACTIVITIES	
• Dialogue 1: <i>Calling a Clinic for Immunization Information</i> .....	230
• Dialogue 2: <i>Calling the County for Dental Services</i> .....	231
• Dialogue 3: <i>Reporting Domestic Violence</i> .....	232
• Dialogue 4: <i>Calling the Hospital for Information</i> .....	233
• Dialogue 5: <i>Making a Doctor's Appointment</i> .....	234
• Action Research Activity: <i>Health Care in Your Community</i> .....	235
• Writing Activity: <i>Patient Information Form</i> .....	236
• Pair Activity: <i>Health Care Providers</i> .....	237
• Cultural Comparison Activity: <i>Health Care Services</i> .....	238
◆ EXPERIENTIAL ACTIVITIES .....	239

## TEACHER NOTES

Before beginning this module, familiarize yourself with the health care facilities in your students' communities. Explore the web sites of the community hospitals, the city/county department of public health, and social service agencies that provide help for domestic abuse, substance abuse, and mental health problems. Brochures and newsletters describing community health care services are available from the township office, city hall, public schools, clinics, and community hospitals. Brochures that you collect may be used in class to initiate discussion about the different types of health care available in the United States.

Introduce the topic of public health services by asking who provides health care in students' native countries. If there are both private and public health care systems, ask students how they are different (e.g., better facilities, newer equipment, specialists, doctors with more recent training, etc.). Ask students who pays for the costs of health care in their countries – individuals, the government, employers, etc. Ask also if anyone is excluded from health care services in their native countries.

### COMPETENCIES FOR MODULE 5

Students will learn to:

1. Explain the differences between private and public health care.
2. Locate public and private health care providers in their community.
3. Identify community resources for wellness programs (including prenatal care, immunizations, and screenings) and crisis services (including domestic violence, child abuse, and substance abuse).
4. Check eligibility requirements for public health care services.
5. Make an appointment for health care services.
6. Complete a patient information/medical history form.

### THE VOCABULARY ACTIVITIES AND THE READING PASSAGE

The Reading Passage contains a large number of vocabulary words that may be unfamiliar to students. To facilitate the teaching of this module, Vocabulary Activities 1-A and 1-B correspond to the first part of the Reading Passage only (through "Public Health Clinics"), while Vocabulary Activities 2-A and 2-B correspond to the rest of the Reading Passage ("Community Hospitals" through the end). You may choose to teach the Reading Passage in two parts, at two different class meetings, depending on the level of your class.

### THE WRITING ACTIVITY

For the writing activity, students will need to translate vocabulary for a variety of diseases and medical conditions. You may need to provide translations or have students use bilingual dictionaries for these terms. Students might also work in groups with others from their language background for this activity.



**TEACHER NOTES** continued**EXPANSION IDEAS**Role-Plays

In addition to the dialogues in this unit, you may want to have students role-play common scenarios that patients encounter. Role-plays could address a variety of topics including health insurance, medications they are taking, smoking, drinking, symptoms, and medical procedures such as blood pressure measurement, ear/throat/eye exams, blood tests, urine samples, and throat cultures.

Health Insurance Information

If the level of the class and student interest warrant it, discuss health insurance in the United States. Explore the following vocabulary: premium, deductible, co-pay, urgent/immediate care center, HMO/PPO, prescription drug insurance, etc. Elicit students' experiences with health insurance providers. If possible, distribute and discuss a copy of a paycheck showing deductions for health insurance.

**POSSIBLE AUTHENTIC MATERIALS**

- Brochures describing health services offered by the county, city, or local public schools
- Newsletters from community hospitals (these often list free or low-cost wellness programs)
- Health history forms from doctors' and dentists' offices
- Appointment cards from doctors, dentists, or public health clinics
- Child's health form (including immunization history) required by the school system

**RESOURCES\***Print Materials

*A Health Guide for Refugees*, (2001), Illinois Department of Public Health (217) 782-4977 or [www.idph.state.il.us/about/minority\\_hlth/default.htm](http://www.idph.state.il.us/about/minority_hlth/default.htm). Provides basic information about the U.S. health care system, visiting the doctor, treating serious illnesses, and where to go for medical care. Booklet available at no cost or online as PDF document. Available in English, Spanish, French, Chinese, Arabic, Bosnian, Russian, and Vietnamese.

*Immunization Fact Sheets* (in English and Spanish) available for these immunizations: Chickenpox; Diphtheria, Tetanus, and Pertussis (DPT); Tetanus and Diphtheria (TD); Polio; and Measles, Mumps, and Rubella (MMR). American Academy of Pediatrics, (800) 433-9016, [www.aap.org](http://www.aap.org).

*"Do You Understand?" Communicating with the Non-English Speaking Patient Handbook*, (1989) Literacy Volunteers of America. Textbook with simple drawings and translations (Cambodian, Laotian, Vietnamese, Polish, Russian, and Spanish) of language used in common medical situations. Clear illustrations convey meaning; text provides many role-play ideas. An excellent resource for use with low-level students.

## TEACHER NOTES continued

*Comprehensive Resources for Your Health & Safety Programs*, Krames Health and Safety Education, 1100 Grundy Lane, San Bruno, CA 94066, (800) 333-3032. Catalog of brochures, booklets, and videos on topics such as the food pyramid, nutrition, and work safety.

Prevention First, Inc. State of Illinois-funded clearinghouse of materials on substance abuse, STD's, and domestic violence. Offers on-line catalog for substance abuse-related brochures and videos at [www.prevention.org](http://www.prevention.org). Materials are free to Illinois residents and may be previewed at their libraries in Chicago and Springfield.

U.S. Federal Drug Administration Easy-to-Read Publications. Easy-to-read publications (in both English and Spanish) on topics such as "Keeping Food Safe," "What to do for Colds and Flu," "Use Medicine Safely," and "Eating for a Healthy Heart." Most can be downloaded in either PDF or HTML formats from [www.fda.gov/opacom/lowlit/englow.html](http://www.fda.gov/opacom/lowlit/englow.html). Some are available free (up to 50 copies) from FDA, HFI-40, Rockville, MD 20857.

Web Sites

Illinois Department of Children and Family Services, (800) 25-ABUSE  
[www.state.il.us/dcfs](http://www.state.il.us/dcfs)

Offers answers (in basic English) to frequently asked questions about child abuse and neglect, as well as listings of other resources.

National Center for ESL Literacy Education's Health Literacy  
[www.cal.org/ncl/healthlit.htm](http://www.cal.org/ncl/healthlit.htm)

Includes a series of lessons entitled "Picture Stories for Adult ESL Health Literacy," a bibliography of health literacy materials for ESL teachers, and Questions and Answers on Health Literacy (an ERIC Q & A article).

National Institute for Literacy's Health and Literacy Special Collection  
[www.worlded.org/us/health/lincs](http://www.worlded.org/us/health/lincs)

Curricula on health subjects, suggested ESL/bilingual materials on health care, and links to many health information web sites.

Nutrition Education for New Americans  
[multiculturalhealth.org](http://multiculturalhealth.org)

Downloadable materials in 37 languages (including English) about food pyramids, healthy lifestyles for adults, mothers, and mature adults.

U.S. Federal Drug Administration Publications Catalog  
[www.fda.gov/opacom/catalog/decemcat.html](http://www.fda.gov/opacom/catalog/decemcat.html)

Non-technical health-related materials for the general public. Materials include articles in English and Spanish; Easy Readers; and Fact Sheets. Most publications are available online.

**TEACHER NOTES** continued

USDA's Women, Infants and Children

[www.fns.usda.gov/wic/](http://www.fns.usda.gov/wic/)

Information about the WIC Program, a nutrition program for low-income women, infants, and children. Includes income guidelines for participation, information about program benefits, and links to local WIC program locations.

Videos

*Ensure Domestic Tranquility* (2003). A video for adult ESL learners about the legal ramifications of domestic violence and sources of help. Includes a packet with multi-level lesson plans. Available by sending a \$15 check or money order to Media Center, Room 104, Evans Community Adult School, 717 N. Figueroa Street, Los Angeles, CA 90012

\* This list of resources is also located at [www.thecenterweb.org](http://www.thecenterweb.org) (click on "The Adult Learning Resource Center") where it is updated annually.

PICTURES FOR VOCABULARY DEVELOPMENT

public health clinic

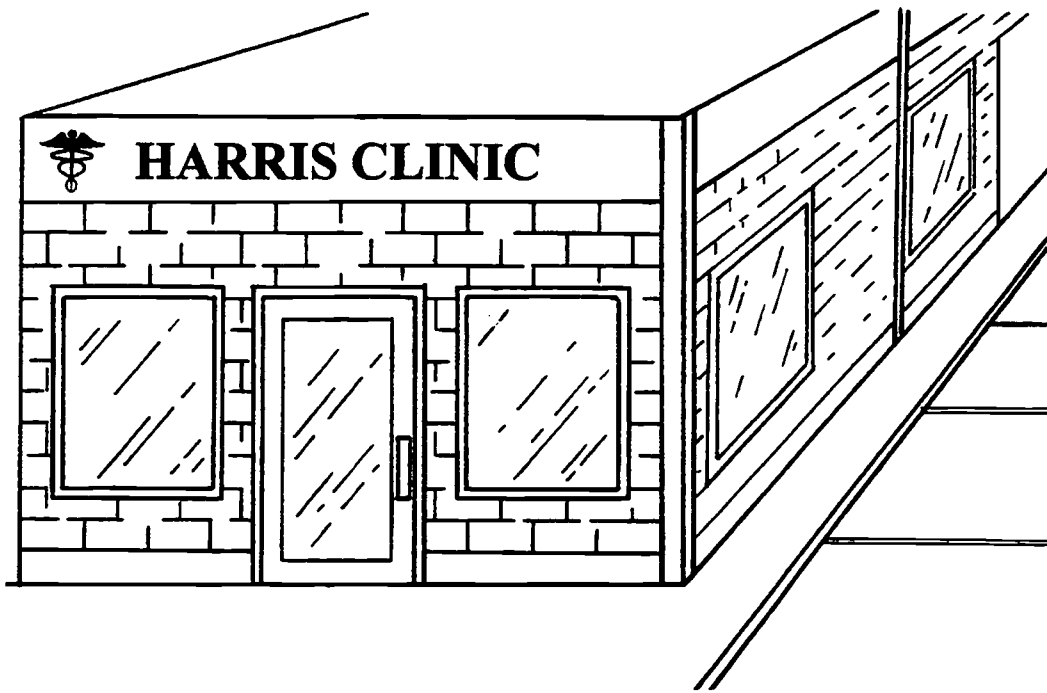

appointment

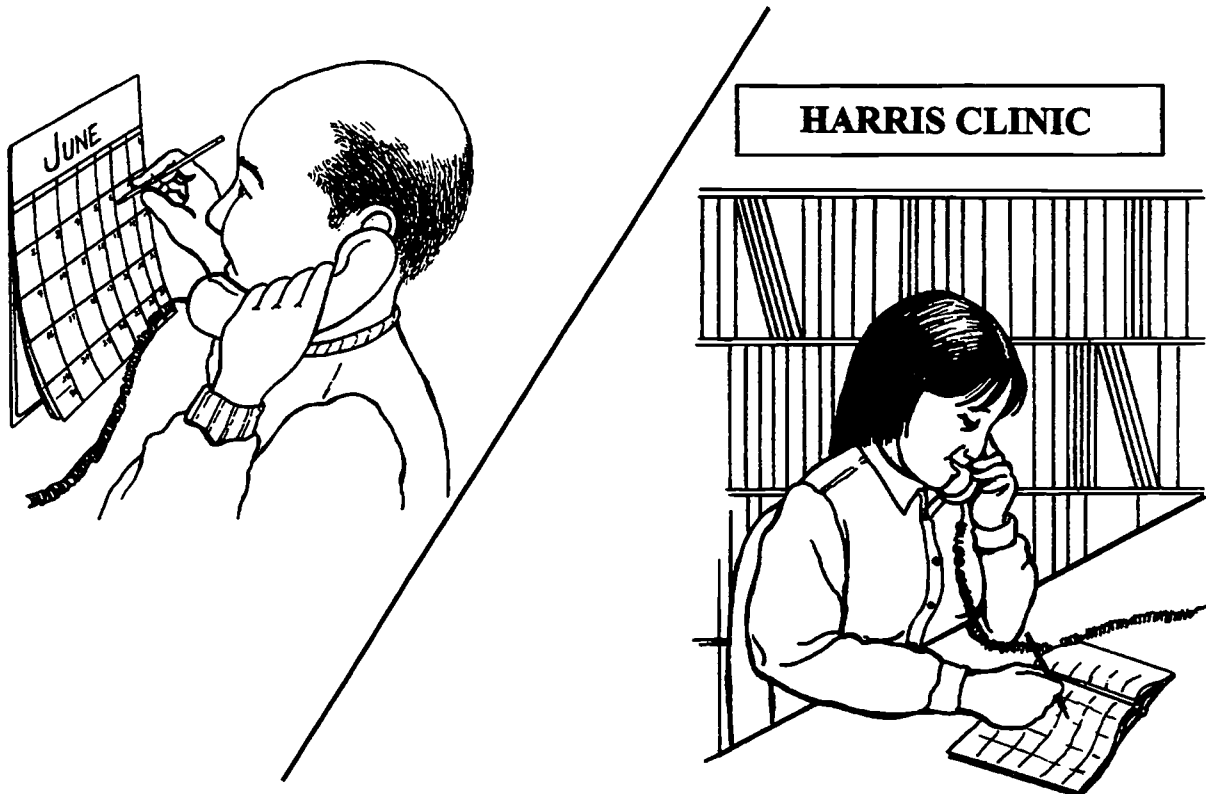

PICTURES FOR VOCABULARY DEVELOPMENT continued

walk-in clinic

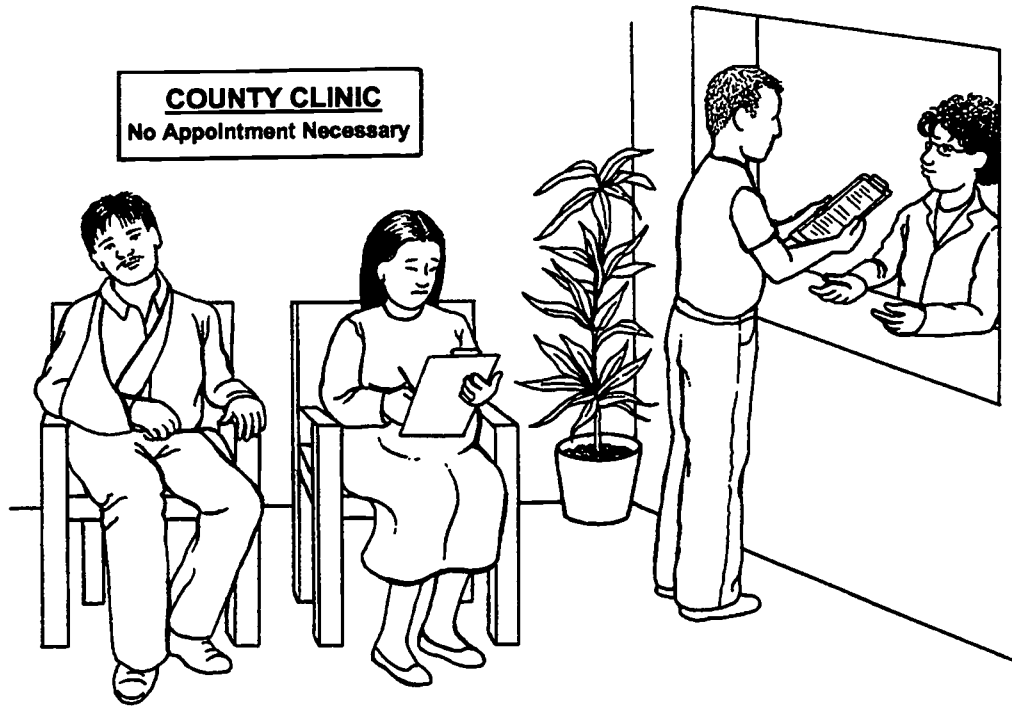

health insurance

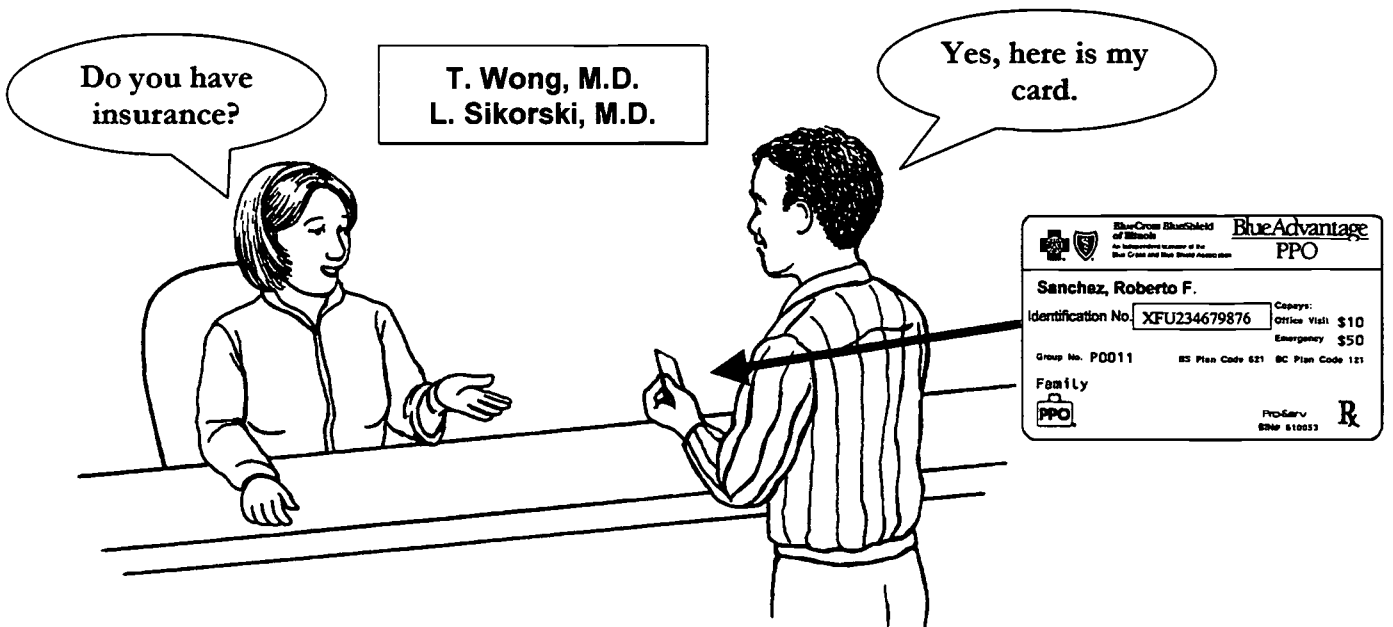

PICTURES FOR VOCABULARY DEVELOPMENT continued

ELIGIBILITY REQUIREMENTS

age

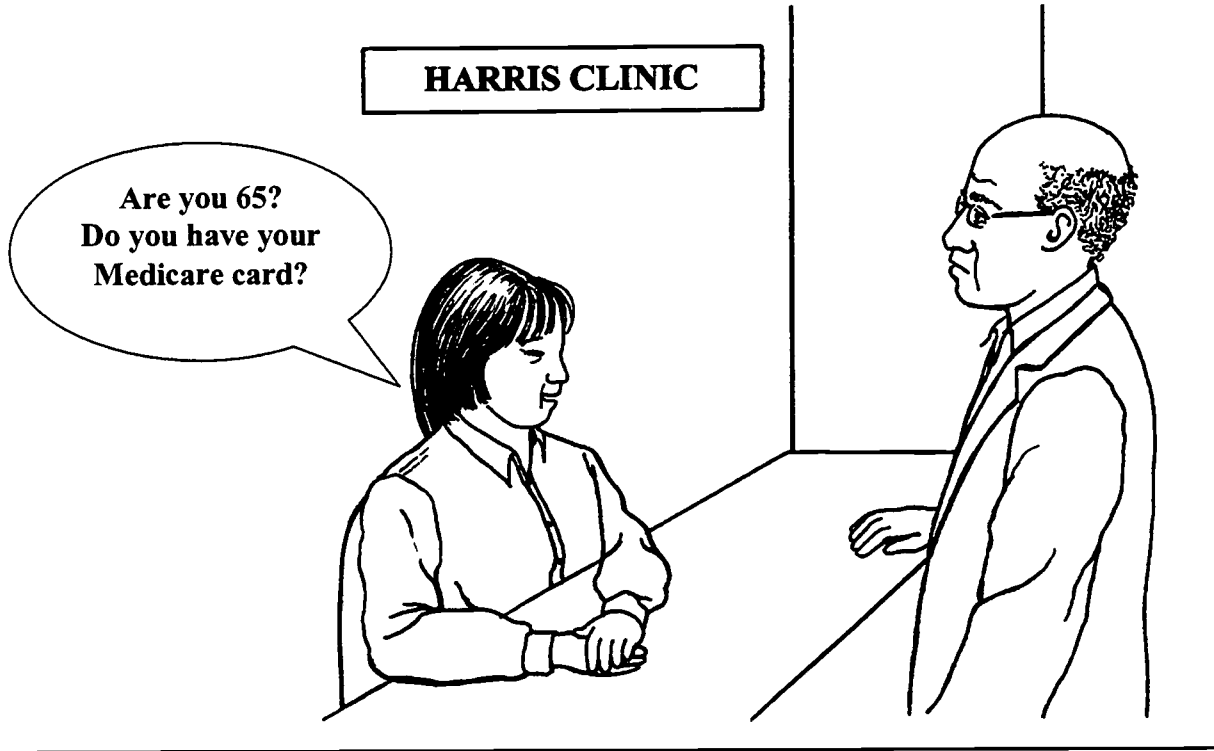

low income

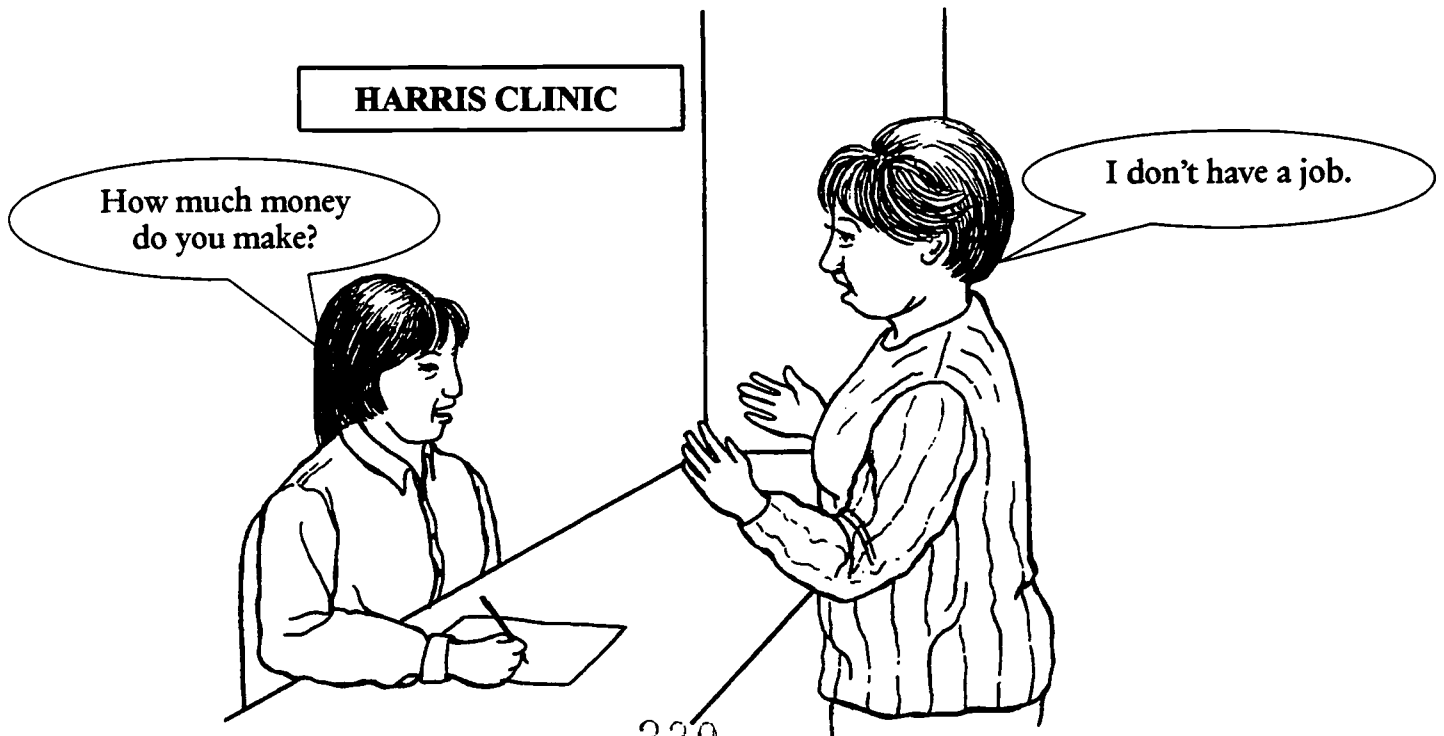

230

PICTURES FOR VOCABULARY DEVELOPMENT continued

HEALTH CARE SERVICES

check up/physical exam



dental care



PICTURES FOR VOCABULARY DEVELOPMENT continued

HEALTH CARE SERVICES

testing for STDs or HIV/AIDS

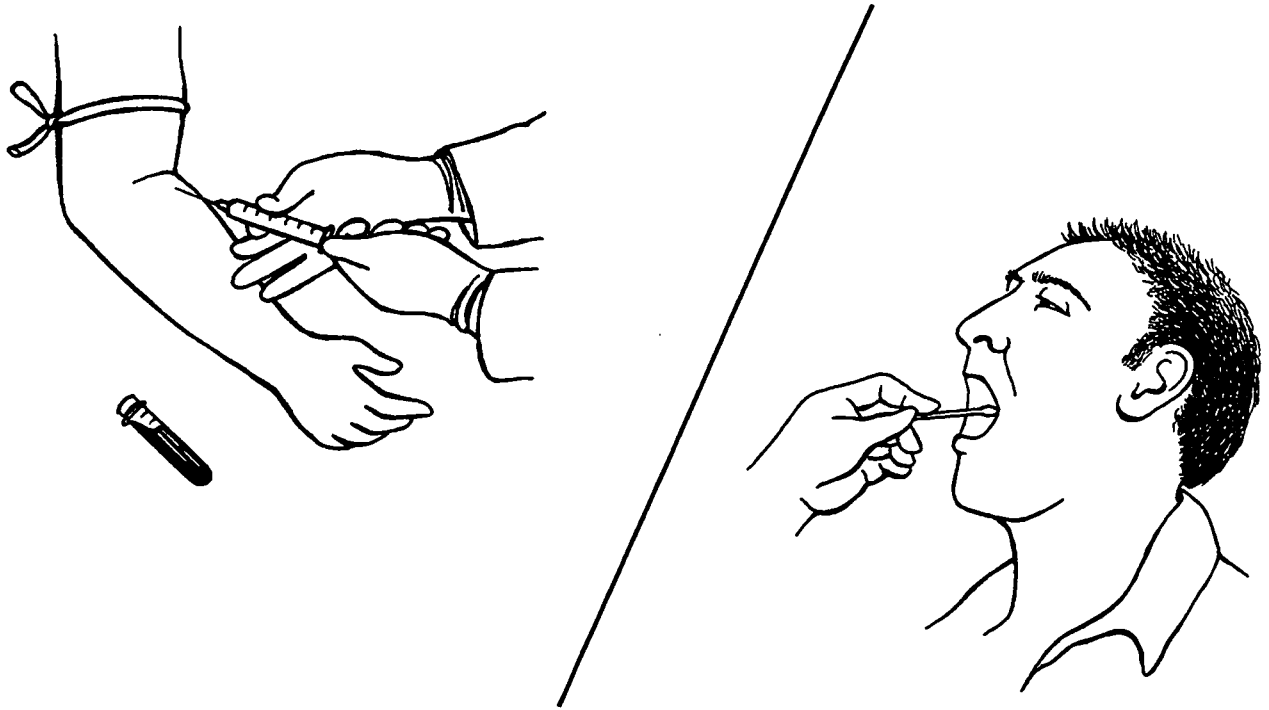

family planning





PICTURES FOR VOCABULARY DEVELOPMENT continued

HEALTH CARE SERVICES

prenatal care

pregnant

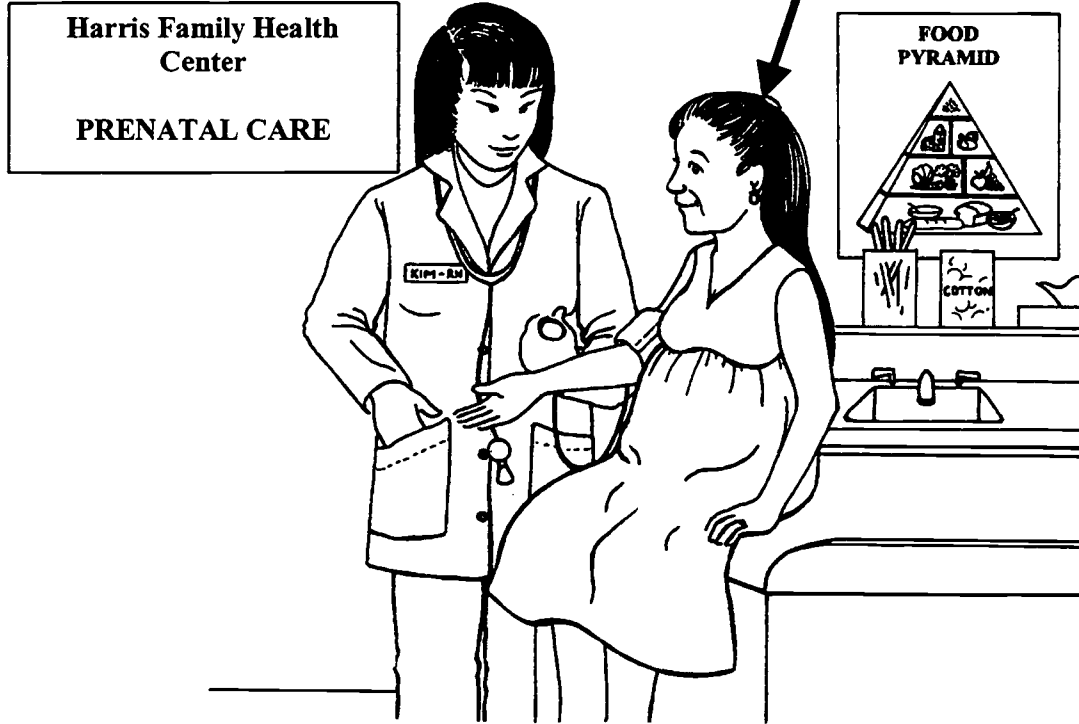

well child care



PICTURES FOR VOCABULARY DEVELOPMENT continued

HEALTH CARE SERVICES

immunization

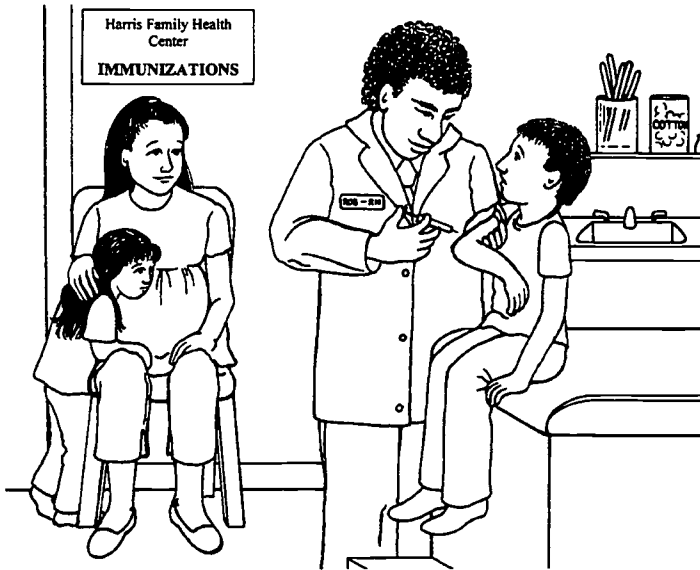

school health form/  
immunization record

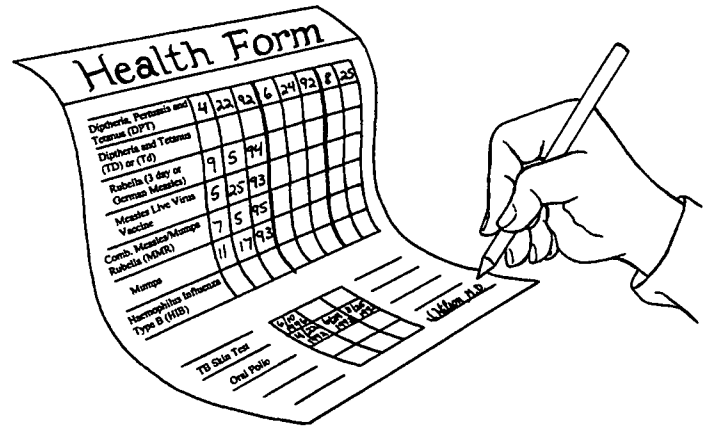

vision screening



hearing screening

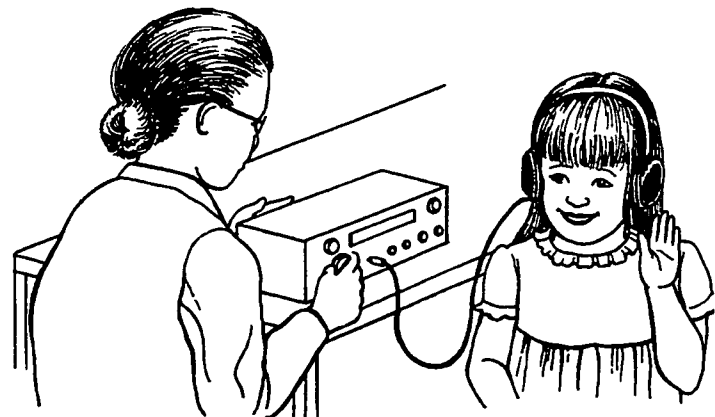

PICTURES FOR VOCABULARY DEVELOPMENT continued

WELLNESS PROGRAMS

cholesterol testing

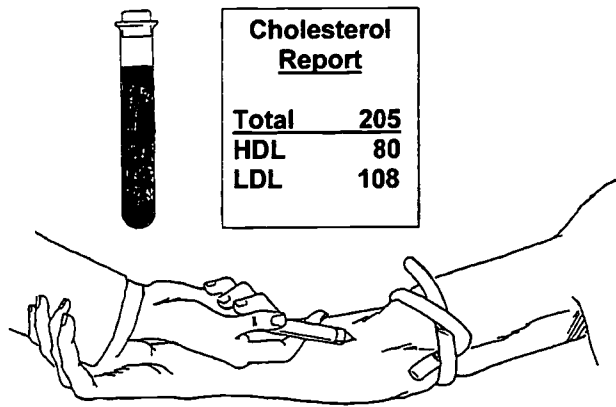

stress management



fitness center

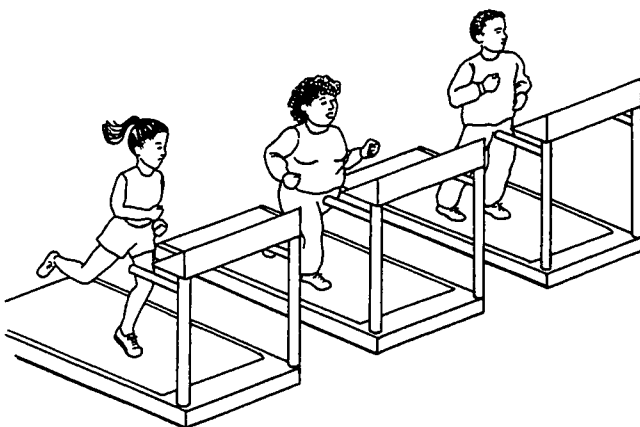

nutrition counseling

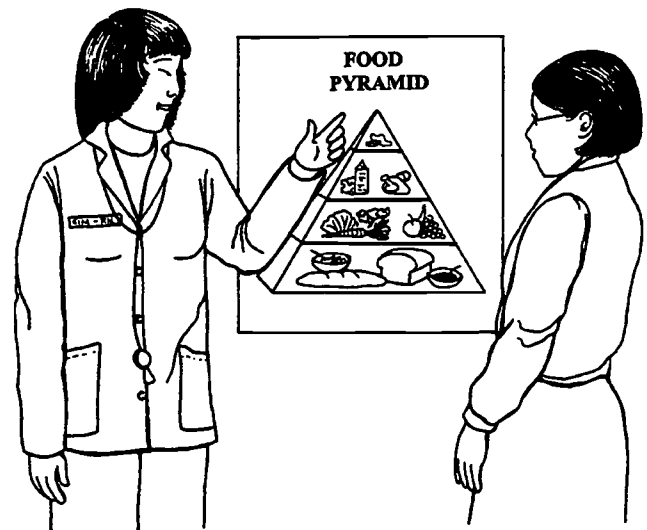

PICTURES FOR VOCABULARY DEVELOPMENT continued

domestic violence

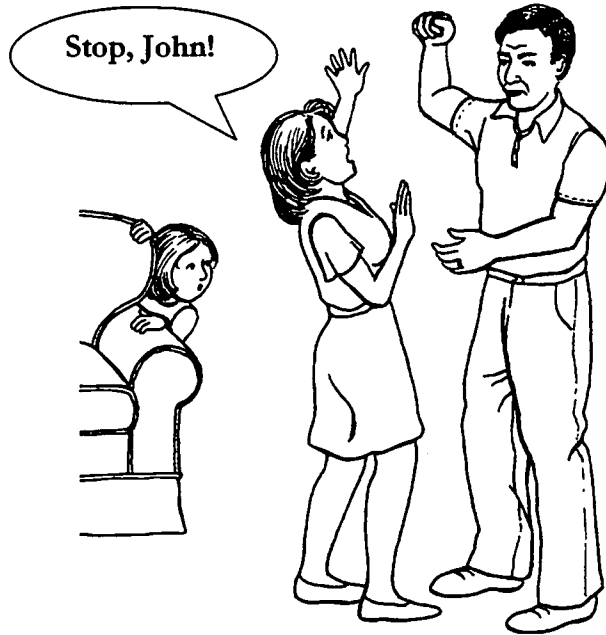

hotline

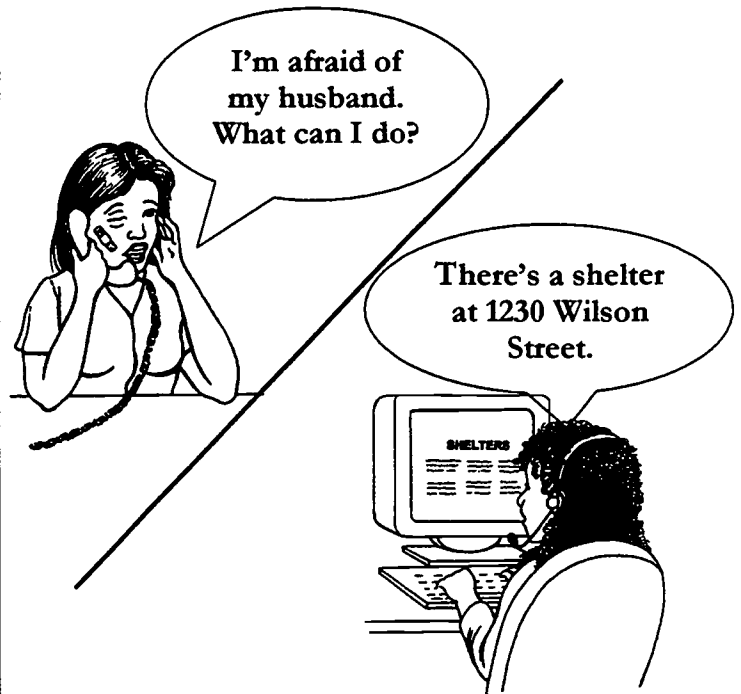

emergency shelter

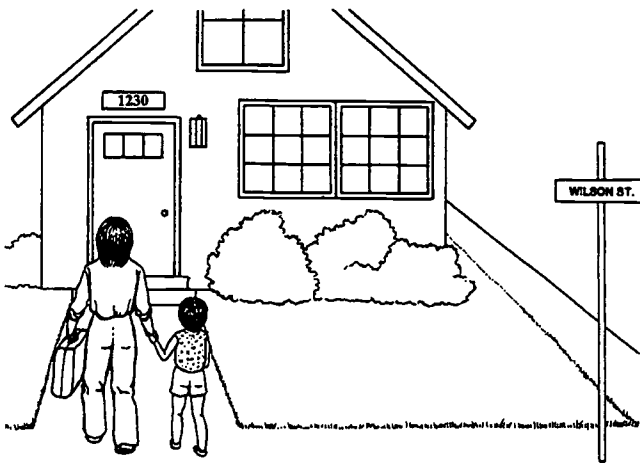

counseling



## PICTURES FOR VOCABULARY DEVELOPMENT continued

## child abuse



## child neglect

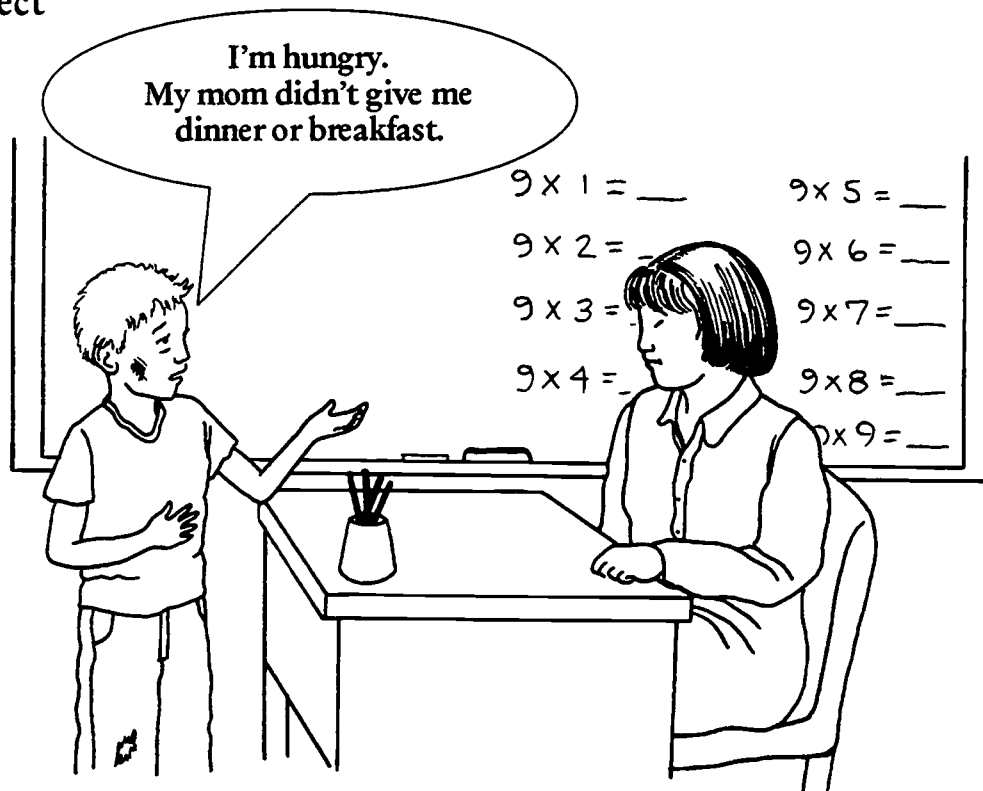

PICTURES FOR VOCABULARY DEVELOPMENT continued

SUBSTANCE ABUSE

drugs



alcohol



self-help group/support group

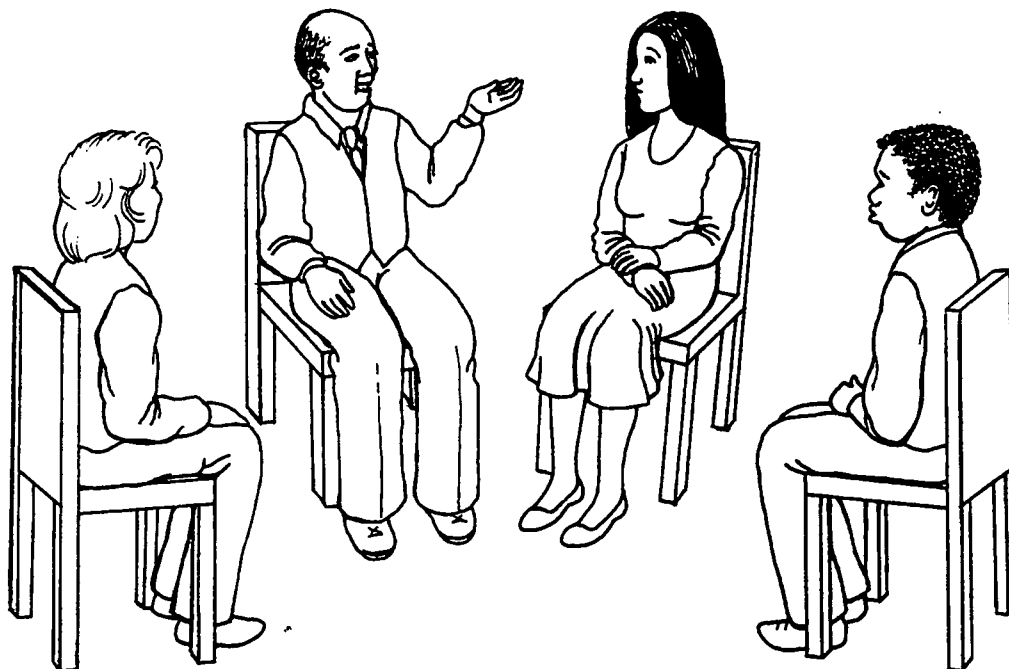

# PICTURES FOR LANGUAGE EXPERIENCE

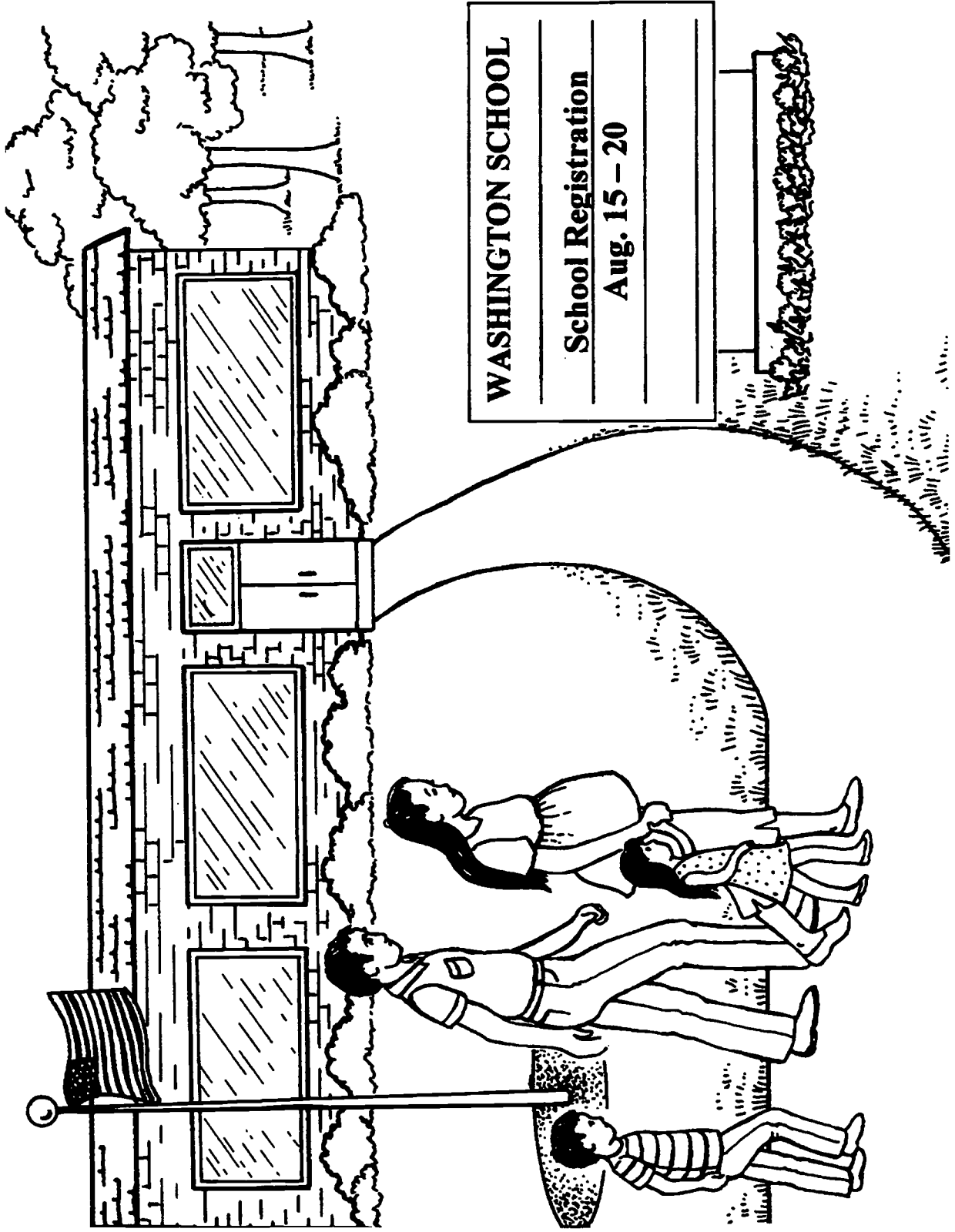

PICTURES FOR LANGUAGE EXPERIENCE continued

# Washington School Registration

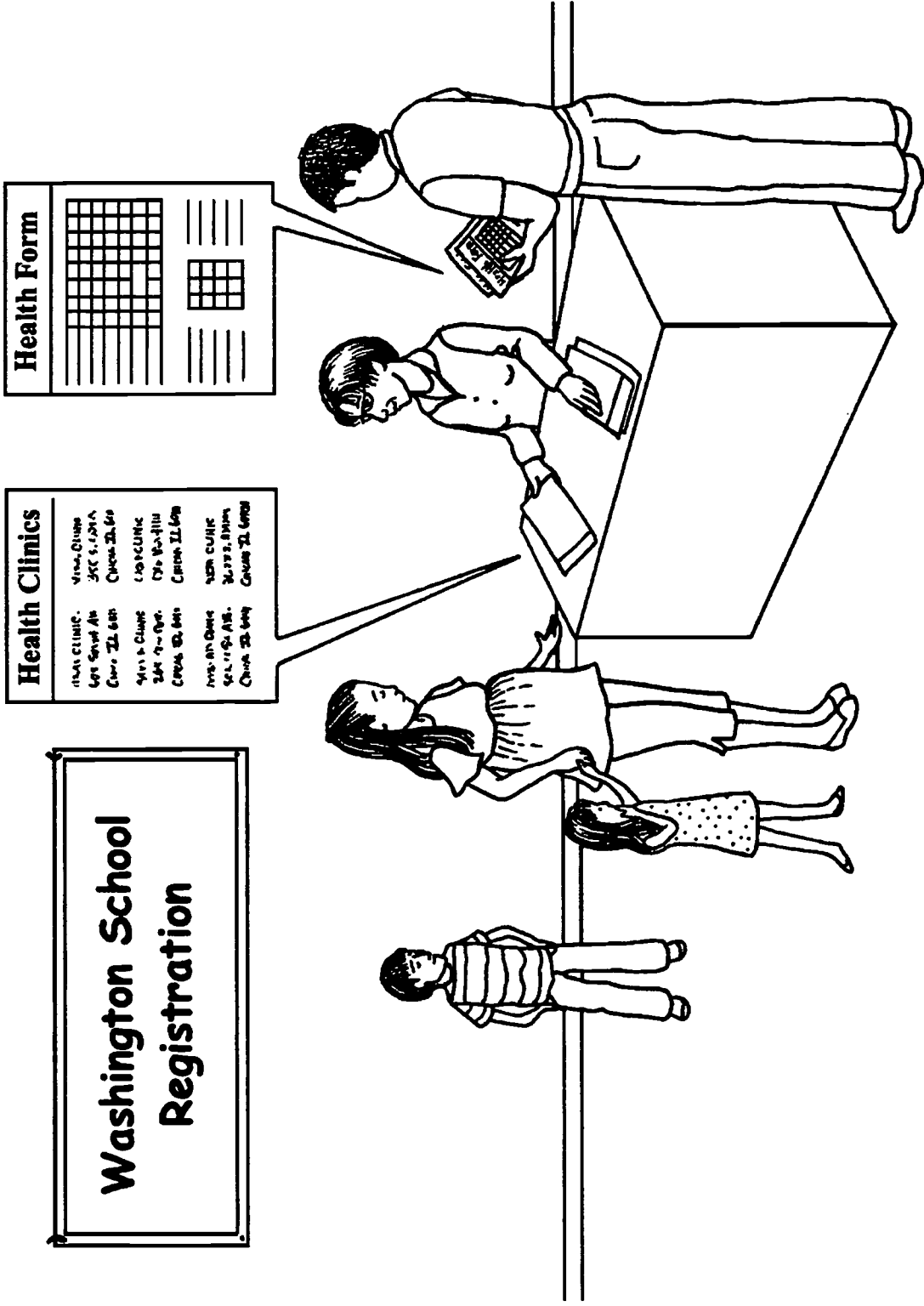



PICTURES FOR LANGUAGE EXPERIENCE continued

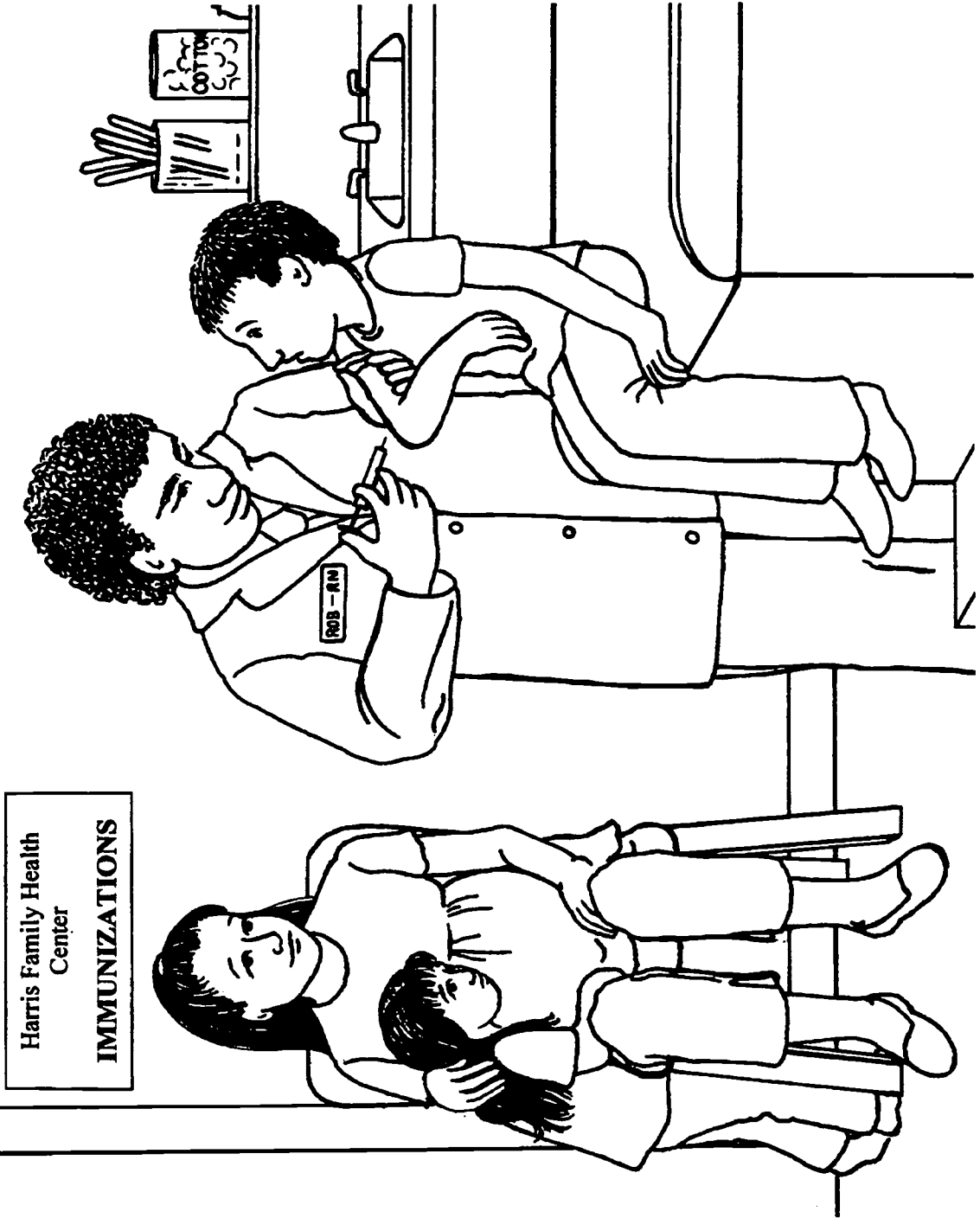

3

PICTURES FOR LANGUAGE EXPERIENCE continued



4

PICTURES FOR LANGUAGE EXPERIENCE continued

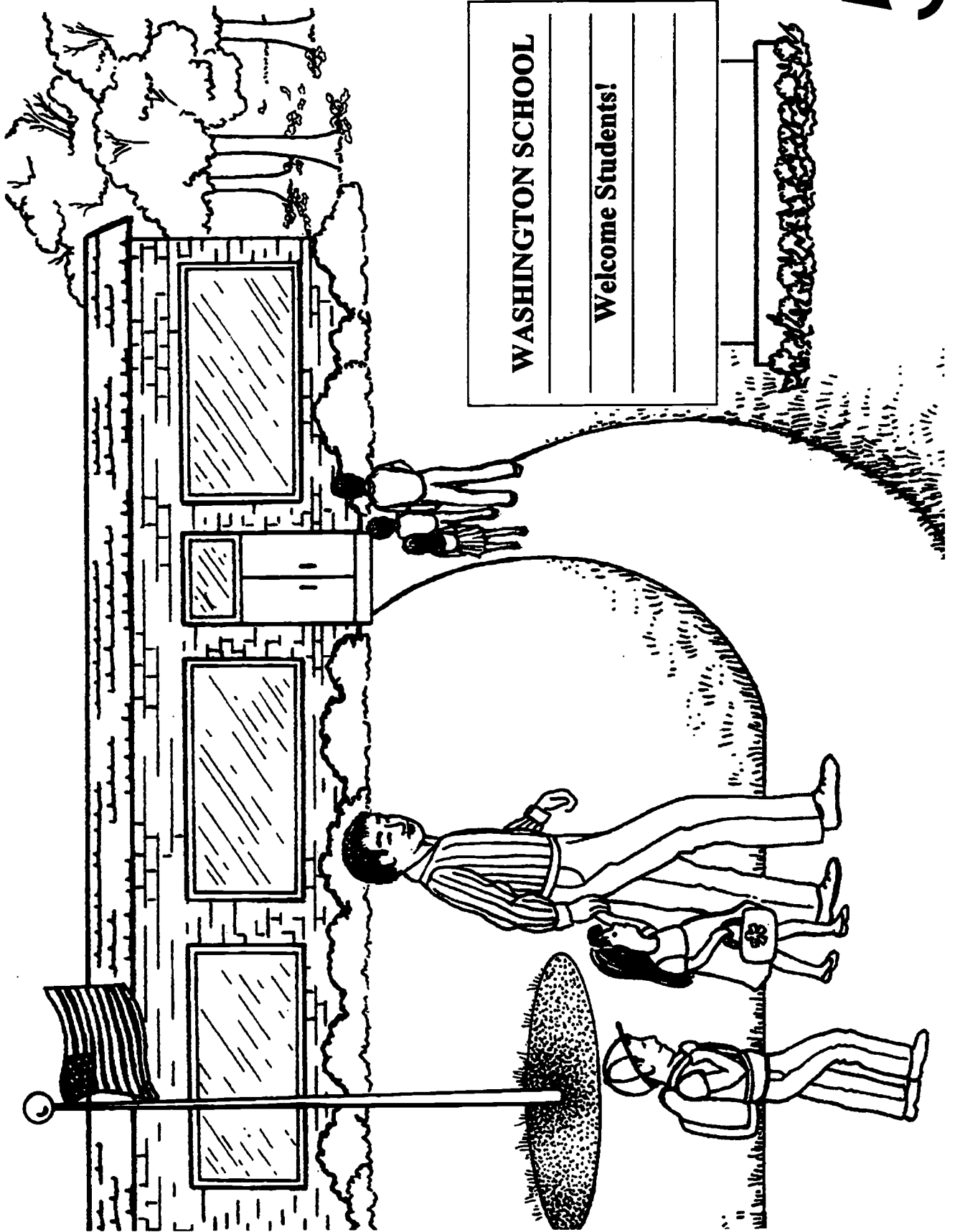

5

PICTURES FOR GROUP STORY WRITING

*Directions:* Work in groups of three or four. Write a story about the pictures below and on the next page. Write one or more sentences for each picture. Then share your story with the class.

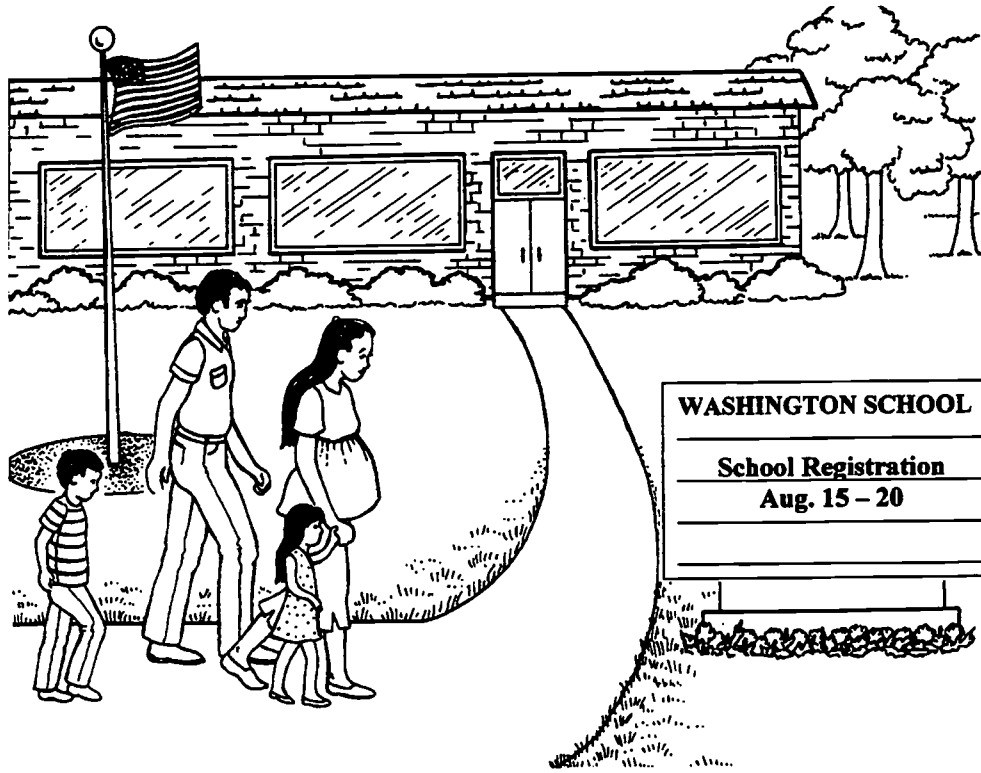

1

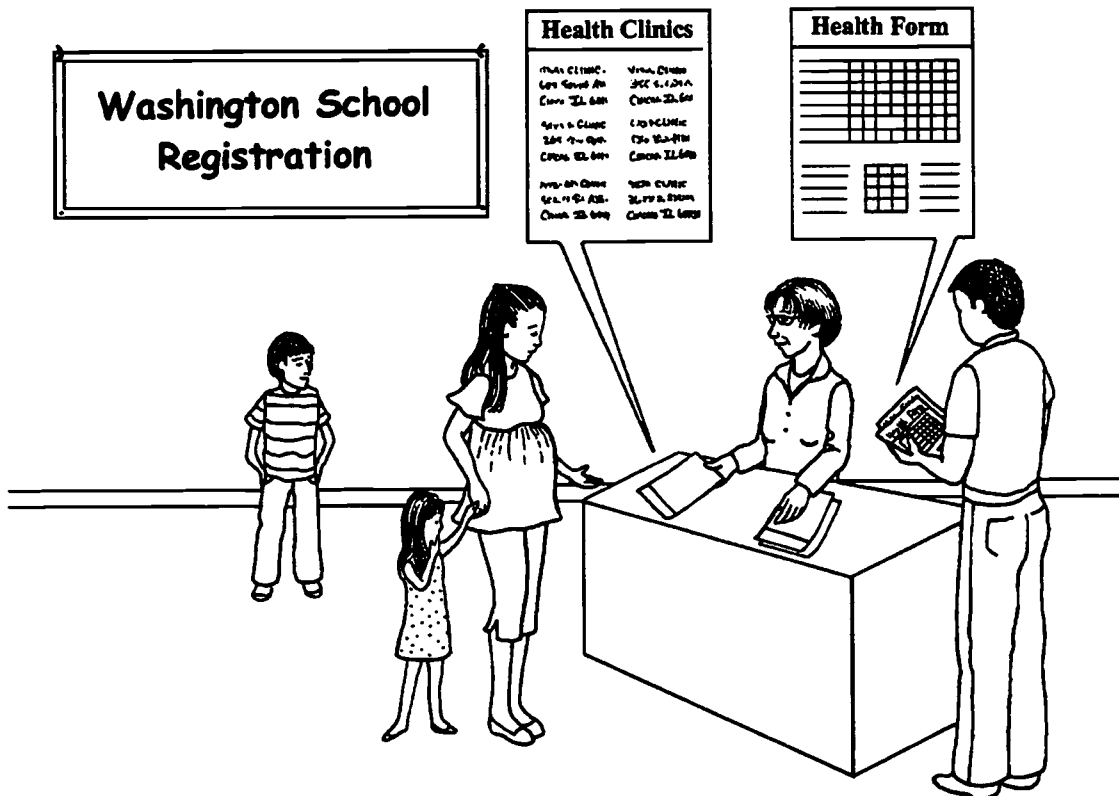

2

BEST COPY AVAILABLE

PICTURES FOR GROUP STORY WRITING continued

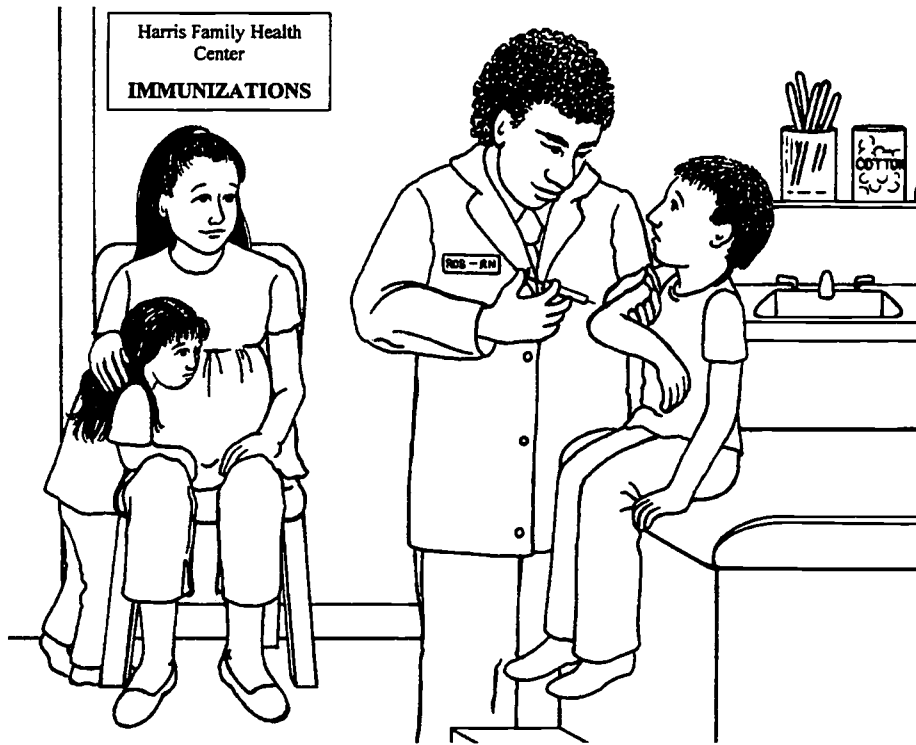

3



4

245

PICTURES FOR GROUP STORY WRITING continued

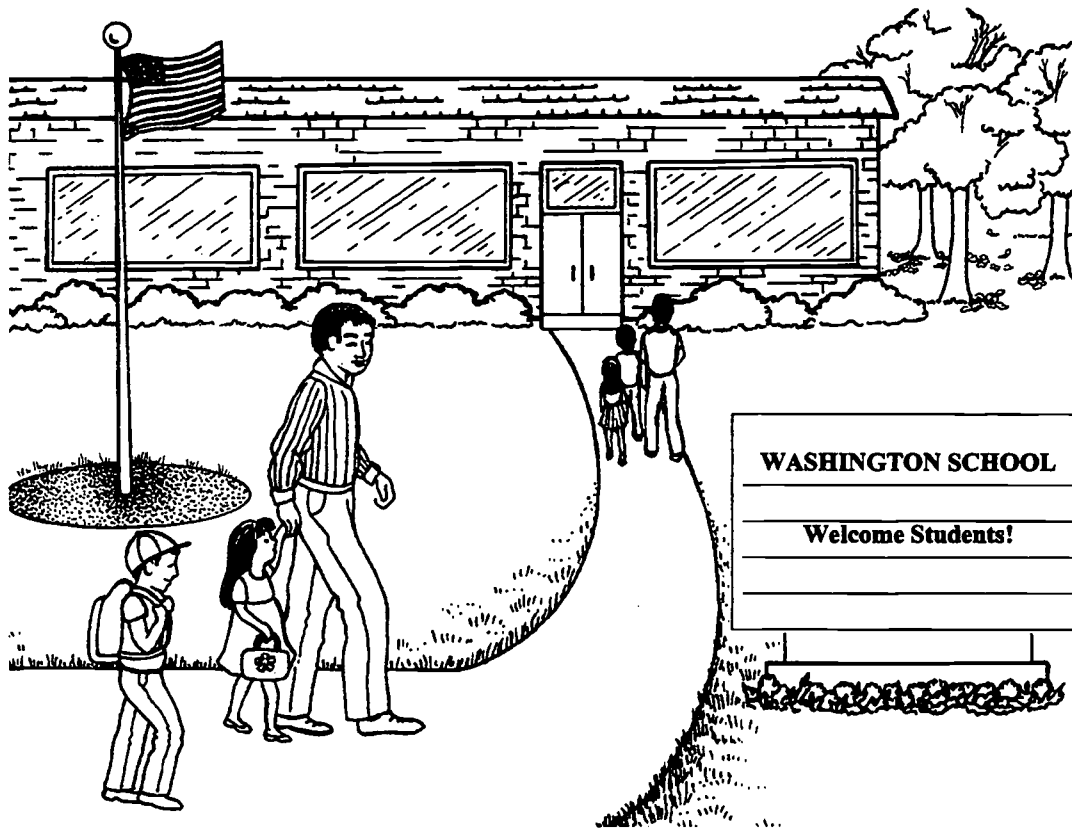

5



## READING PASSAGE

There are many health services for people in the community. Some health care services are private. People can get private health care from their own doctors or dentists. But private health care is usually expensive. People often have health insurance to help pay for their medical bills. Employers often provide free or low-cost health insurance for their full-time employees. But full-time employees usually have to pay for their spouse or other family members. People may also buy health insurance individually, but this is very expensive.

The government helps pay for public health services. People can get public health care through their local health department. Public health care services are often free or low cost for some low-income people. People with low incomes earn little or no money.

### GOVERNMENT HEALTH CARE PROGRAMS

The state and the federal government have programs to help people pay for health care.

*Medicaid* is a state and federal program that pays for health services for these low-income people:

- children and their caretakers
- pregnant women
- blind or disabled people
- people 65 years of age and older

*KidCare* is a free or low cost health insurance program in Illinois for these low-income people:

- children age 18 and younger
- pregnant women

*Medicare* is a federal government health insurance program for:

- people age 65 or older
- some people with disabilities under age 65
- some people with permanent kidney failure

The *WIC Program* (Women, Infants, and Children) provides healthy food and nutrition information to low-income women, infants, and children up to age 5.

Other health care services are often available through the city or county department of public health.

### PUBLIC HEALTH CLINICS

There are public health clinics in most communities. Some clinics are walk-in and others schedule appointments. At walk-in clinics, you don't need an appointment, but you often have to wait a long time. Some clinics have eligibility requirements such as low income or residency. Many services are free or low cost. People should call the clinic before a visit to check days and times open and eligibility requirements.

Clinics provide family health services such as check ups, dental care, and mental health care. Adult services can include family planning, prenatal care for pregnant women, and screenings for different diseases. Other clinic programs offer well-child care, immunizations, vision and hearing screening for school children, and school physical exams.



**READING PASSAGE** continued

Clinics also provide testing, counseling, and treatment for STDs (sexually transmitted diseases) and HIV/AIDS (acquired immune deficiency syndrome). These services are free, confidential, and anonymous.

**COMMUNITY HOSPITALS**

Community hospitals also provide many health services. Hospitals must provide emergency medical care even if a person cannot pay. Most hospitals also offer free or low-cost wellness programs to give people important health information. Examples of wellness programs are cholesterol testing, stress management, and nutrition counseling. There are also wellness programs for pregnant women, such as prenatal care, childbirth preparation, and breastfeeding classes.

Community hospitals usually have free support groups for different diseases such as diabetes or cancer. Some hospitals also have fitness centers where people can work out or take exercise classes. People must pay membership fees to use fitness centers.

**DOMESTIC VIOLENCE**

Domestic violence is physical, sexual, or psychological mistreatment of another adult in the home. It can happen between married people or other people living together. If someone calls the police to report domestic violence, the police will come to the house. Domestic violence agencies in the community provide emergency shelters and hotlines. Victims receive help such as counseling and legal assistance.

**CHILD ABUSE AND NEGLECT**

In the United States, there are laws to protect children. If adults hurt children, the adults may be arrested. The government may take children away from abusive parents. Adults who leave young children alone at home or who don't take care of them can be arrested for neglect. If you know of a child who is abused or neglected, you should call the Child Protective Services office in your community. Medical and school workers are required by law to report child abuse and neglect.

**SUBSTANCE ABUSE**

The community can help adults and teens with alcohol or other drug problems. Social service agencies and hospitals provide counseling and treatment for people with substance abuse problems. City and township government offices can make referrals to substance abuse programs and self-help groups. There are free or low cost programs available.

## READING PASSAGE continued

## GETTING HELP

People can contact their county or city health department to learn about clinics, domestic violence agencies, or substance abuse help. Sometimes health department information is also on the county or city web site. The public library has the *Human Care Services Directory*, a large book that lists services for different counties. Hospitals and schools also have information on health care services.

## A TRUE STORY

The Sánchez family moved to Chicago from Colombia last month. The parents took their children, José and María, to register for school. The school secretary said the children needed physical examinations and immunizations before they could start school. But the family had little money. The secretary gave them information about a public health clinic.

Mrs. Sánchez took her children to the clinic for immunizations. The nurse saw that Mrs. Sánchez was pregnant. The nurse told Mrs. Sánchez about free prenatal care at the clinic. Mrs. Sánchez went to the clinic the next week for prenatal care.

Soon José and María started school. Mrs. Sánchez received medical care during her pregnancy. The family learned to use public health services in the United States.

---

**READING PASSAGE: Vocabulary Activity 1-A**

*Directions:* Say these words after your teacher. Discuss the meaning of each word.  
(Optional: Write the meaning next to each word.)

1. health care/health services
2. health insurance
3. low income
4. public health clinics
5. walk-in clinic
6. appointment
7. eligibility requirements
8. check ups/physical exams
9. dental care
10. family planning
11. prenatal care
12. pregnant
13. well child care
14. immunization
15. vision/hearing screening
16. testing for STDs or HIV/AIDS

Other words:

## READING PASSAGE: Vocabulary Activity 1-B

*Directions:* Write the correct word or words in each sentence. Use the word bank for help. Each word can be used only once.

1. Maria made a doctor's \_\_\_\_\_ for Tuesday, April 4 at 3:00 p.m.
2. You do not need an appointment for health services at a \_\_\_\_\_.
3. \_\_\_\_\_ offer free or low-cost medical and dental care to low income people.
4. Children must have \_\_\_\_\_ against polio and other diseases before they start school.
5. Another name for birth control is \_\_\_\_\_.
6. \_\_\_\_\_ at clinics is free, confidential, and anonymous.
7. Doctors recommend annual \_\_\_\_\_ to stay healthy.
8. A woman who is going to have a baby is \_\_\_\_\_.
9. People see a dentist for \_\_\_\_\_.
10. Schools have \_\_\_\_\_ to check students' ability to see.
11. A pregnant woman needs \_\_\_\_\_ to check the health of her unborn baby.
12. \_\_\_\_\_ helps people pay for health care.
13. \_\_\_\_\_ people earn little or no money.
14. People must meet \_\_\_\_\_ to get services at a public health clinic.
15. Doctors check a baby's height and weight during visits for \_\_\_\_\_.
16. Immunizations, check ups, and prenatal care are examples of \_\_\_\_\_.

### WORD BANK

AIDS testing	appointment	check ups	dental care
eligibility requirements	family planning	health care	health insurance
immunizations	low income	prenatal care	public health clinics
vision screening	walk-in clinic	well child care	pregnant

**READING PASSAGE: Vocabulary Activity 2-A**

*Directions:* Say these words after your teacher. Discuss the meaning of each word.  
(Optional: Write the meaning next to each word.)

1. wellness programs
2. cholesterol testing
3. stress management
4. nutrition counseling
5. self-help group/support group
6. fitness center
7. domestic violence
8. emergency shelters
9. hotlines
10. counseling
11. child abuse
12. child neglect
13. substance abuse
14. alcohol
15. drugs

Other new words:

## READING PASSAGE: Vocabulary Activity 2-B

*Directions:* Write the letter of the correct meaning next to each word.

- |                             |   |
|-----------------------------|---|
| ___ 1. fitness center       | a. wine, beer, or liquor  |
| ___ 2. hotline              | b. talking with a counselor for help with problems  |
| ___ 3. domestic violence    | c. places that provide food and housing in an emergency   |
| ___ 4. alcohol              | d. medicine or narcotics such as cocaine or heroin  |
| ___ 5. stress management    | e. a blood test to measure cholesterol and screen for heart disease   |
| ___ 6. child neglect        | f. using illegal drugs, drinking too much alcohol, or taking drugs improperly                               |
| ___ 7. substance abuse      | g. a gym or other place to work out or exercise   |
| ___ 8. nutrition counseling | h. a telephone number that someone can call for help in an emergency  |
| ___ 9. counseling           | i. leaving a young child alone or not taking care of a child  |
| ___ 10. support group       | j. mistreatment of an adult in the home, often married people or other people living together               |
| ___ 11. wellness programs   | k. free or low-cost programs to help people stay healthy  |
| ___ 12. cholesterol testing | l. hurting a child  |
| ___ 13. drugs               | m. learning to control anxiety or nervousness by exercise, yoga, meditation, or other relaxation techniques |
| ___ 14. emergency shelters  | n. advice about foods and diet  |
| ___ 15. child abuse         | o. a group of people with the same disease or problem who meet to help each other                           |

## READING PASSAGE: Comprehension Check

*Directions:* Take turns reading each sentence with a partner. Decide if each sentence is TRUE or FALSE. Put an X under TRUE or FALSE. (Optional: Correct the false sentences.)

	TRUE	FALSE
1. In the United States, private health care is expensive.	_____	_____
2. Full-time workers usually receive free health insurance for their families.	_____	_____
3. Medicaid is a government program that helps some low income people.	_____	_____
4. KidCare provides health care to all children in Illinois.	_____	_____
5. Medicare is government health insurance for people 55 and older.	_____	_____
6. Public health clinics provide free or low cost health care to everyone.	_____	_____
7. Public health clinic services include family planning, prenatal care, screening for diseases, and STD testing.	_____	_____
8. Hospitals do not offer free or low cost wellness programs.	_____	_____
9. Hospitals often have support groups or self-help groups for diseases such as cancer or diabetes.	_____	_____
10. Adults can be arrested for child abuse or neglect.	_____	_____
11. There are hotlines and emergency shelters to help victims of domestic violence.	_____	_____
12. Social service agencies and hospitals offer counseling and treatment for people with substance abuse problems.	_____	_____
13. The county or city health department, libraries, and hospitals have information about community health care services.	_____	_____

**DIALOGUE 1: Calling a Clinic for Immunization Information**

*Directions:* Listen to the dialogue. Then practice the dialogue with your teacher and classmates.

Sapna Shah wants her children to get immunizations for school. The school nurse gives her the phone number of the local immunization clinic. Sapna calls the clinic for more information.

Receptionist: Hello. Wheeling Immunization Clinic.

Sapna: Hello. My children need immunizations for school. When is the clinic open?

Receptionist: We give immunizations on the 2<sup>nd</sup> Monday of the month, between 5:30 and 7:30 p.m.

Sapna: The 2<sup>nd</sup> Monday between 5:30 and 7:30 p.m.?

Receptionist: Yes. That's right.

Sapna: Do I need an appointment?

Receptionist: No, it's a walk-in clinic. But please don't come any later than 7:00.

Sapna: Okay. Thank you.

Receptionist: You're welcome. Goodbye.

Sapna: Goodbye.



---

**DIALOGUE 2: Calling the County for Dental Services**

*Directions:* Listen to the dialogue. Then practice the dialogue with your teacher and classmates.

Ania Clebek is a single mother with a low-income job. She needs a dental examination but cannot afford a private dentist. She calls the county health department for dental care.

Receptionist: Cook County Department of Public Health.

Ania: Hello. I would like information about dental services.

Receptionist: Before we make an appointment, we must know if you are eligible for dental care.

Ania: What information do you need?

Receptionist: We need to know your weekly income before taxes and the size of your family.

Ania: Well, I am a single mother with one child. I earn about \$300 a week.

Receptionist: Yes, you are eligible. Our next appointment is Friday, November 9 at 10:00 a.m. at the Skokie clinic.

Ania: November 9 at 10:00 a.m. in Skokie. Okay.

Receptionist: You have to bring check stubs from your last 2 paychecks to the appointment. And bring a utility bill for proof of residency.

Ania: Okay. Thank you.

Receptionist: Goodbye.

**DIALOGUE 3: Reporting Domestic Violence**

*Directions:* Listen to the dialogue. Then practice the dialogue with your teacher and classmates.

Sung Woo is very worried. He hears his next-door neighbors fighting and knows that there has been domestic violence before. When he hears the woman next door scream, he calls 911.

Operator: Emergency Operator. What is your emergency?

Sung Woo: Hello. I'm calling to report domestic violence next door. I think the police should come.

Operator: Please describe the problem.

Sung Woo: The man next door hits his wife. They are fighting now and she is screaming. I think she is in danger.

Operator: What is their address?

Sung Woo: They are at 1922 Lorel Avenue. The family's name is Park.

Operator: We will send the police right away.

Sung Woo: Thank you. Goodbye.

Operator: Goodbye.

## DIALOGUE 4: Calling the Hospital for Information

*Directions:* Listen to the dialogue. Then practice the dialogue with your teacher and classmates.

Joséfina wants information about health care programs. She calls the community hospital for information.

Hospital Operator: Good morning. Northwest Community Hospital.

Joséfina: Hello. I'm calling for information about (a) \_\_\_\_\_ .

Hospital Operator: Yes. How can I help you?

Joséfina: Could you tell me (b) \_\_\_\_\_ ?

Hospital Operator: Sure. \_\_\_\_\_ Is there anything else?

Joséfina: No. Thanks for your help. Goodbye.

Hospital Operator: Goodbye.

Partner A: Joséfina	Partner B: Hospital Operator
1. (a) the Fitness Center (b) when it is open	1. It's open Monday through Friday from 6:00 a.m. to 9:00 p.m., Saturdays from 6:00 a.m. to 5:00 p.m., and it's closed on Sundays.
2. (a) the Cancer Support Group (b) when and where it meets	2. The Cancer Support Group meets the first Tuesday of the month at 7:30 p.m. in the hospital auditorium.
3. (a) the Community Wellness Day on Saturday, October 6. (b) if blood pressure tests will be available	3. There will be free blood pressure tests all day from 9:00 a.m. to 4:00 p.m.

**DIALOGUE 5: Making a Doctor's Appointment**

*Directions:* Listen to the dialogue. Then practice the dialogue with your teacher and classmates.

Tomek Wolski wants to get a physical examination. He calls his doctor for an appointment.

Receptionist: Hello. Northwest Medical Practice.

Tomek: Hello. My name is Tomek Wolski. I'd like to make an appointment with Dr. Petrovich.

Receptionist: Have you seen Dr. Petrovich before?

Tomek: Yes. I saw her last winter for a sinus infection.

Receptionist: Why do you want to see the doctor now?

Tomek: I'd like to get a check up. Do you have any evening appointments?

Receptionist: Yes. Dr. Petrovich can see you next Tuesday, September 9, at 7:00 p.m.

Tomek: Oh, I'm sorry. I can't come that day. Do you have anything else?

Receptionist: How about Thursday, September 18 at 7:30 p.m.?

Tomek: Yes. That's good.

Receptionist: Could you spell your name for me please?

Tomek: It's Tomek. T-o-m-e-k. Wolski. W-o-l-s-k-i.

Receptionist: Okay, Mr. Wolski. We'll see you on Thursday, September 18 at 7:30 p.m.

Tomek: Thank you.

Receptionist: You're welcome. Goodbye.

Tomek: Bye.

**ACTION RESEARCH ACTIVITY: Health Care in Your Community**

*Directions:* Work together as a class or in small groups with other students from your neighborhood. Use a map of the community, a telephone directory, and the *Human Care Services Directory* (if available) to find the following:

- nearest public health clinic
- nearest hospital
- immediate care facility
- fitness center
- other health care facilities

Write the names, addresses, and phone numbers in the chart. Also write the names of other health care providers that are important for you and your family such as:

- private doctor
- dentist or dental clinic
- immunization clinic

NAME	ADDRESS	PHONE NUMBER

**WRITING ACTIVITY: Patient Information Form**

*Directions:* Look at this patient information form from a dental clinic. Fill in the information.

**PATIENT INFORMATION**

(last name)	(first name)	(middle initial)	(birth date)	(marital status)
(address)	(city)	(state)	(zip code)	(home phone) (work phone)
(occupation)	(employer)	(business address, city, state, zip code)		(social security #)
(name of spouse)	(spouse's occupation)	(spouse's employer)	(spouse's business address)	
(dental insurance company)	(policy number)	(referred by)		
(name of physician)	(physician's address)	(physician's phone number)		
(name of emergency contact)	(relationship to patient)	(emergency phone number)		

**MEDICAL HISTORY**

Please complete this brief medical history. Health problems that you may have or medications that you are taking could have an important interrelationship with your dental care.

	Yes	No
1. Have you ever been hospitalized for major surgery or serious illness? If so, what? _____	_____	_____
2. Are you under any medical treatment now?	_____	_____
3. Are you allergic to any drugs? If so, which ones? _____	_____	_____
4. Has there been a change in your body recently?	_____	_____
5. Have you ever had a blood transfusion?	_____	_____
6. Have you ever had kidney dialysis?	_____	_____
7. Have you ever had abnormal bleeding after a cut or after a tooth has been pulled?	_____	_____
8. Are you now taking any drugs or medications? If so, what? _____	_____	_____
9. Has a doctor ever told you that you had:	Yes	No
Heart Problem	_____	_____
High Blood Pressure	_____	_____
Rheumatic Fever	_____	_____
Angina	_____	_____
Heart Murmur	_____	_____
Mitral Valve Prolapse	_____	_____
Stroke	_____	_____
Blood Disease	_____	_____
Hemophilia	_____	_____
Prosthetic Heart Valve or Joint	_____	_____
Asthma	_____	_____
Hepatitis or Yellow Jaundice	_____	_____
Liver Disease	_____	_____
Venereal Disease	_____	_____
HIV or AIDS	_____	_____
Stomach or Intestinal Disease	_____	_____
Tumors or Growths	_____	_____
Kidney Disease	_____	_____
Diabetes	_____	_____
Tuberculosis	_____	_____
Respiratory Disease	_____	_____
Epilepsy	_____	_____
10. Women: Are you pregnant? Expected Date of Delivery _____	_____	_____

FOR OFFICE USE ONLY

Medical History Summary

Patient Signature \_\_\_\_\_ Date 262

Blood Pressure: \_\_\_\_\_

**BEST COPY AVAILABLE**

**PAIR ACTIVITY: Health Care Providers**

*Directions:* With a partner, decide the type or place of health care service for each situation. Write A, B, or C. Then explain your answers to the class.

A = community hospital

B = public health clinic

C = domestic violence or substance abuse counseling

- \_\_\_\_\_ 1. On Sunday, Roberto fell off his bike and cut his head badly. He needs stitches and medical care to stop the bleeding and prevent infection.
- \_\_\_\_\_ 2. Alonzo has a low income job. He has pain when he urinates and thinks he may have an STD (sexually transmitted disease).
- \_\_\_\_\_ 3. Kasia's husband abuses her when he has too much alcohol to drink. She wants to stop him from hurting her.
- \_\_\_\_\_ 4. Jigesh and Parul are 5 years old. They need MMR (Measles, Mumps, and Rubella) vaccinations for school. Their father has a low income job and their mother doesn't work.
- \_\_\_\_\_ 5. Young Ho just learned that he has diabetes. He wants to join a support group so he can better understand this disease.
- \_\_\_\_\_ 6. Griselda has lost her job and has no insurance. She thinks she may be pregnant and wants to get health care.
- \_\_\_\_\_ 7. Adrian is 16 years old and is using drugs. His father finds out and wants to get help for his son's addiction.
- \_\_\_\_\_ 8. Tomás and María have 5 children. They have low income jobs and do not want any more children. They want birth control information.
- \_\_\_\_\_ 9. Chou came to the United States 2 months ago and does not have a job yet. She has a toothache but cannot afford to see a dentist.

## CULTURAL COMPARISON ACTIVITY: Health Care Services

*Directions:* Think about health care in your native country and in the United States. Discuss the answers to the questions below with your classmates.  
(Optional: Write the information in the chart.)

	IN _____ (native country)	IN THE U.S.
1. Can people get private health care from their own doctors and dentists? Is this care expensive?		
2. Do full-time workers have health insurance through their employers? Can full-time workers pay extra to insure their spouse or family?		
3. Does the government help pay for health care? Who can get health care through the government?		
4. Are there public health clinics? What services do public health clinics offer?		
5. How can people get help for domestic abuse?		
6. How can people get help for substance abuse?		
7. What services do community hospitals provide?		



## EXPERIENTIAL ACTIVITIES

As a class, identify an important issue that affects the group. Some ideas are:

- finding out about health care services available in the community
- finding out about bilingual health care services available in the community
- getting information about immunizations and school physicals
- finding substance abuse resources in the community
- finding domestic abuse resources in the community
- registering for and attending a wellness program sponsored by the community hospital
- getting information about private health insurance or COBRA health care

Determine the best course of action from the suggestions below or have students generate their own plan of action. Choose an activity requiring a response by health care personnel. Also select an activity in which students have a vested interest so that they will follow through to a satisfactory conclusion.

1. As a class, attend a hospital wellness program on a topic of interest to the class (for example, stress management, nutrition, weight loss, or fitness). Have a follow-up discussion in class afterwards.

*risk: low*

*language level: intermediate – advanced*

2. After identifying a health condition or issue of interest to the class, invite a public health worker as a guest speaker to address that topic. Have the class prepare questions in advance of the visit.

*risk: medium-high*

*language level: high beginning – advanced*

3. Invite a school nurse to be a guest speaker. Have students prepare questions beforehand. Topics might include school physicals, immunizations, taking medicine during school hours, contagious diseases, or resources for parents (e.g., smoking cessation or substance abuse programs).

*risk: high*

*language level: high beginning – advanced*

4. Plan a Student Health Fair. Invite the local health department to provide screenings for cholesterol, blood pressure, diabetes, vision and hearing problems, and tuberculosis. Prepare students ahead of time by discussing relevant vocabulary and completing any necessary registration forms in advance. Follow-up with an in-class discussion to share the students' experiences.

*risk: medium*

*language level: high beginning – advanced*

**EXPERIENTIAL ACTIVITIES** continued

5. Have students call the county public health clinic to find out the eligibility requirements for medical and/or dental care. (Eligibility requirements may include family income before taxes, family size, or residency.) Students can either make phone calls in class using a speaker phone (so all can hear) or from home, reporting the information to the class.  
*risk: high*  
*language level: intermediate – advanced*
  
6. Have students call their community hospital to find out if there is a support group for a particular health condition or issue. If they find out that the hospital has no such group, have them ask where such a group can be found.  
*risk: high*  
*language level: intermediate – advanced*
  
7. Have students (working individually or in pairs) access the web site for the nearest community hospital. Have them find information on topics of interest to them such as health and family education programs, health information resources, community calendar, or physician referral. Then have them report back to the class.  
*risk: low*  
*language level: all*
  
8. Have students (working individually, in pairs, or in groups) email a question to the community hospital. Then have students report the hospital's response to the class.  
*risk: low*  
*language level: high beginning – advanced*
  
9. Have students use email to order brochures of interest to them from the community hospital. When students receive the brochures, have them give brief oral reports in class on the contents of the brochures.  
*risk: low*  
*language level: high beginning – advanced*

MODULE 6

◆◆◆ HOUSING ◆◆◆

COMPONENTS

	Page
◆ TEACHER NOTES .....	242
◆ PICTURES	
• Pictures for Vocabulary Development.....	246
• Pictures for Language Experience .....	259
• Pictures for Group Story Writing.....	265
◆ READING PASSAGE	
• Pre-Reading Activity.....	268
• Reading Passage .....	269
• Vocabulary Activity 1-A .....	271
• Vocabulary Activity 1-B.....	272
• Vocabulary Activity 2-A .....	273
• Vocabulary Activity 2-B.....	274
• Comprehension Check .....	275
◆ EXTENSION ACTIVITIES	
• Dialogue 1: <i>Calling the Landlord About a Leak</i> .....	276
• Dialogue 2: <i>Calling the Landlord About Insufficient Heat</i> .....	277
• Dialogue 3: <i>Reporting a Power Outage</i> .....	278
• Dialogue 4: <i>Calling the Phone Company About a Bill</i> .....	280
• Action Research Activity: <i>Housing and Utilities: Important Phone Numbers</i> .....	281
• Writing Activity: <i>A Letter to the Landlord</i> .....	282
• Pair Activity: <i>Tenant and Landlord Responsibilities</i> .....	283
• Cultural Comparison Activity: <i>Housing</i> .....	284
◆ EXPERIENTIAL ACTIVITIES .....	285

## TEACHER NOTES

Some of the topics addressed in this module will be of interest to tenants only (e.g., landlord-tenant responsibilities), some topics will interest homeowners only (e.g., building permits, contractors, and property taxes), and other topics will be of interest to both homeowners and tenants (e.g., utilities). Before beginning the module, survey the number of renters vs. homeowners in your class so that you can select topics and experiential activities that are of interest to your class.

To introduce the concept of utilities, shut off the classroom lights. Ask students what they would do if there were a sudden power outage. Continue by asking students what utilities are and what kinds of utility service they have. Explain that the module will cover important information on utilities.

### COMPETENCIES FOR MODULE 6

Students will learn to:

1. Identify the rights and responsibilities of landlords and tenants.
2. Contact their landlords or property associations regarding housing problems.
3. Report a problem with utility service or billing.
4. Obtain information about utility payment plans.
5. Locate resources for building permits or property tax questions.
6. Check a contractor's or solicitor's references or report a complaint against them.

### THE VOCABULARY ACTIVITIES AND THE READING PASSAGE

The Reading Passage contains a large number of vocabulary words that may be unfamiliar to students. To facilitate the teaching of this module, Vocabulary Activities 1-A and 1-B correspond to the first part of the Reading Passage only (through "Utilities"), while Vocabulary Activities 2-A and 2-B correspond to the rest of the Reading Passage ("Property Taxes" through the end). You may choose to teach the Reading Passage in two parts, at two different class meetings, depending on the level of your class.

### EXPANSION IDEAS

#### Fair Housing Act and Housing Discrimination

Students may have experienced discrimination in the area of housing and this issue might be productively explored in the classroom. You may want to research the Fair Housing Act to see what is legal and illegal in your area. It is also important to find out what recourse people have in cases of discrimination. See "Resources" for more information.

#### Community Newspapers

If the level of the class and student interest warrant it, you may want to include more classroom instruction on ads for 1) apartments and other housing and 2) contractors. Present and practice vocabulary used in want ads (e.g., number of bedrooms, utilities included, security deposit, etc.) and role-play apartment hunting scenarios. Have students research ads for contractors and tradesmen to see how they advertise and solicit business.

## TEACHER NOTES continued

Credit History and Home Ownership

Since students may be affected by their credit history as they apply for apartments or mortgages, you may want to address the topic of credit (i.e., why it's advisable and how to establish credit as well as how to obtain a copy of one's credit report). If possible, obtain a copy of an actual credit report (remove the name and other personal information). If students are interested in learning about purchasing a home or applying for a mortgage, the Fannie Mae Foundation offers a wealth of free information in several languages (see Resources), including booklets about credit, home buying, and mortgages. Local mortgage lenders and real estate agencies may be sources of additional information.

Word Forms

A usage focus that you may want to highlight in the context of this module is vocabulary development with verb, noun, and adjective forms of words. Here are some examples:

1. He pays the **rent** every month. (*noun*)
  2. They **rent** an apartment on Center Street. (*verb*)
- 
1. He **repairs** the roof when it leaks. (*verb*)
  2. The **repairs** take a lot of time. (*noun*)
- 
1. Lightning can **damage** property. (*verb*)
  2. There was a lot of **damage** to the tree. (*noun*)
- 
1. His **building** is on the corner. (*noun*)
  2. He's **building** an addition to his house. (*verb*)
  3. He needs a **building** permit for his driveway. (*adjective*)
- 
1. The landlord repaired the **leaks** in the roof. (*noun*)
  2. The roof **leaks** when it rains. (*verb*)
  3. The man fixed the **leaking** roof. (*adjective*)

## POSSIBLE AUTHENTIC MATERIALS

- A monthly rental agreement form (lease)
- Brochures from the Office of the Illinois Attorney General regarding landlord and tenant rights
- Guides to local property maintenance codes
- Utility company bills and brochures for payment options

**TEACHER NOTES** continued**RESOURCES\***Print Materials

*Consumer Rights for Immigrants*, Deanne Loonin and Chi Chi Wu (2002). The National Consumer Law Center, Inc. (2002). Boston, MA (617) 523-8089. A handbook for advocates including information on the most critical consumer issues faced by low-income immigrants.

Web Sites

## ABTolls' Reading Your Phone Bill

[www.abelltolls.com/information/readingbills.html](http://www.abelltolls.com/information/readingbills.html)

A non-profit phone rate watchdog web site providing information on reading the charges on phone bills and finding the best rates.

## Angie's List

[www.angieslist.com](http://www.angieslist.com)

Consumer-driven organization providing customer reviews on local service companies in 15 major U.S. cities. Covers 250 categories such as roofing, plumbing, and landscaping. Fee for membership.

## Better Business Bureau

[www.bbb.org](http://www.bbb.org)

Articles, free publications, and information on how to file a complaint against a business as well as consumer information on purchasing and maintaining a home.

## Citizens Utility Board

[www.citizensutilityboard.org](http://www.citizensutilityboard.org)

Non-profit Illinois state consumer advocate organization providing up-to-date news on utility issues and helpful tips to consumers.

## Exelon (parent company of ComEd and PECO)

[www.cecoco.com/](http://www.cecoco.com/)

Illinois electric companies' web site providing information on gas rates, reading gas bills, bill payment options, and a payment assistance program.

## Fannie Mae Foundation

[www.fanniemaefoundation.org](http://www.fanniemaefoundation.org)

Information and free publications on credit, mortgages, and home buying; many materials are available in other languages and in easy-to-read English.

## Federal Trade Commission Consumer Information

[www.ftc.gov/bcp/menu-credit.htm](http://www.ftc.gov/bcp/menu-credit.htm)

Information and brochures (some in Spanish) on topics such as credit, loans, home equity loans, and mortgage discrimination.

**TEACHER NOTES** continued

## Helping People Help Themselves

[www.ahandup.com](http://www.ahandup.com)

A program helping low-income customers pay off delinquent utility bills through volunteer work or education. Web site includes names of participating utility companies and social service agencies.

## Metropolitan St. Louis Equal Housing Opportunity Council

[stlouis.missouri.org/501c/ehoc/law.html](http://stlouis.missouri.org/501c/ehoc/law.html)

Information about the Fair Housing Act.

## Nicor Gas

[www.nicorinc.com](http://www.nicorinc.com)

Information on gas rates, reading gas bills, bill payment options, and the budget payment plan to spread costs over a whole year.

## Office of the Illinois Attorney General Consumer Protection Information

[www.ag.state.il.us/consumer/consume.htm](http://www.ag.state.il.us/consumer/consume.htm)

Consumer information on credit, home equity, household moves, and landlord/tenant rights and laws.

## U.S. Postal Service

[www.usps.com](http://www.usps.com)

Information on certified mail, other mail tracking services, and online change of address form.

Video

*Crossroads Café* (1996). Unit 11, “No Vacancy” (tenant rights/discrimination) and Unit 23, “The Gift” (taxes). Videos and tape scripts available from Intelecom, (800) 576-2988, [www.intelecom.org](http://www.intelecom.org). Textbooks are available from Heinle & Heinle, [www.heinle.com](http://www.heinle.com). Videos may be used independently of textbooks.

\* This list of resources is also located at [www.thecenterweb.org](http://www.thecenterweb.org) (click on “The Adult Learning Resource Center”) where it is updated annually.

PICTURES FOR VOCABULARY DEVELOPMENT

homeowner



tenant

landlord





## PICTURES FOR VOCABULARY DEVELOPMENT continued

lease

**APARTMENT LEASE**  
**Thomas Property Management**  
**89 First Street**  
**Harris, IL 56570**  
**(555) 356-9076**

This Lease Agreement (this "Lease") is dated April 25, 2003, by and between Thomas Property Management ("Landlord") and Jóse Perez ("Tenant"). The parties agree as follows:

**TERM:** The lease term will begin on May 1, 2003 and will terminate on April 30, 2004.

**PAYMENTS:** Tenant shall pay to landlord lease payments of \$750.00 payable in advance on the first day of each month...

**PETS:** Pets shall not be allowed without...

---

**LANDLORD:** Samuel Thomas April 25, 2003  
 Thomas Property Management Date

**TENANT:** Jóse Perez April 25, 2003  
 Date

written notice

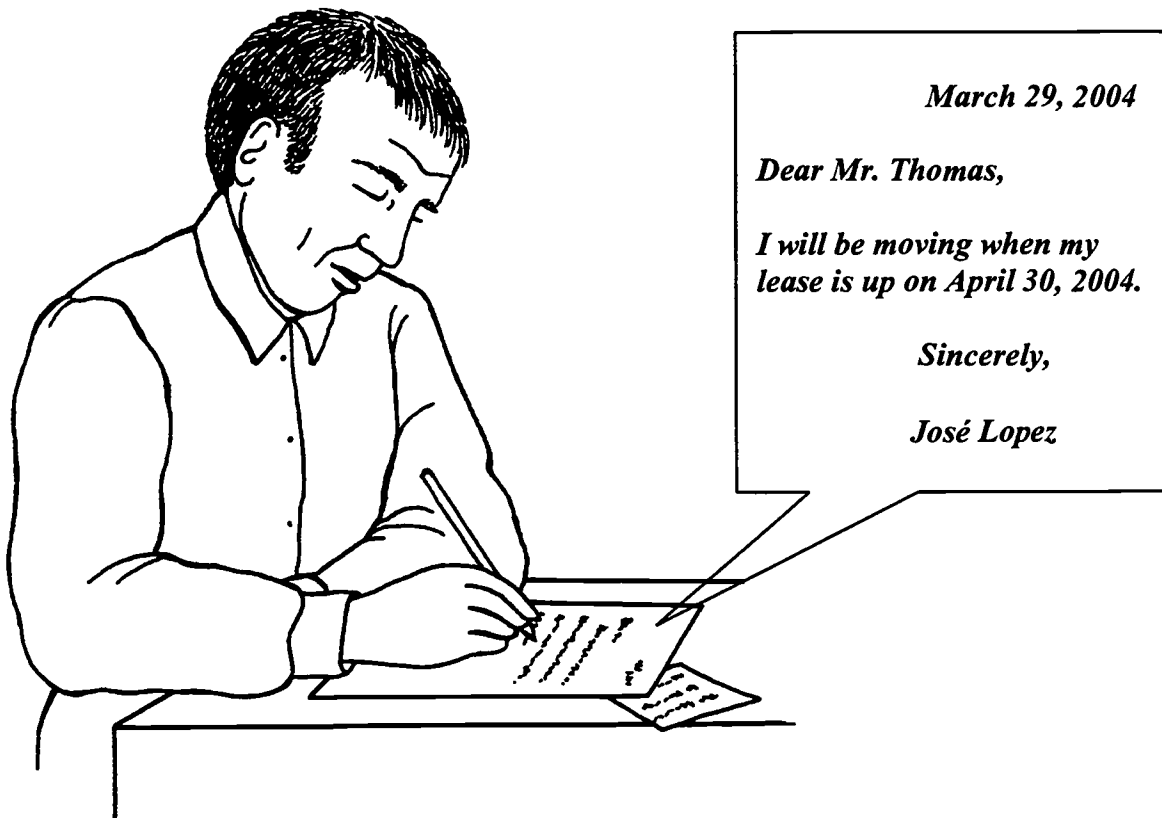

PICTURES FOR VOCABULARY DEVELOPMENT continued

damage

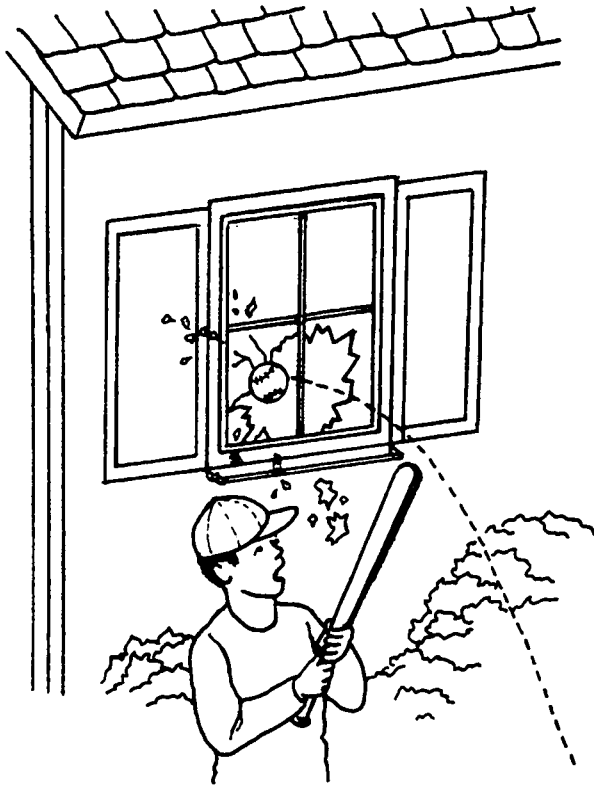

repair

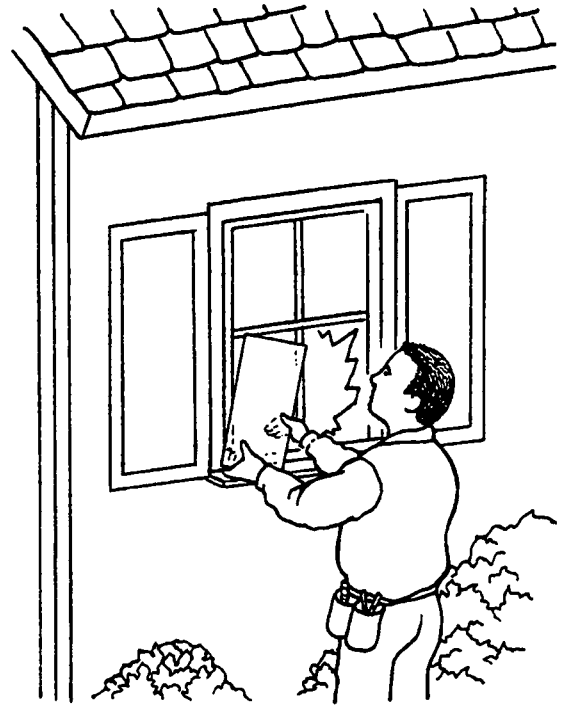

leak



PICTURES FOR VOCABULARY DEVELOPMENT continued

registered mail  
certified mail

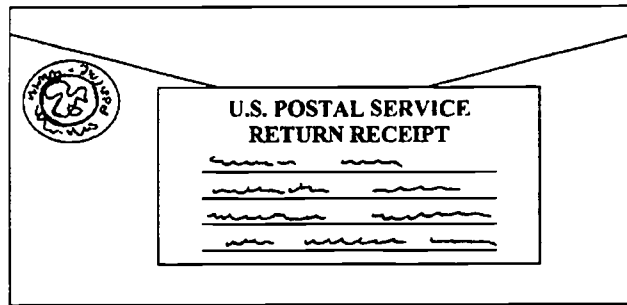
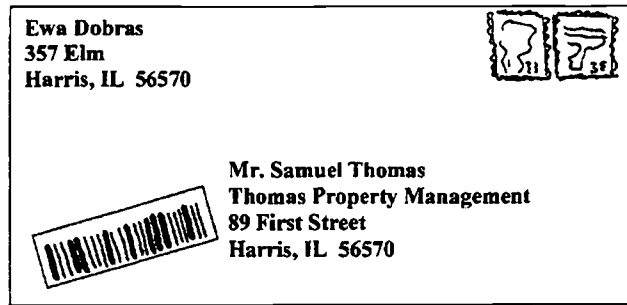

lawyer/attorney



PICTURES FOR VOCABULARY DEVELOPMENT continued

discrimination

March 2  
9:00 a.m.

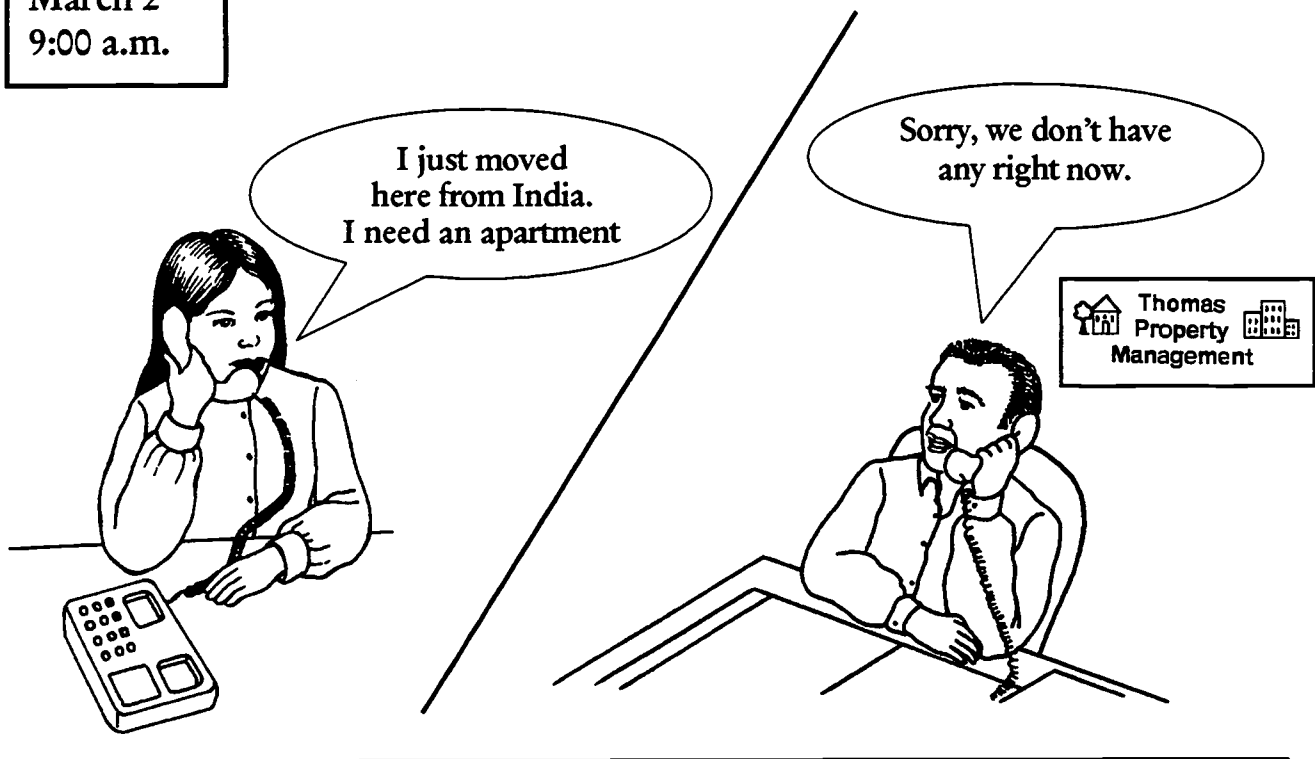

March 2  
9:30 a.m.



PICTURES FOR VOCABULARY DEVELOPMENT continued

UTILITIES

telephone



natural gas

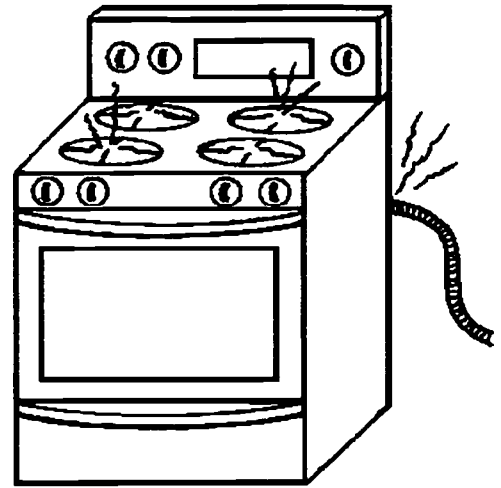

water

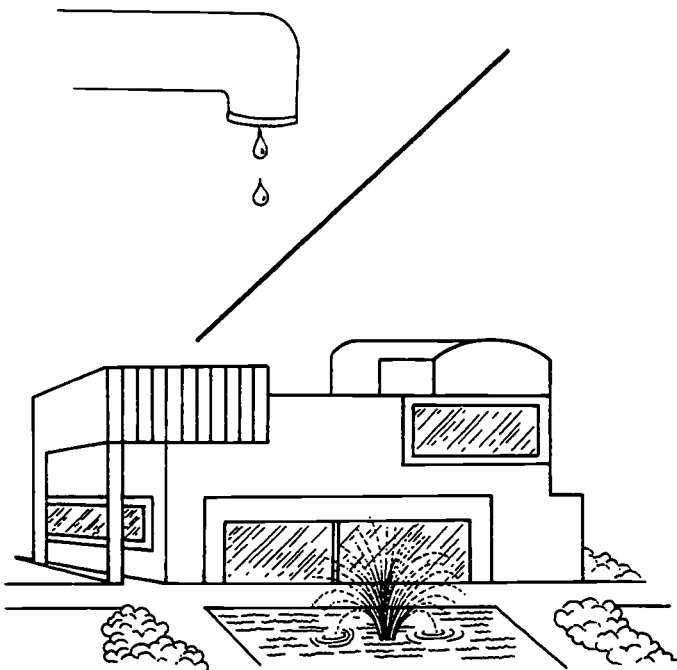

electric

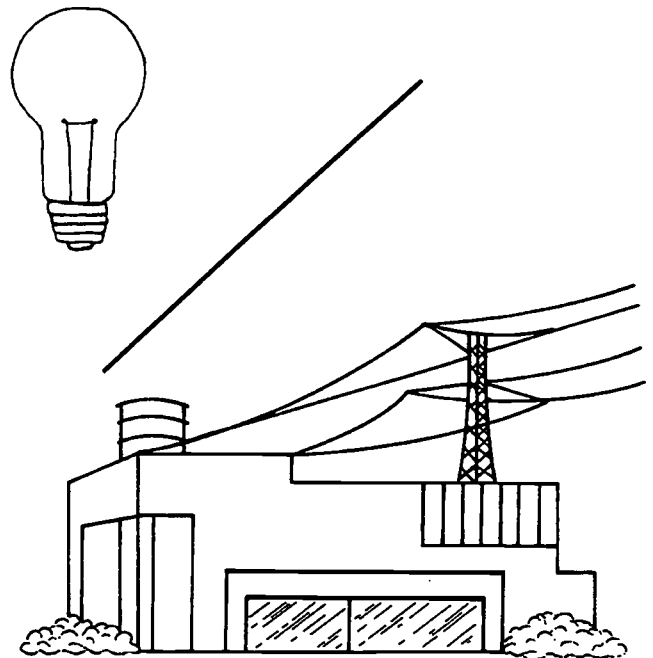

PICTURES FOR VOCABULARY DEVELOPMENT continued

UTILITY BILLS

meter

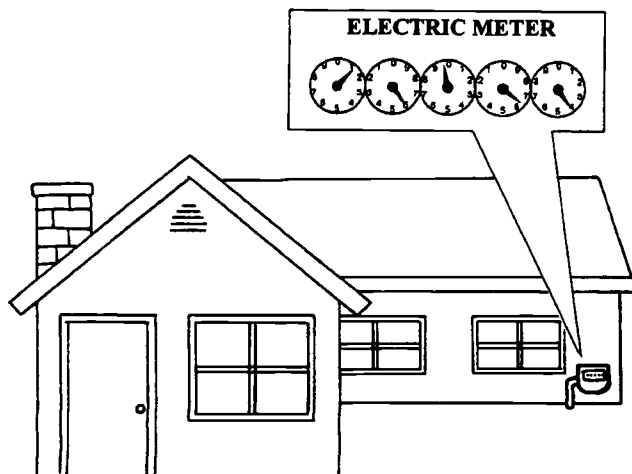

budget plan

GAS BILL: BUDGET PLAN

Month	Bill	Month	Bill
January	\$80.00	July	\$80.00
February	\$80.00	August	\$80.00
March	\$80.00	September	\$80.00
April	\$80.00	October	\$80.00
May	\$80.00	November	\$80.00
June	\$80.00	December	\$80.00

Total: \$960.00

GAS BILL: REGULAR BILLING

Month	Bill	Month	Bill
January	\$135.00	July	\$30.00
February	\$127.00	August	\$33.00
March	\$101.00	September	\$40.00
April	\$75.00	October	\$90.00
May	\$59.00	November	\$110.00
June	\$35.00	December	\$125.00

Total: \$960.00

customer service

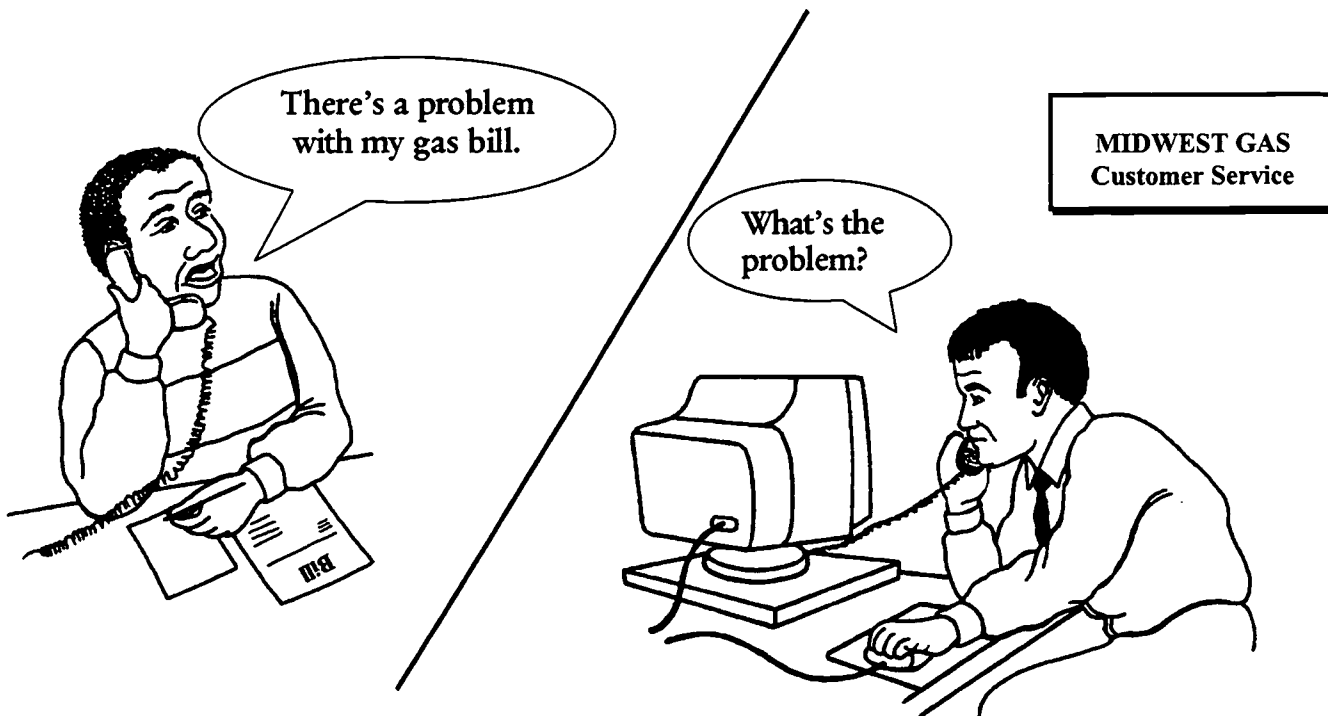

PICTURES FOR VOCABULARY DEVELOPMENT continued

local telephone service

Chicago  
(773) 555-2435



Chicago  
(773) 555-5987



long distance telephone service

Chicago  
(773) 555-2435



New York  
(212) 555-3678



PICTURES FOR VOCABULARY DEVELOPMENT continued

property taxes

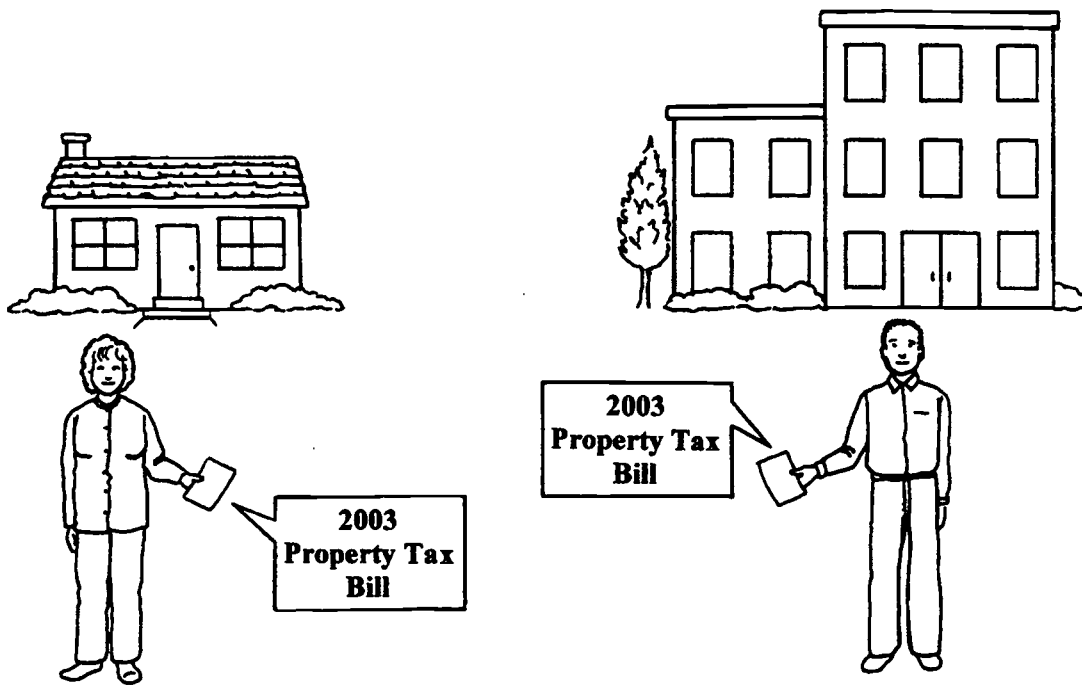

assessor





## PICTURES FOR VOCABULARY DEVELOPMENT continued

## HIRING A CONTRACTOR

calling the Better Business Bureau for information

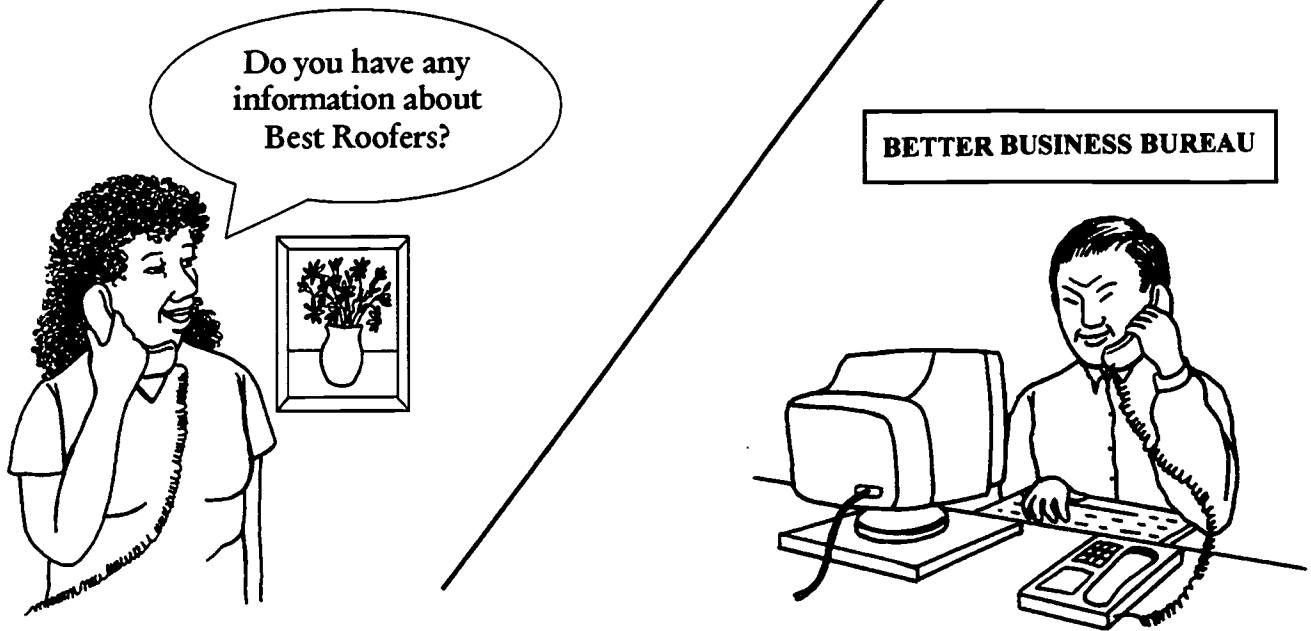

references

**BEST ROOFERS**  
*People love our work!*

Tom Smith	(354) 555-2976
132 Oak St.	
Harris, IL	
Julia Kowalska	(597) 555-6088
2987 75 <sup>th</sup> St.	
Greensburg, IL	

contractor

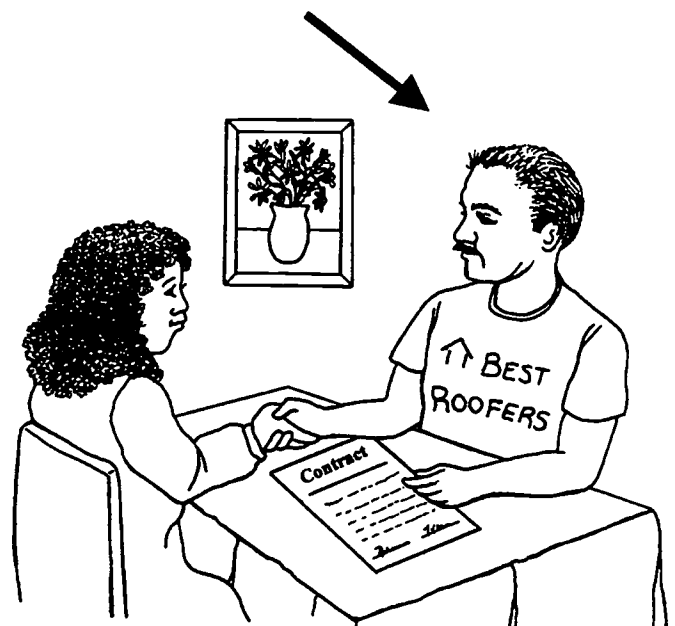

PICTURES FOR VOCABULARY DEVELOPMENT continued

HIRING A CONTRACTOR

building permit



roofing contractor

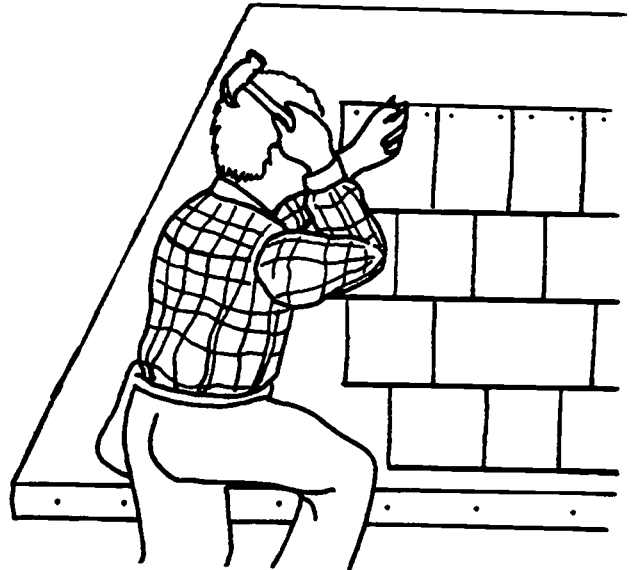

calling the Better Business Bureau to make a complaint

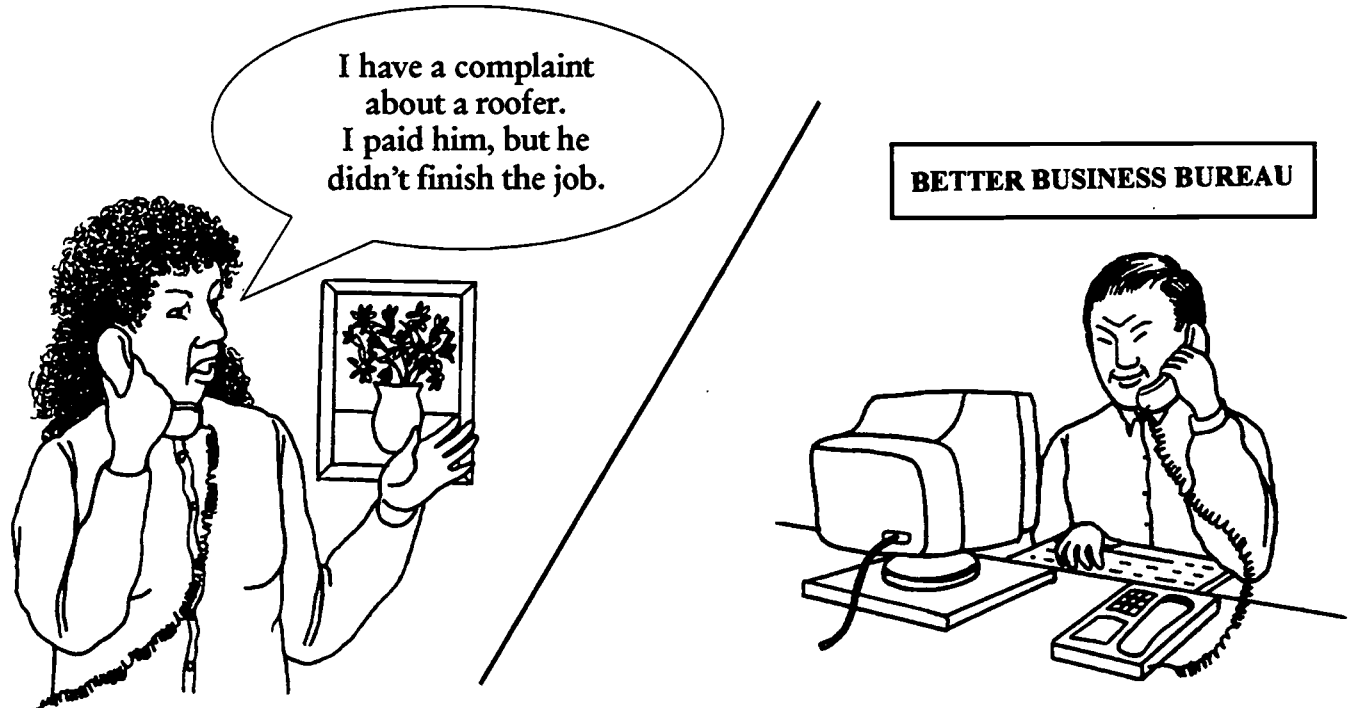

PICTURES FOR VOCABULARY DEVELOPMENT continued

solicitor



telephone solicitor

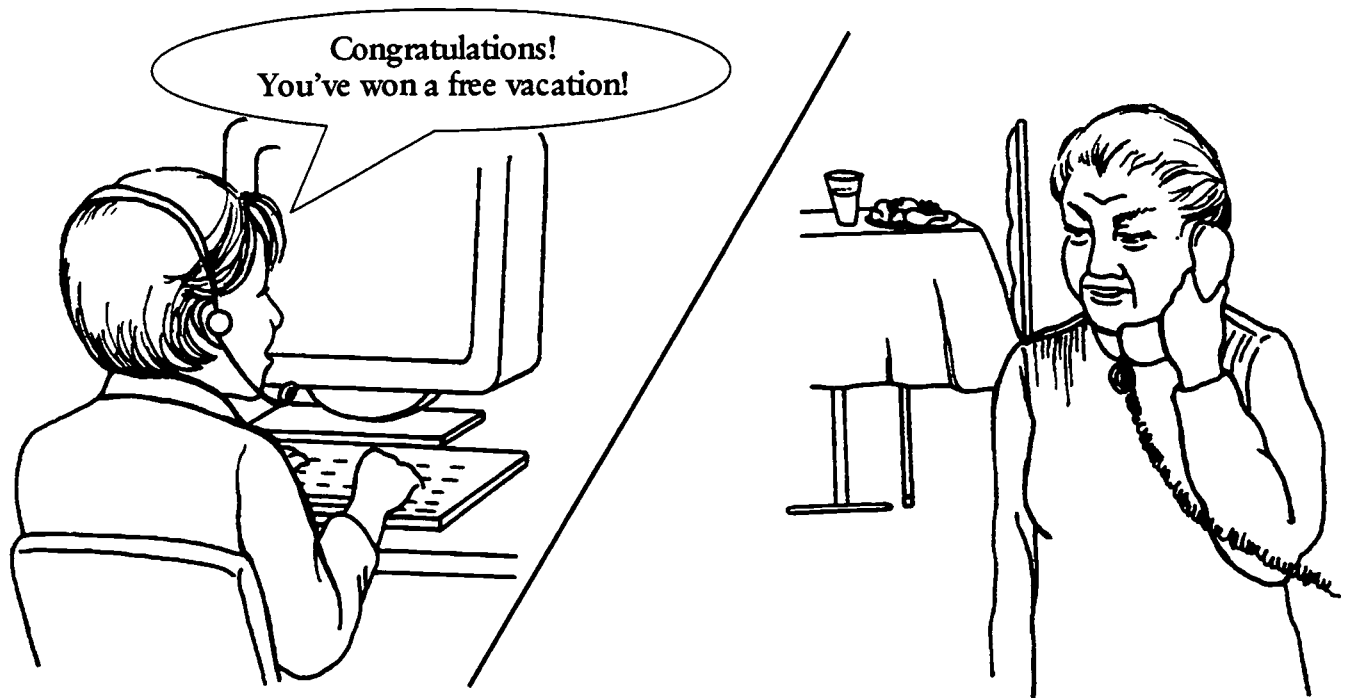

PICTURES FOR VOCABULARY DEVELOPMENT continued

garbage collection

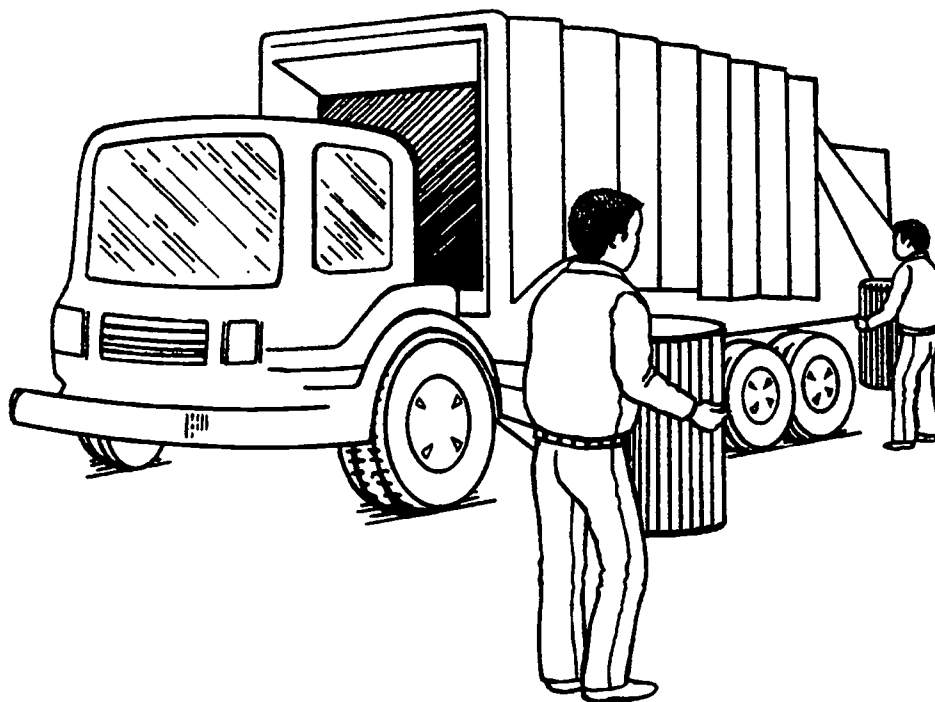

recycling

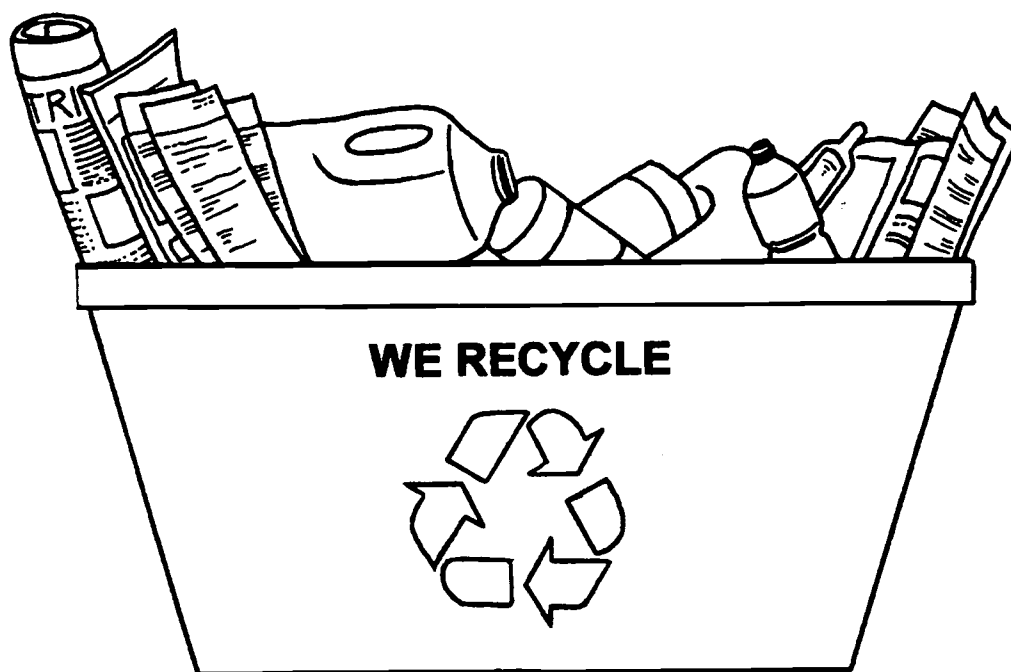

PICTURES FOR LANGUAGE EXPERIENCE

April 3

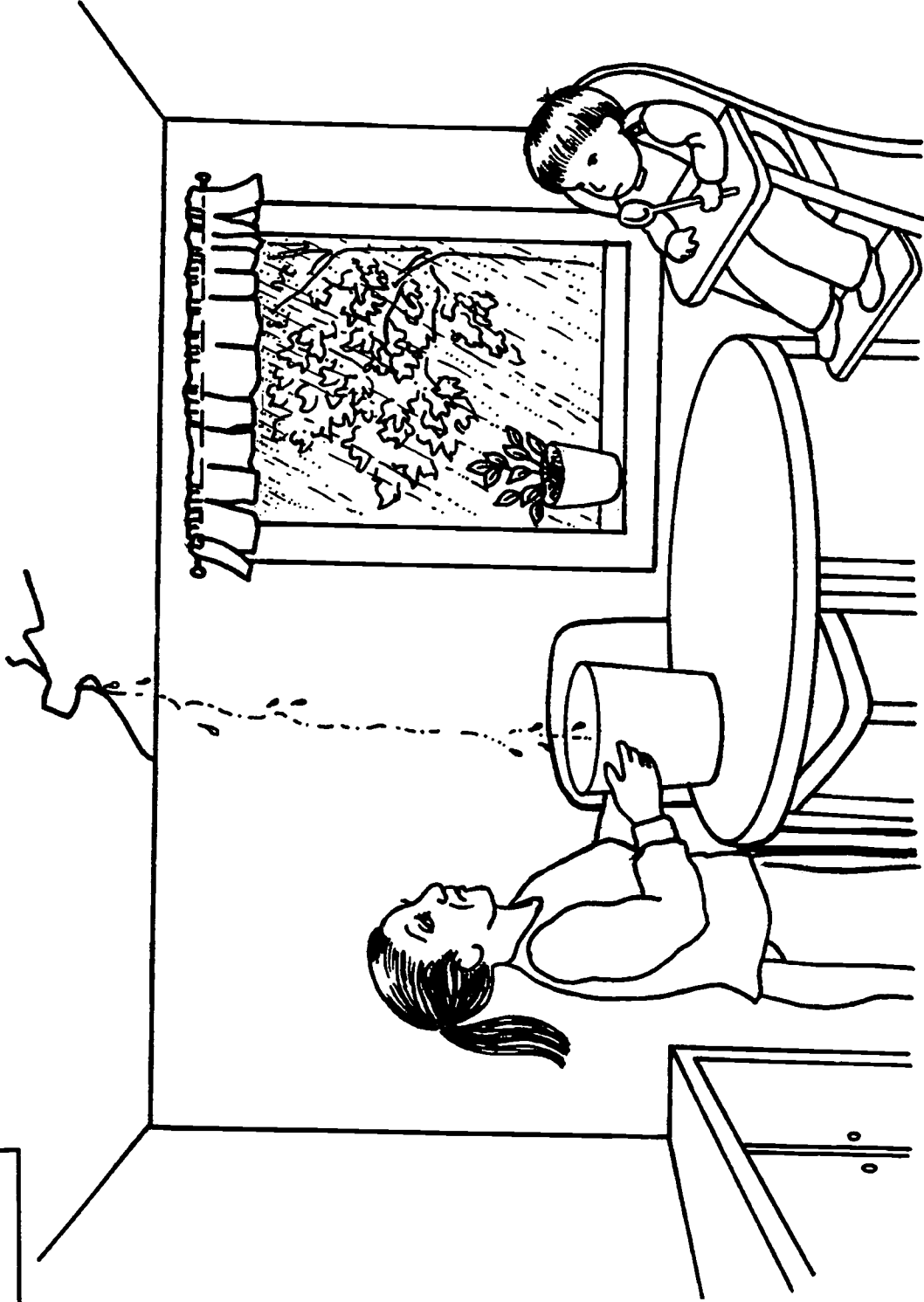

1

PICTURES FOR LANGUAGE EXPERIENCE continued

April 3

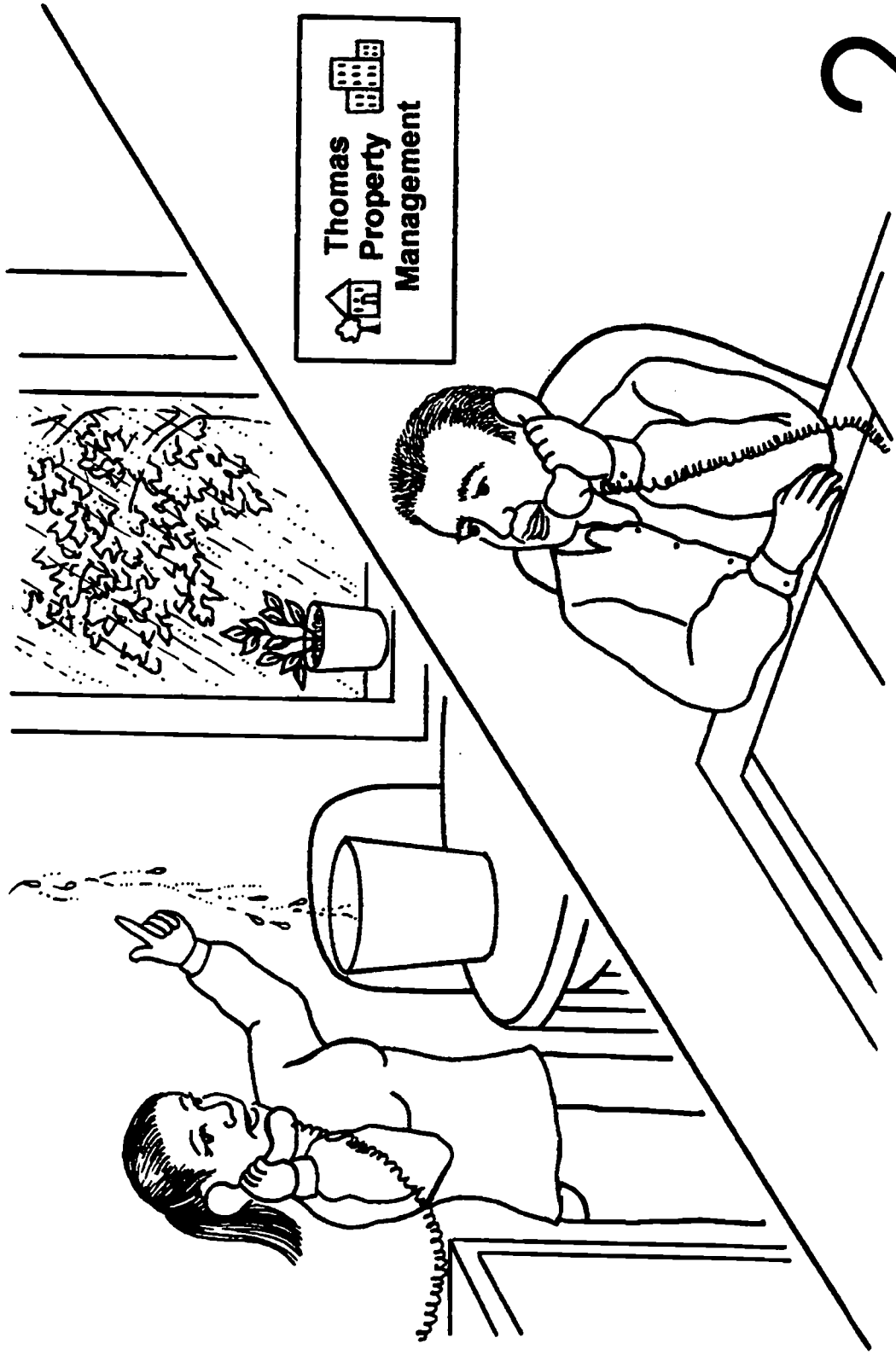

2

PICTURES FOR LANGUAGE EXPERIENCE continued

April 17

Dear Mr. Thomas:  
I called you on April 3  
about our leaking  
ceiling. You promised  
to fix it...

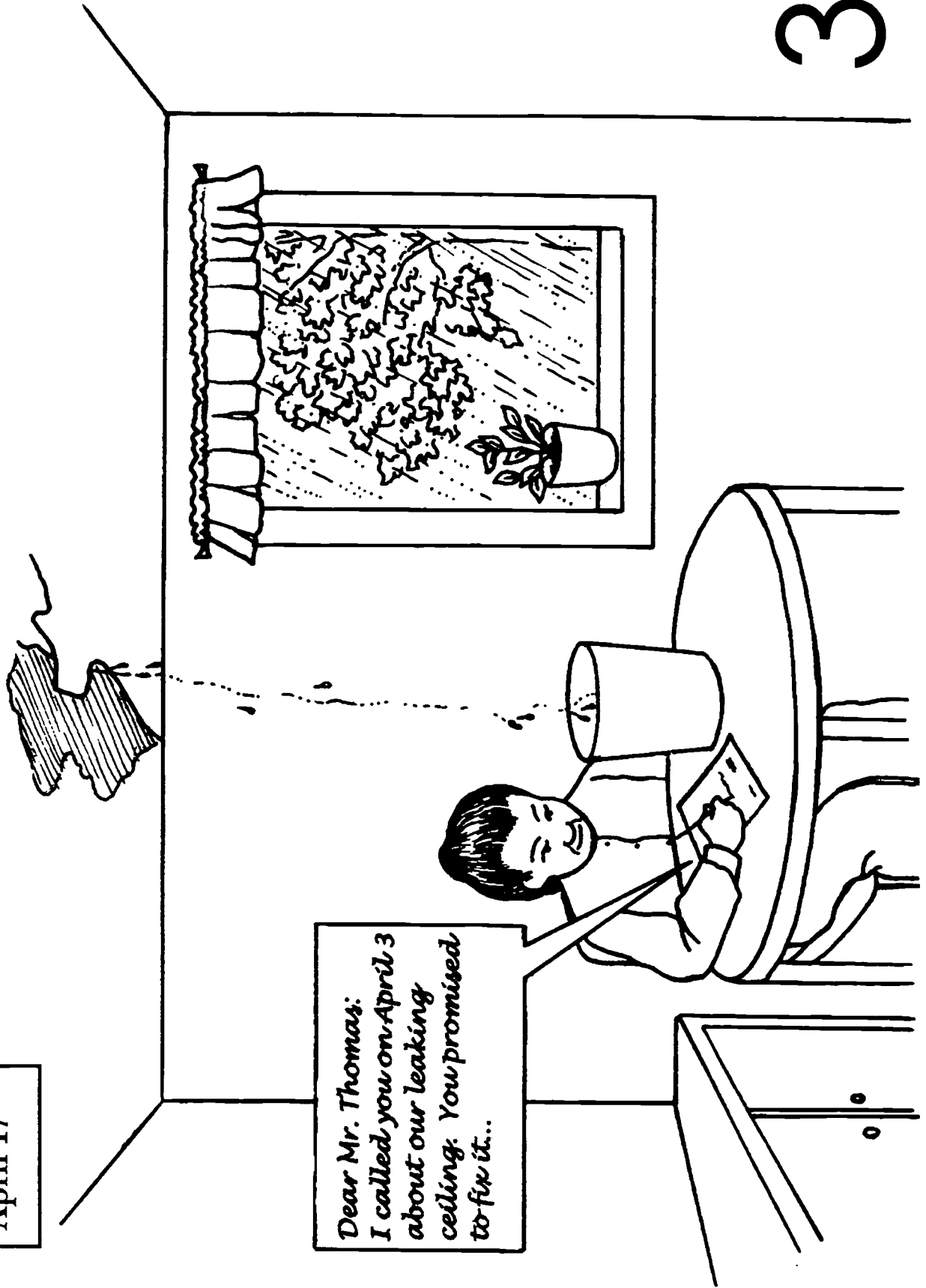

3

PICTURES FOR LANGUAGE EXPERIENCE continued

April 17

U.S. POST OFFICE

I want to send this  
by Certified Mail  
with a return receipt.

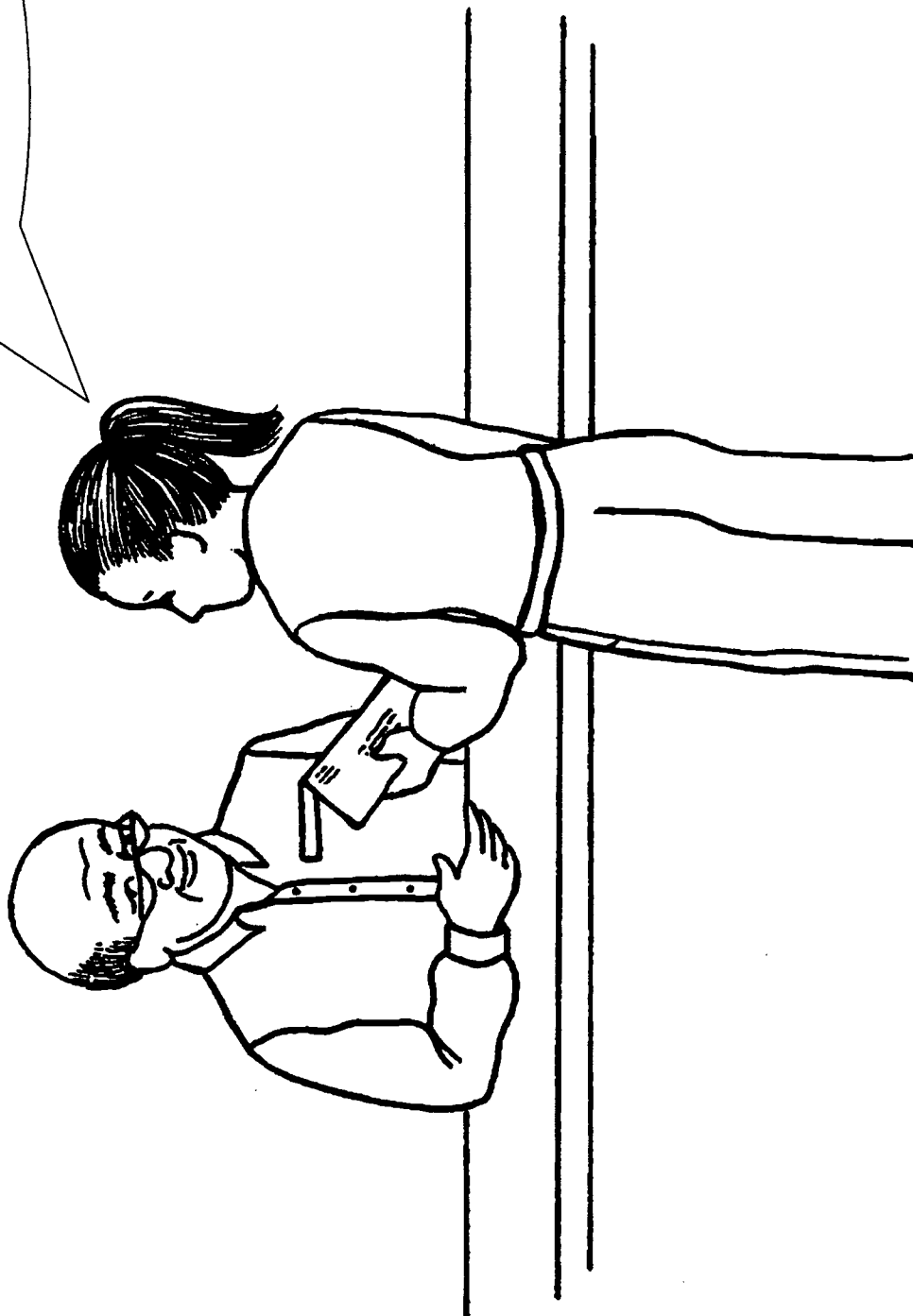

4



PICTURES FOR LANGUAGE EXPERIENCE continued

April 18

   
**Thomas  
Property  
Management**

*Dear Mr. Thomas:  
I called you on April 3  
about our leaking  
ceiling. You promised  
to fix it...*

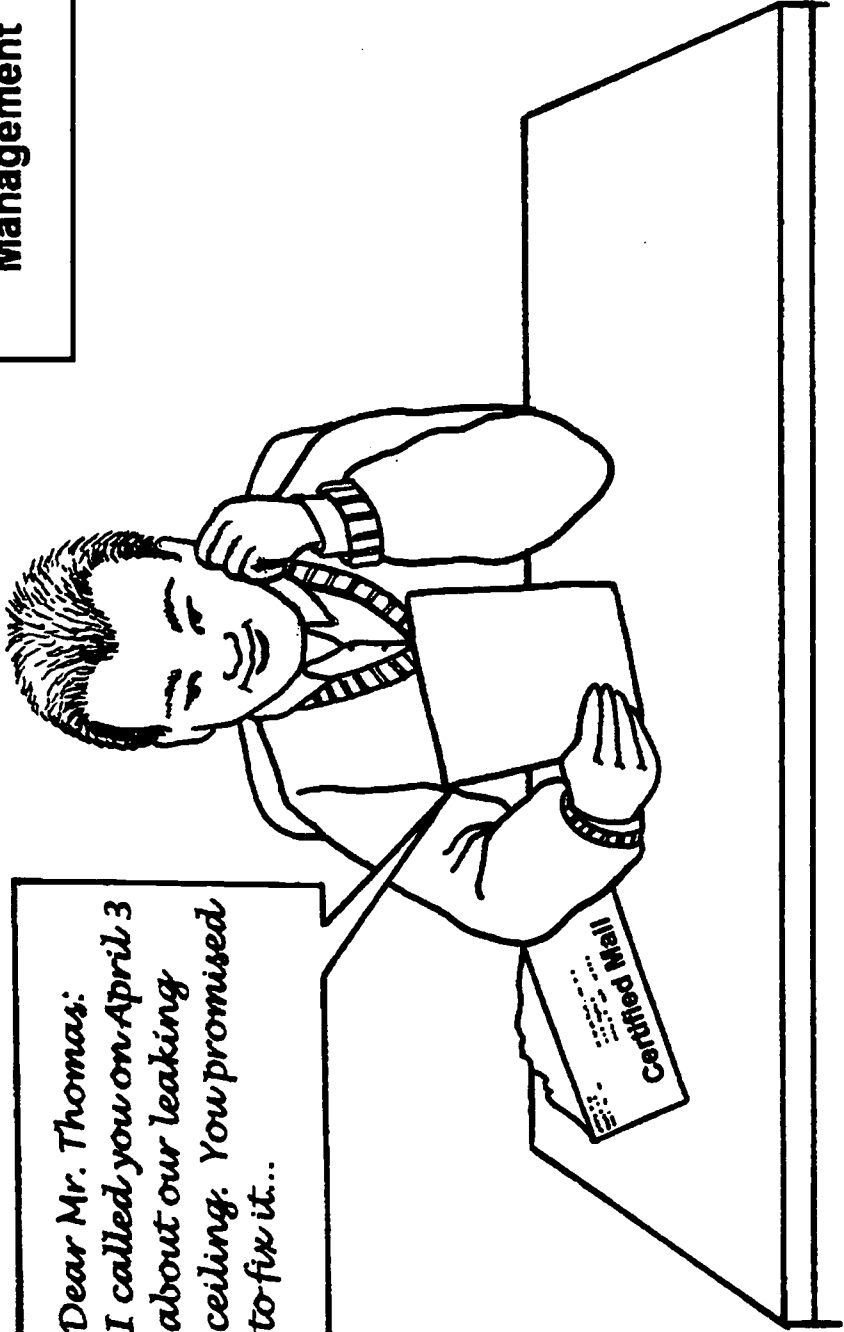

PICTURES FOR LANGUAGE EXPERIENCE continued

April 20

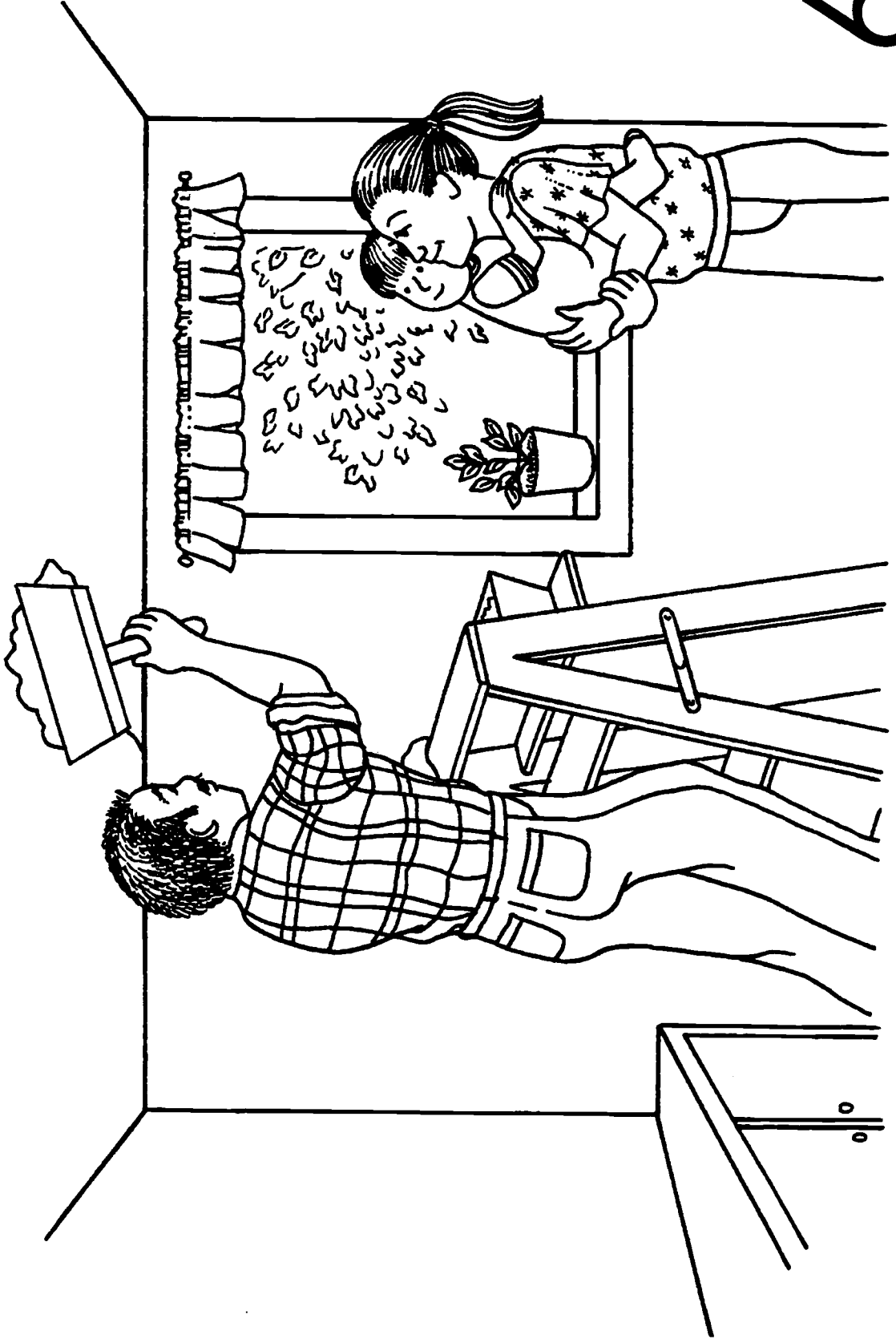

6

# PICTURES FOR GROUP STORY WRITING

*Directions:* Work in groups of three or four. Write a story about the pictures below and on the next page. Write one or more sentences for each picture. Then share your story with the class.

April 3



1

April 3



2

PICTURES FOR GROUP STORY WRITING continued

April 17

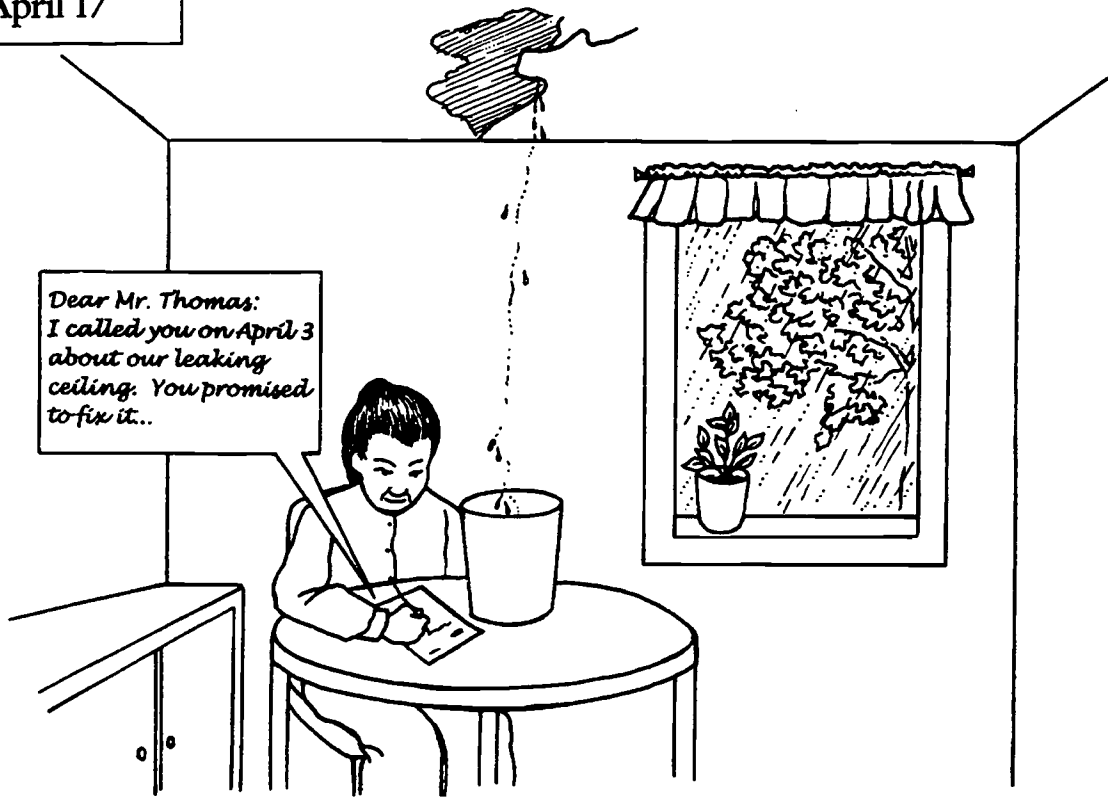

Dear Mr. Thomas:  
I called you on April 3  
about our leaking  
ceiling. You promised  
to fix it...

3

April 17

**U.S. POST OFFICE**

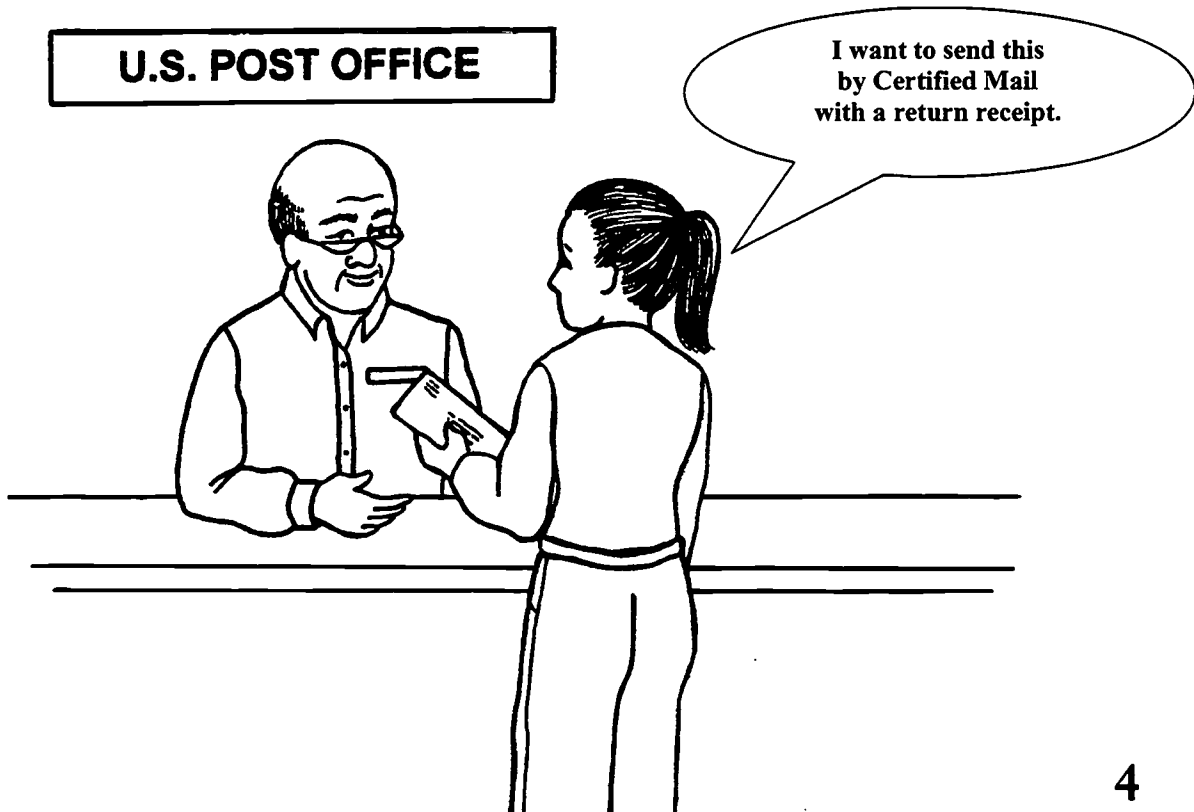

4

PICTURES FOR GROUP STORY WRITING continued

April 18



April 20



**READING PASSAGE: Pre-Reading Activity**

*Directions:* Think about housing in your community. Discuss the answers to the questions below with your classmates. (Optional: Write the answers to the questions.)

1. Do you rent a house or apartment? Or do you own your own house or condominium?
2. What responsibilities do tenants have? What responsibilities do landlords have?
3. What utilities do you pay for? If you rent, what utilities are included in your rent?
4. What can people do if they have trouble paying a utility bill?
5. Do you have a regular phone or a cell phone? What telephone services do you use? (Some telephone services are long distance, caller ID, and call waiting).
6. Does your neighborhood recycle? If so, how do you recycle things?

**Questions for Homeowners**

1. What can you do if you think your property taxes are too high?
2. Have you ever hired a contractor to work on your home? What happened?

## READING PASSAGE

Some people buy their own houses and are called homeowners. Other people rent houses or apartments, and pay rent each month to a landlord. People who rent are called tenants.

### LANDLORDS AND TENANTS

Landlords must provide a clean, safe apartment with adequate heat and drinking water. Tenants should sign a lease before renting an apartment. It is important to read the lease carefully. Tenants must:

- pay the rent on time
- keep the unit clean
- repair what they damage
- not paint or make other changes to the apartment without the landlord's permission
- give written notice before moving

Sometimes tenants have housing problems. For emergencies such as no water or heat, they should call the landlord right away. For repairs, they should also call the landlord. If the landlord does not respond after several days, tenants should contact the landlord by registered or certified mail. Tenants must pay the rent even if they are waiting for repairs.

For landlord problems, tenants can get help from:

- a lawyer or attorney (the Illinois Lawyer Referral Service can help find a lawyer)
- legal aid services if they are eligible for free legal services
- the Illinois Attorney General's Office
- the Illinois Department of Human Rights (for discrimination complaints)

### A TRUE STORY

Ewa Dobras rents an apartment on the top floor of a building. Last month, the roof started to leak. When it rained, water came through the ceiling of the kitchen. Ewa called her landlord to report the problem. He said he would come to fix it.

Ewa waited 2 weeks but no one came to fix the leak. She sent a letter to the landlord by certified mail to remind him about the problem. The landlord got the certified letter and called Ewa. Two days later, someone came to repair the roof and fix the leak.

### UTILITIES

Utilities are companies that provide natural gas, electricity, telephone service, and water. Homeowners must pay for these services. Tenants pay for telephone service and sometimes pay for other utilities, too.

Sometimes people have problems with utilities. One kind of problem is when the utility does not work. For example, the telephone may not work, or there may be no electricity in the house or apartment. Sometimes there are mistakes on utility bills. For problems with utility service or utility bills, people should call the utility's customer service number.

**READING PASSAGE continued**

Utility companies have meters for gas and electricity inside or outside of every house or apartment building. Utility workers read the meters and the companies send bills every month. Sometimes the cost is very high and people have trouble paying their bills. There are different payment plans to help people. Some payment plans are:

- a budget plan to make equal payments over 12 months
- the Low Income Home Energy Assistance Program (LIHEAP)
- the Salvation Army Sharing Program

For more information about payment plans, people can call the customer service department of their utility company. They can also check the utility's web site.

Phone bills have charges for local and long distance telephone service. Several different companies provide local and long distance service in Illinois. People should compare the rates of different companies to get the best price. Monthly phone bills show charges for phone services, including optional services like call waiting and caller ID.

**PROPERTY TAXES**

Homeowners must pay property taxes to the county. Taxes pay for schools, parks, libraries, and other services. Taxes are assessed every 3 years. But they may go up after 1 year if the local or state government asks for more money. When people have questions about their property taxes they can contact the assessor's office at the township or county.

**BUILDING PERMITS AND CONTRACTORS**

Homeowners who want to make additions or major changes to their property must apply for and pay for a building permit at city hall or the county office. The building permit gives permission to make changes. During and after the work, inspectors check the property.

People should be careful when they hire a contractor to make changes to their property. They should talk with friends and neighbors, check the contractor's references, and call the Better Business Bureau. People with serious complaints about a contractor should call the Better Business Bureau to report the complaint. If necessary, they should hire a lawyer.

**SOLICITORS**

Solicitors sell products and services to households. Sometimes solicitors put advertisements by people's doors or in the mail. Some solicitors call on the telephone to sell products and services. Some solicitors might also come to your door to sell things. People should be very careful before they buy anything from solicitors or give personal information to solicitors.

**GARBAGE COLLECTION AND RECYCLING**

Most communities have weekly garbage and recycling service. People must put their garbage and recyclables by the street or alley on the set day. Sometimes the city, village, or township provides residents with garbage cans. They may also provide special recycling containers for newspaper, glass, paper, aluminum, and plastic. The township office or city or village hall has information about garbage collection and recycling. If there is a problem with garbage collection, people can call their township office or city or village hall.



**READING PASSAGE: Vocabulary Activity 1-A**

*Directions:* Say these words after your teacher. Discuss the meaning of each word.  
(Optional: Write the meaning next to each word.)

1. homeowner
2. landlord
3. tenant
4. lease
5. repair (*noun or verb*)
6. damage (*noun or verb*)
7. written notice
8. registered mail/certified mail
9. lawyer/attorney
10. discrimination
11. leak (*noun or verb*)
12. utilities
13. customer service
14. meter
15. budget plan
16. local telephone service
17. long distance telephone service

## READING PASSAGE: Vocabulary Activity 1-B

*Directions:* Write the letter of the correct meaning next to each word.

- |   |   |
|---|---|
| ___ 1. utilities                        | a. paying your utility bill in equal payments over 12 months                        |
| ___ 2. homeowner                        | b. a person who practices law and represents people in court                        |
| ___ 3. customer service                 | c. telephone service for calling someone who lives in your community                |
| ___ 4. discrimination                   | d. you can call this number if you have a problem with your utility bill or service |
| ___ 5. repair                           | e. companies that provide natural gas, electricity, water, and telephone service    |
| ___ 6. budget plan                      | f. to break or harm something   |
| ___ 7. lease                            | g. telephone service for calling someone in another state or country                |
| ___ 8. tenant                           | h. a property owner who rents to tenants  |
| ___ 9. meter                            | i. a person who owns his or her own house   |
| ___ 10. local telephone service         | j. a hole or crack where water drips or gas escapes                                 |
| ___ 11. damage                          | k. a written contract between a tenant and a landlord                               |
| ___ 12. lawyer/attorney                 | l. a small machine that measures how much electricity, water, or gas is used        |
| ___ 13. long distance telephone service | m. a person who pays rent each month to a landlord                                  |
| ___ 14. registered or certified mail    | n. a letter to your landlord about your plans to move                               |
| ___ 15. leak                            | o. to fix something that is broken or damaged                                       |
| ___ 16. landlord                        | p. use this kind of mail delivery if you want a receipt                             |
| ___ 17. written notice                  | q. refusing to rent to someone because of race, sex, or religion                    |

---

**READING PASSAGE: Vocabulary Activity 2-A**

*Directions:* Say these words after your teacher. Discuss the meaning of each word.  
(Optional: Write the meaning next to each word.)

1. property taxes
2. assessor
3. building permit
4. contractors
5. references
6. Better Business Bureau
7. complaint
8. solicitors
9. garbage collection
10. recycling

Other new words:

299

## READING PASSAGE: Vocabulary Activity 2-B

*Directions:* Write the correct word or words in each sentence. Use the word bank for help. Each word can be used only once.

1. \_\_\_\_\_ is a community service to pick up trash and waste.
2. Homeowners pay \_\_\_\_\_ to the local government each year.
3. \_\_\_\_\_ sell products or services by telephone, mail, or door-to-door.
4. Homeowners must get a \_\_\_\_\_ from their city hall or township office to make major changes to their property.
5. Names of people who are happy with a contractor's work are \_\_\_\_\_.
6. A problem with a person or company is a \_\_\_\_\_.
7. You can call the \_\_\_\_\_ to find out if people have had problems with a business.
8. If you have questions about your property taxes, you can call the township or county \_\_\_\_\_.
9. Builders, painters, or roofers are kinds of \_\_\_\_\_.
10. Many communities have \_\_\_\_\_ programs to collect newspapers, bottles, or cans to use again.

### WORD BANK

references	assessor	property taxes	Better Business Bureau
solicitors	building permit	garbage collection	complaint
	recycling	contractors	

## READING PASSAGE: Comprehension Check

*Directions:* Take turns reading each sentence below with a partner. Decide if each sentence is TRUE or FALSE. Put an X under TRUE or FALSE.  
(Optional: Correct the false sentences.)

	TRUE	FALSE
1. Landlords must provide clean, safe apartments for tenants.	_____	_____
2. Tenants can paint their apartments without permission from the landlord.	_____	_____
3. Tenants don't have to pay rent if they are waiting for repairs.	_____	_____
4. If there is a problem in the apartment, tenants should call their landlord for repairs.	_____	_____
5. Utilities are natural gas, electric, telephone, and water services.	_____	_____
6. For problems with bills, people should call the utility's customer service number.	_____	_____
7. Utilities have different payment plans to help people pay bills.	_____	_____
8. Electric bills have charges for local and long distance telephone calls.	_____	_____
9. Homeowners must pay property taxes to the state.	_____	_____
10. Homeowners do not need building permits to build additions to their homes.	_____	_____
11. People should be careful when they hire a contractor or buy something from a solicitor.	_____	_____
12. The township office or village or city hall has information about garbage collection and recycling.	_____	_____

**DIALOGUE 1: Calling the Landlord About a Leak**

*Directions:* Listen to the dialogue. Then practice the dialogue with your teacher and classmates.

Ewa Dobras calls her landlord to report a leak in her ceiling.

Mr. Thomas: Hello. Thomas Property Management.

Ewa: Hello, Mr. Thomas. This is your tenant, Ewa Dobras in 3-B.

Mr. Thomas: Hi, Mrs. Dobras. What can I do for you?

Ewa: My kitchen ceiling is leaking. Water is coming in.

Mr. Thomas: Oh, that's not good. I'll send someone to fix it.

Ewa: When will he come?

Mr. Thomas: Well I don't know, but I'll try to send someone today.

Ewa: OK. Please call me when you know.

Mr. Thomas: OK, I will. Thank you for calling. Good-bye.

Ewa: Good-bye.

Mr. Thomas: Bye.

## DIALOGUE 2: Calling the Landlord About Insufficient Heat

*Directions:* Look at the chart below and listen to the dialogue. Practice the dialogue with your teacher and classmates. Then use the chart to practice different times.

TIME	MINIMUM TEMPERATURE*
6:30 a.m. - 10:30 p.m.	68 degrees
10:30 p.m. - 6:30 a.m.	65 degrees

Kartik Desai has a problem with the heat in his apartment. He calls his landlord to complain.

Mr. Patel: Hello. This is Ravi Patel.

Kartik: Hello, Mr. Patel. This is your tenant, Kartik Desai.

Mr. Patel: Yes, Mr. Desai. How can I help you?

Kartik: There is a problem with the heat in my apartment. It's too cold.

Mr. Patel: What's the temperature in your apartment?

Kartik: It's only 58 degrees.

Mr. Patel: Well, that's not so bad.

Kartik: But it's 9:00 a.m. The law says the temperature should be at least 68 degrees at this time.

Mr. Patel: Ok, Mr. Desai. I'll come over to adjust the thermostat.

Kartik: Thank you, Mr. Patel. I hope it will be warmer soon.

Mr. Patel: I will be there in a half hour.

Kartik: Thank you. Good-bye.

Mr. Patel: Good-bye.

**\*Note to the Teacher:** This dialogue is based on the Arlington Heights, Illinois Heat Ordinance mandating minimum temperatures year round as indicated in the table above. Other cities have similar laws.

**DIALOGUE 3: Reporting a Power Outage**

*Directions:* Listen to the dialogue. Then practice the dialogue with your teacher and classmates.

Twenty minutes ago, all the lights went out in Anna Rodríguez's house. She calls the electric company's customer service number for help.

Taped message: Thank you for calling PowerCo. For all billing inquiries, press 1. For all moving inquiries, press 2. To report a power outage, press 3. For all other inquiries, press 4.

Anna: (Presses 3)

Taped message: To report a power outage, press 1. To check the status of a power outage, press 2. To report a downed wire, press 3. For dim or flashing lights, or other power problems, press 4.

Anna: (Presses 1)

Clerk: Customer Service. How can I help you?

Anna: I have no electricity in my house.

Clerk: Do your neighbors have power?

Anna: Yes.

Clerk: How long has your power been out?

Anna: About 20 minutes.

Clerk: OK. Please give me your name, address, and a phone number where we can reach you.

Anna: My name is Anna Rodríguez. My address is 2801 North Major in Chicago. My cell phone number is (773) 555-5561.

Clerk: That's Anna Rodríguez. 2801 North Major. (773) 555-5561.

Anna: That's right.

Clerk: OK. We will send the first available crew to your home. They should be there this afternoon.

Anna: OK. Thank you.

Clerk: You're welcome. Goodbye.

Anna: Bye.



## DIALOGUE 3 continued

*Note to the Teacher:* The taped message on the previous page is representative of what the customer hears after calling a utility's customer service number. However, it is important for students to hear the actual recording from their local electric company. If possible, record the actual taped message from the local electric company using a telephone pick-up device (available for about \$5 at electronics stores). Adjust the dialogue to reflect the actual taped message, and have students listen to this recording in class.

**DIALOGUE 4: Calling the Phone Company About a Bill**

*Directions:* Listen to the dialogue. Then practice the dialogue with your teacher and classmates.

Maria Corelli has a problem with her phone bill. She calls the customer service number, listens to the recorded message, and presses “2” for the billing department.

**Billing Representative:** Ameritalk Billing Department. Please give me your telephone number beginning with the area code.

**Maria:** (847) 555-8320

**Representative:** What is the name on the account, please?

**Maria:** Maria Corelli. C-O-R-E-L-L-I

**Representative:** How can I help you, Ms. Corelli?

**Maria:** My bill shows a long distance call I didn't make.

**Representative:** What call is that?

**Maria:** It's the call to New York City on January 25 for 22 minutes.

**Representative:** Let me see... That's the number for New York County Hospital.

**Maria:** A hospital? I'm sure I didn't make that call.

**Representative:** Are you sure nobody else in your house made it?

**Maria:** Yes, I'm sure. Will you take it off my bill?

**Representative:** OK. Your new balance is \$55.97.

**Maria:** So I should pay \$55.97?

**Representative:** Yes.

**Maria:** OK. Thank you.

**Representative:** Thank you for calling Ameritalk. Good-bye.

**ACTION RESEARCH ACTIVITY: Housing and Utilities: Important Phone Numbers**

*Directions:* Complete this chart about housing. Use a telephone directory, your utility bills, or the Internet for help.

	NAME	TELEPHONE NUMBER
Landlord or Property Association		
Gas Company		
Electric Company		
Water Department		
Local Telephone Company		
Long Distance Telephone Company		
City/Village Hall or Township Office		

## WRITING ACTIVITY: A Letter to the Landlord

*Directions:* Ewa Dobras has a problem with a leak in her apartment. She sends a certified letter to her landlord about the problem. Read her letter.

Ewa Dobras  
357 Elm Street  
Harris, Illinois 56570

April 17, 2004

Dear Mr. Thomas:

There is a problem with my apartment. Every time it rains, the roof leaks. The water comes through my kitchen ceiling. There is a big crack in the ceiling and the drip is getting worse.

On April 3<sup>rd</sup>, I called you about our leaking ceiling. You promised to come to fix it. Please fix it as soon as possible. Thank you.

Sincerely,  
*Ewa Dobras*

Now write a letter to your landlord or property association to ask for help with a problem.

\_\_\_\_\_

\_\_\_\_\_ :

\_\_\_\_\_

\_\_\_\_\_

\_\_\_\_\_

\_\_\_\_\_

\_\_\_\_\_

\_\_\_\_\_

\_\_\_\_\_

\_\_\_\_\_

**PAIR ACTIVITY: Tenant and Landlord Responsibilities**

*Directions:* With a partner, look at the following list of responsibilities. Decide together if a landlord or tenant is responsible for each. Write **L** or **T** on the line. Then explain your answer to the class.

**L** = Landlord  
**T** = Tenant

- \_\_\_\_\_ 1. Makes sure the apartment meets the local health and housing laws.
- \_\_\_\_\_ 2. Pays the rent on time.
- \_\_\_\_\_ 3. Tells the landlord when there is a problem with the apartment (for example, a leaking toilet).
- \_\_\_\_\_ 4. Keeps the apartment clean and undamaged.
- \_\_\_\_\_ 5. Can charge a late fee for late rent.
- \_\_\_\_\_ 6. Pays to repair damage caused by the tenant (for example, the tenant's child breaks a window).
- \_\_\_\_\_ 7. Provides heat and clean drinking water.
- \_\_\_\_\_ 8. Gives written notice before moving.
- \_\_\_\_\_ 9. Decides the amount of rent and security deposit.
- \_\_\_\_\_ 10. Enters the apartment only with the tenant's permission except in an emergency.
- \_\_\_\_\_ 11. Pays to repair apartment damage not caused by the tenant (for example, a leaking ceiling).

## CULTURAL COMPARISON ACTIVITY: Housing

*Directions:* Think about housing in your native country and in the United States. Discuss the answers to the questions below with your classmates. (Optional: Write the information in the chart.)

	IN _____ (native country)	IN THE U.S.
1. Do most people rent or own their homes?		
2. What responsibilities do landlords have? What responsibilities do tenants have?		
3. What can tenants do if they have problems with their landlords?		
4. What utilities do people pay for? Who supplies utilities – private companies or the government?		
5. Do all people have telephones in their homes? Do many people have cell phones?		
6. Do people recycle? Which items? Who collects garbage and recyclable items?		
7. Do people pay property taxes? How does the government use money from property taxes?		

## EXPERIENTIAL ACTIVITIES

As a class, identify an important issue that affects the group. Some ideas are:

- Handling landlord problems
- Understanding a rental agreement/lease
- Starting utility service
- Reporting a gas leak
- Reporting a power outage
- Questioning a telephone charge
- Investigating utility payment plans
- Finding out the community recycling policy
- Appealing property taxes
- Getting a building permit
- Investigating a prospective contractor
- Reporting a bad contractor

Determine the best course of action from the suggestions below or have students generate their own plan of action. Choose an activity requiring a response by a local official, utility representative, or other appropriate authority. Also select an activity in which students have a vested interest so that they will follow through to a satisfactory conclusion.

1. Invite a guest speaker to talk about landlord/tenant issues of interest to your class. Possible speakers might be a representative from the local housing authority, a lawyer, or someone from the Illinois Department of Human Rights. Have students prepare questions in advance.  
*risk: low – medium*  
*language level: high beginning – advanced*
2. Have students contact the local housing authority by telephone to request that information on tenant/landlord rights and responsibilities be mailed to them.  
*risk: high*  
*language level: intermediate – advanced*
3. Have students contact the local housing authority by telephone to request a copy of the local ordinance regulating heat in apartments. (This information may also be available on the local government's web site).  
*risk: high*  
*language level: intermediate - advanced*
4. Visit a local senior citizen residence to learn about senior housing in the United States and to engage in conversation with the residents. Call ahead to arrange a tour. Have students prepare questions in advance to ask the staff and the residents.  
*risk: low – medium*  
*language level: all*
5. Invite a guest speaker to address mortgages and home buying. There may be a local program to assist low-income home buyers. Have students prepare questions in advance.  
*risk: low – medium*  
*language level: high beginning – advanced*

## EXPERIENTIAL ACTIVITIES continued

6. Invite a guest speaker from a local bank, credit union, or social service agency to provide information about how and why to establish a credit history. Have students prepare questions in advance.  
*risk: low – medium*  
*language level: high beginning – advanced*
  
7. Bring apartment ads from the community newspaper to class. After you explain the usual abbreviations, have students explain individual ads. More advanced students can actually call to inquire about apartments (including the cost of utilities) and report back to the class.  
*risk: low – high*  
*language level: all*
  
8. Have pairs or small groups of students go to the web site for the Better Business Bureau. Have them choose a business to enter and investigate. They may choose a business from an ad in the community newspaper, an ad received at their home from a solicitor, or information they received from a telephone solicitation. Have them present their findings to the class.  
*risk: low*  
*language level: intermediate – advanced*
  
9. Contact the city/village hall or township office for information about building permits. Find out what kinds of changes or improvements require permits, how to obtain them, and what they cost. (This information may also be available on the local government web site.)  
*risk: medium – high*  
*language level: intermediate – advanced*
  
10. Visit the local recycling facility. Call ahead to arrange a speaker and tour. Have students prepare questions in advance.  
*risk: low – medium*  
*language level: all*





*U.S. Department of Education  
Office of Educational Research and Improvement (OERI)  
National Library of Education (NLE)  
Educational Resources Information Center (ERIC)*



## **NOTICE**

### **Reproduction Basis**

This document is covered by a signed "Reproduction Release (Blanket)" form (on file within the ERIC system), encompassing all or classes of documents from its source organization and, therefore, does not require a "Specific Document" Release form.

This document is Federally-funded, or carries its own permission to reproduce, or is otherwise in the public domain and, therefore, may be reproduced by ERIC without a signed Reproduction Release form (either "Specific Document" or "Blanket").