

DOCUMENT RESUME

ED 481 152

TM 035 234

TITLE North Carolina State Testing Results 2000-01. North Carolina Grade 3 Pretest, End-of-Grade, High School Comprehensive and End-of-Course Multiple Choice Tests. Reporting on the State and 117 Public School Systems and 87 Charter Schools. "The Green Book."

INSTITUTION North Carolina State Dept. of Public Instruction, Raleigh. Div. of Accountability Services/Research.

PUB DATE 2002-04-00

NOTE 256p.; For preliminary state-level data that preceded this report, see TM 033 693.

PUB TYPE Numerical/Quantitative Data (110) -- Reports - Descriptive (141)

EDRS PRICE EDRS Price MF01/PC11 Plus Postage.

DESCRIPTORS *Academic Standards; *Achievement Tests; *Charter Schools; Elementary Secondary Education; Language Arts; Mathematics; *State Programs; *Testing Programs

IDENTIFIERS *North Carolina; North Carolina Competency Tests; North Carolina End of Course Testing Program

ABSTRACT

This document contains student and school system performance data on North Carolina's grade 3 pretest, end-of-grade tests, high school comprehensive test, and end-of-course tests. Results were generated from tests administered statewide in the 2000-2001 school year. The grade 3 pretest was administered in reading and mathematics, and the end-of-grade tests were given in reading and mathematics in grades 3 through 8. The high school comprehensive test measured reading and mathematics in grade 10, and the end-of-course tests were administered in high school subject areas. State- and system-level results in this document may be used to make grade-to-grade, subject-to-subject, and year-to-year comparisons. In addition to the summary statistics, the document contains disaggregated test results for subgroups for the multiple choice grade 3 pretest, the end-of-grade tests, the high school comprehensive test, and the end-of-course tests. Test results show that 71.1% of students entering third grade scores at or above Achievement Level III on the reading pretest, while 79.2% scored at or about Achievement Level III on the mathematics pretest. Data from 2000-2001 indicate that the percentage of students in grades 3 through 8 performing at Achievement Level III and above continued to grow in both reading and mathematics, from 53.0% in 1992-1993 to 71.7% in 2000-2001. The percent of students achieving at Achievement Level III or above declined slightly for the high school comprehensive test, and comparison figures across the years are not generally available for the end-of-course tests. (Contains 119 tables and 64 figures.) (SLD)

Reproductions supplied by EDRS are the best that can be made
from the original document.

ED 481 152

TM TMTR 0225

The North Carolina State Testing Results

2000-01

PERMISSION TO REPRODUCE AND DISSEMINATE THIS MATERIAL HAS BEEN GRANTED BY

F. Bradburn

TO THE EDUCATIONAL RESOURCES INFORMATION CENTER (ERIC)

North Carolina Grade 3 Pretest End-of-Grade

High School Comprehensive and End-of-Course Multiple-Choice Tests

Reporting on the state and 117 public school systems and 87 charter schools

TM035234

Published April 2002

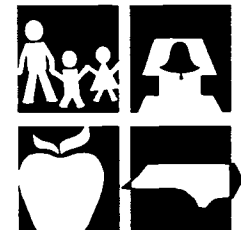
U.S. DEPARTMENT OF EDUCATION Office of Educational Research and Improvement EDUCATIONAL RESOURCES INFORMATION CENTER (ERIC)

- This document has been reproduced as received from the person or organization originating it.
- Minor changes have been made to improve reproduction quality.
- Points of view or opinions stated in this document do not necessarily represent official OERI position or policy.

“The Green Book”

Public Schools of North Carolina State Board of Education Department of Public Instruction Office of Instructional and Accountability Services Division of Accountability Services / Testing Section 301 North Wilmington Street Raleigh, North Carolina 27601-2825

w.ncpublicschools.org/accountability/testing



BEST COPY AVAILABLE

2

State Board of Education

Phillip J. Kirk, Jr.
Chairman
Raleigh

Jane P. Norwood
Vice Chair
Charlotte

Kathy A. Taft
Greenville

Michelle Howard-Vital
Wilmington

Edgar D. Murphy
Durham

Evelyn B. Monroe
West End

Maria T. Palmer
Chapel Hill

Ronald E. Deal
Hickory

Wayne McDevitt
Asheville

Zoe W. Locklear
Pembroke

Patricia Willoughby
Raleigh

Beverly Perdue
Lieutenant Governor
New Bern

Richard Moore
State Treasurer
Kittrell

NC Department of Public Instruction

Michael E. Ward, State Superintendent

301 North Wilmington Street • Raleigh, North Carolina 27601-2825 • Web site: www.ncpublicschools.org

The 2000-01 North Carolina

State Testing Results

North Carolina
Grade 3 Pretest, End-of-Grade,
High School Comprehensive
and End-of-Course
Multiple-Choice Tests

April 2002

Public Schools of North Carolina
State Board of Education
Department of Public Instruction
Office of Instructional and Accountability Services
Division of Accountability Services / Testing Section
301 North Wilmington Street
Raleigh, North Carolina 27601-2825

Website: www.ncpublicschools.org/accountability/testing

Acknowledgments

The development of a comprehensive document that contains student and school system performance data on the grade 3 pretest, end-of-grade tests, high school comprehensive test and end-of-course tests, requires the skill and effort of many individuals. At the North Carolina Department of Public Instruction, we thank Mildred Bazemore, Monica Geary, Hope Tesh-Blum and Ken Barbour for assistance in preparing all phases of this publication as well as George Stubblefield for providing the statistical data. At the Center for Urban Affairs and Community Services, North Carolina State University, Technical Outreach for Public Schools (TOPS) Analysis Group, we thank Alissa Bernholc, Erin Lyjak, Betty Marsh and Anthony Wells for creating the tables and figures, and Karin Wolfe for verifying data accuracy as well as report editing and production.

Abstract

The 2000-01 North Carolina State Testing Results Grade 3 Pretest, End-of-Grade, High School Comprehensive, and End-of Course Multiple-Choice Tests

Background

- Results included in this document were generated from tests administered statewide during the 2000-01 school year. The local schools or school systems scanned the students' answer sheets with software developed by the North Carolina Department of Public Instruction. The data were sent to the North Carolina Department of Public Instruction where it was concatenated. All summary data reported in this report are calculated from any data that the school systems sent to the North Carolina Department of Public Instruction by August 2001. The data are limited to public and charter schools.
- Note: The State Board of Education approved revisions to the *North Carolina Mathematics Standard Course of Study* at the May 1998 monthly meeting. Effective with the 2000-01 school year, North Carolina mathematics tests measure the goals and objectives from the 1998 curriculum. Prior to the 2000-01 school year, the most recent revisions of the state mathematics curriculum occurred in 1989 (grades K-8) and 1992 (grades 9-12). Due to the 1998 revisions in the mathematics curriculum and the revised tests, the mathematics curriculum and the revised tests, the mathematics developmental scale scores were revised for the grade 3 pretest and end-of-grade tests. The revised mathematics developmental scale scores adopted by the State Board of Education in September 2001 are used to report 2000-01 student performance in this publication. The old and revised mathematics scales are not to be compared without using the conversion tables published September 2001. The end-of-course mathematics tests (Algebra I, Algebra II and Geometry) retained the scale previously used.
- Changes in Reporting. Test information is not included in this report this year. Information about the North Carolina Testing Program can be found at the NCDPI/Testing website at:
www.ncpublicschools.org/accountability/testing
In addition, LEA data is not included in this report this year. Test data by LEA can be found at the following website:
www.ncpublicschools.org/vol2/rsds
- Grade 3 Pretest. Initially implemented during the 1996-97 school year, the North Carolina Pretest-Grade 3 is a multiple-choice reading and mathematics test administered to students during the first three weeks of the third grade. Scores on this test are used to measure student growth in performance when compared to the end-of-grade test

results at the end of the third grade year in the areas of reading and mathematics. The pretest at grade 3 measures the knowledge and skills specified for grade 2 from the reading and mathematics goals and objectives of the North Carolina *Standard Course of Study*. The pretest was administered to approximately 102,000 students during the first three weeks of the 2000-01 school year.

- End-of-Grade Tests. Beginning in the 1992-93 school year, the North Carolina State Board of Education authorized administration of North Carolina-developed end-of-grade tests. These multiple-choice tests in reading and mathematics are aligned with the competencies specified in the North Carolina *Standard Course of Study*. These state-normed curriculum-based tests were administered to approximately 590,000 students in grades 3 through 8 during the final three weeks of the 2000-01 school year.
- High School Comprehensive Test. The North Carolina High School Comprehensive Test in reading and mathematics was first administered in 1997-98 to all students in grade 10. The multiple-choice test assesses the English language arts and mathematics competencies the typical student should master by the end of grade 10. The test is used to measure student growth in achievement in reading and mathematics since completion of grade 8. The test was administered to more than 80,000 students in the final three weeks of April 2001 for the purpose of school accountability.
- Multiple-Choice End-of-Course Tests. End-of-course tests measure achievement on curricular goals and objectives with an emphasis on higher-order thinking skills. These multiple-choice tests were administered in: Algebra I; Algebra II; Biology; Chemistry; Economic, Legal, and Political Systems (ELPS); English I; Geometry; Physical Science; Physics and U. S. History to approximately 647,000 students within the final two weeks (or the equivalent for the non-traditional schedules) of the 2000-01 school year.

Grade 3 Pretest Findings

- Achievement Level III or Above. Results show that 71.1 percent of students entering third grade scored at or above Achievement Level III on the *reading* pretest while 79.2 percent scored at or above Achievement Level III on the *mathematics* pretest. The percent of students scoring at or above Achievement Level III on the grade 3 *reading* pretest in 2000-01 increased 1.3 percentage points from 1999-00. The percent of students scoring at or above Achievement Level III on the grade 3 *mathematics* pretest in 2000-01 increased 2.3 percentage points from 1999-00. The *mathematics* component of the pretest was revised for the 2000-01 school year to reflect revisions in the curriculum.
- Mean Scale Scores. The grade 3 *reading* pretest mean scale score

increased from 138.7 in 1999-2000 to 138.9 in 2000-01. The grade 3 *mathematics* pretest mean scale score for 2000-01 was placed on a revised developmental scale. The revised grade 3 pretest scale runs from 211 to 260.

- ***Gender***. A higher percentage of females than males, in their respective ethnic categories, performed at Achievement Level III or above in the grade 3 *reading* and *mathematics* pretests.
- ***Ethnicity***. Disparities in performance among subgroups were noted in the results. In *reading*, the Black (58.1%), Hispanic (58.4%) and American Indian (60.3%) subgroups had lower percentages performing at Achievement Level III or above than the Multi-Racial (73.1%), Asian (75.8%) and White (78.4%) subgroups in the data. In *mathematics*, the Black (65.2%), American Indian (68.3%), and Hispanic (72.0%) subgroups had lower percentages performing at Achievement Level III or above than the Multi-Racial (80.1%), Asian (85.5%), and White (86.5%) subgroups. In comparison to 1999-00, all subgroups have higher percentages of students performing at Achievement Level III or above in *reading* and *mathematics* in 2000-01.

End-of-Grade Test

Findings

- ***Achievement Level III or Above***. Data from 2000-01 indicate the percentage of students in grades 3-8 performing at Achievement Level III and above in both *reading* and *mathematics* continues to grow, from 53.0 percent in 1992-93 to 71.7 percent in 2000-01.
- ***Mean Scale Scores***. In these data, mean scale scores for *reading* increased at least slightly from 1999-00 to 2000-01 at every grade level except grade 7. Mean scale scores for *mathematics* increased at every grade level. On average, student performance increased on end-of-grade testing every year. The developmental scale for *mathematics* was revised effective with the 2000-01 school year to a scale of 218 to 310 across grades 3 through 8.
- ***Gender***. In 2000-01, a higher percentage of females (74.3%) than males (69.1%) scored at or above Achievement Level III in both *reading* and *mathematics* in grades 3-8 combined. Although the number of females and males performing at Achievement Level III continues to rise across the years, the performance of females consistently exceeds that of males.
- ***Ethnicity***. Disparities in performance were present among the ethnic subgroups in 2000-01. The Black (52.0%), Hispanic (58.7%) and American Indian (60.0%) subgroups had lower percentages performing at Achievement Level III or above in both *reading* and *mathematics* in grades 3-8 combined than the Multi-Racial (74.7%), Asian (78.6%) and White (82.0%) subgroups in these data. Each subgroup, however,

High School Comprehensive Test Findings

had a higher percentage of students scoring at Achievement Level III or above than in 1999-00.

- *Students with Limited English Proficiency*. In grades 3-8 combined, 40.1 percent of students identified as limited English proficient scored at Achievement Level III or above in *reading* and *mathematics* in 2000-01 in comparison to 35.2 percent in 1999-00.
- *Students with Disabilities*. At grades 3-8 combined, 37.0 percent of students with disabilities performed at or above Achievement Level III in *reading* and *mathematics*. In 1999-00, 33.0 percent of students with disabilities met this standard.
- *Title I and Migrant*. In grades 3-8 combined, 63.6 percent of students who performed at Achievement Level III or above in both *reading* and *mathematics* are in a Schoolwide Title I program. For those receiving services in a Migrant program, 54.0 percent of students in grades 3-8 performed at Achievement Level III or above in both *reading* and *mathematics*.
- *Achievement Level III or Above*. The results show that 61.6 percent of students taking the high school comprehensive test scored at or above Achievement Level III in *reading* while 66.8 percent scored at or above Achievement Level III in *mathematics*. The percent of students scoring at or above Achievement Level III on the high school comprehensive test in *reading* in 2000-01 slightly decreased by 0.1 percentage points from 1999-00. The percent of students scoring at or above Achievement Level III on the high school comprehensive test in *mathematics* in 2000-01 increased 2.1 percentage points from 1999-00.
- *Mean Scale Scores*. The high school comprehensive mean scale score in *reading* remained the same at 164.9 in both 1999-00 and 2000-01. The high school comprehensive mean scale score in *mathematics* increased from 177.5 in 1999-00 to 178.4 in 2000-01.
- *Gender*. A higher percentage of females than males, in their respective ethnic categories, performed at Achievement Level III or above in *reading* and *mathematics* in these data. The percent of females at or above Achievement Level III in *reading* remained at 66.8 in 2000-01. The percent of males at or above Achievement Level III in *reading* slightly decreased from 56.6 in 1999-00 to 56.3 in 2000-01. The percent of females at or above Achievement Level III in *mathematics* increased from 66.2 in 1999-00 to 68.3 in 2000-01. The percent of males at or above Achievement Level III in *mathematics* increased from 63.1 in 1999-00 to 65.2 in 2000-01.
- *Ethnicity*. Disparities in performance among the ethnic subgroups were noted in the results. In *reading*, the Black (40.0%), American

Indian (43.9%) and Hispanic (47.9%) subgroups had lower percentages performing at or above Achievement Level III than the Asian (63.4%), Multi-Racial (66.3%) and White (71.2%) subgroups. In *mathematics*, the Black (44.2%), American Indian (52.8%) and Hispanic (54.6%) subgroups had lower percentages performing at or above Achievement Level III than the Multi-Racial (68.2%), White (76.4%) and Asian (76.5%) subgroups in these data. In comparison to 1999-00, the performance of all subgroups increased with the exception of the Hispanic, Multi-Racial and White subgroups' performance in *reading*. All ethnic subgroups had an increase in performance in *mathematics*.

- *Students with Limited English Proficiency*. These results show that 0.9 percent of all students taking the high school comprehensive test were identified as limited English proficiency in 2000-01 as compared to 0.8 percent in 1999-00. The approximate percent of exclusions from taking the test, 1.2 percent, did not change from 1999-00. Approximately 21.8 percent of students identified as limited English proficient in 2000-01 scored at or above Achievement Level III *reading*, which was a decrease of 2.8 percent from 1999-00. Approximately 38.6 percent of these students scored at or above Achievement Level III in *mathematics*, a decrease of 2.1 percent from 1999-00.
- *Students with Disabilities*. In 2000-01, 21.4 percent of students with disabilities performed at or above Achievement Level III in *reading* as compared to 21.3 percent in 1999-00. There was also an increase in the percent of students with disabilities who met this standard for *mathematics* from 26.2 percent in 1999-00 to 27.3 percent in 2000-01.
- *Title I and Migrant*. Among the students participating in a Schoolwide Title I program, 37.7 percent performed at Achievement Level III or above in *reading* and 39.9 performed at Achievement Level III or above in *mathematics*. For those students receiving services in a Migrant program, 32.3 percent performed at Achievement Level III or above in *reading* and 40.9 percent performed at Achievement Level III or above in *mathematics*.

End-of-Course Test Findings

- The statewide administration of end-of-course tests in the areas of Algebra II, Chemistry, Geometry, Physical Science and Physics was mandated for the 1998-99 and 1999-00 school years, however, comparisons across years (for the 1995-96, 1996-97 and 1997-98 school years) are not available. During those years the tests in Algebra II, Chemistry, Geometry, Physical Science and Physics were used as a local (LEA) option.
- *Achievement Level III or Above*. From 1999-00 to 2000-01, student performance at or above Achievement Level III increased in nine of

the ten end-of-course tests. The comparison of results from 1999-00 to 2000-01 is as follows: Algebra I increased from 68.9% to 76.0%; Algebra II increased from 62.7% to 73.0%; Biology increased from 57.6% to 61.0%; Chemistry increased from 62.0% to 65.5%; Economic, Legal, and Political Systems increased from 67.3% to 70.0%; English I slightly decreased from 68.4% to 68.3%; Geometry increased from 60.0% to 63.9%; Physical Science increased from 57.1% to 59.9%; Physics increased from 72.9% to 74.4% and U.S. History increased from 46.9% to 50.5%.

- **Mean Scale Scores.** The 2000-01 end-of-course mean scale scores are: Algebra I (61.1); Algebra II (63.8); Biology (56.8); Chemistry (58.9); Economic, Legal, and Political Systems (55.7); English I (55.4); Geometry (59.8); Physical Science (55.5); Physics (57.0) and U.S. History (56.6). All mean scale scores increased from 1999-00 to 2000-01 with the exception of English I which remained the same as in 1999-00 at 55.4 and Physics which had a slight decrease from 57.1 in 1999-00 to 57.0 in 2000-01.
- **Gender.** A higher percentage of females than males performed at Achievement Level III or above on the end-of-course tests on Algebra I and English I in these data. More males than females scored at or above Achievement Level III on the Algebra II; Biology; Chemistry; Economic, Legal, and Political Systems; Geometry; Physical Science; Physics and U.S. History end-of-course tests. Percent at or above Achievement Level III performance on end-of-course tests are as follows: Algebra I (male, 74.7%; female, 77.3%); Algebra II (male 73.5%; female, 72.5%); Biology (male 62.7%; female, 59.2%); Chemistry (male, 68.8%; female, 62.8%); Economic, Legal, and Political Systems; (male, 71.0%; female 69.1%); English I (male, 63.5%; female, 73.2%); Geometry (male, 67.8%; female, 60.6%); Physical Science (male, 62.3%; female, 57.5%); Physics (male, 80.3%; female, 67.1%); U.S. History (male, 54.5%; female, 46.7%).
- **Ethnicity.** The trend showing disparities in performance among the ethnic subgroups continued in 2000-01. However, all subgroups had an increase in performance from 1999-00 to 2000-01 in all EOC subjects with the exception of English I, Geometry and Physics. Percent at or above Achievement Level III performance on end-of-course tests are as follows: Algebra I (American Indian, 67.6%; Asian, 82.5%; Black, 57.1%; Hispanic, 70.0%; Multi-Racial, 76.0%; and White, 84.6%); Algebra II (American Indian, 55.6%; Asian, 82.2%; Black, 52.5%; Hispanic, 67.7%; Multi-Racial, 74.5%; and White, 79.6%); Biology (American Indian, 46.3%; Asian, 63.7%; Black, 34.9%; Hispanic, 47.2%; Multi-Racial, 68.1%; and White, 73.1%); Chemistry (American Indian, 44.6%; Asian, 68.8%; Black, 41.8%; Hispanic, 57.8%; Multi-Racial, 69.8%; and White, 72.4%); Economic,

Legal, and Political Systems (American Indian, 54.5%; Asian, 70.5%; Black, 48.9%; Hispanic, 56.6%; Multi-Racial, 71.3%; and White, 80.0%); English I (American Indian, 50.8%; Asian, 72.0%; Black, 49.0%; Hispanic, 52.6%; Multi-Racial, 69.3%; and White, 78.0%); Geometry (American Indian, 45.4%; Asian, 71.6%; Black, 34.6%; Hispanic, 50.3%; Multi-Racial, 64.6%; and White, 75.0%); Physical Science (American Indian, 40.5%; Asian, 65.0%; Black, 37.1%; Hispanic, 44.3%; Multi-Racial, 61.5%; and White, 72.0%); Physics (American Indian, 46.3%; Asian, 78.8%; Black, 43.9%; Hispanic, 64.0%; Multi-Racial, 78.4%; and White, 79.8%); and U.S. History (American Indian, 34.7%; Asian, 56.2%; Black, 28.4%; Hispanic, 40.7%; Multi-Racial, 54.5%; and White, 59.8%).

- ***Students with Limited English Proficiency.*** Among students meeting the limited English proficiency requirement in 2000-01, the highest average performance was in Algebra II, with 69.4 percent scoring at Achievement Level III or above. Performance on the other end-of-course tests are as follows: Algebra I (61.3%); Physics (54.1%); Geometry (44.5%); Chemistry (46.0%); Economic, Legal, and Political Systems (29.1%); English I (28.8%); Physical Science (26.5%); Biology (21.8%) and U.S. History (19.1%). The percent of students classified as limited English proficient on end-of-course tests in 2000-01 ranged from 0.3 percent in Chemistry and Physics, to 1.0 percent in English I.
- ***Students with Disabilities.*** The results show that students with disabilities had an increase in performance from 1999-00 to 2000-01 in all end-of-course tests with the exception of English I. The comparison of percent of students with disabilities at or above Achievement Level III from 1999-00 to 2000-01 is as follows: Algebra I increased from 37.9% to 47.6%; Algebra II increased from 49.0% to 62.4%; Biology increased from 26.3% to 31.4%; Chemistry increased from 51.8% to 58.3%; Economic, Legal, and Political Systems increased from 33.2% to 36.7%; English I slightly decreased from 26.2% to 25.9%; Geometry increased from 44.6% to 48.1%; Physical Science increased from 30.0% to 31.4%; Physics increased from 70.4% to 74.6% and U.S. History increased from 21.1% to 24.4%.
- ***Title I.*** Among the students participating in a Schoolwide Title I program, a higher percentage of students scored at or above Achievement Level III in Algebra I (67.7%); Physics (46.6%) and Economic, Legal, and Political Systems (46.5%) than in Algebra II (42.1%), English I (43.8%), Chemistry (35.7%), Physical Science (33.0%) and Biology (27.2%). Students enrolled in U.S. History (24.2%) and Geometry (23.5%) had the lowest percentages at or above Achievement Level III.

- ***Migrant.*** These data show that of the students receiving services in a Migrant program, a higher percentage of these students scored at or above Achievement Level III in Algebra I (75.7%) and Economic, Legal, and Political Systems (52.9%). Performance in the other reported end-of-course subjects are as follows: Physical Science (47.8%), Geometry (43.3%), English I (38.0%), Biology (36.4%) and U.S. History (13.9%). Algebra II, Chemistry and Physics cannot be reported because fewer than thirty students were included.

**The 2000-01 North Carolina State Testing Results
Grade 3 Pretest, End-of-Grade,
High School Comprehensive and End-of Course
Multiple-Choice Tests**

Table of Contents

List of Tables.....	i
List of Figures.....	viii
Introduction	1
Introductory Figures.....	3
Grade 3 Pretest Multiple-Choice Results.....	23
Statewide Summary.....	25
Goal Summaries	37
Frequency Distribution	38
End-of-Grade Multiple-Choice Test Results	41
Statewide Summary.....	43
Goal Summaries.....	114
Frequency Distribution	120
Student Performance by LEA	132
High School Comprehensive Multiple-Choice Test Results.....	145
Statewide Summary.....	147
Goal Summaries.....	162
Frequency Distribution	163
End-of-Course Multiple-Choice Test Results.....	169
Statewide Summary.....	171
Goal Summaries.....	205
Frequency Distribution	221
Appendix	237
List of Charter Schools	239

List of Tables

Grade 3 Pretest Multiple-Choice Test Results

Table 1. 1996-97 to 2000-01 Grade 3 Pretest Multiple-Choice Results, Statewide Summary, Reading and Mathematics	25
Table 2. 1996-97 to 2000-01 Grade 3 Pretest Multiple-Choice Results, Percent of Students at Each Achievement Level by Gender and Ethnicity, Reading.....	26
Table 3. 1996-97 to 2000-01 Grade 3 Pretest Multiple-Choice Results, Percent of Students at Each Achievement Level by Gender and Ethnicity, Mathematics	27
Table 4. 2000-01 Grade 3 Pretest Multiple-Choice Results, Performance of Academically Gifted, Exceptional, Limited English Proficient and Title I Students	34
Table 5. 2000-01 Grade 3 Pretest Multiple-Choice Results, Performance of Students Using Accommodations.....	35
Table 6. 2000-01 Grade 3 Pretest Multiple-Choice Results, Participation of Students with Special Needs**	36
Table 7. 2000-01 Grade 3 Pretest Goal Summary Report.....	37
Table 8. 2000-01 Grade 3 Pretest Distribution of Scale Scores–Reading.....	38
Table 9. 2000-01 Grade 3 Pretest Distribution of Scale Scores–Mathematics	39

End-of-Grade Test Results

Table 1. 2000-01 End-of-Grade Multiple-Choice Test Results, Statewide Summary, Reading and Mathematics	43
Table 2. 1992-93 to 2000-01 End-of-Grade Multiple-Choice Test Results, Statewide Summary of Student Performance, Reading	44
Table 3. 1992-93 to 2000-01 End-of-Grade Multiple-Choice Test Results, Statewide Summary of Student Performance, Mathematics*	45
Table 4. 1992-93 to 2000-01 End-of-Grade Multiple-Choice Test Results, Statewide Summary of Student Performance, Reading	46
Table 5. 1992-93 to 2000-01 End-of-Grade Multiple-Choice Test Results, Statewide Summary of Student Performance, Mathematics*	48

Table 6. 2000-01 End-of-Grade Multiple-Choice Tests, Achievement Level Ranges by Subject and Grade	50
Table 7. 1992-93 to 2000-01 End-of-Grade Multiple-Choice Test Results, Percent of Students at Each Achievement Level by Grade, Reading.....	51
Table 8. 1992-93 to 2000-01 End-of-Grade Multiple-Choice Test Results, Percent of Students at Each Achievement Level by Grade, Mathematics*	52
Table 9. 2000-01 End-of-Grade Multiple-Choice Test Results, Percent of Students by Achievement Level, by Grade and Ethnicity	85
Table 10. 2000-01 End-of-Grade Multiple-Choice Test Results, Percent of Students by Achievement Level, by Grade and Gender.....	86
Table 11. 2000-01 End-of-Grade Multiple-Choice Test Results, Performance of Academically Gifted, Exceptional, Limited English Proficient and Title I Students, Grades 3-8	87
Table 12. 2000-01 End-of-Grade Multiple-Choice Test Results, Performance of Students Using Accommodations, Grades 3-8.....	91
Table 13. 2000-01 End-of-Grade Multiple-Choice Test Results, Participation of Students with Special Needs**	95
Table 14. 2000-01 End-of-Grade Multiple-Choice Test Results, Characteristics and Performance of Grade 3 Students	102
Table 15. 2000-01 End-of-Grade Multiple-Choice Test Results, Characteristics and Performance of Grade 4 Students.....	104
Table 16. 2000-01 End-of-Grade Multiple-Choice Test Results, Characteristics and Performance of Grade 5 Students	106
Table 17. 2000-01 End-of-Grade Multiple-Choice Test Results, Characteristics and Performance of Grade 6 Students.....	108
Table 18. 2000-01 End-of-Grade Multiple-Choice Test Results, Characteristics and Performance of Grade 7 Students.....	110
Table 19. 2000-01 End-of-Grade Multiple-Choice Test Results, Characteristics and Performance of Grade 8 Students.....	112
Table 20. 2000-01 End-of-Grade Grade 3 Goal Summary Report.....	114
Table 21. 2000-01 End-of-Grade Grade 4 Goal Summary Report.....	115

Table 22. 2000-01 End-of-Grade Grade 5 Goal Summary Report.....	116
Table 23. 2000-01 End-of-Grade Grade 6 Goal Summary Report.....	117
Table 24. 2000-01 End-of-Grade Grade 7 Goal Summary Report.....	118
Table 25. 2000-01 End-of-Grade Grade 8 Goal Summary Report.....	119
Table 26. 2000-01 End-of-Grade Distribution of Scale Scores, Grade 3 Reading	120
Table 27. 2000-01 End-of-Grade Distribution of Scale Scores, Grade 3 Mathematics	121
Table 28. 2000-01 End-of-Grade Distribution of Scale Scores, Grade 4 Reading	122
Table 29. 2000-01 End-of-Grade Distribution of Scale Scores, Grade 4 Mathematics	123
Table 30. 2000-01 End-of-Grade Distribution of Scale Scores, Grade 5 Reading	124
Table 31. 2000-01 End-of-Grade Distribution of Scale Scores, Grade 5 Mathematics	125
Table 32. 2000-01 End-of-Grade Distribution of Scale Scores, Grade 6 Reading	126
Table 33. 2000-01 End-of-Grade Distribution of Scale Scores, Grade 6 Mathematics	127
Table 34. 2000-01 End-of-Grade Distribution of Scale Scores, Grade 7 Reading	128
Table 35. 2000-01 End-of-Grade Distribution of Scale Scores, Grade 7 Mathematics	129
Table 36. 2000-01 End-of-Grade Distribution of Scale Scores, Grade 8 Reading	130
Table 37. 2000-01 End-of-Grade Distribution of Scale Scores, Grade 8 Mathematics	131
Table 38. 2000-01 End-of-Grade Multiple-Choice Test Results, Grade 3 Mean Scale Score by LEA – Reading	132
Table 39. 2000-01 End-of-Grade Multiple-Choice Test Results, Grade 3 Mean Scale Score by LEA – Mathematics	133
Table 40. 2000-01 End-of-Grade Multiple-Choice Test Results, Grade 4 Mean Scale Score by LEA – Reading	134
Table 41. 2000-01 End-of-Grade Multiple-Choice Test Results, Grade 4 Mean Scale Score by LEA – Mathematics	135
Table 42. 2000-01 End-of-Grade Multiple-Choice Test Results, Grade 5 Mean Scale Score by LEA – Reading	136

Table 43. 2000-01 End-of-Grade Multiple-Choice Test Results, Grade 5 Mean Scale Score by LEA – Mathematics	137
Table 44. 2000-01 End-of-Grade Multiple-Choice Test Results, Grade 6 Mean Scale Score by LEA – Reading	138
Table 45. 2000-01 End-of-Grade Multiple-Choice Test Results, Grade 6 Mean Scale Score by LEA – Mathematics	139
Table 46. 2000-01 End-of-Grade Multiple-Choice Test Results, Grade 7 Mean Scale Score by LEA – Reading	140
Table 47. 2000-01 End-of-Grade Multiple-Choice Test Results, Grade 7 Mean Scale Score by LEA – Mathematics	141
Table 48. 2000-01 End-of-Grade Multiple-Choice Test Results, Grade 8 Mean Scale Score by LEA – Reading	142
Table 49. 2000-01 End-of-Grade Multiple-Choice Test Results, Grade 8 Mean Scale Score by LEA – Mathematics	143

High School Comprehensive Test Results

Table 1. 1997-98 to 2000-01 North Carolina High School Comprehensive Multiple-Choice Test Results, Statewide Summary, Reading and Mathematics	147
Table 2. 1997-98 to 2000-01 North Carolina High School Comprehensive Multiple-Choice Test Results, Percent of Students at Each Achievement Level by Gender and Ethnicity, Reading.....	148
Table 3. 1997-98 to 2000-01 North Carolina High School Comprehensive Multiple-Choice Test Results, Percent of Students at Each Achievement Level by Gender and Ethnicity, Mathematics*	149
Table 4. 2000-01 North Carolina High School Comprehensive Multiple-Choice Test Results, Performance of Academically Gifted, Exceptional, Limited English Proficient and Title I Students	156
Table 5. 2000-01 North Carolina High School Comprehensive Multiple-Choice Test Results, Performance of Students Using Accommodations.....	157
Table 6. 2000-01 North Carolina High School Comprehensive Multiple-Choice Test Results, Participation of Students with Special Needs**	158
Table 7. 2000-01 North Carolina High School Comprehensive Multiple-Choice Test Results, Characteristics and Performance.....	159

Table 8. 2000-01 North Carolina High School Comprehensive Multiple-Choice Test Results, Teacher Evaluation and Performance	161
Table 9. 2000-01 North Carolina High School Comprehensive Test Goal Summary Report	162
Table 10. 2000-01 North Carolina High School Comprehensive Test, Distribution of Scale Scores – Reading.....	163
Table 11. 2000-01 North Carolina High School Comprehensive Test, Distribution of Scale Scores – Mathematics.....	165
Table 12. 2000-01 North Carolina High School Comprehensive Multiple-Choice Test Results, Mean Scale Score by LEA – Reading.....	167
Table 13. 2000-01 North Carolina High School Comprehensive Multiple-Choice Test Results, Mean Scale Score by LEA – Mathematics	168

End-of-Course Test Results

Table 1. 1991-92 to 2000-01 End-of-Course Multiple-Choice Test Results, Statewide Summary.....	171
Table 2. End-of-Course Multiple-Choice Test Results, 1999-00 to 2000-01 Comparison of Percent of Students At or Above Level III, by Ethnicity	172
Table 3. 2000-01 End-of-Course Multiple-Choice Test Results, Achievement Level Ranges by Course.....	173
Table 4. 2000-01 End-of-Course Multiple-Choice Test Results, Percent of Students by Achievement Level, by Course and Ethnicity	174
Table 5. 2000-01 End-of-Course Multiple-Choice Test Results, Percent of Students by Achievement Level, by Course and Gender	182
Table 6. 2000-01 End-of-Course Multiple-Choice Test Results, Performance of Academically Gifted, Exceptional, Limited English Proficient and Title I Students, by Course	184
Table 7. 2000-01 End-of-Course Multiple-Choice Test Results, Performance of Students Using Accommodations, by Course	189
Table 8. 2000-01 End-of-Course Multiple-Choice Test Results, Participation of Students with Special Needs**	194
Table 9. 2000-01 End-of-Course Multiple-Choice Test Results, Characteristics and Performance of Students Taking Algebra I.....	195

Table 10. 2000-01 End-of-Course Multiple-Choice Test Results, Characteristics and Performance of Students Taking Algebra II	196
Table 11. 2000-01 End-of-Course Multiple-Choice Test Results, Characteristics and Performance of Students Taking Biology	197
Table 12. 2000-01 End-of-Course Multiple-Choice Test Results, Characteristics and Performance of Students Taking Chemistry.....	198
Table 13. 2000-01 End-of-Course Multiple-Choice Test Results, Characteristics and Performance of Students Taking Economic, Legal, and Political Systems.....	199
Table 14. 2000-01 End-of-Course Multiple-Choice Test Results, Characteristics and Performance of Students Taking English I	200
Table 15. 2000-01 End-of-Course Multiple-Choice Test Results, Characteristics and Performance of Students Taking Geometry	201
Table 16. 2000-01 End-of-Course Multiple-Choice Test Results, Characteristics and Performance of Students Taking Physical Science	202
Table 17. 2000-01 End-of-Course Multiple-Choice Test Results, Characteristics and Performance of Students Taking Physics	203
Table 18. 2000-01 End-of-Course Multiple-Choice Test Results, Characteristics and Performance of Students Taking U.S. History	204
Table 19. 2000-01 End-of-Course Goal Summary Report, Algebra I.....	205
Table 20. 2000-01 End-of-Course Goal Summary Report, Algebra II	206
Table 21. 2000-01 End-of-Course Goal Summary Report, Biology.....	207
Table 22. 2000-01 End-of-Course Goal Summary Report, Chemistry	208
Table 23. 2000-01 End-of-Course Goal Summary Report, Economic, Legal, and Political Systems	209
Table 24. 2000-01 End-of-Course Goal Summary Report, English I	210
Table 25. 2000-01 End-of-Course Goal Summary Report, Geometry.....	211
Table 26. 2000-01 End-of-Course Goal Summary Report, Physical Science.....	212
Table 27. 2000-01 End-of-Course Goal Summary Report, Physics.....	213
Table 28. 2000-01 End-of-Course Goal Summary Report, U.S. History.....	214

Table 29. 2000-01 End-of-Course Distribution of Scale Scores, Algebra I.....	215
Table 30. 2000-01 End-of-Course Distribution of Scale Scores, Algebra II	217
Table 31. 2000-01 End-of-Course Distribution of Scale Scores, Biology	218
Table 32. 2000-01 End-of-Course Distribution of Scale Scores, Chemistry	219
Table 33. 2000-01 End-of-Course Distribution of Scale Scores, Economic, Legal, and Political Systems	220
Table 34. 2000-01 End-of-Course Distribution of Scale Scores, English I.....	221
Table 35. 2000-01 End-of-Course Distribution of Scale Scores, Geometry.....	222
Table 36. 2000-01 End-of-Course Distribution of Scale Scores, Physical Science	223
Table 37. 2000-01 End-of-Course Distribution of Scale Scores, Physics.....	224
Table 38. 2000-01 End-of-Course Distribution of Scale Scores, U.S. History.....	225
Table 39. 2000-01 End-of-Course Multiple-Choice Test Results, Algebra I – Mean Scale Score by LEA	226
Table 40. 2000-01 End-of-Course Multiple-Choice Test Results, Algebra II – Mean Scale Score by LEA	227
Table 41. 2000-01 End-of-Course Multiple-Choice Test Results, Biology – Mean Scale Score by LEA.....	228
Table 42. 2000-01 End-of-Course Multiple-Choice Test Results, Chemistry – Mean Scale Score by LEA.....	229
Table 43. 2000-01 End-of-Course Multiple-Choice Test Results, Economic, Legal, and Political Systems – Mean Scale Score by LEA.....	230
Table 44. 2000-01 End-of-Course Multiple-Choice Test Results, English I – Mean Scale Score by LEA	231
Table 45. 2000-01 End-of-Course Multiple-Choice Test Results, Geometry – Mean Scale Score by LEA.....	232
Table 46. 2000-01 End-of-Course Multiple-Choice Test Results, Physical Science – Mean Scale Score by LEA.....	233

Table 47. 2000-01 End-of-Course Multiple-Choice Test Results, Physics – Mean Scale Score by LEA.....	234
Table 48. 2000-01 End-of-Course Multiple-Choice Test Results, U.S. History – Mean Scale Score by LEA	235

List of Figures

Introductory Figures

Intro. Figure 1. 1996-97 to 2000-01 Grade 3 Pretest Multiple-Choice Results, Percent of Students at Each Achievement Level in Reading	5
Intro. Figure 2. 1996-97 to 2000-01 Grade 3 Pretest Multiple-Choice Results, Percent of Students at Each Achievement Level in Mathematics	5
Intro. Figure 3. 1992-93 to 2000-01 End-of-Grade Multiple-Choice Test Results, Percent of Students at Each Achievement Level in Reading, Across All Grades (3-8)	6
Intro. Figure 4. 1992-93 to 2000-01 End-of-Grade Multiple-Choice Test Results, Percent of Students at Each Achievement Level in Mathematics, Across All Grades (3-8)	6
Intro. Figure 5. 1992-93 to 2000-01 End-of-Grade Multiple-Choice Test Results, Percent of Students At or Above Achievement Level III, Reading and Mathematics, Grades 3-8.....	7
Intro. Figure 6. 1992-93 to 2000-01 End-of-Grade Multiple-Choice Test Results, Percent of Students At or Above Level III in <u>Both</u> Reading and Mathematics, Grades 3-8	7
Intro. Figure 7. 1992-93 to 2000-01 End-of-Grade Multiple-Choice Test Results, Percent of Students At or Above Level III in <u>Both</u> Reading and Mathematics, Grades 3-8	8
Intro. Figure 8. 1992-93 to 2000-01 End-of-Grade Multiple-Choice Test Results, Percent of Students At or Above Level III in <u>Both</u> Reading and Mathematics, Grades 3-8, for Black and White Students	8
Intro. Figure 9. 1992-93 to 2000-01 End-of-Grade Multiple-Choice Test Results, Percent of Students At or Above Level III in <u>Both</u> Reading and Mathematics, Grades 3-8, by Ethnicity	9
Intro. Figure 10. 2000-01 End-of-Grade Multiple-Choice Test Results: Minimum, Maximum, Median and Mean Reading Scale Scores, Grades 3-8, by Ethnicity.....	10

Intro. Figure 11. 2000-01 End-of-Grade Multiple-Choice Test Results, Minimum, Maximum, Median and Mean Mathematics Scale Scores, Grades 3-8, by Ethnicity.....	11
Intro. Figure 12. 1992-93 to 2000-01 End-of-Grade Multiple-Choice Test Results, Percent of Students At or Above Level III in <u>Both</u> Reading and Mathematics, Grades 3-8, by Disability.....	12
Intro. Figure 13. 1997-99 to 2000-01 North Carolina High School Comprehensive Multiple- Choice Test Results, Percent of Students at Each Achievement Level in Reading.....	13
Intro. Figure 14. 1997-98 to 2000-01 North Carolina High School Comprehensive Multiple-Choice Test Results, Percent of Students at Each Achievement Level in Mathematics.....	13
Intro. Figure 15. 1994-95 to 2000-01 End-of-Course Multiple-Choice Test Results, Percent of Scores at Each Achievement Level in Ten Core Courses* (Algebra I; Algebra II; Biology; Chemistry; Economic, Legal, & Political Systems; English I; Geometry; Physical Science; Physics and U.S. History)	14
Intro. Figure 16. 1994-95 to 2000-01 End-of-Course Multiple-Choice Test Results, Percent of Students At or Above Level III, by Course**	19
Intro. Figure 17. 1994-95 to 2000-01 End-of-Course Multiple-Choice Test Results, Percent of Students At or Above Level III Across the Five Core Courses** (Algebra I; Biology; Economic, Legal, and Political Systems; English I and U.S. History), for Black and White Students	19
Intro. Figure 18. 1994-95 to 2000-01 End-of-Course Multiple-Choice Test Results, Percent of Students At or Above Level III Across the Five Core Courses* (Algebra I; Biology; Economic, Legal, and Political Systems; English I and U.S. History), by Ethnicity.....	20
Intro. Figure 19. 1994-95 to 2000-01 End-of-Course Multiple-Choice Test Results, Percent of Students At or Above Level III Across the Five Core Courses* (Algebra I; Biology; Economic, Legal, & Political Systems; English I and U.S. History), by Disability.....	21

Grade 3 Pretest Results

Figure 1. 1996-97 to 2000-01 Grade 3 Pretest Multiple-Choice Results, Percent of Students At or Above Level III in Reading, by Ethnicity	28
Figure 2. 1996-97 to 2000-01 Grade 3 Pretest Multiple-Choice Results, Percent of Students At or Above Level III in Mathematics, by Ethnicity.....	28

Figure 3. 2000-01 Grade 3 Pretest Multiple-Choice Results, Percent of Students At or Above Level III in Reading and Mathematics, by Ethnicity	29
Figure 4. 2000-01 Grade 3 Pretest Multiple-Choice Results, Percent of Students At or Above Level III in Reading, by Gender and Ethnicity	30
Figure 5. 2000-01 Grade 3 Pretest Multiple-Choice Results, Percent of Students At or Above Level III in Mathematics, by Gender and Ethnicity.....	31
Figure 6. 2000-01 Grade 3 Pretest Multiple-Choice Results, Percent of Students at Each Achievement Level in Reading, by Gender and Ethnicity	32
Figure 7. 2000-01 Grade 3 Pretest Multiple-Choice Results, Percent of Students at Each Achievement Level in Mathematics, by Gender and Ethnicity.....	33

End-of-Grade Test Results

Figure 1. 2000-01 End-of-Grade Multiple-Choice Test Results, Percent of Students at Each Achievement Level in Reading, Grades 3-8 Combined, by Ethnicity	53
Figure 2. 2000-01 End-of-Grade Multiple-Choice Test Results, Percent of Students at Each Achievement Level in Mathematics, Grades 3-8 Combined, by Ethnicity	54
Figure 3. 1992-93 to 2000-01 End-of-Grade Multiple-Choice Test Results, Percent of Students At or Above Levels III in Reading and Mathematics, Grades 3-8	55
Figure 4. 1992-93 to 2000-01 End-of-Grade Multiple-Choice Test Results, Percent of Students At or Above Level III in <u>Both</u> Reading and Mathematics, Grades 3-8	57
Figure 5. 1992-93 to 2000-01 End-of-Grade Multiple-Choice Test Results, Percent of Students At or Above Level III in <u>Both</u> Reading and Mathematics, Grades 3-8 Combined, by Ethnicity	59
Figure 6. 1992-93 to 2000-01 End-of-Grade Multiple-Choice Test Results, Percent of Students At or Above Level III in <u>Both</u> Reading and Mathematics, Grades 3-8 Combined, by Gender	61
Figure 7a. 1992-93 to 2000-01 End-of-Grade Multiple-Choice Test Results, Percent of Students At or Above Level III in <u>Both</u> Reading and Mathematics, Grade 3, by Ethnicity	62
Figure 7b. 1992-93 to 2000-01 End-of-Grade Multiple-Choice Test Results, Percent of Students At or Above Level III in <u>Both</u> Reading and Mathematics, Grade 3, by Ethnicity	64

Figure 7c. 1992-93 to 2000-01 End-of-Grade Multiple-Choice Test Results, Percent of Students At or Above Level III in <u>Both</u> Reading and Mathematics, Grade 3, by Gender	66
Figure 8a. 1992-93 to 2000-01 End-of-Grade Multiple-Choice Test Results, Percent of Students At or Above Level III in <u>Both</u> Reading and Mathematics, Grade 5, by Ethnicity	67
Figure 8b. 1992-93 to 2000-01 End-of-Grade Multiple-Choice Test Results, Percent of Students At or Above Level III in <u>Both</u> Reading and Mathematics, Grade 5, by Ethnicity	69
Figure 8c. 1992-93 to 2000-01 End-of-Grade Multiple-Choice Test Results, Percent of Students At or Above Level III in <u>Both</u> Reading and Mathematics, Grade 5, by Gender	71
Figure 9a. 1992-93 to 2000-01 End-of-Grade Multiple-Choice Test Results, Percent of Students At or Above Level III in <u>Both</u> Reading and Mathematics, Grade 8, by Ethnicity	72
Figure 9b. 1992-93 to 2000-01 End-of-Grade Multiple-Choice Test Results, Percent of Students At or Above Level III in <u>Both</u> Reading and Mathematics, Grade 8, by Ethnicity	73
Figure 9c. 1992-93 to 2000-01 End-of-Grade Multiple-Choice Test Results, Percent of Students At or Above Level III in <u>Both</u> Reading and Mathematics, Grade 8, by Gender	75
Figure 10. 1997-98 to 2000-01 End-of-Grade Multiple-Choice Test Results, Percent of Students At or Above Level III in <u>Both</u> Reading and Mathematics, Cohort Comparison, Grade 3 to Grade 6.....	76
Figure 11. 1995-96 to 2000-01 End-of-Grade Multiple-Choice Test Results, Percent of Students At or Above Level III in <u>Both</u> Reading and Mathematics, Cohort Comparison, Grade 3 to Grade 8.....	77
Figure 12. 2000-01 End-of-Grade Multiple-Choice Test Results, Percent of Students At or Above Level III in <u>Both</u> Reading and Mathematics, Grades 3-8, by Gender and Ethnicity	78
Figure 13. 2000-01 End-of-Grade Multiple-Choice Test Results, Percent of Students At or Above Level III in <u>Both</u> Reading and Mathematics, Grade 3, by Gender and Ethnicity	79
Figure 14. 2000-01 End-of-Grade Multiple-Choice Test Results, Percent of Students At or Above Level III in <u>Both</u> Reading and Mathematics, Grade 5, by Gender and Ethnicity	80
Figure 15. 2000-01 End-of-Grade Multiple-Choice Test Results, Percent of Students At or Above Level III in <u>Both</u> Reading and Mathematics, Grade 8, by Gender and Ethnicity	81

Figure 16. 2000-01 End-of-Grade Multiple-Choice Test Results, Percent of Students at Each Achievement Level in Reading, Grades 3-8 Combined, by Gender and Ethnicity	82
Figure 17. 2000-01 End-of-Grade Multiple-Choice Test Results, Percent of Students at Each Achievement Level in Mathematics, Grades 3-8 Combined, by Gender and Ethnicity...	83
Figure 18. 1992-93 to 2000-01 End-of-Grade Multiple-Choice Test Results, Gains in Mean Scale Scores - Reading, Grades 3-8	84
Figure 19. 1992-93 to 2000-01 End-of-Grade Multiple-Choice Test Results, Gains in Mean Scale Scores - Mathematics, Grades 3-8	84

High School Comprehensive Test Results

Figure 1. 1999-00 to 2000-01 North Carolina High School Comprehensive Multiple-Choice Test Results, Percent of Students At or Above Level III in Reading, by Ethnicity.....	150
Figure 2. 1999-00 to 2000-01 North Carolina High School Comprehensive Multiple-Choice Test Results, Percent of Students At or Above Level III in Mathematics, by Ethnicity ..	150
Figure 3. 2000-01 North Carolina High School Comprehensive Multiple-Choice Test Results, Percent of Students At or Above Level III in Reading and Mathematics, by Ethnicity.....	151
Figure 4. 2000-01 North Carolina High School Comprehensive Multiple-Choice Test Results, Percent of Students At or Above Level III in Reading, by Gender and Ethnicity.....	152
Figure 5. 2000-01 North Carolina High School Comprehensive Multiple-Choice Test Results, Percent of Students At or Above Level III in Mathematics, by Gender and Ethnicity	153
Figure 6. 2000-01 North Carolina High School Comprehensive Multiple-Choice Test Results, Percent of Students at Each Achievement Level in Reading, by Gender and Ethnicity	154
Figure 7. 2000-01 North Carolina High School Comprehensive Multiple-Choice Test Results, Percent of Students at Each Achievement Level in Mathematics, by Gender and Ethnicity	155

End-of-Course Test Results

Figure 1. 1998-99 to 2000-01 End-of-Course Multiple-Choice Test Results, Percent of Students At or Above Level III in Algebra I, by Ethnicity	176
Figure 2. 1998-99 to 2000-01 End-of-Course Multiple-Choice Test Results, Percent of Students At or Above Level III in Algebra II, by Ethnicity	176
Figure 3. 1998-99 to 2000-01 End-of-Course Multiple-Choice Test Results, Percent of Students At or Above Level III in Biology, by Ethnicity.....	177

Figure 4. 1998-99 to 2000-01 End-of-Course Multiple-Choice Test Results, Percent of Students At or Above Level III in Chemistry, by Ethnicity177

Figure 5. 1998-99 to 2000-01 End-of-Course Multiple-Choice Test Results, Percent of Students At or Above Level III in Economic, Legal, and Political Systems, by Ethnicity178

Figure 6. 1998-99 to 2000-01 End-of-Course Multiple-Choice Test Results, Percent of Students At or Above Level III in English I, by Ethnicity178

Figure 7. 1998-99 to 2000-01 End-of-Course Multiple-Choice Test Results, Percent of Students At or Above Level III in Geometry, by Ethnicity179

Figure 8. 1998-99 to 2000-01 End-of-Course Multiple-Choice Test Results, Percent of Students At or Above Level III in Physical Science, by Ethnicity179

Figure 9. 1998-99 to 2000-01 End-of-Course Multiple-Choice Test Results, Percent of Students at or Above Level III in Physics, by Ethnicity180

Figure 10. 1998-99 to 2000-01 End-of-Course Multiple-Choice Test Results, Percent of Students At or Above Level III for U.S. History, by Ethnicity180

Figure 11. 1998-99 to 2000-01 End-of-Course Multiple-Choice Test Results, Percent of Students At or Above Level III Across the Five Core Courses* (Algebra I; Biology; Economic, Legal, and Political Systems; English I and U.S. History), by Ethnicity181

Figure 12. 1998-99 to 2000-01 End-of-Course Multiple-Choice Test Results, Percent of Students At or Above Level III Across the Five Core Courses* (Algebra I; Biology; Economic, Legal, and Political Systems; English I and U.S. History), by Gender181

INTRODUCTION

The *2000-01 North Carolina State Testing Results* document provides information on student performance at the state, regional and school system levels on the following multiple-choice tests administered as components of the 2000-01 North Carolina Testing Program: grade 3 pretest (reading and mathematics), end-of-grade tests (grades 3-8 in reading and mathematics) high school comprehensive test (grade 10 in reading and mathematics), and end-of-course tests (high school subjects). The figures and tables in this document were generated using student test data from the grade 3 pretest fall 2000 test administration; the end-of-grade spring 2001 test administration; the high school comprehensive spring 2001 test administration; and the end-of-course summer 2000, fall 2000 and spring 2001 test administrations. These test data were generated from raw data files provided by each local education agency (LEA), including charter schools. Some minor duplication for end-of-course test data can occur when students re-take courses and, therefore, are required to re-take the test. Test data were reconciled with school systems' test data through August 2001, the cutoff for the 2000-01 school year reporting.

The general focus of the *2000-01 State Testing Results* is on student *performance* on multiple-choice tests administered during the 2000-01 school year. However, many data are reported across years in order to show gains and trends in student performance. Student absolute *performance* and *growth* are the key components of the State Board of Education's ABCs of Public Education school-level accountability program. School-level accountability results are found in the *State Report Card*, which is published annually.

State- and system-level results contained within this document may be used to make grade-to-grade, subject-to-subject and year-to-year comparisons. In addition, comparisons of developmental scale scores of cohort groups as they move through grades 3-8 in reading and mathematics can be made. A variety of statistical descriptions, test scores and formats have been used to present the aggregate student data. Mean scale scores; the percent of students identified at the four achievement levels; the percent of students identified as Achievement Level III or above on the grade 3 pretest, end-of-grade tests in grades 3-8, the high school comprehensive test, and end-of-course tests are also presented. Information in this document may be used as a reference for educational stakeholders interested in making comparisons, conducting analyses and generating reports.

In addition to the summary statistics, this document contains disaggregated test results for subgroups for the multiple-choice grade 3 pretest, end-of-grade tests, high school comprehensive test and end-of-course tests. The state-level goal summary reports serve as a curriculum reference of student performance on the curriculum goals across grades and subjects. These results represent average student performance on the curriculum competencies defined in the North Carolina *Standard Course of Study*. The frequency distributions provide state-level summary statistics for 2000-01.

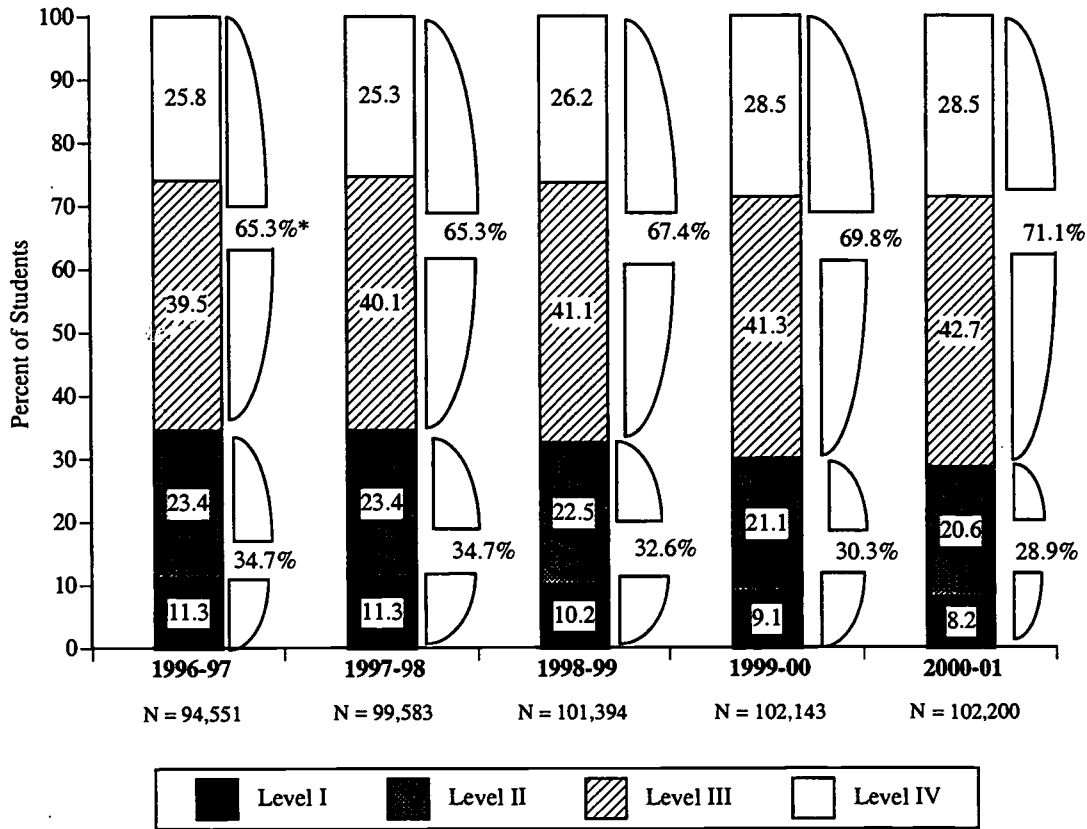
End-of-course testing began as a part of the North Carolina Testing Program in 1985-86 with the first administration of the Algebra I test. Other high school subject tests were added over time until 1994-95 when the program included eleven tests: Algebra I; Algebra II; Biology; Chemistry; Economic, Legal, and Political Systems (ELPS); English I; English II; Geometry; Physical Science; Physics and U.S. History. In 1995-96, under the ABCs plan, end-of-course tests were reduced to include Algebra I; Biology; Economic, Legal, and Political Systems (ELPS); English I and U.S. History. For the 2000-01 school year, the following ten end-of-course tests were mandated: Algebra I; Algebra II; Biology; Chemistry; Economic, Legal, and Political Systems; English I; Geometry; Physical Science; Physics and U.S. History.

End-of-grade testing was implemented initially in 1992-93 when more challenging assessment strategies replaced the California Achievement Tests (1978-92). During the 2000-01 school year, end-of-grade tests administered as a component of the statewide accountability program included reading and mathematics multiple-choice tests in grades 3 through 8. The administration of the North Carolina Grade 3 Pretest began in 1996-97. The High School Comprehensive Test of reading and mathematics began as a part of the North Carolina Testing Program in 1997-98.

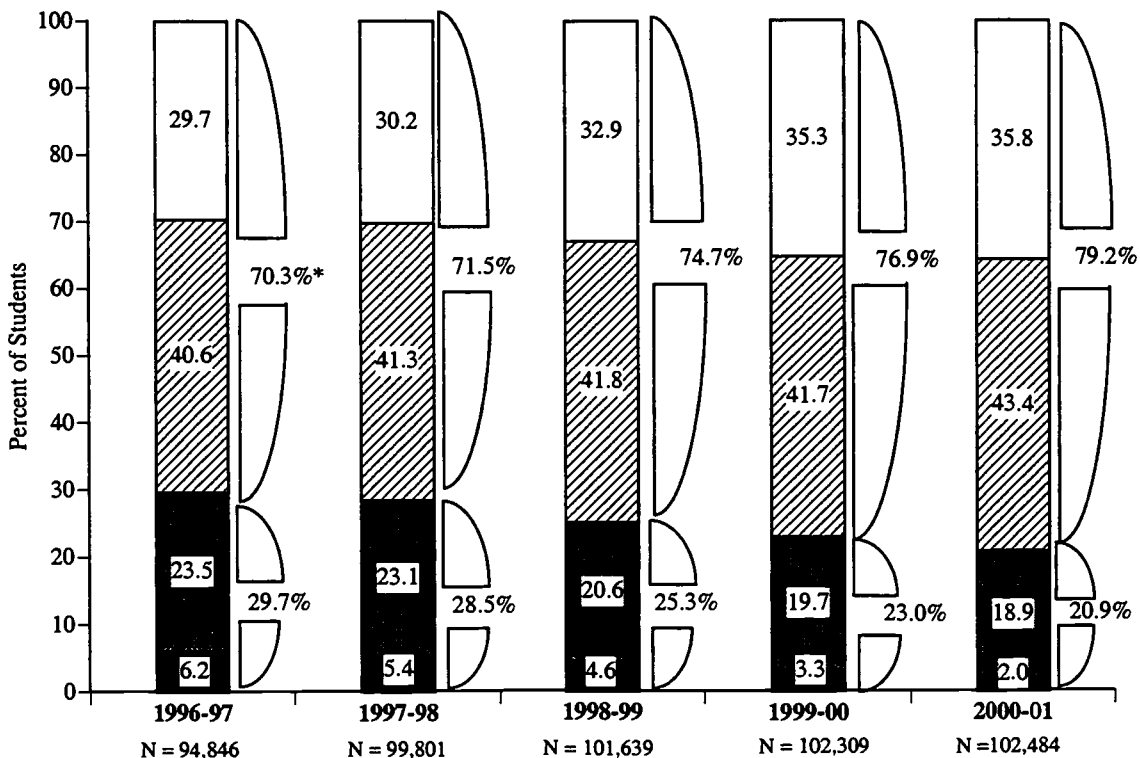
The purpose of this publication is to provide a longitudinal, comprehensive compendium of test results from grade 3 pretest, end-of-grade tests in grades 3-8, high school comprehensive test in grade 10 and end-of-course multiple-choice tests from 1992-93 to 2000-01 with a focus on reports of the 2000-01 school year performance. As the public schools of North Carolina continue to implement the ABCs of public education, the *State Testing Results* documents student performance and provides the reader an opportunity to develop an overall perspective on absolute student achievement in North Carolina.

Introductory Figures

**Intro. Figure 1. 1996-97 to 2000-01 Grade 3 Pretest Multiple-Choice Results
Percent of Students at Each Achievement Level in Reading**



**Intro. Figure 2. 1996-97 to 2000-01 Grade 3 Pretest Multiple-Choice Results
Percent of Students at Each Achievement Level in Mathematics**

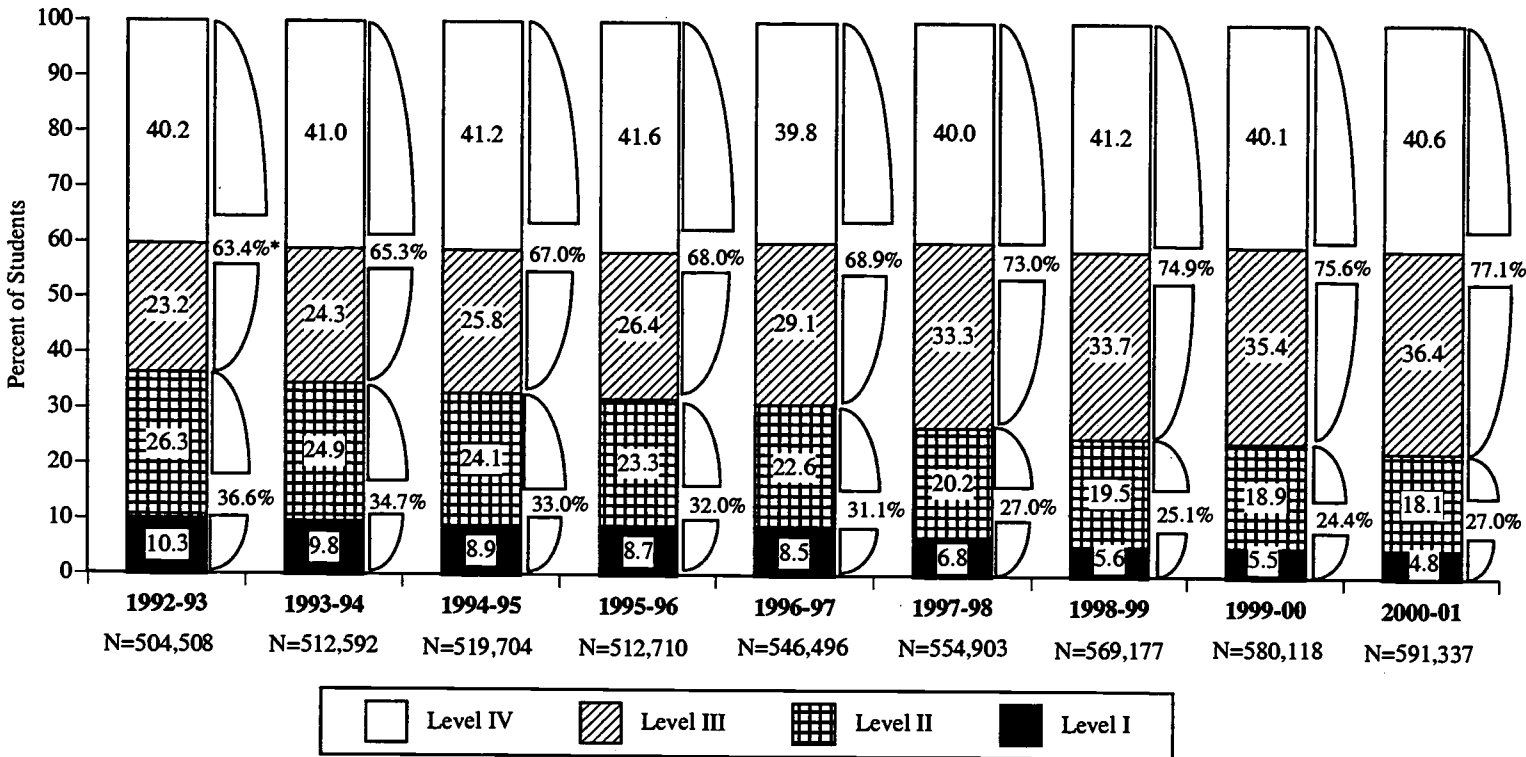


Notes: Due to rounding, data for some years may not add to 100%.

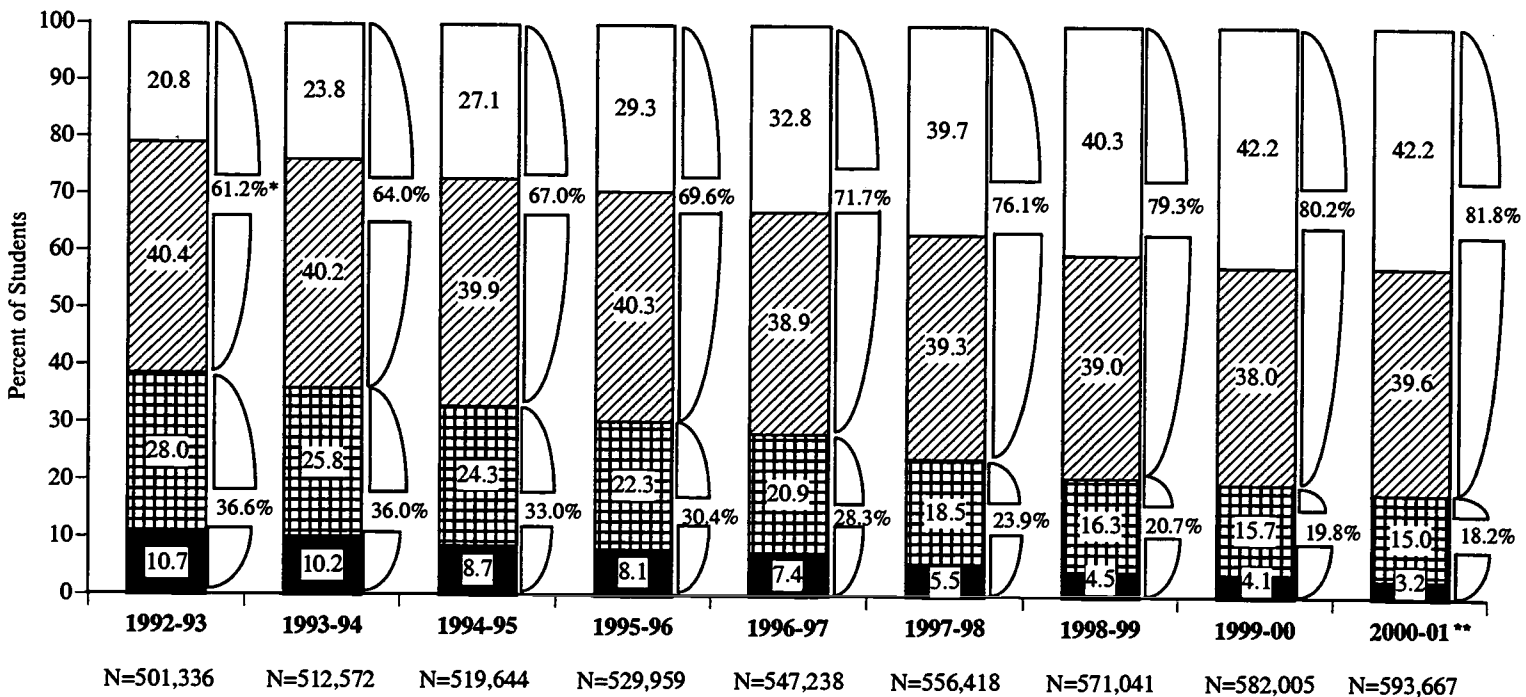
*Level I/II and Level III/IV percents are calculated based on actual N-counts and are not the sum of each percent. Data received from LEAs and charter schools after August 2001 are not included in these figures. Prepared by the NCDPI Division of Accountability Services/Testing Section.

BEST COPY AVAILABLE

**Intro. Figure 3. 1992-93 to 2000-01 End-of-Grade Multiple-Choice Test Results
Percent of Students at Each Achievement Level in Reading
Across All Grades (3-8)**



**Intro. Figure 4. 1992-93 to 2000-01 End-of-Grade Multiple-Choice Test Results
Percent of Students at Each Achievement Level in Mathematics
Across All Grades (3-8)**



Notes: Due to rounding, data for some years may add to 100%.

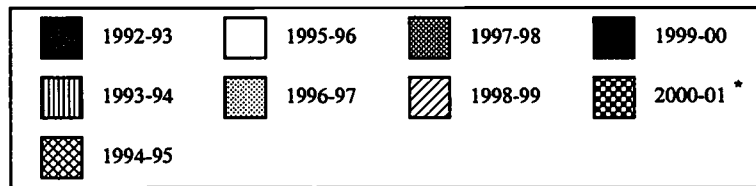
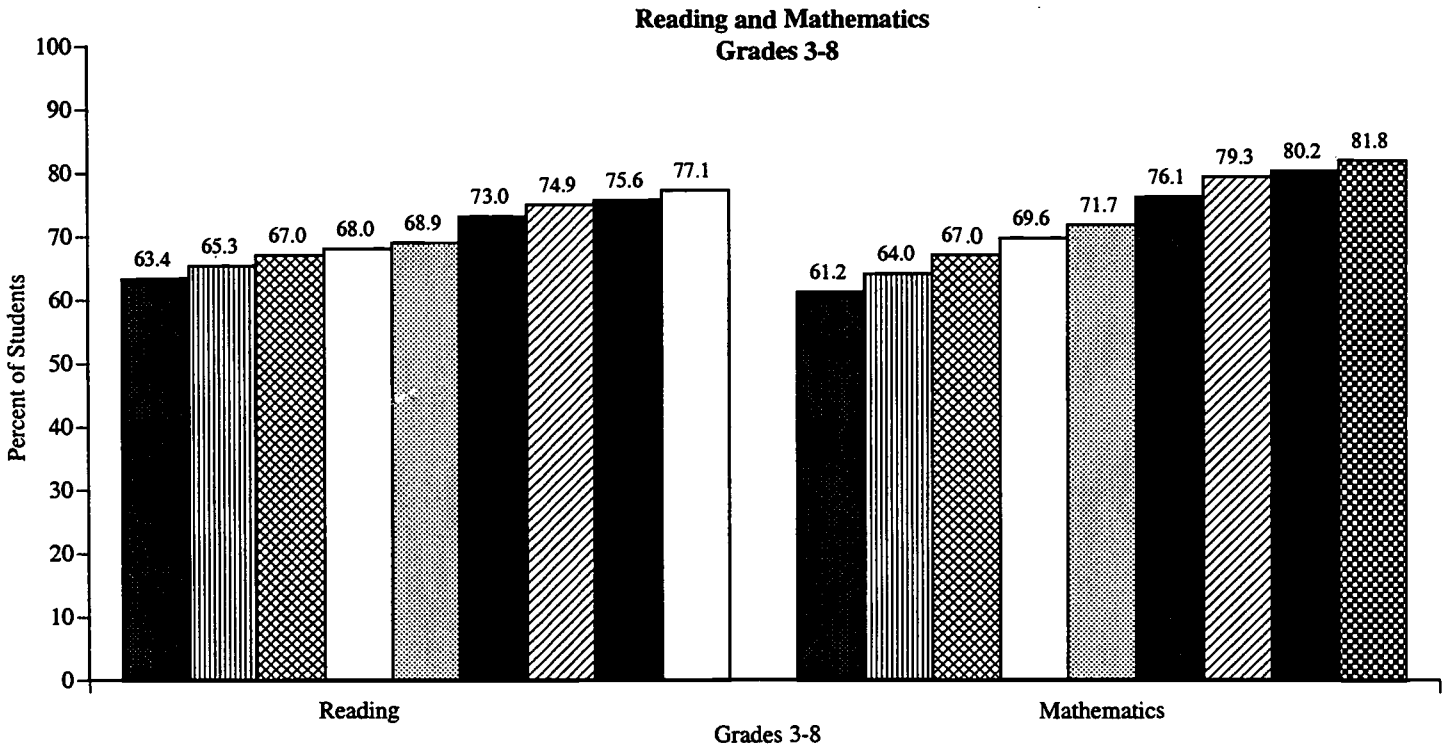
*Level I/II and Level III/IV percents are calculated based on N-counts and are not the sum of each percent.

**The North Carolina mathematics tests measure the competencies in the 1998 North Carolina mathematics curriculum beginning in the 2000-01 school year.

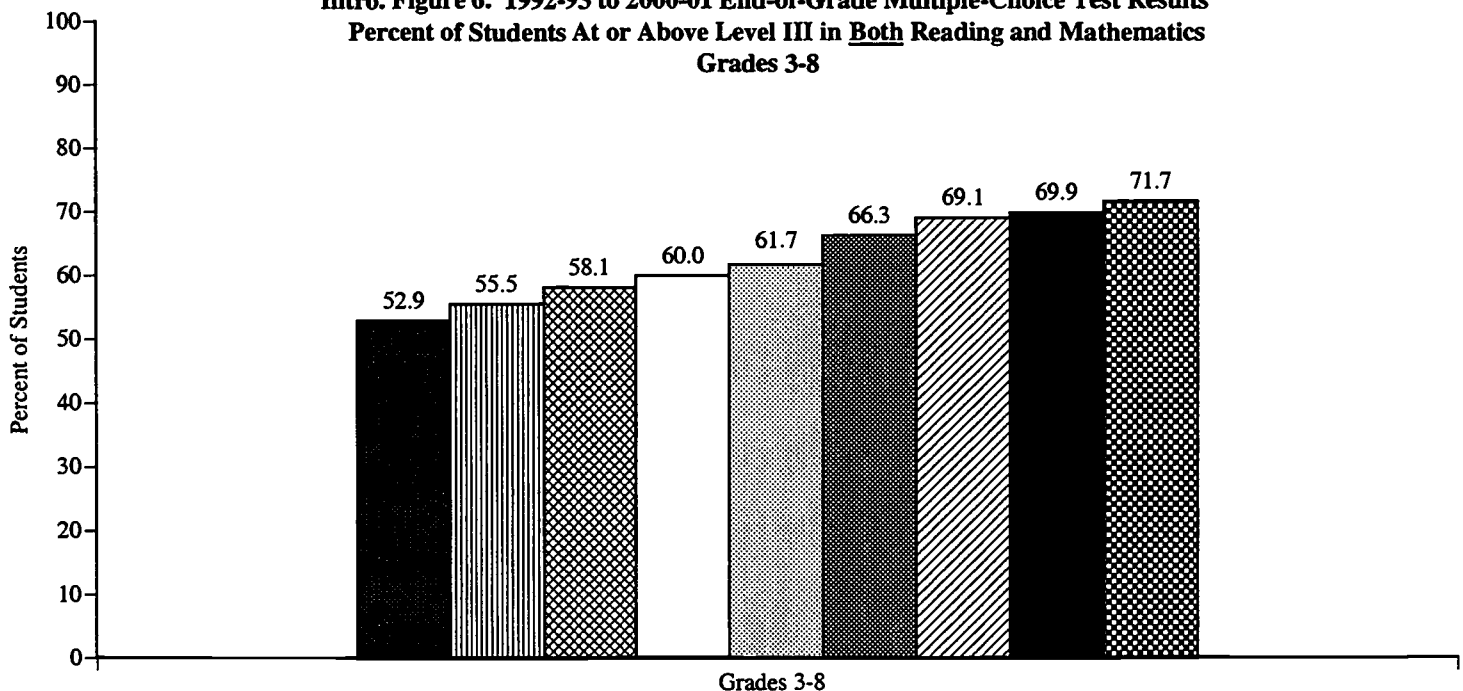
Data received from LEAs and charter schools after August 2001 are not included in these figures.

Prepared by the NCDPI Division of Accountability Services/Testing Section.

**Intro. Figure 5. 1992-93 to 2000-01 End-of-Grade Multiple-Choice Test Results
Percent of Students At or Above Level III**



**Intro. Figure 6. 1992-93 to 2000-01 End-of-Grade Multiple-Choice Test Results
Percent of Students At or Above Level III in Both Reading and Mathematics
Grades 3-8**

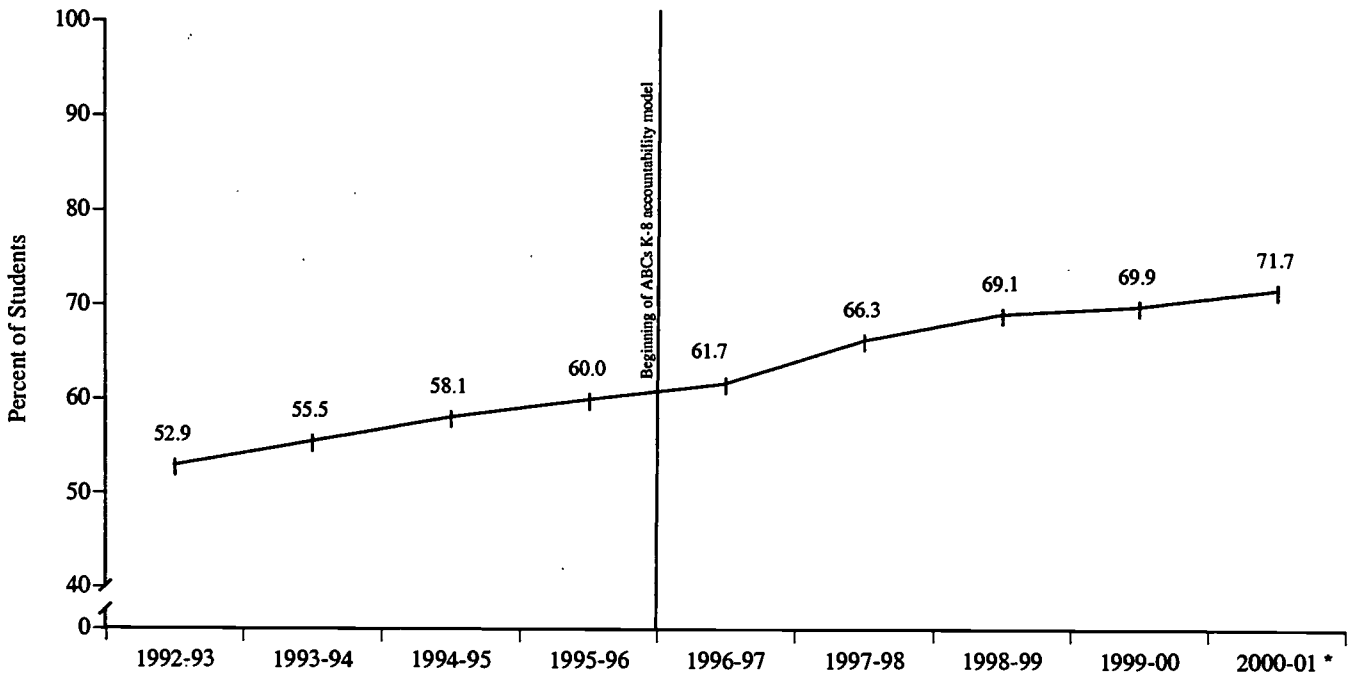


Note: *The North Carolina mathematics tests measure the competencies in the 1998 North Carolina mathematics curriculum beginning in the 2000-01 school year.

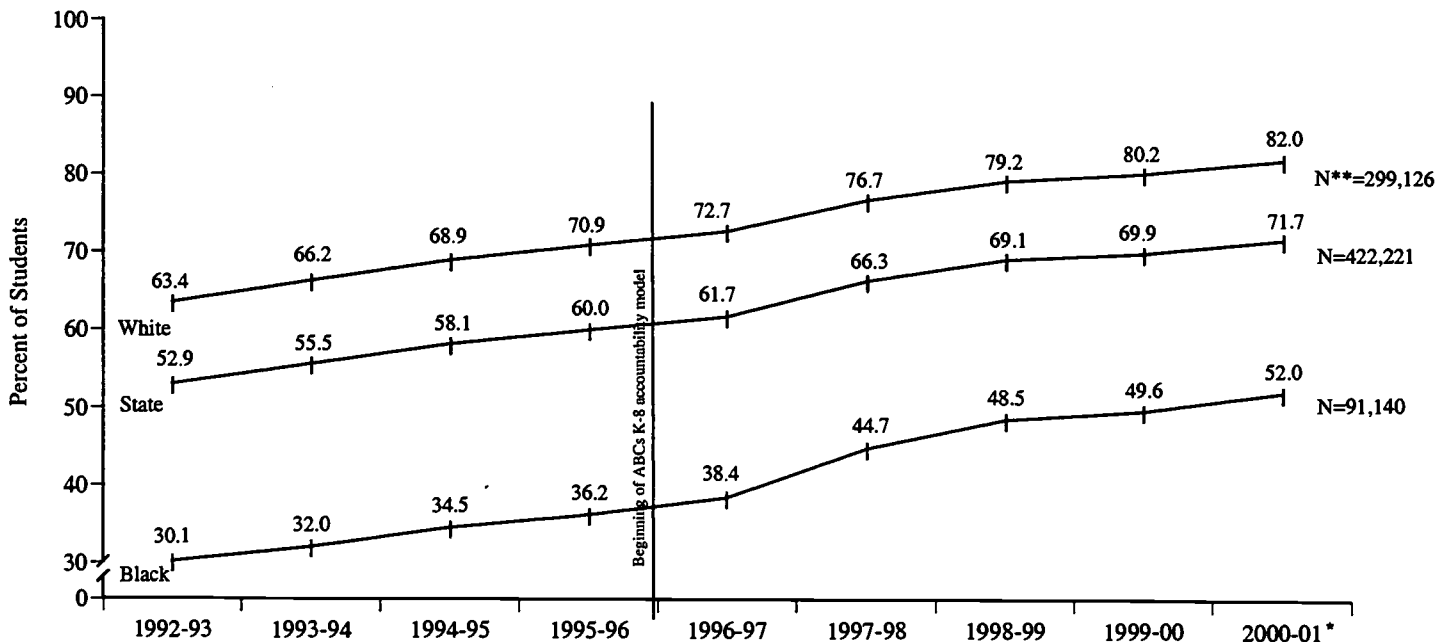
Data received from LEAs and charter schools after August 2001 are not included in these figures.

Prepared by the NCDPI Division of Accountability Services/Testing Section.

**Intro. Figure 7. 1992-93 to 2000-01 End-of-Grade Multiple-Choice Test Results
Percent of Students At or Above Level III in Both Reading and Mathematics
Grades 3-8**



**Intro. Figure 8. 1992-93 to 2000-01 End-of-Grade Multiple-Choice Test Results
Percent of Students At or Above Level III in Both Reading and Mathematics
Grades 3-8, for Black and White Students**



Notes: *The North Carolina mathematics tests measure the competencies in the 1998 North Carolina mathematics curriculum beginning in the 2000-01 school year.

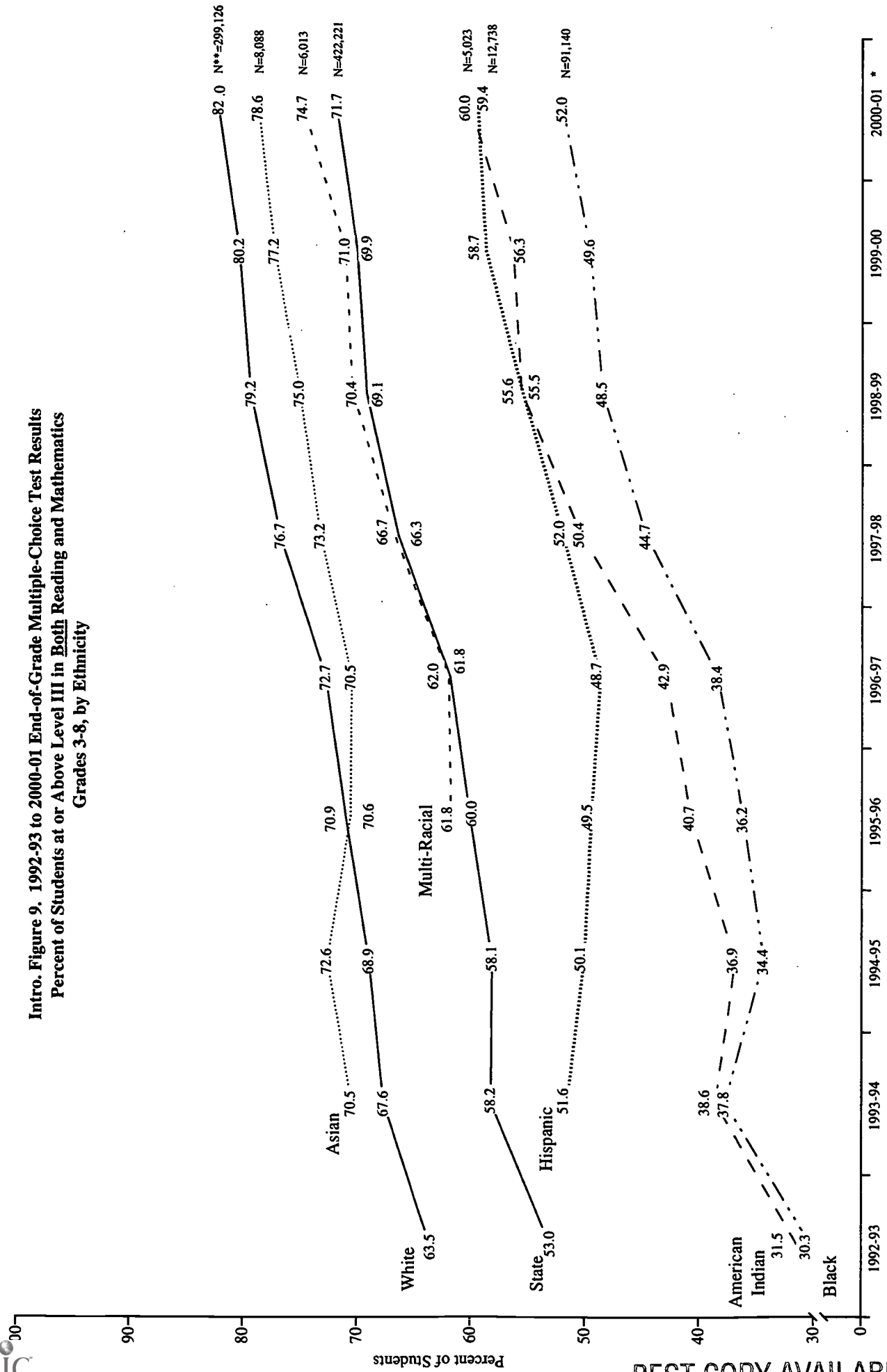
**N counts equal the number of students At or Above Level III in both reading and mathematics for 2000-01. Previous years are comparable.

The inclusion of Black and White ethnic groups in this figure reflects their status as the largest ethnic groups in the state.

Data received from LEAs and charter schools after August 2001 are not included in these figures.

Prepared by the NCDPI Division of Accountability Services/Testing Section.

**Intro. Figure 9. 1992-93 to 2000-01 End-of-Grade Multiple-Choice Test Results
Percent of Students at or Above Level III in Both Reading and Mathematics
Grades 3-8, by Ethnicity**



Notes: *The North Carolina mathematics tests measure the competencies in the 1998 North Carolina mathematics curriculum beginning in the 2000-01 school year.

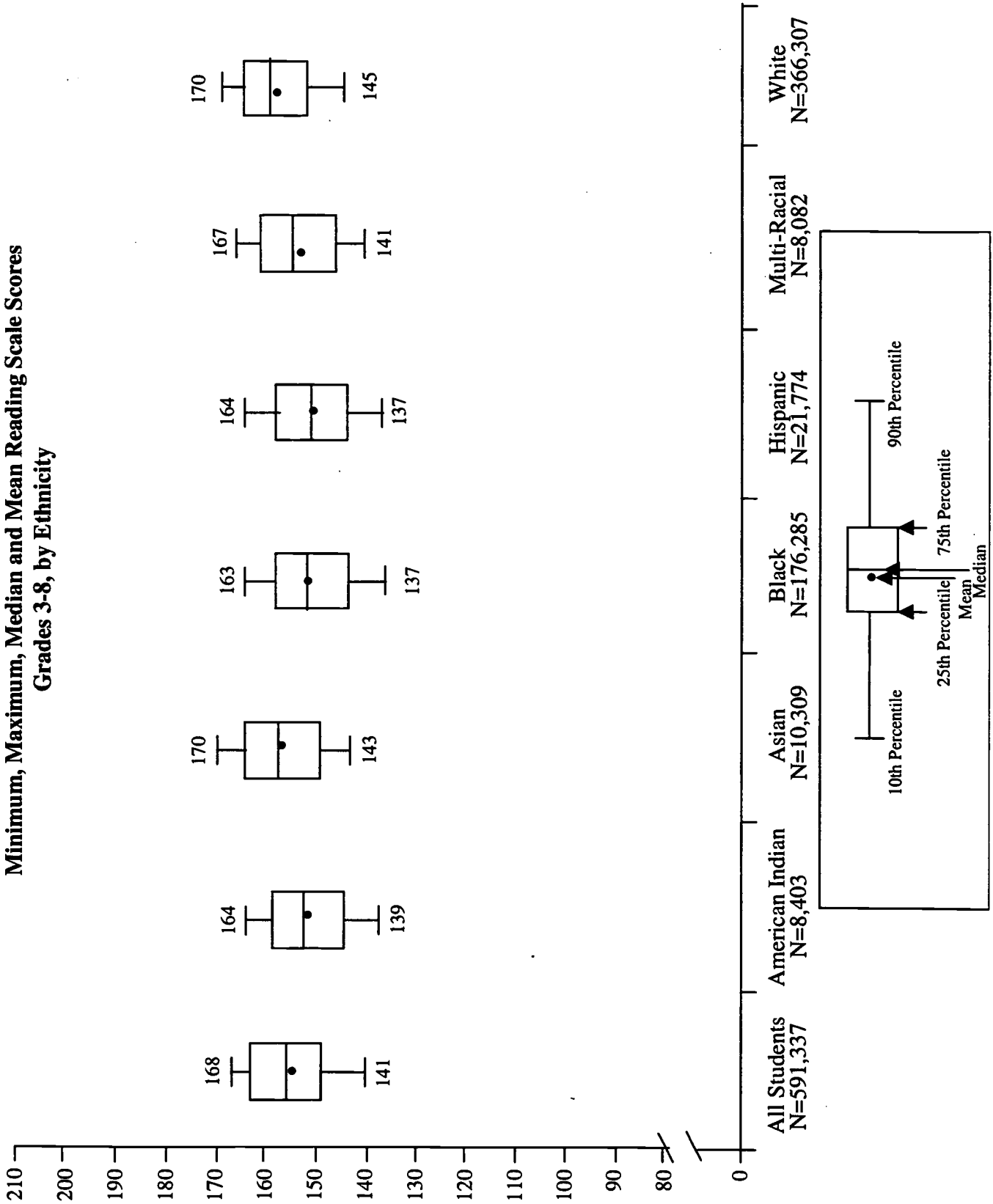
**N counts equal the number of students at or above level III in both reading and mathematics for 2000-01; previous years are comparable.

Asian and Hispanic results were not reported in 1992-93. Results in the Multi-Racial category were not reported in 1992-93, 1993-94 and 1994-95.

Data received from LEAs and charter schools after August 2001 are not included in this figure.

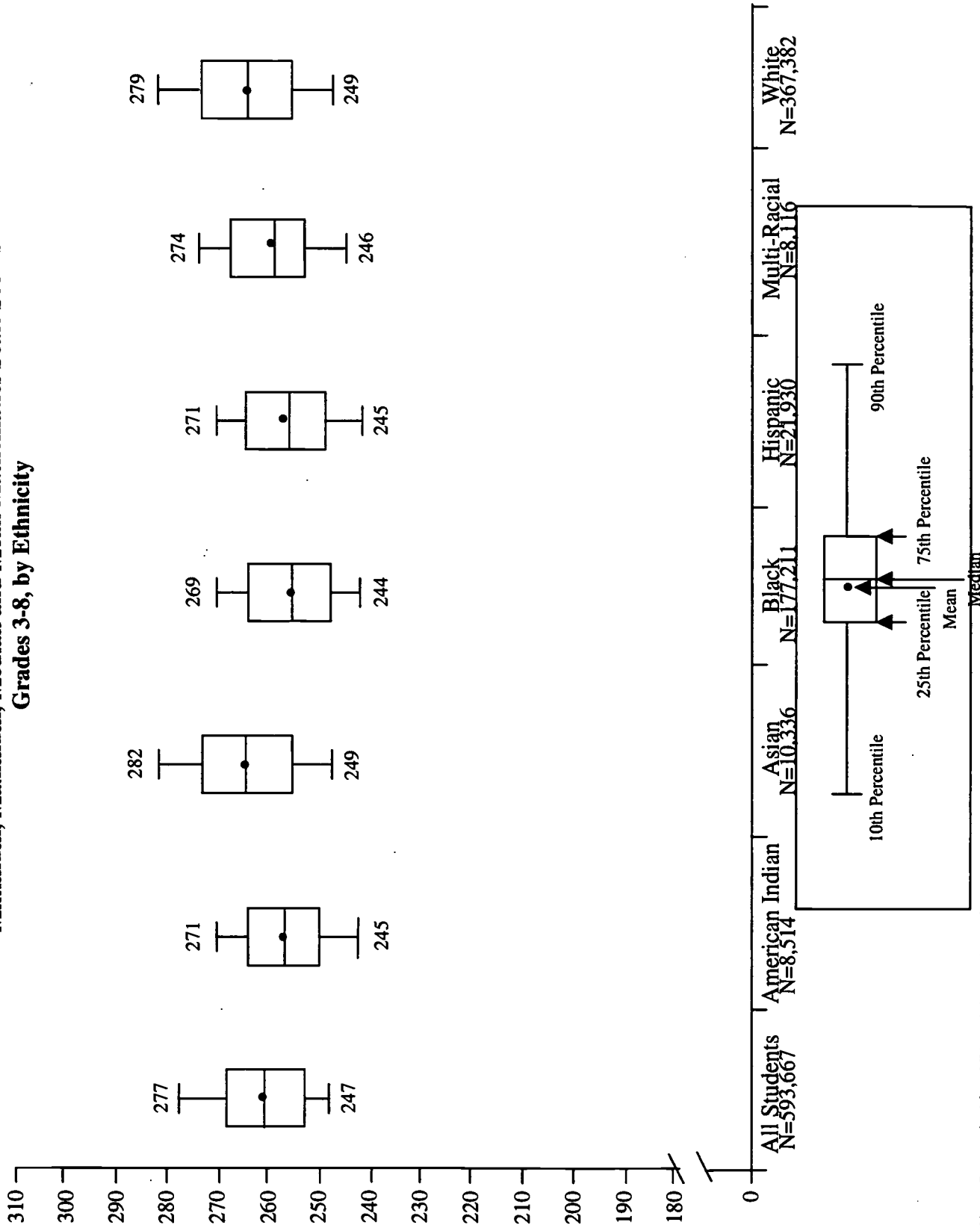
Prepared by the NCDPI Division of Accountability Services/Testing Section.

**Intro. Figure 10. 2000-01 End-of-Grade Multiple-Choice Test Results
Minimum, Maximum, Median and Mean Reading Scale Scores
Grades 3-8, by Ethnicity**



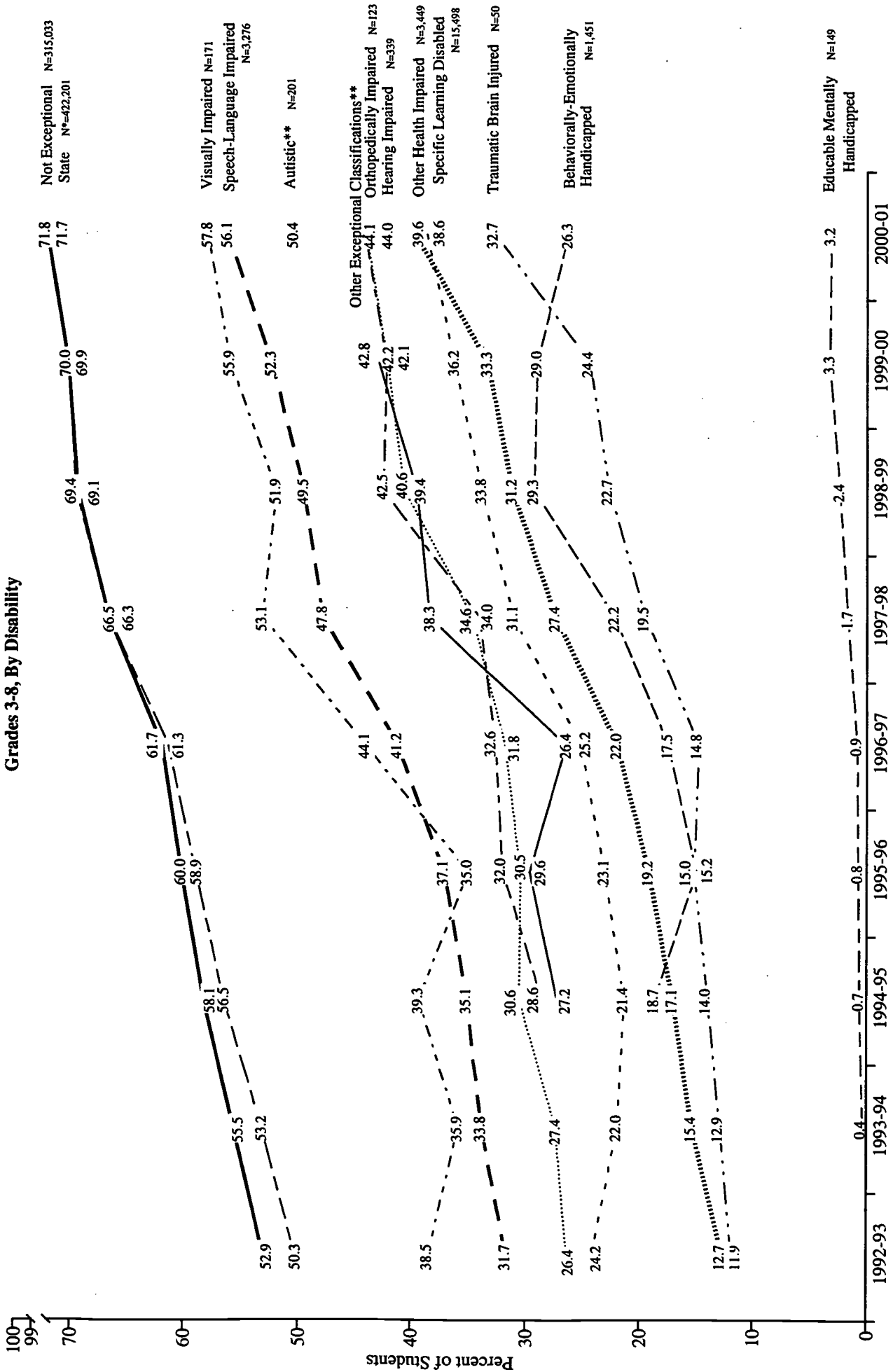
Notes: Data received from LEAs and charter schools after August 2001 are not included in this figure.
Prepared by the NCDPI Division of Accountability Services/Testing Section.

**Intro. Figure 11. 2000-01 End-of-Grade Multiple-Choice Test Results
Minimum, Maximum, Median and Mean Mathematics Scale Scores
Grades 3-8, by Ethnicity**



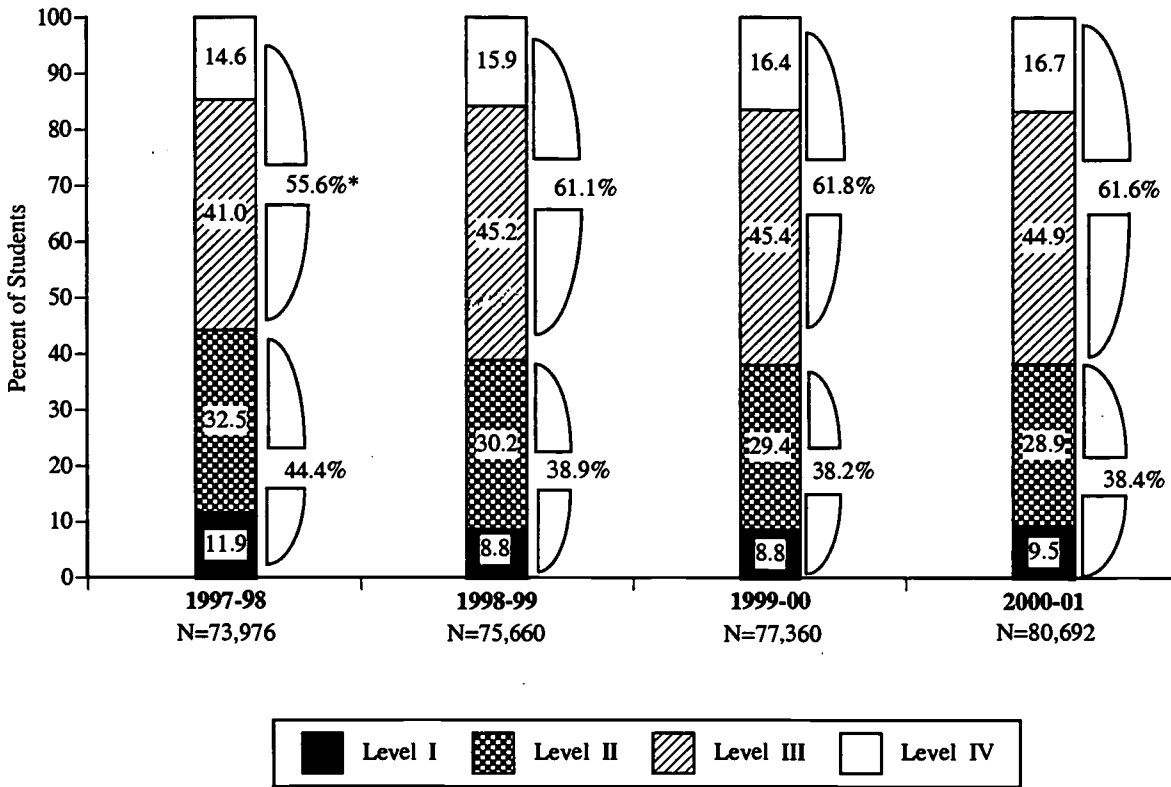
Notes: Data received from LEAs and charter schools after August 2001 are not included in this figure.
Prepared by the NCDPI Division of Accountability Services/Testing Section.

**Intro. Figure 12. 1992-93 to 2000-01 End-of-Grade Multiple-Choice Test Results
Percent of Students At or Above Level III in Both Reading and Mathematics
Grades 3-8, By Disability**

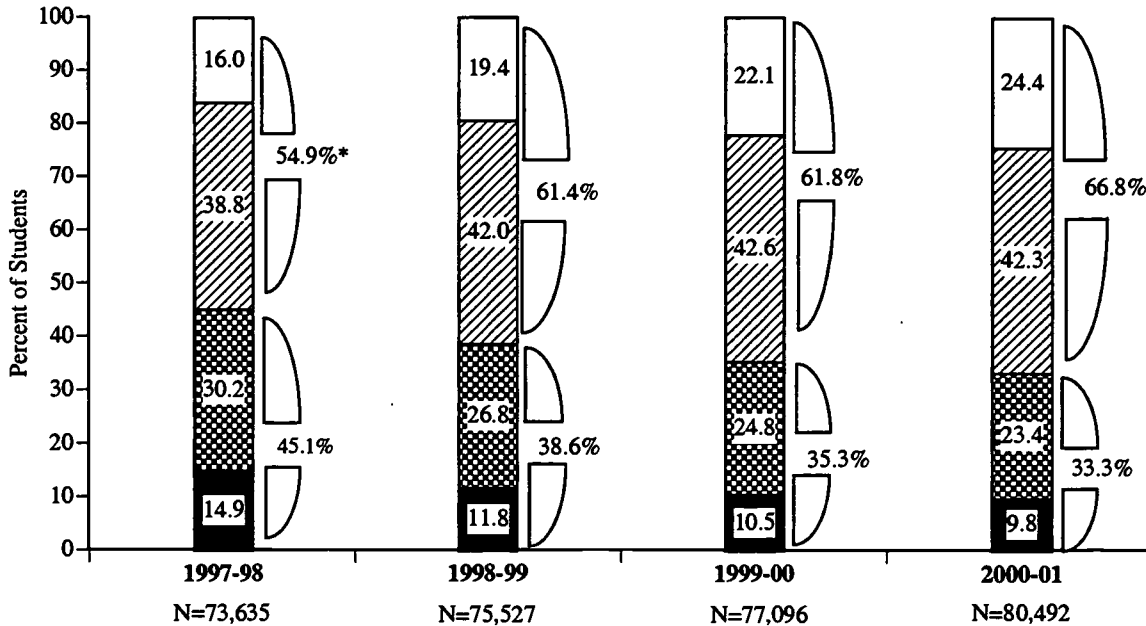


Notes: Orthopedically Impaired, Traumatic Brain Injured, and Other Exceptional Classifications were not reported in 1992-93 and 1993-94; Educable Mentally Handicapped was not reported in 1992-93.
*N counts equal the number of students At or Above Level III in both reading and mathematics for 2000-01; previous years are comparable. No scores are reported for groups with fewer than thirty students.
**Other Exceptional Classifications is no longer reported as a category starting in 2000-01; Autistic is first reported as a separate category in 2000-01.
Data received from LEAs and charter schools after August 2000-01 are not included in this figure.
Prepared by the NCDPI Division of Accountability Services/Testing Section.

**Intro. Figure 13. 1997-98 to 2000-01 North Carolina High School Comprehensive Multiple-Choice Test Results
Percent of Students at Each Achievement Level in Reading**



**Intro. Figure 14. 1997-98 to 2000-01 North Carolina High School Comprehensive Multiple-Choice Test Results
Percent of Students at Each Achievement Level in Mathematics**



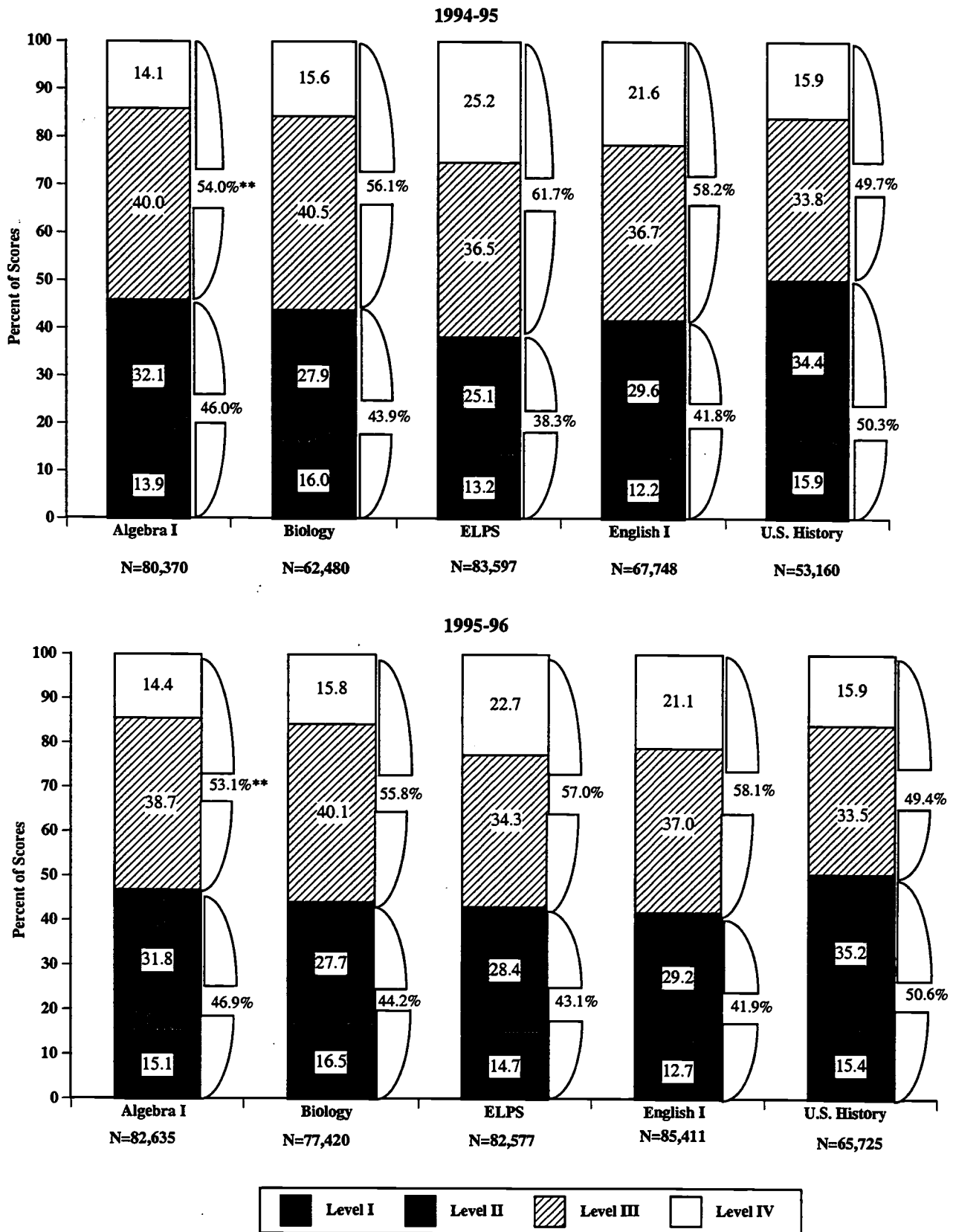
Notes: Due to rounding, data for some years may not add to 100%.

*Level I/II and Level III/IV percents are calculated based on actual N-counts and are not the sum of each percent.

Data received from LEAs and charter schools after August 2001 are not included in this figure.

Prepared by the NCDPI Division of Accountability Services/Testing Section.

**Intro. Figure 15. 1994-95 to 2000-01 End-of-Course Multiple-Choice Test Results
Percent of Scores at Each Achievement Level in the Ten Core Courses*
(Algebra I; Algebra II; Biology; Chemistry; Economics, Legal, & Political Systems;
English I; Geometry; Physical Science; Physics and U.S. History)**



Notes: * Beginning in the 1998-99 school year Algebra II, Chemistry, Geometry, Physical Science and Physics were mandated statewide; data for these tests are not available for 1994-95 through 1997-98.

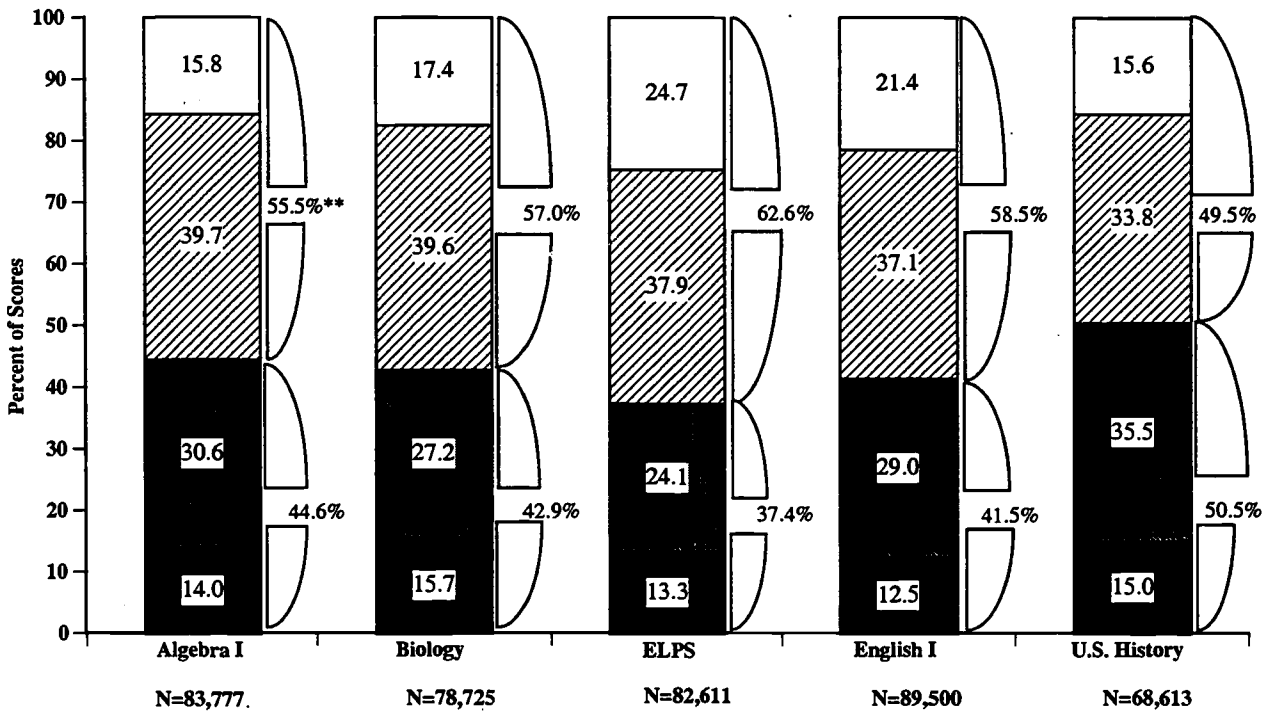
**Level I/II and Level III/IV percents are calculated based on actual N-counts and are not the sum of each percent. Due to rounding, data for some courses may not add to 100%.

Data received from LEAs and charter schools after August 2001 are not included in these figures.

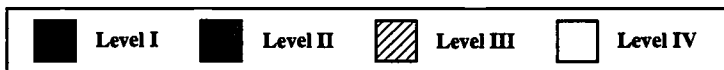
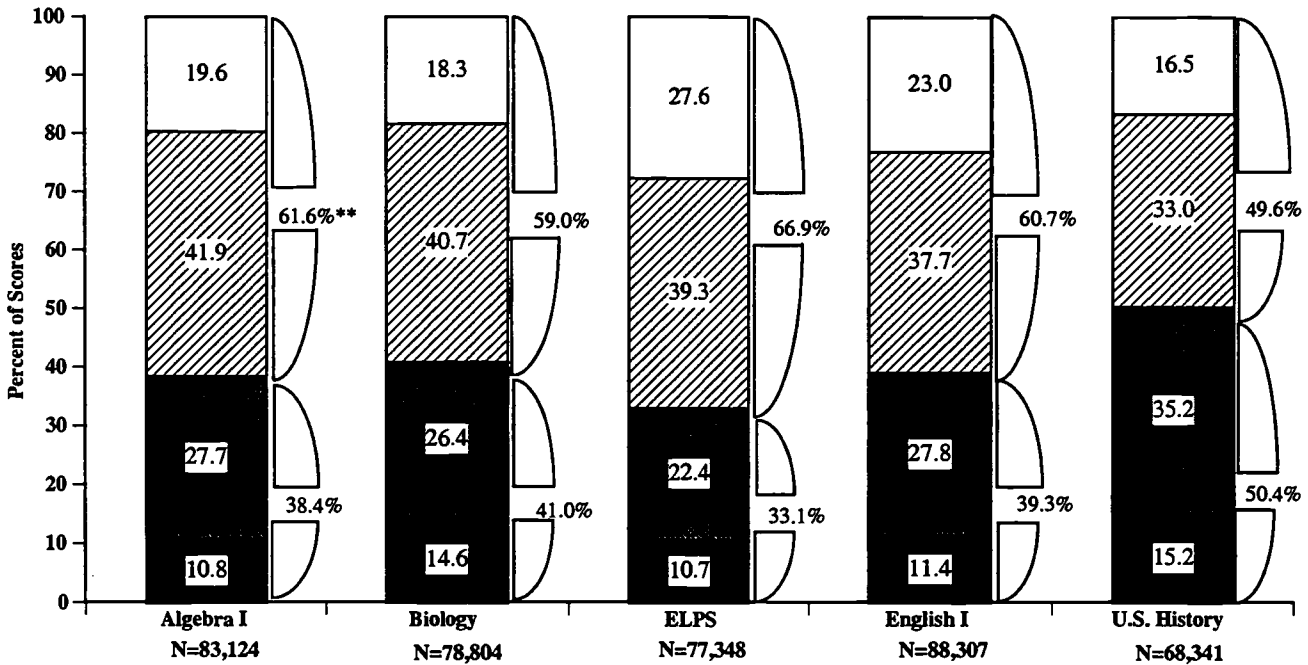
Prepared by the NCDPI Division of Accountability Services/Testing Section.

**Intro. Figure 15. 1994-95 to 2000-01 End-of-Course Multiple-Choice Test Results
Percent of Scores at Each Achievement Level in the Ten Core Courses*
(Algebra I; Algebra II; Biology; Chemistry; Economic, Legal, & Political Systems;
English I; Geometry; Physical Science; Physics and U.S. History) (continued)**

1996-97

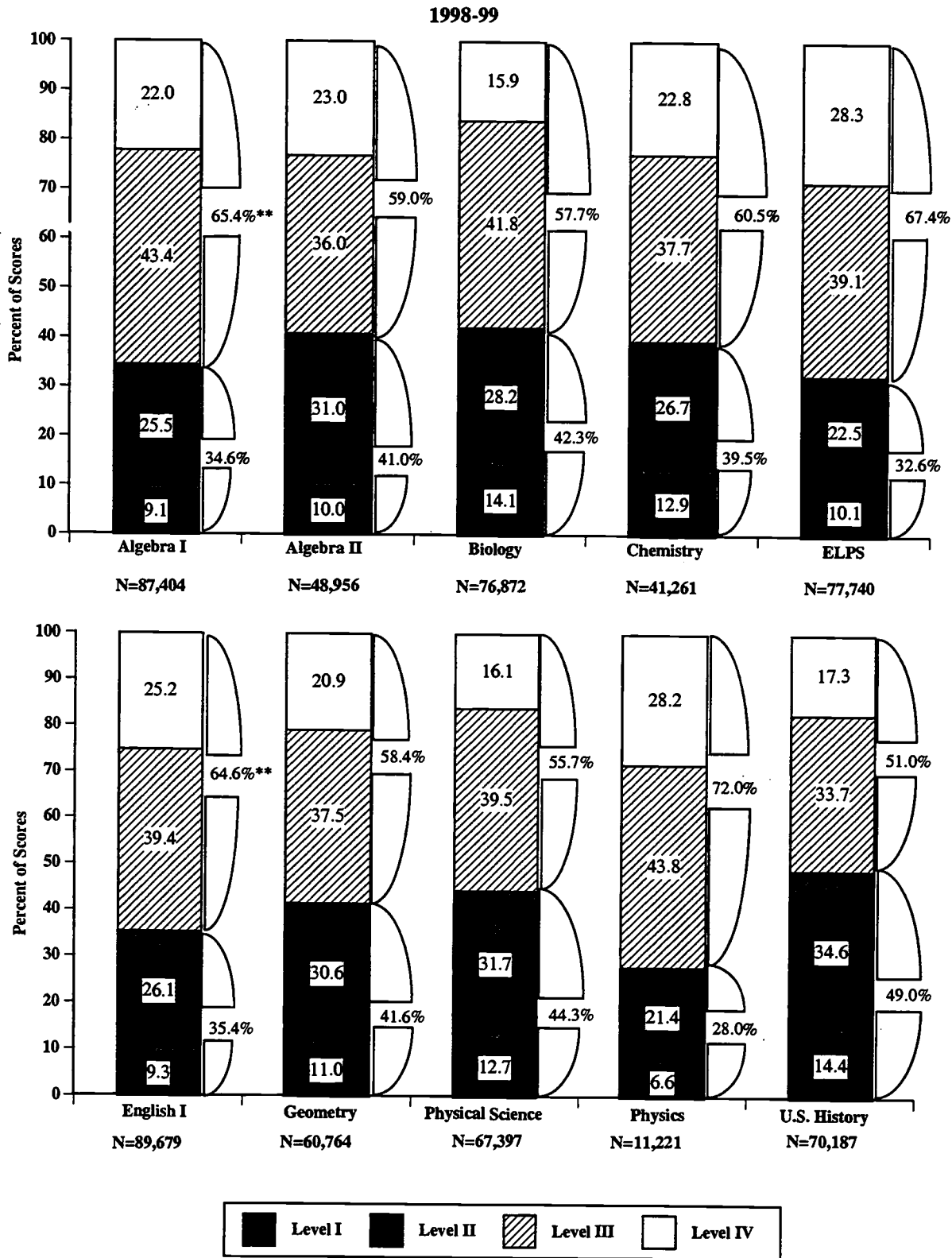


1997-98



Notes: *Beginning in the 1998-99 school year Algebra II, Chemistry, Geometry, Physical Science and Physics were mandated statewide; data for these tests are not available for 1994-95 through 1997-98.
**Level I/II and III/IV percents are calculated based on actual N-counts and are not the sum of each percent. Data for 1996-97 Algebra and Biology reflect changes made after publication of the 1996-97 Report Card. Due to rounding, data for some courses may not add to 100%.
Data received from LEAs and charter schools after August 2001 are not included in these figures.
Prepared by the NCDPI Division of Accountability Services/Testing Section.

Intro. Figure 15. 1994-95 to 2000-01 End-of-Course Multiple-Choice Test Results
Percent of Scores at Each Achievement Level in the Ten Core Courses*
 (Algebra I; Algebra II; Biology; Chemistry; Economic, Legal, & Political Systems; English I;
 Geometry; Physical Science; Physics and U.S. History) (continued)



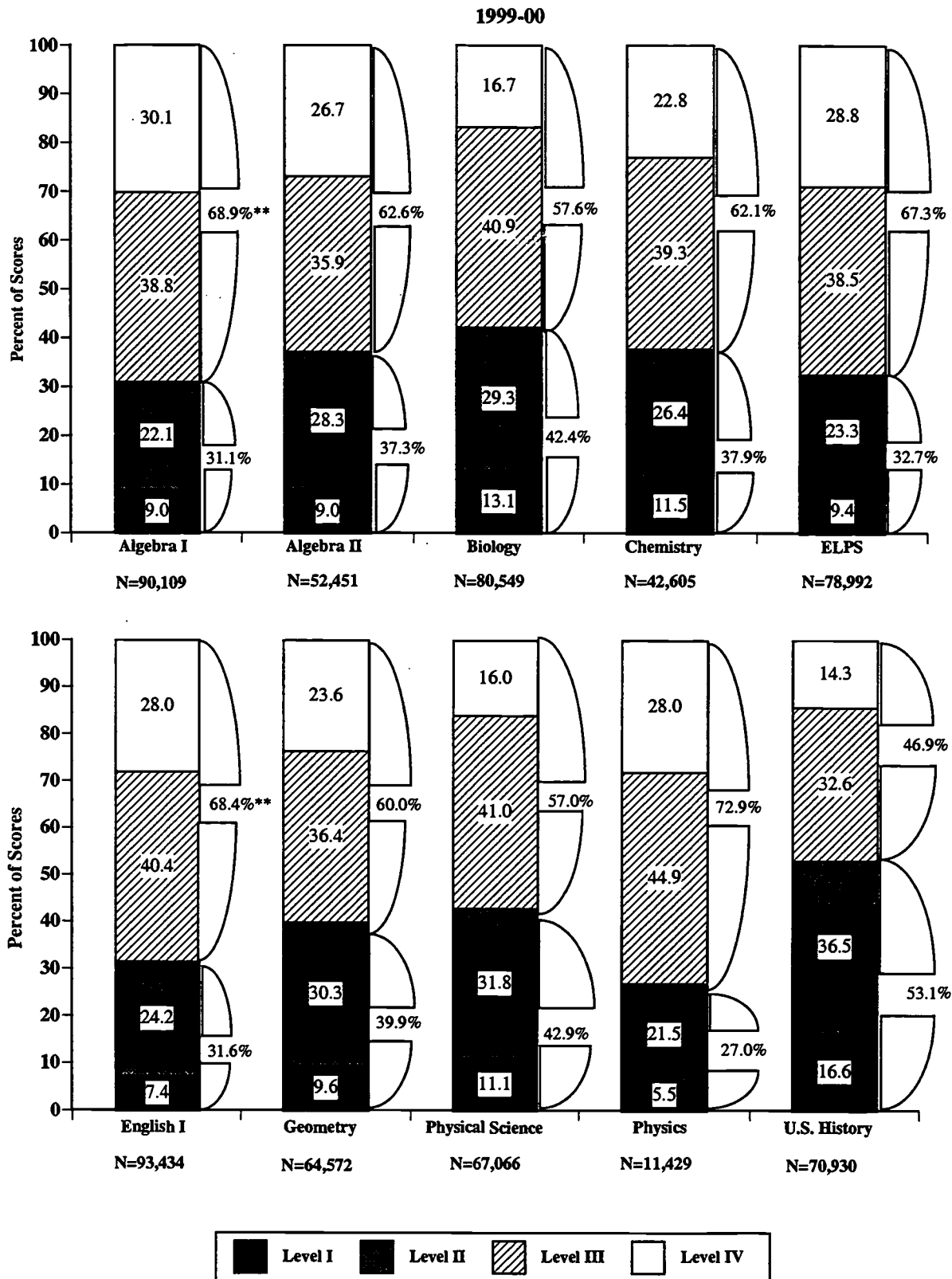
Notes: * Beginning in the 1998-99 school year Algebra II, Chemistry, Geometry, Physical Science and Physics were mandated statewide; data for these tests are not available for 1994-95 through 1997-98.

**Level I/II and Level III/IV percents are calculated based on actual N-counts and are not the sum of each percent. Due to rounding, data for some courses may not add to 100%.

Data received from LEAs and charter schools after August 2001 are not included in these figures.

Prepared by the NCDPI Division of Accountability Services/Testing Section.

Intro. Figure 15. 1994-95 to 2000-01 End-of-Course Multiple-Choice Test Results
Percent of Scores at Each Achievement Level in the Ten Core Courses*
 (Algebra I; Algebra II; Biology; Chemistry; Economic, Legal, & Political Systems; English I;
 Geometry; Physical Science; Physics and U.S. History) (continued)



Notes: * Beginning in the 1998-99 school year Algebra II, Chemistry, Geometry, Physical Science and Physics were mandated statewide; data for these tests are not available for 1994-95 through 1997-98.

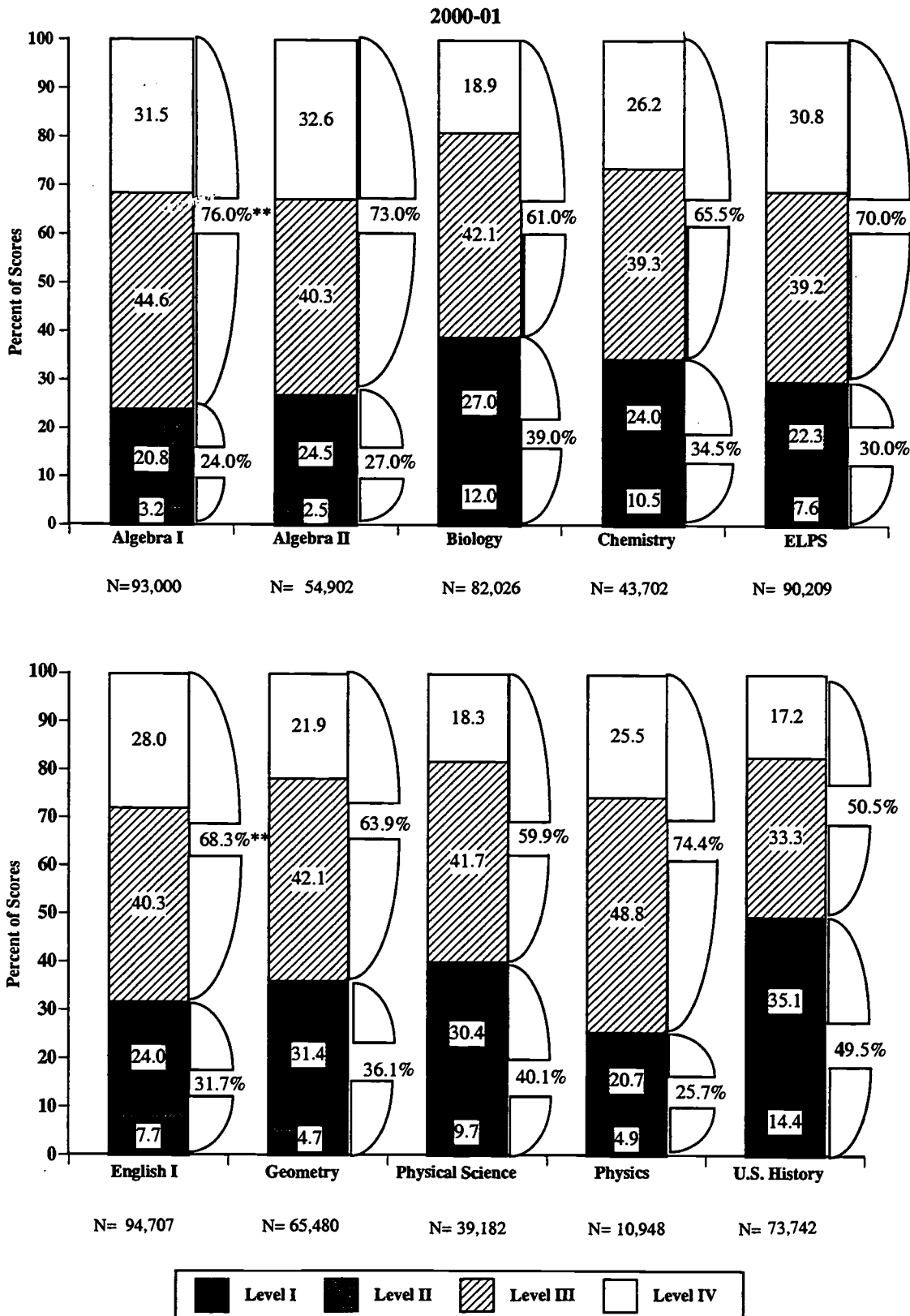
**Level I/II and Level III/IV percents are calculated based on actual N-counts and are not the sum of each percent.

Due to rounding, data for some courses may not add to 100%.

Data received from LEAs and charter schools after August 2001 are not included in these figures.

Prepared by the NCDPI Division of Accountability Services/Testing Section.

Intro. Figure 15. 1994-95 to 2000-01 End-of-Course Multiple-Choice Test Results
Percent of Scores at Each Achievement Level in the Ten Core Courses*
 (Algebra I; Algebra II; Biology; Chemistry; Economic, Legal, & Political Systems; English I;
 Geometry; Physical Science; Physics and U.S. History) (continued)



Notes: * Beginning in the 1998-99 school year Algebra II, Chemistry, Geometry, Physical Science and Physics were mandated statewide; data for these tests are not available for 1994-95 through 1997-98.

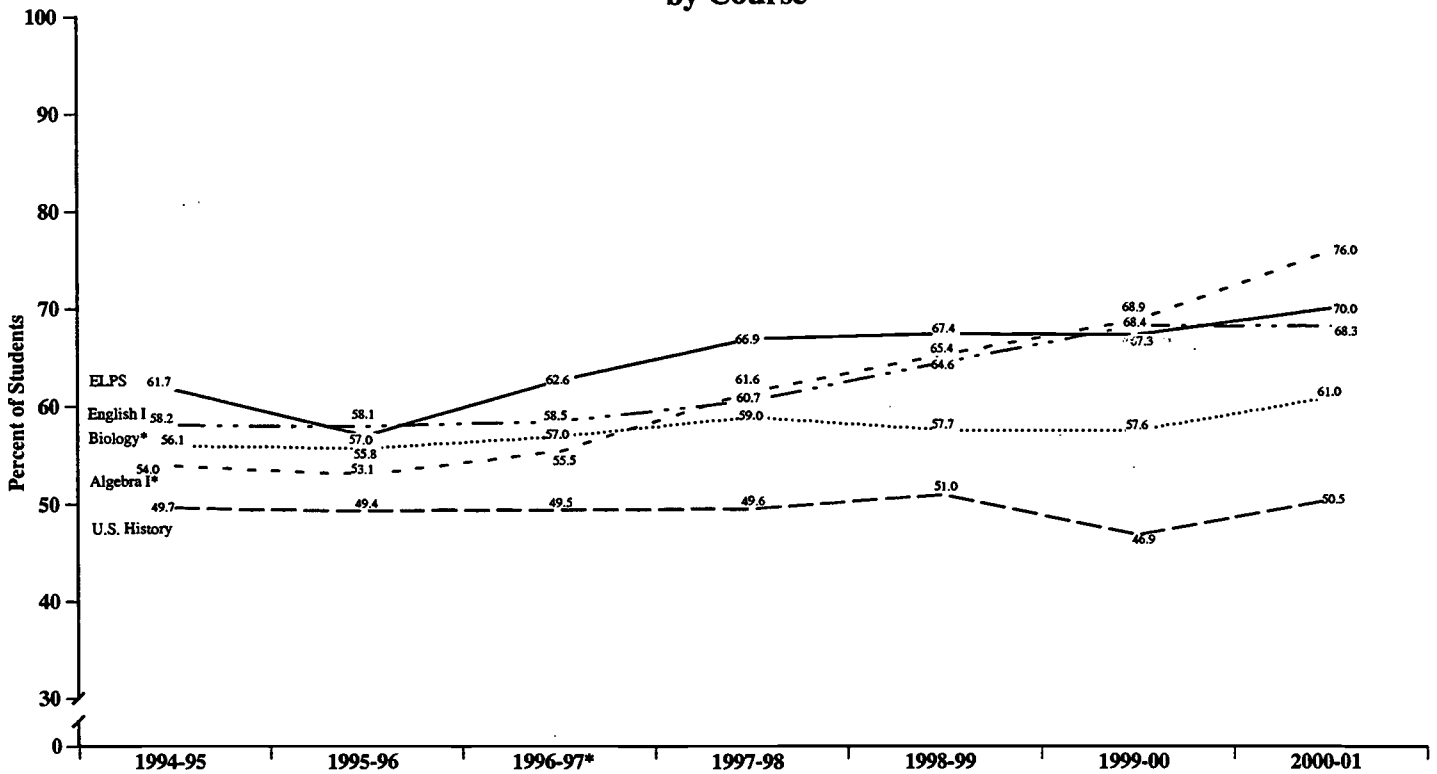
**Level I/II and Level III/IV percents are calculated based on actual N-counts and are not the sum of each percent.

Due to rounding, data for some courses may not add to 100%.

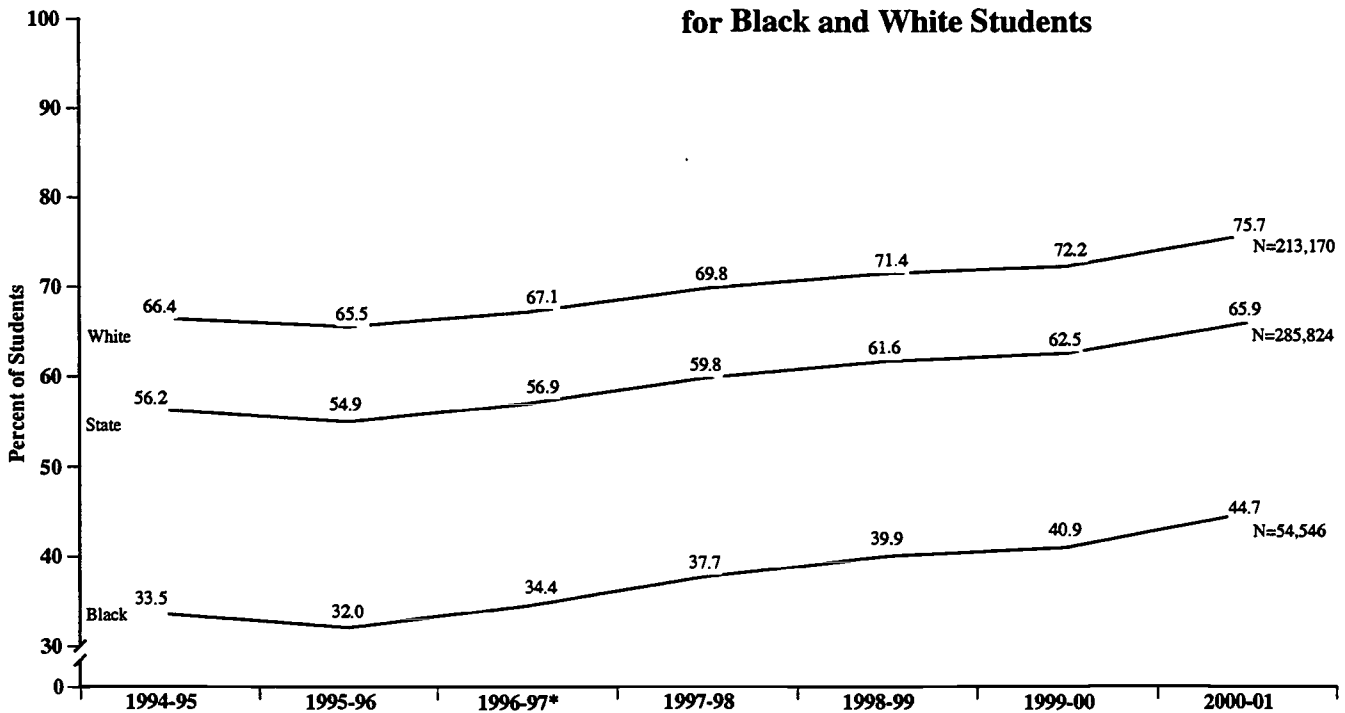
Data received from LEAs and charter schools after August 2001 are not included in these figures.

Prepared by the NCDPI Division of Accountability Services/Testing Section.

**Intro. Figure 16. 1994-95 to 2000-01 End-of-Course Multiple-Choice Test Results
Percent of Students At or Above Level III
by Course****



**Intro. Figure 17. 1994-95 to 2000-01 End-of-Course Multiple-Choice Test Results
Percent of Students At or Above Level III Across the Five Core Courses**
(Algebra I; Biology; Economic, Legal, and Political Systems; English I and U.S. History)
for Black and White Students**



Notes: *Data for 1996-97 Algebra I and Biology reflect changes made after publication of the 1996-97 Report Card.

**As of 1998-99, five additional courses were mandated. Since there are no data available from 1994-95 through 1997-98 for these five courses, they are not included in this figure.

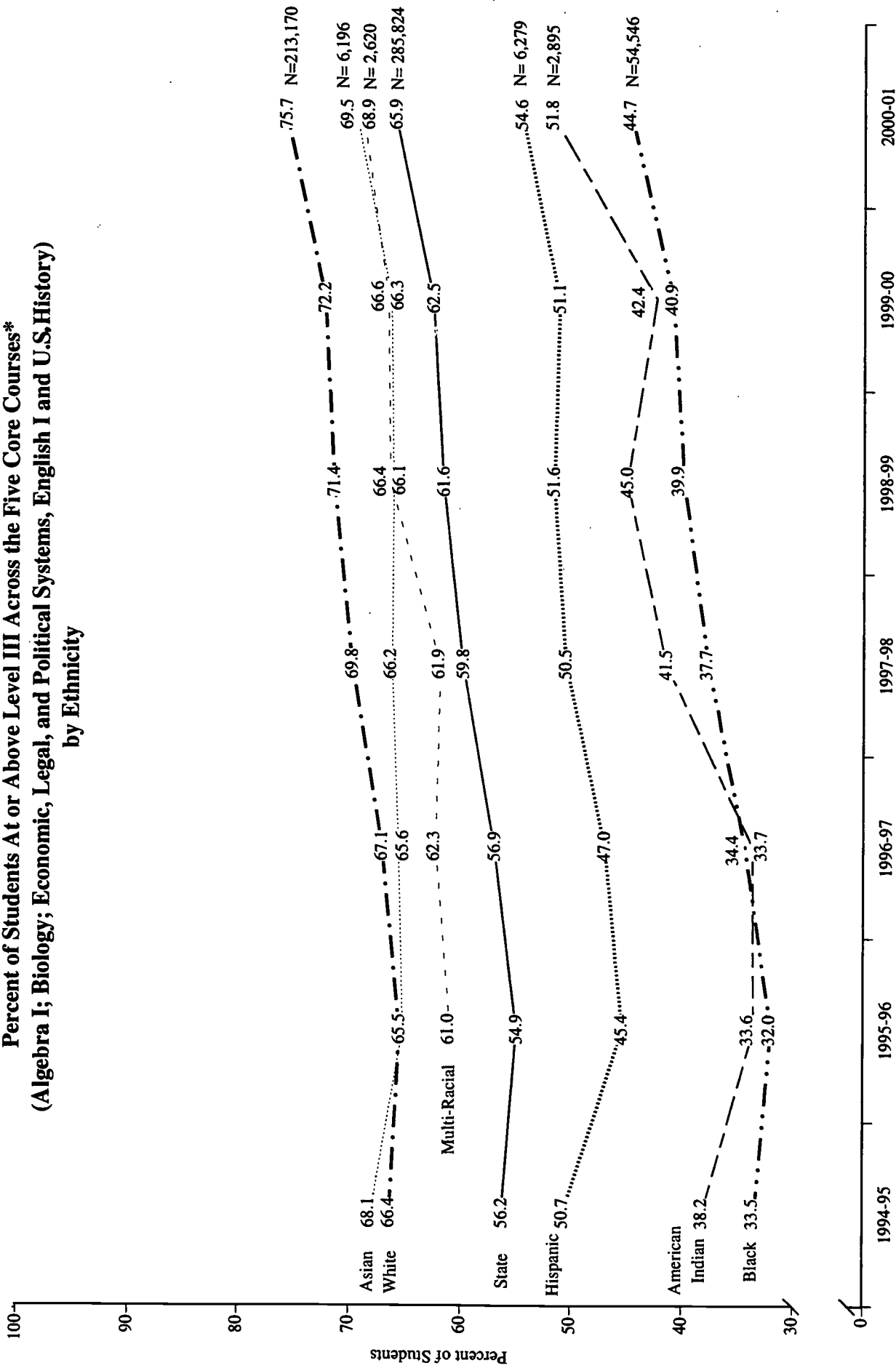
The inclusion of Black and White ethnic groups in this figure reflects their status as the largest ethnic groups in the state.

N counts equal the number of students At or Above Level III across the five courses for 2000-01; previous years are comparable.

Data received from LEAs and charter schools after August 2001 are not included in these figures.

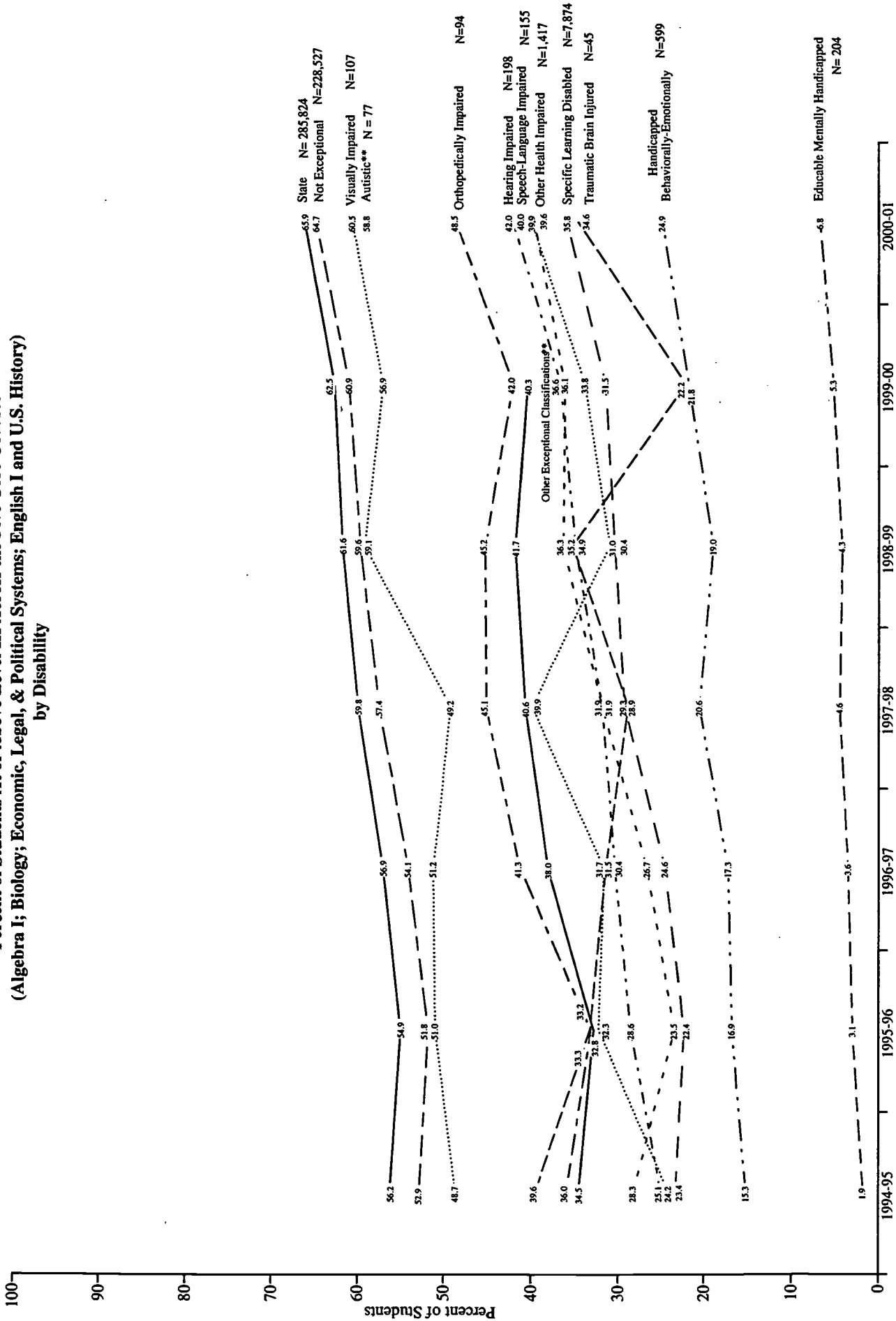
Prepared by the NCDPI Division of Accountability Services/Testing Section.

**Intro. Figure 18. 1994-95 to 2000-01 End-of-Course Multiple-Choice Test Results
Percent of Students At or Above Level III Across the Five Core Courses*
(Algebra I; Biology; Economic, Legal, and Political Systems, English I and U.S. History)
by Ethnicity**



Notes: *As of 1998-99, five additional courses were mandated. Since there are no data available from 1994-95 through 1997-98 for these five courses, they are not included in this figure.
Data for 1996-97 Algebra I and Biology reflect changes made after publication of the 1996-97 Report Card.
Multi-Racial results were not reported in 1994-95.
N counts equal the number of students At or Above Level III across the five courses for 2000-01; previous years are comparable.
Data received from LEAs and charter schools after August 2001 are not included in this figure.
Prepared by the NCDPI Division of Accountability Services/Testing Section.

**Intro. Figure 19. 1994-95 to 2000-01 End-of-Course Multiple-Choice Test Results
Percent of Students At or Above Level III Across the Five Core Courses*
(Algebra I; Biology; Economic, Legal, & Political Systems; English I and U.S. History)
by Disability**



Notes: *As of 1998-99, five additional courses were mandated. Since there are no data available from 1994-95 through 1997-98 for these five courses, they are not included in this figure.

**Other Exceptional Classifications is no longer reported as a category starting in 2000-01; Autistic is reported as a separate category in 2000-01.

Data for 1996-97 Algebra I and Biology reflect changes made after publication of the 1996-97 Report Card.

N counts equal the number of students at or above Level III across the five courses for 2000-01; previous years are comparable. No scores are reported for groups with fewer than thirty students.

Data received from LEAs and charter schools after August 2001 are not included in this figure.

Prepared by the NCDPI Division of Accountability Services/Testing Section.

Grade 3 Pretest Multiple-Choice Results

Table 1. 1996-97 to 2000-01 Grade 3 Pretest Multiple-Choice Results
Statewide Summary
Reading and Mathematics

	Reading			Mathematics		
	Number Tested	Mean Scale Score	Percent Students at Achievement Levels III, IV	Number Tested	Mean Scale Score	Percent Students at Achievement Levels III, IV
1996-97	94,551 137.8	65.3% 8.6	94,846 130.0	70.3% 8.2		
1997-98	99,583 137.7	65.3% 8.5	99,801 130.2	71.5% 8.0		
1998-99	101,394 138.1	67.4% 8.5	101,639 130.9	74.7% 7.9		
1999-00	102,143 138.7	69.8% 8.6	102,309 131.6	76.9% 7.8		
2000-01	102,200 138.9	71.1% 8.4	102,484 236.1	79.2% 8.1		

Notes: The North Carolina mathematics tests measure the competencies in the 1998 North Carolina mathematics curriculum beginning in the 2000-01 school year. Prior to 2000-01, the grade 3 pretest mathematics scale score range was 105 to 154; beginning in 2000-01, the grade 3 pretest mathematics scale score range is 211 to 260. The adjusted achievement level ranges for mathematics generated in September 2001 were used to calculate all 2001 data in this publication. Data received from LEAs and charter schools after August 2001 are not included in this table. Prepared by the NCDPI Division of Accountability Services/Testing Section

**Table 2. 1996-97 to 2000-01 Grade 3 Pretest Multiple-Choice Results
Percent of Students at Each Achievement Level by Gender and Ethnicity
Reading**

Achievement Levels	All Students		American					Multi-	
	Female	Male	Indian	Asian	Black	Hispanic	Racial	White	
Level I									
Students performing at Achievement Level I do not have sufficient mastery of knowledge and skills in the subject area to be successful at the next grade level.	1997 11.3	8.8	13.7	17.6	8.4	17.4	16.0	12.2	8.2
	1998 11.3	8.9	13.7	17.8	7.3	17.5	17.9	10.5	7.9
	1999 10.2	7.7	12.5	15.2	7.7	15.3	14.4	8.7	7.4
	2000 9.1	7.1	11.1	13.4	7.5	13.8	14.2	8.0	6.4
	2001 8.2	6.3	10.1	13.7	5.2	12.6	11.4	7.9	5.9
Level II									
Students performing at Achievement Level II demonstrate inconsistent mastery of knowledge and skills in the subject area and are minimally prepared to be successful at the next grade level.	1997 23.4	20.6	26.2	31.7	18.7	32.3	33.9	23.1	18.8
	1998 23.4	20.8	25.9	30.4	19.6	32.2	30.6	21.9	18.7
	1999 22.5	20.0	24.8	31.1	19.3	30.8	31.5	20.8	17.9
	2000 21.1	18.3	23.7	29.8	19.5	28.8	28.5	19.2	16.6
	2001 20.6	17.8	23.3	26.0	19.0	29.2	30.2	19.0	15.7
Level III									
Students performing at Achievement Level III consistently demonstrate mastery of the grade level subject matter and skills and are well-prepared for the next grade level.	1997 39.5	41.5	37.5	39.0	40.7	39.0	36.8	43.2	39.7
	1998 40.1	42.4	37.8	39.7	42.1	39.2	38.7	41.6	40.5
	1999 41.1	42.6	39.7	39.7	39.5	41.6	40.3	42.2	41.0
	2000 41.3	42.7	39.8	40.9	38.3	43.3	42.0	43.2	40.2
	2001 42.7	44.4	41.1	45.4	42.0	44.3	44.8	43.1	41.9
Level IV									
Students performing at Achievement Level IV consistently perform in a superior manner clearly beyond that required to be proficient at grade level work.	1997 25.8	29.1	22.7	11.7	32.2	11.3	13.4	21.5	33.3
	1998 25.3	27.9	22.7	12.1	31.1	11.1	12.8	25.9	32.8
	1999 26.2	29.6	23.0	14.0	33.6	12.3	13.8	28.3	33.7
	2000 28.5	31.8	25.3	15.9	34.7	14.1	15.4	29.7	36.8
	2001 28.5	31.6	25.5	15.0	33.8	13.8	13.7	30.0	36.5

Grade 3 Pretest Achievement Level Ranges - Reading

Level I	Level II	Level III	Level IV
119-127	128-132	133-144	145-162

Notes: Percents are rounded to the nearest tenth. Due to rounding, data may not add to 100%.
Data received from LEAs and charter schools after August 2001 are not included in this table.
Prepared by the NCDPI Division of Accountability Services/Testing Section

**Table 3. 1996-97 to 2000-01 Grade 3 Pretest Multiple-Choice Results
Percent of Students at Each Achievement Level by Gender and Ethnicity
Mathematics**

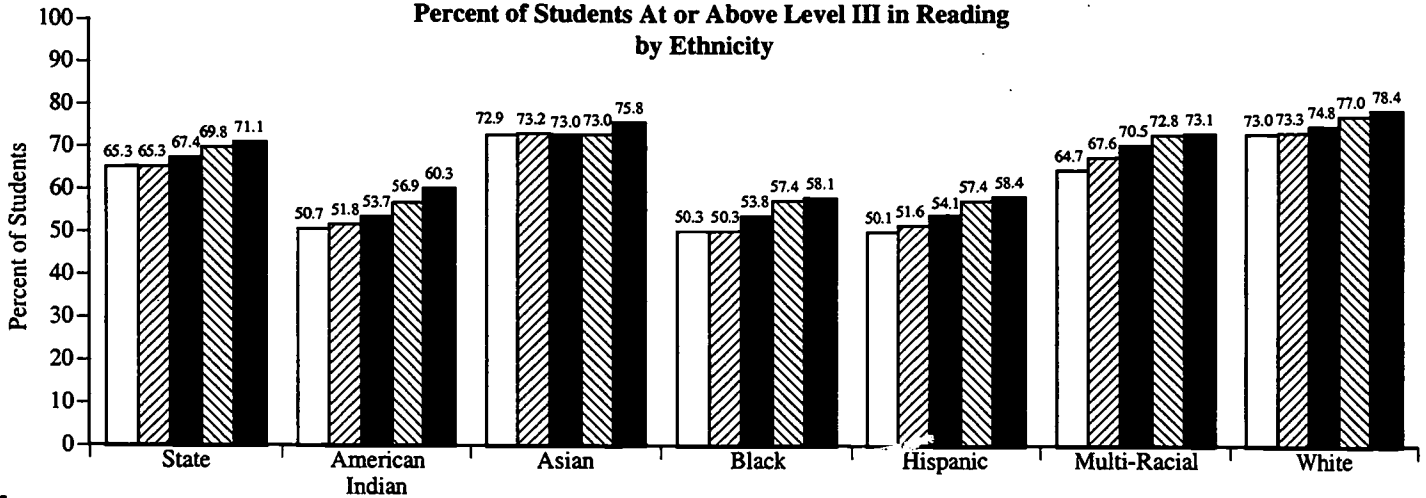
Achievement Levels	All Students		American				Multi-	
	Female	Male	Indian	Asian	Black	Hispanic	Racial	White
Level I								
Students performing at Achievement Level I do not have sufficient mastery of knowledge and skills in the subject area to be successful at the next grade level.	1997 6.2	5.4 6.9	8.6	2.6	10.9	9.7	5.2	3.8
	1998 5.4	4.7 6.1	7.6	2.8	9.6	7.4	4.0	3.3
	1999 4.6	4.0 5.2	7.5	1.8	8.3	6.7	4.7	2.7
	2000 3.3	2.9 3.8	6.6	1.4	5.9	4.8	1.8	2.0
	2001 2.0	1.6 2.4	3.3	1.0	3.7	2.8	1.6	1.1
Level II								
Students performing at Achievement Level II demonstrate inconsistent mastery of knowledge and skills in the subject area and are minimally prepared to be successful at the next grade level.	1997 23.5	22.5 24.6	37.2	16.4	35.4	32.0	24.7	17.5
	1998 23.1	22.2 24.0	33.8	16.2	34.3	33.2	23.5	17.1
	1999 20.6	19.5 21.7	31.1	14.4	31.0	28.5	18.1	15.1
	2000 19.7	18.6 20.8	28.6	14.3	29.8	24.8	18.9	14.2
	2001 18.9	17.8 19.9	28.4	13.5	31.1	25.2	18.3	12.4
Level III								
Students performing at Achievement Level III consistently demonstrate mastery of the grade level subject matter and skills and are well-prepared for the next grade level.	1997 40.6	41.6 39.5	41.2	40.0	41.8	42.9	44.0	39.9
	1998 41.3	42.6 40.0	43.5	38.4	44.1	43.1	45.3	39.8
	1999 41.8	42.9 40.8	43.5	40.5	46.1	46.3	44.3	39.5
	2000 41.7	42.7 40.7	42.2	36.4	47.4	48.0	44.4	38.5
	2001 43.4	44.9 41.9	46.6	40.6	49.7	50.3	44.4	40.1
Level IV								
Students performing at Achievement Level IV consistently perform in a superior manner clearly beyond that required to be proficient at grade level work.	1997 29.7	30.5 28.9	13.0	41.0	11.9	15.5	26.1	38.7
	1998 30.2	30.5 39.9	15.2	42.6	12.0	16.2	27.2	39.7
	1999 32.9	33.6 32.3	17.9	43.3	14.7	18.5	32.8	42.7
	2000 35.3	35.8 34.7	22.7	47.9	16.9	22.4	35.0	45.3
	2001 35.8	35.7 35.9	21.7	44.9	15.5	21.7	35.7	46.5

Grade 3 Pretest Achievement Level Ranges - Mathematics			
Level I	Level II	Level III	Level IV
211-219	220-229	230-239	240-260

Notes: Percents are rounded to the nearest tenth. Due to rounding, data may not add to 100%.
Data received from LEAs and charter schools after August 2001 are not included in this table.
Prepared by the NCDPI Division of Accountability Services/Testing Section.



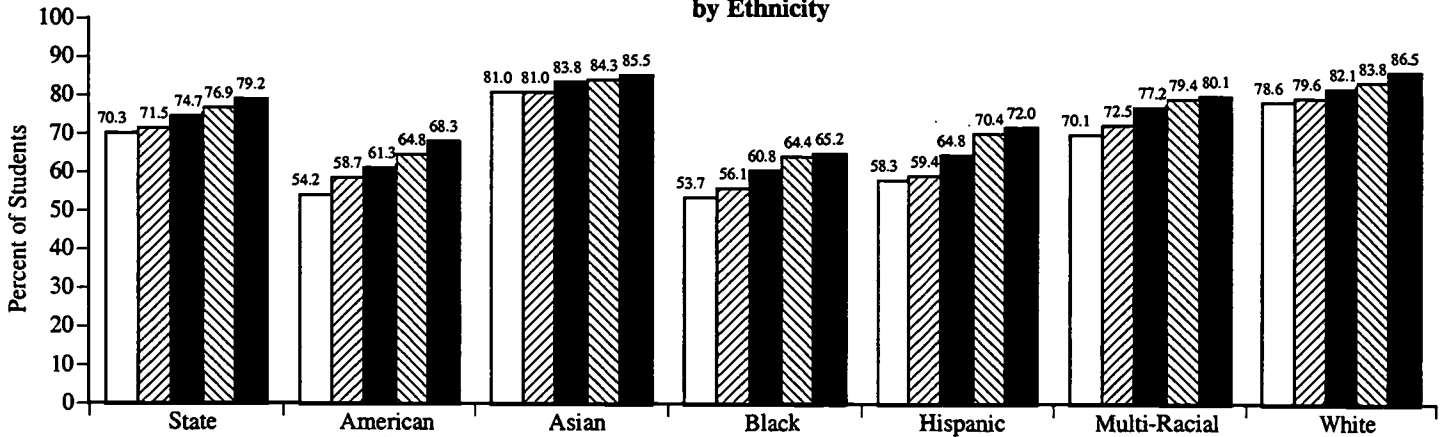
**Figure 1. 1996-97 to 2000-01 Grade 3 Pretest Multiple-Choice Results
Percent of Students At or Above Level III in Reading
by Ethnicity**



	State	American Indian	Asian	Black	Hispanic	Multi-Racial	White
1996-97							
N Tested	94,551	1,396	1,149	28,565	1,931	572	60,620
N Level III, IV	61,725	708	838	14,373	968	370	44,254
1997-98							
N Tested	99,583	1,482	1,375	30,610	2,440	752	62,708
N Level III, IV	65,068	768	1,006	15,396	1,258	508	45,982
1998-99							
N Tested	101,394	1,487	1,538	30,994	2,928	1,169	63,153
N Level III, IV	68,313	799	1,123	16,690	1,583	824	47,208
1999-00							
N Tested	102,143	1,595	1,594	31,504	3,590	1,531	62,158
N Level III, IV	71,282	907	1,163	18,071	2,060	1,115	47,852
2000-01							
N Tested	102,200	1,528	1,583	30,151	4,293	1,746	58,951
N Level III, IV	72,712	922	1,200	17,531	2,509	1,277	46,225



**Figure 2. 1996-97 to 2000-01 Grade 3 Pretest Multiple-Choice Results
Percent of Students At or Above Level III in Mathematics
by Ethnicity**



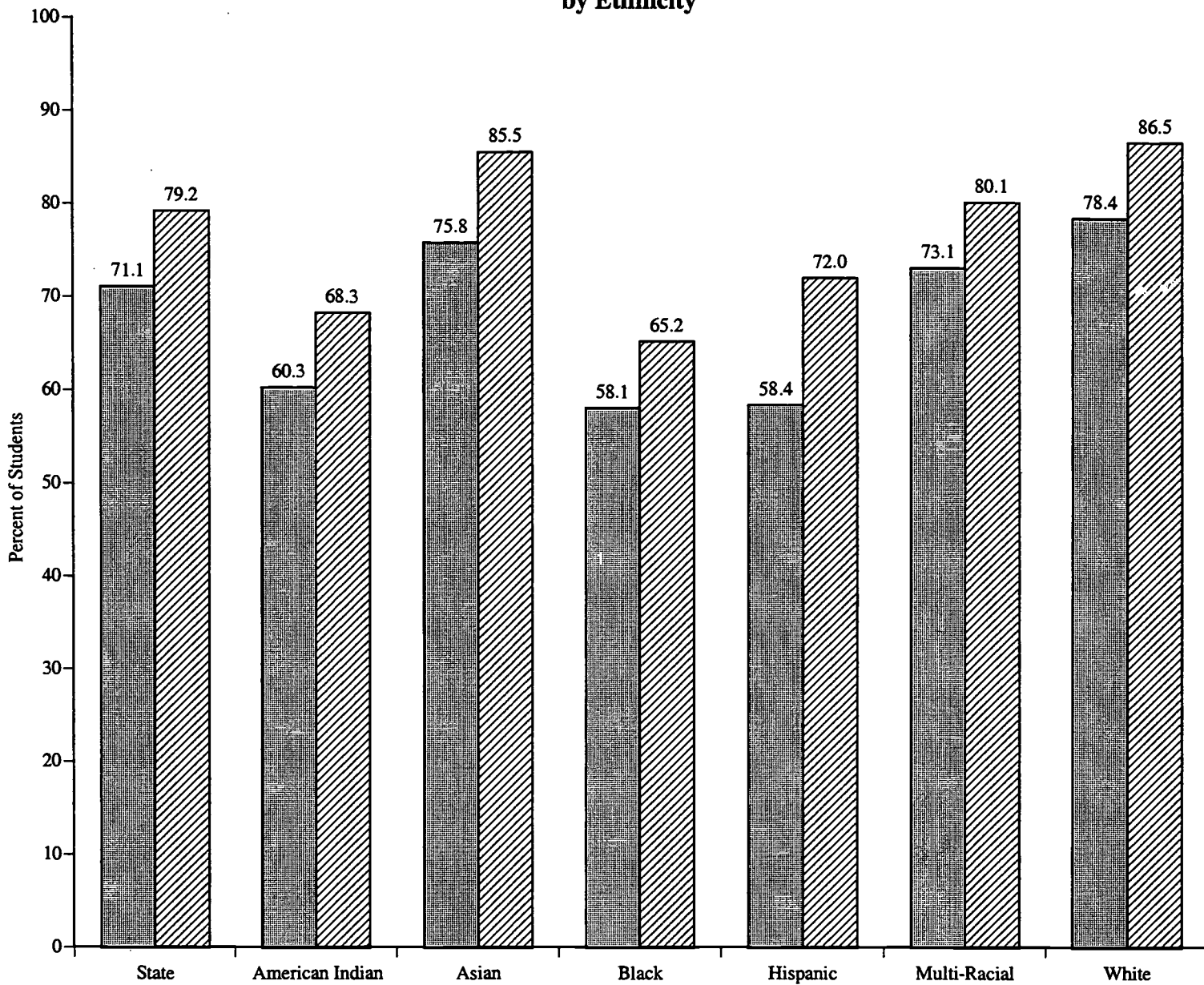
	State	American Indian	Asian	Black	Hispanic	Multi-Racial	White
1996-97							
N Tested	94,846	1,400	1,158	28,681	1,961	575	60,750
N Level III, IV	66,659	759	938	15,395	1,144	403	47,768
1997-98							
N Tested	99,801	1,483	1,379	30,696	2,459	753	62,816
N Level III, IV	71,363	870	1,117	17,225	1,460	546	49,979
1998-99							
N Tested	101,639	1,498	1,539	31,119	2,946	1,169	63,242
N Level III, IV	75,967	919	1,290	18,906	1,909	902	51,943
1999-00							
N Tested	102,309	1,601	1,598	31,583	3,598	1,533	62,225
N Level III, IV	78,712	1,038	1,347	20,333	2,532	1,217	52,129
2000-01							
N Tested	102,484	1,531	1,582	30,259	4,316	1,750	59,081
N Level III, IV	81,121	1,045	1,353	19,732	3,107	1,401	51,122

Notes: "N Tested" and "N Level III, IV" for the ethnicity categories do not sum to the "N Tested" and "N Level III, IV" because students for whom an ethnicity was not indicated were reported in the state data only.

Data received from LEAs and charter schools after August 2001 are not included in these figures.

Prepared by the NCDPI Division of Accountability Services/Testing Section.

**Figure 3. 2000-01 Grade 3 Pretest Multiple-Choice Results
Percent of Students At or Above Level III in Reading and Mathematics
by Ethnicity**



Reading

N Tested	102,200	1,528	1,583	30,151	4,293	1,746	58,951
N Level III, IV	72,712	922	1,200	17,531	2,509	1,277	46,225

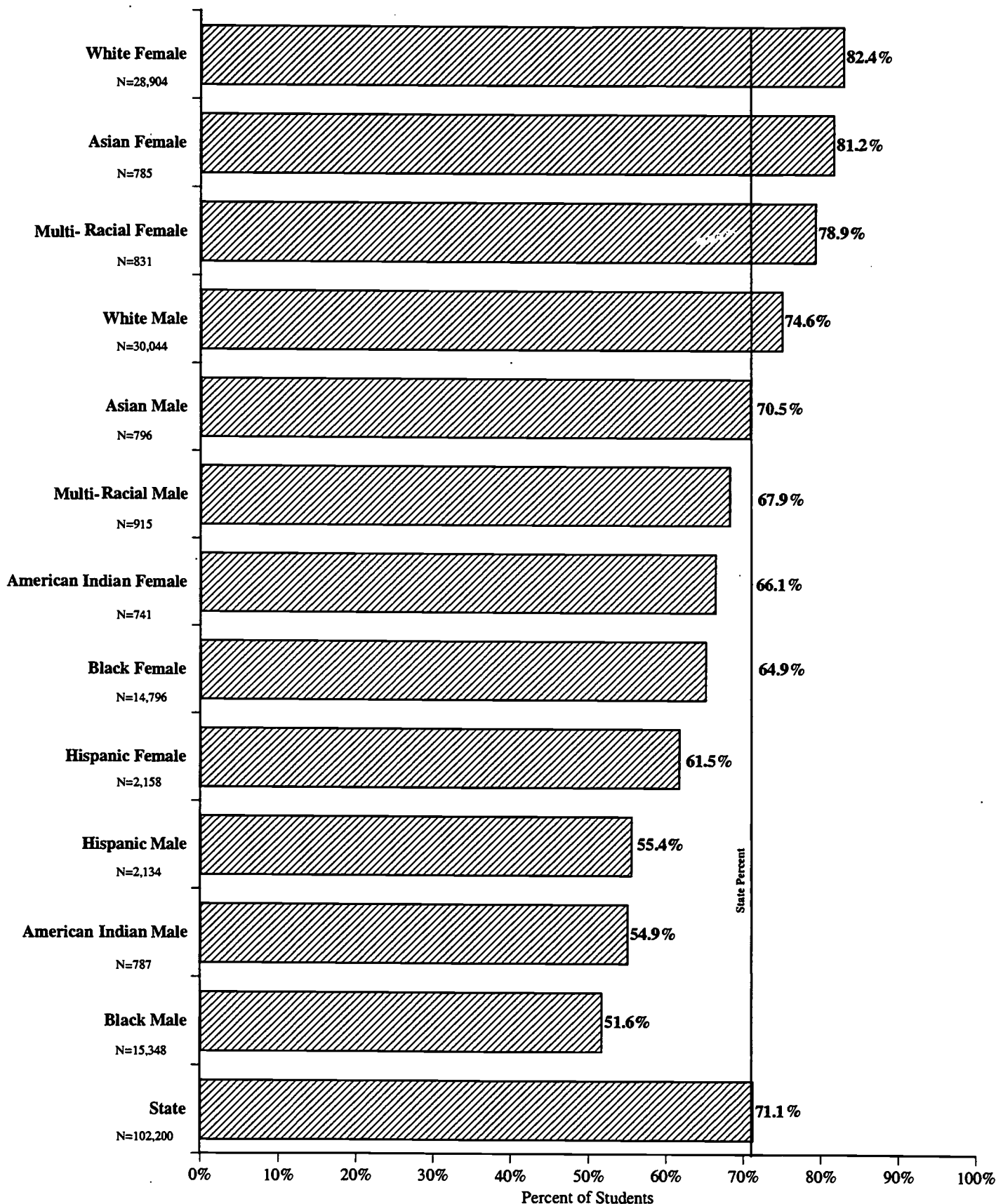
Mathematics

N Tested	102,484	1,531	1,582	30,259	4,316	1,750	59,081
N Level III, IV	81,121	1,045	1,353	19,732	3,107	1,401	51,122



Note: Data received from LEAs and charter schools after August 2001 are not included in this figure.
Prepared by the NCDPI Division of Accountability Services/Testing Section.

**Figure 4. 2000-01 Grade 3 Pretest Multiple-Choice Results
Percent of Students At or Above Level III in Reading
by Gender and Ethnicity**



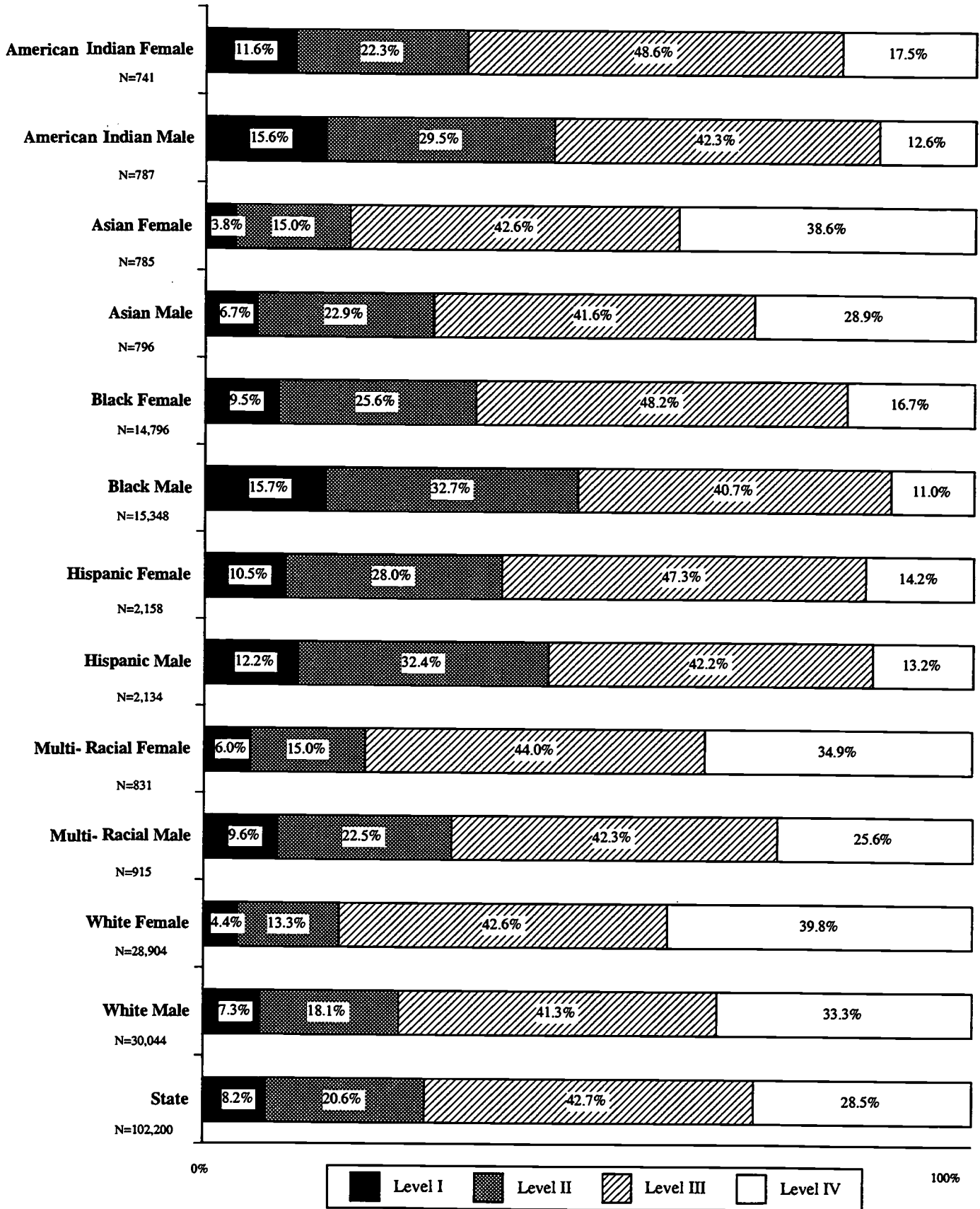
Note: Data received from LEAs and charter schools after August 2001 are not included in this figure.
Prepared by the NCDPI Division of Accountability Services/Testing Section.

**Figure 5. 2000-01 Grade 3 Pretest Multiple-Choice Results
Percent of Students At or Above Level III in Mathematics
by Gender and Ethnicity**



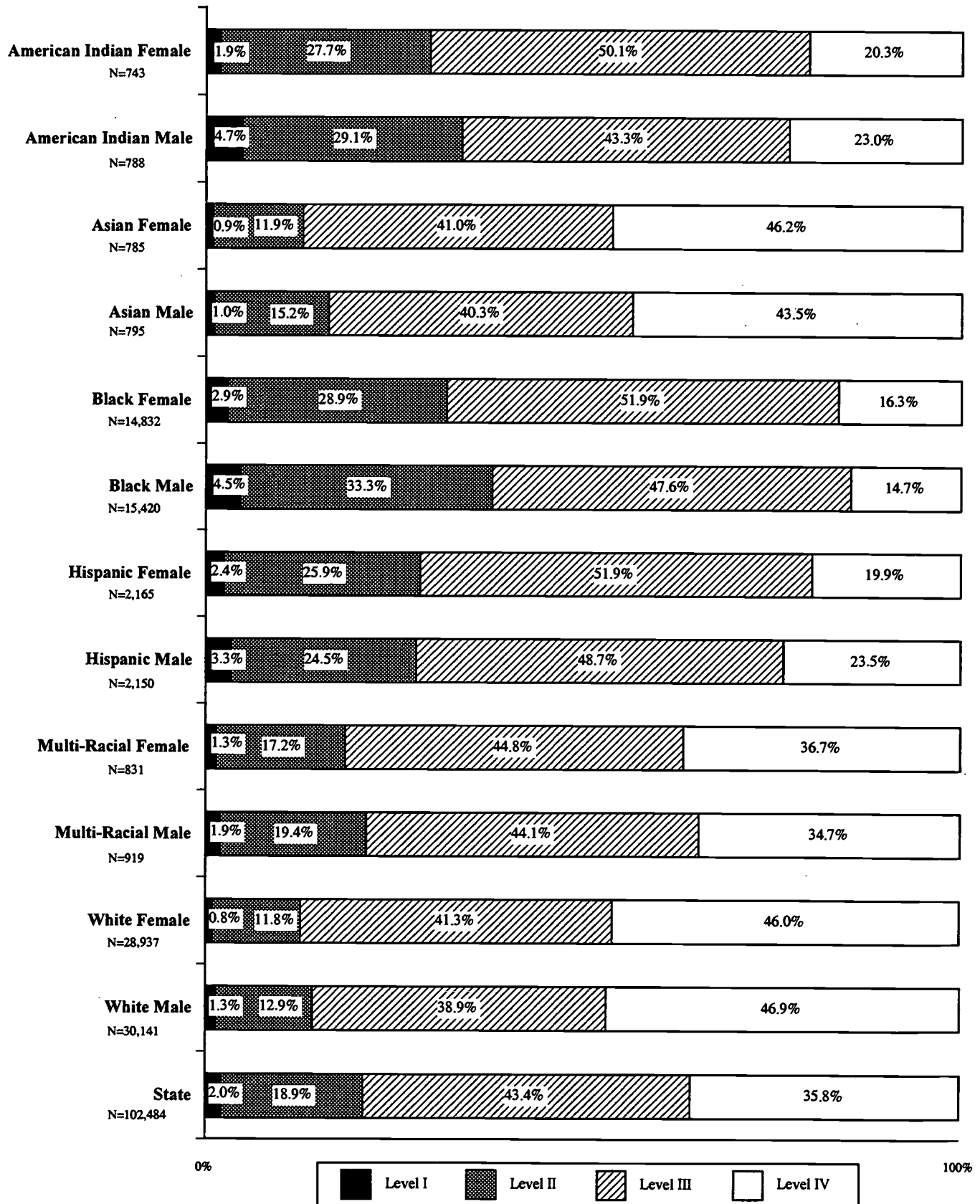
Note: Data received from LEAs and charter schools after August 2001 are not included in this figure. Prepared by the NCDPI Division of Accountability Services/Testing Section.

**Figure 6. 2000-01 Grade 3 Pretest Multiple-Choice Results
Percent of Students at Each Achievement Level in Reading
by Gender and Ethnicity**



Notes: Achievement levels for each ethnic category may not add to 100% due to rounding.
Data received from LEAs and charter schools after August 2001 are not included in this figure.
Prepared by the NCDPI Division of Accountability Services/Testing Section.

**Figure 7. 2000-01 Grade 3 Pretest Multiple-Choice Results
Percent of Students at Each Achievement Level in Mathematics
by Gender and Ethnicity**



Notes: Achievement levels for each ethnic category may not add to 100% due to rounding.
Data received from LEAs and charter schools after August 2001 are not included in this figure.
Prepared by the NCDPI Division of Accountability Services/Testing Section.

**Table 4. 2000-01 Grade 3 Pretest Multiple-Choice Results
Performance of Academically Gifted, Exceptional, Limited English Proficient and Title I Students**

<u>Category</u>	<u>Number Tested</u>	<u>Percent**</u>	<u>Percent At or Above Level III</u>	<u>Percent At or Above Level III</u>	<u>Average Scale Score</u>	<u>Average Scale Score</u>
			<u>Reading</u>	<u>Mathematics</u>	<u>Reading</u>	<u>Mathematics***</u>
All Students	102,200	100.0	71.1	79.2	138.9	236.1
Not Exceptional	87,312	85.7	73.1	80.3	139.0	236.1
Academically Gifted	4,304	4.2	98.5	99.3	149.3	246.4
Students with Disabilities	10,247	10.1	43.4	61.5	133.4	232.1
Behaviorally-Emotionally Handicapped	563	0.6	36.1	54.1	132.2	230.5
Hearing Impaired	135	0.1	55.6	62.1	134.8	231.9
Educable Mentally Handicapped	905	0.9	18.8	17.0	129.3	224.4
Specific Learning Disabled	4,602	4.5	35.4	64.5	132.1	232.4
Speech-Language Impaired	2,819	2.8	64.5	73.0	137.1	234.7
Visually Impaired	54	0.1	50.0	72.2	134.9	233.8
Other Health Impaired	970	1.0	43.4	61.4	133.1	231.5
Orthopedically Impaired	60	0.1	60.0	59.0	135.5	230.5
Traumatic Brain Injured	15	0.0	*	*	*	*
Autistic	109	0.1	50.5	57.1	134.3	231.7
Severe/Profound Mentally Disabled	1	0.0	*	*	*	*
Multihandicapped	13	0.0	*	*	*	*
Deaf-Blind	1	0.0	*	*	*	*
Section 504	410	0.4	58.5	71.8	135.9	233.7
Limited English Proficient	2,150	2.1	46.2	65.9	133.3	232.0
Not Served by Title I	57,285	56.1	76.4	84.3	140.3	237.6
Schoolwide Title I Program	40,741	39.9	65.2	73.2	137.2	234.3
Targeted Assistance	3,425	3.4	55.7	66.2	135.5	232.9
Migrant	859	0.8	55.2	66.2	135.0	232.8

Notes: *No scores are reported for groups with fewer than thirty students.

**Percent for "Not Exceptional" through "Deaf-Blind" is based on the sum of the students in those categories.

Percent for "Section 504" through "Migrant" is based on the number tested in the "All Students" category.

"Not Exceptional," "Academically Gifted" and "Students with Disabilities" do not sum to "All Students" because some answer sheets did not indicate whether or not students were classified as exceptional. The "All Students" and "Not Exceptional" categories are added for comparison purposes.

Data received from LEAs and charter schools after August 2001 are not included in this table.

**The adjusted achievement level ranges for mathematics generated in September 2001 were used to calculate all 2001 data.

Prepared by the NCDPI Division of Accountability Services/Testing Section

**Table 5. 2000-01 Grade 3 Pretest Multiple-Choice Results
Performance of Students Using Accommodations**

<u>Category</u>	<u>Number Tested</u>	<u>Percent</u>	<u>Percent At or</u>	<u>Percent At or</u>	<u>Average</u>	<u>Average</u>
			<u>Above Level III</u>	<u>Above Level III</u>	<u>Scale Score</u>	<u>Scale Score</u>
			<u>Reading</u>	<u>Mathematics</u>	<u>Reading</u>	<u>Mathematics***</u>
All Students	102,200	100.0	71.1	79.2	138.9	236.1
Braille Edition	5	0.0	*	*	*	*
Large Print	63	0.3	50.8	66.7	135.2	233.3
Assistive Technology	34	0.1	32.4	62.9	131.8	231.0
Cranmer Abacus	4	0.0	*	*	*	*
Dictation to Scribe	120	0.5	30.8	55.3	131.1	231.0
Interpreter Signs Test**	22	0.1	*	*	*	*
Magnification Devices	16	0.1	*	*	*	*
Student Marks in Test Book	4,072	17.0	36.1	62.8	132.1	232.0
Test Administrator Reads Test Aloud**	5,441	22.8	30.4	63.2	131.2	232.0
Use of Typewriter or Word Processor	4	0.0	*	*	*	*
Hospital/Home Testing	3	0.0	*	*	*	*
Multiple Test Sessions	1,710	7.2	33.9	60.0	131.8	231.7
Scheduled Extended Time	6,186	25.9	36.1	62.9	132.0	232.0
Testing in a Separate Room	6,142	25.7	35.5	62.0	132.0	231.8
English/Native Language Dictionary/ Electronic Translator	92	0.4	41.3	80.4	132.7	233.9

Notes: * No scores are reported for groups with fewer than thirty students.

**The "Interpreter Signs Test" and "Test Administrator Reads Test Aloud" accommodations are prohibited from use during the administration of state tests that measure reading skills.

Accommodations are available for students with disabilities, limited English proficiency or temporary disabilities.

***The adjusted achievement level ranges for mathematics generated in September 2001 were used to calculate all 2001 data.

All data are rounded to the nearest tenth, therefore, accommodation categories may not sum to 100%.

Data received from LEAs and charter schools after August 2001 are not included in this table.

Prepared by the NCDPI Division of Accountability Services/Testing Section.

**Table 6. 2000-01 Grade 3 Pretest Multiple-Choice Test Results
Participation of Students with Special Needs****

<u>Grade 3 Pretest</u>	<u>Reading Tested</u>	<u>Percent</u>	<u>Mathematics Tested</u>	<u>Percent</u>
Statewide*	106,621	100.0	106,621	100.0
All Students with IEPs	12,398	11.6	12,398	11.6
Standard Administration	10,247	9.6	10,247	9.6
With Accommodations	6,150	5.8	6,150	5.8
Alternate Assessments				
NCAAP***	140	0.1	140	0.1
Behaviorally-Emotionally Disabled	6	0.0	6	0.0
Hearing Impaired	4	0.0	4	0.0
Educable Mentally Disabled	31	0.0	31	0.0
Specific Learning Disabled	7	0.0	7	0.0
Speech-Language Impaired	1	0.0	1	0.0
Visually impaired	0	0.0	0	0.0
Other Health Impaired	5	0.0	5	0.0
Orthopedically Impaired	1	0.0	1	0.0
Traumatic Brain Injured	0	0.0	0	0.0
Autistic	32	0.0	32	0.0
Severe/Profound Mentally Disabled	38	0.0	38	0.0
Multihandicapped	15	0.0	15	0.0
Deaf-Blind	0	0.0	0	0.0
Trainable Mentally Disabled	0	0.0	0	0.0
All Students Identified Only Under Section 504**	436	0.4	436	0.4
Standard Administration	410	0.4	411	0.4
With Accommodations	285	0.3	285	0.3
Alternate Assessments				
NCAAP***	4	0.0	4	0.0
All Limited English Proficient Students**	3,007	2.8	3,007	2.8
Standard Administration	2,150	2.0	2,165	2.0
With Accommodations	1,107	1.0	1,107	1.0
Not Participating				
First Year	536	0.5	536	0.5
Second Year	330	0.3	330	0.3

Notes: *Actual student membership is used for the statewide N-counts.

**Due to miscoding or rounding, some columns may not add up to the total. These data represent coding on the 2000-01 grade 3 pretest answer sheets. These data do not reflect the actual number of alternate assessments scored in the 2000-01 school year.

***NCAAP is the North Carolina Alternate Assessment Portfolio.

Data received from LEAs and charter schools after August 2001 are not included in this table.

Prepared by the NCDPI Division of Accountability Services/Testing Section.

Table 7. 2000-01 Grade 3 Pretest Goal Summary Report

	Developmental Score Mean	Number of Observations*	# of Items	Percent Correct**
READING (Average of Averages)	138.9	102,200	28	
GOAL 1: Use strategies and processes that enhance control of communications skills development.			0	
GOAL 2: Use language for the acquisition, interpretation, and application of information.			70	53.2
Obj 2.1: Identify, collect or select information and ideas.			31	57.6
Obj 2.2: Analyze, synthesize, and organize information and ideas and discover related ideas, concepts or generalizations.			33	50.9
Obj 2.3: Apply, extend and expand on information and concepts.			6	42.6
GOAL 3: Use language for critical analysis and evaluation.			14	35.6
MATHEMATICS (Average of Averages)	236.1	102,484	40	
Math Calculator Inactive			36	63.7
Math Calculator Active			84	59.3
GOAL 1: Identify and use numbers to less than 10,000.			45	64.6
GOAL 2: Understand and use basic geometric properties and standard units of measurement.			42	59.2
GOAL 3: Understand classification, pattern and seriation.			21	58.9
GOAL 4: Understand data collection, display and interpretation.			12	53.4
NUMBER OF STUDENTS TAKING FORM	D ----- 34,139	E ----- 34,386	F ----- 33,959	

Notes: * "Number of Observations" includes students who attempted at least one item on the test.
 *** "Percent Correct" is the number of correct responses to an item divided by the number of students who took that item summed over all items for a goal or objective divided by the number of items for that goal or objective.
 Data received from LEAs and charter schools after August 2001 are not included in this table.
 Prepared by the NCDPI Division of Accountability Services/Testing Section.

Table 8. 2000-01 Grade 3 Pretest Distribution of Scale Scores - Reading

<u>NUMBER OF STUDENTS WITH VALID SCORES*</u>	102,200	<u>HIGH SCORE</u>	162
		<u>LOW SCORE</u>	119
<u>MEAN</u>	138.9	<u>STATE PERCENTILES</u>	<u>SCALE SCORE</u>
<u>STANDARD DEVIATION</u>	8.4	90	150.51
		75	145.53
<u>VARIANCE</u>	71.1	50 (MEDIAN)	138.67
		25	131.18
		10	127.90

FREQUENCY DISTRIBUTION

<u>SCALE SCORE</u>	<u>FREQUENCY</u>	<u>CUMULATIVE FREQUENCY</u>	<u>PERCENT</u>	<u>CUMULATIVE PERCENT</u>	<u>1996 STATE PERCENTILE</u>
162	12	102200	0.01	100.00	99
160	59	102188	0.06	99.99	99
158	443	102129	0.43	99.93	99
157	484	101686	0.47	99.50	99
156	1008	101202	0.99	99.02	99
155	1599	100194	1.56	98.04	98
154	316	98595	0.31	96.47	97
153	2306	98279	2.26	96.16	96
152	2162	95973	2.12	93.91	94
151	1856	93811	1.82	91.79	92
150	1658	91955	1.62	89.98	90
149	4135	90297	4.05	88.35	88
148	2651	86162	2.59	84.31	85
147	1992	83511	1.95	81.71	83
146	5004	81519	4.90	79.76	79
145	3401	76515	3.33	74.87	76
144	2057	73114	2.01	71.54	73
143	5709	71057	5.59	69.53	70
142	4142	65348	4.05	63.94	65
141	4424	61206	4.33	59.89	62
140	1932	56782	1.89	55.56	59
139	4519	54850	4.42	53.67	56
138	4611	50331	4.51	49.25	52
137	1724	45720	1.69	44.74	49
136	4605	43996	4.51	43.05	46
135	4153	39391	4.06	38.54	42
134	1986	35238	1.94	34.48	40
133	3764	33252	3.68	32.54	37
132	2108	29488	2.06	28.85	34
131	5644	27380	5.52	26.79	30
130	3679	21736	3.60	21.27	25
129	5135	18057	5.02	17.67	20
128	4502	12922	4.41	12.64	14
127	4907	8420	4.80	8.24	8
126	2008	3513	1.96	3.44	4
125	244	1505	0.24	1.47	2
124	675	1261	0.66	1.23	1
123	308	586	0.30	0.57	1
122	161	278	0.16	0.27	1
121	65	117	0.06	0.11	1
120	14	52	0.01	0.05	1
LESS THAN 120	38	38	0.04	0.04	1

Notes: *Students with valid scores are those students who attempted at least one item on the test.
 Data received from LEAs and charter schools after August 2001 are not included in this table.
 Prepared by the NCDPI Division of Accountability Services/Testing Section.

Table 9. 2000-01 Grade 3 Pretest Distribution of Scale Scores - Mathematics

<u>NUMBER OF STUDENTS WITH VALID SCORES*</u>	102,484	<u>HIGH SCORE</u>	260
		<u>LOW SCORE</u>	211
<u>MEAN</u>	236.1	<u>STATE PERCENTILES</u>	<u>SCALE SCORE</u>
<u>STANDARD DEVIATION</u>	8.1	90	246.80
		75	241.90
<u>VARIANCE</u>	65.5	50 (<u>MEDIAN</u>)	235.83
		25	230.59
		10	225.33

FREQUENCY DISTRIBUTION

<u>SCALE SCORE</u>	<u>FREQUENCY</u>	<u>CUMULATIVE FREQUENCY</u>	<u>PERCENT</u>	<u>CUMULATIVE PERCENT</u>	<u>2000 STATE PERCENTILE</u>
260	74	102484	0.07	100.00	99
259	64	102410	0.06	99.93	99
257	270	102346	0.26	99.87	99
256	212	102076	0.21	99.60	99
255	535	101864	0.52	99.40	99
253	391	101329	0.38	98.87	99
252	944	100938	0.92	98.49	98
251	620	99994	0.60	97.57	97
250	2160	99374	2.11	96.97	96
249	1721	97214	1.68	94.86	94
248	965	95493	0.94	93.18	93
247	3263	94528	3.18	92.24	91
246	2374	91265	2.32	89.05	88
245	1243	88891	1.21	86.74	86
244	3967	87648	3.87	85.52	84
243	4180	83681	4.08	81.65	80
242	4374	79501	4.27	77.57	75
241	4506	75127	4.40	73.31	71
240	4798	70621	4.68	68.91	67
239	4846	65823	4.73	64.23	62
238	3265	60977	3.19	59.50	58
237	3214	57712	3.14	56.31	55
236	4895	54498	4.78	53.18	51
235	4860	49603	4.74	48.40	46
234	4767	44743	4.65	43.66	41
233	6085	39976	5.94	39.01	36
232	4489	33891	4.38	33.07	31
231	4161	29402	4.06	28.69	27
230	3878	25241	3.78	24.63	23
229	3662	21363	3.57	20.85	19
228	3280	17701	3.20	17.27	16
227	1964	14421	1.92	14.07	13
226	1815	12457	1.77	12.16	11
225	2373	10642	2.32	10.38	9
224	2080	8269	2.03	8.07	7
223	1260	6189	1.23	6.04	5
222	1035	4929	1.01	4.81	4
221	813	3894	0.79	3.80	3
220	1048	3081	1.02	3.01	2
219	728	2033	0.71	1.98	2
218	378	1305	0.37	1.27	1
217	399	927	0.39	0.90	1
216	204	528	0.20	0.52	1
215	128	324	0.12	0.32	1
214	83	196	0.08	0.19	1
213	32	113	0.03	0.11	1
212	29	81	0.03	0.08	1
211	52	52	0.05	0.05	1

Notes: *Students with valid scores are those students who attempted at least one item on the test.
 Data received from LEAs and charter schools after August 2001 are not included in this table.
 Prepared by the NCDPI Division of Accountability Services/Testing Section.

End-of-Grade Multiple-Choice Test Results

**Table 1. 2000-01 End-of-Grade Multiple-Choice Test Results
Statewide Summary
Reading and Mathematics**

	Reading			Mathematics*				
	Number Tested	Mean Scale Score	Percent Students at Achievement Levels III, IV	Standard Deviation	Number Tested	Mean Scale Score***	Percent Students at Achievement Levels III, IV**	Standard Deviation
Grade 3	101,652 147.0		76.4% 9.3		102,160 250.6		73.6% 7.7	
Grade 4	99,717 150.3		74.6% 9.3		100,392 255.8		86.8% 8.3	
Grade 5	99,639 156.0		82.7% 8.2		100,226 260.0		86.7% 9.6	
Grade 6	100,079 156.7		70.6% 9.6		100,367 263.2		82.9% 9.9	
Grade 7	96,945 159.9		75.3% 8.5		97,114 267.1		81.2% 10.6	
Grade 8	93,305 163.1		83.3% 8.1		93,408 270.0		79.5% 11.0	

Notes: *The North Carolina mathematics tests measure the competencies in the 1998 North Carolina mathematics curriculum beginning in the 2000-01 school year.

**The adjusted achievement level ranges for mathematics generated in September 2001 were used to calculate all 2001 data.

***Prior to 2000-01, the end-of-grade mathematics scale score range was 98 to 208; beginning in 2000-01, the end-of-grade mathematics scale score range is 218 to 310. Data received from LEAs and charter schools after August 2001 are not included in this table.

Prepared by the NCDPI Division of Accountability Services/Testing Section.

**Table 2. 1992-93 to 2000-01 End-of-Grade Multiple-Choice Test Results
Statewide Summary of Student Performance**

Reading

	1992-93	1993-94	1994-95	1995-96	1996-97	1997-98	1998-99	1999-00	2000-01
	Number Tested Mean Scale Score	Number Tested Mean Scale Score	Number Tested Mean Scale Score	Number Tested Mean Scale Score	Number Tested Mean Scale Score	Number Tested Mean Scale Score	Number Tested Mean Scale Score	Number Tested Mean Scale Score	Number Tested Mean Scale Score
Grade 3	Percent Students at Achievement Levels III, IV 85,381 142.7 61.2%	Percent Students at Achievement Levels III, IV 88,301 142.8 60.4%	Percent Students at Achievement Levels III, IV 88,573 143.4 63.4%	Percent Students at Achievement Levels III, IV 90,594 143.8 64.8%	Percent Students at Achievement Levels III, IV 95,356 144.1 65.8%	Percent Students at Achievement Levels III, IV 98,389 145.7 71.6%	Percent Students at Achievement Levels III, IV 99,451 146.5 74.4%	Percent Students at Achievement Levels III, IV 101,064 146.4 73.6%	Percent Students at Achievement Levels III, IV 101,652 147.0 76.4%
Grade 4	Percent Students at Achievement Levels III, IV 84,811 147.1 62.4%	Percent Students at Achievement Levels III, IV 85,311 147.9 65.8%	Percent Students at Achievement Levels III, IV 88,163 147.6 64.1%	Percent Students at Achievement Levels III, IV 89,115 148.7 69.4%	Percent Students at Achievement Levels III, IV 91,868 148.4 67.7%	Percent Students at Achievement Levels III, IV 94,109 149.3 70.9%	Percent Students at Achievement Levels III, IV 99,451 149.8 72.1%	Percent Students at Achievement Levels III, IV 97,911 149.5 71.4%	Percent Students at Achievement Levels III, IV 99,717 150.3 74.6%
Grade 5	Percent Students at Achievement Levels III, IV 85,337 151.5 64.1%	Percent Students at Achievement Levels III, IV 85,330 151.7 65.4%	Percent Students at Achievement Levels III, IV 86,150 152.4 68.2%	Percent Students at Achievement Levels III, IV 89,237 152.1 66.5%	Percent Students at Achievement Levels III, IV 90,773 153.0 70.8%	Percent Students at Achievement Levels III, IV 91,566 154.3 75.2%	Percent Students at Achievement Levels III, IV 98,099 155.3 79.1%	Percent Students at Achievement Levels III, IV 94,801 154.3 75.8%	Percent Students at Achievement Levels III, IV 99,639 156.0 82.7%
Grade 6	Percent Students at Achievement Levels III, IV 84,278 154.0 62.6%	Percent Students at Achievement Levels III, IV 85,813 154.4 65.1%	Percent Students at Achievement Levels III, IV 86,370 154.5 65.9%	Percent Students at Achievement Levels III, IV 87,310 155.3 67.7%	Percent Students at Achievement Levels III, IV 91,667 155.6 67.1%	Percent Students at Achievement Levels III, IV 91,669 155.8 70.0%	Percent Students at Achievement Levels III, IV 96,489 156.3 69.5%	Percent Students at Achievement Levels III, IV 93,589 156.7 72.3%	Percent Students at Achievement Levels III, IV 100,079 156.7 70.6%
Grade 7	Percent Students at Achievement Levels III, IV 83,868 157.0 63.5%	Percent Students at Achievement Levels III, IV 84,852 157.3 64.2%	Percent Students at Achievement Levels III, IV 86,478 158.0 68.5%	Percent Students at Achievement Levels III, IV 87,457 157.9 66.9%	Percent Students at Achievement Levels III, IV 89,515 158.2 67.8%	Percent Students at Achievement Levels III, IV 91,267 159.0 71.1%	Percent Students at Achievement Levels III, IV 94,031 160.2 76.4%	Percent Students at Achievement Levels III, IV 92,021 159.9 76.6%	Percent Students at Achievement Levels III, IV 96,945 159.9 75.3%
Grade 8	Percent Students at Achievement Levels III, IV 80,833 158.7 66.5%	Percent Students at Achievement Levels III, IV 82,985 159.7 71.0%	Percent Students at Achievement Levels III, IV 83,802 160.1 72.8%	Percent Students at Achievement Levels III, IV 85,997 160.0 72.7%	Percent Students at Achievement Levels III, IV 87,317 160.9 75.0%	Percent Students at Achievement Levels III, IV 87,903 161.9 79.5%	Percent Students at Achievement Levels III, IV 90,984 162.7 82.5%	Percent Students at Achievement Levels III, IV 90,330 162.3 79.9%	Percent Students at Achievement Levels III, IV 93,305 163.1 83.3%

Note: Data received from LEAs and charter schools after August 2001 are not included in this table.
Prepared by the NCDPI Division of Accountability Services/Testing Section.

**Table 3. 1992-93 to 2000-01 End-of-Grade Multiple-Choice Test Results
Statewide Summary of Student Performance**

Mathematics*

	1992-93	1993-94	1994-95	1995-96	1996-97	1997-98	1998-99	1999-00	2000-01
	Number Tested	Number Tested	Number Tested	Number Tested	Number Tested	Number Tested	Number Tested	Number Tested	Number Tested
	Mean Scale Score	Mean Scale Score	Mean Scale Score	Mean Scale Score	Mean Scale Score	Mean Scale Score	Mean Scale Score	Mean Scale Score	Mean Scale Score**
Percent Students at Achievement Levels III, IV	Percent Students at Achievement Levels III, IV	Percent Students at Achievement Levels III, IV	Percent Students at Achievement Levels III, IV	Percent Students at Achievement Levels III, IV	Percent Students at Achievement Levels III, IV	Percent Students at Achievement Levels III, IV	Percent Students at Achievement Levels III, IV	Percent Students at Achievement Levels III, IV	Percent Students at Achievement Levels III, IV***
Grade 3	85,026	88,414	88,845	90,710	95,608	98,844	101,021	101,572	102,160
	139.9	140.0	141.2	141.9	142.8	142.3	142.9	143.5	250.6
	60.6%	61.6%	65.1%	67.4%	70.2%	68.2%	70.0%	71.8%	73.6%
Grade 4	84,453	85,363	88,230	89,172	92,064	94,499	98,391	99,990	100,392
	146.1	147.2	147.9	148.5	149.5	151.5	152.2	152.9	255.8
	64.1%	67.1%	68.5%	71.5%	74.6%	79.3%	82.7%	84.4%	86.8%
Grade 5	84,999	85,384	86,159	89,261	90,930	91,927	95,258	98,558	100,226
	152.3	153.5	154.4	155.2	156.4	157.4	159.2	159.5	260.0
	59.7%	63.9%	66.5%	70.0%	73.1%	78.0%	82.4%	82.9%	86.7%
Grade 6	83,683	85,850	86,395	87,320	91,720	91,802	93,824	96,708	100,367
	158.3	159.4	160.2	161.4	162.0	163.6	164.8	165.1	263.2
	61.3%	66.2%	67.6%	72.6%	72.7%	78.3%	81.1%	81.0%	82.9%
Grade 7	83,143	84,768	86,439	87,490	89,526	91,368	92,151	94,031	97,114
	164.1	164.8	166.0	166.4	167.5	169.2	170.8	171.0	267.1
	60.0%	63.2%	67.1%	68.5%	70.8%	76.9%	82.5%	80.7%	81.2%
Grade 8	80,032	82,793	83,576	86,006	87,390	87,978	90,396	90,984	93,408
	168.3	169.0	170.3	170.6	171.1	173.7	174.1	175.3	270.0
	61.9%	61.9%	67.6%	67.7%	68.9%	76.3%	77.6%	80.6%	79.5%

Notes: *The North Carolina mathematics tests measure the competencies in the 1998 North Carolina mathematics curriculum beginning in the 2000-01 school year.

**Prior to 2000-01, the end-of-grade mathematics scale score range was 98 to 208; beginning in 2000-01, the end-of-grade mathematics scale score range is 218 to 310.

*** The adjusted achievement level ranges for mathematics generated in September 2001 were used to calculate all 2001 data.

Data received from LEAs and charter schools after August 2001 are not included in this table.

Prepared by the NCDPI Division of Accountability Services/Testing Section.

Table 4. 1992-93 to 2000-01 End-of-Grade Multiple-Choice Test Results
Statewide Summary of Student Performance

		Reading										
		1992-93		1993-94		1994-95		1995-96		1996-97		
	Number Tested	Percent Students at Achievement Levels III, IV	Number Tested	Percent Students at Achievement Levels III, IV	Number Tested	Percent Students at Achievement Levels III, IV	Number Tested	Percent Students at Achievement Levels III, IV	Number Tested	Percent Students at Achievement Levels III, IV	Number Tested	Percent Students at Achievement Levels III, IV
	Mean Scale Score	Percent Students at Achievement Level I	Mean Scale Score	Percent Students at Achievement Level I	Mean Scale Score	Percent Students at Achievement Level I	Mean Scale Score	Percent Students at Achievement Level I	Mean Scale Score	Percent Students at Achievement Level I	Mean Scale Score	Percent Students at Achievement Level I
Grade 3	85,381	61.2%	88,301	60.4%	88,573	63.4%	90,594	64.8%	95,356	65.8%		
Std. Dev.	142.7	13.6%	142.8	13.9%	143.4	12.9%	143.8	11.3%	144.1	11.0%		
	9.9		10.0		10.1		9.7		9.8			
Grade 4	84,811	62.4%	85,311	65.8%	88,163	64.1%	89,115	69.4%	91,868	67.7%		
Std. Dev.	147.1	12.1%	147.9	10.1%	147.6	10.8%	148.7	9.0%	148.4	9.9%		
	9.6		9.3		9.6		9.3		9.6			
Grade 5	85,337	64.1%	85,330	65.4%	86,150	68.2%	89,237	66.5%	90,773	70.8%		
Std. Dev.	151.5	9.5%	151.7	9.8%	152.4	8.0%	152.1	8.9%	153.0	7.6%		
	9.0		8.9		8.8		8.9		8.9			
Grade 6	84,278	62.6%	85,813	65.1%	86,370	65.9%	87,310	67.7%	91,667	67.1%		
Std. Dev.	154.0	9.3%	154.4	9.2%	154.5	7.5%	155.3	8.8%	155.6	8.7%		
	9.1		9.1		8.7		9.3		9.9			
Grade 7	83,868	63.5%	84,852	64.2%	86,478	68.5%	87,457	66.9%	89,515	67.8%		
Std. Dev.	157.0	9.3%	157.3	9.6%	158.0	8.0%	157.9	8.5%	158.2	8.4%		
	8.6		8.7		8.6		8.6		9.0			
Grade 8	80,833	66.5%	82,985	71.0%	83,802	72.8%	85,997	72.7%	87,317	75.0%		
Std. Dev.	158.7	7.9%	159.7	6.0%	160.1	5.7%	160.0	5.5%	160.9	5.0%		
	8.9		8.6		8.6		8.5		8.7			

Note: Data received from LEAs and charter schools after August 2001 are not included in this table.
 Prepared by the NCDPI Division of Accountability Services/Testing Section.

**Table 4. 1992-93 to 2000-01 End-of-Grade Multiple-Choice Test Results
Statewide Summary of Student Performance (continued)**

	Reading							
	1997-98		1998-99		1999-00		2000-01	
	Number Tested	Percent Students at Achievement Levels III, IV	Number Tested	Percent Students at Achievement Levels III, IV	Number Tested	Percent Students at Achievement Levels III, IV	Number Tested	Percent Students at Achievement Levels III, IV
Grade 3	98,389	71.6%	100,525	73.6%	101,064	74.4%	101,652	76.4%
	145.7	8.6%	146.4	6.9%	146.5	6.2%	147.0	5.7%
Std. Dev.	9.7		9.7		9.5		9.3	
Grade 4	94,109	70.9%	97,911	71.4%	99,451	72.1%	99,717	74.6%
	149.3	7.9%	149.5	7.4%	149.8	7.0%	150.3	6.1%
Std. Dev.	9.6		9.4		9.5		9.3	
Grade 5	91,566	75.2%	94,801	75.8%	98,099	79.1%	99,639	82.7%
	154.3	6.1%	154.3	5.0%	155.3	4.4%	156.0	3.4%
Std. Dev.	9.0		8.5		8.7		8.2	
Grade 6	91,669	70.0%	93,589	72.3%	96,489	69.5%	100,079	70.6%
	155.8	7.3%	156.7	5.9%	156.3	6.9%	156.7	6.0%
Std. Dev.	9.3		9.3		9.8		9.6	
Grade 7	91,267	71.1%	92,021	76.6%	94,031	76.4%	96,945	75.3%
	159.0	7.4%	159.9	5.2%	160.2	5.3%	159.9	5.0%
Std. Dev.	8.8		8.2		8.5		8.5	
Grade 8	87,903	79.5%	90,330	79.9%	90,984	82.5%	93,305	83.3%
	161.9	3.4%	162.3	3.2%	162.7	2.9%	163.1	2.3%
Std. Dev.	8.3		8.4		8.1		8.1	

Note: Data received from LEAs and charter schools after August 2001 are not included in this table.
Prepared by the NCDPI Division of Accountability Services/Testing Section.

**Table 5. 1992-93 to 2000-01 End-of-Grade Multiple-Choice Test Results
Statewide Summary of Student Performance**

Mathematics*

	1992-93			1993-94			1994-95			1995-96			1996-97		
	Percent Students at Achievement Levels III, IV			Percent Students at Achievement Levels III, IV			Percent Students at Achievement Levels III, IV			Percent Students at Achievement Levels III, IV			Percent Students at Achievement Levels III, IV**		
	Number Tested	Mean Scale Score	Percent Students at Achievement Level I	Number Tested	Mean Scale Score	Percent Students at Achievement Level I	Number Tested	Mean Scale Score	Percent Students at Achievement Level I	Number Tested	Mean Scale Score	Percent Students at Achievement Level I	Number Tested	Mean Scale Score	Percent Students at Achievement Level I
Grade 3	85,026	139.9	60.6%	88,414	140.0	61.6%	88,845	141.2	65.1%	90,710	141.9	67.4%	95,608	142.8	70.2%
Std. Dev.	11.3	11.5	10.7%	11.5	11.5	10.9%	11.5	11.5	9.3%	11.4	11.4	7.9%	11.3	11.3	6.8%
Grade 4	84,453	146.1	64.1%	85,363	147.2	67.1%	88,230	147.9	68.5%	89,172	148.5	71.5%	92,064	149.5	74.6%
Std. Dev.	10.5	10.7	10.0%	10.7	10.7	8.8%	11.1	11.1	8.6%	10.7	10.7	7.2%	10.8	10.8	6.4%
Grade 5	84,999	152.3	59.7%	85,384	153.5	63.9%	86,159	154.4	66.5%	89,261	155.2	70.0%	90,930	156.4	73.1%
Std. Dev.	9.7	10.0	12.1%	10.0	10.0	10.6%	10.3	10.3	9.4%	10.2	10.2	8.5%	10.4	10.4	7.1%
Grade 6	83,683	158.3	61.3%	85,850	159.4	66.2%	86,395	160.2	67.6%	87,320	161.4	72.6%	91,720	162.0	72.7%
Std. Dev.	10.1	10.2	10.5%	10.2	10.2	9.6%	10.4	10.4	8.2%	10.6	10.6	7.0%	11.1	11.1	6.6%
Grade 7	83,143	164.1	60.0%	84,768	164.8	63.2%	86,439	166.0	67.1%	87,490	166.4	68.5%	89,526	167.5	70.8%
Std. Dev.	10.0	10.4	10.5%	10.4	10.4	11.5%	10.4	10.4	8.4%	10.7	10.7	9.0%	11.4	11.4	8.6%
Grade 8	80,032	168.3	61.9%	82,793	169.0	61.9%	83,576	170.3	67.6%	86,006	170.6	67.7%	87,390	171.1	68.9%
Std. Dev.	10.6	11.0	10.4%	11.0	11.0	10.1%	11.1	11.1	8.2%	11.3	11.3	8.8%	11.8	11.8	9.0%

Notes: *The North Carolina mathematics tests measure the competencies in the 1998 North Carolina mathematics curriculum beginning in the 2000-01 school year.

** The adjusted achievement level ranges for mathematics generated in September 2001 were used to calculate all 2001 data.

***Prior to 2000-01, the end-of-grade mathematics scale score range was 98 to 208; beginning in 2000-01, the end-of-grade mathematics scale score range is 218 to 310.

Data received from LEAs and charter schools after August 2001 are not included in this table.

Prepared by the NCDPI Division of Accountability Services/Testing Section.

**Table 5. 1992-93 to 2000-01 End-of-Grade Multiple-Choice Test Results
Statewide Summary of Student Performance (continued)**

		1997-98			1998-99			1999-00			2000-01		
		Mathematics*			Mathematics*			Mathematics*			Mathematics*		
	Number Tested	Percent Students at Achievement Levels III, IV	Number Tested	Percent Students at Achievement Levels III, IV	Number Tested	Percent Students at Achievement Levels III, IV	Number Tested	Percent Students at Achievement Levels III, IV	Number Tested	Percent Students at Achievement Levels III, IV**	Number Tested	Percent Students at Achievement Levels III, IV**	
	Mean Scale Score	Percent Students at Achievement Level I	Mean Scale Score	Percent Students at Achievement Level I	Mean Scale Score	Percent Students at Achievement Level I	Mean Scale Score	Percent Students at Achievement Level I	Mean Scale Score	Percent Students at Achievement Level I	Mean Scale Score	Percent Students at Achievement Level I	
Grade 3	98,844	68.2%	101,021	70.0%	101,572	71.8%	102,160	73.6%	102,160	73.6%	102,160	73.6%	
Std. Dev.	142.3	7.0%	142.9	6.3%	143.5	5.6%	250.6	4.2%	250.6	4.2%	250.6	4.2%	
Grade 4	94,499	79.3%	98,391	82.7%	99,990	84.4%	100,392	86.8%	100,392	86.8%	100,392	86.8%	
Std. Dev.	151.5	4.0%	152.2	2.9%	152.9	2.1%	255.8	1.2%	255.8	1.2%	255.8	1.2%	
Grade 5	91,927	78.0%	95,258	82.4%	98,558	82.9%	100,226	86.7%	100,226	86.7%	100,226	86.7%	
Std. Dev.	157.4	5.8%	159.2	3.8%	159.5	3.8%	260.0	2.2%	260.0	2.2%	260.0	2.2%	
Grade 6	91,802	78.3%	93,824	81.1%	96,708	81.0%	100,367	82.9%	100,367	82.9%	100,367	82.9%	
Std. Dev.	163.6	5.0%	164.8	4.3%	165.1	4.1%	263.2	3.3%	263.2	3.3%	263.2	3.3%	
Grade 7	91,368	76.9%	92,151	82.5%	94,031	80.7%	97,114	81.2%	97,114	81.2%	97,114	81.2%	
Std. Dev.	169.2	5.4%	170.8	3.9%	171.0	4.5%	267.1	3.2%	267.1	3.2%	267.1	3.2%	
Grade 8	87,978	76.3%	90,396	77.6%	90,984	80.6%	93,408	79.5%	93,408	79.5%	93,408	79.5%	
Std. Dev.	173.7	5.4%	174.1	5.4%	175.3	4.8%	270.0	5.3%	270.0	5.3%	270.0	5.3%	
Std. Dev.	11.6		12.0		11.9		11.0		11.0		11.0		

Notes: *The North Carolina mathematics tests measure the competencies in the 1998 North Carolina mathematics curriculum beginning in the 2000-01 school year.
 **Prior to 2000-01, the end-of-grade mathematics scale score range was 98 to 208; beginning in 2000-01, the end-of-grade mathematics scale score range is 218 to 310.
 ***The adjusted achievement level ranges for mathematics generated in September 2001 were used to calculate all 2001 data.
 Data received from LEAs and charter schools after August 2001 are not included in this table.
 Prepared by the NCDPI Division of Accountability Services/Testing Section.

**Table 6. 2000-01 End-of-Grade Multiple-Choice Tests
Achievement Level Ranges by Subject and Grade**

Reading Developmental Scale Scores (set in 1993)				
Grade	Level I	Level II	Level III	Level IV
3	114-130	131-140	141-150	151-172
4	118-134	135-144	145-155	156-174
5	124-138	139-148	149-158	159-182
6	124-140	141-151	152-161	162-183
7	126-144	145-154	155-163	164-183
8	132-144	145-155	156-165	166-187

Mathematics Developmental Scale Scores (set in September 2001)				
Grade	Level I	Level II	Level III	Level IV
3	218-237	238-245	246-254	255-276
4	221-239	240-246	247-257	258-285
5	221-242	243-249	250-259	260-295
6	228-246	247-253	254-264	265-296
7	231-249	250-257	258-266	267-307
8	235-253	254-260	261-271	272-310

Prepared by the NCDPI Division of Accountability Services/Testing Section.

**Table 7. 1992-93 to 2000-01 End-of-Grade Multiple-Choice Test Results
Percent of Students at Each Achievement Level by Grade**

Achievement Levels	Reading							
	Grade 3	Grade 4	Grade 5	Grade 6	Grade 7	Grade 8		
Level I								
Students performing at Achievement Level I do not have sufficient mastery of knowledge and skills in the subject area to be successful at the next grade level.	1993	13.6	12.1	9.5	9.3	9.3	9.3	7.9
	1994	13.9	10.1	9.8	9.2	9.6	9.6	6.0
	1995	12.9	10.8	8.0	7.5	8.0	8.0	5.7
	1996	11.3	9.0	8.9	8.8	8.5	8.5	5.5
	1997	11.0	9.9	7.6	8.7	8.4	8.4	5.0
	1998	8.6	7.9	6.1	7.3	7.4	7.4	3.4
	1999	6.9	7.4	4.9	5.9	5.2	5.2	3.2
	2000	6.2	7.0	4.4	6.9	5.3	5.3	2.9
	2001	5.7	6.1	3.4	6.0	5.0	5.0	2.3
Level II								
Students performing at Achievement Level II demonstrate inconsistent mastery of knowledge and skills in the subject area and are minimally prepared to be successful at the next grade level.	1993	25.2	25.6	26.4	28.1	27.1	27.1	25.6
	1994	25.7	24.1	24.8	25.7	26.2	26.2	23.0
	1995	23.7	25.1	23.8	26.6	23.5	23.5	21.5
	1996	23.9	21.6	24.6	23.5	24.7	24.7	21.8
	1997	23.2	22.4	21.6	24.2	23.8	23.8	20.0
	1998	19.8	21.2	18.8	22.7	21.4	21.4	17.2
	1999	19.5	21.2	19.3	21.8	18.2	18.2	16.9
	2000	19.4	21.0	16.6	23.6	18.2	18.2	14.6
	2001	17.9	19.4	13.9	23.4	19.7	19.7	14.3
Level III								
Students performing at Achievement Level III consistently demonstrate mastery of the grade level subject matter and skills and are well-prepared for the next grade level.	1993	38.5	41.2	39.7	39.8	39.4	39.4	42.5
	1994	36.1	44.0	41.8	41.3	38.9	38.9	44.2
	1995	37.2	41.6	41.3	43.3	40.6	40.6	43.7
	1996	37.9	44.8	41.3	40.4	39.4	39.4	45.8
	1997	37.6	42.9	41.4	37.3	36.4	36.4	43.6
	1998	36.3	41.5	40.4	39.3	39.0	39.0	43.7
	1999	36.7	43.8	43.1	39.6	41.2	41.2	43.1
	2000	38.0	42.3	41.0	36.6	39.4	39.4	43.8
	2001	38.4	43.2	43.2	37.7	37.5	37.5	43.9
Level IV								
Students performing at Achievement Level IV consistently perform in a superior manner clearly beyond that required to be proficient at grade level work.	1993	22.7	21.2	24.4	22.8	24.1	24.1	24.0
	1994	24.3	21.8	23.7	23.8	25.3	25.3	26.8
	1995	26.2	22.6	26.9	22.6	27.8	27.8	29.1
	1996	26.9	24.6	25.3	27.4	27.4	27.4	26.8
	1997	28.3	24.8	29.4	29.7	31.4	31.4	31.4
	1998	35.3	29.4	34.8	30.7	32.2	32.2	35.8
	1999	36.9	27.6	32.7	32.7	35.4	35.4	36.8
	2000	36.4	29.7	38.1	32.9	37.1	37.1	38.6
	2001	38.0	31.3	39.4	32.9	37.8	37.8	39.5

Notes: Percents are rounded to the nearest tenth.
 Due to rounding, data for some grades in certain years may not add to 100%.
 Data received from LEAs and charter schools after August 2001 are not included in this table.
 Prepared by the NCDPI Division of Accountability Services/Testing Section

**Table 8. 1992-93 to 2000-01 End-of-Grade Multiple-Choice Test Results
Percent of Students at Each Achievement Level by Grade**

Mathematics*

Achievement Levels

	Grade 3	Grade 4	Grade 5	Grade 6	Grade 7	Grade 8
Level I						
Students performing at Achievement Level I do not have sufficient mastery of knowledge and skills in the subject area to be successful at the next grade level.	1993 10.7	10.0	12.1	10.5	10.5	10.4
	1994 10.9	8.8	10.6	9.6	11.5	10.1
	1995 9.3	8.6	9.4	8.2	8.4	8.2
	1996 7.9	7.2	8.5	7.0	9.0	8.8
	1997 6.8	6.4	7.1	6.6	8.6	9.0
	1998 7.0	4.0	5.8	5.0	5.4	5.4
	1999 6.3	2.9	3.8	4.3	4.0	5.4
	2000 5.6	2.1	3.8	4.1	4.5	4.8
	2001* 4.2	1.2	2.2	3.3	3.2	5.3
Level II						
Students performing at Achievement Level II demonstrate inconsistent mastery of knowledge and skills in the subject area and are minimally prepared to be successful at the next grade level.	1993 28.6	25.9	28.2	28.2	29.5	27.7
	1994 27.5	24.1	25.5	24.3	25.3	28.1
	1995 25.6	22.9	24.1	24.1	24.5	24.2
	1996 24.7	21.3	21.5	20.5	22.5	23.5
	1997 23.0	19.1	19.8	20.7	20.6	22.1
	1998 24.8	16.8	16.1	16.7	17.7	18.3
	1999 23.7	14.4	13.7	14.6	13.6	17.0
	2000 22.6	13.4	13.3	14.9	14.8	14.6
	2001* 22.2	12.0	11.2	13.8	15.5	15.2
Level III						
Students performing at Achievement Level III consistently demonstrate mastery of the grade level subject matter and skills and are well-prepared for the next grade level.	1993 39.5	44.0	38.3	41.7	38.0	41.1
	1994 39.7	43.2	37.7	43.9	38.3	38.4
	1995 39.7	41.3	37.3	42.5	38.6	40.1
	1996 39.7	43.6	38.0	43.0	38.8	38.7
	1997 39.6	41.9	36.2	40.5	36.9	38.4
	1998 39.8	41.7	37.8	40.7	38.3	37.6
	1999 40.2	43.0	35.5	39.8	37.4	37.9
	2000 40.0	43.7	34.3	38.1	35.1	36.5
	2001* 43.3	46.7	36.6	40.5	33.3	36.8
Level IV						
Students performing at Achievement Level IV consistently perform in a superior manner clearly beyond that required to be proficient at grade level work.	1993 21.2	20.1	21.4	19.5	22.0	20.8
	1994 21.9	23.8	26.2	22.3	25.0	23.5
	1995 25.4	27.2	29.2	25.1	28.5	27.5
	1996 27.7	28.0	32.0	29.6	29.7	29.1
	1997 30.7	32.7	36.8	32.2	34.0	30.5
	1998 28.4	37.6	40.2	37.7	38.6	38.7
	1999 29.8	39.6	46.9	41.3	45.0	39.7
	2000 31.8	40.8	48.6	42.9	45.6	44.1
	2001* 30.3	40.0	50.1	42.4	48.0	42.7

Notes: Percents are rounded to the nearest tenth.

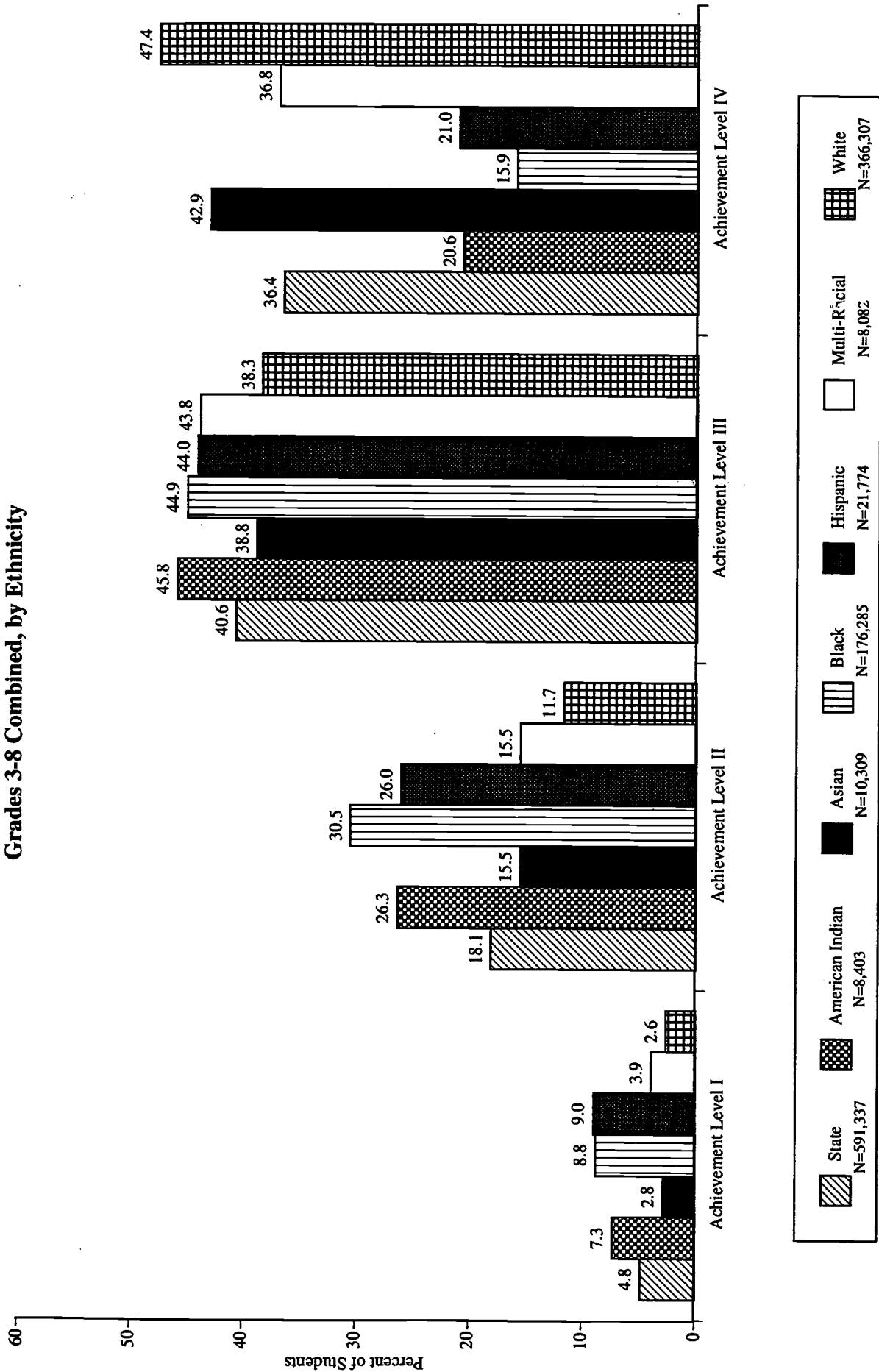
Due to rounding, data for some grades in certain years may not add to 100%.

Data received from LEAs and charter schools after August 2001 are not included in this table.

Prepared by the NCDPI Division of Accountability Services/Testing Section.

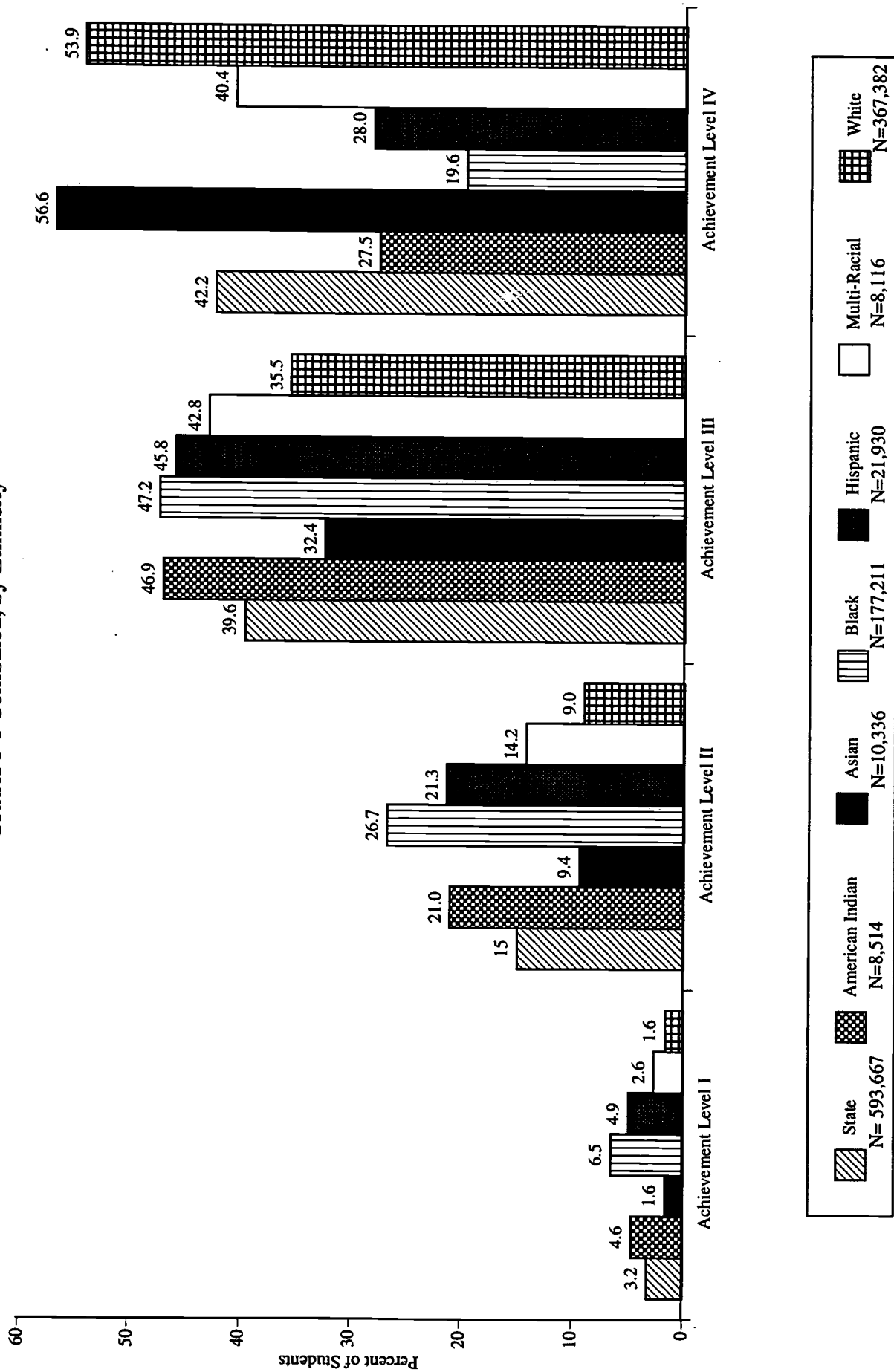
*The adjusted achievement level ranges for mathematics generated in September 2001 were used to calculate all 2001 data.

**Figure 1. 2000-01 End-of-Grade Multiple-Choice Test Results
Percent of Students at Each Achievement Level in Reading
Grades 3-8 Combined, by Ethnicity**



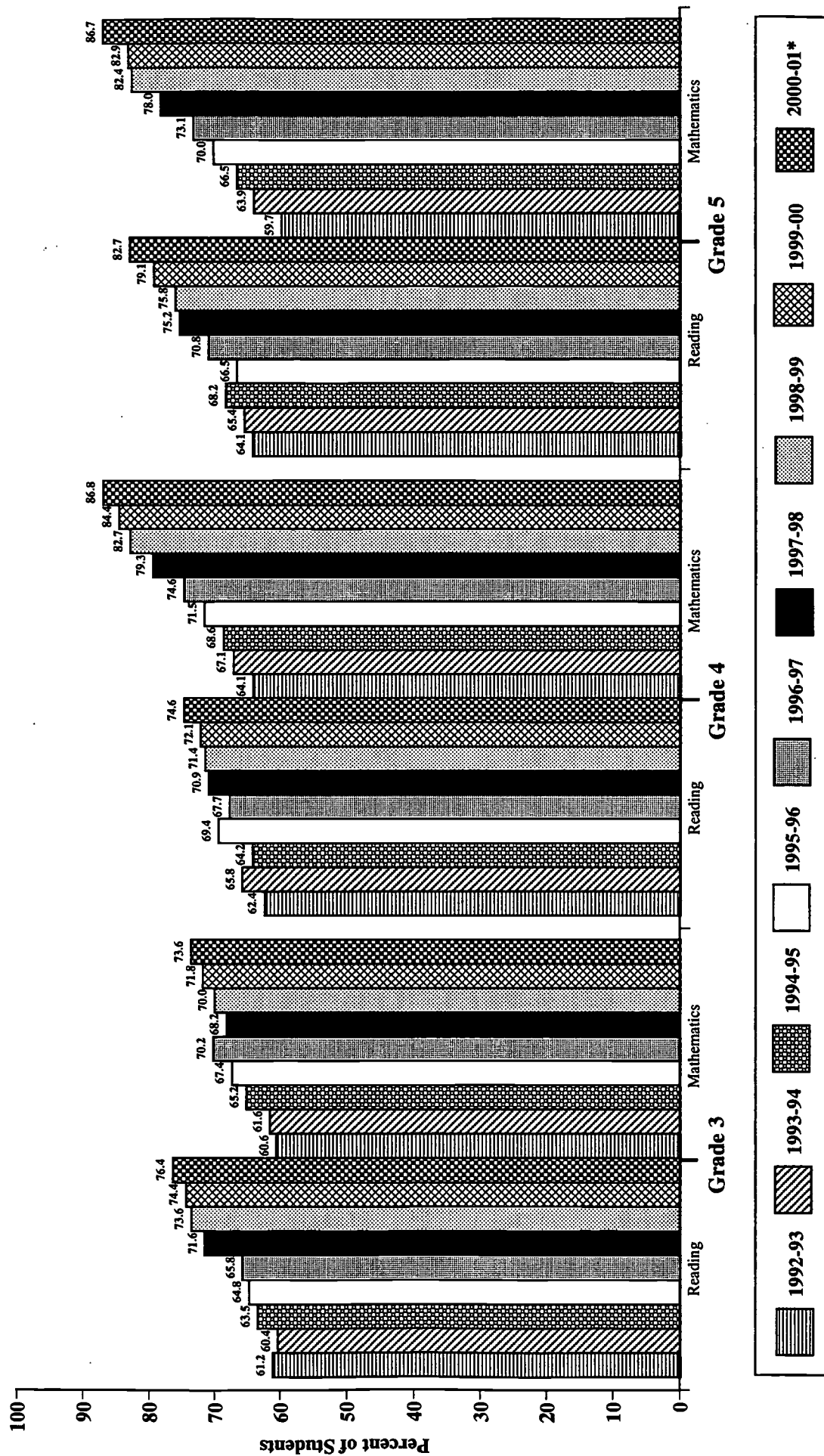
Notes: The State total is the total number of students tested in reading.
Data received by LEAs and charter school after August 2001 are not included in this figure.
Prepared by the NCDPI Division Services/Testing Section.

**Figure 2. 2000-01 End-of-Grade Multiple-Choice Test Results
Percent of Students at Each Achievement Level in Mathematics
Grades 3-8 Combined, by Ethnicity**



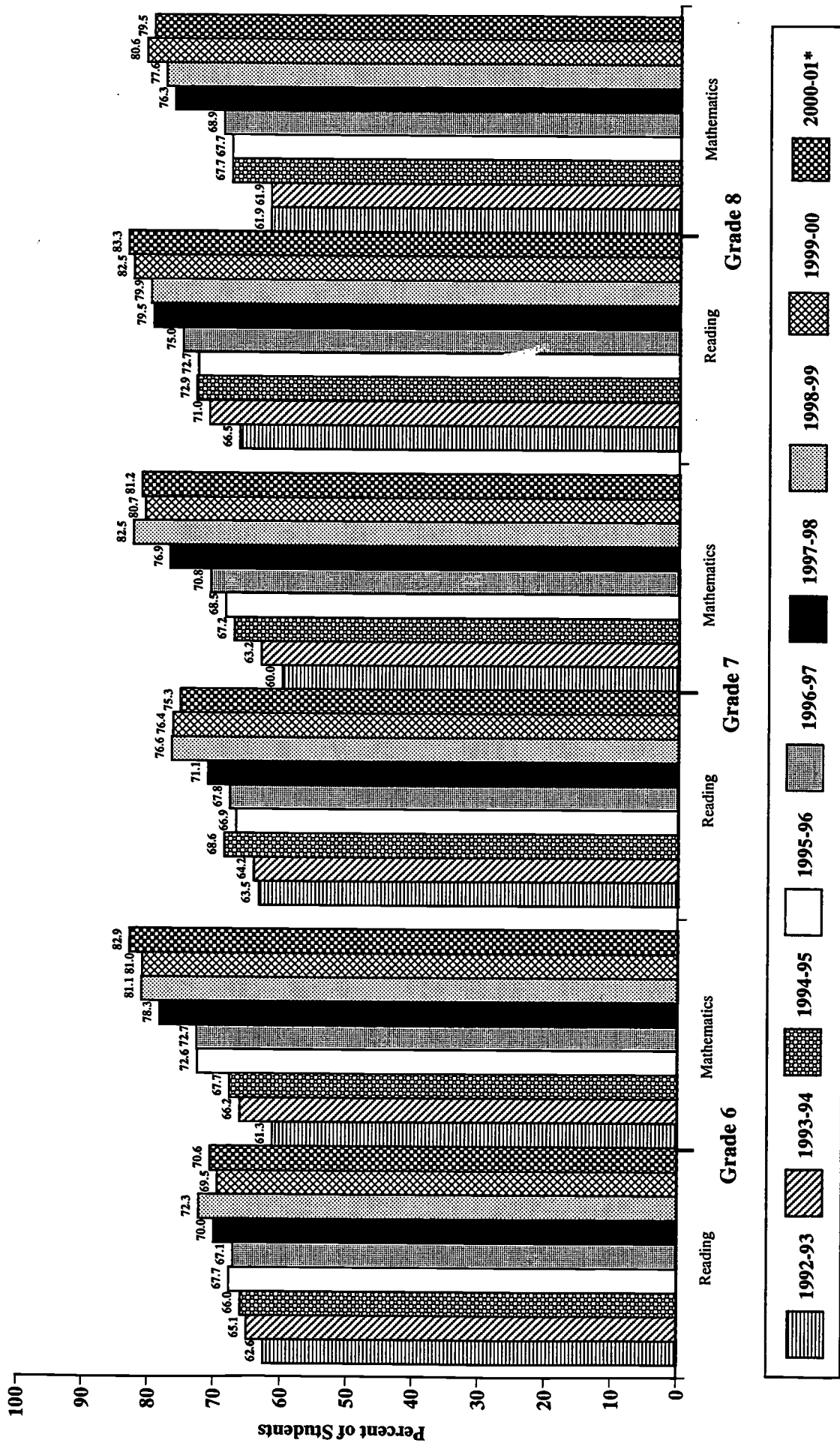
Notes: The State total is the total number of students tested in mathematics.
Data received by LEAs and charter school after August 2001 are not included in this figure.
Prepared by the NCDPI Division Services/Testing Section.

**Figure 3. 1992-93 to 2000-01 End-of-Grade Multiple-Choice Test Results
Percent of Students At or Above Level III in Reading and Mathematics
Grades 3-8**



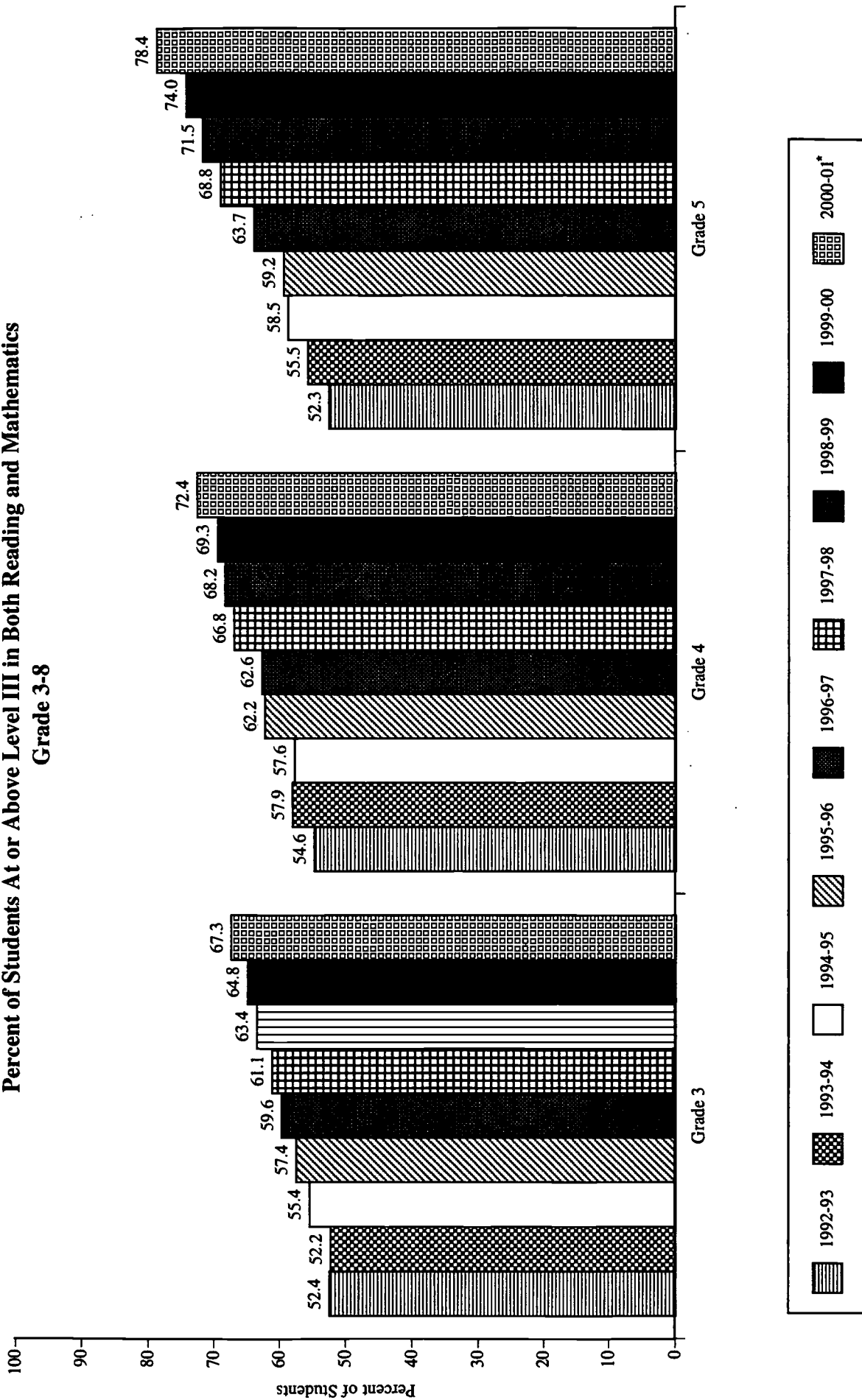
Notes: *The North Carolina mathematics tests measure the competencies in the 1998 North Carolina mathematics curriculum beginning in the 2000-01 school year.
Data received from LEAs and charter schools after August 2001 are not included in this figure.
Prepared by the NCDPI Division of Accountability Services/Testing Section.

**Figure 3. 1992-93 to 2000-01 End-of-Grade Multiple-Choice Test Results
Percent of Students At or Above Level III in Reading and Mathematics
Grades 3-8 (continued)**



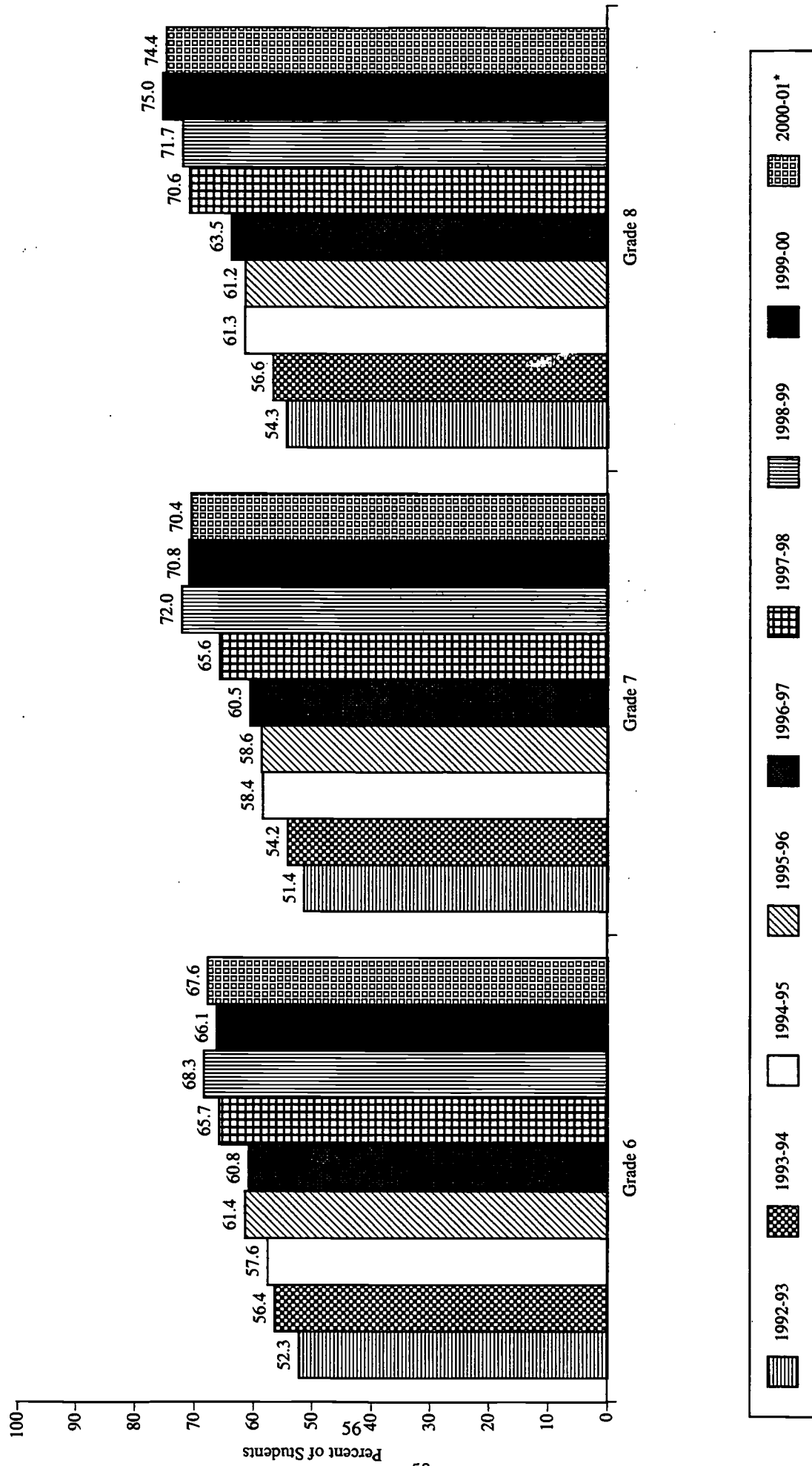
Notes: *The North Carolina mathematics tests measure the competencies in the 1998 North Carolina mathematics curriculum beginning in the 2000-01 school year. Data received from LEAs and charter schools after August 2001 are not included in this figure. Prepared by the NCDPI Division of Accountability Services/Testing Section.

**Figure 4. 1992-93 to 2000-01 End-of-Grade Multiple Choice Test Results
Percent of Students At or Above Level III in Both Reading and Mathematics
Grade 3-8**



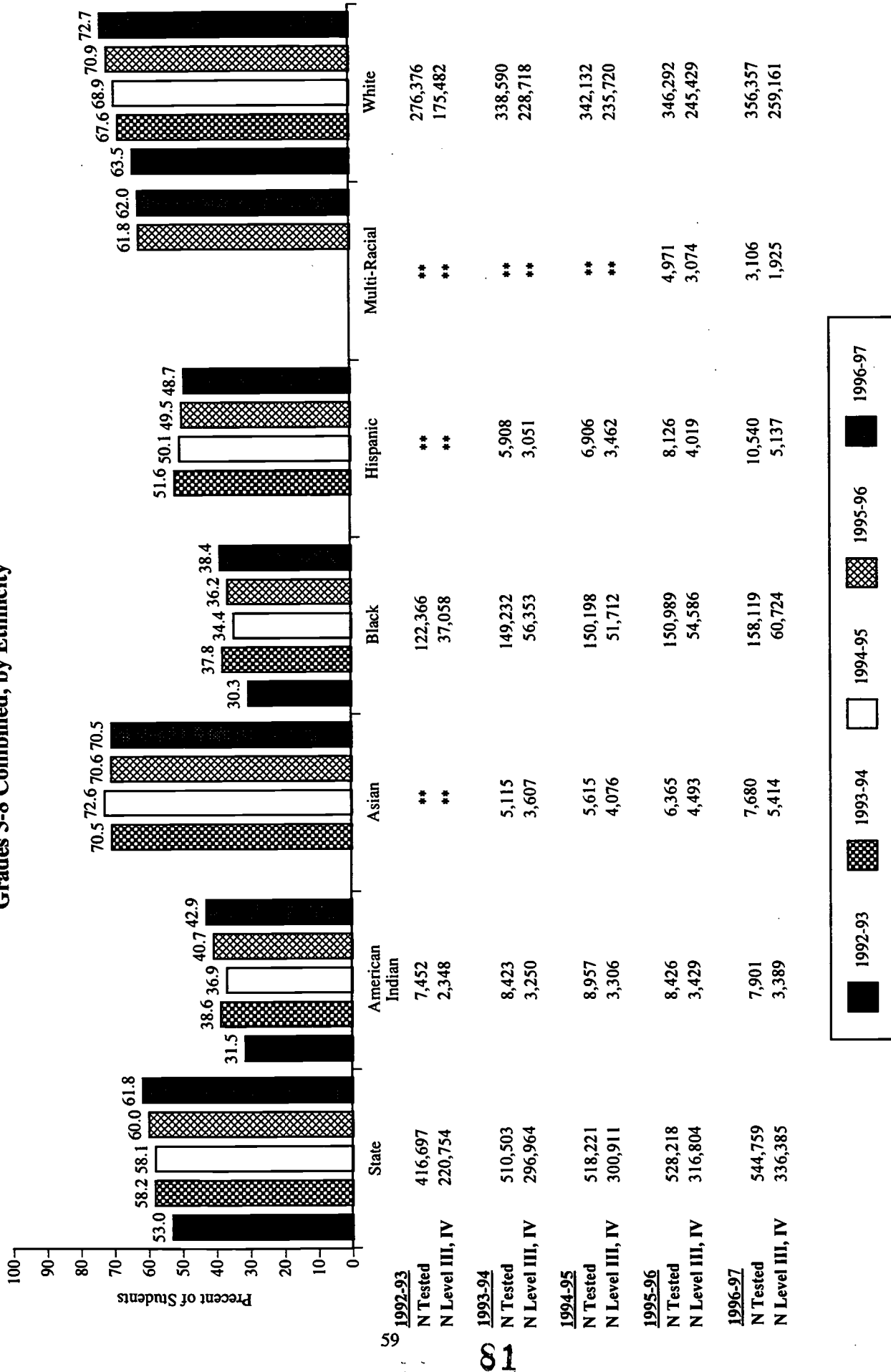
Notes: *The North Carolina mathematics tests measure the competencies in the 1998 North Carolina mathematics curriculum beginning in the 2000-01 school year. Data received from LEAs and charter schools after August 2001 are not included in this figure. Prepared by the NCDPI Division of Accountability Services/Testing Section.

**Figure 4. 1992-93 to 2000-01 End-of-Grade Multiple Choice Test Results
Percent of Students At or Above Level III in Both Reading and Mathematics
Grade 3-8 (continued)**



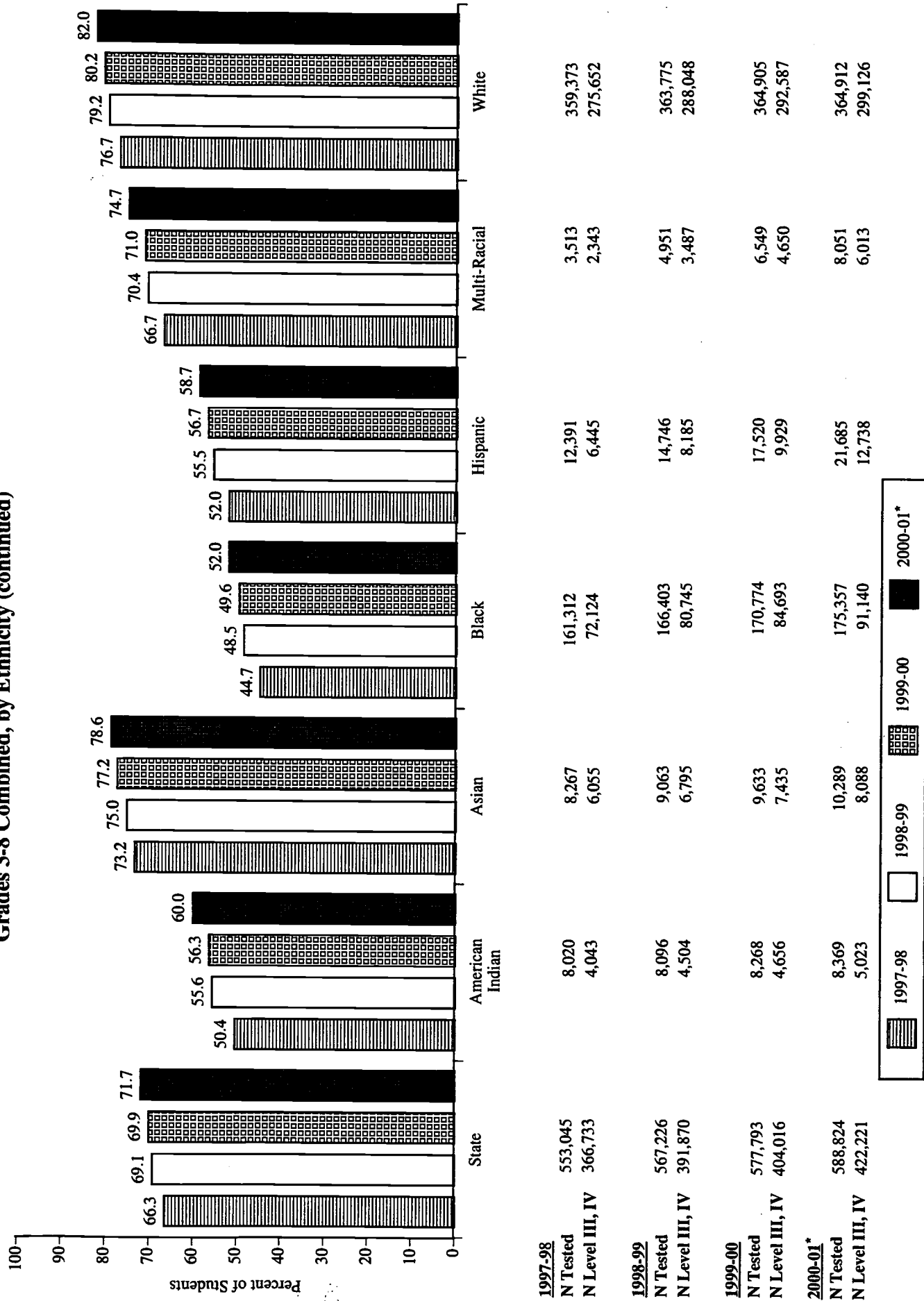
Notes: *The North Carolina mathematics tests measure the competencies in the 1998 North Carolina mathematics curriculum beginning in the 2000-01 school year. Data received from LEAs and charter schools after August 2001 are not included in this figure. Prepared by the NCDPI Division of Accountability Services/Testing Section.

**Figure 5. 1992-93 to 2000-01 End-of-Grade Multiple-Choice Test Results
Percent of Students At or Above Level III in Both Reading and Mathematics
Grades 3-8 Combined, by Ethnicity**



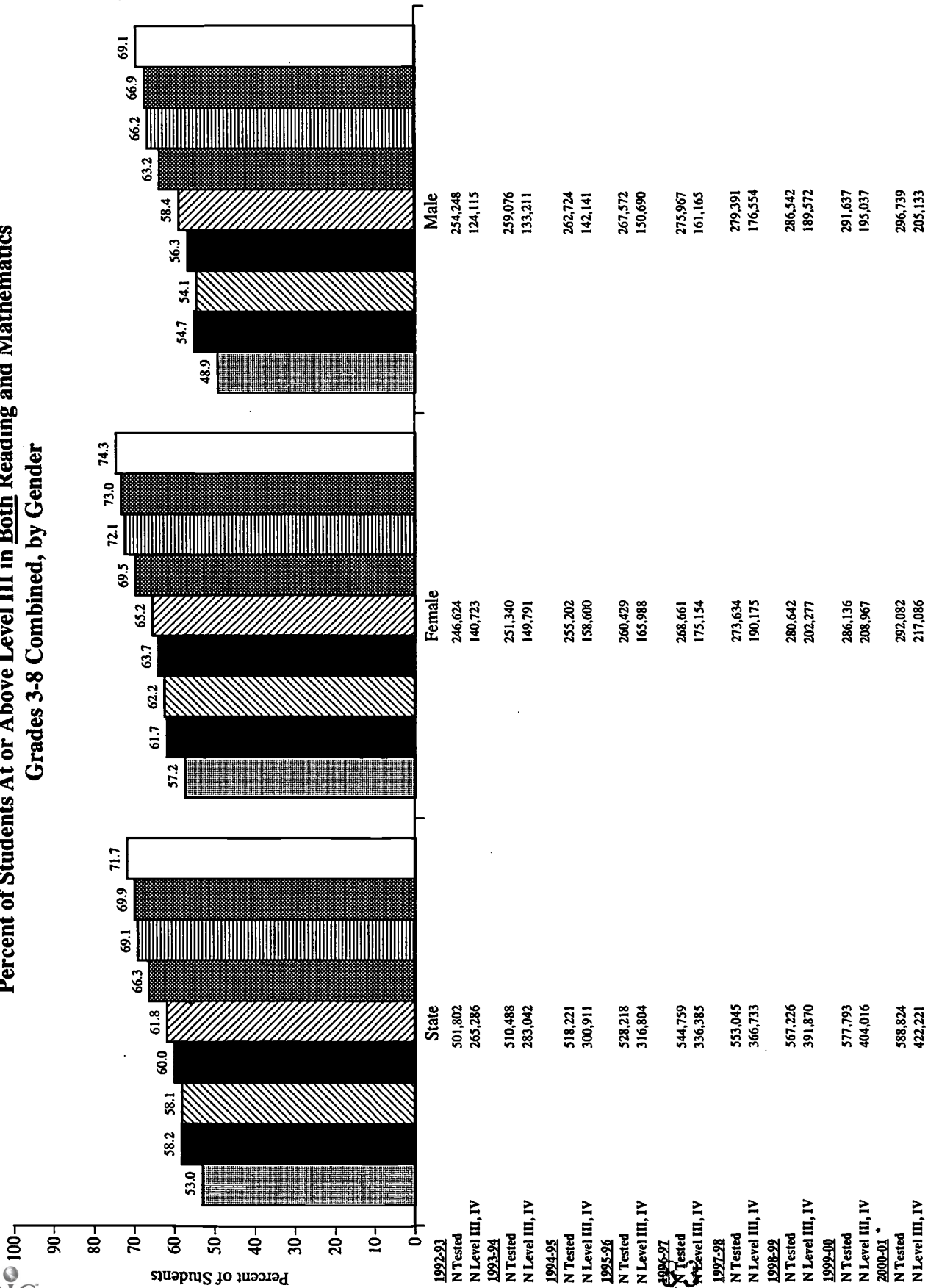
Notes: *The North Carolina mathematics tests measure the competencies in the 1998 North Carolina mathematics curriculum in the 2000-01 school year. "N Tested" and "N Level III, IV" for ethnicity categories do not sum to the state "N Tested" and "N Level III, IV" because ethnicity was not coded on some student answer sheets and, therefore, some students were reported in the state data only. **Results for the Asian and Hispanic categories were not reported in 1992-93. Results for the Multi-Racial category were not reported in 1992-93, 1993-94 and 1994-95. Data received from LEAs and charter schools after August 2001 are not included in this figure. Prepared by the NCDPI Division of Accountability Services/Testing Section.

**Figure 5. 1992-93 to 2000-01 End-of-Grade Multiple-Choice Test Results
Percent of Students At or Above Level III in Both Reading and Mathematics
Grades 3-8 Combined, by Ethnicity (continued)**



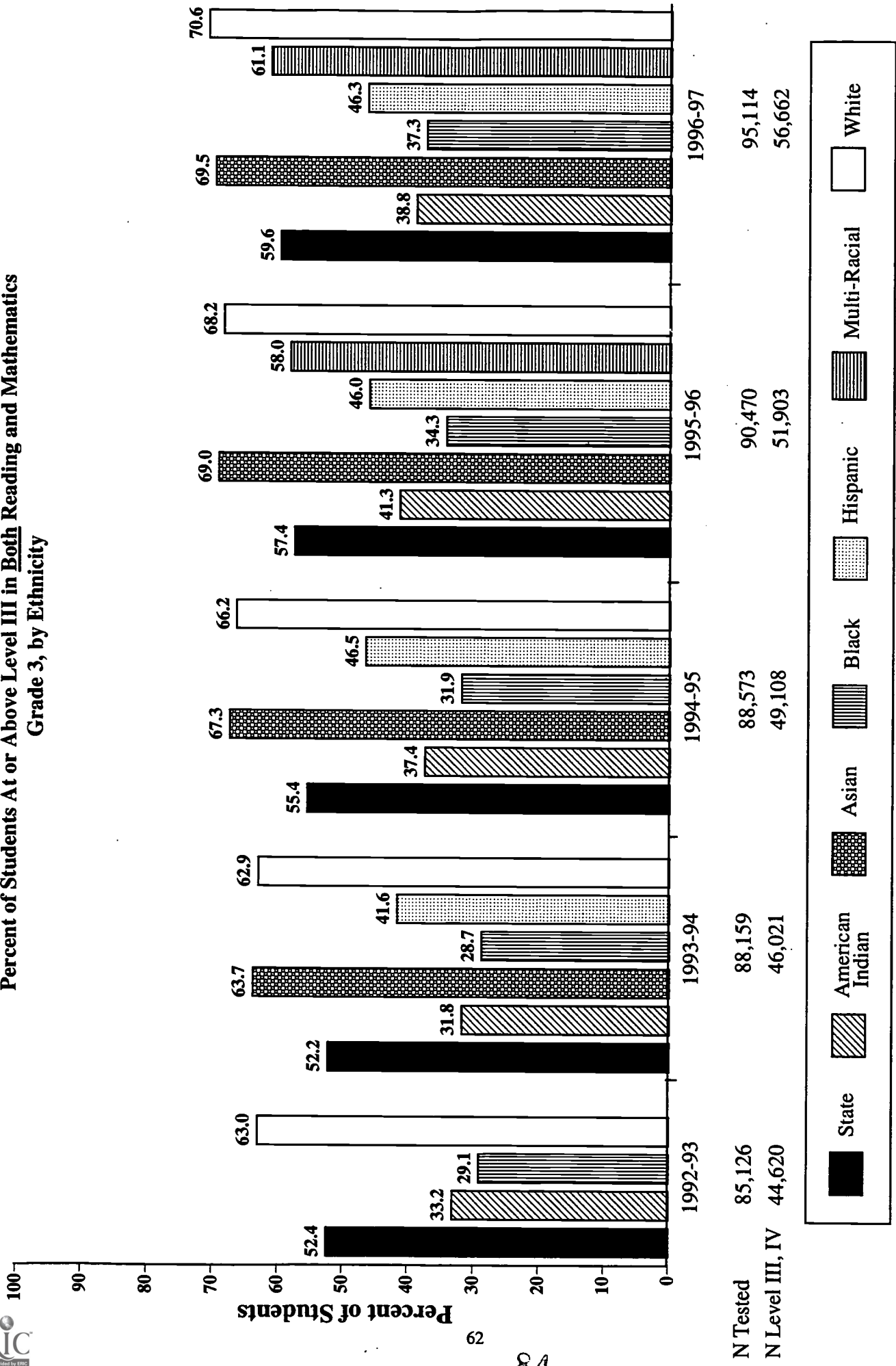
Notes: *The North Carolina mathematics tests measure the competencies in the 1998 North Carolina mathematics curriculum in the 2000-01 school year.
 "N Tested" and "N Level III, IV" for ethnicity categories do not sum to the state "N Tested" and "N Level III, IV" because ethnicity was not coded on some student answer sheets and, therefore, some students were reported in the state data only.
 Data received from LEAs and charter schools after August 2001 are not included in this figure.
 Prepared by the NCDPI Division of Accountability Services/Testing Section.

**Figure 6. 1992-93 to 2000-01 End-of-Grade Multiple-Choice Test Results
Percent of Students At or Above Level III in Both Reading and Mathematics
Grades 3-8 Combined, by Gender**



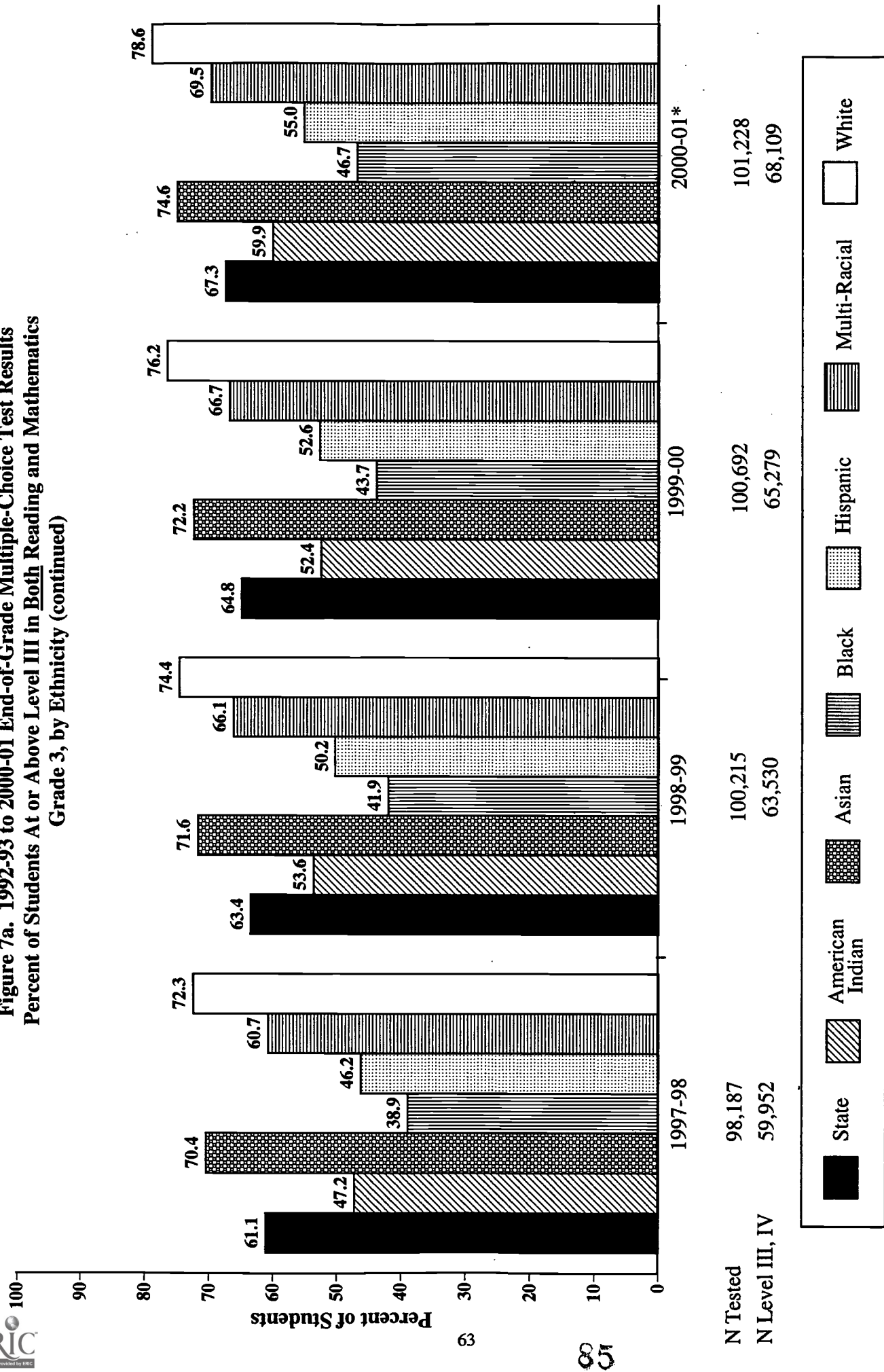
Notes: *The North Carolina mathematics tests measure the competencies in the 1998 North Carolina mathematics curriculum beginning in the 2000-01 school year. Data received from LEAs and charter schools after August 2001 are not included in this figure. Prepared by the NCDPI Division of Accountability Services/Testing Section.

**Figure 7a. 1992-93 to 2000-01 End-of-Grade Multiple-Choice Test Results
Percent of Students At or Above Level III in Both Reading and Mathematics
Grade 3, by Ethnicity**



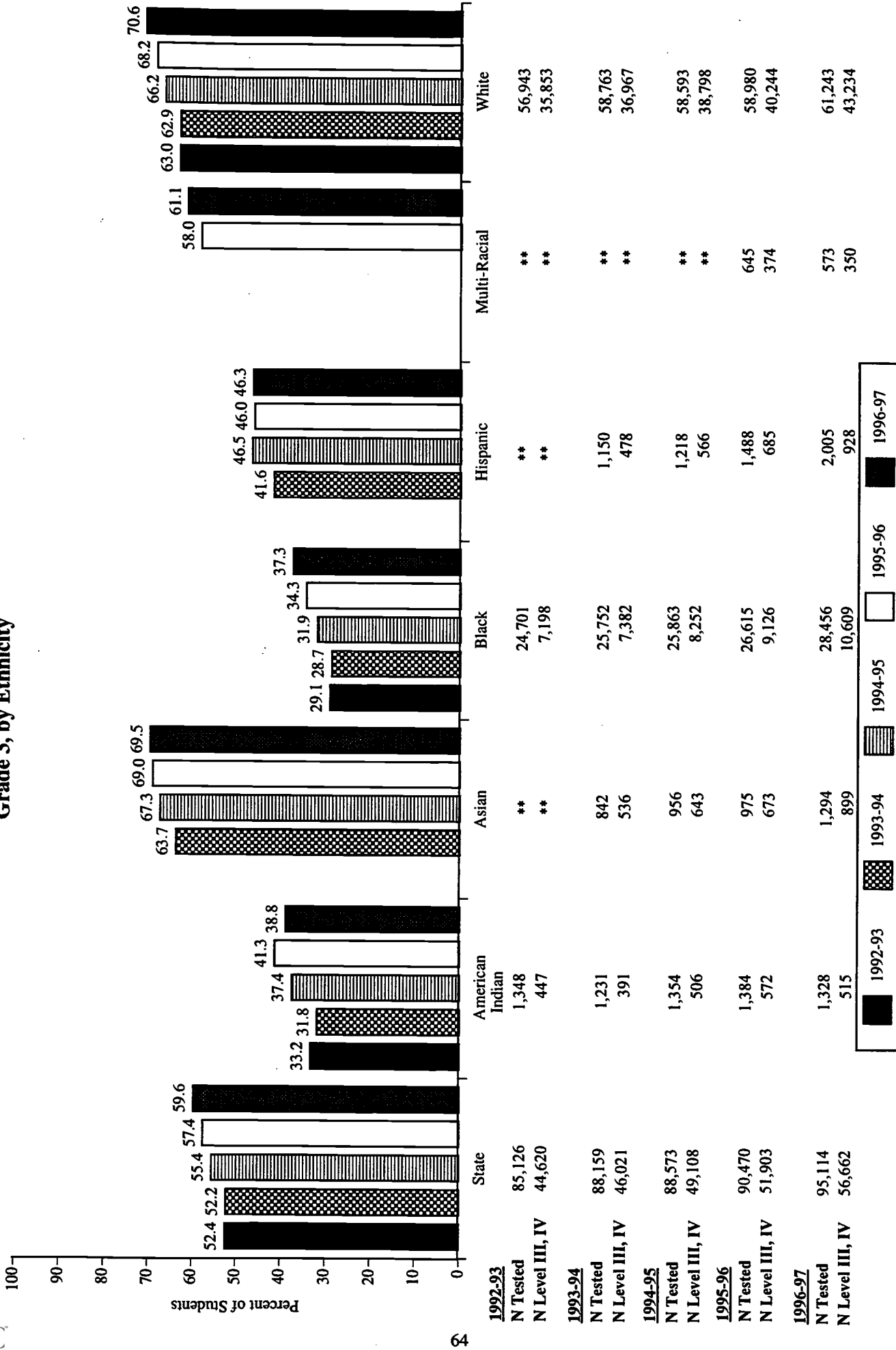
Notes: *The North Carolina mathematics tests measure the competencies in the 1998 North Carolina mathematics curriculum beginning in the 2000-01 school year. Results for the Multi-Racial category were not reported in 1992-93 through 1994-95. Results for the Asian and Hispanic categories were not reported in 1992-93. Data received from LEAs and charter schools after August 2001 are not included in this figure. Prepared by the NCDPI Division of Accountability Services/Testing Section.

**Figure 7a. 1992-93 to 2000-01 End-of-Grade Multiple-Choice Test Results
Percent of Students At or Above Level III in Both Reading and Mathematics
Grade 3, by Ethnicity (continued)**



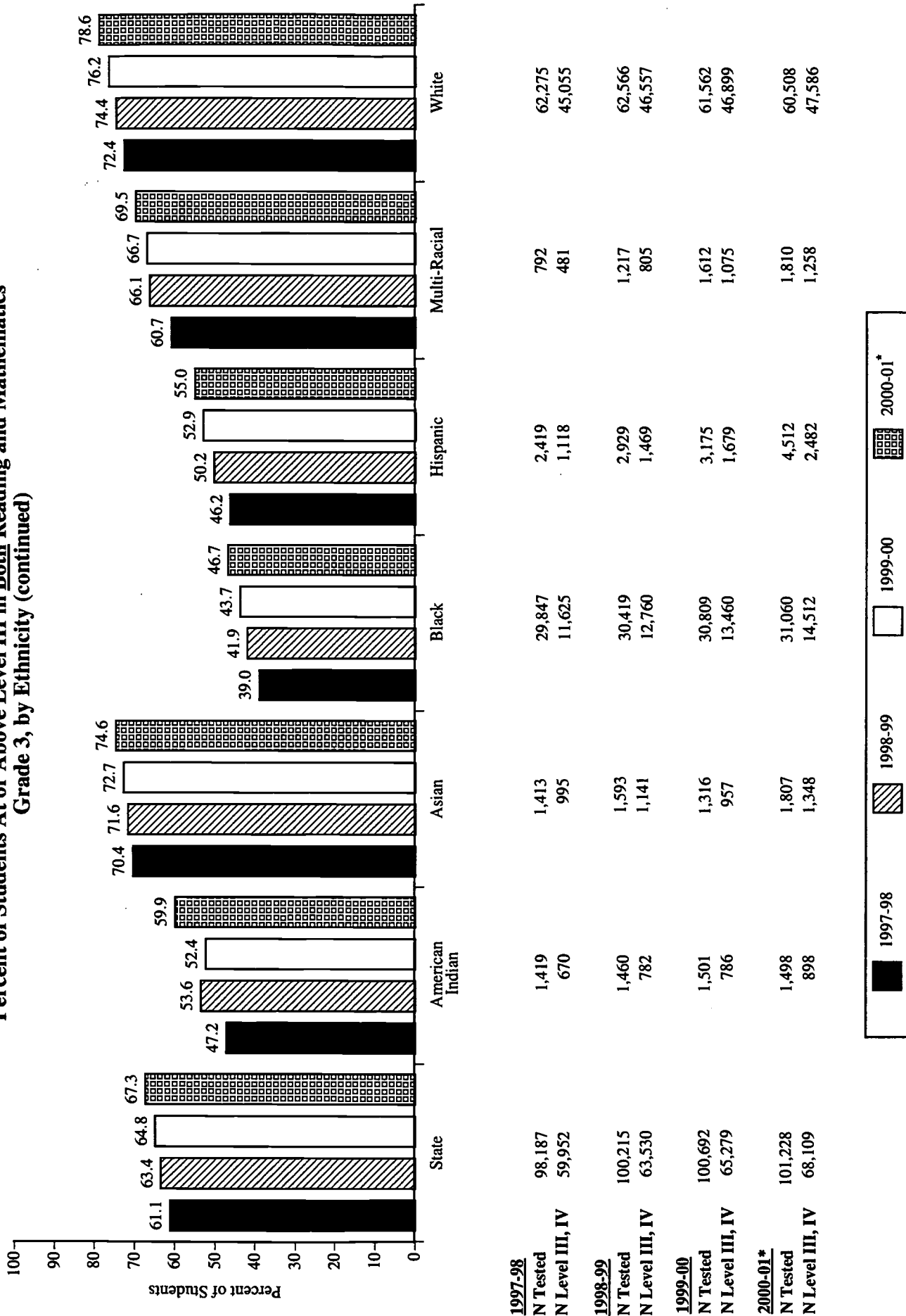
Notes: *The North Carolina mathematics tests measure the competencies in the 1998 North Carolina mathematics curriculum beginning in the 2000-01 school year. Results for the Multi-Racial category were not reported in 1992-93 through 1994-95. Results for the Asian and Hispanic categories were not reported in 1992-93. Data received from LEAs and charter schools after August 2001 are not included in this figure. Prepared by the NCDPI Division of Accountability Services/Testing Section.

**Figure 7b. 1992-93 to 2000-01 End-of-Grade Multiple-Choice Test Results
Percent of Students At or Above Level III in Both Reading and Mathematics
Grade 3, by Ethnicity**



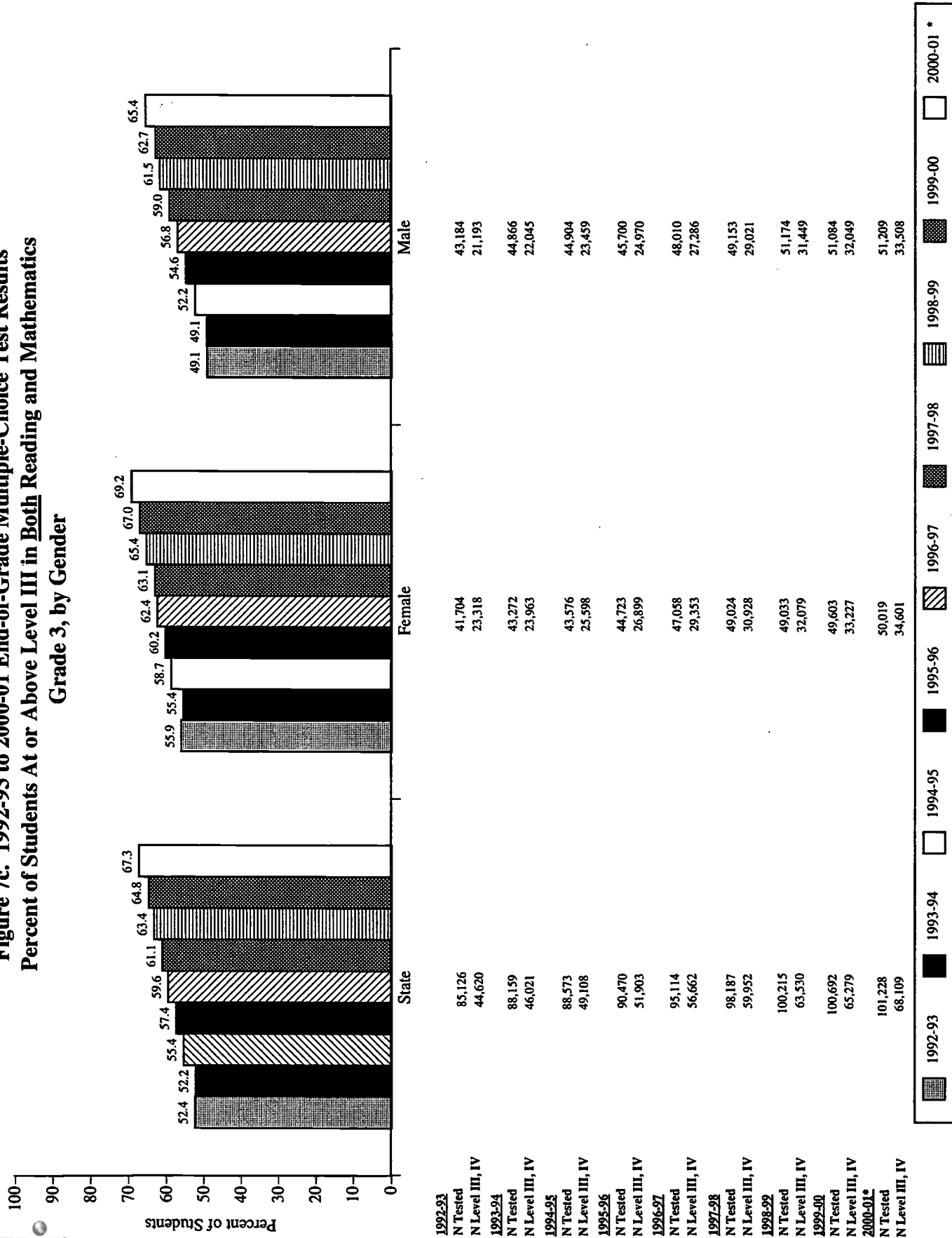
Notes: *The North Carolina mathematics tests measure the competencies in the 1998 North Carolina mathematics curriculum beginning in the 2000-01 school year.
 "N Tested" and "N Level III, IV" for the ethnicity categories do not sum to the "N Tested" and "N Level III, IV" for the state because ethnicity was not coded on some student answer sheets and, therefore, some students were reported in the state data only.
 **Results for the Asian and Hispanic categories were not reported in 1992-93. Results for the Multi-Racial category were not reported in 1992-93, 1993-94 and 1994-95.
 Data received by LEAs and charter schools after August 2001 are not included in this figure.
 Prepared by the NCDPI Division of Accountability Services/Testing Section.

**Figure 7b. 1992-93 to 2000-01 End-of-Grade Multiple-Choice Test Results
Percent of Students At or Above Level III in Both Reading and Mathematics
Grade 3, by Ethnicity (continued)**



Notes: *The North Carolina mathematics tests measure the competencies in the 1998 North Carolina mathematics curriculum beginning in the 2000-01 school year. "N Tested" and "N Level III, IV" for the ethnicity categories do not sum to the "N Tested" and "N Level III, IV" for the state because ethnicity was not coded on some student answer sheets and, therefore, some students were reported in the state data only.
Data received by LEAs and charter schools after August 2001 are not included in this figure.
Prepared by the NCDPI Division of Accountability Services/Testing Section.

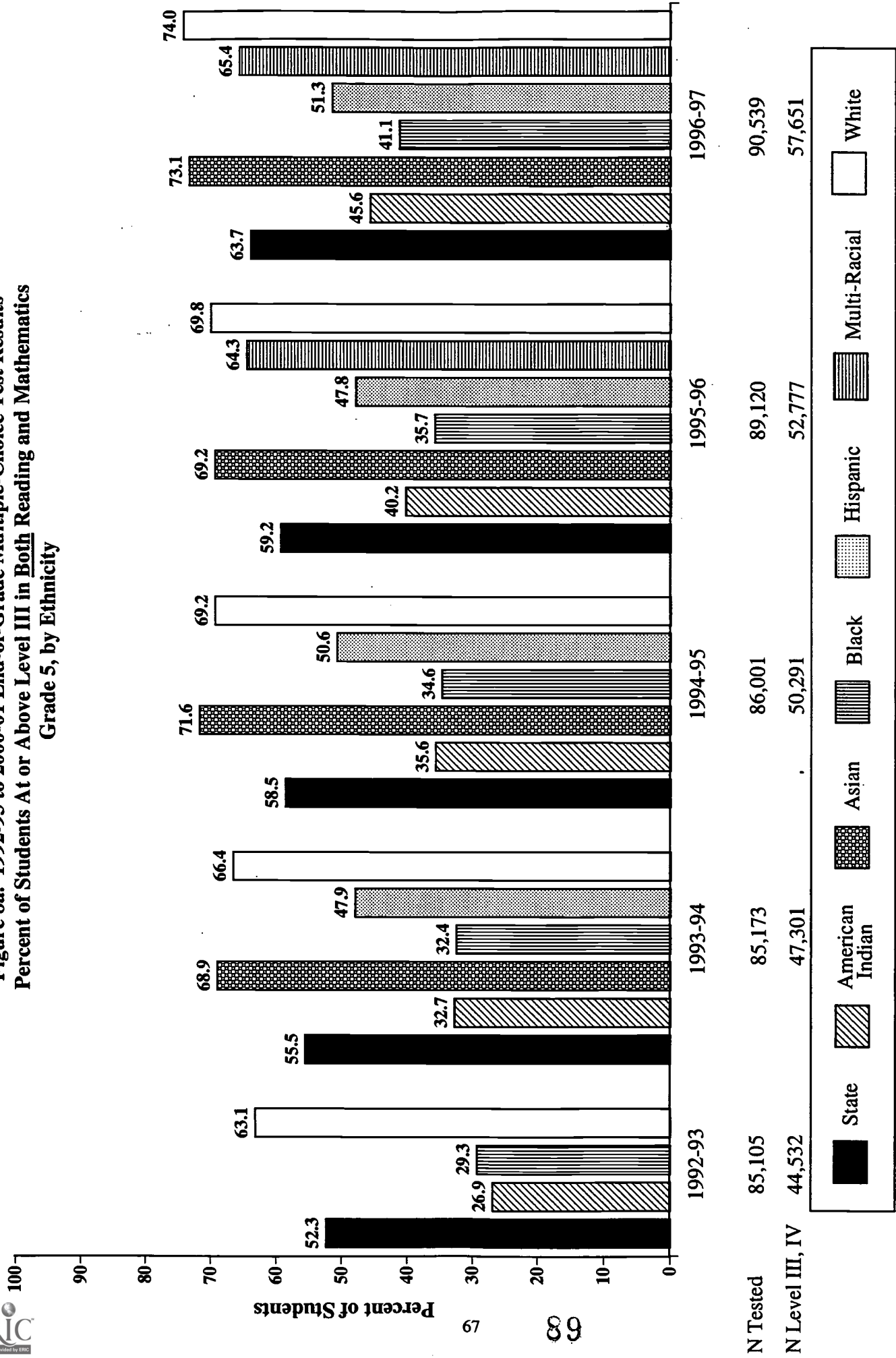
**Figure 7c. 1992-93 to 2000-01 End-of-Grade Multiple-Choice Test Results
Percent of Students At or Above Level III in Both Reading and Mathematics
Grade 3, by Gender**



1992-93	85,126	41,704	43,184
N Tested	44,620	23,318	21,193
N Level III, IV	88,159	43,272	44,866
1993-94	46,021	23,963	22,045
N Tested	88,573	43,576	44,904
N Level III, IV	49,108	25,598	23,459
1995-96	90,470	44,723	45,700
N Tested	51,903	26,899	24,970
N Level III, IV	95,114	47,058	48,010
1996-97	56,662	29,353	27,286
N Tested	98,187	49,024	49,153
N Level III, IV	59,952	30,928	29,021
1997-98	100,215	49,033	51,174
N Tested	63,530	32,079	31,449
N Level III, IV	100,692	49,603	51,084
1998-99	65,279	33,227	32,049
N Tested	101,228	50,019	51,209
N Level III, IV	68,109	34,601	33,508

Notes: *The North Carolina mathematics tests measure the competencies in the 1998 North Carolina mathematics curriculum beginning in the 2000-01 school year.
 "N Tested" and "N Level III, IV" for the gender categories do not sum to the "N Tested" and "N Level III, IV" for the state because gender was not coded on some student answer sheets and, therefore, some students were reported in the state data only.
 Data received from LEAs and charter schools after August 2001 are not included in this figure.
 Prepared by the NCDPI Division of Accountability Services/Testing Section.

**Figure 8a. 1992-93 to 2000-01 End-of-Grade Multiple-Choice Test Results
Percent of Students At or Above Level III in Both Reading and Mathematics
Grade 5, by Ethnicity**



Notes: *The North Carolina mathematics tests measure the competencies in the 1998 North Carolina mathematics curriculum beginning in the 2000-01 school year.

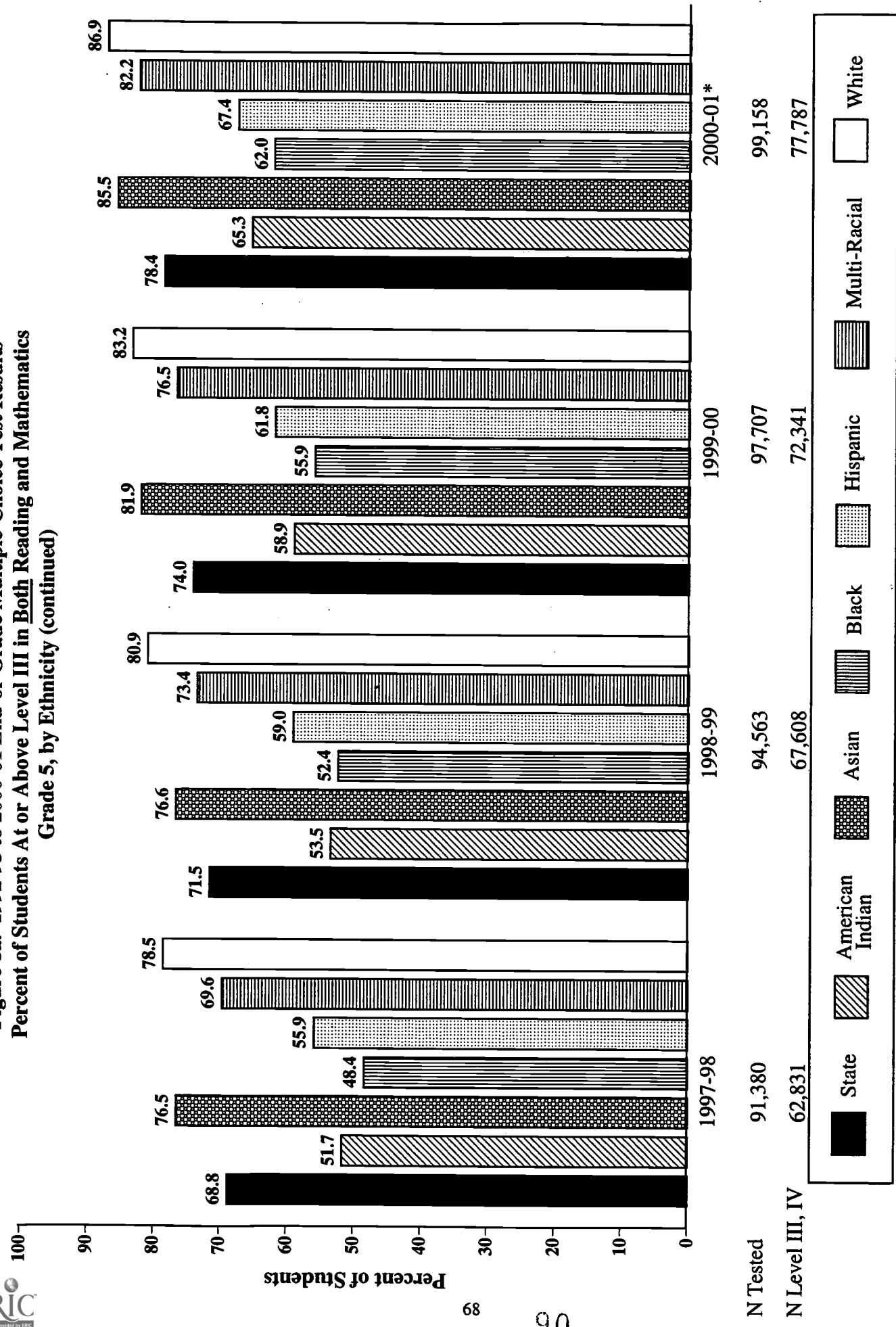
Results for the Multi-Racial category were not reported in 1992-93 through 1994-95. Results for the Asian and Hispanic categories were not reported in 1992-93.

"N Tested" and "N Level III, IV" for ethnicity categories do not sum to the "N Tested" and "N Level III, IV" for the state because ethnicity was not coded on some student answer sheets and, therefore, some students were reported in the state data only.

Data received from LEAs and charter schools after August 2001 are not included in this figure.

Prepared by the NCDPI Division of Accountability Services/Testing Section.

**Figure 8a. 1992-93 to 2000-01 End-of-Grade Multiple-Choice Test Results
Percent of Students At or Above Level III in Both Reading and Mathematics
Grade 5, by Ethnicity (continued)**

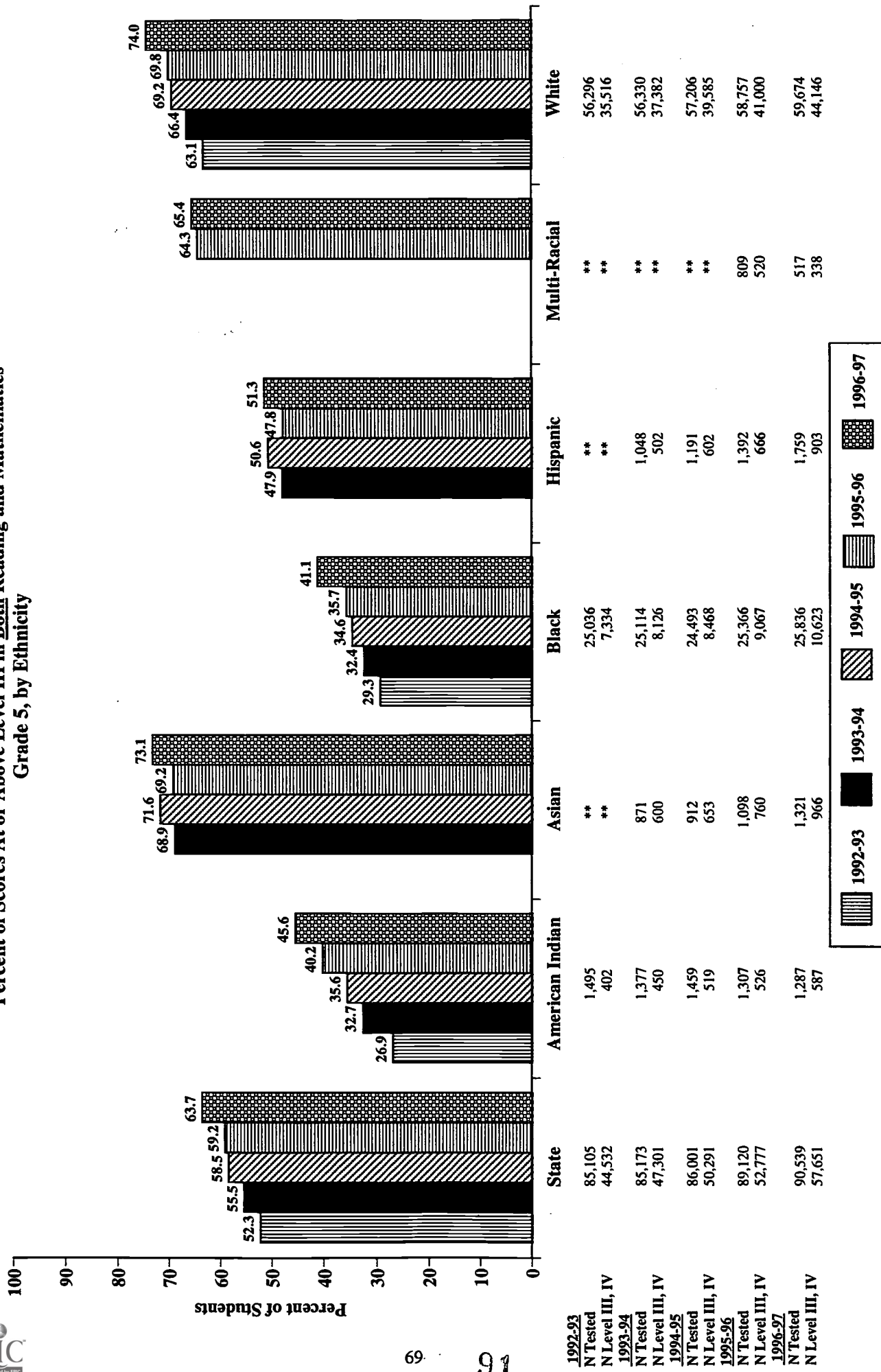


Notes: *The North Carolina mathematics tests measure the competencies in the 1998 North Carolina mathematics curriculum beginning in the 2000-01 school year. Results for the Multi-Racial category were not reported in 1992-93 through 1994-95. Results for the Asian and Hispanic categories were not reported in 1992-93. "N Tested" and "N Level III, IV" for ethnicity categories do not sum to the "N Tested" and "N Level III, IV" for the state because ethnicity was not coded on some student answer sheets and, therefore, some students were reported in the state data only.

Data received from LEAs and charter schools after August 2001 are not included in this figure.

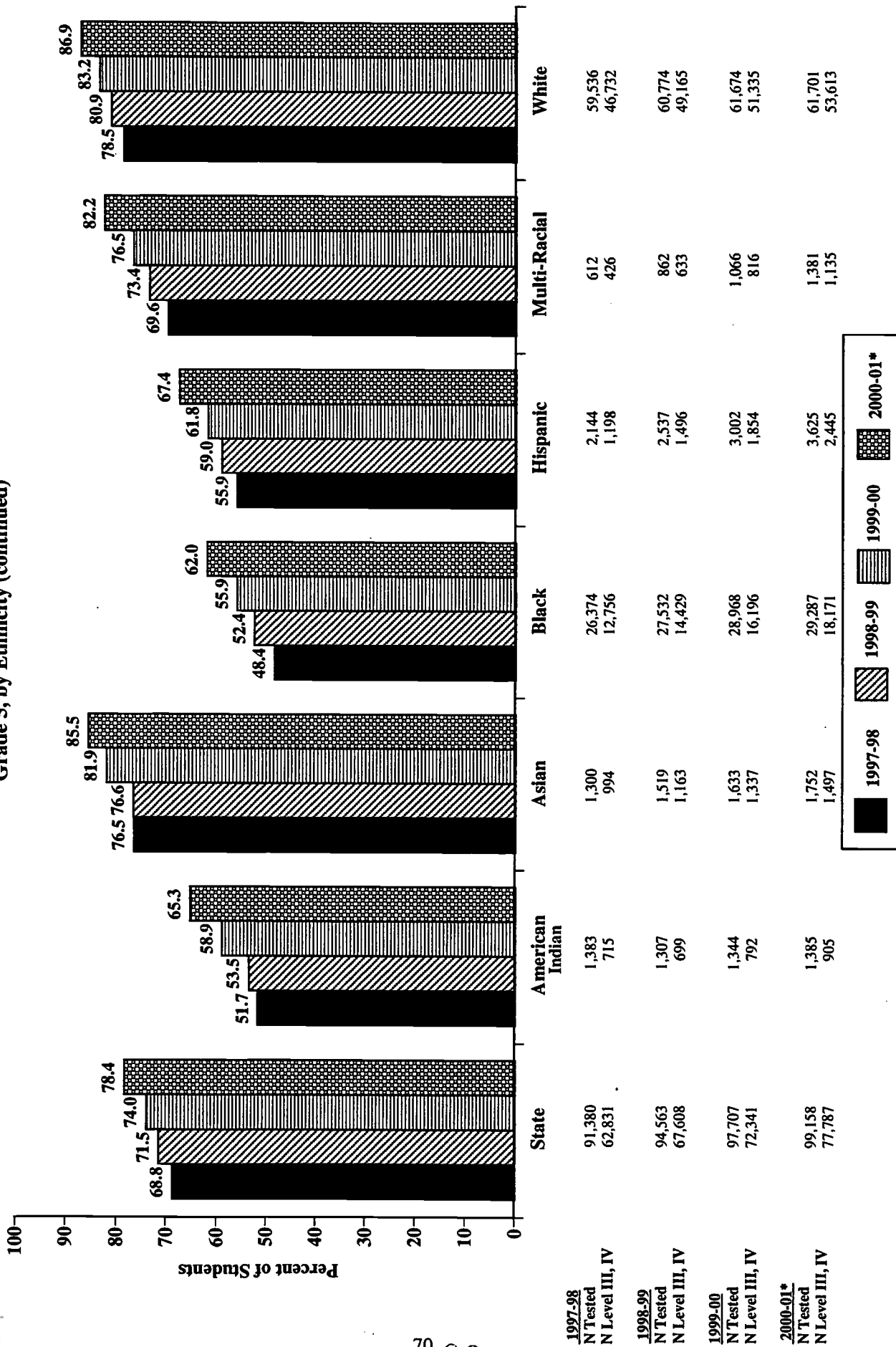
Prepared by the NCDPI Division of Accountability Services/Testing Section.

**Figure 8b. 1992-93 to 2000-01 End-of-Grade Multiple-Choice Test Results
Percent of Scores At or Above Level III in Both Reading and Mathematics
Grade 5, by Ethnicity**



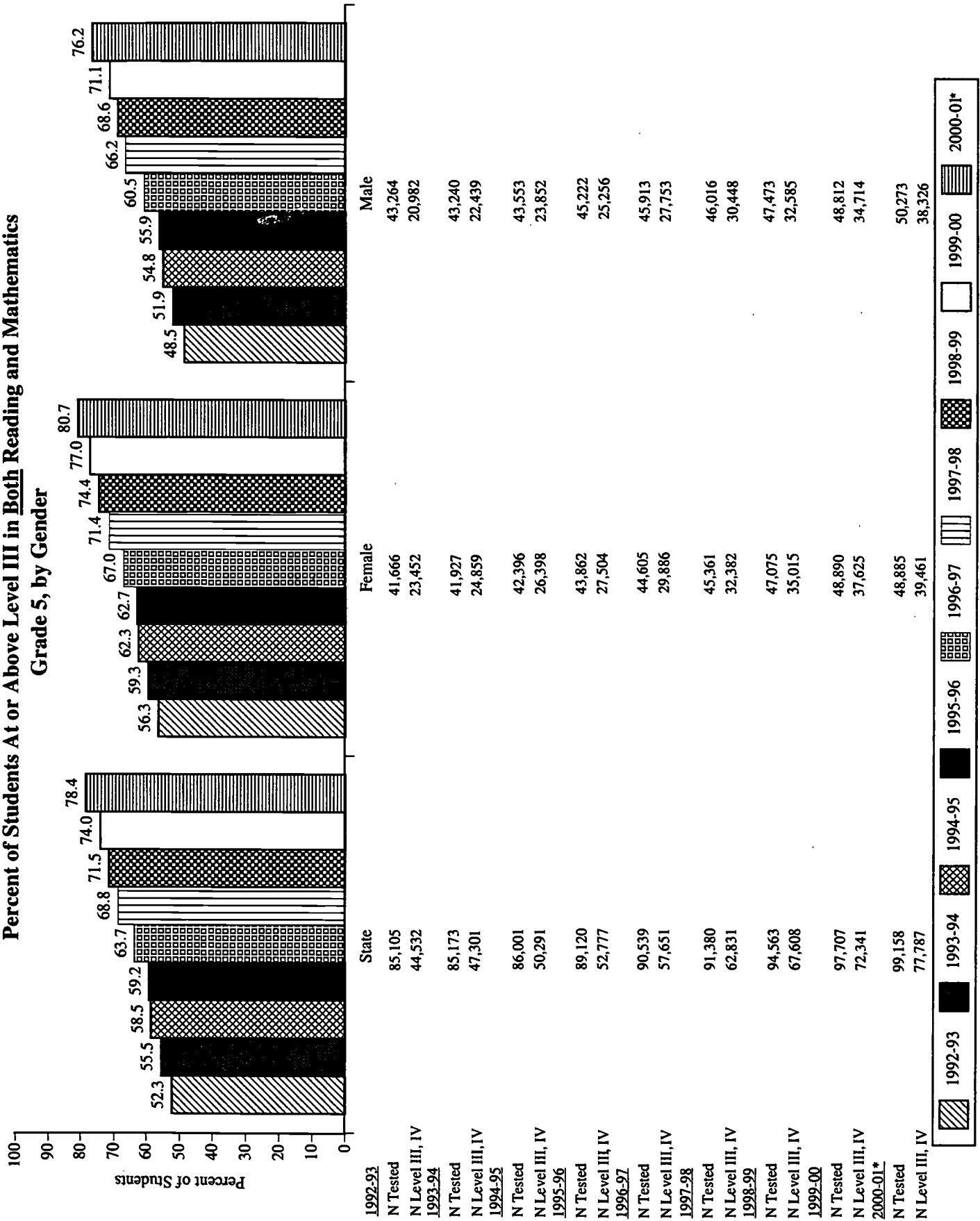
Notes: *The North Carolina mathematics tests measure the competencies in the 1998 North Carolina mathematics curriculum beginning in the 2000-01 school year.
 **Results for the Asian and Hispanic categories were not reported in 1992-93. Results for the Multi-Racial category were not reported in 1992-93, 1993-94 and 1994-95.
 "N Tested" and "N Level III, IV" for the ethnicity categories do not sum to the "N Tested" and "N Level III, IV" for the state because ethnicity was not coded on some student answer sheets and, therefore, some students were reported in the state data only.
 Data received from LEAs and charter schools after August 2001 are not included in these figures.
 Prepared by the NCDPI Division of Accountability Services/Testing Section.

**Figure 8b. 1992-93 to 2000-01 End-of-Grade Multiple-Choice Test Results
Percent of Scores At or Above Level III in Both Reading and Mathematics
Grade 5, by Ethnicity (continued)**



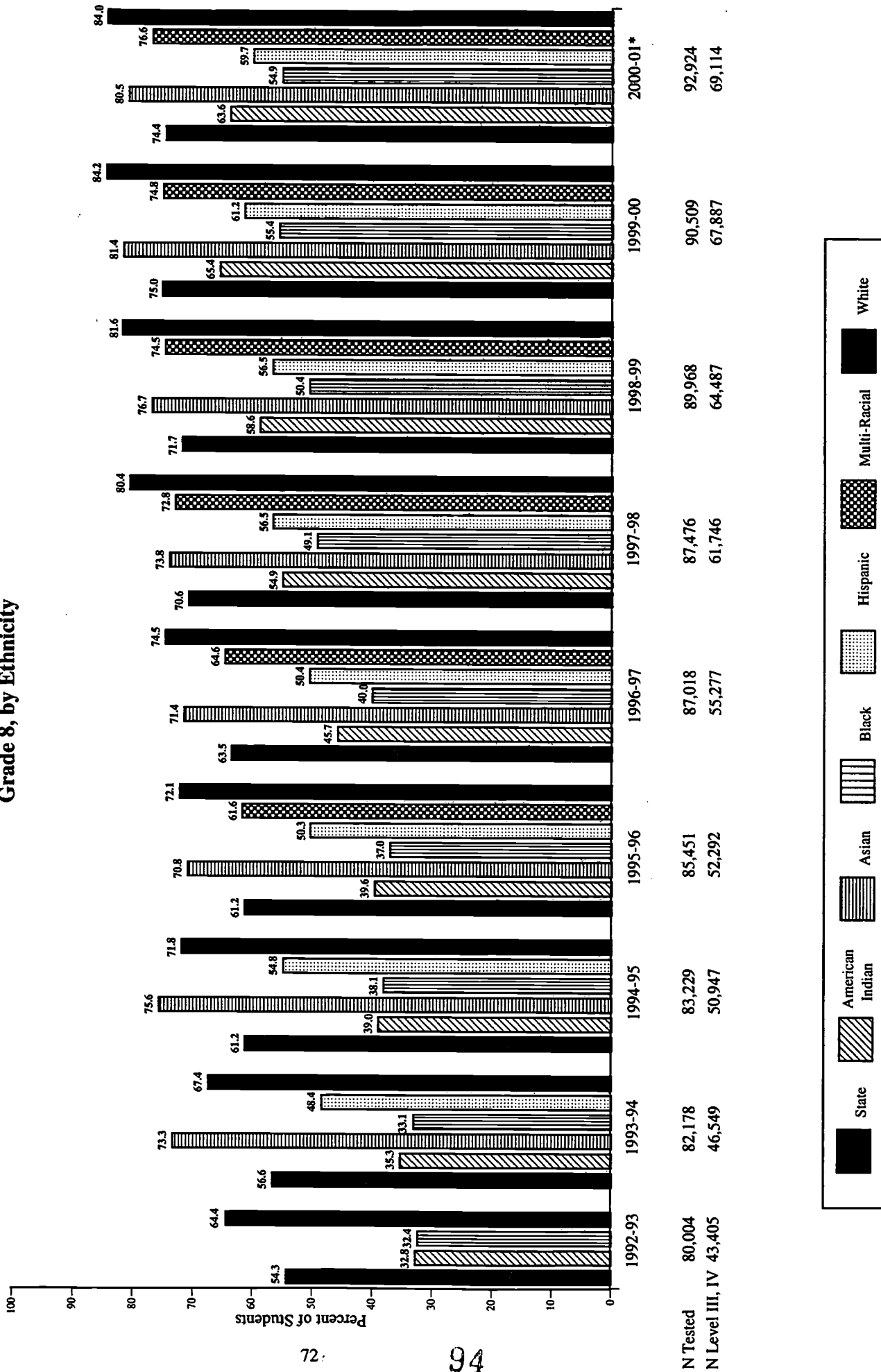
Notes: *The North Carolina mathematics tests measure the competencies in the 1998 North Carolina mathematics curriculum beginning in the 2000-01 school year. "N Tested" and "N Level III, IV" for the ethnicity categories do not sum to the "N Tested" and "N Level III, IV" for the state because ethnicity was not coded on some student answer sheets and, therefore, some students were reported in the state data only. Data received from LEAs and charter schools after August 2001 are not included in these figures. Prepared by the NCDPI Division of Accountability Services/Testing Section.

**Figure 8c. 1992-93 to 2000-01 End-of-Grade Multiple-Choice Test Results
Percent of Students At or Above Level III in Both Reading and Mathematics
Grade 5, by Gender**



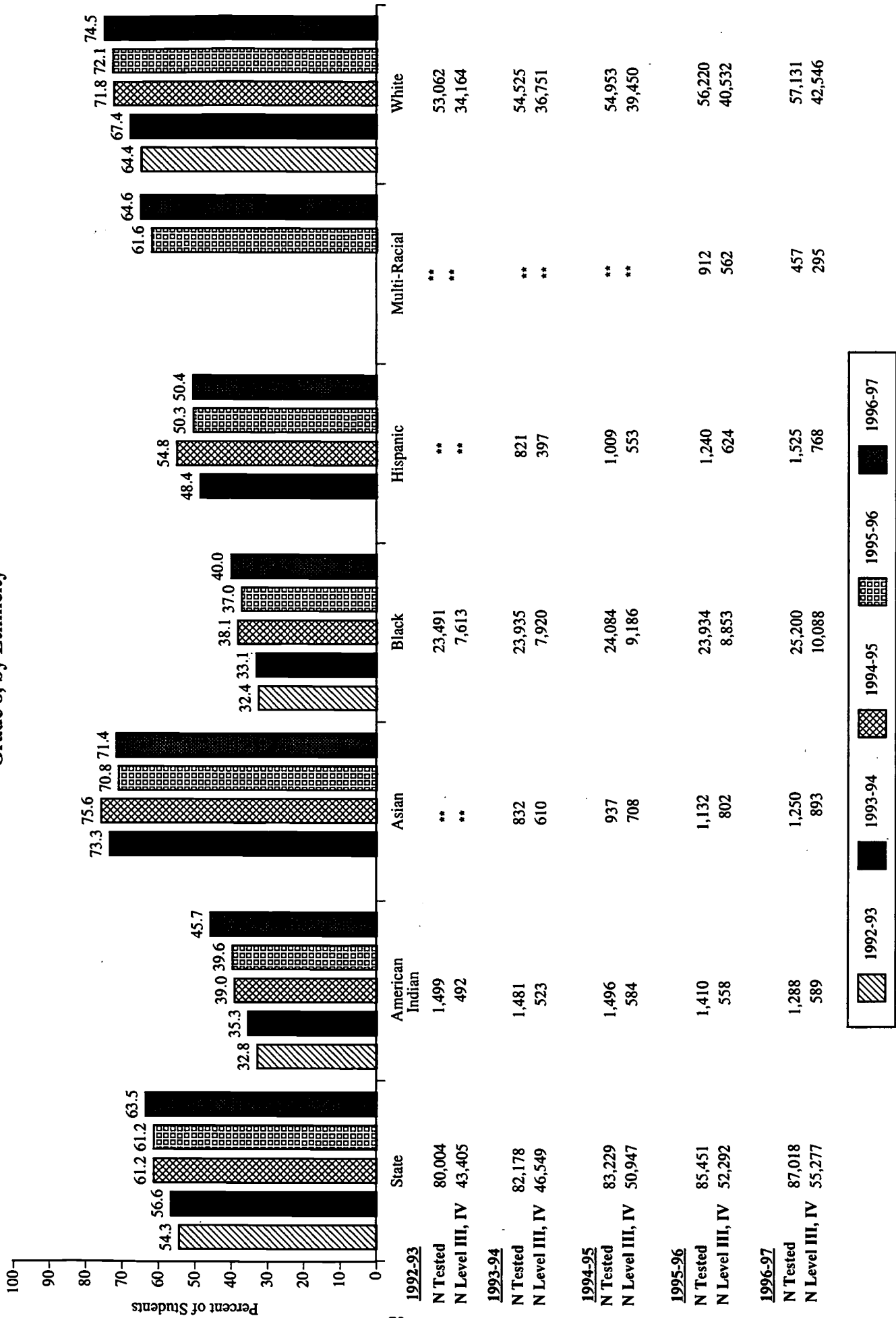
Notes: *The North Carolina mathematics tests measure for competencies in the 1998 North Carolina mathematics curriculum beginning in the 2000-01 school year. "N Tested" and "N Level III, IV" for the gender categories do not sum to the "N Tested" and "N Level III, IV" for the state because gender was not coded on some student answer sheets and, therefore, some students were in the state data only. Data received from LEAs and charter schools after August 2001 are not included in these figures. Prepared by the NCDPI Division of Accountability Services/Testing Section.

**Figure 9a. 1992-93 to 2000-01 End-of-Grade Multiple-Choice Test Results
Percent of Students At or Above Level III in Both Reading and Mathematics
Grade 8, by Ethnicity**



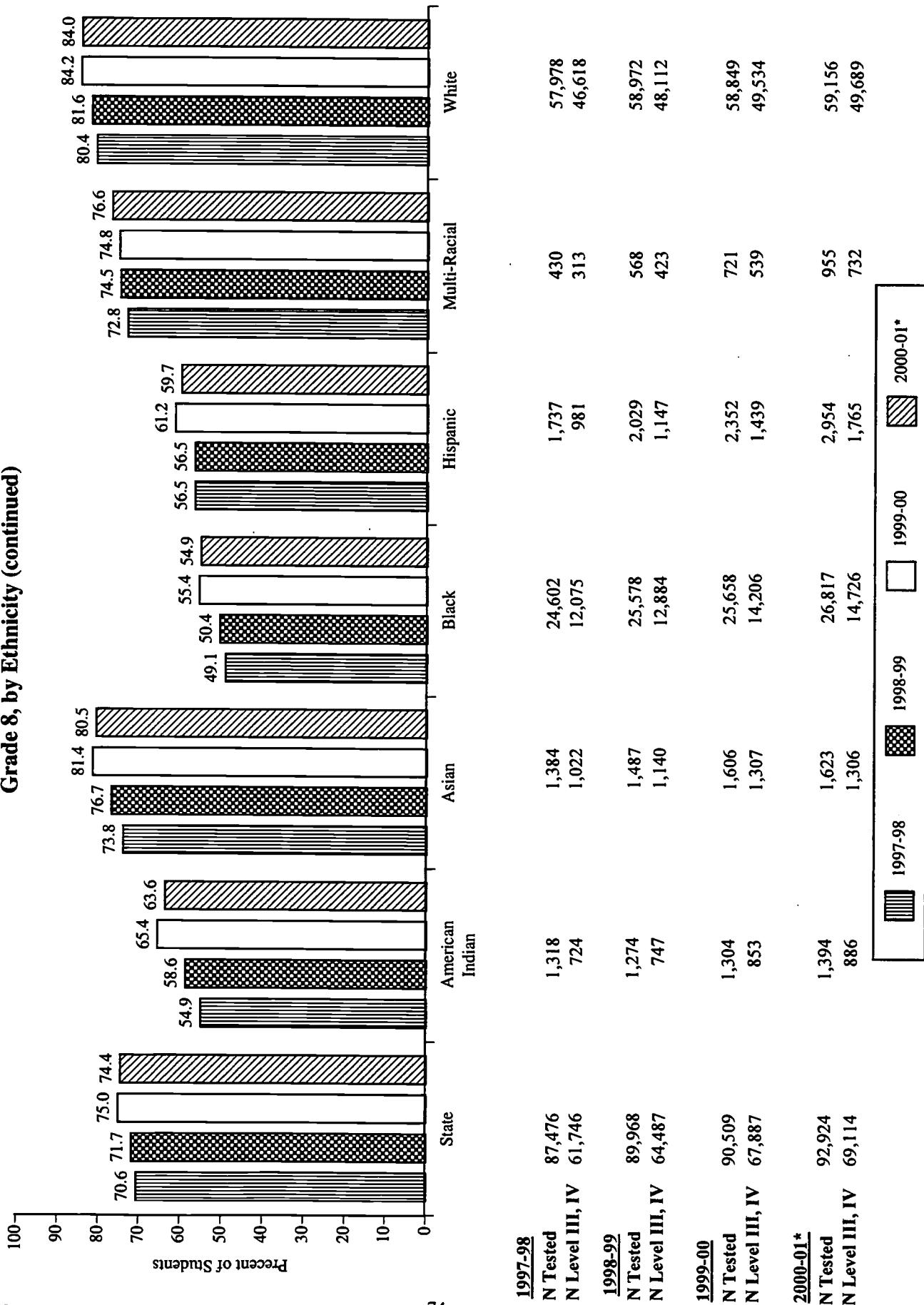
Notes: *The North Carolina mathematics tests measure the competencies in the 1998 North Carolina mathematics curriculum beginning in the 2000-01 school year. Results for the Multi-Racial category were not reported in 1992-93 through 1994-95. Results for the Asian and Hispanic categories were not reported in 1992-93. Data received from LEAs and charter schools after August 2001 are not included in this figure. Prepared by the NCDPI Division of Accountability Services/Testing Section.

**Figure 9b. 1992-93 to 2000-01 End-of-Grade Multiple-Choice Test Results
Percent of Students At or Above Level III in Both Reading and Mathematics
Grade 8, by Ethnicity**



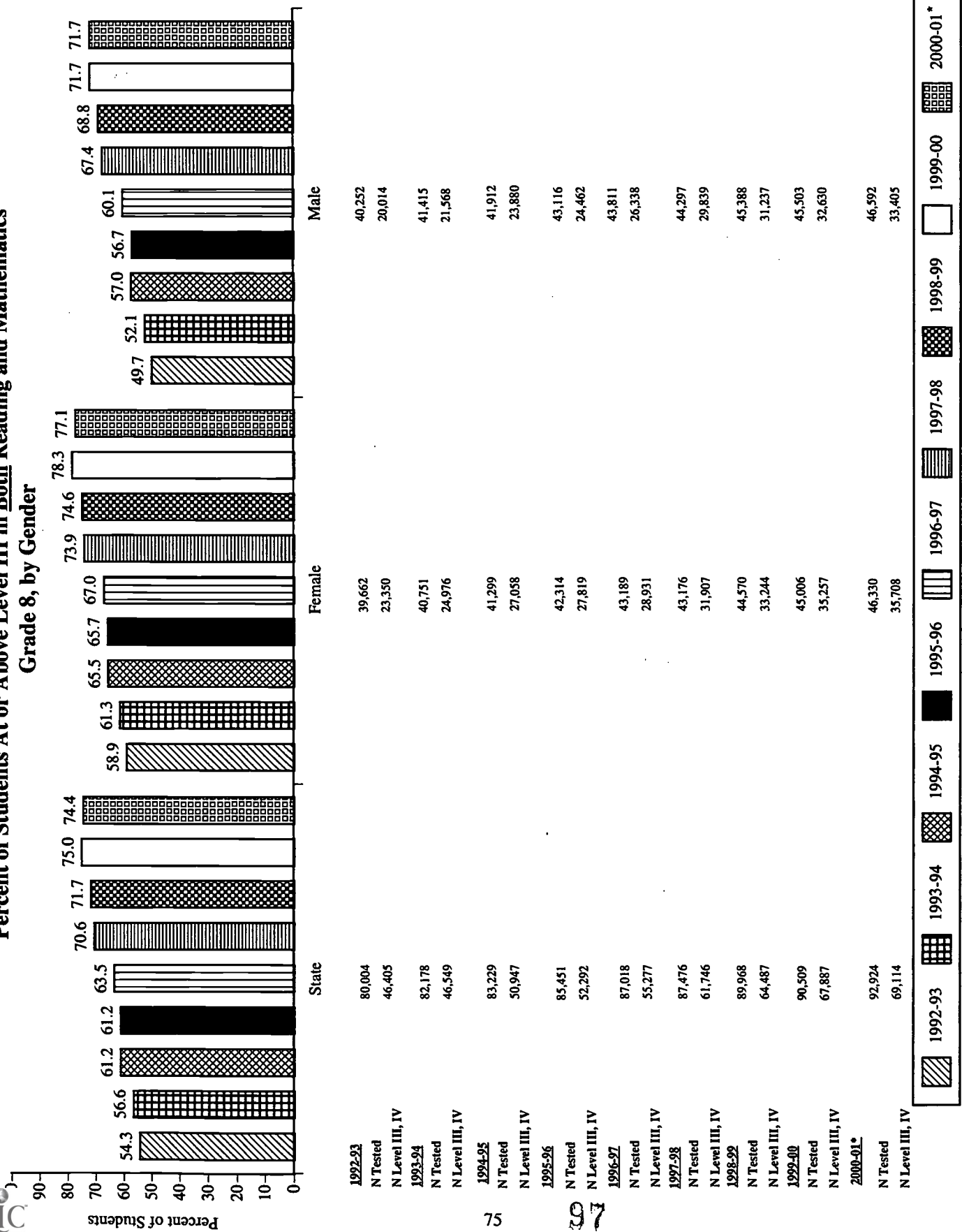
Notes: *The North Carolina mathematics tests measure the competencies in the 1998 North Carolina mathematics curriculum beginning in the 2000-01 school year.
 **Results for the Multi-Racial category were not reported in 1992-93 through 1994-95. Results for the Asian and Hispanic categories were not reported in 1992-93.
 Data received from LEAs and charter schools after August 2001 are not included in this figure.
 Prepared by the NCDPI Division of Accountability Services/Testing Section.

**Figure 9b. 1992-93 to 2000-01 End-of-Grade Multiple-Choice Test Results
Percent of Students At or Above Level III in Both Reading and Mathematics
Grade 8, by Ethnicity (continued)**



Notes: *The North Carolina mathematics tests measure the competencies in the 1998 North Carolina mathematics curriculum beginning in the 2000-01 school year. Data received from LEAs and charter schools after August 2001 are not included in this figure. Prepared by the NCDPI Division of Accountability Services/Testing Section.

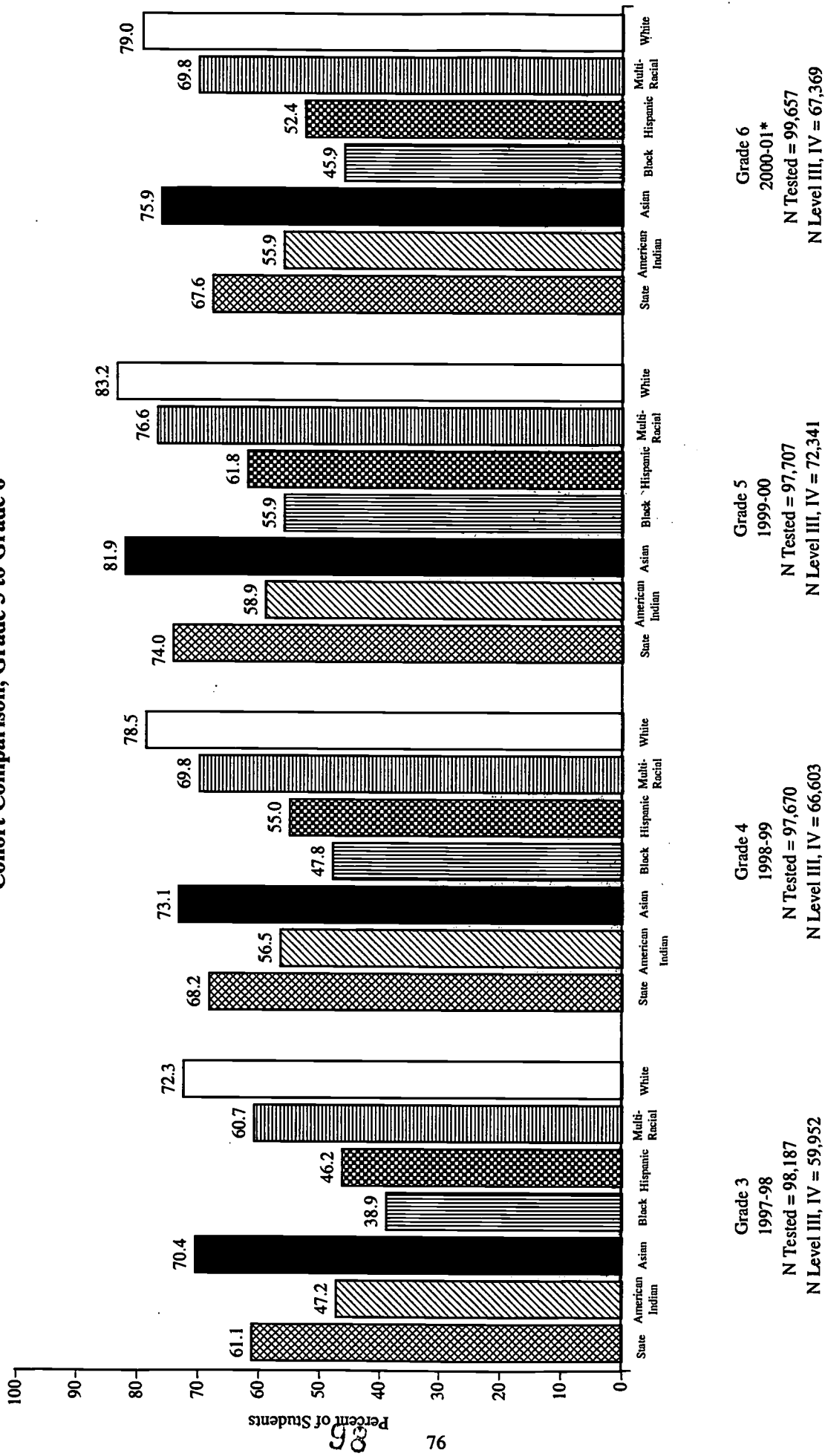
**Figure 9c. 1992-93 to 2000-01 End-Of Grade Multiple-Choice Test Results
Percent of Students At or Above Level III in Both Reading and Mathematics
Grade 8, by Gender**



Notes: *The North Carolina mathematics tests measures the competencies in the 1998 North Carolina mathematics curriculum beginning in the 2000-01 school year.
 "N Tested" and "N Level III, IV" for the gender categories do not sum to the "N Tested" and "N Level III, IV" for the state because gender was not coded on some student answer sheets and, therefore, some students were reported in the state data only.
 Data received by LEAs and charter schools after August 2001 are not included in this figure.
 Prepared by the NCDPI Division of Accountability Services/Testing Section.

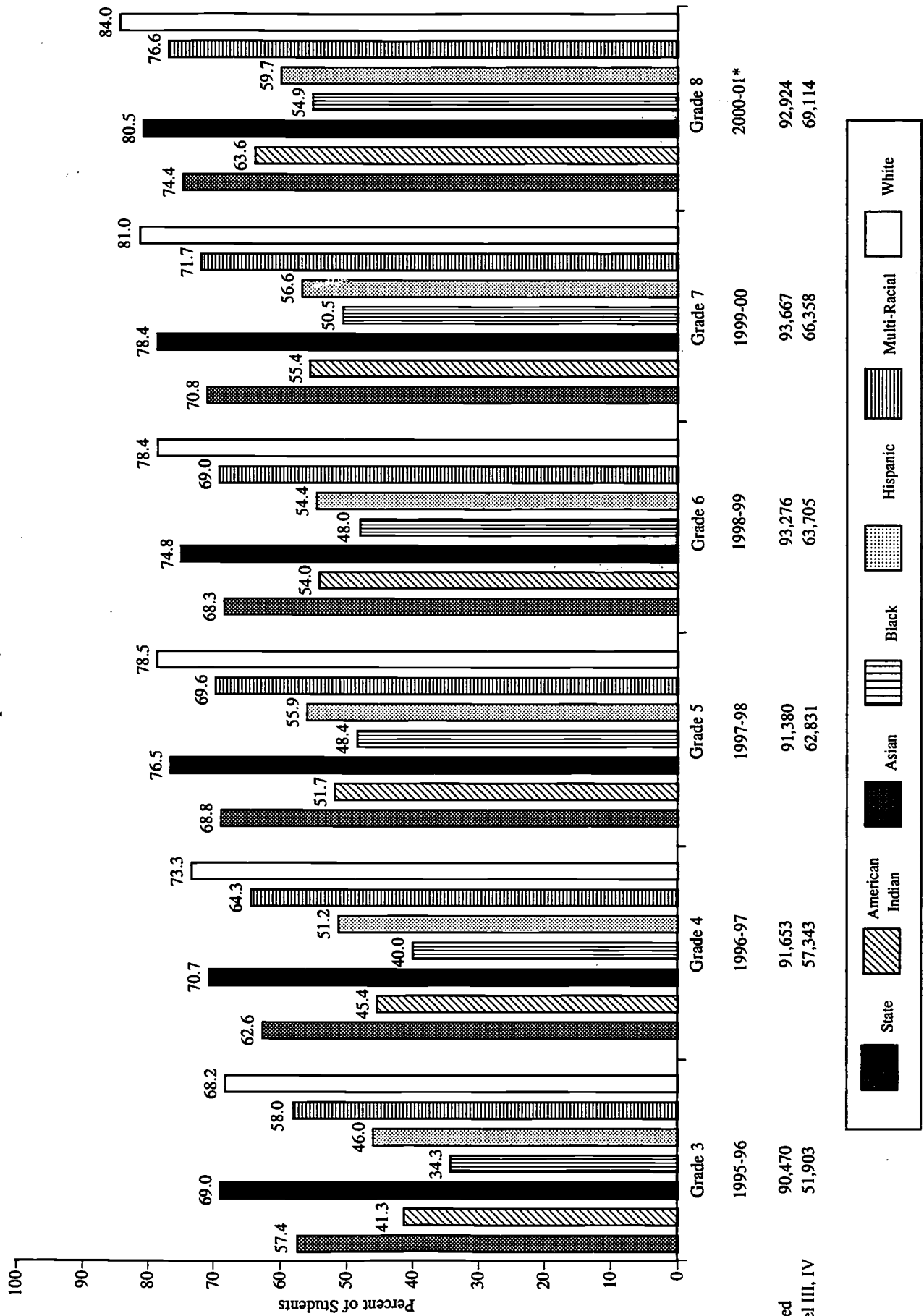
**Figure 10. 1997-98 to 2000-01 End-of-Grade Multiple-Choice Test Results
Percent of Students At or Above Level III in Both Reading and Mathematics**

Cohort Comparison, Grade 3 to Grade 6



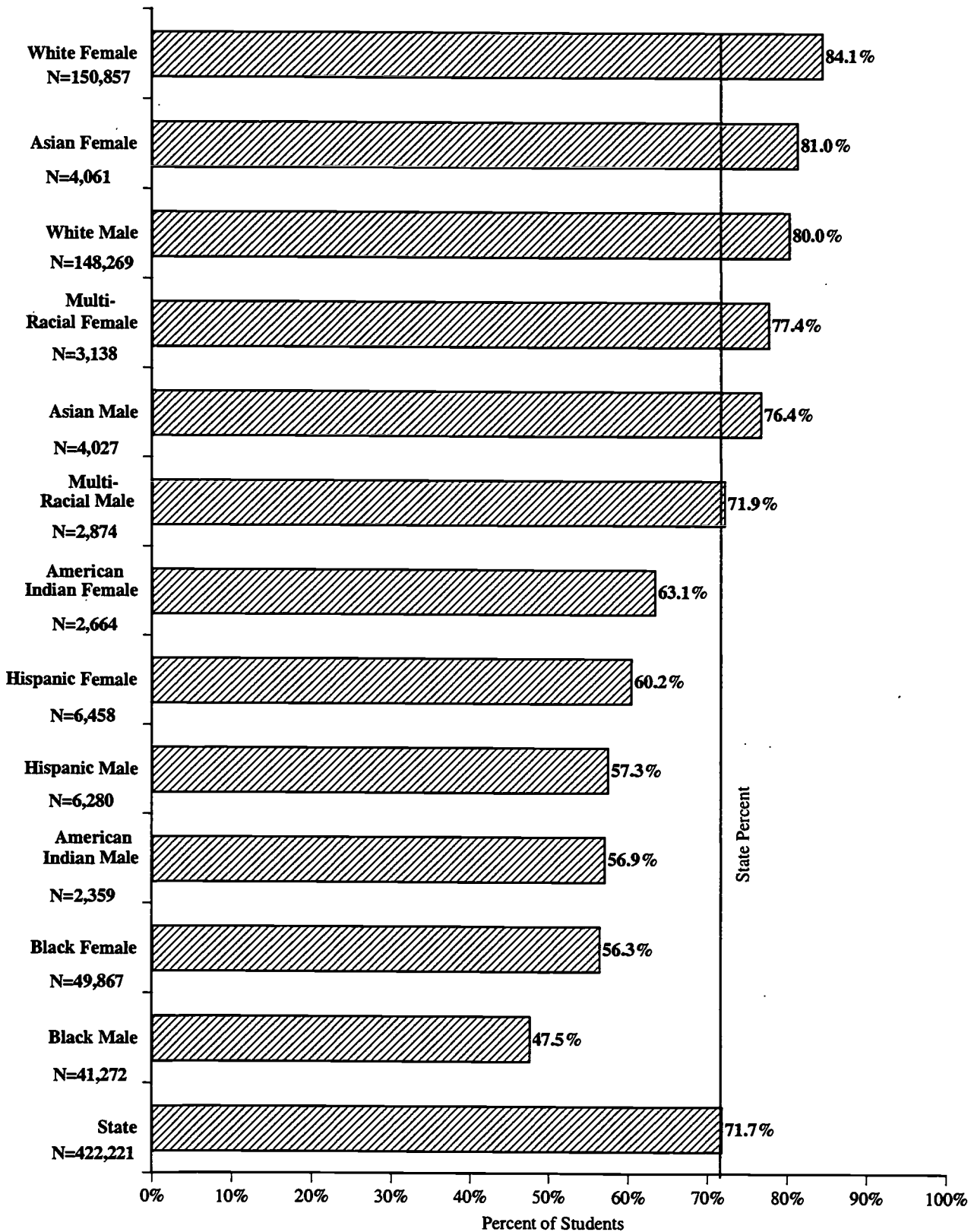
Note: *The North Carolina mathematics tests measure the competencies in the 1998 North Carolina mathematics curriculum beginning in the 2000-01 school year. Data received from LEAs and charter schools after August 2001 are not included in this figure. Prepared by the NCDPI Division of Accountability Services/Testing Section.

**Figure 11. 1995-96 to 2000-01 End-of-Grade Multiple-Choice Test Results
Percent of Students At or Above Level III in Both Reading and Mathematics
Cohort Comparison, Grade 3 to Grade 8**



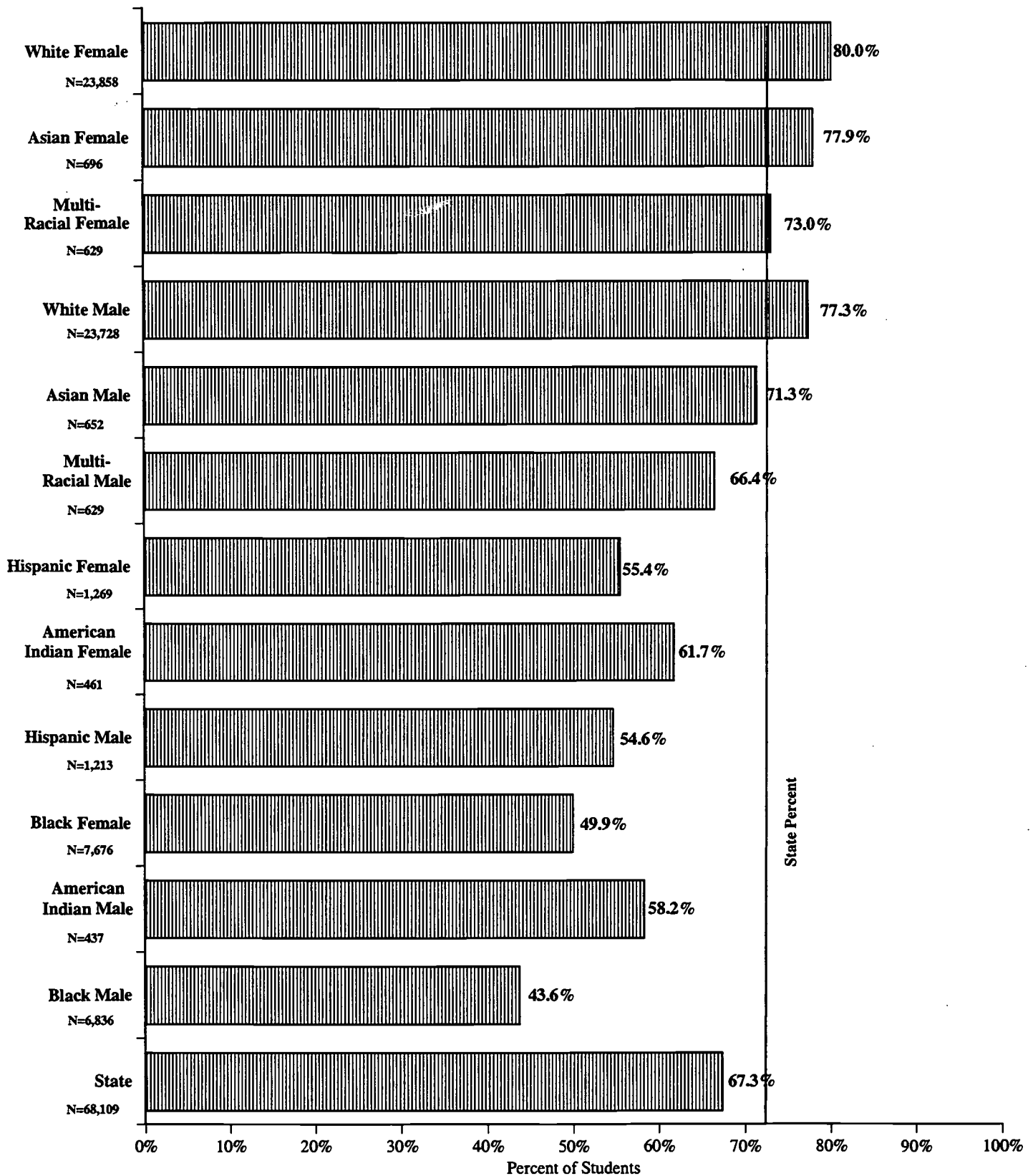
Notes: *The North Carolina mathematics tests measure the competencies in the 1998 North Carolina mathematics curriculum beginning in the 2000-01 school year. Data received from LEAs and charter schools after August 2001 are not included in this figure. Prepared by the NCDPI Division of Accountability Services/Testing Section.

**Figure 12. 2000-01 End-of-Grade Multiple-Choice Test Results
Percent of Students At or Above Level III in Both Reading and Mathematics
Grades 3-8, by Gender and Ethnicity**



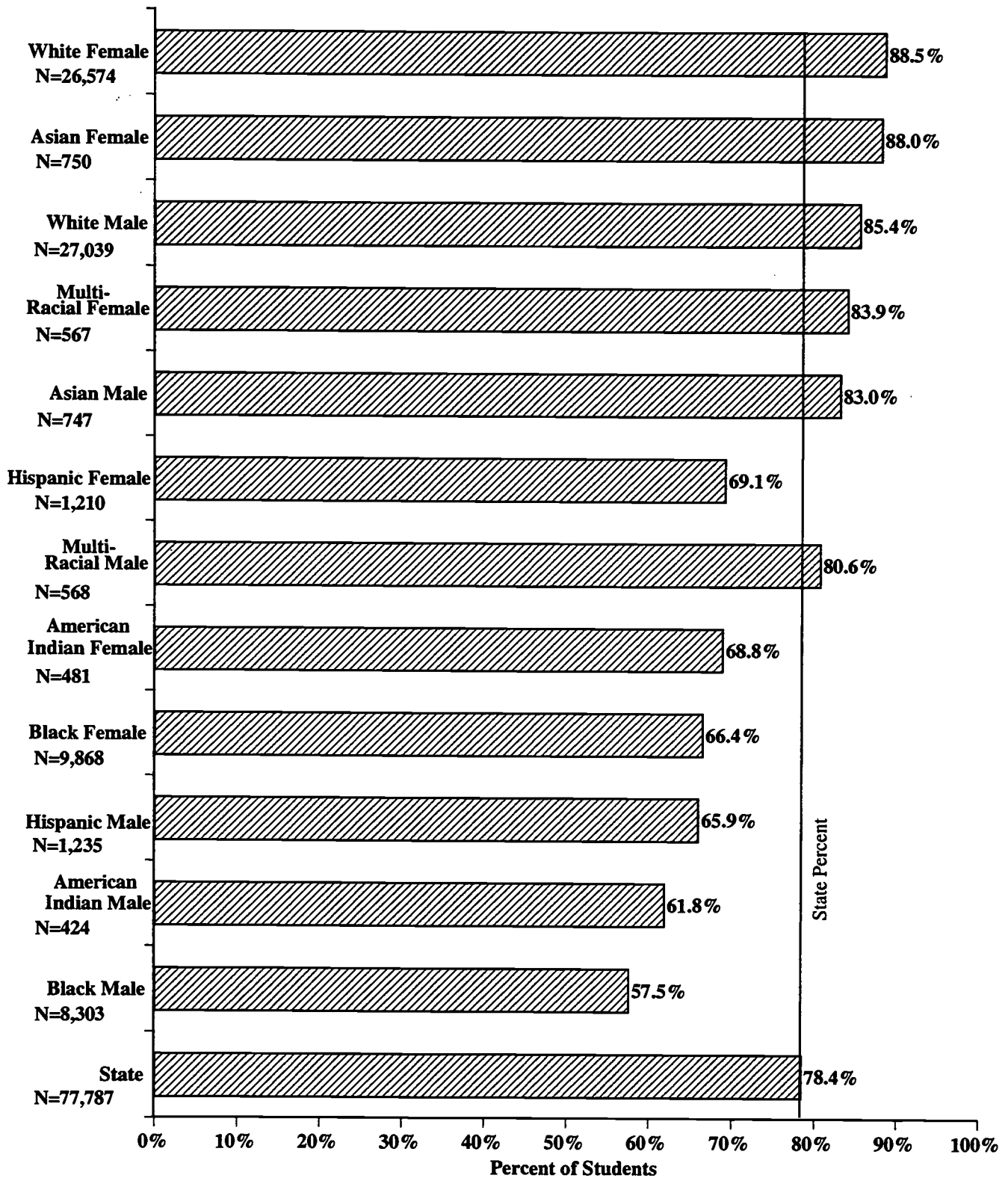
Notes: N is the number of students at or above Level III in both reading and mathematics.
Date received from LEAs and charter school after August 2001 are not included in this figure.
Prepared by the NCDPI Division of Accountability Services/Testing Section.

**Figure 13. 2000-01 End-of-Grade Multiple-Choice Test Results
Percent of Students At or Above Level III in Both Reading and Mathematics
Grade 3, by Gender and Ethnicity**



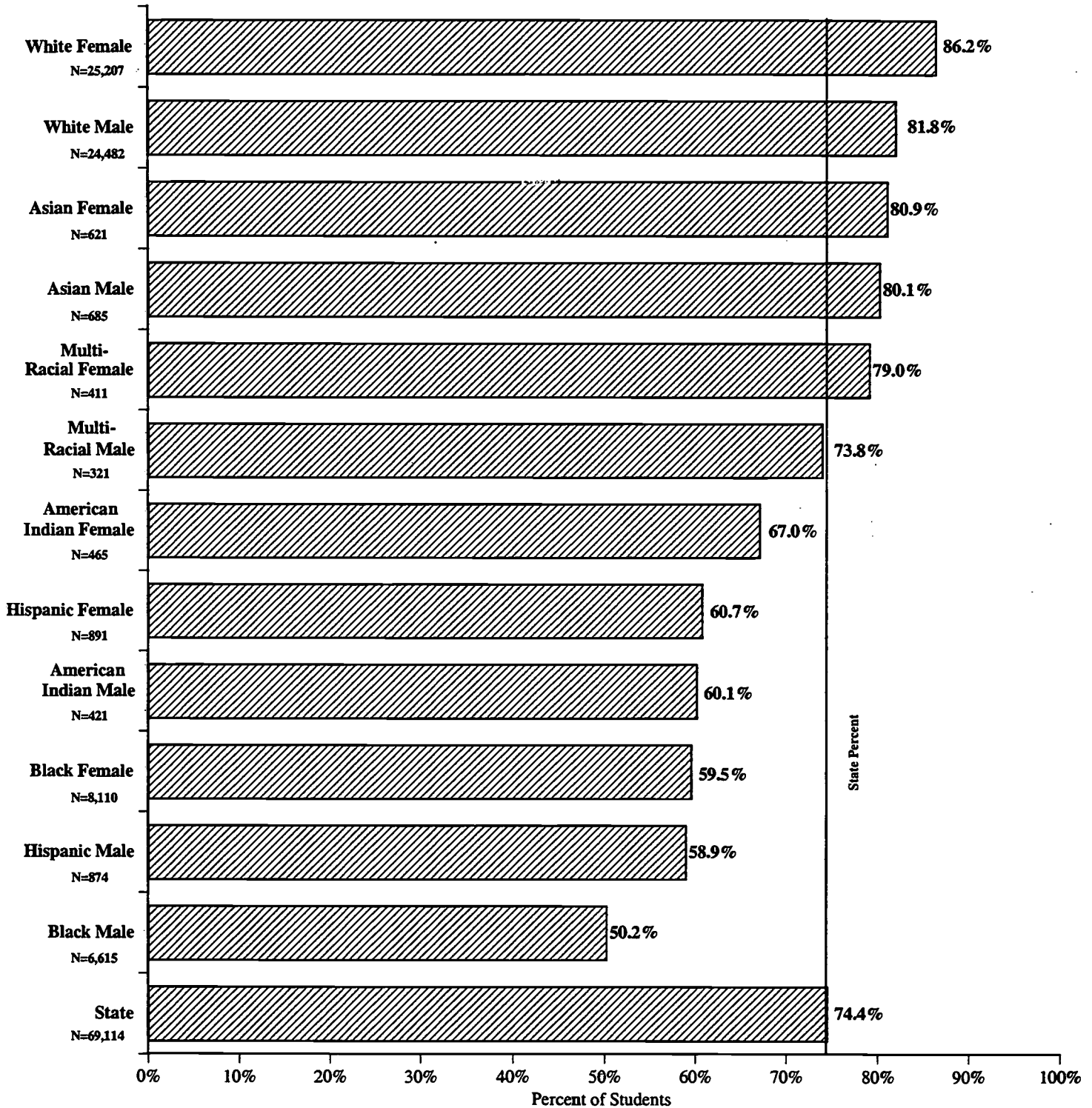
Note: N is the number of students at or above Level III in both reading and mathematics.
Data received from LEAs and charter schools after August 2001 are not included in this figure.
Prepared by the NCDPI Division of Accountability Services/Testing Section.

**Figure 14. 2000-01 End-of-Grade Multiple-Choice Test Results
Percent of Students At or Above Level III in Both Reading and Mathematics
Grade 5, by Gender and Ethnicity**



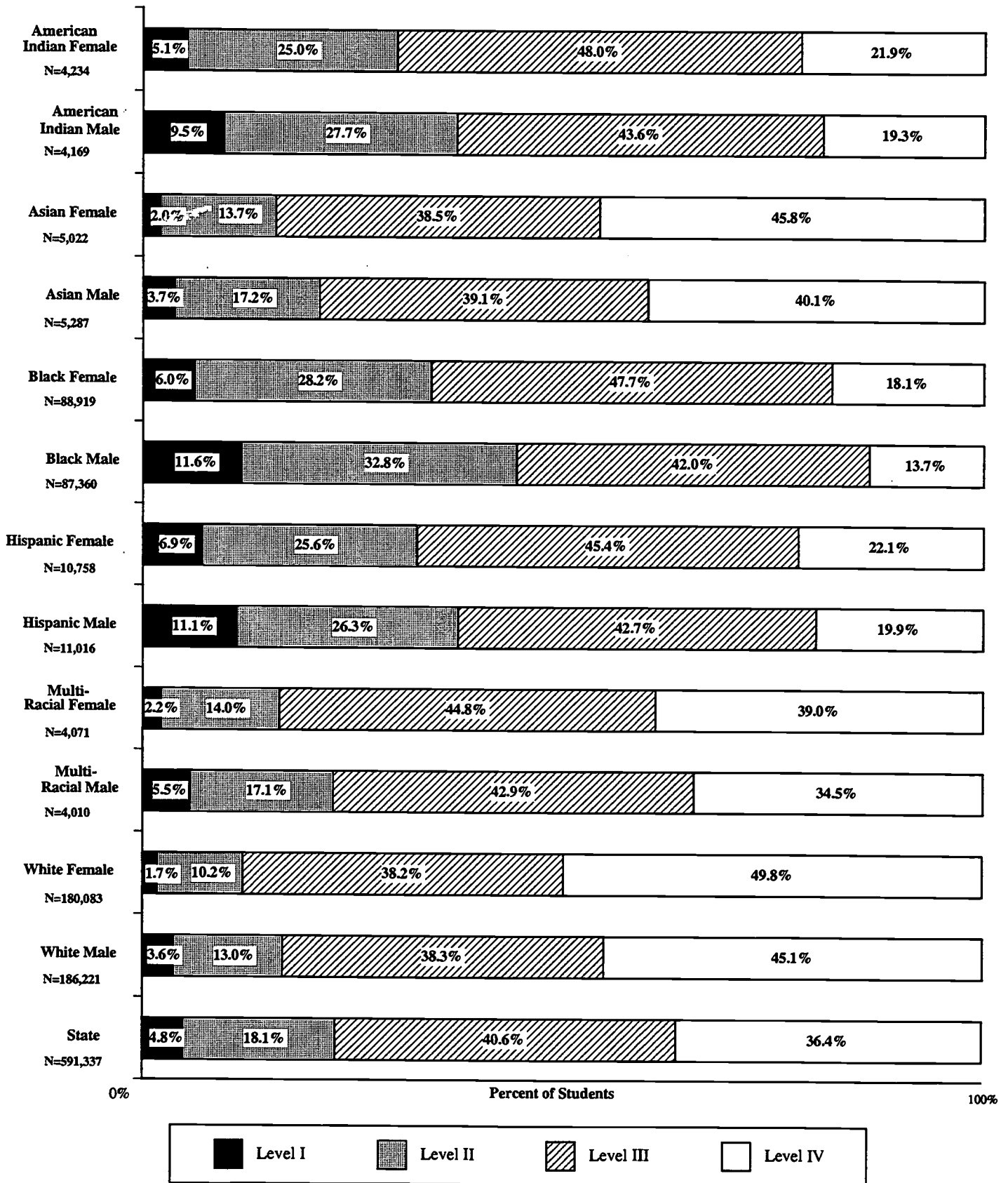
Notes: N is the number of students at or above Level III in both reading and mathematics.
Data received from LEAs and charter schools after August 2001 are not included in this figure.
Prepared by the NCDPI Division of Accountability Services/Testing Section.

**Figure 15. 2000-01 End-of-Grade Multiple-Choice Test Results
Percent of Students At or Above Level III in Both Reading and
Mathematics
Grade 8, by Gender and Ethnicity**



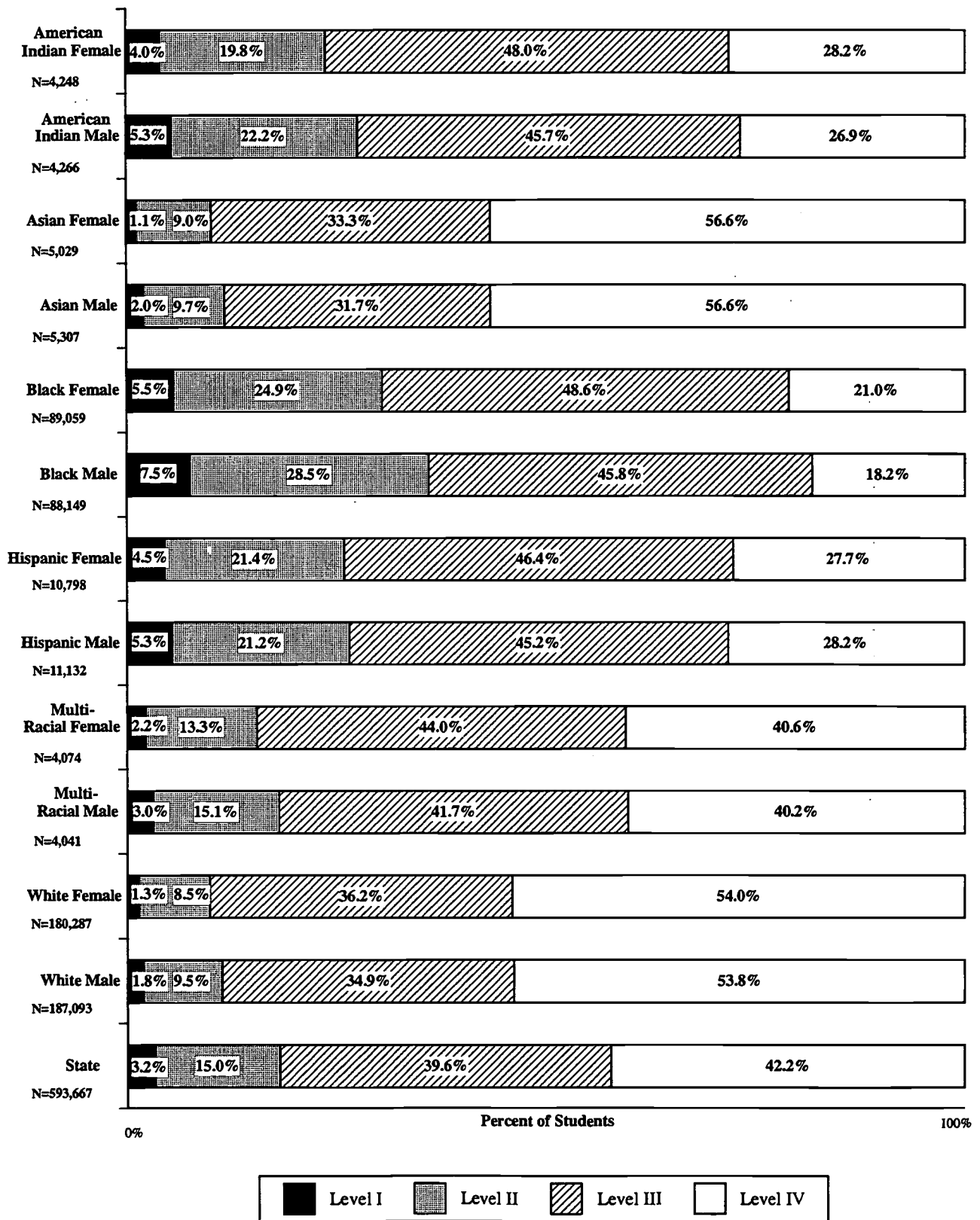
Note: N is the number of students at or above Level III in both reading and mathematics.
Data received from LEAs and charter schools after August 2001 are not included in this figure.
Prepared by the NCDPI Division of Accountability Services/Testing Section.

**Figure 16. 2000-01 End-of-Grade Multiple-Choice Test Results
Percent of Students at Each Achievement Level in Reading
Grades 3-8 Combined, by Gender and Ethnicity**



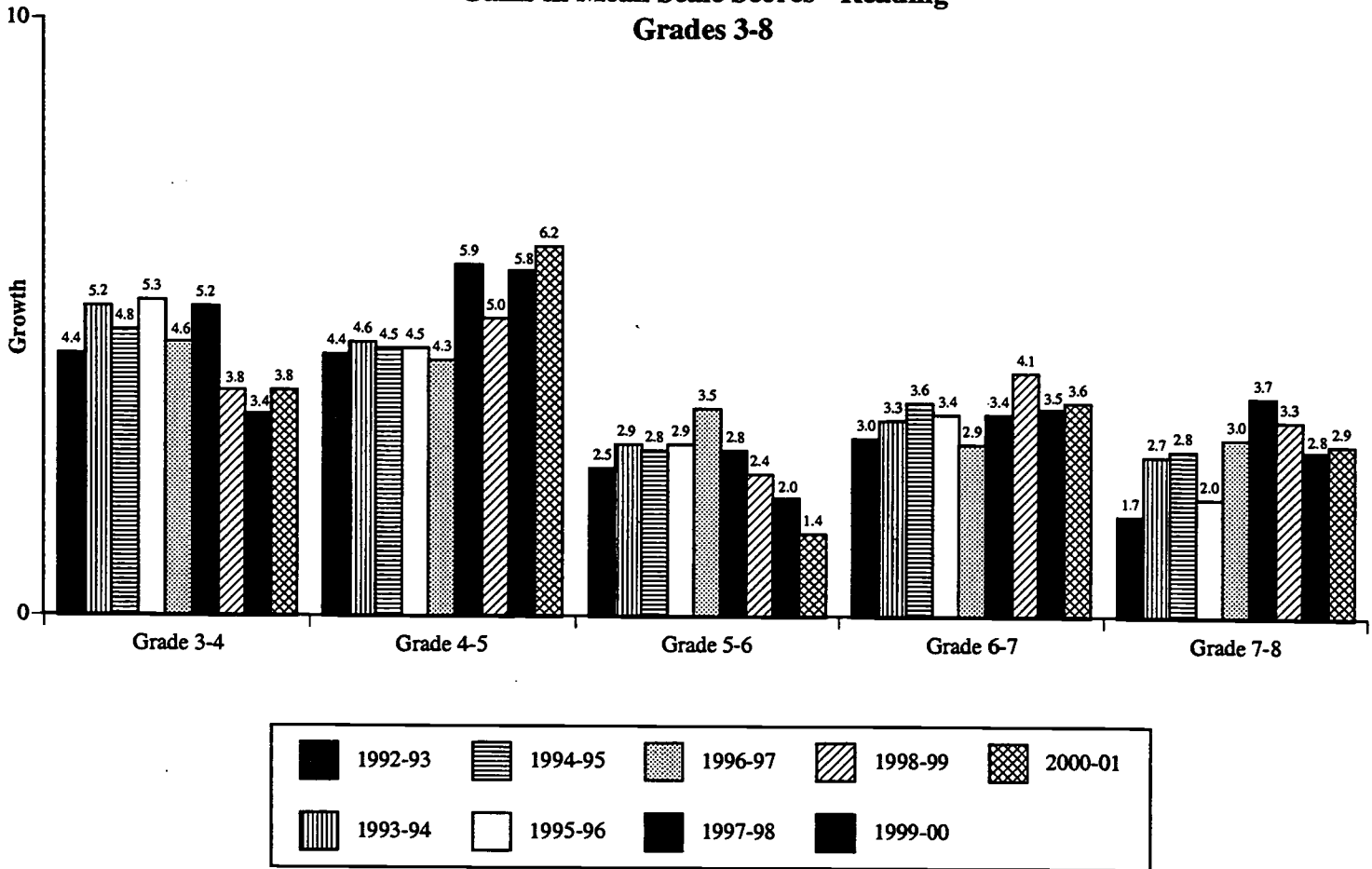
Notes: Achievement levels for each gender/ethnic category may not add to 100% due to rounding.
Data received from LEAs and charter schools after August 2001 are not included in this figure.
Prepared by the NCDPI Division of Accountability Services/Testing Section.

**Figure 17. 2000-01 End-of-Grade Multiple-Choice Test Results
Percent of Students at Each Achievement Level in Mathematics
Grades 3-8 Combined, by Gender and Ethnicity**

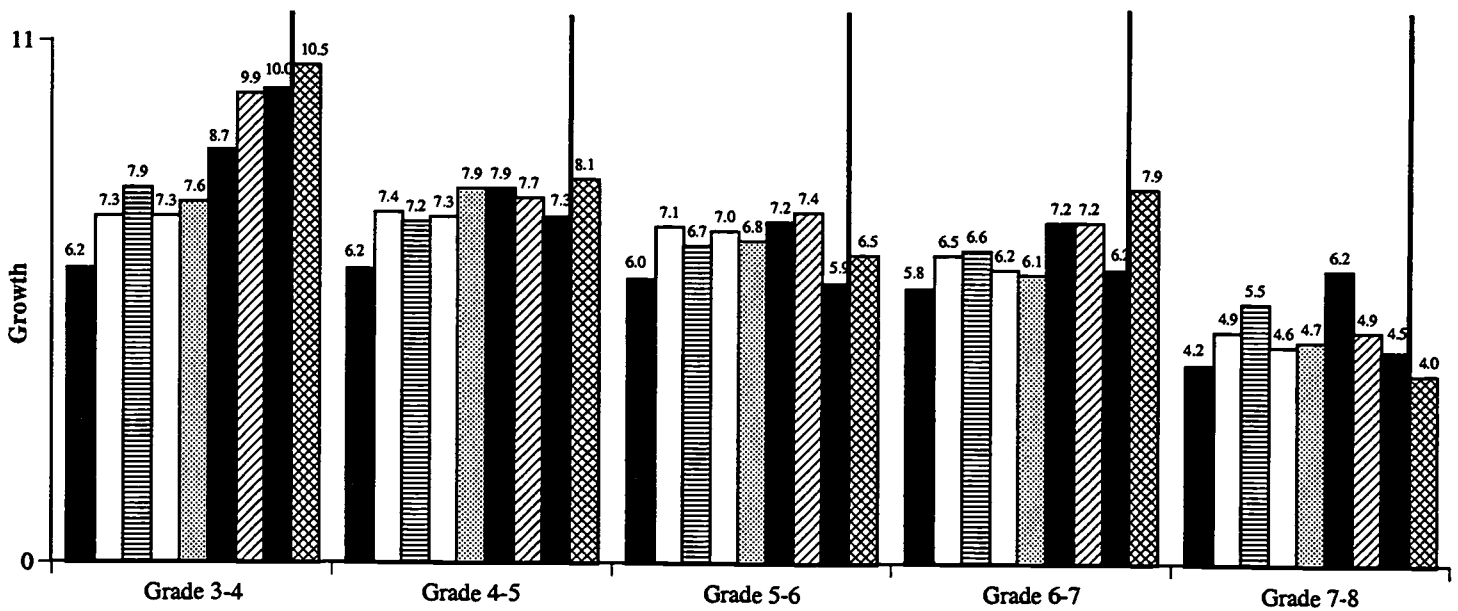


Notes: Achievement levels for each gender/ethnic category may not add to 100% due to rounding.
Data received from LEAs and charter schools after August 2001 are not included in this figure.
Prepared by the NCDPI Division of Accountability Services/Testing Section.

**Figure 18. 1992-93 to 2000-01 End-of-Grade Multiple-Choice Test Results
Gains in Mean Scale Scores - Reading
Grades 3-8**



**Figure 19. 1992-93 to 2000-01 End-of-Grade Multiple-Choice Test Results
Gains in Mean Scale Scores - Mathematics
Grades 3-8**



Note: The bold vertical lines between the years indicates that the mathematics scale score ranges changed. Prior to 2000-01, the end-of-grade mathematics scale score range was 98 to 208. Beginning in 2000-01, the end-of-grade mathematics scale score range is 218 to 310.

received from LEAs and charter schools after August 2001 are not included in these figures.
by the NCDPI Division of Accountability Services/Testing Section.

**Table 9. 2000-01 End-of-Grade Multiple-Choice Test Results
Percent of Students by Achievement Level
by Grade and Ethnicity**

	Grade	American Indian		Asian		Black		Hispanic		Multi-Racial		White	
		R*	M*	R	M	R	M	R	M	R	M	R	M
Achievement Level I	3	7.3	5.3	4.1	2.2	9.7	8.4	9.5	4.9	5.4	3.7	3.3	2.1
	4	9.7	1.6	3.2	0.4	11.2	2.6	9.7	1.4	4.0	0.9	3.3	0.5
	5	5.0	4.3	2.1	0.9	6.3	4.4	6.8	3.5	2.2	1.9	1.9	1.0
	6	9.0	4.8	3.1	1.7	11.1	6.7	11.8	6.0	5.5	2.6	3.3	1.5
	7	8.8	5.1	2.9	1.5	9.4	6.7	10.7	5.7	3.4	2.8	2.7	1.5
	8	4.1	6.8	1.4	2.7	4.4	10.6	5.0	9.5	1.4	4.2	1.3	2.8
Achievement Level II	3	23.3	25.9	14.7	16.8	28.7	37.4	25.5	29.5	15.5	21.2	11.8	13.9
	4	28.8	19.5	18.4	6.7	31.4	22.6	26.3	16.0	16.5	10.5	12.9	6.5
	5	23.6	17.9	11.0	5.6	24.5	20.6	21.4	15.4	10.8	9.2	8.4	6.5
	6	32.2	20.0	19.5	8.0	38.1	25.2	31.7	19.9	21.8	13.6	15.7	8.0
	7	29.0	21.6	16.4	9.1	33.4	27.9	27.4	23.6	16.1	13.9	12.8	9.5
	8	21.5	20.7	13.0	9.8	26.3	26.1	23.7	22.3	11.9	15.4	8.3	9.9
Achievement Level III	3	43.5	48.0	38.2	40.6	43.2	43.5	43.5	47.4	41.1	46.8	35.4	42.7
	4	45.0	53.4	41.0	40.2	44.9	56.7	47.1	54.3	48.8	47.5	42.0	41.3
	5	50.7	44.5	39.1	25.7	51.1	47.9	47.8	44.6	45.8	37.3	39.1	30.8
	6	41.1	49.6	38.5	32.7	38.0	49.4	38.9	46.0	38.0	42.7	37.4	35.8
	7	42.2	41.2	35.3	26.3	40.2	41.5	38.4	38.8	41.0	37.7	36.1	29.1
	8	52.2	43.9	40.9	28.7	52.5	43.8	47.9	40.6	48.4	41.0	39.6	33.4
Achievement Level IV	3	25.9	20.9	43.0	40.3	18.3	10.7	21.4	18.3	37.9	28.3	49.4	41.3
	4	16.6	25.5	37.4	52.8	12.5	18.1	16.9	28.3	30.7	41.1	41.8	51.7
	5	20.8	33.3	47.8	67.8	18.1	27.1	23.9	36.5	41.1	51.6	50.6	61.7
	6	17.7	25.6	38.9	57.6	12.8	18.7	17.6	28.1	34.7	41.1	43.6	54.7
	7	20.0	32.1	45.4	63.0	16.9	24.0	23.5	31.9	39.5	45.6	48.4	60.0
	8	22.2	28.6	44.7	58.8	16.7	19.6	23.4	27.6	38.3	39.4	50.9	53.9
Percent At or Above Level III†	3	69.4	68.8	81.2	81.0	61.5	54.2	65.0	65.6	79.1	75.1	84.9	84.0
	4	61.6	78.9	78.4	93.0	57.4	74.8	64.0	82.7	79.5	88.6	83.8	93.0
	5	71.5	77.8	86.9	93.5	69.2	75.0	71.8	81.1	86.9	88.9	89.7	92.5
	6	58.8	75.2	77.4	90.3	50.8	68.1	56.5	74.2	72.7	83.8	81.0	90.5
	7	62.2	73.3	80.6	89.3	57.1	65.5	61.9	70.7	80.6	83.3	84.5	89.0
	8	74.4	72.5	85.6	87.5	69.2	63.4	71.3	68.2	86.7	80.4	90.5	87.3

	Grade 3		Grade 4		Grade 5		Grade 6		Grade 7		Grade 8	
	N**	%	N	%	N	%	N	%	N	%	N	%
American Indian	1,506	1.5	1,436	1.4	1,392	1.4	1,341	1.3	1,331	1.4	1,397	1.5
Asian	1,808	1.8	1,678	1.7	1,758	1.8	1,740	1.7	1,699	1.8	1,626	1.7
Black	31,191	30.7	30,080	30.2	29,443	29.6	30,131	30.1	28,455	29.4	26,985	28.9
Hispanic	4,537	4.5	3,937	3.9	3,637	3.7	3,488	3.5	3,208	3.3	2,967	3.2
Multi-Racial	1,819	1.8	1,621	1.6	1,386	1.4	1,233	1.2	1,065	1.1	958	1.0
White	60,757	59.8	60,937	61.1	61,994	62.2	62,107	62.1	61,166	63.1	59,346	63.6
Total	101,618		99,689		99,610		100,040		96,924		93,279	

Notes: **"R" = Reading; "M" = Mathematics.

†"Percent At or Above Level III" is calculated based on actual N-counts and is not summed.

** "N" is the number of students who took the end-of-grade test in reading.

Due to rounding, some ethnicity categories in some grades may not sum to 100%.

When summed, ethnic N-counts may not match the state N-counts because an ethnic category may not have been coded on the answer sheet, or, the choice of "Other" was coded.

Data received from LEAs and charter schools after August 2001 are not included in this table.

Prepared by the NCDPI Division of Accountability Services/Testing Section.

**Table 10. 2000-01 End-of-Grade Multiple-Choice Test Results
Percent of Students by Achievement Level
by Grade and Gender**

	Grade	Male		Female	
		Reading	Mathematics	Reading	Mathematics
Achievement Level I	3	7.3	4.7	4.0	3.7
	4	7.6	1.3	4.4	1.0
	5	4.5	2.5	2.3	1.9
	6	8.0	3.9	4.1	2.7
	7	6.8	3.8	3.2	2.7
	8	3.3	6.0	1.4	4.6
Achievement Level II	3	19.5	22.3	16.2	22.1
	4	20.8	12.9	17.9	11.1
	5	15.2	12.0	12.6	10.3
	6	24.9	14.7	21.8	12.9
	7	20.8	16.7	18.5	14.4
	8	16.5	16.1	12.2	14.2
Achievement Level III	3	37.5	42.5	39.5	44.1
	4	41.9	45.8	44.6	47.7
	5	42.6	35.8	43.9	37.4
	6	36.3	39.3	39.1	41.7
	7	36.9	32.4	38.1	34.1
	8	43.2	35.7	44.6	37.9
Achievement Level IV	3	35.7	30.5	40.3	30.1
	4	29.6	39.9	33.1	40.2
	5	37.7	49.7	41.2	50.4
	6	30.8	42.1	35.0	42.8
	7	35.5	47.1	40.1	48.8
	8	37.1	42.1	41.9	43.3
Percent At or Above Level III†	3	73.2	73.0	79.8	74.2
	4	71.5	85.7	77.7	87.9
	5	80.3	85.5	85.1	87.8
	6	67.1	81.4	74.1	84.4
	7	72.4	79.6	78.2	82.9
	8	80.2	77.8	86.5	81.2

Grade	Male		Female	
	N*	Percent	N*	Percent
3	51,441	51.4	50,210	48.7
4	50,258	51.6	49,457	48.8
5	50,544	50.7	49,091	49.3
6	50,376	51.1	49,703	48.9
7	48,732	51.2	48,211	48.8
8	46,810	50.9	46,493	49.1

Notes: †All percents are calculated based on actual N-counts and are not summed.
 **N* is the number of students who took the end-of-grade test in reading.
 Due to rounding, some categories in some grades may not sum to 100%.
 When summed, male and female N-counts may not match the state N-counts because gender was not coded on some student answer sheets.
 Data received from LEAs and charter schools after August 2001 are not included in this table.
 Prepared by the NCDPI Division of Accountability Services/Testing Section.

**Table 11. 2000-01 End-of-Grade Multiple-Choice Test Results
Performance of Academically Gifted, Exceptional, Limited English Proficient and Title I Students
Grades 3-8**

<u>Grade 3</u>	<u>Category</u>	<u>Number Tested</u>	<u>Percent At or Above Level III²</u>		<u>Average Scale Score</u>	<u>Average Scale Score</u>
			<u>Percent¹</u>	<u>Reading</u>	<u>Mathematics</u>	
	All Students	101,652	100.0	67.3	147.0	250.6
	Not Exceptional	82,693	81.4	68.8	147.1	250.4
	Academically Gifted	6,954	6.8	99.1	157.8	260.8
	Reading	5,660	5.6	99.3	158.0	260.9
	Mathematics	5,352	5.3	99.4	157.9	261.1
	Students with Disabilities	11,928	11.7	37.8	139.6	246.2
	Behaviorally-Emotionally Handicapped	690	0.7	28.4	138.2	243.8
	Hearing Impaired	139	0.1	43.5	141.8	246.8
	Educable Mentally Handicapped	738	0.7	3.5	131.1	237.8
	Specific Learning Disabled	6,003	5.9	34.3	138.4	246.5
	Reading	4,515	4.4	32.3	137.4	246.6
	Mathematics	2,506	2.5	26.5	137.7	244.3
	Writing	4,103	4.0	36.0	138.5	245.8
	Other	249	0.2	32.7	138.6	245.0
	Speech-Language Impaired	2,724	2.7	56.9	144.5	248.7
	Visually Impaired	54	0.1	61.5	143.3	248.2
	Other Health Impaired	1,367	1.3	36.4	140.3	245.6
	Orthopedically Impaired	64	0.1	34.4	142.5	246.1
	Traumatic Brain Injured	19	0.0	*	*	*
	Autistic	118	0.1	39.3	141.8	246.2
	Severe/Profound Mentally Disabled	0	0.0	*	*	*
	Multihandicapped	7	0.0	*	*	*
	Deaf-Blind	1	0.0	*	*	*
	Trainable Mentally Disabled	4	0.0	*	*	*
	Section 504	1,488	1.5	49.8	143.3	248.0
	Limited English Proficient	2,421	2.4	40.9	140.1	246.6
	Not Served by Title I	57,138	56.2	74.7	148.7	252.1
	Schoolwide Title I Program	40,204	39.6	59.0	145.0	248.8
	Targeted Assistance	4,160	4.1	46.6	142.5	247.0
	Migrant	581	0.6	51.9	142.1	247.9
<u>Grade 4</u>	All Students	99,717	100.0	72.4	150.3	255.8
	Not Exceptional	74,987	75.2	72.4	149.5	254.7
	Academically Gifted	13,090	13.1	99.6	161.2	266.8
	Reading	10,177	10.2	99.7	161.8	267.0
	Mathematics	10,563	10.6	99.6	161.3	267.3
	Students with Disabilities	11,588	11.6	40.9	142.9	250.5
	Behaviorally-Emotionally Handicapped	773	0.8	33.7	141.5	248.3
	Hearing Impaired	146	0.1	45.1	144.2	251.3
	Educable Mentally Handicapped	618	0.6	5.4	134.8	242.7
	Specific Learning Disabled	6,771	6.8	39.6	142.5	250.9
	Reading	4,724	4.7	35.0	141.2	250.9
	Mathematics	2,444	2.5	32.9	141.5	248.8
	Writing	5,413	5.4	40.5	142.6	251.2
	Other	221	0.2	37.9	142.6	250.4
	Speech-Language Impaired	1,549	1.6	58.6	146.9	252.9
	Visually Impaired	54	0.1	61.1	149.6	254.3
	Other Health Impaired	1,506	1.5	43.9	143.9	250.1
	Orthopedically Impaired	51	0.1	51.0	147.4	251.3
	Traumatic Brain Injured	24	0.0	*	*	*
	Autistic	88	0.1	53.5	146.4	251.3
	Severe/Profound Mentally Disabled	0	0.0	*	*	*
	Multihandicapped	8	0.0	*	*	*
	Deaf-Blind	0	0.0	*	*	*
	Trainable Mentally Disabled	0	0.0	*	*	*
	Section 504	1,999	2.0	57.8	146.7	252.6
	Limited English Proficient	1,864	1.9	45.0	143.3	251.4
	Not Served by Title I	58,876	59.0	78.7	152.0	257.3
	Schoolwide Title I Program	37,618	37.7	64.3	148.1	253.8
	Targeted Assistance	3,060	3.1	50.8	145.9	252.0
	Migrant	520	0.5	49.4	144.4	251.6

Notes: *No scores are reported for groups with fewer than thirty students.

¹Percent for "Not Exceptional" through "Trainable Mentally Disabled" is based on the sum of the students in those categories.

Percent for "Learning Disabled," "Academically Gifted" and "Section 504" through "Migrant" is based on the number tested in the "All Students" category.

²The standard for grade-level proficiency is a test score at Level III or above on end-of-grade tests in reading and mathematics.

The "All Students" and "Not Exceptional" categories are shown for the purpose of comparison.

"Not Exceptional," "Academically Gifted" and "Students with Disabilities" do not sum to "All Students" because whether or not some students were classified as exceptional was not coded on the answer sheets.

All data are rounded to the nearest tenth, therefore, exceptional categories may not sum to 100%.

"Number Tested" is the number of students who took the end-of-grade test in reading.

Data received from LEAs and charter schools after August 2001 are not included in this table.

Prepared by the NCDPI Division of Accountability Services/Testing Section.

Table 11. 2000-01 End-of-Grade Multiple-Choice Test Results
Performance of Academically Gifted, Exceptional, Limited English Proficient and Title I Students
Grades 3-8 (continued)

<u>Grade 5</u>	<u>Category</u>	<u>Number</u>	<u>Percent At or</u>		<u>Average</u>	<u>Average</u>
		<u>Tested</u>	<u>Percent¹</u>	<u>Above Level III²</u>	<u>Scale Score</u>	<u>Scale Score</u>
					<u>Reading</u>	<u>Mathematics</u>
	All Students	99,639	100.0	78.4	156.0	260.0
	Not Exceptional	72,337	72.6	78.8	155.2	258.5
	Academically Gifted	15,730	15.8	99.9	164.8	272.2
	Reading	12,685	12.7	99.9	165.2	272.4
	Mathematics	12,659	12.7	99.8	164.9	272.9
	Students with Disabilities	11,536	11.6	46.6	149.0	253.2
	Behaviorally-Emotionally Handicapped	937	0.9	36.6	147.4	250.4
	Hearing Impaired	118	0.1	53.8	149.6	254.1
	Educable Mentally Handicapped	664	0.7	3.7	140.5	244.4
	Specific Learning Disabled	7,127	7.1	49.4	149.3	254.1
	Reading	4,686	4.7	44.0	147.8	253.7
	Mathematics	2,325	2.3	39.0	147.9	251.1
	Writing	5,839	5.9	51.0	149.5	254.5
	Other	217	0.2	35.8	147.4	251.7
	Speech-Language Impaired	891	0.9	62.2	152.2	256.3
	Visually Impaired	53	0.1	64.2	154.7	257.1
	Other Health Impaired	1,601	1.6	45.9	149.9	252.6
	Orthopedically Impaired	42	0.0	78.9	153.0	255.2
	Traumatic Brain Injured	28	0.0	*	*	*
	Autistic	68	0.1	62.1	153.2	257.2
	Severe/Profound Mentally Disabled	0	0.0	*	*	*
	Multihandicapped	4	0.0	*	*	*
	Deaf-Blind	0	0.0	*	*	*
	Trainable Mentally Disabled	3	0.0	*	*	*
	Section 504	2,094	2.1	66.5	152.8	255.9
	Limited English Proficient	1,642	1.6	51.3	148.8	254.3
	Not Served by Title I	60,027	60.2	83.6	157.3	261.6
	Schoolwide Title I Program	36,669	36.8	71.5	154.0	257.7
	Targeted Assistance	2,874	2.9	59.6	152.2	255.7
	Migrant	534	0.5	58.3	150.3	254.8
<u>Grade 6</u>	All Students	100,079	100.0	67.6	156.7	263.2
	Not Exceptional	72,621	72.6	66.7	155.8	261.8
	Academically Gifted	15,805	15.8	99.4	167.4	276.0
	Reading	12,517	12.5	99.6	167.9	276.2
	Mathematics	12,451	12.4	99.4	167.5	276.5
	Students with Disabilities	11,621	11.6	29.5	147.9	255.2
	Behaviorally-Emotionally Handicapped	1,068	1.1	22.7	147.0	253.0
	Hearing Impaired	127	0.1	43.1	150.4	257.4
	Educable Mentally Handicapped	899	0.9	1.9	139.9	247.2
	Specific Learning Disabled	7,414	7.4	31.7	148.3	256.2
	Reading	5,028	5.0	25.5	146.6	255.5
	Mathematics	2,648	2.6	22.0	146.5	252.9
	Writing	6,171	6.2	32.2	148.3	256.2
	Other	237	0.2	27.7	147.8	254.8
	Speech-Language Impaired	333	0.3	39.8	150.3	258.0
	Visually Impaired	55	0.1	50.9	152.8	257.2
	Other Health Impaired	1,560	1.6	34.7	149.6	255.5
	Orthopedically Impaired	51	0.1	26.5	150.5	252.9
	Traumatic Brain Injured	30	0.0	23.3	145.9	254.5
	Autistic	68	0.1	48.4	153.1	259.5
	Severe/Profound Mentally Disabled	0	0.0	*	*	*
	Multihandicapped	11	0.0	*	*	*
	Deaf-Blind	1	0.0	*	*	*
	Trainable Mentally Disabled	4	0.0	*	*	*
	Section 504	1,636	1.6	50.5	152.7	259.3
	Limited English Proficient	1,182	1.2	28.1	147.2	255.9
	Not Served by Title I	83,414	83.3	70.0	157.3	263.9
	Schoolwide Title I Program	15,239	15.2	57.3	154.0	260.4
	Targeted Assistance	1,187	1.2	39.2	150.8	257.1
	Migrant	601	0.6	47.9	151.5	258.9

Notes: *No scores are reported for groups with fewer than thirty students.

¹Percent for "Not Exceptional" through "Trainable Mentally Disabled" is based on the sum of the students in those categories.

Percent for "Learning Disabled," "Academically Gifted" and "Section 504" through "Migrant" is based on the number tested in the "All Students" category.

²The standard for grade-level proficiency is a test score at Level III or above on end-of-grade tests in reading and mathematics.

The "All Students" and "Not Exceptional" categories are shown for the purpose of comparison.

"Not Exceptional," "Academically Gifted" and "Students with Disabilities" do not sum to "All Students" because whether or not some students were classified as exceptional was not coded on the answer sheets.

All data rounded to the nearest tenth, therefore, exceptional categories may not sum to 100%.

"Number Tested" is the number of students who took the end-of-grade test in reading.

Data received from LEAs and charter schools after August 2001 are not included in this table.

Prepared by the NCDPI Division of Accountability Services/Testing Section.

**Table 11. 2000-01 End-of-Grade Multiple-Choice Test Results
Performance of Academically Gifted, Exceptional, Limited English Proficient and Title I Students
Grades 3-8 (continued)**

<u>Grade 7</u>	<u>Category</u>	<u>Number</u>	<u>Percent At or</u>		<u>Average</u>	<u>Average</u>
		<u>Tested</u>	<u>Percent¹</u>	<u>Above Level III²</u>	<u>Scale Score</u>	<u>Scale Score</u>
					<u>Reading</u>	<u>Mathematics</u>
	All Students	96,945	100.0	70.4	159.9	267.1
	Not Exceptional	70,000	72.2	69.8	159.2	265.4
	Academically Gifted	15,942	16.4	99.5	169.0	280.7
	Reading	12,192	12.6	99.7	169.6	281.2
	Mathematics	12,590	13.0	99.5	169.0	281.2
	Students with Disabilities	10,978	11.3	31.7	151.7	258.4
	Behaviorally-Emotionally Handicapped	1,116	1.2	20.5	149.9	255.7
	Hearing Impaired	139	0.1	33.1	151.6	259.4
	Educable Mentally Handicapped	946	1.0	1.3	143.8	250.7
	Specific Learning Disabled	6,941	7.2	36.2	152.5	259.7
	Reading	4,525	4.7	29.7	151.0	259.1
	Mathematics	2,385	2.5	23.9	150.8	256.2
	Writing	5,998	6.2	37.2	152.6	260.8
	Other	193	0.2	31.4	151.8	258.2
	Speech-Language Impaired	219	0.2	38.7	154.1	260.4
	Visually Impaired	39	0.0	62.2	158.7	264.3
	Other Health Impaired	1,465	1.5	35.8	153.3	258.6
	Orthopedically Impaired	43	0.0	34.1	155.7	256.9
	Traumatic Brain Injured	24	0.0	*	*	*
	Autistic	36	0.0	58.8	158.0	267.4
	Severe/Profound Mentally Disabled	1	0.0	*	*	*
	Multihandicapped	5	0.0	*	*	*
	Deaf-Blind	2	0.0	*	*	*
	Trainable Mentally Disabled	2	0.0	*	*	*
	Section 504	1,391	1.4	50.7	156.1	262.2
	Limited English Proficient	1,149	1.2	29.3	151.0	259.1
	Not Served by Title I	82,442	85.0	72.4	160.4	267.7
	Schoolwide Title I Program	13,296	13.7	59.7	157.6	263.8
	Targeted Assistance	1,031	1.1	52.1	155.9	262.8
	Migrant	527	0.5	54.9	156.2	262.9
<u>Grade 8</u>	All Students	93,305	100.0	74.4	163.1	270.0
	Not Exceptional	67,669	72.6	74.6	162.3	268.3
	Academically Gifted	15,362	16.5	99.7	171.7	283.7
	Reading	11,745	12.6	99.7	172.1	284.0
	Mathematics	11,754	12.6	99.6	171.7	284.4
	Students with Disabilities	10,235	11.0	34.8	154.8	260.6
	Behaviorally-Emotionally Handicapped	1,059	1.1	19.9	152.8	257.7
	Hearing Impaired	110	0.1	47.3	156.8	262.7
	Educable Mentally Handicapped	998	1.1	4.0	147.5	254.1
	Specific Learning Disabled	6,429	6.9	40.1	155.8	261.8
	Reading	4,158	4.5	33.5	154.0	260.8
	Mathematics	2,631	2.8	24.7	153.7	258.4
	Writing	5,497	5.9	40.3	155.6	262.0
	Other	159	0.2	44.2	157.3	262.5
	Speech-Language Impaired	145	0.2	42.4	156.5	262.7
	Visually Impaired	45	0.0	46.7	157.4	262.1
	Other Health Impaired	1,329	1.4	40.6	156.7	261.2
	Orthopedically Impaired	40	0.0	48.7	161.4	264.4
	Traumatic Brain Injured	30	0.0	33.3	155.1	259.6
	Autistic	32	0.0	53.1	158.0	267.7
	Severe/Profound Mentally Disabled	1	0.0	*	*	*
	Multihandicapped	7	0.0	*	*	*
	Deaf-Blind	6	0.0	*	*	*
	Trainable Mentally Disabled	4	0.0	*	*	*
	Section 504	1,256	1.3	57.0	159.6	265.5
	Limited English Proficient	1,155	1.2	37.8	154.8	262.7
	Not Served by Title I	79,317	85.0	76.2	163.5	270.6
	Schoolwide Title I Program	12,842	13.8	64.9	160.8	172.4
	Targeted Assistance	951	1.0	54.6	159.4	264.7
	Migrant	492	0.5	63.4	160.0	266.7

Notes: *No scores are reported for groups with fewer than thirty students.

¹Percent for "Not Exceptional" through "Trainable Mentally Disabled" is based on the sum of the students in those categories.

Percent for "Learning Disabled," "Academically Gifted" and "Section 504" through "Migrant" is based on the number tested in the "All Students" category.

²The standard for grade-level proficiency is a test score at Level III or above on end-of-grade tests in reading and mathematics.

The "All Students" and "Not Exceptional" categories are shown for the purpose of comparison.

"Not Exceptional," "Academically Gifted" and "Students with Disabilities" do not sum to "All Students" because whether or not some students were classified as exceptional was not coded on the answer sheets.

All data rounded to the nearest tenth, therefore, exceptional categories may not sum to 100%.

"Number Tested" is the number of students who took the end-of-grade test in reading.

Data received from LEAs and charter schools after August 2001 are not included in this table.

Prepared by the NCDPI Division of Accountability Services/Testing Section.

**Table 11. 2000-01 End-of-Grade Multiple-Choice Test Results
Performance of Academically Gifted, Exceptional, Limited English Proficient and Title I Students
Grades 3-8 (continued)**

<u>Grades 3 - 8</u>	<u>Category</u>	<u>Number Tested</u>	<u>Percent At or</u>		<u>Average</u>	<u>Average</u>
			<u>Percent¹</u>	<u>Above Level III²</u>	<u>Scale Score Reading</u>	<u>Scale Score Mathematics</u>
	All Students	591,337	100.0	71.7	155.4	260.9
	Not Exceptional	440,307	74.5	71.8	154.5	259.5
	Academically Gifted	82,883	14.0	99.6	166.2	274.9
	Reading	64,976	11.0	99.7	166.6	275.0
	Mathematics	65,369	11.1	99.6	166.2	275.4
	Students with Disabilities	67,886	11.5	37.0	147.4	253.7
	Behaviorally-Emotionally Handicapped	5,643	1.0	26.3	146.9	252.1
	Hearing Impaired	779	0.1	44.0	148.7	254.9
	Educable Mentally Handicapped	4,863	0.8	3.2	140.3	246.8
	Specific Learning Disabled	40,685	6.9	38.6	147.9	254.9
	Reading	27,636	4.7	33.3	146.2	254.2
	Mathematics	14,939	2.5	27.9	146.4	251.9
	Writing	33,081	5.6	39.6	148.4	255.5
	Other	1,276	0.2	34.4	146.8	253.0
	Speech-Language Impaired	5,861	1.0	56.1	147.3	252.3
	Visually Impaired	300	0.1	57.8	152.3	256.7
	Other Health Impaired	8,828	1.5	39.6	148.9	253.8
	Orthopedically Impaired	291	0.0	44.1	150.8	253.6
	Traumatic Brain Injured	155	0.0	32.7	147.2	253.2
	Autistic	410	0.1	50.4	149.3	254.7
	Severe/Profound Mentally Disabled	2	0.0	*	*	*
	Multihandicapped	42	0.0	19.0	141.7	247.4
	Deaf-Blind	10	0.0	*	*	*
	Trainable Mentally Disabled	17	0.0	*	*	*
	Section 504	9,864	1.7	56.1	151.5	256.7
	Limited English Proficient	9,413	1.6	40.1	146.3	253.6
	Not Served by Title I	421,214	71.3	75.4	157.2	263.0
	Schoolwide Title I Program	155,868	26.4	63.6	151.1	256.0
	Targeted Assistance	13,263	2.2	50.7	148.3	253.4
	Migrant	3,255	0.6	54.0	150.5	262.9

Notes: *No scores are reported for groups with fewer than thirty students.

¹Percent for "Not Exceptional" through "Trainable Mentally Disabled" is based on the sum of the students in those categories.

Percent for "Learning Disabled," "Academically Gifted" and "Section 504" through "Migrant" is based on the number tested in the "All Students" category.

²The standard for grade-level proficiency is a test score at Level III or above on end-of-grade tests in reading and mathematics.

The "All Students" and "Not Exceptional" categories are shown for the purpose of comparison.

"Not Exceptional," "Academically Gifted" and "Students with Disabilities" do not sum to "All Students" because whether or not some students were classified as exceptional was not coded on the answer sheets.

All data rounded to the nearest tenth, therefore, exceptional categories may not sum to 100%.

"Number Tested" is the number of students who took the end-of-grade test in reading.

Data received from LEAs and charter schools after August 2001 are not included in this table.

Prepared by the NCDPI Division of Accountability Services/Testing Section.

**Table 12. 2000-01 End-of-Grade Multiple-Choice Test Results
Performance of Students Using Accommodations
Grades 3-8**

<u>Grade 3</u>	<u>Category</u>	<u>Number</u>		<u>Percent At or</u>	<u>Average</u>	<u>Average</u>
		<u>Tested</u>	<u>Percent</u>	<u>Above Level III</u>	<u>Scale Score</u>	<u>Scale Score</u>
					<u>Reading</u>	<u>Mathematics</u>
	All Students	101,652	100.0	67.3	147.0	250.6
	Braille Edition	6	0.0	*	*	*
	Large Print	78	0.1	52.6	142.5	248.5
	Assistive Technology	40	0.0	47.4	140.6	245.4
	Braille Writer	5	0.0	*	*	*
	Cranmer Abacus	7	0.0	*	*	*
	Dictation to Scribe	187	0.2	30.6	137.3	244.6
	Interpreter Signs Test**	21	0.0	*	*	*
	Magnification Devices	18	0.0	*	*	*
	Student Marks in Test Book	6,991	6.9	33.8	138.7	245.7
	Test Administrator Reads Test Aloud**	8,408	8.3	27.0	136.9	245.1
	Use of Typewriter or Word Processor	0	0.0	*	*	*
	Hospital/Home Testing	3	0.0	*	*	*
	Multiple Test Sessions	3,377	3.3	32.6	138.6	245.6
	Scheduled Extended Time	10,608	10.4	32.8	138.5	245.7
	Testing in a Separate Room	10,015	9.9	31.3	138.2	245.4
	English/Native Language Dictionary/Electronic Translator	149	0.1	40.5	140.2	246.6
	One Test Item Per Page	8	0.0	*	*	*
<hr/>						
<u>Grade 4</u>						
	All Students	99,717	100.0	72.4	150.3	255.8
	Braille Edition	5	0.0	*	*	*
	Large Print	75	0.1	61.3	147.9	253.6
	Assistive Technology	47	0.0	53.2	145.2	251.9
	Braille Writer	5	0.0	*	*	*
	Cranmer Abacus	5	0.0	*	*	*
	Dictation to Scribe	333	0.3	37.7	141.9	249.6
	Interpreter Signs Test**	23	0.0	*	*	*
	Magnification Devices	9	0.0	*	*	*
	Student Marks in Test Book	6,622	6.6	39.0	142.4	250.3
	Test Administrator Reads Test Aloud **	7,995	8.0	29.3	140.2	249.3
	Use of Typewriter or Word Processor	3	0.0	*	*	*
	Hospital/Home Testing	11	0.0	*	*	*
	Multiple Test Sessions	3,565	3.6	38.5	142.4	250.0
	Scheduled Extended Time	11,313	11.3	39.7	142.6	250.4
	Testing in a Separate Room	10,436	10.5	37.7	142.1	250.0
	English/Native Language Dictionary/Electronic Translator	134	0.1	41.0	142.4	250.6
	One Test Item Per Page	9	0.0	*	*	*

Notes: *No scores are reported for groups with fewer than thirty students.

Accommodations are available for students with disabilities, limited English proficiency or temporary disabilities.

**The "Interpreter Signs Test" and "Test Administrator Reads Test Aloud" accommodations are prohibited from use during the administration of state tests that measure reading skills.

All data are rounded to the nearest tenth, therefore, accommodation categories may not sum to 100%.

Data received from LEAs and charter schools after August 2001 are not included in this table.

Prepared by the NCDPI Division of Accountability Services/Testing Section.

**Table 12. 2000-01 End-of-Grade Multiple-Choice Test Results
Performance of Students Using Accommodations (continued)
Grades 3-8**

<u>Grade 5</u>	<u>Category</u>	<u>Number Tested</u>	<u>Percent</u>	<u>Percent At or Above Level III</u>	<u>Average Scale Score Reading</u>	<u>Average Scale Score Mathematics</u>
	All Students	99,639	100.0	78.4	156.0	260.0
	Braille Edition	12	0.0	*	*	*
	Large Print	62	0.1	54.1	151.6	256.4
	Assistive Technology	33	0.0	59.4	150.0	255.2
	Braille Writer	9	0.0	*	*	*
	Cranmer Abacus	5	0.0	*	*	*
	Dictation to Scribe	260	0.3	37.6	146.9	251.9
	Interpreter Signs Test**	9	0.0	*	*	*
	Magnification Devices	19	0.0	*	*	*
	Student Marks in Test Book	6,397	6.4	45.8	148.8	253.1
	Test Administrator Reads Test Aloud **	7,654	7.7	36.5	146.5	252.0
	Use of Typewriter or Word Processor	4	0.0	*	*	*
	Hospital/Home Testing	11	0.0	*	*	*
	Multiple Test Sessions	3,455	3.5	44.8	148.5	252.8
	Scheduled Extended Time	11,587	11.6	46.6	148.8	253.2
	Testing in a Separate Room	10,396	10.4	43.9	148.3	252.7
	English/Native Language Dictionary/Electronic Translator	147	0.1	40.4	146.7	252.6
	One Test Item Per Page	11	0.0	*	*	*
<hr/>						
<u>Grade 6</u>						
	All Students	100,079	100.0	67.6	156.7	263.2
	Braille Edition	7	0.0	*	*	*
	Large Print	62	0.1	56.5	153.8	259.9
	Assistive Technology	16	0.0	*	*	*
	Braille Writer	6	0.0	*	*	*
	Cranmer Abacus	4	0.0	*	*	*
	Dictation to Scribe	163	0.2	30.9	147.4	255.6
	Interpreter Signs Test**	20	0.0	*	*	*
	Magnification Devices	14	0.0	*	*	*
	Student Marks in Test Book	3,864	3.9	29.4	148.0	255.3
	Test Administrator Reads Test Aloud **	6,562	6.6	16.3	144.6	253.3
	Use of Typewriter or Word Processor	2	0.0	*	*	*
	Hospital/Home Testing	25	0.0	*	*	*
	Multiple Test Sessions	2,019	2.0	27.8	147.4	254.7
	Scheduled Extended Time	11,052	11.0	29.0	147.7	255.1
	Testing in a Separate Room	8,857	8.9	25.5	146.9	254.4
	English/Native Language Dictionary/Electronic Translator	247	0.2	21.1	145.6	255.0
	One Test Item Per Page	2	0.0	*	*	*

Notes: *No scores are reported for groups with fewer than thirty students.

Accommodations are available for students with disabilities, limited English proficiency or temporary disabilities.

**The "Interpreter Signs Test" and "Test Administrator Reads Test Aloud" accommodations are prohibited from use during the administration of state tests that measure reading skills.

All data are rounded to the nearest tenth, therefore, accommodation categories may not sum to 100%.

Data received from LEAs and charter schools after August 2001 are not included in this table.

Prepared by the NCDPI Division of Accountability Services/Testing Section.

**Table 12. 2000-01 End-of-Grade Multiple-Choice Test Results
Performance of Students Using Accommodations (continued)
Grades 3-8**

<u>Grade 7</u>	<u>Category</u>	<u>Number</u>	<u>Percent</u>	<u>Percent At or</u>	<u>Average</u>	<u>Average</u>
		<u>Tested</u>			<u>Above Level III</u>	<u>Scale Score</u>
					<u>Reading</u>	<u>Mathematics</u>
	All Students	96,945	100.0	70.4	159.9	267.1
	Braille Edition	11	0.0	*	*	*
	Large Print	50	0.1	52.1	157.4	262.0
	Assistive Technology	20	0.0	*	*	*
	Braille Writer	6	0.0	*	*	*
	Cranmer Abacus	6	0.0	*	*	*
	Dictation to Scribe	155	0.2	27.5	150.7	258.1
	Interpreter Signs Test**	29	0.0	*	*	*
	Magnification Devices	12	0.0	*	*	*
	Student Marks in Test Book	3,018	3.1	31.1	151.7	258.4
	Test Administrator Reads Test Aloud **	5,673	5.9	16.0	148.2	256.0
	Use of Typewriter or Word Processor	19	0.0	*	*	*
	Hospital/Home Testing	44	0.0	24.4	150.2	255.7
	Multiple Test Sessions	1,588	1.6	25.3	150.3	257.4
	Scheduled Extended Time	10,304	10.6	30.0	151.4	258.2
	Testing in a Separate Room	8,163	8.4	26.0	150.6	257.5
	English/Native Language Dictionary/Electronic Translator	319	0.3	20.4	148.9	257.7
	One Test Item Per Page	1	0.0	*	*	*
<hr/>						
<u>Grade 8</u>						
	All Students	93,305	100.0	74.4	163.1	270.0
	Braille Edition	2	0.0	*	*	*
	Large Print	48	0.1	46.8	157.0	263.5
	Assistive Technology	15	0.0	*	*	*
	Braille Writer	2	0.0	*	*	*
	Cranmer Abacus	1	0.0	*	*	*
	Dictation to Scribe	85	0.1	33.3	152.8	260.7
	Interpreter Signs Test**	19	0.0	*	*	*
	Magnification Devices	15	0.0	*	*	*
	Student Marks in Test Book	2,468	2.6	35.7	154.9	260.8
	Test Administrator Reads Test Aloud **	5,102	5.5	20.7	151.6	258.5
	Use of Typewriter or Word Processor	14	0.0	*	*	*
	Hospital/Home Testing	39	0.0	25.6	153.0	258.7
	Multiple Test Sessions	1,485	1.6	26.8	153.3	259.4
	Scheduled Extended Time	9,840	10.5	33.5	154.6	260.5
	Testing in a Separate Room	7,248	7.8	29.0	153.7	259.7
	English/Native Language Dictionary/Electronic Translator	353	0.4	36.9	153.8	262.2
	One Test Item Per Page	4	0.0	*	*	*

Notes: *No scores are reported for groups with fewer than thirty students.

Accommodations are available for students with disabilities, limited English proficiency or temporary disabilities.

**The "Interpreter Signs Test" and "Test Administrator Reads Test Aloud" accommodations are prohibited from use during the administration of state tests that measure reading skills.

All data are rounded to the nearest tenth, therefore, accommodation categories may not sum to 100%.

Data received from LEAs and charter schools after August 2001 are not included in this table.

Prepared by the NCDPI Division of Accountability Services/Testing Section.

**Table 12. 2000-01 End-of-Grade Multiple-Choice Test Results
Performance of Students Using Accommodations (continued)
Grades 3-8**

<u>Grades</u> <u>3 to 8</u>	<u>Category</u>	<u>Number</u>	<u>Percent</u>	<u>Percent At or</u>	<u>Average</u>	<u>Average</u>
		<u>Tested</u>		<u>Above Level III</u>	<u>Scale Score</u>	<u>Scale Score</u>
					<u>Reading</u>	<u>Mathematics</u>
	All Students	591,337	100.0	71.7	155.4	260.9
	Braille Edition	43	0.0	67.4	153.2	258.3
	Large Print	375	0.1	54.5	150.8	256.5
	Assistive Technology	171	0.0	51.8	148.0	254.0
	Braille Writer	33	0.0	66.7	152.4	256.5
	Cranmer Abacus	28	0.0	*	*	*
	Dictation to Scribe	1,183	0.2	34.0	145.0	251.9
	Interpreter Signs Test**	121	0.0	25.8	145.0	254.4
	Magnification Devices	87	0.0	52.9	151.1	256.2
	Student Marks in Test Book	29,360	5.0	36.9	145.7	252.1
	Test Administrator Reads Test Aloud **	41,394	7.0	25.2	143.9	251.6
	Use of Typewriter or Word Processor	42	0.0	66.7	157.8	264.1
	Hospital/Home Testing	133	0.0	32.0	150.6	256.4
	Multiple Test Sessions	15,489	2.6	34.8	145.5	251.9
	Scheduled Extended Time	64,704	10.9	35.5	147.1	253.7
	Testing in a Separate Room	55,115	9.3	32.8	146.1	252.7
	English/Native Language Dictionary/Electronic Translator	1,349	0.2	31.3	147.8	255.8
	One Test Item Per Page	35	0.0	39.4	148.0	250.1

Notes: *No scores are reported for groups with fewer than thirty students.

Accommodations are available for students with disabilities, limited English proficiency or temporary disabilities.

**The "Interpreter Signs Test" and "Test Administrator Reads Test Aloud" accommodations are prohibited from use during the administration of state tests that measure reading skills.

All data are rounded to the nearest tenth, therefore, accommodation categories may not sum to 100%.

Data received from LEAs and charter schools after August 2001 are not included in this table.

Prepared by the NCDPI Division of Accountability Services/Testing Section.

**Table 13. 2000-01 End-of-Grade Multiple-Choice Test Results
Participation of Students with Special Needs****

Grade 3	Reading		Mathematics	
	Tested	Percent	Tested	Percent
Statewide*	107,110	100.0	107,110	100.0
All Students with IEPs	15,509	14.5	15,509	14.5
Standard Administration	11,928	11.1	12,411	11.6
With Accommodations	10,798	10.1	10,798	10.1
NCCATS Accommodation Pilot***	1,527	1.4	1,302	1.2
Behaviorally-Emotionally Disabled	138	0.1	120	0.1
Hearing Impaired	10	0.0	10	0.0
Educable Mentally Disabled	599	0.6	593	0.6
Specific Learning Disabled	535	0.5	354	0.3
Speech-Language Impaired	14	0.0	13	0.0
Visually Impaired	3	0.0	3	0.0
Other Health Impaired	144	0.1	128	0.1
Orthopedically Impaired	3	0.0	5	0.0
Traumatic Brain Injured	4	0.0	3	0.0
Autistic	52	0.0	49	0.0
Severe/Profound Mentally Disabled	0	0.0	0	0.0
Multihandicapped	12	0.0	11	0.0
Deaf-Blind	0	0.0	0	0.0
Trainable Mentally Disabled	13	0.0	13	0.0
Alternate Assessments				
NCAAAI Pilot***	1,440	1.3	1,185	1.1
Behaviorally-Emotionally Disabled	69	0.1	59	0.1
Hearing Impaired	17	0.0	11	0.0
Educable Mentally Disabled	726	0.7	694	0.6
Specific Learning Disabled	388	0.4	200	0.2
Speech-Language Impaired	12	0.0	9	0.0
Visually Impaired	3	0.0	3	0.0
Other Health Impaired	106	0.1	92	0.1
Orthopedically Impaired	5	0.0	6	0.0
Traumatic Brain Injured	4	0.0	4	0.0
Autistic	51	0.0	48	0.0
Severe/Profound Mentally Disabled	1	0.0	1	0.0
Multihandicapped	20	0.0	20	0.0
Deaf-Blind	1	0.0	1	0.0
Trainable Mentally Disabled	37	0.0	37	0.0
NCAAP****	452	0.4	452	0.4
Behaviorally-Emotionally Disabled	1	0.0	1	0.0
Hearing Impaired	2	0.0	2	0.0
Educable Mentally Disabled	48	0.0	48	0.0
Specific Learning Disabled	0	0.0	0	0.0
Speech-Language Impaired	1	0.0	1	0.0
Visually Impaired	1	0.0	1	0.0
Other Health Impaired	10	0.0	10	0.0
Orthopedically Impaired	7	0.0	7	0.0
Traumatic Brain Injured	3	0.0	3	0.0
Autistic	131	0.1	131	0.1
Severe/Profound Mentally Disabled	54	0.1	54	0.1
Multihandicapped	68	0.1	68	0.1
Deaf-Blind	1	0.0	1	0.0
Trainable Mentally Disabled	125	0.1	125	0.1
All Students Identified Only Under Section 504**	1,530	1.4	1,530	1.4
Standard Administration	1,488	1.4	1,495	1.4
With Accommodations	1,386	1.3	1,386	1.3
NCCATS Accommodation Pilot***	18	0.0	14	0.0
Alternate Assessments				
NCAAAI***	7	0.0	6	0.0
NCAAP****	1	0.0	1	0.0
All Limited English Proficient Students**	3,722	3.5	3,722	3.5
Standard Administration	2,421	2.3	2,447	2.3
With Accommodations	1,734	1.6	1,734	1.6
Not Participating				
First Year	893	0.8	893	0.8
Second Year	333	0.3	333	0.3

Notes: * Actual student membership is used for the statewide N-counts.

**Due to miscoding or rounding, some columns may not add up to the total. These data represent coding on the 2000-01 end-of-grade answer sheets. These data do not reflect the actual number of alternate assessments scored in the 2000-01 school year.

***NCCATS is the North Carolina Computerized Adaptive Testing System accommodation, and the NCAAAI is the North Carolina Alternate Assessment Academic Inventory; both were pilots for the 2000-01 school year.

****NCAAP is the North Carolina Alternate Assessment Portfolio.

Data received from LEAs and charter schools after August 2001 are not included in this table.

Prepared by the NCDPI Division of Accountability Services/Testing Section.

**Table 13. 2000-01 End-of-Grade Multiple-Choice Test Results
Participation of Students with Special Needs** (continued)**

Grade 4	Reading		Mathematics	
	Tested	Percent	Tested	Percent
Statewide*	105,662	100.0	105,662	100.0
All Students with IEPs	15,750	14.9	15,750	14.9
Standard Administration	11,588	11.0	12,241	11.6
With Accommodations	11,970	11.3	11,970	11.3
NCCATS Accommodation Pilot***	2,219	2.1	1,784	1.7
Behaviorally-Emotionally Disabled	147	0.1	132	0.1
Hearing Impaired	21	0.0	22	0.0
Educable Mentally Disabled	823	0.8	820	0.8
Specific Learning Disabled	947	0.9	559	0.5
Speech-Language Impaired	9	0.0	7	0.0
Visually Impaired	2	0.0	3	0.0
Other Health Impaired	177	0.2	149	0.1
Orthopedically Impaired	11	0.0	11	0.0
Traumatic Brain Injured	7	0.0	6	0.0
Autistic	41	0.0	40	0.0
Severe/Profound Mentally Disabled	0	0.0	0	0.0
Multihandicapped	12	0.0	12	0.0
Deaf-Blind	0	0.0	0	0.0
Trainable Mentally Disabled	22	0.0	23	0.0
Alternate Assessments				
NCAAAI Pilot***	1,355	1.3	1,141	1.1
Behaviorally-Emotionally Disabled	67	0.1	57	0.1
Hearing Impaired	20	0.0	14	0.0
Educable Mentally Disabled	709	0.7	656	0.6
Specific Learning Disabled	342	0.3	198	0.2
Speech-Language Impaired	4	0.0	4	0.0
Visually Impaired	3	0.0	2	0.0
Other Health Impaired	74	0.1	77	0.1
Orthopedically Impaired	7	0.0	7	0.0
Traumatic Brain Injured	4	0.0	4	0.0
Autistic	53	0.1	51	0.0
Severe/Profound Mentally Disabled	0	0.0	0	0.0
Multihandicapped	14	0.0	14	0.0
Deaf-Blind	0	0.0	0	0.0
Trainable Mentally Disabled	58	0.1	57	0.1
NCAAP****	474	0.4	474	0.4
Behaviorally-Emotionally Disabled	1	0.0	1	0.0
Hearing Impaired	2	0.0	2	0.0
Educable Mentally Disabled	38	0.0	38	0.0
Specific Learning Disabled	1	0.0	1	0.0
Speech-Language Impaired	0	0.0	0	0.0
Visually Impaired	0	0.0	0	0.0
Other Health Impaired	18	0.0	18	0.0
Orthopedically Impaired	1	0.0	1	0.0
Traumatic Brain Injured	2	0.0	2	0.0
Autistic	105	0.1	105	0.1
Severe/Profound Mentally Disabled	55	0.1	55	0.1
Multihandicapped	74	0.1	74	0.1
Deaf-Blind	2	0.0	2	0.0
Trainable Mentally Disabled	175	0.2	175	0.2
All Students Identified Only Under Section 504**	2,046	1.9	2,046	1.9
Standard Administration	1,999	1.9	2,000	1.9
With Accommodations	1,831	1.7	1,831	1.7
NCCATS Accommodation Pilot***	17	0.0	16	0.0
Alternate Assessments		0.0		0.0
NCAAAI***	2	0.0	0	0.0
NCAAP****	3	0.0	3	0.0
All Limited English Proficient Students**	3,093	2.9	3,093	2.9
Standard Administration	1,864	1.8	1,891	1.8
With Accommodations	1,358	1.3	1,358	1.3
Not Participating				
First Year	730	0.7	730	0.7
Second Year	433	0.4	433	0.4

Notes: *Actual student membership is used for the statewide N-counts.

**Due to miscoding or rounding, some columns may not add up to the total. These data represent coding on the 2000-01 end-of-grade answer sheets. These data do not reflect the actual number of alternate assessments scored in the 2000-01 school year.

***NCCATS is the North Carolina Computerized Adaptive Testing System accommodation, and the NCAAAI is the North Carolina Alternate Assessment Academic Inventory; both were pilots for the 2000-01 school year.

****NCAAP is the North Carolina Alternate Assessment Portfolio.

Data received from LEAs and charter schools after August 2001 are not included in this table.

Prepared by the NCDPI Division of Accountability Services/Testing Section.

**Table 13. 2000-01 End-of-Grade Multiple-Choice Test Results
Participation of Students with Special Needs** (continued)**

<u>Grade 5</u>	<u>Reading</u>		<u>Mathematics</u>	
	<u>Tested</u>	<u>Percent</u>	<u>Tested</u>	<u>Percent</u>
Statewide*	106,184	100.0	106,184	100.0
All Students with IEPs	16,336	15.4	16,336	15.4
Standard Administration	11,536	10.9	12,097	11.4
With Accommodations	12,903	12.2	12,903	12.2
NCCATS Accommodation Pilot***	2,918	2.7	2,492	2.3
Behaviorally-Emotionally Disabled	210	0.2	192	0.2
Hearing Impaired	19	0.0	17	0.0
Educable Mentally Disabled	1,136	1.1	1,120	1.1
Specific Learning Disabled	1,185	1.1	809	0.8
Speech-Language Impaired	16	0.0	16	0.0
Visually Impaired	5	0.0	2	0.0
Other Health Impaired	236	0.2	222	0.2
Orthopedically Impaired	9	0.0	12	0.0
Traumatic Brain Injured	9	0.0	9	0.0
Autistic	45	0.0	45	0.0
Severe/Profound Mentally Disabled	0	0.0	0	0.0
Multihandicapped	12	0.0	12	0.0
Deaf-Blind	0	0.0	0	0.0
Trainable Mentally Disabled	36	0.0	36	0.0
Alternate Assessments				
NCAAAI Pilot***	1,195	1.1	1,052	1.0
Behaviorally-Emotionally Disabled	55	0.1	47	0.0
Hearing Impaired	11	0.0	8	0.0
Educable Mentally Disabled	653	0.6	631	0.6
Specific Learning Disabled	250	0.2	148	0.1
Speech-Language Impaired	6	0.0	6	0.0
Visually Impaired	2	0.0	3	0.0
Other Health Impaired	75	0.1	67	0.1
Orthopedically Impaired	8	0.0	8	0.0
Traumatic Brain Injured	10	0.0	10	0.0
Autistic	37	0.0	37	0.0
Severe/Profound Mentally Disabled	0	0.0	0	0.0
Multihandicapped	14	0.0	13	0.0
Deaf-Blind	0	0.0	0	0.0
Trainable Mentally Disabled	74	0.1	74	0.1
NCAAP****	549	0.5	549	0.5
Behaviorally-Emotionally Disabled	0	0.0	0	0.0
Hearing Impaired	1	0.0	1	0.0
Educable Mentally Disabled	32	0.0	32	0.0
Specific Learning Disabled	4	0.0	4	0.0
Speech-Language Impaired	0	0.0	0	0.0
Visually Impaired	1	0.0	1	0.0
Other Health Impaired	12	0.0	12	0.0
Orthopedically Impaired	5	0.0	5	0.0
Traumatic Brain Injured	5	0.0	5	0.0
Autistic	134	0.1	134	0.1
Severe/Profound Mentally Disabled	97	0.1	97	0.1
Multihandicapped	103	0.1	103	0.1
Deaf-Blind	0	0.0	0	0.0
Trainable Mentally Disabled	155	0.1	155	0.1
All Students Identified Only Under Section 504**	2,143	2.0	2,143	2.0
Standard Administration	2,094	2.0	2,099	2.0
With Accommodations	1,868	1.8	1,868	1.8
NCCATS Accommodation Pilot***	26	0.0	23	0.0
Alternate Assessments		0.0		0.0
NCAAAI***	2	0.0	2	0.0
NCAAP****	4	0.0	4	0.0
All Limited English Proficient Students**	2,827	2.7	2,827	2.7
Standard Administration	1,642	1.5	1,673	1.6
With Accommodations	1,182	1.1	1,182	1.1
Not Participating				
First Year	740	0.7	740	0.7
Second Year	379	0.4	379	0.4

Notes: *Actual student membership is used for the statewide N-counts.

**Due to miscoding or rounding, some columns may not add up to the total. These data represent coding on the 2000-01 end-of-grade answer sheets. These data do not reflect the actual number of alternate assessments scored in the 2000-01 school year.

***NCCATS is the North Carolina Computerized Adaptive Testing System accommodation, and the NCAAAI is the North Carolina Alternate Assessment Academic Inventory; both were pilots for the 2000-01 school year.

****NCAAP is the North Carolina Alternate Assessment Portfolio.

Data received from LEAs and charter schools after August 2001 are not included in this table.

Prepared by the NCDPI Division of Accountability Services/Testing Section.

**Table 13. 2000-01 End-of-Grade Multiple-Choice Test Results
Participation of Students with Special Needs** (continued)**

Grade 6	Reading		Mathematics	
	Tested	Percent	Tested	Percent
Statewide*	105,616	100.0	105,616	100.0
All Students with IEPs	15,367	14.5	15,367	14.5
Standard Administration	11,621	11.0	11,893	11.3
With Accommodations	12,655	12.0	12,655	12.0
NCCATS Accommodation Pilot***	2,431	2.3	2,198	2.1
Behaviorally-Emotionally Disabled	192	0.2	186	0.2
Hearing Impaired	13	0.0	12	0.0
Educable Mentally Disabled	1,110	1.1	1,111	1.1
Specific Learning Disabled	837	0.8	611	0.6
Speech-Language Impaired	10	0.0	10	0.0
Visually Impaired	4	0.0	4	0.0
Other Health Impaired	160	0.2	156	0.2
Orthopedically Impaired	11	0.0	13	0.0
Traumatic Brain Injured	6	0.0	5	0.0
Autistic	28	0.0	28	0.0
Severe/Profound Mentally Disabled	0	0.0	0	0.0
Multihandicapped	17	0.0	17	0.0
Deaf-Blind	0	0.0	0	0.0
Trainable Mentally Disabled	43	0.0	45	0.0
Alternate Assessments				
NCAAAI Pilot***	770	0.7	715	0.7
Behaviorally-Emotionally Disabled	34	0.0	34	0.0
Hearing Impaired	3	0.0	1	0.0
Educable Mentally Disabled	514	0.5	500	0.5
Specific Learning Disabled	120	0.1	87	0.1
Speech-Language Impaired	3	0.0	3	0.0
Visually Impaired	1	0.0	1	0.0
Other Health Impaired	36	0.0	34	0.0
Orthopedically Impaired	9	0.0	6	0.0
Traumatic Brain Injured	6	0.0	7	0.0
Autistic	10	0.0	10	0.0
Severe/Profound Mentally Disabled	0	0.0	0	0.0
Multihandicapped	3	0.0	3	0.0
Deaf-Blind	0	0.0	0	0.0
Trainable Mentally Disabled	31	0.0	29	0.0
NCAAP****	339	0.3	339	0.3
Behaviorally-Emotionally Disabled	1	0.0	1	0.0
Hearing Impaired	2	0.0	2	0.0
Educable Mentally Disabled	39	0.0	39	0.0
Specific Learning Disabled	2	0.0	2	0.0
Speech-Language Impaired	0	0.0	0	0.0
Visually Impaired	0	0.0	0	0.0
Other Health Impaired	12	0.0	12	0.0
Orthopedically Impaired	1	0.0	1	0.0
Traumatic Brain Injured	6	0.0	6	0.0
Autistic	74	0.1	74	0.1
Severe/Profound Mentally Disabled	61	0.1	61	0.1
Multihandicapped	49	0.0	49	0.0
Deaf-Blind	0	0.0	0	0.0
Trainable Mentally Disabled	152	0.1	152	0.1
All Students Identified Only Under Section 504**	1,660	1.6	1,660	1.6
Standard Administration	1,636	1.5	1,633	1.5
With Accommodations	1,301	1.2	1,301	1.2
NCCATS Accommodation Pilot***	10	0.0	10	0.0
Alternate Assessments		0.0		0.0
NCAAAI***	0	0.0	0	0.0
NCAAP****	1	0.0	1	0.0
All Limited English Proficient Students**	2,258	2.1	2,258	2.1
Standard Administration	1,182	1.1	1,190	1.1
With Accommodations	828	0.8	828	0.8
Not Participating				
First Year	672	0.6	672	0.6
Second Year	356	0.3	356	0.3

Notes: *Actual student membership is used for the statewide N-counts.
 **Due to miscoding or rounding, some columns may not add up to the total. These data represent coding on the 2000-01 end-of-grade answer sheets. These data do not reflect the actual number of alternate assessments scored in the 2000-01 school year.
 *** NCCATS is the North Carolina Computerized Adaptive Testing System accommodation, and the NCAAAI is the North Carolina Alternate Assessment Academic Inventory; both were pilots for the 2000-01 school year.
 ****NCAAP is the North Carolina Alternate Assessment Portfolio.
 Data received from LEAs and charter schools after August 2001 are not included in this table.
 Prepared by the NCDPI Division of Accountability Services/Testing Section.

**Table 13. 2000-01 End-of-Grade Multiple-Choice Test Results
Participation of Students with Special Needs** (continued)**

Grade 7	Reading		Mathematics	
	Tested	Percent	Tested	Percent
Statewide*	102,366	100.0	102,366	100.0
All Students with IEPs	14,590	14.3	14,590	14.3
Standard Administration	10,978	10.7	11,217	11.0
With Accommodations	11,937	11.7	11,937	11.7
NCCATS Accommodation Pilot***	2,337	2.3	2,120	2.1
Behaviorally-Emotionally Disabled	212	0.2	205	0.2
Hearing Impaired	15	0.0	15	0.0
Educable Mentally Disabled	1,093	1.1	1,090	1.1
Specific Learning Disabled	759	0.7	557	0.5
Speech-Language Impaired	10	0.0	10	0.0
Visually Impaired	3	0.0	3	0.0
Other Health Impaired	150	0.1	141	0.1
Orthopedically Impaired	8	0.0	8	0.0
Traumatic Brain Injured	9	0.0	9	0.0
Autistic	29	0.0	32	0.0
Severe/Profound Mentally Disabled	0	0.0	0	0.0
Multihandicapped	14	0.0	14	0.0
Deaf-Blind	0	0.0	0	0.0
Trainable Mentally Disabled	35	0.0	36	0.0
Alternate Assessments				
NCAAAI Pilot***	669	0.7	616	0.6
Behaviorally-Emotionally Disabled	27	0.0	28	0.0
Hearing Impaired	4	0.0	4	0.0
Educable Mentally Disabled	413	0.4	393	0.4
Specific Learning Disabled	106	0.1	74	0.1
Speech-Language Impaired	1	0.0	1	0.0
Visually Impaired	4	0.0	4	0.0
Other Health Impaired	31	0.0	31	0.0
Orthopedically Impaired	5	0.0	6	0.0
Traumatic Brain Injured	2	0.0	2	0.0
Autistic	19	0.0	18	0.0
Severe/Profound Mentally Disabled	1	0.0	1	0.0
Multihandicapped	9	0.0	8	0.0
Deaf-Blind	0	0.0	0	0.0
Trainable Mentally Disabled	47	0.0	46	0.0
NCAAP****	354	0.3	354	0.3
Behaviorally-Emotionally Disabled	4	0.0	4	0.0
Hearing Impaired	0	0.0	0	0.0
Educable Mentally Disabled	31	0.0	31	0.0
Specific Learning Disabled	0	0.0	0	0.0
Speech-Language Impaired	0	0.0	0	0.0
Visually Impaired	2	0.0	2	0.0
Other Health Impaired	7	0.0	7	0.0
Orthopedically Impaired	0	0.0	0	0.0
Traumatic Brain Injured	1	0.0	1	0.0
Autistic	58	0.1	58	0.1
Severe/Profound Mentally Disabled	36	0.0	36	0.0
Multihandicapped	62	0.1	62	0.1
Deaf-Blind	0	0.0	0	0.0
Trainable Mentally Disabled	153	0.1	153	0.1
All Students Identified Only Under Section 504**	1,413	1.4	1,413	1.4
Standard Administration	1,391	1.4	1,385	1.4
With Accommodations	1,069	1.0	1,069	1.0
NCCATS Accommodation Pilot***	5	0.0	4	0.0
Alternate Assessments				
NCAAAI***	1	0.0	1	0.0
NCAAP****	0	0.0	0	0.0
All Limited English Proficient Students**	2,255	2.2	2,255	2.2
Standard Administration	1,149	1.1	1,158	1.1
With Accommodations	862	0.8	862	0.8
Not Participating				
First Year	728	0.7	728	0.7
Second Year	323	0.3	323	0.3

Notes: *Actual student membership is used for the statewide N-counts.

**Due to miscoding or rounding, some columns may not add up to the total. These data represent coding on the 2000-01 end-of-grade answer sheets. These data do not reflect the actual number of alternate assessments scored in the 2000-01 school year.

***NCCATS is the North Carolina Computerized Adaptive Testing System accommodation, and the NCAAAI is the North Carolina Alternate Assessment Academic Inventory; both were pilots for the 2000-01 school year.

****NCAAP is the North Carolina Alternate Assessment Portfolio.

Data received from LEAs and charter schools after August 2001 are not included in this table.
Prepared by the NCDPI Division of Accountability Services/Testing Section.

**Table 13. 2000-01 End-of-Grade Multiple-Choice Test Results
Participation of Students with Special Needs** (continued)**

Grade 8	Reading		Mathematics	
	Tested	Percent	Tested	Percent
Statewide*	98,298	100.0	98,298	100.0
All Students with IEPs	13,540	13.8	13,540	13.8
Standard Administration	10,235	10.4	10,359	10.5
With Accommodations	10,991	11.2	10,991	11.2
NCCATS Accommodation Pilot***	2,129	2.2	2,017	2.1
Behaviorally-Emotionally Disabled	173	0.2	169	0.2
Hearing Impaired	13	0.0	13	0.0
Educable Mentally Disabled	1,097	1.1	1,105	1.1
Specific Learning Disabled	618	0.6	504	0.5
Speech-Language Impaired	9	0.0	9	0.0
Visually Impaired	2	0.0	2	0.0
Other Health Impaired	117	0.1	115	0.1
Orthopedically Impaired	17	0.0	17	0.0
Traumatic Brain Injured	11	0.0	10	0.0
Autistic	17	0.0	17	0.0
Severe/Profound Mentally Disabled	0	0.0	0	0.0
Multihandicapped	17	0.0	19	0.0
Deaf-Blind	0	0.0	0	0.0
Trainable Mentally Disabled	38	0.0	37	0.0
Alternate Assessments				
NCAAAI Pilot***	519	0.5	490	0.5
Behaviorally-Emotionally Disabled	10	0.0	9	0.0
Hearing Impaired	2	0.0	2	0.0
Educable Mentally Disabled	350	0.4	336	0.3
Specific Learning Disabled	52	0.1	38	0.0
Speech-Language Impaired	0	0.0	0	0.0
Visually Impaired	1	0.0	1	0.0
Other Health Impaired	17	0.0	19	0.0
Orthopedically Impaired	5	0.0	6	0.0
Traumatic Brain Injured	1	0.0	1	0.0
Autistic	6	0.0	6	0.0
Severe/Profound Mentally Disabled	1	0.0	1	0.0
Multihandicapped	16	0.0	14	0.0
Deaf-Blind	0	0.0	0	0.0
Trainable Mentally Disabled	58	0.1	57	0.1
NCAAP****	445	0.5	445	0.5
Behaviorally-Emotionally Disabled	4	0.0	4	0.0
Hearing Impaired	0	0.0	0	0.0
Educable Mentally Disabled	28	0.0	28	0.0
Specific Learning Disabled	0	0.0	0	0.0
Speech-Language Impaired	0	0.0	0	0.0
Visually Impaired	1	0.0	1	0.0
Other Health Impaired	10	0.0	10	0.0
Orthopedically Impaired	2	0.0	2	0.0
Traumatic Brain Injured	0	0.0	0	0.0
Autistic	92	0.1	92	0.1
Severe/Profound Mentally Disabled	57	0.1	57	0.1
Multihandicapped	78	0.1	78	0.1
Deaf-Blind	0	0.0	0	0.0
Trainable Mentally Disabled	173	0.2	173	0.2
All Students Identified Only Under Section 504**	1,272	1.3	1,272	1.3
Standard Administration	1,256	1.3	1,257	1.3
With Accommodations	956	1.0	956	1.0
NCCATS Accommodation Pilot***	4	0.0	4	0.0
Alternate Assessments		0.0		0.0
NCAAAI***	1	0.0	0	0.0
NCAAP****	0	0.0	0	0.0
All Limited English Proficient Students**	2,067	2.1	2,067	2.1
Standard Administration	1,155	1.2	1,169	1.2
With Accommodations	862	0.9	862	0.9
Not Participating				0.0
First Year	541	0.6	541	0.6
Second Year	315	0.3	315	0.3

Notes: *Actual student membership is used for the statewide N-counts.

**Due to miscoding or rounding, some columns may not add up to the total. These data represent coding on the 2000-01 end-of-grade answer sheets. These data do not reflect the actual number of alternate assessments scored in the 2000-01 school year.

***NCCATS is the North Carolina Computerized Adaptive Testing System accommodation, and the NCAAAI is the North Carolina Alternate Assessment Academic Inventory; both were pilots for the 2000-01 school year.

****NCAAP is the North Carolina Alternate Assessment Portfolio.

Data received from LEAs and charter schools after August 2001 are not included in this table.

Prepared by the NCDPI Division of Accountability Services/Testing Section.

**Table 13. 2000-01 End-of-Grade Multiple-Choice Test Results
Participation of Students with Special Needs** (continued)**

<u>Grade3-8</u>	<u>Reading</u>		<u>Mathematics</u>	
	<u>Tested</u>	<u>Percent</u>	<u>Tested</u>	<u>Percent</u>
Statewide*	625,236	100.0	625,236	100.0
All Students with IEPs	91,092	14.6	91,092	14.6
Standard Administration	67,886	10.9	70,218	11.2
With Accommodations	71,254	11.4	71,254	11.4
NCCATS Accommodation Pilot***	13,561	2.2	11,913	1.9
Behaviorally-Emotionally Disabled	1,072	0.2	1,004	0.2
Hearing Impaired	91	0.0	89	0.0
Educable Mentally Disabled	5,858	0.9	5,839	0.9
Specific Learning Disabled	4,881	0.8	3,394	0.5
Speech-Language Impaired	68	0.0	65	0.0
Visually Impaired	19	0.0	17	0.0
Other Health Impaired	984	0.2	911	0.1
Orthopedically Impaired	59	0.0	66	0.0
Traumatic Brain Injured	46	0.0	42	0.0
Autistic	212	0.0	211	0.0
Severe/Profound Mentally Disabled	0	0.0	0	0.0
Multihandicapped	84	0.0	85	0.0
Deaf-Blind	0	0.0	0	0.0
Trainable Mentally Disabled	187	0.0	190	0.0
Alternate Assessments				
NCAAAI Pilot***	5,948	1.0	5,199	0.8
Behaviorally-Emotionally Disabled	262	0.0	234	0.0
Hearing Impaired	57	0.0	40	0.0
Educable Mentally Disabled	3,365	0.5	3,210	0.5
Specific Learning Disabled	1,258	0.2	745	0.1
Speech-Language Impaired	26	0.0	23	0.0
Visually Impaired	14	0.0	14	0.0
Other Health Impaired	339	0.1	320	0.1
Orthopedically Impaired	39	0.0	39	0.0
Traumatic Brain Injured	27	0.0	28	0.0
Autistic	176	0.0	170	0.0
Severe/Profound Mentally Disabled	3	0.0	3	0.0
Multihandicapped	76	0.0	72	0.0
Deaf-Blind	1	0.0	1	0.0
Trainable Mentally Disabled	305	0.0	300	0.0
NCAAP****	2,673	0.4	2,673	0.4
Behaviorally-Emotionally Disabled	11	0.0	11	0.0
Hearing Impaired	7	0.0	7	0.0
Educable Mentally Disabled	216	0.0	216	0.0
Specific Learning Disabled	7	0.0	7	0.0
Speech-Language Impaired	1	0.0	1	0.0
Visually Impaired	5	0.0	5	0.0
Other Health Impaired	69	0.0	69	0.0
Orthopedically Impaired	16	0.0	16	0.0
Traumatic Brain Injured	17	0.0	17	0.0
Autistic	594	0.1	594	0.1
Severe/Profound Mentally Disabled	360	0.1	360	0.1
Multihandicapped	434	0.1	434	0.1
Deaf-Blind	3	0.0	3	0.0
Trainable Mentally Disabled	933	0.1	933	0.1
All Students Identified Only Under Section 504**	10,064	1.6	10,064	1.6
Standard Administration	9,864	1.6	9,869	1.6
With Accommodations	8,411	1.3	8,411	1.3
NCCATS Accommodation Pilot***	80	0.0	71	0.0
Alternate Assessments		0.0		0.0
NCAAAI***	13	0.0	9	0.0
NCAAP****	9	0.0	9	0.0
All Limited English Proficient Students**	16,222	2.6	16,222	2.6
Standard Administration	9,413	1.5	9,528	1.5
With Accommodations	6,826	1.1	6,826	1.1
Not Participating		0.0		0.0
First Year	4,304	0.7	4,304	0.7
Second Year	2,139	0.3	2,139	0.3

Notes: *Actual student membership is used for the statewide N-counts.

**Due to miscoding or rounding, some columns may not add up to the total. These data represent coding on the 2000-01 end-of-grade answer sheets. These data do not reflect the actual of alternate assessments scored in the 2000-01 school year.

***NCCATS is the North Carolina Computerized Adaptive Testing System accommodation, and the NCAAAI is the North Carolina Alternate Assessment Academic Inventory; both were pilots for the 2000-01 school year.

****NCAAP is the North Carolina Alternate Assessment Portfolio.

Data received from LEAs and charter schools after August 2001 are not included in this table.

Prepared by the NCDPI Division of Accountability Services/Testing Section.

**Table 14. 2000-01 End-of-Grade Multiple-Choice Test Results
Characteristics and Performance of Grade 3 Students**

	N	Percent	Percent At or Above Level III in Both <u>Reading and Mathematics</u>	Average Scale Score Reading	Average Scale Score Mathematics
All Students	101,652	100.0	67.3	147.0	250.6
Gender					
Male	51,441	50.6	65.4	146.2	250.5
Female	50,210	49.4	69.2	147.8	250.6
Ethnic Group					
American Indian	1,506	1.5	59.9	144.5	248.8
Asian	1,808	1.8	74.6	148.3	252.7
Black	31,191	30.7	46.7	142.6	246.3
Hispanic	4,537	4.5	55.0	143.3	248.3
Multi-Racial	1,819	1.8	69.5	147.1	250.6
White	60,757	59.8	78.6	149.5	252.9
Other	30	0.0	*	*	*
Parental Education					
Did not finish high school	11,194	11.1	40.1	140.5	245.7
High school graduate	47,083	46.8	59.5	144.9	248.7
Trade or business school	4,168	4.1	71.6	147.5	250.9
Community college	13,426	13.3	75.4	148.5	251.5
Four-year college degree	20,643	20.5	88.8	152.5	255.4
Graduate school	4,166	4.1	95.0	155.6	258.4
Hours of Homework (per week)					
None assigned	2,277	2.3	40.3	140.9	245.3
1 hour or less	31,740	31.6	63.6	146.0	249.5
1 to 3 hours	30,146	30.0	70.9	147.8	251.2
More than 3, less than 5 hours	16,738	16.7	72.1	148.3	251.9
Between 5-10 hours	12,922	12.9	73.9	148.5	252.2
More than 10 hours	5,328	5.3	63.4	146.1	249.9
Assigned but not done	1,677	1.7	26.6	138.0	243.4
Hours Watching TV (each school day)					
None	8,989	8.9	59.8	145.7	249.4
1 hour	36,472	36.2	69.3	147.6	251.0
2 hours	21,031	20.9	70.9	147.8	251.4
3 hours	14,071	14.0	69.8	147.3	251.0
Between 4 and 5 hours	9,635	9.6	69.6	147.1	250.8
More than 6 hours	10,437	10.4	55.3	143.9	247.9
Free Time Spent Reading in a Week					
None	6,826	6.8	51.0	143.0	247.5
About 30 minutes	49,993	49.8	63.9	145.9	249.7
About one hour	21,829	21.7	73.3	148.3	251.9
Between 1 and 2 hours	12,430	12.4	78.2	150.0	253.2
More than 2 hours	9,335	9.3	70.5	148.6	251.5
Reading Homework					
Read and answer questions	54,261	53.4	66.6	146.9	250.4
Read, do not answer questions	25,870	25.4	73.9	148.5	252.1
Choose what to read and report to teacher	24,958	24.6	66.9	147.0	250.7
Choose what to read, do not report	15,966	15.7	71.1	148.0	251.7
Required to Explain How Math Problems Are Solved					
Never	1,963	2.0	49.1	142.9	247.0
1-2 times per month	5,997	6.0	61.0	145.6	249.6
1 time per week	14,244	14.3	68.0	147.2	250.9
Almost every day	77,475	77.7	68.5	147.2	250.8
Calculator Use in Math Class					
Never use	6,076	6.1	56.6	145.0	248.6
Hardly ever use	39,734	39.6	71.7	148.1	251.4
1-2 times per month	15,335	15.3	70.8	147.8	251.4
1-2 times per week	24,161	24.1	67.4	146.9	250.5
Almost every day	15,009	15.0	57.4	144.5	248.7

Notes: "N" is the number of students who took the end-of-grade test in reading and no scores are reported for groups with fewer than thirty students.

When summed, gender and ethnicity N-counts may not match the state N-counts because gender and/or ethnicity may not have been coded for some students.

Data received from LEAs and charter schools after August 2001 are not included in this table.

Prepared by the NCDPI Division of Accountability Services/Testing Section.

**Table 14. 2000-01 End-of-Grade Multiple-Choice Test Results
Characteristics and Performance of Grade 3 Students (continued)**

	N	Percent	Percent At or Above Level III in <u>Both</u> <u>Reading and Mathematics</u>	Average Scale Score Reading	Average Scale Score Mathematics
Computer Use at Home					
Almost every day	6,888	6.9	44.6	142.1	246.5
1-2 times per week	7,595	7.6	64.0	146.3	250.0
1-2 times per month	7,240	7.2	77.1	149.6	253.0
Hardly ever	25,846	25.8	73.7	148.7	252.1
Never (owns computer)	31,357	31.3	75.1	148.5	251.8
No computer at home	21,359	21.3	54.0	143.7	247.7
Testing Cycle					
Traditional, regular program	88,499	93.4	67.5	147.0	250.6
Year-round school	6,245	6.6	68.8	147.5	251.2
Anticipated Math Grade					
A	26,685	26.4	96.9	155.0	258.1
B	34,502	34.1	80.2	148.2	251.4
C	25,871	25.6	47.3	142.5	246.5
D	10,369	10.2	19.9	137.8	242.8
F	3,742	3.7	8.0	134.6	240.2
Teacher Math Judgement					
Level 4	23,403	23.2	98.4	155.6	258.7
Level 3	45,955	45.5	79.6	148.1	251.3
Level 2	23,929	23.7	32.3	140.4	244.8
Level 1	7,250	7.2	6.6	134.2	240.0
Not clear example of any level	443	0.4	45.2	141.2	245.6
Student Took Makeup Test					
Yes	2,245	2.2	55.6	144.4	248.4
Misadministration					
Yes	434	0.4	59.9	145.0	248.8
National School Lunch Program					
Not eligible	50,055	50.2	81.1	150.2	253.4
Reduced price	9,239	9.3	62.0	145.3	249.0
Free lunch	34,509	34.6	47.8	142.5	246.8
Information not available	5,022	5.0	73.8	148.4	251.5
School not participating	936	0.9	69.3	148.0	250.7

Notes: "N" is the number of students who took the end-of-grade test in reading.

*No scores are reported for groups with fewer than thirty students.

When summed, gender and ethnicity N-counts may not match the state N-counts because gender and/or ethnicity may not have been coded for some students.

Data received from LEAs and charter schools after August 2001 are not included in this table.

Prepared by the NCDPI Division of Accountability Services/Testing Section.

**Table 15. 2000-01 End-of-Grade Multiple-Choice Test Results
Characteristics and Performance of Grade 4 Students**

	N	Percent	Percent At or Above Level III in <u>Both</u> <u>Reading and Mathematics</u>	Average Scale Score Reading	Average Scale Score Mathematics
All Students	99,717	100.0	72.4	150.3	255.8
Gender					
Male	50,258	50.4	69.5	149.6	255.7
Female	49,457	49.6	75.3	151.0	255.9
Ethnic Group					
American Indian	1,436	1.4	59.2	146.6	252.8
Asian	1,678	1.7	77.5	151.9	259.0
Black	30,080	30.2	53.6	145.6	251.3
Hispanic	3,937	3.9	61.9	146.9	253.5
Multi-Racial	1,621	1.6	76.7	151.0	255.8
White	60,937	61.1	82.4	152.9	258.1
Other	22	0.0	*	*	*
Parental Education					
Did not finish high school	9,999	10.1	44.6	143.5	250.3
High school graduate	44,791	45.4	64.6	147.9	253.5
Trade or business school	4,406	4.5	76.2	150.5	255.9
Community college	13,605	13.8	80.5	151.7	256.8
Four-year college degree	21,564	21.8	91.2	155.9	260.9
Graduate school	4,331	4.4	96.7	159.3	264.3
Hours of Homework (per week)					
None assigned	1,391	1.4	46.0	144.1	250.6
1 hour or less	28,595	28.9	66.1	148.4	253.9
1 to 3 hours	33,885	34.3	75.5	151.0	256.2
More than 3, less than 5 hours	16,607	16.8	77.5	151.9	257.6
Between 5-10 hours	13,435	13.6	79.2	152.4	258.0
More than 10 hours	3,820	3.9	70.4	150.1	256.1
Assigned but not done	1,159	1.2	29.9	140.7	248.2
Hours Watching TV (each school day)					
None	6,429	6.5	67.0	149.9	255.5
1 hour	32,382	32.8	74.6	151.1	256.4
2 hours	23,447	23.7	76.3	151.3	256.8
3 hours	15,801	16.0	75.1	150.7	256.1
Between 4 and 5 hours	10,945	11.1	71.3	149.5	255.1
More than 6 hours	9,780	9.9	57.2	146.2	252.1
Free Time Spent Reading in a Week					
None	6,483	6.6	53.7	145.5	252.0
About 30 minutes	45,548	46.2	66.7	148.6	254.4
About one hour	23,561	23.9	78.5	151.8	257.1
Between 1 and 2 hours	14,477	14.7	84.5	153.9	258.9
More than 2 hours	8,565	8.7	81.1	153.5	257.9
Reading Homework					
Read and answer questions	53,932	54.1	72.5	150.4	255.9
Read, do not answer questions	24,356	24.4	78.1	151.9	257.4
Choose what to read and report to teacher	23,082	23.1	74.8	151.2	256.8
Choose what to read, do not report	15,254	15.3	77.6	152.1	257.8
Required to Explain How Math Problems Are Solved					
Never	1,223	1.2	52.3	145.6	251.2
1-2 times per month	3,986	4.1	66.2	148.9	254.6
1 time per week	12,325	12.5	72.5	150.3	255.8
Almost every day	80,688	82.1	73.3	150.5	256.0
Calculator Use in Math Class					
Never use	4,951	5.0	61.6	147.9	253.5
Hardly ever use	37,414	38.0	73.8	150.6	255.8
1-2 times per month	14,130	14.3	77.4	151.8	257.2
1-2 times per week	26,724	27.1	73.8	150.6	256.2
Almost every day	15,357	15.6	66.4	148.6	254.8

Notes: "N" is the number of students who took the end-of-grade test in reading.

*No scores are reported for groups with fewer than thirty students.

When summed, gender and ethnicity N-counts may not match the state N-counts because gender and/or ethnicity may not have been coded for some students.

Data received from LEAs and charter schools after August 2001 are not included in this table.

Prepared by the NCDPI Division of Accountability Services/Testing Section.

**Table 15. 2000-01 End-of-Grade Multiple-Choice Test Results
Characteristics and Performance of Grade 4 Students (continued)**

	N	Percent	Percent At or Above Level III in <u>Both</u> <u>Reading and Mathematics</u>	Average Scale Score Reading	Average Scale Score Mathematics
Computer Use at Home					
Almost every day	5,503	5.6	56.6	146.7	252.6
1-2 times per week	9,346	9.5	72.2	150.6	256.1
1-2 times per month	11,515	11.7	84.4	153.8	259.0
Hardly ever	27,994	28.4	78.3	152.1	257.5
Never (owns computer)	24,602	25.0	75.0	150.5	255.8
No computer at home	19,580	19.9	58.9	146.6	252.4
Testing Cycle					
Traditional, regular program	87,732	93.5	72.5	150.3	255.8
Year-round school	6,050	6.5	72.8	150.8	256.3
Anticipated Math Grade					
A	24,081	24.3	97.7	158.7	264.3
B	33,497	33.7	85.6	152.0	257.0
C	27,093	27.3	57.5	146.0	251.5
D	10,959	11.0	31.1	141.4	247.8
F	3,628	3.7	18.4	138.9	245.6
Teacher Math Judgement					
Level 4	23,465	23.7	98.5	159.0	264.6
Level 3	43,685	44.1	83.8	151.3	256.4
Level 2	24,171	24.4	44.3	143.8	249.7
Level 1	7,171	7.2	14.5	138.0	245.2
Not clear example of any level	470	0.5	53.3	145.4	252.0
Student Took Makeup Test					
Yes	2,230	2.2	59.3	147.2	253.0
Misadministration					
Yes	705	0.7	71.3	149.2	253.8
National School Lunch Program					
Not eligible	50,358	51.4	84.4	153.5	258.7
Reduced price	8,981	9.2	67.6	148.4	254.1
Free lunch	32,396	33.1	53.6	145.5	251.6
Information not available	5,099	5.2	79.9	152.1	257.1
School not participating	1,064	1.1	76.0	152.0	256.5

Notes: "N" is the number of students who took the end-of-grade test in reading.

*No scores are reported for groups with fewer than thirty students.

When summed, gender and ethnicity N-counts may not match the state N-counts because gender and/or ethnicity may not have been coded for some students.

Data received from LEAs and charter schools after August 2001 are not included in this table.

Prepared by the NCDPI Division of Accountability Services/Testing Section.

**Table 16. 2000-01 End-of-Grade Multiple-Choice Test Results
Characteristics and Performance of Grade 5 Students**

	N	Percent	Percent At or Above Level III in <u>Both Reading and Mathematics</u>	Average Scale Score Reading	Average Scale Score Mathematics
All Students	99,639	100.0	78.4	156.0	260.0
Gender					
Male	50,544	50.7	76.2	155.4	259.9
Female	49,091	49.3	80.7	156.5	260.1
Ethnic Group					
American Indian	1,392	1.4	65.3	152.5	256.0
Asian	1,758	1.8	85.4	157.6	264.6
Black	29,443	29.6	62.0	151.8	254.9
Hispanic	3,637	3.7	67.4	152.7	256.9
Multi-Racial	1,386	1.4	82.2	156.8	260.4
White	61,994	62.2	86.9	158.1	262.5
Other	24	0.0	*	*	*
Parental Education					
Did not finish high school	9,743	9.9	52.8	150.0	253.6
High school graduate	43,086	43.7	72.1	153.8	257.2
Trade or business school	4,593	4.7	81.9	156.1	259.7
Community college	13,847	14.0	85.1	157.1	260.9
Four-year college degree	22,465	22.8	93.7	160.5	265.6
Graduate school	4,858	4.9	97.0	163.3	269.8
Hours of Homework (per week)					
None assigned	957	1.0	53.8	150.2	253.5
1 hour or less	25,526	25.8	70.0	153.8	257.1
1 to 3 hours	38,963	39.4	80.8	156.3	260.2
More than 3, less than 5 hours	16,455	16.6	84.3	157.7	262.3
Between 5-10 hours	13,122	13.3	85.9	158.1	263.2
More than 10 hours	3,072	3.1	77.6	156.0	260.7
Assigned but not done	858	0.9	35.7	147.3	250.7
Hours Watching TV (each school day)					
None	5,044	5.1	74.8	156.1	260.5
1 hour	28,379	28.7	80.4	156.8	261.0
2 hours	25,263	25.6	82.7	157.0	261.3
3 hours	18,315	18.5	80.1	156.0	260.0
Between 4 and 5 hours	12,655	12.8	76.9	154.9	258.6
More than 6 hours	9,205	9.3	62.7	152.0	255.2
Free Time Spent Reading in a Week					
None	6,340	6.4	60.9	151.6	255.5
About 30 minutes	45,132	45.7	73.5	154.5	258.4
About one hour	24,654	25.0	83.7	157.1	261.4
Between 1 and 2 hours	14,990	15.2	88.4	158.9	263.2
More than 2 hours	7,637	7.7	86.9	159.3	262.7
Reading Homework					
Read and answer questions	56,253	56.5	79.4	156.3	260.4
Read, do not answer questions	22,055	22.1	83.7	157.4	261.9
Choose what to read and report to teacher	21,416	21.5	81.3	157.0	261.5
Choose what to read, do not report	14,551	14.6	84.8	157.9	262.8
Required to Explain How Math Problems Are Solved					
Never	1,052	1.1	54.9	151.2	254.5
1-2 times per month	3,469	3.5	71.8	154.6	258.4
1 time per week	11,566	11.7	77.3	155.7	259.9
Almost every day	82,365	83.7	79.4	156.2	260.2
Calculator Use in Math Class					
Never use	2,470	2.5	63.3	152.9	256.1
Hardly ever use	24,803	25.1	76.2	155.5	258.9
1-2 times per month	12,495	12.7	83.7	157.4	261.7
1-2 times per week	33,380	33.8	81.0	156.5	260.8
Almost every day	25,579	25.9	76.7	155.3	259.7

Notes: "N" is the number of students who took the end-of-grade test in reading.

*No scores are reported for groups with fewer than thirty students.

When summed, gender and ethnicity N-counts may not match the state N-counts because gender and/or ethnicity may not have been coded for some students.

Data received from LEAs and charter schools after August 2001 are not included in this table.

Prepared by the NCDPI Division of Accountability Services/Testing Section.

**Table 16. 2000-01 End-of-Grade Multiple-Choice Test Results
Characteristics and Performance of Grade 5 Students (continued)**

	N	Percent	Percent At or Above Level III in <u>Both</u> <u>Reading and Mathematics</u>	Average Scale Score Reading	Average Scale Score Mathematics
Computer Use at Home					
Almost every day	5,167	5.2	68.5	153.8	257.8
1-2 times per week	11,651	11.8	81.3	156.9	261.4
1-2 times per month	16,901	17.1	89.5	159.1	264.0
Hardly ever	28,667	29.0	83.3	157.2	261.4
Never (owns computer)	18,404	18.6	76.5	154.9	258.4
No computer at home	17,905	18.1	63.7	152.2	255.5
Testing Cycle					
Traditional, regular program	88,360	93.9	78.4	156.0	260.0
Year-round school	5,713	6.1	79.1	156.2	260.7
Anticipated Math Grade					
A	24,223	24.4	98.3	162.8	269.7
B	33,287	33.6	90.0	157.3	261.2
C	25,893	26.1	68.8	152.6	255.2
D	11,293	11.4	43.8	148.8	251.2
F	4,402	4.4	28.4	146.4	249.1
Teacher Math Judgement					
Level 4	26,317	26.6	99.1	163.0	269.9
Level 3	45,765	46.2	87.2	156.2	259.6
Level 2	20,900	21.1	49.8	149.8	252.1
Level 1	5,531	5.6	17.8	144.3	247.4
Not clear example of any level	450	0.5	66.7	151.7	254.3
Student Took Makeup Test					
Yes	1,687	1.7	66.4	153.4	257.3
Misadministration					
Yes	618	0.6	76.1	154.5	256.7
National School Lunch Program					
Not eligible	51,997	53.2	88.7	158.7	263.2
Reduced price	8,967	9.2	73.7	154.1	257.6
Free lunch	30,565	31.2	61.4	151.6	254.9
Information not available	5,091	5.2	84.4	157.3	261.3
School not participating	1,207	1.2	83.0	157.9	261.8

Notes: "N" is the number of students who took the end-of-grade test in reading.

*No scores are reported for groups with fewer than thirty students.

When summed, gender and ethnicity N-counts may not match the state N-counts because gender and/or ethnicity may not have been coded for some students.

Data received from LEAs and charter schools after August 2001 are not included in this table.

Prepared by the NCDPI Division of Accountability Services/Testing Section

**Table 17. 2000-01 End-of-Grade Multiple-Choice Test Results
Characteristics and Performance of Grade 6 Students**

	N	Percent	Percent At or Above Level III in Both Reading and Mathematics	Average Scale Score Reading	Average Scale Score Mathematics
All Students	100,079	100.0	67.6	156.7	263.2
Gender					
Male	50,376	50.3	64.4	155.8	263.1
Female	49,703	49.7	70.8	157.6	263.3
Ethnic Group					
American Indian	1,341	1.3	55.9	153.3	259.6
Asian	1,740	1.7	75.9	158.5	267.4
Black	30,131	30.1	45.9	151.7	257.7
Hispanic	3,488	3.5	52.4	152.7	259.7
Multi-Racial	1,233	1.2	69.8	157.2	262.9
White	62,107	62.1	79.0	159.4	266.1
Other	36	0.0	33.3	148.8	255.8
Parental Education					
Did not finish high school	9,134	9.2	37.9	149.8	256.6
High school graduate	43,208	43.6	57.7	154.0	260.3
Trade or business school	4,029	4.1	68.5	156.4	262.8
Community college	13,719	13.8	75.5	158.0	264.2
Four-year college degree	23,781	24.0	87.4	161.9	268.7
Graduate school	5,332	5.4	92.5	164.8	272.3
Hours of Homework (per week)					
None assigned	1,276	1.3	32.9	148.1	254.7
1 hour or less	27,527	27.8	56.2	153.9	260.2
1 to 3 hours	44,150	44.6	70.9	157.3	263.6
More than 3, less than 5 hours	14,081	14.2	77.2	159.4	266.5
Between 5-10 hours	9,146	9.2	81.8	160.8	268.1
More than 10 hours	1,676	1.7	73.8	158.9	266.4
Assigned but not done	1,319	1.3	28.8	147.5	254.6
Hours Watching TV (each school day)					
None	3,935	4.0	65.4	157.1	263.7
1 hour	24,501	24.7	72.0	158.1	264.9
2 hours	25,754	26.0	74.3	158.3	264.9
3 hours	20,386	20.6	69.1	156.7	263.1
Between 4 and 5 hours	14,539	14.7	63.2	155.2	261.4
More than 6 hours	9,992	10.1	45.2	151.5	257.8
Free Time Spent Reading in a Week					
None	10,075	10.2	48.3	152.0	259.2
About 30 minutes	48,032	48.5	63.5	155.6	262.4
About one hour	22,382	22.6	74.9	158.4	264.8
Between 1 and 2 hours	12,085	12.2	81.2	160.3	266.2
More than 2 hours	6,424	6.5	80.1	160.6	265.3
Reading Homework					
Read and answer questions	55,641	55.6	68.3	157.0	263.5
Read, do not answer questions	16,012	16.0	73.2	158.1	265.1
Choose what to read and report to teacher	16,080	16.1	73.8	158.5	265.5
Choose what to read, do not report	9,490	9.5	76.8	159.1	266.4
Required to Explain How Math Problems Are Solved					
Never	1,621	1.6	46.0	151.8	257.9
1-2 times per month	4,068	4.1	60.3	155.1	261.5
1 time per week	12,860	13.0	66.1	156.3	262.9
Almost every day	80,168	81.2	69.0	157.0	263.6

Notes: "N" is the number of students who took the end-of-grade test in reading.

*No scores are reported for groups with fewer than thirty students.

When summed, gender and ethnicity N-counts may not match the state N-counts because gender and/or ethnicity may not have been coded for some students.

Data received from LEAs and charter schools after August 2001 are not included in this table.

Prepared by the NCDPI Division of Accountability Services/Testing Section.

**Table 17. 2000-01 End-of-Grade Multiple-Choice Test Results
Characteristics and Performance of Grade 6 Students (continued)**

	N	Percent	Percent At or Above Level III in Both <u>Reading and Mathematics</u>	Average Scale Score <u>Reading</u>	Average Scale Score <u>Mathematics</u>
<u>Calculator Use in Math Class</u>					
Never use	2,044	2.1	47.5	152.1	258.1
Hardly ever use	18,221	18.4	61.3	155.2	261.2
1-2 times per month	11,218	11.3	72.8	157.8	264.3
1-2 times per week	36,400	36.8	71.2	157.5	264.1
Almost every day	31,023	31.4	67.1	156.7	263.5
<u>Computer Use at Home</u>					
Almost every day	7,274	7.4	62.4	155.5	261.8
1-2 times per week	14,766	14.9	75.1	158.8	265.5
1-2 times per month	20,751	21.0	80.5	160.0	266.9
Hardly ever	26,406	26.7	70.6	157.3	263.8
Never (owns computer)	13,152	13.3	60.6	154.7	260.8
No computer at home	16,609	16.8	48.9	152.2	258.5
<u>Testing Cycle</u>					
Traditional, regular program	91,833	96.2	67.4	156.7	263.2
Year-round school	3,601	3.8	69.7	157.4	263.8
<u>Anticipated Math Grade</u>					
A	22,784	22.9	94.6	164.3	272.7
B	31,077	31.2	79.9	158.6	265.0
C	25,325	25.5	56.2	153.5	259.3
D	13,293	13.4	36.7	149.9	255.7
F	7,025	7.1	25.5	147.9	253.7
<u>Teacher Math Judgement</u>					
Level 4	30,665	30.9	96.3	164.5	272.8
Level 3	40,531	40.9	72.7	156.5	262.3
Level 2	20,905	21.1	33.6	149.6	255.3
Level 1	6,583	6.6	13.5	144.9	251.1
Not clear example of any level	439	0.4	47.5	151.6	257.0
<u>Student Took Makeup Test</u>					
Yes	2,298	2.3	49.4	152.3	259.2
<u>Misadministration</u>					
Yes	427	0.4	36.2	149.7	256.9
<u>National School Lunch Program</u>					
Not eligible	51,705	52.7	80.4	159.8	266.5
Reduced price	8,696	8.9	58.3	154.2	260.6
Free lunch	28,964	29.5	45.3	151.4	257.8
Information not available	7,463	7.6	75.7	158.6	264.8
School not participating	1,248	1.3	69.4	157.5	263.3

Notes: "N" is the number of students who took the end-of-grade test in reading.

*No scores are reported for groups with fewer than thirty students.

When summed, gender and ethnicity N-counts may not match the state N-counts because gender and/or ethnicity may not have been coded for some students.

Data received from LEAs and charter schools after August 2001 are not included in this table.

Prepared by the NCDPI Division of Accountability Services/Testing Section.

**Table 18. 2000-01 End-of-Grade Multiple-Choice Test Results
Characteristics and Performance of Grade 7 Students**

	N	Percent	Percent At or Above Level III in Both Reading and Mathematics	Average Scale Score Reading	Average Scale Score Mathematics
All Students	96,945	100.0	70.4	159.9	267.1
Gender					
Male	48,732	50.3	67.7	159.2	266.9
Female	48,211	49.7	73.2	160.7	267.3
Ethnic Group					
American Indian	1,331	1.4	55.9	156.4	263.1
Asian	1,699	1.8	77.9	161.5	271.5
Black	28,455	29.4	49.3	155.5	261.2
Hispanic	3,208	3.3	56.2	156.5	263.0
Multi-Racial	1,065	1.1	74.6	160.6	266.8
White	61,166	63.1	81.0	162.2	270.0
Other	18	0.0	*	*	*
Parental Education					
Did not finish high school	8,082	8.4	40.9	153.5	259.9
High school graduate	42,142	43.9	60.9	157.6	263.9
Trade or business school	3,677	3.8	72.6	159.9	266.7
Community college	12,739	13.3	78.2	161.1	268.0
Four-year college degree	23,643	24.6	87.8	164.2	272.6
Graduate school	5,710	5.9	93.1	166.6	276.9
Hours of Homework (per week)					
None assigned	1,464	1.5	31.5	151.9	257.9
1 hour or less	24,561	25.5	57.8	157.3	263.7
1 to 3 hours	43,905	45.7	73.0	160.2	267.1
More than 3, less than 5 hours	14,245	14.8	81.1	162.5	270.6
Between 5-10 hours	8,901	9.3	86.3	163.9	273.1
More than 10 hours	1,551	1.6	82.4	163.4	272.5
Assigned but not done	1,535	1.6	39.5	153.4	260.0
Hours Watching TV (each school day)					
None	3,243	3.4	68.6	160.3	268.0
1 hour	21,570	22.4	75.7	161.5	269.3
2 hours	25,401	26.4	76.8	161.3	268.9
3 hours	20,943	21.8	71.9	159.9	266.9
Between 4 and 5 hours	15,217	15.8	64.9	158.4	264.7
More than 6 hours	9,743	10.1	49.6	155.6	261.5
Free Time Spent Reading in a Week					
None	11,412	11.9	54.5	156.3	263.4
About 30 minutes	45,803	47.7	67.8	159.2	266.6
About one hour	21,671	22.6	76.2	161.2	268.4
Between 1 and 2 hours	11,311	11.8	81.7	162.7	269.7
More than 2 hours	5,861	6.1	81.4	163.2	269.2
Reading Homework					
Read and answer questions	56,045	57.8	71.6	160.3	267.5
Read, do not answer questions	13,569	14.0	77.2	161.5	269.6
Choose what to read and report to teacher	15,253	15.7	77.3	161.8	269.9
Choose what to read, do not report	8,113	8.4	79.6	162.2	270.7
Required to Explain How Math Problems Are Solved					
Never	2,198	2.3	53.1	156.7	262.7
1-2 times per month	4,755	5.0	65.7	159.2	265.9
1 time per week	13,111	13.7	68.9	159.6	266.7
Almost every day	75,728	79.1	71.8	160.2	267.4
Calculator Use in Math Class					
Never use	1,265	1.3	46.0	154.7	260.7
Hardly ever use	7,305	7.6	55.8	157.1	263.2
1-2 times per month	4,543	4.7	66.9	159.2	266.0
1-2 times per week	26,264	27.4	71.6	160.1	267.1
Almost every day	56,549	59.0	72.9	160.5	267.9

Notes: "N" is the number of students who took the end-of-grade test in reading.

*No scores are reported for groups with fewer than thirty students.

When summed, gender and ethnicity N-counts may not match the state N-counts because gender and/or ethnicity may not have been coded for some students.

Data received from LEAs and charter schools after August 2001 are not included in this table.

Prepared by the NCDPI Division of Accountability Services/Testing Section.

**Table 18. 2000-01 End-of-Grade Multiple-Choice Test Results
Characteristics and Performance of Grade 7 Students (continued)**

	N	Percent	Percent At or Above Level III in Both Reading and Mathematics	Average Scale Score Reading	Average Scale Score Mathematics
Computer Use at Home					
Almost every day	8,573	8.9	67.2	159.3	266.1
1-2 times per week	17,768	18.5	78.6	161.9	269.9
1-2 times per month	22,266	23.2	82.2	162.6	270.5
Hardly ever	22,937	23.9	71.2	159.9	267.0
Never (owns computer)	9,857	10.3	59.6	157.4	263.6
No computer at home	14,579	15.2	51.4	155.8	261.8
Testing Cycle					
Traditional, regular program	89,676	96.6	70.4	159.9	267.1
Year-round school	3,187	3.4	72.0	160.3	266.9
Anticipated Math Grade					
A	20,046	20.8	94.7	166.2	277.0
B	30,168	31.3	83.2	161.8	269.3
C	25,665	26.6	61.9	157.7	263.4
D	13,365	13.9	43.2	154.6	259.7
F	7,091	7.4	29.9	152.4	257.4
Teacher Math Judgement					
Level 4	29,019	30.2	97.2	166.6	277.4
Level 3	40,085	41.7	76.4	159.9	265.9
Level 2	20,283	21.1	37.7	154.0	258.8
Level 1	6,247	6.5	16.9	149.4	254.7
Not clear example of any level	407	0.4	49.4	155.0	261.4
Student Took Makeup Test					
Yes	2,363	2.4	46.9	155.2	261.7
Misadministration					
Yes	430	0.4	52.3	155.8	262.3
National School Lunch Program					
Not eligible	51,637	54.5	81.8	162.4	270.2
Reduced price	8,047	8.5	62.4	158.0	264.2
Free lunch	26,119	27.6	47.7	155.1	261.2
Information not available	7,583	8.0	78.8	161.6	268.7
School not participating	1,340	1.4	72.3	160.9	267.9

Notes: "N" is the number of students who took the end-of-grade test in reading.

*No scores are reported for groups with fewer than thirty students.

When summed, gender N-counts and ethnicity N-counts may not match the state N-counts because gender and/or ethnicity may not have been coded for some students.

Data received from LEAs and charter schools after August 2001 are not included in this table.

Prepared by the NCDPI Division of Accountability Services/Testing Section.

**Table 19. 2000-01 End-of-Grade Multiple-Choice Test Results
Characteristics and Performance of Grade 8 Students**

	N	Percent	Percent At or Above Level III in Both <u>Reading and Mathematics</u>	Average Scale Score Reading	Average Scale Score Mathematics
All Students	93,305	100.0	74.4	163.1	270.0
Gender					
Male	46,810	50.2	71.7	162.3	269.9
Female	46,493	49.8	77.1	163.8	270.1
Ethnic Group					
American Indian	1,397	1.5	63.6	159.9	266.6
Asian	1,626	1.7	80.5	164.1	274.7
Black	26,985	28.9	54.9	158.7	264.1
Hispanic	2,967	3.2	59.7	159.6	265.9
Multi-Racial	958	1.0	76.6	163.3	269.7
White	59,346	63.6	84.0	165.2	272.9
Other	19	0.0	*	*	*
Parental Education					
Did not finish high school	7,471	8.1	45.3	156.7	262.5
High school graduate	37,461	40.5	65.4	160.6	266.6
Trade or business school	3,690	4.0	76.0	162.9	269.4
Community college	14,248	15.4	80.7	163.9	270.7
Four-year college degree	23,449	25.4	89.2	166.8	275.1
Graduate school	6,163	6.7	94.7	169.8	280.0
Hours of Homework (per week)					
None assigned	1,506	1.6	36.0	155.4	261.0
1 hour or less	20,893	22.6	62.0	160.2	266.2
1 to 3 hours	42,597	46.1	75.6	163.0	269.6
More than 3, less than 5 hours	15,113	16.4	84.8	165.5	273.5
Between 5-10 hours	9,483	10.3	89.4	167.2	276.2
More than 10 hours	1,530	1.7	87.3	167.1	276.8
Assigned but not done	1,411	1.5	48.5	158.0	264.5
Hours Watching TV (each school day)					
None	2,771	3.0	72.2	163.7	271.6
1 hour	20,391	22.1	79.7	164.7	272.5
2 hours	24,131	26.1	80.5	164.5	271.9
3 hours	20,764	22.5	75.3	162.9	269.6
Between 4 and 5 hours	15,286	16.5	69.5	161.5	267.4
More than 6 hours	9,123	9.9	55.3	158.9	264.4
Free Time Spent Reading in a Week					
None	11,814	12.8	62.9	160.2	267.2
About 30 minutes	44,019	47.6	73.7	162.8	270.0
About one hour	20,986	22.7	78.1	163.8	270.7
Between 1 and 2 hours	10,472	11.3	81.6	165.1	271.6
More than 2 hours	5,123	5.5	80.9	165.5	271.3
Reading Homework					
Read and answer questions	60,087	64.4	75.5	163.5	270.4
Read, do not answer questions	12,277	13.2	80.6	164.7	272.6
Choose what to read and report to teacher	14,630	15.7	81.3	164.9	272.9
Choose what to read, do not report	6,419	6.9	81.5	164.8	273.2
Required to Explain How Math Problems Are Solved					
Never	2,705	2.9	61.9	161.1	267.4
1-2 times per month	5,213	5.6	69.9	162.5	269.5
1 time per week	12,540	13.6	72.2	162.8	269.8
Almost every day	71,712	77.6	75.9	163.3	270.3
Calculator Use in Math Class					
Never use	1,069	1.2	46.1	157.7	263.7
Hardly ever use	5,932	6.4	62.7	161.0	267.4
1-2 times per month	3,605	3.9	69.7	162.7	269.5
1-2 times per week	20,212	21.9	73.2	162.9	269.5
Almost every day	61,508	66.6	77.0	163.5	270.6

Notes: "N" is the number of students who took the end-of-grade test in reading.

*No scores are reported for groups with fewer than thirty students.

When summed, gender and ethnicity N-counts may not match the state N-counts because gender and/or ethnicity may not have been coded for some students.

Data received from LEAs and charter schools after August 2001 are not included in this table.

Prepared by the NCDPI Division of Accountability Services/Testing Section.

**Table 19. 2000-01 End-of-Grade Multiple-Choice Test Results
Characteristics and Performance of Grade 8 Students (continued)**

	N	Percent	Percent At or Above Level III in Both Reading and Mathematics	Average Scale Score Reading	Average Scale Score Mathematics
Computer Use at Home					
Almost every day	10,187	11.0	74.1	163.0	270.1
1-2 times per week	20,190	21.9	81.8	165.1	272.8
1-2 times per month	23,441	25.4	83.2	165.1	272.6
Hardly ever	19,590	21.2	73.1	162.6	269.1
Never (owns computer)	6,566	7.1	62.9	160.3	266.1
No computer at home	12,385	13.4	55.5	158.7	264.4
Testing Cycle					
Traditional, regular program	85,854	96.5	74.5	163.1	270.0
Year-round school	3,134	3.5	74.9	163.2	269.7
Anticipated Math Grade					
A	18,214	19.7	96.0	169.0	280.0
B	29,377	31.7	86.0	164.8	272.3
C	24,918	26.9	68.8	161.2	266.7
D	13,500	14.6	50.2	158.3	262.8
F	6,641	7.2	34.4	156.1	260.0
Teacher Math Judgement					
Level 4	29,581	32.0	98.3	169.2	280.2
Level 3	38,581	41.7	80.2	162.8	268.5
Level 2	18,246	19.7	41.5	157.1	261.0
Level 1	5,677	6.1	19.3	152.7	257.3
Not clear example of any level	343	0.4	46.0	157.1	262.0
Student Took Makeup Test					
Yes	2,495	2.7	52.1	158.6	264.5
Misadministration					
Yes	361	0.4	61.5	160.0	267.1
National School Lunch Program					
Not eligible	51,924	56.9	84.1	165.3	272.9
Reduced price	7,297	8.0	66.5	160.7	266.8
Free lunch	23,277	25.5	52.7	158.3	263.9
Information not available	7,547	8.3	81.8	164.5	271.7
School not participating	1,138	1.2	75.7	164.1	270.9

Notes: "N" is the number of students who took the end-of-grade test in reading.

*No scores are reported for groups with fewer than thirty students.

When summed, gender and ethnicity N-counts may not match the state N-counts because gender and/or ethnicity may not have been coded for some students.

Data received from LEAs and charter schools after August 2001 are not included in this table.

Prepared by the NCDPI Division of Accountability Services/Testing Section.

Table 20. 2000-01 End-of-Grade Grade 3 Goal Summary Report

	Developmental Score Mean	Number of Observations*	# of Items	Percent Correct**
READING (Average of Averages)	147.0	101,652	56 [†]	
GOAL 1: Use strategies and processes that enhance control of communications skills development.			0	
GOAL 2: Use language for the acquisition, interpretation, and application of information.			131	67.3
Obj 2.1: Identify, collect or select information and ideas.			62	69.4
Obj 2.2: Analyze, synthesize, and organize information and ideas and discover related ideas, concepts or generalizations.			50	64.7
Obj 2.3: Apply, extend, and expand on information and concepts.			19	67.4
GOAL 3: Use language for critical analysis and evaluation.			37	57.1
MATHEMATICS (Average of Averages)	250.6	102,160	80	
Math Calculator Inactive			72	67.7
Math Calculator Active			168	69.3
GOAL 1: Identify and use numbers to less than 10,000.			96	69.2
GOAL 2: Understand and use basic geometric properties and standard units of measurement			72	68.6
GOAL 3: Understand classification, pattern, and seriation.			36	62.2
GOAL 4: Understand data collection, display, and interpretation.			36	75.0

NUMBER OF STUDENTS TAKING FORM***	A	B	C
	34,143	34,155	33,862

Notes: [†]Reading forms O and Q contain 56 questions; form P contains 55 questions.

**"Number of Observations" includes students who attempted at least one item on the test.

***"Percent Correct" is the number of correct responses to an item divided by the number of students who took that item summed over all items for a goal or objective divided by the number of items for that goal or objective.

*** Forms A, B and C refer to the math curriculum adopted in 1998 but still contain reading forms O, P and Q from the 1992 curriculum. Data received from LEAs and charter schools after August 2001 are not included in this table.

Prepared by the NCDPI Division of Accountability Services/Testing Section.

Table 21. 2000-01 End-of-Grade Grade 4 Goal Summary Report

	Developmental Score Mean	Number of Observations*	# of Items	Percent Correct**
READING (Average of Averages)	150.3	99,717	65 [†]	
GOAL 1: Use strategies and processes that enhance control of communications skills development.			0	
GOAL 2: Use language for the acquisition, interpretation, and application of information.			159	65.5
Obj 2.1: Identify, collect or select information and ideas.			61	72.0
Obj 2.2: Analyze, synthesize, and organize information and ideas and discover related ideas, concepts or generalizations.			71	60.9
Obj 2.3: Apply, extend, and expand on information and concepts.			27	63.0
GOAL 3: Use language for critical analysis and evaluation.			36	63.5
MATHEMATICS (Average of Averages)	255.8	100,392	80	
Math Calculator Inactive			72	66.1
Math Calculator Active			168	65.1
GOAL 1: Read, write, model, and compute with rational numbers.			90	67.5
GOAL 2: Understand and use properties and relationships of geometry and standard units of metric and customary measurement			69	65.7
GOAL 3: Understand patterns and relationships			33	64.7
GOAL 4: Understand and use graphing, probability, and data analysis			48	61.5
NUMBER OF STUDENTS TAKING FORM***	A	B	C	
	33,654	33,345	33,393	

Notes: [†] Reading forms O and Q contain 56 questions; form P contains 55 questions.

**"Number of Observations" includes students who attempted at least one item on the test.

***"Percent Correct" is the number of correct responses to an item divided by the number of students who took that item summed over all items for a goal or objective divided by the number of items for that goal or objective.

*** Forms A, B and C refer to the math curriculum adopted in 1998 but still contain reading forms O, P and Q from the 1992 curriculum. Data received from LEAs and charter schools after August 2001 are not included in this table. Prepared by the NCDPI Division of Accountability Services/Testing Section.

Table 22. 2000-01 End-of-Grade Grade 5 Goal Summary Report

	Developmental Score Mean	Number of Observations*	# of Items	Percent Correct**
READING (Average of Averages)	156.0	99,639	65 [†]	
GOAL 1: Use strategies and processes that enhance control of communications skills development.			13	65.6
GOAL 2: Use language for the acquisition, interpretation, and application of information.			130	72.4
Obj 2.1: Identify, collect or select information and ideas.			59	77.0
Obj 2.2: Analyze, synthesize, and organize information and ideas and discover related ideas, concepts or generalizations.			50	70.2
Obj 2.3: Apply, extend, expand on information, concepts.			21	64.6
GOAL 3: Use language for critical analysis and evaluation.			52	63.2
MATHEMATICS (Average of Averages)	260.0	100,226	80	
Math Calculator Inactive			72	64.6
Math Calculator Active			168	58.7
GOAL 1: Understand and compute with rational numbers			96	69.8
GOAL 2: Understand and use properties and relationships of geometry and standard units of metric and customary measurement			60	54.0
GOAL 3: Understand patterns, relationships, and elementary algebraic representation			39	55.8
GOAL 4: Understand and use graphing, probability, and data analysis			45	53.4
NUMBER OF STUDENTS TAKING FORM***	A	B	C	
	33,719	33,272	33,235	

Notes: [†]Reading forms O and Q contain 56 questions; form P contains 55 questions.

**"Number of Observations" includes students who attempted at least one item on the test.

***"Percent Correct" is the number of correct responses to an item divided by the number of students who took that item summed over all items for a goal or objective divided by the number of items for that goal or objective.

*** Forms A, B and C refer to the math curriculum adopted in 1998 but still contain reading forms I, P and J from the 1992 curriculum. Data received from LEAs and charter schools after August 2001 are not included in this table.

Prepared by the NCDPI Division of Accountability Services/Testing Section.

Table 23. 2000-01 End-of-Grade Grade 6 Goal Summary Report

	Developmental Score Mean	Number of Observations*	# of Items	Percent Correct**
READING (Average of Averages)	156.7	100,079	65 [†]	
GOAL 1: Use strategies and processes that enhance control of communications skills development.			16	63.9
GOAL 2: Use language for the acquisition, interpretation, and application of information.			149	66.9
Obj 2.1: Identify, collect or select information and ideas.			49	72.5
Obj 2.2: Analyze, synthesize, and organize information and ideas and discover related ideas, concepts or generalizations.			82	63.7
Obj 2.3: Apply, extend, and expand on information and concepts.			18	66.1
GOAL 3: Use language for critical analysis and evaluation.			30	62.7
MATHEMATICS (Average of Averages)	263.2	100,367	80	
Math Calculator Inactive			72	63.4
Math Calculator Active			168	58.5
GOAL 1: Understand and compute with rational numbers			87	67.2
GOAL 2: Understand and use properties and relationships of geometry and standard units of metric and customary measurement			69	53.2
GOAL 3: Understand patterns, relationships, and algebraic representations			42	57.7
GOAL 4: Understand and use graphing, probability, and data analysis			42	58.5
NUMBER OF STUDENTS TAKING FORM***	A	B	C	
	33,575	33,532	33,260	

Notes: [†] Reading forms O and Q contain 56 questions; form P contains 55 questions.

**"Number of Observations" includes students who attempted at least one item on the test.

***"Percent Correct" is the number of correct responses to an item divided by the number of students who took that item summed over all items for a goal or objective divided by the number of items for that goal or objective.

*** Forms A, B and C refer to the math curriculum adopted in 1998 but still contain reading forms O, P and Q from the 1992 curriculum. Data received from LEAs and charter schools after August 2001 are not included in this table.

Prepared by the NCDPI Division of Accountability Services/Testing Section.

Table 24. 2000-01 End-of-Grade Grade 7 Goal Summary Report

	Developmental Score Mean	Number of Observations*	# of Items	Percent Correct**
READING (Average of Averages)	159.9	96,945	66 [†]	
GOAL 1: Use strategies and processes that enhance control of communications skills development.			10	70.6
GOAL 2: Use language for the acquisition, interpretation, and application of information.			112	68.1
Obj 2.1: Identify, collect or select information and ideas.			43	71.8
Obj 2.2: Analyze, synthesize, and organize information and ideas and discover related ideas, concepts or generalizations.			66	65.4
Obj 2.3: Apply, extend, and expand on information and concepts.			3	73.7
GOAL 3: Use language for critical analysis and evaluation.			10	68.3
MATHEMATICS (Average of Averages)	267.1	97,114	80	
Math Calculator Inactive			48	51.8
Math Calculator Active			112	55.9
GOAL 1: Understand and compute with real numbers			48	62.4
GOAL 2: Understand and use properties and relationships of geometry and standard units of metric and customary measurement			28	54.1
GOAL 3: Understand patterns, relationships, and fundamental algebraic concepts			40	55.6
GOAL 4: Understand and use graphing, probability, and data analysis			44	45.8
NUMBER OF STUDENTS TAKING FORM***	A ----- 48,797	B ----- 48,317		

Notes: [†]Reading forms O and Q contain 56 questions; form P contains 55 questions.

*"Number of Observations" includes students who attempted at least one item on the test.

**"Percent Correct" is the number of correct responses to an item divided by the number of students who took that item summed over all items for a goal or objective divided by the number of items for that goal or objective.

*** Forms A and B refer to the math curriculum adopted in 1998 but still contain reading forms O and P from the 1992 curriculum. Data received from LEAs and charter schools after August 2001 are not included in this table.

Prepared by the NCDPI Division of Accountability Services/Testing Section.

Table 25. 2000-01 End-of-Grade Grade 8 Goal Summary Report

	Developmental Score Mean	Number of Observations*	# of Items	Percent Correct**
READING (Average of Averages)	163.1	93,305	68 [†]	
GOAL 1: Use strategies and processes that enhance control of communications skills development.			12	59.2
GOAL 2: Use language for the acquisition, interpretation, and application of information.			102	69.1
Obj 2.1: Identify, collect or select information and ideas.			38	75.1
Obj 2.2: Analyze, synthesize, and organize information and ideas and discover related ideas, concepts or generalizations.			55	64.8
Obj 2.3: Apply, extend, and expand on information and concepts.			9	70.2
GOAL 3: Use language for critical analysis and evaluation.			22	65.1
MATHEMATICS (Average of Averages)	270.0	93,408	80	
Math Calculator Inactive			48	45.4
Math Calculator Active			112	52.0
GOAL 1: Understand and compute with real numbers			74	46.0
GOAL 2: Understand and use properties and relationships of geometry and standard units of metric and customary measurement			40	51.7
GOAL 3: Understand patterns, relationships, and fundamental algebraic concepts			22	55.9
GOAL 4: Understand and use graphing, probability, and data analysis			24	54.3
NUMBER OF STUDENTS TAKING FORM***	A ----- 46,895	B ----- 46,513		

Notes: [†]Reading forms O and Q contain 56 questions; form P contains 55 questions.

**"Number of Observations" includes students who attempted at least one item on the test.

***"Percent Correct" is the number of correct responses to an item divided by the number of students who took that item summed over all items for a goal or objective divided by the number of items for that goal or objective.

*** Forms A and B refer to the math curriculum adopted in 1998 but still contain reading forms O and P from the 1992 curriculum.

Data received from LEAs and charter schools after August 2001 are not included in this table.

Prepared by the NCDPI Division of Accountability Services/Testing Section.

**Table 26. 2000-01 End-of-Grade Distribution of Scale Scores
Grade 3 Reading**

<u>NUMBER OF STUDENTS WITH VALID SCORES*</u>	101,652	<u>HIGH SCORE</u>	172
		<u>LOW SCORE</u>	114
<u>MEAN</u>	147.0	<u>2001 STATE PERCENTILES</u>	<u>SCALE SCORE</u>
<u>STANDARD DEVIATION</u>	9.3	90	158.69
		75	153.77
		50 (MEDIAN)	147.55
<u>VARIANCE</u>	86.5	25	140.98
		10	134.03

FREQUENCY DISTRIBUTION

<u>SCALE SCORE</u>	<u>FREQUENCY</u>	<u>CUMULATIVE FREQUENCY</u>	<u>PERCENT</u>	<u>CUMULATIVE PERCENT</u>	<u>1999 STATE PERCENTILE</u>
172	27	101652	0.03	100.00	99
171	32	101625	0.03	99.97	99
170	53	101593	0.05	99.94	99
169	71	101540	0.07	99.89	99
168	159	101469	0.16	99.82	99
167	136	101310	0.13	99.66	99
166	615	101174	0.61	99.53	99
165	247	100559	0.24	98.92	99
164	1114	100312	1.10	98.68	98
163	391	99198	0.38	97.59	97
162	2183	98807	2.15	97.20	96
160	2711	96624	2.67	95.05	94
159	3000	93913	2.95	92.39	91
158	938	90913	0.92	89.44	89
157	3517	89975	3.46	88.51	87
156	3743	86458	3.68	85.05	83
155	3770	82715	3.71	81.37	80
154	3703	78945	3.64	77.66	76
153	3700	75242	3.64	74.02	73
152	3585	71542	3.53	70.38	69
151	4898	67957	4.82	66.85	65
150	5743	63059	5.65	62.03	60
149	3324	57316	3.27	56.38	56
148	3323	53992	3.27	53.11	53
147	5307	50669	5.22	49.85	49
146	3105	45362	3.05	44.62	45
145	5848	42257	5.75	41.57	41
144	2728	36409	2.68	35.82	37
143	4217	33681	4.15	33.13	34
142	2489	29464	2.45	28.99	31
141	2998	26975	2.95	26.54	28
140	2886	23977	2.84	23.59	25
139	2076	21091	2.04	20.75	23
138	2508	19015	2.47	18.71	20
137	1732	16507	1.70	16.24	18
136	2254	14775	2.22	14.53	16
135	1632	12521	1.61	12.32	14
134	1537	10889	1.51	10.71	12
133	1397	9352	1.37	9.20	11
132	855	7955	0.84	7.83	9
131	1315	7100	1.29	6.98	8
130	1182	5785	1.16	5.69	6
129	721	4603	0.71	4.53	5
128	628	3882	0.62	3.82	5
127	846	3254	0.83	3.20	4
126	675	2408	0.66	2.37	3
125	662	1733	0.65	1.70	2
124	397	1071	0.39	1.05	1
123	280	674	0.28	0.66	1
122	194	394	0.19	0.39	1
121	83	200	0.08	0.20	1
120	69	117	0.07	0.12	1
LESS THAN 120	48	48	0.05	0.05	1

Notes: *Students with valid scores are those students who attempted at least one item on the test.
Data received from LEAs and charter schools after August 2001 are not included in this table.
Prepared by the NCDPI Division of Accountability Services/Testing Section.

**Table 27. 2000-01 End-of-Grade Distribution of Scale Scores
Grade 3 Mathematics**

<u>NUMBER OF STUDENTS WITH VALID SCORES*</u>	102,160	<u>HIGH SCORE</u>	276
		<u>LOW SCORE</u>	218
<u>MEAN</u>	250.6	<u>2001 STATE PERCENTILES</u>	<u>SCALE SCORE</u>
<u>STANDARD DEVIATION</u>	7.7	90	260.58
		75	255.95
		50 (<u>MEDIAN</u>)	250.21
<u>VARIANCE</u>	60.0	25	245.15
		10	240.66

FREQUENCY DISTRIBUTION

<u>SCALE SCORE</u>	<u>FREQUENCY</u>	<u>CUMULATIVE FREQUENCY</u>	<u>PERCENT</u>	<u>CUMULATIVE PERCENT</u>	<u>2001 STATE PERCENTILE</u>
276	7	102160	0.01	100.00	99
275	41	102153	0.04	99.99	99
274	80	102112	0.08	99.95	99
273	210	102032	0.21	99.87	99
271	514	101822	0.50	99.67	99
269	206	101308	0.20	99.17	99
268	621	101102	0.61	98.96	99
267	756	100481	0.74	98.36	98
266	382	99725	0.37	97.62	97
265	1550	99343	1.52	97.24	96
264	1241	97793	1.21	95.73	95
263	528	96552	0.52	94.51	94
262	2034	96024	1.99	93.99	93
261	2216	93990	2.17	92.00	91
260	2424	91774	2.37	89.83	89
259	3332	89350	3.26	87.46	86
258	3609	86018	3.53	84.20	82
257	3762	82409	3.68	80.67	79
256	3668	78647	3.59	76.98	75
255	3771	74979	3.69	73.39	72
254	4658	71208	4.56	69.70	67
253	5469	66550	5.35	65.14	62
252	4709	61081	4.61	59.79	57
251	3734	56372	3.66	55.18	53
250	5282	52638	5.17	51.53	49
249	5817	47356	5.69	46.35	44
248	4696	41539	4.60	40.66	38
247	5833	36843	5.71	36.06	33
246	4019	31010	3.93	30.35	28
245	4177	26991	4.09	26.42	24
244	4174	22814	4.09	22.33	20
243	2845	18640	2.78	18.25	17
242	3079	15795	3.01	15.46	14
241	2966	12716	2.90	12.45	11
240	1987	9750	1.94	9.54	9
239	1688	7763	1.65	7.60	7
238	1771	6075	1.73	5.95	5
237	1589	4304	1.56	4.21	3
236	507	2715	0.50	2.66	2
235	816	2208	0.80	2.16	2
234	600	1392	0.59	1.36	1
233	238	792	0.23	0.78	1
232	276	554	0.27	0.54	1
231	102	278	0.10	0.27	1
230	61	176	0.06	0.17	1
229	63	115	0.06	0.11	1
228	19	52	0.02	0.05	1
227	7	33	0.01	0.03	1
226	7	26	0.01	0.03	1
225	6	19	0.01	0.02	1
LESS THAN 225	13	13	0.01	0.01	1

Notes: *Students with valid scores are those students who attempted at least one item on the test.
Data received from LEAs and charter schools after August 2001 are not included in this table.
Prepared by the NCDPI Division of Accountability Services/Testing Section.

**Table 28. 2000-01 End-of-Grade Distribution of Scale Scores
Grade 4 Reading**

<u>NUMBER OF STUDENTS WITH VALID SCORES*</u>	99,717	<u>HIGH SCORE</u>	179
		<u>LOW SCORE</u>	118
<u>MEAN</u>	150.3	<u>2001 STATE PERCENTILES</u>	<u>SCALE SCORE</u>
<u>STANDARD DEVIATION</u>	9.3	90	161.84
		75	157.07
		50 (<u>MEDIAN</u>)	151.07
<u>VARIANCE</u>	87.3	25	144.27
		10	137.22

FREQUENCY DISTRIBUTION

<u>SCALE SCORE</u>	<u>FREQUENCY</u>	<u>CUMULATIVE FREQUENCY</u>	<u>PERCENT</u>	<u>CUMULATIVE PERCENT</u>	<u>1999 STATE PERCENTILE</u>
179	4	99717	0.00	100.00	99
177	12	99713	0.01	100.00	99
176	17	99701	0.02	99.98	99
175	52	99684	0.05	99.97	99
173	87	99632	0.09	99.91	99
172	176	99545	0.18	99.83	99
171	167	99369	0.17	99.65	99
170	390	99202	0.39	99.48	99
169	336	98812	0.34	99.09	99
168	652	98476	0.65	98.76	99
167	930	97824	0.93	98.10	98
166	1096	96894	1.10	97.17	97
165	617	95798	0.62	96.07	97
164	2118	95181	2.12	95.45	96
163	1574	93063	1.58	93.33	94
162	2639	91489	2.65	91.75	92
161	2851	88850	2.86	89.10	90
160	3160	85999	3.17	86.24	87
159	3288	82839	3.30	83.07	84
158	3315	79551	3.32	79.78	81
157	3347	76236	3.36	76.45	78
156	4422	72889	4.43	73.10	74
155	3404	68467	3.41	68.66	70
154	4152	65063	4.16	65.25	66
153	4233	60911	4.25	61.08	62
152	5137	56678	5.15	56.84	57
151	3875	51541	3.89	51.69	53
150	3760	47666	3.77	47.80	49
149	4434	43906	4.45	44.03	45
148	3298	39472	3.31	39.58	41
147	4692	36174	4.71	36.28	37
146	2095	31482	2.10	31.57	33
145	4038	29387	4.05	29.47	30
144	1853	25349	1.86	25.42	27
143	3522	23496	3.53	23.56	24
142	1635	19974	1.64	20.03	22
141	2530	18339	2.54	18.39	19
140	2025	15809	2.03	15.85	17
139	1802	13784	1.81	13.82	15
138	1648	11982	1.65	12.02	13
137	1277	10334	1.28	10.36	11
136	1195	9057	1.20	9.08	10
135	1825	7862	1.83	7.88	8
134	1052	6037	1.05	6.05	7
133	962	4985	0.96	5.00	6
132	867	4023	0.87	4.03	4
131	778	3156	0.78	3.16	3
130	646	2378	0.65	2.38	3
129	531	1732	0.53	1.74	2
128	385	1201	0.39	1.20	1
127	278	816	0.28	0.82	1
126	257	538	0.26	0.54	1
125	152	281	0.15	0.28	1
124	52	129	0.05	0.13	1
LESS THAN 124	77	77	0.08	0.08	1

Notes: *Students with valid scores are those students who attempted at least one item on the test.
Data received from LEAs and charter schools after August 2001 are not included in this table.
Prepared by the NCDPI Division of Accountability Services/Testing Section.

**Table 29. 2000-01 End-of-Grade Distribution of Scale Scores
Grade 4 Mathematics**

<u>NUMBER OF STUDENTS WITH VALID SCORES*</u>	100,392	<u>HIGH SCORE</u>	285
		<u>LOW SCORE</u>	221
<u>MEAN</u>	255.8	<u>2001 STATE PERCENTILES</u>	<u>SCALE SCORE</u>
<u>STANDARD DEVIATION</u>	8.3	90	266.86
		75	261.30
		50 (<u>MEDIAN</u>)	255.41
<u>VARIANCE</u>	69.2	25	249.50
		10	245.30

FREQUENCY DISTRIBUTION

<u>SCALE SCORE</u>	<u>FREQUENCY</u>	<u>CUMULATIVE FREQUENCY</u>	<u>PERCENT</u>	<u>CUMULATIVE PERCENT</u>	<u>2001 STATE PERCENTILE</u>
285	13	100392	0.01	100.00	99
284	14	100379	0.01	99.99	99
283	24	100365	0.02	99.97	99
282	43	100341	0.04	99.95	99
281	70	100298	0.07	99.91	99
280	207	100228	0.21	99.84	99
279	134	100021	0.13	99.63	99
277	359	99887	0.36	99.50	99
276	463	99528	0.46	99.14	99
275	277	99065	0.28	98.68	99
274	612	98788	0.61	98.40	98
273	816	98176	0.81	97.79	97
272	845	97360	0.84	96.98	97
271	908	96515	0.90	96.14	96
270	1687	95607	1.68	95.23	94
269	525	93920	0.52	93.55	93
268	1804	93395	1.80	93.03	92
267	1940	91591	1.93	91.23	90
266	2048	89651	2.04	89.30	88
265	2133	87603	2.12	87.26	86
264	3811	85470	3.80	85.14	83
263	3039	81659	3.03	81.34	80
262	2382	78620	2.37	78.31	77
261	4805	76238	4.79	75.94	74
260	2449	71433	2.44	71.15	70
259	4758	68984	4.74	68.71	66
258	4030	64226	4.01	63.98	62
257	4747	60196	4.73	59.96	58
256	4856	55449	4.84	55.23	53
255	4577	50593	4.56	50.40	48
254	4729	46016	4.71	45.84	43
253	4454	41287	4.44	41.13	39
252	4263	36833	4.25	36.69	35
251	4068	32570	4.05	32.44	30
250	3877	28502	3.86	28.39	26
249	3784	24625	3.77	24.53	23
248	4559	20841	4.54	20.76	18
247	3014	16282	3.00	16.22	15
246	2731	13268	2.72	13.22	12
245	2477	10537	2.47	10.50	9
244	2083	8060	2.07	8.03	7
243	1827	5977	1.82	5.95	5
242	1226	4150	1.22	4.13	4
241	809	2924	0.81	2.91	3
240	932	2115	0.93	2.11	2
239	322	1183	0.32	1.18	1
238	395	861	0.39	0.86	1
237	210	466	0.21	0.46	1
236	106	256	0.11	0.26	1
235	61	150	0.06	0.15	1
234	41	89	0.04	0.09	1
233	21	48	0.02	0.05	1
232	9	27	0.01	0.03	1
LESS THAN 232	18	18	0.02	0.02	1

Notes: *Students with valid scores are those students who attempted at least one item on the test.
Data received from LEAs and charter schools after August 2001 are not included in this table.
Prepared by the NCDPI Division of Accountability Services/Testing Section.

**Table 30. 2000-01 End-of-Grade Distribution of Scale Scores
Grade 5 Reading**

<u>NUMBER OF STUDENTS WITH VALID SCORES*</u>	99,639	<u>HIGH SCORE</u>	181
		<u>LOW SCORE</u>	126
<u>MEAN</u>	156.0	<u>2001 STATE PERCENTILES</u>	<u>SCALE SCORE</u>
<u>STANDARD DEVIATION</u>	8.2	90	165.80
		75	161.87
		50 (MEDIAN)	156.49
<u>VARIANCE</u>	67.1	25	150.94
		10	144.95

FREQUENCY DISTRIBUTION

<u>SCALE SCORE</u>	<u>FREQUENCY</u>	<u>CUMULATIVE FREQUENCY</u>	<u>PERCENT</u>	<u>CUMULATIVE PERCENT</u>	<u>1999 STATE PERCENTILE</u>
181	4	99639	0.00	100.00	99
178	61	99635	0.06	100.00	99
176	170	99574	0.17	99.93	99
175	86	99404	0.09	99.76	99
174	252	99318	0.25	99.68	99
173	440	99066	0.44	99.42	99
172	427	98626	0.43	98.98	99
171	725	98199	0.73	98.55	99
170	678	97474	0.68	97.83	98
169	2108	96796	2.12	97.15	98
168	1535	94688	1.54	95.03	96
167	1212	93153	1.22	93.49	95
166	3227	91941	3.24	92.27	93
165	3590	88714	3.60	89.04	91
164	3945	85124	3.96	85.43	88
163	3936	81179	3.95	81.47	85
162	4007	77243	4.02	77.52	81
161	5169	73236	5.19	73.50	77
160	3942	68067	3.96	68.31	73
159	3760	64125	3.77	64.36	69
158	6061	60365	6.08	60.58	64
157	4454	54304	4.47	54.50	59
156	5437	49850	5.46	50.03	55
155	3912	44413	3.93	44.57	49
154	4706	40501	4.72	40.65	45
153	4943	35795	4.96	35.92	41
152	4409	30852	4.42	30.96	36
151	2752	26443	2.76	26.54	32
150	3109	23691	3.12	23.78	29
149	3301	20582	3.31	20.66	26
148	2918	17281	2.93	17.34	22
147	1691	14363	1.70	14.42	19
146	1968	12672	1.98	12.72	17
145	1342	10704	1.35	10.74	15
144	1681	9362	1.69	9.40	13
143	1156	7681	1.16	7.71	11
142	1029	6525	1.03	6.55	10
141	749	5496	0.75	5.52	8
140	680	4747	0.68	4.76	7
139	642	4067	0.64	4.08	5
138	1005	3425	1.01	3.44	4
137	525	2420	0.53	2.43	4
136	455	1895	0.46	1.90	3
135	533	1440	0.53	1.45	2
134	291	907	0.29	0.91	1
133	240	616	0.24	0.62	1
132	186	376	0.19	0.38	1
131	105	190	0.11	0.19	1
130	58	85	0.06	0.09	1
LESS THAN 130	27	27	0.03	0.03	1

Notes: *Students with valid scores are those students who attempted at least one item on the test.
Data received from LEAs and charter schools after August 2001 are not included in this table.
Prepared by the NCDPI Division of Accountability Services/Testing Section.

**Table 31. 2000-01 End-of-Grade Distribution of Scale Scores
Grade 5 Mathematics**

<u>NUMBER OF STUDENTS WITH VALID SCORES*</u>	100,226	<u>HIGH SCORE</u>	295
		<u>LOW SCORE</u>	221
<u>MEAN</u>	260.0	<u>2001 STATE PERCENTILES</u>	<u>SCALE SCORE</u>
<u>STANDARD DEVIATION</u>	9.6	90	273.14
		75	266.33
		50 (MEDIAN)	259.52
<u>VARIANCE</u>	92.6	25	253.13
		10	247.98

FREQUENCY DISTRIBUTION

<u>SCALE SCORE</u>	<u>FREQUENCY</u>	<u>CUMULATIVE FREQUENCY</u>	<u>PERCENT</u>	<u>CUMULATIVE PERCENT</u>	<u>2001 STATE PERCENTILE</u>
295	22	100226	0.02	100.00	99
293	13	100204	0.01	99.98	99
291	65	100191	0.06	99.97	99
290	50	100126	0.05	99.90	99
288	147	100076	0.15	99.85	99
287	100	99929	0.10	99.70	99
286	227	99829	0.23	99.60	99
285	126	99602	0.13	99.38	99
284	202	99476	0.20	99.25	99
283	386	99274	0.39	99.05	99
282	492	98888	0.49	98.67	98
281	275	98396	0.27	98.17	98
280	583	98121	0.58	97.90	98
279	718	97538	0.72	97.32	97
278	718	96820	0.72	96.60	96
277	1240	96102	1.24	95.89	95
276	1384	94862	1.38	94.65	94
275	989	93478	0.99	93.27	93
274	1519	92489	1.52	92.28	92
273	2135	90970	2.13	90.76	90
272	1725	88835	1.72	88.63	88
271	1739	87110	1.74	86.91	86
270	1864	85371	1.86	85.18	84
269	1821	83507	1.82	83.32	82
268	3880	81686	3.87	81.50	80
267	1947	77806	1.94	77.63	77
266	4106	75859	4.10	75.69	74
265	2110	71753	2.11	71.59	71
264	4254	69643	4.24	69.49	67
263	2930	65389	2.92	65.24	64
262	3569	62459	3.56	62.32	61
261	4401	58890	4.39	58.76	57
260	4447	54489	4.44	54.37	52
259	2852	50042	2.85	49.93	49
258	3730	47190	3.72	47.08	45
257	4476	43460	4.47	43.36	41
256	4423	38984	4.41	38.90	37
255	4206	34561	4.20	34.48	32
254	4098	30355	4.09	30.29	28
253	3250	26257	3.24	26.20	25
252	3193	23007	3.19	22.96	21
251	3094	19814	3.09	19.77	18
250	3350	16720	3.34	16.68	15
249	2074	13370	2.07	13.34	12
248	2431	11296	2.43	11.27	10
247	1790	8865	1.79	8.85	8
246	1598	7075	1.59	7.06	6
245	1724	5477	1.72	5.46	5
244	825	3753	0.82	3.74	3
243	738	2928	0.74	2.92	3
242	625	2190	0.62	2.19	2
241	482	1565	0.48	1.56	1
240	339	1083	0.34	1.08	1
239	235	744	0.23	0.74	1
238	181	509	0.18	0.51	1
237	146	328	0.15	0.33	1
236	80	182	0.08	0.18	1
235	25	102	0.02	0.10	1
234	27	77	0.03	0.08	1
233	23	50	0.02	0.05	1
232	16	27	0.02	0.03	1
LESS THAN 232	11	11	0.01	0.01	1

Notes: *Students with valid scores are those students who attempted at least one item on the test.
Data received from LEAs and charter schools after August 2001 are not included in this table.
Prepared by the NCDPI Division of Accountability Services/Testing Section.

**Table 32. 2000-01 End-of-Grade Distribution of Scale Scores
Grade 6 Reading**

<u>NUMBER OF STUDENTS WITH VALID SCORES*</u>	100,079	<u>HIGH SCORE</u>	183
		<u>LOW SCORE</u>	124
<u>MEAN</u>	156.7	<u>2001 STATE PERCENTILES</u>	<u>SCALE SCORE</u>
<u>STANDARD DEVIATION</u>	9.6	90	168.64
		75	163.96
<u>VARIANCE</u>	92.4	50 (<u>MEDIAN</u>)	157.42
		25	150.40
		10	143.36

FREQUENCY DISTRIBUTION

<u>SCALE SCORE</u>	<u>FREQUENCY</u>	<u>CUMULATIVE FREQUENCY</u>	<u>PERCENT</u>	<u>CUMULATIVE PERCENT</u>	<u>1999 STATE PERCENTILE</u>
183	17	100079	0.02	100.00	99
181	21	100062	0.02	99.98	99
180	94	100041	0.09	99.96	99
179	103	99947	0.10	99.87	99
178	155	99844	0.15	99.77	99
177	123	99689	0.12	99.61	99
176	573	99566	0.57	99.49	99
175	266	98993	0.27	98.91	99
174	902	98727	0.90	98.65	99
173	1047	97825	1.05	97.75	98
172	1238	96778	1.24	96.70	97
171	1498	95540	1.50	95.46	96
170	1549	94042	1.55	93.97	94
169	2827	92493	2.82	92.42	92
168	3057	89666	3.05	89.60	89
167	3258	86609	3.26	86.54	87
166	3315	83351	3.31	83.29	84
165	3240	80036	3.24	79.97	80
164	3198	76796	3.20	76.74	77
163	3237	73598	3.23	73.54	73
162	3202	70361	3.20	70.31	69
161	4034	67159	4.03	67.11	65
160	5121	63125	5.12	63.08	61
159	2856	58004	2.85	57.96	56
158	4749	55148	4.75	55.10	52
157	4484	50399	4.48	50.36	48
156	3393	45915	3.39	45.88	43
155	3263	42522	3.26	42.49	39
154	3947	39259	3.94	39.23	36
153	3743	35312	3.74	35.28	32
152	2131	31569	2.13	31.54	29
151	4207	29438	4.20	29.41	26
150	2043	25231	2.04	25.21	23
149	3038	23188	3.04	23.17	21
148	2325	20150	2.32	20.13	18
147	2669	17825	2.67	17.81	16
146	1543	15156	1.54	15.14	14
145	1483	13613	1.48	13.60	13
144	1890	12130	1.89	12.12	11
143	1617	10240	1.62	10.23	9
142	1116	8623	1.12	8.62	8
141	1478	7507	1.48	7.50	7
140	978	6029	0.98	6.02	5
139	941	5051	0.94	5.05	4
138	856	4110	0.86	4.11	4
137	675	3254	0.67	3.25	3
136	651	2579	0.65	2.58	2
135	544	1928	0.54	1.93	1
134	408	1384	0.41	1.38	1
133	312	976	0.31	0.98	1
LESS THAN 133	664	664	0.66	0.66	1

Notes: *Students with valid scores are those students who attempted at least one item on the test.
Data received from LEAs and charter schools after August 2001 are not included in this table.
Prepared by the NCDPI Division of Accountability Services/Testing Section.

**Table 33. 2000-01 End-of-Grade Distribution of Scale Scores
Grade 6 Mathematics**

NUMBER OF STUDENTS WITH VALID SCORES*	100,367	HIGH SCORE	296
		LOW SCORE	228
MEAN	263.2	2001 STATE PERCENTILES	SCALE SCORE
STANDARD DEVIATION	9.9	90	276.76
		75	269.93
		50 (MEDIAN)	262.38
VARIANCE	98.2	25	255.96
		10	250.86

FREQUENCY DISTRIBUTION

SCALE SCORE	FREQUENCY	CUMULATIVE FREQUENCY	PERCENT	CUMULATIVE PERCENT	2001 STATE PERCENTILE
296	13	100294	0.01	100.00	99
294	54	100281	0.05	99.99	99
293	94	100227	0.09	99.93	99
291	233	100133	0.23	99.84	99
290	112	99900	0.11	99.61	99
288	583	99788	0.58	99.50	99
286	727	99205	0.72	98.91	99
284	923	98478	0.92	98.19	98
283	746	97555	0.74	97.27	97
282	376	96809	0.37	96.53	96
281	1215	96433	1.21	96.15	96
280	951	95218	0.95	94.94	94
279	1390	94267	1.39	93.99	93
278	1476	92877	1.47	92.60	92
277	1531	91401	1.53	91.13	90
276	1607	89870	1.60	89.61	89
275	2214	88263	2.21	88.00	87
274	2215	86049	2.21	85.80	85
273	1695	83834	1.69	83.59	83
272	2860	82139	2.85	81.90	80
271	2334	79279	2.33	79.05	78
270	3041	76945	3.03	76.72	75
269	3029	73904	3.02	73.69	72
268	3014	70875	3.01	70.67	69
267	3771	67861	3.76	67.66	66
266	3848	64090	3.84	63.90	62
265	2516	60242	2.51	60.07	59
264	3785	57726	3.77	57.56	56
263	3305	53941	3.30	53.78	52
262	4028	50636	4.02	50.49	48
261	4005	46608	3.99	46.47	44
260	4843	42603	4.83	42.48	40
259	4085	37760	4.07	37.65	36
258	3428	33675	3.42	33.58	32
257	3328	30247	3.32	30.16	28
256	3454	26919	3.44	26.84	25
255	3872	23465	3.86	23.40	21
254	2475	19593	2.47	19.54	18
253	3561	17118	3.55	17.07	15
252	2211	13557	2.20	13.52	12
251	2066	11346	2.06	11.31	10
250	1984	9280	1.98	9.25	8
249	1727	7296	1.72	7.27	6
248	1361	5569	1.36	5.55	5
247	935	4208	0.93	4.20	4
246	825	3273	0.82	3.26	3
245	690	2448	0.69	2.44	2
244	511	1758	0.51	1.75	1
243	405	1247	0.40	1.24	1
242	313	842	0.31	0.84	1
241	202	529	0.20	0.53	1
240	116	327	0.12	0.33	1
239	109	211	0.11	0.21	1
LESS THAN 239	103	103	0.10	0.10	1

Notes: *Students with valid scores are those students who attempted at least one item on the test.
Data received from LEAs and charter schools after August 2001 are not included in this table.
Prepared by the NCDPI Division of Accountability Services/Testing Section.

**Table 34. 2000-01 End-of-Grade Distribution of Scale Scores
Grade 7 Reading**

<u>NUMBER OF STUDENTS WITH VALID SCORES*</u>	96,945	<u>HIGH SCORE</u>	183
		<u>LOW SCORE</u>	126
<u>MEAN</u>	159.9	<u>2001 STATE PERCENTILES</u>	<u>SCALE SCORE</u>
<u>STANDARD DEVIATION</u>	8.5	90	170.39
		75	165.98
<u>VARIANCE</u>	72.6	50 (<u>MEDIAN</u>)	160.72
		25	154.60
		10	148.58

FREQUENCY DISTRIBUTION

<u>SCALE SCORE</u>	<u>FREQUENCY</u>	<u>CUMULATIVE FREQUENCY</u>	<u>PERCENT</u>	<u>CUMULATIVE PERCENT</u>	<u>2001 STATE PERCENTILE</u>
183	35	96945	0.04	100.00	99
181	178	96910	0.18	99.96	99
179	187	96732	0.19	99.78	99
178	258	96545	0.27	99.59	99
177	354	96287	0.37	99.32	99
176	480	95933	0.50	98.96	99
175	1277	95453	1.32	98.46	98
174	839	94176	0.87	97.14	98
173	945	93337	0.97	96.28	97
172	2203	92392	2.27	95.30	95
171	2605	90189	2.69	93.03	93
170	2908	87584	3.00	90.34	91
169	3151	84676	3.25	87.34	88
168	3428	81525	3.54	84.09	84
167	3525	78097	3.64	80.56	81
166	3573	74572	3.69	76.92	77
165	3531	70999	3.64	73.24	72
164	7163	67468	7.39	69.59	67
163	3456	60305	3.56	62.21	62
162	3338	56849	3.44	58.64	56
161	6453	53511	6.66	55.20	51
160	3035	47058	3.13	48.54	45
159	5627	44023	5.80	45.41	41
158	2775	38396	2.86	39.61	36
157	5051	35621	5.21	36.74	32
156	3392	30570	3.50	31.53	28
155	3252	27178	3.35	28.03	25
154	2938	23926	3.03	24.68	22
153	2832	20988	2.92	21.65	19
152	3307	18156	3.41	18.73	17
151	1490	14849	1.54	15.32	14
150	1966	13359	2.03	13.78	12
149	1846	11393	1.90	11.75	11
148	1155	9547	1.19	9.85	10
147	1004	8392	1.04	8.66	8
146	1318	7388	1.36	7.62	7
145	1194	6070	1.23	6.26	6
144	724	4876	0.75	5.03	5
143	678	4152	0.70	4.28	4
142	631	3474	0.65	3.58	3
141	568	2843	0.59	2.93	2
140	491	2275	0.51	2.35	2
139	397	1784	0.41	1.84	1
138	354	1387	0.37	1.43	1
137	466	1033	0.48	1.07	1
136	271	567	0.28	0.58	1
135	149	296	0.15	0.31	1
134	53	147	0.05	0.15	1
133	49	94	0.05	0.10	1
LESS THAN 133	45	45	0.05	0.05	1

Notes: *Students with valid scores are those students who attempted at least one item on the test. Data received from LEAs and charter schools after August 2001 are not included in this table. Prepared by the NCDPI Division of Accountability Services/Testing Section.

**Table 35. 2000-01 End-of-Grade Distribution of Scale Scores
Grade 7 Mathematics**

NUMBER OF STUDENTS WITH VALID SCORES*	97,114	HIGH SCORE	305
		LOW SCORE	231
MEAN	267.1	2001 STATE PERCENTILES	SCALE SCORE
STANDARD DEVIATION	10.6	90	281.96
		75	273.94
		50 (MEDIAN)	266.07
VARIANCE	113.2	25	259.34
		10	254.19

SCALE SCORE	FREQUENCY DISTRIBUTION			CUMULATIVE PERCENT	2001 STATE PERCENTILE
	FREQUENCY	CUMULATIVE FREQUENCY	PERCENT		
305	9	97060	0.01	100.00	99
304	14	97051	0.01	99.99	99
302	75	97037	0.08	99.98	99
300	55	96962	0.06	99.90	99
299	73	96907	0.08	99.84	99
298	116	96834	0.12	99.77	99
297	114	96718	0.12	99.65	99
295	285	96604	0.29	99.53	99
294	430	96319	0.44	99.24	99
292	509	95889	0.52	98.79	99
291	312	95380	0.32	98.27	98
290	280	95068	0.29	97.95	98
289	759	94788	0.78	97.66	97
288	771	94029	0.79	96.88	96
287	913	93258	0.94	96.08	96
286	539	92345	0.56	95.14	95
285	990	91806	1.02	94.59	94
284	1128	90816	1.16	93.57	93
283	1683	89688	1.73	92.40	92
282	1221	88005	1.26	90.67	90
281	1346	86784	1.39	89.41	89
280	1313	85438	1.35	88.03	87
279	1370	84125	1.41	86.67	86
278	2073	82755	2.14	85.26	84
277	2348	80682	2.42	83.13	82
276	1530	78334	1.58	80.71	80
275	2546	76804	2.62	79.13	78
274	2639	74258	2.72	76.51	75
273	2664	71619	2.74	73.79	72
272	2798	68955	2.88	71.04	70
271	2831	66157	2.92	68.16	67
270	4097	63326	4.22	65.24	63
269	2107	59229	2.17	61.02	60
268	4293	57122	4.42	58.85	57
267	2341	52829	2.41	54.43	53
266	4597	50488	4.74	52.02	50
265	4689	45891	4.83	47.28	45
264	2425	41202	2.50	42.45	41
263	4721	38777	4.86	39.95	38
262	2369	34056	2.44	35.09	34
261	4632	31687	4.77	32.65	30
260	2262	27055	2.33	27.87	27
259	3332	24793	3.43	25.54	24
258	3245	21461	3.34	22.11	20
257	2140	18216	2.20	18.77	18
256	2043	16076	2.10	16.56	16
255	3799	14033	3.91	14.46	13
254	1735	10234	1.79	10.54	10
253	1586	8499	1.63	8.76	8
252	1452	6913	1.50	7.12	6
251	1255	5461	1.29	5.63	5
250	1074	4206	1.11	4.33	4
249	889	3132	0.92	3.23	3
248	306	2243	0.32	2.31	2
247	393	1937	0.40	2.00	2
246	519	1544	0.53	1.59	1
245	369	1025	0.38	1.06	1
244	263	656	0.27	0.68	1
243	178	393	0.18	0.40	1
242	86	215	0.09	0.22	1
241	54	129	0.06	0.13	1
240	10	75	0.01	0.08	1
239	22	65	0.02	0.07	1
238	26	43	0.03	0.04	1
LESS THAN 238	17	17	0.02	0.02	1

Notes: *Students with valid scores are those students who attempted at least one item on the test. Data received from LEAs and charter schools after August 2001 are not included in this table. Prepared by the NCDPI Division of Accountability Services/Testing Section.

**Table 36. 2000-01 End-of-Grade Distribution of Scale Scores
Grade 8 Reading**

<u>NUMBER OF STUDENTS WITH VALID SCORES*</u>	93,305	<u>HIGH SCORE</u>	186
		<u>LOW SCORE</u>	132
<u>MEAN</u>	163.1	<u>2001 STATE PERCENTILES</u>	<u>SCALE SCORE</u>
<u>STANDARD DEVIATION</u>	8.1	90	172.93
		75	168.48
<u>VARIANCE</u>	64.9	50 (MEDIAN)	163.76
		25	158.20
		10	152.36

FREQUENCY DISTRIBUTION

<u>SCALE SCORE</u>	<u>FREQUENCY</u>	<u>CUMULATIVE FREQUENCY</u>	<u>PERCENT</u>	<u>CUMULATIVE PERCENT</u>	<u>2001 STATE PERCENTILE</u>
186	14	93305	0.02	100.00	99
184	69	93291	0.07	99.98	99
182	234	93222	0.25	99.91	99
181	231	92988	0.25	99.66	99
180	268	92757	0.29	99.41	99
179	405	92489	0.43	99.13	99
178	459	92084	0.49	98.69	99
177	1249	91625	1.34	98.20	98
176	729	90376	0.78	96.86	97
175	1960	89647	2.10	96.08	96
174	2235	87687	2.40	93.98	94
173	2606	85452	2.79	91.58	91
172	3004	82846	3.22	88.79	89
171	3121	79842	3.34	85.57	86
170	3262	76721	3.50	82.23	82
169	3352	73459	3.59	78.73	79
168	6889	70107	7.38	75.14	74
167	3370	63218	3.61	67.75	69
166	3353	59848	3.59	64.14	65
165	6418	56495	6.88	60.55	60
164	4610	50077	4.94	53.67	55
163	4463	45467	4.78	48.73	49
162	4079	41004	4.37	43.95	45
161	5142	36925	5.51	39.57	40
160	4496	31783	4.82	34.06	36
159	3094	27287	3.32	29.24	32
158	2895	24193	3.10	25.93	28
157	3468	21298	3.72	22.83	25
156	2282	17830	2.45	19.11	21
155	2619	15548	2.81	16.66	18
154	1256	12929	1.35	13.86	16
153	2201	11673	2.36	12.51	14
152	1005	9472	1.08	10.15	12
151	922	8467	0.99	9.07	11
150	1644	7545	1.76	8.09	9
149	790	5901	0.85	6.32	8
148	732	5111	0.78	5.48	7
147	719	4379	0.77	4.69	6
146	593	3660	0.64	3.92	5
145	880	3067	0.94	3.29	4
144	700	2187	0.75	2.34	3
143	392	1487	0.42	1.59	2
142	312	1095	0.33	1.17	2
141	259	783	0.28	0.84	1
140	309	524	0.33	0.56	1
139	83	215	0.09	0.23	1
138	69	132	0.07	0.14	1
137	28	63	0.03	0.07	1
136	14	35	0.02	0.04	1
LESS THAN 136	21	21	0.02	0.02	1

Notes: *Students with valid scores are those students who attempted at least one item on the test.
Data received from LEAs and charter schools after August 2001 are not included in this table.
Prepared by the NCDPI Division of Accountability Services/Testing Section.

**Table 37. 2000-01 End-of-Grade Distribution of Scale Scores
Grade 8 Mathematics**

NUMBER OF STUDENTS WITH VALID SCORES*	93,408	HIGH SCORE	310
		LOW SCORE	235
MEAN	270.0	2001 STATE PERCENTILES	SCALE SCORE
STANDARD DEVIATION	11.0	90	284.65
		75	277.63
VARIANCE	119.9	50 (MEDIAN)	269.26
		25	262.27
		10	256.02

FREQUENCY DISTRIBUTION

SCALE SCORE	FREQUENCY	CUMULATIVE FREQUENCY	PERCENT	CUMULATIVE PERCENT	2001 STATE PERCENTILE	
310	2	93408		0.00	100.00	99
309	8	93406		0.01	100.00	99
307	20	93398		0.02	99.99	99
306	22	93378		0.02	99.97	99
305	50	93356		0.05	99.94	99
303	53	93306		0.06	99.89	99
302	79	93253		0.08	99.83	99
301	169	93174		0.18	99.75	99
299	211	93005		0.23	99.57	99
297	291	92794		0.31	99.34	99
296	373	92503		0.40	99.03	99
295	405	92130		0.43	98.63	98
293	499	91725		0.53	98.20	98
292	587	91226		0.63	97.66	97
291	585	90639		0.63	97.04	97
290	726	90054		0.78	96.41	96
289	1151	89328		1.23	95.63	95
288	822	88177		0.88	94.40	94
287	1397	87355		1.50	93.52	93
286	988	85958		1.06	92.02	91
285	1064	84970		1.14	90.97	90
284	2234	83906		2.39	89.83	89
283	1158	81672		1.24	87.44	87
282	2400	80514		2.57	86.20	85
281	1359	78114		1.45	83.63	83
280	2686	76755		2.88	82.17	81
279	1377	74069		1.47	79.30	79
278	3014	72692		3.23	77.82	76
277	1573	69678		1.68	74.60	74
276	3184	68105		3.41	72.91	71
275	2495	64921		2.67	69.50	68
274	2605	62426		2.79	66.83	65
273	2633	59821		2.82	64.04	63
272	3647	57188		3.90	61.22	59
271	2869	53541		3.07	57.32	56
270	2956	50672		3.16	54.25	53
269	4212	47716		4.51	51.08	49
268	2130	43504		2.28	46.57	45
267	3254	41374		3.48	44.29	43
266	3471	38120		3.72	40.81	39
265	3482	34649		3.73	37.09	35
264	3658	31167		3.92	33.37	31
263	3598	27509		3.85	29.45	28
262	2415	23911		2.59	25.60	24
261	2326	21496		2.49	23.01	22
260	2338	19170		2.50	20.52	19
259	2223	16832		2.38	18.02	17
258	2221	14609		2.38	15.64	14
257	2096	12388		2.24	13.26	12
256	1967	10292		2.11	11.02	10
255	1757	8325		1.88	8.91	8
254	1578	6568		1.69	7.03	6
253	1323	4990		1.42	5.34	5
252	1083	3667		1.16	3.93	3
251	424	2584		0.45	2.77	3
250	432	2160		0.46	2.31	2
249	668	1728		0.72	1.85	1
248	396	1060		0.42	1.13	1
247	285	664		0.31	0.71	1
246	174	379		0.19	0.41	1
245	45	205		0.05	0.22	1
244	52	160		0.06	0.17	1
243	45	108		0.05	0.12	1
242	37	63		0.04	0.07	1
241	11	26		0.01	0.03	1
240	3	15		0.00	0.02	1
LESS THAN 240	12	12		0.01	0.01	1

Notes: *Students with valid scores are those students who attempted at least one item on the test.
Data received from LEAs and charter schools after August 2001 are not included in this table.
Prepared by the NCDPI Division of Accountability Services/Testing Section.

**Table 38. 2000-01 End-of-Grade Multiple-Choice Test Results
Grade 3 Mean Scale Score by LEA - Reading**

State	Mean Score [†]	2001 LEA Performance
	159.5	Metrolina Regional**
	158.5	Quest Academy**
	153.5	Mountain Community**
	152.9	Chapel Hill-Carrboro City
	152.7	Summit Charter**
	152.1	Cape Fear Center**
	151.9	Tiller School**
	151.5	Elkin City
	151.3	Orange Co. Charter**
	151.1	Vance Charter**
	150.9	The Learning Center**
	150.7	Watauga
	150.3	Polk, Wake
	150.1	Avery, Carteret, Madison
	149.9	Macon
	149.5	Buncombe
	149.3	Camden
	149.1	Craven, Onslow, Union Academy**
	148.9	Cherokee, Clay, Currituck, Henderson, Millennium**, Mooresville City
	148.7	Lincoln Charter**, Newton Conover City
	148.5	Alleghany, Ashe, Kings Mountain City, Swain
	148.3	Burke, Davidson, River Mill Charter**, Transylvania, Yancey
	148.1	Cabarrus, Davie, New Hanover
	147.9	Caldwell, Haywood, Moore, Mount Airy City, Rutherford, Union
	147.7	Johnston, Pender
	147.5	Asheville City, Brunswick, Dare, Lenoir, Orange, Sterling Montessori**, Washington Montessori**, Wilson
2001 State	147.3	Cleveland, Roanoke Rapids City
	147.1	Alexander, Charlotte/Mecklenburg, Franklin Academy**, Jones, Mitchell, Perquimans, Tyrrell, Wilkes
	146.9	Arapahoe**, Beaufort, Chatham Charter**, Gaston, Gates, Pamlico, Person, Research Triangle**, Yadkin
1999,2000 State	146.7	Catawba, Greensboro Academy**, Iredell-Statesville
	146.5	Clinton City, Cumberland, Guilford, Harnett, Lincoln, McDowell, Nash-Rocky Mount, Phoenix Academy**, Stokes, Surry, Wayne, Whiteville City, Winston-Salem/Forsyth
	146.3	Granville, Randolph, Sampson, Stanly
1998 State	146.1	Asheboro City, Caswell, Chatham, Jackson, Rowan-Salisbury
	145.9	Brevard Academy**, Duplin, Pitt
	145.7	Alamance-Burlington, Durham, Evergreen Community**, Lee, Rocky Mt Charter Public**, Shelby City
	145.5	Elizabeth City/Pasquotank, Graham, Hickory City, Kannapolis City, Rockingham
	145.1	American Renaissance**, Columbus, STARS**
	144.9	Lexington City
	144.7	Martin, Maureen Joy**, Robeson
	144.5	Franklin, Scotland
1997 State	144.1	Edenton/Chowan, Greene
1996 State	143.9	East Wake Academy**
	143.7	Edgecombe, Vance
1995 State	143.5	Halifax, Hoke, Montgomery, Northampton, Piedmont Community**, Richmond
	143.3	Bladen, Hyde
	143.1	Englemann**
1993,1994 State	142.9	Thomasville City
	142.5	Anson, Bertie, Bethel Hill**, Bridges**, Warren
	142.3	Community Charter**
	141.9	Forsyth Academies**
	141.5	Francine Delany**, Hertford
	140.9	S.B. Howard**, SPARC Academy**, Washington
	140.7	Children's Village Academy**
	140.5	Dillard Academy**, Village Charter**
	140.3	Weldon City
	139.9	Haliwa-Saponi Tribal**, Success Institute**
	138.5	Rowan Academy**
	138.1	C.G. Woodson**
	137.9	Healthy Start**
	137.7	Sugar Creek**
	136.9	Omuteko Gwamaziima**
	136.7	Northeast Raleigh**
	136.5	Turning Point**
	135.1	Carter Community**
	134.9	East Winston Primary**
	134.5	Harnett Early Childhood**, Stanly Co. Community**
	*	Crossnore Academy**, Grandfather Academy**

Notes: [†]Mean scale scores are rounded up to the nearest two-tenths of a point.

*Data are not reported where number tested is fewer than five.

**Denotes a charter school. For reporting purposes the charter school name has been abbreviated; the complete charter school name can be found in the Appendix.

Data received from LEAs and charter schools after August 2001 are not included in this table.

Prepared by the NCDPI Division of Accountability Services/Testing Section.

**Table 39. 2000-01 End-of-Grade Multiple-Choice Test Results
Grade 3 Mean Scale Score by LEA - Mathematics**

State***	Mean Score	2001 LEA Performance
	264.1	Metrolina Regional**
	...	
	263.7	Quest Academy**
	...	
	255.9	Chapel Hill-Carrboro City
	...	
	254.9	Elkin City
	...	
	254.3	Watauga
	254.1	Mountain Community**
	253.9	Madison, Wake
	...	
	253.5	Carteret
	...	
	252.9	Polk
	252.7	Ashe
	252.5	Avery, Cape Fear Center,** Cherokee, Henderson, Macon, New Hanover
	252.3	Vance Charter**
	252.1	Buncombe, Cabarrus, Moore, Mooresville City, Roanoke Rapids City, Tiller School**
	251.9	Currituck, Millennium,** Onslow, Orange Co. Charter,** Union
	251.7	Johnston
	251.5	Craven, Davidson, Davie, Haywood, Surry, Yadkin, Yancey
	251.3	Brunswick, Camden, Jackson, Tyrrell
	251.1	Alleghany, Newton Conover City, Orange, Pamlico, Pender, Swain, Union Academy**
	250.9	Burke, Charlotte/Mecklenburg, Clay, Gates, Kings Mountain City, Lee, Lenoir, Mount Airy City, Randolph, Summit Charter,** Whiteville City
2001 State	250.7	Alamance-Burlington, Jones, Rutherford
	250.5	Asheboro City, Asheville City, Beaufort, Caldwell, Chatham, Cleveland, Cumberland, Dare, Gaston, Harnett, Person, Stanly, Transylvania, Wilkes
2000 State	250.3	Alexander, Guilford, The Learning Center,** Wayne
	250.1	Greensboro Academy,** Iredell-Statesville, Lincoln, Lincoln Charter,** Mitchell, Stoke
	249.9	Durham, Nash-Rocky Mount, Sampson, Wilson, Winston-Salem/Forsyth
	249.7	Caswell, Chatham Charter,** Clinton City, Hickory City, Perquimans
	249.5	Catawba, Franklin Academy,** Granville, Pitt, Rowan-Salisbury, Shelby City
	249.3	Columbus, Duplin
1997,1998,1999 State	249.1	Graham, Rocky Mt Charter Public**
	248.9	Arapahoe,** Brevard Academy,** Elizabeth City/Pasquotank, Kannapolis City, McDowell, Robeson
	248.7	Martin, Rockingham
	248.5	East Wake Academy,** Lexington City, River Mill Charter,** Scotland
	248.3	Sterling Montessori**
1995,1996 State	248.1	Franklin, Hyde
	247.9	Phoenix Academy,**Piedmont Community,** Vance
	247.7	Bladen, Edenton/Chowan, Hoke, Montgomery
	247.5	Edgecombe, Englemann,** Greene, Village Charter,** Warren
	247.3	Richmond, Washington Montessori**
1993,1994 State	247.1	Evergreen Community,** Thomasville City
	246.9	American Renaissance**
	246.7	Bertie, STARS**
	246.5	Anson, Bridges,** Halifax, Northampton
	246.3	Forsyth Academies**
	...	
	245.9	Weldon City
	245.7	Hertford
	...	
	245.1	C.G. Woodson,** Francine Delany,** Maureen Joy,** Research Triangle**
	244.9	S.B. Howard,** Washington
	...	
	244.5	Bethel Hill**
	244.3	Haliwa-Saponi Tribal**
	244.1	Success Institute**
	...	
	243.1	Children's Village Academy**
	242.9	Community Charter,** Healthy Start**
	...	
	242.5	SPARC Academy**
	...	
	241.9	Carter Community**
	...	
	240.9	Rowan Academy,** Turning Point**
	240.7	Dillard Academy**
	...	
	240.1	Northeast Raleigh**
	...	
	239.7	Sugar Creek**
	...	
	239.5	East Winston Primary,** Harnett Early Childhood,** Stanly County Community**
	...	
	238.1	Omuteko Gwamaziima**
	*	Crossnore Academy,** Grandfather Academy**

Notes: †Mean scale scores are rounded up to the nearest two-tenths of a point.

*Data are not reported where number tested is fewer than five.

**Denotes a charter school. For reporting purposes the charter school name has been abbreviated; the complete charter school name can be found in the Appendix.

***State counts for 1993-00 have been converted to the 2000-01 scale for mathematics using results from the 2000-01 equating study.

Data received from LEAs and charter schools after August 2001 are not included in this table.

Prepared by the NCDPI Division of Accountability Services/Testing Section.

**Table 40. 2000-01 End-of-Grade Multiple-Choice Test Results
Grade 4 Mean Scale Score by LEA - Reading**

State	Mean Score†	2001 LEA Performance
	160.9	Magellan**, Metrolina Regional**
	160.1	Quest Academy**
	157.9	Tiller School**
	156.7	Chapel Hill-Carrboro City
	155.5	Brevard Academy**
	155.3	Clay
	154.9	Franklin Academy**, STARS**, Watauga
	154.7	Orange Co. Charter**
	154.5	Cape Fear Center**
	154.1	Elkin City, Union Academy**, Wake
	153.9	Arapahoe**
	153.5	Cherokee, Greensboro Academy**, Phoenix Academy**
	153.3	River Mill Charter**, Summit Charter**
	153.1	Currituck, Dare, Francine Delany**, Henderson, Pamlico
	152.9	Avery, Buncombe, Camden, Chatham Charter**, Transylvania, Yancey
	152.7	Lincoln Charter**, Macon
	152.5	Carteret, Haywood, Onslow, Polk
	152.3	Evergreen Community**, Orange
	152.1	Kings Mountain City, New Hanover
	151.9	Bethel Hill**, Craven, Mitchell, Swain
	151.5	Ashe, Burke, Cabarrus, Caldwell, Madison, Millennium**, Mount Airy City, Sterling Montessori**
	151.3	Davidson, Johnston, Roanoke Rapids City
	151.1	Catawba, Davie, Rutherford, Wilson
	150.9	Alexander, Cleveland, Mooresville City
	150.7	Alleghany, Union
2001 State	150.5	Clinton City, Gates, Hickory City, Jackson, Lenoir, Moore, Newton Conover City, Wilkes, Winston-Salem/Forsyth
	150.3	Brunswick, Nash-Rocky Mount, Pender
2000 State	150.1	Charlotte/Mecklenburg, Mountain Community**, Yadkin
	149.9	Alamance-Burlington, Durham, Guilford, Stanly
	149.7	Iredell-Statesville, Rockingham
1998,1999 State	149.5	American Renaissance**, Asheboro City, Asheville City, Chatham, Cumberland, Elizabeth City/Pasquotank, Gaston, Harnett, Kannapolis City, Lee, Lincoln, McDowell, Person, Shelby City, Stokes, Surry
	149.3	Randolph
	149.1	Graham, Rowan-Salisbury, Vance Charter**
1996 State	148.9	Duplin, East Wake Academy**, Edenton/Chowan, Forsyth Academies**, Hyde, Pitt, Sampson, Tyrrell, Village Charter**, Wayne
	...	
1997 State	148.5	Bridges**, Granville, Perquimans, The Learning Center**, Whiteville City
	148.1	Beaufort, Children's Village Academy**, Franklin
1994 State	147.9	Grandfather Academy**, Greene, Jones, Scotland
1995 State	147.7	
	147.5	Caswell, Columbus, Englemann**, Halifax
	147.3	Bladen
1993 State	147.1	
	146.9	Community Charter**, Hoke
	146.7	Edgecombe, Robeson
	146.5	Martin, Thomasville City, Vance
	146.3	Bertie, S.B. Howard**
	146.1	Northampton, Warren
	145.9	Hertford, Lexington City, Montgomery, Richmond
	145.5	Washington
	145.1	Anson, Rocky Mt Charter Public**
	144.9	Harnett Early Childhood**
	144.1	Success Institute**
	143.7	Maureen Joy**
	143.3	SPARC Academy**, Weldon City
	142.9	Piedmont Community**
	142.5	Haliwa-Saponi Tribal**, Sugar Creek**
	141.3	Northeast Raleigh**
	141.1	Rowan Academy**
	140.7	Research Triangle**
	140.5	Healthy Start**, Turning Point**
	140.1	Carter Community**
	138.3	C.G. Woodson**
	132.1	Omuteko Gwamaziima**
	*	Crossnore Academy**, Woods Charter**

Notes: †Mean scale scores are rounded up to the nearest two-tenths of a point.

**Data are not reported where number tested is fewer than five

**Denotes a charter school. For reporting purposes the charter school name has been abbreviated; the complete charter school name can be found in the Appendix.

Data received from LEAs and charter schools after August 2001 are not included in this table.

Prepared by the NCDPI Division of Accountability Services/Testing Section.

**Table 41. 2000-01 End-of-Grade Multiple-Choice Test Results
Grade 4 Mean Scale Score by LEA - Mathematics**

State***	Mean Score†	2001 LEA Performance
	267.3	Magellan**
	267.1	Quest Academy**
	...	
	263.5	Metrolina Regional**
	...	
	262.1	Chapel Hill-Carrboro City
	...	
	260.3	Brevard Academy**
	260.1	Clay
	259.9	Watauga
	259.7	Tiller School**
	259.5	Elkin City
	259.3	Arapahoe**
	259.1	Wake
	258.9	Kings Mountain City, Polk
	258.7	Orange Co. Charter**
	258.5	Camden, Madison, Yancey
	258.3	Currituck, Union Academy**
	258.1	Cherokee, New Hanover
	257.9	Carteret, Henderson, Macon, Transylvania
	257.7	Cape Fear Center**, Dare
	257.5	Buncombe, Roanoke Rapids City
	257.3	Avery, Cabarrus, Cleveland
	257.1	Chatham Charter**, Francine Delany**, Franklin Academy*
	256.9	Davidson, Onslow, Orange, Pamlico, Rutherford
	256.7	Alamance-Burlington, Ashe, Haywood, Hickory City
	256.5	Craven, Davie, Greensboro Academy**, Johnston, Mount Airy City, Union, Wilkes, Yadkin
	256.3	Caldwell, Lincoln
2001 State	256.1	Catawba, Kannapolis City, Moore, Mooresville City, Mountain Community**, Pender, Surr.
	255.9	Alleghany, Burke, Charlotte/Mecklenburg, Lee, Lincoln Charter**, Mitchell, Nash-Rocky Mount, Wilso
	255.7	Durham, Guilford, Swain, Winston-Salem/Forsyth
	255.5	Gaston, Jackson, Newton Conover City, Person
	255.3	Cumberland
2000 State	255.1	Chatham, Duplin, Gates, Lenoir, Randolph, River Mill Charter**
	254.9	Alexander, Brunswick, Clinton City, Harnett, Millennium**, Rowan-Salisbury, Stanly, Stokes, Village Charter*
	254.7	Iredell-Statesville
	254.5	Asheboro City, Columbus, Elizabeth City/Pasquotank, Phoenix Academy**, Rockingham, STARS**, Whiteville Ci
	254.3	Asheville City, Granville, McDowell, Summit Charter**, Wayne
1998,1999 State	254.1	Beaufort, Perquimans, Pitt, Sampson
	253.9	Bertie, Franklin, Graham, Jones, Scotland, Shelby City, The Learning Center**, Tyrrel
	253.7	Bethel Hill**
	253.5	Caswell, Evergreen Community**, Forsyth Academies**
	253.3	Bladen, Vance
1997 State	253.1	Edenton/Chowan, Greene, Robeson
	252.9	Halifax, Martin
	...	
	252.5	Hyde, Lexington City
	252.3	S.B. Howard**
1996 State	252.1	Hertford, Hoke
	251.9	American Renaissance**, Anson, Edgecombe, Richmond
	251.7	Englemann**
	251.5	Community Charter**, Northampton, Success Institute**, Vance Charter**, Washingto
	251.3	Montgomery
1995 State	251.1	Sterling Montessori**, Warrer
	250.9	Thomasville City
	...	
	250.5	East Wake Academy**, Weldon City
1994 State	250.1	Maureen Joy**
	249.9	Bridges**, Haliwa-Saponi Tribal**, Piedmont Community*
	...	
1993 State	249.1	
	248.9	Children's Village Academy**, Grandfather Academy**, Rocky Mt Charter Public*
	...	
	248.5	Harnett Early Childhood**, Rowan Academy**
	...	
	247.5	Healthy Start**
	247.3	SPARC Academy**
	247.1	C.G. Woodson**, Northeast Raleigh**
	...	
	246.5	Research Triangle**
	...	
	246.1	Turning Point**
	245.9	Carter Community**
	...	
	244.9	Sugar Creek**
	...	
	244.1	Omuteko Gwamaziima**
	*	Crossnore Academy**, Woods Charter**

Notes: †Mean scale scores are rounded up to the nearest two-tenths of a point.

*Data are not reported where number tested is fewer than five

**Denotes a charter school. For reporting purposes the charter school name has been abbreviated; the complete charter school name can be found in the Appendix.

***State counts for 1993-00 have been converted to the 2000-01 scale for mathematics using results from the 2000-01 equating study.

Data received from LEAs and charter school after August 2001 are not included in this table.

Prepared by the NCDPI Division of Accountability Services/Testing Section.

**Table 42. 2000-01 End-of-Grade Multiple-Choice Test Results
Grade 5 Mean Scale Score by LEA - Reading**

State	Mean Score†	2001 LEA Performance
	167.9	Metrolina Regional**
	164.7	Cape Fear Center**
	164.3	Magellan**
	161.5	Chapel Hill-Carrboro City, Lake Norman**
	161.1	Mountain Community**
	160.9	Francine Delany**, Quest Academy**
	159.7	Watauga
	159.3	Camden
	159.1	Avery, Wake
	158.7	Transylvania
	158.5	Buncombe, Dare, Henderson, Macon, Polk
	158.3	Clay
	157.9	Carteret, Currituck, Davie, Elkin City, Greensboro Academy**, Haywood, Lincoln Charter**, Mount Airy City, Onslow, River Mill Charter**
	157.7	Evergreen Community**
	157.5	Cabarrus, Swain
	157.3	Madison
	157.1	Craven, Davidson, Kings Mountain City, New Hanover, Summit Charter**, Yancey
	156.9	Alleghany, Ashe, Caldwell, Cherokee, Franklin Academy**, Gates, Moore, Orange
	156.7	Burke, Newton Conover City, Pamlico
	156.5	Alexander, Brunswick, Catawba, Johnston, Person, Rutherford, Union, Wilkes, Wilson
	156.3	Charlotte/Mecklenburg, Mitchell
2001 State	156.1	Asheville City, Chatham, Hickory City, Lenoir, Mooresville City, Rowan-Salisbury, Yadkin
	155.9	Alamance-Burlington, Arapahoe**, Guilford, Lincoln, Nash-Rocky Mount, Pender, Randolph, Stokes, Surry, Winston-Salem/Forsyth
	155.7	Bridges**, Iredell-Statesville
2000 State	155.5	Cleveland, Graham, Lee, Phoenix Academy**, Stanly
	155.3	Gaston, Jackson, McDowell
	155.1	Brevard Academy**, Cumberland, Tiller School**
	154.9	Asheboro City, Clinton City, Duplin, East Wake Academy**, Greene, Jones, Perquimans, Pitt, Roanoke Rapids City, Rockingham, Sampson, Village Charter**
1998,1999 State	154.7	Harnett, Wayne, Whiteville City
	154.5	Beaufort, Bethel Hill**, Elizabeth City/Pasquotank, Franklin, Kannapolis City, Orange Co. Charter**, Scotland, Shelby City, Tyrrell
	154.3	Durham
	154.1	Edenton/Chowan, Sterling Montessori**
	153.9	Caswell, Community Charter**, Forsyth Academies**, Halifax
	153.5	American Renaissance**, Bladen, Hyde, Richmond
1997 State	153.1	Granville, Rocky Mt Charter Public**
	152.9	Columbus, Lexington City, Martin, Northampton, S.B. Howard**
	152.7	Warren
1995 State	152.5	Hoke, Vance
	152.3	Vance Charter**
1996 State	152.1	Bertie, MAST**, Montgomery, Robeson
1994 State	151.9	
	151.7	Piedmont Community**, Washington
1993 State	151.5	Edgecombe, Englemann**
	151.3	Anson
	151.1	Hertford, Thomasville City
	150.9	Healthy Start**, Omuteko Gwamaziima**, Weldon City, Woods Charter**
	150.5	Children's Village Academy**
	150.3	Carter Community**, Haliwa-Saponi Tribal**
	149.9	Chatham Charter**, Maureen Joy**
	149.5	C.G. Woodson**
	148.9	The Learning Center**
	148.5	SPARC Academy**
	147.9	Northeast Raleigh**
	147.5	Turning Point**
	147.1	Sugar Creek**
	146.3	Rowan Academy**
	145.9	Harnett Early Childhood**
	145.5	STARS**
	143.9	Grandfather Academy**
	*	Crossnore Academy**, Research Triangle**, Success Institute**

Notes: †Mean scale scores are rounded up to the nearest two-tenths of a point.

**Data are not reported where number tested is fewer than five.

**Denotes a charter school. For reporting purposes the charter school name has been abbreviated; the complete charter school name can be found in the Appendix.

Data received from LEAs and charter schools after August 2001 are not included in this table.

Prepared by the NCDPI Division of Accountability Services/Testing Section.

**Table 43. 2000-01 End-of-Grade Multiple-Choice Test Results
Grade 5 Mean Scale Score by LEA - Mathematics**

State***	Mean Score†	2001 LEA Performance
	276.7	Metrolina Regional**
	271.9	Magellan**
	270.5	Quest Academy**
	270.1	Cape Fear Center**
	268.5	Lake Norman**
	267.3	Chapel Hill-Carrboro City
	265.5	Francine Delany**
	263.9	Transylvania, Wake, Watauga
	263.5	Mount Airy City, Polk
	263.1	Avery
	262.9	Elkin City
	262.7	Davie
	262.5	Henderson
	262.3	Buncombe, New Hanover
	262.1	Dare, Yancey
	261.9	Ashe, Cabarrus, Greensboro Academy**
	261.7	Carteret, Kings Mountain City, Macon, Summit Charter**, Surr
	261.5	Alamance-Burlington, Arapahoe**, Orange, Union
	261.1	Alleghany, Hickory City, Lincoln, Person
	260.9	Camden, Catawba, Cherokee, Currituck, Haywood, Moore, Mountain Community**, Newton Conover City, Onslow
	260.7	Davidson, Graham, Lee, Madison
	260.5	Cleveland, Craven, Guilford, Johnston, Mooresville City, Randolph
2001 State	260.3	Caldwell, Charlotte/Mecklenburg, Pamlico, Roanoke Rapids City, Rutherford
	260.1	Lenoir, River Mill Charter**, Rowan-Salisbury, Swain, Wilkes
	259.9	Beaufort, Burke, Iredell-Statesville, Pender, Perquimans, Winston-Salem/Forsyth, Yadkin
	259.7	Asheville City, Chatham
	259.5	Brunswick, Cumberland, Gaston, Lincoln Charter**, Wilson
1999,2000 State	259.3	Clay
	259.1	Clinton City, Franklin Academy**, Nash-Rocky Moun
	258.9	Alexander, Elizabeth City/Pasquotank, Stokes
	258.7	Asheboro City, McDowell
	258.5	Brevard Academy**, Duplin, Durham, Evergreen Community**, Halifax, Jackson, Pitt, Shelby City, Whiteville Ci
	258.3	Jones
	258.1	Gates, Greene, Rockingham, Sampson, Stanly, Wayne
	257.9	Caswell, Harnett, Kannapolis City, Lexington City, Tyrrel
	257.7	S.B. Howard**
	257.5	Chatham Charter**, Scotland
	257.3	East Wake Academy**, Franklin
	257.1	Vance
	256.9	Bladen, Columbus, Hyde, Mitchell, Rocky Mt Charter Public**
	256.7	Vance Charter**
	256.5	Bertie, Edenton/Chowan, Martin, Phoenix Academy**, Richmond
1998 State	256.3	Forsyth Academies**, Tiller School**, Village Charter**, Warren
	256.1	Bridges**, Granville, Robeson
	255.9	Hoke
1997 State	255.1	Anson, Montgomery, Northampton, Piedmont Community**
	254.9	American Renaissance**, Sterling Montessori**, Washington
	254.5	Orange Co. Charter**
1996 State	254.1	Weldon City
	253.9	Bethel Hill**, Edgecombe, Hertford, Thomasville Cit
	253.5	Maureen Joy**
1995 State	253.3	Haliwa-Saponi Tribal**
	253.1	Englemann**, MAST**
	252.5	C.G. Woodson**, Healthy Start**
1994 State	252.1	The Learning Center**
	251.9	Community Charter**
1993 State	251.3	Carter Community**, SPARC Academy**, Woods Charter**
	251.1	Children's Village Academy**
	250.9	Northeast Raleigh**
	249.9	Turning Point**
	249.3	Sugar Creek**
	249.1	Grandfather Academy**, Omuteko Gwamaziima**
	248.9	Rowan Academy**, STARS**
	248.5	Harnett Early Childhood**
	246.9	Crossnore Academy**, Research Triangle**, Success Institute**

Notes: †Mean scale scores are rounded up to the nearest two-tenths of a point.

**Data are not reported where number tested is fewer than five.

**Denotes a charter school. For reporting purposes the charter school name has been abbreviated; the complete charter school name can be found in the Appendix.

***State counts for 1993-00 have been converted to the 2000-01 scale for mathematics using results from the 2000-01 equating study.

Data received from LEAs and charter school after August 2001 are not included in this table.

Prepared by the NCDPI Division of Accountability Services/Testing Section

**Table 44. 2000-01 End-of-Grade Multiple-Choice Test Results
Grade 6 Mean Scale Score by LEA - Reading**

State	Mean Score†	2001 LEA Performance
	169.3	Metrolina Regional**
	165.1	Magellan**, Quest Academy**
	164.7	Exploris**
	163.7	Chapel Hill-Carrboro City
	162.5	Orange Co. Charter**, Transylvania
	162.1	Francine Delany**, Lake Norman**
	161.9	Watauga
	161.3	Mountain Community**
	160.9	Tiller School**
	160.5	Clay, Currituck, Elkin City, Henderson, Mount Airy City, Thomas Jefferson**
	160.1	Cherokee
	159.9	Brevard Academy**, Dare, Greensboro Academy**, Wake
	159.5	Ashe, Camden, Franklin Academy**, Woods Charter**
	159.3	Macon, Polk
	159.1	Alleghany, Buncombe, Sterling Montessori**
	158.9	Avery, Cabarrus, McDowell, Moore, Yancey
	158.7	Davie, Haywood, Summit Charter**
	158.5	Davidson, Graham, Johnston, Kings Mountain City, Onslow, River Mill Charter**, Stanly, Union, Village Charter**
	158.3	Carteret, Madison, Pamlico
	158.1	Evergreen Community**, Mooresville City, New Hanover
	157.9	Burke, Jackson, Swain
	157.7	Catawba
	157.5	Bridges**, Caldwell, Chatham, Gates, Pender, Surry, Wilkes, Yadkin
	157.1	Craven, Orange, Rutherford
1999,2001 State	156.9	Alexander, Arapahoe**, Downtown Middle**, East Wake Academy**, Guilford, S.B. Howard**, Wilson, Winston-Salem/Forsyth
2000 State	156.5	Asheboro City, Bethel Hill**, Hyde, Perquimans, Person, Randolph, Tyrrell
	156.3	Iredell-Statesville, Roanoke Rapids City
	156.1	Charlotte/Mecklenburg, Cleveland, Cumberland, Lincoln, Mitchell, Stokes
1998 State	155.9	Harnett, Kestrel Heights**, Lenoir, Lincoln Charter**, Newton Conover City, Pitt, Rowan-Salisbury, Shelby City
1997 State	155.7	Alamance-Burlington, Asheville City, Brunswick, Duplin
1996 State	155.5	Gaston, Hickory City, MAST**, Nash-Rocky Mount, Wayne, Whiteville City
	155.1	Elizabeth City/Pasquotank, Rockingham, Vance Charter**
	154.9	Caswell, Durham, Granville, Kannapolis City, Lee, Richmond, Rowan Academy**, Sampson
	154.7	Clinton City, Forsyth Academies**
1994,1995 State	154.5	American Ren. Middle**, Beaufort, Columbus, Franklin
1993 State	154.1	Edenton/Chowan, Scotland
	153.9	Bethany Community**, Englemann**, Greene, Jones
	153.5	Bladen, Hoke
	153.3	Rocky Mt Charter Public**, Thomasville City
	152.9	Children's Village Academy**, Halifax, Lexington City, Montgomery, Robeson
	152.5	Anson, Chatham Charter**, Hertford
	152.1	Northampton
	151.9	Edgecombe, Martin
	151.7	Warren
	151.5	The Learning Center**, Washington
	150.9	Northeast Raleigh**, SPARC Academy**, Vance
	150.5	Alpha Academy**
	150.3	Turning Point**
	149.9	Bertie, Quality Education**
	149.3	Carter Community**
	149.1	Sugar Creek**
	148.9	Imani Institute**
	148.5	C.G. Woodson**, Weldon City
	147.5	Omuteko Gwamaziima**
	146.7	Provisions Academy**
	143.5	CIS Academy**
	*	Crossnore Academy**, Grandfather Academy**, Harnett Early Childhood**, Kennedy Charter**, Lakeside School**

Notes: † Mean scale scores are rounded up to the nearest two-tenths of a point.

*Data are not reported where number tested is fewer than five.

**Denotes a charter school. For reporting purposes the charter school name has been abbreviated; the complete charter school name can be found in the Appendix.

Data received from LEAs and charter schools after August 2001 are not included in this table.

Prepared by the NCDPI Division of Accountability Services/Testing Section.

**Table 45. 2000-01 End-of-Grade Multiple-Choice Test Results
Grade 6 Mean Scale Score by LEA - Mathematics**

State***	Mean Score†	2001 LEA Performance
	279.1	Metrolina Regional**
	275.5	Quest Academy**
	275.1	Magellan**
	271.1	Chapel Hill-Carrboro City, Orange Co. Charter**
	270.1	Transylvania
	269.5	Exploris**, Francine Delany**
	269.3	Kings Mountain City
	269.1	Lake Norman**
	268.5	Thomas Jefferson**
	267.9	Watauga
	267.3	Henderson
	266.9	Elkin City, Greensboro Academy**, Tiller School**
	266.5	Buncombe, Currituck, Mountain Community**, Yancey
	266.3	Brevard Academy**, Mount Airy City
	266.1	Ashe, Cabarrus, Camden, Franklin Academy**, Wake
	265.9	Cherokee, Dare, Madison, Polk, Union
	265.7	Pamlico
	265.5	Avery, Moore, Yadkin
	265.3	Haywood, New Hanover
	265.1	Alleghany, Davie, Stanly
	264.9	Clay, Davidson, Johnston, Kestrel Heights**, Macor
	264.5	Burke, Hyde, Lincoln, Wilkes
	264.3	Cleveland
	264.1	Arapahoe**, McDowell, Onslow, Pender, Surry
	263.9	Alexander, Caldwell, Chatham, East Wake Academy**, Jackson, Shelby City
	263.7	Carteret, Catawba, Newton Conover City, Orange, Summit Charter**
	263.5	Bethel Hill**, Gaston, Gates, Graham, Iredell-Statesville, Lee, Stokes, Winston-Salem/Forsyth
	263.3	
2001 State	263.1	Asheboro City, Bethany Community**, Lenoir, Person, Tyrrell, Vance Charter*
	262.9	Alamance-Burlington, Craven, Mooresville City, Perquimans, Randolph, Roanoke Rapids City, Rutherford
	262.7	Charlotte/Mecklenburg, Village Charter**
	262.5	Guilford, Harnett, Pitt, Rowan-Salisbury, Wilson
	262.1	Brunswick, Caswell, Cumberland, Whiteville City
1999,2000 State	261.9	Kannapolis City, Wayne
	261.7	MAST**, Nash-Rocky Mount
	261.5	Elizabeth City/Pasquotank, Rockingham
	261.3	Sampson
1998 State	261.1	Asheville City, Downtown Middle**, Edenton/Chowan
	260.9	Greene, Hickory City, Jones, Richmond, Sterling Montessori**, Swain
	260.7	Bladen, Columbus, Durham
	260.5	Beaufort, Duplin, Franklin, Hoke, Mitchell
	260.3	Granville
	260.1	Clinton City, Evergreen Community**, Forsyth Academies**, River Mill Charter*
	259.9	Englemann**, Montgomery, S.B. Howard**, Scotland, Thomasville City
	259.5	Anson, Robeson
1997 State	259.1	Halifax, Lincoln Charter**
	258.9	Chatham Charter**, Martin
	258.5	Edgecombe, Hertford
1996 State	258.1	Northampton, Rowan Academy**
	257.9	The Learning Center**, Washington
	257.7	Lexington City, Woods Charter**
	257.5	Bertie, Vance
1994,1995 State	257.3	Rocky Mt Charter Public**
	257.1	
	256.9	Warren
	256.5	Bridges**
1993 State	256.1	
	255.9	Northeast Raleigh**, Weldon City
	255.1	American Ren. Middle**, C.G. Woodson**
	254.9	Children's Village Academy**
	254.7	Turning Point**
	254.5	Sugar Creek**
	254.1	Alpha Academy**, Carter Community**
	253.9	CIS Academy**, Omuteko Gwamaziima**, Quality Education*
	253.1	Imani Institute**, SPARC Academy**
	250.9	Provisions Academy**
	*	Crossnore Academy**, Grandfather Academy**, Harnett Early Childhood**, Kennedy Charter**, Lakeside School**

Notes: †Mean scale scores are rounded up to the nearest two-tenths of a point.

*Data are not reported where number tested is fewer than five.

**Denotes a charter school. For reporting purposes the charter school name has been abbreviated; the complete charter school name can be found in the Appendix.

***State counts for 1993-00 have been converted to the 2000-01 scale for mathematics using results from the 2000-01 equating study.

Data received from LEAs and charter school after August 2001 are not included in this table.

Prepared by the NCDPI Division of Accountability Services/Testing Section.

**Table 46. 2000-01 End-of-Grade Multiple-Choice Test Results
Grade 7 Mean Scale Score by LEA - Reading**

State	Mean Score†	2001 LEA Performance	
2000 State	168.3	Exploris**	
	167.7	Quest Academy**	
	166.9	Magellan**	
	165.9	Chapel Hill-Carrboro City, Francine Delany**	
	164.7	Transylvania	
	164.3	Watauga	
	164.1	Ashe, Lake Norman**	
	163.9	Camden, Mountain Community**	
	163.5	Mount Airy City	
	162.9	Wake	
	162.7	Clay, Franklin Academy**	
	162.5	Avery, Cherokee, Orange Co. Charter**, Woods Charter**	
	162.3	Buncombe	
	162.1	Dare, Henderson, Kestrel Heights**, Yancey	
	161.9	Asheville City, Mooresville City, Newton Conover City	
	161.5	Alleghany, Carteret, Currituck, Elkin City, Jackson, Mitchell, Onslow, Polk	
	161.3	Cabarrus, Chatham, Stanly	
	161.1	Asheboro City, Caldwell, Catawba, Craven, Davie, Haywood, Johnston, New Hanover	
	160.9	Davidson, Downtown Middle**, Graham, Macon, Orange, Rutherford, Surry, Union, Wilkes	
	160.7	Swain	
	160.5	Brevard Academy**, Burke, Clinton City, Madison, McDowell, Moore, Summit Charter**, Village Charter**	
	160.3	Arapahoe**, Chatham Charter**, Pender	
	160.1	Kings Mountain City, Person, Pitt	
	159.9	Brunswick, Cumberland, Guilford, Hyde, Lenoir, River Mill Charter**, Thomas Jefferson**, Vance Charter**, Whiteville City, Winston-Salem/Forsyth, Yadkin	
	159.7	Edenton/Chowan, Evergreen Community**, Shelby City	
	159.5	Charlotte/Mecklenburg, Granville, Hickory City, Lincoln Charter**, Nash-Rocky Mount, Rockingham	
	159.3	Cleveland, Duplin, East Wake Academy**, Harnett, Iredell-Statesville, Pamlico, Randolph, Rowan-Salisbury, Sterling Montessori**, Wilson	
	1998 State	159.1	Stokes
		158.9	Alamance-Burlington, Alexander, Gaston, Gates, Roanoke Rapids City
		158.7	Lee
	158.5	American Ren. Middle**, Beaufort, Jones, Lincoln, Perquimans, Sampson, Wayne	
	1997 State	158.3	Durham, Scotland
	1995 State	158.1	Elizabeth City/Pasquotank, Franklin, Richmond
	1996 State	157.9	Bladen
	157.7	Greene, Kannapolis City	
	1994 State	157.5	Alpha Academy**, Anson, Caswell, Columbus, The Learning Center**, Tyrrell
	157.3	Hoke	
	1993 State	157.1	
	156.9	Martin, Montgomery, Rocky Mt Charter Public**	
	156.5	C.G. Woodson**, Imani Institute**, Warren	
	156.3	Quality Education**	
	156.1	Halifax, Northampton	
155.9	Robeson, S.B. Howard**		
155.5	Hertford, Lexington City, Thomasville City		
155.3	Edgecombe		
154.9	Carter Community**, MAST**		
154.7	Bethany Community**, Weldon City		
154.5	CIS Academy**		
154.1	Bertie, SPARC Academy**, Washington		
153.9	Vance		
153.5	Provisions Academy**		
152.5	Crossnore Academy**, Omuteko Gwamaziima**		
146.3	Success Academy**		
142.9	Lift Academy**		
*	Bridges**, Grandfather Academy**, Kennedy Charter**, Lakeside School**		

Notes: † Mean scale scores are rounded up to the nearest two-tenths of a point.

*Data are not reported where number tested is fewer than five.

**Denotes a charter school. For reporting purposes the charter school name has been abbreviated; the complete charter school name can be found in the Appendix.

Data received from LEAs and charter schools after August 2001 are not included in this table.

Prepared by the NCDPI Division of Accountability Services/Testing Section.

**Table 47. 2000-01 End-of-Grade Multiple-Choice Test Results
Grade 7 Mean Scale Score by LEA - Mathematics**

State***	Mean Score†	2001 LEA Performance
	280.9	Magellan**
	...	
	275.9	Exploris**
	...	
	274.9	Chapel Hill-Carrboro City
	...	
	274.5	Francine Delany**, Lake Norman**
	...	
	273.9	Mount Airy City, Transylvania
	...	
	273.5	Quest Academy**
	...	
	272.5	Mountain Community**, Watauga
	272.3	Franklin Academy**
	272.1	Ashe
	...	
	271.1	Henderson, Mooresville City, Orange Co. Charter**
	270.9	Buncombe
	270.7	Alleghany, Avery, Newton Conover City, Polk
	270.5	Wake
	...	
	270.1	Camden, Cherokee
	269.9	Elkin City
	...	
	269.5	Dare, Johnston, Surry, Yancey
	269.3	Asheville City
	269.1	Chatham Charter**, New Hanover, Union
	268.9	Caldwell, Haywood, Lee, Madison, Onslow
	...	
	268.5	Catawba, Clay, Currituck, Jackson, Orange, Stanly
	268.1	Cabarrus
	267.9	Brunswick, Cleveland, Davidson, Kings Mountain City, Lenoir, Pender, Pitt, Roanoke Rapids City, Rutherford, Summit Charter**, Wilkes
	267.7	Arapahoe**, Carteret, Iredell-Statesville, Moore, Perquimans
	267.5	Edenton/Chowan, Graham, Lincoln, McDowell, Wilson, Woods Charter**
	...	
2001 State	267.1	Alamance-Burlington, Burke, Chatham, Davie, Winston-Salem/Forsyth, Yadkin
	266.9	Asheboro City, Gaston, Harnett, Macon
	266.7	Hyde, Vance Charter**
	266.5	Clinton City, Craven, Gates, Nash-Rocky Mount, Pamlico, Person, Randolph, Shelby City
	266.3	Duplin, Guilford
	266.1	Charlotte/Mecklenburg, Stokes, Wayne
	265.9	Alexander, Downtown Middle**, Lincoln Charter**, Rowan-Salisbury
	265.7	The Learning Center**
	265.5	Hickory City, Kestrel Heights**, Martin, Rockingham, Thomas Jefferson**, Village Charter**
	265.3	Mitchell
	265.1	Elizabeth City/Pasquotank, Scotland, Tyrrell
	264.9	Beaufort, Cumberland, Durham, East Wake Academy**, Franklin, Kannapolis City, Swain, Whiteville City
	...	
	264.5	Granville, Sampson, Sterling Montessori**
	264.3	Bladen
1999,2000 State	264.1	Richmond
	263.9	Anson, Columbus, Greene, Jones
	263.7	Montgomery
	263.5	Hoke
	263.3	Caswell
	263.1	Bethany Community**, Brevard Academy**
	...	
	262.7	Robeson
	262.5	River Mill Charter**
	...	
1998 State	262.1	
	261.9	Edgecombe, Hertford, Northampton
	261.7	Rocky Mt Charter Public**
	261.5	Lexington City
	261.3	American Ren. Middle**, Halifax
1997 State	261.1	S.B. Howard**, Warren
	260.5	Thomasville City, Vance
	...	
1995,1996 State	260.1	
	259.5	C.G. Woodson**, Evergreen Community**, Weldon City
	...	
1993,1994 State	259.1	Imani Institute**
	258.9	Bertie, Washington
	258.7	Alpha Academy**
	...	
	257.9	CIS Academy**, MAST**, Quality Education**
	257.7	Carter Community**
	...	
	256.9	Omuteko Gwamaziima**, SPARC Academy**
	256.5	Provisions Academy**
	...	
	253.9	Crossnore Academy**
	...	
	252.9	Lift Academy**
	...	
	251.9	Success Academy**
	*	Bridges**, Grandfather Academy**, Kennedy Charter**, Lakeside School**

Notes: †Mean scale scores are rounded up to the nearest two-tenths of a point.

*Data are not reported where number tested is fewer than five.

**Denotes a charter school. For reporting purposes the charter school name has been abbreviated; the complete charter school name can be found in the Appendix.

***State counts for 1993-00 have been converted to the 2000-01 scale for mathematics using results from the 2000-01 equating study.

Data received from LEAs and charter school after August 2001 are not included in this table.

Prepared by the NCDPI Division of Accountability Services/Testing Section.

**Table 48. 2000-01 End-of-Grade Multiple-Choice Test Results
Grade 8 Mean Scale Score by LEA - Reading**

State	Mean Score [†]	2001 LEA Performance
	170.9	Magellan**
	169.9	Exploris**
	169.5	Chapel Hill-Carrboro City
	168.7	Francine Delany**
	168.1	Quest Academy**, Watauga
	167.5	Summit Charter**
	166.7	Yancey
	166.5	Clay, Lake Norman**, Orange Co. Charter**, Sterling Montessori**, Transylvania
	165.9	Alleghany, Evergreen Community**, Mount Airy City, Polk, Thomas Jefferson**, Wake
	165.7	Brevard Academy**, Cherokee
	165.5	Buncombe, Dare, River Mill Charter**, Village Charter**
	165.1	Camden, Moore, Mooresville City, Woods Charter**
	164.9	Currituck, Graham, Henderson, Johnston
	164.7	Burke, East Wake Academy**, Swain
	164.5	Avery, Cabarrus, Catawba, Elkin City, Madison, Orange, Surry, Union
	164.3	American Ren. Middle**, Ashe, Asheboro City, Craven, Onslow
	164.1	Carteret, Chatham, Davidson, Jackson, Kestrel Heights**, Mitchell, New Hanover
	163.9	Haywood, McDowell, Pamlico, Pender, Stanly
	163.7	Chatham Charter**, Kings Mountain City, Shelby City
	163.5	Alexander, Clinton City, Davie, Roanoke Rapids City, Rutherford, Wilkes, Winston-Salem/Forsyth
	163.3	Gates, Newton Conover City, Pitt
2001 State	163.1	Brunswick, Caldwell, Iredell-Statesville, Lenoir, Wilson
2000 State	162.9	Arapahoe**, Cleveland, Downtown Middle**, Guilford, Hyde, Macon, Person, Yadkin
	162.7	Asheville City, Quality Education**
1999 State	162.5	Alamance-Burlington, Charlotte/Mecklenburg, Duplin, Granville, Harnett, Hickory City, Lee, Randolph, Rockingham, Stokes
	162.3	Bethany Community**, Lincoln, Whiteville City
	162.1	Cumberland, Gaston, Sampson
1998 State	161.9	Rocky Mt Charter Public**, Wayne
	161.7	Durham, Elizabeth City/Pasquotank, MAST**
	161.5	Beaufort, Columbus, Edenton/Chowan, Greene, Lincoln Charter**, Perquimans, Richmond, Rowan-Salisbury, Thomasville City
	161.3	Nash-Rocky Mount
	161.1	Caswell
1997 State	160.9	Jones, Kannapolis City, Scotland
	160.5	Bladen, Franklin, Tyrrell
1995,1996 State	160.3	Martin, Montgomery
1994 State	160.1	
	159.9	Bertie, Northampton
	159.5	Anson, Hoke, Provisions Academy**
	159.3	Robeson, S.B. Howard**
	159.1	C.G. Woodson**, Lexington City
1993 State	158.9	Alpha Academy**, Edgecombe, Hertford, Vance
	158.5	Washington
	158.3	Warren
	158.1	Halifax
	156.9	SPARC Academy**
	156.1	Bridges**, Weldon City
	155.9	Grandfather Academy**
	155.7	Kennedy Charter**
	155.5	Imani Institute**
	154.9	Lakeside School**
	153.5	Crossnore Academy**, Omuteko Gwamaziima**
	152.3	Carter Community**
	151.9	CIS Academy**
	150.5	Lift Academy**
	149.9	Laurinburg Homework**
	146.5	Success Academy**
	*	The Learning Center**

Notes: [†]Mean scale scores are rounded up to the nearest two-tenths of a point.

*Data are not reported where number tested is fewer than five.

**Denotes a charter school. For reporting purposes the charter school name has been abbreviated; the complete charter school name can be found in the Appendix.

Data received from LEAs and charter schools after August 2001 are not included in this table.

Prepared by the NCDPI Division of Accountability Services/Testing Section.

Table 49. 2000-01 End-of-Grade Multiple-Choice Test Results
Grade 8 Mean Scale Score by LEA - Mathematics

State***	Mean Score†	2001 LEA Performance
	286.3	Magellan**
	278.5	Francine Delany**
	278.1	Chapel Hill-Carrboro City
	277.9	Exploris**
	277.5	Lake Norman**
	277.1	Watuga
	276.5	Transylvania
	275.5	Mount Airy City
	275.1	Quest Academy**
	274.7	Cherokee
	274.5	Buncombe, Currituck
	274.1	Mooresville City, Yancey
	273.9	Wake
	273.7	Surry
	273.5	Avery, Clay, Henderson, Orange Co. Charter**, Polk
	273.1	Johnston, Newton Conover City
	272.9	Alleghany, Graham
	272.7	Moore
	272.5	Dare, Madison, Thomas Jefferson**
	272.3	Catawba
	272.1	Arapahoe**, Lenoir, River Mill Charter**
	271.9	Ashe, Haywood, Jackson, Onslow, Pender, Union
	271.7	Cabarrus, Lee, Stanly, Summit Charter**
	271.5	Davidson, Hyde, New Hanover, Pamlico, Perquimans, Wilkes
	271.3	Asheboro City, Clinton City, Iredell-Statesville
	271.1	Gates, McDowell
	270.9	Brunswick, Davie, Village Charter**, Wilsor
	270.7	Burke, Caldwell, Kestrel Heights**
	270.5	Camden, Chatham, Lincoln, Person
	270.3	Chatham Charter**
2000,2001 State	270.1	Altamonte-Burlington, Brevard Academy**, Cleveland, Kings Mountain City
	269.9	Asheville City, Carteret, Edenton/Chowan, Elkin City, Mitchell, Rutherford, Shelby City, Sterling Montessori*
	269.7	Harnett, Pitt, Winston-Salem/Forsyth
	269.5	Beaufort, Craven, Duplin, Evergreen Community**, Hickory City, Roanoke Rapids City
	269.3	Randolph
1998,1999 State	269.1	Alexander, Gaston, Kannapolis City, Orange, Yadkin
	268.9	Guilford, Stokes, Swain
	268.7	Charlotte/Mecklenburg, Macon, Rockingham
	268.5	Whiteville City
	268.3	Rowan-Salisbury
	268.1	East Wake Academy**, Elizabeth City/Pasquotank, Scotland, Tyrrel
	267.9	Downtown Middle**, Martin, Nash-Rocky Mount, Sampson, Wayne, Woods Charter**
	267.7	Granville
	267.5	Columbus, Cumberland
	267.3	Franklin
1996,1997 State	267.1	Durham, Montgomery, Richmond
	266.9	Bladen, Lincoln Charter**, Thomasville City
	266.5	Robeson, Rocky Mt Charter Public**
	266.3	Jones
1995 State	266.1	
	265.9	Edgecombe, Greene
	265.7	Hertford, Northampton
	265.5	American Ren. Middle**, Bethany Community**, Hok
	265.3	Anson
1994 State	265.1	
	264.9	Halifax
	264.7	Lexington City
	264.5	Bertie, MAST**, Vance, Washington
1993 State	264.1	
	263.5	Caswell, Quality Education**
	263.3	S.B. Howard**, Warren
	263.1	Grandfather Academy**
	262.1	Provisions Academy**
	261.3	Weldon City
	259.9	C.G. Woodson**
	259.7	Bridges**
	259.3	Orrmteko Gwamaziima**
	258.9	CIS Academy**, Imani Institute**
	258.5	SPARC Academy**
	258.3	Crossnore Academy**
	257.9	Alpha Academy**
	256.5	Kennedy Charter**
	255.7	Success Academy**
	255.5	Carter Community**
	255.1	Laurinburg Homework**
	254.9	Lift Academy**
	254.5	Lakeside School**
	*	The Learning Center**

Notes: †Mean scale scores are rounded up to the nearest two-tenths of a point.

**Data are not reported where number tested is fewer than five.

*Denotes a charter school. For reporting purposes the charter school name has been abbreviated; the complete charter school name can be found in the Appendix.

***State counts for 1993-00 have been converted to the 2000-01 scale for mathematics using results from the 2000-01 equating study.

Data received from LEAs and charter schools after August 2001 are not included in this table.

Prepared by the NCDPI Division of Accountability Services/Testing Section.

High School Comprehensive Multiple-Choice Test Results

Table 1. 1997-98 to 2000-01 North Carolina High School Comprehensive Multiple-Choice Test Results
Statewide Summary
Reading and Mathematics

	Reading			Mathematics*		
	Number Tested	Percent Students at Achievement Levels III, IV	Percent Students at Achievement Levels III, IV	Number Tested	Percent Students at Achievement Level I	Percent Students at Achievement Levels III, IV
1997-98						
	73,976	55.6%	73,635	54.9%		
Standard Deviation	163.3	11.9%	174.3	14.9%		
	10.2		13.5			
1998-99						
	75,660	61.1%	75,527	61.4%		
Standard Deviation	164.8	8.8%	176.3	11.8%		
	9.8		13.6			
1999-00						
	77,360	61.7%	77,096	64.7%		
Standard Deviation	164.9	8.8%	177.5	10.5%		
	9.8		13.8			
2000-01						
	80,692	61.6%	80,492	66.8%		
Standard Deviation	164.9	9.5%	178.4	9.8%		
	10.0		14.1			

Notes: *The North Carolina mathematics tests measure the competencies in the 1998 North Carolina mathematics curriculum beginning in the 2000-01 school year.
 Data received from LEAs and charter schools after August 2001 are not included in this table.
 Prepared by the NCDPI Division of Accountability Services/Testing Section.

**Table 2. 1997-98 to 2000-01 North Carolina High School Comprehensive Multiple-Choice Test Results
Percent of Students at Each Achievement Level by Gender and Ethnicity**
Reading

Achievement Levels	All Students	Gender		American			Hispanic	Multi-Racial	White	
		Female	Male	Indian	Asian	Black				
Level I										
Students performing at Achievement Level I do not have sufficient mastery of knowledge and skills in the subject area to be successful at the next grade level.	1998	11.9	7.0	17.0	19.1	9.9	19.1	15.1	8.1	8.8
	1999	8.8	5.4	12.2	15.0	9.6	15.7	12.7	6.8	5.7
	2000	8.8	5.5	12.3	17.6	10.6	16.0	12.0	6.6	5.6
	2001	9.5	5.7	13.5	17.7	9.1	16.3	13.7	7.1	6.5
Level II										
Students performing at Achievement Level II demonstrate inconsistent mastery of knowledge and skills in the subject area and are minimally prepared to be successful at the next grade level.	1998	32.5	31.1	34.0	41.8	30.5	46.1	39.9	26.4	26.7
	1999	30.2	28.8	31.5	42.2	30.3	45.9	38.8	27.4	23.2
	2000	29.4	27.7	31.2	40.3	31.4	44.6	39.4	22.8	22.8
	2001	28.9	27.5	30.3	38.4	27.5	43.7	38.5	26.5	22.4
Level III										
Students performing at Achievement Level III consistently demonstrate mastery of the grade level subject matter and skills and are well-prepared for the next grade level.	1998	41.0	45.5	36.4	34.2	40.2	31.0	36.6	43.8	45.4
	1999	45.2	48.6	41.7	37.8	40.3	34.6	39.8	45.6	50.0
	2000	45.4	48.9	41.8	36.4	40.4	35.5	40.3	51.5	49.8
	2001	44.9	49.0	40.8	37.9	41.6	35.8	39.8	49.4	49.0
Level IV										
Students performing at Achievement Level IV consistently perform in a superior manner clearly beyond that required to be proficient at grade level work.	1998	14.6	16.4	12.6	4.9	19.4	3.7	8.4	21.7	19.1
	1999	15.9	17.3	14.6	5.0	19.9	3.8	8.8	20.3	21.1
	2000	16.4	17.9	14.8	5.7	17.5	3.8	8.3	19.2	21.8
	2001	16.7	17.9	15.5	6.0	21.8	4.2	8.1	16.9	22.2

High School Comprehensive Test Achievement Level Ranges - Reading

Level I	Level II	Level III	Level IV
132-150	151-162	163-174	175-201

Notes: Percents are rounded to the nearest tenth. Due to rounding, data may not add to 100%.
Data received from LEAs and charter schools after August 2001 are not included in this table.
Prepared by the NCDPI Division of Accountability Services/Testing Section.

**Table 3. 1997-98 to 2000-01 North Carolina High School Comprehensive Multiple-Choice Test Results
Percent of Students at Each Achievement Level by Gender and Ethnicity
Mathematics***

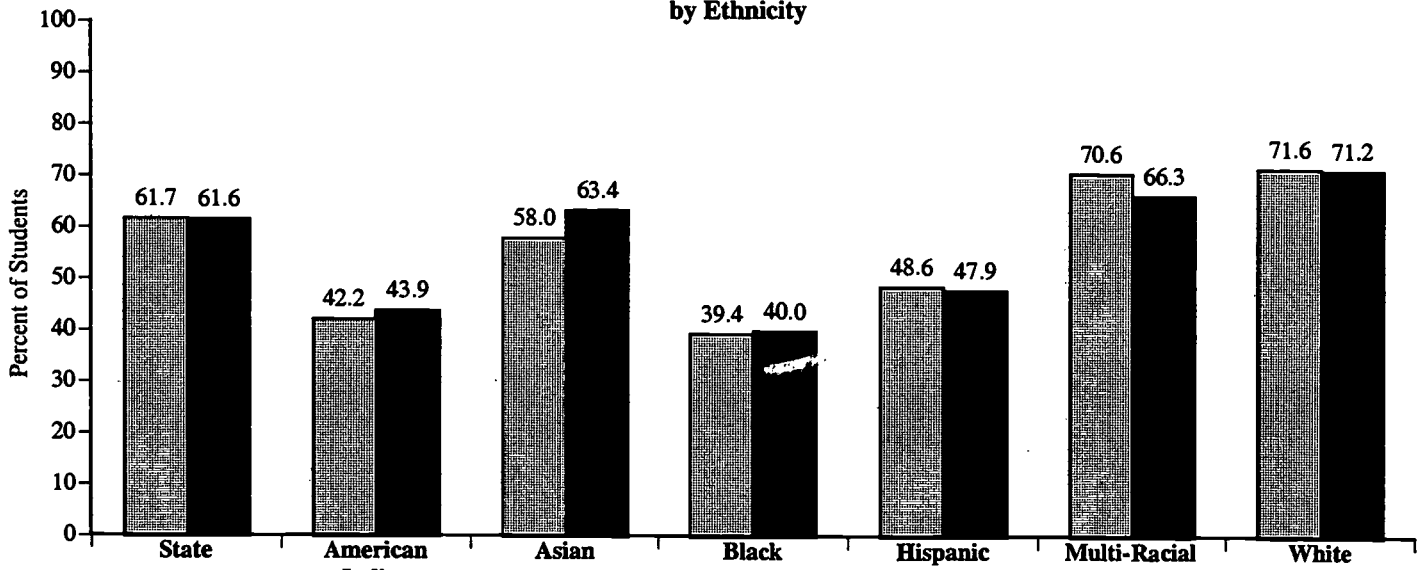
Achievement Levels	All Students	Gender		American Indian			Black	Hispanic	Multi-Racial	White
		Female	Male	Indian	Asian	Hispanic				
Level I										
Students performing at Achievement Level I do not have sufficient mastery of knowledge and skills in the subject area to be successful at the next grade level.	1998	14.9	12.8	17.1	24.2	7.8	26.2	18.3	15.7	10.2
	1999	11.8	10.6	12.9	16.7	8.1	22.9	15.2	11.6	7.1
	2000	10.5	9.2	11.9	18.7	7.4	20.6	14.7	10.3	6.3
	2001	9.8	8.2	11.5	16.0	6.6	18.7	14.8	8.5	6.0
Level II										
Students performing at Achievement Level II demonstrate inconsistent mastery of knowledge and skills in the subject area and are minimally prepared to be successful at the next grade level.	1998	30.2	30.1	30.3	41.2	18.8	42.0	37.8	25.7	25.3
	1999	26.8	26.9	26.7	38.4	21.2	40.3	34.6	27.9	21.0
	2000	24.8	24.6	25.0	36.3	19.2	38.6	31.7	23.7	19.0
	2001	23.4	23.5	23.4	31.2	16.9	37.0	30.6	23.4	17.6
Level III										
Students performing at Achievement Level III consistently demonstrate mastery of the grade level subject matter and skills and are well-prepared for the next grade level.	1998	38.8	41.6	35.9	29.9	38.5	28.6	35.9	36.4	43.3
	1999	42.0	43.9	39.9	38.6	35.6	32.5	39.5	39.9	46.2
	2000	42.6	45.0	40.2	37.3	39.7	35.1	43.2	44.8	45.8
	2001	42.3	44.5	40.2	41.1	36.8	37.4	42.5	45.3	44.5
Level IV										
Students performing at Achievement Level IV consistently perform in a superior manner clearly beyond that required to be proficient at grade level work.	1998	16.0	15.5	16.6	4.8	34.9	3.2	8.0	22.1	21.2
	1999	19.4	18.5	20.5	6.2	35.1	4.3	10.7	20.7	25.7
	2000	22.1	21.3	22.9	7.7	33.7	5.8	10.3	21.2	28.9
	2001	24.4	23.9	25.0	11.7	39.7	6.9	12.1	22.9	31.9

High School Comprehensive Test Achievement Level Ranges - Mathematics

Level I	Level II	Level III	Level IV
141-159	160-171	172-188	189-226

Notes: *The North Carolina mathematics tests measure the competencies in the 1998 North Carolina mathematics curriculum beginning in the 2000-01 school year. Percents are rounded to the nearest tenth. Due to rounding, data may not add to 100%.
Data received from LEAs and charter schools after August 2001 are not included in this table.
Prepared by the NCDPI Division of Accountability Services/Testing Section.

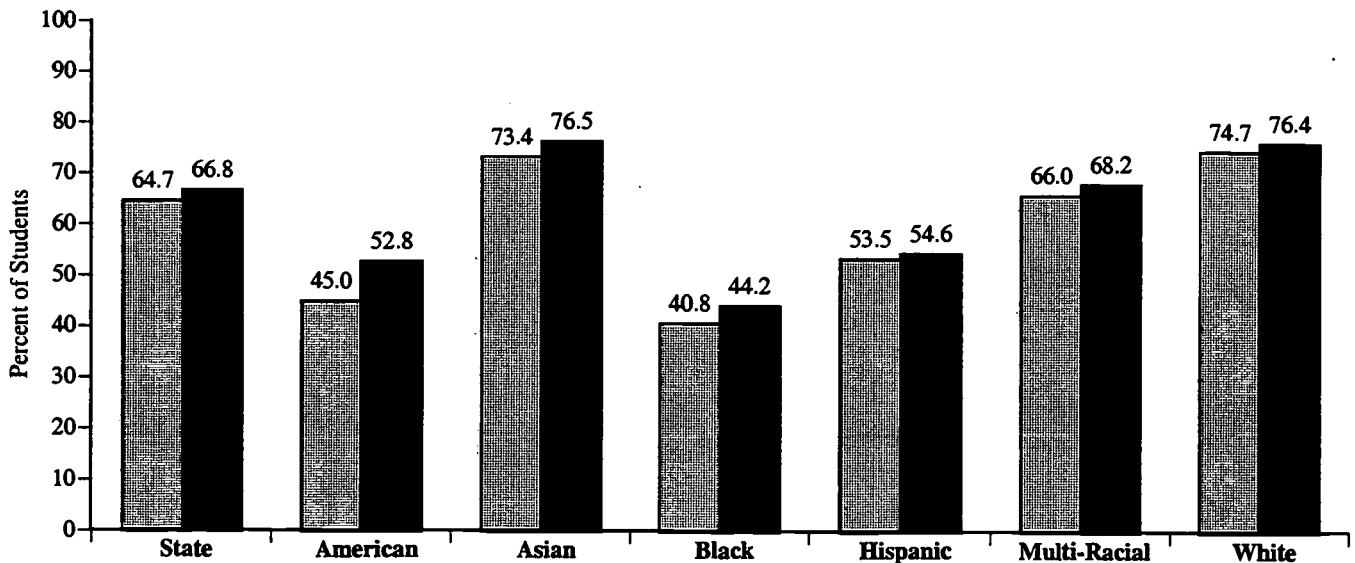
**Figure 1. 1999-00 to 2000-01 North Carolina High School Comprehensive Multiple-Choice Test Results
Percent of Students At or Above Level III in Reading
by Ethnicity**



	State	American Indian	Asian	Black	Hispanic	Multi-Racial	White
1999-00							
N Tested	77,360	1,083	1,591	20,794	1,669	606	51,502
N Level III, IV	47,756	457	922	8,184	811	428	36,873
2000-01							
N Tested	80,692	997	1,636	21,872	2,054	686	53,387
N Level III, IV	49,686	438	1,037	8,755	983	455	37,986



**Figure 2. 1999-00 to 2000-01 North Carolina High School Comprehensive Multiple-Choice Test Results
Percent of Students At or Above Level III in Mathematics
by Ethnicity**



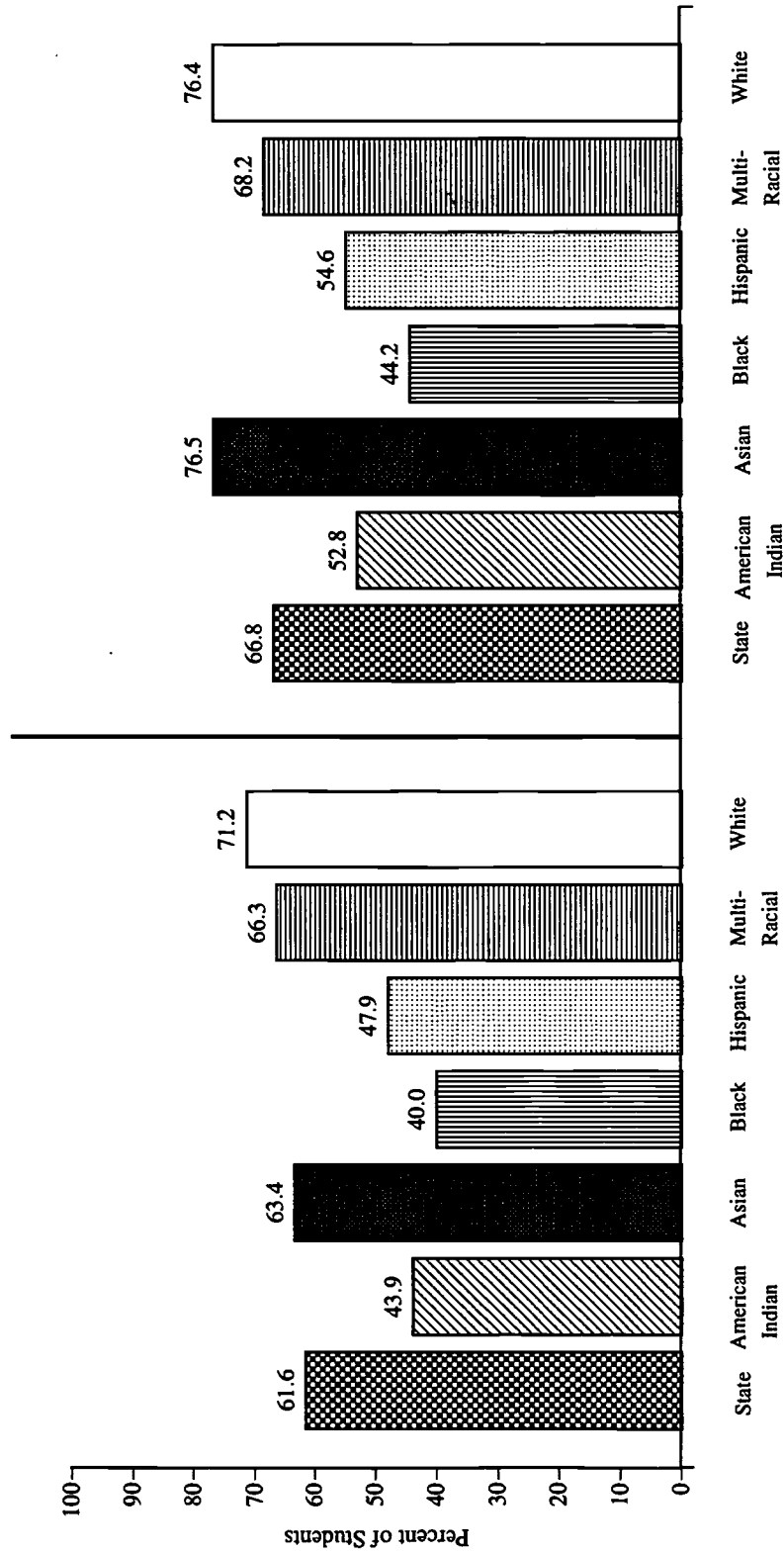
	State	American Indian	Asian	Black	Hispanic	Multi-Racial	White
1999-00							
N Tested	77,096	1,075	1,590	20,666	1,657	594	51,396
N Level III, IV	49,855	484	1,167	8,438	887	392	38,409
2000-01							
N Tested	80,492	990	1,642	21,814	2,041	685	53,260
N Level III, IV	53,732	523	1,256	9,652	1,115	467	40,689

Notes: "N Tested" and "N Level III, IV" for the ethnicity categories do not sum to the "N Tested" and "N Level III, IV" for the state because ethnicity was not coded on some student answer sheets and, therefore, some students were reported in the state data only.

Data received from LEAs and charter schools after August 2001 are not included in these figures.

Prepared by the NCDPI Division of Accountability Services/Testing Section.

**Figure 3. 2000-01 North Carolina High School Comprehensive Multiple-Choice Test Results
Percent of Students At or Above Level III in Reading and Mathematics
by Ethnicity**

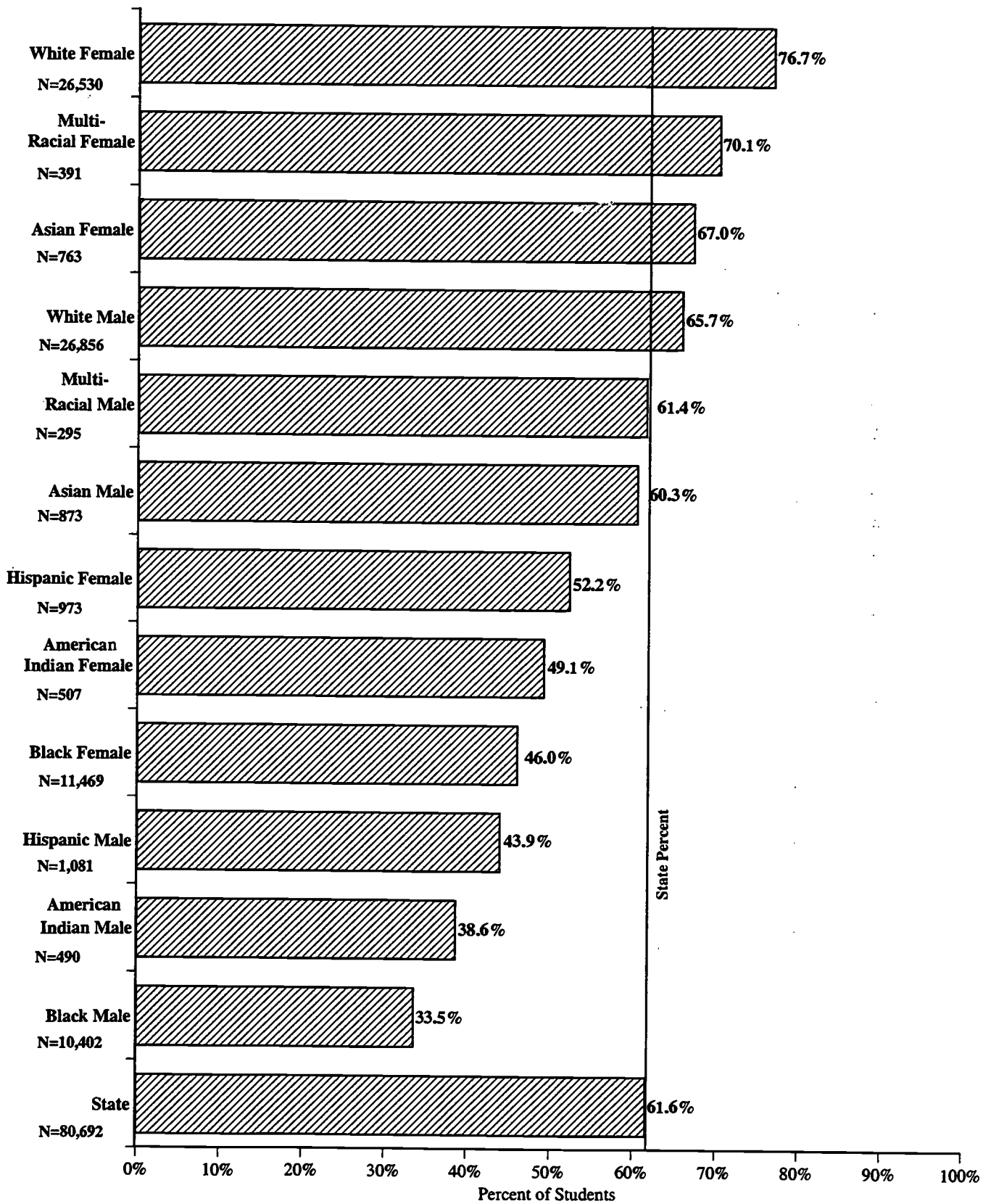


Reading
N Tested = 80,692
N Level III, IV = 49,686

Mathematics
N Tested = 80,492
N Level III, IV = 53,732

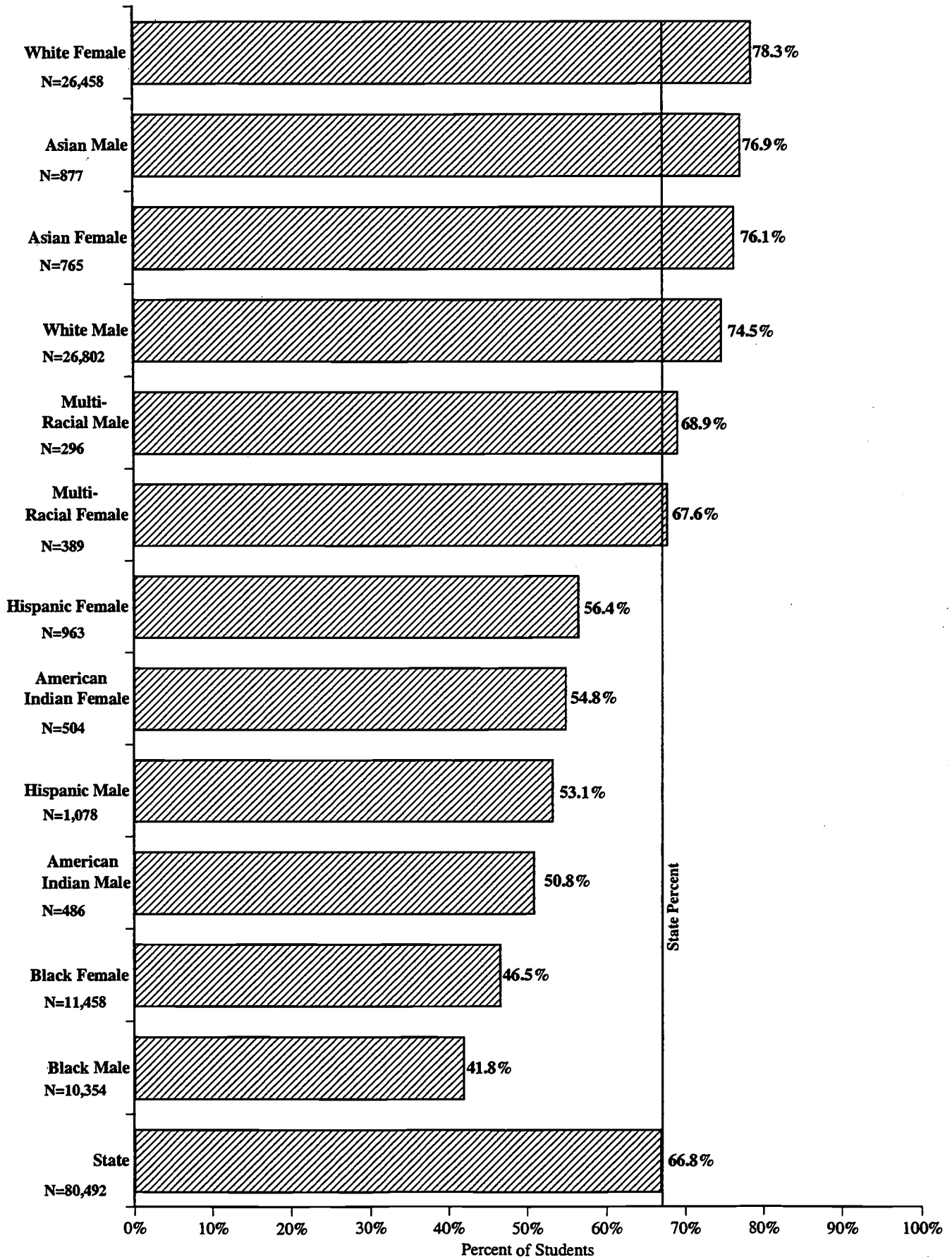
Note: Data received from LEAs and charter schools after August, 2001 are not included in this figure.
Prepared by the NCDPI Division of Accountability Services/Testing Section.

**Figure 4. 2000-01 North Carolina High School Comprehensive Multiple-Choice Test Results
Percent of Students At or Above Level III in Reading
by Gender and Ethnicity**



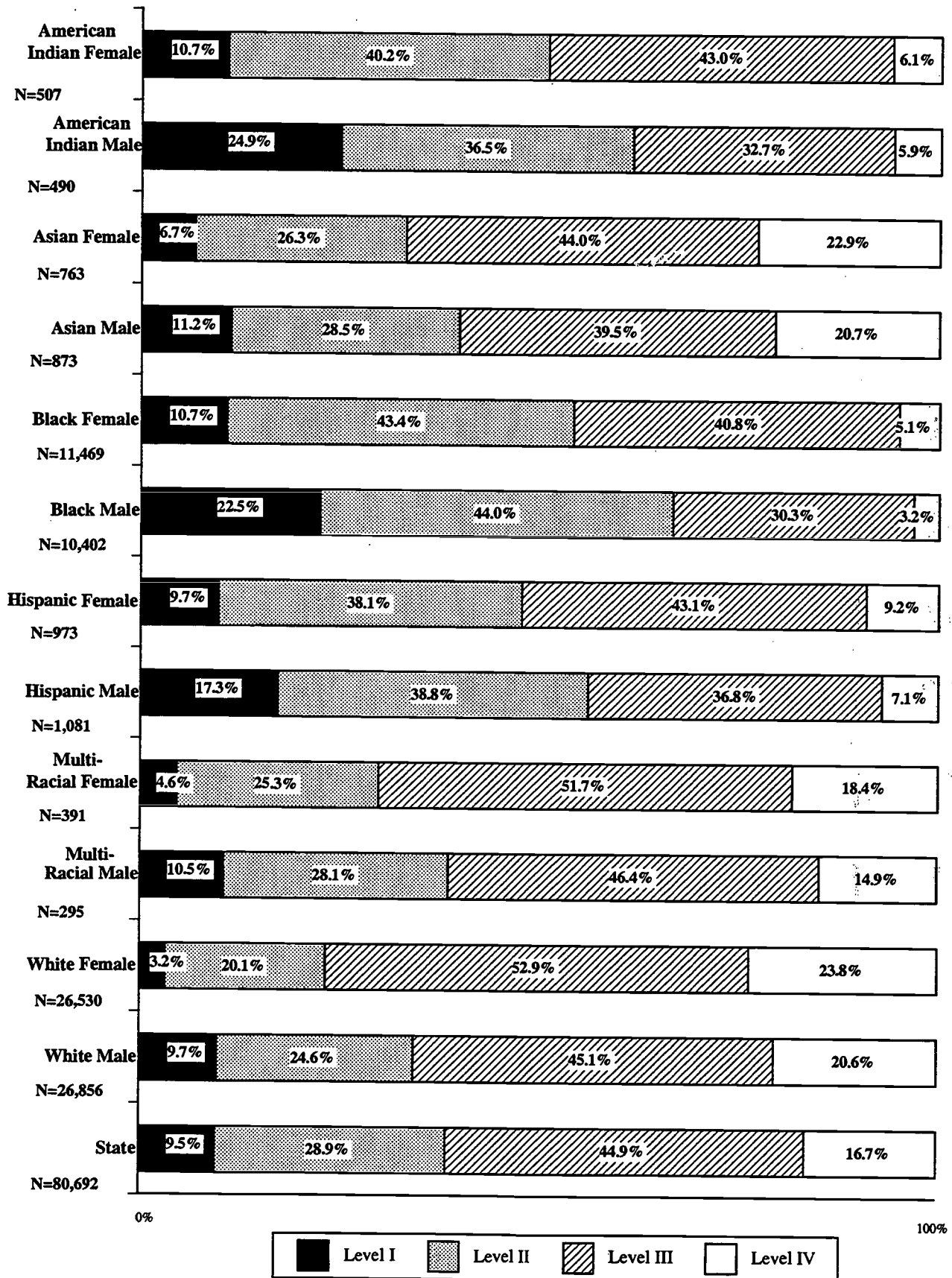
Notes: Data received from LEAs and charter schools after August 2001 are not included in this figure. Prepared by the NCDPI Division of Accountability Services/Testing Section.

**Figure 5. 2000-01 North Carolina High School Comprehensive Multiple-Choice Test Results
Percent of Students At or Above Level III in Mathematics
by Gender and Ethnicity**



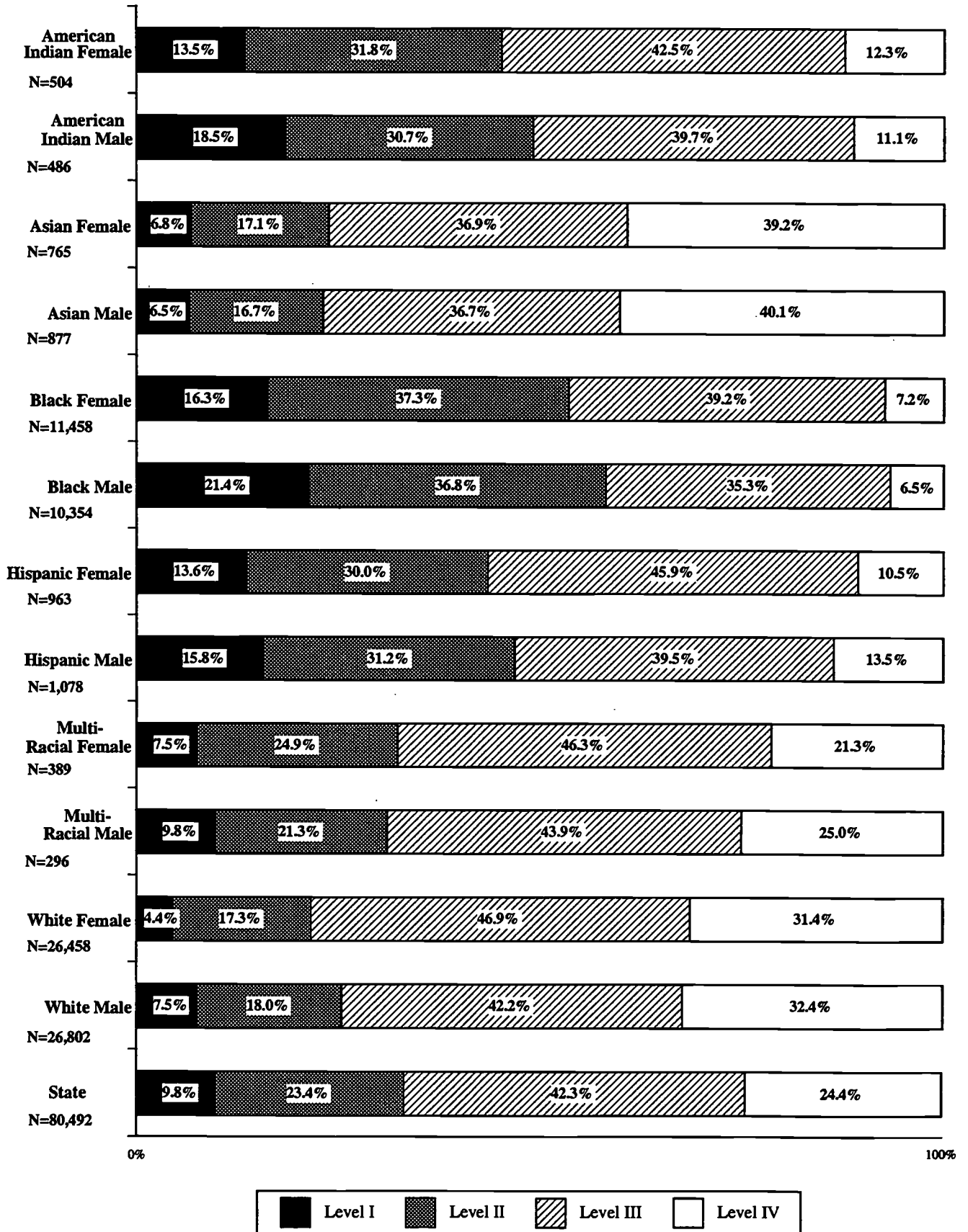
Note: Data received from LEAs and charter schools after August 2001 are not included in this figure.
Prepared by the NCDPI Division of Accountability Services/Testing Section.

**Figure 6. 2000-01 North Carolina High School Comprehensive Multiple-Choice Test Results
Percent of Students at Each Achievement Level in Reading
by Gender and Ethnicity**



Notes: Achievement levels for each category may not add to 100% due to rounding.
 Date received from LEAs and charter schools after August 2001 are not included in this figure.
 Prepared by the NCDPI Division of Accountability Services/Testing Section.

**Figure 7. 2000-01 North Carolina High School Comprehensive Multiple-Choice Tests Results
Percent of Students at Each Achievement Level in Mathematics
by Gender and Ethnicity**



Notes: Achievement levels for each category may not add to 100% due to rounding.
Date received from LEAs and charter schools after August 2001 are not included in this figure.
Prepared by the NCDPI Division of Accountability Services/Testing Section.

**Table 4. 2000-01 North Carolina High School Comprehensive Multiple-Choice Test Results
Performance of Academically Gifted, Exceptional, Limited English Proficient and Title I Students**

<u>Category</u>	<u>Number Tested</u>	<u>Percent¹</u>	<u>Percent At or Above Level III</u>		<u>Average Scale Score</u>	
			<u>Reading²</u>	<u>Mathematics²</u>	<u>Reading</u>	<u>Mathematics</u>
All Students	80,692	100.0	61.6	66.8	164.9	178.4
Not Exceptional	66,748	83.0	61.4	67.0	164.7	177.7
Academically Gifted	7,507	9.3	95.7	97.4	175.1	194.6
AG Reading	4,566	5.7	95.8	97.1	175.4	194.8
AG Math	4,457	5.5	95.8	97.8	175.2	195.7
Students with Disabilities	6,164	7.7	21.4	27.3	154.8	165.9
Behaviorally-Emotionally Handicapped	411	0.5	17.5	16.2	153.5	162.8
Hearing Impaired	82	0.1	25.6	37.8	155.8	168.1
Educable Mentally Handicapped	901	1.1	2.2	3.4	148.9	157.8
Specific Learning Disabled	3,898	4.8	23.8	32.4	155.6	167.5
LD Reading	2,404	3.0	16.8	29.2	153.9	166.5
LD Math	1,636	2.0	19.5	21.2	154.3	164.4
LD Written Expression	3,061	3.8	23.8	34.1	155.6	168.0
LD Other	104	0.1	23.1	26.7	156.1	166.2
Speech-Language Impaired	67	0.1	26.9	25.4	157.8	166.8
Visually Impaired	35	0.0	48.6	52.9	162.7	174.9
Other Health Impaired	661	0.8	31.6	33.1	157.7	168.2
Orthopedically Impaired	37	0.0	48.6	38.9	159.2	170.7
Traumatic Brain Injured	22	0.0	*	*	*	*
Autistic	34	0.0	41.2	35.3	158.5	168.7
Severe/Profound Mentally Disabled	0	0.0	*	*	*	*
Multihandicapped	8	0.0	*	*	*	*
Deaf-Blind	2	0.0	*	*	*	*
Trainable Mentally Disabled	6	0.0	*	*	*	*
Section 504	571	0.7	41.5	48.2	160.5	172.7
Limited English Proficient	748	0.9	21.8	38.6	155.6	169.1
Not Served by Title I	78,748	97.6	61.9	67.2	165.0	178.5
Schoolwide Title I Program	1,184	1.5	37.7	39.9	159.1	169.6
Targeted Assistance	31	0.0	48.4	41.9	159.7	170.8
Migrant	93	0.1	32.3	40.9	158.3	170.1

Notes: *No scores are reported for groups with fewer than thirty students.

¹Percents for "Not Exceptional" through "Trainable Mentally Disabled" are based on the sum of the students in those categories.

Percents for "Section 504" through "Migrant" as well as AG and LD categories are based on the number tested in the "All Students" category.

²The standard for grade-level proficiency is a test score at Level III or above on high school comprehensive tests in reading and mathematics.

The "All Students" and "Not Exceptional" categories are shown for the purpose of comparison.

"Not Exceptional," "Academically Gifted" and "Students with Disabilities" do not sum to "All Students" because some student answer sheets were not coded completely.

All data are rounded to the nearest tenth, therefore, exceptional categories may not sum to 100%.

"Number Tested" is the number of students who took the high school comprehensive test in reading.

Data received from LEAs and charter schools after August 2001 are not included in this table.

Prepared by the NCDPI Division of Accountability Services/Testing Section.

**Table 5. 2000-01 North Carolina High School Comprehensive Multiple-Choice Test Results
Performance of Students Using Accommodations**

<u>Category</u>	<u>Number</u>		<u>Percent At or</u>	<u>Percent At or</u>	<u>Average</u>	<u>Average</u>
	<u>Tested</u>	<u>Percent</u>	<u>Above Level III</u>	<u>Above Level III</u>	<u>Scale Score</u>	<u>Scale Score</u>
			<u>Reading</u>	<u>Mathematics</u>	<u>Reading</u>	<u>Mathematics</u>
All Students	80,692	100.0	61.6	66.8	164.9	178.4
Braille Edition	5	0.0	*	*	*	*
Large Print	25	0.0	*	*	*	*
Assistive Technology	8	0.0	*	*	*	*
Braille Writer	4	0.0	*	*	*	*
Cranmer Abacus	0	0.0	*	*	*	*
Dictation to Scribe	22	0.0	*	*	*	*
Interpreter Signs Test**	16	0.0	*	*	*	*
Magnification Devices	7	0.0	*	*	*	*
Student Marks in Test Book	810	1.0	18.8	24.0	154.3	164.9
Test Administrator Reads Test Aloud**	1,999	2.5	6.7	15.1	151.3	162.4
Use of Typewriter or Word Processor	9	0.0	*	*	*	*
Hospital/Home Testing	41	0.1	51.2	46.2	161.0	169.8
Multiple Test Sessions	404	0.5	15.1	20.3	153.7	163.7
Scheduled Extended Time	4,417	5.5	21.3	28.5	155.0	166.3
Testing in a Separate Room	3,521	4.4	15.7	23.1	153.5	164.6
English/Native Language Dictionary/Electronic Translator	237	0.3	20.3	43.6	155.4	170.5
One Test Item per Page	0	0.0	*	*	*	*

Notes: *No scores are reported for groups with fewer than thirty students.

Accommodations reported may have been implemented only for reading, only for mathematics, or for both portions of the test.

Accommodations are available for students with disabilities, limited English proficiency or temporary disabilities.

All data rounded to the nearest tenth, therefore, accommodation categories may not sum to 100%.

"Number tested" is the number of students who took the High School Comprehensive test in reading.

**The "Interpreter Signs Test" and "Test Administrator Reads Test Aloud" accommodations are prohibited from use during the administration of tests that measure reading skills.

Data received from LEAs and charter schools after August 2001 are not included in this table.

Prepared by the NCDPI Division of Accountability Services/Testing Section.

**Table 6. 2000-01 High School Comprehensive Multiple-Choice Test Results
Participation of Students with Special Needs****

<u>High School Comprehensive</u>	<u>Reading</u>		<u>Mathematics</u>	
	<u>Tested</u>	<u>Percent</u>	<u>Tested</u>	<u>Percent</u>
Statewide*	85,570	100.0	85,570	100.0
All Students with IEPs	7,860	9.2	7,860	9.2
Standard Administration	6,164	7.2	6,154	7.2
With Accommodations	5,587	6.5	5,587	6.5
NCCATS Accommodation Pilot***	783	0.9	779	0.9
Behaviorally-Emotionally Disabled	32	0.0	32	0.0
Hearing Impaired	4	0.0	5	0.0
Educable Mentally Disabled	455	0.5	454	0.5
Specific Learning Disabled	165	0.2	166	0.2
Speech-Language Impaired	3	0.0	3	0.0
Visually Impaired	3	0.0	3	0.0
Other Health Impaired	43	0.1	41	0.0
Orthopedically Impaired	4	0.0	4	0.0
Traumatic Brain Injured	7	0.0	7	0.0
Autistic	10	0.0	11	0.0
Severe/Profound Mentally Disabled	5	0.0	5	0.0
Multihandicapped	14	0.0	14	0.0
Deaf-Blind	0	0.0	0	0.0
Trainable Mentally Disabled	38	0.0	34	0.0
Alternate Assessments				
NCAAAI Pilot***	198	0.2	201	0.2
Behaviorally-Emotionally Disabled	7	0.0	7	0.0
Hearing Impaired	2	0.0	2	0.0
Educable Mentally Disabled	118	0.1	118	0.1
Specific Learning Disabled	22	0.0	21	0.0
Speech-Language Impaired	0	0.0	0	0.0
Visually Impaired	0	0.0	0	0.0
Other Health Impaired	14	0.0	14	0.0
Orthopedically Impaired	2	0.0	2	0.0
Traumatic Brain Injured	0	0.0	1	0.0
Autistic	10	0.0	10	0.0
Severe/Profound Mentally Disabled	0	0.0	2	0.0
Multihandicapped	5	0.0	5	0.0
Deaf-Blind	0	0.0	0	0.0
Trainable Mentally Disabled	18	0.0	19	0.0
NCAAP****	270	0.3	270	0.3
Behaviorally-Emotionally Disabled	1	0.0	1	0.0
Hearing Impaired	0	0.0	0	0.0
Educable Mentally Disabled	50	0.1	50	0.1
Specific Learning Disabled	1	0.0	1	0.0
Speech-Language Impaired	0	0.0	0	0.0
Visually Impaired	0	0.0	0	0.0
Other Health Impaired	8	0.0	8	0.0
Orthopedically Impaired	1	0.0	1	0.0
Traumatic Brain Injured	1	0.0	1	0.0
Autistic	26	0.0	26	0.0
Severe/Profound Mentally Disabled	43	0.1	43	0.1
Multihandicapped	38	0.0	38	0.0
Deaf-Blind	0	0.0	0	0.0
Trainable Mentally Disabled	101	0.1	101	0.1
All Students Identified Only Under Section 504**	604	0.7	604	0.7
Standard Administration	571	0.7	569	0.7
With Accommodations	352	0.4	352	0.4
NCCATS Accommodation Pilot***	5	0.0	3	0.0
Alternate Assessments				
NCAAAI***	0	0.0	0	0.0
NCAAP****	0	0.0	0	0.0
All Limited English Proficient Students**	1,025	1.2	1,025	1.2
Standard Administration	748	0.9	743	0.9
With Accommodations	452	0.5	452	0.5
Not Participating				
First Year	139	0.2	139	0.1
Second Year	109	0.1	109	0.1

Notes: *Actual student membership is used for the statewide N-counts.

**Due to miscoding or rounding, some columns may not add up to the total. These data represent coding on the 2000-01 high school comprehensive test answer sheets. These data do not reflect the actual number of alternate assessments scored for the 2000-01 school year.

***NCCATS is the North Carolina Computerized Adaptive Testing System accommodation and the NCAAAI is the North Carolina Alternate Assessment Academic Inventory; both were pilots for the 2000-01 school year.

****NCAAP is the North Carolina Alternate Assessment Portfolio.

Data received from LEAs and charter schools after August 2001 are not included in this table.

Prepared by the NCDPI Division of Accountability Services/Testing Section.

**Table 7. 2000-01 North Carolina High School Comprehensive Multiple-Choice Test Results
Characteristics and Performance**

	<u>N</u>	<u>Percent</u>	<u>Percent At or Above Level III Reading</u>	<u>Percent At or Above Level III Mathematics</u>	<u>Average Scale Score Reading</u>	<u>Average Scale Score Mathematics</u>
<u>All Students</u>	80,692	100.0	61.6	66.8	164.9	178.4
<u>Gender</u>						
Male	40,032	49.6	56.3	65.2	163.6	178.2
Female	40,657	50.4	66.8	68.3	166.2	178.6
<u>Ethnic Group</u>						
American Indian	997	1.2	43.9	52.8	160.5	172.9
Asian	1,636	2.0	63.4	76.5	165.9	184.2
Black	21,872	27.1	40.0	44.3	159.9	170.5
Hispanic	2,054	2.6	47.9	54.6	161.6	173.4
Multi-Racial	686	0.9	66.3	68.2	165.8	178.3
White	53,387	66.2	71.2	76.4	167.1	181.8
Other	39	0.1	51.3	45.0	162.0	173.4
<u>Parental Education</u>						
Did not finish high school	4,909	6.3	34.9	42.8	158.7	170.0
High school graduate	19,706	25.2	46.6	54.5	161.3	173.5
After high school education	8,018	10.3	64.3	68.1	165.0	177.8
Trade or business school	2,970	3.8	58.5	62.0	163.7	176.4
Community college	14,044	18.0	63.7	69.2	165.0	178.1
Four-year college degree	19,586	25.1	73.3	77.1	167.8	182.5
Graduate school	8,928	11.4	84.0	86.3	171.6	188.5
<u>Hours of Homework (per week)</u>						
None assigned	1,555	2.0	26.2	28.4	155.4	166.3
Assigned but not done	2,564	3.2	44.4	51.5	160.4	173.5
1 hour or less	18,524	23.4	47.4	54.5	161.5	173.7
1 to 3 hours	35,105	44.3	61.3	66.5	164.6	177.5
More than 3, less than 5 hours	11,849	15.0	76.6	80.8	168.6	183.8
Between 5-10 hours	7,508	9.5	85.1	88.2	171.3	188.1
More than 10 hours	2,088	2.6	85.4	88.3	172.3	190.7
<u>Days Absent (so far this year)</u>						
0-7 days	54,687	68.6	66.3	72.2	166.1	180.4
8-14 days	16,910	21.2	55.8	60.1	163.4	175.5
15-21 days	5,035	6.3	47.2	50.5	161.3	172.4
More than 21 days	3,053	3.8	37.2	37.8	158.8	168.9

Notes: "N" is the number of students who took the High School Comprehensive test in reading. Students may identify more than one "Courses Taken" or "Use of Outside Reading," therefore, "N" will be greater than "All Students" and "Percent" will sum to greater than 100. Data received from LEAs and charter schools after August 2001 are not included in this table. Prepared by the NCDPI Division of Accountability Services/Testing Section.

Table 7. 2000-01 North Carolina High School Comprehensive Multiple-Choice Test Results Characteristics and Performance (continued)

	<u>N</u>	<u>Percent</u>	<u>Percent At or Above Level III Reading</u>	<u>Percent At or Above Level III Mathematics</u>	<u>Average Scale Score Reading</u>	<u>Average Scale Score Mathematics</u>
<u>Use of Outside Readings*</u>						
Class Discussions	46,867	58.1	69.3	74.1	166.7	180.8
Oral Reports	20,816	25.8	68.0	72.7	166.5	180.5
Quizzes	45,382	56.2	67.6	72.6	166.3	180.2
Essays	35,068	43.5	72.6	76.9	167.5	182.1
Apply to activity	28,625	35.5	72.6	77.1	167.4	181.7
Apply to course project	14,363	17.8	76.0	80.5	168.7	183.8
No Follow-up	5,722	7.1	53.1	58.7	162.8	175.7
<u>Use of Graphing Calculator</u>						
No regular access	13,263	16.8	48.9	51.9	161.6	172.5
Has access, doesn't use	11,647	14.7	61.2	65.5	164.5	177.1
Uses 1-2 times a month	10,129	12.8	56.5	61.2	163.5	175.6
Uses 1-2 times a week	13,648	17.3	62.5	68.1	165.1	178.7
Uses daily	30,372	38.4	69.6	76.2	167.2	182.7
<u>Courses Taken*</u>						
Pre-Algebra	42,077	52.2	69.2	73.4	166.8	181.1
Algebra IA	27,553	34.2	51.5	56.9	162.4	174.3
Algebra I or IB	56,266	69.7	68.1	74.0	166.5	180.7
Technical Math	5,697	7.1	50.1	56.6	162.1	174.3
Geometry	46,022	57.0	78.5	85.2	168.8	184.4
Algebra II	22,631	28.1	90.1	95.3	172.4	192.0
Advanced Math	2,807	3.5	90.6	94.0	174.8	198.5
Science - outside reading	47,665	59.1	66.6	71.9	166.0	179.8
Science - no outside reading	17,597	21.8	69.6	73.5	167.2	181.7
Social Studies - reading	48,054	59.6	69.2	74.2	166.7	180.9
Social Studies - no reading	12,937	16.0	69.9	74.4	167.0	181.4
Vocational - reading	18,848	23.4	73.0	77.9	167.2	181.5
Vocational - no reading	13,841	17.2	77.2	81.8	168.5	183.7
No Sci., SS, or Voc.	1,360	1.7	26.5	31.8	156.6	167.6
<u>Student Took Make-up Test</u>						
Yes	4,556	5.7	39.3	44.3	159.3	171.0
<u>Misadministration</u>						
Yes	333	0.4	56.2	58.3	162.7	175.1

Notes: "N" is the number of students who took the High School Comprehensive test in reading. Students may identify more than one "Courses Taken" or "Use of Outside Reading," therefore, "N" will be greater than "All Students" and "Percent" will sum to greater than 100. Data received from LEAs and charter schools after August 2001 are not included in this table. Prepared by the NCDPI Division of Accountability Services/Testing Section.

**Table 8. 2000-01 North Carolina High School Comprehensive Multiple-Choice Test Results
Teacher Evaluation and Performance**

	<u>N</u>	<u>Percent</u>	<u>Percent At or Above Level III Reading</u>	<u>Percent At or Above Level III Mathematics</u>	<u>Average Scale Score Reading</u>	<u>Average Scale Score Mathematics</u>
All Students	80,692	100.0	61.6	66.8	164.9	178.4
<u>Teacher Evaluation - Reading</u>						
Expected Grade A	12,280	16.4	90.0	91.2	172.9	190.0
Expected Grade B	24,650	33.0	73.3	77.6	167.1	181.2
Expected Grade C	23,814	31.8	51.3	58.4	162.3	174.6
Expected Grade D	10,336	13.8	35.7	42.7	159.0	170.3
Expected Grade F	3,701	5.0	26.7	35.4	156.9	168.1
Assessed as Level 1	8,275	11.3	27.0	34.2	156.8	167.9
Assessed as Level 2	21,857	29.7	44.5	52.2	161.0	172.9
Assessed as Level 3	29,874	40.6	70.3	75.4	166.4	180.0
Assessed as Level 4	13,559	18.4	92.2	92.7	173.3	190.5
<u>Teacher Evaluation - Math</u>						
Expected Grade A	10,392	14.2	89.4	93.7	172.8	192.1
Expected Grade B	21,359	29.1	73.7	80.2	167.4	182.2
Expected Grade C	23,566	32.1	55.6	62.3	163.3	175.6
Expected Grade D	12,087	16.5	41.3	45.1	160.1	170.7
Expected Grade F	5,990	8.2	33.5	34.0	158.3	167.7
Assessed as Level 1	11,725	15.9	35.2	36.9	158.7	168.5
Assessed as Level 2	23,374	31.6	50.7	56.6	162.2	173.8
Assessed as Level 3	26,646	36.1	71.2	78.0	166.7	181.1
Assessed as Level 4	12,144	16.4	91.0	95.2	173.1	192.5

Notes: "N" is the number of students who took the High School Comprehensive test in reading.

Data received from LEAs and charter schools after August 2001 are not included in this table.

Prepared by the NCDPI Division of Accountability Services/Testing Section.

**Table 9. 2000-01 North Carolina High School Comprehensive Test
Goal Summary Report**

	Developmental Score Mean	Number of Observations*	# of Items	Percent Correct**
READING (Average of Averages)	164.9	80,692	71	
GOAL 1: Use strategies and processes that enhance control of communications skills development.			18	65.5
GOAL 2: Use language for the acquisition, interpretation, and application of information.			163	55.6
Obj 2.1: Identify, collect or select information and ideas.			54	59.6
Obj 2.2: Analyze, synthesize, and organize information and ideas and discover related ideas, concepts or generalizations.			72	53.2
Obj 2.3: Apply, extend, and expand on information and concepts.			37	54.5
GOAL 3: Use language for critical analysis and evaluation.			32	59.5
Obj 3.1: Assess the validity and accuracy of information and ideas			4	
Obj 3.2: Determine the value of information and ideas			13	67.1
Obj 3.3: Develop criteria and evaluate the quality, relevance, and importance of the information and ideas			15	53.4
MATHEMATICS (Average of Averages)	178.4	80,492	70	
GOAL 1: Numerical Relationships			21	60.4
Obj 1.1: Perform operations with real numbers			3	
Obj 1.2: Solve problems involving number theory			9	61.7
Obj 1.3: Solve problems using ratios, proportions, and percents			9	51.7
GOAL 2: Growth and Measurement			63	47.2
Obj 2.1: Geometric problems using two and three-dimensional shapes			18	53.7
Obj 2.2: Solve problems using properties of angles, lines, and planes			9	57.7
Obj 2.3: Solve problems using perimeter, area, and volume formulas			15	35.1
Obj 2.4: Solve problems using right triangle relationships			12	42.4
Obj 2.5: Transform polygons in the coordinate plane			9	50.2
GOAL 3: Algebraic Concepts			72	51.4
Obj 3.1: Use the language of algebra and formulas to solve problems			13	57.1
Obj 3.2: Demonstrate an understanding of relations and functions			12	56.7
Obj 3.3: Graph and use linear equations and inequalities			14	51.6
Obj 3.4: Solve problems that involve nonlinear equations			14	46.3
Obj 3.5: Use an appropriate method to solve problems involving systems of equations and inequalities			14	42.4
Obj 3.6: Perform operations with polynomials			5	62.3
GOAL 4: Data Analysis			54	46.8
Obj 4.1: Solve real world problems using statistics			23	58.8
Obj 4.2: Solve real world problems using probability			21	40.4
Obj 4.3: Fit a line or curve to a set of data			10	32.3
NUMBER OF STUDENTS TAKING FORM	A ----- 26,881	B ----- 27,017	C ----- 26,794	

Notes: * "Number of Observations" includes students who attempted at least one item on the test.

** "Percent Correct" is the number of correct responses to an item divided by the number of students who took that item summed over all items for a goal or objective divided by the number of items for that goal or objective.

Data received from LEAs after August 2001 are not included in this table.

Prepared by the NCDPI Division of Accountability Services/Testing Section.

**Table 10. 2000-01 North Carolina High School Comprehensive Test
Distribution of Scale Scores - Reading**

<u>NUMBER OF STUDENTS WITH VALID SCORES*</u>	80,692	<u>HIGH SCORE</u>	198
		<u>LOW SCORE</u>	132
<u>MEAN</u>	164.9	<u>STATE PERCENTILES</u>	<u>SCALE SCORE</u>
<u>STANDARD DEVIATION</u>	10.0	90	177.37
		75	172.07
		50 (<u>MEDIAN</u>)	165.40
<u>VARIANCE</u>	100.2	25	158.28
		10	150.83

FREQUENCY DISTRIBUTION

<u>SCALE SCORE</u>	<u>FREQUENCY</u>	<u>CUMULATIVE FREQUENCY</u>	<u>PERCENT</u>	<u>CUMULATIVE PERCENT</u>	<u>1998 STATE PERCENTILE</u>
198	1	80692	0.00	100.00	99
197	5	80691	0.01	100.00	99
195	4	80686	0.00	99.99	99
194	12	80682	0.01	99.99	99
193	16	80670	0.02	99.97	99
192	24	80654	0.03	99.95	99
191	28	80630	0.03	99.92	99
190	83	80602	0.10	99.89	99
189	94	80519	0.12	99.79	99
188	110	80425	0.14	99.67	99
187	220	80315	0.27	99.53	99
186	225	80095	0.28	99.26	99
185	140	79870	0.17	98.98	99
184	531	79730	0.66	98.81	99
183	658	79199	0.82	98.15	98
182	816	78541	1.01	97.33	98
181	982	77725	1.22	96.32	97
180	1106	76743	1.37	95.11	96
179	1304	75637	1.62	93.74	95
178	1446	74333	1.79	92.12	93
177	2107	72887	2.61	90.33	91
176	1689	70780	2.09	87.72	89
175	1865	69091	2.31	85.62	87
174	2678	67226	3.32	83.31	84
173	2795	64548	3.46	79.99	82
172	2855	61753	3.54	76.53	79
171	2942	58898	3.65	72.99	76
170	2910	55956	3.61	69.35	73
169	3076	53046	3.81	65.74	69
168	3885	49970	4.81	61.93	66
167	2949	46085	3.65	57.11	62
166	2314	43136	2.87	53.46	58
165	4663	40822	5.78	50.59	55
164	2294	36159	2.84	44.81	51
163	2859	33865	3.54	41.97	47
162	2176	31006	2.70	38.43	43
161	4193	28830	5.20	35.73	40
160	2021	24637	2.50	30.53	36
159	1911	22616	2.37	28.03	32
158	2365	20705	2.93	25.66	30
157	2322	18340	2.88	22.73	27
156	1618	16018	2.01	19.85	24
155	1973	14400	2.45	17.85	22
154	1394	12427	1.73	15.40	19
153	867	11033	1.07	13.67	17
152	1311	10166	1.62	12.60	15
151	1167	8855	1.45	10.97	13
150	1162	7688	1.44	9.53	11
149	1034	6526	1.28	8.09	9
148	947	5492	1.17	6.81	8
147	936	4545	1.16	5.63	7
146	531	3609	0.66	4.47	6
145	545	3078	0.68	3.81	5
144	683	2533	0.85	3.14	4
143	543	1850	0.67	2.29	3

Notes: *Students with valid scores are those students who attempted at least one item on the test.
Data received from LEAs and charter schools after August 2001 are not included in this table.
Prepared by the NCDPI Division of Accountability Services/Testing Section.

**Table 10. 2000-01 North Carolina High School Comprehensive Test
Distribution of Scale Scores – Reading (continued)**

FREQUENCY DISTRIBUTION

<u>SCALE SCORE</u>	<u>FREQUENCY</u>	<u>CUMULATIVE FREQUENCY</u>	<u>PERCENT</u>	<u>CUMULATIVE PERCENT</u>	<u>1998 STATE PERCENTILE</u>
142	417	1307	0.52	1.62	2
141	325	890	0.40	1.10	1
140	256	565	0.32	0.70	1
139	107	309	0.13	0.38	1
138	86	202	0.11	0.25	1
137	34	116	0.04	0.14	1
136	24	82	0.03	0.10	1
LESS THAN 136	58	58	0.07	0.07	1

Notes: *Students with valid scores are those students who attempted at least one item on the test.
Data received from LEAs and charter schools after August 2001 are not included in this table.
Prepared by the NCDPI Division of Accountability Services/Testing Section.

**Table 11. 2000-01 North Carolina High School Comprehensive Test
Distribution of Scale Scores – Mathematics**

<u>NUMBER OF STUDENTS WITH VALID SCORES*</u>	80,492	<u>HIGH SCORE</u>	226
		<u>LOW SCORE</u>	141
<u>MEAN</u>	178.4	<u>STATE PERCENTILES</u>	<u>SCALE SCORE</u>
<u>STANDARD DEVIATION</u>	14.1	90	197.22
		75	188.28
		50 (<u>MEDIAN</u>)	178.10
<u>VARIANCE</u>	199.0	25	167.86
		10	159.62

FREQUENCY DISTRIBUTION

<u>SCALE SCORE</u>	<u>FREQUENCY</u>	<u>CUMULATIVE FREQUENCY</u>	<u>PERCENT</u>	<u>CUMULATIVE PERCENT</u>	<u>1998 STATE PERCENTILE</u>
226	1	80492	0.00	100.00	99
225	7	80491	0.01	100.00	99
224	7	80484	0.01	99.99	99
223	25	80477	0.03	99.98	99
221	49	80452	0.06	99.95	99
220	19	80403	0.02	99.89	99
218	66	80384	0.08	99.87	99
217	38	80318	0.05	99.78	99
216	124	80280	0.15	99.74	99
215	51	80156	0.06	99.58	99
214	169	80105	0.21	99.52	99
213	98	79936	0.12	99.31	99
212	195	79838	0.24	99.19	99
211	127	79643	0.16	98.95	99
210	252	79516	0.31	98.79	99
209	123	79264	0.15	98.47	99
208	254	79141	0.32	98.32	99
207	475	78887	0.59	98.01	99
206	365	78412	0.45	97.42	99
205	394	78047	0.49	96.96	98
204	417	77653	0.52	96.47	98
203	469	77236	0.58	95.95	98
202	795	76767	0.99	95.37	97
201	793	75972	0.99	94.38	97
200	859	75179	1.07	93.40	96
199	923	74320	1.15	92.33	95
198	659	73397	0.82	91.19	95
197	1046	72738	1.30	90.37	94
196	1034	71692	1.28	89.07	93
195	1507	70658	1.87	87.78	92
194	1168	69151	1.45	85.91	91
193	1240	67983	1.54	84.46	90
192	1282	66743	1.59	82.92	89
191	1323	65461	1.64	81.33	88
190	1853	64138	2.30	79.68	86
189	1453	62285	1.81	77.38	85
188	2078	60832	2.58	75.58	83
187	1594	58754	1.98	72.99	81
186	1662	57160	2.06	71.01	80
185	1723	55498	2.14	68.95	78
184	1791	53775	2.23	66.81	76
183	1865	51984	2.32	64.58	74
182	1977	50119	2.46	62.27	72
181	2670	48142	3.32	59.81	70
180	2070	45472	2.57	56.49	67
179	2246	43402	2.79	53.92	64
178	2255	41156	2.80	51.13	62
177	2357	38901	2.93	48.33	59
176	2257	36544	2.80	45.40	56
175	1633	34287	2.03	42.60	54
174	1654	32654	2.05	40.57	52
173	1670	31000	2.07	38.51	50
172	2570	29330	3.19	36.44	47
171	2502	26760	3.11	33.25	43

Notes: *Students with valid scores are those students who attempted at least one item on the test.
Data received from LEAs and charter schools after August 2001 are not included in this table.
Prepared by the NCDPI Division of Accountability Services/Testing Section.

**Table 11. 2000-01 North Carolina High School Comprehensive Test
Distribution of Scale Scores – Mathematics (continued)**

FREQUENCY DISTRIBUTION

SCALE SCORE	FREQUENCY	CUMULATIVE FREQUENCY	PERCENT	CUMULATIVE PERCENT	1998 STATE PERCENTILE
170	1654	24258	2.05	30.14	40
169	840	22604	1.04	28.08	38
168	2547	21764	3.16	27.04	36
167	1630	19217	2.03	23.87	33
166	808	17587	1.00	21.85	31
165	2468	16779	3.07	20.85	28
164	696	14311	0.86	17.78	26
163	1538	13615	1.91	16.91	24
162	2160	12077	2.68	15.00	21
161	683	9917	0.85	12.32	18
160	1339	9234	1.66	11.47	16
159	1739	7895	2.16	9.81	13
158	555	6156	0.69	7.65	11
157	1016	5601	1.26	6.96	10
156	1331	4585	1.65	5.70	8
155	724	3254	0.90	4.04	6
154	519	2530	0.64	3.14	4
153	489	2011	0.61	2.50	3
152	574	1522	0.71	1.89	2
151	362	948	0.45	1.18	1
150	223	586	0.28	0.73	1
149	167	363	0.21	0.45	1
148	71	196	0.09	0.24	1
LESS THAN 148	125	125	0.16	0.16	1

Notes: *Students with valid scores are those students who attempted at least one item on the test.
Data received from LEAs and charter schools after August 2001 are not included in this table.
Prepared by the NCDPI Division of Accountability Services/Testing Section.

**Table 12. 2000-01 North Carolina High School Comprehensive Multiple-Choice Test Results
Mean Scale Score by LEA - Reading**

State Mean	Mean Score*	2001 LEA Performance
	176.1	Thomas Jefferson**
	175.7	Raleigh Charter HS**
	174.5	Woods Charter**
	174.1	Quest Academy**
	173.5	Chapel Hill-Carrboro City
	168.9	Transylvania, Wake
	168.5	Asheville City, Clay, Graham, Watauga
	168.1	Elkin City, Shelby City
	167.5	Avery, Orange, Polk
	167.3	Cherokee
	167.1	Camden, Johnston, New Hanover
	166.7	Mount Airy City
	166.5	Cabarrus, Granville, Kestrel Heights**, Winston-Salem/Forsyth
	166.3	Hickory City
	166.1	Alleghany, Asheboro City, Buncombe, Guilford, Henderson, Roanoke Rapids City
	165.9	Burke, Carteret, Craven, Haywood, Kings Mountain City, Moore, Mooresville City, Onslow, Surry, Swain, Union
	165.7	Jackson
	165.5	Alamance-Burlington, Ashe, Chatham, Davie, Durham
1999, 2000, 2001 State	165.1	Catawba, Dare, Iredell-Statesville, Macon, Mitchell, Pender
	164.9	Lee, Newton Conover City, Pitt
	164.7	Charlotte/Mecklenburg, Stanly, Wayne
	164.5	Gaston, Lexington City, Madison, McDowell, Person, Rowan-Salisbury, Rutherford
	164.1	Caldwell, Clinton City, Cumberland, Lenoir, Wilkes
1998 State	163.9	Cleveland, Richmond
	163.7	Edenton/Chowan, Gates
	163.5	Duplin, Elizabeth City/Pasquotank, Franklin, Harnett, Lincoln, Perquimans, Rockingham, Thomasville City, Yancey
	163.3	Beaufort, Greene, Randolph
	163.1	Alexander, Yadkin
	162.9	Currituck, Hyde, Martin
	162.7	Nash-Rocky Mount
	162.5	Kannapolis City, Sampson
	162.1	Hoke, Jones, Montgomery, Pamlico
	161.9	Brunswick, Tyrrell, Whiteville City
	161.5	Davidson, Edgecombe, Northampton, River Mill Charter**, Scotland, Washington, Wilson
	161.3	Stokes
	160.9	Bladen, Warren
	160.7	Columbus
	160.5	Anson, Vance
	160.3	Caswell, Robeson
	160.1	Bertie
	159.9	Hertford
	159.5	Cape Lookout Marine**, J.H. Baker Jr High**
	157.9	Halifax, Weldon City
	157.5	Laurinburg Homework**
	153.5	New Century**
	150.5	Laurinburg**
	145.9	Wayne Academy**
	***	Kennedy Charter**, Lakeside School**, Omuteko Gwamaziima**

Notes: *Scale scores from the region tables are rounded up to the nearest two-tenths of a point.

**Denotes a charter school. For reporting purposes the charter school name has been abbreviated; the complete charter school name can be found in the Appendix.

***Data are not reported where number tested is fewer than five.

Data received from LEAs and charter schools after August 2001 are not included in this table.

Prepared by the NCDPI Division of Accountability Services/Testing Section.

**Table 13. 2000-01 North Carolina High School Comprehensive Multiple-Choice Test Results
Mean Scale Score by LEA - Mathematics**

State Mean	Mean Score*	2001 LEA Performance
	194.0	Thomas Jefferson**
	...	
	192.0	Raleigh Charter HS**
	191.5	Chapel Hill-Carrboro City
	...	
	187.5	Woods Charter**
	...	
	186.0	Clay
	185.5	Transylvania
	185.0	Graham
	184.5	Shelby City, Wake
	184.0	Buncombe, Elkin City
	183.5	Cherokee
	183.0	Watauga
	182.5	Johnston, Mount Airy City
	182.0	Alleghany, Asheville City, Polk, Quest Academy**
	181.5	Newton Conover City, Orange, Roanoke Rapids City
	181.0	Avery, Cabarrus, Dare, Haywood, New Hanover
	180.5	Ashe, Catawba, Hickory City, Surry, Union
	180.0	Burke, Durham, Guilford, Henderson, Perquimans, Winston-Salem/Forsyth
	179.5	Asheboro City, Granville
	179.0	Camden, Carteret, Chatham, Davie, Iredell-Statesville, Jackson, Moore, Pender, Stanly
2001 State	178.5	Alamance-Burlington, Caldwell, Charlotte/Mecklenburg, Craven, Lenoir, Onslow, Pitt, Wilkes
	178.0	Kestrel Heights**, Kings Mountain City, Lee, Lincoln, McDowell, Pamlico, Person
2000 State	177.5	Currituck, Madison, Rowan-Salisbury, Swain
	177.0	Alexander, Cleveland, Clinton City, Davidson, Edenton/Chowan, Gaston, Macon, Mooresville City, Rockingham, Rutherford, Wayne
1999 State	176.5	Franklin, Greene, Harnett, Martin, Mitchell, Scotland, Stokes, Yadkin, Yancey
	176.0	Beaufort, Lexington City, Randolph, Richmond, Thomasville City
	175.5	Duplin, Elizabeth City/Pasquotank, Gates, Nash-Rocky Mount, Sampson, Wilson
	175.0	Kannapolis City
1998 State	174.5	Brunswick, Cumberland, Hyde
	174.0	Hoke
	173.5	Edgecombe
	173.0	Montgomery, Tyrrell
	172.5	Columbus, River Mill Charter**, Vance, Whiteville City
	172.0	Anson, Bladen, Northampton, Robeson, Warren, Washington
	171.5	Cape Lookout Marine**
	...	
	170.5	Caswell, Jones
	170.0	Bertie, Hertford, Weldon City
	...	
	168.5	Halifax, Laurinburg Homework**
	...	
	165.0	J.H. Baker Jr High**
	...	
	164.0	New Century**
	...	
	162.5	Laurinburg**
	...	
	159.5	Wayne Academy**
	***	Kennedy Charter**, Lakeside School**, Omuteko Gwamaziima**

Notes: *Scale scores from the region tables are rounded up to the nearest five-tenths of a point.

**Denotes a charter school. For reporting purposes the charter school name has been abbreviated; the complete charter school name can be found in the Appendix.

***Data are not reported where number tested is fewer than five.

Data received from LEAs and charter schools after August 2001 are not included in this table.

Prepared by the NCDPI Division of Accountability Services/Testing Section.

End-of-Course Multiple-Choice Test Results

**Table 1. 1991-92 to 2000-01 End-of-Course Multiple-Choice Test Results
Statewide Summary**

	1991-92		1992-93		1993-94		1994-95		1995-96		1996-97		1997-98		1998-99		1999-00		2000-01	
	Number Tested	Participation Index ¹	Number Tested	Participation Index ¹	Number Tested	Participation Index ¹	Number Tested	Participation Index ¹	Number Tested	Participation Index ¹	Number Tested	Participation Index ¹	Number Tested	Participation Index ¹	Number Tested	Participation Index ¹	Number Tested	Participation Index ¹	Number Tested	Participation Index ¹
Algebra I²	66,424	81.2%	70,114	86.4%	69,162	N/A	80,370	94.0%	82,635	96.6%	83,777	95.0%	83,124	95.8%	87,404	95.8%	90,109	95.3%	93,000	95.2%
1985-86	40.4	39.9	9.6	49.6%	55.1	9.1	54.7	9.3	55.0	9.7	55.6	9.7	57.0	9.7	58.0	9.6	59.5	10.5	61.1	9.3
Algebra II	37,221	45.5%	38,909	49.6%	42,497	51.9%	44,928	55.3%							48,956	56.2%	52,451	58.1%	54,902	58.1%
1986-87	38.2	38.8			37.6		38.3								60.0	10.9	61.1	11.0	63.8	9.9
Biology²	71,832	91.5%	75,748	92.6%	74,840	92.2%	62,480	N/A	71,420	90.5%	78,723	92.0%	78,804	91.8%	76,872	88.7%	80,549	88.2%	82,026	86.0%
1986-87	41.5	40.0	11.1	40.0	39.9	10.6	55.5	8.7	55.5	8.7	55.9	8.9	56.2	8.8	56.0	8.5	56.1	8.5	56.8	8.5
Chemistry	34,682	42.4%	35,738	45.1%	38,462	47.0%	39,289	48.4%							41,261	47.3%	42,605	47.2%	43,702	46.2%
1988-89	39.3	40.1			39.1		40.6								57.8	8.8	58.1	8.7	58.9	8.7
ELPS	79,313	96.9%	79,070	97.4%	81,290	97.0%	83,597	97.8%	82,577	96.5%	82,611	93.4%	77,348	89.5%	77,740	83.1%	78,992	83.5%	90,209	92.4%
1990-91	42.8	43.7	11.5	43.4	43.4	11.3	44.0	11.7	43.4	11.9	53.8	9.3	54.8	9.1	55.0	9.0	55.1	8.9	55.7	8.7
English I²	75,381	92.1%	76,183	93.8%	81,685	97.5%	67,748	N/A	85,411	99.8%	89,500	100.0%	88,307	100.0%	89,679	98.3%	93,434	98.8%	94,707	97.0%
1989-90	67.0	66.7	18.0	66.4	66.4	17.7	53.1	8.9	53.1	8.9	53.2	8.9	53.6	8.8	54.5	8.7	55.4	8.6	55.4	8.6
Geometry	46,623	59.4%	49,494	60.1%	53,932	66.4%	55,657	66.4%							60,764	69.6%	64,572	70.7%	65,480	68.7%
1988-89	39.1	38.8			38.6		38.6								58.4	9.9	59.1	10.0	59.8	8.9
Physical Science	66,137	80.0%	63,036	77.6%	65,777	78.5%	66,106	77.3%							67,397	73.2%	67,066	70.9%	39,182	40.1%
1990-91	41.1	41.3			40.2		42.9								54.5	9.0	54.9	8.7	55.5	8.7
Physics	10,075	12.2%	10,754	13.2%	10,803	13.8%	10,935	13.4%							11,221	13.2%	11,429	13.1%	10,948	12.1%
1989-90	39.4	39.5			39.7		40.2								56.8	9.2	57.1	9.0	57.0	8.5
U.S. History²	65,329	79.9%	63,034	80.0%	65,872	80.5%	53,160	N/A	65,725	78.4%	68,613	79.9%	68,341	80.7%	70,187	80.0%	70,930	81.1%	73,742	78.0%
1987-88	42.2	42.3	9.7	40.4	40.4	10.5	56.2	8.3	56.3	8.2	56.2	8.2	56.3	8.4	56.6	8.3	55.8	8.3	56.6	8.4

Notes: The year of implementation is listed below the subject. Beginning in 1993-94, where possible, scores for the entire accountability year are reported. The 1995-96 data are based on all cycles of testing for the July 1 to June 30 accountability year. Algebra I was first scaled in 1993-94, and U.S. History, English I and Biology in 1994-95 and 1995-96. Bold vertical lines between years indicate that the scores changed from mean raw core scores to mean scale scores and, therefore, are not comparable across years separated by the bold vertical lines. Numbers to the left of these lines are mean raw core scores and numbers to the right are mean scale scores. From 1995-96 to 1997-98, five tests were administered statewide in the five high school subject areas. Other end-of-course multiple-choice tests were administered as a local option and are not included in this report. Beginning in 1998-99, the ten tests in the table above were mandated statewide. Data for 1995-96 through 1997-98 are not available for Algebra II, Chemistry, Geometry, Physical Science and Physics as these tests were not mandated during this period.

¹Participation Index is the number of students enrolled in the course, divided by the number of students who were in the eighth grade the year in which typical students in the course were in grade eight.

²The Algebra I score in 1993-94 and the Biology, English I and U.S. History scores in 1994-95 are the mean scale scores.

³Average core score is the mean raw score on the common items for all students.

Data received from LEAs and charter schools after August 2001 are not included in this table.

Prepared by the NCDPI Division of Accountability Services/Testing Section.



**Table 2. End-of-Course Multiple-Choice Test Results
1999-00 to 2000-01 Comparison of Percent of Students At or Above Level III
by Ethnicity**

Course	2000-01		Percent of Students At or Above Level III														
	Number Tested	Mean Scale Score	Standard Deviation	1999-00		2000-01		1999-00		2000-01		1999-00		2000-01			
				State	State	State	State	Asian	Black	Hispanic	Multi-Racial	White	Asian	Black	Hispanic	Multi-Racial	White
Algebra I	93,000	61.1	9.3	68.9	76.0	52.1	67.6	79.0	82.5	48.0	57.1	62.4	70.0	72.6	76.0	77.7	84.6
Algebra II	54,902	63.8	9.9	62.7	73.0	37.3	55.6	73.1	82.2	39.6	52.5	58.8	67.7	67.5	74.5	70.0	79.6
Biology	82,026	56.8	8.5	57.6	61.0	36.6	46.3	59.0	63.7	32.0	34.9	44.0	47.2	60.0	68.1	68.6	73.1
Chemistry	43,702	58.9	8.7	62.0	65.5	39.8	44.6	67.5	68.8	38.1	41.8	52.7	57.8	57.7	69.8	69.3	72.4
Economic, Legal, & Political Systems	90,209	55.7	8.7	67.3	70.0	41.9	54.5	68.3	70.5	45.9	48.9	53.3	56.6	70.5	71.3	77.6	80.0
English I	94,707	55.4	8.6	68.4	68.3	48.3	50.8	71.7	72.0	49.3	49.0	51.7	52.6	72.7	69.3	77.8	78.0
Geometry	65,480	59.8	8.9	60.0	63.9	37.6	45.4	68.4	71.6	32.4	34.6	51.9	50.3	57.1	64.6	70.6	75.0
Physical Science	39,182	55.5	8.7	57.1	59.9	32.4	40.5	59.6	65.0	33.0	37.1	42.6	44.3	61.0	61.5	69.5	72.0
Physics	10,948	57.0	8.5	72.9	74.4	45.9	46.3	72.4	78.8	46.3	43.9	64.8	64.0	66.7	78.4	77.9	79.8
U.S. History	73,742	56.6	8.4	46.9	50.5	27.4	34.7	50.3	56.2	24.6	28.4	38.6	40.7	48.8	54.5	56.5	59.8

Notes: Data received from LEAs and charter schools after August 2001 are not included in this table.
Prepared by the NCDPI Division of Accountability Services/Testing Section.

**Table 3. 2000-01 End-of-Course Multiple-Choice Tests
Achievement Level Ranges
by Course**

Course	Level I	Level II	Level III	Level IV
Algebra I	23-44	45-54	55-65	66-87
Algebra II	23-45	46-57	58-68	69-92
Biology	23-46	47-54	55-64	65-89
Chemistry	23-47	48-55	56-64	65-90
Economic, Legal, & Political Systems	21-42	43-51	52-60	61-87
English I	22-42	43-51	52-60	61-86
Geometry	23-45	46-56	57-66	67-91
Physical Science	23-43	44-53	54-63	64-89
Physics	23-42	43-51	52-62	63-87
U.S. History	23-47	48-56	57-64	65-90

Prepared by the NCDPI Division of Accountability Services/Testing Section.

**Table 4. 2000-01 End-of-Course Multiple-Choice Test Results
Percent of Students by Achievement Level
by Course and Ethnicity**

Achievement Level	Ethnicity	Algebra I		Algebra II		Biology		Chemistry		Economic, Legal, & Political Systems	
		N	%	N	%	N	%	N	%	N	%
		Achievement Level I	American Indian	51	4.2	33	5.7	162	16.2	95	21.3
Asian	50		2.6	20	1.3	229	12.9	150	12.1	165	8.8
Black	1,719		6.5	649	5.2	5,818	25.0	2,026	22.7	3,922	15.5
Hispanic	108		4.2	35	3.3	425	19.8	105	13.7	324	13.5
Multi-Racial	27		3.0	16	3.8	67	9.4	32	9.5	43	5.5
White	993		1.7	622	1.6	3,151	5.9	2,185	6.8	2,277	3.9
Achievement Level II	American Indian	338	28.1	225	38.7	374	37.4	152	34.1	363	33.2
	Asian	283	14.9	244	16.5	413	23.3	238	19.1	390	20.7
	Black	9,612	36.4	5,273	42.3	9,340	40.1	3,165	35.5	9,042	35.6
	Hispanic	660	25.8	305	28.9	710	33.0	219	28.6	718	29.9
	Multi-Racial	186	20.9	91	21.7	161	22.5	70	20.7	182	23.2
	White	8,251	13.8	7,326	18.8	11,129	21.0	6,646	20.8	9,443	16.1
Achievement Level III	American Indian	606	50.4	231	39.8	385	38.5	147	33.0	404	36.9
	Asian	749	39.5	498	33.6	675	38.2	407	32.7	663	35.2
	Black	12,090	45.8	5,031	40.3	7,068	30.4	2,919	32.7	9,336	36.8
	Hispanic	1,245	48.7	445	42.2	804	37.4	289	37.7	933	38.9
	Multi-Racial	398	44.8	184	43.8	347	48.5	141	41.7	317	40.4
	White	26,334	43.9	15,737	40.5	25,204	47.5	13,258	41.5	23,720	40.5
Achievement Level IV	American Indian	207	17.2	92	15.8	78	7.8	52	11.7	193	17.6
	Asian	816	43.0	720	48.6	452	25.6	448	36.0	663	35.2
	Black	2,963	11.2	1,516	12.2	1,051	4.5	812	9.1	3,070	12.1
	Hispanic	545	21.3	269	25.5	211	9.8	154	20.1	425	17.7
	Multi-Racial	277	31.2	129	30.7	140	19.6	95	28.1	242	30.9
	White	24,429	40.7	15,180	39.1	13,585	25.6	9,877	30.9	23,196	39.6
Percent At or Above Level III*	American Indian	813	67.6	323	55.6	463	46.3	199	44.6	597	54.5
	Asian	1,565	82.5	1,218	82.2	1,127	63.7	855	68.8	1,326	70.5
	Black	15,053	57.1	6,547	52.5	8,119	34.9	3,731	41.8	12,406	48.9
	Hispanic	1,790	70.0	714	67.7	1,015	47.2	443	57.8	1,358	56.6
	Multi-Racial	675	76.0	313	74.5	487	68.1	236	69.8	559	71.3
	White	50,763	84.6	30,917	79.6	38,789	73.1	23,135	72.4	46,916	80.0

State Results	Ethnicity	Algebra I		Algebra II		Biology		Chemistry		Economic, Legal, & Political Systems	
		N	%	N	%	N	%	N	%	N	%
		American Indian	1,202	1.3	581	1.1	999	1.2	446	1.0	1,095
Asian	1,898	2.0	1,482	2.7	1,769	2.2	1,243	2.8	1,881	2.1	
Black	26,384	28.4	12,469	22.7	23,277	28.4	8,922	20.4	25,370	28.1	
Hispanic	2,558	2.8	1,054	1.9	2,150	2.6	767	1.8	2,400	2.7	
Multi-Racial	888	1.0	420	0.8	715	0.9	338	0.8	784	0.9	
White	60,007	64.5	38,865	70.8	53,069	64.7	31,966	73.1	58,636	65.0	
Total		93,000		54,902		82,026		43,702		90,209	

Notes: * "Percent At or Above Level III" is calculated based on actual N-counts and is not summed.

Due to rounding, some ethnicity categories in some subjects may not sum to 100%.

When summed, ethnic N-counts may not match the state N-counts because an ethnic category may not have been coded on the answer sheet, or, the choice of "Other" was coded.

Data received from LEAs and charter schools after August 2001 are not included in this table.

Prepared by the NCDPI Division of Accountability Services/Testing Section.

**Table 4. 2000-01 End-of-Course Multiple-Choice Test Results
Percent of Students by Achievement Level
by Course and Ethnicity (continued)**

Achievement Level	Ethnicity	English I		Geometry		Physical Science		Physics		U.S. History	
		N	%	N	%	N	%	N	%	N	%
Achievement Level I	American Indian	242	17.3	64	8.6	80	18.8	9	11.0	201	22.3
	Asian	117	6.6	61	4.0	49	7.9	32	6.0	205	12.9
	Black	3,660	13.4	1,896	11.7	2,165	18.1	233	15.7	5,357	27.0
	Hispanic	403	14.5	106	7.2	169	14.7	18	10.1	309	19.1
	Multi-Racial	58	6.7	20	3.8	26	7.5	4	5.4	71	12.8
	White	2,772	4.6	925	2.1	1,297	5.3	243	2.8	4,482	9.1
Achievement Level II	American Indian	444	31.8	343	46.0	173	40.7	35	42.7	387	43.0
	Asian	383	21.4	369	24.4	169	27.2	80	15.1	490	30.9
	Black	10,236	37.6	8,687	53.7	5,374	44.8	598	40.4	8,870	44.7
	Hispanic	910	32.8	628	42.5	470	40.9	46	25.8	650	40.2
	Multi-Racial	206	23.9	166	31.6	108	31.0	12	16.2	181	32.7
	White	10,567	17.4	10,326	22.9	5,600	22.7	1,495	17.4	15,263	31.0
Achievement Level III	American Indian	535	38.4	279	37.4	143	33.6	29	35.4	237	26.3
	Asian	655	36.7	561	37.1	266	42.8	245	46.3	530	33.4
	Black	10,485	38.5	4,820	29.8	3,886	32.4	563	38.0	4,569	23.0
	Hispanic	1,046	37.7	569	38.5	395	34.4	83	46.6	480	29.7
	Multi-Racial	363	42.2	241	45.9	141	40.5	38	51.4	204	36.8
	White	25,037	41.3	21,078	46.8	11,491	46.7	4,387	51.0	18,494	37.6
Achievement Level IV	American Indian	174	12.5	60	8.0	29	6.8	9	11.0	76	8.4
	Asian	631	35.3	521	34.5	138	22.2	172	32.5	362	22.8
	Black	2,851	10.5	773	4.8	562	4.7	88	5.9	1,063	5.4
	Hispanic	412	14.9	175	11.8	114	9.9	31	17.4	178	11.0
	Multi-Racial	234	27.2	98	18.7	73	21.0	20	27.0	98	17.7
	White	22,249	36.7	12,682	28.2	6,232	25.3	2,470	28.7	10,922	22.2
Percent At or Above Level III ¹	American Indian	709	50.8	339	45.4	172	40.5	38	46.3	313	34.7
	Asian	1,286	72.0	1,082	71.6	404	65.0	417	78.8	892	56.2
	Black	13,336	49.0	5,593	34.6	4,448	37.1	651	43.9	5,632	28.4
	Hispanic	1,458	52.6	744	50.3	509	44.3	114	64.0	658	40.7
	Multi-Racial	597	69.3	339	64.6	214	61.5	58	78.4	302	54.5
	White	47,286	78.0	33,760	75.0	17,723	72.0	6,857	79.8	29,416	59.8
State Results	Ethnicity	English I		Geometry		Physical Science		Physics		U.S. History	
		N	%	N	%	N	%	N	%	N	%
	American Indian	1,395	1.5	746	1.1	425	1.1	82	0.7	901	1.2
	Asian	1,786	1.9	1,512	2.3	622	1.6	529	4.8	1,587	2.2
	Black	27,232	28.8	16,176	24.7	11,987	30.6	1,482	13.5	19,859	26.9
	Hispanic	2,771	2.9	1,478	2.3	1,148	2.9	178	1.6	1,617	2.2
	Multi-Racial	861	0.9	525	0.8	348	0.9	74	0.7	554	0.8
	White	60,625	64.0	45,011	68.7	24,620	62.8	8,595	78.5	49,161	66.7
Total	94,707		65,480		39,182		10,948		73,742		

Notes: ¹"Percent At or Above Level III" is calculated based on actual N-counts and is not summed.

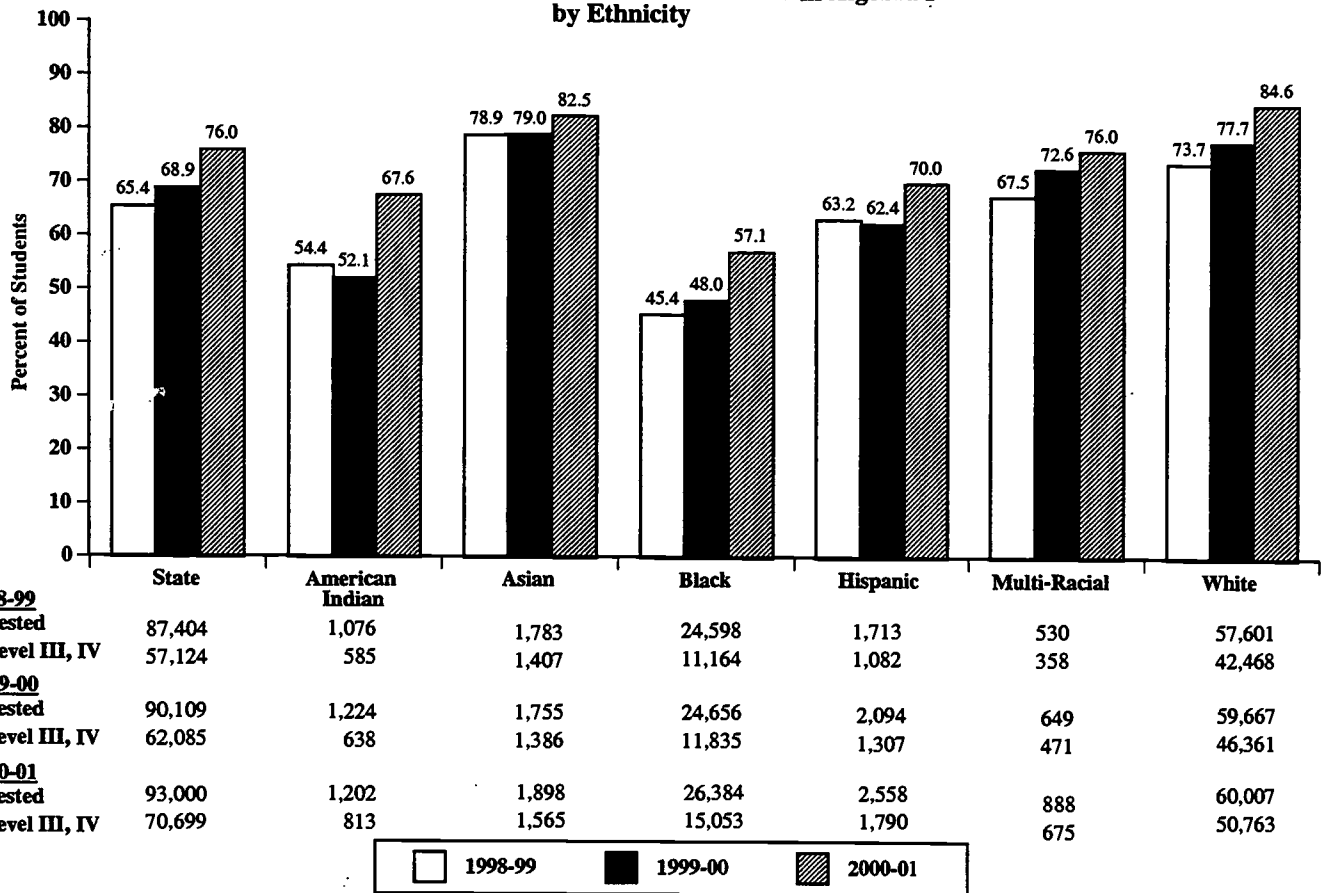
Due to rounding, some ethnicity categories in some courses may not sum to 100%.

When summed, ethnic N-counts may not match the state N-counts because an ethnic category may not have been coded on the answer sheet, or, the choice of "Other" was coded.

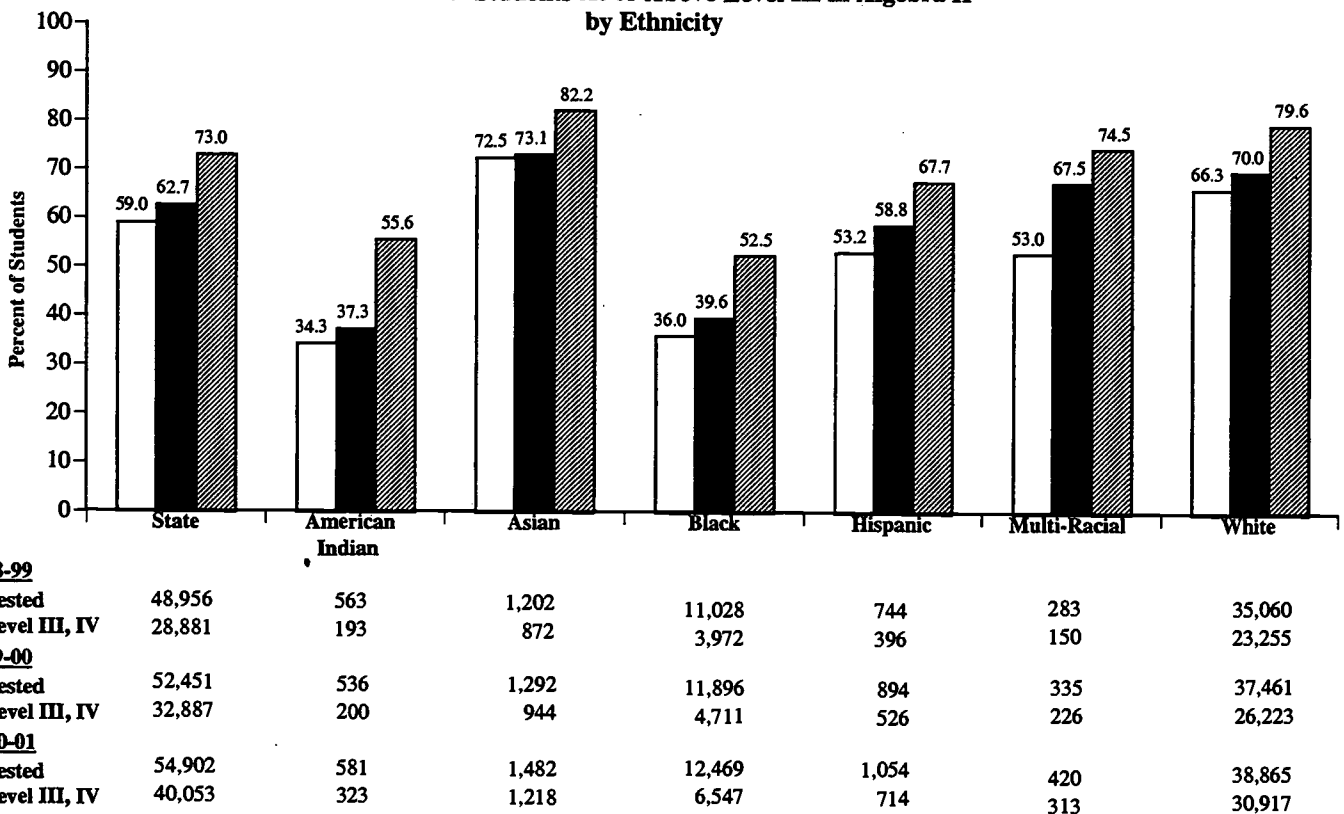
Data received from LEAs and charter schools after August 2001 are not included in this table.

Prepared by the NCDPI Division of Accountability Services/Testing Section.

**Figure 1. 1998-99 to 2000-01 End-of-Course Multiple-Choice Test Results
Percent of Students At or Above Level III in Algebra I
by Ethnicity**

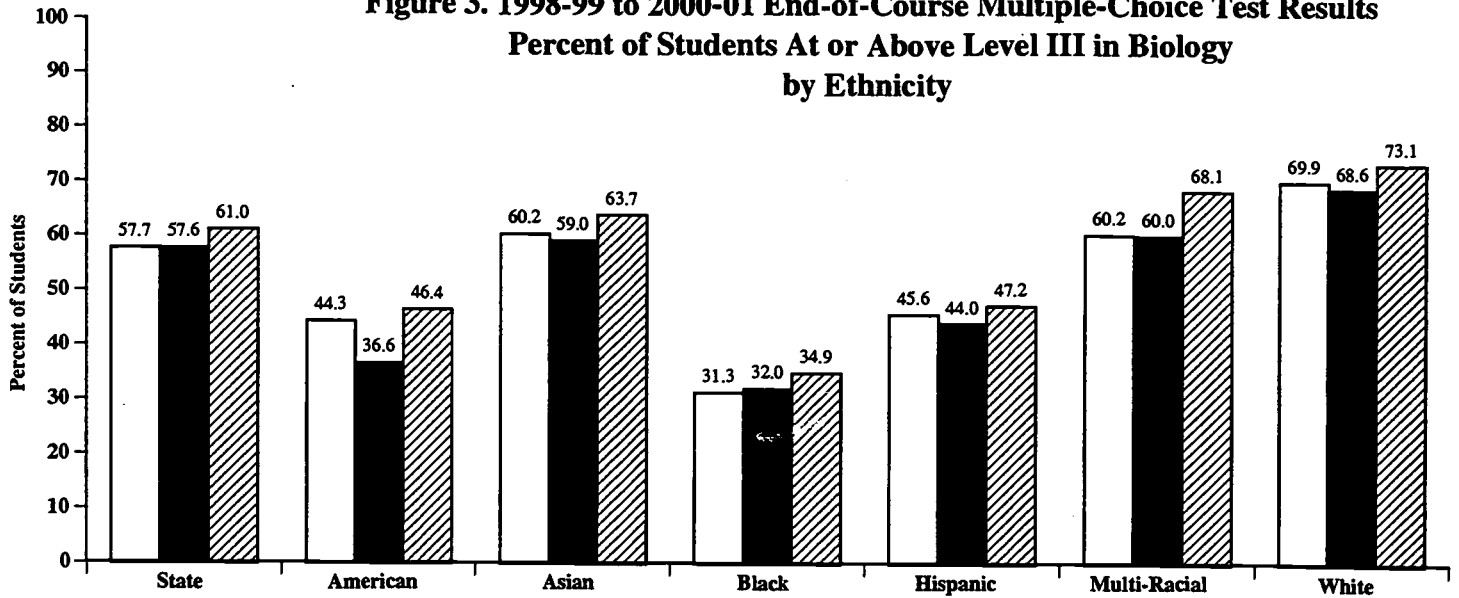


**Figure 2. 1998-99 to 2000-01 End-of-Course Multiple-Choice Test Results
Percent of Students At or Above Level III in Algebra II
by Ethnicity**



Notes: "N Tested" and "N Level III, IV" for the ethnicity categories do not sum to the "N Tested" and "N Level III, IV" for the state because ethnicity was not coded on some student answer sheets and, therefore, some students were reported in the state data only. Beginning in the 1998-99 school year Algebra II, Chemistry, Geometry, Physical Science and Physics were mandated statewide; data for these tests are not available prior to 1998-99. Data received from LEAs and charter schools after August 2001 are not included in these figures. Prepared by the NCDPI Division of Accountability Services/Testing Section.

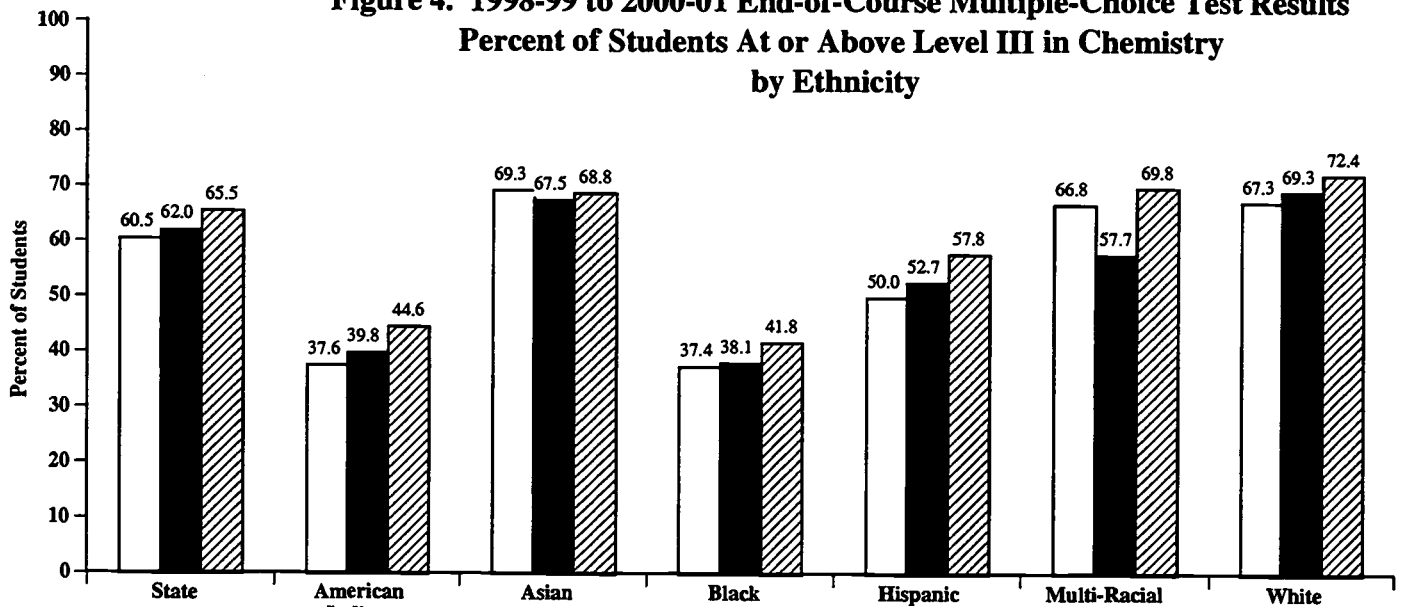
**Figure 3. 1998-99 to 2000-01 End-of-Course Multiple-Choice Test Results
Percent of Students At or Above Level III in Biology
by Ethnicity**



	State	American Indian	Asian	Black	Hispanic	Multi-Racial	White
1998-99							
N Tested	76,872	920	1,456	22,240	1,450	415	50,315
N Level III, IV	44,355	408	877	6,952	661	250	35,162
1999-00							
N Tested	80,549	1,091	1,669	21,514	1,758	555	53,931
N Level III, IV	46,396	399	985	6,884	774	333	36,997
2000-01							
N Tested	82,026	999	1,769	23,277	2,150	715	53,069
N Level III, IV	50,013	463	1,127	8,119	1,015	487	38,789



**Figure 4. 1998-99 to 2000-01 End-of-Course Multiple-Choice Test Results
Percent of Students At or Above Level III in Chemistry
by Ethnicity**



	State	American Indian	Asian	Black	Hispanic	Multi-Racial	White
1998-99							
N Tested	41,261	476	1,087	8,656	572	202	30,205
N Level III, IV	24,943	179	753	3,236	286	135	20,321
1999-00							
N Tested	42,605	384	1,139	9,070	634	239	31,114
N Level III, IV	26,415	153	769	3,456	334	138	21,562
2000-01							
N Tested	43,702	446	1,243	8,922	767	338	31,966
N Level III, IV	28,609	199	855	3,731	443	236	23,135

Notes: "N Tested" and "N Level III, IV" for the ethnic categories do not sum to the "N Tested" and "N Level III, IV" for the state because ethnicity was not coded on all student answer sheets and, therefore, some students were reported in the state data only.

Beginning in the 1998-99 school year Algebra II, Chemistry, Geometry, Physical Science, and Physics were mandated statewide; data for these tests are not available prior to 1998-99. Data received from LEAs and charter schools after August 2001 are not included in these figures.

Prepared by the NCDPI Division of Accountability Services/Testing Section.

Figure 5. 1998-99 to 2000-01 End-of-Course Multiple-Choice Test Results
Percent of Students At or Above Level III in
Economic, Legal, and Political Systems
by Ethnicity

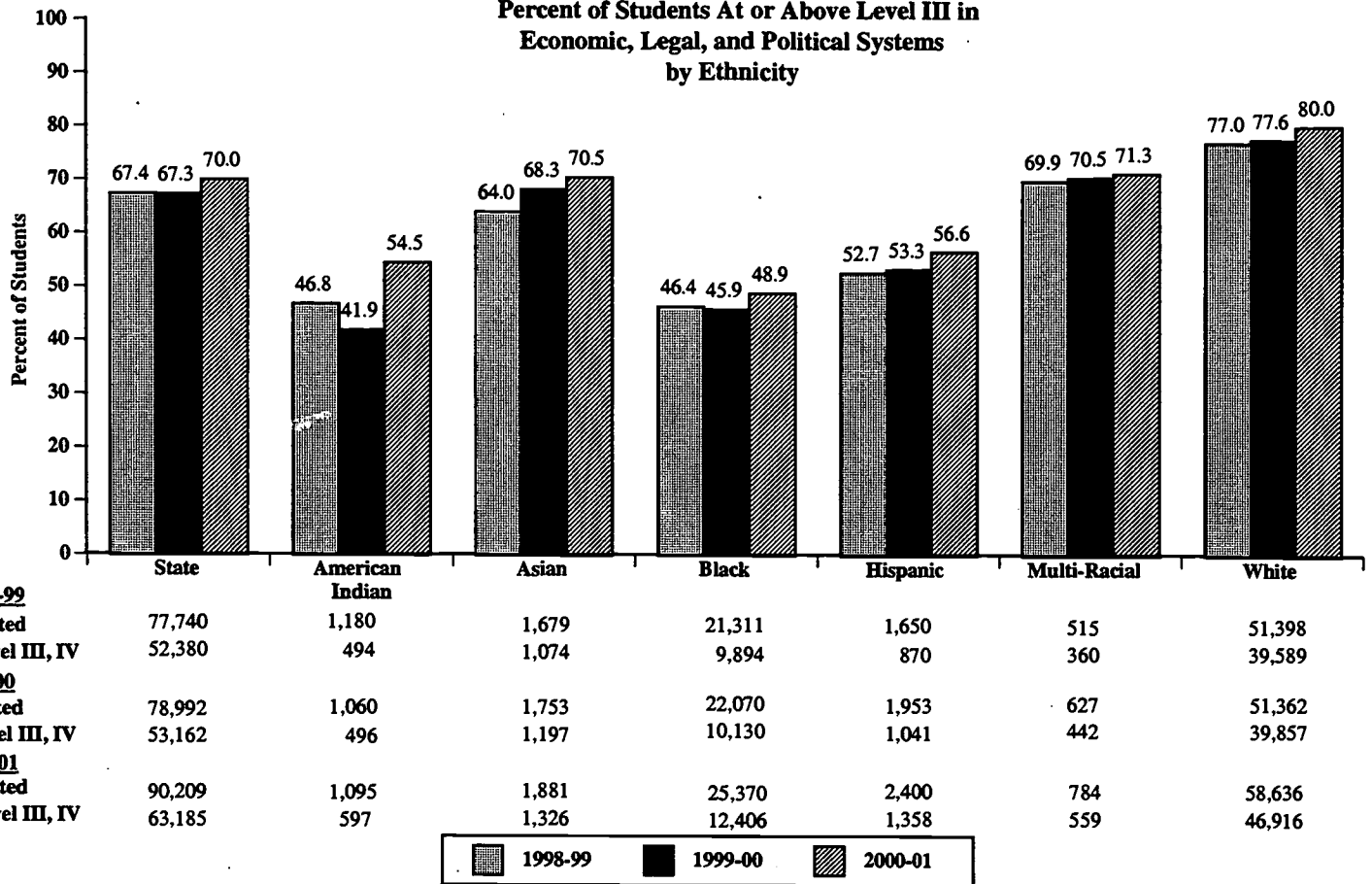
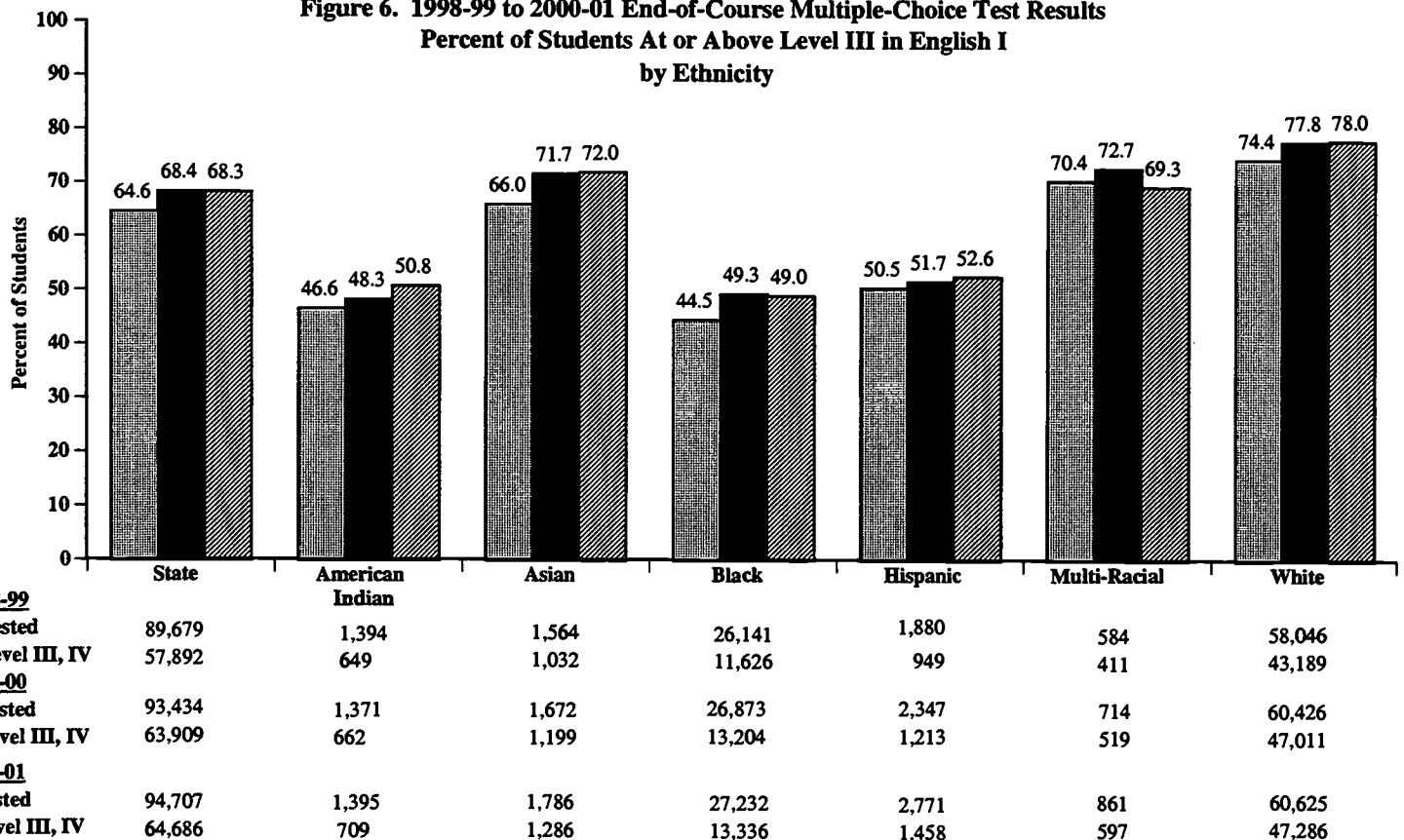


Figure 6. 1998-99 to 2000-01 End-of-Course Multiple-Choice Test Results
Percent of Students At or Above Level III in English I
by Ethnicity

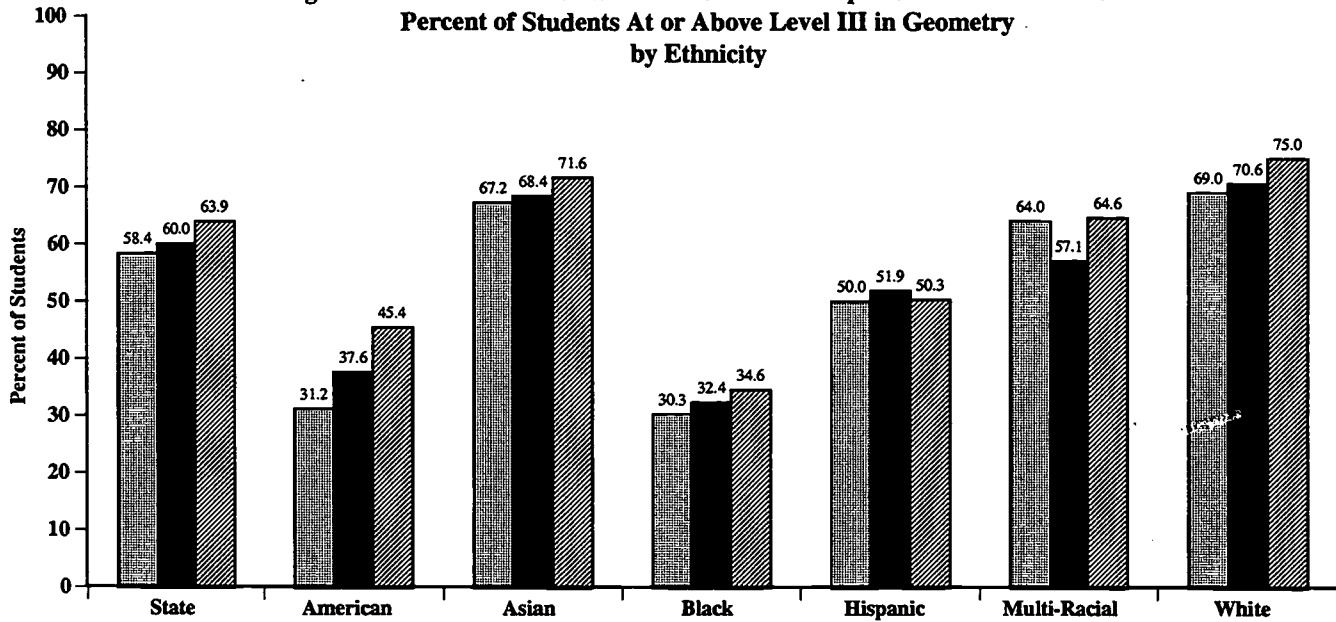


Notes: "N Tested" and "N Level III, IV" for the ethnic categories do not sum to the "N Tested" and "N Level III, IV" for the state because ethnicity was not coded on all student answer sheets and, therefore, some students were reported in the state data only. Beginning in the 1998-99 school year, Algebra II, Chemistry, Geometry, Physical Science and Physics were mandated statewide; data for these tests are not available prior to 1998-99.

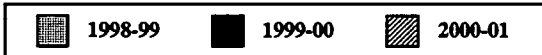
Data received from LEAs and charter schools after August 2001 are not included in these figures.

Prepared by the NCDPI Division of Accountability Services/Testing Section.

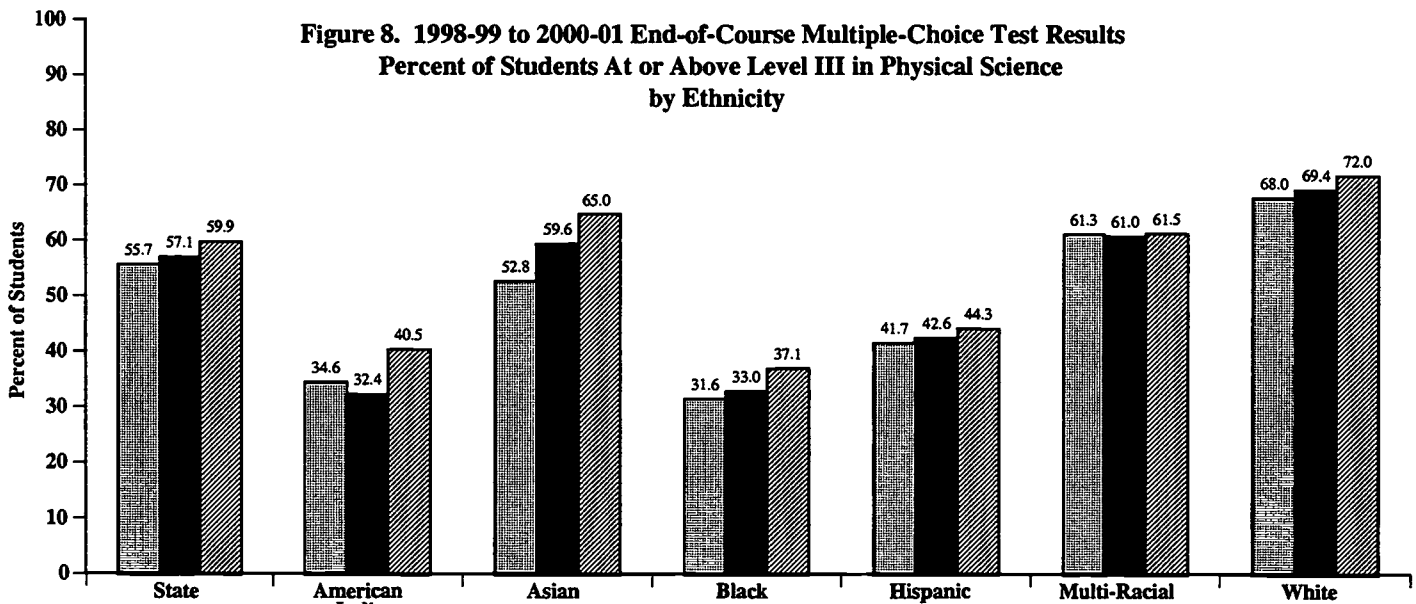
**Figure 7. 1998-99 to 2000-01 End-of-Course Multiple-Choice Test Results
Percent of Students At or Above Level III in Geometry
by Ethnicity**



	State	American Indian	Asian	Black	Hispanic	Multi-Racial	White
1998-99							
N Tested	60,764	696	1,303	15,209	1,003	339	42,131
N Level III, IV	35,508	217	875	4,602	501	217	29,050
1999-00							
N Tested	64,572	742	1,614	16,333	1,223	438	44,180
N Level III, IV	38,743	279	1,104	5,292	635	250	31,191
2000-01							
N Tested	65,480	746	1,512	16,176	1,478	525	45,011
N Level III, IV	41,870	339	1,082	5,593	744	339	33,760



**Figure 8. 1998-99 to 2000-01 End-of-Course Multiple-Choice Test Results
Percent of Students At or Above Level III in Physical Science
by Ethnicity**

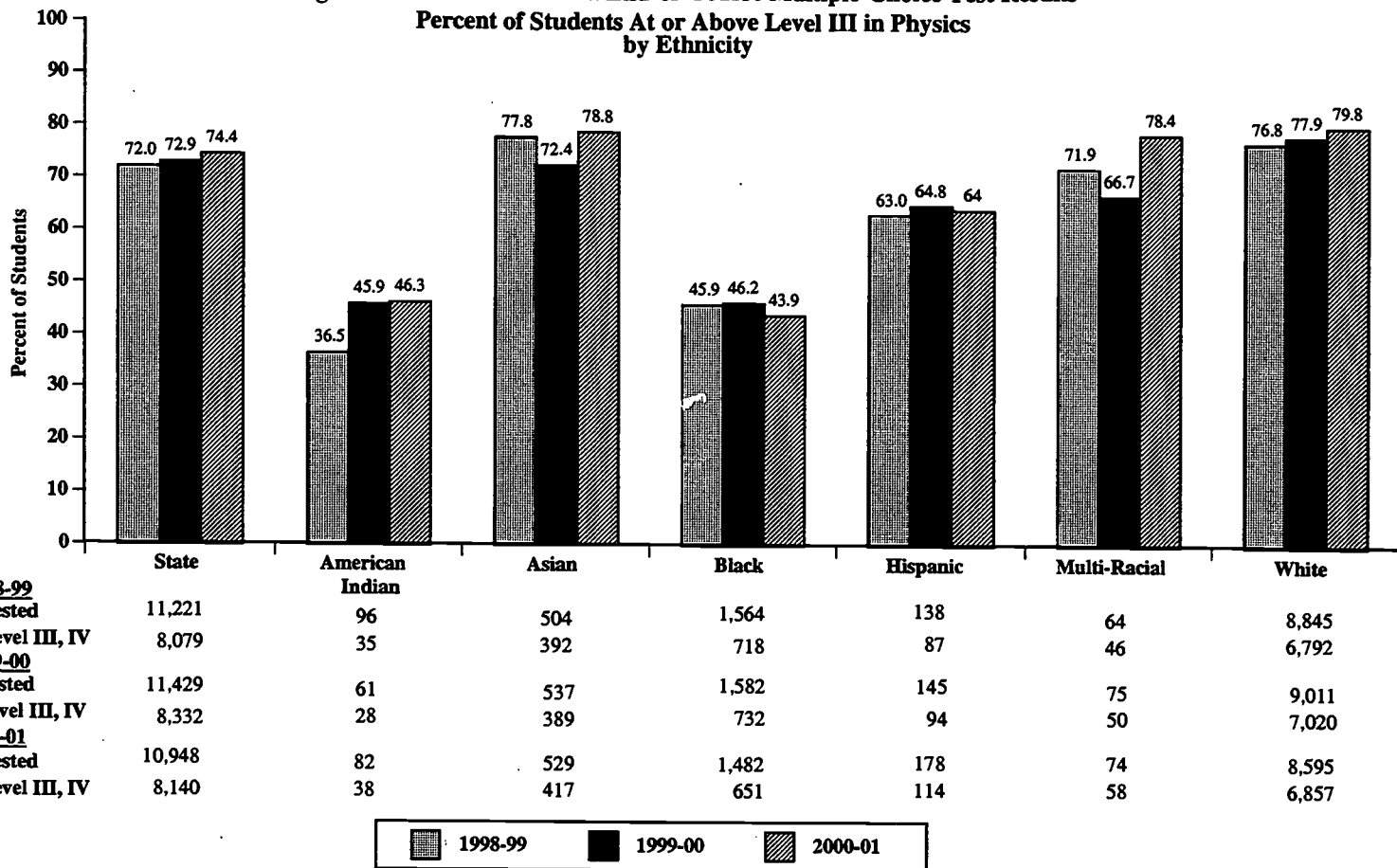


	State	American Indian	Asian	Black	Hispanic	Multi-Racial	White
1998-99							
N Tested	67,397	962	1,130	20,300	1,509	455	42,967
N Level III, IV	37,522	333	597	6,417	630	279	29,229
1999-00							
N Tested	67,066	1,130	1,115	19,926	1,733	485	42,655
N Level III, IV	38,294	366	665	6,576	738	296	29,603
2000-01							
N Tested	39,182	425	622	11,987	1,148	348	24,620
N Level III, IV	23,481	172	404	4,448	509	214	17,723

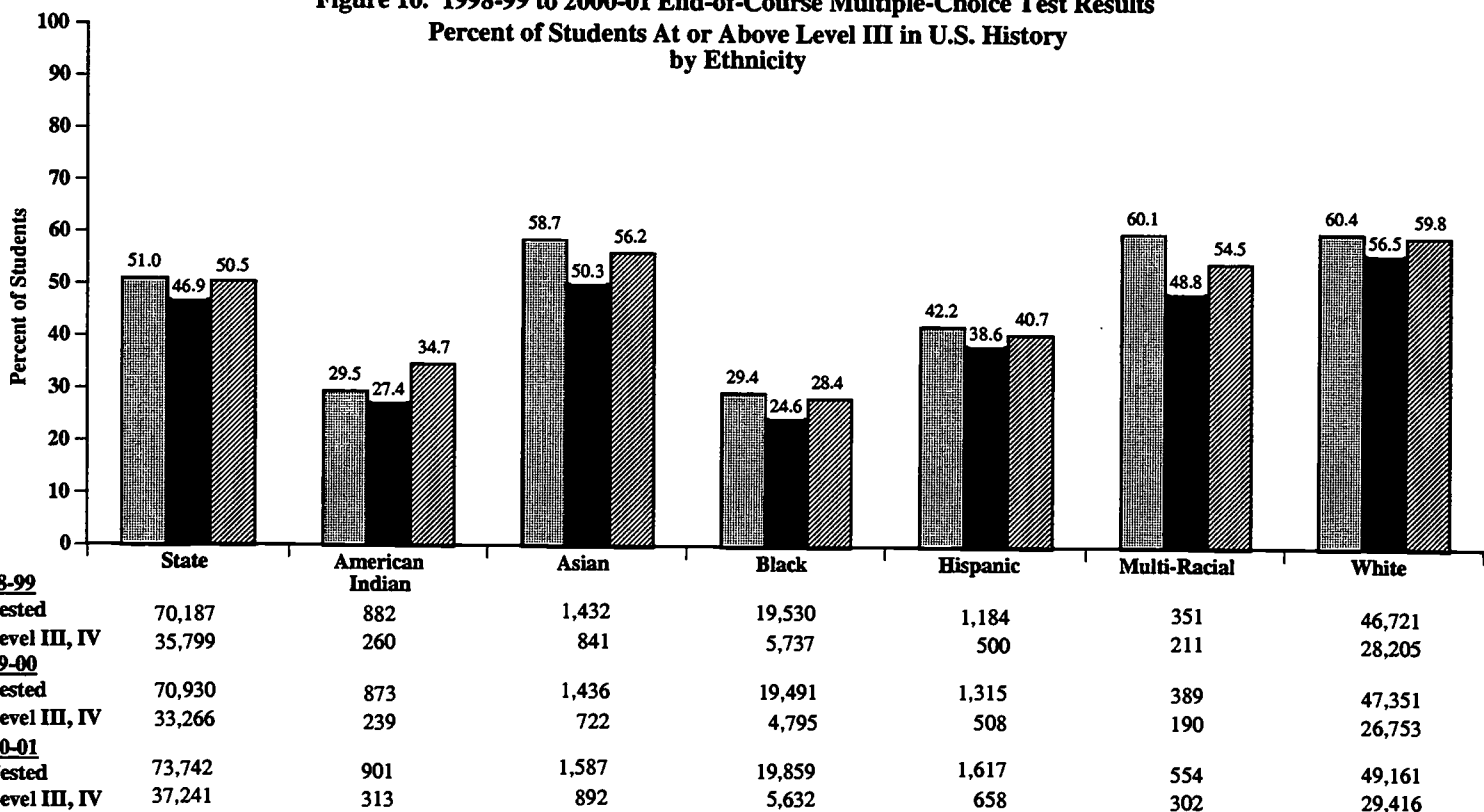
Notes: "N Tested" and "N Level III, IV" for the ethnic categories do not sum to the "N Tested" and "N Level III, IV" for the state because ethnicity was not coded on all student answer sheets and, therefore, some students were reported in the state data only. Beginning in the 1998-99 school year, Algebra II, Chemistry, Geometry, Physical Science and Physics were mandated statewide; data for these tests are not available prior to 1998-99.

Data received from LEAs and charter schools after August 2001 are not included in these figures.
Prepared by the NCDPI Division of Accountability Services/Testing Section.

**Figure 9. 1998-99 to 2000-01 End-of-Course Multiple-Choice Test Results
Percent of Students At or Above Level III in Physics
by Ethnicity**

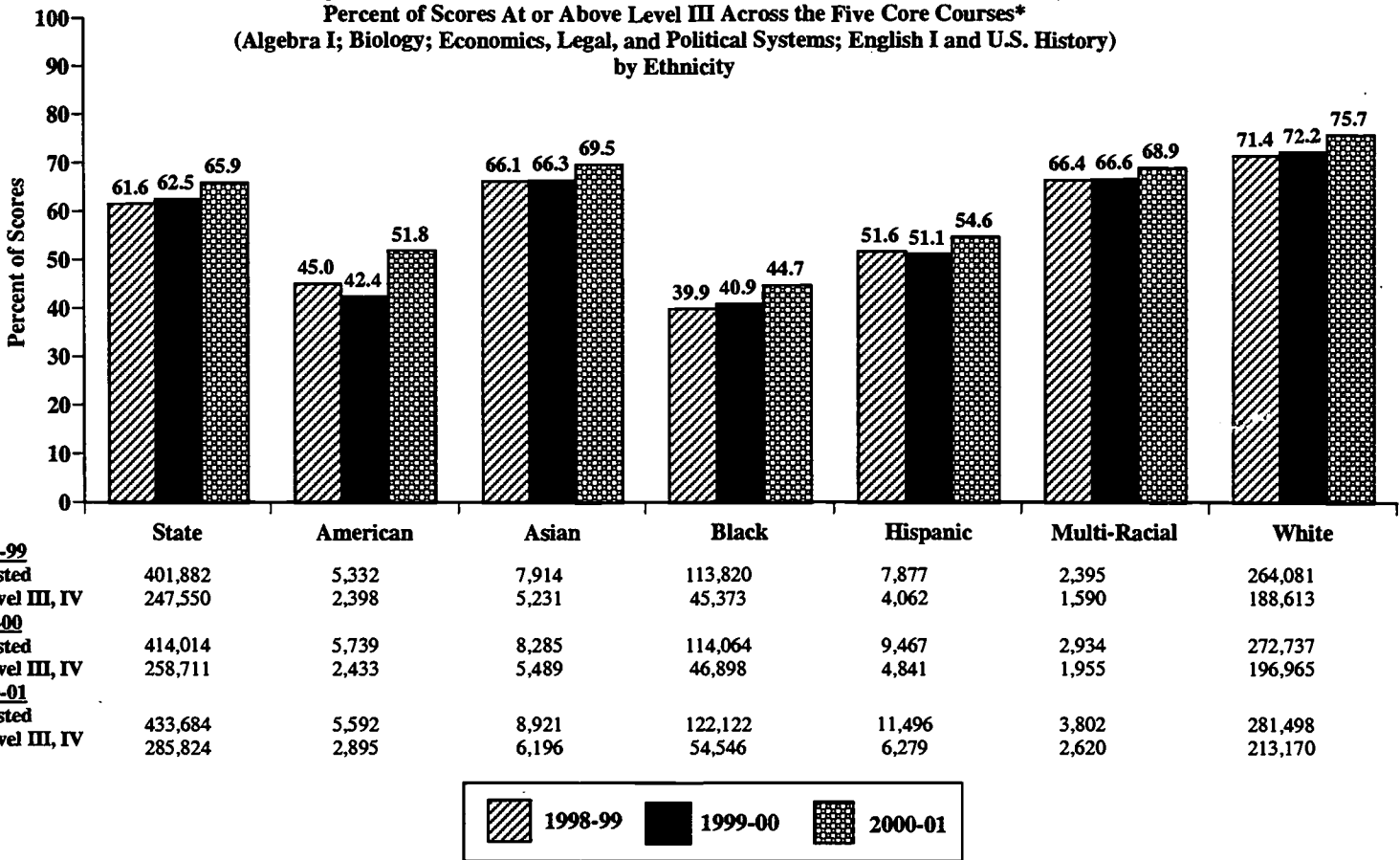


**Figure 10. 1998-99 to 2000-01 End-of-Course Multiple-Choice Test Results
Percent of Students At or Above Level III in U.S. History
by Ethnicity**

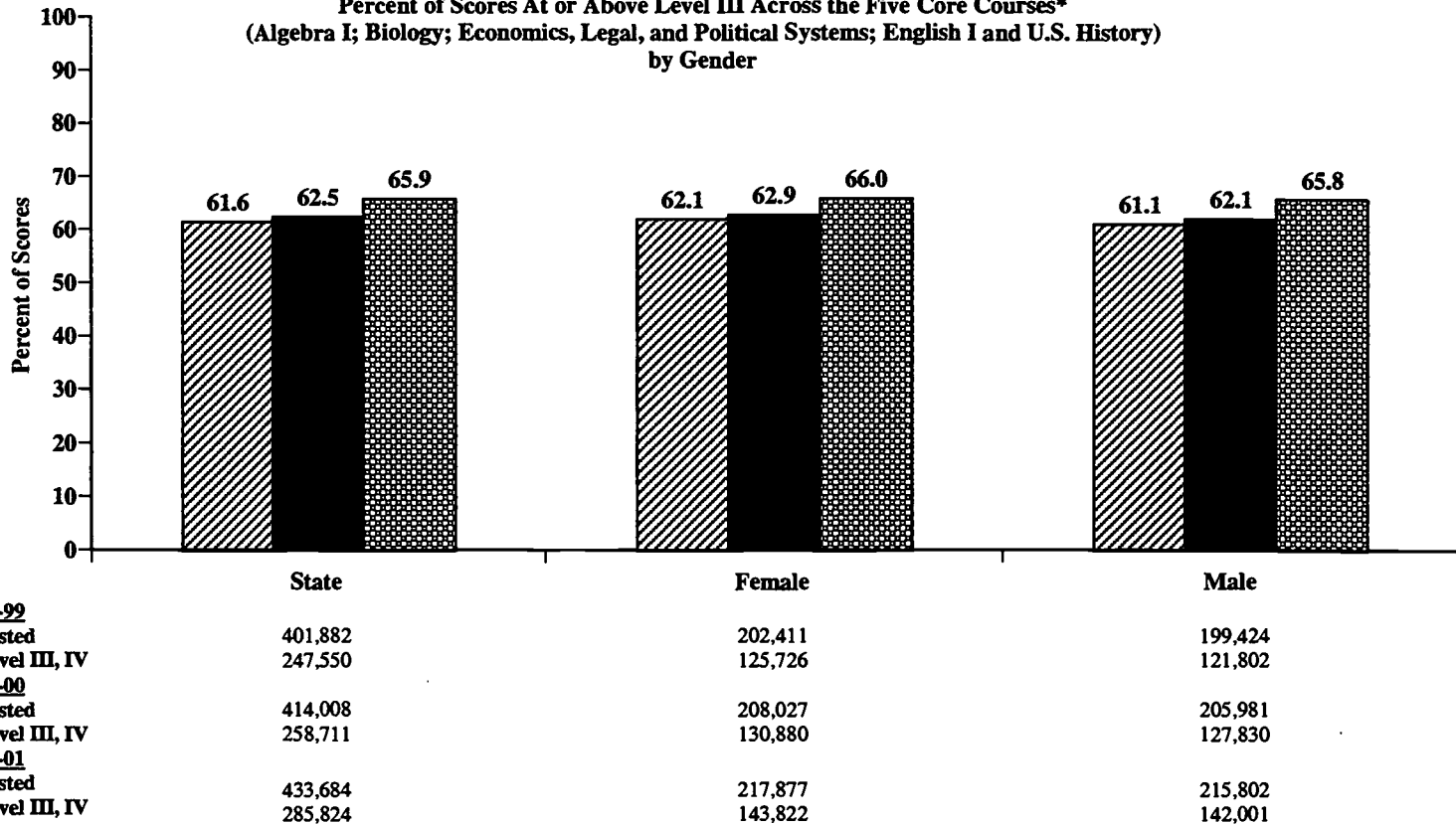


Notes: "N Tested" and "N Level III, IV" for the ethnic categories do not sum to the "N Tested" and "N Level III, IV" for the state because ethnicity was not coded on all student answer sheets and, therefore, some students were reported in the state data only.
Beginning in the 1998-99 school year, Algebra II, Chemistry, Geometry, Physical Science and Physics were mandated statewide; data for these tests are not available prior to 1998-99.
Data received from LEAs and charter schools after August 2001 are not included in these figures.

**Figure 11. 1998-99 to 2000-01 End-of-Course Multiple-Choice Test Results
Percent of Scores At or Above Level III Across the Five Core Courses*
(Algebra I; Biology; Economics, Legal, and Political Systems; English I and U.S. History)
by Ethnicity**



**Figure 12. 1998-99 to 2000-01 End-of-Course Multiple-Choice Test Results
Percent of Scores At or Above Level III Across the Five Core Courses*
(Algebra I; Biology; Economics, Legal, and Political Systems; English I and U.S. History)
by Gender**



Notes: *As of 1998-99, five additional courses were mandated; since there are no data available prior to 1998-99 for these five courses, they are not included in these figures. "N Tested" and "N Level III, IV" for the ethnic categories do not sum to the "N Tested" and "N Level III, IV" for the state because ethnicity was not coded in some student answer sheets and, therefore, some students were reported in the state data only. Data received from LEAs and charter schools after August 2001 are not included in these figures. Data provided by the NCDPI Division of Accountability Services/Testing Section.

**Table 5. 1999-00 to 2000-01 End-of-Course Multiple-Choice Test Results
Percent of Students by Achievement Level
by Course and Gender
(Algebra I, Algebra II and Geometry)**

Level	Gender	1999-00 Algebra I		2000-01 Algebra I		1999-00 Algebra II		2000-01 Algebra II		1999-00 Geometry		2000-01 Geometry	
		N	%	N	%	N	%	N	%	N	%	N	%
Achievement Level I	Male	4,708	10.5	1,621	3.5	2,175	9.1	666	2.6	2,733	9.1	1,368	4.5
	Female	3,436	7.6	1,330	2.8	2,560	9.0	708	2.4	3,490	10.1	1,709	4.9
Achievement Level II	Male	9,904	22.1	10,051	21.8	6,616	27.7	6,044	23.8	8,506	28.3	8,510	27.8
	Female	10,012	22.1	9,299	19.8	8,238	28.8	7,430	25.1	11,084	32.1	12,023	34.5
Achievement Level III	Male	16,953	37.8	19,736	42.8	8,391	35.2	9,832	38.8	11,029	36.6	13,114	42.8
	Female	18,017	39.8	21,714	46.3	10,464	36.6	12,310	41.7	12,492	36.2	14,445	41.5
Achievement Level IV	Male	13,269	29.6	14,709	31.9	6,667	28.0	8,813	34.8	7,825	26.0	7,663	25.0
	Female	13,809	30.5	14,540	31.0	7,339	25.7	9,098	30.8	7,412	21.5	6,648	19.1
Percent At or Above Level III*	Male	30,222	67.4	34,445	74.7	15,058	63.1	18,645	73.5	18,854	62.7	20,777	67.8
	Female	31,826	70.3	36,254	77.3	17,803	62.2	21,408	72.5	19,904	57.7	21,093	60.6

State Results	Gender	1999-00		2000-01		1999-00		2000-01		1999-00		2000-01	
		N	%	N	%	N	%	N	%	N	%	N	%
State Results	Male	44,834	49.8	46,117	49.6	23,849	45.5	25,355	46.2	30,093	46.6	30,655	46.8
	Female	45,274	50.2	46,883	50.4	28,601	54.5	29,546	53.8	34,478	53.4	34,825	53.2

Notes: *"Percent At or Above Level III" is calculated based on actual N counts and is not summed.
 Due to rounding, some categories in some courses may not sum to 100%.
 When summed, male and female N counts may not match the state N counts because gender was not coded on some student answer sheets.
 Data received from LEAs and charter schools after August 2001 are not included in this table.
 Prepared by the NCDPI Division of Accountability Services/Testing Section.

**Table 5. 2000-01 End-of-Course Multiple-Choice Test Results
Percent of Students by Achievement Level,
by Course and Gender (continued)
(Biology; Chemistry; Economic, Legal, and Political Systems;
English I; Physical Science; Physics and U.S. History)**

Level	Gender	Biology		Chemistry		Economic, Legal, and Political Systems		English I		Physical Science		Physics		U.S. History	
		N	%	N	%	N	%	N	%	N	%	N	%	N	%
Achievement Level I	Male	5,190	12.7	1,901	9.7	3,764	8.4	4,945	10.3	2,096	10.5	226	3.7	4,796	13.3
	Female	4,675	11.4	2,696	11.2	3,108	6.8	2,312	5.0	1,695	8.8	315	6.4	5,844	15.5
Achievement Level II	Male	10,059	24.6	4,193	21.5	9,158	20.5	12,616	26.2	5,446	27.2	965	16.0	11,601	32.2
	Female	12,088	29.4	6,303	26.1	10,992	24.1	10,147	21.8	6,464	33.7	1,302	26.5	14,260	37.8
Achievement Level III	Male	16,910	41.3	7,364	37.7	16,393	36.8	18,652	38.7	8,091	40.5	2,914	48.3	12,318	34.2
	Female	17,583	42.8	9,803	40.5	18,995	41.6	19,481	41.9	8,236	42.9	2,433	49.5	12,215	32.4
Achievement Level IV	Male	8,756	21.4	6,066	31.1	15,277	34.3	11,951	24.8	4,368	21.8	1,932	32.0	7,299	20.3
	Female	6,763	16.5	5,376	22.2	12,520	27.4	14,602	31.4	2,786	14.5	861	17.5	5,409	14.3
Percent At or Above Level III*	Male	25,666	62.7	13,430	68.8	31,670	71.0	30,603	63.5	12,459	62.3	4,846	80.3	19,617	54.5
	Female	24,346	59.2	15,179	62.8	31,515	69.1	34,083	73.2	11,022	57.5	3,294	67.1	17,624	46.7

State Results	Gender	Biology		Chemistry		Economic, Legal, and Political Systems		English I		Physical Science		Physics		U.S. History	
		N	%	N	%	N	%	N	%	N	%	N	%	N	%
State Results	Male	40,915	49.9	19,524	44.7	44,592	49.4	48,164	50.9	20,001	51.0	6,037	55.1	36,014	48.8
	Female	41,109	50.1	24,178	55.3	45,615	50.6	46,542	49.1	19,181	49.0	4,911	44.9	37,728	51.2

Notes: *Percent At or above Level III" is calculated based on actual N counts and is not summed.

Due to rounding, some categories in some courses may not sum to 100%.

When summed, male and female N counts may not match the state N counts because gender was not coded on some student answer sheets.

Data received from LEAs and charter schools after August 2001 are not included in this table.

Prepared by the NCDPI Division of Accountability Services/Testing Section.

**Table 6. 2000-01 End-of-Course Multiple-Choice Test Results
Performance of Academically Gifted, Exceptional, Limited English Proficient and Title I Students
by Course**

<u>Course</u>	<u>Category</u>	<u>Number Tested</u>	<u>Percent*</u>	<u>Percent At or Above Level III</u>	<u>Mean Scale Score</u>
Algebra I	All Students	93,000	100.0	76.0	61.1
	Not Exceptional	72,648	78.1	74.1	59.8
	Academically Gifted	14,031	15.1	98.6	71.1
	Students with Disabilities	6,291	6.8	47.6	54.4
	Behaviorally Emotionally Handicapped	409	0.4	34.7	51.9
	Hearing Impaired	93	0.1	65.6	57.3
	Educable Mentally Handicapped	566	0.6	14.5	48.2
	Specific Learning Disabled	4,329	4.7	51.5	55.1
	Speech-Language Impaired	75	0.1	61.3	56.1
	Visually Impaired	36	0.0	66.7	57.8
	Other Health Impaired	681	0.7	53.0	55.7
	Orthopedically Impaired	37	0.0	43.2	56.2
	Traumatic Brain Injured	28	0.0	**	**
	Autistic	30	0.0	66.7	60.9
	Severe/Profound Mentally Disabled	2	0.0	**	**
	Multihandicapped	2	0.0	**	**
	Deaf-Blind	3	0.0	**	**
	Trainable Mentally Disabled	0	0.0	**	**
	Section 504	808	0.9	66.0	59.0
	Limited English Proficient	683	0.7	61.3	57.5
	Not Served by Title 1	89,592	96.3	76.3	61.1
	Schoolwide Title 1 Program	3,132	3.4	67.7	60.1
	Targeted Assistance	144	0.2	75.7	62.6
Migrant	185	0.2	75.7	60.6	
Algebra II	All Students	54,902	100.0	73.0	63.8
	Not Exceptional	45,553	83.0	69.3	62.4
	Academically Gifted	8,160	14.9	95.0	72.2
	Students with Disabilities	1,187	2.2	62.4	60.7
	Behaviorally Emotionally Handicapped	30	0.1	63.3	61.6
	Hearing Impaired	31	0.1	58.1	58.1
	Educable Mentally Handicapped	10	0.0	**	**
	Specific Learning Disabled	877	1.6	62.3	60.6
	Speech-Language Impaired	10	0.0	**	**
	Visually Impaired	25	0.0	**	**
	Other Health Impaired	177	0.3	66.7	61.7
	Orthopedically Impaired	11	0.0	**	**
	Traumatic Brain Injured	5	0.0	**	**
	Autistic	9	0.0	**	**
	Severe/Profound Mentally Disabled	0	0.0	**	**
	Multihandicapped	1	0.0	**	**
	Deaf-Blind	1	0.0	**	**
	Trainable Mentally Disabled	0	0.0	**	**
	Section 504	315	0.6	70.2	63.3
	Limited English Proficient	216	0.4	69.4	62.7
	Not Served by Title 1	54,026	98.4	73.4	63.9
	Schoolwide Title 1 Program	821	1.5	42.1	56.3
	Targeted Assistance	36	0.1	47.2	57.3
Migrant	18	0.0	**	**	

Notes: *Percent for "Not Exceptional" through "Trainable Mentally Disabled" is based on the sum of the students in those categories. Percent for "Section 504" through "Migrant" is based on the number tested in the "All Students" category.

**No scores are reported for groups with fewer than thirty students.

"Not Exceptional," "Academically Gifted" and "Students with Disabilities" do not sum to "All Students" because whether or not some students were classified as exceptional was not coded on the answer sheets. The "All Students" and "Not Exceptional" categories are added for comparison purposes.

Data received from LEAs and charter schools after August 2001 are not included in this table.

Prepared by the NCDPI Division of Accountability Services/Testing Section.

**Table 6. 2000-01 End-of-Course Multiple-Choice Test Results
Performance of Academically Gifted, Exceptional, Limited English Proficient and Title I Students
by Course (continued)**

<u>Course</u>	<u>Category</u>	<u>Number</u>		<u>Percent</u>	<u>Mean</u>
		<u>Tested</u>	<u>Percent*</u>	<u>At or Above Level III</u>	<u>Scale Score</u>
Biology	All Students	82,026	100.0	61.0	56.8
	Not Exceptional	67,904	82.8	59.4	56.3
	Academically Gifted	8,030	9.8	96.9	66.0
	Students with Disabilities	6,085	7.4	31.4	50.6
	Behaviorally Emotionally Handicapped	379	0.5	24.8	49.3
	Hearing Impaired	87	0.1	44.8	52.8
	Educable Mentally Handicapped	590	0.7	2.9	43.5
	Specific Learning Disabled	4,154	5.1	34.1	51.3
	Speech-Language Impaired	83	0.1	39.8	52.8
	Visually Impaired	25	0.0	**	**
	Other Health Impaired	662	0.8	37.5	52.0
	Orthopedically Impaired	43	0.1	41.9	52.4
	Traumatic Brain Injured	24	0.0	**	**
	Autistic	30	0.0	66.7	57.0
	Severe/Profound Mentally Disabled	1	0.0	**	**
	Multihandicapped	6	0.0	**	**
	Deaf-Blind	1	0.0	**	**
	Trainable Mentally Disabled	0	0.0	**	**
	Section 504	611	0.7	47.0	54.3
	Limited English Proficient	554	0.7	21.8	48.8
	Not Served by Title 1	80,406	98.0	61.6	56.9
	Schoolwide Title 1 Program	1,447	1.8	27.2	50.1
Targeted Assistance	55	0.1	49.1	53.9	
Migrant	55	0.1	36.4	52.3	
Chemistry	All Students	43,702	100.0	65.5	58.9
	Not Exceptional	35,801	81.9	60.6	57.7
	Academically Gifted	7,161	16.4	90.4	65.2
	Students with Disabilities	736	1.7	58.3	57.3
	Behaviorally Emotionally Handicapped	19	0.0	**	**
	Hearing Impaired	30	0.1	43.3	55.9
	Educable Mentally Handicapped	7	0.0	**	**
	Specific Learning Disabled	529	1.2	56.3	57.0
	Speech-Language Impaired	7	0.0	**	**
	Visually Impaired	17	0.0	**	**
	Other Health Impaired	103	0.2	68.0	59.4
	Orthopedically Impaired	10	0.0	**	**
	Traumatic Brain Injured	4	0.0	**	**
	Autistic	8	0.0	**	**
	Severe/Profound Mentally Disabled	0	0.0	**	**
	Multihandicapped	1	0.0	**	**
	Deaf-Blind	1	0.0	**	**
	Trainable Mentally Disabled	0	0.0	**	**
	Section 504	238	0.5	55.1	57.1
	Limited English Proficient	150	0.3	46.0	54.2
	Not Served by Title 1	43,154	98.7	65.8	59.0
	Schoolwide Title 1 Program	515	1.2	35.7	52.9
Targeted Assistance	7	0.0	**	**	
Migrant	14	0.0	**	**	

Notes: *Percent for "Not Exceptional" through "Trainable Mentally Disabled" is based on the sum of the students in those categories. Percent for "Section 504" through "Migrant" is based on the number tested in the "All Students" category.

**No scores are reported for groups with fewer than thirty students.

"Not Exceptional," "Academically Gifted" and "Students with Disabilities" do not sum to "All Students" because whether or not some students were classified as exceptional was not coded on the answer sheets. The "All Students" and "Not Exceptional" categories are added for comparison purposes.

Data received from LEAs and charter schools after August 2001 are not included in this table.

Prepared by the NCDPI Division of Accountability Services/Testing Section.

**Table 6. 2000-01 End-of-Course Multiple-Choice Test Results
Performance of Academically Gifted, Exceptional, Limited English Proficient and Title I Students
by Course (continued)**

<u>Course</u>	<u>Category</u>	<u>Number</u>		<u>Percent</u>	<u>Mean</u>
		<u>Tested</u>	<u>Percent*</u>	<u>At or Above Level III</u>	<u>Scale Score</u>
Economic, Legal, & Political Systems	All Students	90,209	100.0	70.0	55.7
	Not Exceptional	74,835	83.0	69.8	55.3
	Academically Gifted	8,632	9.6	98.5	64.5
	Students with Disabilities	6,734	7.5	36.7	48.4
	Behaviorally Emotionally Handicapped	507	0.6	27.4	45.4
	Hearing Impaired	94	0.1	31.9	49.1
	Educable Mentally Handicapped	648	0.7	9.4	41.8
	Specific Learning Disabled	4,539	5.0	40.2	49.3
	Speech-Language Impaired	78	0.1	35.9	49.1
	Visually Impaired	34	0.0	76.5	57.1
	Other Health Impaired	736	0.8	41.8	49.9
	Orthopedically Impaired	43	0.0	60.5	53.4
	Traumatic Brain Injured	27	0.0	**	**
	Autistic	22	0.0	**	**
	Severe/Profound Mentally Disabled	0	0.0	**	**
	Multihandicapped	3	0.0	**	**
	Deaf-Blind	2	0.0	**	**
	Trainable Mentally Disabled	1	0.0	**	**
	Section 504	676	0.7	57.4	52.8
	Limited English Proficient	697	0.8	29.1	47.2
	Not Served by Title 1	88,401	98.0	70.5	55.8
Schoolwide Title 1 Program	1,675	1.9	46.5	50.6	
Targeted Assistance	51	0.1	56.9	51.5	
Migrant	70	0.1	52.9	51.4	
English I	All Students	94,707	100.0	68.3	55.4
	Not Exceptional	76,224	80.5	69.2	55.1
	Academically Gifted	9,758	10.3	99.1	65.3
	Students with Disabilities	8,703	9.2	25.9	46.7
	Behaviorally Emotionally Handicapped	821	0.9	20.6	45.2
	Hearing Impaired	118	0.1	38.1	49.4
	Educable Mentally Handicapped	739	0.8	3.5	41.6
	Specific Learning Disabled	5,798	6.1	27.3	47.1
	Speech-Language Impaired	99	0.1	34.3	48.2
	Visually Impaired	36	0.0	55.6	52.3
	Other Health Impaired	991	1.0	34.4	48.8
	Orthopedically Impaired	38	0.0	47.4	51.7
	Traumatic Brain Injured	27	0.0	**	**
	Autistic	29	0.0	**	**
	Severe/Profound Mentally Disabled	0	0.0	**	**
	Multihandicapped	2	0.0	**	**
	Deaf-Blind	2	0.0	**	**
	Trainable Mentally Disabled	3	0.0	**	**
	Section 504	836	0.9	49.9	51.6
	Limited English Proficient	911	1.0	28.8	47.2
	Not Served by Title 1	92,736	97.9	68.8	55.5
Schoolwide Title 1 Program	1,754	1.9	43.8	50.1	
Targeted Assistance	49	0.1	51.0	51.6	
Migrant	108	0.1	38.0	47.7	

Notes: *Percent for "Not Exceptional" through "Trainable Mentally Disabled" is based on the sum of the students in those categories. Percent for "Section 504" through "Migrant" is based on the number tested in the "All Students" category.

**No scores are reported for groups with fewer than thirty students.

"Not Exceptional," "Academically Gifted" and "Students with Disabilities" do not sum to "All Students" because whether or not some students were classified as exceptional was not coded on the answer sheets. The "All Students" and "Not Exceptional" categories are added for comparison purposes. Data received from LEAs and charter schools after August 2001 are not included in this table.

Prepared by the NCDPI Division of Accountability Services/Testing Section.

**Table 6. 2000-01 End-of-Course Multiple-Choice Test Results
Performance of Academically Gifted, Exceptional, Limited English Proficient and Title I Students
by Course (continued)**

<u>Course</u>	<u>Category</u>	<u>Number Tested</u>	<u>Percent*</u>	<u>Percent At or Above Level III</u>	<u>Mean Scale Score</u>
Geometry	All Students	65,480	100.0	63.9	59.8
	Not Exceptional	53,948	82.4	58.9	58.4
	Academically Gifted	9,647	14.7	95.4	68.6
	Students with Disabilities	1,881	2.9	48.1	56.1
	Behaviorally Emotionally Handicapped	62	0.1	30.6	51.9
	Hearing Impaired	52	0.1	48.1	56.0
	Educable Mentally Handicapped	32	0.0	9.4	47.1
	Specific Learning Disabled	1,383	2.1	49.5	56.2
	Speech-Language Impaired	27	0.0	**	**
	Visually Impaired	29	0.0	**	**
	Other Health Impaired	240	0.4	48.8	57.4
	Orthopedically Impaired	23	0.0	**	**
	Traumatic Brain Injured	9	0.0	**	**
	Autistic	16	0.0	**	**
	Severe/Profound Mentally Disabled	1	0.0	**	**
	Multihandicapped	1	0.0	**	**
	Deaf-Blind	6	0.0	**	**
	Trainable Mentally Disabled	0	0.0	**	**
	Section 504	402	0.6	55.5	58.0
	Limited English Proficient	326	0.5	44.5	55.9
	Not Served by Title 1	64,404	98.4	64.6	59.9
Schoolwide Title 1 Program	976	1.5	23.5	52.0	
Targeted Assistance	23	0.0	**	**	
Migrant	30	0.0	43.3	54.6	
Physical Science	All Students	39,182	100.0	59.9	55.5
	Not Exceptional	33,069	84.4	59.6	55.2
	Academically Gifted	2,783	7.1	97.7	66.2
	Students with Disabilities	3,325	8.5	31.4	49.6
	Behaviorally Emotionally Handicapped	320	0.8	20.3	46.5
	Hearing Impaired	52	0.1	32.7	50.9
	Educable Mentally Handicapped	337	0.9	4.2	43.4
	Specific Learning Disabled	2,148	5.5	36.1	50.7
	Speech-Language Impaired	43	0.1	34.9	49.7
	Visually Impaired	16	0.0	**	**
	Other Health Impaired	367	0.9	35.4	50.6
	Orthopedically Impaired	18	0.0	**	**
	Traumatic Brain Injured	9	0.0	**	**
	Autistic	14	0.0	**	**
	Severe/Profound Mentally Disabled	0	0.0	**	**
	Multihandicapped	1	0.0	**	**
	Deaf-Blind	0	0.0	**	**
	Trainable Mentally Disabled	0	0.0	**	**
	Section 504	324	0.8	46.3	52.8
	Limited English Proficient	275	0.7	26.5	49.4
	Not Served by Title 1	37,916	96.8	60.8	55.7
Schoolwide Title 1 Program	1,151	2.9	33.0	49.4	
Targeted Assistance	47	0.1	31.9	50.5	
Migrant	46	0.1	47.8	52.0	

Notes: *Percent for "Not Exceptional" through "Trainable Mentally Disabled" is based on the sum of the students in those categories. Percent for "Section 504" through "Migrant" is based on the number tested in the "All Students" category.

**No scores are reported for groups with fewer than thirty students.

"Not Exceptional," "Academically Gifted" and "Students with Disabilities" do not sum to "All Students" because whether or not some students were classified as exceptional was not coded on the answer sheets. The "All Students" and "Not Exceptional" categories are added for comparison purposes. Data received from LEAs and charter schools after August 2001 are not included in this table.

Prepared by the NCDPI Division of Accountability Services/Testing Section.

**Table 6. 2000-01 End-of-Course Multiple-Choice Test Results
Performance of Academically Gifted, Exceptional, Limited English Proficient and Title I Students
by Course (continued)**

<u>Course</u>	<u>Category</u>	<u>Number Tested</u>	<u>Percent*</u>	<u>Percent</u>	<u>Mean</u>
				<u>At or Above Level III</u>	<u>Scale Score</u>
Physics	All Students	10,948	100.0	74.4	57.0
	Not Exceptional	8,086	73.9	69.5	55.8
	Academically Gifted	2,718	24.8	88.9	60.6
	Students with Disabilities	142	1.3	74.6	56.9
	Behaviorally Emotionally Handicapped	6	0.1	**	**
	Hearing Impaired	3	0.0	**	**
	Educable Mentally Handicapped	4	0.0	**	**
	Specific Learning Disabled	96	0.9	74.0	56.4
	Speech-Language Impaired	1	0.0	**	**
	Visually Impaired	2	0.0	**	**
	Other Health Impaired	25	0.2	**	**
	Orthopedically Impaired	2	0.0	**	**
	Traumatic Brain Injured	1	0.0	**	**
	Autistic	2	0.0	**	**
	Severe/Profound Mentally Disabled	0	0.0	**	**
	Multihandicapped	0	0.0	**	**
	Deaf-Blind	0	0.0	**	**
	Trainable Mentally Disabled	0	0.0	**	**
	Section 504	57	0.5	77.2	57.9
	Limited English Proficient	37	0.3	54.1	52.6
Not Served by Title 1	10,829	98.9	74.6	57.0	
Schoolwide Title 1 Program	116	1.1	46.6	51.0	
Targeted Assistance	0	0.0	**	**	
Migrant	1	0.0	**	**	
U. S. History	All Students	73,742	100.0	50.5	56.6
	Not Exceptional	61,688	83.7	47.7	56.0
	Academically Gifted	7,354	10.0	90.9	64.9
	Students with Disabilities	4,683	6.4	24.4	50.5
	Behaviorally Emotionally Handicapped	292	0.4	18.8	48.8
	Hearing Impaired	79	0.1	29.1	51.6
	Educable Mentally Handicapped	458	0.6	3.9	43.9
	Specific Learning Disabled	3,170	4.3	25.8	51.0
	Speech-Language Impaired	54	0.1	25.9	51.4
	Visually Impaired	46	0.1	50.0	56.4
	Other Health Impaired	505	0.7	31.5	52.6
	Orthopedically Impaired	33	0.0	48.5	55.5
	Traumatic Brain Injured	24	0.0	**	**
	Autistic	20	0.0	**	**
	Severe/Profound Mentally Disabled	0	0.0	**	**
	Multihandicapped	2	0.0	**	**
	Deaf-Blind	0	0.0	**	**
	Trainable Mentally Disabled	0	0.0	**	**
	Section 504	539	0.7	39.1	54.5
	Limited English Proficient	460	0.6	19.1	50.0
Not Served by Title 1	72,360	98.1	51.0	56.7	
Schoolwide Title 1 Program	1,253	1.7	24.2	50.6	
Targeted Assistance	28	0.0	**	**	
Migrant	36	0.0	13.9	51.3	

Notes: *Percent for "Not Exceptional" through "Trainable Mentally Disabled" is based on the sum of the students in those categories. Percent for "Section 504" through "Migrant" is based on the number tested in the "All Students" category.

**No scores are reported for groups with fewer than thirty students.

"Not Exceptional," "Academically Gifted" and "Students with Disabilities" do not sum to "All Students" because whether or not some students were classified as exceptional was not coded on the answer sheets. The "All Students" and "Not Exceptional" categories are added for comparison purposes. Data received from LEAs and charter schools after August 2001 are not included in this table.

Prepared by the NCDPI Division of Accountability Services/Testing Section.

**Table 7. 2000-01 End-of-Course Multiple-Choice Test Results
Performance of Students Using Accommodations
by Course**

<u>Course</u>	<u>Category</u>	<u>Number Tested</u>	<u>Percent</u>	<u>Percent At or Above Level III</u>	<u>Mean Scale Score</u>
Algebra I	All Students	93,000	100.0	76.0	61.1
	Braille Edition	3	0.0	*	*
	Large Print	31	0.0	80.6	61.0
	Assistive Technology	9	0.0	*	*
	Braille Writer	3	0.0	*	*
	Cranmer Abacus	2	0.0	*	*
	Dictation to Scribe	27	0.0	*	*
	Interpreter Signs Test**	16	0.0	*	*
	Magnification Devices	7	0.0	*	*
	Student Marks in Test Book	720	0.8	54.9	56.5
	Test Administrator Reads Test Aloud**	1,548	1.7	43.2	53.5
	Use of Typewriter or Word Processor	7	0.0	*	*
	Hospital/Home Testing	46	0.0	47.8	55.9
	Multiple Test Sessions	347	0.4	43.8	53.9
	Scheduled Extended Time	3,868	4.2	52.5	55.6
	Testing in a Separate Room	2,691	2.9	43.5	53.7
	English/Native Language Dictionary/Electronic Translator	136	0.1	69.9	59.7
One Test Item per Page	4	0.0	*	*	
Algebra II	All Students	54,902	100.0	73.0	63.8
	Braille Edition	6	0.0	*	*
	Large Print	16	0.0	*	*
	Assistive Technology	4	0.0	*	*
	Braille Writer	2	0.0	*	*
	Cranmer Abacus	3	0.0	*	*
	Dictation to Scribe	8	0.0	*	*
	Interpreter Signs Test**	4	0.0	*	*
	Magnification Devices	3	0.0	*	*
	Student Marks in Test Book	70	0.1	61.4	63.1
	Test Administrator Reads Test Aloud**	75	0.1	41.3	57.0
	Use of Typewriter or Word Processor	0	0.0	*	*
	Hospital/Home Testing	19	0.0	*	*
	Multiple Test Sessions	32	0.1	46.9	58.0
	Scheduled Extended Time	658	1.2	67.2	62.4
	Testing in a Separate Room	313	0.6	54.3	59.3
	English/Native Language Dictionary/Electronic Translator	37	0.1	83.8	66.0
One Test Item per Page	1	0.0	*	*	

Notes: *No scores are reported for groups with fewer than thirty students.

**The "Interpreter Signs Test" and "Test Administrator Reads Test Aloud" accommodations are prohibited from use during the administration of state tests that measure reading skills.

Accommodations are available for students with disabilities, limited English proficiency or temporary disabilities.

All data are rounded to the nearest tenth, therefore, accommodation categories may not sum to 100%.

Data received from LEAs and charter schools after August 2001 are not included in this table.

Prepared by the NCDPI Division of Accountability Services/Testing Section.

**Table 7. 2000-01 End-of-Course Multiple-Choice Test Results
Performance of Students Using Accommodations
by Course (continued)**

<u>Course</u>	<u>Category</u>	<u>Number Tested</u>	<u>Percent</u>	<u>Percent At or Above Level III</u>	<u>Mean Scale Score</u>
Biology	All Students	82,026	100.0	61.0	56.8
	Braille Edition	0	0.0	*	*
	Large Print	16	0.0	*	*
	Assistive Technology	8	0.0	*	*
	Braille Writer	0	0.0	*	*
	Cranmer Abacus	0	0.0	*	*
	Dictation to Scribe	20	0.0	*	*
	Interpreter Signs Test**	11	0.0	*	*
	Magnification Devices	5	0.0	*	*
	Student Marks in Test Book	651	0.8	29.5	50.2
	Test Administrator Reads Test Aloud**	2,012	2.5	17.4	48.2
	Use of Typewriter or Word Processor	8	0.0	*	*
	Hospital/Home Testing	43	0.1	46.5	53.4
	Multiple Test Sessions	288	0.4	28.1	49.6
	Scheduled Extended Time	3,142	3.8	25.2	49.5
	Testing in a Separate Room	2,552	3.1	23.4	49.1
	English/Native Language Dictionary/Electronic Translator	102	0.1	28.4	50.3
One Test Item per Page	0	0.0	*	*	
Chemistry	All Students	43,702	100.0	65.5	58.9
	Braille Edition	3	0.0	*	*
	Large Print	10	0.0	*	*
	Assistive Technology	1	0.0	*	*
	Braille Writer	1	0.0	*	*
	Cranmer Abacus	0	0.0	*	*
	Dictation to Scribe	5	0.0	*	*
	Interpreter Signs Test**	4	0.0	*	*
	Magnification Devices	2	0.0	*	*
	Student Marks in Test Book	57	0.1	66.7	59.9
	Test Administrator Reads Test Aloud**	62	0.1	40.3	54.6
	Use of Typewriter or Word Processor	2	0.0	*	*
	Hospital/Home Testing	9	0.0	*	*
	Multiple Test Sessions	12	0.0	*	*
	Scheduled Extended Time	336	0.8	54.2	56.6
	Testing in a Separate Room	188	0.4	50.5	56.5
	English/Native Language Dictionary/Electronic Translator	24	0.1	*	*
One Test Item per Page	3	0.0	*	*	

Notes: *No scores are reported for groups with fewer than thirty students.

**The "Interpreter Signs Test" and "Test Administrator Reads Test Aloud" accommodations are prohibited from use during the administration of state tests that measure reading skills.

Accommodations are available for students with disabilities, limited English proficiency or temporary disabilities

All data are rounded to the nearest tenth, therefore, accommodation categories may not sum to 100%.

Data received from LEAs and charter schools after August 2001 are not included in this table.

Prepared by the NCDPI Division of Accountability Services/Testing Section.

**Table 7. 2000-01 End-of-Course Multiple-Choice Test Results
Performance of Students Using Accommodations
by Course (continued)**

<u>Course</u>	<u>Category</u>	<u>Number Tested</u>	<u>Percent</u>	<u>Percent At or Above Level III</u>	<u>Mean Scale Score</u>
Economic, Legal, & Political Systems	All Students	90,209	100.0	70.0	55.7
	Braille Edition	3	0.0	*	*
	Large Print	23	0.0	*	*
	Assistive Technology	7	0.0	*	*
	Braille Writer	1	0.0	*	*
	Cranmer Abacus	0	0.0	*	*
	Dictation to Scribe	26	0.0	*	*
	Interpreter Signs Test**	20	0.0	*	*
	Magnification Devices	4	0.0	*	*
	Student Marks in Test Book	836	0.9	37.4	48.9
	Test Administrator Reads Test Aloud**	2,331	2.6	25.4	46.5
	Use of Typewriter or Word Processor	2	0.0	*	*
	Hospital/Home Testing	57	0.1	47.4	51.1
	Multiple Test Sessions	328	0.4	35.7	48.3
	Scheduled Extended Time	3,667	4.1	33.0	47.5
	Testing in a Separate Room	3,107	3.4	29.6	46.9
	English/Native Language Dictionary/Electronic Translator	224	0.2	28.1	46.2
	One Test Item per Page	0	0.0	*	*
<hr/>					
English I	All Students	94,707	100.0	68.3	55.4
	Braille Edition	48	0.1	33.3	49.1
	Large Print	73	0.1	41.1	50.4
	Assistive Technology	52	0.1	38.5	49.6
	Braille Writer	50	0.1	32.0	48.8
	Cranmer Abacus	49	0.1	32.7	48.8
	Dictation to Scribe	70	0.1	35.7	49.5
	Interpreter Signs Test**	61	0.1	32.8	48.3
	Magnification Devices	52	0.1	30.8	48.1
	Test Administrator Reads Test Aloud**	0	0.0	*	*
	Student Marks in Test Book	1,054	1.1	25.6	46.7
	Use of Typewriter or Word Processor	49	0.1	32.7	48.9
	Hospital/Home Testing	94	0.1	35.1	49.0
	Multiple Test Sessions	528	0.6	19.3	45.6
	Scheduled Extended Time	4,717	5.0	22.3	46.1
	Testing in a Separate Room	3,689	3.9	18.7	45.4
	English/Native Language Dictionary/Electronic Translator	310	0.3	25.2	46.6
	One Test Item per Page	55	0.1	27.3	47.7

Notes: *No scores are reported for groups with fewer than thirty students.

** The "Interpreter Signs Test" and "Test Administrator Reads Test Aloud" accommodations are prohibited from use during the administration of state tests that measure reading skills.

Accommodations are available for students with disabilities, limited English proficiency or temporary disabilities

All data are rounded to the nearest tenth, therefore, accommodation categories may not sum to 100%.

Data received from LEAs and charter schools after August 2001 are not included in this table.

Prepared by the NCDPI Division of Accountability Services/Testing Section.

**Table 7. 2000-01 End-of-Course Multiple-Choice Test Results
Performance of Students Using Accommodations
by Course (continued)**

<u>Course</u>	<u>Category</u>	<u>Number Tested</u>	<u>Percent</u>	<u>Percent At or Above Level III</u>	<u>Mean Scale Score</u>
Geometry	All Students	65,480	100.0	63.9	59.8
	Braille Edition	5	0.0	*	*
	Large Print	19	0.0	*	*
	Assistive Technology	6	0.0	*	*
	Braille Writer	4	0.0	*	*
	Cranmer Abacus	2	0.0	*	*
	Dictation to Scribe	17	0.0	*	*
	Interpreter Signs Test**	11	0.0	*	*
	Magnification Devices	4	0.0	*	*
	Student Marks in Test Book	160	0.2	46.3	56.6
	Test Administrator Reads Test Aloud**	221	0.3	31.7	53.3
	Use of Typewriter or Word Processor	1	0.0	*	*
	Hospital/Home Testing	23	0.0	*	*
	Multiple Test Sessions	77	0.1	50.6	56.6
	Scheduled Extended Time	954	1.5	49.9	56.8
	Testing in a Separate Room	593	0.9	40.3	54.5
	English/Native Language Dictionary/Electronic Translator	46	0.1	47.8	59.2
One Test Item per Page	1	0.0	*	*	
<hr/>					
Physical Science	All Students	39,182	100.0	59.9	55.5
	Braille Edition	3	0.0	*	*
	Large Print	13	0.0	*	*
	Assistive Technology	2	0.0	*	*
	Braille Writer	0	0.0	*	*
	Cranmer Abacus	0	0.0	*	*
	Dictation to Scribe	15	0.0	*	*
	Interpreter Signs Test**	9	0.0	*	*
	Magnification Devices	2	0.0	*	*
	Student Marks in Test Book	342	0.9	33.6	50.6
	Test Administrator Reads Test Aloud**	1,141	2.9	22.5	47.9
	Use of Typewriter or Word Processor	0	0.0	*	*
	Hospital/Home Testing	22	0.1	*	*
	Multiple Test Sessions	204	0.5	26.5	48.1
	Scheduled Extended Time	1,771	4.5	30.2	49.2
	Testing in a Separate Room	1,483	3.8	27.2	48.6
	English/Native Language Dictionary/Electronic Translator	80	0.2	26.3	49.5
One Test Item per Page	0	0.0	*	*	

Notes: *No scores are reported for groups with fewer than thirty students.

**The "Interpreter Signs Test" and "Test Administrator Reads Test Aloud" accommodations are prohibited from use during the administration of state tests that measure reading skills.

Accommodations are available for students with disabilities, limited English proficiency or temporary disabilities.

All data are rounded to the nearest tenth, therefore, accommodation categories may not sum to 100%.

Data received from LEAs and charter schools after August 2001 are not included in this table.

Prepared by the NCDPI Division of Accountability Services/Testing Section..

**Table 7. 2000-01 End-of-Course Multiple-Choice Test Results
Performance of Students Using Accommodations
by Course (continued)**

<u>Course</u>	<u>Category</u>	<u>Number Tested</u>	<u>Percent</u>	<u>Percent At or Above Level III</u>	<u>Mean Scale Score</u>
Physics	All Students	10,948	100.0	74.4	57.0
	Braille Edition	0	0.0	*	*
	Large Print	1	0.0	*	*
	Assistive Technology	0	0.0	*	*
	Braille Writer	0	0.0	*	*
	Cranmer Abacus	0	0.0	*	*
	Dictation to Scribe	1	0.0	*	*
	Interpreter Signs Test**	0	0.0	*	*
	Magnification Devices	1	0.0	*	*
	Student Marks in Test Book	15	0.1	*	*
	Test Administrator Reads Test Aloud**	11	0.1	*	*
	Use of Typewriter or Word Processor	1	0.0	*	*
	Hospital/Home Testing	2	0.0	*	*
	Multiple Test Sessions	4	0.0	*	*
	Scheduled Extended Time	67	0.6	88.1	58.9
	Testing in a Separate Room	35	0.3	85.7	58.0
	English/Native Language Dictionary/Electronic Translator	5	0.0	*	*
	One Test Item per Page	0	0.0	*	*
<hr/>					
U. S. History	All Students	73,742	100.0	50.5	56.6
	Braille Edition	40	0.1	25.0	52.0
	Large Print	73	0.1	30.1	52.9
	Assistive Technology	43	0.1	23.3	51.4
	Braille Writer	39	0.1	25.6	51.7
	Cranmer Abacus	38	0.1	23.7	51.4
	Dictation to Scribe	69	0.1	36.2	54.1
	Interpreter Signs Test**	50	0.1	22.0	51.4
	Magnification Devices	40	0.1	22.5	51.6
	Student Marks in Test Book	530	0.7	24.0	50.6
	Test Administrator Reads Test Aloud**	1,613	2.2	14.6	48.2
	Use of Typewriter or Word Processor	47	0.1	31.9	52.9
	Hospital/Home Testing	86	0.1	24.4	51.8
	Multiple Test Sessions	248	0.3	16.1	49.1
	Scheduled Extended Time	2,510	3.4	20.8	49.9
	Testing in a Separate Room	2,167	2.9	17.3	48.9
	English/Native Language Dictionary/Electronic Translator	157	0.2	17.8	49.9
	One Test Item per Page	40	0.1	22.5	51.6

Notes: *No scores are reported for groups with fewer than thirty students.

**The "Interpreter Signs Test" and "Test Administrator Reads Test Aloud" accommodations are prohibited from use during the administration of state tests that measure reading skills.

Accommodations are available for students with disabilities, limited English proficiency or temporary disabilities.

All data are rounded to the nearest tenth, therefore, accommodation categories may not sum to 100%.

Data received from LEAs and charter schools after August 2001 are not included in this table.

Prepared by the NCDPI Division of Accountability Services/Testing Section.

**Table 8. 2000-01 End-of-Course Multiple-Choice Test Results
Participation of Students with Special Needs****

	Algebra I		Algebra II		Biology		Chemistry		Economic, Legal, and Political Systems		English I		Geometry		Physical Science		Physics		U.S. History	
	N	%	N	%	N	%	N	%	N	%	N	%	N	%	N	%	N	%	N	%
Statewide*	95,035	100.0	55,826	100.0	83,833	100.0	44,145	100.0	92,442	100.0	97,996	100.0	66,547	100.0	40,390	100.0	11,036	100.0	75,042	100.0
All Students with IEPs	6,461	6.8	1,214	2.2	6,306	7.5	745	1.7	7,034	7.6	9,084	9.3	1,935	2.9	3,463	8.6	144	1.3	4,807	6.4
Standard Administration	6,291	6.6	1,187	2.1	6,085	7.3	736	1.7	6,734	7.3	8,703	8.9	1,881	2.8	3,325	8.2	142	1.3	4,683	6.2
With Accommodations	3,905	4.1	527	0.9	3,807	4.5	293	0.7	4,253	4.6	4,994	5.1	852	1.3	2,114	5.2	52	0.5	2,965	4.0
Not Participating	0	0.0	0	0.0	0	0.0	0	0.0	0	0.0	1	0.0	0	0.0	1	0.0	0	0.0	0	0.0
All Students Identified Only Under Section 504**	823	0.9	323	0.6	617	0.7	241	0.5	682	0.7	850	0.9	406	0.6	331	0.8	57	0.5	547	0.7
Standard Administration	808	0.9	315	0.6	611	0.7	238	0.5	676	0.7	836	0.9	402	0.6	324	0.8	57	0.5	539	0.7
With Accommodations	436	0.5	155	0.3	285	0.3	73	0.2	304	0.3	402	0.4	164	0.2	154	0.4	22	0.2	272	0.4
Not Participating	0	0.0	0	0.0	0	0.0	0	0.0	0	0.0	1	0.0	0	0.0	0	0.0	0	0.0	0	0.0
All Limited English Proficient Students**	842	0.9	245	0.4	724	0.9	162	0.4	981	1.1	1,498	1.5	363	0.5	386	1.0	38	0.3	536	0.7
Standard Administration	683	0.7	216	0.4	554	0.7	150	0.3	697	0.8	911	0.9	326	0.5	275	0.7	37	0.3	460	0.6
With Accommodations	319	0.3	72	0.1	219	0.3	37	0.1	376	0.4	478	0.5	97	0.1	170	0.4	6	0.1	233	0.3
Not Participating																				
First Year	87	0.1	21	0.0	86	0.1	6	0.0	163	0.2	392	0.4	21	0.0	67	0.2	1	0.0	43	0.1
Second Year	58	0.1	4	0.0	76	0.1	1	0.0	106	0.1	157	0.2	10	0.0	37	0.1	0	0.0	29	0.0

Notes: *Actual student membership is used for statewide N-counts.
 **Due to miscoding or rounding, some columns may not add up to the total. These data represent coding on 2000-01 end-of-course answer sheets.
 These data do not reflect the actual number of alternate assessments scored in the 2000-01 school year.
 Data received from LEAs and charter schools after August 2001 are not included in this table.
 Prepared by the NCDPI Division of Accountability Services/Testing Section.

Table 9. 2000-01 End-of-Course Multiple-Choice Test Results Characteristics and Performance of Students Taking Algebra I

	Percent At or Above		Percent At or Above		Percent At or Above	
	N	Level III	N	Level III	N	Level III
All Students	93,000	100.0	76.0	15,040	16.2	97.6
Gender						
Male	46,117	49.6	74.7	25,017	27.0	91.2
Female	46,883	50.4	77.3	24,379	26.3	77.2
Ethnic Group						
American Indian	1,202	1.3	67.6	5,850	6.5	63.0
Asian	1,898	2.0	82.5	22,508	24.8	67.9
Black	26,384	28.4	57.1	10,146	11.2	78.4
Hispanic	2,558	2.8	70.0	2,995	3.3	73.0
Multi-Racial	888	1.0	76.0	15,816	17.4	77.6
White	60,007	64.5	84.6	23,256	25.6	82.1
Other	61	0.1	62.3	10,118	11.2	88.1
Grade Level						
7	1,813	1.9	98.2	1,441	1.6	42.6
8	19,400	20.9	95.7	19,769	21.6	66.8
9	44,467	47.8	78.4	44,538	48.6	76.6
10	18,270	19.6	60.9	19,936	21.8	86.6
11	6,515	7.0	49.2	4,215	4.6	88.6
12	2,519	2.7	45.7	1,666	1.8	56.9
Typical Homework						
Outside Reading	9,185	9.9	77.7	3,519	3.9	75.6
Worksheets	67,272	72.3	79.0	22,617	24.8	80.8
Textbook Problems	74,679	80.3	79.8	24,923	27.3	80.9
Written Assignments	8,978	9.7	78.8	20,369	22.3	75.2
Research	6,610	7.1	81.1	13,254	14.5	70.0
Other	11,852	12.7	82.0	6,518	7.1	61.5
Course Description						
2 year/2 block	6,495	7.1	66.0	13,901	15.3	74.1
Regular year/block	63,886	70.3	76.5	20,494	22.5	80.4
Honors	8,616	9.5	92.2	20,680	22.7	82.9
College Placement	5,627	6.2	72.9	18,430	20.2	77.4
Advanced Placement	1,303	1.4	77.7	6,115	6.7	69.6
Other Type	5,001	5.5	66.2	11,448	12.6	62.9
Anticipated Final Grade						
A						
B						
C						
D						
F						
Parental Education						
Less than High School						
High School						
Some College/Didn't Graduate						
Trade/Business School						
Community/Junior College						
Four-Year College Degree						
Graduate School						
Hours of Homework Assigned Per Week						
None assigned						
Less than 1						
1 to 3						
More than 3, less than 5						
More than 5						
More than 10						
Assigned but not done						
Hours of TV Watched Per Week						
None						
1 or less						
2 hours						
3 hours						
4 to 5						
6 or more						
Computer Use at Home						
Almost Every Day						
1-2 times per week						
1-2 times per month						
Hardly Ever						
Never (owns computer)						
No computer at home						
Teacher's Judgement						
Mastery Not Sufficient						
Mastery Inconsistent						
Demonstrate Mastery						
Superior Performance						
Unclear						
Extracurricular Activity						
Athletics						
Academics						
Fine Arts						
Vocational Clubs						
Service Clubs						
Other Activities						
No Activities						
Calculator Use						
Simple 4-function						
Fraction						
Scientific						
Graphing						
Calculator Location						
Only in Class						
Class and Home						
Post-High School Plans						
Seek employment						
Military service						
Trade/Business School						
Community/Junior College						
Four-Year College						
Undecided						
Other						

Notes: *No scores are reported for groups with fewer than thirty students.

Data received from LEAs and charter schools after August 2001 are not included in this table.

Prepared by the NCDPI Division of Accountability Services/Testing Section.

**Table 10. 2000-01 End-of-Course Multiple-Choice Test Results
Characteristics and Performance of Students Taking Algebra II**

	Percent At or Above Level III		Percent At or Above Level III		Percent At or Above Level III	
	N	Percent	N	Percent	N	Percent
All Students	54,902	100.0	73.0	8,955	16.3	96.5
Gender						
Male	25,355	46.2	73.5	15,695	28.6	86.9
Female	29,546	53.8	72.5	14,883	27.2	71.1
Ethnic Group						
American Indian	581	1.1	55.6	1,877	3.5	61.0
Asian	1,482	2.7	82.2	10,650	19.8	63.7
Black	12,469	22.7	52.5	5,225	9.7	71.4
Hispanic	1,054	1.9	67.7	1,957	3.6	71.3
Multi-Racial	420	0.8	74.5	9,992	18.6	70.0
White	38,865	70.8	79.6	15,694	29.2	77.5
Other	31	0.1	67.7	8,326	15.5	84.9
Grade Level						
7	3	0.0	*	351	0.6	55.8
8	67	0.1	98.5	8,125	15.0	62.2
9	1,922	3.5	95.6	24,095	44.6	69.5
10	21,245	38.7	89.1	15,341	28.4	80.7
11	22,408	40.8	66.6	5,152	9.5	86.6
12	9,257	16.9	46.3	986	1.8	67.4
Typical Homework						
Outside Reading	3,572	6.5	68.1	2,997	5.6	77.9
Worksheets	41,652	75.9	75.7	17,614	32.7	77.1
Textbook Problems	49,920	90.9	74.4	15,465	28.7	75.0
Written Assignments	4,279	7.8	75.7	10,183	18.9	69.6
Research	3,175	5.8	77.6	5,554	10.3	63.4
Other	4,455	8.1	76.7	2,128	3.9	60.5
Computer Use at Home						
Almost Every Day	612	1.1	55.1	9,695	18.0	74.3
Regular year/block	32,812	61.0	66.1	14,291	26.5	75.8
Honors	14,819	27.5	93.5	13,640	25.3	76.8
College Placement	4519	8.4	62.9	9,373	17.4	71.0
Advanced Placement	219	0.4	64.8	2,411	4.5	66.2
Other Type	819	1.5	57.0	4,422	8.2	58.3
Teacher's Judgement						
Mastery Not Sufficient	8,258	15.3	36.7	27,286	49.7	76.5
Mastery Inconsistent	15,967	29.6	63.7	8,622	15.7	85.5
Demonstrates Mastery	19,876	36.9	85.7	16,741	30.5	79.0
Superior Performance	9,246	17.2	97.3	9,291	16.9	73.5
Unclear	515	1.0	54.8	11,956	21.8	83.3
Extracurricular Activity						
Athletics	27,286	49.7	76.5	20,036	36.5	78.5
Academics	8,622	15.7	85.5	7,729	14.1	62.2
Fine Arts	16,741	30.5	79.0			
Vocational Clubs	9,291	16.9	73.5			
Service Clubs	11,956	21.8	83.3			
Other Activities	20,036	36.5	78.5			
No Activities	7,729	14.1	62.2			
Calculator Use						
Simple 4-function	925	1.7	51.4			
Fraction	421	0.8	55.1			
Scientific	7,644	14.3	62.3			
Graphing	44,642	83.2	75.6			
Calculator Location						
Only in Class	11,795	22.0	65.6			
Class and Home	41,838	78.0	75.3			
Post-High School Plans						
Seek employment	716	1.3	53.4			
Military service	1,657	3.1	56.6			
Trade/Business School	580	1.1	54.0			
Community/Junior College	7,947	14.7	56.2			
Four-Year College	39,659	73.6	78.3			
Undecided	2,818	5.2	67.7			
Other	510	0.9	66.9			

Notes: *No scores are reported for groups with fewer than thirty students.
Data received from LEAs and charter schools after August 2001 are not included in this table.
Prepared by the NCDPI Division of Accountability Services/Testing Section.

Table 11. 2000-01 End-of-Course Multiple-Choice Test Results Characteristics and Performance of Students Taking Biology

	Percent At or Above		Percent At or Above		Percent At or Above		
	N	Level III	N	Level III	N	Level III	
All Students	82,026	100.0	61.0		12,882	16.2	24.0
Gender					25,752	32.4	47.9
Male	40,915	49.9	62.7		30,010	37.7	77.8
Female	41,109	50.1	59.2		10,588	13.3	95.2
Ethnic Group					367	0.5	31.1
American Indian	999	1.2	46.4		36,918	45.0	67.8
Asian	1,769	2.2	63.7		7,382	9.0	81.0
Black	23,277	28.4	34.9		20,978	25.6	73.0
Hispanic	2,150	2.6	47.2		9,021	11.0	69.0
Multi-Racial	715	0.9	68.1		9,841	12.0	80.5
White	53,069	64.7	73.1		23,968	29.2	71.2
Other	47	0.1	27.7		18,165	22.1	47.9
Grade Level							
7	4	0.0	*		13,576	16.9	63.5
8	8	0.0	*		18,808	23.4	68.2
9	18,794	22.9	71.8		17,745	22.0	69.5
10	54,927	67.0	60.8		14,886	18.5	59.1
11	6,671	8.1	38.4		4,959	6.2	51.3
12	1,621	2.0	34.0		10,507	13.1	40.1
Typical Homework							
Outside Reading	25,233	30.8	64.4		165	52.7	35.2
Worksheets	66,510	81.1	64.1		5	1.6	*
Textbook Problems	45,978	56.1	66.6		18	5.8	*
Written Assignments	37,295	45.5	70.8		26	8.3	*
Research	28,566	34.8	72.2		41	13.1	41.5
Other	14,336	17.5	69.7		58	18.5	31.0
How Science Learned							
Read	47,287	57.6	69.8		2,978	3.7	35.8
Lab activity	62,397	76.1	68.8		4,318	5.4	46.2
Observe Demonstrations	45,968	56.0	70.4		1,792	2.2	37.1
Listening	64,958	79.2	68.1		11,979	14.9	47.1
Lab groups	62,795	76.6	68.3		49,541	61.6	71.1
Activity outside	24,999	30.5	70.5		7,834	9.7	50.3
Technology	29,697	36.2	74.0		1,926	2.4	40.3
Course Description							
2 year/2 block	1,765	2.2	32.4				
Regular year/block	47,571	59.3	53.1				
Honors	19,385	24.2	89.6				
College Placement	7,972	9.9	59.2				
Advanced Placement	543	0.7	51.0				
Other Type	2,961	3.7	32.5				
Anticipated Final Grade							
A	11,352	13.9	93.4				
B	22,614	27.6	78.9				
C	24,339	29.7	56.4				
D	15,286	18.7	37.9				
F	8,332	10.2	23.9				
Parental Education							
Less than High School	5,179	6.5	36.7				
High School	20,264	25.3	46.5				
Some College/Didn't Graduate	8,112	10.1	64.0				
Trade/Business School	2,903	3.6	60.0				
Community/Junior College	14,125	17.6	62.5				
Four-Year College Degree	20,328	25.3	71.5				
Graduate School	9,305	11.6	81.6				
Hours of Homework Assigned Per Week							
None assigned	1,499	1.9	37.4				
Less than 1	17,287	21.4	48.8				
1 to 3	38,124	47.2	58.3				
More than 3, less than 5	17,311	21.4	75.8				
More than 10	4,886	6.0	84.4				
Assigned but not done	1,680	2.1	58.8				
Hours of TV Watched Per Week							
None	3,649	4.5	66.9				
1 or less	21,252	26.4	68.8				
2 hours	21,900	27.2	66.3				
3 hours	17,154	21.3	58.2				
4 to 5	11,037	13.7	49.8				
6 or more	5,471	6.8	41.3				
Most Time Spent in Class							
Read Books	30,087	36.7	63.7				
Lab activities	38,164	46.5	67.1				
Observe Demonstrations	13,582	16.6	55.6				
Listening	65,509	79.9	65.8				
Working in Groups	43,555	53.1	68.0				
Activity Outside	4,197	5.1	46.7				
Technology	4,300	5.2	57.6				
Teacher's Judgement							
Mastery Not Sufficient	11,352	13.9	93.4				
Mastery Inconsistent	22,614	27.6	78.9				
Demonstrates Mastery	24,339	29.7	56.4				
Superior Performance	15,286	18.7	37.9				
Unclear	8,332	10.2	23.9				
Extracurricular Activity							
Athletics	5,179	6.5	36.7				
Academics	20,264	25.3	46.5				
Fine Arts	8,112	10.1	64.0				
Vocational Clubs	2,903	3.6	60.0				
Service Clubs	14,125	17.6	62.5				
Other Activities	20,328	25.3	71.5				
No Activities	9,305	11.6	81.6				
Computer Use							
Almost every day	1,499	1.9	37.4				
1-2 times per week	17,287	21.4	48.8				
1-2 times per month	38,124	47.2	58.3				
Hardly ever	17,311	21.4	75.8				
Never (owns computer)	4,886	6.0	84.4				
No computer at home	1,680	2.1	58.8				
Job Hours							
None	3,649	4.5	66.9				
Less than 2	21,252	26.4	68.8				
2 to 4	21,900	27.2	66.3				
5 to 10	17,154	21.3	58.2				
11 to 20	11,037	13.7	49.8				
Over 20	5,471	6.8	41.3				
Post-High School Plans							
Seek employment	30,087	36.7	63.7				
Military service	38,164	46.5	67.1				
Trade/Business School	13,582	16.6	55.6				
Community/Junior College	65,509	79.9	65.8				
Four-Year College	43,555	53.1	68.0				
Undecided	4,197	5.1	46.7				
Other	4,300	5.2	57.6				

Notes: * No scores are reported for groups with fewer than thirty students.
Data received from LEAs and charter schools after August 2001 are not included in this table.
Prepared by the NCDPI Division of Accountability Services/Testing Section.

**Table 12. 2000-01 End-of-Course Multiple-Choice Test Results
Characteristics and Performance of Students Taking Chemistry**

	Percent At or Above		Percent At or Above		Percent At or Above	
	N	Level III	N	Level III	N	Level III
All Students	43,702	100.0	65.5	7,844	18.0	94.2
Gender						
Male	19,524	44.7	68.8	13,281	30.4	78.5
Female	24,178	55.3	62.8	12,397	28.4	58.2
Ethnic Group						
American Indian	446	1.0	44.6	1,247	2.9	50.0
Asian	1,243	2.8	68.8	7,652	17.9	53.2
Black	8,922	20.4	41.8	3,941	9.2	62.6
Hispanic	767	1.8	57.8	1,694	4.0	63.0
Multi-Racial	338	0.8	69.8	7,672	17.9	60.3
White	31,966	73.1	72.4	12,978	30.3	70.2
Other	20	0.0	*	7,630	17.8	80.6
Typical Homework						
Outside Reading	11,132	25.5	63.6	352	0.8	51.7
Worksheets	36,682	83.9	67.4	6,146	14.3	53.1
Textbook Problems	33,991	77.8	67.6	18,294	42.5	59.4
Written Assignments	24,109	55.2	71.2	12,561	29.2	74.0
Research	11,171	25.6	70.3	4,893	11.4	82.9
Other	5,843	13.4	71.3	781	1.8	71.2
Computer Use						
Almost every day	8,389	19.6	67.5	2,759	6.4	76.5
1-2 times per week	12,406	28.9	69.7	15,165	35.3	70.1
1-2 times per month	11,063	25.8	68.0	12,166	28.3	66.9
Hardly ever	6,548	15.3	61.9	7,510	17.5	58.7
Never (owns computer)	1,472	3.4	54.3	3,774	8.8	52.9
No computer at home	3,026	7.1	48.4	1,542	3.6	56.1
How Science Learned						
Read	21,318	48.8	68.9	8,817	20.2	63.2
Lab activity	38,145	87.3	68.0	19,926	45.6	67.6
Observe Demonstrations	35,529	81.3	69.2	13,143	30.1	65.5
Listening	38,576	88.3	68.1	37,353	85.5	67.7
Lab groups	37,518	85.8	68.3	23,157	53.0	70.0
Activity outside	8,524	19.5	67.8	1,008	2.3	53.9
Technology	32,035	73.3	69.4	11,599	26.5	65.3
Grade Level						
8	2	0.0	*			
9	150	0.3	68.7			
10	12,132	27.8	82.3			
11	25,351	58.0	62.7			
12	6,067	13.9	43.3			
Anticipated Final Grade						
A						
B						
C						
D						
F						
Parental Education						
Less than High School						
High School						
Some College/Didn't Graduate						
Trade/Business School						
Community/Junior College						
Four-Year College Degree						
Graduate School						
Hours of Homework Assigned Per Week						
None assigned						
Less than 1						
1 to 3						
More than 3, less than 5						
More than 10						
Assigned but not done						
Hours of TV Watched Per Week						
None						
1 or less						
2 hours						
3 hours						
4 to 5						
6 or more						
Most Time Spent in Class						
Read Books						
Lab activities						
Observe Demonstrations						
Listening						
Working in Groups						
Activity Outside						
Technology						
Teacher's Judgment						
Mastery Not Sufficient						
Mastery Inconsistent						
Demonstrates Mastery						
Superior Performance						
Unclear						
Extracurricular Activity						
Athletics						
Academics						
Fine Arts						
Vocational Clubs						
Service Clubs						
Other Activities						
No Activities						
Course Description						
2 year/2 block						
Regular year/block						
Honors						
College Placement						
Advanced Placement						
Other Type						
Job Hours						
None						
Less than 2						
2 to 4						
5 to 10						
11 to 20						
Over 20						
Post-High School Plans						
Seek employment						
Military service						
Trade/Business School						
Community/Junior College						
Four-Year College						
Undecided						
Other						

Notes: *No scores are reported for groups with fewer than thirty students.
Data received from LEAs and charter schools after August 2001 are not included in this table.
Prepared by the NCDPI Division of Accountability Services/Testing Section.

**Table 13. 2000-01 End-of-Course Multiple-Choice Test Results
Characteristics and Performance of Students Taking Economic, Legal, and Political Systems**

	Percent At or Above Level III		Percent At or Above Level III		Percent At or Above Level III	
	N	Percent	N	Percent	N	Percent
All Students	90,209	100.0	16,871	18.7	12,619	14.4
Gender						
Male	44,592	49.4	26,217	29.1	25,490	29.1
Female	45,615	50.6	24,481	27.2	33,709	38.5
Ethnic Group						
American Indian	1,095	1.2	6,024	6.8	40,765	45.2
Asian	1,881	2.1	21,996	24.9	7,559	8.4
Black	25,370	28.1	9,747	11.0	22,787	25.3
Hispanic	2,400	2.7	3,041	3.4	8,781	9.7
Multi-Racial	784	0.9	14,992	17.0	9,536	10.6
White	58,636	65.0	22,241	25.2	26,147	29.0
Other	42	0.0	10,307	11.7	20,930	23.2
Grade Level						
7	1	0.0	1,916	2.2	14,932	16.8
8	4	0.0	20,525	23.0	20,644	23.3
9	57,615	63.9	41,858	47.0	18,614	21.0
10	20,078	22.3	18,048	20.3	17,098	19.3
11	3,876	4.3	4,887	5.5	5,675	6.4
12	8,633	9.6	1,863	2.1	11,773	13.3
Typical Homework						
Outside Reading	27,892	30.9	3,878	4.4	119	53.6
Worksheets	68,061	75.4	22,973	25.9	6	2.7
Textbook Problems	49,095	54.4	23,837	26.9	13	5.9
Written Assignments	32,302	35.8	18,943	21.3	32	14.4
Research	27,446	30.4	12,540	14.1	23	10.4
Other	17,834	19.8	6,566	7.4	29	13.1
Course Description						
2 year/2 block	2,219	2.5	69,042	76.5	3,423	3.9
Regular year/block	58,095	65.6	34,001	37.7	4,709	5.3
Honors	16,372	18.5	39,535	43.8	1,917	2.2
College Placement	6,894	7.8	6,369	7.1	12,432	14.0
Advanced Placement	764	0.9	3,016	3.3	55,003	62.0
Other Type	4,163	4.7	2,703	3.0	8,782	9.9
Extra Activities						
Independent Research	63,368	70.2	14,932	16.8	2,379	2.7
Group Project	13,450	14.9	20,644	23.3		
Completed Portfolio	51,363	56.9	18,614	21.0		
Field Trip	6,921	7.7	17,098	19.3		
Community Service	5,168	5.7	5,675	6.4		
Social Studies Organization	9,926	11.0	11,773	13.3		
Teacher's Judgment						
Mastery Not Sufficient						
Mastery Inconsistent						
Demonstrates Mastery						
Superior Performance						
Unclear						
Extracurricular Activity						
Athletics						
Academics						
Fine Arts						
Vocational Clubs						
Service Clubs						
Other Activities						
No Activities						
Computer Use at Home						
Almost Every Day						
1-2 times per week						
1-2 times per month						
Hardly Ever						
Never (owns computer)						
No computer at home						
Job Hours						
None						
Less than 2						
2 to 4						
5 to 10						
11 to 20						
Over 20						
Post-High School Plans						
Seek employment						
Military service						
Trade/Business School						
Community/Junior College						
Four-Year College						
Undecided						
Other						

Notes: *No scores are reported for groups with fewer than thirty students.
Data received from LEAs and charter schools after August 2001 are not included in this table.
Prepared by the NCDPI Division of Accountability Services/Testing Section.

Table 14. 2000-01 End-of-Course Multiple-Choice Test Results Characteristics and Performance of Students Taking English I

	Percent At or Above		Percent At or Above		Percent At or Above	
	N	Level III	N	Level III	N	Level III
All Students	94,707	100.0	14,031	14.8	11,439	12.6
Gender						
Male	48,164	50.9	28,035	29.6	26,741	29.5
Female	46,542	49.1	26,512	28.0	38,148	42.0
Ethnic Group						
American Indian	1,395	1.5	7,262	7.8	43,522	46.0
Asian	1,786	1.9	23,653	25.5	6,280	6.6
Black	27,232	28.8	10,764	11.6	23,606	24.9
Hispanic	2,771	2.9	2,977	3.2	6,884	7.3
Multi-Racial	861	0.9	15,161	16.4	7,814	8.3
White	60,625	64.0	22,590	24.4	26,428	27.9
Other	36	0.0	10,235	11.0	23,031	24.3
Grade Level						
7	25	0.0	2,415	2.6	81,826	86.4
8	16	0.0	22,393	24.0	75,787	80.0
9	92,271	97.4	43,468	46.5	55,178	58.3
10	2,028	2.1	18,300	19.6	52,654	55.6
11	266	0.3	4,724	5.1	69,139	73.0
12	101	0.1	2,177	2.3	77,594	81.9
Typical Homework						
Outside Reading	48,200	50.9	3,639	3.9	546	54.3
Worksheets	62,928	66.4	21,947	23.6	37	3.7
Textbook Problems	37,906	40.0	24,359	26.2	80	8.0
Written Assignments	56,364	59.5	20,292	21.8	140	13.9
Research	33,164	35.0	14,380	15.4	109	10.8
Other	22,195	23.4	8,487	9.1	93	9.3
Course Description						
2 year/2 block	2,422	2.6	15,258	16.4	3,677	4.0
Regular year/block	52,708	56.8	21,089	22.7	5,261	5.7
Honors	22,656	24.4	19,359	20.8	2,109	2.3
College Placement	9,109	9.8	17,902	19.2	10,020	10.8
Advanced Placement	875	0.9	6,160	6.6	57,947	62.3
Other Type	5,035	5.4	13,313	14.3	10,700	11.5
Computer Access						
Classroom	21,662	22.9			3,280	3.5
Media Center During School	67,159	70.9				
Media Center After School	47,807	50.5				
Home	68,302	72.1				
Teacher's Judgement						
Mastery Not Sufficient						
Mastery Inconsistent						
Demonstrates Mastery						
Superior Performance						
Unclear						
Extracurricular Activity						
Athletics						
Academics						
Fine Arts						
Vocational Clubs						
Service Clubs						
Other Activities						
No Activities						
Class Activity						
Read or Studied Novels						
Read or Studied Fables						
Studied Biography						
Studied Informational						
Read or Studied Drama						
Read or Studied Poetry						
Job Hours						
None						
Less than 2						
2 to 4						
5 to 10						
11 to 20						
Over 20						
Post-High School Plans						
Seek employment						
Military service						
Trade/Business School						
Community/Junior College						
Four-Year College						
Undecided						
Other						

Notes: *No scores are reported for groups with fewer than thirty students.
Data received from LEAs and charter schools after August 2001 are not included in this table.
Prepared by the NCDPI Division of Accountability Services/Testing Section.

Table 15. 2000-01 End-of-Course Multiple-Choice Test Results Characteristics and Performance of Students Taking Geometry

	Percent At or Above		Percent At or Above		Percent At or Above	
	N	Level III	N	Level III	N	Level III
All Students	65,480	100.0	63.9	10,584	16.2	96.3
Gender						
Male	30,655	46.8	67.8	17,394	26.6	60.9
Female	34,825	53.2	60.6	12,336	18.8	37.6
Ethnic Group						
American Indian	746	1.1	45.4	2,759	4.3	44.9
Asian	1,512	2.3	71.6	13,800	21.6	50.9
Black	16,176	24.7	34.6	6,775	10.6	63.6
Hispanic	1,478	2.3	50.3	2,342	3.7	60.5
Multi-Racial	525	0.8	64.6	11,802	18.4	60.9
White	45,011	68.7	75.0	17,921	28.0	71.8
Other	31	0.1	38.7	8,615	13.5	82.1
Grade Level						
7	14	0.0	*	523	0.8	42.7
8	1,472	2.2	98.0	11,108	17.2	52.6
9	19,035	29.1	88.6	30,467	47.2	59.8
10	30,776	47.0	60.8	16,703	25.9	73.6
11	11,019	16.8	37.0	4,620	7.2	81.4
12	3,163	4.8	24.7	1,068	1.7	62.4
Typical Homework						
Outside Reading	5,975	9.1	60.6	2,920	4.5	72.5
Worksheets	49,309	75.3	67.6	18,522	28.8	71.3
Textbook Problems	57,313	87.5	66.1	18,311	28.5	68.5
Written Assignments	6,261	9.6	67.1	13,343	20.7	59.6
Research	5,130	7.8	70.1	7,902	12.3	50.4
Other	8,518	13.0	73.7	3,339	5.2	43.5
Course Description						
2 year/2 block	897	1.4	37.1	11,040	17.2	62.4
Regular year/block	40,226	62.7	56.3	15,996	24.9	69.7
Honors	15,479	24.1	90.9	15,596	24.3	69.0
College Placement	5642	8.8	54.8	12,021	18.7	64.8
Advanced Placement	421	0.7	63.9	3,309	5.2	57.5
Other Type	1494	2.3	50.4	6,242	9.7	43.3
Teacher's Judgment						
Mastery Not Sufficient	11,030	17.2	21.7	32,708	50.0	69.5
Mastery Inconsistent	18,600	29.0	49.4	6,565	10.0	77.9
Demonstrates Mastery	22,565	35.2	81.5	19,221	29.4	72.4
Superior Performance	11,447	17.9	97.4	7,803	11.9	65.1
Unclear	399	0.6	35.8	9,131	13.9	75.3
Extracurricular Activity						
Athletics	3,181	5.0	44.7	11,417	17.4	51.9
Academics	1,747	2.7	56.7	20,784	31.7	71.3
Fine Arts	24,392	38.2	64.0	11,417	17.4	51.9
Vocational / Clubs	34,605	54.1	66.6	3,181	5.0	44.7
Service Clubs	7,803	11.9	65.1	1,747	2.7	56.7
Other Activities	20,784	31.7	71.3	24,392	38.2	64.0
No Activities	11,417	17.4	51.9	34,605	54.1	66.6
Calculator Use						
Simple 4-function	3,181	5.0	44.7	10,293	16.1	54.3
Fraction	1,747	2.7	56.7	53,593	83.9	66.2
Scientific	24,392	38.2	64.0	10,293	16.1	54.3
Graphing	34,605	54.1	66.6	53,593	83.9	66.2
Calculator Location						
Only in Class	10,293	16.1	54.3	10,293	16.1	54.3
Class and Home	53,593	83.9	66.2	53,593	83.9	66.2
Post-High School Plans						
Seek employment	984	1.5	43.6	984	1.5	43.6
Military service	2,542	4.0	46.9	2,542	4.0	46.9
Trade/Business School	962	1.5	41.9	962	1.5	41.9
Community/Junior College	8,463	13.2	45.1	8,463	13.2	45.1
Four-Year College	45,810	71.3	70.4	45,810	71.3	70.4
Undecided	4,655	7.2	58.2	4,655	7.2	58.2
Other	840	1.3	54.3	840	1.3	54.3

Notes: *No scores are reported for groups with fewer than thirty students.
Data received from LEAs and charter schools after August 2001 are not included in this table.
Prepared by the NCDPI Division of Accountability Services/Testing Section.

**Table 16. 2000-01 End-of-Course Multiple-Choice Test Results
Characteristics and Performance of Students Taking Physical Science**

	Percent At or Above			N	Percent At or Above			N	Percent At or Above		
	Level III		Level III		Level III		Level III		Level III		Level III
	N	Percent	Level III		N	Percent	Level III		N	Percent	Level III
All Students	39,182	100.0	59.9	5,091	13.0	93.1	6,623	17.6	23.6		
Gender											
Male	20,001	51.0	62.3	10,618	27.2	78.8	12,268	32.6	48.2		
Female	19,181	49.0	57.5	11,465	29.3	56.8	13,826	36.8	78.4		
Ethnic Group											
American Indian	425	1.1	40.5	3,013	7.9	39.7	16,582	42.3	67.4		
Asian	622	1.6	65.0	10,724	28.1	48.7	2,470	6.3	75.3		
Black	11,987	30.6	37.1	4,224	11.1	65.2	9,000	23.0	70.5		
Hispanic	1,148	2.9	44.3	1,425	3.7	60.1	3,633	9.3	68.3		
Multi-Racial	348	0.9	61.5	6,854	18.0	64.0	3,192	8.1	77.7		
White	24,620	62.8	72.0	8,622	22.6	70.9	10,225	26.1	68.0		
Other	32	0.1	34.4	3,291	8.6	75.8	10,155	25.9	50.0		
Grade Level											
7	16	0.0	*	1,156	3.0	37.5	5,869	15.3	60.4		
8	538	1.4	91.1	10,043	26.1	50.8	7,823	20.4	66.4		
9	23,928	61.1	63.0	18,134	47.2	60.3	7,778	20.3	69.5		
10	8,972	22.9	56.4	6,648	17.3	75.4	7,984	20.9	61.4		
11	4,097	10.5	49.7	1,475	3.8	79.0	2,885	7.5	53.1		
12	1,631	4.2	50.2	979	2.5	51.7	5,940	15.5	42.4		
Typical Homework											
Outside Reading	9,295	23.7	60.8	1,408	3.7	63.2	90	49.2	46.7		
Worksheets	30,756	78.5	63.6	9,255	24.2	67.2	3	1.6	*		
Textbook Problems	22,254	56.8	65.5	10,063	26.3	66.0	14	7.7	*		
Written Assignments	13,708	35.0	69.6	8,492	22.2	58.6	17	9.3	*		
Research	8,535	21.8	70.1	5,869	15.3	51.6	33	18.0	48.5		
Other	6,112	15.6	65.6	3,193	8.3	42.0	26	14.2	*		
How Science Learned											
Read	20,442	52.2	67.9	13,855	35.4	61.8	1,749	4.6	39.7		
Lab activity	26,616	67.9	69.3	14,466	36.9	65.9	2,388	6.3	50.9		
Observe Demonstrations	25,321	64.6	70.5	13,010	33.2	64.5	1,010	2.6	39.1		
Listening	29,861	76.2	67.1	29,374	75.0	65.1	5,845	15.3	50.5		
Lab groups	26,352	67.3	69.6	15,380	39.3	67.7	21,563	56.5	70.2		
Activity outside	12,751	32.5	70.6	1,863	4.8	43.1	4,411	11.6	49.5		
Technology	20,100	51.3	71.8	5,537	14.1	63.0	1,201	3.1	38.7		
Course Description											
2 year/2 block	1,063	2.8	30.9								
Regular year/block	25,144	65.8	56.6								
Honors	6,202	16.2	87.5								
College Placement	3,569	9.3	63.9								
Advanced Placement	272	0.7	48.2								
Other Type	1,938	5.1	34.1								
Anticipated Final Grade											
A	5,091	13.0	93.1								
B	10,618	27.2	78.8								
C	11,465	29.3	56.8								
D	7,572	19.4	37.9								
F	4,347	11.1	22.0								
Parental Education											
Less than High School	3,013	7.9	39.7								
High School	10,724	28.1	48.7								
Some College/Didn't Graduate	4,224	11.1	65.2								
Trade/Business School	1,425	3.7	60.1								
Community/Junior College	6,854	18.0	64.0								
Four-Year College Degree	8,622	22.6	70.9								
Graduate School	3,291	8.6	75.8								
Hours of Homework Assigned Per Week											
None assigned	1,156	3.0	37.5								
Less than 1	10,043	26.1	50.8								
1 to 3	18,134	47.2	60.3								
More than 3, less than 5	6,648	17.3	75.4								
More than 10	1,475	3.8	79.0								
Assigned but not done	979	2.5	51.7								
Hours of TV Watched Per Week											
None	1,408	3.7	63.2								
1 or less	9,255	24.2	67.2								
2 hours	10,063	26.3	66.0								
3 hours	8,492	22.2	58.6								
4 to 5	5,869	15.3	51.6								
6 or more	3,193	8.3	42.0								
Most Time Spent In Class											
Read Books	13,855	35.4	61.8								
Lab activities	14,466	36.9	65.9								
Observe Demonstrations	13,010	33.2	64.5								
Listening	29,374	75.0	65.1								
Working in Groups	15,380	39.3	67.7								
Activity Outside	1,863	4.8	43.1								
Technology	5,537	14.1	63.0								
Teacher's Judgement											
Mastery Not Sufficient	16,582	42.3	67.4								
Mastery Inconsistent	2,470	6.3	75.3								
Demonstrates Mastery	9,000	23.0	70.5								
Superior Performance	3,633	9.3	68.3								
Unclear	3,192	8.1	77.7								
Extracurricular Activity											
Athletics	16,582	42.3	67.4								
Academics	2,470	6.3	75.3								
Fine Arts	9,000	23.0	70.5								
Vocational Clubs	3,633	9.3	68.3								
Service Clubs	3,192	8.1	77.7								
Other Activities	10,225	26.1	68.0								
No Activities	10,155	25.9	50.0								
Computer Use											
Almost every day	5,869	15.3	60.4								
1-2 times per week	7,823	20.4	66.4								
1-2 times per month	7,778	20.3	69.5								
Hardly ever	7,984	20.9	61.4								
Never (owns computer)	2,885	7.5	53.1								
No computer at home	5,940	15.5	42.4								
Job Hours											
None	90	49.2	46.7								
Less than 2	3	1.6	*								
2 to 4	14	7.7	*								
5 to 10	17	9.3	*								
11 to 20	33	18.0	48.5								
Over 20	26	14.2	*								
Post-High School Plans											
Seek employment	1,749	4.6	39.7								
Military service	2,388	6.3	50.9								
Trade/Business School	1,010	2.6	39.1								
Community/Junior College	5,845	15.3	50.5								
Four-Year College	21,563	56.5	70.2								
Undecided	4,411	11.6	49.5								
Other	1,201	3.1	38.7								

Notes: *No scores are reported for groups with fewer than thirty students.
Data received from LEAs and charter schools after August 2001 are not included in this table.
Prepared by the NCDPI Division of Accountability Services/Testing Section.

**Table 17. 2000-01 End-of-Course Multiple-Choice Test Results
Characteristics and Performance of Students Taking Physics**

	Percent At or Above		Percent At or Above		Percent At or Above	
	N	Percent	N	Percent	N	Percent
All Students	10,948	100.0	74.4	26.7	94.2	81.1
Gender						
Male	6,037	55.1	80.3	37.0	79.2	24.2
Female	4,911	44.9	67.1	23.6	62.2	43.4
Ethnic Group						
American Indian	82	0.7	46.3	8.9	44.9	23.7
Asian	529	4.8	78.8	3.8	33.2	0.6
Black	1,482	13.5	43.9	1.9	53.7	53.3
Hispanic	178	1.6	64.1	12.3	62.6	34.1
Multi-Racial	74	0.7	78.4	8.0	68.7	32.3
White	8,595	78.5	79.8	3.7	72.9	19.5
Other	8	0.1	*	13.8	65.3	40.6
Grade Level						
9	20	0.2	*	33.8	77.1	50.7
10	465	4.2	83.7	26.5	84.3	7.8
11	3,602	32.9	81.2	1.2	60.8	49.8
12	6,861	62.7	70.3	13.7	67.6	85.0
Typical Homework						
Outside Reading	2,594	23.7	69.9	34.0	67.3	83.2
Worksheets	7,729	70.6	75.2	30.1	78.3	90.9
Textbook Problems	9,509	86.9	75.5	17.9	85.5	83.9
Written Assignments	5,482	50.1	77.2	3.0	84.1	46.8
Research	2,454	22.4	76.3	2.846	26.5	84.3
Other	1,857	17.0	76.6	1.2	60.8	76.1
Course Description						
2 year/2 block	61	0.6	62.3	130	60.8	76.1
Regular year/block	4,022	37.5	65.7	1,481	13.7	67.6
Honors	4,870	45.4	80.9	3,671	34.0	67.3
College Placement	515	4.8	62.1	3,251	30.1	78.3
Advanced Placement	1,091	10.2	84.3	1,935	17.9	85.5
Other Type	177	1.6	70.6	328	3.0	84.1
Anticipated Final Grade						
A	2,913	26.7	94.2	9.4	84.1	62.3
B	4,048	37.0	79.2	40.0	78.0	64.2
C	2,576	23.6	62.2	26.9	74.7	50.9
D	971	8.9	44.9	14.1	65.7	54.7
F	419	3.8	33.2	6.3	59.7	76.6
Parental Education						
Less than High School	205	1.9	46.3	3.3	64.9	65.4
High School	1,325	12.3	78.8	17.4	72.5	75.3
Some College/Didn't Graduate	863	8.0	68.7	41.2	75.5	77.4
Trade/Business School	395	3.7	72.9	37.1	76.4	77.6
Community/Junior College	1,482	13.8	78.4	84.1	75.6	74.4
Four-Year College Degree	3,627	33.8	79.8	52.1	76.6	68.5
Graduate School	2,846	26.5	*	3.1	66.9	61.2
Hours of Homework Assigned Per Week						
None assigned	130	1.2	60.8	28.9	71.9	51.6
Less than 1	1,481	13.7	83.7	17.4	72.5	77.4
1 to 3	3,671	34.0	81.2	41.2	75.5	77.6
More than 3, less than 5	3,251	30.1	78.3	37.1	76.4	74.4
More than 10	1,935	17.9	70.3	84.1	75.6	68.5
Assigned but not done	328	3.0	84.1	3.1	66.9	61.2
Hours of TV Watched Per Week						
None	1,015	9.4	84.1	17.4	72.5	77.4
1 or less	4,304	40.0	78.0	41.2	75.5	77.6
2 hours	2,896	26.9	74.7	37.1	76.4	74.4
3 hours	1,518	14.1	65.7	84.1	75.6	68.5
4 to 5	684	6.3	59.7	52.1	76.6	61.2
6 or more	356	3.3	64.9	3.1	66.9	61.2
Teacher's Judgment						
Mastery Not Sufficient	858	8.1	31.1	17.4	72.5	77.4
Mastery Inconsistent	2,576	24.2	56.2	41.2	75.5	77.6
Demonstrates Mastery	4,613	43.4	80.8	37.1	76.4	74.4
Superior Performance	2,524	23.7	97.1	84.1	75.6	68.5
Unclear	61	0.6	63.9	52.1	76.6	61.2
Extracurricular Activity						
Athletics	5,839	53.3	75.8	28.9	71.9	51.6
Academics	3,728	34.1	82.4	17.4	72.5	77.4
Fine Arts	3,538	32.3	77.6	41.2	75.5	77.6
Vocational Clubs	2,138	19.5	68.3	37.1	76.4	74.4
Service Clubs	4,448	40.6	79.8	84.1	75.6	68.5
Other Activities	5,552	50.7	78.2	52.1	76.6	61.2
No Activities	856	7.8	67.1	3.1	66.9	61.2
How Science Learned						
Read	5,447	49.8	76.1	28.9	71.9	51.6
Lab activity	9,309	85.0	76.2	17.4	72.5	77.4
Observe Demonstrations	9,114	83.2	76.7	41.2	75.5	77.6
Listening	9,954	90.9	75.6	37.1	76.4	74.4
Lab groups	9,188	83.9	76.1	84.1	75.6	68.5
Activity outside	5,128	46.8	76.7	52.1	76.6	61.2
Technology	8,528	77.9	76.5	3.1	66.9	61.2
Post-High School Plans						
Seek employment	69	0.6	62.3	28.9	71.9	51.6
Military service	165	1.5	64.2	17.4	72.5	77.4
Trade/Business School	59	0.5	50.9	41.2	75.5	77.6
Community/Junior College	775	7.2	54.7	37.1	76.4	74.4
Four-Year College	9,372	87.0	76.6	84.1	75.6	68.5
Undecided	257	2.4	65.4	52.1	76.6	61.2
Other	77	0.7	75.3	3.1	66.9	61.2
Computer Use						
Almost every day	2,856	26.5	77.4	17.4	72.5	77.4
1-2 times per week	3,668	34.1	77.6	41.2	75.5	77.6
1-2 times per month	2,342	21.8	74.4	37.1	76.4	74.4
Hardly ever	1,184	11.0	68.5	84.1	75.6	68.5
Never (owns computer)	276	2.6	61.2	52.1	76.6	61.2
No computer at home	434	4.0	51.6	3.1	66.9	61.2

Notes: * No scores are reported for groups with fewer than thirty students.

Data received from LEAs and charter schools after August 2001 are not included in this table.

Prepared by the NCDPI Division of Accountability Services/Testing Section.

Table 18. 2000-01 End-of-Course Multiple-Choice Test Results Characteristics and Performance of Students Taking U.S. History

	Percent At or Above		Anticipated Final Grade		Percent At or Above		Teacher's Judgment				
	N	Percent	A	B	C	D	F	Mastery Not Sufficient	Mastery Inconsistent	Mastery Superior	Unclear
All Students	73,742	100.0	50.5		10,103	13.7	87.6	10,684	15.0	12.7	
Gender					21,458	29.1	68.0	23,954	33.6	33.4	
Male	36,014	48.8	54.5		22,653	30.8	42.5	27,323	38.3	68.3	
Female	37,728	51.2	46.7		13,901	18.9	24.1	9,170	12.8	92.3	
Ethnic Group					5,514	7.5	14.4	237	0.3	21.9	
American Indian	901	1.2	34.7		4,091	5.7	27.8	30,853	41.8	57.1	
Asian	1,587	2.2	56.2		17,906	24.7	35.0	11,147	15.1	77.9	
Black	19,859	26.9	28.4		6,686	9.2	51.7	18,443	25.0	61.4	
Hispanic	1,617	2.2	40.7		2,984	4.1	51.6	12,177	16.5	57.3	
Multi-Racial	554	0.8	54.5		13,547	18.7	47.4	14,618	19.8	73.8	
White	49,161	66.7	59.8		18,031	24.9	61.4	25,179	34.1	62.6	
Other	62	0.1	43.6		9,130	12.6	75.3	15,557	21.1	34.9	
Grade Level											
7	1	0.0	*		1,414	1.9	32.5	118	35.2	26.3	
8	1	0.0	*		14,551	20.0	39.4	6	1.8	*	
9	509	0.7	26.1		32,235	44.2	44.1	17	5.1	*	
10	4,682	6.3	30.2		16,652	22.9	63.2	32	9.6	3.1	
11	62,346	84.5	53.8		6,532	9.0	78.6	59	17.6	30.5	
12	6,203	8.4	35.0		1,478	2.0	60.6	103	30.7	13.6	
Typical Homework											
Outside Reading	27,489	37.3	55.8		4,275	5.9	64.2	54,079	73.3	54.1	
Worksheets	53,831	73.0	51.6		23,238	32.0	56.5	7,724	10.5	49.0	
Textbook Problems	29,398	39.9	48.9		19,523	26.9	52.6	38,882	52.7	57.4	
Written Assignments	30,961	42.0	61.8		13,759	18.9	45.2	5319	7.2	59.0	
Research	24,602	33.4	60.7		8,084	11.1	38.1	2223	3.0	49.3	
Other	16,463	22.3	61.4		3,744	5.2	37.5	5857	7.9	28.7	
Course Description											
2 year/2 block	1917	2.6	32.4		13,190	18.2	56.7	2,753	3.8	24.3	
Regular year/block	41,727	57.6	39.2		18,181	25.1	58.0	3,584	4.9	37.0	
Honors	14,067	19.4	75.5		15,970	22.0	55.3	1,730	2.4	29.9	
College Placement	5834	8.1	42.0		12,379	17.1	45.9	15,075	20.8	32.7	
Advanced Placement	6568	9.1	89.2		3,828	5.3	40.6	42,314	58.4	63.0	
Other Type	2357	3.3	36.5		9,020	12.4	30.5	5,771	8.0	40.3	
Class Activities											
Read Primary Resources	66,547	90.2	52.1					1,283	1.8	34.6	
Studied News Magazines	19,231	26.1	62.2								
Studied Newspapers	13,407	18.2	59.8								
Studied Fiction	9,114	12.4	62.6								
Studied Drama	3,367	4.6	56.6								
Studied Poetry	5,286	7.2	60.8								

Notes: *No scores are reported for groups with fewer than thirty students.
Data received from LEAs and charter schools after August 2001 are not included in this table.
Prepared by the NCDPI Division of Accountability Services/Testing Section.

**Table 19. 2000-01 End-of-Course Goal Summary Report
Algebra I**

	Number of Observations*	Number of Items /Area	Mean Scale Score
ALGEBRA 1	93,000	80	61.1
GOAL 1: Operations on real numbers and polynomials		36	63.2
Obj 1.1: Operate with real numbers		12	55.6
Obj 1.2: Operate with polynomials		12	64.2
Obj 1.3: Factor polynomials		12	69.7
GOAL 2: Solve problems in a geometric context		12	52.0
Obj 2.1: Formulas/algebraic expressions to solve problems		6	52.4
Obj 2.2: Express algebraically various geometric patterns		6	51.6
GOAL 3: Graph and use relations and functions to solve problems		168	50.4
Obj 3.1: Translate words to expressions/equations		6	50.1
Obj 3.2: Properties of data in tables, graphs equations		12	62.0
Obj 3.3: Distinguish relations vs. functions, independent vs. dependent variables, domain vs. range		12	45.2
Obj 3.4: Graph/interpret in the context of the problems on the coordinate plane		15	54.4
Obj 3.5: Slopes of linear relationships to solve problems		18	51.9
Obj 3.6: Write equation of and graph linear relationships		18	51.8
Obj 3.7: Effects of changes in slope/intercepts on the graph and equation of a line		18	45.2
Obj 3.8: Use linear equations/inequalities to solve problems		18	50.2
Obj 3.9: Use linear equations or inequalities in two variables to solve problems		15	52.7
Obj 3.10: Graph quadratic equations		12	49.8
Obj 3.11: Use quadratic equations to solve problems		12	45.5
Obj 3.12: User formulas/graphs with exponential functions		12	45.1
GOAL 4: Collect/interpret data to solve problems		24	50.4
Obj 4.1: Use matrices to display and interpret data		6	56.8
Obj 4.2: Identify linear and non-linear data		6	48.7
Obj 4.3: Use linear models based on real data		12	48.0
<hr/>			
NUMBER OF STUDENTS TAKING FORM	A ----- 31,090	B ----- 30,964	C ----- 30,946

Notes: **Number of Observations" includes students who attempted at least one item on the test.
Data received from LEAs and charter schools after August 2001 are not included in this table.
Prepared by the NCDPI Division of Accountability Services/Testing Section.

**Table 20. 2000-01 End-of-Course Goal Summary Report
Algebra II**

	Number of Observations*	Number of Items /Area	Mean Scale Score
ALGEBRA 2	54,902	60	63.8
GOAL 1: Operations with numbers and polynomials to solve problems		24	48.9
Obj 1.1: Operate with numbers		9	51.2
Obj 1.2: Operate with algebraic expressions		15	47.5
GOAL 2: Describe geometric figures algebraically in coordinate plane		9	59.2
Obj 2.1: Write equations in standard form of circles and parabolas		6	60.9
GOAL 3: Graph and use relations and functions to solve problems		120	49.8
Obj 3.1: Describe graphically, algebraically, and verbally real world phenomena as functions; identify the independent and dependent variables		6	38.2
Obj 3.2: Translate among graphic, algebraic and verbal representations of relations		6	54.1
Obj 3.3: Graph relations/functions and find zero of functions		6	67.9
Obj 3.4: Find the composition and inverse of functions		6	56.0
Obj 3.5: Use quadratic equations and inequalities to solve problems		15	49.4
Obj 3.6: Find and interpret the maximum and minimum values and intercepts of a quadratic function		6	40.7
Obj 3.7: Use polynomial equations (to 4th degree) to solve problems		6	65.7
Obj 3.8: Find zeros, intercepts, and approximate turning points of polynomial functions		6	35.6
Obj 3.10: Use rational equations to solve problems		6	42.1
Obj 3.11: Use equations with radical expressions to solve problems		6	57.1
Obj 3.12: Use systems of two or more equations to solve problems		12	54.7
Obj 3.13: Use systems of three or more inequalities to solve problems		6	37.8
Obj 3.14: Use equations and inequalities with absolute value to solve problems		6	50.7
Obj 3.15: Write and graph exponential functions		6	40.3
Obj 3.16: Recognize as inverses the exponential and logarithmic functions		6	61.4
Obj 3.17: Use logarithmic/exponential functions to solve problems		12	43.7
GOAL 4: Collect, organize and interpret data with functions of best-fit and matrices to solve problems		27	43.3
Obj 4.1: Use equations of curves (linear, exponential, quadratic) which models a set of data		6	35.0
Obj 4.2: Find equations of the curve of best fit (linear, exponential, quadratic) for a set of data		6	36.5
Obj 4.3: Use exponential equations with rate of growth or decay to solve problems		6	42.2
Obj 4.4: Operate with matrices to solve problems		9	54.2
NUMBER OF STUDENTS TAKING FORM	A ----- 18,323	B ----- 18,291	C ----- 18,288

Notes: **"Number of Observations" includes students who attempted at least one item on the test.
Data received from LEAs and charter schools after August 2001 are not included in this table.
Prepared by the NCDPI Division of Accountability Services/Testing Section.

**Table 21. 2000-01 End-of-Course Goal Summary Report
Biology**

	Number of Observations*	Number of Items /Area	Mean Scale Score				
The 1995 State Average of 55.5 is a point of comparison for Biology Scale Scores.	82,026	95	56.8				
SKILL GOALS							
GOAL 1: Develop an understanding of the nature of science.		20	53.2				
GOAL 2: Develop the ability to use science process skills.		335	56.9				
GOAL 3: Develop the ability to use science manipulative skills.		21	51.6				
GOAL 5: Have an understanding of the relevance of current topics in biology.		44	53.5				
CONCEPTUAL KNOWLEDGE: Understand the fundamental concepts, principles and facts of science.		244	55.2				
CONTENT GOALS							
GOAL 6: Understand the chemical and physical basis of life.		209	54.5				
Obj 6.1: Demonstrate knowledge of the differences between living and non-living things.		30	52.2				
Obj 6.2: Demonstrate knowledge of the cell.		51	52.0				
Obj 6.3: Demonstrate knowledge of the chemical processes of life.		52	52.6				
Obj 6.4: Demonstrate knowledge that living things exist in a state of Dynamic equilibrium.		25	52.9				
Obj 6.5: Demonstrate knowledge of anatomy and physiology.		51	53.2				
GOAL 7: Understand the continuity of life.		262	56.2				
Obj 7.1: Demonstrate knowledge that living things receive characteristics from the parent organism(s).		54	53.5				
Obj 7.2: Demonstrate knowledge of the chemical basis of heredity.		43	54.4				
Obj 7.3: Demonstrate knowledge that organic variation is important and necessary for species survival.		53	53.3				
Obj 7.4: Demonstrate knowledge of the nature of human origin development.		27	52.1				
Obj 7.5: Demonstrate knowledge of the diversity and classification of living things.		53	54.0				
Obj 7.6: Demonstrate knowledge of major genetic and environmental factors affecting human health.		32	52.3				
GOAL 8: Have an understanding of ecology.		192	56.8				
Obj 8.1: Demonstrate knowledge of populations, communities and ecosystems.		71	55.3				
Obj 8.2: Demonstrate knowledge of the influences of human activity on the environment.		60	53.6				
Obj 8.3: Demonstrate that for all organisms, survival requires suitable responses to the external environment.		61	55.7				
NUMBER OF STUDENTS TAKING FORM	M ----- 113	P ----- 2	Q ----- 1	S ----- 9,017	T ----- 18,449	U ----- 27,221	V ----- 27,223

Notes: *"Number of Observations" includes students who attempted at least one item on the test.
Data received from LEAs and charter schools after August 2001 are not included in this table.
Prepared by the NCDPI Division of Accountability Services/Testing Section.

**Table 22. 2000-01 End-of-Course Goal Summary Report
Chemistry**

	Number of Observations*	Number of Items /Area	Mean Scale Score		
The 1997 State Average of 56.8 is the point of comparison for Chemistry Scale Scores.	43,702	88/87	58.9		
SKILL GOALS					
GOAL 1: Understand the nature of science.		25	53.1		
GOAL 2: Have ability to use science process skills.		217	58.1		
GOAL 3: Have ability to use science manipulative skills.		20	52.3		
GOAL 5: Understand the relevance of current topics in chemistry.		19	52.3		
CONCEPTUAL KNOWLEDGE: Understand the fundamental concepts, principles and facts of science.		158	57.6		
CONTENT GOALS/OBJECTIVES					
GOAL 6: Understand properties of solutions.		109	53.4		
Obj 6.1: Demonstrate knowledge of concentrations of solutions.		40	52.8		
Obj 6.2: Demonstrate knowledge of the properties of ionic and covalent solutions.		34	51.0		
Obj 6.3: Demonstrate knowledge of solutes and solubilities.		35	51.8		
GOAL 7: Understand the regularities of chemistry.		215	58.7		
Obj 7.1: Demonstrate knowledge of the mole concept/ stoichiometry.		45	54.8		
Obj 7.2: Demonstrate knowledge of the periodic table and periodic law.		40	54.2		
Obj 7.3: Demonstrate knowledge of acids, bases and pH.		45	56.1		
Obj 7.4: Demonstrate knowledge of chemical reactions.		45	55.2		
Obj 7.5: Demonstrate knowledge of gas laws.		40	54.6		
GOAL 8: Understand the changes in chemistry.		80	58.0		
Obj 8.1: Demonstrate knowledge of factors that affect reaction rate.		39	55.7		
Obj 8.2: Demonstrate knowledge of energy changes.		41	56.2		
GOAL 9: Understand the models in chemistry.					
Obj 9.1: Knowledge of the changing model of the atom.		35	54.6		
NUMBER OF STUDENTS TAKING FORM	10	14,611	9	14,524	14,548

Notes: **Number of Observations* includes students who attempted at least one item on the test.
Data received from LEAs and charter schools after August 2001 are not included in this table.
Prepared by the NCDPI Division of Accountability Services/Testing Section.

**Table 23. 2000-01 End-of-Course Goal Summary Report
Economic, Legal, and Political Systems**

	Number of Observations*	Number of Items /Area	Mean Scale Score
The 1997 State Average of 53.8 is the point of comparison for Economic, Legal, and Political Systems Scale Scores.	90,209	100/99**	55.7
GOAL 1: Awareness and understanding of issues and problems confronting the American economic, legal and political systems.		45	52.3
GOAL 2: Knowledge of the rights and an understanding of the obligations of responsible citizenship.		54	52.5
GOAL 3: Understand how and why individuals and groups make economic decisions.		50	53.9
GOAL 4: Features of the United States economic system.		55	53.5
GOAL 5: Factors influencing the United States economy.		56	54.0
GOAL 6: Understand the function and importance of the North Carolina and United States Constitutions.		56	54.8
GOAL 7: Know the structure and functions of local, state and national governments and understand their relationships.		50	54.0
GOAL 8: Understand why laws are needed and how they are enacted, implemented and enforced.		55	54.4
GOAL 9: Understand how political and legal systems provide for balancing competing interests and resolving conflicts.		50	54.1
GOAL 10: Understand the influence of ethical and moral principles and religious beliefs on the development of our economic, legal, and political systems.		25	53.6
Economics		260	54.7
Law and Government		236	56.1

NUMBER OF STUDENTS TAKING FORM	A	E	F	G	H	I
	30,124	9,549	30,044	20,411	0	81

Notes: * "Number of Observations" includes students who attempted at least one item on the test.
 ** Forms E, F, G and I contain 99 scored questions.
 Data received from LEAs and charter schools after August 2001 are not included in this table.
 Prepared by the NCDPI Division of Accountability Services/Testing Section.

**Table 24. 2000-01 End-of-Course Goal Summary Report
English I**

	Number of Observations*	Number of Items /Area	Mean Scale Score			
The 1995 State Average of 53.1 is the point of comparison for English I Scale Scores.	94,707	72/71**	55.4			
GOAL 1: Use strategies and processes that enhance control of communication skills development.		182	53.7			
GOAL 2: Use language for the acquisition, interpretation and application of information.		184	55.6			
Obj 2.1: Identify, collect, or select information and ideas.		37	52.8			
Obj 2.2: Analyze, synthesize and organize information and discover related ideas, concepts and generalizations.		106	55.7			
Obj 2.3: Apply, extend and expand on information and concepts.		41	52.7			
GOAL 3: Use language for critical analysis and evaluation.		65	53.7			
GOAL 4: Use language for aesthetic and personal response (not tested).						
Editing		180	53.5			
Textual Analysis		251	55.9			
NUMBER OF STUDENTS TAKING FORM	J	L	N	P	Q	R
	-----	-----	-----	-----	-----	-----
	22,137	9,176	9,501	31,462	22,081	350

Notes: * "Number of Observations" includes students who attempted at least one item on the test.

** Form R has 71 questions that are scored; the other forms have 72 questions.

Data received from LEAs and charter schools after August 2001 are not included in this table.

Prepared by the NCDPI Division of Accountability Services/Testing Section.

**Table 25. 2000-01 End-of-Course Goal Summary Report
Geometry**

	Number of Observations*	Number of Items /Area	Mean Scale Score
GEOMETRY	65,480	72	59.8
GOAL 2: Use properties of geometric figures to solve problems and write proofs		186	56.4
Obj 2.3: Find the length and midpoint of a segment in two or three dimensions to solve problems		9	68.3
Obj 2.5: Use the structure (definitions, postulates, theorems, properties) of deductive reasoning to solve problems		9	63.3
Obj 2.7: Write direct and indirect proofs		9	60.6
Obj 2.8: Use properties, definitions and theorems of angles and lines to solve problems and write proofs		18	70.4
Obj 2.9: Use properties, definitions and theorems of polygons		12	47.3
Obj 2.10: Identify and model regular and non-regular polyhedra		6	66.5
Obj 2.11: Use coordinate geometry to confirm properties of polygons		12	58.0
Obj 2.12: Properties of quadrilaterals to solve problems/write proofs		9	54.9
Obj 2.13: Properties of triangles: similar, congruent, isosceles, equilateral triangles; relationships of corresponding parts of triangles; altitudes, bisectors, medians		18	57.1
Obj 2.14: Properties of triangles: interior/exterior angles; segment joining midpoints of sides; segments divided proportionally		9	66.2
Obj 2.15: Properties of right triangles: geometric mean; Pythagorean Theorem and its converse; special right triangles, definitions of sine, cosine and tangent		21	52.6
Obj 2.16: Properties of circles: definition of circle; equations of circle, center, radius length; congruent and concentric circles and their common tangents; inscribed figures		18	45.7
Obj 2.17: Properties of circles: arcs and angles; chords, tangents, secants and radii of a circle		9	58.8
Obj 2.19: Use formulas to solve problems related to perimeter, circumference, areas and surface area of geometric figures and ratios of these parts of similar figures		15	45.8
GOAL 3: Solve problems with geometric figures on a coordinate plane		21	42.7
Obj 3.1: Use slopes to determine if two lines are parallel or perpendicular		6	39.5
Obj 3.2: Write the equation of a line parallel or perpendicular to a give line through a point		6	38.3
Obj 3.3: Transform polygons in the coordinate plane; describe transformation in simple algebraic terms.		9	47.8
GOAL 4: Use geometric figures to solve problems with probability		9	48.1

NUMBER OF STUDENTS TAKING FORM	A	B	C
	21,871	21,825	21,789

Notes: ***"Number of Observations" includes students who attempted at least one item on the test.
Data received from LEAs and charter schools after August 2001 are not included in this table.
Prepared by the NCDPI Division of Accountability Services/Testing Section.

**Table 26. 2000-01 End-of-Course Goal Summary Report
Physical Science**

	Number of Observations*	Number of Items /Area	Mean Scale Score	
The 1997 State Average of 53.7 is the point of comparison for Physical Science Scale Scores.	39,182	80	55.5	
SKILL GOALS				
GOAL 2: Develop the ability to use science process skills.		164	55.4	
GOAL 3: Develop the ability to use science manipulative skills.		22	52.9	
GOAL 5: Understand the relevance of current topics in physical science.		15	51.2	
CONCEPTUAL KNOWLEDGE: Understand the fundamental concepts, principles and facts of science.		117	54.4	
CONTENT GOALS/OBJECTIVES				
GOAL 6: Understand sound, light and heat.		48	52.7	
Obj 6.1: Demonstrate knowledge of the basic principles of sound.		23	51.5	
Obj 6.2: Demonstrate knowledge of the basic principles of light.		12	51.2	
Obj 6.3: Demonstrate knowledge of the basic principles of heat.		13	50.7	
GOAL 7: Understand the basic principles of chemistry.		72	52.8	
Obj 7.1: Demonstrate knowledge of the Periodic Table of Elements.		20	51.3	
Obj 7.2: Demonstrate knowledge of chemical properties of the elements.		16	51.3	
Obj 7.3: Demonstrate knowledge of mixtures, compounds and elements.		20	50.9	
Obj 7.4: Demonstrate knowledge of chemical reactions.		16	51.9	
GOAL 8: Understand mechanics.		72	54.7	
Obj 8.1: Demonstrate knowledge of work, energy and power.		20	53.7	
Obj 8.2: Demonstrate knowledge of the laws of motion.		16	52.6	
Obj 8.3: Demonstrate knowledge of forces.		19	52.1	
Obj 8.4: Demonstrate knowledge of concepts of fluids.		17	51.6	
GOAL 9: Understand electricity and magnetism.		88	55.2	
Obj 9.1: Demonstrate knowledge of static electricity.		20	52.3	
Obj 9.2: Demonstrate knowledge of magnetism.		17	52.3	
Obj 9.3: Demonstrate knowledge of parallel and series circuits.		17	52.8	
Obj 9.4: Demonstrate knowledge of measuring and controlling electric current.		19	53.2	
Obj 9.5: Demonstrate knowledge of a relationship between electricity and magnetism.		15	52.2	
GOAL 10: Understand energy.		40	54.0	
Obj 10.1: Demonstrate knowledge of the basic principles of energy conversion.		20	53.1	
Obj 10.2: Demonstrate knowledge of the basic principles of energy conservation.		20	52.7	
NUMBER OF STUDENTS TAKING FORM	D	E	F	G
	71	12,986	13,109	13,016

Notes: **Number of Observations* includes students who attempted at least one item on the test.
Data received from LEAs and charter schools after August 2001 are not included in this table.
Prepared by the NCDPI Division of Accountability Services/Testing Section.

**Table 27. 2000-01 End-of-Course Goal Summary Report
Physics**

	Number of Observations*	Number of Items /Area	Mean Scale Score		
The 1997 State Average of 55.9 is the point of comparison for Physics Scale Scores.	10,948	70/69**	57.0		
SKILL GOALS:					
GOAL 1: Develop an understanding of the nature of science.		2			
GOAL 2: Develop the ability to use science process skills.		142	57.4		
GOAL 3: Develop ability to use science manipulative skills.		3	51.8		
CONCEPTUAL KNOWLEDGE: Understand the fundamental concepts, principles and facts of science.		51	54.2		
GOAL 5: Understand relevance of current topics in physics.		9	51.6		
CONTENT GOALS/OBJECTIVES					
GOAL 6: Understand basic mechanics.		84	55.2		
Obj 6.1: Laws, mathematic expressions, and factors which represent and affect various types of motion.		24	53.7		
Obj 6.2: Analyze systems involving vector quantities and component forces.		24	53.7		
Obj 6.3: Behavior of gravitational forces.		15	52.6		
Obj 6.4: Mechanical energy.		12	52.7		
Obj 6.5: Kinetic molecular theory.		9	50.3		
GOAL 7: Understand elementary principles of thermodynamics.		33	54.7		
Obj 7.1: Factors associated with the characteristics of heat and the conservation of energy.		19	53.9		
Obj 7.2: Make determinations of the heat equivalent of work.		14	52.5		
GOAL 8: Understand wave motion.		48	55.7		
Obj 8.1: General properties and characteristics of waves.		16	53.3		
Obj 8.2: Investigate and describe sound.		17	54.3		
Obj 8.3: Investigate and describe light in a quantified manner.		15	52.9		
GOAL 9: Understand electricity and magnetism.		45	56.1		
Obj 9.1: Electrostatic phenomena.		15	52.7		
Obj 9.2: Direct current circuits and alternating current circuits.		16	53.7		
Obj 9.3: Magnetism and how it relates to electricity.		14	53.3		
NUMBER OF STUDENTS TAKING FORM	A	B	C	D	E
	3,679	0	0	3,637	3,632

Notes: * "Number of Observations" includes students who attempted at least one item on the test.

** Form B has 69 scored questions; forms A and C have 70.

Data received from LEAs and charter schools after August 2001 are not included in this table.

Prepared by the NCDPI Division of Accountability Services/Testing Section.

**Table 28. 2000-01 End-of-Course Goal Summary Report
U.S. History**

	Number of Observations*	Number of Items /Area	Mean Scale Score
The 1995 State Average of 56.2 is the point of comparison for U.S. History Scale Scores.	73,742	100/99**	56.6
GOAL 1: Analyze elements in the American colonial experience that led to separation from England.		35	54.1
GOAL 2: Apply ideas of self-government as expressed in America's founding documents.		40	54.1
GOAL 3: Judge effectiveness of the institutions of the new nation in completing its independence (1781-1815).		30	53.2
GOAL 4: Assess the contending goals of nationalism and sectionalism in the period 1815-1850.		49	55.0
GOAL 5: Evaluate the Civil War and Reconstruction as an affirmation of the power of the national government.		35	53.3
GOAL 6: Interpret economic, social and political trends of the late 19th and early 20th centuries.		30	53.7
GOAL 7: Analyze the causes and effects of the United States' involvement in international affairs.		49	53.6
GOAL 8: Appraise the economic, social and political changes of the decades of the 1920s and 1930s.		40	54.0
GOAL 9: Analyze and evaluate the significance of causes, events and effects of the World War II era.		50	55.3
GOAL 10: Trace economic and social developments and assess their significance for the lives of Americans in the last half-century.		50	56.0
GOAL 11: Analyze changes in American political life in the last half-century.		50	55.5
GOAL 12: Evaluate the conduct of United States' foreign policy over the last half-century.		40	55.9

NUMBER OF STUDENTS TAKING FORM	S	T	V	W	X
	7,386	17,392	17,314	24,357	7,293

Notes: * "Number of Observations" includes students who attempted at least one item on the test.
 ** Forms W and X contain 99 scored questions; the other forms have 100.
 Data received from LEAs and charter schools after August 2001 are not included in this table.
 Prepared by the NCDPI Division of Accountability Services/Testing Section.

**Table 29. 2000-01 End-of-Course Distribution of Scale Scores
Algebra I**

<u>NUMBER OF STUDENTS WITH VALID SCORES*</u>	93,000	<u>HIGH SCORE</u>	96
		<u>LOW SCORE</u>	31
<u>MEAN</u>	61.1	<u>2001 STATE PERCENTILES</u>	<u>SCALE SCORE</u>
<u>STANDARD DEVIATION</u>	9.3	90	73.21
<u>VARIANCE</u>	86.8	75	67.28
		50 (<u>MEDIAN</u>)	60.78
		25	54.71
		10	49.07

FREQUENCY DISTRIBUTION

<u>SCALE SCORE</u>	<u>FREQUENCY</u>	<u>CUMULATIVE FREQUENCY</u>	<u>PERCENT</u>	<u>CUMULATIVE PERCENT</u>	<u>2001 STATE PERCENTILE</u>
96	11	93000	0.01	100.00	99
95	10	92989	0.01	99.99	99
94	23	92979	0.02	99.98	99
93	19	92956	0.02	99.95	99
92	22	92937	0.02	99.93	99
91	45	92915	0.05	99.91	99
90	36	92870	0.04	99.86	99
89	84	92834	0.09	99.82	99
88	108	92750	0.12	99.73	99
87	50	92642	0.05	99.62	99
86	203	92592	0.22	99.56	99
85	192	92389	0.21	99.34	99
84	218	92197	0.23	99.14	99
83	253	91979	0.27	98.90	99
82	406	91726	0.44	98.63	98
81	488	91320	0.52	98.19	98
80	514	90832	0.55	97.67	97
79	610	90318	0.66	97.12	97
78	718	89708	0.77	96.46	96
77	1324	88990	1.42	95.69	95
76	874	87666	0.94	94.26	94
75	1287	86792	1.38	93.32	93
74	1361	85505	1.46	91.94	91
73	1524	84144	1.64	90.48	90
72	2065	82620	2.22	88.84	88
71	1886	80555	2.03	86.62	86
70	2973	78669	3.20	84.59	83
69	2739	75696	2.95	81.39	80
68	2397	72957	2.58	78.45	77
67	3635	70560	3.91	75.87	74
66	3174	66925	3.41	71.96	70
65	2701	63751	2.90	68.55	67
64	4315	61050	4.64	65.65	63
63	4510	56735	4.85	61.01	59
62	2959	52225	3.18	56.16	55
61	3847	49266	4.14	52.97	51
60	4609	45419	4.96	48.84	46
59	3879	40810	4.17	43.88	42
58	3131	36931	3.37	39.71	38
57	4675	33800	5.03	36.34	34
56	2372	29125	2.55	31.32	30
55	4452	26753	4.79	28.77	26
54	2222	22301	2.39	23.98	23
53	2763	20079	2.97	21.59	20
52	2933	17316	3.15	18.62	17
51	2504	14383	2.69	15.47	14
50	1861	11879	2.00	12.77	12
49	1666	10018	1.79	10.77	10
48	1611	8352	1.73	8.98	8
47	1483	6741	1.59	7.25	6
46	1238	5258	1.33	5.65	5
45	1069	4020	1.15	4.32	4
44	884	2951	0.95	3.17	3

Notes: * Students with valid scores are those who attempted at least one item on the test.
Data received from LEAs and charter schools after August 2001 are not included in this table.
Prepared by the NCDPI Division of Accountability Services/Testing Section.

**Table 29. 2000-01 End-of-Course Distribution of Scale Scores
Algebra I (continued)**

FREQUENCY DISTRIBUTION

<u>SCALE SCORE</u>	<u>FREQUENCY</u>	<u>CUMULATIVE FREQUENCY</u>	<u>PERCENT</u>	<u>CUMULATIVE PERCENT</u>	<u>2001 STATE PERCENTILE</u>
43	663	2067	0.71	2.22	2
42	518	1404	0.56	1.51	1
41	340	886	0.37	0.95	1
40	208	546	0.22	0.59	1
39	153	338	0.16	0.36	1
38	68	185	0.07	0.20	1
37	67	117	0.07	0.13	1
36	12	50	0.01	0.05	1
35	10	38	0.01	0.04	1
34	6	28	0.01	0.03	1
33	7	22	0.01	0.02	1
32	3	15	0.00	0.02	1
LESS THAN 32	12	12	0.01	0.01	1

Notes: * Students with valid scores are those who attempted at least one item on the test.
Data received from LEAs and charter schools after August 2001 are not included in this table.
Prepared by the NCDPI Division of Accountability Services/Testing Section.

**Table 30. 2000-01 End-of-Course Distribution of Scale Scores
Algebra II**

<u>NUMBER OF STUDENTS WITH VALID SCORES*</u>	54,902	<u>HIGH SCORE</u>	101
		<u>LOW SCORE</u>	33
<u>MEAN</u>	63.8	<u>2001 STATE PERCENTILES</u>	<u>SCALE SCORE</u>
<u>STANDARD DEVIATION</u>	9.9	90	76.68
		75	70.90
		50 (<u>MEDIAN</u>)	63.62
<u>VARIANCE</u>	97.9	25	56.96
		10	50.47

FREQUENCY DISTRIBUTION

<u>SCALE SCORE</u>	<u>FREQUENCY</u>	<u>CUMULATIVE FREQUENCY</u>	<u>PERCENT</u>	<u>CUMULATIVE PERCENT</u>	<u>2001 STATE PERCENTILE</u>
101	1	54902	0.00	100.00	99
99	8	54901	0.01	100.00	99
97	17	54893	0.03	99.98	99
95	32	54876	0.06	99.95	99
93	72	54844	0.13	99.89	99
91	80	54772	0.15	99.76	99
90	66	54692	0.12	99.62	99
89	38	54626	0.07	99.50	99
88	183	54588	0.33	99.43	99
87	131	54405	0.24	99.09	99
86	244	54274	0.44	98.86	99
85	115	54030	0.21	98.41	98
84	341	53915	0.62	98.20	98
83	408	53574	0.74	97.58	97
82	492	53166	0.90	96.84	96
81	342	52674	0.62	95.94	96
80	534	52332	0.97	95.32	95
79	658	51798	1.20	94.35	94
78	1042	51140	1.90	93.15	92
77	834	50098	1.52	91.25	90
76	1054	49264	1.92	89.73	89
75	1059	48210	1.93	87.81	87
74	1169	47151	2.13	85.88	85
73	1667	45982	3.04	83.75	82
72	1927	44315	3.51	80.72	79
71	2010	42388	3.66	77.21	75
70	1608	40378	2.93	73.55	72
69	1779	38770	3.24	70.62	69
68	1795	36991	3.27	67.38	66
67	1958	35196	3.57	64.11	62
66	2007	33238	3.66	60.54	59
65	1959	31231	3.57	56.88	55
64	2063	29272	3.76	53.32	51
63	2214	27209	4.03	49.56	48
62	2198	24995	4.00	45.53	44
61	2155	22797	3.93	41.52	40
60	1412	20642	2.57	37.60	36
59	2244	19230	4.09	35.03	33
58	2137	16986	3.89	30.94	29
57	2067	14849	3.76	27.05	25
56	1343	12782	2.45	23.28	22
55	636	11439	1.16	20.84	20
54	1949	10803	3.55	19.68	18
53	1710	8854	3.11	16.13	15
52	1077	7144	1.96	13.01	12
51	540	6067	0.98	11.05	11
50	1396	5527	2.54	10.07	9
49	765	4131	1.39	7.52	7
48	721	3366	1.31	6.13	5
47	578	2645	1.05	4.82	4
46	692	2067	1.26	3.76	3
45	375	1375	0.68	2.50	2
44	385	1000	0.70	1.82	1
43	116	615	0.21	1.12	1
42	225	499	0.41	0.91	1
41	143	274	0.26	0.50	1
40	61	131	0.11	0.24	1
LESS THAN 40	70	70	0.13	0.13	1

Notes: * Students with valid scores are those who attempted at least one item on the test.
Data received from LEAs and charter schools after August 2001 are not included in this table.
Prepared by the NCDPI Division of Accountability Services/Testing Section.

**Table 31. 2000-01 End-of-Course Distribution of Scale Scores
Biology**

<u>NUMBER OF STUDENTS WITH VALID SCORES*</u>	82,026	<u>HIGH SCORE</u>	91
		<u>LOW SCORE</u>	25
<u>MEAN</u>	56.8	<u>2001 STATE PERCENTILES</u>	<u>SCALE SCORE</u>
<u>STANDARD DEVIATION</u>	8.5	90	67.80
		75	62.87
		<u>50 (MEDIAN)</u>	56.91
<u>VARIANCE</u>	72.7	25	51.01
		10	45.57

FREQUENCY DISTRIBUTION

<u>SCALE SCORE</u>	<u>FREQUENCY</u>	<u>CUMULATIVE FREQUENCY</u>	<u>PERCENT</u>	<u>CUMULATIVE PERCENT</u>	<u>1995 STATE PERCENTILE</u>
91	1	82026	0.00	100.00	99
88	4	82025	0.00	100.00	99
86	8	82021	0.01	99.99	99
85	13	82013	0.02	99.98	99
83	29	82000	0.04	99.97	99
82	37	81971	0.05	99.93	99
81	50	81934	0.06	99.89	99
80	70	81884	0.09	99.83	99
79	93	81814	0.11	99.74	99
78	150	81721	0.18	99.63	99
77	201	81571	0.25	99.45	99
76	229	81370	0.28	99.20	99
75	431	81141	0.53	98.92	99
74	590	80710	0.72	98.40	99
73	518	80120	0.63	97.68	98
72	879	79602	1.07	97.04	98
71	900	78723	1.10	95.97	97
70	1096	77823	1.34	94.88	96
69	1768	76727	2.16	93.54	95
68	1627	74959	1.98	91.38	93
67	1779	73332	2.17	89.40	91
66	2375	71553	2.90	87.23	88
65	2671	69178	3.26	84.34	86
64	2911	66507	3.55	81.08	83
63	3296	63596	4.02	77.53	79
62	2756	60300	3.36	73.51	76
61	3385	57544	4.13	70.15	72
60	2992	54159	3.65	66.03	68
59	3771	51167	4.60	62.38	64
58	3843	47396	4.69	57.78	59
57	4324	43553	5.27	53.10	55
56	3796	39229	4.63	47.83	51
55	3420	35433	4.17	43.20	46
54	3197	32013	3.90	39.03	42
53	3636	28816	4.43	35.13	37
52	3537	25180	4.31	30.70	34
51	2314	21643	2.82	26.39	30
50	3462	19329	4.22	23.56	26
49	1587	15867	1.93	19.34	23
48	3039	14280	3.70	17.41	20
47	1375	11241	1.68	13.70	17
46	1793	9866	2.19	12.03	15
45	1810	8073	2.21	9.84	12
44	1000	6263	1.22	7.64	10
43	1066	5263	1.30	6.42	9
42	813	4197	0.99	5.12	7
41	694	3384	0.85	4.13	6
40	784	2690	0.96	3.28	5
39	495	1906	0.60	2.32	3
38	595	1411	0.73	1.72	2
37	234	816	0.29	0.99	1
36	212	582	0.26	0.71	1
35	161	370	0.20	0.45	1
34	95	209	0.12	0.25	1
LESS THAN 34	114	114	0.14	0.14	1

Notes: * Students with valid scores are those who attempted at least one item on the test.
Data received from LEAs and charter schools after August 2001 are not included in this table.
Prepared by the NCDPI Division of Accountability Services/Testing Section.

**Table 32. 2000-01 End-of-Course Distribution of Scale Scores
Chemistry**

<u>NUMBER OF STUDENTS WITH VALID SCORES*</u>	43,702	<u>HIGH SCORE</u>	88
		<u>LOW SCORE</u>	27
<u>MEAN</u>	58.9	<u>2001 STATE PERCENTILES</u>	<u>SCALE SCORE</u>
<u>STANDARD DEVIATION</u>	8.7	90	69.98
		75	64.81
		50 (<u>MEDIAN</u>)	58.81
<u>VARIANCE</u>	76.5	25	53.03
		10	47.29

FREQUENCY DISTRIBUTION

<u>SCALE SCORE</u>	<u>FREQUENCY</u>	<u>CUMULATIVE FREQUENCY</u>	<u>PERCENT</u>	<u>CUMULATIVE PERCENT</u>	<u>1997 STATE PERCENTILE</u>
88	5	43702	0.01	100.00	99
87	11	43697	0.03	99.99	99
86	22	43686	0.05	99.96	99
85	26	43664	0.06	99.91	99
84	38	43638	0.09	99.85	99
83	49	43600	0.11	99.77	99
82	60	43551	0.14	99.65	99
81	104	43491	0.24	99.52	99
80	109	43387	0.25	99.28	99
79	171	43278	0.39	99.03	99
78	152	43107	0.35	98.64	99
77	218	42955	0.50	98.29	99
76	369	42737	0.84	97.79	99
75	245	42368	0.56	96.95	98
74	468	42123	1.07	96.39	98
73	571	41655	1.31	95.32	97
72	643	41084	1.47	94.01	96
71	677	40441	1.55	92.54	95
70	836	39764	1.91	90.99	94
69	1117	38928	2.56	89.08	92
68	1287	37811	2.94	86.52	90
67	1472	36524	3.37	83.58	88
66	1106	35052	2.53	80.21	86
65	1686	33946	3.86	77.68	83
64	1553	32260	3.55	73.82	80
63	1994	30707	4.56	70.26	76
62	1771	28713	4.05	65.70	72
61	1841	26942	4.21	61.65	68
60	2389	25101	5.47	57.44	64
59	1247	22712	2.85	51.97	60
58	2530	21465	5.79	49.12	56
57	2171	18935	4.97	43.33	51
56	1671	16764	3.82	38.36	46
55	1665	15093	3.81	34.54	42
54	1715	13428	3.92	30.73	37
53	1665	11713	3.81	26.80	33
52	1529	10048	3.50	22.99	28
51	1097	8519	2.51	19.49	25
50	986	7422	2.26	16.98	22
49	951	6436	2.18	14.73	19
48	888	5485	2.03	12.55	16
47	1069	4597	2.45	10.52	13
46	619	3528	1.42	8.07	11
45	602	2909	1.38	6.66	9
44	350	2307	0.80	5.28	8
43	470	1957	1.08	4.48	6
42	391	1487	0.89	3.40	4
41	330	1096	0.76	2.51	3
40	215	766	0.49	1.75	2
39	254	551	0.58	1.26	1
38	103	297	0.24	0.68	1
37	71	194	0.16	0.44	1
36	67	123	0.15	0.28	1
35	33	56	0.08	0.13	1
LESS THAN 35	23	23	0.05	0.05	1

Notes: * Students with valid scores are those who attempted at least one item on the test.
Data received from LEAs and charter schools after August 2001 are not included in this table.
Prepared by the NCDPI Division of Accountability Services/Testing Section.

**Table 33. 2000-01 End-of-Course Distribution of Scale Scores
Economic, Legal, and Political Systems**

<u>NUMBER OF STUDENTS WITH VALID SCORES*</u>	90,209	<u>HIGH SCORE</u>	86
		<u>LOW SCORE</u>	21
<u>MEAN</u>	55.7	<u>2001 STATE PERCENTILES</u>	<u>SCALE SCORE</u>
<u>STANDARD DEVIATION</u>	8.7	90	66.65
		75	61.90
		50 (MEDIAN)	56.06
<u>VARIANCE</u>	76.0	25	50.07
		10	44.04

FREQUENCY DISTRIBUTION

<u>SCALE SCORE</u>	<u>FREQUENCY</u>	<u>CUMULATIVE FREQUENCY</u>	<u>PERCENT</u>	<u>CUMULATIVE PERCENT</u>	<u>1997 STATE PERCENTILE</u>
86	1	90209	0.00	100.00	99
84	1	90208	0.00	100.00	99
83	5	90207	0.01	100.00	99
82	4	90202	0.00	99.99	99
81	23	90198	0.03	99.99	99
80	39	90175	0.04	99.96	99
79	36	90136	0.04	99.92	99
78	35	90100	0.04	99.88	99
77	143	90065	0.16	99.84	99
76	222	89922	0.25	99.68	99
75	276	89700	0.31	99.44	99
74	149	89424	0.17	99.13	99
73	434	89275	0.48	98.96	99
72	882	88841	0.98	98.48	99
71	979	87959	1.09	97.51	98
70	867	86980	0.96	96.42	97
69	1303	86113	1.44	95.46	96
68	1956	84810	2.17	94.02	95
67	1968	82854	2.18	91.85	93
66	2032	80886	2.25	89.67	91
65	2363	78854	2.62	87.41	89
64	3204	76491	3.55	84.79	87
63	3296	73287	3.65	81.24	84
62	3877	69991	4.30	77.59	81
61	3702	66114	4.10	73.29	77
60	3775	62412	4.18	69.19	73
59	3636	58637	4.03	65.00	70
58	4205	55001	4.66	60.97	65
57	3791	50796	4.20	56.31	61
56	4289	47005	4.75	52.11	57
55	3752	42716	4.16	47.35	52
54	4579	38964	5.08	43.19	48
53	3604	34385	4.00	38.12	44
52	3757	30781	4.16	34.12	39
51	3212	27024	3.56	29.96	36
50	2939	23812	3.26	26.40	33
49	2783	20873	3.09	23.14	29
48	2576	18090	2.86	20.05	26
47	2362	15514	2.62	17.20	23
46	1535	13152	1.70	14.58	20
45	1962	11617	2.17	12.88	18
44	1390	9655	1.54	10.70	16
43	1392	8265	1.54	9.16	14
42	840	6873	0.93	7.62	12
41	1106	6033	1.23	6.69	10
40	871	4927	0.97	5.46	9
39	822	4056	0.91	4.50	8
38	724	3234	0.80	3.59	6
37	505	2510	0.56	2.78	5
36	520	2005	0.58	2.22	4
35	534	1485	0.59	1.65	3
34	270	951	0.30	1.05	2
33	286	681	0.32	0.75	1
32	165	395	0.18	0.44	1
31	98	230	0.11	0.25	1
LESS THAN 31	132	132	0.15	0.15	1

Notes: * Students with valid scores are those who attempted at least one item on the test.
Data received from LEAs and charter schools after August 2001 are not included in this table.
Prepared by the NCDPI Division of Accountability Services/Testing Section.

**Table 34. 2000-01 End-of-Course Distribution of Scale Scores
English I**

<u>NUMBER OF STUDENTS WITH VALID SCORES*</u>	94,707	<u>HIGH SCORE</u>	83
		<u>LOW SCORE</u>	22
<u>MEAN</u>	55.4	<u>2001 STATE PERCENTILES</u>	<u>SCALE SCORE</u>
<u>STANDARD DEVIATION</u>	8.6	90	66.16
		75	61.24
<u>VARIANCE</u>	73.3	50 (MEDIAN)	55.60
		25	49.76
		10	43.98

FREQUENCY DISTRIBUTION

<u>SCALE SCORE</u>	<u>FREQUENCY</u>	<u>CUMULATIVE FREQUENCY</u>	<u>PERCENT</u>	<u>CUMULATIVE PERCENT</u>	<u>1995 STATE PERCENTILE</u>
83	10	94707	0.01	100.00	99
82	9	94697	0.01	99.99	99
81	19	94688	0.02	99.98	99
80	52	94669	0.05	99.96	99
79	24	94617	0.03	99.90	99
78	145	94593	0.15	99.88	99
77	93	94448	0.10	99.73	99
76	136	94355	0.14	99.63	99
75	340	94219	0.36	99.48	99
74	219	93879	0.23	99.13	99
73	530	93660	0.56	98.89	99
72	715	93130	0.75	98.33	99
71	781	92415	0.82	97.58	98
70	1047	91634	1.11	96.76	97
69	1243	90587	1.31	95.65	97
68	1387	89344	1.46	94.34	96
67	1894	87957	2.00	92.87	94
66	2429	86063	2.56	90.87	93
65	2680	83634	2.83	88.31	91
64	2540	80954	2.68	85.48	89
63	4034	78414	4.26	82.80	86
62	2342	74380	2.47	78.54	84
61	3884	72038	4.10	76.06	81
60	4623	68154	4.88	71.96	77
59	3548	63531	3.75	67.08	73
58	4540	59983	4.79	63.34	70
57	4719	55443	4.98	58.54	66
56	3732	50724	3.94	53.56	62
55	5083	46992	5.37	49.62	58
54	3735	41909	3.94	44.25	53
53	4508	38174	4.76	40.31	49
52	3645	33666	3.85	35.55	45
51	3367	30021	3.56	31.70	40
50	4006	26654	4.23	28.14	37
49	2347	22648	2.48	23.91	32
48	3074	20301	3.25	21.44	28
47	3167	17227	3.34	18.19	25
46	1911	14060	2.02	14.85	22
45	1848	12149	1.95	12.83	19
44	1604	10301	1.69	10.88	16
43	1439	8697	1.52	9.18	14
42	1288	7258	1.36	7.66	11
41	1133	5970	1.20	6.30	9
40	1005	4837	1.06	5.11	8
39	887	3832	0.94	4.05	6
38	761	2945	0.80	3.11	5
37	558	2184	0.59	2.31	4
36	505	1626	0.53	1.72	3
35	363	1121	0.38	1.18	2
34	253	758	0.27	0.80	2
33	177	505	0.19	0.53	1
32	126	328	0.13	0.35	1
31	108	202	0.11	0.21	1
30	37	94	0.04	0.10	1
LESS THAN 30	57	57	0.06	0.06	1

Notes: * Students with valid scores are those who attempted at least one item on the test.
Data received from LEAs and charter schools after August 2001 are not included in this table.
Prepared by the NCDPI Division of Accountability Services/Testing Section.

**Table 35. 2000-01 End-of-Course Distribution of Scale Scores
Geometry**

<u>NUMBER OF STUDENTS WITH VALID SCORES*</u>	65,480	<u>HIGH SCORE</u>	93
		<u>LOW SCORE</u>	32
<u>MEAN</u>	59.8	<u>2001 STATE PERCENTILES</u>	<u>SCALE SCORE</u>
<u>STANDARD DEVIATION</u>	8.9	90	71.23
		75	65.78
		50 (MEDIAN)	59.65
<u>VARIANCE</u>	78.4	25	53.51
		10	48.23

FREQUENCY DISTRIBUTION

<u>SCALE SCORE</u>	<u>FREQUENCY</u>	<u>CUMULATIVE FREQUENCY</u>	<u>PERCENT</u>	<u>CUMULATIVE PERCENT</u>	<u>2001 STATE PERCENTILE</u>
93	2	65480	0.00	100.00	99
92	4	65478	0.01	100.00	99
91	7	65474	0.01	99.99	99
90	4	65467	0.01	99.98	99
89	38	65463	0.06	99.97	99
88	15	65425	0.02	99.92	99
87	35	65410	0.05	99.89	99
86	62	65375	0.09	99.84	99
85	97	65313	0.15	99.74	99
84	52	65216	0.08	99.60	99
83	149	65164	0.23	99.52	99
82	140	65015	0.21	99.29	99
81	170	64875	0.26	99.08	99
80	228	64705	0.35	98.82	99
79	362	64477	0.55	98.47	98
78	460	64115	0.70	97.92	98
77	509	63655	0.78	97.21	97
76	538	63146	0.82	96.44	96
75	627	62608	0.96	95.61	95
74	721	61981	1.10	94.66	94
73	1032	61260	1.58	93.56	93
72	873	60228	1.33	91.98	91
71	1594	59355	2.43	90.65	89
70	1493	57761	2.28	88.21	87
69	1586	56268	2.42	85.93	85
68	2159	54682	3.30	83.51	82
67	1354	52523	2.07	80.21	79
66	2844	51169	4.34	78.14	76
65	2056	48325	3.14	73.80	72
64	2755	46269	4.21	70.66	69
63	2867	43514	4.38	66.45	64
62	2346	40647	3.58	62.08	60
61	3588	38301	5.48	58.49	56
60	2326	34713	3.55	53.01	51
59	3013	32387	4.60	49.46	47
58	2918	29374	4.46	44.86	43
57	2846	26456	4.35	40.40	38
56	2288	23610	3.49	36.06	34
55	2766	21322	4.22	32.56	30
54	2212	18556	3.38	28.34	27
53	2641	16344	4.03	24.96	23
52	2081	13703	3.18	20.93	19
51	1445	11622	2.21	17.75	17
50	1446	10177	2.21	15.54	14
49	1744	8731	2.66	13.33	12
48	1600	6987	2.44	10.67	9
47	1053	5387	1.61	8.23	7
46	1257	4334	1.92	6.62	6
45	762	3077	1.16	4.70	4
44	616	2315	0.94	3.54	3
43	527	1699	0.80	2.59	2
42	403	1172	0.62	1.79	1
41	319	769	0.49	1.17	1
40	184	450	0.28	0.69	1
39	126	266	0.19	0.41	1
38	103	140	0.16	0.21	1
LESS THAN 38	37	37	0.06	0.06	1

Notes: * Students with valid scores are those who attempted at least one item on the test.
Data received from LEAs and charter schools after August 2001 are not included in this table.
Prepared by the NCDPI Division of Accountability Services/Testing Section.

**Table 36. 2000-01 End-of-Course Distribution of Scale Scores
Physical Science**

<u>NUMBER OF STUDENTS WITH VALID SCORES*</u>	39,182	<u>HIGH SCORE</u>	88
		<u>LOW SCORE</u>	26
<u>MEAN</u>	55.5	<u>2001 STATE PERCENTILES</u>	<u>SCALE SCORE</u>
<u>STANDARD DEVIATION</u>	8.7	90	66.57
		75	61.75
		50 (<u>MEDIAN</u>)	55.83
<u>VARIANCE</u>	76.2	25	49.57
		32	43.67

FREQUENCY DISTRIBUTION

<u>SCALE SCORE</u>	<u>FREQUENCY</u>	<u>CUMULATIVE FREQUENCY</u>	<u>PERCENT</u>	<u>CUMULATIVE PERCENT</u>	<u>1997 STATE PERCENTILE</u>
88	1	39182	0.00	100.00	99
85	2	39181	0.01	100.00	99
84	4	39179	0.01	99.99	99
83	6	39175	0.02	99.98	99
82	14	39169	0.04	99.97	99
80	31	39155	0.08	99.93	99
79	41	39124	0.10	99.85	99
78	37	39083	0.09	99.75	99
77	80	39046	0.20	99.65	99
76	109	38966	0.28	99.45	99
75	123	38857	0.31	99.17	99
74	149	38734	0.38	98.86	99
73	170	38585	0.43	98.48	99
72	307	38415	0.78	98.04	98
71	480	38108	1.23	97.26	97
70	448	37628	1.14	96.03	96
69	435	37180	1.11	94.89	95
68	986	36745	2.52	93.78	94
67	532	35759	1.36	91.26	92
66	1041	35227	2.66	89.91	90
65	1150	34186	2.94	87.25	88
64	1008	33036	2.57	84.31	86
63	1358	32028	3.47	81.74	83
62	1706	30670	4.35	78.28	80
61	1300	28964	3.32	73.92	77
60	1637	27664	4.18	70.60	73
59	1686	26027	4.30	66.43	70
58	1814	24341	4.63	62.12	66
57	1751	22527	4.47	57.49	61
56	1765	20776	4.50	53.02	57
55	1757	19011	4.48	48.52	54
54	1553	17254	3.96	44.04	49
53	1782	15701	4.55	40.07	46
52	1030	13919	2.63	35.52	42
51	2115	12889	5.40	32.90	38
50	1049	10774	2.68	27.50	35
49	1049	9725	2.68	24.82	31
48	1582	8676	4.04	22.14	28
47	869	7094	2.22	18.11	25
46	869	6225	2.22	15.89	22
45	830	5356	2.12	13.67	20
44	735	4526	1.88	11.55	17
43	660	3791	1.68	9.68	15
42	633	3131	1.62	7.99	13
41	501	2498	1.28	6.38	11
40	590	1997	1.51	5.10	9
39	389	1407	0.99	3.59	7
38	273	1018	0.70	2.60	5
37	213	745	0.54	1.90	4
36	270	532	0.69	1.36	3
35	87	262	0.22	0.67	2
34	77	175	0.20	0.45	1
33	44	98	0.11	0.25	1
32	22	54	0.06	0.14	1
LESS THAN 32	32	32	0.08	0.08	1

Notes: * Students with valid scores are those who attempted at least one item on the test.
Data received from LEAs and charter schools after August 2001 are not included in this table.
Prepared by the NCDPI Division of Accountability Services/Testing Section.

**Table 37. 2000-01 End-of-Course Distribution of Scale Scores
Physics**

<u>NUMBER OF STUDENTS WITH VALID SCORES*</u>	10,948	<u>HIGH SCORE</u>	85
		<u>LOW SCORE</u>	30
<u>MEAN</u>	57.0	<u>2001 STATE PERCENTILES</u>	<u>SCALE SCORE</u>
<u>STANDARD DEVIATION</u>	8.5	90	67.93
		75	62.65
		50 (MEDIAN)	57.04
<u>VARIANCE</u>	71.6	25	51.34
		10	46.03

FREQUENCY DISTRIBUTION

<u>SCALE SCORE</u>	<u>FREQUENCY</u>	<u>CUMULATIVE FREQUENCY</u>	<u>PERCENT</u>	<u>CUMULATIVE PERCENT</u>	<u>1997 STATE PERCENTILE</u>
85	2	10948	0.02	100.00	99
84	4	10946	0.04	99.98	99
82	10	10942	0.09	99.95	99
81	16	10932	0.15	99.85	99
80	3	10916	0.03	99.71	99
79	25	10913	0.23	99.68	99
78	35	10888	0.32	99.45	99
77	65	10853	0.59	99.13	99
76	12	10788	0.11	98.54	99
75	38	10776	0.35	98.43	98
74	90	10738	0.82	98.08	98
73	74	10648	0.68	97.26	97
72	93	10574	0.85	96.58	96
71	115	10481	1.05	95.73	95
70	132	10366	1.21	94.68	94
69	164	10234	1.50	93.48	93
68	378	10070	3.45	91.98	91
67	191	9692	1.74	88.53	89
66	228	9501	2.08	86.78	87
65	302	9273	2.76	84.70	84
64	440	8971	4.02	81.94	82
63	376	8531	3.43	77.92	78
62	518	8155	4.73	74.49	75
61	425	7637	3.88	69.76	71
60	294	7212	2.69	65.88	68
59	682	6918	6.23	63.19	63
58	471	6236	4.30	56.96	59
57	626	5765	5.72	52.66	54
56	477	5139	4.36	46.94	50
55	522	4662	4.77	42.58	46
54	497	4140	4.54	37.82	42
53	427	3643	3.90	33.28	37
52	408	3216	3.73	29.38	33
51	434	2808	3.96	25.65	30
50	329	2374	3.01	21.68	27
49	281	2045	2.57	18.68	23
48	238	1764	2.17	16.11	20
47	341	1526	3.11	13.94	17
46	193	1185	1.76	10.82	14
45	191	992	1.74	9.06	12
44	117	801	1.07	7.32	10
43	143	684	1.31	6.25	8
42	139	541	1.27	4.94	7
41	105	402	0.96	3.67	5
40	74	297	0.68	2.71	4
39	73	223	0.67	2.04	3
38	42	150	0.38	1.37	2
37	41	108	0.37	0.99	2
36	27	67	0.25	0.61	1
35	18	40	0.16	0.37	1
LESS THAN 35	22	22	0.20	0.20	1

Notes: * Students with valid scores are those who attempted at least one item on the test.
Data received from LEAs and charter schools after August 2001 are not included in this table.
Prepared by the NCDPI Division of Accountability Services/Testing Section.

**Table 38. 2000-01 End-of-Course Distribution of Scale Scores
U.S. History**

<u>NUMBER OF STUDENTS WITH VALID SCORES*</u>	73,742	<u>HIGH SCORE</u>	87
		<u>LOW SCORE</u>	25
<u>MEAN</u>	56.6	<u>2001 STATE PERCENTILES</u>	<u>SCALE SCORE</u>
<u>STANDARD DEVIATION</u>	8.4	90	67.31
		75	62.28
		50 (<u>MEDIAN</u>)	56.61
<u>VARIANCE</u>	70.0	25	50.80
		10	45.72

FREQUENCY DISTRIBUTION

<u>SCALE SCORE</u>	<u>FREQUENCY</u>	<u>CUMULATIVE FREQUENCY</u>	<u>PERCENT</u>	<u>CUMULATIVE PERCENT</u>	<u>1995 STATE PERCENTILE</u>
87	2	73742	0.00	100.00	99
86	2	73740	0.00	100.00	99
85	4	73738	0.01	99.99	99
84	8	73734	0.01	99.99	99
83	12	73726	0.02	99.98	99
82	32	73714	0.04	99.96	99
81	50	73682	0.07	99.92	99
80	82	73632	0.11	99.85	99
79	92	73550	0.12	99.74	99
78	104	73458	0.14	99.61	99
77	135	73354	0.18	99.47	99
76	248	73219	0.34	99.29	99
75	224	72971	0.30	98.95	99
74	490	72747	0.66	98.65	99
73	425	72257	0.58	97.99	98
72	704	71832	0.95	97.41	98
71	769	71128	1.04	96.46	97
70	981	70359	1.33	95.41	96
69	1126	69378	1.53	94.08	94
68	1596	68252	2.16	92.56	92
67	1525	66656	2.07	90.39	90
66	1904	65131	2.58	88.32	88
65	2193	63227	2.97	85.74	85
64	2411	61034	3.27	82.77	82
63	2600	58623	3.53	79.50	78
62	3294	56023	4.47	75.97	74
61	3295	52729	4.47	71.50	70
60	3082	49434	4.18	67.04	66
59	3120	46352	4.23	62.86	61
58	3339	43232	4.53	58.63	57
57	3392	39893	4.60	54.10	52
56	3888	36501	5.27	49.50	48
55	3080	32613	4.18	44.23	44
54	3472	29533	4.71	40.05	39
53	3259	26061	4.42	35.34	35
52	2449	22802	3.32	30.92	30
51	2721	20353	3.69	27.60	27
50	2774	17632	3.76	23.91	23
49	2214	14858	3.00	20.15	20
48	2004	12644	2.72	17.15	17
47	2092	10640	2.84	14.43	15
46	1507	8548	2.04	11.59	12
45	1016	7041	1.38	9.55	10
44	1294	6025	1.75	8.17	8
43	1256	4731	1.70	6.42	6
42	685	3475	0.93	4.71	5
41	580	2790	0.79	3.78	4
40	455	2210	0.62	3.00	3
39	500	1755	0.68	2.38	2
38	487	1255	0.66	1.70	1
37	282	768	0.38	1.04	1
36	147	486	0.20	0.66	1
35	146	339	0.20	0.46	1
34	100	193	0.14	0.26	1
LESS THAN 34	93	93	0.13	0.13	1

Notes: * Students with valid scores are those who attempted at least one item on the test. Data received from LEAs and charter schools after August 2001 are not included in this table. Prepared by the NCDPI Division of Accountability Services/Testing Section.

**Table 39. 2000-01 End-of-Course Multiple-Choice Test Results
Algebra I -- Mean Scale Score by LEA (Maximum=87)**

State	Mean Score	2001 LEA Performance
	76.5	Magellan**
	75.9	Lake Norman**
	73.9	Exploris**
	69.9	Quest Academy**
	69.5	Francine Delany**
	67.1	Downtown Middle**
	66.9	Watauga
	66.7	Mount Airy City
	66.5	Arapahoe**, Buncombe
	66.1	Burke, Chapel Hill-Carrboro City
	65.9	Transylvania
	65.7	Ashe
	65.5	Clay
	65.3	Madison
	65.1	Catawba, Henderson, Wake
	64.9	Orange Co. Charter**
	64.5	Johnston, Orange, Surry, Thomas Jefferson**, Wilkes
	64.3	Cabarrus, Perquimans, Summit Charter**
	63.9	Alexander, Haywood, Newton Conover City, Pitt, Rutherford, Shelby City, Stanly
	63.7	Gates, Moore, Scotland
	63.5	Chatham Charter**, Union
	63.3	Carteret, Dare
	63.1	Pender, Polk
	62.9	Cherokee, Edenton/Chowan, Elkin City, McDowell, Randolph, Yancey
	62.7	Lee
	62.5	Clinton City, Kannapolis City, Kestrel Heights**, Macon, New Hanover, Raleigh Charter HS**, Rowan-Salisbury
	62.1	Asheboro City, Chatham, Cleveland, Currituck, Gaston, Greene, Hickory City, Jackson, Pamlico, Wilson, Winston-Salem/Forsyth, Yadkin
	61.9	American Ren. Middle**, Craven, Kings Mountain City, Lincoln, Swain
	61.5	Avery, Beaufort, Brevard Academy**
	61.3	Alamance-Burlington, Davidson, Graham, Iredell-Statesville, Sampson
2001 State	61.1	Lenoir, Rocky Mt Charter Public**, Thomasville City
	60.9	Davie, Harnett, Person, Stokes
	60.7	Granville, Mooresville City, Tyrrell
	60.5	Alleghany, Cape Lookout Marine**, Mitchell, Onslow, Sterling Montessori**
	60.3	Caldwell, Duplin
	60.1	Asheville City, Brunswick, Rockingham
	59.9	Camden, Hyde, Nash-Rocky Mount, Richmond, Wayne
2000 State	59.7	Evergreen Community**
	59.5	Franklin
	59.1	Columbus, Durham, Guilford, Martin
	58.9	Bladen, River Mill Charter**, Woods Charter**
	58.7	Edgecombe, Roanoke Rapids City
1999 State	58.1	Anson, Cumberland, Montgomery
	57.9	Vance, Whiteville City
	57.5	Northampton
1998 State	57.1	
	56.9	Charlotte/Mecklenburg, Robeson
	56.7	Hoke
	56.5	Bertie
	55.9	Elizabeth City/Pasquotank
1997 State	55.7	
1994, 1996 State	55.1	Imani Institute**, Washington
1995 State	54.9	Caswell, Warren
	54.5	Halifax
	54.3	Jones, Lexington City
	53.9	East Wake Academy**
	52.9	Laurinburg Homework**
	52.7	Laurinburg**, New Century**
	52.5	Weldon City
	51.1	Crossnore Academy**
	50.9	Hertford
	50.5	Lakeside School**
	49.5	J.H. Baker Jr High**
	48.5	Kennedy Charter**
	47.5	Carter Community**, Omuteko Gwamaziima**
	46.9	Lift Academy**
	45.5	Wayne Academy**
	*	Grandfather Academy**, Provisions Academy**, Village Charter**

Notes: ¹Scale scores are rounded up to the nearest two-tenths of a point.

*Data are not reported where the number tested is fewer than five.

**Denotes a charter school. For reporting purposes the charter school name has been abbreviated; the complete charter school name can be found in the Appendix.

Data received from LEAs and charter schools after August 2001 are not included in this table.

Prepared by the NCDPI Division of Accountability Services/Testing Section.

**Table 40. 2000-01 End-of-Course Multiple-Choice Test Results
Algebra II -- Mean Scale Score by LEA (Maximum=92)**

State	Mean Score†	2001 LEA Performance
2001 State	73.1	Raleigh Charter HS**
	...	
	71.1	Chapel Hill-Carrboro City
	70.9	Transylvania
	...	
	70.1	Elkin City
	...	
	69.1	Buncombe
	...	
	68.7	Newton Conover City, Watauga
	68.5	Haywood
	68.3	Shelby City
	68.1	Edenton/Chowan
	67.9	Burke
	67.7	Stanly, Thomas Jefferson**
	67.5	Granville, Orange
	67.3	Pamlico
	67.1	Iredell-Statesville, Wake, Yancey
	66.9	Clay, Currituck, Hickory City, Johnston
	...	
	66.5	Henderson, Moore, Mount Airy City, Thomasville City
	66.3	McDowell, Wilkes
	66.1	Cabarrus, Graham, Madison, Pitt, Swain
	65.9	Dare, Perquimans, Union
	...	
	65.5	Asheville City, Catawba, Craven, Wilson
	...	
	64.9	Carteret, Davie, Gates, Lenoir, Lincoln, Onslow
	64.7	Macon, Winston-Salem/Forsyth
	64.5	Camden, Chatham, Cherokee, New Hanover, Rowan-Salisbury, Surry, Yadkin
	64.3	Ashe, Durham
	64.1	Alexander, Caldwell, Davidson, Lee, Rockingham, Scotland
	63.9	Alleghany, Cape Lookout Marine**, Pender
	63.7	Kings Mountain City
	63.5	Anson, Guilford, Hyde, Rutherford
	63.3	Cleveland, Wayne
	63.1	Harnett
	62.9	Alamance-Burlington, Person, Polk, Randolph, Roanoke Rapids City
	...	
	62.5	Greene
	62.3	Sampson
	62.1	Asheboro City, Charlotte/Mecklenburg, Duplin, Franklin, Gaston, Richmond
	...	
	61.5	Beaufort, Martin
	61.3	Stokes, Whiteville City
	61.1	Mooresville City, River Mill Charter**
	60.9	Brunswick, Jackson
60.7	Clinton City	
...		
1999 State	60.1	Avery
	59.9	Caswell, Elizabeth City/Pasquotank, Mitchell
	59.7	Montgomery, Warren
	59.5	Nash-Rocky Mount
	59.3	Vance
	59.1	Bladen
	58.9	Cumberland, Kannapolis City
	...	
	58.5	Edgecombe, Robeson
	...	
	57.9	Columbus, Hoke
	...	
	57.1	Lexington City
	...	
	56.5	Washington
	...	
	55.5	Bertie, Tyrrell
...		
55.1	Weldon City	
54.9	Halifax, Jones, Northampton	
...		
54.1	Laurinburg**	
...		
53.1	Hertford	
...		
45.5	Lift Academy**	
...		
*	Chatham Charter**, J.H. Baker Jr High**, Kennedy Charter**, Kestrel Heights**, Lakeside School**, Quest Academy**, Woods Charter**	

Notes: †Scale scores are rounded up to the nearest two-tenths of a point.

*Data are not reported where the number tested is fewer than five.

**Denotes a charter school. For reporting purposes the charter school name has been abbreviated; the complete charter school name can be found in the Appendix.

Data received from LEAs and charter schools after August 2001 are not included in this table.

Prepared by the NCDPI Division of Accountability Services/Testing Section.

**Table 41. 2000-01 End-of-Course Multiple-Choice Test Results
Biology -- Mean Scale Score by LEA (Maximum=89)**

State	Mean Score†	2001 LEA Performance
	68.9	Raleigh Charter HS**
	...	
	63.5	Thomas Jefferson**
	...	
	62.9	Chapel Hill-Carrboro City
	...	
	60.7	Elkin City
	...	
	60.1	Carteret, Hickory City, Newton Conover City
	59.9	Dare, Johnston, Macon
	59.7	Cherokee, Quest Academy**
	59.5	Jackson, Watauga
	59.3	Buncombe, Wake
	59.1	Graham, Transylvania, Wilkes
	58.9	Avery, Burke, Cabarrus, Orange
	...	
	58.5	Catawba, Haywood, Lincoln, New Hanover, Onslow
	58.3	Davie
	58.1	Clay, Craven
	57.9	Asheboro City, McDowell, Pitt, Yancey
	57.7	Chatham, Person, Thomasville City, Whiteville City
	57.5	Cleveland, Davidson, Guilford, Henderson, Mount Airy City, Stanly
	57.3	Moore, Shelby City, Surry
	57.1	Alexander, Ashe, Edenton/Chowan, Granville, Union, Yadkin
2001 State	56.9	Camden, Durham, Gaston, Kannapolis City, Kings Mountain City, Mitchell, Pender, Perquimans, Rowan-Salisbury, Swain
	56.7	Polk
	56.5	Brunswick, Charlotte/Mecklenburg, Franklin, Madison, Rutherford, Scotland
1998 State	56.3	Caldwell, Lee
1999,2000 State	56.1	Harnett, Jones, Richmond, Roanoke Rapids City
1997 State	55.9	Alleghany, Elizabeth City/Pasquotank, Iredell-Statesville, Lexington City, Mooresville City, Randolph, River Mill Charter**, Stokes, Wayne, Winston-Salem/Forsyth
	...	
1995,1996 State	55.5	Cumberland, Edgecombe, Pamlico, Rockingham
	55.3	Alamance-Burlington, Gates, Wilson
	55.1	Sampson
	54.9	Clinton City, Lenoir
	...	
	54.5	Beaufort, Bladen, Caswell, Currituck, Duplin, Kestrel Heights**, Martin
	...	
	54.1	Columbus
	53.9	Montgomery, Nash-Rocky Mount
	...	
	53.5	Vance
	53.3	Anson, Robeson
	...	
	52.5	Hoke
	52.3	Hyde, Tyrrell
	52.1	Asheville City, Northampton
	...	
	51.3	Washington
	51.1	Greene, Warren
	50.9	Bertie, New Century**
	...	
	50.5	Cape Lookout Marine**
	...	
	49.9	Laurinburg**
	...	
	49.5	Halifax
	49.3	Hertford
	...	
	47.5	J.H. Baker Jr High**
	...	
	47.1	Laurinburg Homework**
	...	
	46.3	Kennedy Charter**
	...	
	44.9	Wayne Academy**, Weldon City
	...	
	43.5	Lift Academy**
	...	
	*	Crossnore Academy**, Omuteko Gwamaziima**

Notes: †Scale scores are rounded up to the nearest two-tenths of a point.

*Data are not reported where the number tested is fewer than five.

**Denotes a charter school. For reporting purposes the charter school name has been abbreviated; the complete charter school name can be found in the Appendix.

Data received from LEAs and charter schools after August 2001 are not included in this table.

Prepared by the NCDPI Division of Accountability Services/Testing Section.

**Table 42. 2000-01 End-of-Course Multiple-Choice Test Results
Chemistry -- Mean Scale Score by LEA (Maximum=87)**

State	Mean Score†	2001 LEA Performance
	69.1	Transylvania
	65.5	Chapel Hill-Carrboro City
	64.5	Orange, Yancey
	64.1	Raleigh Charter HS**
	63.1	Cherokee
	62.9	Thomas Jefferson**
	62.5	Cabarrus, Carteret
	62.3	Thomasville City
	62.1	Wake, Watauga
	61.9	Alexander, Currituck, Dare, Davie, Hickory City, Pender, Whiteville City, Wilkes
	61.7	McDowell
	61.5	Newton Conover City
	61.1	Scotland, Union
	60.9	Alleghany
	60.7	Catawba, Shelby City
	60.5	Buncombe, Camden, Iredell-Statesville
	60.3	Durham
	60.1	Guilford, Martin
	59.9	Burke, Henderson, Lexington City, Lincoln, Mount Airy City, New Hanover, Stanly
	59.7	Winston-Salem/Forsyth
	59.5	Craven, Elkin City, Greene, Macon, Onslow, Roanoke Rapids City, Rowan-Salisbury
	59.3	Johnston, Kings Mountain City, Sampson, Stokes
	59.1	Surry, Warren, Wilson
2001 State	58.9	Moore
	58.7	Davidson, Haywood, Lee, Pitt
	58.5	Caldwell, Franklin, Jackson, Rutherford, Wayne
	58.3	Gates, Mitchell
2000 State	58.1	Clinton City, Duplin, Gaston, Granville, Randolph
1999 State	57.9	Beaufort, Harnett, Mooresville City, Nash-Rocky Mount, Richmond
	57.7	Polk
	57.5	Alamance-Burlington, Ashe, Elizabeth City/Pasquotank, Perquimans, Rockingham, Swain
	57.3	Clay, Hyde
	56.9	Asheville City, Brunswick, Cleveland, Lenoir, Pamlico
	56.7	Person
	56.5	Caswell, Charlotte/Mecklenburg, Cumberland, Graham
	56.1	Kannapolis City, Madison, Yadkin
	55.9	Avery, Bladen, Chatham, Jones
	55.7	Asheboro City
	55.5	Anson, Edenton/Chowan, Edgecombe, Washington
	54.9	Hoke
	54.5	Columbus, Montgomery
	53.9	Robeson
	53.1	Vance
	52.1	Northampton
	51.9	Tyrrell
	51.1	Laurinburg**
	50.9	Bertie, Weldon City
	50.7	Hertford
	50.5	New Century**
	49.3	Halifax
	48.7	River Mill Charter**
	47.5	Kennedy Charter**
	*	J.H. Baker Jr High**, Quest Academy**, Woods Charter**

Notes: †Scale scores are rounded up to the nearest two-tenths of a point.

*Data are not reported where the number tested is fewer than five.

**Denotes a charter school. For reporting purposes the charter school name has been abbreviated; the complete charter school name can be found in the Appendix.
Data received from LEAs and charter schools after August 2001 are not included in this table.

Prepared by the NCDPI Division of Accountability Services/Testing Section

**Table 43. 2000-01 End-of-Course Multiple-Choice Test Results
Economic, Legal, and Political Systems -- Mean Scale Score by LEA (Maximum=87)**

State	Mean Score†	2001 LEA Performance
	64.9	Raleigh Charter HS**
	62.5	Swain
	62.1	Currituck
	61.7	Woods Charter**
	60.9	Chapel Hill-Carrboro City
	60.5	Cherokee
	59.7	Hyde
	59.5	Madison, Transylvania
	59.1	Cape Lookout Marine**, Polk
	58.5	Burke, Dare, Edgecombe, Johnston, Rowan-Salisbury, Yancey
	58.3	Cleveland, Randolph
	57.9	Avery, Buncombe, Graham, Newton Conover City, Onslow
	57.7	Granville, Kings Mountain City, Wake
	57.5	Camden, Elkin City, Pitt, Stanly
	57.3	Cabarrus
	57.1	Brunswick, Iredell-Statesville
	56.9	Davidson, Gaston, Henderson, Orange, Pender, Scotland, Shelby City, Surry, Watauga, Wilke
	56.5	Beaufort, Catawba, Clay, Harnett, Union
	56.3	Chatham, Guilford
	56.1	Alleghany, Davie, Kannapolis City, Lenoir, Martin, Whiteville Cit
2001 State	55.9	Ashe, Carteret, East Wake Academy**, Haywood, New Hanover, Perquimans, Person, Rockingham, Wayne, Yadki
	55.7	Roanoke Rapids City
	55.5	Asheville City, Craven, Gates, Lincoln, Macon, McDowell, Moore, New Century*
	55.3	Greene
1999, 2000 State	55.1	
1998 State	54.9	Edenton/Chowan, Jackson, Mooresville City, Mount Airy City, Rutherford, Winston-Salem/Forsyth
	54.7	Montgomery
	54.5	Columbus, Cumberland, Lee, Mitchell, Stokes, Wilson
	54.3	Clinton City, River Mill Charter**
1997 State	54.1	Bladen, Charlotte/Mecklenburg, Durham, Franklin, Hertford, Hickory City
	53.9	Caldwell
	53.7	Lexington City, Richmond
	53.5	Alexander, Asheboro City, Elizabeth City/Pasquotank, Pamlico, Thomasville Cit
	53.1	Nash-Rocky Mount, Sampson
	52.9	Alamance-Burlington, Bertie, Caswell, Jones, Tyrrel
	52.7	Northampton
	52.1	Hoke
	51.9	Duplin
	51.5	Robeson
	50.9	Vance
	50.1	Washington
	49.9	Laurinburg**
	49.7	Warren
	49.5	Halifax
	48.9	Lakeside School**
	48.5	Weldon City
	46.9	Anson
	45.9	Carter Community**, Kennedy Charter**
	43.7	Laurinburg Homework**
	42.9	Omuteko Gwamaziima**
	42.5	Wayne Academy**
	40.9	J.H. Baker Jr High**
	*	Crossnore Academy**, Grandfather Academy**, Lift Academy**, Provisions Academy**, Quest Academy*

Notes: †Scale scores are rounded up to the nearest two-tenths of a point.

*Data are not reported where the number tested is fewer than five

**Denotes a charter school. For reporting purposes the charter school name has been abbreviated; the complete charter school name can be found in the Appendix.

Data received from LEAs and charter schools after August 2001 are not included in this table

pared by the NCDPI Division of Accountability Services/Testing Section

**Table 44. 2000-01 End-of-Course Multiple-Choice Test Results
English I -- Mean Scale Score by LEA (Maximum=90)**

State	Mean Score†	2001 LEA Performance
	66.1	Raleigh Charter HS**
	...	
	63.3	Woods Charter**
	...	
	62.3	Chapel Hill-Carrboro City
	...	
	61.1	Thomas Jefferson**
	...	
	59.7	Transylvania
	...	
	58.9	Clay
	...	
	58.5	Watauga
	58.3	Yancey
	58.1	Cherokee, Wake
	57.9	Camden, Graham, Newton Conover City
	57.7	Swain
	57.5	New Hanover
	57.3	Elkin City
	57.1	East Wake Academy**, Mitchell
	56.9	Buncombe, Dare, Johnston, Person, Shelby City
	56.7	Asheville City, Currituck, Haywood, Henderson, Union
	56.5	Asheboro City, Burke, Cabarrus, Craven, Davidson, Mount Airy City, Pender
	56.3	Carteret, Hickory City, Mooresville City
	56.1	Alleghany, Moore, Orange
	55.9	Catawba, Chatham, Durham, Guilford, McDowell, Pitt, Polk, Stanly, Winston-Salem/Forsyth
	55.7	Caldwell, Jackson, Macon, Onslow
2000, 2001 State	55.5	Ashe, Charlotte/Mecklenburg, Davie, Gaston, Pamlico, Surry, Wilkes
	55.3	Gates, Lincoln, Richmond
	55.1	Montgomery, Roanoke Rapids City, Rockingham, Rutherford, Whiteville City
	54.9	Alexander, Avery, Cape Lookout Marine**, Cleveland, Granville, Iredell-Statesville, Perquimans, Rowan-Salisbury
	54.7	Harnett
1999 State	54.5	Clinton City, Cumberland, Lee, Lenoir, Randolph, Scotland, Wayne, Yadkin
	54.3	Alamance-Burlington, Duplin
	54.1	Brunswick, Caswell, Elizabeth City/Pasquotank
	53.9	Edenton/Chowan, Kings Mountain City, Nash-Rocky Mount
1998 State	53.7	Hyde, Thomasville City
	53.5	Columbus, Edgecombe, Sampson, Stokes, Wilson
1997 State	53.3	Crossnore Academy**
1995, 1996 State	53.1	Franklin, Madison
	52.9	Beaufort, Greene, Hoke, Kannapolis City, Martin, Tyrrell
	...	
	52.5	Bladen, Jones
	52.3	Vance
	...	
	51.9	Lexington City
	...	
	51.5	Community Partners High**, Warren
	...	
	51.1	Anson, Kestrel Heights**
	50.9	Northampton, River Mill Charter**
	50.7	Washington
	...	
	50.1	Hertford, Robeson
	...	
	49.5	Bertie
	49.3	Halifax
	...	
	48.9	Lakeside School**
	48.7	New Century**, Weldon City
	...	
	47.7	Omuteko Gwamaziima**
	...	
	47.1	Kennedy Charter**
	...	
	46.7	J.H. Baker Jr High**
	46.5	Provisions Academy**
	...	
	45.5	Laurinburg Homework**
	45.3	Carter Community**
	...	
	43.9	Wayne Academy**
	...	
	43.1	Laurinburg**
	...	
	40.5	Lift Academy**
	...	
	*	Grandfather Academy**, Quest Academy**

Notes: †Scale scores are rounded up to the nearest two-tenths of a point.

*Data are not reported where the number tested is fewer than five.

**Denotes a charter school. For reporting purposes the charter school name has been abbreviated; the complete charter school name can be found in the Appendix. Data received from LEAs and charter schools after August 2001 are not included in this table

Prepared by the NCDPI Division of Accountability Services/Testing Section

**Table 45. 2000-01 End-of-Course Multiple-Choice Test Results
Geometry -- Mean Scale Score by LEA (Maximum=91)**

State	Mean Score [†]	2001 LEA Performance
	80.1	Magellan**
	...	
	74.9	Exploris**
	...	
	72.9	Lake Norman**
	...	
	68.1	Currituck
	...	
	66.9	Chapel Hill-Carrboro City
	...	
	66.5	Raleigh Charter HS**
	...	
	65.9	Transylvania
	...	
	65.1	Watauga
	64.9	Elkin City, Orange Co. Charter**
	...	
	63.9	Buncombe, Catawba, Wake, Yancey
	...	
	63.5	Cherokee, Polk
	63.3	Madison
	63.1	Haywood, Henderson
	62.9	Alleghany, Cabarrus, Newton Conover City, Orange, Shelby City
	62.7	Surry
	62.5	Clay, Dare, Quest Academy**, Wilkes
	62.3	Ashe, Burke, Roanoke Rapids City
	62.1	Alexander, Mount Airy City, Thomasville City
	61.9	Stanly
	61.7	Chatham, Graham
	61.5	Gates, Hickory City, Iredell-Statesville, Johnston, Moore, Pitt, Rutherford, Union
	61.3	Rowan-Salisbury
	61.1	Cleveland, Davidson, Pender
	60.9	Guilford, McDowell, New Hanover, Pamlico, Scotland, Stokes
	60.7	Davie, Onslow
	60.5	Harnett, Mooresville City, Perquimans
	60.3	Asheboro City
	60.1	Avery, Beaufort, Carteret, Lincoln
2001 State	59.9	Caldwell, Edenton/Chowan, Granville, Greene, Jackson, Lenoir
	59.7	Lee
	59.5	Alamance-Burlington, Craven, Macon, Winston-Salem/Forsyth
	59.3	Camden, Cape Lookout Marine**
2000 State	59.1	Asheville City, Clinton City, Durham
	58.9	Gaston, Mitchell, Person, Randolph, Tyrrell, Wilson
	58.7	Kings Mountain City
1999 State	58.5	Kannapolis City, Nash-Rocky Mount, Rockingham
	...	
	57.9	Franklin, Kestrel Heights**, Martin, Sampson, Wayne
	...	
	57.5	Brunswick, Charlotte/Mecklenburg, Elizabeth City/Pasquotank, Swain, Whiteville City
	...	
	57.1	Columbus, Duplin
	56.9	Anson, River Mill Charter**
	...	
	56.5	Edgecombe, Lexington City
	56.3	Richmond
	56.1	Cumberland, Yadkin
	55.9	Caswell
	...	
	55.5	Montgomery
	...	
	55.1	Hyde
	54.9	Bladen, Robeson, Warren
	...	
	54.5	Vance
	...	
	53.1	Hoke
	52.9	New Century**
	52.7	Washington
	52.5	Jones
	...	
	52.1	Northampton
	...	
	51.7	Bertie
	51.5	Hertford
	...	
	50.5	Halifax
	...	
	50.1	Laurinburg Homework**
	...	
	48.9	Kennedy Charter**
	...	
	48.1	Weldon City
	...	
	47.7	Laurinburg**
	...	
	45.1	Lift Academy**
	...	
	*	East Wake Academy**, J.H. Baker Jr High**, Omuteko Gwamaziima**, Thomas Jefferson**, Village Charter**

Notes: [†]Scale scores are rounded up to the nearest two-tenths of a point.

*Data are not reported where the number tested is fewer than five.

**Denotes a charter school. For reporting purposes the charter school name has been abbreviated; the complete charter school name can be found in the Appendix.

Data received from LEAs and charter schools after August 2001 are not included in this table.

Prepared by the NCDPI Division of Accountability Services.

**Table 46. 2000-01 End-of-Course Multiple-Choice Test Results
Physical Science -- Mean Scale Score by LEA (Maximum=89)**

State	Mean Score†	2001 LEA Performance
	62.9	Avery
	...	
	62.5	Woods Charter**
	62.3	Alleghany
	...	
	61.1	Johnston
	60.9	Transylvania
	60.7	Cherokee
	60.5	Chapel Hill-Carrboro City, Cleveland
	60.3	Sampson
	...	
	59.9	Wilkes
	59.7	Carteret, Wayne
	59.5	Buncombe, Dare, Pender
	...	
	59.1	Currituck
	58.9	Ashe, Burke
	58.7	Gates
	58.5	Elkin City, Greene, Union
	58.3	Pitt
	58.1	Stanly
	57.9	Craven, Franklin, Iredell-Statesville, Surry
	57.7	Catawba
	...	
	57.3	Swain
	57.1	Onslow
	56.9	Graham, Macon, Perquimans
	...	
	56.5	Lincoln, Whiteville City
	56.3	Gaston, Stokes, Wake
	56.1	Cabarrus, Martin, Pamlico, Person, Randolph, Shelby City, Yadkin
	55.9	Davie, Granville, Guilford, Jones, Kannapolis City, Rockingham, Rutherford, Thomasville City
	...	
2001 State	55.5	Hyde, Rowan-Salisbury, Scotland
	55.3	Brunswick
	55.1	Jackson
2000 State	54.9	Alexander, Caldwell, Chatham, Davidson, Mitchell, Newton Conover City, Polk, Watauga
	54.7	Durham, Haywood
1999 State	54.5	Columbus, Kings Mountain City
	54.3	Wilson
	54.1	Bladen, Duplin, Madison, Mount Airy City, New Hanover
	...	
	53.7	Lenoir, Orange
	53.5	East Wake Academy**, Mooresville City
	53.3	Winston-Salem/Forsyth
	53.1	Alamance-Burlington, Asheville City, Beaufort, Harnett, Montgomery
	52.9	Cumberland
	...	
	52.5	Caswell, Vance
	52.3	Richmond
	52.1	Charlotte/Mecklenburg
	51.9	Cape Lookout Marine**, River Mill Charter**
	51.7	Anson, Lee, Moore
	51.5	Nash-Rocky Mount
	...	
	51.1	Asheboro City, Henderson
	50.9	Bertie, Elizabeth City/Pasquotank, Halifax
	...	
	50.5	Washington
	...	
	50.1	Lakeside School**, Robeson
	49.9	Edenton/Chowan, Lexington City, Warren
	...	
	49.5	Hickory City, McDowell
	49.3	Northampton
	49.1	Hoke
	...	
	48.3	Roanoke Rapids City
	...	
	47.5	Weldon City
	...	
	47.1	Crossnore Academy**
	...	
	46.1	Hertford, Laurinburg**
	45.9	Omuteko Gwamaziima**
	...	
	45.5	J.H. Baker Jr High**
	45.3	Provisions Academy**
	...	
	44.7	Kennedy Charter**
	...	
	44.1	Laurinburg Homework**
	...	
	43.3	Wayne Academy**
	...	
	*	Grandfather Academy**, Lift Academy**, Quest Academy**

Notes: †Scale scores are rounded up to the nearest two-tenths of a point.

*Data are not reported where the number tested is fewer than five.

**Denotes a charter school. For reporting purposes the charter school name has been abbreviated; the complete charter school name can be found in the Appendix. Data received from LEAs and charter schools after August 2001 are not included in this table.

Prepared by the NCDPI Division of Accountability Services/Testing Section.233

**Table 47. 2000-01 End-of-Course Multiple-Choice Test Results
Physics -- Mean Scale Score by LEA (Maximum=87)**

State	Mean Score [†]	2001 LEA Performance
2000, 2001 State 1999 State	64.1	Pitt, Transylvania
	63.5	Clay, Mitchell
	62.9	Chapel Hill-Carrboro City, Raleigh Charter HS**
	60.9	Harnett, Mooresville City
	60.5	Macon, Randolph, Wilkes
	60.3	Carteret
	60.1	Alleghany
	59.9	Clinton City, Sampson, Thomasville City, Winston-Salem/Forsyth
	59.5	Asheville City
	59.3	Newton Conover City, Swain
	59.1	Cabarrus, Currituck, Union, Wake
	58.9	Alexander, Ashe, Cleveland, Moore, New Hanover, Yancey
	58.5	Onslow, Stokes
	58.1	Rowan-Salisbury
	57.9	Cherokee, Craven, Elkin City, Guilford, Henderson, Lee, Pender, Scotland
	57.5	Alamance-Burlington, Avery, Catawba, Davie, Hickory City, Stanly
	57.3	Burke
	57.1	Buncombe, Orange, Richmond
	56.9	Lincoln
	56.7	Durham, Madison
	56.5	Iredell-Statesville, Johnston
	56.3	Charlotte/Mecklenburg
	56.1	Kings Mountain City, Watauga, Wayne, Wilson
	55.9	Dare, Jackson, Mount Airy City
	55.7	Kannapolis City, Whiteville City, Yadkin
	55.5	Anson, Asheboro City, Davidson, Duplin, Edgecombe, Nash-Rocky Mount, Pamlico
	55.3	Gaston, Surry
	55.1	Franklin, Shelby City
	54.9	Rutherford
	54.5	Haywood
	54.3	Edenton/Chowan, Greene
	54.1	Bladen, Brunswick, Chatham
	53.9	Beaufort, Cumberland, Jones, Rockingham
	53.5	Camden, Elizabeth City/Pasquotank, Warren
	53.1	Roanoke Rapids City
	52.7	Caldwell, Columbus
	51.9	Granville, Lenoir, Vance
	51.7	Martin
	51.5	Bertie, Polk
	51.1	McDowell, Montgomery
	50.9	Robeson
	50.5	Caswell
	50.1	Hoke
	49.5	Person, Washington
	48.5	Weldon City
	47.7	Gates
	47.5	Northampton
46.9	Halifax	
38.1	Carter Community**	
*	Perquimans, Quest Academy**	

Notes: [†]Scale scores are rounded up to the nearest two-tenths of a point.

*Data are not reported where the number tested is fewer than five.

**Denotes a charter school. For reporting purposes the charter school name has been abbreviated; the complete charter school name can be found in the Appendix.

Data received from LEAs and charter schools after August 2001 are not included in this table.

Prepared by the NCDPI Division of Accountability Services/Testing Section.

253

**Table 48. 2000-01 End-of-Course Multiple-Choice Test Results
U.S. History -- Mean Scale Score by LEA (Maximum=86)**

State	Mean Score†	2001 LEA Performance
	65.5	Woods Charter**
	...	
	63.9	Raleigh Charter HS**
	63.7	Madison
	...	
	61.9	Chapel Hill-Carrboro City
	...	
	61.5	Swain
	...	
	60.3	Elkin City
	60.1	Orange
	...	
	59.5	Cleveland, Wake
	...	
	59.1	Dare
	58.9	Newton Conover City, Pender
	58.7	Gaston, Yadkin
	58.5	Asheville City, Hickory City, Mooresville City
	58.3	Davie
	58.1	Asheboro City, Buncombe, Graham, Jackson
	57.9	Burke, Lincoln, Transylvania, Watauga, Wilson
	57.7	Scotland, Stanly, Union
	57.5	Ashe, Clay, Currituck, Guilford, Johnston, New Hanover, Pitt, Thomasville City
	57.3	Henderson, Pamlico, Roanoke Rapids City
	57.1	Cabarrus, Carteret, Winston-Salem/Forsyth, Yancey
	56.9	Charlotte/Mecklenburg, Chatham, Clinton City, Harnett, Macon, McDowell, Shelby City, Wilkes
1999, 2001 State	56.7	Avery, Camden, Davidson
1996, 1998 State	56.5	Alleghany, Beaufort, Cherokee, Craven, Durham, Edenton/Chowan, Granville, Kings Mountain City, Polk, Whiteville City
1995, 1997 State	56.3	Kannapolis City
	56.1	Gates, Moore, Perquimans, Randolph
2000 State	55.9	Catawba, Columbus, Haywood, Lee, Mitchell, Onslow, Rockingham, Surry
	55.7	Hyde, Iredell-Statesville, Rutherford
	55.5	Cumberland, River Mill Charter**, Wayne
	...	
	54.9	Alamance-Burlington, Duplin, Greene, Lenoir, Nash-Rocky Mount, Rowan-Salisbury, Sampson
	...	
	54.5	Alexander, Bladen, Caldwell, Caswell, Edgecombe, Martin, Mount Airy City, Vance
	54.3	Montgomery, Richmond
	54.1	Franklin, Lexington City
	53.9	Person, Stokes
	53.7	Robeson
	53.5	Brunswick, Northampton, Warren
	53.3	Elizabeth City/Pasquotank
	...	
	52.7	Washington
	52.5	Cape Lookout Marine**, Laurinburg**
	...	
	52.1	Jones
	...	
	51.5	Hoke
	...	
	51.1	Anson
	...	
	50.5	Tyrrell
	...	
	49.5	Crossnore Academy**, Hertford
	...	
	48.9	Bertie, New Century**
	...	
	48.5	Halifax
	...	
	47.1	J.H. Baker Jr High**
	46.9	Weldon City
	...	
	45.1	Kennedy Charter**
	...	
	43.1	Wayne Academy**
	...	
	42.1	Lift Academy**
	...	
	*	Grandfather Academy**, Lakeside School**, Quest Academy**

Notes: †Scale scores are rounded up to the nearest two-tenths of a point.

*Data are not reported where the number tested is fewer than five.

**Denotes a charter school. For reporting purposes the charter school name has been abbreviated; the complete charter school name can be found in the Appendix.

Data received from LEAs and charter schools after August 2001 are not included in this table.

Prepared by the NCDPI Division of Accountability Services/Testing Section

Appendix

North Carolina Charter Schools, 2000-01

Alpha Academy
American Renaissance Charter School
American Renaissance Middle School
Arapahoe Charter School
Bethany Community Middle School
Bethel Hill Charter School
Brevard Academy
Bridges Charter School
Cape Fear Center for Inquiry
Cape Lookout Marine Science High School
Carter Community School
Carter G. Woodson School of Challenge
Charter Day School
Chatham Charter School
Children's Village Academy
CIS Academy
Community Charter School
Community Partners High
Crossnore Academy
Developmental Day School
Dillard Academy
Downtown Middle School
East Wake Academy
East Winston Primary School
Engelmann School of the Arts and Sciences
Evergreen Community Charter School
Exploris Middle School
Forsyth Academies
Francine Delany New School for Children
Franklin Academy
Grandfather Academy
Greensboro Academy
Haliwa-Saponi Tribal
Harnett Early Childhood Academy
Healthy Start Academy Charter Elementary School
Highland Charter Public School
Imani Institute Charter School
John H. Baker, Jr., High School
Kennedy School
Kestrel Heights School
Lake Norman Charter School
Lakeside School
Laurinburg Charter School
Laurinburg Homework Center Charter School
LIFT Academy
Lincoln Charter
Magellan Charter School
MAST School
Maureen Joy Charter School
Metrolina Regional Scholars' Academy
Millennium Charter Academy
New Century School
Northeast Raleigh Charter Academy
Oma's Inc. Charter School
Omuteko Gwamaziima
Orange County Charter School
Phoenix Academy
Piedmont Community School
PreEminent Charter School
Provisions Academy
Quality Education Academy
Quest Academy
Raleigh Charter High School
Research Triangle Charter Academy
River Mill Academy
Rocky Mount Charter Public School
Rowan Academy
Sallie B. Howard School
Sandhills Theatre Arts Renaissance School (STARS)
SPARC Academy
Stanly County Community Outreach Charter School
Sterling Montessori Academy
Success Academy
Success Institute
Sugar Creek Charter School
Summit Charter School
The Learning Center
The Mountain Community School
The Woods Charter School
Thomas Jefferson Classical Academy
Tiller School
Turning Point Academy
Union Academy
Vance Charter School
Village Charter School
Washington Montessori - A Public Charter School
Wayne County Technical Academy



*U.S. Department of Education
Office of Educational Research and Improvement (OERI)
National Library of Education (NLE)
Educational Resources Information Center (ERIC)*



NOTICE

Reproduction Basis

- This document is covered by a signed "Reproduction Release (Blanket)" form (on file within the ERIC system), encompassing all or classes of documents from its source organization and, therefore, does not require a "Specific Document" Release form.
- This document is Federally-funded, or carries its own permission to reproduce, or is otherwise in the public domain and, therefore, may be reproduced by ERIC without a signed Reproduction Release form (either "Specific Document" or "Blanket").