

## DOCUMENT RESUME

ED 480 723

CE 085 466

TITLE The New Technicians Study: Opportunities for Entry-Level Workers in Information Technology Occupations. Working Paper.

PUB DATE 2003-05-26

NOTE 102p.; Produced by California State Department of Employment Development, Labor Market Information Division.

AVAILABLE FROM For full text: [http://www.calmis.ca.gov/specialreports/ New-IT-TechniciansReport.pdf](http://www.calmis.ca.gov/specialreports/New-IT-TechniciansReport.pdf).

PUB TYPE Reports - Research (143)

EDRS PRICE EDRS Price MF01/PC05 Plus Postage.

DESCRIPTORS Adult Education; Career Education; Community Colleges; Computer Assisted Design; Computer Graphics; Computer Networks; Computer Software; Computers; Employment Level; \*Employment Opportunities; \*Entry Workers; Higher Education; \*Information Technology; Labor Needs; \*Occupational Information; Postsecondary Education; Screen Design (Computers); Secondary Education; \*Technical Occupations; World Wide Web

IDENTIFIERS \*Computer Occupations; Web Site Design

## ABSTRACT

The purpose of this study was to develop a body of labor market information to support the development of regional information technology instructional programs by a consortium of California Community Colleges located in the San Francisco Bay Region. This collection of summaries of six occupations begins with a guide that explains the components of each summary. Included are a job description; job titles; career ladder; hours worked; compensation (wages, benefits); employer requirements (education and vocational training, experience); supply and demand; growth; openings filled; location of jobs; and estimates of employment in each industry presented in the job location section. These occupations are included in the guide: computer-aided design technicians; computer and software support technicians; computer network technicians; computer support specialists; graphic designers; and Internet web site designers and developers (webmasters). Appendixes include the questionnaire; alternate job titles; and industries represented. (YLB)



Labor Market Information Division

"Your Information Source"

Working Paper

The New Technicians Study

Opportunities for Entry-Level Workers in Information Technology Occupations

May 26, 2003

For more information, contact the California Cooperative Occupational Information System at:

Employment Development Department
Labor Market Information Division
7000 Franklin Blvd. Ste. 1100
Sacramento, CA 95823

Phone: (916) 262-2353

www.calmis.ca.gov

U.S. DEPARTMENT OF EDUCATION
Office of Educational Research and Improvement
EDUCATIONAL RESOURCES INFORMATION CENTER (ERIC)

- This document has been reproduced as received from the person or organization originating it.
Minor changes have been made to improve reproduction quality.

- Points of view or opinions stated in this document do not necessarily represent official OERI position or policy.

PERMISSION TO REPRODUCE AND DISSEMINATE THIS MATERIAL HAS BEEN GRANTED BY

J. Koller

TO THE EDUCATIONAL RESOURCES INFORMATION CENTER (ERIC)

# TABLE OF CONTENTS

Executive Summary	i
Introduction	1
Guide to Occupational Summaries	11
Computer Aided Design/Drafter (CAD) Technicians	15
Computer and Software Support Technicians	24
Computer Network Technicians	33
Computer Support Specialists	42
Graphic Designers	51
Webmasters	60
Appendix A, Questionnaire Used	69
Appendix B, Alternate Job Titles	73
Appendix C, Industries Represented	85

# Executive Summary

## Background

During the period immediately preceding the "Dot Com Bust" of 2001, which reversed the fortunes and prosperity of many information technology (IT) companies, workers, and investors, there was an abundance of well-paying, entry-level IT jobs in the San Francisco Bay Area. Through the late 1990s, firms were expanding to capture new markets and creating new positions in the process. Jobs and job duties were rapidly transforming in the struggle to keep up with dynamic changes in technology.

Employers competed vigorously for workers to fill their vacant IT positions by bidding wages higher and offering premium benefit packages as well as other attractive incentives to lure qualified applicants. Between 1999 and 2001, entry-level IT jobs were paying \$12.00 to \$20.00 per hour for inexperienced new hires and the jobs often did not require more than a high school education. A majority of IT workers enjoyed comprehensive benefits packages, including medical, dental, vision, sick leave, paid vacation, and retirement plans, as part of their compensation.

This is a study of selected entry-level technical occupations in transition at the turn of the millennium as a result of advancements in technology. The study is based on occupational surveys that were conducted primarily during the second half of 2001 in the Bay Area Region of Northern California.

## Purpose

The purpose of this study was to develop a body of labor market information (LMI) to support the development of regional IT instructional programs by a consortium of California Community Colleges located in the San Francisco Bay Region. The Bay Area Information Technology Consortium (BayITC) is a group of 26 Community Colleges located in the 12 county Bay Area. The regional approach to the delivery of IT training programs is intended to promote consistency in the preparation of a workforce possessing the skill sets sought by local employers.

## Geographic Area

For the purposes of the New Technicians Study the Northern California Bay Area Region consists of 12 contiguous counties whose commerce and workforce are closely related. The included counties are Alameda, Contra Costa, Marin, Monterey, Napa, San Benito, San Francisco, San Mateo, Santa Clara, Santa Cruz, Solano, and Sonoma.

## Occupations

Six occupations were selected for inclusion in the New Technicians Study based on their emerging or transitional character and the level of education, training, compensation, and skills required for entry-level employment. These occupations have either recently come into being or are changing dramatically as a result of changes in computer and communication technology.

BEST COPY AVAILABLE

The six occupations included in this study are:

- Computer Support Specialist
- Computer and Software Support Technician
- Computer Network Technician
- Graphic Designer (Using Desktop Computer Graphics)
- Computer Aided Design Technician/Drafter
- Internet Web Designer/Developer

### **Criteria for Selection of Occupations**

Occupations selected for this study had to be entry-level positions requiring completion of high school and some post secondary education. Hourly compensation was expected to be between \$12.00 and \$18.00 for inexperienced new hires. Also, the selected occupations were expected to be broadly distributed across industry sectors and be subject to high employer demand.

### **Partners**

A partnership consisting of the BayITC, the California Employment Development Department's (EDD) Labor Market Information Division (LMID), and the local workforce investment boards (LWIB) in the Bay Area who contract with the EDD for the California Cooperative Occupational Information System (CCOIS) worked in partnership to collect data for the New Technicians Study.

### **Methodology**

After the occupations for the New Technicians Study were selected and defined, an employer sample was developed for each occupation in each county.

The CCOIS employer sample is intended to represent the characteristics of an occupation across different industries, geographic regions, and size of firm, within a given survey area. In most cases the sample consists of 40 firms, from all significant employment settings, distributed by industry, in proportion to the share of employment each industry contributes to the occupation. A standard survey instrument was used for data collection for each occupation across all counties.

A minimum goal of 15 employer responses was required for each occupation by county. The survey responses were entered into a database, tabulations were generated, and occupational summaries were prepared. Each occupational summary included information on training and hiring requirements, size of the occupation, employment trends, supply/demand assessment, wages and fringe benefits and other information. Specific employer information is kept confidential.

### **Findings - Wages**

- Each of the six occupations had a starting wage for new hires without experience that fell within the range of \$12.00 to \$20.00 per hour.
- The wage range for new hires with prior experience in the same or similar occupation was \$15.00 to \$22.00.
- Employees in these occupations having three or more years with their firm could expect to make between \$19.00 and \$29.00 per hour.

### ***Benefits***

- The benefit packages for each of the six occupations were relatively generous for entry-level jobs.
- One hundred percent of the employers of Computer Aided Design (CAD) Technicians provided medical insurance benefits, either paid for in full by the employer or cost shared with the workers.
- For each of the occupations, more than 90 percent of the employers provided medical benefits.
- Between 75 and 95 percent of responding employers also provided vision and dental care insurance for their employees.
- Over 90 percent of responding employers provided their employees paid vacations, and over 80 percent provided paid sick leave.

### ***Ease of Recruitment***

- Over two-thirds of the employers of Software Support Specialists, CAD Technicians, and Graphic Designers reported that it was difficult or very difficult for them to find qualified experienced applicants to hire.
- Over half of the employers of Computer and Software Support Technicians, CAD Technicians, and Graphic Designers reported that it was also difficult or very difficult to find qualified workers without experience.

### ***Prior Experience***

- For each of the six occupations, more than 90 percent of the employers required or preferred that applicants have experience in the occupations before being hired. The amount of experience varied from 19 to 23 months.

### ***Vocational Training***

- Fifty-eight percent of the employers of CAD Technicians required or preferred that applicants have an average of 17 months of vocational training before being hired.
- Two-thirds of employers of Computer and Software Support Technicians expected their new hires to have about 18 months of vocational training prior to application.
- However, only about one-third of the employers of Webmasters expected their new hires to have vocation training.

### ***Education***

- Half of the responding employers would hire Computer and Software Support Technicians, Computer Support Specialists, Network Technicians, and Graphic Designers with only a high school education.
- For all six occupations, about one-quarter of the responding employers required AA degrees and one quarter required four-year degrees.

### ***Job Openings***

- For all occupations, the majority of job opening resulted either from the creation of new permanent jobs or from staff leaving their jobs to go to other firms.

### ***Industries***

- Industry representation was very broad for all occupations except CAD Technicians, which were most frequently found in Architectural and Engineering Services and Printed Circuit Board industries; and Graphic Designers which were found predominantly in Publishing, Printing, and Commercial Art industries.

# THE NEW TECHNICIANS STUDY-INTRODUCTION

## THE NEW TECHNICIANS STUDY-INTRODUCTION

### Purpose

This is a study of selected entry-level technical occupations in transition as a result of advancements in technology. The study is concentrated in the Bay Area Region of Northern California.

The purpose of this study is to develop a body of labor market information (LMI) in support of a California Community College proposal to institute regional Information Technology (IT) instructional programs.

The Bay Area Information Technology Consortium (BayITC), a group of 26 Community Colleges located in the Bay Area, has proposed a regional approach to the delivery of IT instructional programs throughout the 12 counties of the Bay Area Region. This regional approach will promote consistency in the training of a workforce possessing the skill sets sought by local employers. The novelty of the proposed regional approach is that it will allow students to earn and easily transfer credits toward graduation or certification at any of the participating Bay Area Community Colleges. Approval for the planned regional approach must be obtained from the Chancellor's Office of the California Community College System and will be predicated on supporting LMI to justify the proposal.

### Occupations

We identified six occupations for the New Technicians Study based on the emerging or transitioning character of the occupations and the level of education, training, compensation, and skills required for entry-level employment. These occupations have either recently come into being or are changing dramatically as a result of changes in computer and communication technology. Each is considered an entry-level position requiring completion of high school and some post secondary education. Hourly compensation is typically \$12.00 to \$18.00 for inexperienced new hires. Finally, the occupations were selected because of their wide distribution across industry sectors and anticipated high employer demand.

The six occupations included in this study are:

- Computer Aided Design (CAD) Technicians/Drafters
- Computer and Software Support Technicians
- Computer Network Technicians
- Computer Support Specialists
- Graphic Designers
- Internet Web Designers and Developers (Webmasters)

BEST COPY AVAILABLE



## THE NEW TECHNICIANS STUDY-INTRODUCTION

### Partners

A partnership consisting of the BayITC, the California Employment Development Department's (EDD) Labor Market Information Division (LMID), and the local workforce investment boards (LWIB) in the Bay Area that contract with the EDD for the California Cooperative Occupational Information System (CCOIS) (UE) associated with local workforce investment areas are shown below.

The population and unemployment rates (UE) associated with local workforce investment areas are shown below.

### Geographic Area<sup>1,2</sup>

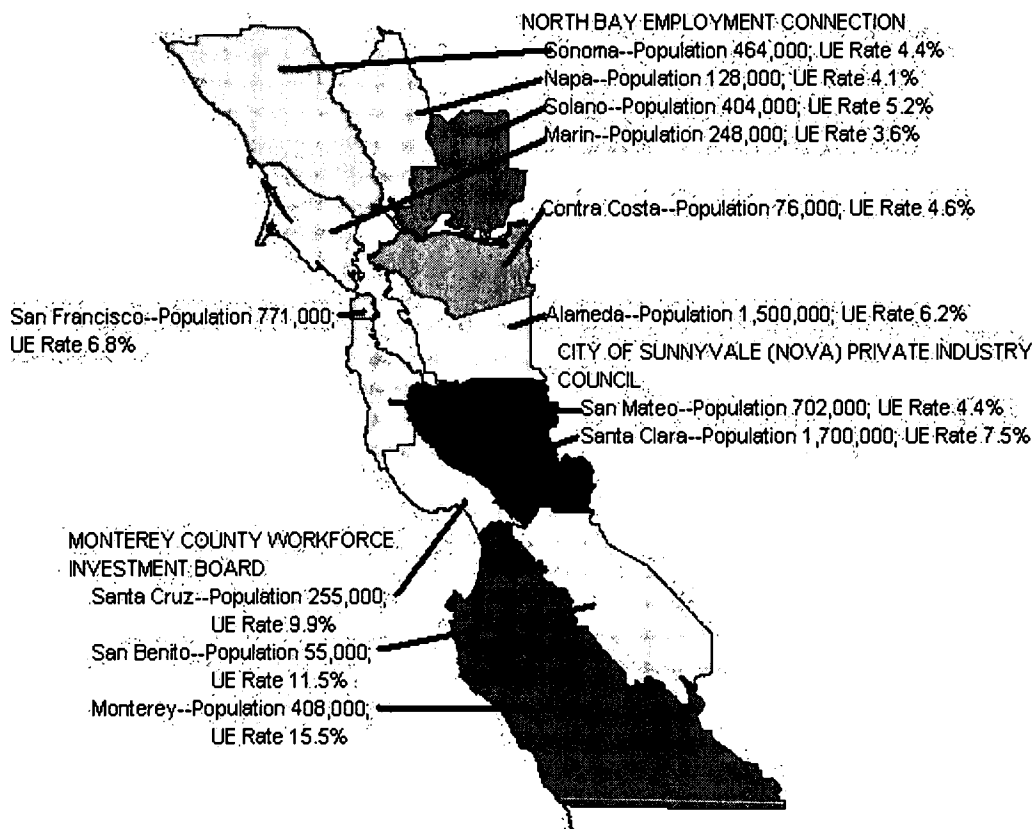

<sup>1</sup>Population Data: Census Data, July 2001

<sup>2</sup>Unemployment Rate: EDD, LMID, County Snapshots, 2001

BEST COPY AVAILABLE

## THE NEW TECHNICIANS STUDY-INTRODUCTION

### Industrial Composition<sup>3</sup>

**Alameda:** Alameda County's employment is dominated by services, government, and retail trade. Together these three industries account for 62 percent of total employment. Services is the largest industry in the county, accounting for 29 percent of employment. Industry projections for 1997-2004 forecast that 76 percent of the job growth in Alameda County during the period will be in services, manufacturing, and wholesale and retail trade. The services industry is projected to reach 242,000 jobs by 2004. Growth in this industry is expected to be concentrated in business services, influenced in part by the spread of high-technology employment.

**Contra Costa:** Services, retail trade, and government dominate Contra Costa County's employment, accounting for 66 percent of total employment in the county. Other industries which are increasing their share of Contra Costa's total employment include construction, manufacturing, wholesale trade, transportation and public utilities, and agriculture. The services industry accounts for 33 percent of the county's total employment. Within the services industry, growth is expected to be concentrated in business, health, and other service components, adding 26,000 jobs by 2004.

**Marin:** Employment in Marin is dominated by the services, retail trade, and government sectors which together account for 74 percent of total employment in the county. Marin County's economy is dominated by small and medium-sized businesses. In addition to being a strong base of business services, the county is home to multimedia, software development, motion picture production, and other high-tech industries. Industry projections for 1997-2004 estimate that 80 percent of the job growth in Marin County during the forecast period will be in services, trade, and transportation and public utilities.

<sup>3</sup>EDD, LMID, County Snapshots, 2001

BEST COPY AVAILABLE

## THE NEW TECHNICIANS STUDY-INTRODUCTION

### Industrial Composition (Continued)

- Monterey:** The agriculture, services, retail trade, and government industries dominate Monterey County employment, accounting for 79 percent of total employment in the county. Employment in services has been growing steadily since 1996 and accounts for 23 percent of employment in the county. Industry projections for 1997-2004 estimate that the services industry should increase by 7,500 jobs during the forecast period, with the fastest growth being in business services, while government will grow by 3,200 jobs, mostly in local government. Monterey county is the third highest agriculture-producing county in California and one of the nation's leading vegetable-producing areas.
- Napa:** Napa's employment is dominated by services, retail trade, and manufacturing. Together these three industries account for 62 percent of total employment in Napa County. Other industries with increasing shares of Napa's total employment included agriculture, government, and construction and mining. Seventy-five percent of job growth between 1997 and 2004 in Napa County is projected to be in services, retail trade, and manufacturing. The majority of the growth is expected to be in business services, with most of the gain in employment agencies and help supply service groups. Health services is also expected to add significantly to future services employment.
- San Benito:** Employment in San Benito County is heavily concentrated in government, services, retail trade, manufacturing, and agriculture. Together these industries account for 78 percent of the county's total employment. Government is the largest industry in the county and has been growing steadily for the past few years. Within government, the majority of jobs is in local government. Government is projected to grow by 320 jobs over the 1997-2004 forecast period. Increases in employment in construction and mining, manufacturing, and retail trade are projected to make up 61 percent of new jobs in San Benito County between 1997 and 2004. Retail trade is expected to grow by 410 jobs during the period.

BEST COPY AVAILABLE

## THE NEW TECHNICIANS STUDY-INTRODUCTION

### Industrial Composition (Continued)

- San Francisco:** The services, retail trade, and government sectors dominate San Francisco County's total employment, accounting for 70 percent of all jobs. Services is the largest industry employer in the county and is projected to gain 30,700 jobs during the 1997-2004 forecast period. Within services, business services is the largest component and is expected to grow by 10,000 jobs over the forecast period. Tourism is also a large employment generator, providing large numbers of jobs in hotels, restaurants, gift shops, and tourist-oriented retail outlets and recreations. As much as 84 percent of future job growth in San Francisco is project to be in services, retail trade, and government.
- San Mateo:** The services, retail trade, and transportation and public utilities sectors make up 64 percent of San Mateo County's total employment with government and manufacturing accounting for another 19 percent of total employment. Industry projections for 1997-2004 estimate that services, retail trade, and transportation and public utilities will continue to dominate and will account for 85 percent of the job growth in San Mateo County. Over a third of the retail trade jobs are currently found in eating and drinking places. The majority of growth in retail during the forecast period will be in the apparel and accessory stores sector, which is projected to grow by 90 percent. The services industry is projected to add 147,000 jobs by 2004.
- Santa Clara:** The civilian labor force for Santa Clara County is just over one million. Services, manufacturing, and retail trade account for 74 percent of Santa Clara County's total employment. Northwestern Santa Clara County is part of the region known as the Silicon Valley, an industrial region centered around the southern shores of San Francisco Bay. Recently the economic emphasis of the Silicon Valley has shifted somewhat from computer manufacturing to research, development and marketing of computer products and software. Services is the largest industry in the county and it is projected to grow by 137,900 new jobs, to reach a total employment of almost 440,000 by 2004.

## THE NEW TECHNICIANS STUDY-INTRODUCTION

### Industrial Composition (Continued)

- Santa Clara:** (Continued) Industry projections for 1997-2004 indicate that 84 percent of job growth in Santa Clara County will be in services, retail trade, and manufacturing. The business services component is expected to account for the largest share of the growth.
- Santa Cruz:** Services, retail trade, and government dominate employment in Santa Cruz county, accounting for 67 percent of total employment. The county is also largely dependent on tourism and recreation. Between 1997 and 2004, 84 percent of job growth is projected to be in services, government, and retail trade. By 2004, government is projected to add 2,300 jobs and services should add about 2,000. The county's retail trade industry will add about 1,000 jobs during the forecast period. Construction is also projected to grow by 800 jobs. The southern area of Santa Cruz County is a productive agricultural district. Food processing firms, closely tied to farming, are located in or near Watsonville. Employment not directly related to agriculture or tourism, such as computer services, educational services, and electronics-related manufacturing are scattered throughout the county.
- Solano:** Services, retail trade, and government sectors are the largest employers in Solano County and make up 69 percent of total employment. Services are concentrated in the other services component, which includes social services like individual and family social services and residential care. Trade, both retail and wholesale, have been growing steadily since 1996 and are expected to reach a total of 28,400 jobs by 2004. Industry projections for 1997-2004 indicate that services, government, and retail trade will continue to dominate and will account for 71 percent of job growth in the county. Solano County's affordable land is attracting new industries such as call centers, biotech manufacturing, food manufacturing, and small start-up high-tech industries.

# THE NEW TECHNICIANS STUDY-INTRODUCTION

## Industrial Composition (Continued)

**Sonoma:** Sonoma County's employment is dominated by services, retail trade, and manufacturing. Together these industries account for 63 percent of total employment in the county. Construction and mining, government, and agriculture are also seeing significant job growth. Over the forecast period of 1997-2004, 74 percent of job growth is projected to be in services, retail trade, and manufacturing. Within services, business services is projected to experience the largest increase over the forecast period with an estimated 64.9 percent growth. Sonoma is also a key producer of wine and farm products. Since 1996, employment in the agriculture industry has increased 21 percent in a consistent pattern of growth.

## Map: Bay Area Community Colleges

### Location of Bay Area Community Colleges

The Bay Area Community Colleges participating in this project are shown on the map below.



## THE NEW TECHNICIANS STUDY-INTRODUCTION

### Methodology

After the occupations for the New Technicians Study were selected and defined, an employer sample was developed for each occupation by county. Using EDD employer tax administrative databases and occupational staffing patterns within industries as identified by the Bureau of Labor Statistics Occupational Employment Statistics program, LMID staff selected a representative sample of employers for each of the occupations in each of the survey areas.

The CCOIS sample is intended to represent the characteristics of an occupation across different industries, geographic regions, and size of firms, within a given survey area. In most cases the sample consists of 40 firms, from all significant employment settings, distributed by industry, in proportion to the share of employment each industry contributes to the occupation. The refined sample for each occupation includes small, medium, and large firms which are geographically distributed throughout the region. Employers are surveyed for no more than three occupations. The sample also contains government employers such as schools, hospitals, and the post office. A minimum response goal of 15 is required for each occupation in each county.

The same basic questionnaire was used for all occupations. (See Appendix A.)

Using the employer samples and the standard questionnaire, each local workforce investment board applied the following basic survey procedures:

- Staff began by attempting to obtain phone numbers for each employer on the finalized list of employers proposed for the study. This involved use of the telephone book and the City Directory. Some employers were eliminated from the list at this time because they were no longer in business or a local address or phone number could not be verified without extraordinary efforts.
- Employers were then called to verify company name and address, verify the existence of the occupation at the company, obtain the name of a contact person, describe the study, and encourage participation. Employers were eliminated from the list at this point if they did not employ in that occupation.
- Employers willing to participate in the survey were encouraged to complete the questionnaire during the initial contact by phone. They were read the questionnaire over the phone. If that was not a

## THE NEW TECHNICIANS STUDY-INTRODUCTION

### Methodology (Continued)

convenient time, employers willing to complete the questionnaire were called back at a time they designated, or sent a survey by mail or fax, or a personal visit was made.

- Employers not responding after five working days of mailing a questionnaire were again contacted by phone to encourage them to return the questionnaire and they were again given the opportunity to complete the questionnaire by telephone.
- All surveys were reviewed by the local workforce investment board coordinator to ensure accuracy and completeness. Employers were contacted if the answer(s) was unclear or conflicted with other answers or information obtained about the occupation.
- If a sufficient number of responses could not be obtained in a reasonable time with the finalized list of up to 40 employers, additional employers were added to the list based on knowledge of local firms, the firms listed in the Yellow Pages, or the firms listed with the Chamber of Commerce.
- In addition to contacting employers, the local workforce investment board staff contacted labor unions, employment agencies, training providers, etc. to learn about a specific occupation.

The survey responses were entered into a database and tabulations were produced. From those tabulations the data were analyzed and the final occupational summaries were prepared. Each occupational summary provides information on training and hiring requirements, size of the occupation, employment trends, supply/demand assessment, wages and fringe benefits, and other information. Specific employer information is and will remain confidential.

Most of the data reported in the following occupational summaries were gathered during the second half of 2001. Some counties gathered information for some of the occupations in 2000 and in 1999.



## GUIDE TO OCCUPATIONAL SUMMARIES

## GUIDE TO OCCUPATIONAL SUMMARIES

**Job Description** Most of the occupations included in this survey are not found in the Occupational Employment Statistics (OES) Dictionary published by the U.S. Bureau of Labor Statistics. These occupations are referred to as Non-OES and have been given titles and definitions that describe the jobs and duties as commonly used by employers in California. One occupation, Computer Support Specialist, use the OES Dictionary definition and title.

**Job Titles** This section lists the job titles most frequently used by the employers surveyed. A list of all the job titles that pertain to the job description appears in Appendix A.

**Career Ladder** This section lists the most frequently cited promotional opportunities for the occupation and skills needed for career advancement.

**Hours Worked** This section presents the percentages of employers who offer full-time and part-time employment. The average number of weekly hours worked and the range of weekly hours worked as reported by the responding employers are included.

**Compensation** Wages

Wages included in this report are those paid by employers participating in the survey for employees at three levels of experience. The report does not include extreme wages. Although wages are shown to the nearest cent for ease of comparison, the reader should not interpret this as an indication of precision. Wage data were collected between 1999 and 2001, and reflect the following definitions.

- |                               |   |
|-------------------------------|---|
| New Hires, No Experience:     | Persons trained or otherwise qualified, but with no previous experience in the occupation |
| New Hires, Experienced:       | Persons at the journey level, but starting at the firm                                    |
| 3+ Years Experience with firm | Persons at the journey-level with at least three years of experience with the firm        |

Wage information is presented as a tool for evaluating and comparing the potential earnings of one occupation with another. Wage information is not intended to represent official prevailing wages.

## GUIDE TO OCCUPATIONAL SUMMARIES

### Compensation (Continued)

#### Benefits

This section presents the benefits offered by employers (in terms of percentage of frequency) to full-time workers. It is important to keep in mind that some employers may require a waiting or probationary period before some or all benefits go into effect. Also, the share of benefits costs paid by employers and employees, as well as degree of insurance coverage, may vary by employer.

### Employer Requirements

#### Education and Vocational Training

This section presents the amount and kind of education and vocational training required by the responding employers. While minimum educational requirements have been shown as employers expressed them, these educational requirements are not always essential for the performance of job duties. Because the lack of education will create a barrier with some employers, employers' educational statements have been included in this report.

#### Experience

This section presents the percentage of employers who require and percentage of those who prefer that their new hires have previous experience in the occupation. The average number of months of experience reported by the surveyed employers are included.

### Supply and Demand

In this section, graphs show the degree of difficulty employers reported in finding qualified experienced and inexperienced applicants. The following terms are used:

Not Difficult	Supply of qualified applicants is considerably greater than demand, creating a very competitive job market for applicants.
A Little Difficult	Supply of qualified applicants is somewhat greater than demand. Applicants will find a moderately competitive job market.
Somewhat Difficult	Demand is somewhat greater than the supply of qualified applicants. Employers may have some difficulty in finding qualified applicants at times.
Very Difficult	Demand is considerably greater than the supply of qualified applicants. Employers often cannot find qualified applicants when an opening exists.

## GUIDE TO OCCUPATIONAL SUMMARIES

<b>Growth</b>	A graph shows the percentage of surveyed employers that reported that employment in the occupation grew, remained stable, declined over the previous 12 months and the percentage of employers that anticipated that employment in the occupation will grow, remain stable, and decline over the next 24 months.
<b>Openings Filled</b>	This section provides a summary of the number of individuals hired by the employers surveyed for the particular occupational title. It also gives the reasons openings existed at the responding employers and the overall turnover rate for the occupation.
<b>Where The Jobs Are</b>	This section presents industries that employed the greatest concentration of each occupation as well as industries that most frequently reported employing each occupation.
<b>Estimates of Employment in These Industries</b>	This section provides a summary of the estimated occupational employment for each industry presented in the "Where The Jobs Are" section.

## COMPUTER AIDED DESIGN (CAD) TECHNICIANS

# COMPUTER AIDED DESIGN (CAD) TECHNICIANS

Non-OES 003362999

## Job Description

Computer Aided Design (CAD) Technicians operate computer-aided design systems and peripheral equipment to draft and modify drawings from rough or detailed sketches or notes to specified dimensions for manufacturing, construction, engineering, or other purposes. They utilize knowledge of various CAD programs, machines, engineering practices, mathematics, building materials, and other physical sciences to complete drawings.

## Job Titles

*Q: What job titles does your firm use for these duties?*

The most frequently cited job titles used by employers surveyed that apply to this job description are:

- CAD
- CAD Drafter
- CAD Technician
- CAD Designer
- CAD Operator

See Appendix B for the list of all job titles used.

## Career Ladder

*Q: Does your firm ever promote CAD technicians to higher level positions? If yes, what are the titles of the positions to which they are promoted?*

Most employers stated that promotional opportunities existed for their CAD Technicians. The most frequently mentioned promotional titles were:

- Designer
- Job Captain
- Manager
- CAD Manager
- Project Manager

*Q: What skills are important for career advancement?*

The skills required for career advancement most frequently cited were:

- CAD
- People
- Management
- Communication
- Architectural
- Math

BEST COPY AVAILABLE

## COMPUTER AIDED DESIGN (CAD) TECHNICIANS

### Hours Worked

*Q: How many hours do the CAD Technicians you employ work each week?*

Ninety-five percent of the CAD Technicians represented in this survey worked full time. They averaged 40 hours per week, with a range of 30 to 50 hours per week. Three percent of the CAD Technicians worked part time. They averaged 23 hours per week.

### Compensation

#### Wages

*Q: What is the usual income earned by your firm's CAD Technicians at these levels of experience?*

EMPLOYEE EXPERIENCE LEVEL	RANGE	MEDIAN
New Hires with No Experience	\$ 9.97 to \$ 20.00	\$ 14.50
New Hires with Experience	\$ 11.00 to \$ 28.77	\$ 18.22
3 Yrs + Experience with Firm	\$ 14.96 to \$ 35.96	\$ 23.00

#### Benefits

*Q: Which benefits does your firm offer its full-time CAD Technicians, and who pays for them?*

BENEFIT	EMPLOYER PAYS ALL	COST SHARED	EMPLOYEE PAYS ALL	NOT PROVIDED
Vacation	90%	1%	1%	7%
Sick Leave	85%	1%	3%	10%
Retirement	31%	38%	9%	22%
Medical	63%	37%	-	-
Dental	57%	31%	-	12 %
Vision	43%	26%	1%	29%
Life	57%	13%	1%	28%
Child Care	-	4%	6%	90%

# COMPUTER AIDED DESIGN (CAD) TECHNICIANS

## Employer Requirements

### Education

Q: What is the minimum level of education your firm requires when hiring a CAD Technician?

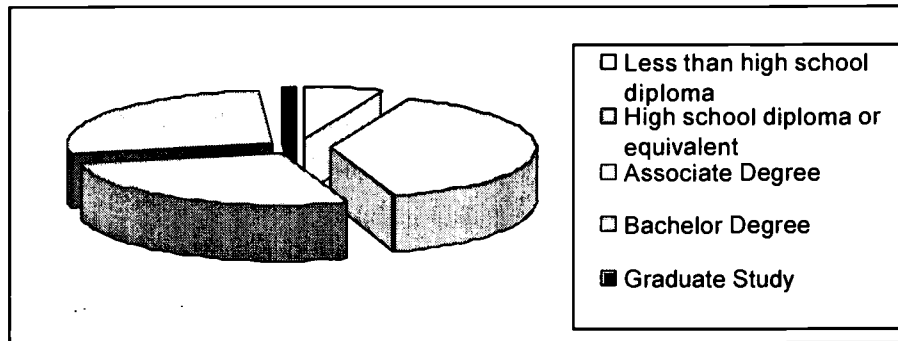

Forty-five percent of responding employers do not require CAD Technicians they hire to have more than a High School Diploma. Twenty-seven percent of employers required an Associate degree, and 28 percent required a Bachelor Degree or Graduate Study.

### Vocational Training

Q: Is technical or vocational training required prior to employment as a CAD Technician? If yes or preferred, what kind of training is required?

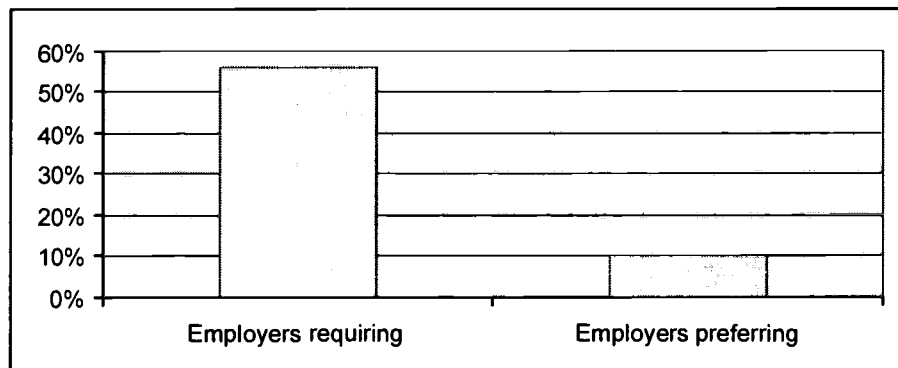

Fifty-six percent of the responding employers reported that they require technical or vocational training prior to employment and 10 percent preferred that new hires have it. Employers most frequently required CAD and AutoCAD Training/Certificate, Architectural CAD, and Drafting training. The average period of training required was 18 months.



## COMPUTER AIDED DESIGN (CAD) TECHNICIANS

### Employer Requirements (Continued)

#### Experience

Q: When you hire CAD Technicians, is prior experience in this occupation required?

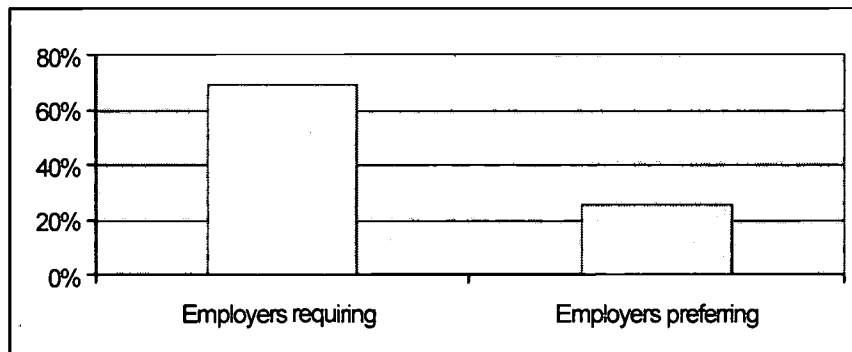

Sixty-nine percent of the employers reported requiring prior experience in this occupation for their new hires and 26 percent preferred it. The average amount of experience required was 19 months.

#### Vocational Training vs. Experience

Q: Is vocational training or experience more frequently required by employers when they hire CAD Technicians?

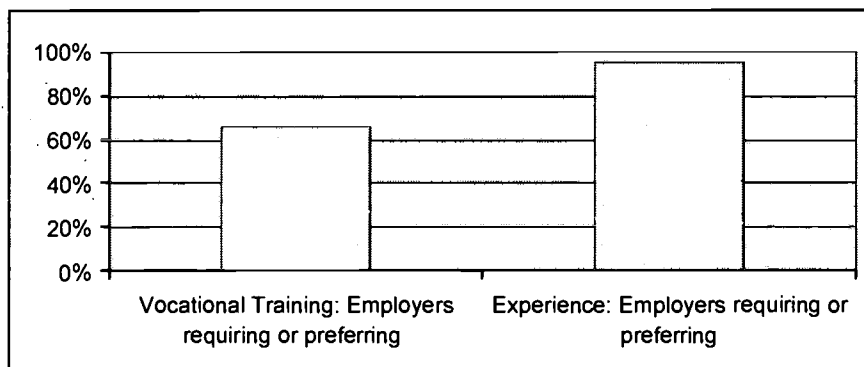

Sixty-six percent of the employers reported requiring or preferring technical or vocational training prior to employment, while 95 percent reported requiring or preferring prior experience in this occupation for their new hires.

BEST COPY AVAILABLE

## COMPUTER AIDED DESIGN (CAD) TECHNICIANS

Supply  
and  
Demand

Q: How difficult is it for your firm to find fully qualified experienced applicants?

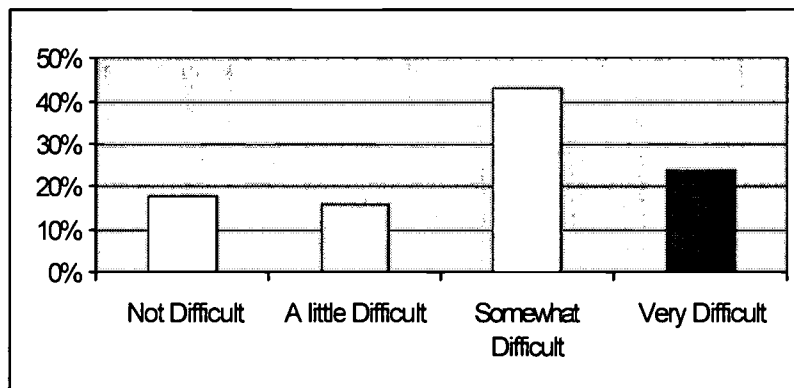

Thirty-four percent of employers reported that it was not difficult or a little difficult to find **experienced** applicants for CAD Technician vacancies. Sixty-six percent reported that it was somewhat or very difficult to find **experienced** applicants.

Q: How difficult is it for your firm to find fully qualified inexperienced applicants?

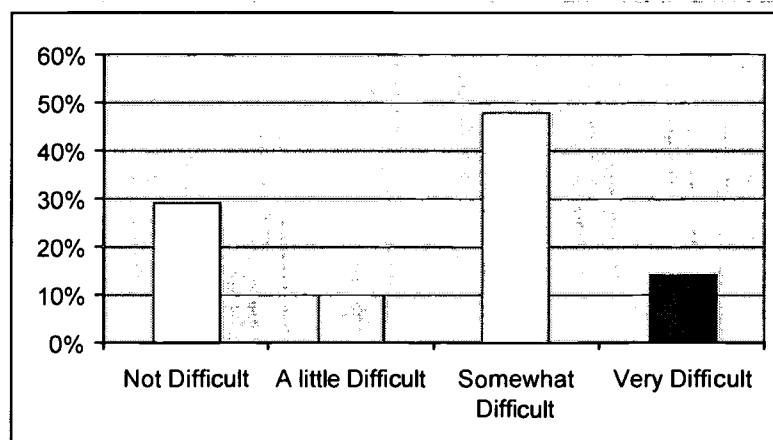

Thirty-nine percent of employers reported that it was not difficult or a little difficult to find **inexperienced** applicants for CAD Technician vacancies. Sixty-one percent reported that it was somewhat or very difficult to find **inexperienced** applicants.

## COMPUTER AIDED DESIGN (CAD) TECHNICIANS

### Growth

Q: During the last 12 months, did your firm's employment of CAD Technicians grow, remain stable, or decline?

Q: Over the next 24 months, will your firm's employment of CAD Technicians grow, remain stable, or decline?

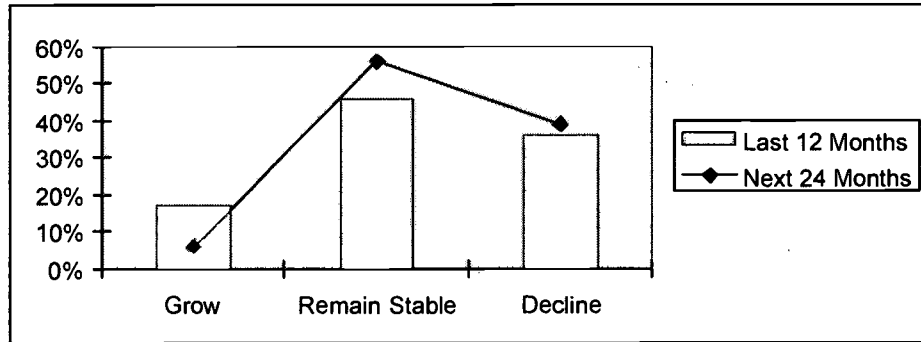

Seventeen percent of employers reported that the number of CAD Technicians they employed increased during the 12 months prior to the survey. In contrast, 36 percent reported that employment in this occupation declined during the period. Over the next 24 months, six percent of employers expected growth in employment of this occupation, while 39 percent anticipated decline in employment.

### Openings Filled

Q: How many CAD Technicians were hired to fill new permanent positions resulting from growth, vacancies resulting from promotions, vacancies resulting from people in permanent positions leaving your firm, and temporary, on-call or seasonal positions in the last 12 months?

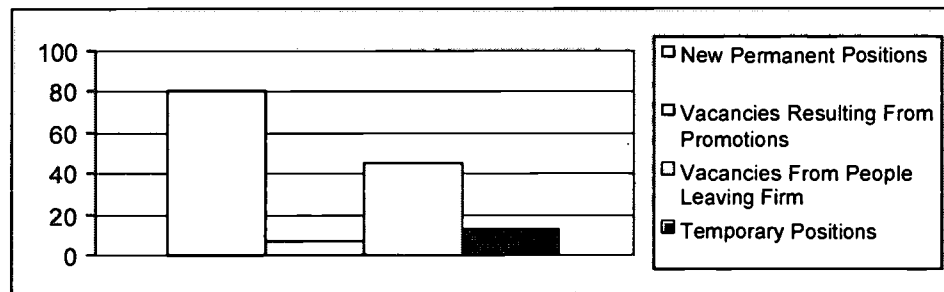

The firms surveyed hired 145 CAD Technicians in the 12 months preceding the survey. This represents 21 percent of the total number of CAD Technicians employed by the responding firms. Eighty-seven CAD Technicians were hired to fill new positions or vacancies left by people who had been promoted within the firm. Fifty-eight CAD Technicians were hired to fill vacancies created by people leaving the firm or temporary positions.

# COMPUTER AIDED DESIGN (CAD) TECHNICIANS

## Where The Jobs Are

The 70 Bay Area firms that participated in the survey of this occupation employed 691 CAD Technicians. The firms surveyed were classified in 21 different industries. These industries are shown in Appendix C.

*Q: What industries are most likely to hire CAD Technicians?*

The graph below shows which industries in our sample most frequently reported employing CAD technicians.

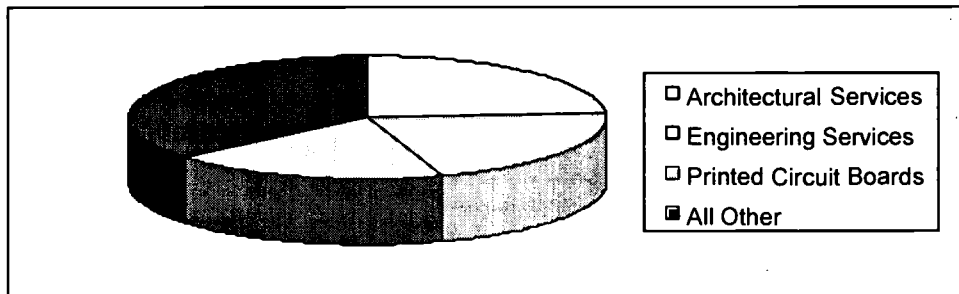

More than half of the firms that provided information about CAD Technicians are classified into three industries. Twenty-four percent of the employers responding to the survey provide architectural services. Twenty-one percent provide engineering services, and 19 percent manufacture printed circuit boards.

*Q: Which industries have the greatest concentration of this occupation?*

The graph below shows the industries in our sample that employed the greatest concentration of CAD Technicians.

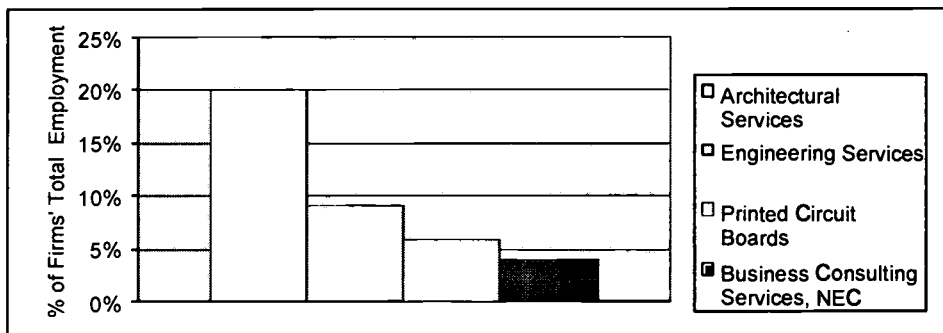

CAD Technicians account for 20 percent of the workforce in firms that provide architectural services, nine percent of the workforce in firms that provide engineering services, six percent of the workforce in manufacturers of printed circuit boards, and four percent of the workforce of business consulting firms that are not elsewhere classified, such as economic consulting and radio consultants.

## COMPUTER AIDED DESIGN (CAD) TECHNICIANS

### Estimates of Employment in These Industries

Q: *How many CAD Technicians are employed in these industries?*

If the employment that we found in our sample is representative of the entire Bay Area, we can estimate that these four industries employ about 6,400 CAD technicians in the 12-county region. The estimates for each industry follow.

	<u>Estimated Occ Employment</u>	<u>Total Industry Employment</u>
Engineering Services Firms	2,900	31,800
Architectural Services Firms	1,900	9,400
Printed Circuit Board Manufacturing Firms	1,000	16,700
Business Consulting Firms, NEC (e.g., Economic Consulting, and Radio Consultants)	<u>600</u>	<u>15,700</u>
Totals	6,400	73,600

BEST COPY AVAILABLE

## **COMPUTER AND SOFTWARE SUPPORT TECHNICIANS**

# COMPUTER AND SOFTWARE SUPPORT TECHNICIANS Non-OES 213132999

## Job Description

Computer and Software Support Technicians assist in monitoring operations of computers and peripheral equipment. They have knowledge of a variety of word processing, spreadsheet, and data base applications. They assist and provide training in the operation of computers, peripheral equipment, and software; enter commands to help computer operators identify and correct errors; revise input data and programs; recommend changes in programs, in routines, and in quality-control standards to improve computer operating efficiency.

## Job Titles

*Q: What job titles does your firm use for these duties?*

The most frequently cited job titles used by employers surveyed that apply to this job description are:

- Computer and Software Support Technician
- Computer Technician
- Network Technician

See Appendix B for the list of all job titles used.

## Career Ladder

*Q: Does your firm ever promote Computer and Software Support Technicians to higher level positions? If yes, what are the titles of the positions to which they are promoted?*

Most employers stated that promotional opportunities existed for their Computer and Software Support Technicians. The most frequently mentioned promotional titles were:

- Director
- Information Specialist
- Manager
- Network Administrator

*Q: What skills are important for career advancement?*

The skills required for career advancement most frequently cited were:

- Communication
- Customer Service
- Managerial
- Programming
- Technical
- Networking
- Trade Skills

BEST COPY AVAILABLE

## COMPUTER AND SOFTWARE SUPPORT TECHNICIANS

### Hours Worked

*Q: How many hours do the Computer and Software Support Technicians you employ work each week?*

Ninety-six percent of the Computer and Software Support Technicians represented in this survey worked full time. They averaged 41 hours per week, with a range of 37 to 45 hours per week. Three percent of the Computer and Support Technicians worked part time. They averaged 25 hours per week.

### Compensation

#### Wages

*Q: What is the usual income earned by your firm's Computer and Software Support Technicians at these levels of experience?*

EMPLOYEE EXPERIENCE LEVEL	RANGE	MEDIAN
New Hires with No Experience	\$ 7.00 to \$ 31.16	\$ 19.59
New Hires with Experience	\$ 11.99 to \$ 31.16	\$ 19.18
3 Yrs + Experience with Firm	\$ 12.00 to \$ 40.00	\$ 23.73

#### Benefits

*Q: Which benefits does your firm offer its full-time Computer and Software Support Technicians, and who pays for them?*

BENEFIT	EMPLOYER PAYS ALL	COST SHARED	EMPLOYEE PAYS ALL	NOT PROVIDED
Vacation	93%	3%	-	4%
Sick Leave	90%	3%	-	7%
Retirement	30%	46%	6%	18%
Medical	66%	30%	-	4%
Dental	73%	22%	-	4%
Vision	64%	16%	5%	15%
Life	61%	10%	-	28%
Child Care	3%	3%	28%	66%



# COMPUTER AND SOFTWARE SUPPORT TECHNICIANS

## Employer Requirements

### Education

*Q: What is the minimum level of education your firm requires when hiring a Computer and Software Support Technician?*

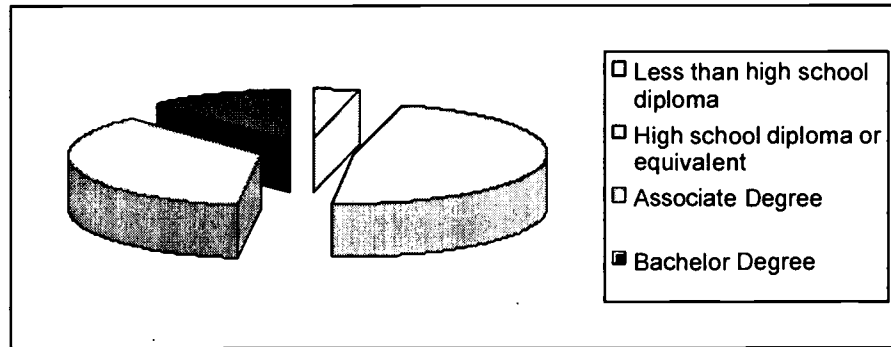

Fifty-two percent of responding employers do not require Computer and Software Support Technicians they hire to have more than a High School Diploma. Forty-eight percent of employers required an Associate or Bachelor Degree.

### Vocational Training

*Q: Is technical or vocational training required prior to employment as a Computer and Software Support Technician? If yes or preferred, what kind of training is required?*

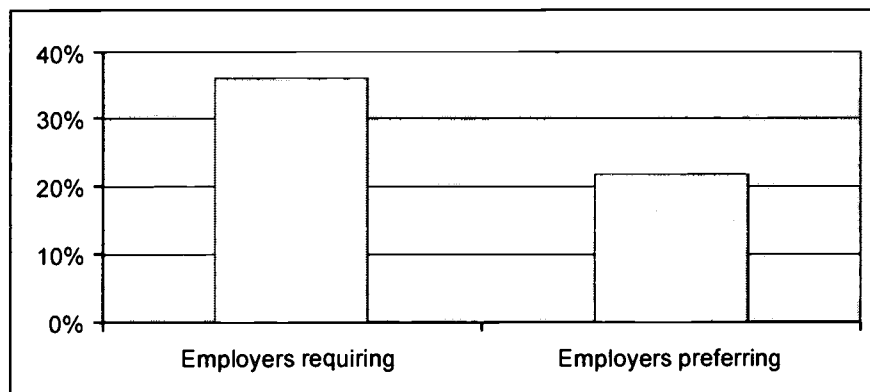

Thirty-six percent of the responding employers reported that they require technical or vocational education prior to employment and 22 percent preferred that new hires have it. Employers most frequently required Microsoft Certification and technical school training. The average period of training required was 17 months.

## COMPUTER AND SOFTWARE SUPPORT TECHNICIANS

### Employer Requirements (Continued)

#### Experience

*Q: When you hire Computer and Software Support Technicians, is prior experience in this occupation required?*

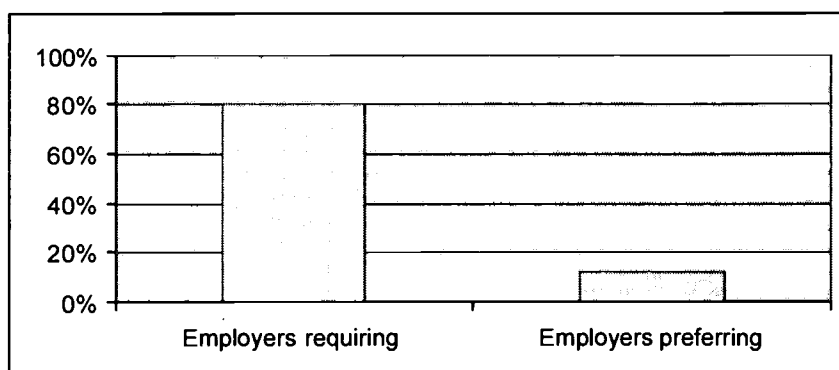

Eighty percent of the employers reported requiring prior experience in this occupation for their new hires and 12 percent preferred it. The average amount of experience required was 21 months.

#### Vocational Training vs. Experience

*Q: Is vocational training or experience more frequently required by employers when they hire Software Support Technicians?*

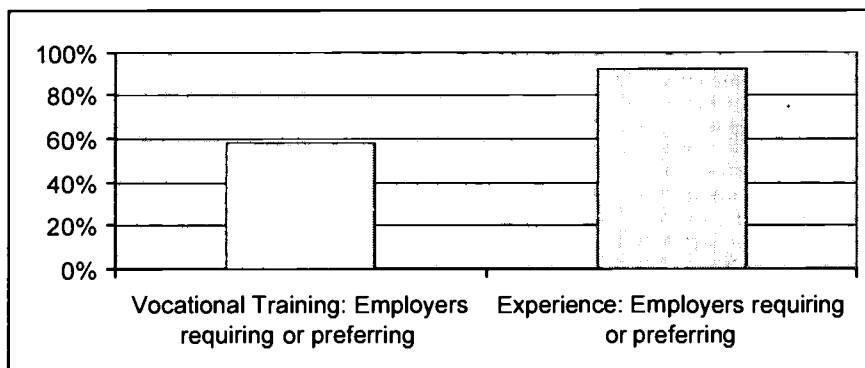

Fifty-eight percent of the employers reported requiring or preferring technical or vocational training prior to employment, while 92 percent reported requiring or preferring prior experience in this occupation for their new hires.

BEST COPY AVAILABLE

## COMPUTER AND SOFTWARE SUPPORT TECHNICIANS

### Supply and Demand

Q: How difficult is it for your firm to find fully qualified experienced applicants?

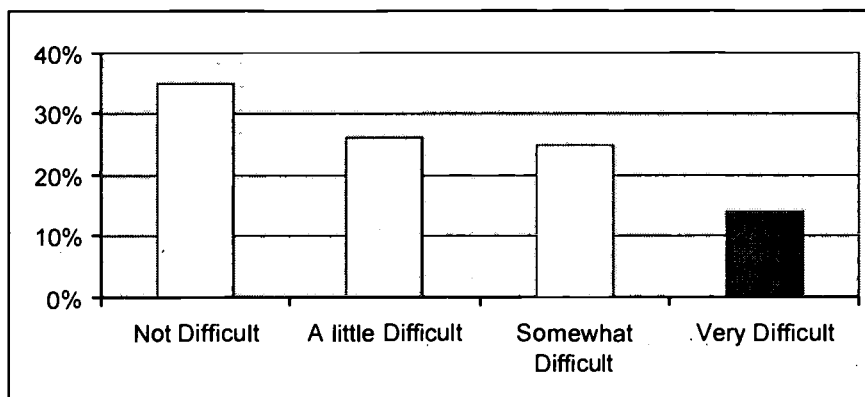

Sixty-one percent of employers reported that it was not difficult or a little difficult to find **experienced** applicants for Computer and Software Support Technician vacancies. Thirty-nine percent reported that it was somewhat or very difficult to find **experienced** applicants.

Q: How difficult is it for your firm to find fully qualified inexperienced applicants?

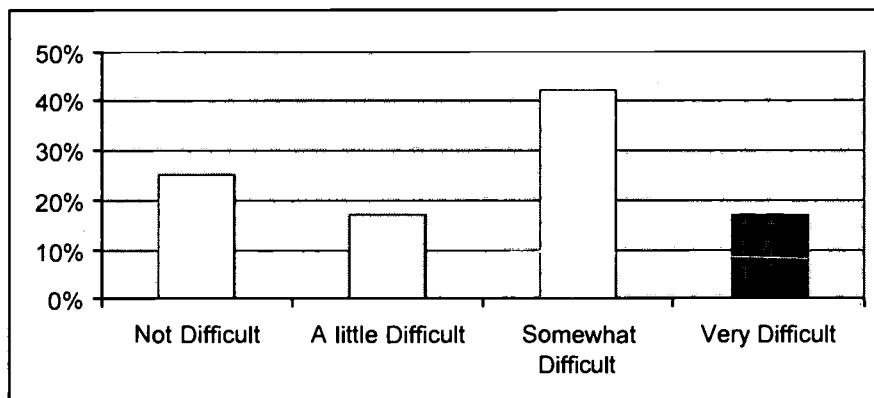

Forty-two percent of employers reported that it was not difficult or a little difficult to find **inexperienced** applicants for Computer and Software Support Technician vacancies. Fifty-eight percent reported that it was somewhat or very difficult to find **inexperienced** applicants.

## COMPUTER AND SOFTWARE SUPPORT TECHNICIANS

### Growth

Q: During the last 12 months, did your firm's employment of Computer and Software Support Technicians grow, remain stable, or decline?

Q: Over the next 24 months, will your firm's employment of Computer and Software Support Technicians grow, remain stable, or decline?

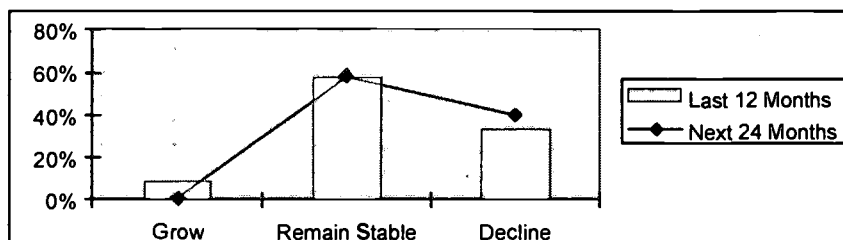

Nine percent of employers reported that the number of Computer and Software Support Technicians they employed increased during the 12 months prior to the survey. In contrast, 33 percent reported that employment in this occupation declined during the period. Over the next 24 months, one percent of employers expected growth in employment of this occupation, while 41 percent anticipated decline in employment. The majority of employers reported that employment in this occupation has been and will remain stable.

### Openings Filled

Q: How many Computer and Software Support Technicians were hired to fill new permanent positions resulting from growth, vacancies resulting from promotions, vacancies resulting from people in permanent positions leaving your firm, and temporary, on-call or seasonal positions in the last 12 months?

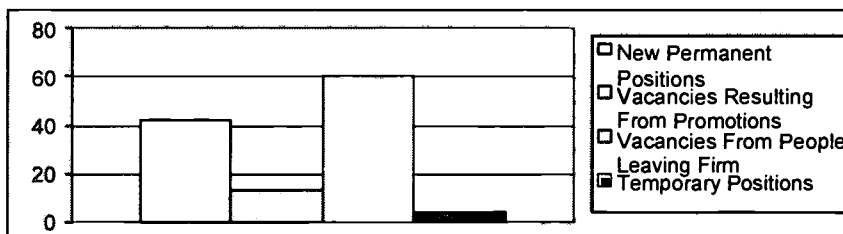

The firms surveyed hired 119 Computer and Software Support Technicians in the 12 months preceding the survey. This represents 31 percent of the total number of Computer and Software Support Technicians employed by the responding firms. Fifty-five Computer and Software Support Technicians were hired to fill new positions or vacancies left by people who had been promoted within the firm. Sixty-four Computer and Software Support Technicians were hired to fill vacancies created by people leaving the firm or temporary positions.

## COMPUTER AND SOFTWARE SUPPORT TECHNICIANS

### Where The Jobs Are

The 65 Bay Area firms that participated in the survey of this occupation employed 372 Computer and Software Support Technicians. The firms surveyed represent 22 different industries. These industries are shown in Appendix C.

*Q: What industries are most likely to hire Computer and Software Support Technicians?*

The graph below shows which industries in our sample most frequently reported employing Computer and Software Support Technicians.

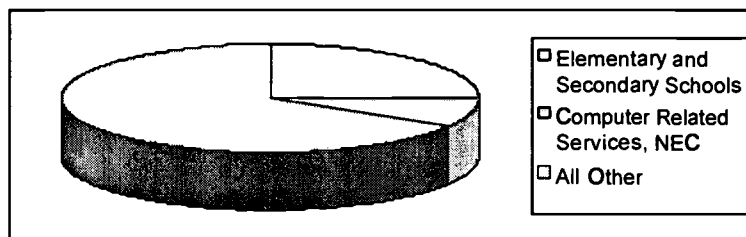

Approximately one-third of the firms that provided information about Computer and Software Support Technicians are classified into two industries. Twenty-five percent are Elementary and Secondary Schools. Nine percent supply computer related services that are not elsewhere classified such as computer consultants and database developers. The balance of firms represented in this survey are found in a wide variety of industries.

*Q: Which industries have the greatest concentration of this occupation?*

The graph below shows the industries in our sample that employed the greatest concentration of Computer and Software Support Technicians.

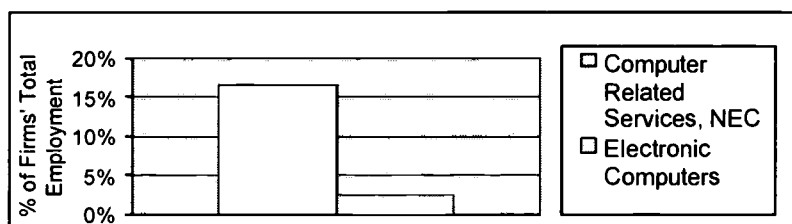

Computer and Software Support Technicians account for 17 percent of the workforce in firms that supply computer related service that are not elsewhere classified (e.g. computer consultants, and database developers). Computer and Software Support Technicians also account for three percent of the workforce in electronic computer manufacturers.

## COMPUTER AND SOFTWARE SUPPORT TECHNICIANS

### Estimates of Employment in These Industries

*Q: How many Computer and Software Support Technicians are employed in these industries?*

If the employment that we found in our sample is representative of the entire Bay Area, we can estimate that these two industries employ about 5,900 Computer and Software Support Technicians in the 12-county region. The estimates for each industry follow.

	<u>Estimated Occ Employment</u>	<u>Total Industry Employment</u>
Computer Related Services Firms, NEC (e.g., Computer Consultants, and Database Developers)	4,300	24,900
Electronic Computer Manufacturing Firms	<u>1,600</u>	<u>52,200</u>
Totals	5,900	77,100

BEST COPY AVAILABLE

## COMPUTER NETWORK TECHNICIANS

# COMPUTER NETWORK TECHNICIANS

Non-OES 033162996

## Job Description

Computer Network Technicians install and maintain personal computers and connect them to local and/or wide area networks (LANs/WANs). Technicians perform troubleshooting, diagnosis, and repair of computers and peripheral equipment; they also work on network related hardware and software problems. They may assign passwords, use manuals, maintain a variety of logs and communicate with Network Managers or others about specific system problems. In addition, they may provide training and education to other staff on network operations, applications, and usage.

## Job Titles

*Q: What job titles does your firm use for these duties?*

The most frequently cited job titles used by employers surveyed that apply to this job description are:

- Computer Network Technician
- Computer Technician
- Network Administrator
- Network Technician
- System Administrator

See Appendix B for the list of all job titles used.

## Career Ladder

*Q: Does your firm ever promote Computer Network Technicians to higher level positions? If yes, what are the titles of the positions to which they are promoted?*

Most employers stated that promotional opportunities existed for their Computer Network Technicians. The most frequently mentioned promotional titles were:

- Manager
- Senior Technician
- Network Administrator
- System Administrator

*Q: What skills are important for career advancement?*

The skills required for career advancement most frequently cited were:

- Technical
- Networking
- Customer Service
- Management
- Communication
- Programming
- Troubleshooting
- Leadership



## COMPUTER NETWORK TECHNICIANS

### Hours Worked

*Q: How many hours do the Computer Network Technicians you employ work each week?*

Ninety percent of the Computer Network Technicians represented in this survey worked full time. They averaged 40 hours per week, with a range of 30 to 50 hours per week. Six percent of the Computer Network Technicians worked part time. They averaged 23 hours per week.

### Compensation

#### Wages

*Q: What is the usual income earned by your firm's Computer Network Technicians at these levels of experience?*

EMPLOYEE EXPERIENCE LEVEL	RANGE	MEDIAN
New Hires with No Experience	\$ 8.00 to \$ 28.77*	\$ 15.00
New Hires with Experience	\$ 7.00 to \$ 33.56	\$ 20.00
3 Yrs + Experience with Firm	\$ 11.00 to \$ 41.23	\$ 25.00

\*Very few employers hire Computer Network Technicians with no experience. Consequently, the wages they reported are skewed in this category.

#### Benefits

*Q: Which benefits does your firm offer its full-time Computer Network Technicians, and who pays for them?*

BENEFIT	EMPLOYER PAYS ALL	COST SHARED	EMPLOYEE PAYS ALL	NOT PROVIDED
Vacation	91%	3%	-	6%
Sick Leave	88%	3%	-	9%
Retirement	43%	34%	7%	17%
Medical	68%	26%	1%	6%
Dental	66%	24%	2%	8%
Vision	63%	17%	2%	19%
Life	65%	14%	2%	19%
Child Care	5%	1%	8%	87%

# COMPUTER NETWORK TECHNICIANS

## Employer Requirements

### Education

Q: *What is the minimum level of education your firm requires when hiring a Computer Network Technician?*

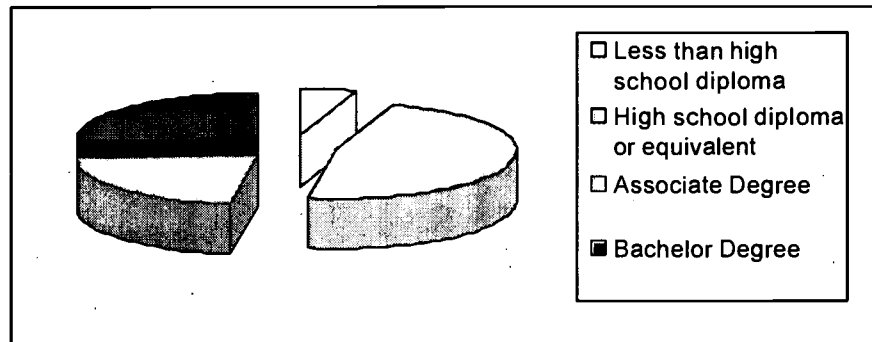

Fifty-three percent of responding employers do not require Computer Network Technicians they hire to have more than a High School Diploma. Forty-seven percent of employers required an Associate or Bachelor degree.

### Vocational Training

Q: *Is technical or vocational training required prior to employment as a Computer Network Technician? If yes or preferred, what kind of training is required?*

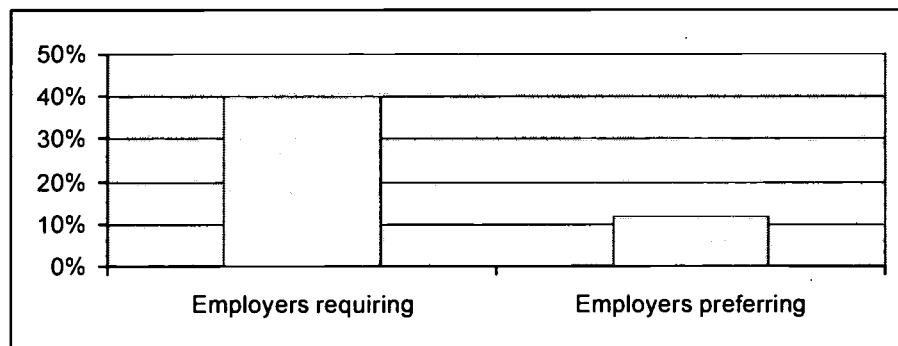

Forty percent of the responding employers reported that they require technical or vocational education prior to employment and 12 percent preferred that new hires have it. Employers most frequently required Network training and Microsoft Certified Systems Engineer (MCSE). The average period of training required was 18 months.

BEST COPY AVAILABLE

# COMPUTER NETWORK TECHNICIANS

## Employer Requirements (Continued)

### Experience

Q. When you hire Computer Network Technicians, is prior experience in this occupation required?

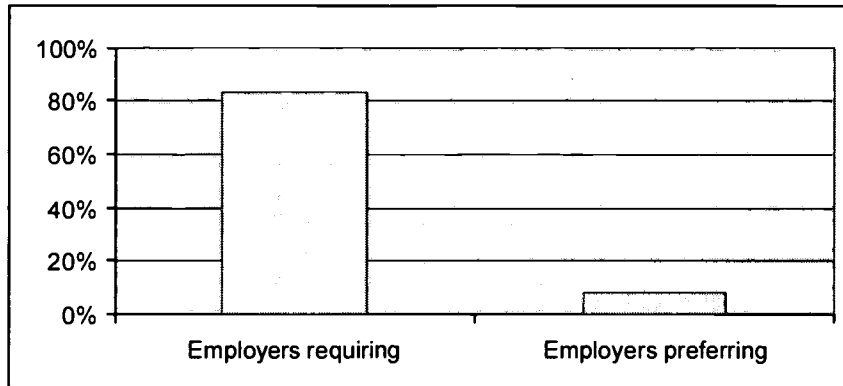

Eighty-three percent of the employers reported requiring prior experience in this occupation for their new hires and eight percent preferred it. The average amount of experience required was 23 months.

### Vocational Training vs. Experience

Q. Is vocational training or experience more frequently required by employers when they hire Computer Network Technicians?

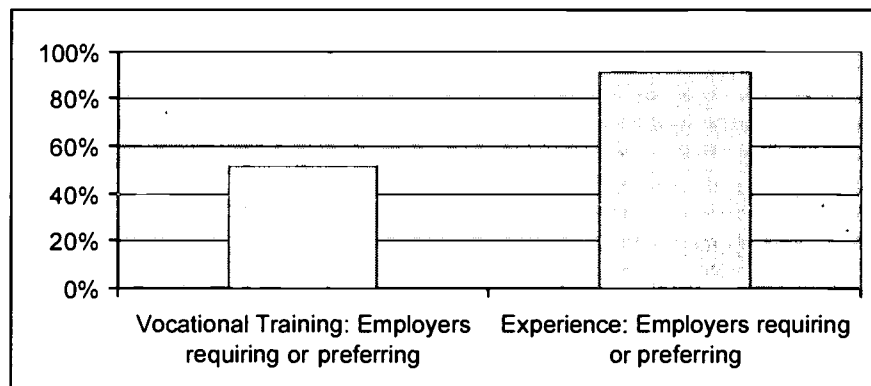

Fifty-two percent of the employers reported requiring or preferring technical or vocational training prior to employment, while 91 percent reported requiring or preferring prior experience in this occupation for their new hires.

# COMPUTER NETWORK TECHNICIANS

## Supply and Demand

Q: How difficult is it for your firm to find fully qualified experienced applicants?

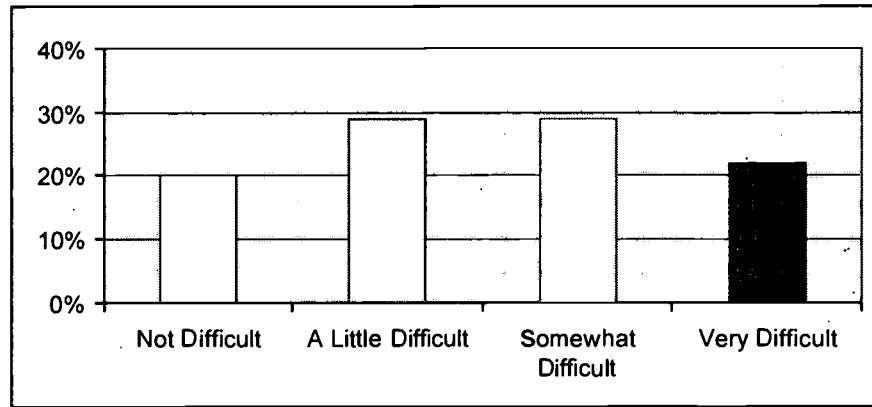

Forty-nine percent of employers reported that it was not difficult or a little difficult to find **experienced** applicants for Computer Network Technician vacancies. Fifty-one percent reported that it was somewhat or very difficult to find **experienced** applicants.

Q: How difficult is it for your firm to find fully qualified inexperienced applicants?

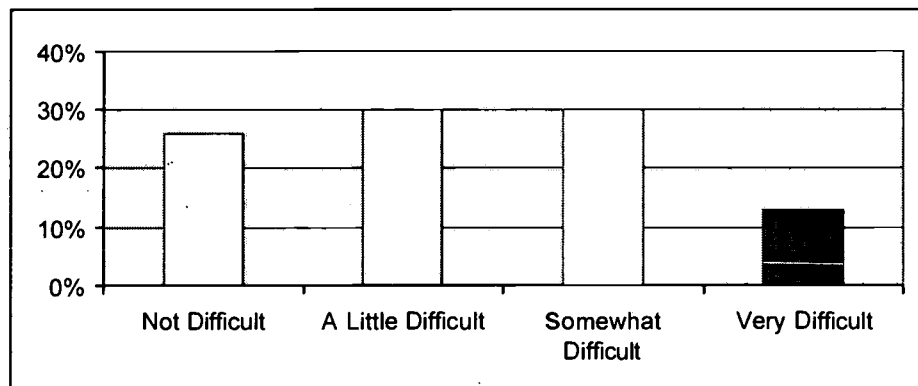

Fifty-six percent of employers reported that it was not difficult or a little difficult to find **inexperienced** applicants for Computer Network Technician vacancies. Forty-four percent reported that it was somewhat or very difficult to find **inexperienced** applicants.

## COMPUTER NETWORK TECHNICIANS

### Growth

Q: During the **last 12 months**, did your firm's employment of Computer Network Technicians grow, remain stable, or decline?

Q: Over the next **24 months**, will your firm's employment of Computer Network Technicians grow, remain stable, or decline?

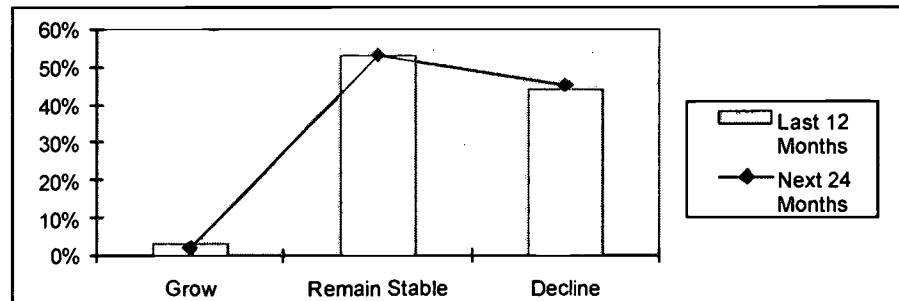

Three percent of employers reported that the number of Computer Network Technicians they employed increased during the 12 months prior to the survey. In contrast, 44 percent reported that employment in this occupation declined during the period. Over the next 24 months, two percent of employers expected growth in employment of this occupation, while 45 percent anticipated decline in employment.

### Openings Filled

Q: How many Computer Network Technicians were hired to fill new permanent positions resulting from growth, vacancies resulting from promotions, vacancies resulting from people in permanent positions leaving your firm, and temporary, on-call or seasonal positions in the last 12 months?

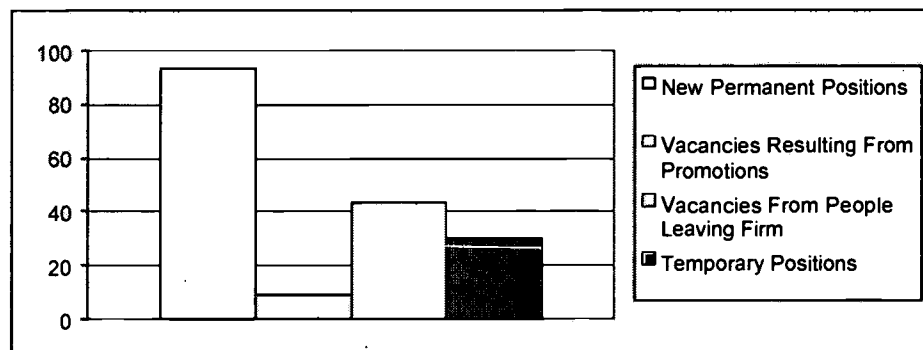

The firms surveyed hired 175 Computer Network Technicians in the 12 months preceding the survey. This represents 31 percent of the total number of Computer Network Technicians employed by the responding firms. One hundred two Computer Network Technicians were hired to fill new positions or vacancies left by people who had been promoted within the firm. Seventy-three Computer Network Technicians were hired to fill vacancies created by people leaving the firm or temporary positions.

BEST COPY AVAILABLE

# COMPUTER NETWORK TECHNICIANS

## Where The Jobs Are

The 126 Bay Area firms that participated in the survey of this occupation employed 476 Computer Network Technicians. The firms surveyed represent 54 different industries. These industries are shown in Appendix C.

*Q: What industries are most likely to hire Computer Network Technicians ?*

The graph below shows which industries in our sample most frequently reported employing Computer Network Technicians.

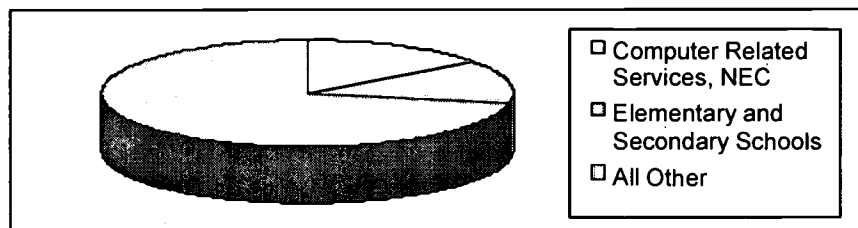

Approximately one-fourth of the firms that provided information about Computer Network Technicians are classified into two industries. Fifteen percent supply computer related services that are not elsewhere classified such as computer consultants and database developers. Thirteen percent are Elementary and Secondary Schools. The balance of firms represented in this survey are found in a wide variety of industries.

*Q: Which industries have the greatest concentration of this occupation?*

The graph below shows the industries in our sample that employed the greatest concentration of Computer Network Technicians.

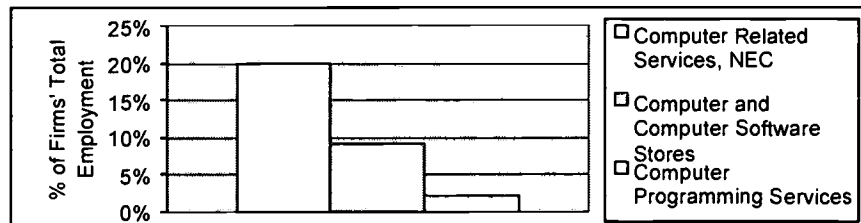

Computer Network Technicians account for 20 percent of the workforce in the firms that supply computer related services that are not elsewhere classified such as computer consultants and database developers. They also account for nine percent of the workforce in Computer and Computer Software Stores, and two percent of the workforce in firms that provide computer programming services.

## COMPUTER NETWORK TECHNICIANS

### Estimates of Employment in These Industries

Q: How many Computer Network Technicians are employed in these industries?

If the employment that we found in our sample is representative of the entire Bay Area, we can estimate that these three industries employ about 7,100 Computer Network Technicians in the 12-county region. The estimates for each industry follow.

	<u>Estimated Occ Employment</u>	<u>Total Industry Employment</u>
Computer Related Services Firms, NEC (e.g., Computer Consultants, and Database Developers)	5,000	24,900
Computer Programming Services Firms	1,200	61,000
Computer and Computer Software Stores	<u>900</u>	<u>9,500</u>
Totals	7,100	95,400

BEST COPY AVAILABLE

## COMPUTER SUPPORT SPECIALISTS



# COMPUTER SUPPORT SPECIALISTS

OES 251040

## Job Description

Computer Support Specialists provide technical assistance and training to computer system users. They investigate and resolve computer software and hardware problems of users. They answer clients' inquiries in person and via telephone concerning the use of computer hardware and software, including printing, word processing, programming languages, electronic mail, and operating systems.

## Job Titles

*Q: What job titles does your firm use for these duties?*

The most frequently cited job titles used by employers surveyed that apply to this job description are:

- Computer Support Specialist
- Computer Technician
- PC Technician
- Tech Support
- Technician

See Appendix B for the list of all job titles used.

## Career Ladder

*Q: Does your firm ever promote Computer Support Specialists to higher level positions? If yes, what are the titles of the positions to which they are promoted?*

Most employers stated that promotional opportunities existed for their Computer Support Specialists. The most frequently mentioned promotional titles were:

- Manager
- Programmer
- Supervisor
- Systems Engineer
- Senior Technician
- Network Administrator
- Project Manager
- Network Engineer

*Q: What skills are important for career advancement?*

The skills required for career advancement most frequently cited were:

- Communication
- Management
- Leadership
- Troubleshooting
- Technical
- Computer
- Organizational
- Interpersonal
- Customer Service
- People

## COMPUTER SUPPORT SPECIALISTS

### Hours Worked

*Q: How many hours do the Computer Support Specialists you employ work each week?*

Ninety-five percent of the Computer Support Specialists represented in this survey worked full time. They averaged 41 hours per week, with a range of 32 to 60 hours per week. Three percent of the Computer Support Specialists worked part time. They averaged 25 hours per week.

### Compensation

#### Wages

*Q: What is the usual income earned by your firm's Computer Support Specialists at these levels of experience?*

EMPLOYEE EXPERIENCE LEVEL	RANGE	MEDIAN
New Hires with No Experience	\$ 6.00 to \$ 23.97	\$ 14.91
New Hires with Experience	\$ 9.00 to \$ 31.16	\$ 17.40
3 Yrs + Experience with Firm	\$ 11.18 to \$ 38.36	\$ 21.58

#### Benefits

*Q: Which benefits does your firm offer its full-time Computer Support Specialists, and who pays for them?*

BENEFIT	EMPLOYER PAYS ALL	COST SHARED	EMPLOYEE PAYS ALL	NOT PROVIDED
Vacation	90%	8%	-	2%
Sick Leave	85%	8%	-	6%
Retirement	44%	35%	8%	13%
Medical	53%	46%	1%	-
Dental	53%	39%	1%	7%
Vision	42%	34%	2%	23%
Life	54%	25%	1%	20%
Child Care	2%	5%	8%	85%

# COMPUTER SUPPORT SPECIALISTS

## Employer Requirements

### Education

Q: What is the minimum level of education your firm requires when hiring a Computer Support Specialist?

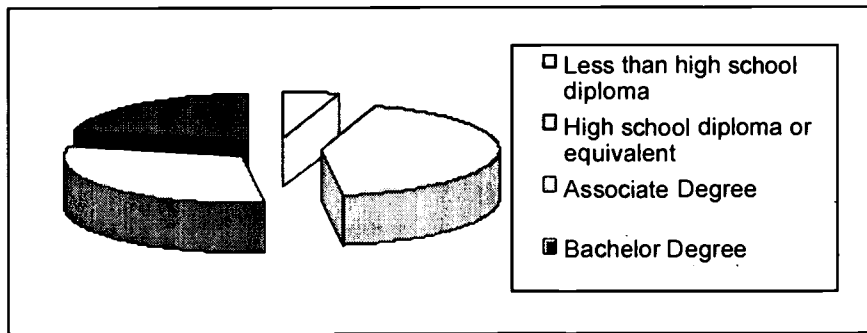

Forty-eight percent of responding employers do not require the Computer Support Specialists they hire to have more than a High School Diploma. Fifty-two percent of employers required an Associate or Bachelor Degree.

### Vocational Training

Q: Is technical or vocational training required prior to employment as a Computer Support Specialist? If yes or preferred, what kind of training is required?

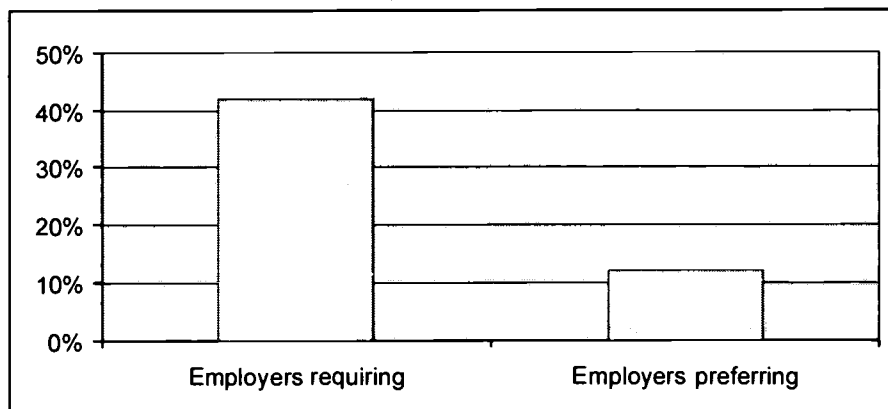

Forty-two percent of the responding employers reported that they require technical or vocational education prior to employment and 12 percent preferred that new hires have it. Employers most frequently required Microsoft Certified Systems Engineer (MCSE), technical training, and computer network training. The average period of training required was 14 months.

# COMPUTER SUPPORT SPECIALISTS

## Employer Requirements (Continued)

### Experience

Q: *When you hire Computer Support Specialists, is prior experience in this occupation required?*

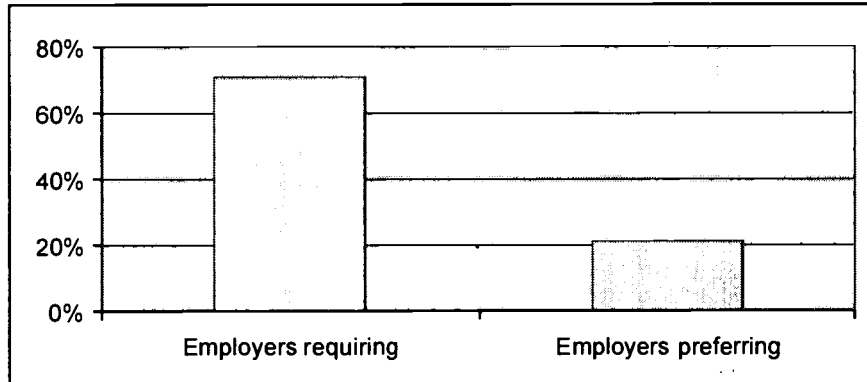

Seventy-one percent of the employers reported requiring prior experience in this occupation for their new hires and 21 percent preferred it. The average amount of experience required was 21 months.

### Vocational Training vs. Experience

Q: *Is vocational training or experience more frequently required by employers when they hire Computer Support Specialists?*

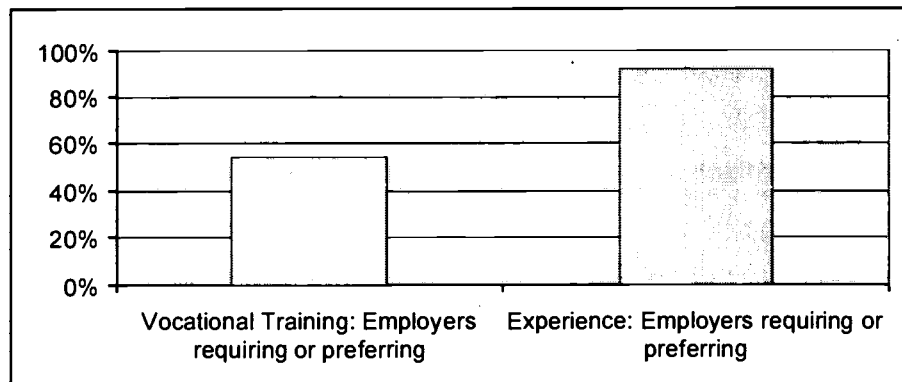

Fifty-four percent of the employers reported requiring or preferring technical or vocational training prior to employment, while 92 percent reported requiring or preferring prior experience in this occupation for their new hires.

BEST COPY AVAILABLE

## COMPUTER SUPPORT SPECIALISTS

### Supply and Demand

Q: How difficult is it for your firm to find fully qualified experienced applicants?

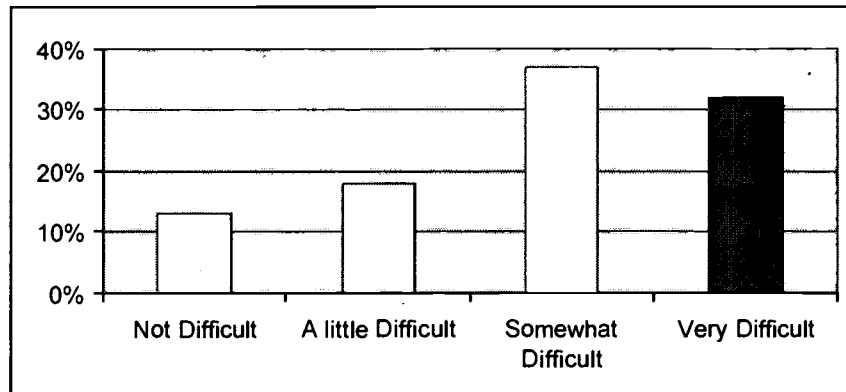

Thirty-one percent of employers reported that it was not difficult or a little difficult to find **experienced** applicants for Computer Support Specialist vacancies. Sixty-nine percent reported that it was somewhat or very difficult to find **experienced** applicants.

Q: How difficult is it for your firm to find fully qualified inexperienced applicants?

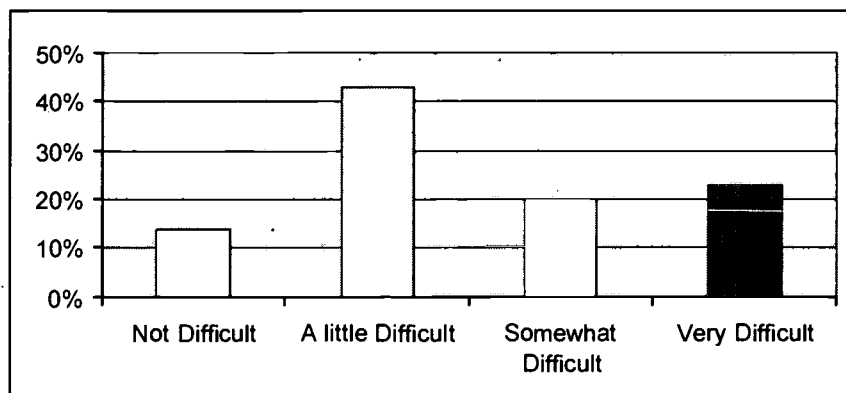

Fifty-seven percent of employers reported that it was not difficult or a little difficult to find **inexperienced** applicants for Computer Support Specialist vacancies. Forty-three percent reported that it was somewhat or very difficult to find **inexperienced** applicants.

## COMPUTER SUPPORT SPECIALISTS

### Growth

*Q: During the last 12 months, did your firm's employment of Computer Support Specialists grow, remain stable, or decline?*

*Q: Over the next 24 months, will your firm's employment of Computer Support Specialists grow, remain stable, or decline?*

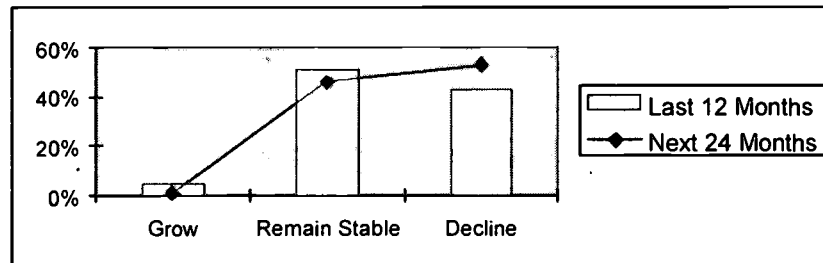

Five percent of employers reported that the number of Computer Support Specialists they employed increased during the 12 months prior to the survey. In contrast, 43 percent reported that employment in this occupation declined during the period. Over the next 24 months, one percent of employers expected growth in employment of this occupation, while 53 percent anticipated decline in employment.

### Openings Filled

*Q: How many Computer Support Specialists were hired to fill new permanent positions resulting from growth, vacancies resulting from promotions, vacancies resulting from people in permanent positions leaving your firm, and temporary, on-call or seasonal positions in the last 12 months?*

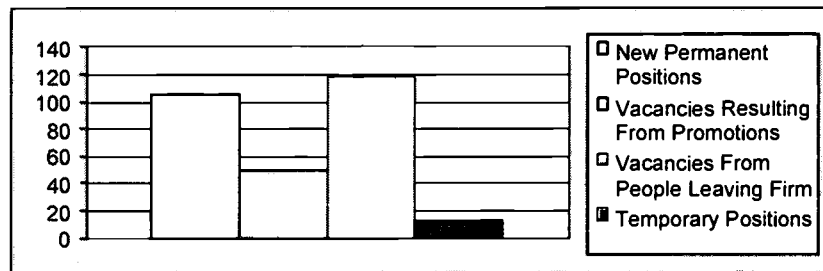

The firms surveyed hired 287 Computer Support Specialists in the 12 months preceding the survey. This represents 30 percent of the total number of Computer Support Specialists employed by the responding firms. One hundred fifty-five Computer Support Specialists were hired to fill new positions or vacancies left by people who had been promoted within the firm. One hundred thirty-two Computer Support Specialists were hired to fill vacancies created by people leaving the firm or temporary positions.

## COMPUTER SUPPORT SPECIALISTS

### Where The Jobs Are

The 132 Bay Area firms that participated in the survey of this occupation employed 958 computer support specialists. The firms surveyed represent 59 different industries. These industries are shown in Appendix C.

*Q: What industries are most likely to hire Computer Support Specialists?*

The graph below shows which industries in our sample most frequently reported employing Computer Support Specialists.

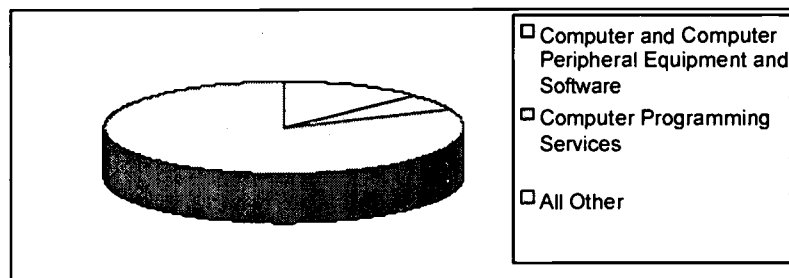

Approximately 20 percent of the firms that provided information about Computer Support Specialists are classified in two industries. Thirteen percent are wholesalers of computer and computer peripheral equipment and software, and six percent provide computer programming services. The balance of firms represented in this survey are found in a wide variety of industries.

*Q: Which industries have the greatest concentration of this occupation?*

The graph below shows the industries in our sample that employed the greatest concentration of Computer Support Specialists.

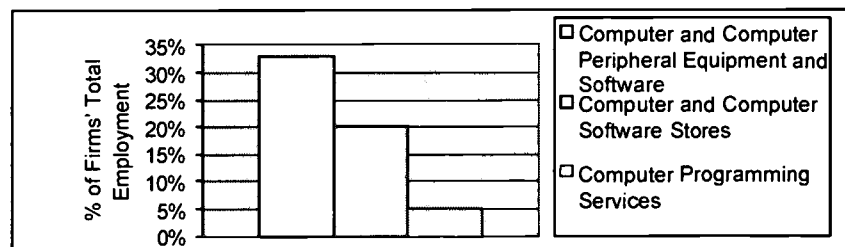

Computer Support Specialists account for 33 percent of the workforce in firms that sell wholesale computer and computer peripheral equipment and software. They also account for 20 percent of the workforce in Computer and Computer Software Stores, and five percent of the workforce in firms that provide computer programming

## COMPUTER SUPPORT SPECIALISTS

### Estimates of Employment in These Industries

*Q: How many Computer Support Specialists are employed in these industries?*

If the employment that we found in our sample is representative of the entire Bay Area, we can estimate that these three industries employ about 12,600 Computer Support Specialists in the 12-county region. The estimates for each industry follow.

	<u>Estimated Occ Employment</u>	<u>Total Industry Employment</u>
Computer and Computer Peripheral Equipment Wholesalers	7,600	23,000
Computer Programming Services Firms	3,100	61,000
Computer and Computer Software Stores	<u>1,900</u>	<u>9,500</u>
Totals	12,600	93,500

BEST COPY AVAILABLE



## GRAPHIC DESIGNERS

# GRAPHIC DESIGNERS

Non-OES 141061998

## Job Description

Graphic Designers create original artwork using computer layout and design to visually enhance a product, concept, or message. Graphic Designers work closely with Project Managers in advertising and marketing departments.

## Job Titles

*Q: What job titles does your firm use for these duties?*

The most frequently cited job titles used by employers surveyed that apply to this job description are:

- Art Director
- Designer
- Graphic Designer
- Production Artist
- Graphic Artist

See Appendix B for the list of all job titles used.

## Career Ladder

*Q: Does your firm ever promote Graphic Designers to higher level positions? If yes, what are the titles of the positions to which they are promoted?*

Most employers stated that promotional opportunities existed for their Graphic Designers. The most frequently mentioned promotional titles were:

- Art Director
- Creative Director
- Manager
- Production Manager
- Senior Designer
- Supervisor

*Q: What skills are important for career advancement?*

The skills required for career advancement most frequently cited were:

- Communication
- Creativity
- Design
- Leadership
- Management
- Interpersonal
- Artistic Skills

BEST COPY AVAILABLE

## GRAPHIC DESIGNERS

### Hours Worked

*Q: How many hours do the Graphic Designers you employ work each week?*

Eighty-eight percent of the Graphic Designers represented in this survey worked full time. They averaged 40 hours per week, with a range of 35 to 50 hours per week. Nine percent of the Graphic Designers worked part time. They averaged 20 hours per week.

### Compensation

#### Wages

*Q: What is the usual income earned by your firm's Graphic Designers at these levels of experience?*

EMPLOYEE EXPERIENCE LEVEL	RANGE	MEDIAN
New Hires with No Experience	\$ 7.00 to \$ 19.18	\$ 11.99
New Hires with Experience	\$ 7.00 to \$ 26.37	\$ 15.00
3 Yrs + Experience with Firm	\$ 10.00 to \$ 40.00	\$ 19.18

#### Benefits

*Q: Which benefits does your firm offer its full-time Graphic Designers, and who pays for them?*

BENEFIT	EMPLOYER PAYS ALL	COST SHARED	EMPLOYEE PAYS ALL	NOT PROVIDED
Vacation	85%	5%	-	10%
Sick Leave	74%	6%	-	20%
Retirement	23%	37%	7%	33%
Medical	46%	44%	-	9%
Dental	33%	40%	2%	25%
Vision	27%	30%	2%	41%
Life	27%	21%	5%	47%
Child Care	-	2%	9%	90%

# GRAPHIC DESIGNERS

## Employer Requirements

### Education

Q: *What is the minimum level of education your firm requires when hiring a Graphic Designer?*

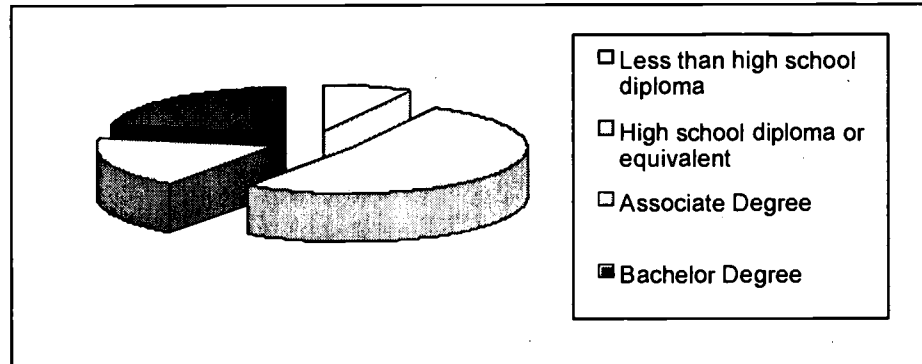

Sixty percent of responding employers do not require the Graphic Designers they hire to have more than a High School Diploma. Forty percent of employers required an Associate or Bachelor Degree.

### Vocational Training

Q: *Is technical or vocational training required prior to employment as a Graphic Designer? If yes or preferred, what kind of training is required?*

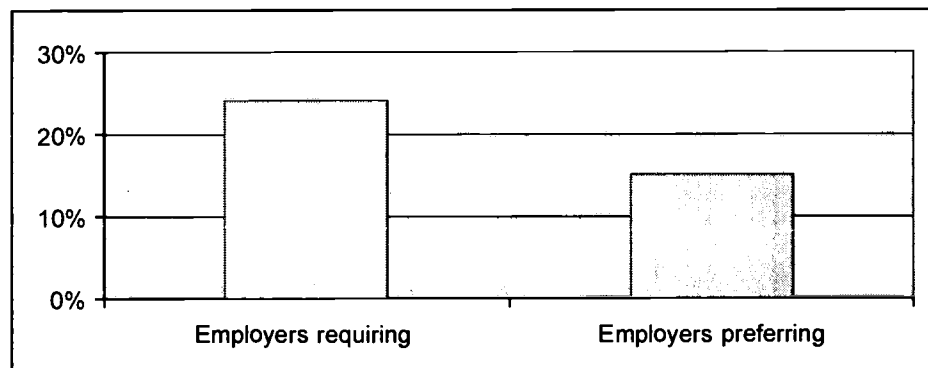

Twenty-four percent of the responding employers reported that they require technical or vocational education prior to employment and 15 percent preferred that new hires have it. Employers most frequently required Graphic Design, Graphic Art, Design, and Adobe Photoshop training. The average period of training required was 22 months.

## GRAPHIC DESIGNERS

### Employer Requirements (Continued)

#### Experience

Q. When you hire Graphic Designers, is prior experience in this occupation required?

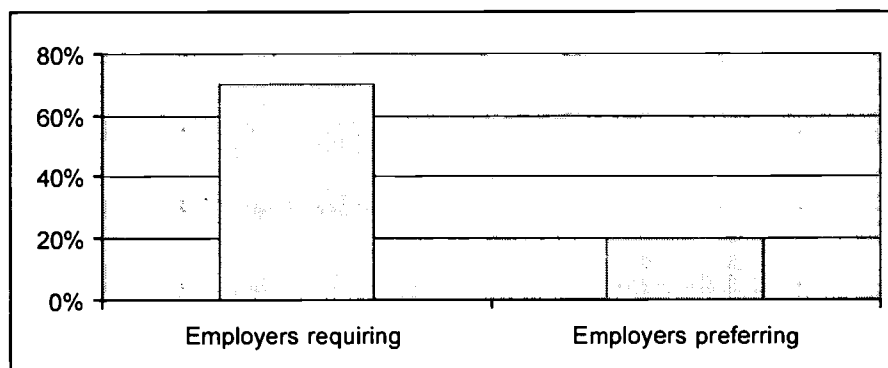

Seventy percent of the employers reported requiring prior experience in this occupation for their new hires and 20 percent preferred it. The average amount of experience required was 22 months.

#### Vocational Training vs. Experience

Q. Is vocational training or experience more frequently required by employers when they hire Graphic Designers?

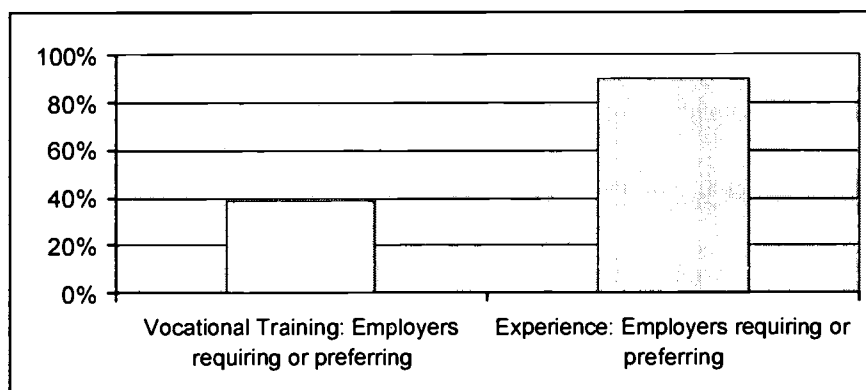

Thirty-nine of the employers reported requiring or preferring technical or vocational training prior to employment, while 90 percent reported requiring or preferring prior experience in this occupation for their new hires.

## GRAPHIC DESIGNERS

### Supply and Demand

Q. How difficult is it for your firm to find fully qualified experienced applicants?

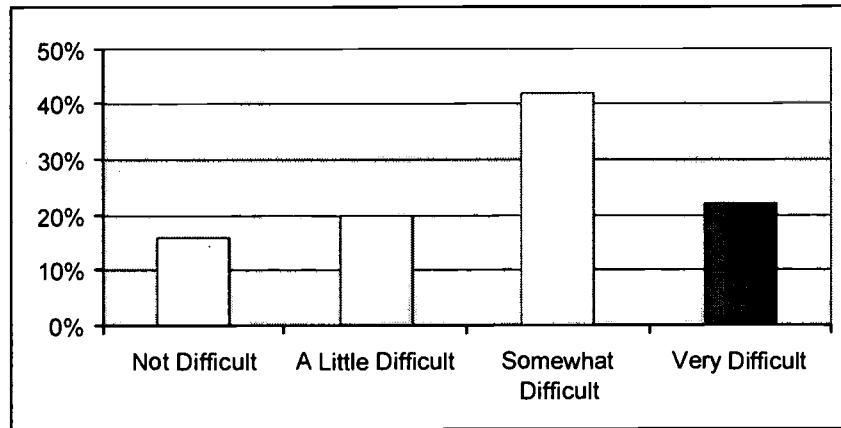

Thirty-six percent of employers reported that it was not difficult or a little difficult to find **experienced** applicants for Graphic Designer vacancies. Sixty-four percent reported that it was somewhat or very difficult to find **experienced** applicants.

Q. How difficult is it for your firm to find fully qualified inexperienced applicants?

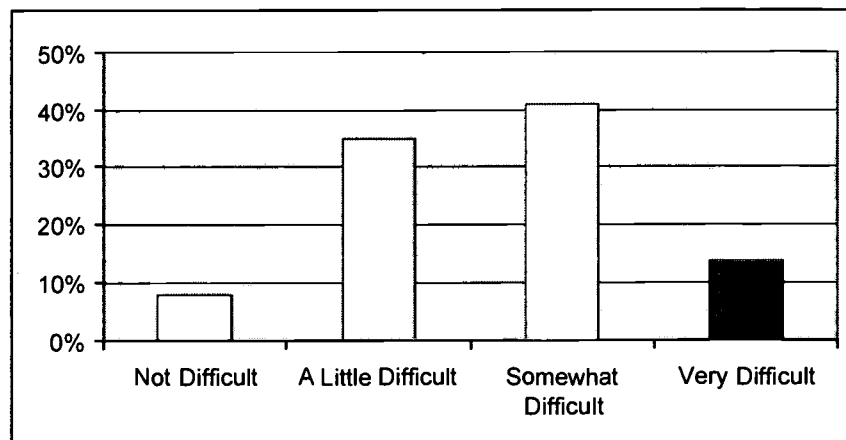

Forty-four percent of employers reported that it was not difficult or a little difficult to find **inexperienced** applicants for Graphic Designer vacancies. Fifty-six percent reported that it was somewhat or very difficult to find **inexperienced** applicants.

## GRAPHIC DESIGNERS

### Growth

Q: During the last 12 months, did your firm's employment of Graphic Designers grow, remain stable, or decline?

Q: Over the next 24 months, will your firm's employment of Graphic Designers grow, remain stable, or decline?

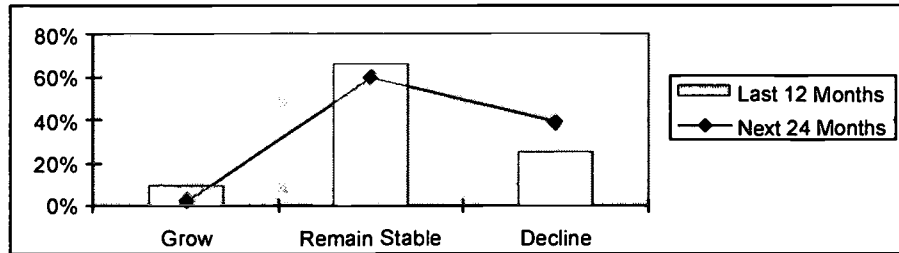

Nine percent of employers reported that the number of Graphic Designers they employed increased during the 12 months prior to the survey. In the contrast, 25 percent reported that employment in this occupation declined during the period. Over the next 24 months, two percent of employers expected growth in employment of this occupation, while 39 percent anticipated decline in employment. The majority of employers reported that employment in this occupation has been and will remain stable.

### Openings Filled

Q: How many Graphic Designers were hired to fill new permanent positions resulting from growth, vacancies resulting from promotions, vacancies resulting from people in permanent positions leaving your firm, and temporary, on-call or seasonal positions in the last 12 months?

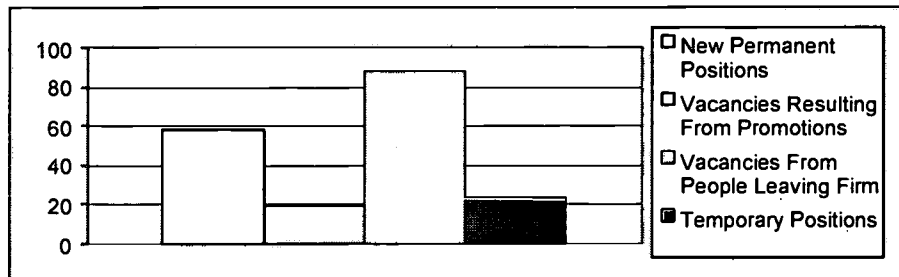

The firms surveyed hired 187 Graphic Designers in the 12 months preceding the survey. This represents 37 percent of the total number of Graphic Designers employed by the responding firms. Seventy-seven Graphic Designers were hired to fill new positions or vacancies left by people who had been promoted within the firm. One hundred ten Graphic Designers were hired to fill vacancies created by people leaving the firm or temporary positions.

# GRAPHIC DESIGNERS

## Where The Jobs Are

The 123 Bay Area firms that participated in the survey of this occupation employed 510 Graphic Designers. The firms surveyed represent 28 different industries. These industries are shown in Appendix C.

*Q: What industries are most likely to hire Graphic Designers?*

The graph below shows which industries in our sample most frequently reported employing Graphic Designers.

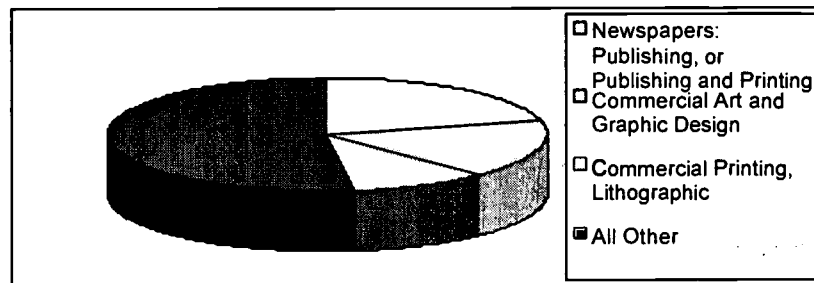

Approximately one-half of the firms that provided information about Graphic Designers are classified into three industries. Twenty-one percent of the employers responding to the survey publish or publish and print newspapers, 17 percent provide commercial art or graphic design services, and 10 percent are engaged in printing by the lithographic process.

*Q: Which industries have the greatest concentration of this occupation?*

The graph below shows the industries in our sample that employed the greatest concentration of Graphic Designers.

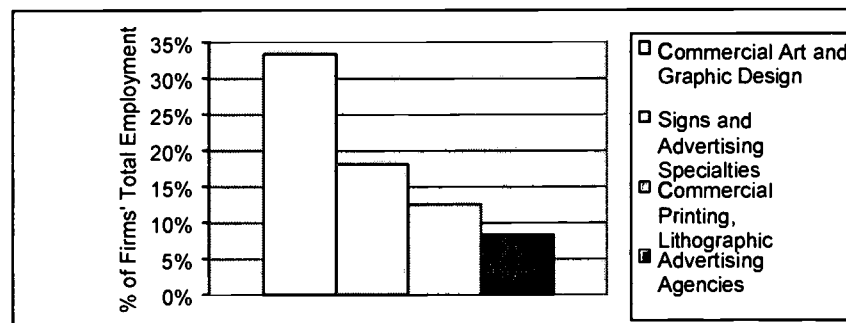

Graphic Designers account for 33 percent of the workforce in firms that provide commercial art or graphic design services, and 18 percent of the workforce in manufacturers of signs and advertising displays. They also account for 13 percent of the workforce in firms engaged in printing by the lithographic process, and eight percent of the total workforce in advertising agencies.



# GRAPHIC DESIGNERS

**Estimates of  
Employment  
in These  
Industries**

*Q: How many Graphic Designers are employed in these industries?*

If the employment that we found in our sample is representative of the entire Bay Area, we can estimate that these four industries employ about 3,400 Graphic Designers in the 12-county region. The estimates for each industry follow.

	<u>Estimated Occ Employment</u>	<u>Total Industry Employment</u>
Commercial Art and Graphic Design Services Firms	1,800	5,500
Commercial Lithographic Printing Firms	1,000	7,800
Advertising Agencies	400	5,500
Signs and Advertising Specialties Firms	<u>200</u>	<u>1,000</u>
Totals	3,400	19,800

BEST COPY AVAILABLE

## **INTERNET WEB SITE DESIGNERS AND DEVELOPERS (WEBMASTERS)**

# INTERNET WEB SITE DESIGNERS AND DEVELOPERS (WEBMASTERS)

Non-OES 031064999

## Job Description

Internet Web Site Designers/Developers (Webmasters) are responsible for managing the content of an organization's Internet web site. Usually using specialized software, they create, design and maintain web pages to communicate an organization's message to Internet users.

## Job Titles

*Q: What job titles does your firm use for these duties?*

The most frequently cited job titles used by employers surveyed that apply to this job description are:

- Web(site) Designer
- Web Developer
- Webmaster

See Appendix B for the list of all job titles used.

## Career Ladder

*Q: Does your firm ever promote Webmasters to higher level positions? If yes, what are the titles of the positions to which they are promoted?*

Most employers stated that promotional opportunities existed for their Webmasters. The most frequently mentioned promotional titles were:

- Manager
- Project Manager
- IT Manager
- Director
- Senior Webmaster
- Senior Designer
- Marketing
- Supervisor

*Q: What skills are important for career advancement?*

The skills required for career advancement most frequently cited were:

- Leadership
- HTML
- Technical
- Management
- Creativity
- Programming
- Communication
- Java Script

## INTERNET WEB SITE DESIGNERS AND DEVELOPERS (WEBMASTERS)

### Hours Worked

*Q: How many hours do the Webmasters you employ work each week?*

Ninety percent of the Webmasters represented in this survey worked full time. They averaged 41 hours per week, with a range of 38 to 55 hours per week. Eight percent of the Webmasters worked part time. They averaged 19 hours per week.

### Compensation

#### Wages

*Q: What is the usual income earned by your firm's Webmasters at these levels of experience?*

EMPLOYEE EXPERIENCE LEVEL	RANGE	MEDIAN
New Hires with No Experience	\$ 6.75 to \$ 40.00	\$ 20.00
New Hires with Experience	\$ 6.75 to \$ 50.47	\$ 21.58
3 Yrs + Experience with Firm	\$ 10.00 to \$ 70.00	\$ 28.77

#### Benefits

*Q: Which benefits does your firm offer its full-time Webmasters, and who pays for them?*

BENEFIT	EMPLOYER PAYS ALL	COST SHARED	EMPLOYEE PAYS ALL	NOT PROVIDED
Vacation	91%	1%	1%	7%
Sick Leave	85%	1%	1%	13%
Retirement	38%	35%	4%	23%
Medical	65%	27%	1%	7%
Dental	60%	21%	2%	17%
Vision	55%	20%	-	25%
Life	67%	9%	2%	22%
Child Care	4%	2%	16%	78%

BEST COPY AVAILABLE

# INTERNET WEB SITE DESIGNERS AND DEVELOPERS (WEBMASTERS)

## Employer Requirements

### Education and Training

Q: *What is the minimum level of education your firm requires when hiring a Webmaster?*

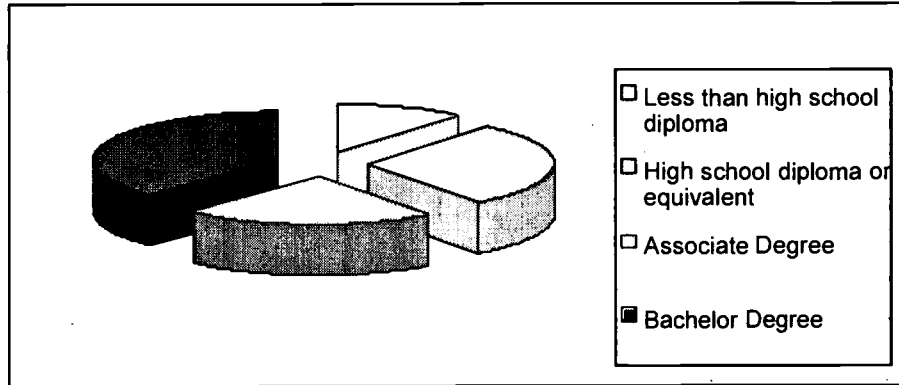

Forty percent of responding employers do not require the Webmasters they hire to have more than a High School Diploma. Sixty percent of employers required an Associate or Bachelor Degree.

### Vocational Training

Q: *Is technical or vocational training required prior to employment as a Webmaster? If yes or preferred, what kind of training is required?*

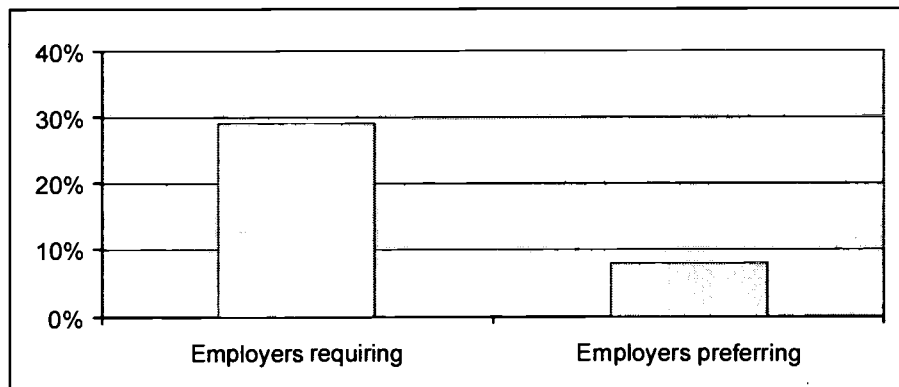

Twenty-nine percent of the responding employers reported that they require technical or vocational education prior to employment and eight percent preferred that new hires have it. Employers most frequently required Web Design/Web Coursework and HTML training. The average period of training required was 13 months.

BEST COPY AVAILABLE

# INTERNET WEB SITE DESIGNERS AND DEVELOPERS (WEBMASTERS)

## Employer Requirements (Continued)

### Experience

Q: *When you hire Webmasters, is prior experience in this occupation required?*

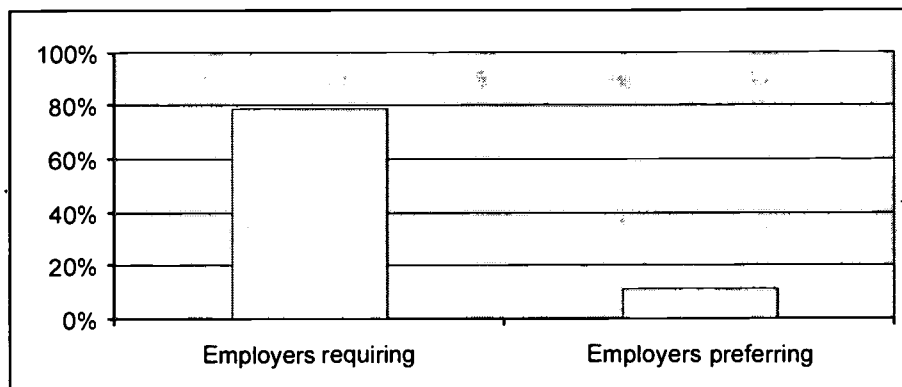

Seventy-nine percent of the employers reported requiring prior experience in this occupation for their new hires and 11 percent preferred it. The average amount of experience required was 21 months.

### Vocational Training vs. Experience

*Is vocational training or experience more frequently required when employers hire Webmasters?*

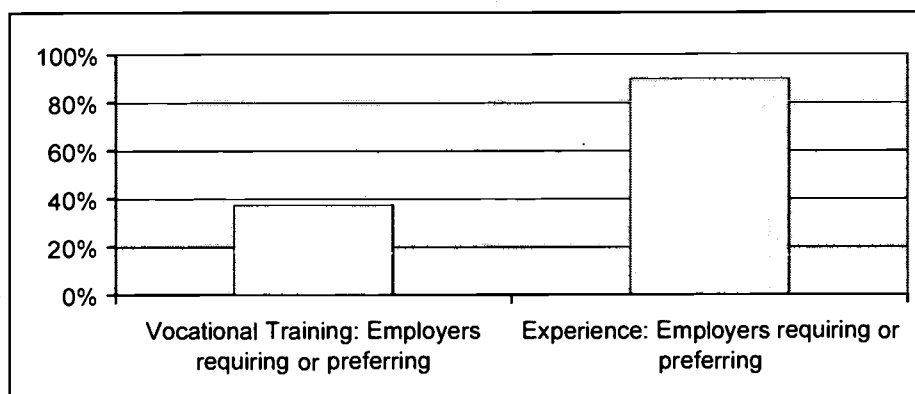

Thirty-seven percent of the employers reported requiring or preferring technical or vocational training prior to employment, while 90 percent reported requiring or preferring prior experience in this occupation for their new hires.

BEST COPY AVAILABLE

# INTERNET WEB SITE DESIGNERS AND DEVELOPERS (WEBMASTERS)

Supply  
and  
Demand

Q: How difficult is it for your firm to find fully qualified experienced applicants?

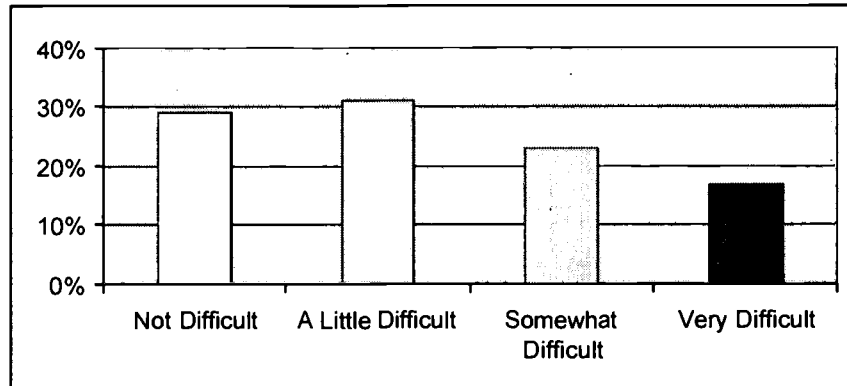

Sixty percent of employers reported that it was not difficult or a little difficult to find **experienced** applicants for Webmaster vacancies. Forty percent reported that it was somewhat or very difficult to find **experienced** applicants.

Q: How difficult is it for your firm to find fully qualified inexperienced applicants?

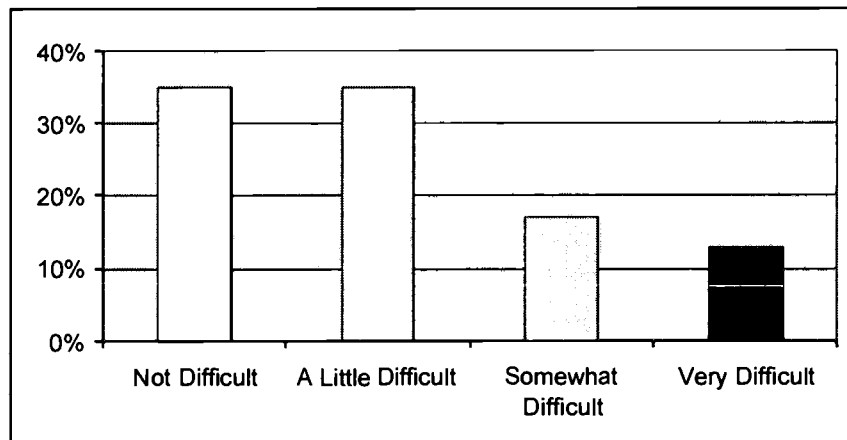

Seventy percent of employers reported that it was not difficult or a little difficult to find **inexperienced** applicants for Webmaster vacancies. Thirty percent reported that it was somewhat or very difficult to find **inexperienced** applicants.

BEST COPY AVAILABLE

## INTERNET WEB SITE DESIGNERS AND DEVELOPERS (WEBMASTERS)

### Growth

Q: During the last 12 months, did your firm's employment of Webmasters grow, remain stable, or decline?

Q: Over the next 24 months, will your firm's employment of Webmasters grow, remain stable, or decline?

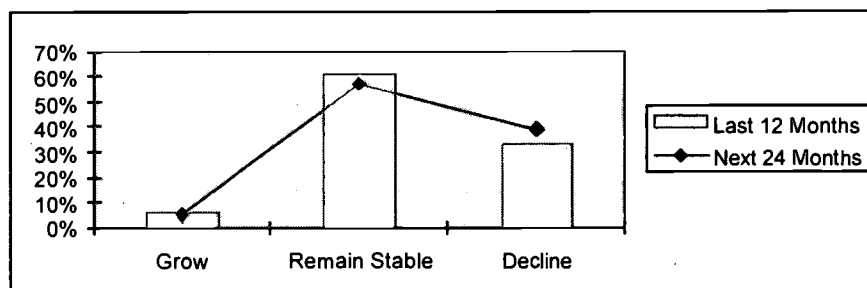

Six percent of employers reported that the number of Webmasters they employed increased during the 12 months prior to the survey. In contrast, 33 percent reported that employment in this occupation declined during the period. Over the next 24 months, five percent of employers expected growth in employment of this occupation, while 39 percent anticipated decline in employment. The majority of employers reported that employment in this occupation has been and will remain stable.

### Openings Filled

Q: How many Webmasters were hired to fill new permanent positions resulting from growth, vacancies resulting from promotions, vacancies resulting from people in permanent positions leaving your firm, and temporary, on-call or seasonal positions in the last 12 months?

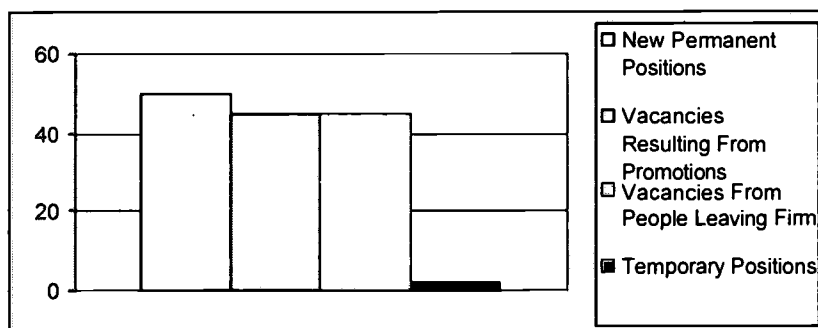

The firms surveyed hired 142 Webmasters in the 12 months preceding the survey. This represents 39 percent of the total number of Webmasters employed by the responding firms. Ninety-five Webmasters were hired to fill new positions or vacancies left by people who had been promoted within the firm. Forty-seven Webmasters were hired to fill vacancies created by people leaving the firm or temporary positions.



# INTERNET WEB SITE DESIGNERS AND DEVELOPERS (WEBMASTERS)

## Where The Jobs Are

The 107 Bay Area firms that participated in the survey of this occupation employed 364 Webmasters. The firms surveyed were classified in 37 different industries. These industries are shown in Appendix C.

*Q: What industries are most likely to hire Webmasters?*

The graph below shows which industries in our sample most frequently reported employing Webmasters.

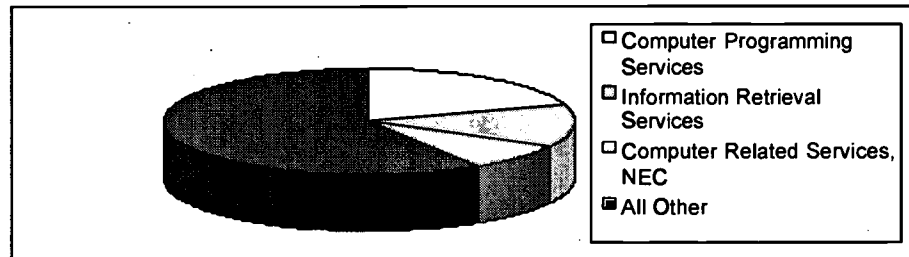

Approximately 40 percent of the firms that provided information about Webmasters are classified into three industries. Twenty percent provide computer programming services, and 13 percent provide information retrieval services. Eight percent supply computer related services that are not elsewhere classified such as computer consultants and database developers.

*Q: Which industries have the greatest concentration of this occupation?*

The graph below shows the industries in our sample that employed the greatest concentration of Webmasters.

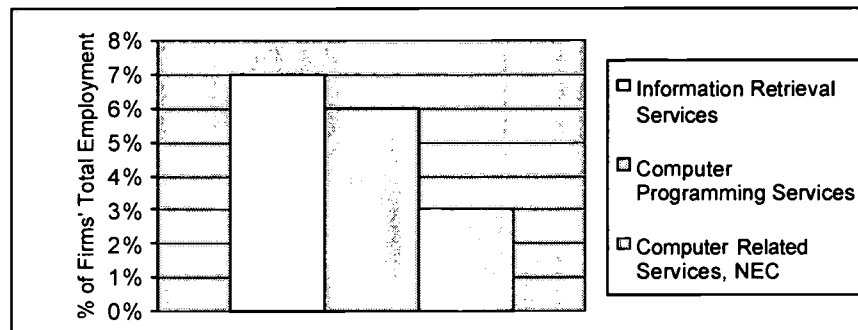

Webmasters account for seven percent of the workforce in firms that provide information retrieval services, and six percent of the workforce in firms that provide computer programming services. They also account for three percent of the workforce in firms that supply computer related service that are not elsewhere classified such as computer consultants and database developers.

BEST COPY AVAILABLE

## INTERNET WEB SITE DESIGNERS AND DEVELOPERS (WEBMASTERS)

**Estimates of  
Employment  
in These  
Industries**

*Q: How many Webmasters are employed in these industries?*

If the employment that we found in our sample is representative of the entire Bay Area, we can estimate that these three industries employ about 6,500 Webmasters in the 12-county region. The estimates for each industry follow.

	<u>Estimated Occ Employment</u>	<u>Total Industry Employment</u>
Computer Programming Services Firms	3,700	61,000
Information Retrieval Services Firms	2,000	28,700
Computer Related Services Firms, NEC (e.g. Computer Consultants, and Database Developers)	<u>800</u>	<u>24,900</u>
Totals	6,500	114,600

BEST COPY AVAILABLE

**APPENDIX A**  
**QUESTIONNAIRE USED**

# APPENDIX A

## QUESTIONNAIRE USED

Does your firm employ any individual performing the duties in the occupation described above?  
 ? Yes ? No

If yes, please complete this survey for the occupation described.  
 If no, please return this questionnaire to the above address.

1. What job title(s) does your firm use for **these duties**?

\_\_\_\_\_

2a. How many employees does your firm currently have in **this occupation**? \_\_\_\_\_

2b. In **this occupation**, how many are: Male? \_\_\_\_\_ Female? \_\_\_\_\_

2c. In **this occupation**, how many current employees are there, and, on average, how many weekly hours do they work?

Regular, Full Time: _____	Average Weekly Hours Worked: _____
Regular, Part Time: _____	Average Weekly Hours Worked: _____
Temporary/On Call: _____	Average Weekly Hours Worked: _____
Seasonal: _____	Average Weekly Hours Worked: _____

3. In your firm, what shifts are available for **this occupation**? (check all that apply)

? Day ? Swing ? Graveyard ? Other (Please specify): \_\_\_\_\_

4. Has your firm hired in **this occupation** within the last 12 months? ? Yes ? No

If yes,

How many were hired to fill vacancies resulting from promotions within your firm?

\_\_\_\_\_

How many were hired to fill vacancies resulting from people in permanent positions leaving your firm?

\_\_\_\_\_

How many were hired to fill new permanent positions resulting from growth?

\_\_\_\_\_

How many were hired to fill temporary, on call, or seasonal positions?

\_\_\_\_\_

5a. During the last 12 months, did your firm's employment in **this occupation**: (Check one)

? Decline ? Remain Stable ? Grow

5b. Over the next 24 months, do you expect your firm's employment in **this occupation** to: (Check one)

? Decline ? Remain Stable ? Grow

6a. When you hire applicants for **this occupation**, is prior experience in this occupation required?

? Yes ? No ? Not required, but preferred

If **yes** or **preferred**, how much experience in **this occupation** is required/preferred? \_\_\_\_\_ (months)

6b. Is experience in other occupations accepted? ? Yes ? No

If yes, please specify: Occupation: \_\_\_\_\_ (months)

7. If prior experience is required when you hire applicants for **this occupation**, please indicate how difficult it is for your firm to find fully qualified applicants. (Circle one)

Not Difficult    1    2    3    4    Difficult

# APPENDIX A

## QUESTIONNAIRE USED

8. If prior experience is not required when you hire applicants for **this occupation**, please indicate how difficult it is for your firm to find qualified applicants. (Circle one)

Not Difficult      1      2      3      4      Difficult

9. Does your firm accept training as a substitute for experience in **this occupation**? ? Yes ? No

If yes, how many months of training can generally be substituted? \_\_\_\_\_ (months)

10. Is technical or vocational training required prior to employment in **this occupation**?

? Yes ? No ? Not required, but preferred

If yes or preferred, what kind of training is **required**? \_\_\_\_\_ (months)

11. What is the minimum level of education your firm **requires** when hiring an applicant in **this occupation**? (Check one).

? Less than high school diploma      ? High school diploma or equivalent  
 ? Associate Degree (2 year)      ? Bachelor Degree (4 year)      ? Graduate Study

12a. What is the usual income earned by your firm's employees in **this occupation** at the following levels of skill and experience?

	Base Wage or Salary
New hires, no experience (trained or untrained):	\$ _____
New hires who are experienced:	\$ _____
Experienced employees after 3 years:	\$ _____
Please check one: ? Hour ? Week ? Month ? Year	

12b. For other compensation, if applicable, please indicate the average overall earnings and types(s) of compensation.

New hires, no experience (trained or untrained):	\$ _____
New hires who are experienced:	\$ _____
Experienced employees after 3 years:	\$ _____
Please check one: ? Hour ? Week ? Month ? Year	
Type of Compensation: ? Commission ? Tips ? Bonus ? Piece Rate	
? Other (Please specify): _____	

13. Are the wages for employees in **this occupation** subject to a collective bargaining or union agreement? ? Yes ? No

If yes, what is the name of the union or local number?

14. Please check which benefits your firm offers full-time (FT) and part-time (PT) employees in **this occupation** and which best describes who pays for them:

	Employer Pays All		Share Cost		Employee Pays All		Not Provided	
	FT	PT	FT	PT	FT	PT	FT	PT
Medical Insurance	?	?	?	?	?	?	?	?
Dental Insurance	?	?	?	?	?	?	?	?
Vision Insurance	?	?	?	?	?	?	?	?
Life Insurance	?	?	?	?	?	?	?	?
Sick Leave	?	?	?	?	?	?	?	?
Vacation	?	?	?	?	?	?	?	?
Retirement Plan	?	?	?	?	?	?	?	?
Child Care	?	?	?	?	?	?	?	?
Other (Please Specify):	?	?	?	?	?	?	?	?

# APPENDIX A

## QUESTIONNAIRE USED

15a. Does your firm ever promote employees in **this occupation** to higher level positions?

? Yes ? No

If yes, what are the titles of the positions to which they may be promoted?

\_\_\_\_\_

\_\_\_\_\_

15b. What skills are important for career advancement?

\_\_\_\_\_

\_\_\_\_\_

15c. Does your firm ever promote employees into this occupation from **lower level** positions?

? Yes ? No

If yes, what are the career paths that can lead to this occupation?

\_\_\_\_\_

\_\_\_\_\_

16. What computer software skills, if any, does your firm seek in applicants for **this occupation**? (Check all that apply)

? None ? Word Processing ? Spreadsheet ? Database

? Desktop Publishing ? Other

Specify software names: \_\_\_\_\_

\_\_\_\_\_

17. What other new skills are needed to perform the duties of this occupation?

\_\_\_\_\_

18. When your firm hires employees for **this occupation**, which are the **top three** most successful recruitment methods?

? In-house promotions or transfers	? Newspaper ads	? Internet
? EDD	? Walk-in applicants	? Colleges/Universities
? School/program referrals	? Union hall referrals	? Employee referrals
? Private employment agencies	? Trade journals	? Other (Please specify):

19. Are you aware of any new, changing, or emerging occupations in your industry? ? Yes ? No

If yes, please specify:

\_\_\_\_\_

\_\_\_\_\_

20. Do you have an employee in this occupation that is both skilled and articulate? If so, may we contact him/her to discuss the possibility of a brief 'Career Dialogue' interview that may be published in our Occupational Outlook & Training Directory?

Name: \_\_\_\_\_ Phone: \_\_\_\_\_

**Thank you for your participation in this CCOIS survey!**

**APPENDIX B**  
**ALTERNATE JOB TITLES FOR OCCUPATION SURVEYED**

## APPENDIX B

### JOB TITLES USED FOR EACH OCCUPATION SURVEYED

#### Computer Aided Design (CAD) Technicians

Job Title	Number of Employers*
ARCHITECTURAL TECHNICIAN	1
ASSOCIATE PLANNER	1
CAD	7
CAD DESIGNER	8
CAD DRAFTER	6
CAD DRAFTSMAN	1
CAD DRAFTSPERSON	1
CAD ENGINEER	2
CAD OPERATOR	5
CAD PLANNER	1
CAD TECHNICIAN	17
CAD/CAM	1
CAD/SURVEYOR TECHNICIAN	1
CADD MANAGER	1
CADD OPERATOR	1
CADD SPECIALIST	1
CADD/GRAPHICS	1
CIVIL ENGINEER	1
COMPUTER TECHNICIAN	1
DESIGN ASSISTANT	1
DESIGNER	2
DRAFTER	4
DRAFTSMAN	1
DRAFTSPERSON	1
ENGINEER	1
ENGINEERING TECHNICIAN	1
INTERMEDIATE DESIGNER	1
JUNIOR DESIGNER	2
JUNIOR DRAFTSMAN	2
MASK DESIGNER	1
PCB DESIGNER	1
PROJECT CAD SPECIALIST	1
PROJECT DESIGNER	1
PROJECT MANAGER	1
SENIOR CAD SPECIALIST	1
SENIOR DESIGNER	2
SENIOR DRAFTER	2
SENIOR DRAFTSMAN	1
SENIOR PLANNER	1

\* Some employers reported using more than one job title for this occupation.



## APPENDIX B

### JOB TITLES USED FOR EACH OCCUPATION SURVEYED

#### Computer and Software Support Technicians

Job Title	Number of Employers*
APPLICATION SUPPORT TECHNICIAN	1
APPLICATION ENGINEER	1
APPLICATION SUPPORT TECHNICIAN	1
BENCH TECHNICIAN	1
COMPUTER AND SOFTWARE SUPPORT	1
COMPUTER AND SOFTWARE SUPPORT TECHNICIAN	3
COMPUTER OPERATOR	2
COMPUTER SPECIALIST	1
COMPUTER SUPPORT	2
COMPUTER SUPPORT TECHNICIAN	1
COMPUTER SYSTEMS TECHNCIAN	1
COMPUTER TECHNICIAN	6
CUSTOMER SUPPORT TECHNICIAN	1
DATA COMMUNICATIONS TECHNICIAN	1
DESK TOP TECHNICIAN	1
DISTRICT TECHNICIAN	1
FIELD SERVICE TECHNICIAN	1
HELP DESK OPERATOR	2
HELP DESK SUPPORT	1
HELP DESK TECHNICIAN	1
INFORMATION SERVICES ADMINISTRATOR	2
INFORMATION SERVICES TECHNOLOGIST	1
INFORMATION SYSTEM TECHNICIAN	2
INFORMATION SYSTEMS SPECIALIST	1
INFORMATION SYSTEMS TECHNICIAN	1
INSTRUCTIONAL TECHNICIANS	1
IT ENGINEER	1
IT SUPPORT	1
JUNIOR PROGRAMMER	1
LEARNING NETWORK SPECIALIST	1
MEDIA SPECIALIST	1
MICROCOMPUTER SUPPORT SPECIALIST	1
MICROCOMPUTER TECHNICIAN	1
MIS	1
MIS COMPUTER OPERATOR	1
NETWORK ADMINISTRATOR	2
NETWORK SPECIALIST	1
NETWORK SPECIALIST TRAINEE	1
NETWORK TECHNICIAN	3

\* Some employers reported using more than one job title for this occupation.

## APPENDIX B

### JOB TITLES USED FOR EACH OCCUPATION SURVEYED

#### Computer and Software Support Technicians

Job Title	Number of Employers*
OPERATIONS MANAGER	1
PC TECHNICIAN	1
PRODUCT TECHNICAL SUPPORT	1
SENIOR APPLICATIONS ENGINEER	1
SENIOR NETWORK SPECIALIST	1
SERVICE TECHNICIAN	1
SOFTWARE SUPPORT	2
SOFTWARE TECHNICIAN	2
SUPPORT SPECIALIST	1
SUPPORT TECHNICIAN	2
SYSTEM ADMINISTRATOR	1
SYSTEM ANALYST	1
SYSTEMS ANALYST	1
SYSTEMS ENGINEER	1
TECH SUPPORT	1
TECHNICAL SUPPORT ADMINISTRATOR	1
TECHNOLOGY SPECIALIST	1
TECHNOLOGY TECHNICIAN	1
TECHNOLOGY SUPPORT SPECIALIST	1
UNIX SYSTEM ADMINISTRATOR	1

\* Some employers reported using more than one job title for this occupation.

BEST COPY AVAILABLE

## APPENDIX B

### JOB TITLES USED FOR EACH OCCUPATION SURVEYED

#### Computer Network Technicians

Job Title	Number of Employers*
ASSOCIATE INFORMATION SYSTEMS ANALYST	1
ASSOCIATE SYSTEM ADMINISTRATOR	1
CIS NETWORK COORDINATOR	1
COMMUNICATION SPECIALIST	1
COMPUTER NETWORK TECHNICIAN	16
COMPUTER ENGINEER	1
COMPUTER OPERATIONS	1
COMPUTER SPECIALIST	2
COMPUTER SUPPORT TECHNICIAN	1
COMPUTER TECHNICIAN	13
DCM	1
DESK TOP TECHNICIAN	1
DIRECTOR OF TECHNOLOGY	1
DISTRICT COMPUTER TECHNICIAN	1
DISTRICT TECHNOLOGY SUPPORT SPECIALIST	1
FIELD TECHNICIAN	1
FIRST LEVEL SUPPORT	1
HARDWARE TECHNICIAN	1
HELP DESK, SYSTEM ADMINISTRATOR	1
INFORMATION SYSTEMS ANALYST	2
INFORMATION SYSTEMS NETWORK TECHNICIAN	1
INFORMATION SYSTEMS SPECIALIST	1
INFORMATION SYSTEMS TECHNICIAN	1
INFORMATION TECHNICIAN	1
INFORMATION TECHNICIAN SPECIALIST	1
INFORMATION TECHNICIANS ANALYST	1
INFORMATION SYSTEMS ASSISTANT	1
IS MANAGER	1
IS SPECIALIST	1
IS TECHNICIAN	3
JUNIOR NETWORK ADMINISTRATOR	1
LAN / WAN SUPPORT TECHNICIAN	1
LAN ADMINISTRATOR	1
MIS TECHNICIAN	1
MUNICIPAL INFORMATION TECHNICIAN	1
NETWORK ADMINISTRATOR	10
NETWORK ANALYST	2
NETWORK COORDINATOR	1
NETWORK DESKTOP CUSTOMER SUPPORT ANALYST	1

\* Some employers reported using more than one job title for this occupation.

## APPENDIX B

### JOB TITLES USED FOR EACH OCCUPATION SURVEYED

#### Computer Network Technicians

Job Title	Number of Employers*
NETWORK ENGINEER	3
NETWORK ENGINEER/REPAIR TECHNICIAN	1
NETWORK SPECIALIST	2
NETWORK TECHICIAN	15
OFFICE MANAGER	2
PC SERVICES COORDINATOR	1
PC TECHNICIAN	3
PROGRAMMER	1
SECURITY ENGINEER	1
SENIOR MIS TECHNICIAN	1
SENIOR R&D ELECTRONICS TECHNICIAN	1
SENIOR TECHNICIAN	1
SOFTWARE NETWORK TECHNICIANS	1
STAFF TECHNICAL SUPPORT, WIDE AND LOCAL	1
SYSTEM ADMINISTRATOR	9
SYSTEM INTEGRATOR	1
SYSTEM TECHNICIAN	1
SYSTEMS ALALYST	2
SYSTEMS ANALYST SPECIALIST	1
SYSTEMS COORDINATOR	1
SYSTEMS MANAGER	1
TECH. ASSISTANT	1
TECHNICAL SUPPORT	2
TECHNICAL SUPPORT SPECIALIST	1
TECHNICIAN	5
TECHNOLOGY ANALYST	1
TECHNOLOGY SPECIALIST	1
USER SUPPORT TECHNICIAN	1

\* Some employers reported using more than one job title for this occupation.

## APPENDIX B

### JOB TITLES USED FOR EACH OCCUPATION SURVEYED

#### Computer Support Specialists

Job Title	Number of Employers*
ASSISTANT ADMINISTRATOR	1
ASSISTANT INFORMATION SYSTEMS ANALYST	1
BENCH TECHNICIAN	2
BRANCH LIASION	1
CAMPUS NETWORK SPECIALIST	1
CAMPUS SPECIALIST	1
CLIENT SUPPORT ANALYST	1
COMPUTER CLIENT SUPPORT ANALYST	1
COMPUTER INFORMATION SPECIALIST	1
COMPUTER OFFICE STAFF	1
COMPUTER OPERATIONS TECHNICIAN	1
COMPUTER SUPPORT	3
COMPUTER SUPPORT SPECIALIST	8
COMPUTER SUPPORT TECHNICIAN	3
COMPUTER TECHNICIAN	4
COMPUTER TELEPHONE TECHNICIAN	1
COMPUTERS OPERATOR	1
CUSTOMER SUPPORT	3
CUSTOMER SUPPORT SPECIALIST	1
DATABASE SUPPORT	1
DESKTOP SUPPORT	1
DIGITAL SOLUTIONS SPECIALIST	1
DISTRICT SOFTWARE TECHNICIAN	1
END USER SUPPORT ANALYST	1
FIELD ENGINEER	3
FIELD TECHNICIAN OR TELEPHONE SUPPORT	1
HARDWARE TECHNICIAN	1
HELP DESK	1
HELP DESK MANAGER	2
HELP DESK TECHNICIAN	2
INFORMATION CENTER ANALYST	1
INFORMATION SYSTEMS ASSISTANT	1
INFORMATION SYSTEMS SUPPORT TECHNICIAN	1
INFORMATION SYSTEMS TECHNICIAN	2
INFORMATION TECHNICAL SUPPORT	1
INFORMATION TECHNOLOGY TECHNICIAN	1
IS	1
IS ANALYST	1
IS ENGINEER	1

\* Some employers reported using more than one job title for this occupation.

## APPENDIX B

### JOB TITLES USED FOR EACH OCCUPATION SURVEYED

#### Computer Support Specialists

Job Title	Number of Employers*
IS TECH SUPPORT SPECILIST	1
IS TECHNICIAN	2
IT	1
JUNIOR BENCH TECHNICIAN	1
JUNIOR SYSTEMS ANALYST	1
LAN ADMINISTRATOR	1
MANAGER OF INFORMATION SERVICES	1
MANAGING INFORMATION SYSTEMS	1
MICROSUPPORT TECHNICIAN	1
MIS	2
MIS ASSISTANT	1
MIS COORDINATOR	1
MIS MANAGER	1
MIS TECHNICIAN	1
NETWORK ADMINISTRATOR	1
NETWORK ANALYST	2
NETWORK ENGINEER	2
NETWORK SPECIALIST	1
NETWORK TECHNICIAN	1
ORACLE ANALYST	1
PC SUPPORT SPECIALIST	1
PC SUPPORT TECHNICIAN	2
PC TECHNICIAN	4
PROGRAMMER	1
PROGRAMMER TRAINEE	1
SALES ENGINEER	2
SENIOR TECHNICIAN	1
SERVICE DESK	1
SOFTWARE ENGINEER	2
SUPOPORT TECHNICIAN	1
SUPPORT	1
SUPPORT ANALYST	2
SUPPORT PERSONNEL	1
SUPPORT SPECIALIST	2
SYSTEM ADMINISTRATOR	2
SYSTEM IMPLEMENTATION COORDINATOR	1
SYSTEM TECHNICIAN	1
SYSTEMS	1
SYSTEMS ADMINISTRATOR	3

\* Some employers reported using more than one job title for this occupation.

## APPENDIX B

### JOB TITLES USED FOR EACH OCCUPATION SURVEYED

#### Computer Support Specialists

Job Title	Number of Employers*
SYSTEMS ANALYST	2
SYSTEMS SPECIALIST	1
SYSTEMS TECHNICIAN	2
TECH SUPPORT	5
TECH SUPPORT ENGINEER	1
TECH SUPPORT REPRESENTATIVE	1
TECH SUPPORT SPECIALIST	1
TECHNICAL ASSOCIATES	1
TECHNICAL SALES	1
TECHNICAL SERVICES REPRESENTATIVE	1
TECHNICAL SUPPORT	3
TECHNICAL SUPPORT ENGINEER	1
TECHNICAL SUPPORT SPECIALIST	2
TECHNICIAN	4
TECHNOLOGY SPECIALIST	1
TECHNOLOGY SUPPORT ASSISTANT	1
TECHNOLOGY SYSTEMS MANAGER	1
TECHNICAL ASSISTANT	1
TEST TECHNICIAN	1
USER SUPPORT ANALYST	1
WORKSTATION AND SYSTEM TECHNICIAN	1

\* Some employers reported using more than one job title for this occupation.

## APPENDIX B

### JOB TITLES USED FOR EACH OCCUPATION SURVEYED

#### Graphic Designers

Job Title	Number of Employers*
AD BUILDER	1
AD DESIGNER	1
AD SERVICE DESIGNER	1
ART DESIGNER	1
ART DIRECTOR	5
ART DIRECTOR DESIGNER	2
ARTIST	2
COLOR TECHNICIAN	1
COMMUNICATIONS SPECIALIST	1
COMPUTER GRAPHICS COORDINATOR	1
CREATIVE SERVICES	1
DESIGNER	4
DESIGNER, PRODUCTION	1
DESKTOP PUBLISHER	1
ELECTRONIC PRE PRESS	1
ELECTRONIC PRODUCTION ARTIST	1
GRAPGIC DESIGNER	1
GRAPHIC ARTIST	24
GRAPHIC COORDINATOR	1
GRAPHIC DESIGN	2
GRAPHIC DESIGNER	54
GRAPHICS	1
GRAPHICS ARTIST	1
GRAPHICS DESIGNER	3
ILLUSTRATORS	2
JUNIOR DESIGNER	1
MAC OPERATIONS	1
NEWS ARTIST	1
PRE PRESS	1
PREPRESS TECHNICIAN	1
PRODUCTION ARTIST	4
PRODUCTION ASSISTANT	1
PRODUCTION GRAPHIC ARTIST	1
PRODUCTION MANAGER	3
PRODUCTIONS ARTIST	1
PROJECT DIRECTOR	1
SENIOR DESIGNER	2
SENIOR GRAPHIC ARTIST	1
SIGN DESIGNER	1
TYPESETTER	3

\* Some employers reported using more than one job title for this occupation.

BEST COPY AVAILABLE



## APPENDIX B

### JOB TITLES USED FOR EACH OCCUPATION SURVEYED

#### Internet Web Site Designers and Developers (Webmasters)

Job Title	Number of Employers*
ACTIVITY NETWORK MANAGER	1
ADMINISTRATOR	1
ART DIRECTOR	1
COMMUNICATIONS COORDINATOR	1
COMPUTER CONSULTANT	1
CREATIVE DESIGNER	2
DATABASE MANAGER	1
DESIGNER	1
DEVELOPER	1
DIRECTOR E BUSINESS	1
EXECUTIVE ASSISTANT	1
FRONT END WEB DEVELOPER	1
GRAHPIC DESIGNER	2
INFORMATION SERVICES PROJECT MANAGER	1
INFORMATION SYSTEMS/NETWORK MANAGER	1
INTERFACE DESIGNER	1
INTERNET WEB SITE DESIGNER	1
JOB ENGINEER	1
MEDIA PRODUCER	1
NETWORK TECHNICIAN	1
ONLINE PROJECT EDITOR	1
PRODUCTION DESIGNER	1
PRODUCTION ENGINEER	1
PROGRAMMER	1
SENIOR BUSINESS ANALYST	1
SENIOR ENGINEER	1
SENIOR WEB DESIGNER	1
TECH SUPPORT MANAGER	1
TECHNICAL SUPERVISOR	1
TECHNOLOGY COORDINATOR	1
WEB ADMINISTRATOR	1
WEB APPLICATIONS ENGINEER	1
WEB DATABASE DEVELOPER	1
WEB DESIGNER	18
WEB DESIGNER MANAGER	1
WEB DESIGNS	1
WEB DEVELOPER	9
WEB ENGINEER	1
WEB INTEGRATOR	1
WEB PRODUCER	1

\* Some employers reported using more than one job title for this occupation.

BEST COPY AVAILABLE

## APPENDIX B

### JOB TITLES USED FOR EACH OCCUPATION SURVEYED

#### Internet Web Site Designers and Developers (Webmasters)

Job Title	Number of Employers*
WEB PROGRAMMER	1
WEB PUBLISHER	1
WEB SITE ADMINISTRATOR	1
WEB SITE DESGNER	14
WEB SITE DESIGN, CREATIVE CONSULTANT	1
WEB SITE DEVELOPER	3
WEB SITE PROGRAMMER	1
WEB SPECIALIST	1
WEB TECHNICIAN	1
WEBMASTER	33

\* Some employers reported using more than one job title for this occupation.

BEST COPY AVAILABLE

**APPENDIX C**  
**INDUSTRIES REPRESENTED IN EACH OCCUPATION SURVEYED**

## APPENDIX C

### INDUSTRIES REPRESENTED IN EACH OCCUPATION SURVEYED

#### Computer Aided Design (CAD) Technicians

Standard Industrial Classification Code	Standard Industrial Classification Title	Number of Employers	Number of Employees
1521	General Contractors - Single-Family Houses	1	1
1542	General Contractors - Nonresidential Buildings, Other Than Industrial Buildings and Warehouses	1	4
1711	Trade Contractors - Plumbing, Heating and Air-Conditioning	1	3
2675	Die-Cut Paper and Paperboard and Cardboard Manufacturers	1	3
3599	Industrial and Commercial Machinery and Equipment Manufactures, Not Elsewhere Classified	3	11
3661	Telephone and Telegraph Apparatus Manufactures	1	2
3672	Printed Circuit Boards Manufactures	13	67
3674	Semiconductors and Related Devices Manufacturers	1	25
3679	Electronic Components Manufacturers, Not Elsewhere Classified	1	4
3812	Manufactures - Search, Detection, Navigation, Guidance, Aeronautical, and Nautical Systems and Instruments	1	22
3825	Manufactures - Instruments for Measuring and Testing of Electricity and Electrical Signals	1	4
7373	Computer Integrated Systems Design	2	17
7521	Automobile Parking	1	45
8711	Engineering Services	15	159
8712	Architectural Services	17	227
8713	Surveying Services	3	22
8741	Management Services	1	1
8742	Management Consulting Services	1	3
8748	Business Consulting Services, Not Elsewhere Classified	3	61
9131	Executive and Legislative Offices Combined	1	5
9532	Administration of Urban Planning and Community and Rural Development	1	5

## APPENDIX C

### INDUSTRIES REPRESENTED IN EACH OCCUPATION SURVEYED

#### Computer and Software Support Technicians

Standard Industrial Classification Code	Standard Industrial Classification Title	Number of Employers	Number of Employees
3571	Electronic Computers	1	50
3651	Household Audio and Video Equipment	1	2
3669	Communications Equipment, Not Elsewhere Classified	1	1
3674	Semiconductors and Related Services	2	48
3823	Industrial Instruments for Measurement, Display, and Control of Process Variables; and Related Products	1	4
3845	Electromedical and Electrotherapeutic Apparatus	1	2
5734	Computer and Computer Software Stores	3	15
7371	Computer Programming Services	2	36
7372	Prepackaged Software	3	25
7373	Computer Integrated Systems Design	3	6
7375	Information Retrieval Services	3	23
7378	Computer Maintenance and Repair	2	7
7379	Computer Related Services, Not Elsewhere Classified	6	36
7999	Amusement and Recreation Services, Not Elsewhere Classified	2	10
8062	General Medical and Surgical Hospitals	5	16
8111	Legal Services	1	9
8211	Elementary and Secondary Schools	16	43
8222	Junior Colleges and Technical Institutes	5	25
8331	Job Training and Vocational Rehabilitation Services	1	2
8713	Surveying Services	1	2
9131	Executive and Legislative Offices Combined	4	6
9311	Public Finance, Taxation, and Monetary Policy	1	4

BEST COPY AVAILABLE

## APPENDIX C

### INDUSTRIES REPRESENTED IN EACH OCCUPATION SURVEYED

#### Computer Network Technicians

Standard Industrial Classification Code	Standard Industrial Classification Title	Number of Employers	Number of Employees
1629	Heavy Construction, Not Elsewhere Classified	1	1
1742	Plastering, Drywall, Acoustical, and Insulation Work	1	1
2084	Wines, Brandy, and Brandy Spirits	1	1
2711	Newspapers: Publishing, or Publishing and Printing	1	10
2759	Commercial Printing, Not Elsewhere Classified	1	2
2842	Specialty Cleaning, Polishing, and Sanitation Preparations	1	4
3556	Food Products Machinery	1	1
3559	Specialty Industry Machinery, Not Elsewhere Classified	1	1
3571	Electronic Computers	1	1
3577	Computer Peripheral Equipment, Not Elsewhere Classified	2	12
3669	Communications Equipment, Not Elsewhere Classified	1	1
3674	Semiconductors and Related Devices	2	3
3826	Laboratory Analytical Instruments	1	10
3845	Electromedical and Electrotherapeutic Apparatus	1	1
4513	Air Courier Services	1	4
4813	Telephone Communications, Except Radiotelephone	1	4
5045	Computers and Computer Peripheral Equipment and Software	1	3
5049	Professional Equipment and Supplies, Not Elsewhere Classified	1	1
5411	Grocery Stores	1	6
5734	Computer and Computer Software Stores	8	21
6022	State Commercial Banks	1	1
6035	Savings Institutions, Federally Chartered	1	4
6211	Security Brokers, Dealers, and Flotation Companies	1	3

## APPENDIX C

### INDUSTRIES REPRESENTED IN EACH OCCUPATION SURVEYED

#### Computer Network Technicians

Standard Industrial Classification Code	Standard Industrial Classification Title	Number of Employers	Number of Employees
6282	Investment Advice	1	6
6411	Insurance Agents, Brokers, and Service	1	2
7011	Hotels and Motels	1	2
7363	Help Supply Services	1	19
7371	Computer Programming Services	5	38
7372	Prepackaged Software	3	37
7373	Computer Integrated Systems Design	2	4
7374	Computer Processing and Data Preparation and Processing Services	1	20
7375	Information Retrieval Service	4	12
7378	Computer Maintenance and Repair	1	3
7379	Computer Related Services, Not Elsewhere Classified	19	67
7389	Business Services, Not Elsewhere Classified	2	2
7996	Amusement Parks	1	3
8011	Offices and Clinics of Doctors of Medicine	2	8
8062	General Medical and Surgical Hospitals	6	21
8063	Psychiatric Hospitals	1	3
8211	Elementary and Secondary Schools	16	33
8221	Colleges, Universities, and Professional Schools	2	9
8222	Junior Colleges and Technical Institutes	3	9
8231	Libraries	1	1
8249	Vocational Schools, Not Elsewhere Classified	1	1
8331	Job Training and Vocational Rehabilitation Services	2	4
8361	Residential Care	1	1
8399	Social Services, Not Elsewhere Classified	1	1
8731	Commercial Physical and Biological Research	2	4
8748	Business Consulting Services, Not Elsewhere Classified	2	3

BEST COPY AVAILABLE

## APPENDIX C

### INDUSTRIES REPRESENTED IN EACH OCCUPATION SURVEYED

#### Computer Network Technicians

Standard Industrial Classification Code	Standard Industrial Classification Title	Number of Employers	Number of Employees
9131	Executive and Legislative Offices Combined	7	37
9221	Police Protection	1	4
9229	Public Order and Safety, Not Elsewhere Classified	2	6
9511	Air and Water Resource and Solid Waste Management	1	13
9621	Regulation and Administration of Transportation Programs	1	7



## APPENDIX C

### INDUSTRIES REPRESENTED IN EACH OCCUPATION SURVEYED

#### Computer Support Specialists

Standard Industrial Classification Code	Standard Industrial Classification Title	Number of Employers	Number of Employees
2033	Canned Fruits, Vegetables, Preserves, Jams, and Jellies	1	1
2084	Wines, Brandy, and Brandy Spirits	4	11
2711	Newspapers: Publishing, or Publishing and Printing	3	13
2721	Periodicals: Publishing, or Publishing and Printing	2	11
2731	Books: Publishing, or Publishing and Printing	1	2
2834	Pharmaceutical Preparations	1	3
3559	Special Industry Machinery, Not Elsewhere Classified	1	1
3571	Electronic Computers	6	65
3575	Computer Terminals	1	8
3577	Computer Peripheral Equipment, Not Elsewhere Classified	3	14
3669	Communications Equipment, Not Elsewhere Classified	1	5
3671	Electron Tubes	1	3
3825	Instruments for Measuring and Testing of Electricity and Electrical Signals	1	6
3829	Measuring and Controlling Devices, Not Elsewhere Classified	1	1
4111	Local and Suburban Transit	1	8
4412	Deep Sea Foreign Transportation of Freight	1	3
4491	Marine Cargo Handling	1	1
4513	Air Courier Services	1	18
4612	Crude Petroleum Pipelines	1	18
4731	Arrangement of Transportation of Freight and Cargo	1	4
4812	Radiotelephone Communications	1	10
4813	Telephone Communications, Except Radiotelephone	1	7
4932	Gas and Other Services Combined	1	155
5031	Lumber, Plywood, Millwork, and Wood Panels	1	1

## APPENDIX C

### INDUSTRIES REPRESENTED IN EACH OCCUPATION SURVEYED

#### Computer Support Specialists

Standard Industrial Classification Code	Standard Industrial Classification Title	Number of Employers	Number of Employees
5044	Office Equipment	1	2
5045	Computers and Computer Peripheral Equipment and Software	17	115
5049	Professional Equipment and Supplies, Not Elsewhere Classified	1	3
5191	Farm Supplies	1	1
5194	Tobacco and Tobacco Products	1	2
5611	Men's and Boys' Clothing and Accessory Stores	1	2
5734	Computer and Computer Software Stores	7	43
5912	Drug Stores and Proprietary Stores	1	12
6022	State Commercial Banks	2	4
6162	Mortgage Bankers and Loan Correspondents	1	10
6211	Security Brokers, Dealers, and Flotation Companies	1	15
6282	Investment Advice	1	3
7331	Direct Mail Advertising Services	1	3
7336	Commercial Art and Graphic Design	1	5
7363	Help Supply Services	4	19
7371	Computer Programming Services	8	54
7372	Prepackaged Software	7	117
7374	Computer Processing and Data Preparation and Processing Services	1	3
7375	Information Retrieval Service	2	8
7378	Computer Maintenance and Repair	4	19
7379	Computer Related Services, Not Elsewhere Classified	1	4
8011	Offices and Clinics of Doctors of Medicine	1	2
8062	General Medical and Surgical Hospitals	1	31
8211	Elementary and Secondary Schools	3	6

BEST COPY AVAILABLE

## APPENDIX C

### INDUSTRIES REPRESENTED IN EACH OCCUPATION SURVEYED

#### Computer Support Specialists

Standard Industrial Classification Code	Standard Industrial Classification Title	Number of Employers	Number of Employees
8221	Colleges, Universities, and Professional Schools	6	13
8222	Junior Colleges and Technical Institutes	7	36
8231	Libraries	3	25
8299	Schools and Educational Services, Not Elsewhere Classified	2	4
8361	Residential Care	1	4
8712	Architectural Services	1	1
8721	Accounting, Auditing, and Bookkeeping Services	1	3
8741	Management Services	1	3
8748	Business Consulting Services, Not Elsewhere Classified	2	10
9131	Executive and Legislative Offices Combined	1	4
9611	Administration of General Economic Programs	1	3

## APPENDIX C

### INDUSTRIES REPRESENTED IN EACH OCCUPATION SURVEYED

#### Graphic Designers

Standard Industrial Classification Code	Standard Industrial Classification Title	Number of Employers	Number of Employees
2653	Corrugated and Solid Fiber Boxes	1	5
2711	Newspapers: Publishing, or Publishing and Printing	26	131
2721	Periodicals: Publishing, or Publishing and Printing	3	12
2741	Miscellaneous Publishing	2	9
2752	Commercial Printing, Lithographic	12	20
2759	Commercial Printing, Not Elsewhere Classified	8	66
2771	Greeting Cards	1	1
2791	Typesetting	1	5
3993	Signs and Advertising Specialties	11	20
4833	Television Broadcasting Stations	2	7
5112	Stationery and Office Supplies	2	3
5199	Nondurable Goods, Not Elsewhere Classified	1	3
5734	Computer and Computer Software Stores	1	1
7311	Advertising Agencies	11	34
7313	Radio, Television, and Publishers' Advertising Representatives	2	4
7331	Direct Mail Advertising Services	1	2
7334	Photocopying and Duplicating Services	2	13
7336	Commercial Art and Graphic Design	21	151
7371	Computer Programming Services	1	1
7372	Prepackaged Software	1	2
7373	Computer Integrated Systems Design	1	1
7379	Computer Related Services, Not Elsewhere Classified	1	1
7389	Business Services, Not Elsewhere Classified	3	6
7812	Motion Picture and Video Tape Production	1	2
8211	Elementary and Secondary Schools	1	1
8221	Colleges, Universities, and Professional Schools	2	2
8748	Business Consulting Services, Not Elsewhere Classified	3	3
9199	General Government, Not Elsewhere Classified	1	4

## APPENDIX C

### INDUSTRIES REPRESENTED IN EACH OCCUPATION SURVEYED

#### Internet Web Site Designers and Developers (Webmasters)

Standard Industrial Classification Code	Standard Industrial Classification Title	Number of Employers	Number of Employees
2339	Women's, Misses', and Juniors' Outerwear, Not Elsewhere Classified	1	5
2711	Newspapers: Publishing, or Publishing and Printing	2	3
2731	Books: Publishing, or Publishing and Printing	1	1
2752	Commercial Printing, Lithographic	1	1
3572	Computer Storage Devices	1	10
3577	Computer Peripheral Equipment, Not Elsewhere Classified	1	4
3674	Semiconductors and Related Devices	2	2
3676	Electronic Resistors	1	1
3825	Instruments for Measuring and Testing of Electricity and Electrical Signals	2	3
3845	Electromedical and Electrotherapeutic Apparatus	1	2
4111	Local and Suburban Transit	1	1
5045	Computers and Peripheral Equipment and Software	2	4
5199	Nondurable Goods, Not Elsewhere Classified	1	1
5499	Miscellaneous Food Stores	1	1
5734	Computer and Computer Software Stores	1	2
5812	Eating Places	1	6
6531	Real Estate Agents and Managers	1	1
7311	Advertising Agencies	3	7
7336	Commercial Art and Graphic Design	2	3
7359	Equipment Rental and Leasing, Not Elsewhere Classified	1	1
7363	Help Supply Services	1	5
7371	Computer Programming Services	21	122
7372	Prepackaged Software	6	33
7373	Computer Integrated Systems Design	3	6
7375	Information Retrieval Services	14	46

BEST COPY AVAILABLE

## APPENDIX C

### INDUSTRIES REPRESENTED IN EACH OCCUPATION SURVEYED

#### Internet Web Site Designers and Developers (Webmasters)

Standard Industrial Classification Code	Standard Industrial Classification Title	Number of Employers	Number of Employees
7376	Computer Facilities Management Services	1	2
7379	Computer Related Services, Not Elsewhere Classified	9	45
7389	Business Services, Not Elsewhere Classified	1	10
8211	Elementary and Secondary Schools	1	1
8221	Colleges, Universities, and Professional Schools	6	9
8222	Junior Colleges and Technical Institutes	7	12
8331	Job Training and Vocational Rehabilitation Services	2	2
8733	Noncommercial Research Organizations	1	2
9131	Executive and Legislative Offices Combined	3	3
9229	Public Order and Safety, No Elsewhere Classified	1	1
9441	Administration of Social, Human Resource and Income Maintenance Programs	1	1
9999	Nonclassifiable Establishments	2	5

BEST COPY AVAILABLE



U.S. Department of Education
Office of Educational Research and Improvement (OERI)
National Library of Education (NLE)
Educational Resources Information Center (ERIC)

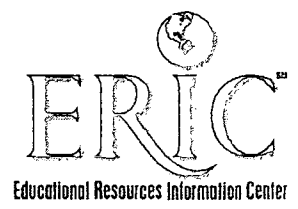

REPRODUCTION RELEASE
(Specific Document)

I. DOCUMENT IDENTIFICATION:

Title: New Technicians Study - Opportunities for Entry-Level Workers in Information Technology Occupations
Author(s): Labor Market Information Division
Corporate Source: Employment Development Department
Publication Date: MAY 26 2003

II. REPRODUCTION RELEASE:

In order to disseminate as widely as possible timely and significant materials of interest to the educational community, documents announced in the monthly abstract journal of the ERIC system, Resources in Education (RIE), are usually made available to users in microfiche, reproduced paper copy, and electronic media, and sold through the ERIC Document Reproduction Service (EDRS).

If permission is granted to reproduce and disseminate the identified document, please CHECK ONE of the following three options and sign at the bottom of the page.

Level 1: PERMISSION TO REPRODUCE AND DISSEMINATE THIS MATERIAL HAS BEEN GRANTED BY [Signature] TO THE EDUCATIONAL RESOURCES INFORMATION CENTER (ERIC)

Level 2A: PERMISSION TO REPRODUCE AND DISSEMINATE THIS MATERIAL IN MICROFICHE, AND IN ELECTRONIC MEDIA FOR ERIC COLLECTION SUBSCRIBERS ONLY, HAS BEEN GRANTED BY [Signature] TO THE EDUCATIONAL RESOURCES INFORMATION CENTER (ERIC)

Level 2B: PERMISSION TO REPRODUCE AND DISSEMINATE THIS MATERIAL IN MICROFICHE ONLY HAS BEEN GRANTED BY [Signature] TO THE EDUCATIONAL RESOURCES INFORMATION CENTER (ERIC)

Level 1 checkbox with signature icon and instructions: Check here for Level 1 release, permitting reproduction and dissemination in microfiche or other ERIC archival media (e.g., electronic) and paper copy.

Level 2A checkbox with empty box and instructions: Check here for Level 2A release, permitting reproduction and dissemination in microfiche and in electronic media for ERIC archival collection subscribers only

Level 2B checkbox with empty box and instructions: Check here for Level 2B release, permitting reproduction and dissemination in microfiche only

Documents will be processed as indicated provided reproduction quality permits. If permission to reproduce is granted, but no box is checked, documents will be processed at Level 1.

I hereby grant to the Educational Resources Information Center (ERIC) nonexclusive permission to reproduce and disseminate this document as indicated above. Reproduction from the ERIC microfiche or electronic media by persons other than ERIC employees and its system contractors requires permission from the copyright holder. Exception is made for non-profit reproduction by libraries and other service agencies to satisfy information needs of educators in response to discrete inquiries.

Sign here, please ->

Signature: [Handwritten Signature]
Printed Name/Position/Title: JEFFREY KILMER / RESEARCH MGR II
Organization/Address: 7000 Franklin Blvd. Bldg 1100 Sacramento CA 95823
Telephone: 916-262-2327
Date: 8/22/03



### III. DOCUMENT AVAILABILITY INFORMATION (FROM NON-ERIC SOURCE):

If permission to reproduce is not granted to ERIC, or, if you wish ERIC to cite the availability of the document from another source, please provide the following information regarding the availability of the document. (ERIC will not announce a document unless it is publicly available, and a dependable source can be specified. Contributors should also be aware that ERIC selection criteria are significantly more stringent for documents that cannot be made available through EDRS.)

Publisher/Distributor:
Address:
Price:

### IV. REFERRAL OF ERIC TO COPYRIGHT/REPRODUCTION RIGHTS HOLDER:

If the right to grant this reproduction release is held by someone other than the addressee, please provide the appropriate name and address:

Name:
Address:

### V. WHERE TO SEND THIS FORM:

Send this form to the following ERIC Clearinghouse: <p style="text-align: center;"><b>Acquisitions Coordinator</b> <b>ERIC Clearinghouse on Adult, Career, and Vocational Education</b> <b>Center on Education and Training for Employment</b> <b>1900 Kenny Road</b> <b>Columbus, OH 43210-1090</b></p>
---

However, if solicited by the ERIC Facility, or if making an unsolicited contribution to ERIC, return this form (and the document being contributed) to: