

DOCUMENT RESUME

ED 478 351

EF 006 324

TITLE Best Practices Manual, 2002 Edition.
INSTITUTION Collaborative for High Performance Schools, CA.
PUB DATE 2002-00-00
NOTE 715p.; Document is an update of document ED 459 587.
AVAILABLE FROM For full text: <http://www.chps.net/manual/index.htm>.
PUB TYPE Guides - Non-Classroom (055)
EDRS PRICE EDRS Price MF04/PC29 Plus Postage.
DESCRIPTORS Child Health; Conservation (Environment); *Educational Facilities Design; *Educational Facilities Planning; *Public Schools; School Buildings; Sustainable Development
IDENTIFIERS Best Practices; *California

ABSTRACT

The goal of this manual is to create a new generation of high performance school facilities in California. The focus is on public schools and levels K-12, although many of the design principals apply to private schools and higher education facilities as well. High performance schools are healthy, comfortable, energy efficient, resource efficient, water efficient, safe, secure, adaptable, and easy to operate and maintain. They help school districts achieve higher test scores, retain quality teachers and staff, reduce operating cost, increase average daily attendance (ADA), and reduce liability, while at the same time being friendly to the environment. The manual is split into three volumes. Volume I addresses the needs of school districts, including superintendents, parents, teachers, school board members, administrators, and those persons in the school district that are responsible for facilities. These may include the assistant superintendent for facilities (in large districts), buildings and grounds committees, energy managers, and new construction project managers. Volume I describes why high performance schools are important, what components are involved in their design, and how to navigate the design and construction process to ensure that they are built. Volume II contains design guidelines for high performance schools. These are tailored for California climates and are written for the architects and engineers who are responsible for designing schools as well as the project managers who work with the design teams. Volume II is organized by design disciplines and addresses specific design strategies for high performance schools. Volume III is the Collaborative for High Performance Schools (CHPS) Criteria. These criteria are a flexible yardstick that precisely defines a high performance school so that it may qualify for supplemental funding, priority processing, and perhaps bonus points in the state funding procedure. School districts can also include the criteria in their educational specifications to assure that new facilities qualify as high performance. (EV)

Reproductions supplied by EDRS are the best that can be made
from the original document.

ED 478 351

the



collaborative



for high



performance



schools

Best Practices Manual

VOLUME I

PLANNING

2002 EDITION

U.S. DEPARTMENT OF EDUCATION
Office of Educational Research and Improvement
EDUCATIONAL RESOURCES INFORMATION
CENTER (ERIC)

This document has been reproduced as received from the person or organization originating it.

Minor changes have been made to improve reproduction quality.

• Points of view or opinions stated in this document do not necessarily represent official OERI position or policy.

PERMISSION TO REPRODUCE AND
DISSEMINATE THIS MATERIAL HAS
BEEN GRANTED BY

Gregg Ander

TO THE EDUCATIONAL RESOURCES
INFORMATION CENTER (ERIC)

1

Full text available at:

BEST COPY AVAILABLE

<http://www.chps.net/manual/index.htm>

F 006 324

Best Practices Manual

Volume I



High Performance Schools
Best Practices Manual
2002 Edition

DISCLAIMER

IMPORTANT NOTICE TO THE READER: This publication is designed to provide accurate and authoritative information with regard to the subject matter covered. It is distributed with the understanding that local, state and federal laws, regulations and requirements will vary based on the particular circumstances such as building characteristics, geographic region and similar factors. It is also distributed with the understanding the publisher is not engaged in rendering engineering, architectural, legal, or other professional advice or service. The publisher and its participants, officers, directors, employees, contractors and affiliates cannot be responsible for errors or omissions, or any material set forth or referenced in this publication. If professional advice or other expert assistance is required, the services of a competent advisor familiar with the law, regulation, practices and circumstances of the project should be sought.

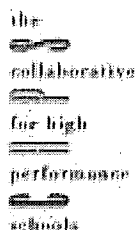

The Collaborative for High Performance Schools

(877) 642-CHPS

www.chps.net

Copyright 2002 CHPS Inc.



CHPS BEST PRACTICES MANUAL 2002 **VOLUME I—PLANNING** PAGE ii

©2002 CHPS, Inc.

BEST COPY AVAILABLE

Preface

Background

This is a unique period in California history. The state, already educating one out of every eight students in America, has seen historical enrollment rates four times higher than national averages. Hundreds of schools a year are being built to house the 100,000 new students per year moving into the system and to accommodate state-mandated class-size reductions. The current infrastructure is aging and over 30% of existing facilities are in need of major renovation. At the same time, California schools are spending nearly \$450 million per year on energy¹ in a time of rising concern over energy supplies and tight school budgets. These figures illustrate an enormous opportunity for our state's school districts to build the next generation of school facilities that improve the learning environment while saving energy, resources, and money.

The goal of this Best Practices Manual is to create a new generation of high performance school facilities in California. The focus is on public schools and levels K-12, although many of the design principals apply to private schools and higher education facilities as well. High performance schools are healthy, comfortable, energy efficient, resource efficient, water efficient, safe, secure, adaptable, and easy to operate and maintain. They help school districts achieve higher test scores, retain quality teachers and staff, reduce operating cost, increase average daily attendance (ADA), reduce liability, while at the same time being friendly to the environment.

¹ These costs are based on data prior to the California energy crisis, which begin during the winter of 2000-2001. During this period, wholesale energy costs rose by a factor of eight. Eventually, some or all of these costs will be passed on to schools and other utility customers.



Best Practices Manual Organization

This Best Practices Manual is split into three volumes:

- Volume I addresses the needs of school districts, including superintendents, parents, teachers, school board members, administrators, and those persons in the school district that are responsible for facilities. These may include the assistant superintendent for facilities (in large districts), buildings and grounds committees, energy managers, and new construction project managers. Volume I describes why high performance schools are important, what components are involved in their design, and how to navigate the design and construction process to ensure that they are built.
- Volume II contains design guidelines for high performance schools. These are tailored for California climates and are written for the architects and engineers who are responsible for designing schools as well as the project managers who work with the design teams. Volume II is organized by design disciplines and addresses specific design strategies for high performance schools.
- Volume III is the CHPS Criteria. These criteria are a flexible yardstick that precisely defines a high performance school so that it may qualify for supplemental funding, priority processing, and perhaps bonus points in the state funding procedure. School districts can also include the criteria in their educational specifications to assure that new facilities qualify as high performance.

The Best Practices Manual is supported by the CHPS website (www.chps.net), which contains research papers, support documents, databases and other information that support the Best Practices Manual.

Who is CHPS

The Collaborative for High Performance Schools (CHPS) began in November 1999, when the California Energy Commission called together Pacific Gas and Electric Company, San Diego Gas and Electric, and Southern California Edison to discuss the best way to improve the performance of California's schools. Out of this partnership, CHPS grew to include a diverse range of government, utility, and non-profit organizations with a unifying goal to improve the quality of education for California's children. With the successful launch of the Best Practices Manuals in 2001, interest in high performance design grew, and CHPS expanded its focus beyond California, developing a national version of the manuals as well as other state-specific

CHPS, Inc.

Officers

Chair

**Commissioner Robert Parnell,
California Energy Commission**

Vice Chair

**Gregg Ander, FAIA, Southern
California Edison**

Secretary

**Stephan Castellanos, FAIA,
Division of the State Architect**

Treasurer

**Randall Higa, PE, Southern
California Gas**

Board Members

**Chuck Angyl, AIA, San Diego
Gas & Electric**

**Jim Barnett, AIA, Sacramento
Municipal Utility District**

**Duwayne Brooks, California
Department of Education**

**Oliver Kesting, Pacific Gas &
Electric**

**Bill Orr, California Integrated
Waste Management Board**

Charter Members

California Department of Education (CDE); Coalition for Adequate School Housing (CASH); Division of the State Architect (DSA); Office of Public School Construction (OPSC); California Energy Commission (CEC); California Integrated Waste Management Board (CIWMB); Los Angeles Department of Water and Power (LADWP); Pacific Gas and Electric Company (PG&E); Sacramento Municipal Utility District (SMUD); San Diego Gas and Electric (SDG&E); Southern California Edison (SCE); Southern California Gas Company (SoCalGas); California Air Resources Board (CARB); California Department of Health Services (DHS); Natural Resources Defense Council



versions. In early 2002, CHPS incorporated as a non-profit organization, further solidifying its commitment to environmentally sound design that enhances the educational environment for all schoolchildren.

Acknowledgements

A great number of people have contributed to the development of the Best Practices Manual and this 2002 update. Charles Eley is the executive director of CHPS, Inc. and served as the technical editor.

For Volume I: Deane Evans (Sustainable Buildings Industries Council) and Randy Karels (Eley Associates). Donald Simon (Wendel, Rosen, Black & Dean) wrote the section on construction contracts. The Newport Coast Elementary case study was adapted from the paper *Mainstreaming the Sustainably Designed School* by Deborah Weintraub and Tony Pierce of Southern California Edison.

For Volume II: Jim Benya (Benya Lighting Design); Anthony Bernheim (SMWM), Barbara Erwine (Cascadia Conservation); Lisa Heschong (Heschong Mahone Group); Erik Kolderup, Joe Kastner, and Anamika (Eley Associates); Hal Levin (Building Ecology Research Group); Kathleen O'Brien (O'Brien and Company); Kerry Parker (TMAD Engineers); Jane Simmons (O'Brien and Company); Kerry Parker (TMAD Engineers); and Adam Wheeler (Control Group).

The commissioning section of this manual is a modified version of the *Building Commissioning Guidelines* prepared for Pacific Gas & Electric Company by Portland Energy Conservation, Inc. (PECI) for the Energy Design Resources program. Certain sections of this document were excerpted and modified from *Commissioning for Better Buildings in Oregon*, written by PEGI for the Oregon Office of Energy, and *Building Commissioning: The Key to Quality Assurance*, written by PEGI for the U.S. Department of Energy's Rebuild America program.

From Eley Associates, Kimberly Got edited and coordinated production on Volumes I and II. Debra Janis developed additional graphics and provided layout assistance. Randy Karels and Arman Shehabi provided assistance with coordination and technical content review. Patricia Adamos worked to secure graphic permissions.

The CHPS Best Practices Manual 2002 Update Task Force contributed countless hours reviewing the document and providing valuable direction and input. Special thanks to Panama Bartholomy (Division of the State Architect), Gary Flamm (California Energy Commission), Bill Orr and Dana Papke (California Integrated Waste Management Board), Tom Phillips (California Air Resources Board), and Jed Waldman (Department of Health Services).

Beginning with the first edition, many people contributed to the development of the manual through their technical content review: Tor Allen (Rahus Institute); Dennis Dunston (HMC Architects), Wael El-Sharif (Geothermal Heat Pump Consortium), Andrew Gorton and



Dennis Paoletti (Shen Milsom & Wilke / Paoletti), John Guill (Quattrocchi / Kwok Architects), Gary Mason (Wolfe Mason Associates), Lynn N. Simon (Simon & Associates), and George Wiens (WLC Architects).

The following individuals contributed significantly to this project, particularly in the early development of the manuals: Manuel Alvarez, Jan Johnson and Lisa Stoddard (Southern California Edison), Richard Conrad and Chip Smith (Division of the State Architect), Don Cunningham (Los Angeles Department of Water and Power), Julia Curtis, Ray Darby, Grant Duhon (Pacific Gas & Electric), Lisa Fabula and Chip Fox (San Diego Gas & Electric), Kathy Frevert (California Integrated Waste Management Board), Greg Golick (Coalition for Adequate School Housing), Tony Hesch (California Department of Education), Bill Jones, Kathleen McElroy (Xenergy), Daryl Mills and Mike Sloss (California Energy Commission), Jim Parks (Sacramento Municipal Utility District), and Richard Sheffield (Office for Public School Construction).

Finally, the CHPS Board of Directors deserves special acknowledgement for their continued guidance and funding support. Robert Pernell (California Energy Commission), Gregg Ander (Southern California Edison), Stephan Castellanos (Division of the State Architect), Randall Higa (Southern California Gas), Chuck Angyl (San Diego Gas & Electric), Jim Barnett (Sacramento Municipal Utility District), Duwayne Brooks (California Department of Education), Oliver Kesting (Pacific Gas & Electric), and Bill Orr (California Integrated Waste Management Board).



Table of Contents

Disclaimer	ii
Preface	iii
Background	iii
Best Practices Manual Organization	iv
Who is CHPS	iv
Acknowledgements	v
Table of Contents	vii
Volume I – Planning	1
Understanding High Performance Schools	3
Benefits of a High Performance School	4
Characteristics of a High Performance School	10
Set District Goals Early and Use Integrated Design	13
Use Daylighting	18
Protect Indoor Air Quality	22
Install High Performance Lighting and Controls	27
Use High Performance HVAC Strategies	30
Choose Materials Wisely	33
Optimize Acoustics	36
Minimize Water Use	38
Choose and Develop the Site Wisely	39
Use Sustainable Construction Practices	41
Don't Forget the Portables	42
Train the Staff and Maintain the Building	43
Financing High Performance Schools	45
Life-Cycle Costing	45
Reduced Operating Expenses	46
Increased Funds	47
Financial Incentive and Technical Assistance Programs	48
Contacts	49
Avoided Costs and Litigation Risk	50
Process Guide	52
Key Steps in the Process	52
Building a School in California	52
Construction Contract Considerations	54
Process Steps	59
Discussion Guide	61
Programming and Goal Setting	62
Selecting the A/E Team	64
Site Analysis	67
Schematic Design	69
Design Development	72
Construction Documents	75
Bidding	78
Construction Administration	81
Case Study 1: Daylit Classroom	84
Design Summary	84
Construction Costs	87
Lessons Learned	87



Case Study 2: The Capistrano Unified School District	89
The Skylighting System	90
Electric Lighting.....	91
Research Experience Pays Off.....	91
Case Study 3: Ross School	92
Overview	92
Thermal Comfort	93
Lighting and Daylighting.....	94
Indoor Air Quality	95
Material Efficiency	95
Site Issues	96
Lessons Learned	96
Case Study 4: Newport Coast Elementary School.....	97
Site Design.....	98
Daylighting	99
Natural Ventilation and Thermal Comfort Analysis.....	101
DOE-2 Energy Modeling	103
Conclusion	105



Volume I – Planning

California schools are facing multiple challenges: unprecedented student population growth, demands for improved student performance, constantly tight budgets, and thousands of school buildings in need of repair.

To meet these demands, districts will spend billions of dollars in the upcoming years to build or renovate hundreds of schools. How these schools are designed will affect the quality of the building, decades of operational expenses, and — most importantly — the health and productivity of generations of students and staff.

High performance school buildings — those that incorporate the very best of today's design strategies and building technologies — can simultaneously provide better learning environments for children, cost less to operate, and help protect the environment.

The Collaborative for High Performance Schools (CHPS) can help school districts and their design teams bring better performance into the classroom. Creating such schools is possible now. All that's needed is the vision, determination, and knowledge to do so.

This portion of the Best Practices Manual is written for school superintendents, school business officers, school facility planners, school board members, interested parents and others who are engaged in the process of planning new school facilities. It describes the benefits and characteristics of high performance schools, as well as reviews the process of planning for, designing, and getting approval for these schools. It also discusses the programs available to supplement funding.

Volume II

Volume II of the manual has detailed guidelines for architects, engineers, school planners, and contractors that lay out the specifics of how to design and build a high performance school.

Volume III

Volume III, the CHPS Criteria, is a yardstick that explicitly defines a high performance school. School districts can use the criteria to clearly specify their design goals. Volume III addresses all aspects of high performance schools such as energy efficiency, water efficiency, site planning, materials, and indoor environmental quality (IEQ), which encompasses factors

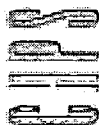

including thermal comfort and indoor air quality (IAQ). School districts and/or design teams can use the checklist in Volume III to self-certify their school as a "CHPS School." In each area, the system is composed of both prerequisites and optional credits. Points are assigned to each credit. A "CHPS School" must meet all of the prerequisites and earn at least 28 (at least two points must be from the Energy category) out of 81 points. The more credits a building earns, the better it is, but the CHPS criteria are a pass/fail system. As documentation, design teams must complete a brief report that identifies with a brief narrative the approach used to earn each point. The reports are sent to CHPS, which will spot check the reports, but may not evaluate everyone.



UNDERSTANDING HIGH PERFORMANCE SCHOOLS

High performance schools are facilities that improve the learning environment while saving energy, resources, and money. So what's the catch? Aren't these designs prohibitively expensive and time consuming? The short answer is no; the key lies in understanding the lifetime value of high performance schools, hiring skilled designers, and effectively managing priorities during the design and construction process. The detailed answer is woven throughout this manual and addresses these important issues facing schools today:

- How will high performance schools help educate students? High performance design can have a positive effect on health and comfort, and design strategies such as daylighting have been shown to enhance student learning. Good indoor air quality is essential for teacher and student health. Good design also produces more comfortable environments with proper lighting, air temperature, humidity, and noise levels. These factors reduce distractions and create environments where students and teachers can see clearly, hear accurately, and not feel too warm or too cold.
- Is high performance design cost effective? Yes. High performance design creates environments that are energy and resource efficient. These increased efficiencies save money on utility bills and are so valuable that some organizations will provide building owners with funds to have them included in the design. Furthermore, healthier environments can bring money into the school by lowering absenteeism and increasing funding based on average daily attendance. These financial, health, and productivity benefits are the result of integrated design: understanding how building elements affect one another to optimize the performance of the entire school.
- Do I have to choose between housing more students and high performance? No. Because a school facility must be able to house as many students as possible, building high performance schools at the expense of fewer classrooms is not an option. The key is to identify goals and budgets in advance and to verify that the designers and contractors explicitly understand your needs and their responsibilities, and have the skills to deliver what you want. School construction budgets are tight, but cost-effective solutions can be found for nearly any budget.
- Will I have the time to do this? Yes. School design and construction timelines are short, but better design does not have to be a roadblock. As a district, you must identify your educational and high performance goals early and communicate them clearly with the design team. Integrate your goals into the design from an early stage and implement commissioning to reduce time- and money-intensive changes later in the process. The CHPS Criteria (Volume III) is a convenient and flexible system for identifying your high performance goals. A pre-design goal setting meeting (sometimes referred to as a "charrette") with all of the stakeholders, using the CHPS Criteria as a guide, can aid this effort.
- Do I need to be an expert in high performance building design? No. It's the architect's and engineer's role to make sure the design is as effective as possible. You must, however, identify and prioritize your goals, and hire designers with the appropriate skill sets. Without the luxury of expansive timelines and budgets, every school design becomes a balanced



system of trade-offs. Understanding the value of high performance design will be important as choices arise.

- Will high performance schools demand extensive maintenance? No. They do not require any more maintenance than traditional designs. High performance design does not imply using overly complicated, maintenance-intensive systems. It is a design philosophy that integrates daylight, electric lighting, air conditioning and ventilation systems, site planning, materials, and controls to create the best facility for your budget. All schools, from traditional to high performance buildings, require regular maintenance to ensure they perform as designed. Health, comfort, and efficiency can all be compromised without adequate maintenance.



Gentle, diffuse daylight permeates a classroom with both sidelight and toplight. Note that all surfaces are painted white to distribute light more efficiently and reduce contrast glare.

Photo courtesy Barbara Erwine.

Benefits of a High Performance School

The quality of school facilities affects the district on many levels. The bottom line is high performance schools help educate students. The six primary benefits resonate from the individual classroom to the district office:

- Higher test scores.
- Increased average daily attendance.
- Reduced operating costs.
- Increased teacher satisfaction and retention.
- Reduced liability exposure.
- Reduced environmental impacts.

These benefits are achievable only when districts establish high performance as a specific design goal from the very beginning, and fight for it over the course of the development process. A focus on student and teacher performance, coupled with a concern for the environment and a commitment to cost effectiveness, will help ensure that the effort is successful and that any school — no matter what its budget — achieves the highest performance level possible for its particular circumstances.

Higher Test Scores

Learning is a dynamic, complicated process that can, and does, occur in all types of buildings and settings. Anecdotally, the argument linking increased student performance with high-quality school facilities is straightforward. Students in classrooms that are quiet, well-lit, and properly ventilated with healthy air will learn faster because they are more comfortable, are sick less often, can see and hear better, and are less distracted. Poor lighting, poor acoustics, and



poor indoor air quality are barriers to education. High performance schools remove these barriers, allowing teachers and students to work under the best possible conditions.

Indoor air quality has an indirect, yet profound, effect on learning. Inadequate ventilation leads to the buildup of carbon dioxide and other indoor pollutants, which are often associated with discomfort and the inability to concentrate. Exposures to volatile organic compounds (VOCs) and other indoor pollutants can cause a range of acute symptoms at relatively low concentrations; eye and respiratory irritation are the most common complaints. These contaminants can also cause headaches, mental confusion, behavioral problems, and fatigue — all of which diminish students' ability to concentrate or assimilate information. Among asthmatics, the increased need for medication (often with sedating side effects), exacerbations of asthma attacks, and related absences from school further undermine education in affected classrooms.

Quantifying the influence of school facilities on learning is a longstanding and highly debated subject in the educational community. Research studies are complicated by the highly systemic nature of education, and the range of social, pedagogical, psychological, and environmental variables involved. However, a growing number of studies are confirming the relationship between a school's physical condition — especially its lighting, acoustics, and indoor air quality — and student performance.

It is well known that light has profound effects on humans, and new research has directly linked daylighting and increased learning in students.

- The most compelling study² examined school districts in California, Washington, and Colorado and indicates a strong correlation between increased daylighting and improved student performance. In the California district, for example, students in classrooms with the most daylighting progressed 20% faster on math tests and 26% faster on reading tests in a one-year period than those in classrooms with the least amount of daylight. See the sidebar on the following page for details.
- After a year of detailed observation of the behavior, hormone levels, and health of 90 eight-year-old students, researchers in Sweden³ found significant correlations between these factors and daylight levels. The students were split among four classrooms with different types of natural and artificial light. Their results indicated that “work in classrooms without daylight may upset the basic hormone pattern, and this in turn may influence the children's ability to concentrate or cooperate, and also eventually have an impact on annual body growth and sick leave.”
- Researchers examining the effect of daylight in three North Carolina schools also found correlations between daylight and increased performance.⁴ The study reports positive results for children moving to daylit schools: student performance increased up to 14%.

² The report, “Daylighting in Schools—An Investigation into the Relationship between Daylighting and Human Performance,” was prepared for Pacific Gas & Electric Company and funded by the California Public Utilities Commission. The research was undertaken by the Hescong Mahone Group and the report was released in August 1999. A follow-up report was released in February 2002.

³ Kuller, R. and C. Lindsten. 1992. Health and behavior of children in classrooms with and without windows. *Journal of Environmental Psychology* 12: 305-317.

⁴ Nicklas, M. and G. Bailey. 1997. Analysis of the performance of students in daylit schools. *Proceedings of the American Solar Energy Society*.



A Closer Look — Daylighting and Student Performance

In a 1999 study, the Heschong Mahone Group found a statistically compelling connection between daylighting and student performance. The study isolates daylighting as an illumination source, and separates illumination effects from other qualities associated with daylighting from windows.

Student performance data from three elementary school districts was obtained and correlations investigated between the data and the amount of daylight provided within each student's classroom environment. Data from second- through fifth-grade students in elementary schools was used because extensive information was available from highly standardized tests administered to these students, and because elementary school students are generally assigned to one teacher in one classroom for the entire school year. Thus, it was reasoned that if the physical environment does indeed have an effect on student performance, such a correlation could be established by looking at the performance of these elementary school students.

The research analyzed test score results for over 21,000 student records from the three districts, located in Orange County, California; Seattle, Washington; and Fort Collins, Colorado. The data sets included information about student demographic characteristics and participation in special school programs. Architectural plans, aerial photographs, and maintenance records were reviewed, and the research team visited a sample of the schools in each district to classify the daylighting conditions in over 2,000 classrooms. Each classroom was assigned a series of codes on a simple zero-to-five scale, indicating the size and tint of its windows, the presence and type of any skylighting, and the overall amount of daylight expected.

The daylighting conditions at California's Capistrano Unified School District were the most diverse, and the data from that district were also the most detailed. Thus, Capistrano provided the most precise model. In this district, it was possible to study the change in student test scores over a school year. Controlling for about 40 other variables, it was found that students with the most daylighting in their classrooms progressed 20% faster on math tests and 26% faster on reading tests in one year than those with the least daylighting. Similarly, students with the largest window areas were found to progress 15% faster in math and 23% faster in reading than those with the smallest windows. And students that had a well-designed skylight in their room — one that diffused the daylight throughout the room, reduced glare, and allowed teachers to control the amount of daylight entering the room — also improved by 19% to 20% faster than those students without a skylight.

The research team also identified another window-related effect: students in classrooms where windows could be opened for natural ventilation were found to progress 7% to 8% faster than those with fixed windows, regardless of whether the room also had air conditioning. These effects were all observed with 99% statistical certainty.

The studies in Seattle and Fort Collins used the final scores on math and reading tests at the end of the school year, rather than the amount of change from the beginning of the year. In both of these districts, the research also found positive, highly significant effects from the daylighting. Students in classrooms with the most daylighting were found to have 7% to 18% higher scores than those with the least daylighting.

These performance benefits could be caused by a variety of daylighting effects from, including increased visibility due to higher illumination levels and light quality; improved student health, mood, and behavior; reduced effects of daylight deprivation; and higher arousal levels.

The three districts have different curriculum and teaching styles, different school building designs, and very different climates. And yet, the results of studies show consistently positive and significant effects. This consistency persuasively argues that there is a valid and predictable effect of daylighting on student performance.

However, the presence of daylight alone does not necessarily always translate to increased student productivity. Quality is a critically important factor in daylighting design. Classrooms with clear, non-diffused skylights are susceptible to patches of very bright light and glare which can become a detriment to learning. In fact, the Heschong Mahone Group found that students with these types of skylights progressed up to 21% more slowly in reading.



Indoor air quality can also be linked to student performance. Because of the complexities of indoor chemistry and the wide variety of sources of indoor pollutants, no study has yet directly tied differences in indoor air quality to student performance. However, a recent report from Lawrence Berkeley National Laboratories (LBNL)⁵ summarized the history of school investigations initiated by health symptoms and/or environmental complaints. They reviewed 53 Health Hazard Evaluation Reports for 1981-94 from the National Institute for Occupational Safety and Health (NIOSH), and 35 California indoor air quality investigations for 1988-96. They found that the frequency of recurring symptoms, such as headaches, fatigue, memory problems, eye irritation and cough, in schools where there had been complaints was markedly increased relative to schools without complaints. Similar symptoms in office buildings have been associated with reduced worker productivity, suggesting that school indoor air quality problems can be severe and persistent enough to affect the learning ability of students individually or as a group.



A Closer Look — Maidu Elementary School, Roseville, CA

Despite its location in California's central valley, all instructional spaces in the 500-student Maidu Elementary School have completely natural ventilation. Classrooms have operable windows. The library and media center rooms are surrounded by classrooms, limiting exterior exposure. Operable windows in these spaces create a chimney effect to draw air from the classrooms and exhaust it through clerestories, while spreading natural light throughout the space. In 1998, this school won a Coalition for Adequate School Housing/American Institute of Architects Award of Merit.

Photo courtesy Stafford King Wiese Architects.

The message is clear, and it confirms what teachers, students, and parents have known anecdotally for years: a better facility — one with appropriate acoustics, lighting, indoor air quality, and other high performance features — will enhance learning and can improve test results.

Increased Average Daily Attendance

Average daily attendance is an important metric because it is one way to illustrate the most important school design issue — protecting student health. Although many factors can influence whether a student comes to school, inadequate facilities can cause and exacerbate physical problems that lead to absenteeism. Consider asthma, for example. Poor indoor air quality triggers asthma attacks in susceptible children. The U.S. Environmental Protection Agency states that asthma is the leading cause of school absenteeism due to a chronic illness, accounting for an estimated 1.2 million missed school days per year in California. The American Lung Association states flatly that asthma is the leading cause of school absences.

⁵ Daisey, J.M. and W.J. Angell. 1998. A survey and critical review of the literature on indoor air quality. Ventilation and Health Symptoms in Schools, Indoor Environment Program, Lawrence Berkeley National Laboratory, Berkeley, CA. Report No. LBNL-41517. Prepared for the Office of Environmental Health Hazard Assessment, March 1998.



Although many studies have correlated characteristics of the indoor environment to changes in student health, behavior, and performance, estimating the degree to which absenteeism might be reduced by a given investment in high performance design is unknown. Ongoing research may eventually provide an answer, but for now, it's reasonable and appropriate to assume that investing in high indoor environmental quality can improve student health. A high performance school provides superior indoor air quality by controlling sources of contaminants, providing adequate ventilation, and preventing moisture accumulation. These tactics, designed to reduce sources of health problems and inhibit the spread of airborne infections, help keep pollutants, stale air, and mold growth out of the classroom.

Since healthier students and staff will have fewer sick days, it is important to recognize that absenteeism has large financial costs as well. The majority of a school's operating budget is directly dependent on average daily attendance, so even a small increase can significantly affect district budgets.

Reduced Operating Costs

High performance schools are specifically designed — using life-cycle cost methods — to minimize the long-term costs of facility ownership. By using less energy and water than standard schools, overall operating costs are lower — most notably in times of rising and uncertain energy prices — and, with good operation and maintenance, will remain so for the life of the facility. School districts can save 20% to 40% on annual utility costs for new schools and 20% to 30% for renovated schools by applying high performance design concepts. Savings can be used to supplement other budgets, such as maintenance, computers, books, special education, additional classrooms, and salaries.



A Closer Look — Durant Road Middle School, Wake County, NC

Daylighting and electric lighting are seamlessly integrated in this 1,300-student school in Raleigh, North Carolina. The design team repeatedly analyzed the interactions between the size and location of the roof monitors; the size and configuration of the electric lighting fixtures; the color and reflectance of the walls, floor, and ceiling; and the amount of light hitting the desks. "We worked the problem using computer simulation tools until we had just the right combination," notes Mike Niklas, chief architect for the project. "The result is a group of classrooms that are bright, fun places to be; that rely on natural sunlight for the bulk of their lighting needs; that virtually eliminate glare; and that save the school money on energy — all at the same time."

Principal Tom Benton highlights the benefits his school has seen from the design.

"The daylight classrooms have increased the well being of the students and teachers, and are at least partially responsible for our record high attendance rates," he says. "We are running about 3% ahead of the rest of the county in attendance. We stay around 98%."

Photo courtesy Innovative Designs.



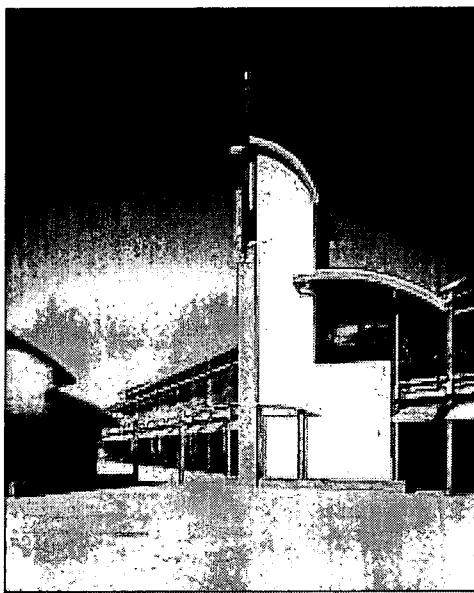

A Closer Look — Wangenheim Middle School, San Diego, CA

San Diego, CA. This 24-classroom addition to Wangenheim Middle School is designed to optimize energy efficiency and indoor comfort using passive systems. The site and envelope design of the new one- and two-story buildings promote cross ventilation and daylighting through use of operable windows, clerestories, light shelves, and interior reflective surfaces. Appropriately sized shading devices protect the interiors from unwanted solar gain.

Teacher response has been favorable. Comments include: "On bright days, we operate the classrooms frequently without any of the lights on." "We like the cross ventilation. These classrooms are much more comfortable than the others. On hot days, the classrooms are at least ten degrees cooler than the portables."

Photo courtesy Platt/Whitelaw Architects. Hewitt Garrison, photographer.

Increased Teacher Satisfaction and Retention

Many districts are facing teacher shortages and high turnover rates. The educational and financial costs of recruiting and training teachers are significant. High performance classrooms are designed to be pleasant, effective places to work. Visual and thermal comfort is high, acoustics are good, and the indoor air is fresh and clean. Such environments become positive factors in recruiting and retaining teachers and in improving their overall satisfaction with their work.

Reduced Liability Exposure

Because they emphasize health and superior indoor environmental quality, high performance school buildings reduce a district's exposure to health-related problems, lawsuits, and loss of credibility. Remediation expenses for schools with indoor environment problems often reach a quarter of a million dollars, and legal costs can be much higher. Consequently, proactive measures that prevent problems are good investments.

Reduced Environmental Impacts

High performance school buildings are consciously designed to have low environmental impact. They are energy and water efficient. They use durable, non-toxic materials high in recycled content, and the buildings themselves can be recycled. They preserve pristine natural areas on their sites and restore damaged ones. And they use non-polluting, renewable energy to the greatest extent possible. As a consequence, high performance school buildings are good environmental citizens, and are designed to stay that way for the entire life of the building.

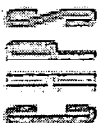

CHARACTERISTICS OF A HIGH PERFORMANCE SCHOOL

“High performance school” refers to the physical facility — the school building and its grounds. Good teachers and motivated students can overcome inadequate facilities and perform at a high level almost anywhere, but a well-designed facility can truly enhance performance and make education a more enjoyable and rewarding experience.

Because schools are complicated structures, high performance design covers a broad and diverse range of disciplines and choices. Building a high performance school does not mean buying and installing the latest, most expensive equipment. Rather, it is a design philosophy focused on choices that improve the learning environment and save resources. Some choices are essential and others are discretionary; it’s important to keep the range of choices in perspective and focus on the key design issues.

Schools are unique buildings that every day house one-fifth of the population: almost 6 million children and more than 200,000 teachers and support staff. There are few other settings in which 20 to 30 people occupy such a small space or work on such a wide a range of activities as in a school classroom. Occupant density is approximately four times as great as a typical office building, and schools include many “special use” areas all within the same facility, such as laboratories, art studios, industrial shops, duplication facilities, and gymnasiums.

Creating a high performance school is not difficult, but it requires an integrated, “whole building,” team approach to the design process. Key systems and technologies must be considered together, from the beginning of the design process, and optimized based on their combined impact on the comfort and productivity of students and teachers. A high performance school is:

- **Healthy.** The significant amount of time that students and teachers spend inside schools during their educational career, combined with children’s increased susceptibility to indoor pollutants, underscores the importance of good indoor air quality.
- **Thermally, visually, and acoustically comfortable.** Thermal comfort means that teachers, students, and administrators should be neither hot nor cold as they teach, learn, and work. Visual comfort means that quality lighting makes visual tasks, such as reading and following classroom presentations, easier. The lighting for each room is “designed,” not simply specified. Acoustic comfort means teachers and students can hear one another easily. Noisy ventilation systems are eliminated, and the design minimizes the amount of disruptive outdoor and indoor noise affecting the classroom.
- **Energy efficient.** Energy-efficient schools cost less to operate, which means that more money can be used for books, computers, teacher salaries, and other items essential to the educational goals of schools. Energy-efficient schools also reduce emissions to the environment, since energy use is related to emissions of chemicals that contribute to global warming and acid rain. By following the guidelines in this manual, energy use can be reduced by up to 40% compared to conventional buildings that minimally comply with the



California's Energy Efficiency Standards for Residential and Nonresidential Buildings (Title 24).

- **Material efficient.** To the maximum extent possible, the school incorporates building materials that have been recycled or produced in a way that conserves raw materials. Such materials may be manufactured with a rapidly renewable resource or recycled content, are durable, or can be recycled or reused. In addition, the school has been designed and built in a manner that reduces waste and keeps re-usable or recyclable materials out of the landfill.
- **Water efficient.** Water scarcity is a major problem in much of California. High performance schools are designed to use water efficiently, saving money while reducing the depletion of aquifers and river systems and minimizing the use of sewage treatment systems. The school uses as little off-site water as possible to meet its needs, controls and reduces water runoff from its site, and consumes fresh water as efficiently as possible.
- **Easy to maintain and operate.** Building systems are simple and easy to use and maintain. Teachers have control over the temperature, airflow, acoustics, and lighting in their classrooms, and are trained how to most effectively use them.
- **Commissioned.** The school operates the way it was designed and meets the district's needs. This happens through a formal commissioning process — a form of “systems check” for the facility. The process tests, verifies, and fine-tunes the performance of key building systems so that they perform at the highest levels of efficiency and comfort, and then trains the staff to properly operate and maintain the systems.
- **An environmentally responsive site.** The site is recognized as an essential element of the school building's high performance features. To the extent possible, the school's site conserves existing natural areas and restores damaged ones; minimizes stormwater runoff and controls erosion; and incorporates products and techniques that do not introduce pollutants or degradation to the project site or at the site of extraction, harvest, or production.
- **A teaching tool.** By incorporating important concepts such as energy, water, and material efficiency, schools can become tools to illustrate a wide spectrum of scientific, mathematical, and social issues. Heating, ventilation, and air conditioning (HVAC) systems; lighting equipment; and controls systems can be used to illustrate lessons on energy use and conservation, and daylighting systems can help students understand the daily and yearly movements of the sun.
- **Safe and secure.** High performance does not compromise safety. Students and teachers feel safe anywhere in the building or on the grounds. A secure environment is created primarily by design: opportunities for natural surveillance are optimized; a sense of community is reinforced; and access is controlled.
- **A community resource.** The most successful schools have a high level of parent and community involvement. This involvement can be enhanced if schools are designed for neighborhood meetings and other community functions.
- **Stimulating architecture.** High performance schools should invoke a sense of pride and be considered a genuine asset for the community.

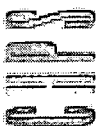

Building a school that encompasses all these concepts may seem overwhelming, but with thorough planning and committed execution, it doesn't have to be. The 13 items listed below, which are outlined in the following pages, provide guidance for creating a high performance school:

1. Set district goals early and use integrated design.
2. Commission the school.
3. Use daylighting.
4. Protect indoor air quality.
5. Install high performance lighting and controls.
6. Use High Performance HVAC strategies.
7. Choose materials wisely.
8. Optimize acoustics.
9. Minimize water use.
10. Choose and develop the site wisely.
11. Use sustainable construction practices.
12. Don't forget the portables.
13. Train the staff and maintain the building.



Set District Goals Early and Use Integrated Design

Explicitly outlining the design goals for the school as soon as possible is the most important action that school districts can take to influence the performance of their facility. For best results, high performance goals should be reflected in all aspects of project documentation. Goals established during programming should be clearly stated in the educational specifications, the request for proposals (RFP) to select the design team, in the instruction to bidders, and as part of the project summary.

Districts can use the CHPS Criteria (Volume III) to facilitate and streamline the design process. The criteria explicitly quantify what differentiates a high performance school from standard designs. It is a system of pre-requisites and credits divided into categories including Site, Water, Energy, Materials, Indoor Environmental Quality, and District Resolutions. Districts can use it to clearly communicate their design goals in three ways:

- Specify that the new school must be a "CHPS School" as defined by the CHPS Criteria. This requires the design team earn 28 out of the 81 possible points.
- Specify that the facility must be a "CHPS School" and earn specific credits that are important to the district. Because the credits are independent of one another, the district can highlight certain high performance features by specifically highlighting individual credits. For example, if the district wants a "CHPS School" that includes daylit classrooms and low-VOC materials, then those particular credits can be identified and required in the contract documents.
- Specify individual credits that are important to the district, but not require them in the design to be a "CHPS School." Of course, CHPS recommends that schools meet the requirements of the CHPS Criteria, but if this is not possible, then any incremental high performance features that can be incorporated should be specified.

The typical design process for schools begins with programming and selection of the architectural-engineering team. The sooner high performance goals are considered in the

Details and implementation rules for individual design strategies.

While reading about the individual strategies, please do not lose sight of the fact that whole building performance is what matters.

The design process used to achieve high performance schools is fundamentally different from conventional practice. To be most effective, this process requires a significant commitment on the part of design professionals to:

- *Meet environmental performance criteria and optimize design choices through simulations, models or other design tools. Life-cycle cost analysis should be used wherever possible.*
- *Incorporate interdisciplinary collaboration throughout the design and construction process. Integrate all significant building design decisions and strategies — beginning no later than the programming phase.*
- *Maintain a view of the building and site as a seamless entity, within the context of its community. Work with the understanding that the building exists within a natural ecosystem even when the setting is urban.*
- *Commission all building equipment and systems to assure continued optimum performance.*
- *Provide clear guidance, documentation, and training for operations and maintenance staff. Document high performance materials in the building so that maintenance and repairs can be made in accordance with the original design intent. Encourage sustainable construction operations and building maintenance.*



design process, the easier and less costly they are to incorporate. Many of the guidelines presented in this document must be considered early in the design process in order for them to be successful. The figure below illustrates how quickly the opportunities for high performance diminish as the design progress progresses.

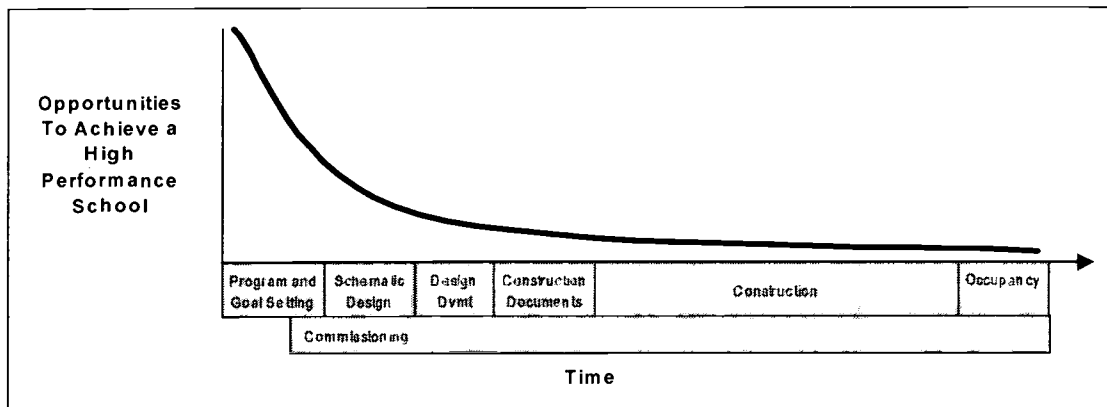

Opportunities in the Design Process

Integrated design is the consideration and design of all building systems and components together. It brings together the various disciplines involved in designing a building and reviews their recommendations as a whole. It recognizes that each discipline's recommendations have an impact on other aspects of the building project. This approach allows for optimization of both building performance and cost. Too often, for example, lighting systems are designed without consideration of daylighting opportunities. The architect, mechanical engineer, electrical engineer, contractors, and other team members each have their scope of work and often pursue it without adequate communication and interaction with other team members, resulting in oversized systems or systems that are optimized for non-typical conditions.

Even a small degree of integration provides some benefits. It allows professionals working in various disciplines to take advantage of efficiencies that are not apparent when they are working in isolation. It can also point out areas where trade-offs can be implemented to enhance resource efficiency. Design integration is the best way to avoid redundancy or conflicts with aspects of the building project planned by others.

For a high performance school, team collaboration and integration of design choices should begin no later than the programming phase. The team may be more broadly defined than in the past, including energy analysts, materials consultants, cost consultants, lighting designers, and commissioning agents. Design activities may include charrettes, modeling, and simulations.

Additional Resources

Volume II

Volume II gives detailed technical design information for all major high performance issues.

Volume III Resources

Volume III is a convenient tool that districts can use to clearly specify a high performance school and prioritize their goals.

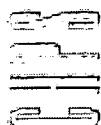

Commission the School

High performance schools can only be achieved with some level of commissioning. No matter how carefully a school is designed, if the building materials, equipment, and systems weren't installed properly or aren't operating as intended, the health, productivity, and other benefits of high performance design will not be achieved. Commissioning is a quality assurance program that is intended to show that the building is constructed and performs as designed. It is a powerful tool to indicate if the designers and contractors have done what they were hired to do. Studies show that many building systems will not operate as expected unless they are commissioned. One study of 60 newly-constructed, nonresidential buildings revealed that more than half had controls problems, 40% had malfunctioning HVAC equipment, and one-third had sensors that did not operate properly. In many of the buildings, equipment called for in the plans and specifications was actually missing. One-fourth of the buildings had energy management control systems (EMCS), with economizers or variable-speed drives that did not run properly.

Systems that Require Commissioning:

- HVAC plant.
- Air and water delivery system.
- Energy management system.
- Electrical and lighting system.
- Fire/life safety system.
- Data networks/communications.
- Security system.
- Kitchen equipment and fume hoods.
- Building envelope.
- Renewable energy system.
- Science lab gas delivery system.
- Emergency power supply.
- Plumbing.
- Irrigation system.

Commissioning is a systematic process of ensuring that all building systems perform interactively according to the contract documents, the design intent, and the district's operational needs. The commissioning process integrates the traditionally separate functions of design peer review; equipment startup; control system calibration; testing, adjusting and balancing; equipment documentation; and facility staff training, as well as adds the activities of documented functional testing and verification.

Commissioning is occasionally confused with testing, adjusting, and balancing (TAB). Testing, adjusting, and balancing measures building air and water flows, but commissioning encompasses a much broader scope of work. Commissioning typically involves four distinct "phases" in which specific tasks are performed by the various team members throughout the process. The four phases are pre-design, design, construction, and warranty. During the construction phase, commissioning involves functional testing to determine how well mechanical and electrical systems meet the operational goals established during the design process. Although commissioning can begin at the construction phase, districts receive the most cost-effective benefits when the process begins during the pre-design phase when the project team is assembled.



Commissioning can take place for one building system or for the entire facility; however, the more comprehensive the commissioning, the greater the impact on school performance. Whichever level of commissioning chosen, a commissioning provider should be engaged during the schematic design phase or earlier. It is therefore important that commissioning responsibilities — particularly who will bear the cost of correcting conditions that do not meet specifications — are clearly spelled out in the beginning of the design process. For best results, the provider should be an independent contractor or a member of the design team who is not directly involved in the design.

The commissioning agent is responsible for implementing the commissioning plan, including the tasks outlined below:

- Create a clear statement of the design intent for each building system. Write the commissioning specifications and incorporate them in the appropriate divisions of the construction documents.
- Carry out pre-functional and functional testing of all equipment and systems to be commissioned, using procedures designed in advance. Check installed equipment to ensure that all associated equipment and accessories are in place. Verify and document that systems are performing as expected, and that all sensors and other system control devices are properly calibrated.
- Prepare comprehensive operation and maintenance manuals, coupled with training of building operations staff.
- Ensure that all required documentation has been provided, such as a statement of the design intent and operating protocols for all building systems. A final report with all commissioning documentation and recommendations must be given to the district.
- Conduct ongoing monitoring after the school is occupied to ensure that equipment and systems continue to perform according to design intent.

A Closer Look — Kern High School District, Liberty High School Commissioning, Bakersfield, CA

The Kern High School District, like many other districts in California, has been constructing new schools to satisfy its increasing student population. On many of its new construction projects, equipment did not function properly at turnover, resulting in numerous contractor callbacks. Projects with 100 or more callbacks were the rule, rather than the exception. In 1994, as it began the planning for the construction of the new 200,000-ft² Liberty High School campus, the school district decided to incorporate commissioning as a quality assurance process. The commissioning goal was to improve the outcome of this project, and to reduce or eliminate this callback problem. The commissioning budget was set at \$40,000 of the total construction budget of \$28 million. The district wrote their own request for commissioning services proposal and hired a commissioning provider to conduct construction phase commissioning on the mechanical systems and verify proper electrical phasing. After the provider was selected and hired, he began development of the commissioning plan. As construction commenced, regular meetings were held between the commissioning provider and the construction team. When construction was completed, the district maintenance staff worked with the commissioning provider and contractors to functionally test each system and verify proper operation. Although no major deficiencies were found, numerous minor adjustments and system integration issues were identified and rectified as part of this commissioning process. The net result was a 75% reduction in contractor callbacks after the turnover of the new facility. This reduction also resulted in significant labor and maintenance budget savings for the district. Resources normally used to address these turnover problems were now being redirected elsewhere.

The district learned many lessons on its first commissioning project. If budget will allow for it on the next commissioning project, the district would like to include analysis of the systems, specification review, and possibly design review, as part of the commissioning provider's scope of work.



Selecting the Commissioning Provider

District representatives, designers, the commissioning provider, installing contractors, and facility managers all have roles in the commissioning process. The goal of the commissioning team is to promote communication among team members and to identify and resolve problems early in the process. One of the most important commissioning decisions a district can make is selecting the commissioning provider and determining who will hold the commissioning provider's contract. Commissioning activities can be handled by a number of parties:

- *Independent third party under contract to the district.* Many districts that have commissioned their buildings recommend using an independent third party. An independent commissioning provider can play an objective role and ensure that the district will truly get the building performance expected. For large and/or complex projects, especially in buildings with highly integrated, sophisticated systems, future savings from commissioning outweigh the slightly higher costs with an additional contract.
- *Architect or design engineer overseeing the commissioning process.* If commissioning requirements in the project specifications are rigorous and detailed, districts may consider having the architect manage the contract of a commissioning provider. The designer chosen to provide commissioning services must not have responsibility for the design of the project. One advantage of using a designer is that he or she is already familiar with the design intent of the project. Districts considering this option should bear in mind that commissioning is not included in a design professionals basic fees. Districts should require that all findings of the commissioning process be directly reported to both the designer and to the district as they occur, to manage the potential conflict of interest created by having the commissioning services under the designer.
- *Contractor.* As standard practice, many contracting firms historically conducted performance tests and check-out procedures on the equipment they installed. As construction budgets tightened, this service was typically dropped. Although contractors may have the knowledge and capability to test the equipment, they may not be skilled at testing or diagnosing system integration problems. In addition, some contend that it is difficult for contractors to objectively test and assess their own work, especially when repairing any deficiencies they find may increase their costs. However, under certain circumstances, the contractor may be the most appropriate choice to complete commissioning.

Additional Resources

Volume II

Volume II contains a chapter addressing commissioning, as well as additional guidance and resources in the Appendix.

Volume III Resources

Commissioning is not required, however up to three points are awarded for commissioning tasks. Energy Prerequisite 2 requires that a third party or district official verify that critical building systems have been tested prior to occupancy and that training is provided to the teachers and staff.

Energy Credit 4.1 (2 points) requires that a commissioning agent be engaged and perform basic commissioning tasks.

Energy Credit 4.2 (1 point) rewards more advanced commissioning such as focused design, construction document, contractor submittal, and post-occupancy reviews.

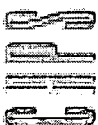

Use Daylighting

Daylighting forms the cornerstone of sustainable, high performance design for schools. Affecting occupants on both conscious and subconscious levels, it provides light to see the environment and to do work, a natural rhythm that determines the cycles of days and seasons, and biological stimulation for hormones that regulate body systems and moods. In addition, it offers opportunities for natural ventilation and tremendous energy savings in electrically lit interiors. These advantages of daylighting translate to higher performance in schools. Recent research has shown that children achieve significantly higher test scores in classrooms that are daylit than in those that are not, making daylighting one of the best building-related investments for the learning environment.

Performing visual tasks is a central component of the learning process for both students and teachers. A high performance school should provide a rich visual environment — one that enhances, rather than hinders, learning and teaching — by carefully integrating natural and electric lighting strategies; by balancing the quantity and quality of light in each room; and by controlling or eliminating glare.

When properly designed, daylighting systems can also substantially reduce operating costs. The first step is decreasing the need for electric lighting, which can account for 35% to 50% of a school's electrical energy consumption. As an added benefit, waste heat from the lighting system is reduced, lowering demands on the school's cooling equipment. The savings can be as much as 10% to 20% of a school's cooling energy use. And daylight provides these savings during the day when demand for electric power is at its peak and electricity rates are at their highest.

As straightforward as these advantages appear, they do not just happen. The design team must work together using the principles of integrated design to maximize the effectiveness of daylighting systems, and the building occupants need to be educated about how the systems

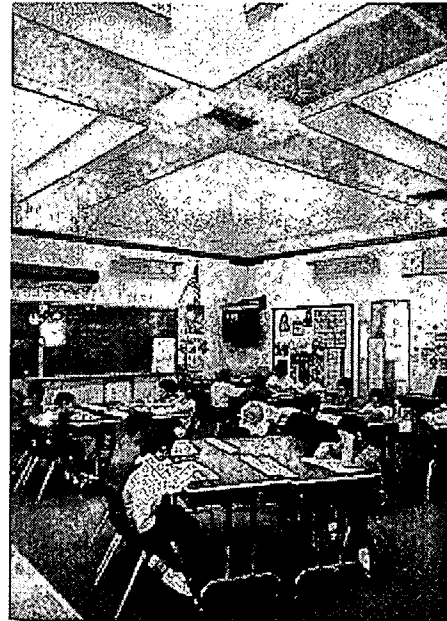

A Closer Look — Dena Boer Elementary School, Salida, CA.

Skylights are used to distribute natural daylight to the classrooms, library, multipurpose room and offices of this 800-student, K-5 school near Modesto, California. Louvers installed in the skylight wells help control daylight levels and can be used to darken rooms when necessary. Classroom windows provide additional daylight and are protected by deep overhangs to control direct sunlight and glare. All these "extras" were provided within the standard construction budget for the school, which was completed in 1997. The key was making daylighting a priority for the school and then shifting funds from elsewhere in the budget to pay for it.

The extra sunlight has proven very popular. "The skylights create an open, bright work environment. We just seem to have more room. Visitors say it sure is a pleasant place to come into," notes school principal Rick Bartkowski.

Photo courtesy Sun Optics.



work. Lighting options range from no-cost and low-cost choices to sophisticated state of the art systems. It's important to communicate daylighting goals clearly with the design team, and find a solution that fits the budget.

The following six principles (discussed further in Volume II's Daylighting chapter) provide fundamental guidance in designing daylit schools:

1. Prevent direct sunlight penetration. Direct beam sunlight is an extremely strong source of light. It is so bright, and so hot, that it can create great visual and thermal discomfort. Daylight, on the other hand, which comes from the blue sky, from clouds, or from diffused or reflected sunlight, is much more gentle and can efficiently provide excellent illumination without the negative impacts of direct sunlight. Good daylighting design typically relies on maximizing the use of gentle, diffuse daylight, and minimizing the penetration of direct beam sunlight. In general, sunlight should only be allowed to enter a space in small quantities, as dappled light, and only in areas where people are not required to do work.

2. Provide gentle, uniform illumination. Daylight is most successful when it provides gentle, even illumination throughout a space. Evenly diffused daylight will provide the most energy savings and the best visual quality. Achieving this balanced diffuse daylight throughout a space is one of the greatest achievements of a good daylight designer.

The arrangement of reflective surfaces that help to distribute the light are just as important as the arrangement of daylight openings for providing gentle, uniform illumination. Whenever possible, place daylight apertures next to a sloped or perpendicular surface so the daylight washes either a ceiling or a wall plane, and is reflected deeper into the space. It is essential to recognize that walls and ceilings are part of the daylighting design. For greatest efficiency and visual comfort, they should be painted white, or a very light color that has a high light reflectance value.

3. Avoid glare. Excessively high contrast causes glare. Direct glare is the presence of a bright surface (for example, a bright diffusing glazing or direct view of the sun) in the field of view that causes discomfort or loss in visual performance. This can have negative effects on student and staff performance.

4. Provide control of daylight. Daylight is highly variable throughout the day and the year, requiring careful design to provide adequate illumination for the maximum number of hours while contributing the least amount possible to the cooling load. Teachers should have easy access to controls for shades or blinds to adjust light levels as needed throughout the day. These systems should be reliable, easy, and economic to clean and repair. Manually operated controls are slightly less convenient but also less expensive and less likely to need repair.

5. Integrate with electric lighting design. The daylight and the electric light systems should be designed together so they complement each other to create high quality lighting. This requires an understanding of how both systems deliver light to the space. The electric lighting should be circuited and controlled to coincide with the patterns of daylight in the space, so that the lights can be turned off in areas where daylight is abundant and left on where it is deficient.



Controls can either be manual or automatic. Automatic controls use a small photosensor that monitors light levels in the space. Manual controls are substantially less expensive, but need to be convenient and well labeled to ensure their use. Automatic controls guarantee savings, but are more expensive and must have overrides so the teacher can darken the room for audio/visual use.

6. Plan the layout of interior spaces. Successful daylighting designs must include careful consideration of interior space planning. Since daylighting illuminance can vary considerably within the space, especially with sidelighting, it's important to locate work areas where there is appropriate daylighting. Perhaps more importantly, visual tasks (especially the teaching wall) should be located to reduce the probability of discomfort or disability glare. In general, work areas should be oriented so that daylighting is available from the side or from above. Facing a window may introduce direct glare into the visual field, while facing away from a window may produce shadows or reflected glare.

Additional Resources

Volume II

Volume II dedicates an entire chapter to daylighting design.

Volume III

IEQ Credit 1 awards up to four points if 75% of classrooms are daylit and 90% have windows within the line of sight.

In addition, up to 10 points are available for advanced energy efficiency. Moderate to high levels of energy savings are only achievable with a quality daylighting design tightly integrated with the electric lighting and HVAC systems.

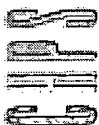

Daylighting Strategies

The location, orientation, and size of the daylighting apertures are of paramount importance, as are the selection of the glazing materials used and how they are shaded from direct sun. When possible, it's always better to locate daylighting apertures in the ceiling plane (toplighting). With toplighting, glare is easier to control, and daylight distributions are more even. The other basic strategy, sidelighting, allows daylight to enter through windows in vertical walls. However, controlling glare and providing uniform illuminance is more difficult.

To fully daylight most spaces, the guidelines should be combined with each other or repeated as a pattern across the space. For example, Wall Wash Toplighting (Guideline DL4) on an interior wall could be combined with High Clerestory Sidelighting (DL2) and View Windows (DL1) on an exterior wall to fully daylight a classroom. Each guideline represents a daylight delivery system with inherent advantages and disadvantages. They are applicable to all climate regions and should be planned in the schematic design phase. It is appropriate for all climate regions, and should be considered during the programmatic, schematic, and design development phases of a school building project.

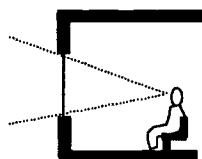

Guideline DL1: View Windows. Provide access to exterior views through view windows for all interior spaces where students or staff will be working for extended periods of time. **A view window is vertical glazing at eye level, which provides a view to the exterior or interior adjacent spaces.** View windows are essential in all school spaces (except spaces requiring visual privacy) to provide relaxing views and information about exterior natural conditions. They are applicable to all climate regions and should be planned in the schematic design phase.

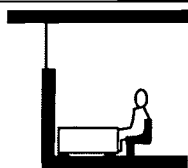

Guideline DL2: High Sidelighting — Clerestory and Guideline DL3: High Sidelighting — Clerestory with Light Shelf or Louvers. High sidelighting clerestories are vertical glazing in an exterior wall above eye level (usually above 7 ft), and can be used in all school spaces to provide deep penetration of daylight. A light shelf is a horizontal panel placed below high clerestory glazing (with a view window generally below it) that improves light distribution as daylight reflects off the top surface of the light shelf or louver onto the ceiling. Use light shelves or louvers with high clerestory glazing in perimeter walls to improve daylight distribution, block direct sun penetration, and minimize glare.

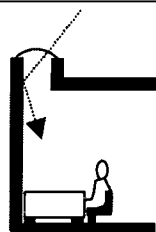

Guideline DL4: Classroom Daylighting — Wall Wash Toplighting. Use wall wash top lighting for interior classroom walls to balance daylight from window walls, brighten interior classrooms, and make them seem more spacious. Wall wash toplighting provides daylight from above through a linear skylight or monitor to wash an interior wall. The glazing is obscured from direct view by the skylight or monitor well. Daylight is diffused with diffusing glazing, baffles or reflections off of matte reflective light well and interior walls.

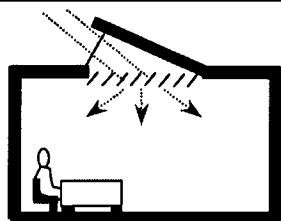

Guideline DL5: Central Toplighting. Use central toplighting in single-story or top floor spaces including classrooms, libraries, multipurpose spaces, and administrative offices to provide high levels of even, balanced daylight across the entire room. Central toplighting is accomplished by a central monitor or skylight (or cluster of skylights) that distributes daylight evenly across the room. Daylight is diffused with diffusing glazing or baffles that can be fixed or operable. Daylight levels are highest directly under the aperture and gradually reduce toward the perimeter of the space.

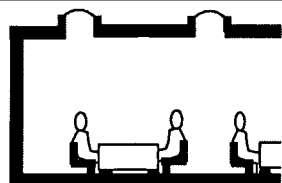

Guideline DL6: Patterned Toplighting. Use patterned toplighting in interior spaces that need even, low glare illumination across a large area. Patterned toplighting provides daylight through a two-dimensional grid of skylights or rows of linear monitors (sawtooth or square). Spacing of the pattern is largely a function of the ceiling height. It is especially good for gymnasium, library, and multipurpose or cafeteria spaces.

BEST COPY AVAILABLE

Protect Indoor Air Quality

The quality of the air inside a school is critical to the health and performance of children, teachers, and staff. A high performance school should provide superior-quality indoor air by: eliminating and controlling the sources of contamination; providing adequate ventilation; commissioning the building; and implementing effective operations and maintenance procedures. For years, news reports, scientific inquiries, and educational efforts have brought attention to the symptoms, causes, and solutions to indoor air quality problems.

According to the U.S. Environmental Protection Agency, the concentration of pollutants inside a building may be two to five times higher than outside levels. Maintaining a high level of indoor air quality is therefore critical for schools. Failure to do so can negatively impact student and teacher performance; increase the potential for long- and short-term health problems for students and staff; increase absenteeism; accelerate deterioration and reduce efficiency of the school's physical plant; create negative publicity that could damage a school's image; and create potential liability problems.

Indoor pollutants such as chemical toxins and biological agents can create significant health risks and adverse learning conditions. Pollutants can affect a range of body systems, and affect health, learning, productivity and self-esteem. Health effects can be both transient (sick building syndrome) and long-term (building related illness, multiple chemical sensitivity), and may not affect all of classroom occupants in the same way. Symptoms range from mild discomfort and the perception of bothersome odors to severe illness and permanent injury. Health effects include increased rates of infectious diseases (influenza and the common cold, for example), eye and respiratory irritation, allergies and asthma, chronic sinusitis, headaches, and an array of other diseases. Environmental factors such as light quality, acoustics and overcrowding may also contribute to or create similar problems. Health problems are typically classified as follows.⁶

- Sick building syndrome (SBS). SBS describes a collection of symptoms experienced by building occupants that are generally short-term and may disappear after the individuals leave the building. The most common symptoms are sore throat, fatigue, lethargy, dizziness, lack of concentration, respiratory irritation, headaches, eye irritation, sinus congestion, dryness of the skin (face or hands), and other cold-, influenza-, and allergy-type symptoms.
- Building-related illness (BRI). BRIs are more serious than SBS conditions and are clinically verifiable diseases that can be attributed to a specific source or pollutant within a building. Examples include cancer and Legionnaires' disease.
- Multiple chemical sensitivities (MCS). More research is needed to fully understand these complex illnesses. The initial symptoms of MCS are generally acquired during an identifiable exposure to specific VOCs. While these symptoms may be observed to affect more than one body organ system, they can recur and disappear in response to exposure

⁶ United States Green Building Council. 1996. Sustainable Building Technical Manual. The following definitions are quoted from Chapter 13: "Indoor Air Quality" by Anthony Bernhiem. <http://www.usgbc.org/>.



to the stimuli. Exposure to low levels of chemicals of diverse structural classes can produce symptoms. However, no standard test of the organ system function explaining the symptoms is currently available.

Key to the concern about indoor air quality problems in schools is that children are believed to be much more vulnerable than adults to environmental contaminants and injury.⁷ Relative to their size, both their breathing rates and metabolic rates are significantly greater than adults. Children will therefore breathe in and metabolize greater doses of airborne toxins than adults in the same environment. Because children's bodies are actively growing, they absorb and retain more of these toxins. Their defense mechanisms are less effective at preventing contaminants and infectious organisms from entering their bodies, and their immune systems are less able to respond when agents do enter.

In addition, an increasing number of students and staff are coming into the classroom with already highly sensitized respiratory systems. Across the country, student and staff populations have seen sharp increases in both the prevalence and severity of asthma.⁸ Rates in urban areas have been especially high.

Pollutants of concern include mold and microbial growth, airborne chemicals (VOCs, carcinogens, reproductive toxins), inorganic chemicals, and airborne particles including dust and dirt. Exposures to common molds and damp environments have been associated with childhood respiratory illnesses,⁹ such as persistent wheezing, shortness of breath, and bronchitis. Molds typically cause health problems when large quantities of air-borne spores are inhaled.

School districts have the power to control their indoor air quality. Because of the diverse range of pollutant sources and the potentially high costs of corrective actions, schools should focus on prevention. Many no-cost and low-cost approaches are available to prevent problems. The key elements are:

Adequate ventilation

Adequate ventilation is the cornerstone of good indoor air quality. Ventilation is critical to removing indoor pollutants from the classroom, and state building codes specify minimum ventilation rates for schools. National standards recommend 20 cubic feet per minute (cfm) per person. In California, the law requires 15 cfm per person, although 20 cfm should be considered. Unfortunately, many schools never meet these guidelines. A 1995 California Energy Commission (CEC) report found that schools consistently had sub-standard ventilation rates, and one in three classrooms were ventilated at less than half the legal minimums. Other times, sufficient ventilation is entering the room, but it is not distributed effectively to all the occupants. Districts and designers must ensure that the proper amount of air is reaching all of the students in the school. Of particular concern are portable classrooms with loud HVAC systems. Teachers are

⁷ National Institute of Environmental Health Sciences. 1999. Children's Environmental Health and Disease Prevention Research. *Environmental Health Perspective* 107 (Supplement 3, June).

⁸ Monnino, D.M. et al. 1998. Surveyance for asthma — United States, 1960-1995. Centers for Disease Control & Prevention, *MMW* 47(SS No. 1, April 24).

⁹ Spengler, J. et al. 1994. *Indoor Air* 4:72-82. Verhoeff, A.P. et al. 1995. *American Journal of Epidemiology* 141:103-110.



commonly forced into the unacceptable compromise of turning off noisy air conditioners (and sacrificing ventilation) in order to communicate with their students.

Maintenance

Maintenance practices are crucial to preventing indoor air quality problems.

Mold and microbial growth are the largest potential problems. Any moisture intrusions or spills must be cleaned up thoroughly and immediately to prevent mold from growing. Dead mold spores are often as dangerous as live spores, so prevention is crucial. Once mold is established, it can be very difficult to effectively remediate. All teachers and staff should be trained on how to prevent and identify mold.

HVAC systems must be regularly inspected and maintained to ensure adequate ventilation rates. Filters should be regularly replaced to ensure their effectiveness.

Maintenance practices themselves can introduce and/or remove pollutants. Regular carpet and floor cleanings minimize surface dust. Many cleaning solutions emit VOCs and other chemicals that can remain in the classrooms and cause indoor air quality problems. Districts should consider using interior surfaces that require less frequent or less toxic maintenance practices. Districts should also evaluate their cleaning and landscape management products and consider less toxic alternatives. Herbicides and pesticides are of particular concern. Districts should employ integrated pest management techniques to minimize the use of toxic materials.

Envelope Design

By designing the envelope to reduce moisture build-up through condensation, mold growth can be avoided.

Materials selection

By requiring architects to specify safe materials and materials that resist growth of molds and mildews, indoor air quality problems may be avoided.

Commissioning

By documenting design intent and verifying building systems performance, commissioning is a valuable way to ensure that indoor air quality has been properly addressed.

Additional Resources

Volume II

Indoor air quality is addressed throughout Volume II. Because Volume II is organized by building system, no single chapter completely addresses the issues. The Interior Surfaces Chapter has the most information, specifically about indoor pollutants emitted from flooring, wall, and ceiling finishes.

Volume III

Several prerequisites and up to 10 points are dedicated to providing good indoor air quality.

Site Selection Prerequisite 1 requires that the exterior air be shown to not affect student health, including discharges from all neighboring or nearby facilities, traffic routes and intersections, and natural sources.

IEQ Prerequisite 1 details minimum ventilation rates, construction-related indoor air quality measures, and drainage requirements.

IEQ Credit 2 (1-4 points) requires that major indoor surface materials be tested and emit less indoor pollutants than specified and the CHPS Material Specifications Section 1350.

IEQ Credit 3 (1-3 points) awards pollutant source control in specific building areas and ventilations systems.

IEQ Credit 4 (1-2 points) awards additional construction indoor air quality measures and building flush out.

District Resolution Credit 2 (1 point) awards districts that develop an indoor air quality management program.



<p>Source Control Indoor pollutants originate from a variety of sources, each requiring a different approach to prevent their accumulation in the classroom.</p>	
<p>Proper siting</p>	<p>Care should be taken to minimize the amount of pollutants in the outside air used for ventilation. Outdoor pollutants that are widely distributed, like ozone, are difficult to control. Other external sources can be avoided during site selection. Always consider local traffic patterns and the amounts of pollutants emitted from sites adjacent or nearby the school. Never place air intake vents near parking lots, bus idling areas, or other local exhausts.</p>
<p>Appropriate materials</p>	<p>To protect indoor environmental quality, the designer should seek to eliminate potential sources of indoor air pollution by selecting the most durable, least toxic, low-emitting, moisture-resistant materials that can be safely installed and maintained. The approval process for substitutions should be clearly spelled out and should require specific product ingredient information, as well as information about any adhesives, solvents, or other materials that might be used during installation or maintenance. However, do not prohibit substitutions. Specialized subcontractors can be a superb source of information about new and improved product alternatives.</p> <p>Carpets, paints, adhesives, furniture, wall-coverings, and pressed wood products such as particle board, have all traditionally contained toxins that contribute to indoor air quality problems. In today's market, low-emitting alternatives are available for most building and finishing materials. CHPS has developed the first health-based standard for testing all major building and surface materials for material emissions. The material specification language¹⁰ identifies maximum emission rates for over 60 indoor chemicals of concern, as well as proper testing protocols for various types of materials.</p> <p>To verify that a particular product passes the CHPS Material Specifications, interested parties (designers, district officials, etc.) should submit the requirements listed in the specification to the manufacturer, along certain site specific factors such as the volume of the space, number of projected air changes per hour, and the amount of surface area covered by the particular material. After testing their products, manufacturers will know if their product passes the specification. Note that emissions testing is a relatively new — but very important — activity in the marketplace. Some manufacturers have the information already on file, while others will need to have their products tested.</p>
<p>Local source control</p>	<p>Any activities that produce high concentrations of pollutants should be controlled at the source if possible. Examples include:</p> <ul style="list-style-type: none"> ▪ Consider recessed grates, "walk off" mats and other techniques to reduce dirt entering the building. ▪ Careful location of vent pollution sources such as copy rooms, chemical storage and mixing areas (laboratory and janitorial), food preparation spaces, and other polluting educational activities such as metalworking stations.

BEST COPY AVAILABLE

¹⁰ The CHPS Material Specifications are included in the specification section 01350 language available for download from <http://www.chps.net>.¹¹ Niskar, A.S., Kieszad, S.M., Holmes, A., Esteban, E., Ruben, C. & Brody, D.J. (1998). Prevalence of hearing loss among children 6 to 19 years of age, *Journal of the American Medical Association* 279 (14), 1071-5.



Ventilation	<p>The ventilation system itself can be a source of indoor air quality problems.</p> <ul style="list-style-type: none"> ▪ Avoid plenums. Plenums are easily contaminated with mold and dust, and ducted air returns should be used wherever possible. ▪ Discourage the use of fibrous or off-gasing materials in ductwork. Ducts are made to efficiently distribute air. However, if contaminated with mold, dust, or other pollutants, they can very quickly spread the problem throughout the school. ▪ Filters are an important defense. Use particle arrestance filtration rated at greater than 65% in all mechanical ventilation systems.
IAQ measures during construction	<p>Each of the listed construction practices will improve indoor air quality by minimizing the amount of indoor pollutants that are distributed and retained by the surface materials and ventilation systems during construction.</p> <ul style="list-style-type: none"> ▪ Mold protection: Immediately remove materials showing signs of mold and mildew from the site, properly dispose of them, and replace them with new, undamaged materials. ▪ Filters: Replace all filtration media immediately prior to occupancy. ▪ Temporary construction ventilation: Continuously ventilate during installation of materials that emit VOCs until emissions dissipate. Ventilate areas directly to outside areas. ▪ Dust protection: Turn the ventilation system off, and protect HVAC supply and return openings from dust infiltration during dust producing activities (e.g., drywall installation and finishing). Provide temporary ventilation as required. ▪ Preconditioning: Allow products that have odors and significant VOC emissions to off-gas in dry, well-ventilated space to dissipate emissions prior to delivery to the construction site. ▪ Sequencing: Install odorous and/or high VOC-emitting products before porous and fibrous materials. If this is not possible, protect porous materials with plastic. ▪ HEPA vacuuming and duct cleaning: Vacuum carpeted and soft surfaces with a high-efficiency particulate arrestor (HEPA) vacuum. If ducts contain dust and dirt, clean them before they are used to circulate air. ▪ Flush out the building continuously with 100% outdoor air for as long as possible prior to substantial completion. Flushing out the building with 100% outside air will help remove indoor pollutants prior to occupancy. ▪ Do not "bake-out" the building by increasing the temperature of the space. Although it was once a recommended procedure, new research shows that "baking-out" the building can decrease the life of materials by heating them beyond their recommended temperatures and decrease indoor air quality. Increasing the temperature of the space often does increase the amount of chemicals released from building materials. However, the pollutants stay in the space and decrease indoor air quality as they are absorbed by other materials (such as gypsum board, carpet, and acoustical tile) and re-released over a long period of time.
Prevent unwanted moisture accumulation	<p>Unwanted moisture accumulation can quickly lead to mold contamination. To prevent this:</p> <ul style="list-style-type: none"> ▪ Design the ventilation system to maintain the indoor relative humidity between 30% and 50%. ▪ Design to minimize water vapor condensation, especially on walls, the underside of roof decks, and around pipes or ducts. ▪ Design to keep precipitation out of the building, off the roof and away from the walls. Take special care to ensure that sites used for portables are properly graded and drained.

BEST COPY AVAILABLE



Install High Performance Lighting and Controls

Electric lighting is one of the major energy uses in schools. Enormous energy savings are possible through the use of efficient equipment, effective controls, and careful design. Using less electric lighting reduces a major source of heat gain, thus saving air-conditioning energy, increasing the potential for natural ventilation, and reducing the space's radiant temperature (improving thermal comfort). Electric lighting design also strongly affects visual performance and visual comfort, by maintaining adequate, appropriate illumination and by controlling reflectance and glare. Finally, visual, accessible light and power meters can educate students and faculty about how lighting systems and energy controls work.

Lighting in schools should provide a visual environment that enhances the learning process for both students and teachers, which can occur only if people can perform their visual tasks quickly and comfortably.



A Closer Look – Austin Creek Elementary School, Santa Rosa, CA.

Suspended luminaries integrated with clerestories bathe this kindergarten classroom at Austin Creek Elementary School with daylight.

Photo courtesy of Quattrocchi / Kwok Architects.

Horizontal Illumination

Too often, schools are designed with excessively high horizontal light levels. Many published school lighting design parameters remain based on antiquated standards calling for excessively high horizontal illuminance. Too often, this results in poor lighting quality, reduced visual performance, wasted lighting energy, and high energy and maintenance costs.

In 1999, the Illuminating Engineering Society of North America (IESNA) revised its recommended lighting design procedure, and issued new recommendations for horizontal illuminance. The recommended horizontal illuminance level for most typical classroom and office reading tasks is now 30 footcandles. Some classroom tasks may justify up to 50 footcandles, so choosing between 30 and 50 is an excellent compromise. Better lighting designs don't stop with horizontal illuminance levels, but also focus on lighting quality issues such as uniformity, vertical illuminance, and glare avoidance.

Vertical Illumination

Achieving adequate vertical illumination is one of the more critical design issues in school lighting. With the exception of desktop reading, nearly all school visual tasks are "heads-up" type activities requiring proper vertical illuminance. In addition, much of the perception of what comprises lighting quality is strongly influenced by vertical illumination. For example, proper wall illumination is a critical factor in obtaining lighting uniformity in classrooms. Similarly, in night environments, vertical illumination that promotes facial recognition is important in creating a sense of safety and security. In addition, good vertical illumination is important for promoting the important school activity of social communication.



Glare Control

Light sources that are too bright create uncomfortable glare. In extreme cases, direct or reflected glare can also impair visual performance by reducing task visibility. Glare causes eye fatigue by forcing the eye to work much harder. All sources of light, including daylight, must be carefully controlled to avoid causing discomfort or disabling glare. Common glare problems in classrooms include uncomfortable direct glare from overhead sources, reflected glare from computer screens and whiteboards, and direct glare from uncontrolled windows or skylights.

Lighting Uniformity

For the most part, illuminate school-building spaces as uniformly as possible, avoiding shadows or sharp patterns of light and dark. Large differences between light and dark spaces forces the eye to constantly adapt to differing light levels and contributes to fatigue. The standard lighting fixture historically used in classrooms (recessed or surface-mounted parabolic fixtures) should be avoided in most spaces. By blocking light from reaching the upper portion of the wall and ceiling, they create a shadowy, cave-like environment. Very bright sources should only be used in high spaces like gyms, or in cove lighting and indirect luminaires in ordinary classrooms and other spaces. The best method of maximizing uniformity is to make a concerted effort to light vertical surfaces and, where possible, the ceiling. Using light-colored, diffuse surface materials also serves to optimize lighting uniformity.

Lighting Control Flexibility

Lighting controls should be designed for flexibility to accommodate the varying nature of many school spaces. In addition to saving energy, multiple level switching or separate circuiting of light fixtures enables selection of different light levels to respond to changing requirements or amounts of natural daylight. Control flexibility increases energy efficiency by encouraging only the use of lights that are needed for the activity at hand. Lighting control systems must be easy to understand and operate. Non-intuitive control interfaces are likely to be ignored at best, and disabled in more extreme cases.

Control flexibility is especially important in classrooms, which typically must accommodate lighting levels for a wide variety of conditions and activities. It is especially critical that teachers have the ability to override any automatic dimming and/or occupancy sensor controls, so that they can switch the lights off manually when necessary.

Integration with Daylight

To achieve its benefits, daylight must be properly controlled. Integrating electric light with daylight is one of the more challenging aspects of school lighting design. At a minimum, luminaires should be circuited to match how daylight enters the space. In other words, luminaires closest to windows or skylights should be circuited separately from other lights in the space. This promotes daylighting's potential energy savings by allowing some or all of the electric lighting to be turned off during the day. To maximize energy savings, consider the additional flexibility of dimming ballasts with manual or automatic dimmers.

Additional Resources

Volume II

One chapter is dedicated to Electric Lighting, and further discusses the guidelines summarized here.

Volume III

One prerequisite and up to 11 points involve high performance lighting.

High performance lighting systems are crucial components of the schools energy efficiency. Energy Prerequisite 1 requires the school to use 10% less energy than Title 24 baselines, and Energy Credit 1 awards up to 10 points for superior energy performance.

Site Credit 5 (1 point) rewards exterior lighting designs that minimize light pollution.



The guidelines discussed in Volume II of this manual include:	
Classrooms Guideline EL1 Guideline EL2 Guideline EL3 Guideline EL4	<p>Use suspended (or pendent-mounted) luminaires. There are two basic types, which both require ceiling heights of at least 10 ft. Direct/indirect luminaires are designed for general classroom use, so that the ceiling, walls, and floor are all illuminated relatively evenly. They cast roughly the same amount of light in both directions. Indirect luminaires were originally designed for office lighting, and are slightly preferable in classrooms with significant computer work. Almost all of the light is projected to the ceiling and reflected to the space below.</p> <p>As a minimum, all classrooms should employ motion sensors, preferably in conjunction with a switch that can turn lights off. For spaces with daylight, automatic daylight sensors are recommended. For spaces with audio/video needs that require manual dimming, a wall-mounted dimmer controller should be used. The cost of fluorescent dimming ballasts has decreased dramatically. Dimming ballasts permit both manual dimming (controlled by the teacher) and automatic dimming (to automatically respond to daylight).</p>
Gyms Guideline EL2	<p>Industrial-style, high bay metal halides are the traditional choice, and can be used in all areas of the gym with high ceilings. Use a protected lamp or wire cage to protect from flying balls and other damage.</p> <p>An improved design uses industrial fluorescent luminaires. These designs, with four to six lamps each, produce high quality, versatile light with less power. Fluorescent lights can be turned on and off instantly, or switched to easily cut their light in half.</p>
Corridors Guideline EL6	<p>Choose lights that illuminate the corridor walls while minimizing downlighting. The best option for interior corridors are recessed indirect luminaires, oriented parallel with the corridor walls. An alternative, especially for schools where vandalism is a concern, is surface ceiling wrap-around luminaires (preferably vandal-resistant or high abuse types). Exterior corridors should primarily employ surface-mounted wrap-arounds or ceiling-mounted, high abuse luminaires.</p>
Multi-Purpose Rooms Guideline EL7	<p>A multipurpose room should have at least two independent lighting systems: a general fluorescent lighting system for uniform illumination, and a dimmable, house lighting system to support the audio/visual and social uses of the room. Use a control system based on an automatic calendar program with motion sensing for "off" hours. Rooms with plentiful daylight should employ automatic daylight switching or dimming (with a manual override) to reduce electric lighting when it is not needed.</p>
Library / Media Center Guideline EL8	<p>Library lighting systems should use standard fluorescent lights to provide general illumination in casual reading, circulation, and seating areas. Install task lighting to illuminate conventional card files, circulation desks, and carrels. Use stack lights when stack location is fixed, and general overhead lighting for areas with high-density stack systems. Media rooms may require special lighting systems.</p>
Outdoor Lighting Guideline EL11	<p>At every door, provide canopy or wall-mounted lights to illuminate the area. For parking lots and driveways, provide full-cutoff pole mounted lights to illuminate the lot and surrounding walks. For walkways intended for night use, provide suitable walkway lighting systems such as pedestrian light poles or bollards. In all cases, employ designs that minimize light pollution and trespass. Use control systems based on an astronomical clock and consider a "dark campus" approach.</p>

BEST COPY AVAILABLE



Use High Performance HVAC Strategies

A school's HVAC strategy ties together many important characteristics of high performance design, including energy efficiency, thermal and acoustic comfort, and indoor air quality. When designed, installed, and maintained correctly, HVAC systems are rarely noticed and quietly deliver the benefits of clean, comfortable air. However, if problems arise, HVAC systems can quickly become the largest source of service calls and comfort complaints. Chose the HVAC strategy that optimizes performance over the lifetime of the building, is easy to control, and meets the needs (and maintenance skills) of the district.

Energy Efficiency

The HVAC system is one of the largest energy consumers in a school. Even modest improvements in system efficiency can represent relatively large savings to a school's operating budget. With the highly efficient systems available today — and the sophisticated analysis tools that can be used to select and size them — there's no reason why every school HVAC system cannot be designed to the highest levels of performance.

Always consider the life-cycle costs of operation and maintenance when choosing an HVAC strategy. To ensure peak operating efficiency, the HVAC system in a high performance school should:

- Use high efficiency equipment. When possible, model the energy use of the entire facility with energy modeling software. The U.S. Department of Energy's "Energy Conservation Voluntary Performance Standards for New Buildings" and the ENERGY STAR programs are two places to start when looking for high efficiency equipment. Consider recovery systems that pre-heat or pre-cool incoming ventilation air, and "economizer cycles" for small, packaged systems. In hot, dry climates, consider evaporative cooling.
- Be "right sized" for the estimated demands of the facility. Select systems that operate well under part-load conditions and consider standard HVAC sizing safety factors as upper limits. Apply any safety factors to a reasonable base condition for the building: not the hottest or coldest day of the year with maximum attendance, and not the most temperate day of the year with the school half full.
- Include controls that boost system performance. Provide individual HVAC controls for each classroom. Consider integrated building management systems that control HVAC, lighting, outside air ventilation, water heating, and building security.

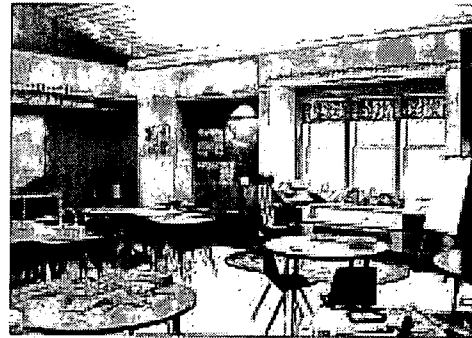

A Closer Look – Boscawen Elementary School, Boscawen, NH.

This 53,000-ft², 420-student school north of Concord, New Hampshire is the first in the country to use a combined displacement and demand-control ventilation system to provide superior indoor air quality and thermal comfort with reduced overall energy costs.

In this system, students and teachers are constantly surrounded by fresh air. Stale air rises above them and is then vented out. None of it is recirculated. The result is a school with exemplary indoor air quality that is, at the same time, energy and cost efficient.

As Dr. G.W. Porter of the New Hampshire State Department of Education notes, "Despite the innovative engineering, its cost was equal, or possibly less than, other typical schools. Maintenance costs, such as heating, are expected to be lower; and even without air-conditioning, the building will be even cooler in spring and fall. Air quality, a problem that's plagued a number of our schools, will also be vastly improved."



The key to optimizing HVAC system performance is an integrated design approach that considers the building as an interactive whole rather than as an assembly of individual systems. For example, the benefits of an energy-efficient building enclosure may be wasted if the HVAC equipment is not sized to take advantage of it. Oversized systems, based on rule-of-thumb sizing calculations, will not only cost more, but will be too large to ever run at peak efficiency and will waste energy every time they turn on. An integrated approach, based on an accurate estimate of the impact of the high efficiency building enclosure, will allow the HVAC system to be sized for optimum performance. The resulting system will cost less to purchase, use less energy, and run more efficiently over time.

Thermal Comfort

Thermal comfort is an important variable in student and teacher performance. Hot, stuffy rooms — and cold, drafty ones — reduce attention spans and limit productivity. They also waste energy, adding unnecessary cost to a school's bottom line. Excessively high humidity levels can also contribute to mold and mildew. Thermal comfort is primarily a function of the temperature and relative humidity in a room, but air speed and the temperature of the surrounding surfaces also affect it. A high performance school should ensure that rooms and HVAC systems are designed to allow temperature and humidity levels to remain within the "comfort zone" at all points in an occupied space. Thermal comfort guidelines are provided in the chapter on HVAC in Volume II of this manual.

Thermal comfort is strongly influenced by how a specific room is designed (for example, the amount of heat its walls and roof gain or lose, the amount of sunlight its windows let in, whether the windows can be opened) and by how effectively the HVAC system can meet the specific needs of that room. Balancing these two factors — room design and HVAC system design — is a back-and-forth process that continues throughout all the stages of developing a new facility. In a high performance school, the process ends with an optimal blend of both components: rooms configured for high student and teacher productivity served by an energy-efficient HVAC system designed, sized, and controlled to maintain thermal comfort under all conditions.

To provide thermally comfortable spaces:

- Design in accordance with American Society of Heating, Refrigerating and Air Conditioning Engineers (ASHRAE) standards. Standard 55-1992 (with 1995 Addenda) defines thermal comfort standards. When a design incorporates natural ventilation (e.g., operable windows to provide direct outdoor air during temperate weather), consider adjusting the requirements of ASHRAE Standard 55-1992 to account for the impact.
- Install controls and monitor system performance. Provide controls in each classroom to give teachers direct control over thermal comfort. Evaluate the potential impact of such controls on the overall efficiency of the HVAC system. Consider temperature and humidity monitoring as part of the building's overall energy management system to ensure optimal thermal comfort performance.
- Analyze room configurations and HVAC distribution layouts to ensure all parts of a room are receiving adequate ventilation and that heat gains from windows and skylights are properly controlled.



Indoor Air Quality

Ventilation systems must effectively distribute air throughout the classrooms to protect indoor air quality.

Acoustics

The chosen HVAC strategy cannot compromise acoustic comfort. Carefully design HVAC and air distribution systems to not exceed recommended noise levels.

Additional Resources

Volume II

One chapter is dedicated to HVAC systems.

Volume III

Three prerequisites and up to 24 points involve high performance HVAC systems.

HVAC systems are crucial components of the schools energy efficiency. Energy Prerequisite 1 requires the school to use 10% less energy than Title 24 baselines, and Energy Credit 1 awards up to 10 points for superior energy performance.

Energy Credit 2 (1-4 points) awards designs with natural ventilation.

Many IEQ credits are also applicable:

IEQ Prerequisite 1 details minimum ventilation rates, construction related IAQ measures, and drainage requirements.

IEQ Prerequisite 2 outlines minimum acoustic performance.

IEQ Prerequisite 3 requires thermal comfort compliance.

IEQ Credit 3 (1-3 points) awards pollutant source control in specific building areas and ventilations systems.

IEQ Credit 4 (1-2 points) awards additional construction IAQ measures and building flush out.

IEQ Credit 5 (1-3 points) awards improved acoustical performance.

IEQ Credit 6 (1-2 points) awards designs with operable windows, as well as individual temperature and lighting controls.



Choose Materials Wisely

Hidden within all materials are the resources, energy, chemicals, and environmental impacts of their entire lifecycle, from their production and installation until they are ultimately recycled or buried in a landfill. Interior surfaces and furnishings provide an excellent opportunity to highlight the high performance approach. Environmentally preferable choices simultaneously protect the health of students, staff, and the larger natural environment. As defined by the U.S. Environmental Protection Agency, environmentally preferable refers to “products or services that have a lesser or reduced effect on human health and the environment when compared with competing products or services that serve the same purpose. The product or service comparison may consider raw materials acquisition, production, manufacturing, packaging, distribution, reuse, operation, maintenance, or disposal” (EO 13101, Section 201).

In a high performance school, materials are selected based on their material efficiency and effect on indoor environmental quality. These go beyond the traditional issues of performance, price, availability, and aesthetics. Remember, all products have environmental impacts and making product choices will require a balance between material efficiency and indoor environmental quality. It is the intent of this manual to guide school districts to make environmentally preferable material choices based on individual and unique circumstances. So, it is important that the district prioritize their design goals to help find the best balance and protect against inevitable product substitutions that occur in the construction phase and can undermine high performance goals.

Protecting Indoor Environmental Quality

Since the majority of a school building's occupants are children or adolescents with still-developing respiratory systems, protecting the school building's indoor environmental quality is a fundamental goal in the design of a high performance school. Common problem substances from construction include formaldehyde and other VOCs that off gas from many interior building materials, dust, and moisture.

Promoting Material Efficiency

Material-efficient building products are manufactured in ways that conserve resources, are reused or salvaged, contain recycled content, and/or can be recycled or reused at the end of the building's service life. Addressing these goals provides significant environmental benefit. According to WorldWatch, buildings account for 40% of many processed materials used (such as stone, gravel, and steel) and 25% of virgin wood harvested. These withdrawals can cause landscape destruction, toxic runoff from mines, deforestation, biodiversity losses, air pollution, water pollution, siltation, and other problems.

Designers should look for materials that are:

- Durable. These types of materials are proven to offer longer service life compared to other options in a given product category.
- Reducing waste. Designing with common, modular dimensions and specifying building systems that precisely fit the module promotes materials conservation. Using preconstructed building elements can also reduce waste. Materials should also be marketed in an environmentally responsible manner, such as products available with minimal packaging.



- Salvaged or reused. This includes materials that are refurbished and used for a similar purpose, not processed or remanufactured for another use.
- Sustainably produced, which means they are extracted, harvested, or manufactured in an environmentally friendly manner. This includes materials that are grown or cultivated, and can be replaced in a relatively short amount of time (rapidly renewable materials). One example is certified wood products, which are produced from trees grown and harvested from Forest Stewardship Council (FSC)-certified, sustainably managed forests. FSC is the accrediting agency for organizations such as the Smart Wood program of the Rainforest Alliance and the Forest Conservation Program of Scientific Certification Systems, which in turn oversee forestry practices and certify their sustainability.
- Made with recycled content, which includes materials that have been recovered or otherwise diverted from the solid waste stream, after consumer use (post-consumer) or during the manufacturing process (pre-consumer). Always maximize the amount of post-consumer material, since this is waste that would have gone into the landfill. High amounts of pre-consumer content may perpetuate inefficient manufacturing processes. The use of recycled content materials helps address problems of solid waste disposal, energy used during manufacture, and the consumption of natural, virgin resources. Related materials are those made with industrial byproducts (fly ash, for example) and include material that is created as a result of an industrial process.
- Recyclable. These materials can be collected, separated, or otherwise recovered from the solid waste stream for reuse, or from the manufacture or assembly of another package or product.

Set a goal to achieve a minimum recycled content rate of 25% (see Volume III for more information).

Many building products that are resource-efficient materials in one or more ways are now available. Examples of material-efficient wood use are engineered lumber and composite wood products, which can be used for casework and trim as well as for framing. Engineered lumber is manufactured by combining wood fibers with plastic resins to produce high quality, structural products. Sheathing products manufactured in this manner, such as oriented strand board (OSB), wafer board, medium density fiberboard, and particleboard, are made primarily of sawmill waste, but are a potential source of formaldehyde. Likewise, finger-jointed lumber made from wood scraps makes use of material that would otherwise be wasted. And composite lumber composed of particleboard with a veneer of hardwood makes efficient use of fine hardwood for uses such as paneling and doors.

Material efficiency does not stop with material selection. Other important concepts include:

- Designing an area within the building dedicated to separating, collecting, storing, and transporting materials for recycling including paper, glass, plastics, and metals.
- Reducing the amount of construction waste going to landfills with a management plan for sorting and recycling construction waste. Consider a goal of recycling or salvaging 75% (by weight) of total construction, demolition, or land clearing waste.
- The design process also offers opportunity to maximize material efficiency through the use of standard dimensions that reduce waste during construction. Toward this end, the use of modular systems, such as carpet tile instead of carpet, greatly minimizes this particular construction waste. Additional building techniques for minimizing waste include reducing unnecessary corners and angles in the structural footprint and utilizing pre-constructed elements, such as modular wall panels.



Other Environmental Considerations

Embodied energy is the energy consumed during the entire life cycle of a product, including resource extraction, manufacturing, packaging, transportation, installation, use, maintenance, and when appropriate, even disposal. Products with low embodied energy are environmentally preferable. Recycled content products can typically be produced using less energy. Since transportation is a component of embodied energy, give preference to products that are locally available.

Additional Resources

Volume II

Materials are addressed throughout Volume II. Because Volume II is organized by building system, no single chapter completely addresses all the issues; however the Interior Surfaces and Materials chapter has the most information.

Volume III

One prerequisite and up to 19 points address material issues.

Materials Prerequisite 1 requires that the school dedicate specific areas to recycling.

Materials Credit 1 (1-2 points) addresses Site Waste Management during construction and demolition.

Materials Credit 2 (1-3 points) awards designs that reuse a minimum of 75% of an existing buildings structure.

Materials Credit 3 (1-2 points) requires a minimum of 5% of building materials to be salvaged.

Materials Credit 4 (1-2 points) awards points based on a recycled content rate.

Materials Credit 5 (1 point) awards the use of rapidly renewable materials.

Materials Credit 6 (1-4 points) requires at least 50% of all wood to come from sustainable sources.

IEQ Credit 2 (1-4 points) awards materials that do not compromise indoor air quality.

IEQ Prerequisite 1.5 and IEQ Credit 4.1 (1 point) outline materials issues during construction that impact indoor air quality.



Optimize Acoustics

When noise levels in the classroom are too high, students and teachers lose the ability to effectively communicate. Typical sources of noise are outdoor sounds (traffic, airplanes, etc.), loud air-conditioning and ventilation systems, and internal noise from other school spaces. The teacher and students' inability to hear one another directly affects student performance. Parents, students, teachers, and administrators across the country are increasingly concerned that classroom acoustics are inadequate for proper learning.

Students are particularly susceptible to the ill effects of background noise. Age, instances of hearing loss, lack of language proficiency, and individual hearing preferences can all affect how well a given student can hear in the classroom. Approximately 15% of children are estimated to have at least a slight hearing loss¹¹, and investigations of school records have linked hearing losses with lack of progression through school. Typically, children do not fully develop the ability to selectively differentiate sounds from background noise until they are teenagers.

Recognition of the widespread acoustic problems in the U. S. is spurring development of a national minimum acoustical standard for classrooms that may be enforced under the auspices of the Americans with Disabilities Act. CHPS, in tandem with the draft recommendations, strongly recommends setting maximum classroom background noise levels at 35 dBA for all classrooms.

To ensure a superior acoustical environment, designers should:

- Reduce sound reverberation time inside the classroom.
- Limit transmission of noise from outside the classroom. Standard building construction and glazing do not easily control exterior noise intrusion from traffic and/or aircraft.
- Minimize background noise from the building's HVAC system. Teachers must sometimes resort to shutting off ventilation systems that are too loud, which can have the unfortunate side effects of reducing indoor air quality and thermal comfort. Typical, low first-cost heating and ventilating systems often cannot meet the recommended levels for background noise. Unit ventilators, "through-the-wall" systems, and window-mounted air conditioners are the worst performers.

The information and tools needed to design classrooms for high acoustical performance are readily available, and can be used to ensure that any newly constructed classroom provides an acoustic environment that positively enhances the learning experience for students and teachers.

Several acoustical issues provide perfect examples to illustrate the design trade-off decisions that sometimes need to be made in high performance schools. For example, increasing the amount of exterior glazing will increase the amount of noise intrusion from outdoor noise sources, unless the acoustical performance of the glazing is increased. Standard building construction and glazing cannot easily control exterior noise intrusion from traffic and/or aircraft. Care should be taken to maintain the acoustical integrity of the building shell while



providing fresh air. Operable windows are highly recommended for indoor air quality, but typically do not provide a high degree of sound isolation and should be avoided in areas with high exterior noise levels. Similarly, internal glass fiber duct lining is often prohibited to preserve good indoor air quality. However, not allowing glass fiber duct lining to be used significantly increases the complexity of noise control. Districts and designers often need to evaluate these conflicts on an individual level and make choices based on their design priorities and goals.

Additional Resources

Volume II

Acoustics are related to the HVAC, Site Planning, Indoor Surfaces, and Daylighting chapters.

Volume III

One prerequisite and up to 3 points address acoustics. IEQ Prerequisite 2 outlines minimum acoustic performance, and IEQ Credit 5 (1-3 points) awards improved acoustical performance. Materials Prerequisite 1 requires that the school dedicate specific areas to recycling.



Minimize Water Use

Fresh water is an increasingly scarce resource in most areas of California. A high performance school should control and reduce water runoff from its site, consume fresh water as efficiently as possible, and recover and reuse gray water to the extent feasible.

Basic efficiency measures can reduce a school's water use by 30% or more. These reductions help the local and regional environment while decreasing operating expenses. While the cost savings may be modest now, since water is relatively inexpensive in most areas, there is a strong potential that these savings will rise over time, especially in areas where water is scarce.

- Design landscaping to use water efficiently by reducing water use and specifying hardy, native vegetation. Consider using an irrigation system for athletic fields only, not for plantings near buildings or in parking lots. Where irrigation is used, use high efficiency irrigation technology (e.g., drip irrigation in lieu of sprinklers). If local climate allows, use captured rain or recycled site water for irrigation and "design in" cisterns for capturing rainwater.
- Set water use goals for the school. A good starting point is using 20% less than the baseline calculated for the building after meeting the Energy Policy Act of 1992 fixture performance requirements. This can be reached with a combination of water-conserving fixtures and equipment such as low-flow or waterless toilets and urinals, automatic lavatory faucet shut-off controls, low-flow showerheads, and high efficiency dishwashers and laundry appliances.
- Use reclaimed water. Reclaimed water is treated, non-potable water that is an excellent resource for irrigation or flushing toilets. Reclaimed water is available in many areas at low and sometimes no cost.

Additional Resources

Volume II

Water Issues are discussed in the Site Planning, General Conditions, and Other Systems chapters.

Volume III

One prerequisite and 5 points address are applicable. Water Prerequisite 1 and Credit 1 (1-2 points) award water-efficient landscaping. Water Credit 2 (1-3 points) awards reductions of potable water for interior uses.



A Closer Look – Windsor High School, Windsor, CA.

The grounds at Windsor High School are irrigated with reclaimed water from the local water municipality. The municipality waived the hookup costs, and the school saves money every month by not using potable water for irrigation.

Photo courtesy of Quattrocchi / Kwok Architects.



Choose and Develop the Site Wisely

A district faces many issues during site selection. Cost, student demographics, and environmental concerns all influence when sites are acquired and how the district uses them. The site is a crucial element in determining the overall sustainability of the school design. Sites are sometimes purchased years in advance, and some options are out of the control of the districts and/or designers at the time the school is being built. However, districts that are considering multiple sites can substantially lower the environmental impact of the school by carefully choosing their school site, optimizing building orientation, protecting the ecosystems, and designing to control urban heat islands.

Site Selection

Protecting student health is the most important issue during site selection. Sites must not contain toxins, pollutants, or safety hazards that will impact student well-being. Of particular concern are:

- Hazardous agents, including industrial, agricultural, and naturally occurring pollutants such as asbestos and heavy metals.
- Nearby facilities which might reasonably be anticipated to emit hazardous air emissions, or to handle hazardous or acutely hazardous materials.
- Other objects that are potentially harmful if located near a school, such as hazardous pipelines, high voltage power-line easements, railroad tracks, adverse levels of traffic noise, and airports.

To further protect valuable land and open space, districts should consider:

- Channeling development to sites that are centrally located within the student population. Cars driven by parents, guardians, or the students themselves are the largest resource users and sources of transportation-related pollution. Centrally located sites allow more students to walk or bike to school, while reducing the distance cars must travel.
- Entering joint use agreements in which parts of the school buildings, parks, or recreation space are shared with local community organizations. Joint use is a growing trend across the country. Schools are being integrated with a variety of organizations, from laundromats and coffee shops, to police stations and park districts. Joint use can have a variety of benefits, including increasing campus security, improving community integration, and reducing site acquisition and construction costs.
- Avoiding development on prime farmland, within flood zones, on habitat for threatened or endangered species, or public parkland. Avoid development on greenfields. Greenfields are defined as those sites that have not been previously developed, or have been restored to agricultural, forestry, or park use. Urban redevelopment reduces environmental impacts by utilizing established infrastructure and preserving the open space of undeveloped lands. Care must be taken to ensure that the sites are safe of hazards prior to use.
- Promoting alternative transportation. Locating the site close to public transportation, creating bike facilities and safe access, and offering bus service, all reduce the automobile-related pollution.

Orientation

When site conditions permit, orient buildings so that major windows face either north or south. Position classrooms so that light and air can be introduced from two sides. Solar orientation should guide the placement of building and site features. Reduce the impact of exterior noise

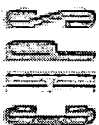

sources by locating noise sensitive areas, such as classrooms, away from noise producers, like roadways, train tracks, etc.

Space heating and cooling accounts for nearly 20% of all energy consumption in the U.S. Optimal orientation of the building creates opportunities to utilize the potential contributions of the sun, topography, and existing vegetation for increased energy efficiency by maximizing heat gain (or minimizing heat loss) in winter and minimizing heat gain in summer. In the case of existing buildings, arrangement of interior spaces, strategic landscaping, and modifications to the building envelope can mitigate unfavorable orientation.

Ecosystem Protection

A high performance school protects the natural ecosystem. As much as possible, the school incorporates products and techniques that do not introduce pollutants or degradation at the project site. Designers should take steps to preserve natural features and restore damaged areas whenever possible.

Stormwater runoff is precipitation that flows over surfaces on the site and enters either the sewage system or receiving waters. Stormwater carries sediment and pollutants from the site into the sewage system and/or local bodies of water. In addition, the cumulative runoff throughout the local area requires significant investments in municipal infrastructure to handle peak runoff loads. Reducing the amount of runoff is the most effective way to minimize its negative impacts.

Strategies include:

- Significantly reducing impervious surfaces, maximize on-site stormwater infiltration, and retain pervious and vegetated areas.
- Capturing rainwater from impervious areas of the building for groundwater recharge or reuse within the building.

Heat Islands

Heat islands are caused when exterior surfaces absorb the sun's energy and heat up the air near the ground. On the school site, rising temperatures make the schools air conditioners work harder, increasing energy costs. In a metropolitan area, heat islands substantially increase the amount of energy spent on air conditioning in the summer and exacerbate urban smog problems.

Providing shade is the best way to reduce the heat island effect. Where possible, shade parking lots and walkways, or replace them with vegetation. Alternatively, use materials with a reflectance of at least 30%. These are typically light-colored materials, although some products are now available that are dark, but reflect enough solar radiation to remain relatively cool in direct sun.

For the school itself, use a "cool roof", which reflects most of the sun's energy instead of absorbing it into the interior spaces below. Cool roofs have high reflectivity and are typically light colored, although new products are available in a range of colors. Also, cool roofs must have high emissivity and therefore cannot be bare metal.

Additional Resources

Volume II

Site selection and planning impact virtually every buildings system. The Site Planning and General Conditions chapters include the most information.

Volume III

Two prerequisites and 15 points are directly dependent on site selection and planning.

Site Prerequisite 1 and Site Credit 1 (1-6 points) address safe and sustainable site selection, including Title 5 compliance and joint use.

Site Credit 2 (1-3 points) award sites near alternative transportation, have ample support for bikes, and that minimize parking.

Site Prerequisite 2 and Site Credit 3 (1 point) address stormwater run-off during and after construction.

Site Credit 4 (1-2 points) award designs that reduce heat island affects.

Site Credit 5 (1 point) rewards sites that minimize light pollution outdoors.

Water Prerequisite 1 and Credit 1 (1-2 points) award water-efficient landscaping.



Use Sustainable Construction Practices

General and trade contractors have a significant role to play in making efficient use of materials, preventing future indoor air quality problems, and protecting the site from degradation.

Construction and Demolition (C&D) Waste Management

Effective job-site waste management will reduce the amount of construction and demolition (C&D) waste generated and divert materials generated through C&D processes from disposal through reuse (salvage) and recycling.

Some waste reduction can be designed into the building project, such as standardized dimensioning, the use of modular or panelized building units, reduced corners and angles in the structural footprint, and layout of openings (see the chapter on Building Enclosure in Volume II). Specifying the use of mechanical fasteners (screws, Velcro) rather than chemical adhesives and solvents will allow components to be easily disassembled and reused. Utilizing mechanical fasteners also avoids some of the indoor air quality problems caused by chemical products, which can affect the health and safety of workers and building occupants.

A readily available goal is to recycle, compost, and/or salvage 50% to 75% (by weight) of construction, demolition, and land clearing waste including recycling of corrugated cardboard, metals, concrete brick, asphalt, land clearing debris (if applicable), beverage containers, clean dimensional wood, plastic, glass, gypsum board, and carpet. The cost effectiveness of recycling rigid insulation, engineered wood products, and other materials must also be evaluated.

In general, C&D waste reduction should also reduce overall construction costs, especially as this becomes standard operating procedure and the C&D recycling/reuse infrastructure matures. If revenues from waste reduction, reuse/salvage, and recycling are allocated to the contractor, it gives the contractor both the responsibility and the incentive for waste reduction. Most contractors report that having a good waste reduction program in place results in a cleaner, safer site.

Indoor Air Quality During Construction

Require indoor air quality planning and preventive job-site practices.

Site Protection During Construction

An effective job-site protection plan will describe construction practices that eliminate unnecessary site disturbance, minimize impact on the site's natural (soil and water) functions, and eliminate water pollution and water quality degradation. Primarily it will include protocols for construction equipment operation and parking, topsoil/vegetation protection and reuse, hazardous materials management, and installation and maintenance of erosion control and stormwater management measures.

Contractor's Commissioning Responsibilities

Contractors can play a key role in effective commissioning by providing timely documentation, understanding the importance of thorough testing and tuning, paying attention to detail when correcting problems, and in general being responsive to the commissioning agent's recommendations and requests.

Additional Resources

Volume II

See the General Conditions and Commissioning chapters for more information.

Volume III

Site Prerequisite 2 requires erosion and sedimentation control during construction.

IEQ Prerequisite 1 and IEQ Credit 4 address indoor air quality during construction.

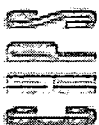

Don't Forget the Portables

Portable — or "relocatable" — classrooms have been a feature of U.S. schools for years. From a district's perspective, the two advantages of relocatable classrooms are low initial cost and short time between specification and occupancy. They are intended to provide flexibility to school districts, enabling quick response to demographic changes and providing the ability to be moved from one school to another as demographics change. However, in reality, relocatable classrooms are seldom moved and become permanent fixtures of the school.

The effects of poor indoor air quality in relocatable classrooms are no different from those in permanent classrooms. All school buildings use similar construction and furnishing materials, so the types of chemicals present in indoor air are not likely to be different for relocatable versus permanent classrooms. However, pressed-wood products (often with high concentrations of formaldehyde) are used more in the factory-built relocatable units than in buildings constructed on-site. As result, levels of airborne chemicals may be higher in new relocatable classrooms, especially if ventilation is reduced.

The most common problems with relocatable classrooms include:

- Poorly functioning HVAC systems that provide minimal ventilation of outside air.
- Poor acoustics from loud ventilation systems.
- Chemical off-gassing from pressed wood and other high-emission materials, compounded by quick occupation after construction or installation of carpets.
- Site pollution from nearby parking lots or loading areas.

Additional Resources

Volume II

See the *Relocatable Classrooms* guideline in the *Other Equipment and Systems* chapter.



A Closer Look – Portables

Recognizing that relocatable classrooms are often used as permanent structures, Southern California Edison created its "Rethinking the Portable Classroom" program to re-design the standard relocatable building. The project, which involved numerous parties with an interest in relocatable classrooms, led to the development of a prototype designed to be a cost-effective alternative to site-built projects. This prototype has been built and will be tested for one year. The prototype design meets all state transportation codes, has a more permanent appearance than conventional relocatable buildings, and is flexible enough to be used at a variety of sites. In addition, the prototype is daylit, configured to optimize teaching space while providing storage space, and designed to improve indoor air quality. It is projected to reduce annual energy costs by 35% over typical designs. For additional information, contact the Edison Customer Technology Application Center (CTAC) at (800) 336-2822.

Photo courtesy of Southern California Edison.

The solutions to these problems are the same as recommendations for improving indoor air quality in permanent structures.

Relocatables range in quality. Care should be taken to ensure that money and student health are not compromised on low-quality designs.



Train the Staff and Maintain the Building

Effective maintenance and operations procedures are fundamentally important to sustaining the performance of all building systems. Student health and productivity can be affected when building systems fail to operate as designed. Sub-standard maintenance or incorrect operation of building systems usually results from a combination of factors. First, maintenance budgets are often the first to be reduced or eliminated when money becomes tight. Second, designers and contractors typically provide the building staff minimal or no training out how the building systems are supposed to operate or be maintained. Finally, schools eventually may lose institutional knowledge of the building systems because of staff turnover and lack of communication.

Districts should create and execute a maintenance plan that addresses the following items:

- Educate the staff on the value of maintenance, and how a properly functioning facility will help them educate their students.
- Establish a budget for maintenance.
- Hire qualified staff or contractors to perform tasks.
- Develop a preventative maintenance plan, including schedules for maintenance checks.
- Develop a predictive maintenance program to prevent problems from occurring.
- Use a work order system to track work orders, maintenance performed, and costs for each piece of equipment.
- Ensure that the maintenance staff has proper Operation and Maintenance manuals.
- Ensure availability of recommended spare parts in the warehouse.
- Provide training to the maintenance staff.

High performance schools are maintenance friendly. Building systems are easy to maintain, and reduced operating costs from energy-efficient design frees money that could be directed to support maintenance efforts.

Like commissioning, successful operation and maintenance begins in the design phase of a project. Soliciting input from operation and maintenance staff during the early stages of building design can facilitate good operation and maintenance practices. The more convenient it is for staff to perform regular checks and maintenance on building systems, the better building performance needs can be met and costly maintenance can be avoided. In addition, the installing contractor's responsibilities concerning operation and maintenance should be clearly detailed in the project contract specifications during the design stage, so that the contractor can adjust the bid price accordingly. For instance, specifications should explicitly state that contractors will be required to provide comprehensive operation and maintenance manuals for equipment and provide training for staff.



Training

Perhaps the most essential component of operation and maintenance is training. Unless building staff is given the skills to perform quality operation and maintenance practices, there is no hope that a building will continue to perform optimally.

As with all training, instruction should be structured to meet the needs of the administration, teachers, and maintenance staff. Additionally, high performance design urges the clear identification of roles, responsibilities, and budget to ensure that important maintenance information is transferred to the building occupants and not lost in the rush to occupy the building after construction is completed. One example would be the creation of a brief classroom operation manual for teachers. This could be developed by the designers and distributed to the staff to teach them the how to work with the building systems to maximize their comfort. Particular issues to be explained would be how to use the lighting system, HVAC controls, and windows; how to avoid glare when using computers; the best methods for controlling temperature; how to prepare the room for A/V presentations; and any other subjects that are important to the teachers and staff.

By videotaping each training session, including the hands-on start up and shutdown procedures for equipment, building operation staff gains a permanent and inexpensive on-site training aid.

Preventative Maintenance

Another important operation and maintenance practice is preventive maintenance. Preventive maintenance can save buildings districts time and money by:

- Maintaining facility operation.
- Extending equipment life.
- Identifying equipment degradation.
- Preventing losses of equipment, time, productivity, and resulting revenue.

Performing regular preventive maintenance can result in energy and cost savings. For example, simply replacing worn fan belts on a regular basis can save 2% to 4% of the energy used to run the fans. Cleaning air filters and cooling coils regularly can save 1% to 3% of the building's energy use for cooling. These basic activities cost very little to perform, but can add up to dramatic savings.

The commissioning provider can assist the owner or facility manager in developing a preventive maintenance plan for a building's HVAC and electrical systems. Most of the information required for developing a preventive maintenance plan is gathered as part of the commissioning process or can be obtained from the operation and maintenance manuals.

Additional Resources

Volume II

See the Commissioning and Maintenance chapter for more information. Also, specific maintenance recommendations are included in a number of the individual guidelines throughout the manual.

Volume III

Energy Prerequisite 2 requires that the school and teaching staff be properly trained to operate the building.

District Credit 3 (1-2 points) awards districts that creates and completely funds a preventative maintenance plan.



FINANCING HIGH PERFORMANCE SCHOOLS

High performance schools are cost effective for a number of reasons. For example, they can:

- Bring more money to the school by increasing average daily attendance.
- Keep more money in the school by significantly reducing utility bills.
- Take advantage of currently available incentive programs.

When the avoided costs of workers' compensation claims and litigation are also considered, high performance schools become an even wiser business choice for school districts.

Discussed below are issues related to financing high performance schools, including life-cycle costing, reduced operating expenses, increased funds, financial incentive and technical assistance programs, avoided costs, and reduced litigation risks.

Life-Cycle Costing

School facilities are investments. State government and local communities spend billions of dollars per year on new facilities for current and future generations of students. Unfortunately, the institutional separation of operational and construction budgets can create schools that are economically, environmentally, and educationally poor investments.

Many high performance measures can be incorporated into a school design without increasing first costs, but additional investments can increase the health and efficiency of the school even further. However, if a conventional financing methodology is used, design measures that save money in the long-term may be rejected because they cost more initially.

Life-cycle costing is a means to calculate and compare different designs to identify which is the best investment. Districts can use it to assess the total cost of ownership for a facility over time. All of the building expenses that can be calculated are included in the analysis, including initial costs (design and construction); operating costs (energy, water, other utilities and personnel); and maintenance, repair, and replacement costs. The values are adjusted for the time-value of money to represent the true value of the investment. Predicted costs for alternative design approaches can then be compared, allowing the district to select the design that provides the lowest overall cost of ownership

A Closer Look – San Diego Unified School District, San Diego, CA.

San Diego Unified has taken steps to ensure that their new buildings are the most cost-effective options for all of their new construction projects. Language included to ensure high performance schools includes:

"If the scope of the project includes mechanical work, the Architect shall require the Mechanical Engineer to provide a heating, ventilation, and air conditioning (HVAC) life-cycle analysis. The Engineer shall submit three HVAC alternatives for conditioned buildings for review by the District. Each alternative shall include initial and life-cycling costs. The selected alternative for the conditioned building(s) shall be modeled by using the most recent edition of Energy Pro or equivalent modeling software as approved by the District. The program results should demonstrate the overall energy efficiency of the building(s) on a performance basis. Modernization projects not suitable for modeling shall include prescriptive Title 24 calculations. The Architect will participate in Utilities' rebate/ reimbursement programs as directed by the District."

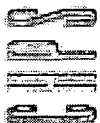

consistent with the desired quality level.

The true cost of a school includes much more than the cost to design and build it. The long-term costs of operating and maintaining the facility must also be included. Only by evaluating all three of these factors can a community understand how much a new school really "costs." And only by looking at all three factors simultaneously can the impacts of specific design approaches, especially those that result in better long-term performance, be evaluated. High performance windows, for example, may cost more upfront but may result in energy savings that pay for the extra costs in a few years and then continue to save the school money for years to come. Life-cycle cost analysis is the key to making these kinds of comparisons and to creating new schools with the lowest long-term costs of ownership. Note, however, that life-cycle costing will only address some of the benefits of high performance design. Many benefits, such as improved health and test scores, are valuable, but difficult to quantify monetarily. A more detailed description of life-cycle cost methods and techniques is included in the electronic Appendix¹² "Calculating Cost Effectiveness."

Reduced Operating Expenses

High performance schools cost less to operate. School districts spend less for electricity, gas, water, maintenance, waste collection, and other ongoing facility operating costs, enabling more money to be spent for salaries, books, teaching supplies, and other items with a more direct link to the true mission of schools: educating students.

How much savings can be expected? School districts can save 30% to 40% on annual utility costs for new schools and 20% to 30% for renovated schools¹³ by applying high performance design and sustainability concepts. The potential for savings is greater in new schools because it's possible to "design out" inefficiencies from the outset, thereby saving money year after year.

The California Energy Commission estimates that the average annual cost of energy, per student, is \$126. Expenditures for electricity and natural gas typically run 2.2% to 2.7% of the total schools budget. High performance design solutions could yield savings of up to \$50 per student with aggressive designs. Furthermore, these savings continue to reap savings as long as they are used as designed.

Integrated design is the key to savings of this magnitude. From the beginning of the design process, each of the building elements (windows, walls, building materials, air-conditioning, landscaping, etc.) is considered part of an integrated system of interacting components. Choices in one area often affect other building systems; integrated design leverages these interactions to maximize the overall building performance.

¹² The electronic Appendix is available at <http://www.chps.net/>, and on the CHPS Best Practices Manual CD-ROM.

¹³ These savings are achievable when compared to the stringency of current standards. The stringency of the California energy standards is regularly increased. These percentages will therefore change.



One good illustration of integrated design is daylighting. When properly designed, daylighting systems can substantially reduce the need for electric lighting and lowers cooling costs. About half of a school utility bill in California pays for lighting. Because of this, lighting systems are often identified for energy-conserving measures and programs. Daylighting saves energy, and therefore money, in two ways. Most obviously, lights that are off are not using energy. But lights that are off are also not generating heat, allowing the air conditioners to be downsized, work less, and save energy. And daylight provides these savings during the day when demand for electric power is at its peak and electricity rates are at their highest.

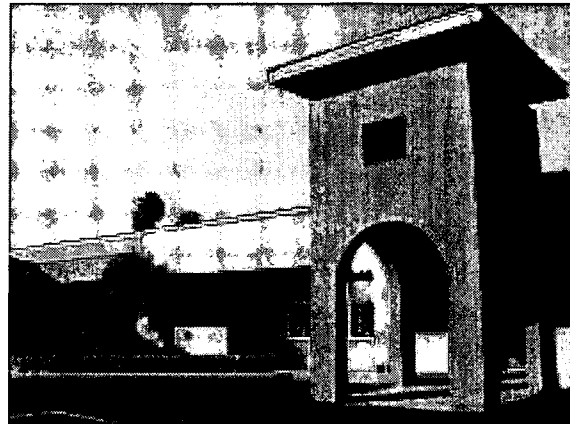

A Closer Look – Garfield Elementary School, San Diego, CA.

San Diego Gas and Electric assisted San Diego Unified to find the most cost effective and energy-efficient design solutions for Garfield Elementary. The final design saves \$100,000 annually. High performance measures include, external shading, highly insulated roofing, high performance windows, T-8 lighting, occupancy sensors, daylighting controls in selected spaces, skylights, and other measures.

Photo courtesy of San Diego Unified School District.

However, note that daylighting alone saves no energy unless the electric lighting system is appropriately controlled, and the cooling system is properly sized. To be effective, daylighting must be thoughtfully integrated with the other major building systems.

Increased Funds

Investing in high performance measures can bring monetary returns to the school district. District funds come from a variety of state, federal, and local sources, and every district has a unique blend of sources. In general, a district's funding can be divided into three components:

- General Purpose Funds are calculated by multiplying a school's Average Daily Attendance (ADA) by its Revenue Limit. Revenue limits for the 2000-2001 school year were \$4,306, \$5,175 and \$4,485 for elementary, high school, and unified schools, respectively, and are increased annually for inflation.
- Categorical aid covers a wide array of programs from special education to instructional materials. The application process and funding amounts vary depending on the programs. Depending on the district, categorical aid can range from small amounts to almost one-third of their total budget.
- Miscellaneous funds comprise the small remaining amount. Typical sources are the lottery and various local sources.

High performance schools can increase school funding by increasing average daily attendance, through reduced illnesses, and more user satisfaction. Because the revenue limits range from \$4,300 to \$5,175, even small changes in attendance can significantly affect a



school's bottom line. Recent changes in the funding mechanism that exclude excused absences from the ADA calculation further increase the financial necessity of keeping as many students in class as possible.

For example, assume that a 500-student elementary school invests \$4 per square foot on high performance lighting and air-conditioning improvements that will improve the indoor environment quality. Based on the \$4,300 revenue limit, an increase in ADA of 1.75% would pay back all of the investments in only two years.¹⁴ And this does not begin to take into effect any utility savings from energy efficiency improvements.

Although many studies have correlated characteristics of the indoor environment to changes in student health, behavior, and performance, estimating the degree to which absenteeism might be reduced by a given investment in high performance design is unknown. Ongoing research may eventually provide an answer, but for now it's reasonable to assume that investing in high indoor environmental may decrease absenteeism.

Financial Incentive and Technical Assistance Programs

Several programs are currently available to financially and technically assist districts and designers in creating high performance schools.

The Savings By Design program promotes energy-efficient design in new construction and renovation projects with financial incentives and technical resources for designers, contractors, and building owners. The program is funded by California utility ratepayers and is administered by Pacific Gas and Electric Company, San Diego Gas & Electric, Southern California Edison, and Southern California Gas Company under the auspices of the California Public Utilities Commission. It is available for any school district within these utilities' service territories. The financial performance-based incentives increase with the energy efficiency of the design and can be a significant source of additional funds.

In addition, Savings By Design offers technical assistance and project-specific design assistance to the school design community. Savings By Design sponsors training and continuing education in integrated school design practice (for example, daylighting systems, proper HVAC sizing, integrating internal loads from other end uses, proper HVAC installation, and building system modeling). More information is available at <http://www.savingsbydesign.com/>.

The California Energy Commission's Bright Schools program offers a full suite of programs to schools considering high performance design strategies in new and existing buildings. School districts can use the program to evaluate potential areas for energy and resource savings and to prioritize their needs. The services are typically provided at little or no cost to districts.

¹⁴ Assumes 960 square feet per classroom and 20 classrooms in the school.



On new construction projects, the Bright Schools program provides a variety of services, including design consultation, cost effectiveness calculations, development of specifications, help in selecting the design team, review of construction documents, and complete value engineering of specific efficiency measures.

Bright Schools also provides comprehensive services for energy renovations. The particular services are determined by the program and the district and may include energy audits, feasibility studies, design review, equipment specifications, and contractor selection and installation assistance. In addition, schools can take advantage of a loan program to help finance the required district match of renovation projects. More information is available at <http://www.energy.ca.gov/efficiency/brightschools/info.html>.

Standard Performance Contracting (SPC) is a renovation incentive program funded by utility ratepayers and administered by Pacific Gas and Electric Company, San Diego Gas and Electric, and Southern California Edison under the auspices of the California Public Utilities Commission. It offers schools additional financial support for implementing energy efficiency improvements to existing facilities.

Under the program, Energy Efficiency Service Providers (EESPs) provide information and energy audit services to analyze energy saving opportunities in existing school buildings. If energy-efficiency projects are identified, the utility will provide funds to help finance the project in exchange for the energy savings. The utility can make a contract with either the school district or the EESP, depending on how the district wants to manage the project. Often, school districts will contract with an EESP for

Contacts

CHPS

<http://www.chps.net/>
877-642-CHPS

Savings By Design

<http://www.savingsbydesign.com/>

Pacific Gas and Electric Company
Contact local representative
or call: 800-468-4743

San Diego Gas and Electric
Charles Angyal, Chief Architect
858-636-5725

Southern California Edison
800-338-8502

Southern California Gas Company
cfox@semprautilities.com

Bright Schools Program

<http://www.energy.ca.gov/efficiency/brightschoools/>

California Energy Commission
Judy Brewster 916-654-4053
jbrewste@energy.state.ca.us

Standard Performance Contracting

Pacific Gas and Electric Company
Don Amuzie 415-973-6208
DEA4@pge.com
Angie Ong-Carrillo 415-973-1887
AXO1@pge.com

San Diego Gas and Electric
Phil Ondler 858-636-6836
pondler@sdge.com

Southern California Edison
Bob Botkin 626-302-8259
botkinrc@sce.com

Municipal Utility Programs

Sacramento Municipal Utility District
916-732-6738

L.A. Dept. of Water and Power
800-GREEN LA



project development, management, and construction, and the EESP will contract with the utility. Either way, the school district receives an improved facility at a lower cost.

Energy Design Resources is a program to develop and disseminate design tools and resources that help elevate energy efficiency in new schools to a higher priority. It is funded by utility ratepayers and administered by Pacific Gas and Electric Company, San Diego Gas and Electric, and Southern California Edison under the auspices of the California Public Utilities Commission. Resources include both informational publications such as design briefs and in-depth handbooks on the latest energy technologies, and software design tools to guide design decision-making. All resources are available for download at the Energy Design Resources website at <http://www.energydesignresources.com/>.

The California Integrated Waste Management Board's **Sustainable Building Task Force** web site contains a funding chart entitled, "California Fiscal Resources for Sustainable Building." Located at <http://www.ciwmb.ca.gov/GreenBuilding/TaskForce/Blueprint/Incentives.xls>, this spreadsheet describes over 150 incentive programs for sustainable design.

The Sacramento Municipal Utility District and the Los Angeles Department of Water and Power have specific incentive programs for efficient air-conditioning and lighting systems. Schools in their territories should contact them directly for more information.

Avoided Costs and Litigation Risk

The considerable costs of poor school indoor environmental quality (IEQ) are borne by students, staff, parents, and the local community. In the school populations, the costs include poor health, reduced learning effectiveness, and increased frustration when IEQ problems become unmanageable. These costs are difficult to quantify. More easily counted are the strained budgets and staff resources expended by districts for facility repairs due to insufficient maintenance, community relations damage control, litigation, and workers' compensation claims. In addressing such problems, schools must use resources that would otherwise be available for educational and other programs.

Poor school IEQ can cause both short-term (reversible) and long-term (chronic) effects in students and staff. Overcrowded, poorly ventilated classrooms contribute substantially to the spread of infectious diseases, such as colds and influenza. Poorly maintained carpets, dirty air ducts, and water-damaged materials are prime breeding grounds for a plethora of substances that can trigger asthma attacks, sensitize allergy-prone individuals, and cause sinus and respiratory infections. Asthma is one of the environmentally triggered diseases acquired during childhood that may be carried well into the adult years. Other chronic diseases include irreversible lung and respiratory illnesses that result from chronic irritation by airborne chemical and/or biological contaminants. The economic costs of these long-term, possibly lifelong, diseases are substantial; the costs in terms of quality of life are more profound, and certainly difficult to measure.



One of the ramifications of school building neglect and its consequent adverse effects on IEQ is the potential for litigation from students, parents, and staff. Crisis-stage IEQ problems can be extremely costly, may lead to litigation, and can be detrimental to long-term relations among school administrators, staff, parents, students, and public agencies. The fiscal, political, and social costs of addressing a crisis situation are often far larger than anticipated. Schools may close temporarily when a formerly manageable problem becomes a financial, logistic, and emotional crisis. Besides the costs of conducting emergency repairs, a school closing requires alternative space and making up missed classes. Reopening schools that have been closed is also a difficult process, due to the logistics of inspections, the uncertainties of authority, and residual fears. Workers' compensation claims by school staff are another financial cost to districts when IEQ complaints escalate.

"I have noticed a big difference in my health since we've been in the new school. I had a lot of absenteeism — in fact, I was hospitalized in the old building. In the new school, I won't say that I'm cured of asthma — I still have it and I still have allergies — but I really don't have many problems at all and I'm feeling great." — Teacher at a new school in New Hampshire using the Advantage Classroom™ design concept.

The threat of increasing IEQ problems, recognition of adverse health effects from indoor air exposures, and the litigious nature of societal interactions warn that poor IEQ in California schools can threaten the financial stability of local school districts. A number of lawsuits concerning IEQ have been filed against California school districts. For example, after complaints, investigations, and legal actions spanning more than three years, a student received a cash settlement for damages from "contaminated air" in his junior high school classroom. At the same time, a third of the school staff filed workers' compensation claims for respiratory and other health problems. In other states, lawsuits have been settled for millions of dollars. In a school district in Washington, D.C., leaky school roofs and other IEQ problems prompted a judge to order the closure of 21 school buildings due to the resultant potential fire hazard. For each incident that makes the evening news or is adjudicated in court, many less-publicized cases are occurring in other districts.

Building a high performance school helps protect districts from IEQ problems by designing out potential problems, and verifying and documenting the facility's health.



PROCESS GUIDE

Key Steps in the Process

Whether building a new school or renovating an existing structure, there are eight key elements to creating a high performance school:

- Set high performance goals early and include them in your educational specifications.
- Select a design team with necessary qualifications and experience in high performance design.
- Communicate goals to designers.
- Pursue integrated design.
- Communicate goals to contractors.
- Monitor construction.
- Verify goals.
- Train occupants.

Building a School in California

In 1998, Proposition 1A reorganized the school design and approval process under a program called the School Facilities Program (SFP). All school districts seeking state money for new construction, modernization, or class-size reduction funds must participate in SFP. Overall project funding is a combination of state and local money; the state will support 50% of new construction costs and 80% of modernization costs. The California legislature appropriated just under \$9.2 billion in bonds to fund these programs. The majority of these funds (\$6.7 billion) were allocated to California's K-12 public school system, and split between new construction, modernization, hardship, and class-size reduction as shown at right.

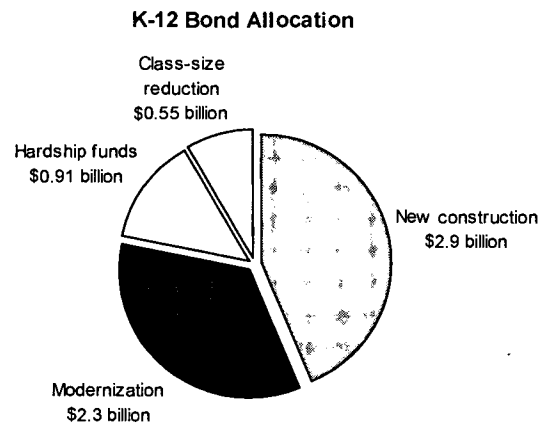

Primary Players

There are five primary players in the California Proposition 1A process:

- The school districts are solely responsible for the origination and management of the entire construction process. They must secure local funding, manage the designers and contractors, and are responsible for any changes required for approval and release of the funding.

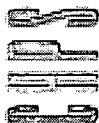

- The State Allocation Board (SAB) distributes all state funding for new construction and modernization of public schools. Funds are distributed quarterly based on a priority points system.
- The Office of Public School Construction (OPSC) is staff to the SAB, and as such, develops programs and policies that carry out the SFP's mandates. Duties include processing applications and creating agendas for the SAB. OPSC is a division of the Department of General Services (DGS).
- The California Department of Education School Facilities Planning Division (SFPD) determines whether the site and plans are safe for the children, and that the facility supports the educational specifications of the district and state. The SFPD must approve the site and plans, and maintains the closest relationship with the district during the process. They publish a range of materials to assist districts through the planning and design process, including Guide to School Site development (2000), School Site Selection and Approval Guide (2000), Educational Specifications (1997), and The Form of Reform (1997). In addition, they have recently updated the section of the Title 5 California Code of Regulations titled "School Facilities Construction." All school construction must comply with the minimum standards and regulations outlined in Title 5. (Subjects include: minimum standards, master plan requirements, minimum distances from power lines and airports, hazardous waste requirements, minimum classroom sizes, waste disposal, surface drainage, traffic and pedestrian safety requirements, etc.)
- The Division of the State Architect (DSA) approves the plans based on structural safety, fire safety, and accessibility. The DSA is also charged with checking for compliance with the state energy efficiency requirements. DSA is a division of DGS. The Construction Inspector of Record (IOR) is approved for each school project by the DSA.

The SFP overhauled the way public schools are financed and the roles of the government agencies involved. Basically, SFP streamlined funding by giving districts a flat grant for new construction and modernization projects. The amount of state funding depends on the number and grade level of the students served by the new facility. The grants are processed by the OPSC, approved by the SAB, and intended to be the entire contribution of the state. Under the SFP, districts have greater freedom in managing their projects, but also bear more responsibility. Any cost overruns are the responsibility of the district, and conversely, the district can keep any savings produced by cost efficient construction.

School districts may also choose to fund entire school construction using their own local bonding authority and proceed without the involvement of OPSC or SFPD.



Construction Contract Considerations

The construction contract documents (contract, plans, and specifications) dictate how a project is constructed. It is important that the construction documents be thorough and unambiguous, because ambiguities are interpreted against the party who prepared the documents, usually the district. Courts often rule that districts have waived or diminished their rights against contractors as a result of such ambiguities. Great care should be taken to ensure that the construction documents clearly mandate and specify the high performance requirements and design criteria.

Districts must also be mindful of Public Contract Code requirements that may impact high performance projects, such as the prohibition against sole source specification provisions. With certain high performance building systems, it is sometimes necessary to specify a product or material of particular brand to ensure optimal performance. However, state law prohibits "sole source" specifications and requires that brand-specific contract provisions list at least two brands and provide bidders the express option of proposing substitutions of equal quality.

In practice, a proposed "equal" seldom is. The architect should be contractually required to review and approve substitution requests by comparing the proposed substitute to the specified product based on applicable criteria, including:

- Does the substitute truly meet or exceed the specified product's performance?
- Does the substitute come with the same, or better, warranty?
- Does the substitute require extra coordination, installation, or additional redesign cost?
- Does the substitute involve ancillary costs, such as higher maintenance, license, or royalty fees?
- Will the substitute adversely impact progress and project scheduling?

An important exception to the sole source and substitution requirements is provided when the district's governing board, by resolution, includes in the specifications that a particular brand is being designated as a field test or experiment to determine its suitability for future use. This exception may be applicable to many high performance design components. Additionally, these requirements do not apply when the district is matching a specific brand product already installed or in the course of completion.

Districts may avoid sole source and substitution issues through properly drafted performance specifications that require bidding contractors to demonstrate that the building systems and construction materials proposed in their bids actually satisfy the performance specifications.

Architectural Contract Considerations

Responsibility for developing a clear design rests largely with the project architect and design consultants. Certain provisions should be included in the architect's contract to facilitate satisfactory performance. The contract should specify as a distinct work activity the architect's responsibility to coordinate the work of all design consultants, since high performance design



requires a collaborative effort by the entire team. Regular meetings among the entire design team should also be required, with minutes prepared by the architect.

Satisfaction of the CHPS Criteria should be mandated through a performance specification in the architect's contract. The contract should further require the architect to provide the district a report at the conclusion of design development that is approved by the entire design team and which analyzes different alternatives to satisfy the CHPS Criteria. The district may wish to engage an independent consultant to review this report. The district must then make a clear choice among alternatives so the design can proceed to completion under a definitive and agreed plan.

Selecting the Contractor

Most school construction contractors have little experience with high performance design features. However, state law limits districts' discretion in selecting a contractor through competitive bidding requirements, and provides detailed rules regarding bid document preparation, bid review, and contract award. Districts are required to accept the lowest "responsive" bid from a "responsible" contractor. However, districts may eliminate unqualified contractors by pre-qualifying a pool of prospective bidders, or by defining in the bid package the minimum qualifications of a responsible bidder. The bid package should also identify the information required for a bid to be considered responsive.

Bidder Pre-qualification

Pre-qualification enables districts to specify in detail the criteria for determining whether a contractor is responsible and qualified to perform the project. The district develops a form contractor financial statement and standardized questionnaire requesting detailed descriptions of the bidder's experience in high performance construction, including the specific components included in the project design. The questionnaire should also request important general information, such as experience in school construction, history of construction claims, timeliness of performance, and claims against the contractor for not following plans and specifications.

These forms must be required of all perspective bidders and must not subjectively act to limit the project to one particular contractor. Districts must adopt an objective, uniform system of rating contractors that establishes minimum qualifications for bidding the project based on information provided in the completed questionnaires and financial statements. Districts must also develop procedures allowing prospective bidders to contest their pre-qualification status.

Bid Responsiveness

A responsive bid is one that conforms to all material terms of the bid package. A detailed bid package with properly drafted performance specifications for high performance components of the design requires bidders to specify how they intend to satisfy the design criteria, while providing districts appropriate discretion to determine responsiveness. The bid package may also require bidders to demonstrate that systems and construction materials proposed in their bids actually satisfy the design specifications.

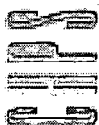

Bidder Responsibility

If a district does not opt for pre-qualification, then bidder responsibility is determined once bids are submitted. A responsible bidder is one who has demonstrated attributes of trustworthiness, as well as quality, fitness, capacity, and experience to satisfactorily perform the construction contract. The factors determining responsibility are project-specific, but similar to the pre-qualification criteria discussed above. The bid package should define the minimum qualifications necessary and require bidders to provide a detailed statement describing the relevant experience of the company and its anticipated crew for the project. Before rejecting a low bidder as non-responsible, districts must provide the bidder evidence supporting this determination and an opportunity to rebut by demonstrating their qualifications.

Selecting the Contract Delivery Method

In the early stages of project planning, the district must choose a construction contract delivery method, which will dictate the roles of the architect, contractors, and consultants. The most common delivery system in public school construction is design-bid-build. This is the “low-bidder” process, where the district hires an architect to prepare the complete design and then awards the project to a general contractor through competitive bidding.

This system provides districts the advantage of having their own design professional who is not affiliated with the contractor and who can monitor construction for compliance with design. Such oversight is helpful for high performance schools, which often include novel components with which contractors may have little experience. Additionally, this system is well understood by contractors and architects. Each knows their respective roles.

Design-bid-build also has its disadvantages. One important factor for high performance schools is that the contractor joins the project team too late to comment on the design, cost, schedule, or phasing prior to bid when their experience would be most useful. Earlier contractor involvement is additionally desirable because contractors are often unfamiliar with high performance design features and their participation in the design can improve their understanding and “buy-in” on the high performance design. As a more general consideration, the clear demarcation of responsibilities between architect and contractor can engender conflict. Each has financial incentive to attribute problems to the other’s area of responsibility by casting issues as design deficiencies or construction deficiencies. Other disadvantages stem from the linear relationship and separation between design and construction, which necessitates a longer project delivery time and can exacerbate schedule problems.

Several other delivery methods common to private construction are being used increasingly on public projects. Districts wishing to consider these alternative delivery methods should consult with legal counsel to structure the system in a manner that complies with competitive bidding and other legal requirements. The more common alternative methods are discussed below. Each offers different advantages for high performance schools, which should be evaluated on a project-specific basis to determine the most advantageous method.

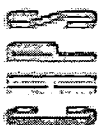

Construction Management/General Contractor (CM/GC)

CM/GC is an option designed to address the primary disadvantages resulting from late contractor involvement in design-bid-build. The district retains, through competitive bidding, a sophisticated general contractor to act as the CM/GC contractor, preferably from a pool of pre-qualified bidders. This contractor should have solid experience in estimating, scheduling, and managing projects. The CM/GC contractor provides construction management services (including input on design) as a member of the project team during the design phase and helps develop a scope of work for each subcontractor necessary for the project.

CM/GC can be advantageous because the CM/GC contractor is involved in the early stages of design and gains a better understanding of the high performance attributes before construction actually begins. This helps the CM/GC contractor better anticipate items with longer lead times, such as certain high performance construction materials that may not be immediately available from local suppliers. Such early involvement can also help reduce conflict by facilitating better cooperation and teambuilding.

One difficulty with CM/GC arises from the legal requirement that contractors list all major subcontractors at the time of the bid. This is problematic because subcontractors are asked to provide a fixed price at a time when the design is incomplete and their scope of work remains somewhat uncertain. The district may face numerous subcontractor substitution requests as subcontractors refuse to perform at their quoted price after they review the completed design. Districts can avoid this problem by competitively bidding each subcontract based on the completed design and assigning each subcontract to the CM/GC contractor. The project is then constructed under the control of a single contractor similar to design-bid-build.

Design-Build and Bridging

Design-build is when a district enters into a contractual relationship with a single entity that assumes the obligation of furnishing the design, supervision, and construction services required to complete the project. The district hires a consulting architect to develop the project conceptual design, from which a detailed scope of work is created. The design-build contractor fulfills this scope of work by completing the design and constructing the project.

The advantages of design-build are derived from centralizing design and construction responsibilities in a single entity. This makes design-build especially useful for projects such as high performance schools, which require close coordination between design and construction phases. It also enables some design and construction activities to proceed simultaneously, thereby shortening project delivery time in comparison to design-bid-build. The district also benefits from having one point of responsibility, which alleviates much of the traditional blame shifting that often occurs between contractors and architects.

One relatively new variation of design-build is bridging. The district hires a criteria architect to establish performance standards and a preliminary design that is more complete than the conceptual design typically prepared in design-build. The design-builder completes the design and constructs the project, but the criteria architect remains on the project to monitor compliance with the design criteria. The result is an unbundling of the preliminary design from



the rest of the project. Bridging provides a combination of key high performance advantages offered by design-bid-build and design-build. Design and construction responsibilities are centralized in a single entity, while the district retains a design professional to protect its interests throughout the project.

Use of design-build and bridging on public works has been limited because of concerns over competitive bidding and subcontractor listing requirements, as discussed above. However, in October 2001, Governor Gray Davis signed into law a bill specifically authorizing design-build for school projects larger than \$10 million. For smaller projects, districts can address these concerns by competitively bidding the design-build contract and subcontracts in the manner described for the CM/GC process. This increases the district's administrative burden, but the advantages provided by alternative delivery methods can sometimes justify the added effort. In addition, the California legislature is presently considering legislation (AB 1543) that would specifically authorize design-build on limited school projects. Districts wishing to consider this delivery system should consult with legal counsel regarding the final resolution of this legislation.

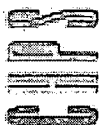

Process Steps

The table below outlines the general process of school construction and the key actions necessary to ensure that a high performance school is specified, designed, and constructed.

	Standard Process	Crucial High Performance Actions
1. Programing and Goal Setting	<p>Determine need. District conducts long range planning. Investigates population trends and current facilities to determine its long-term and current needs.</p> <p>Educational specifications. The educational specification is the primary tool to describe the school's educational goals, and set architectural guidelines to meet those goals.</p> <p>They may include information on the specific spaces to be included in the project, the area required for each space, the relationships between the spaces, and details on the mechanical, electrical, and technological systems. Information on the educational programs, including the curriculum and the methodology in which the curriculum is delivered, may also be included.</p> <p>The CDE highly recommends creating educational specifications. They consider the educational specification crucial to the development of high quality schools, and use it as a tool to educate the districts on relevant issues.</p>	<p>Set high performance goals early and include them in district or educational specifications.</p> <p>Including the goals in specifications is a crucial step. It becomes important and valuable when trade-offs and compromises must be addressed, and throughout the commissioning process to document the original design intent.</p> <p>The CHPS Criteria detailed in Volume III provides a flexible way to set goals. This point system covers the essential elements of high performance design and can be used by districts to clearly identify their priorities.</p>
2. Site Analysis and Approval	<p>District selects site. SFPD conducts an initial review and may grant initial approval. The Department of Toxic Substances Control (DTSC) tests the site, and determines whether it is hazardous. After the site is deemed safe by the SFPD and DTSC, the site is approved. This process can take from a few months to several years to complete, depending on the level of toxins in the site and whether the surrounding community supports the construction.</p>	<p>Minimize the impact of site. Always consider location of site and recognize its impact on the health and safety of the facility. Ensure that the site is safe for the students and staff. Maximize the transit options of students, teachers, and staff. Document the exterior noise levels to ensure they are adequately addressed in the design. Building on previously developed land preserves green space. If building on a new site, disturb as little of the natural environment as possible, and restore damaged portions of the site. Design to reduce stormwater runoff.</p>
3. Selecting the A/E Team	<p>The architectural and engineering (A/E) team must be competitively selected using qualification-based criteria. A fee is negotiated only after an A/E team has been selected on the basis of their qualifications. This process must be followed in order to receive state funding.</p>	<p>Select design team with necessary qualifications for designing a high performance school, and include the requirement for a high performance school in the negotiated design services.</p> <p>Communicate goals to designers. Goals should be included in the educational specifications and Request for Proposals to clearly communicate your design intentions.</p>
4. Schematic Design	<p>During the conceptual design phase, key decisions on the basic scale and layout of the facility are made, and the project's overall scope and direction are established.</p>	<p>Verify that high performance goals have been addressed. Many key elements of the design are decided at this phase; modifying these decisions at later stages may prove to be difficult, costly, and sometimes impossible.</p> <p>Pursue integrated design. Insist on the development of an integrated design team to take full benefit of design options that affect the entire building performance.</p>
5. Design Development	<p>The design is refined and finalized as key building systems and materials (architectural, structural, mechanical, and electrical) are chosen and integrated. Depending on plan approvals, iterations between the designers and CDE/DSA may occur.</p>	<p>Use goals as guides. Trade-offs and compromises are inevitable as the design develops. Be sure that the designers have investigated the impacts of trade-offs on the total building performance.</p>

BEST COPY AVAILABLE



<p>6. Construction Documents</p>	<p>All design elements are finalized and the documents (drawings and specifications) that will guide the construction of the building are completed.</p>	<p>Clearly specify high performance materials and equipment. Many contractors do not have experience with high performance design or "green" materials, especially interior products such as carpets, low-VOC paints, adhesives, and surface finishes. Clearly specifying them in the contract documents will help ensure that the correct materials are used.</p> <p>Clearly identify a substitution and review process that includes the design team and the district, and allows the necessary time to reject a substitution request, if needed. The intent of the specifications are sometimes violated during this substitution process.</p>
<p>7. Plan Approval</p>	<p>Initial CDE plan approval. The SFPD evaluates a schematic and final design of the proposed school in the context of the educational specification and school site safety. Once they feel that the design supports the district's educational mission and have determined that the site is free of hazards, they grant initial approval.</p> <p>Final plan approval. The final architectural and engineering plans are submitted to the DSA and SFPD for independent review. Plans do not need to be submitted concurrently. The districts must make all changes recommended by the DSA and SFPD prior to approval.</p>	
<p>8. Funding</p>	<p>Secure local funding. Funding efforts that began with the decision to construct or renovate the building are secured. Districts seeking state money must secure 50% of the cost for new construction and 20% for renovations.</p> <p>SAB eligibility approval. If receiving state money, districts apply to the OPSC and must verify their eligibility in the program by proving a need for the construction. This can be done at any time in the design process, but must precede SAB approval.</p> <p>SAB funding approval. If receiving state money, districts apply to OPSC for funding and must provide proof that (1) local funding has been secured, (2) plans have been approved by DSA and SFPD, and (3) the site and plans have been approved by the CDE. In the event the district is unable to share in the construction cost, the district can pursue financial assistance through hardship provisions. Once the completed application is received, OPSC processes the application and forwards it to SAB for final approval and release of state funds.</p>	<p>Communicate the value of high performance design with the community to help secure funding. Educating the community about the academic, health, environmental, and monetary benefits of high performance design can help raise awareness and support for the new school.</p>
<p>9. Bidding</p>	<p>Construction projects are competitively bid. The majority of contractors do not have experience with high performance design elements, and care must be taken to ensure that the design is not compromised during construction.</p>	<p>Communicate goals to the contractors. The bid process should require that competing contractors have experience and qualifications to construct high performance schools, including commissioning. If this is not appropriate, care should be taken that substitutions are made with caution and only replaced with materials with equal or better performance.</p>
<p>10. Construction Administration</p>	<p>After the district hires the contractor, SAB releases the funds and construction begins. With all approvals and funding in place, the actual construction time on an average high school of 2,000 students takes approximately two years. Middle and elementary schools take less time. Total design development and construction time from concept to occupancy is between two to four years. When construction is complete, OPSC will perform a final audit.</p>	<p>Monitor construction. Be wary of substitutions or design changes (change orders) during construction that might occur without the consultation of the designer.</p>
<p>11. Occupancy</p>	<p>Post-occupancy review and evaluation.</p>	<p>Verify goals. Commission the building to prove that that the building has been built as designed and meets district specifications.</p> <p>Train occupants. Maintenance personnel, teachers, and staff must understand how to use the building to maximize comfort and building performance.</p>

BEST COPY AVAILABLE



DISCUSSION GUIDE

This Discussion Guide presents a step-by-step method for managing the design process in order to ensure that a high performance school building is achieved.

The guide contains a series of questions, organized by design phase, that the "owners" of a new school (the superintendents, business officials, board members, and others who are guiding the facility development process) can use to make sure their design team actively considers *all* the key components of a high performance school during *every* phase of the development process.

Using the Discussion Guide

Over the course of designing and building a new facility, school representatives will meet regularly with their design team to discuss progress. Use the Process Guide to help guide discussion during these meetings.

The Discussion Guide is divided into eight sections corresponding to key phases in the design/development process:

- Programming and goal setting.
- Selecting the A/E team.
- Site analysis.
- Schematic design.
- Design development.
- Construction documents.
- Bidding.
- Construction administration.

At the start of each phase, consult the appropriate section of the Discussion Guide. Throughout this phase of the process, use the list of questions to help frame discussions with the design team. The questions in each section address the key "building blocks" of any high performance school:

- Acoustic comfort.
- Commissioning.
- Daylighting.
- Energy analysis tools.
- Environmentally preferable materials and products.
- Environmentally responsive site planning.
- High performance heating, ventilating, air conditioning systems.
- High performance electric lighting.
- Life-cycle cost analysis.
- Renewable energy.
- Safety and security.
- Superior indoor air quality.
- Thermal comfort.
- Visual comfort.
- Water efficiency.

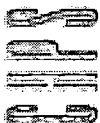

Programming and Goal Setting

Note: The CHPS Criteria (Volume III) is a flexible and convenient means to define your high performance goals.

Superior Indoor Air Quality

- Has superior indoor air quality been established as a design goal for the school?

Acoustic Comfort

- Has good classroom acoustics been established as a design goal for the school?

Thermal Comfort

- Has thermal comfort been established as a design goal, especially for the classrooms?

Visual Comfort

- Has visual comfort been established as a design goal, especially for the classrooms?

Daylighting

- Has providing optimum amounts of daylight been specifically established as a design goal for the school and, in particular, for the classrooms?

Safety and Security

- Has security been established as a design goal for the school?
- As part of programming, are basic room placements and adjacencies being considered in terms of their effects on safety and security (for example, is the main entrance visible from the administrative offices, etc.)?

Life-Cycle Cost Analysis

- Has using some form of life-cycle cost analysis methodology been established as a requirement for the design team?
- What methodology will be used?
- What basic assumptions (for example, projected life of the facility, projected energy costs, rate of inflation, etc.) have been built into the methodology? Are they agreed to by all parties?

Commissioning

- Has commissioning been committed to, and budgeted for, as a basic component of the project?
- Has a commissioning agent been engaged?

Energy Analysis Tools

- Is the design team required to use an energy analysis tool to help maximize the energy effectiveness of the building?
- What tool has been selected?
- At what stages in the design process will the tool be used and what types of analyses will be developed?
- Has an energy use goal (that is, a maximum amount of nonrenewable energy the school should consume in a year) been established? What is it?

Energy-Efficient Building Shell

- Has providing an energy-efficient building shell been established as a goal for the project?
- Does the basic programming allow windows on the east and west to be smaller (to reduce unwanted heat gain) and those on the north and south to be larger (to enhance daylighting opportunities)? For example, are the programming group functions that may need less glazing (auditoriums, kitchens, etc.) on the east and west, and those that will benefit from daylight (classrooms, corridors, etc.) on the north and south?

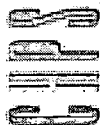

Environmentally Preferable Materials and Products

- Has using environmentally preferable materials and products been established as a design goal?
- Has a goal been set to achieve a minimum 25% recycled content rate?
- Is there agreement between the owner and design team as to the types of environmentally preferable materials and products that should be considered for the project? Are these prioritized?

Waste Reduction

- Has material efficiency been established as a design goal?
- Has construction waste management been established as a goal? Have specific goals for waste reduction been set?

Environmentally Responsive Site Planning

- Is preserving natural areas on the site established as a design goal?
- Is minimizing stormwater runoff a design goal for the site?
- Have goals for alternative transportation been established?
- Does the community support the environmental and visual impacts of the school on the site and surrounding area? Have minimizing these impacts been established as a design goal?

High Performance HVAC

- Is using high efficiency heating, ventilating, and air conditioning equipment a design goal for the project?
- Is "right sizing" this equipment (by accurately predicting demand and sizing the equipment to meet it) a design goal?
- Are low noise levels produced by mechanical equipment a design goal for the project?

High Performance Electric Lighting

- Is a high performance electric lighting system — especially in the classrooms — a design goal?
- Is optimizing the interaction between the electric lighting system and any daylighting strategies a design goal?

Water Efficiency

- Has water efficiency been established as a design goal for the project?
- Have water use goals for the school been established?

Renewable Energy

- Is maximizing the cost effective use of renewable energy a design goal for the project?
- What percentage of the projected annual energy use of the facility should be provided by renewable energy systems? Is this percentage agreed to by all parties?
- Will the district need to hire a qualified technician to maintain the renewable energy sources? What school district budgets and trade union issues will need to be addressed?

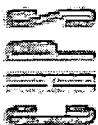

Selecting the A/E Team

Superior Indoor Air Quality

- What is the team's approach to delivering superior indoor air quality?
- In previous projects how has the team addressed: controlling sources of contaminants in a building, providing adequate ventilation, and avoiding moisture accumulation?
- Have any of their buildings experienced indoor air quality problems that required remedial action?

Acoustic Comfort

- Is there an acoustical consultant on the team?
- How has the team addressed acoustic performance in previous projects?
- What specific strategies has the team used to ensure acoustic quality?
- How has the team applied these strategies in classrooms, multi-purpose rooms, stages, performance/music spaces, and hallways?
- What is the team's approach to controlling noise and vibration from the HVAC systems?

Thermal Comfort

- What is the team's approach to maintaining thermal comfort in the buildings they design?
- How much control will teachers have over their individual classrooms? Why is this method proposed?

Visual Comfort

- What is the team's approach to ensuring visual comfort in the buildings they design?
- Do they have examples (preferably classrooms) that can be visited and "test driven"?

Daylighting

- What examples can the team provide of previous projects that incorporate daylighting?
- What daylighting strategies did the team use?
- Are the occupants satisfied with the results?
- Are the strategies saving energy? How much?
- What analysis tools does the team use to optimize performance of the daylighting systems it designs?

Safety and Security

- Does the team have experience with Crime Prevention Through Environmental Design (CPTED)?
- How has the team incorporated CPTED principles into previous projects (preferably schools)?
- How does the team balance the use of security technology and the use of CPTED principles in its buildings? Does it emphasize "security by design" first, and technology second?

Life-Cycle Cost Analysis

- Has a life-cycle cost analysis been included in the contract?
- What life-cycle cost methodology does the team use on its projects?
- How does it use the methodology to reduce the total ownership costs of the buildings it designs?
- Has it applied the methodology to school design? What were the results?
- What methodology does the team propose for the project under discussion?

Commissioning

- Have any of the team's previous buildings gone through a commissioning process?
- How detailed was the commissioning? Who acted as commissioning agent?
- What were the results?



Energy Analysis Tools

- What energy analysis tools does the team use on its projects?
- How does it use these tools to reduce energy consumption in its designs?
- Has it applied the tools to school design? What were the results?
- What tools does the team propose for the project under discussion?

Energy-Efficient Building Shell

- How has the team provided energy efficient walls, floors, and roofs on previous projects?
- What key techniques, materials, and products were used, and what was the resulting impact on energy performance?
- Are the systems still performing as designed?

Environmentally Preferable Materials and Products

- What experience does the team have in specifying environmentally responsible materials and products in its projects?
- Does the team have experience specifying recycled content materials?
- Does the team have knowledge of how these materials and products can be procured, what delivery timelines can be expected, and how they are installed?
- Does the team have knowledge of how these materials and products perform over time?
- Has the team ever specified environmentally responsible materials and products for schools?

Waste Reduction

- Does the team have experience designing for materials efficiency?
- Has the team experience specifying construction waste management?

Environmentally Responsive Site Planning

- Does the team have experience creating environmentally responsive site plans?
- What were the key features, and how are they performing?

High Performance HVAC

- Does the team specify high performance HVAC systems as standard practice?
- What tools does the team use to analyze and optimize the performance of HVAC systems?
- What high performance HVAC systems has the team put in place in previous projects (preferably schools)?
- How much energy savings did these systems generate?
- How have these systems performed over time?
- Did these systems provide a quiet, as well as comfortable, learning environment?
- Is the project going to be design-build, or is an independent mechanical engineer on the team?

High Performance Electric Lighting

- Does the team have experience designing high performance electric lighting systems (preferably in schools)?
- Are these systems providing a high-quality visual environment and saving energy?
- What is the team's experience integrating daylighting and electric lighting systems?
- What tools does the team use to analyze and optimize the combined performance of daylighting and electric lighting systems?

Water Efficiency

- What is the team's experience with water-efficient landscaping, water use reduction techniques, and/or innovative wastewater treatment systems?
- Have they applied any of these techniques to schools?



- What have been the results?
- Does the community support the use of reclaimed/gray water systems? What educational efforts would be needed to build their support?

Renewable Energy

- What is the team's experience designing and/or installing renewable energy systems?
- What specific systems have they used or installed (preferably in schools)?
- How much energy are these systems saving?
- Are they still performing as intended?



Site Analysis

Superior Indoor Air Quality

- Is the site near any current or planned sources of outdoor pollution?
- What are the ambient outdoor air quality conditions and prevailing wind direction(s)?

Acoustic Comfort

- Are there major sources of noise near the site (for example, highways, industrial sites, or shopping areas)?
- Can the site be used to minimize the impacts of these noise sources (for example, through earth berms, setbacks, building orientation, etc.)?

Thermal Comfort

- Are there prevailing breezes that could be used to help naturally ventilate the building? ⊗

Visual Comfort

- Does the site provide special views that should be preserved?

Daylighting

- Does the site allow the building to be oriented on an east-west axis, maximizing southern exposure?
- How will site elements (for example, existing trees or adjacent buildings) affect the building's access to sunlight?

Safety and Security

- Are there clear lines of sight to and from the school building from throughout the site?
- Are there areas (for example, depressions in the ground, stands of trees, thick shrubs) where people can be hidden from view?

Life-Cycle Cost Analysis

- N/A.

Commissioning

- N/A.

Energy Analysis Tools

- N/A.

Energy-Efficient Building Shell

- N/A.

Environmentally Preferable Materials and Products

- Are there materials on the site that can be used in the building project?
- Does the site naturally lend itself to the use of certain environmentally preferable materials?

Waste Reduction

- Can any of the materials on the site, especially if it is previously developed, be safely salvaged or reused in the new construction (landscaping materials, concrete, interior materials)?

Environmentally Responsive Site Planning

- Can existing natural areas or features on the site be preserved?
- Does the site lend itself to controlling stormwater runoff?
- Can areas of the site be restored?
- Can connections to nearby ecosystems be maintained?
- What areas of the site could be used as "outdoor laboratories" for teaching?

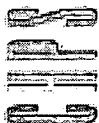

- If the site has been previously developed, what are the opportunities for reuse of building/site materials?
- What toxin risks are present on, or near, the site?
- How many alternative transportation options are easily accessible from the site?
- Will pedestrians and individuals using bikes have safe access to the school?

High Performance HVAC

- N/A.

High Performance Electric Lighting

- N/A.

Water Efficiency

- Does the site lend itself to the use of high efficiency irrigation techniques?
- Can municipal-supplied, reclaimed water be used for irrigation? Does the community, parents, and school board support such a plan?
- Could the site accommodate on-site wastewater treatment? Who would be responsible for its maintenance and operation?

Renewable Energy

- Does the site have good solar access — for daylighting; active and passive solar heating; solar hot water; and/or photovoltaic systems?
- Could the site use wind power to generate electricity?



Schematic Design

Superior Indoor Air Quality

- Will the HVAC system being considered provide adequate ventilation, and how will the design team verify that these goals are being met?
- Does the basic layout of the school keep operable windows and air intake vents away from sources of exhaust (such as cars and buses)?
- Do the preliminary selected materials support superior indoor air quality by limiting VOCs and other off-gased pollutants?
- Will extreme roof or surface temperatures adversely affect the performance of the HVAC system (including air intakes and duct design)?

Acoustic Comfort

- Develop appropriate acoustical criteria (e.g., reverberation time (RT), noise criteria (NC), sound transmission (STC)), for each space that is of concern.
- Does the basic design of the classrooms help or hinder good acoustics? In other words, does it reduce sound reverberation by means of sound-absorbing materials?
- Do any of the classrooms face sources of outside noise, such as playgrounds, roads, or equipment? If so, what measures are proposed to reduce the impact of this noise?
- Are any of the classrooms located next to sources of inside noise (music rooms, rooms that use amplified sound systems, etc.). If so, what measures are proposed to reduce the impact of this noise?
- Have preliminary noise control guidelines (e.g., air velocity, NC criteria, duct layout, equipment location, etc.) been submitted and reviewed by the design team?

Thermal Comfort

- Are windows and skylights being designed to minimize "hot spots" caused by direct sunlight?
- Are temperature controls being considered for each classroom?

Visual Comfort

- Are the basic daylighting and electric lighting designs being developed so that they provide illumination as uniformly as possible, using task or accent lighting as appropriate to meet specific needs?
- Are individual lighting designs being developed for individual room types? Do the designs vary, even within room type, depending on the amount of daylight the room will receive?
- Is the potential for glare being analyzed, and are the lighting/daylighting systems being designed to minimize it?
- Are the color and texture of wall, floor, and ceiling surfaces being taken into account in terms of their interaction with the lighting and their combined impact on the visual environment?

Day lighting

- What basic strategies are being considered for bringing daylight into the school, particularly the classrooms?
- What strategies are being considered to control unwanted heat gain and glare?
- What tools are being used to analyze the impact of any daylighting strategies on the electric lighting system, and on visual comfort and energy use?
- What are the preliminary results of these analyses?

Safety and Security

- How have Crime Prevention Through Environmental Design (CPTED) principles been applied during this phase of the process?
- Are opportunities for natural surveillance and access control being "designed in"?

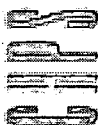

- What security technologies are being considered? How do they reinforce and extend the impact of the school's security-focused design features?

Life-Cycle Cost Analysis

- Has the life-cycle cost methodology selected for the project been used to compare and optimize alternative design strategies at least once (preferably several times) during this phase of the process?

Commissioning

- Is appropriate design documentation being collected by and/or delivered to the commissioning agent?
- Has a preliminary commissioning plan been developed?

Energy Analysis Tools

- Has the energy analysis tool(s) selected for the project been used to project energy consumption at least once (preferably several times) during this phase of design?
- Do the results meet or exceed the energy goal for the facility?

Energy-Efficient Building Shell

- What basic assemblies and configurations are being considered for the walls, floors, and roofs of the facility?
- What types of materials — glazing, shading, insulation, air barriers, structural materials, etc. — are being considered?
- How are trade-offs being analyzed (for example, between amounts of window versus wall, between one type of glazing versus another, etc.), and how will the overall performance of the shell as a whole be optimized?
- How are the impacts of thermal mass being factored in?
- Are light-colored surfaces, particularly roofing, being considered as a means to reduce heat gain?
- Are the proposed roof colors in compliance with local building requirements, and do they have the support of the community?

Environmentally Preferable Materials and Products

- What types of environmentally preferable materials and products are being considered and where will they be used?
- Are materials with post-consumer recycled content being considered?

Waste Reduction

- Does the basic design facilitate recycling by students and faculty?
- Will storage areas be designated in the design for the collection of these recyclables?

Environmentally Responsive Site Planning

- Is the building, particularly the classroom wings, oriented in a predominantly east-west direction to facilitate access to daylight?
- Does the design preserve existing natural areas or features on the site?
- Does the design help control stormwater runoff?
- Does design restore areas of the site?
- Are connections to nearby ecosystems being maintained?
- Does the design minimize areas covered with impervious surfaces (such as parking lots, paved walkways, etc.)?
- Are there opportunities to replace any non-permeable surfaces with permeable surfaces?

High Performance HVAC

- What type of HVAC system is being considered for the school?
- Why is this system optimal from a comfort/energy performance standpoint?



- How are the interactions between the HVAC system and other key building systems (such as lighting, daylighting, acoustics, building shell) being analyzed and optimized?
- Is natural ventilation being considered? If so, are its potential impacts on HVAC performance being factored into the analysis process?
- Can the HVAC equipment be shaded with building or landscaping elements to reduce solar gain?
- Will the acoustics or air flow of the system adversely affect the learning environment?
- Have noise and vibration from mechanical equipment and air distribution systems been analyzed?
- Have drafts been eliminated?

High Performance Electric Lighting

- What electric lighting system is being proposed for the school and, in particular, for the classrooms?
- What are its energy and visual performance benefits?
- How does it interact with the daylighting strategies being used?
- How are these interactions being analyzed and optimized?
- Will the control systems perform as expected during both active and quiet classroom activities?

Water Efficiency

- Is water-efficient landscaping part of the preliminary site design?
- Is irrigating only the athletic fields, not plants near buildings or parking lots, being considered?
- Are water reduction techniques being considered for school plumbing fixtures and equipment?
- Is capturing and reusing rainwater being considered?
- Are innovative wastewater treatment techniques being considered? Will any additional staff be needed to maintain or operate the systems?

Renewable Energy

- What renewable energy strategies are being considered for the school? Will any additional staff be needed to maintain or operate the systems?
- Are the systems as secure as possible to minimize the risk of vandalism?
- How much energy will they save?
- What are their life-cycle cost benefits?
- How will they impact the site plan or the building design?
- How will they impact other building systems (such as lighting, electrical, HVAC, building shell)?



Design Development

Superior Indoor Air Quality

- Will the HVAC system provide adequate ventilation, especially to the classrooms?
- Is the system designed to maintain the indoor relative humidity between 30% to 50%?
- Does the design provide local exhausts for restrooms, kitchens, science labs, janitor's closets, copy rooms, and vocational/industrial shop rooms? How are they controlled?
- Does the design include CO₂ sensors in large assembly areas to monitor air quality?
- Have cleaning products been identified that support good indoor air quality?
- What design elements have been included to facilitate integrated pest management to reduce the need for pesticides?

Acoustic Comfort

- How do the proposed materials and finishes, especially those used in the classrooms, contribute to reducing sound reverberation?
- Have the classrooms been analyzed in terms of projected acoustic performance and speech communication?
- Will the proposed heating, ventilating, air conditioning (HVAC) system for the classrooms create excessive noise? If so, how will the impacts of this noise be dealt with?
- Have the original acoustic criteria been utilized in analyzing the project?

Thermal Comfort

- Are HVAC distribution layouts designed to ensure all parts of a room receive adequate ventilation while eliminating drafts?

Visual Comfort

- Do the daylighting and electric lighting system designs provide illumination as uniformly as possible, using task or accent lighting as appropriate to meet specific needs?
- What tools have been used to model the interactions of both these systems in terms of their impacts on visual comfort?
- Have direct/indirect lighting fixtures been selected for general illumination in classrooms?
- What shading strategies (internal and external) have been selected?
- Have individual lighting designs been developed for individual room types? Do the designs vary, even within room type, depending on the amount of daylight the room will receive?
- Has the potential for glare been analyzed, and have the lighting/daylighting systems been designed to minimize it?
- Have the color and texture of wall, floor and ceiling surfaces been taken into account in terms of their interaction with lighting and their combined impact on the visual environment?

Daylighting

- What daylighting strategies have been selected for the school, particularly the classrooms?
- Are the classrooms receiving as much daylight as possible, while avoiding glare and unwanted heat gain?
- What types of glazing have been selected (for windows, clerestories, skylights, and/or roof monitors) and why are they more energy and cost effective than alternatives?
- How will the daylighting and electric lighting systems interact?
- What analyses have been done to optimize these interactions?
- Will the combined daylighting/electric lighting strategies reduce energy use and lower the school's operating costs over time?



- Has the possibility of reducing the number of light fixtures, or the number of lamps, in daylit rooms been investigated?

Safety and Security

- How have Crime Prevention Through Environmental Design (CPTED) principles been applied during this phase of the process?
- Have opportunities for natural surveillance and access control been “designed in”?
- What security technologies have been selected? How do they reinforce and extend the impact of the school’s security-focused design features?

Life-Cycle Cost Analysis

- Has the life-cycle cost methodology selected for the project been used to compare and optimize alternative design strategies at least once (preferably several times) during this phase of the process?

Commissioning

- Is appropriate design documentation being collected by, or delivered to, the commissioning agent?
- Has a commissioning report been prepared?

Energy Analysis Tools

- Has the energy analysis tool(s) selected for the project been used to project energy consumption at least once (preferably several times) during this phase of design?
- Do the results meet or exceed the energy goal for the facility?

Energy Efficient Building Shell

- What basic wall, floor, and roof assemblies have been selected?
- What types of materials — glazing, shading, insulation, air barriers, structural materials — have been selected, and why are they better, from an energy and life-cycle cost perspective, than other alternatives?
- How have trade-offs been analyzed (between amounts of window versus wall, between one type of glazing versus another, etc.), and how has the performance of the building shell as a whole been optimized?
- Have the impacts of thermal mass been factored in?
- Are light-colored surfaces, particularly roofing, being used as a means to reduce heat gain?

Environmentally Preferable Materials and Products

- What types of environmentally preferable materials and products have been selected, and where will they be used? Have materials with post-consumer recycled content been selected?
- Are all the selected materials and products low emitters of indoor air contaminants?

Waste Reduction

- Does the final design facilitate recycling by students and faculty? How will the materials be stored?

Environmentally Responsive Site Planning

- Does the final design preserve existing natural areas or features on the site?
- Does final design restore areas of the site? How?
- Are connections to nearby ecosystems being maintained? How?
- Does the design help control stormwater runoff?
- Does the design minimize areas covered with impervious surfaces (such as parking lots, paved walkways, etc.)?
- Do landscaping strategies, particularly tree planting, enhance the building’s high performance features (for example, by providing shade where it’s needed but not blocking sunlight that’s used for daylighting)?



High Performance HVAC

- What type of HVAC system has been selected for the school?
- Why is this system optimal from a comfort/energy performance standpoint?
- Is it the best system from a life-cycle cost perspective?
- How have the interactions between the HVAC system and other key building systems (lighting, daylighting, building shell) been analyzed and optimized?
- Has natural ventilation been considered? If so, have its potential impacts on HVAC performance been factored into the analysis process?
- Has the HVAC equipment been "right sized" to meet predicted demand?
- What control system(s) has been selected, and how will it affect performance?
- What level of control will individual teachers have over the heating, ventilating, and air conditioning of their classrooms?
- Is the entire system configured for easy operation, maintenance, and repair?

High Performance Electric Lighting

- What electric lighting system(s) has been selected for the school and, in particular, for the classrooms?
- What are its energy and visual performance benefits?
- How does it interact with the daylighting strategies being used? How have these interactions been analyzed and optimized?
- Have fewer fixtures and/or lamps been specified for daylit spaces?
- What control system(s) has been selected, and how will it affect performance?
- What level of control will teachers have over the lighting in their classrooms?
- What is the energy performance and light distribution of the parking lot, outdoor, and field lighting? How much light pollution will be produced? Are they separately metered?
- To a reasonable extent, have the lighting fixtures been standardized to reduce the numbers of replacement parts that need to be stocked? What is the expected availability of replacement parts over the life of the building? How specialized is the equipment that has been recommended?

Water Efficiency

- Has high efficiency irrigation technology been selected for athletic fields?
- Does the design use captured rainwater or recycled water for irrigation?
- Does the design include high efficiency equipment (dishwashers, laundry, cooling towers)?
- Does the design include low-flow showerheads and automatic lavatory faucet shut-off controls?
- Does the design include innovative wastewater treatment techniques?

Renewable Energy

- What renewable energy strategies have been selected and incorporated into the design?
- How much energy will they save?
- What are their life-cycle cost benefits?
- How do they impact other building systems (lighting, electrical, HVAC, building shell)?
- What analysis has been done to ensure that all these systems interact optimally?



Construction Documents

Superior Indoor Air Quality

- Has a construction IAQ plan been required? Is a flush out required? Has time been allocated in the construction time line for the proper flush out, and what measures have been taken to ensure that the contractors perform the flush out?
- Will the HVAC system as finally configured provide adequate ventilation, especially to the classrooms?
- Will the system maintain the indoor relative humidity between 30% to 50%?
- Are local exhausts with effective controls for restrooms, kitchens, science labs, janitor's closets, copy rooms, and vocational/industrial shop rooms provided?
- Have CO₂ sensors to monitor air quality been included in large assembly areas?
- Are all the selected interior materials and products low emitters of indoor air contaminants?
- Have recessed grates or "walk-off" mats been installed at entrances to reduce the amount of dirt entering the building? What are the maintenance impacts?

Acoustic Comfort

- Are the walls and doors of classrooms that are located next to noise sources designed so that they minimize sound transmission?
- If rooftop HVAC equipment is being used, is it mounted on vibration isolators to reduce noise and vibration transmission?
- Have the original acoustic criteria been utilized in analyzing the project?

Thermal Comfort

- Do HVAC distribution layouts in their final configurations ensure all parts of a room receive adequate ventilation?
- Have controls been installed to provide teachers adequate control over the thermal comfort of their classrooms?

Visual Comfort

- Do the daylighting and electric lighting systems in their final configurations provide illumination as uniformly as possible, using task or accent lighting as appropriate to meet specific needs?
- Have direct/indirect lighting fixtures been specified for general illumination in classrooms?
- What shading strategies (internal and external) have been specified?
- Have the final configurations of other building components — like the color of the walls, floor, or ceiling — been changed in ways that might influence system performance? Have the potential impacts of these changes on visual comfort been accounted for?

Daylighting

- Will the construction details for the daylighting components (the windows, light shelves, roof monitors, skylights, shading devices, etc.) modify the performance of the system as a whole; that is, will the required amount of daylight still reach the classrooms, will glare and heat gain still be controlled, etc.? What will be the impact — on operating costs and on visual comfort — of any changes in performance?
- Will the final construction details of other building components (for example, the color and reflectance of roofing materials adjacent to skylights or roof monitors) change the dynamics of the daylighting system and impact performance? What will be the impact — on operating costs and on visual comfort — of any changes in performance?
- What measures have been taken to eliminate leaks from the daylighting systems?

Safety and Security

- What type of exterior lighting has been specified and how will it improve security?

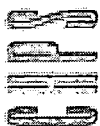

- Have durable materials been specified in critical areas such as entrances?
- What security technologies have been specified? How do they reinforce and enhance the building's security-focused design features?
- Have lens guards been specified in high activity areas like playgrounds, gyms, and fields?

Life-Cycle Cost Analysis

- Has the life-cycle cost methodology selected for the project been used to compare and optimize alternative design strategies at least once during this phase of the process?

Commissioning

- Have commissioning requirements been included in the construction documents?
- Has a written end-of-phase commissioning report been prepared?

Energy Analysis Tools

- Has the energy analysis tool(s) selected for the project been used to project energy consumption at least once during this phase of design?
- Do the results meet or exceed the energy goal for the facility?

Energy-Efficient Building Shell

- Do the final construction details for the wall, floor, and roof assemblies maintain the original design intent in terms of energy performance and sound isolation (for example, do the assemblies allow insulation to be installed at the thickness originally specified; do air barriers cover all the areas they are supposed to; can areas such as roof cavities that need ventilation be adequately vented in the current configuration, etc.)?

Environmentally Preferable Materials and Products

- Are the construction documents clear and explicit concerning the required environmental attributes of the materials and products specified?
- Is language included in the documents requiring that a proposed material or product substitution must be equal to, or better than, the specified product in terms of its environmental attributes?

Waste Reduction

- Has a construction waste management plan been required? Are goals specified for waste reduction and for job-site recycling within the contract documents and specifications?

Environmentally Responsive Site Planning

- Have hardy, indigenous plants been specified in the landscaping plan?
- Have exterior lights been designed to focus downward to reduce light pollution of the night sky?
- Has the exterior lighting been designed with the neighborhood and community in mind?

High Performance HVAC

- Do the equipment and products specified for the HVAC system continue to meet the design and performance goals established previously?
- What analyses have been done to ensure the system is "right sized" for the expected demand? Will it handle both current and projected demand?

High Performance Electric Lighting

- What lamps, ballasts, and fixtures have been specified?
- Why are they the best choices in terms of visual comfort, energy use, and long term performance? What are the manufacturer's warranties? What warranties can be expected for replacement products?
- Will the system as finally configured and specified be easy to operate, maintain, and repair?
- What is the impact of the system as finally configured on electricity use?



- Does the system as finally configured minimize waste heat generation? Has this been taken into account in sizing the cooling system?
- What controls have been specified? How will they help save energy and operating costs?
- What level of control will individual teachers have over the heating, ventilating, and air conditioning of their classrooms?

Water Efficiency

- N/A.

Renewable Energy

- Do the final construction details for the renewable energy systems allow the systems to perform as designed? (For example, are solar systems installed so that they face the right direction, at the correct angle, to receive the right amount of sunlight? Does the final location of another current or planned building component — like a rooftop air conditioner — prevent sunlight from reaching a solar collector?) Are the solar collectors as vandal-proof as possible?
- How are the renewable energy systems in their final configurations anticipated to perform from a life-cycle standpoint?
- What warranty periods have been specified for the systems? Who will service the system once the warranty has expired?

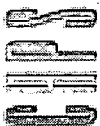

Bidding

Superior Indoor Air Quality

- Have any substitutions been proposed, such as alternative materials or a different ventilation system, that could impact indoor air quality?
- Are all substitute materials and their proposed cleaning agents low emitters of indoor contaminants?
- Do substitute materials require different cleaning processes that may contaminate indoor air?
- Are substitutions being proposed for materials or assemblies designed to act as barriers to sources of indoor contaminants? Will the substitute materials/assemblies also act as effective barriers?

Acoustic Comfort

- Have any substitutions been proposed, such as alternative wall/floor/ceiling materials or different types of HVAC equipment, that could impact acoustical quality, particularly in the classrooms?
- If these substitutions are accepted, how will they impact the original acoustic criteria and overall acoustic comfort?

Thermal Comfort

- Have any substitutions been proposed, such as alternative glazing materials, different types of insulation, or different types of ventilation hardware, that could affect thermal comfort, especially in the classrooms?
- If these substitutions are accepted, how will they impact the thermal comfort of students and teachers, the energy performance of the building, and its life-cycle cost?

Visual Comfort

- Have any substitutions been proposed, such as alternative glazing materials, different types of lamps or light fixtures, or alternative colors for walls, floors, or ceilings, that could affect visual comfort, especially in the classrooms?
- If these substitutions are accepted, how will they impact the visual comfort of students and teachers, the energy performance of the building, and its life-cycle cost?

Daylighting

- Have any substitutions been proposed, such as alternative glazing materials or different types of shading, that could impact the intended performance of the daylighting system?
- If these substitutions are accepted, how will they impact system performance, visual comfort, and life-cycle cost?

Safety and Security

- Have any material substitutions been proposed that could reduce the durability — and increase the vulnerability — of critical areas in the building, such as entrances?
- Have any security technology substitutions been proposed?
- How well will the alternative technologies fit in with and complement the school's design-focused security measures?
- How will the substitute technologies interface with other controls systems in the school (for example, those for the lighting and HVAC systems)?
- If substitutions are accepted, will they be as easy to operate, maintain, and repair as the originally specified products and systems?

Life-Cycle Cost Analysis

- Is the life-cycle cost methodology selected for the project being used to analyze proposed material or product substitutions in terms of their impacts on overall performance and cost effectiveness?

Commissioning

- Has the commissioning plan been clearly described to potential bidders?



Energy Analysis Tools

- Is the energy analysis tool(s) selected for the project being used to evaluate the energy consumption consequences of proposed materials, products, or system substitutions?
- Do the substitutions impact the school's ability to meet its energy goal for the facility?

Energy-Efficient Building Shell

- Have any substitutions been proposed, such as alternative glazing materials, different types of insulation, or alternative roofing products, that could impact the intended performance of the building shell?
- If these substitutions are accepted, how will they impact the energy performance of the building and its life-cycle cost?

Environmentally Preferable Materials and Products

- Are all proposed substitutions equal to, or better than, the specified products in terms of environmental attributes?
- Are the substitutions also functionally equivalent to the specified products? (In other words, if they are accepted, they will not adversely affect the performance of the system or assembly in which they are used.)
- What analyses have been done to ensure substitutions will not degrade environmental quality or system performance?

Waste Reduction

- Has a construction waste management plan that satisfies the goals of the project been submitted?

Environmentally Responsive Site Planning

- Have any substitutions been proposed, such as different plants, alternative materials for parking lots or walkways, or alternative exterior light fixtures, that could reduce the environmental quality of the site plan?
- Will any of these substitutions impact the performance of the building (for example, fewer trees may mean less shade and more heat gain in daylit classrooms)?
- Have these impacts been analyzed? How will they affect the overall life-cycle cost of the facility?

High Performance HVAC

- Have any substitutions been proposed, such as alternative equipment, different types of controls, or alternative delivery hardware (for example, diffusers), that could modify system performance?
- After the substitutions, will the system still be "right sized" to meet the demand (not over or undersized)?
- If these substitutions are accepted, how will they impact the energy performance of the building and its life-cycle cost?

High Performance Electric Lighting

- Have any substitutions been proposed, such as alternative lamps, ballasts, or controls, that could impact the intended performance of the electric lighting system?
- Will these substitutions provide the same level of visual comfort as the design calls for?
- Will they add any additional waste heat to the space?
- Will they work correctly with the specified control system?
- If these substitutions are accepted, how will they impact visual comfort, energy performance, and life-cycle cost?

Water Efficiency

- Have any substitutions been proposed, such as alternative plumbing fixtures, different types of landscape vegetation, or an alternative irrigation system, that could reduce the school's water efficiency?
- If these substitutions are accepted, how will they impact water use and overall life-cycle costs at the facility?



Renewable Energy

- Have any substitutions been proposed to specific systems or to the materials from which the systems are constructed that could impact intended performance?
- If these substitutions are accepted, how will they impact the energy performance and life-cycle cost of the whole facility?

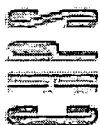

Construction Administration

Superior Indoor Air Quality

- Is the impact of the construction process on indoor air quality — for workers and, in the case of renovations, for students and teachers — being managed?
- Is the building being constructed as designed to ensure high indoor air quality?
- Have any substitutions been proposed, such as alternative materials or a different ventilation system, that could impact indoor air quality?
- Are all substitute materials and their cleaning agents low emitters of indoor contaminants?
- Do substitute materials require different cleaning processes that may contaminate indoor air?
- Are substitutions being proposed for materials or assemblies designed to act as barriers to sources of indoor contaminants? Will the substitute materials/assemblies also act as effective barriers?
- Is there a plan to “flush out” the facility for at least 72 hours after construction and before occupancy?

Acoustic Comfort

- Is the building being constructed as designed to achieve acoustic comfort?
- Have any substitutions been proposed, such as alternative wall/floor/ceiling materials or different types of HVAC equipment, that could impact the original acoustic criteria and acoustical quality, particularly in the classrooms?
- If these substitutions are accepted, how will they impact overall acoustic comfort?
- Has the acoustical consultant performed any site visits?

Thermal Comfort

- Is the building being constructed as designed for optimal thermal comfort, especially in the classrooms?
- Have any substitutions been proposed, such as alternative glazing materials, different types of insulation, or different types of ventilation hardware, that could affect thermal comfort, especially in the classrooms?
- If these substitutions are accepted, how will they impact the thermal comfort of students and teachers, the energy performance of the building, and its life-cycle cost?

Visual Comfort

- Is the building being constructed as designed to enhance visual comfort, especially in the classrooms?
- Have any substitutions been proposed, such as alternative glazing materials, different types of lamps or light fixtures, or alternative colors for walls, floors, or ceilings, that could affect visual comfort, especially in the classrooms?
- If these substitutions are accepted, how will they impact the visual comfort of students and teachers, the energy performance of the building, and its life-cycle cost?

Daylighting

- Is the building, especially the classrooms, being constructed as designed to provide the appropriate or intended levels of natural light?
- Have any substitutions been proposed, such as alternative glazing materials or different types of shading, that could impact the intended performance of the daylighting system?
- If these substitutions are accepted, how will they impact system performance, visual comfort, and life-cycle cost?
- Have the controls been properly installed and commissioned?

Safety and Security

- Is the building being constructed as designed to improve security?
- Are security technologies being installed as designed?



- Have any material substitutions been proposed that could reduce the durability — and increase the vulnerability — of critical areas in the building such as entrances?
- Have any security technology substitutions been proposed?
- How well will the alternative technologies fit in with and complement the school's design-focused security measures?
- How will the substitute technologies interface with other controls systems in the school (for example, those for the lighting and HVAC systems)?
- If substitutions are accepted, will they be as easy to operate, maintain, and repair as the originally specified products and systems?

Life-Cycle Cost Analysis

- Is the life-cycle cost methodology selected for the project being used to analyze proposed material or product substitutions in terms of their impacts on overall performance and cost effectiveness?

Commissioning

- Has the commissioning plan been implemented?
- Has the functional performance of key systems been tested and verified?
- Are the results documented in a commissioning report?
- Have appropriate school staff been trained concerning proper operation of system equipment and controls?

Energy Analysis Tools

- Is the energy analysis tool(s) selected for the project being used to evaluate the energy consumption consequences of proposed materials, products, or system substitutions?
- Do the substitutions impact the school's ability to meet its energy goal for the facility?

Energy-Efficient Building Shell

- Is the building shell being constructed as designed to achieve a high level of energy efficiency?
- Have any substitutions been proposed, such as alternative glazing materials, different types of insulation, or alternative roofing products, that could impact the intended performance of the building shell?
- If these substitutions are accepted, how will they impact the energy performance of the building and its life-cycle cost?

Environmentally Preferable Materials and Products

- Is the building being constructed using the environmentally preferable products specified?
- Are all proposed substitutions equal to, or better than, the specified products in terms of environmental attributes?
- Are the substitutions also functionally equivalent to the specified products? (In other words, if they are accepted they will not adversely affect the performance of the system or assembly in which they are used.)
- What analyses have been done to ensure substitutions will not degrade environmental quality or system performance?

Waste Reduction

- Is the construction waste management plan being carried out?
- Are efforts being made to minimize construction waste?
- Is some percentage of demolition and/or land-clearing waste being salvaged or recycled?

Environmentally Responsive Site Planning

- Is the site being constructed and landscaped in the environmentally responsive way it was designed?



- Have any substitutions been proposed, such as different plants, alternative materials for parking lots or walkways, or alternative exterior light fixtures, that could reduce the environmental quality of the site plan?
- Will any of these substitutions impact the performance of the building (for example, fewer trees may mean less shade and more heat gain in daylight classrooms)?
- Have these impacts been analyzed? How will they affect the overall life-cycle cost of the facility?

High Performance HVAC

- Is the HVAC system being installed as designed to achieve high performance?
- Have any substitutions been proposed, such as alternative equipment, different types of controls, or alternative delivery hardware (for example, diffusers), that could modify system performance?
- After the substitutions, will the system still be “right sized” to meet the demand (not over or undersized)?
- If these substitutions are accepted, how will they impact the energy performance of the building and its life-cycle cost?

High Performance Electric Lighting

- Is the electric lighting system being installed as designed to achieve high performance?
- Have any substitutions been proposed, such as alternative lamps, ballasts, or controls, that could impact the intended performance of the electric lighting system?
- Will these substitutions provide the same level of visual comfort as the design calls for?
- Will they add any additional waste heat to the space?
- Will they work correctly with the specified control system?
- If these substitutions are accepted, how will they impact visual comfort, energy performance, and life-cycle cost?

Water Efficiency

- Are the building and grounds being constructed as designed to conserve water?
- Have any substitutions been proposed, such as alternative plumbing fixtures, different types of landscape vegetation, or an alternative irrigation system, that could reduce the water efficiency of the school?
- If these substitutions are accepted, how will they impact water use and overall life-cycle costs at the facility?

Renewable Energy

- Are the renewable energy systems being installed as designed to achieve high performance?
- Have any substitutions been proposed — to specific systems or to the materials from which the systems are constructed — that could impact intended performance?



CASE STUDY 1: DAYLIT CLASSROOM

Oakridge High School
Location: El Dorado Hills, CA
Architect: Nacht and Lewis

Design Summary

The architectural program for Oakridge High School called for 40 classrooms and associated learning spaces, serving approximately 2,000 students. The design team had worked together for many years, and was just completing a major daylighting and energy efficiency demonstration project in Sacramento. With this strong working background, the design team convinced the school district to pursue a dynamic daylighting, low-energy design approach.

The innovative school they designed provides an excellent example of balanced, low-glare daylight throughout the day. Their design uses a combination of three different daylighting guidelines to create bright, even illumination across each classroom. The architects combined wall wash toplighting (Guideline DL4) along the interior shared classroom wall with both view windows (Guideline DL1) and high clerestory windows (Guideline DL2) on the exterior wall. A linear surface-mounted fluorescent electric lighting scheme is controlled in response to the daylight.

Daylighting

Classroom wings consist of back-to-back classrooms with window walls facing either north or south, and exterior circulation. A scissor-trussed roof allows the ceiling to slope from a high of about 13 ft at the edge of the skylight well to a low of 10 ft at the exterior

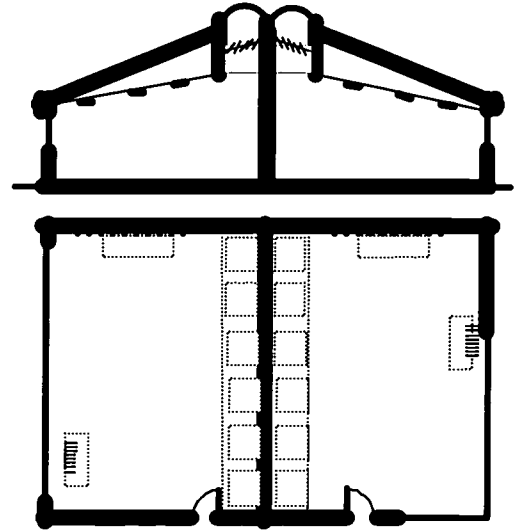

Plan and section of Oakridge High School classrooms.

Graphic courtesy of Kalpana Kuttiah, HMG.

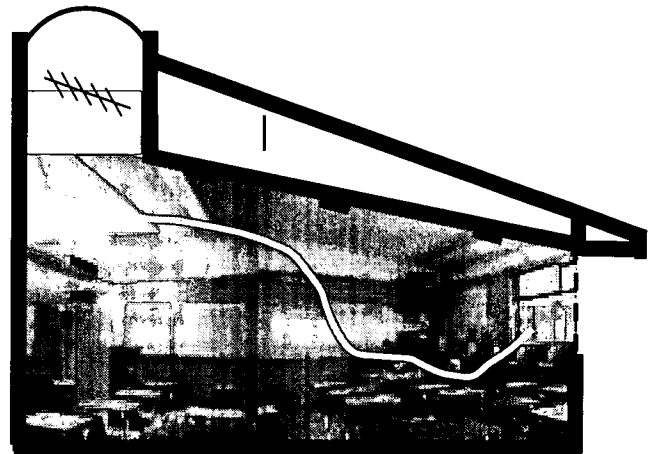

Oakridge High School, daylight illumination levels, north-facing classroom, 11 a.m., clear September day.

Photo courtesy Lisa Heschang.

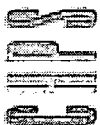

wall. Wall wash toplighting is accomplished by two rows of skylights lining either side of the shared interior wall between classrooms. The key to the design is the diffusing skylights (a linear series of 4 ft x 4 ft, double glazed prismatic domes) that have high visible light transmittance, while scattering all direct sunlight into a gentle, diffuse light.

*"It's possible to run the school even if power goes off. It doesn't happen often, but we recently had one morning without power for two to three hours and didn't need to cancel classes!" —
Oakridge High School Facility Manager*

The skylights sit atop a white rectangular well that is about 4 ft deep. The prismatic lens and adjacent white walls spread diffuse, low glare, ambient daylight across two-thirds of the room. Manually operated louvers in the skylight well provide additional diffusion and allow teachers to modulate daylight levels, darkening the room for AV presentations if desired. A pair of venting skylights in each classroom can also be manually operated to complement the operable windows, allowing through ventilation for the classroom.

Light from the skylights is balanced by clear, double-glazed windows on the exterior wall that extend up to 9 ft — as high as possible in this outer wall. The upper portion provides daylight deeper into the space and the lower portion gives views to the exterior. The upper and lower window sections are separated only by a mullion.

Roofs overhangs and covered walkways shade south windows from direct sun penetration in summer months and reduce brightness of the view on both north and south elevations. Extensive landscaping was designed to further reduce sun penetration and window brightness. But the original trees, unfortunately damaged by vandalism in 1990, no longer shade the south windows. Since the south windows are now exposed to some direct sun in the winter, some south-facing classrooms have been retrofitted with window film to reduce visible transmission to about 20%. This solution to the window brightness problem is less successful than the original landscaping.

The teaching wall is always located on the solid east or west wall so the window and skylight walls flank the main classroom viewing direction. Providing daylighting from both sides results in a comfortable working light for both teachers and students. The daylight apertures are outside the normal viewing angles and eliminate shadows with balanced light from opposite directions.

On a clear fall day, daylight levels on desktops vary from a high of 125 footcandles directly under the skylight to a low of 31 footcandles about 6 ft from the window wall. Vertical illuminance on the walls averages about 40 footcandles, and varies between 60 to 25 footcandles. These values are well within recommended classroom light levels and within a comfortable range of variation. The ceiling and upper portions of the walls are painted white to reflect daylight in the space. In north classrooms, the lower walls are a warm beige or



Overhangs and vegetation were designed to shade windows and prevent reflected glare. Curtains or blinds in windows provide additional control.

Photo courtesy Lisa Hescong.



rose color to balance the cool north daylight; the warmer daylight in south classrooms is balanced with cooler blues and greens.

Electric Lighting

Electric light was originally provided by three rows of pendant-mounted indirect luminaires running parallel to the window wall. In 1995, these fixtures were replaced with three rows of surface-mounted, linear lensed ceiling luminaires as part of an energy efficiency retrofit. The T-8 lamps and electronic ballasts in the new luminaires reduced the lighting power density in the classroom down to 1.4 Watts per square foot, well within energy code standards. Although the new luminaires provide a good, even illumination of 40 to 60 footcandles on every desk, they don't brighten the ceiling as much as the earlier pendants and create more potential for glare in VDT screens as the bright lenses are seen in contrast against the darker ceiling.

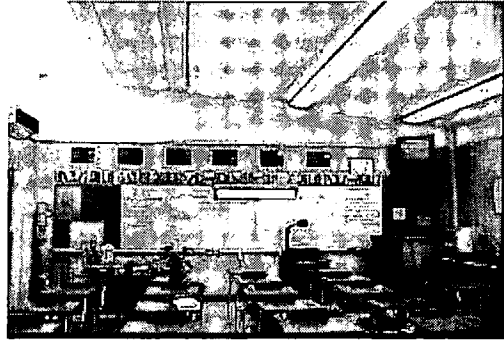

The first row of lights is switched off. The video screen is located in darkest corner of room. Also note the glare on the whiteboard from windows placed in the back wall of a few classrooms.

Photo courtesy Lisa Heschong.

Lighting Controls

Teachers have complete control of daylight levels in the space. A series of manually operated louvers in the skylight well allows teachers to regulate the amount of daylight entering the classroom from the skylights. Blackout drapes can be closed to adjust the daylight from the window wall. The upper and lower glazings do not have separate blinds, so they must be adjusted at the same time.

Since the electric lights run parallel to the window wall and skylight wall slot, they are aligned correctly to be switched in response to changing daylight levels. The first row of light fixtures nearest the skylight is automatically controlled to turn on and off in response to the daylight level. A rough estimate of energy savings from this switching scheme suggests potential energy savings of \$75 to \$150 per classroom per year. The original lighting design called for dimming controls, but currently both lamps in the fixtures are simply turned on or off in response to a signal from the photosensor. Some of the teachers find the switching distracting, and as a result many of the automatic controls have been disabled. Currently these controls are working in only about 20% of the classrooms. Unfortunately, once a control has been disabled, it tends to stay that way, even if a new teacher moves into the room. The teachers also have wall switches to control the lights. (The district has also installed occupancy sensors in some new classrooms that were built without the daylighting features.) Many teachers reportedly feel

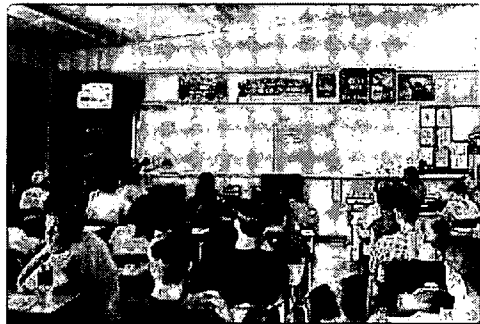

Lights off, but skylight louvers and curtains open, during video lesson.

Photo courtesy Lisa Heschong.



comfortable operating their daylit classrooms without the electric lights on for a good part of the year. The actual energy savings due to local control of the lights has not been monitored for this school.

Other High Performance Features

The school design also included other key features to reduce operating costs. A white-enameled, standing seam metal roof was selected to reject heat build up. Built before the concept "cool roofs" was coined, this roof is a very appropriate choice for the hot Central Valley. Billed as a "lifetime roof," it has had absolutely no maintenance requirements in the 17 years since construction. The sloped, standing seam roof seems to have successfully discouraged students from climbing up on the roof. However, the district does have a few problems to resolve in the near future: some recently retrofitted vents have leaked, and paint on a few metal panels is starting to peel.

The design team also selected a low maintenance, high-thermal mass material for the exterior walls. The split face concrete masonry units (CMU) have held up extremely well. They are uninviting to graffiti, and are easy to sandblast if any occurs. The filled CMU, insulated on the inside, was chosen to provide a thermal lag effect to the area's daily heat swings. Unfortunately, a recently installed, district-wide energy management system has not yet been optimized to account for this particular school's very different thermal load patterns.

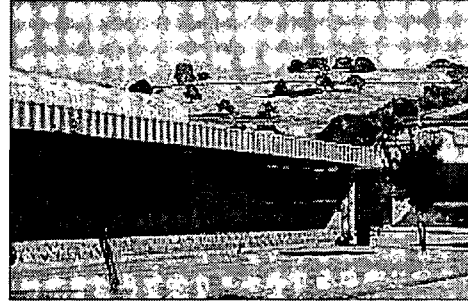

South exterior of Oakridge High School. Overhangs shade the south windows. New trees have been planted to replace vandalized vegetation. White roof and split face CMU walls have held up well.

Photo courtesy Lisa Heschong.

Construction Costs

In spite of the aggressive daylighting design, the school had to meet the state's budget allocation at the time. The design team's objective was to design a school with extremely low operation costs for both energy and maintenance. Even though there was no extra money for the efficiency measures, the project managed to come in more than \$150,000 below budget. The architect's basic strategy was to work with good orientation, a simple plan, and durable, low maintenance materials.

Lessons Learned

- **Teaching Wall:** There is no separate illumination to highlight the teaching wall, so it appears darker than the skylit sidewall. This is not a problem as long as students are facing the teaching wall. Some classrooms have windows along the back wall, in addition to the sidewall. These can cause reflected glare off of the whiteboard, especially when the sun hits the white eaves of the roof.
- **Computer Screens:** In some classrooms, computers are located opposite the teaching wall



Operable louvers are not actively used.
Photo courtesy Lisa Heschong.



and have a view down the length of the classroom. Here, reflections in the monitor screens from windows or the linear, surface-mounted electric lights can make some areas of the screens almost illegible. In other classrooms, computer terminals are located along the window wall facing the windows. The window wall location creates glare by putting the bright window directly within the normal view of the screen. In these classrooms the curtains are usually drawn. This situation could be largely resolved by turning the computer screens 45° away from the window wall.

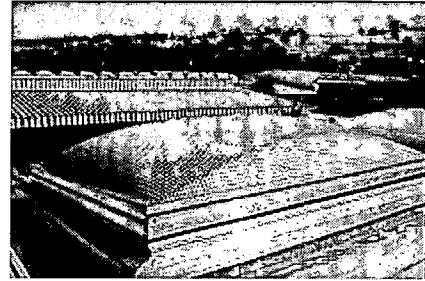

Prismatic skylights diffuse sunlight successfully. Installation has not leaked in 17 years since construction.

Photo courtesy Lisa Heschong.

- **Skylight Maintenance:** There has been no leakage from any of the skylights, except when one of the operable units was left open during a storm. No skylight repairs have been required during their 17 years of operation.
- **Skylight Vandalism:** The skylights have proven to be less of a vandalism problem than the windows. There was no vandalism or skylight breakage for the first 14 years of operation. Then in 1998, a new building was added that allowed easy access to the roof of one classroom wing. Thereafter, someone got up on the roof and intentionally broke two skylights. However, in this same time period, there have been about eight to 10 intentional window breakages per year. Overall, the facility manager does not consider the skylights to be an "attractive nuisance" (in other words, a design feature that some people might find tempting to vandalize).
- **Skylight Louvers:** Teachers do not use the skylight louvers very often to darken the room. This may be because the manual device used to control the louvers is somewhat awkward to operate. It is possible to show a video in the classroom with the louvers open and lights off, so there's no real reason to close the louvers.
- **Operable Vents:** Experience has shown that teachers rarely use the operable venting feature of the skylights. This manual device is also awkward to operate. Teachers may complain about stuffy rooms, but they rarely think to use the natural ventilation option.
- **Reflected Daylight Glare:** The vertical eaves of the white roof are very reflective of low angle sun and cause glare in classrooms opposite them. This could be ameliorated by painting the eaves a darker color. Originally, mature landscaping largely blocked this low angle sun.
- **Electric Lighting Maintenance:** The maintenance supervisor has commented that it was much easier to replace lamps in the previous pendant lights (easily done from a 6-ft ladder). The current surface-mounted fixtures are much more difficult to reach and the lens occasionally slips off its hinges.
- **Switching Controls:** Automatic switching of an entire row of lights has proven distracting. It has been disabled in a majority of the classrooms, which has reduced the energy savings accordingly. Possible solutions would be to use the original dimming scheme, to switch the lights in smaller increments (perhaps only one row of lamps at a time, instead of two), or to only allow switching during passing periods between classes.

What the Staff and Students Say

Acceptance of the integrated daylight and electric lighting scheme in these classrooms is very high. When teachers and administrators in the school were surveyed with the question, "Would you recommend using skylights in another school?", they responded very positively. On a scale of 1 to 7 (where 1 is "definitely not" and 7 is "definitely"), their responses averaged 6.5!



CASE STUDY 2: THE CAPISTRANO UNIFIED SCHOOL DISTRICT

The Capistrano Unified School District is one of the fastest growing districts in Southern California. In the 1970s, the district built some schools whose classrooms had few windows and were lit only with electric lights. The students complained these were “dull” and “claustrophobic.” Based on these complaints, and concerns about energy efficiency and student well-being, the members of the school board became convinced that natural light was essential for a healthy and positive classroom setting. Thus, the board directed all architects hired to design new campuses to maximize natural lighting in the schools, using both skylights and windows. Since this decision in the early 1980s, the district has built nine elementary schools, five middle schools, and two high schools, all of which have skylights in the classrooms. The district is very enthusiastic about its skylights. Paul Haseman, a school board trustee for over 16 years, said:

“While parents tend to complain to the board about everything in a school, I have never heard a single complaint about skylights.”

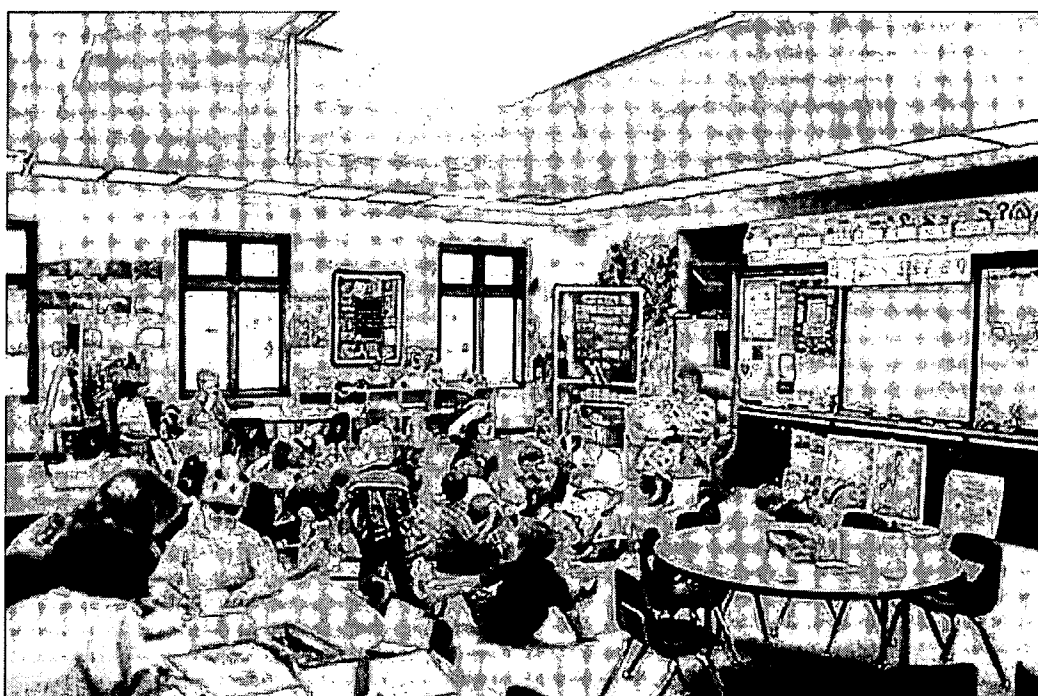

Classroom for lower grades, with skylight at full brightness and electric lights at half power, providing 50 to 150+ footcandles around the room.

Photo courtesy of PJHM Architects. All photographs reprinted with permission from Southern California Edison.



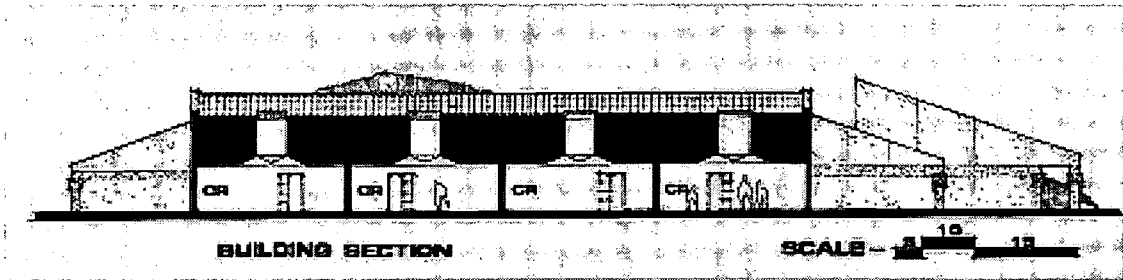

Section through classrooms, showing splayed ceiling and inverted pyramid diffuser.

Graphic courtesy PJHM Architects.

The Skylighting System

The various architectural firms hired by the school district have experimented with a variety of skylighting configurations. Perhaps the most successful is a splayed ceiling design developed by PJHM Architects Southwest (see sidebar). An inverted plastic pyramid diffuser recessed into the splayed ceiling creates an even distribution of light, while minimizing unwanted heat gains and heat losses, and avoiding glare.

Because this diffuser sits above the plane of the ceiling, it is outside of normal vision lines in the classroom and does not create glare. It also adds a third insulating layer to the double glazed skylights, and tends to keep any unwanted heat stratified in the insulated skylight well,

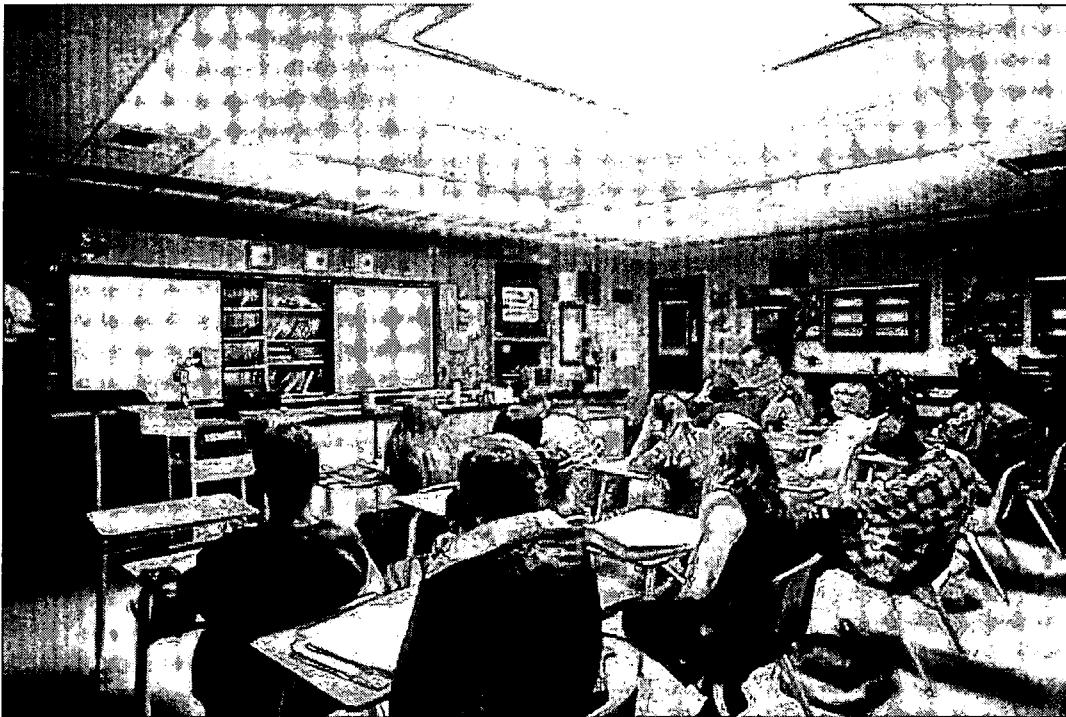

Classroom for upper grades, with lights off and skylight dimmed, viewing video lesson. The dimmed skylight provides 5 to 10 footcandles around the room, excellent conditions for note taking.

Photo courtesy of PJHM Architects.



where it will not add an additional load to the air conditioning system. White gypsum board is used to create a reflective surface in the well to increase the amount of light reflected down into the classroom.



Section through school, showing public areas with skylight highlighting a raised ceiling.

Graphic courtesy PJHM Architects.

An aluminum louver system is mounted under the 6 ft x 6 ft rooftop skylight. The louvers, oriented east-west to control the angle of the sunlight, can be adjusted manually to reduce the amount of daylight entering the room. When the louvers are completely closed, the room still receives a modest amount of daylight, about right for taking notes during a video presentation. Substitutes or new teachers often do not know how to use the louvers, but the children quickly show them.

Public areas in the schools, such as the libraries and multipurpose rooms that have higher ceilings, use a similar skylight design, but without the ceiling diffusers. Here the louvers are controlled with an electric wall switch, similar to a dimming control for lights. Again, when the louvers are completely closed, the rooms are softly lit at about 10 footcandles, sufficiently dim for theatrical or video presentations.

Electric Lighting

Twenty recessed 2 ft x 4 ft fluorescent troffers form a 22 ft square donut of electric lights around the 14 ft x 14 ft skylight well. Prismatic lenses diffuse the light widely, providing even illumination to the classroom's bulletin board walls, which bounce light back into the center of the room. The ring of electric lights provide an additional 25 to 30 footcandles of light on the classroom walls during the day and an average desktop illumination of 50 footcandles at night.

The lighting system, with two T-8 lamps and one electronic ballast per fixture, uses less than 1.4 Watt per square foot at full power. The fixtures are on a bi-level switching system so that half of the lamps can be turned off at any time. Some classrooms also have an additional switch for lights along the front teaching wall so that the teacher's whiteboard can be specifically highlighted.

Research Experience Pays Off

David Hansen, a senior partner at PJHM Architects Southwest, originally got involved in skylighting with a research grant sponsored by the U.S. Department of Energy during his student days at architecture school. He brought knowledge about energy efficiency and natural lighting gained from that experience with him when he joined PJMH.

PJHM has been refining its approach ever since, adding subtle but important details, such as provisions for cleaning the inverted diffusers, or the layout of the HVAC supply and return registers that integrate with the central skylight well. They now use this skylighting design as a standard feature for all their classroom designs, even for other school districts.



CASE STUDY 3: ROSS SCHOOL

Ross Middle School
Location, Ross, CA
Architect: EHDD Architects

Overview

When Ross School leadership decided to update and expand their facilities, they had two primary goals: to design a school that was both healthy for the students and cost effective for the district. Their new high performance facility achieved both.

Ross School is the sole facility in a one-school district serving 500 K-8 students. The original school was built in 1941. In 1947, the first of six additions was completed to expand capacity. Unfortunately, these additions were done haphazardly and did not make the most effective use of the 2.5-acre site. In 1996, meetings were held with school officials, community members, teachers, and parents to gather recommendations for expansion. The planning committee reviewed the input from the various stakeholders, prioritized their space requirements, and engaged the architects to complete a master plan.

Phase I of that plan included the facilities profiled in here. The five existing middle school classrooms were replaced with nine new classrooms on two floors, with learning labs and various support spaces. All classrooms face a large, open hallway with a balcony to the upper classrooms. This space is flooded with daylight, and serves as the primary gathering place for the middle school students.

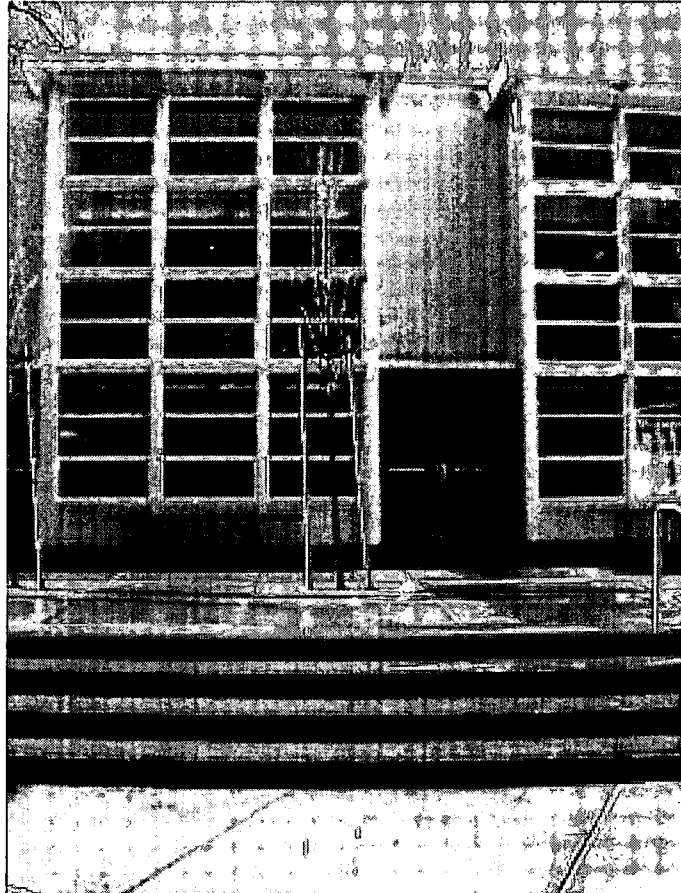

View of the new Middle School from the new courtyard. The windows illuminate the large hallway and gathering space for middle school students.

Photo courtesy Randy Karels.



In its initial design requirements, the design committee did not request all of the high performance features included in the final design. The architects assembled engineering teams with sustainable design experience, and developed their design. They demonstrated how design elements, such as daylighting, low-VOC materials, and natural ventilation, could improve student health and performance while staying in budget. The committee agreed and supported these efforts throughout the rest of the design and construction process.

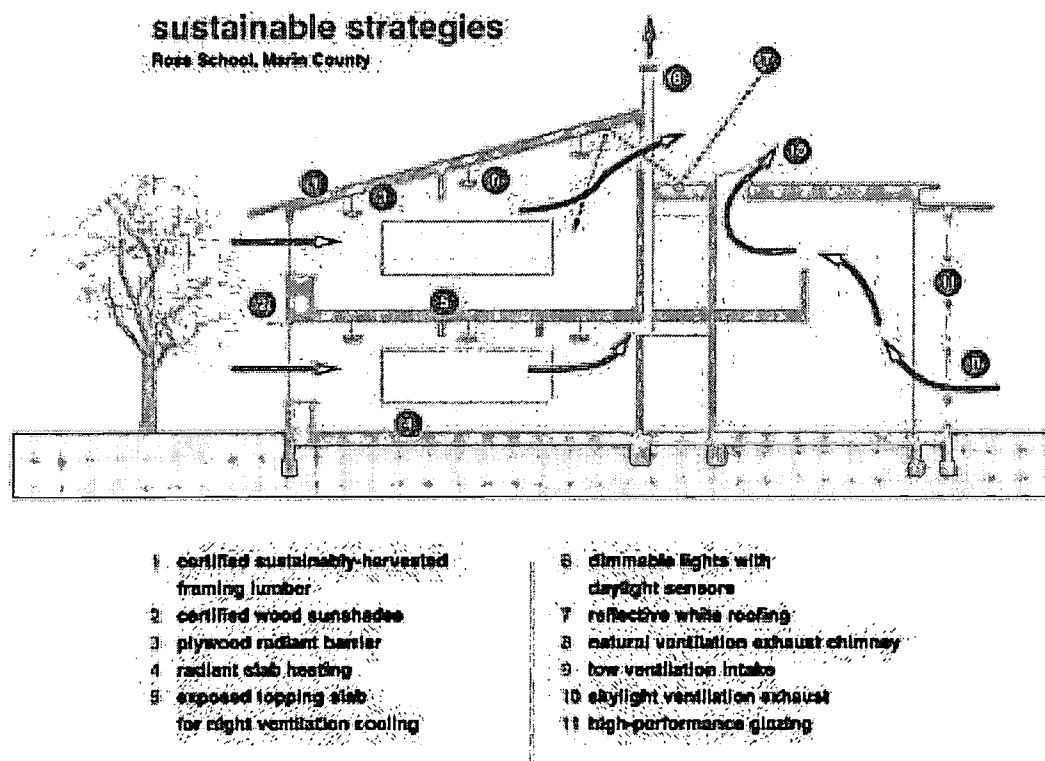

High performance features of Ross School.
Courtesy EHDD Architects.

Thermal Comfort

The most striking feature of the mechanical design is the lack of air conditioning. The design committee had initially requested mechanical cooling, but the designers provided natural ventilation that would cool the building and save over \$200,000 on an air conditioning system. In fact, natural ventilation saved enough money to pay for all of the additional high performance features.

Upper classrooms use cross-ventilation to exhaust warm air out of high clerestory windows. The lower classrooms utilize the "stack effect" to draw cool air from the windows and exhaust it through ventilation chimneys on the roof. The two-story hallway has vented skylights coupled with low intakes to provide air circulation. Stained concrete is the finish floor in all spaces. To



improve comfort during periods of high temperatures, the windows can be kept open at night to cool the mass of the floors. During the day, the pre-cooled floors absorb heat and help keep the classrooms cool. All ventilation windows have limit stops to provide security when night ventilation is used.

Additional measures were taken to reduce heat gain. The sloped roofs have an integral radiant barrier directly applied to the underside of the exterior sheathing. Overhangs, sunshades, or trees shade most windows to reduce direct solar gain. All of the glazing has a visible transmittance of at least 69% and a U-factor of at least 0.3.

An under floor, radiant heating system provides uniform, distributed heat with excellent comfort. The system, by itself efficient, was coupled with a new high efficiency boiler to further reduce energy needs. The system is completely silent, improving the classroom acoustics.

Lighting and Daylighting

To improve the quality of light and reduce energy consumption, daylighting is used extensively throughout the school. Classrooms are designed with balanced daylighting supplied from two or more sides. Clerestories in the upper classrooms provide ample daylight. The white ceiling and roof maximize the available light by reflecting it into and around the classrooms. Bringing daylight into the lower level classrooms was more of a challenge, and the design does not intend to fully illuminate the spaces with daylight. Besides the exterior windows, all lower classrooms have interior windows facing the large two-story hallway. This hallway is lined with 20 ft windows to gather available light and direct as much as possible into the interior spaces.

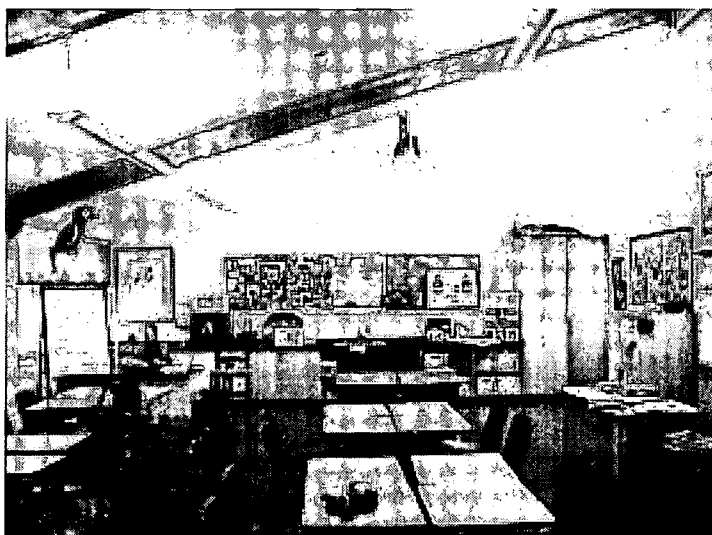

Interior of the upper classrooms. The upper clerestories on the right bring provide daylighting and are opened for natural ventilation.

Photo courtesy Randy Karels.

In the classrooms, direct/indirect pendant light fixtures provide excellent light quality at low footcandle levels. These two-lamp systems use only 1 Watt per square foot of electricity, and can be separately switched to cut the light in half if the teacher desires. All fluorescent lamps have low-mercury and high color rendition. To avoid over lighting the space and wasting energy, lighting systems in the upper classrooms include dimming ballasts and photo controls, which are estimated to save 60% on lighting energy. Some spaces use occupancy sensors to

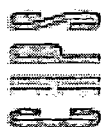

turn off the lighting system when the rooms are unoccupied, and building-wide automatic controls shut off lighting during off hours.

Indoor Air Quality

The health of the students was a primary concern, and steps were taken throughout the design to minimize the sources of indoor pollutants:

- Building has stained concrete floors to eliminate carpet and adhesives.
- Cabinets are made with low-formaldehyde MDF board.
- Adhesives, sealants, and clear sealers are low-VOC products.
- Interior wall and ceiling paint is zero-VOC formulation.
- Contractor must submit Material Safety Data Sheets (MSDS) to verify compliance with VOC specs.
- Custodial room and toilets are directly exhausted to remove indoor pollutants.
- Boiler has electronic ignition and sealed combustion to eliminate combustion by-products indoors.
- Natural ventilation provides ample air changes per hour of 100% outside air.
- Use of porous materials was limited to avoid indoor pollutants from being absorbed and re-released.
- All fiberglass insulation is encapsulated and formaldehyde free.



Students gather between classes. Light enters the large hallway from two sides.

Photo courtesy Randy Karels.

Material Efficiency

Ninety percent of the framing lumber was certified as sustainably harvested material, and glue-lam beams were used instead of large dimension timbers. These measures added less than 0.25% to the project budget, and the quality of the framing lumber was vastly superior. Sunshades and landscape benches are made from certified sustainably harvested Angico or Ipe. All pressure treated wood is ACQ or Borate-treated to eliminate the chromium, copper, and arsenic present with standard CCA treatments.

Materials containing recycled elements were used throughout the building. Flyash replaced 50% of Portland cement, significantly reducing permeability and increasing durability. All acoustic ceiling tile, gypsum board, insulation, and fiberboard were made with recycled content.



The building itself is designed to be recycled. Details for disassembly were added to ease maintenance, modernization, and eventual deconstruction. Roof details were designed for easy roof replacement with removable counter-flashing, and the windows can be replaced without damaging the interior or exterior finishes.

During construction, wood and cardboard recycling were required at the site. Existing two-year-old, 1.6 gallons per minute toilets were salvaged and reinstalled. Some of the existing whiteboards and cabinets were also salvaged.

Site Issues

The building was designed around three large existing oak trees, and extensive measures were taken to protect the trees during construction. The site is designed to minimize surface runoff. Most rain leaders empty directly into landscaped areas, allowing percolation back to water table while filtering out pollutants. Permeable surfaces were used on site wherever possible to reduce peak storm flows and flooding. Finally, a habitat garden in the courtyard includes native plants to minimize water use and educate students about local ecosystems.



Substantial measures were taken to protect these oak trees next to the site. Shade from the trees and the window overhang help reduce solar gain.

Photo courtesy Randy Karels.

Lessons Learned

Both the designers and school officials sited early goal setting to be critical to the success of the new design. Educating the various stakeholders on the benefits of high performance design, and reaching consensus on their financial and environmental goals created a common vision, and provided structure when design decisions and compromises were discussed.

The contractor did not have any prior experience with high performance features, and care was taken to ensure that the building was built as designed. Language was included in the contractor specifications, and explained during walkthroughs, that several high performance materials (such as sustainably harvested wood, zero-VOC paints, and others) were used in the design, and no substitutions would be allowed for these elements.

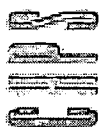

CASE STUDY 4: NEWPORT COAST ELEMENTARY SCHOOL

Newport Coast Elementary School is a recently completed, 25-classroom, K-6 campus in a new residential development in Newport Coast, California. This case study summarizes the daylighting, natural ventilation, and energy efficiency analysis performed as part of the integrated design for the new school.

Perkins and Will led the design team, which included Southern California Edison's Design and Engineering Services (D&ES). D&ES' role in the project was to facilitate an integrated design approach for all building systems to optimize energy usage and to improve the environmental performance of the buildings. The analysis used classrooms as the basic design module of the school. Because of the nature of the equipment and the number of occupants, interior classroom space conditions are interior loaded. Particularly in the sunny, temperate coastal climate of Newport, this meant that the design goals were to reduce the need for electric lighting while minimizing solar heat gain, and to use natural ventilation to achieve thermal comfort when possible. The design team set energy and environmental goals at the beginning of the project, which allowed them to evaluate the energy impacts of building massing, orientation, and siting in early schematic designs.

Perkins and Will established a community design priority that the school has a visible and identifiable physical presence on the main thoroughfare that runs along the west side of the site. The land developer in the area asked that the school have an attractive assemblage of red tiled roofs (since many home sites overlook the school) and that the school buildings have no visible rooftop mechanical equipment.

The school district design committee — which was comprised of teachers, administrators, and parents — wanted a school with flexible learning and teaching environments that would accommodate new computer technology, allow individual control over space conditioning in classrooms, provide good storage, and feature commodious teacher workspaces.

Focus groups consisting of Newport teachers and administrators gauged the interest in the energy and environmental priorities for the new building. In general, participants were very interested in teacher control of classrooms. This included multiple means to control space temperature, outside air, mechanical ventilation, lighting, and daylighting, as well as maintaining flexibility for furniture arrangement and technology.

When queried on their views of energy efficiency, the "...educators were supportive of energy conservation, but did not view it as having an impact on the classroom or life of the school. Teachers said they would rather have energy specialists provide demonstration lessons about renewable energy than have demonstration areas on-site. Teacher and principals viewed the physical plant as affecting student learning only to the extent that the environment could

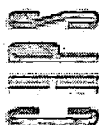

negatively impact student and teacher satisfaction; they did not seem to view the environment as a significant resource that could contribute to student achievement. They emphasized that the important features of a basic learning environment were ventilation, air conditioning (during Santa Ana winds or summer), minimal noise, and sufficient space."¹⁵

Interestingly enough, "principals did not view renewable energy as a cost savings because their schools are not considered cost centers, since utilities are billed to the district office. Principals saw the benefit as one of virtue: modeling conservation for students."¹⁶

In order to compare the rather small sample of opinions from these focus groups, RAND looked at a national telephone survey conducted in 1998 by Heery International with 1,050 respondents. "Many of the opinions expressed in our focus groups were echoed by this national sample of teachers and principals. Both the Heery sample and the Newport focus group participants expressed a desire for individually controlled heat and air conditioning, running water and drinking fountains, accessible phones, decent-sized classrooms, an easily supervisable playground, and natural light. Other parallels between the Newport educators and the national sample included the wish for an additional workroom or conference room for teachers, small rooms to conduct pull-out classes, and the desire for electrical outlets, computers, and computer labs."¹⁷

Like most large, complex architectural projects, the challenge became addressing all of the site opportunities and the design priorities in a synthesized and integrated design.

Site Design

The site provided cooling coastal winds for natural ventilation, in addition to good solar exposure for heating when needed, daylighting, and renewable energy. The site also experienced afternoon, marine-influenced winds (typically reaching up to 15 miles per hour) and a morning marine fog layer.

The climate in Newport Coast is moderate, with a summer daily temperature range of 12°F. The ASHRAE 0.5% summer design conditions for Newport Coast are 80°F dry bulb and 66°F wet bulb,¹⁸ with a corresponding relative humidity of approximately 48%. The winter design condition is 39°F and the winter season averages 1,952 heating degree-days. The mild temperatures and prevailing breezes typical of the Orange County coast suggested natural ventilation as a dominant means of space cooling for the classrooms.

¹⁵ Evaluating the Effects of School Facilities on Educational Outcomes: A Research Proposal for the *School of the Future* Project; pg. 21; Steve Klein, Tammi Chun; Joy Goodwin; and Peter Scott; RAND; November 17, 1998.

¹⁶ Ibid.

¹⁷ Ibid.

¹⁸ American Society of Heating, Refrigerating & Air-Conditioning Engineers, Inc., Southern California and Golden Gate Chapters, *Climatic Data for Region X, Fifth Edition*, ASHRAE, 1982, Alhambra, CA.



The early discussions on site design focused on solar exposure and wind. In terms of solar gain, it was agreed that in the early morning of the winter months, solar gain from eastern sun for morning warm-up would be advantageous. Otherwise, it was more important to limit solar gain for interior comfort, and to achieve daylighting with limited direct beam sunlight. The team also agreed that capturing the cooling winds that come off the ocean from a southwestern direction for natural ventilation in the classrooms would be important, as was shielding the rooms from the stronger, late afternoon marine winds. In addition, the Santa Ana windstorms once or twice a year bring strong, northeastern, hot dry winds.

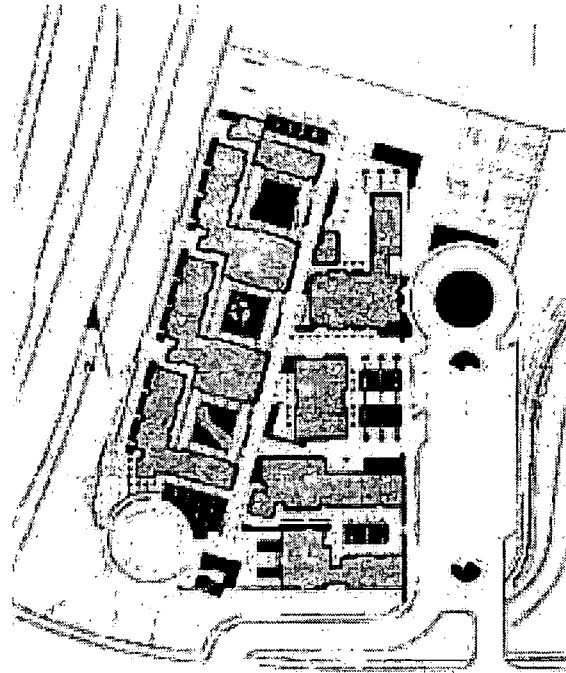

Site plan.

The final site plan shown here took advantage of the ability in Southern California to plan a school with covered exterior circulation, and this design approach to responds to the site's intrinsic environmental opportunities. The site plan did not rigidly interpret the solar and wind analyses, which allowed the architects to meet other important community design objectives.

By breaking the school into classroom courtyards, the design team created an easy connection between interior and protected exterior teaching spaces. For D&ES, the site plan created three types of classroom spaces that were analyzed: Back-to-Back/North and South Exposure Rooms; Single Depth/East and West Exposure Rooms; and Single Depth/North and South Exposure Rooms.

Daylighting

The physical daylight modeling was performed on ½ in. scale models. Light meter devices (Licor Sensors) were placed at regular intervals inside the models, with an additional sensor located above the model in a horizontal position to measure total, unobstructed illuminance. The models were then rotated on a tilt table in direct sunlight to simulate key times throughout the year (the Summer and Winter Solstices, and the Spring/Fall Equinox — the times of the year when the sun angle is highest or lowest above the horizon and at the midway point, respectively).

The model testing addressed two alternatives: the Base Case, or the ceiling plane configuration as designed at that point by the architects, and the Proposed Case. The following sections show the two alternatives.



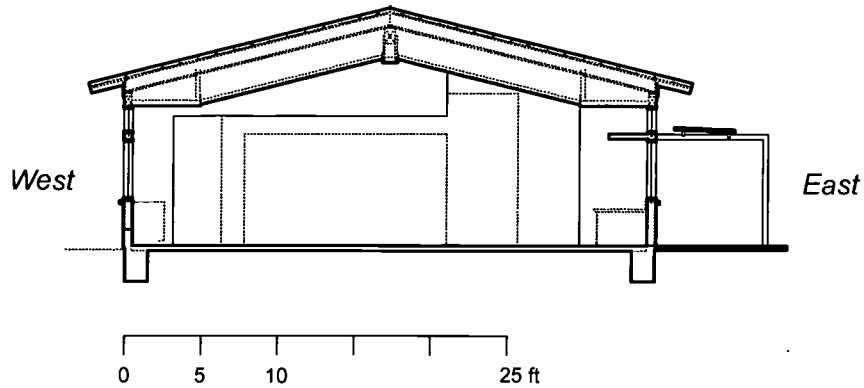

Section of base case single-depth/east and west exposure rooms

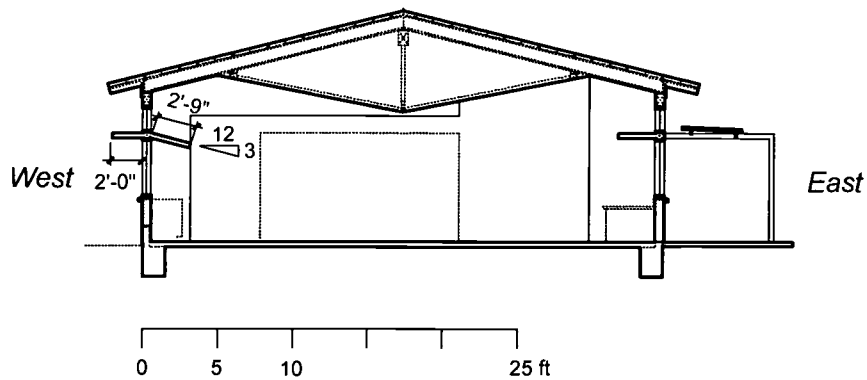

Section of proposed single-depth/east and west exposure rooms

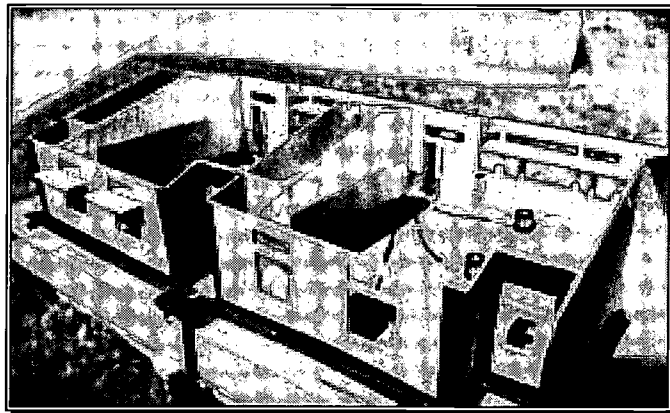

Single-depth model with ceiling removed

The data collected from the Base Case Single-Depth classroom indicated sufficient daylight penetration into the classroom, but in inconsistent amounts through the course of a day. The testing indicated an unacceptable potential for glare, contrast, and direct beam “hotspots” resulting from the morning eastern sun and the afternoon western sun. The Proposed Case

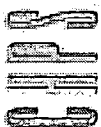

slightly reduced the overall amount of daylight reaching the classroom (as a result of the additional exterior light shelves) but still maintained adequate footcandle levels, providing a more consistent level of daylight across the room.

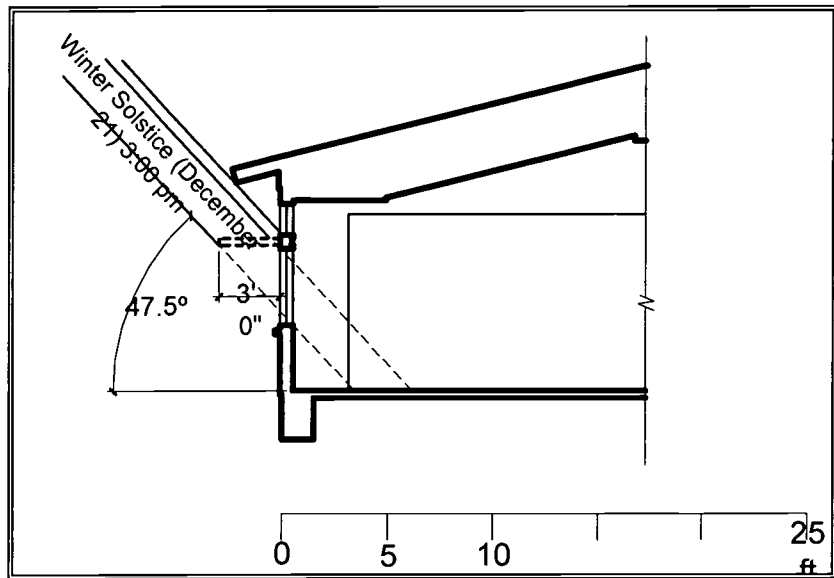

Profile angle analysis of single-depth west wall

The figure above shows an analysis of the sun's profile angles for direct beam penetration in the Single-Depth classrooms at key times. The drawings indicated proposed solutions. The solutions included a 3 ft overhang on the west windows, acknowledging that this would not suffice after 3:00 pm, and the extension of the east roof overhang by 1 ft 3 in. Again, prior to 9:00 am on December 21st, some direct beam would penetrate the east windows in this solution. The architectural solutions were not meant to solve all direct beam problems, but to make window treatments to be largely unnecessary by utilizing daylight the majority of the time.

Ultimately, the architects could not accommodate the 3 ft exterior western overhang, and settled for a 1 ft 6 in.-deep, perforated metal exterior and 1 ft 6 in.-deep fabric interior light shelf combination. This strategy requires the use of blinds on the lower windows in the late afternoon, but still allows bounced daylight through the upper windows off the interior light shelf. The interior light shelves were fabricated with an aluminum frame and a partially translucent, partially reflective, fiberglass solar control fabric. The interior light shelf was intentionally designed using a lightweight material to deter teachers from using the light shelf for storage.

Natural Ventilation and Thermal Comfort Analysis

Conditioning the indoor environment for human thermal comfort is a building science that is often more about statistical probability than applied engineering principles. The individual perceptions of thermal comfort within even small groups of occupants are often widely divergent. The variables affecting human comfort include the individual's metabolic rate and



clothing type; space air temperature and relative humidity; air velocity; surface temperatures of the objects within the space; the direct radiation of sunlight; and the ambient climatic conditions. Many metrics have been studied to evaluate indoor thermal comfort. For the analysis of thermal comfort in the proposed Newport Coast Elementary School classroom, D&ES used the ASHRAE thermal sensation scale. This scale consists of a numerical value that represents a category of thermal sensation, as follows:

ASHRAE Thermal Sensation Scale

Cold	Cool	Slightly cool	Neutral	Slightly warm	Warm	Hot
-3	-2	-1	0	+1	+2	+3

The thermal performance of natural ventilation was examined using computational fluid dynamics (CFD) models. CFD is a method of simultaneously solving the conservation of mass, energy, and momentum equations for discrete volumes that are defined within the modeled space. The simultaneous solution of these equations described the various physical properties within the space. These solutions were then used to plot distributions of space air temperature, relative humidity, or air velocity across the modeled area. Thermal sensation derived from these physical properties was also plotted.

The analysis used a two-dimensional classroom model, with the summer design ambient air temperature, i.e., the dry bulb temperature, (80°F) and air movement of 20 air changes per hour. Fixed louvers below the vision glass were modeled for the ventilation air inlet, and operable monitor windows for the air outlet. The thermal sensation distribution resulting from this simulation is shown here. Note that the area surrounding the children's desks was within +/- 0.5 on the thermal sensation scale. Other analysis showed that although the dry bulb temperatures near the students was nearly 81°F, the thermal sensation category was favorable due to the air velocity in the classroom. These results predicted general satisfaction within the indoor environment using natural or mechanical ventilation for in the middle of the summer, even though the district does not currently anticipate using the school during this time.

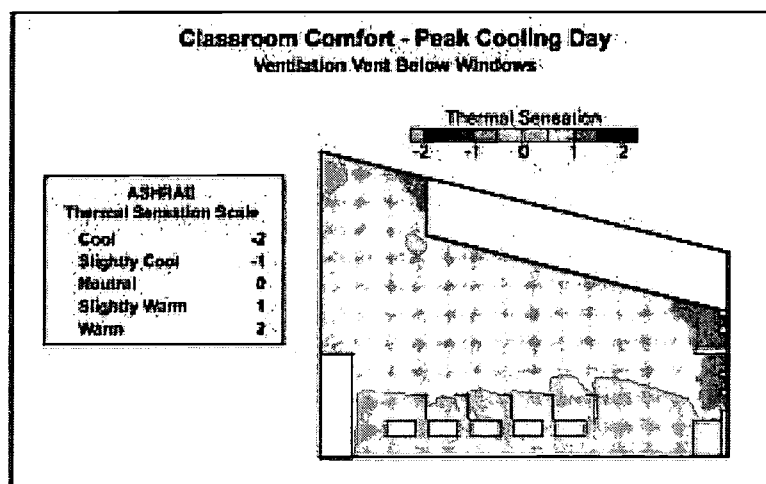

Thermal sensation distribution results

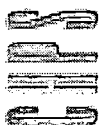

It should be noted that in the final design, ventilation was introduced into the Back-to-Back Rooms through operable vision windows with fan-assisted, hot air removal plenums at the top of the monitor window area. This modification resulted from the security concerns of the district with having operable monitor windows.

As noted earlier, the district was not ready to eliminate the air conditioning all together. They acknowledged that, with the predictions from this natural ventilation analysis, the teachers would be taught to operate their classroom as much as possible with natural and mechanically-assisted ventilation, resorting to air conditioning only as a final comfort tool. In the final design, each classroom was outfitted with a heat pump for mechanical air conditioning. Teacher and staff orientation to the functioning of the classrooms fell to the commissioning and the design teams to carry out.

DOE-2 Energy Modeling

The DOE-2 energy model was performed in the design development stage of the project, and modeled design alternatives that had been discussed at length with the design team to develop consensus. The DOE-2 input consisted of a detailed description of the building, including all building features such as shading, fenestration, interior building mass, envelope building mass, and the dynamic characteristics of the heating and air conditioning system and controls. It also included all hourly schedules for occupants, lighting, equipment, and thermostat settings. This simulation used PowerDOE, an advanced version of DOE-2.1E, which calculates hour-by-hour building energy consumption for an entire year (8,760 hours) using local weather data (in this case, California Thermal Zone CTZ6, Long Beach).

It was assumed that the lighting, HVAC, and kitchen energy loads represented the majority of the operating costs, and the PowerDOE analysis focused on reducing electric lighting and HVAC operating costs. The iterations in the analysis were for envelope measures, fenestration measures, natural ventilation measures, and HVAC equipment measures. Except where noted in the figures below, each energy efficiency measure was evaluated "on top of" the previous measure, in order to model interactive benefits of the final package of measures. Also, the results of the physical daylight modeling were used to calibrate the PowerDOE model.

The table below summarizes the features of the Base Case building and the Proposed building. Close examination of the results revealed that the single largest savings occurred when a dimming system was used for the classroom lighting. At this point, a total 41% savings in energy and a 39% savings in cost over the base case Title 24 minimum resulted. The dimming represents an additional 37% cost savings over all previous energy efficiency measures. Also, of particular interest, note that the PowerDOE simulation showed little return for high efficiency glazing in this climate, and given the cost of these glazing alternatives, they were eliminated. The architects kept double glazing for its sound insulating characteristics on the west wall of the campus that faced a busy street. Single, clear glazing was used for the rest of the campus.

The final conclusions of the PowerDOE simulation were to:



- Increase the wall and roof insulation levels.
- Install operable windows for maximum natural ventilation potential.
- Install single-pane, clear glazings with exterior overhangs.
- Install automatic and manual daylighting/lighting dimming controls.
- Install clerestory windows to improve interior daylighting quality.
- Install high efficiency, air source heat pumps.

These measures were predicted to result in a 43% annual utility savings (\$15,300) over a minimum Title 24 building.

Building Characteristics for Base Case and Proposed Design

	TITLE 24 Base Case	As Designed*	
ARCHITECTURAL FEATURES	Gross Modeled Area	47,000 square feet	**
	Orientation	Site main axis = 20° east of north	**
	Campus arrangement	Eight separate buildings	**
	Exterior Wall Type	2x4 wood frame with R11 batt	2x6 wd frame, R19 batt + ext bd
	Opaque Wall U-value (R-value)	U=0.092 (R11)	U=0.037 (R27)
	Roof U-value (R-value)	U=0.092 (R11)	U=0.024 (R42)
	Exterior Roof Color	0.7 (medium dark)	**
HVAC SYSTEM	Window Type	Sgl-glazed clear (N), gray (non-N)	DbI clear @ west, else sgl clear
	Assumed frame type	Aluminum	Architectural steel
	U-Value (incl. frame effects)	1.23	1.23 (non-west), 0.64 (west)
	Shading Coefficient	0.94 (north), 0.71 (non-north)	0.94 (non-west), 0.81 (west)
	Exterior Overhangs	None	2 to 4 ft deep at most windows
	HVAC System Type	Air-cooled split DX/Furnace	High efficiency air cooled heat pump
	Cooling / Heating Setpoint	75°F / 72°F	**
	Cooling Design Temps. (In/Out)	75DB / 82DB / 70WB	**
	Heating Design Temps. (In/Out)	72DB / 40DB	**
	Outside Air Supply	15 cfm/person	**
Coil Leaving Temperature	55°F	**	
Fan Static (supply only)	0.75 in	**	
Economizer	None	Dry-bulb	
Cooling Equip Efficiency	10 SEER	12 SEER	
Heating Equip Efficiency	78% AFUE	2.6 COP @ 47°F	
BUILDING OPERATION AND INTERNAL LOADING	Classroom Occupancy Schedule	8 a.m.-4 p.m., Mon-Fri, Sep 15-Jun15	
	Office Occupancy Schedule	7 a.m.-5 p.m., Mon-Fri, Sep 15-Jun15	
	Lighting & Equipment Schedule	Follows occupancy in classrooms and offices	
	Fan Schedule	Follows occupancy in classrooms and offices	
	Internal Loads		
	Lighting System Type	T-8 lamps, electric ballasts, touffers	T-8 lamps, electric ballasts, direct/indirect
Lighting Power Density (W/sf)	2.0 classrooms, 1.6 offices	2.2 classrooms, 1.9 offices	
Receptacle Load (diversified)	1.0 classrooms, 1.0 offices	**	
Occupancy Density (sqft/occ)	30 (classrooms), 150 (offices)	**	
Occupant Sens/Lat (Btu/per)	200/130 (class) 250/200 (offices)	**	
* Design was not final.			
**Items unchanged from the TITLE 24 base case are marked with double asterisks.			

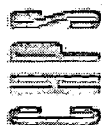

In preparing the PowerDOE results for the district and their design team, D&ES visited a number of other schools in the district, and with accumulated electric energy bills, compared the electric energy unit cost for the Base Case Newport Coast School, the Proposed Newport Coast School, and four other elementary schools in the district. The graph below shows the results of the comparison.

The unexpectedly low electric energy unit cost for Paularino School was noted, and could have a number of explanations. This school is a 1950s-60s design with large, glazed movable panels for one wall of the classrooms, with operable clerestory windows. When visiting the school, it was noted that the teachers are effectively operating these design elements, so perhaps the school was historical proof of many of the design measures investigated for the Newport Coast Elementary School. On the other hand, it was also possible the electric data was missing another meter that records electric energy use at the school. Other than this anomaly, this school energy cost comparison marked clear the improvement in operating energy expenses the Newport Coast Elementary School represents for the district.

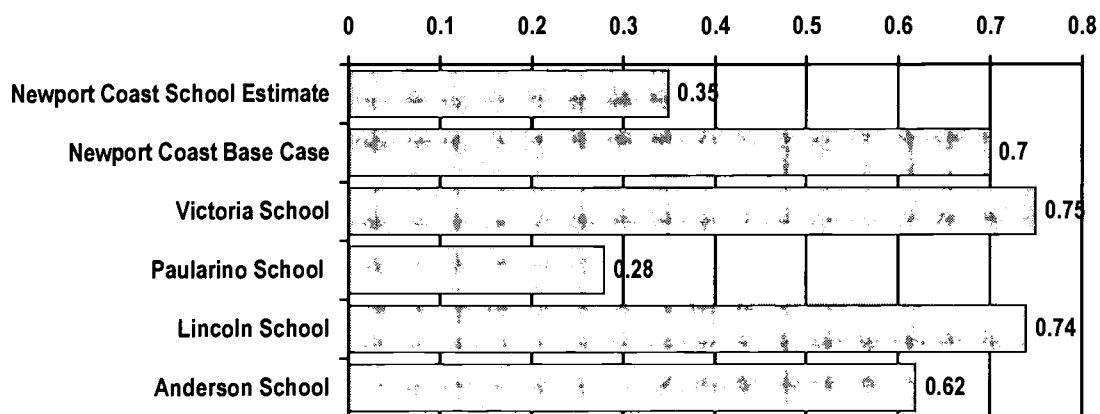

*Comparison of electric energy unit cost for various schools
(\$/ft²/9-month school year)*

Conclusion

The issues of energy use and the environment are primary issues for school design, and the Newport Coast Elementary School represents a test case of the benefits from integrating current energy modeling and analysis techniques into the school design process.

Often a design project seems in retrospect to only vaguely have approximated all of the lofty intentions of the participants in the process, that include everyone from the architects and consultants, to the district officials, to the students and the teachers. It is always a challenge to maintain higher goals through what is often a bruising process. Incorporating the additional daylighting, natural ventilation, and energy performance analysis required the design team to integrate an entirely new set of intentions into a complex process. Even with these challenges,

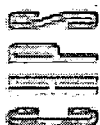

the project has met with success from teachers, many of whom were initially uncertain of the benefits of using the energy-efficient building as a teaching tool.

“I think our school right now is building a better sense of environmental awareness and how to treat the environment, how to take care of the environment,” Newport Coast Elementary School Teacher/Technology Mentor Michael Brewer said. “The kids are really taking that to heart, and we’re living up to the responsibility of really protecting the environment.”

Ultimately, it is clear that without a client’s early dedication to energy efficiency and environmental issues, little value can be derived from the sophisticated analysis tools used in this project. Setting a clear and widely supported sustainability agenda early in the process will go further to meeting the goal of reducing a building’s impact on the environment than all of the sophisticated engineering tools used here.



the



collaborative



for high



performance



schools

Best Practices Manual

VOLUME II

DESIGN

2012 EDITION

BEST COPY AVAILABLE

Best Practices Manual

Volume II



High Performance Schools
Best Practices Manual
2002 Edition

BEST COPY AVAILABLE

DISCLAIMER

IMPORTANT NOTICE TO THE READER: This publication is designed to provide accurate and authoritative information with regard to the subject matter covered. It is distributed with the understanding that local, state and federal laws, regulations and requirements will vary based on the particular circumstances such as building characteristics, geographic region and similar factors. It is also distributed with the understanding the publisher is not engaged in rendering engineering, architectural, legal, or other professional advice or service. The publisher and its participants, officers, directors, employees, contractors and affiliates cannot be responsible for errors or omissions, or any material set forth or referenced in this publication. If professional advice or other expert assistance is required, the services of a competent advisor familiar with the law, regulation, practices and circumstances of the project should be sought.



The Collaborative for High Performance Schools

(877) 642-CHPS

www.chps.net

Copyright 2002 CHPS Inc.



Preface

Background

This is a unique period in California history. The state, already educating one out of every eight students in the U.S., has seen historical enrollment rates four times higher than national averages. Hundreds of schools a year are being built to house the 100,000 new students per year moving into the system and to accommodate state-mandated class-size reductions. The current infrastructure is aging and over 30% of existing facilities are in need of major renovation. At the same time, California schools are spending nearly \$450 million per year on energy¹ in a time of rising concern over energy supplies and tight school budgets. These figures illustrate an enormous opportunity for our state's school districts to build the next generation of school facilities that improve the learning environment while saving energy, resources, and money.

The goal of this Best Practices Manual is to create a new generation of high performance school facilities in California. The focus is on public schools and levels K-12, although many of the design principals apply to private schools and higher education facilities as well. High performance schools are healthy, comfortable, energy efficient, resource efficient, water efficient, safe, secure, adaptable, and easy to operate and maintain. They help school districts achieve higher test scores, retain quality teachers and staff, reduce operating cost, increase average daily attendance (ADA), reduce liability, while at the same time being friendly to the environment.

¹ These costs are based on data prior to the California energy crisis, which begin during the winter of 2000-2001. During this period, wholesale energy costs rose by a factor of eight. Eventually, some or all of these costs will be passed on to schools and other utility customers.



Best Practices Manual Organization

This Best Practices Manual is split into three volumes:

- Volume I addresses the needs of school districts, including superintendents, parents, teachers, school board members, administrators, and those persons in the school district that are responsible for facilities. These may include the assistant superintendent for facilities (in large districts), buildings and grounds committees, energy managers, and new construction project managers. Volume I describes why high performance schools are important, what components are involved in their design, and how to navigate the design and construction process to ensure that they are built.
- Volume II contains design guidelines for high performance schools. These are tailored for California climates and are written for the architects and engineers who are responsible for designing schools as well as the project managers who work with the design teams. Volume II is organized by design disciplines and addresses specific design strategies for high performance schools.
- Volume III is the CHPS Criteria. These criteria are a flexible yardstick that precisely defines a high performance school so that it may qualify for supplemental funding, priority processing, and perhaps bonus points in the state funding procedure. School districts can also include the criteria in their educational specifications to assure that new facilities qualify as high performance.

The Best Practices Manual is supported by the Collaborative for High Performance Schools' website (<http://www.chps.net/>) which contains research papers, support documents, databases and other information that support the manual.

Who is CHPS

CHPS began in November 1999, when the California Energy Commission called together Pacific Gas and Electric Company, San Diego Gas and Electric, and Southern California Edison to discuss the best way to improve the performance of California's schools. Out of this partnership, CHPS grew to include a diverse range of government, utility, and non-profit organizations with a unifying goal to improve the quality of education for California's children. With the successful launch of the Best Practices Manual in 2001, interest in high performance design grew, and CHPS expanded its focus beyond California, developing a national version of the manuals as well as other state-specific versions. In early 2002, CHPS incorporated as a non-profit organization, further solidifying its commitment to environmentally-sound design that enhances the educational environment for all schoolchildren.

Acknowledgements

A great number of people have contributed to the development of the Best Practices Manual and this 2002 update. Charles Eley is the executive director of CHPS, Inc. and served as the technical editor.

For Volume I: Deane Evans (Sustainable Buildings Industries Council) and Randy Karels (Eley Associates). Donald Simon (Wendel, Rosen, Black & Dean) wrote the section on construction contracts. The Newport Coast Elementary case study was adapted from the paper *Mainstreaming the Sustainably Designed School* by Deborah Weintraub and Tony Pierce of Southern California Edison.

For Volume II: Jim Benya (Benya Lighting Design); Anthony Bernheim (SMWM), Barbara Erwine (Cascadia Conservation); Lisa Heschong (Heschong Mahone Group); Erik Kolderup, Joe Kastner, and



Anamika (Eley Associates); Hal Levin (Building Ecology Research Group); Kathleen O'Brien (O'Brien and Company); Kerry Parker (TMAD Engineers); Jane Simmons (O'Brien and Company); Kerry Parker (TMAD Engineers); and Adam Wheeler (Control Group).

The commissioning section of this manual is a modified version of the *Building Commissioning Guidelines* prepared for Pacific Gas & Electric Company by Portland Energy Conservation, Inc. (PECI) for the Energy Design Resources program. Certain sections of this document were excerpted and modified from *Commissioning for Better Buildings in Oregon*, written by PEGI for the Oregon Office of Energy, and *Building Commissioning: The Key to Quality Assurance*, written by PEGI for the U.S. Department of Energy's Rebuild America program.

From Eley Associates, Kimberly Got edited and coordinated production on Volumes I and II. Debra Janis developed additional graphics and provided layout assistance. Randy Karels and Arman Shehabi provided assistance with coordination and technical content review. Patricia Adams worked to secure graphic permissions.

The CHPS Best Practices Manual 2002 Update Task Force contributed countless hours reviewing the document and providing valuable direction and input. Special thanks to Panama Bartholomy (Division of the State Architect), Gary Flamm (California Energy Commission), Bill Orr and Dana Papke (California Integrated Waste Management Board), Tom Phillips (California Air Resources Board), and Jed Waldman (Department of Health Services).

Beginning with the first edition, many people contributed to the development of the manual through their technical content review: Tor Allen (Rahus Institute); Dennis Dunston (HMC Architects), Wael El-Sharif (Geothermal Heat Pump Consortium), Andrew Gorton and Dennis Paoletti (Shen Milsom & Wilke / Paoletti), John Guill (Quattrocchi / Kwok Architects), Gary Mason (Wolfe Mason Associates), Lynn N. Simon (Simon & Associates), and George Wiens (WLC Architects).

The following individuals contributed significantly to this project, particularly in the early development of the manuals: Manuel Alvarez, Jan Johnson and Lisa Stoddard (Southern California Edison), Richard Conrad and Chip Smith (Division of the State Architect), Don Cunningham (Los Angeles Department of Water and Power), Julia Curtis, Ray Darby, Grant Duhon (Pacific Gas & Electric), Lisa Fabula and Chip Fox (San Diego Gas & Electric), Kathy Frevert (California Integrated Waste Management Board), Greg Golick (Coalition for Adequate School Housing), Tony Hesch (California Department of Education), Bill Jones, Kathleen McElroy (Xenergy), Daryl Mills and Mike Sloss (California Energy Commission), Jim Parks (Sacramento Municipal Utility District), and Richard Sheffield (Office for Public School Construction).

Finally, the CHPS Board of Directors deserves special acknowledgement for their continued guidance and funding support. Robert Pernell (California Energy Commission), Gregg Ander (Southern California Edison), Stephan Castellanos (Division of the State Architect), Randall Higa (Southern California Gas), Chuck Angyl (San Diego Gas & Electric), Jim Barnett (Sacramento Municipal Utility District), Duwayne Brooks (California Department of Education), Oliver Kesting (Pacific Gas & Electric), and Bill Orr (California Integrated Waste Management Board).



Table of Contents

Disclaimer	ii
Preface	iii
Background.....	iii
Best Practices Manual Organization	iv
Who is CHPS	iv
Acknowledgements.....	iv
Table of Contents.....	vi
Volume II – Design	1
Guidelines for High Performance Schools.....	1
Introduction to the Guidelines	2
The Design Process	2
Integrated Design.....	3
Goals and Cross-Cutting Issues.....	5
Commissioning, Operation, and Maintenance.....	19
CHPS Criteria	20
Material Selection and Research.....	21
General Purpose Design and Evaluation Tools	24
Anatomy of a Guideline	25
Climates	28
General Conditions	29
Overview	29
Guideline GC1: Sustainable Job-Site Operations Plan	31
Guideline GC2: Construction and Demolition (C&D) Waste Management	33
Guideline GC3: Indoor Air Quality During Construction	37
Guideline GC4: Site Protection During Construction.....	40
Guideline GC5: Contractor’s Commissioning Responsibilities.....	42
Site Planning.....	45
Overview	45
Guideline SP1: Optimum Building Orientation.....	52
Guideline SP2: Landscaping to Provide Shade to HVAC Equipment, Buildings, and Paved Areas ..	55
Guideline SP3: Safe and Energy-Efficient Transportation	57
Guideline SP4: Landscape Design and Management.....	59
Guideline SP5: Impervious Surfaces.....	64
Guideline SP6: Native and Drought-Tolerant Plants	70
Guideline SP7: Landscaping Soil, Amendments, and Mulch	73
Guideline SP8: Water-Efficient Irrigation Systems	76
Guideline SP9: Stormwater Management, Groundwater Management, and Drainage Materials	79
Guideline SP10: Rainwater Collection Systems.....	84
Guideline SP11: Gray Water Systems	89
Guideline SP12: Integrated Weed, Disease, and Pest Management	93
Interior Surfaces and Furnishings.....	97
Overview	97
Guideline IS1: Carpeting.....	115
Guideline IS2: Resilient Flooring	120
Guideline IS3: Ceramic Tile / Terrazzo.....	123
Guideline IS4: Concrete Flooring.....	126
Guideline IS5: Wood Flooring.....	128



Guideline IS6: Bamboo Flooring.....	131
Guideline IS7: Gypsum Board	133
Guideline IS8: Acoustical Wall Panels and Ceilings.....	136
Guideline IS9: Paints and Coatings	139
Guideline IS10: Casework and Trim	142
Guideline IS11: Interior Doors	146
Guideline IS12: Toilet Partitions	148
Electric Lighting and Controls.....	151
Overview	151
Guideline EL1: Pendant-Mounted Lighting.....	171
Guideline EL2: Troffer Lighting	174
Guideline EL3: Industrial-Style Classrooms	177
Guideline EL4: Lighting Controls for Classrooms.....	180
Guideline EL5: Gym Lighting	184
Guideline EL6: Corridor Lighting.....	188
Guideline EL7: Lighting for a Multi-purpose Room.....	191
Guideline EL8: Lighting for a Library or Media Center	195
Guideline EL9: Lighting for Offices and Teacher Support Rooms	199
Guideline EL10: Lighting for Locker and Toilet Rooms	201
Guideline EL11: Outdoor Lighting.....	204
Daylighting and Fenestration Design	209
Overview.....	210
Guideline DL1: View Windows.....	227
Guideline DL2: High Sidelighting—Clerestory.....	231
Guideline DL3: High Sidelighting—Clerestory with Light Shelf or Louvers	235
Guideline DL4: Classroom Daylighting—Wall Wash Toplighting	240
Guideline DL5: Central Toplighting.....	243
Guideline DL6: Patterned Toplighting.....	247
Guideline DL7: Linear Toplighting	250
Guideline DL8: Tubular Skylights	253
Building Enclosure and Insulation.....	257
Overview	257
Guideline IN1: Wall Insulation.....	268
Guideline IN2: Roof Insulation	271
Guideline IN3: Cool Roofs	273
Guideline IN4: Radiant Barriers	277
Guideline IN5: Reduce Infiltration	279
Guideline IN6: Concrete Masonry	282
HVAC	285
Overview	285
Guideline TC1: Cross Ventilation.....	301
Guideline TC2: Stack Ventilation	307
Guideline TC3: Ceiling Fans.....	310
Guideline TC4: Gas/Electric Split System	314
Guideline TC5: Packaged Rooftop System	318
Guideline TC6: Displacement Ventilation System	322
Guideline TC7: Hydronic Ceiling Panel System	325
Guideline TC8: Unit Ventilator System	329
Guideline TC9: Ductless Split System	333
Guideline TC10: Evaporative Cooling System	336
Guideline TC11: VAV Reheat System	339
Guideline TC12: Radiant Slab System	343



Guideline TC13: Baseboard Heating System.....	347
Guideline TC14: Gas-Fired Radiant Heating System.....	350
Guideline TC15: Ground Source Heat Pump (GSHP) System	352
Guideline TC16: Evaporatively Precooled Condenser	356
Guideline TC17: Dedicated Outside Air Systems.....	358
Guideline TC18: Economizers	360
Guideline TC19: Air Distribution Design Guidelines	363
Guideline TC20: Duct Sealing and Insulation.....	369
Guideline TC21: Hydronic Distribution	371
Guideline TC22: Chilled Water Plants	375
Guideline TC23: Hot Water Supply	381
Guideline TC24: Adjustable Thermostats.....	387
Guideline TC25: EMS/DDC	389
Guideline TC26: Demand Controlled Ventilation.....	392
Guideline TC27: CO Sensors for Garage Exhaust Fans.....	394
Other Equipment and Systems.....	395
Overview	395
Guideline OS1: Photovoltaics	397
Guideline OS2: Solar Pool Heating	402
Guideline OS3: Timers for Recirculating Hot Water Systems.....	407
Guideline OS4: Efficient Terminal Devices.....	410
Guideline OS5: Waterless Urinals	412
Guideline OS6: Relocatable Classrooms	415
Commissioning and Maintenance.....	419
Introduction	419
What Exactly Is Building Commissioning?	419
Commissioning Approaches.....	420
Benefits of Commissioning	421
Costs of Building Commissioning	423
Savings from Building Commissioning	424
Selecting a Commissioning Provider.....	425
The Commissioning Team.....	428
Commissioning Phases	430
Operation and Maintenance for Persistence	435
List of Commissioning References and Resources.....	442



(This page intentionally left blank.)



Volume II – Design

Guidelines for High Performance Schools

Volume II of the Best Practices Manual for High Performance Schools is written for architects and engineers who are responsible for designing schools, and for the project managers who work with the design teams.

The design strategies presented in Volume II are organized according to eight design disciplines: general conditions; site planning; interior surfaces and furnishings; electric lighting and controls; daylighting and fenestration; building enclosure and insulation; HVAC; and other equipment and systems. An additional chapter addresses commissioning and maintenance practices. Applying these guidelines will result in schools that are healthy, comfortable, energy efficient, resource efficient, water efficient, safe, secure, adaptable, and easy to operate and maintain.

Overall, the Best Practices Manual is organized in three volumes, each with a specific purpose and directed toward the needs of a specific audience. Volume I addresses the needs of school districts, and is written in particular for those persons in the school district who are responsible for facilities. Volume III contains criteria for high performance schools.



INTRODUCTION TO THE GUIDELINES

The Design Process

The characteristics of a high performance school are outlined in Volume I, and reflect a mix of environmental, economic, and social objectives. The design process used to achieve high performance schools is fundamentally different from conventional practice. To be most effective, this process requires a significant commitment on the part of design professionals to:

- Meet energy and environmental performance criteria.
- Maintain a view of the building and site as a seamless whole within the context of its community.
- Work with the understanding that the building exists within the context of a natural ecosystem even when the setting is urban.
- Incorporate interdisciplinary collaboration throughout the design and construction process.
- Maximize student performance by keeping standards high for air quality and increasing the use of daylighting.
- Integrate all significant building design decisions and strategies — beginning no later than the programming phase.
- Optimize design choices through simulations, models, or other design tools.
- Employ life-cycle cost analysis in all decision making.
- Design all systems to be easy to maintain and operate.
- Commission all building equipment and systems to assure continued optimum performance.
- Document high performance materials and techniques in the building so that maintenance and repairs can be made in accordance with the original design intent.
- Encourage sustainable construction operations and building maintenance.
- Provide clear guidance, documentation, and training for operation and maintenance staff.

The typical design process for schools begins with programming and selection of the architectural-engineering team. It then proceeds through schematic design, design development, contract documents, construction, commissioning, and occupancy. The sooner high performance goals are considered in the design process, the easier and less costly they are to incorporate. Many of the guidelines presented in this document must be considered early in the design process in order for them to be successful. Figure 1 below shows a timeline through the design process and indicates the types of measures and design strategies that can be considered along the way.



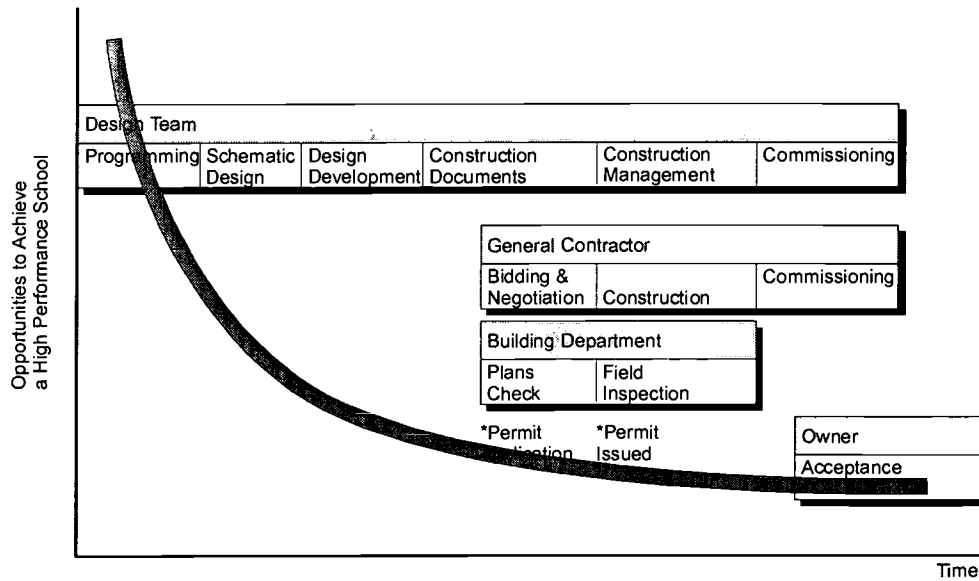

Figure 1 – Opportunities in the Design Process

Volume I outlines the characteristics of a high performance school. In Volume II, these characteristics are described in more detail in the discussion of Goals and Cross-cutting Issues. For best results, these high performance goals should be reflected in all aspects of project documentation. High performance goals established during programming should be clearly stated in the educational specifications, in the request for proposals (RFP) to select the design team, in the instruction to bidders, and as part of the project summary. These goals are best expressed in terms of performance. The CHPS Criteria in Volume III have these goals clearly formulated so that they can be appropriately referenced.

Integrated Design

Integrated design is the consideration and design of all building systems and components together. It brings together the various disciplines involved in designing a building and reviews their recommendations as a whole. It recognizes that each discipline's recommendations have an impact on other aspects of the building project. This approach allows for optimization of both building performance and cost. Too often, HVAC systems are designed independently of lighting systems, for example, and lighting systems are designed without consideration of daylighting opportunities. The architect, mechanical engineer, electrical engineer, contractors, and other team members each have their scope of work and often pursue it without adequate communication and interaction with other team members. This can result in oversized systems or systems that are optimized for non-typical conditions.

Even a small degree of integration provides some benefits. It allows professionals working in various disciplines to take advantage of efficiencies that are not apparent when they are working in isolation. It can also point out areas where trade-offs can be implemented to enhance resource efficiency. Design



integration is the best way to avoid redundancy or conflicts with aspects of the building project planned by others.

The earlier that integration is introduced in the design process, the greater the benefit. For a high performance school, project team collaboration and integration of design choices should begin no later than the programming phase. In addition, the project team is likely to be more broadly defined than in the past, and may include energy analysts, materials consultants, lighting designers, life-cycle cost consultants and commissioning agents. Design activities may expand to include charrettes, modeling exercises, and simulations.

This manual provides details and implementation rules for individual design strategies. Though these individual strategies can improve a building's energy efficiency, only through whole-building analysis and integrated design can energy and cost concerns be balanced most effectively.



Goals and Cross-Cutting Issues

This manual is organized into eight technical chapters that correspond to the major disciplines in the building design process. The guidelines presented in each chapter are directed toward building schools that achieve the following goals, which are issues that cut across each of the major disciplines:

- Health and Indoor Air Quality (IAQ).
- Thermal Comfort.
- Visual Comfort.
- Acoustic Comfort.
- Security and Safety.
- Ecosystem Protection.
- Energy Efficiency.
- Water Efficiency.
- Materials Efficiency.
- Buildings as a Teaching Tool.

Table 1 below shows which of the goals (or cross-cutting issues) apply to each of the technical chapters. The rest of this section describes these relationships in more detail and provides checklists that summarize the key high performance design strategies for each discipline.

Table 1 – Relationship Between Goals and Technical Chapters

		Goals/Cross-Cutting Issues									
		Health and IAQ	Thermal Comfort	Visual Comfort	Acoustic Comfort	Security and Safety	Ecosystem Protection	Energy Efficiency	Water Efficiency	Materials Efficiency	Building as a Teaching Tool
Technical Chapters	General Conditions	●				●	●	●	●	●	
	Site Planning	●	●	●	●	●	●	●	●	●	●
	Interior Surfaces & Furnishings	●			●		●	●		●	●
	Electric Lighting and Controls		●	●				●			●
	Daylighting and Fenestration		●	●		●		●		●	●
	Building Enclosure		●		●			●		●	●
	HVAC	●	●		●	●		●	●	●	●
	Other Equipment and Systems							●	●	●	●

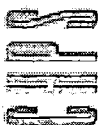

Health and IAQ

The quality of the air inside a school is critical to the health and performance of children, teachers and staff. A high performance school should provide superior quality indoor air by: eliminating and controlling the sources of contamination; providing adequate ventilation; preventing unwanted moisture accumulation; and implementing effective operation and maintenance procedures.

According to the U.S. Environmental Protection Agency (EPA), the concentration of pollutants inside a building may be two to five times higher than outside levels. Children are particularly vulnerable to such pollutants because their breathing and metabolic rates are high relative to their size. Maintaining a high level of IAQ is therefore critical for schools. Failure to do so may, according to the EPA, negatively impact student and teacher performance; increase the potential for long- and short-term health problems for students and staff, increase absenteeism, accelerate deterioration, reduce efficiency of the school's physical plant, create negative publicity, and create potential liability problems.

To eliminate or control contamination, select materials that are low emitters of substances such as volatile organic compounds (VOCs) or toxins. Some of these building materials may be unfamiliar to custodial staff, so provide training to the staff, and select durable products and avoid products that unnecessarily complicate operation and maintenance. Any material can affect the acoustic and visual quality of a school; be sure to consider this when evaluating these materials. The following checklist summarizes strategies to improve a school's IAQ.

A Closer Look -- Boscawen Elementary School, Boscawen, NH

This 53,000 ft², 420-student school north of Concord, NH is the first in the country to use a combined displacement and demand-control ventilation system to provide superior IAQ and thermal comfort with reduced overall energy costs.

In this system, students and teachers are constantly surrounded by fresh air. Stale air rises above them and is then vented out. None of it is recirculated. The result is a school with exemplary IAQ that is, at the same time, energy and cost efficient.

As Dr. G.W. Porter of the New Hampshire State Department of Education notes, "Despite the innovative engineering, its cost was equal, or possibly less than, other typical schools. Maintenance costs, such as heating, are expected to be lower; and even without air-conditioning, the building will be even cooler in spring and fall. Air quality, a problem that's plagued a number of our schools, will also be vastly improved."

Health and IAQ Checklist

Eliminate or control contamination at the source

- ✓ Require a construction IAQ plan.
- ✓ Test the site for sources of contamination such as radon, hazardous waste, or fumes from nearby industrial or agricultural uses.
- ✓ Locate sources of exhaust fumes (e.g., from vehicles) away from air intake vents.
- ✓ Consider recessed grates, "walk off" mats and other techniques to reduce dirt entering the building.

Avoid materials that contaminate indoor air

- ✓ Use materials that pass the emissions limits in the CHPS Material Specifications Section 1350.
- ✓ Specify composite wood or agrifiber products containing no urea-formaldehyde resins.

Provide adequate ventilation

- ✓ Allow adequate time for installed materials and furnishings to "off-gas" before the school is occupied. Run the HVAC system continuously at the highest possible outdoor air supply setting for at least 72 hours after all materials and furnishings have been installed.
- ✓ Design the ventilation system to provide a minimum of 15 cfm/person of filtered outdoor air to all occupied spaces. Consider 20 cfm/person.

- ✓ Ensure that ventilation air is effectively delivered to and distributed through the rooms in a school.
- ✓ Provide local exhaust for restrooms, kitchens, labs, janitor's closets, copy rooms, and shop rooms.

Prevent unwanted moisture accumulation

- ✓ Design the ventilation system to maintain the indoor relative humidity between 30% and 50%.
- ✓ Design to minimize water vapor condensation, especially on walls, the underside of roof decks, around pipes or ducts.
- ✓ Design to keep precipitation out of the building, off the roof, and away from the walls.

Operate and maintain the building effectively

- ✓ Regularly inspect and maintain the ventilation system so that it continues to operate as designed.
- ✓ Install CO₂ sensors in large assembly areas for real-time monitoring of air quality.
- ✓ Minimize the use of toxic cleaning materials.
- ✓ Use the EPA's "Indoor Air Quality—Tools for Schools" to guide the operation and maintenance process.
- ✓ Use the EPA's "Mold Remediation in Schools and Commercial Buildings" to control moisture problems. Available at <http://www.epa.gov/iaq/molds> or (800) 438-4318.

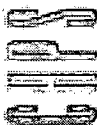

Thermal Comfort

Thermal comfort is an important variable in student and teacher performance. Hot, stuffy rooms — and cold, drafty ones — reduce attention spans and limit productivity. They also waste energy, adding unnecessary cost to a school's bottom line. Excessively high humidity levels can also contribute to mold and mildew. Thermal comfort is primarily a function of the temperature and relative humidity in a room, but air speed and the temperature of the surrounding surfaces also affect it. A high performance school should ensure that rooms and HVAC systems are designed to allow temperature and humidity levels to remain within the "comfort zone" at all points in an occupied space. Thermal comfort guidelines are provided in the technical chapter on HVAC.

Thermal comfort is strongly influenced by how a specific room is designed (for example, the amount of heat its walls and roof gain or lose, the amount of sunlight its windows let in, whether the windows can be opened) and by how effectively the HVAC system can meet the specific needs of that room. Balancing these two factors — room design and HVAC system design — is a back-and-forth process that continues throughout all the stages of developing a new facility. In a high performance school, the process ends with an optimal blend of both components: rooms configured for high student and teacher productivity served by an energy-efficient HVAC system designed, sized, and controlled to maintain thermal comfort under all conditions.

A Closer Look – Designing for Thermal Comfort

A design concept that provides superior thermal comfort through combining low velocity ventilation, room air stratification, and dehumidification cooling has been applied successfully at more than 20 schools in New England. This design approach, called *The Advantage Classroom* developed by The H. L. Turner Group in Concord, NH, reduces drafts and "hot spots," enhances efficiency and control by including thermostats in each room, reduces room noise, and ensures optimal temperature and humidity levels by ongoing monitoring of room conditions.

Kim Cheney, a teacher at one school built with this design concept, is very satisfied with the results: "Everything about it is incredible; the whiteboards eliminate chalk dust, the air is clean, the temperature is perfect, it's all so comfortable. In the old school . . . we'd be really cold, but if you turned on the heat it would get so hot the students would get tired in the afternoon. In moving into the new school we went from the 19th century straight to the 21st."

Thermal Comfort Checklist

Design in accordance with ASHRAE standards

- ✓ Design systems to provide comfort in accord with American Society of Heating, Refrigerating and Air Conditioning Engineers (ASHRAE) Standard 55–1992 (with 1995 Addenda) Thermal Environmental Conditions for Human Occupancy.
- ✓ When a design incorporates natural ventilation (e.g., operable windows to provide direct outdoor air during temperate weather), consider adjusting the requirements of ASHRAE Standard 55–1992 to account for the impact.

Install controls and monitor system performance

- ✓ Install controls in each classroom to give teachers direct control over thermal comfort. Evaluate the potential impact of such controls on the overall efficiency of the HVAC system.

- ✓ Consider providing a temperature and humidity monitoring system to ensure optimal thermal comfort performance.
- ✓ Consider including temperature and humidity monitoring as part of the building's overall energy management system.

Analyze room and system layouts

- ✓ Analyze room configurations and HVAC distribution layouts to ensure all parts of a room are receiving adequate ventilation.
- ✓ Analyze placement of windows and skylights and provide adequate, controllable shading to avoid "hot spots" caused by direct sunlight.

BEST COPY AVAILABLE



Visual Comfort

Performing visual tasks is a central component of the learning process for both students and teachers. A high performance school should provide a rich visual environment — one that enhances, rather than hinders, learning and teaching — by carefully integrating natural and electric lighting strategies; by balancing the quantity and quality of light in each room; and by controlling or eliminating glare.

Students spend much of their day engaged in visual tasks — writing, reading printed material, reading from visual display terminals, or reading from blackboards, whiteboards, and overheads. They must constantly adjust their vision from a "heads-up" to "heads-down" position and back again. Inadequate lighting and/or glare can seriously affect a student's ability to learn. On the other hand, a comfortable, productive visual environment — one that takes into account more than simply the amount of light hitting the desktop — will enhance the learning experience for both students and teachers.

Visual comfort results from a well-designed, well-integrated combination of natural and artificial lighting systems. Any strategy for enhancing the visual environment will therefore strongly affect the size and configuration of both these systems (for example, number, type, and placement of windows; number, type, and placement of light fixtures; etc.). The final configurations will, in turn, affect a school's HVAC systems.

An optimized overall design will provide a high quality luminous environment and will use daylight effectively to reduce the need for artificial lighting. Less artificial lighting means lower electricity bills and less waste heat that, in turn, means less demand for cooling and lower HVAC operating expenses.

A Closer Look – Durant Road Middle School, Wake County, NC

Daylighting and electric lighting are seamlessly integrated in this 1,300-student school in Raleigh, NC. The design team repeatedly analyzed the interactions between the size and location of the roof monitors; the size and configuration of the electric lighting fixtures; the color and reflectance of the walls, floor, and ceiling; and the amount of light hitting the desks.

"We worked the problem using computer simulation tools until we had just the right combination. The result is a group of classrooms that are bright, fun places to be; that rely on natural sunlight for the bulk of their lighting needs; that virtually eliminate glare; and that save the school money on energy; all at the same time," notes Mike Nicklas, chief architect for the project.

Because of the school's exceptional daylighting design it was featured on CNN's "Science and Technology Week" series.

Visual Comfort Checklist

Integrate natural and artificial lighting strategies

- ✓ Take the amount of daylight entering a room into account when designing and sizing the artificial lighting system for that room.
- ✓ Provide controls that turn off lights when sufficient daylight exists.
- ✓ Consider dimming controls that continuously adjust lighting levels to respond to daylight conditions.

Balance the quantity and quality of light in each room

- ✓ Avoid excessively high horizontal light levels.
- ✓ Use the newly revised 9th edition of the Illuminating Engineering Society of North America (IESNA)'s *Lighting Handbook: Design and Application as a guide*.
- ✓ Design for "uniformity with flexibility."
- ✓ Illuminate spaces as uniformly as possible, avoiding shadows or sharp distinctions between dark and light.
- ✓ Provide task or accent lighting to meet specific needs (e.g., display areas, whiteboards, team areas).

- ✓ Develop individual lighting strategies for individual rooms or room types (e.g., classrooms, hallways, cafeteria, library, etc.). Avoid "one size fits all" approaches.

Control or eliminate glare

- ✓ Consider how light sources in a room will affect work surfaces. Design to avoid direct glare (from sources in front or to the side of a work area); overhead glare (from sources above the work area); and reflected glare (from highly reflective surfaces, including glossy paper and computer terminals).
- ✓ Consider increasing the brightness of surrounding surfaces, decreasing the brightness of light sources, or both as control methods.
- ✓ Consider interior (shades, louvers, blinds) or exterior (overhangs, trees) strategies to filter daylight and control glare from sunlight.

BEST COPY AVAILABLE



Acoustic Comfort

Parents, students, teachers, and administrators across the country are increasingly concerned that classroom acoustics are inadequate for proper learning. Noise from outside the school (from vehicles and airplanes, for example), hallways (foot traffic and conversation), other classrooms (amplified sound systems and inadequate sound transmission loss), mechanical equipment (compressors, boilers, and ventilation systems), and even noise from inside the classroom itself (reverberation) can hamper students' concentration.

A Closer Look -- Sterling Montessori Academy, Morrisville, NC

The roof monitors that bring daylight into the classrooms of this 200-student elementary school in a Raleigh, NC suburb provide an added benefit: improved acoustics. The large, open space under the monitors, plus the baffles used to control glare, help dampen sound throughout the classroom. The result is an improved environment for teaching and learning.

Though daylighting was expected to be the most noticeable change for teachers and students, one teacher said the improved acoustics was the best feature.

Trying to hear in a poor acoustical environment is like trying to read in a room with poor lighting: stress increases, concentration decreases, and learning is impaired. This is especially true for younger students (the ability to sort meaningful sounds from noise is not fully developed until children reach their teens); those for whom English is a second language; and those with hearing impairments. Although little consideration has historically been given to acoustic design in classrooms — as opposed to lighting and ventilation — this situation is beginning to change. The information and tools needed to design classrooms for high acoustical performance now exist. They can be used to ensure that any newly constructed classroom provides an acoustic environment that positively enhances the learning experience for students and teachers.

Acoustic Comfort Checklist

Ensure a superior acoustical environment

- ✓ *Reduce sound reverberation time inside the classroom.*
- ✓ *Limit transmission of noise from outside the classroom.*
- ✓ *Minimize background noise from the building's HVAC system.*

BEST COPY AVAILABLE



Security and Safety

Safety and security have become critical concerns for students, teachers, and parents across the country. A high performance school should create a safe and secure environment by design.

Opportunities for natural surveillance should be optimized; a sense of territoriality should be reinforced; access should be controlled; and technology should be used to complement and enhance, rather than substitute for, a facility's security-focused design features.

Crime and vandalism — and the fear they foster — are problems facing school populations throughout the U.S. While better buildings alone cannot solve these problems, they can be powerful factors in helping reduce crime and other antisocial behavior. Thoughtful design that builds on basic Crime Prevention through Environmental Design (CPTED) principles is the key.

Security-based design strategies will influence a school's basic layout and site plan. If properly integrated from the beginning of the development process, these influences will complement and enhance other high performance design strategies used in the facility. For example, daylight classrooms can "share" their natural light with adjacent corridors through windows or glass doors provided primarily for surveillance purposes. This "free" natural light can, in turn, be used to offset the need for electrical lighting in the corridors. Security technology strategies will not strongly impact other systems in the school, unless they are incorporated into a comprehensive automated control system for the whole facility.

A Closer Look -- Boscawen Elementary School, Boscawen, NH

"Room-like," non-institutional corridors, plenty of views out and in, and windows between the classrooms and the hallway, all combine to improve the safety and sense of security in this 53,000-ft², 420-student school north of Concord, NH.

Security and Safety Checklist

Increase opportunities for natural surveillance

- ✓ Design landscaping to minimize places that are hidden from view. Ensure that key areas — parking, bicycle storage, drop-off points, play equipment, entries — are easily observable from inside the building.
- ✓ Design exterior lighting to facilitate nighttime surveillance.
- ✓ Consider providing views through glazed doors or windows from classrooms into circulation corridors.
- ✓ Design to minimize areas within the building that are hidden from view.
- ✓ Consider open stairwells.

Reinforce a sense of territoriality

- ✓ Foster a sense of "ownership" of the school for students and teachers by clearly defining borders — what is part of the school and what is not.
- ✓ Consider decorative fencing and special paving treatments to delineate the boundaries of the school grounds.
- ✓ Consider designing common areas, particularly corridors, so that they are less institutional and more "room-like."

Design for easy maintenance

- ✓ Consider graffiti-resistant materials and finishes.

Control access to the building and grounds

- ✓ Consider decorative fencing to control access to school grounds.
- ✓ Limit the number of entries to the building. Allow visual surveillance of all entries from inside the school.
- ✓ Provide capability to "lock-down" parts of the school when the facility is used for after-hours activities.

Integrate security technology

- ✓ Consider incorporating interior and exterior surveillance cameras.
- ✓ Ensure that all high-risk areas (office, cafeteria, shops, labs, etc.) are protected by high security locks.
- ✓ Consider metal detectors and other security technologies as appropriate.
- ✓ Motion sensors for lighting can also provide effective security control.

BEST COPY AVAILABLE



Ecosystem Protection

A high performance school protects the natural ecosystem. As much as possible, the school incorporates products and techniques that do not introduce pollutants or degradation at the project site or at the site of extraction, harvest, or production. Give preference to materials that are locally extracted or harvested, and locally manufactured to eliminate potential air pollution due to petroleum-based transportation.

Some of these building materials may be unfamiliar to custodial staff. Avoid products that unnecessarily complicate operation and maintenance procedures, and provide training to ensure proper upkeep and ensure full service life. When evaluating materials, be sure to consider their impact on the acoustic and visual quality of a school.

High performance school design is environmentally responsive to the site, incorporating natural conditions such as wind, solar energy, and moisture to enhance the building's performance. Natural features and areas of the site should be preserved; damaged areas should be restored. Take steps to eliminate stormwater runoff and erosion that can affect local waterways and adjacent ecosystems.

The use of these strategies can help teach students about the importance of protecting natural habitats and the impact of human activities on ecological systems.

A Closer Look -- Sakai Intermediate School, Bainbridge Island, WA

This new facility is an excellent example of a school project that went the extra mile to protect the natural environment. The building and sports field's footprint was reduced to increase a buffer zone far beyond what was required in order to protect an adjacent wetland and salmon stream. A culvert that blocked salmon passage was removed. A system separating groundwater from stormwater allowed the groundwater to recharge the natural wetland, and allowed designers to reduce the size of the stormwater retention pond.

Students and other community members were involved in restoring the salmon stream and building an outdoor classroom platform, and they acted as tour guides for the open house explaining the special site protection features.

Ecosystem Protection Checklist

Specify Indigenous materials

- ✓ Specify materials appropriately adapted for the building and site, such as native landscaping and locally extracted building materials.

Specify wood products that are harvested responsibly

- ✓ Set a goal of having 50% of the school's wood-based materials certified in accordance with the Forest Stewardship Guidelines for wood-based components.

Avoid materials that harm the ecosystem

- ✓ Eliminate materials that harm the natural ecosystem through toxic releases or by producing unsafe concentrations of substances.
- ✓ Eliminate the use of ozone-depleting chlorofluorocarbons (CFCs) and hydrochlorofluorocarbons (HCFCs) as refrigerants in all HVAC systems.
- ✓ Give preference to locally manufactured materials and products to eliminate air pollution due to transportation.

- ✓ Eliminate products that pollute water, air, or other natural resources where they are extracted, manufactured, used, or disposed of.
- ✓ Evaluate the potential impact of specified site materials on natural ecosystems located on site or adjacent to the site.

Preserve and restore natural features and areas on, and near, the site

- ✓ During construction, develop and implement a construction operations plan to protect the site.
- ✓ Develop the site to prevent stormwater runoff and erosion.
- ✓ Restore damaged natural areas.
- ✓ Maintain connection to nearby natural ecosystems.

BEST COPY AVAILABLE



Energy Efficiency

Energy-efficient schools cost less to operate, which means that more money can be used for books, computers, teacher salaries, and other items essential to the educational goals of schools. Energy-efficient schools also reduce emissions to the environment, since energy use is related to emissions of carbon dioxide (CO₂), sulfur oxides (SO_x), nitrous oxides (NO_x), and other pollutants. Smaller air conditioners also reduce the likelihood of ozone-depleting gases escaping to the atmosphere. All the chapters and guidelines in this manual relate to energy efficiency in some meaningful way. By following the guidelines in this manual, energy use can be reduced by up to 40% compared to conventional buildings that minimally comply with the California's Title 24 Energy Efficiency Standards for Residential and Nonresidential Buildings.

Guidelines explicitly related to energy efficiency are provided in five of the chapters: electric lighting, daylighting and fenestration, building enclosures, HVAC systems, and other equipment and systems. The key issues are summarized below.



Electric Lighting

Electric lighting systems interact closely with a school's daylighting and HVAC systems. Daylighting strategies that are well integrated with lighting equipment and controls will reduce the demand for electric light. This decrease in demand, if it is met by a combination of high efficiency electric lighting equipment and controls, can substantially lower a school's electricity usage.

An added benefit: more efficient lighting produces less waste heat, reducing the need for cooling and further reducing operating costs. Cooling equipment can be downsized, resulting in first cost and operating cost savings to the school.

These savings are achievable now — in any school — using readily available equipment and controls.

A Closer Look -- Ross Middle School, Ross, CA

This new, 200-student facility north of San Francisco, CA incorporates a full range of high performance electric lighting features. Direct/indirect pendant luminaires provide high quality light at low footcandle levels. In the daylit classrooms, dimming ballasts and photosensors are also used, so light output can vary depending on daylight availability. Used properly, this strategy alone can save up to 60% of the electrical energy needed for lighting these rooms.

Lights have two bulbs that are separately switched, so that half the lamps can be turned off at one time, further reducing energy consumption. Some lights are also tied to occupancy sensors so that they automatically turn off when a room is unoccupied. Finally, the entire lighting system is on a timer to ensure all lights are shut off at night.

These features, combined with daylighting, create a total system that delivers high quality lighting that is energy and cost efficient. Architect Scott Shell hopes that these features, "...will not only make the school a better place for teaching and learning, but will also be used as tools that help make children more aware of how buildings and their use of energy impact the environment." Electric lighting can account for 30% to 50% of a school's electric power consumption. Even modest efficiency improvements can mean substantial bottom-line savings.

Energy Efficiency Checklist for Electric Lighting

Design for high efficiency and visual comfort

- ✓ Develop individual lighting designs for individual rooms or room types (classrooms, hallways, cafeteria, etc.). Avoid overlighting any space.
- ✓ Consider a mix of direct and indirect light sources for each design.
- ✓ Optimize each design so that overall lighting levels (W/ft^2) are as low as possible while still providing optimal task illumination.
- ✓ Analyze the impact of the lighting system on the HVAC system and resize the HVAC system as appropriate.
- ✓ Design systems to facilitate cleaning/lamp replacement.

Specify high efficiency lamps and ballasts

- ✓ Use "Super" T-8 fluorescent lamps with electronic ballasts for most general lighting applications (classrooms, offices, multipurpose rooms, cafeterias). Consider using T-5 lamps if justified by life-cycle cost.
- ✓ Consider dimmable ballasts, especially in daylit rooms.

Optimize the number and type of luminaires

- ✓ Use suspended indirect or direct/indirect luminaires in classrooms to provide soft uniform illumination.

- ✓ Consider using additional accent and directional task lighting for specific uses (such as display areas).
- ✓ Consider using a smaller number of higher efficiency luminaires to light specific spaces, resulting in fewer fixtures to purchase, install, maintain, and clean.

Incorporate controls to ensure peak system performance

- ✓ Use occupancy sensors with manual overrides to control lighting (on-off) in classrooms, offices, restrooms, and other intermittently occupied spaces. Consider scheduled dimming and/or time clocks in other rooms.
- ✓ Consider incorporating lighting controls into the facility's overall energy management system.

Integrate electric lighting and daylighting strategies

- ✓ Treat the electric lighting system as a supplement to natural light. Design for daylighting first and use the electric system to add light as needed during the day and provide sufficient illumination at night.
- ✓ Provide controls to dim or turn off lights at times when daylight is sufficient. Consider photoelectric controls that are sensitive to levels of daylight.
- ✓ Consider controls that provide continuous, rather than stepped, dimming.

BEST COPY AVAILABLE



Daylighting and Fenestration Design

Daylighting is the controlled admission of natural light into a space through windows, skylights or roof monitors. A high performance school should use as much daylight as possible, especially in classrooms, while avoiding excessive heat loss, heat gain, and glare.

Access to natural light may be one of the most important attributes of a high performance school. Daylight is the highest quality light source for visual tasks, enhancing the color and appearance of objects. Studies clearly indicate that daylighting can enhance student performance. Views from windows also provide a connection with the natural world and contribute to eye health by allowing frequent changes in focal distance.

Daylighting can also save schools money.

Properly designed systems can substantially reduce the need for electric lighting, which can account for 35% to 50% of a school's electrical energy consumption. As an added benefit, waste heat from the lighting system is reduced, lowering demands on the school's cooling equipment. The savings can be as much as 10% to 20% of a school's cooling energy use. And daylight provides these savings during the day when demand for electric power is at its peak and electricity rates are at their highest.

A Closer Look -- Dena Boer Elementary School, Salida, CA

Skylights are used to distribute natural daylight to the classrooms, library, multipurpose room and offices of this 800-student, K-5 school near Modesto, CA. Louvers installed in the skylight wells help control daylight levels and can be used to darken rooms when necessary. Classroom windows provide additional daylight and are protected by deep overhangs to control direct sunlight and glare.

All these "extras" were provided within the standard construction budget for the school, which was completed in 1997. The key was making daylighting a priority for the school and then shifting funds from elsewhere in the budget to pay for it.

The extra sunlight has proven very popular. "The skylights create an open, bright work environment. We just seem to have more room. Visitors say it sure is a pleasant place to come into," notes school principal Rick Bartkowski.

Energy Efficiency Checklist for Daylighting

Avoid direct beam sunlight and glare

- ✓ Consider interior (shades, louvers, or blinds) and exterior (overhangs, trees) strategies to control glare and filter daylight.

Design for diffuse, uniform daylight that penetrates deep into the space

- ✓ Use a daylighting analysis tool to help guide the design process.
- ✓ Design windows to allow daylight to penetrate as far as possible into a room. Consider using light shelves (solid horizontal elements placed above eye level, but below the top of the window) to reflect daylight deep into a room.

- ✓ Consider skylights (horizontal glass), roof monitors (vertical glass), light from two sides, and/or clerestory windows.
- ✓ Lay out the room to take advantage of daylight. Consider sloped ceilings. Consider light-colored ceiling surfaces to help reflect daylight within the room.

Integrate daylighting with the electric lighting system

- ✓ Provide controls that turn off lights when sufficient daylight exists. Consider dimming controls that continuously adjust light levels to respond to daylight conditions.

BEST COPY AVAILABLE



Building Enclosures

The building enclosure (walls, roofs, floors, and windows) of a high performance school should enhance energy efficiency without compromising durability, maintainability, or acoustic, thermal, or visual comfort. An energy-efficient building enclosure is one that integrates and optimizes moisture control, insulation levels, glazing, shading, thermal mass, air leakage control, and light-colored exterior surfaces. An energy-efficient building enclosure will reduce a school's overall operating expenses and will also help the environment. Many of the techniques employed — high performance glazing, shading devices, light-colored surfaces — are easy for students to understand and can be used as instructional aids.

The key to optimizing the building enclosure is an integrated approach to design that considers how all the components of the building shell interact with each other and with the building's HVAC systems. Tools to analyze these interactions are readily available and can be used to create the optimal building enclosure based on total system performance. As part of an integrated approach, consider the actions described below.

A Closer Look -- Oquirrh Hills Elementary School, Kearns, UT

Well-insulated metal stud and brick veneer walls, a light-colored roof with R-30 rigid insulation, and windows with low-e glass all contribute to the superior energy performance of this elementary school near Salt Lake City.

The school, completed in 1996, replaced a previous facility that had been destroyed by fire. The new building saves roughly \$22,000 per year in operating costs compared to its predecessor—a result of careful design combined with high performance systems and an energy-efficient building enclosure.

Based on its experience with Oquirrh Hills, the Jordan School District has embraced high performance as a procurement goal and has gone on to build six more energy-efficient schools.

"High performance, energy smart school design means going 'beyond code'...cost effectively. That's just what the architects did at Oquirrh Hills," notes Duane Devey, Director of Energy and Utility Resources for Jordan School District.

Energy Efficiency Checklist for the Building Enclosure

Specify high performance glazing

- ✓ Specify glazing that offers the best combination of insulating value, daylight transmittance and solar heat gain coefficient for the specific application.

Control heat gain and glare

- ✓ Consider exterior shading devices to reduce solar heat gain and minimize glare.
- ✓ Consider using light-colored materials for walls and roofs in order to reflect, rather than absorb, solar energy.

Consider high mass materials, like concrete or brick

- ✓ Use the building's thermal mass to store heat and temper heat transfer.
- ✓ Consider adding thermal mass to increase the storage capacity and energy efficiency of the building.

Control air leakage

- ✓ Consider air retarder systems (also referred to as "air infiltration barriers") as a means to improve energy performance and comfort.

BEST COPY AVAILABLE



Efficient HVAC Systems

A school's HVAC system provides the heating, ventilating and air-conditioning necessary for the comfort and well-being of students, staff, and visitors. To ensure peak operating efficiency, the HVAC system in a high performance school should: use high efficiency equipment; be "right sized" for the estimated demands of the facility; and include controls that boost system performance.

A Closer Look -- Newport Mesa Elementary School, Costa Mesa, CA

After careful analysis of first costs versus performance benefits, high efficiency heat pumps—one for each classroom—were selected for this 400–700 student school south of Los Angeles. The equipment was designed and sized to work well with the natural ventilation systems built into each classroom. Controls for both systems are provided in each classroom so that teachers can maintain optimal conditions at all times. The result is a school that provides a high performing HVAC system and empowers teachers to run it at peak efficiency.

The HVAC system is one of the largest energy consumers in a school. Even modest improvements in system efficiency can represent relatively large savings to a school's operating budget. With the highly efficient systems available today — and the sophisticated analysis tools that can be used to select and size them — there's no reason why every school HVAC system can't be designed to the highest levels of performance.

The key to optimizing HVAC system performance is an integrated design approach that considers the building as an interactive whole rather than as an assembly of individual systems. For example, the benefits of an energy-efficient building enclosure may be wasted if the HVAC equipment is not sized to take advantage of it. Oversized systems, based on rule-of-thumb sizing calculations, will not only cost more, but will be too large to ever run at peak efficiency and will waste energy every time they turn on. An integrated approach, based on an accurate estimate of the impact of the high efficiency building enclosure, will allow the HVAC system to be sized for optimum performance. The resulting system will cost less to purchase, will use less energy, and will run more efficiently over time.

Energy Efficiency Checklist for HVAC Systems

Use high efficiency equipment

- ✓ Specify non-CFC (chlorofluorocarbon)-based refrigerants for systems using large chillers.
- ✓ Specify equipment that meets or exceeds the U.S. Department of Energy's "Energy Conservation Voluntary Performance Standards for New Buildings."
- ✓ Use ENERGY STAR-approved products.
- ✓ Consider recovery systems that pre-heat or pre-cool incoming ventilation air.
- ✓ Consider "economizer cycles" for small, packaged systems.
- ✓ In hot, dry climates, consider evaporative cooling.
- ✓ Investigate the potential for on-site cogeneration.

"Right-size" the system

- ✓ Consider standard HVAC sizing safety factors as upper limits.
- ✓ Apply any safety factors to a reasonable base condition for the building: not the hottest or coldest day of the year with maximum attendance; not the most temperate day of the year with the school half full.
- ✓ Select systems that operate well under part-load conditions.
- ✓ Monitor existing local systems to size future systems.

Incorporate controls that boost system performance

- ✓ Consider integrated building management systems that control HVAC, lighting, outside air ventilation, water heating and building security.
- ✓ Consider individual HVAC controls for each classroom.

BEST COPY AVAILABLE



Water Efficiency

Fresh water is an increasingly scarce resource in most areas of California. A high performance school should control and reduce water runoff from its site, consume fresh water as efficiently as possible, and recover and reuse gray water to the extent feasible.

Basic efficiency measures can reduce a school's water use by 30% or more. These reductions help the environment, locally and regionally. They also lower a school's operating expenses. While the cost savings may be modest now, since water is relatively inexpensive in most areas of the country, there is a strong potential that these savings will rise over time, especially in areas of California where water is scarce and becoming more expensive.

The technologies and techniques used to conserve water — especially landscaping, water treatment, and recycling strategies — can be used to help instruct students about ecology and the environment. Guidelines on the use of drought-resistant plants and efficient irrigation systems are provided in the Site Planning chapter. The HVAC guidelines discuss water consumption issues related to HVAC system choices. Opportunities to save water through water reclamation, gray water systems, and low-flow devices are discussed in the chapter on other (non-HVAC) systems. The following checklist summarizes the key issues related to water efficiency.

A Closer Look -- Roy Lee Walker Elementary School McKinney, TX, Independent School District

Rain is "harvested" from the roof of this 608-student, K-5 school 30 miles north of Dallas, and is used to water the grounds and flush the toilets year round. The water is stored in six above-ground cisterns designed as integral components of the overall architecture of the facility.

The system shows how incredibly efficient rainwater collection can be, even in relatively dry locations. According to architect Gary Keep, just using the roof, "...enough water can be collected in a one-year period to flush toilets and water the grounds for about six years."

Water Efficiency Checklist

Design landscaping to use water efficiently

- ✓ Reduce water use.
- ✓ Consider innovative wastewater treatment options.
- ✓ Specify hardy, native vegetation.
- ✓ Consider using an irrigation system for athletic fields only, not for plantings near buildings or in parking lots.
- ✓ Use high efficiency irrigation technology (e.g., drip irrigation in lieu of sprinklers).
- ✓ Use captured rain or recycled site water for irrigation.
- ✓ "Design in" cisterns for capturing rainwater.

Set water use goals for the school

- ✓ Recommended goal: 20% less than the baseline calculated for the building (not including irrigation) after meeting the Energy Policy Act of 1992 fixture performance requirements.

Specify water-conserving fixtures and equipment.

- ✓ Specify water-conserving plumbing fixtures that exceed Energy Policy Act of 1992 requirements.
- ✓ Specify high efficiency equipment (dishwashers, laundry, cooling towers).
- ✓ Consider single temperature fittings for student toilets/locker rooms.
- ✓ Consider automatic lavatory faucet shutoff controls.
- ✓ Consider low-flow showerheads with pause control.

Consider using recycled or rainwater for non-potable uses

- ✓ Decrease use of potable water for sewage conveyance by using gray and/or black water systems. Opportunities include toilet flushing, landscape irrigation, etc.
- ✓ Consider on-site wastewater treatment, including full or partial "solar aquatics" systems on large sites.
- ✓ Possible applications include HVAC and process make-up water.

BEST COPY AVAILABLE

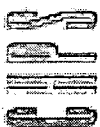

Material Efficiency

Material efficiency in this manual refers specifically to two overarching goals: 1) waste reduction — including construction and demolition (C&D) source reduction, reuse, and recycling; and 2) the use of building products that are manufactured in ways that conserve raw materials, including the use of recycled content products, that conserve energy and water, that are reused or salvaged, or that can be recycled or reused at the end of the building's service life. Addressing these goals provides significant environmental benefit. According to WorldWatch, buildings account for 40% of many processed materials used (such as stone, gravel, and steel) and 25% of virgin wood harvested. These withdrawals can cause landscape destruction, toxic runoff from mines, deforestation, biodiversity losses, air pollution, water pollution, siltation, and other problems.

The checklist below summarizes key material efficiency strategies. When considering recycled content products or other materials-efficient products, be sure to consider their effect on acoustic, visual, and indoor air quality. Be aware that using certain recycled products may conflict with goals for long-term materials efficiency, since a product's recycled composite may be difficult to recycle. Avoid products that unnecessarily complicate operation and maintenance procedures, and be sure that the custodial staff receives training in proper upkeep of the products. Using these strategies can help teach students about the role of waste reduction in protecting the environment.

A Closer Look -- Ocean Park School, Santa Monica, CA

Certified sustainable yield lumber, formaldehyde-free particleboard and insulation, non-VOC sealants, and recycled plastic bathroom partitions were all incorporated into this 45,000 ft², K-8 school in Santa Monica.

"It's not difficult to make our schools healthier and more environmentally responsible, but you have to start early in the process by 'designing in' high performance, non-toxic materials and products from the very beginning," says Betsey Dougherty, lead architect for the project.

Material Efficiency Checklist

Design to facilitate recycling

- ✓ *"Design in" an area within the building dedicated to separating, collecting, storing and transporting materials for recycling including paper, glass, plastics, and metals.*

Reduce the amount of construction waste going to landfills

- ✓ *Develop and implement a management plan for sorting and recycling construction waste.*
- ✓ *Consider a goal of recycling or salvaging 50% (by weight) of total construction, demolition, or land clearing waste.*

Specify salvaged or refurbished materials

- ✓ *Evaluate the potential impact of salvaged materials on overall performance, including energy and water efficiency, and operation and maintenance procedures.*

Maximize recycled content of all new materials

- ✓ *Use EPA-designated recycled content products to the maximum extent practicable.*
- ✓ *Use materials and assemblies with the highest available percentage of post-consumer or post-industrial recycled content.*
- ✓ *Set a goal to achieve a minimum recycled content rate of 25%. (See Volume III for more information.)*

Eliminate materials that may introduce indoor air pollutants

- ✓ *Use materials or assemblies with the lowest level of volatile organic compounds (VOCs).*
- ✓ *Evaluate the potential impact of specified materials on the indoor air quality of the school.*

BEST COPY AVAILABLE



Commissioning, Operation, and Maintenance

Building commissioning is the process of ensuring that systems in schools are designed, installed, tested, and verified as being capable of operating according to the school's needs and the designer's intent. The term comes from shipbuilding where "commissioning a ship" means thoroughly testing it to ensure that it is seaworthy. For buildings, commissioning has a similar meaning, which is, testing the important building systems to ensure that they operate the way the designers expect and that they serve the needs of teachers, students, and school districts.

High performance schools can only be achieved with some level of commissioning. Higher test scores, increased average daily attendance, reduced operational costs, staff retention, and reduced liability may be compromised unless critical systems are commissioned to achieve proper performance. Because it anticipates problems, commissioning can avoid costly change orders, delays, and litigation. In addition to commissioning building systems, design professionals can commission high performance materials by making sure they are installed as specified, and that proper documentation exists so the design intent is not compromised in the event of cleaning, repair, or replacement.

Studies show that building systems will not operate as expected unless they are commissioned. One study of 60 newly constructed nonresidential buildings showed that more than half had controls problems, 40% had malfunctioning HVAC equipment, and one-third had sensors that did not operate properly. In many of the buildings, equipment called for on the plans and specifications was actually missing. One-fourth of the buildings had energy management control systems, economizers, or variable-speed drives that did not run properly.²

Additional information on commissioning can be found in the Commissioning chapter at the end of this manual.

Systems that Require Commissioning

Commissioning can reduce these problems by systematically assuring that the critical systems are properly installed, calibrated, and working. Systems for which commissioning is essential include lighting sweep systems, photocell daylighting controls, energy management systems, variable-speed motor drives, building pressurization control, floating head pressure in refrigeration equipment, anti-condensate heaters in refrigeration systems, and capacity controls in central heating and cooling plants. A more comprehensive list of systems that might require commissioning include:

- HVAC plant.
- Air and water delivery system.
- Energy management system.
- Electrical and lighting system.
- Fire/life safety system.
- Data networks/communications.
- Security system.
- Kitchen equipment and fume hoods.
- Building envelope.
- Renewable energy system.
- Science lab gas delivery system.
- Emergency power supply.
- Plumbing.
- Irrigation system.

² Piette, Mary Ann. 1994. Quantifying savings from commissioning: Preliminary results from the Northwest. Lawrence Berkeley National Laboratory.



The Commissioning Agent

The commissioning agent is responsible for coordinating and carrying out the commissioning process. For complex projects, the commissioning agent should be brought on as part of the design phase. However, for most schools, commissioning may not be needed until construction start-up, and knowledgeable in-house personnel may fill the role of the commissioning agent. Commissioning should continue well into start-up, and be integrated into the operation and maintenance plan.

The responsibilities of the commissioning agent include:

- Assisting with a clear statement of the design intent for each building system.
- Writing the commissioning specifications and incorporating them in the appropriate divisions of the construction specifications.
- Carrying out pre-functional and functional testing of all equipment and systems to be commissioned, using procedures designed in advance.
- Reviewing operation and maintenance documents to be provided by the contractor.
- Developing operation and maintenance training curricula and materials to ensure they meet needs of staff.
- Writing a final report including all commissioning documentation and recommendations for the district.

Cost of Commissioning

For California schools, the cost of commissioning ranges between \$0.10 and \$0.30/ft² square foot of building area. Studies show that commissioning can be very cost effective, with simple paybacks ranging between four and 20 months.³

Commissioning References

American Society of Heating, Refrigerating and Air-Conditioning Engineers (ASHRAE). 1996. *The HVAC Commissioning Process, ASHRAE Guideline 1-1996*. Available on-line at: <http://www.ashrae.org/>.

Commissioning Specifications, C-2000 Program, Canada, 1995.

NEBB. 1993. *Procedural Standards for Building Systems Commissioning*.

U.S. Department of Energy (DOE). 1998. *Model Commissioning Plan and Guide Specifications*. NTIS #DE97004564. Available on-line at: <http://www.peci.org/>.

U.S. Green Building Council. *LEED 2.0 Reference Guide* (for commercial buildings). Available at <http://www.usgbc.org/>.

CHPS Criteria

Environmental performance criteria for high performance schools in California appear in Volume III of this manual. To achieve a high level of environmental performance, performance criteria and goals need to be clearly stated in both the educational specification and the architectural program. Having specific criteria for a high performance school makes it easier for districts to describe what they want

³ Gregerson, Joan. 1997. Cost effectiveness of commissioning 44 existing buildings.



and for architects to meet these goals. Volume III provides school districts and designers with specific yet flexible criteria for building high performance schools.

Material Selection and Research

In a high performance school, materials are selected for several characteristics beyond the traditional issues of performance, price, availability, and aesthetics. Designers should look for environmentally preferable materials that are:

- **Durable.** Offers (proven) longer service life compared to other options in a given product category.
- **“Healthy.”** Does not introduce toxics or polluting emissions into the building.
- **Made with recycled content.** Includes materials that have been recovered or otherwise diverted from the solid waste stream, either during the manufacturing process (pre-consumer), or after consumer use (post-consumer).
- **Salvaged or reused.** Includes materials that are refurbished and used for a similar purpose; not processed or remanufactured for another use.
- **Recyclable.** Can be collected, separated, or otherwise recovered from the solid waste stream for reuse, or in the manufacture or assembly of another package or product.
- **Responsibly produced.** Extracted, harvested or manufactured in an environmentally friendly manner (includes certified wood products).
- **Environmentally benign.** Includes or introduces no, or low amounts of, known pollutants to the natural ecosystem (includes non ozone-depleting or toxic materials).
- **Low in embodied energy.** Does not require significant amounts of energy to produce or transport the material (includes locally manufactured or extracted options in a given product category).
- **Produced from rapidly renewable material.** Includes material that is grown or cultivated and can be replaced in a relatively short amount of time (defined by the type of material).
- **Made with industrial byproducts.** Includes material that is created as a result of an industrial process (flyash, for example).
- **Marketed in an environmentally responsible manner.** Includes products available with minimal packaging.

For the high performance label to be meaningful, it's important for designers to ensure that a significant number of materials used for the project meet one or more of the above attributes. This will require research and documentation. Many sources of information are available to help with this process.

Product Suppliers

Some building material suppliers are making significant efforts to incorporate sustainable goals in their processes and operations and in their products. Companies serious about this commitment will provide detailed information about their product's performance. When investigating products, it is always recommended that the design team consult with the manufacturer's technical rather than sales staff.



Material Safety Data Sheets

Material Safety Data Sheets (MSDS), which must be prepared by product manufacturers, can provide some information and in particular can help “red flag” problem ingredients that may be toxic or emit significant VOCs. For example, the Health Hazard Rating (0 is low, 5 is high) found on an MSDS provides some indication of whether a product is appropriate for indoor school environments. MSDS's are often incomplete, however. Generally they do not include information about environmental attributes other than toxicity of regulated ingredients. MSDS's are primarily useful for eliminating building materials that may cause serious environmental problems.

Product Certification

Product certification programs can help identify environmentally preferable products. Many product suppliers have increased the credibility of their environmental claims by obtaining industry or independent certifications of their products' environmental attributes. Independent programs provide the most objective documentation, and include:

- *ENERGY STAR*. A program of the federal government, manufacturers are allowed to use the ENERGY STAR label only if the product meets certain energy efficiency levels set by either the U.S. EPA or U.S. Department of Energy. Tel: (888) STAR-YES. Web site: <http://www.energystar.gov/>.
- *Green Seal*. Green Seal standards are based on environmental protection. They focus on reduced air and water pollution, reduced consumption of energy and other resources, protection of wildlife and habitats, reduced packaging, quality, and performance. Tel: (202) 588-8400. Web site: <http://www.greenseal.org/>.
- *Scientific Certification Systems (SCS)*. SCS is a nonprofit organization that assesses products based on a life-cycle or “cradle to grave” evaluation. Their Environmental Report Card gives detailed information about the environmental burdens associated with the production, use and disposal of the product. Tel: 800-ECO-FACTS. Web site: <http://www.scs1.com/>.
- *Forest Stewardship Council*. A product bearing the Forest Stewardship Council (FSC) trademark is made with wood certified to have come from a forest that is well managed according to strict environmental, social and economic standards. Look for FSC-certification as opposed to self-certification of forest management practices. FSC is an international nonprofit association working in partnership with industry and other groups to improve forest management worldwide. Tel: (802) 244-6257. Web site: <http://www.fscoax.org/>. Also see Smart Wood, a U.S.-based program of the Rainforest Alliance, accredited by the FSC for the certification of forest management. Tel: (802) 434-5491. Web site: <http://www.smartwood.org/>.

Environmentally Preferable Product Directories

There are several good directories that identify environmentally preferable product options. Some focus on a product category (for example, recycled content products), while others cross categories.

- *Architects/Designers/Planners for Social Responsibility (ADPSR)*, Northern California chapter. *Architectural Resource Guide*. Organized by CSI, this guide lists sustainable, less polluting, local, and recycled building products as well as related information and a recommended reading list. Available as hard copy or CD. Web site: <http://www.adpsr-norcal.org/>.
- *California Multiple Awards Schedule (CMAS)*. Schools can now directly purchase products listed on CMAS, part of the state's procurement system. This allows direct purchases without going through the bidding process, saving time and offering economy of scale. Products are less expensive than if purchased through other means, but schools are encouraged to negotiate prices further. Schools



may issue a purchase order directly to the supplier, while sending a copy of it to this address: CMAS, 1500 5th St. Suite 116, Sacramento, CA 95814. For assistance call the CMAS information line at (916) 324-8045. Web site: <http://www.pd.dgs.ca.gov/select> CMAS).

- U.S. EPA's *Preliminary Guidelines for Recycled Content*. Web site: <http://www.epa.gov/epaoswer/non-hw/procure/products.htm>.
- *Guide to Resource Efficient Building Elements (GREBE)*. 1998. Edited by T. Mumma. Contact: Center for Resourceful Building Technology, Box 100, Missoula, MT 59806. Tel: (406) 549-7678. Web site: <http://www.montana.com/crbt>. Resource book on resource-efficient building systems. Updated regularly.
- *GreenSpec: The Environmental Building News Product Directory and Guidelines Specifications*. 1999. Published by E Build, Inc., Brattleboro, VT. Tel: (802) 257-7300. Web site: <http://www.buildinggreen.com/>. *GreenSpec* is organized in standard CSI divisions.
- California Integrated Waste Management Board's web site provides a "Recycled Content Product Procurement List" at <http://www.ciwmb.ca.gov/RCP/>. The database is searchable by CSI section number and provides links to manufacturers. The CIWMB also sponsors many Buy Recycled programs. Information on these programs can be found at <http://www.ciwmb.ca.gov/BuyRecycled/>.
- Sustainable Products Purchasers Coalition (SPPC). Web site: <http://www.sppcoalition.org/>.
- The Ecoproducts Directory. Web site: <http://www.ecoproducts.com/index.htm>.
- U.S. EPA's *Comprehensive Procurement Guidelines (CPG)*. The CPG program promotes the use of materials recovered from solid waste. Web site: <http://www.epa.gov/epaoswer/non-hw/procure/index.htm>. The products page, <http://www.epa.gov/epaoswer/non-hw/procure/products.htm>, provides an online list of construction, landscaping and other categories of products. The web site briefly describes each of the listed products. You also can view EPA's recommended recycled content ranges and a list of manufacturers, vendors and suppliers for each item. Also see the *Database for Environmentally Preferred Products*: <http://www.notes.erq.com> (this is an EPA contractor's web site).

Environmentally Preferable Product Evaluation Tools

The following resources provide methodologies or suggestions for evaluating products:

- BEES (Building for Environmental and Economic Sustainability) software helps analyze the environmental and economic performance of some building products. The software is downloadable at <http://www.bfrl.nist.gov/oea/software/bees.html>.
- *Environmental Resource Guide*. 1996. Edited by Joseph A. Demkin. Offers a methodology for preparing life-cycle assessments of building materials, materials comparisons, and case study information about how high performance buildings have worked in practice. Tel: (800) 346-0104.
- *Environmental Building News (EBN)*. Brattleboro, VT. Tel: (802) 257-7300. Web site: <http://www.buildinggreen.com/>. The leading green building professional journal. Offers excellent articles, product reviews, book reviews and resources. For online EBN product reviews available. Two pertinent articles are: "What Makes a Product Green?" (Vol. 9, No. 1: January 2000), which offers a simple methodology for evaluating a product; and "Material Selection Tools, Resources and Techniques for Choosing Green," (Vol. 6, No. 1: January 1997), which offers a survey of analytical tools and references for evaluating environmentally preferable materials.
- *Proceedings from the LAUSD Workshop on Sustainable Schools*. February 16, 2000. See the Breakout Session section on "Green" Materials and Systems, and other related sections. Available online at <http://www.eley.com/lausd>.



General Purpose Design and Evaluation Tools

Appropriate design tools are discussed in the overview of each technical chapter and within each guideline. Some general design and analysis tools are addressed here because they are common to many of the technical chapters that follow. More information on design tools can be found at http://www.eren.doe.gov/buildings/energy_tools/.

Conceptual Design Tools

Energy-10 is an educational tool that provides an overview of the performance interactions between different design strategies during conceptual design. For more information, visit the National Renewable Energy Laboratory's Energy-10 web site at <http://www.nrel.gov/buildings/energy10/> or the Sustainable Buildings Industry Council web site at <http://www.sbicouncil.org>.

Green Building Advisor™ (GBA) is a CD-ROM based software tool that can be used as a “first cut” to help designers identify building design strategies that can be incorporated into specific projects. Based on inputs provided by the user, GBA generates a list of prioritized strategies organized by categories. The software provides information on relative cost as well as case studies where the strategy has been implemented. Registered users get a user's manual and free technical support. For more information, call (802) 257-7300 or visit <http://www.buildinggreen.com/>.

Energy Analysis Tools

These are computer programs designed to predict the annual energy consumed by a building. They can be used to evaluate the energy impacts of various design alternatives and, in particular, to compare specific low-energy strategies (for example, higher insulation levels, better glazing, increased thermal mass) in terms of their impacts on overall building performance. Combined with accurate cost estimates, they can help create a high performance school that is optimized in terms of its overall energy performance, which can save money on initial construction costs as well as on long-term operating expenses.

For example, a school that combines daylighting strategies and highly efficient electric lighting in its classrooms will require less electricity to illuminate those classrooms, providing a long-term operating savings. In addition, the rooms, because they take advantage of daylight and use high efficiency lamps, may need fewer light fixtures overall to achieve a high quality visual environment, providing an upfront savings on initial costs. Finally, highly efficient lighting — and, potentially, fewer light fixtures — will result in less waste heat in each classroom. This, in turn, will allow the cooling system for the classrooms to be smaller, generating additional upfront savings.

A wide number of energy analysis tools are currently available, some appropriate for the early stages of a project, some for the later phases. A sampling of these tools is provided below. Energy performance analyses using one or a combination of these tools should be conducted during each of the following design phases: programming, schematic design, design development, construction documents, and bidding and negotiation.



Architectural Design Tools

These are used primarily during a project's programming, schematic design, and design development phases.

- *Building Design Advisor*. Contact: Lawrence Berkeley National Laboratory. Web site: <http://www.lbl.gov/>.
- *Energy Scheming*. Contact: Iris Communications. Web site: <http://www.oikos.com/esb/37/scheming.html>.
- *VisualDOE*. Contact: Eley Associates. Web site: <http://www.greendesigntools.com>.

Load Calculation and HVAC Sizing

These are used primarily during a project's design development and construction documents phases.

- *EnergyPlus*. This computer program, which is being developed by the U.S. Department of Energy, is considered to be the successor to both DOE-2 and BLAST. It combines features from both programs and includes modules for the thermal analysis of windows, radiant transfer within spaces and other features. Contact: Lawrence Berkeley National Laboratory. Web site: <http://www.lbl.gov/>.
- *DOE-2*. This widely used program for analyzing the energy efficiency of buildings uses an hourly weather file and simulates energy performance during a typical year. Contact: Lawrence Berkeley National Laboratory. Web site: <http://www.lbl.gov/>. There are several Windows user interfaces that make it easier to use DOE-2, including VisualDOE, PowerDOE, and EnergyPro.
- HAP. Contact: Carrier Corp. Web site: <http://www.carrier.com/>.
- TRACE. Contact: Trane Corp. Web site: <http://www.trane.com/>.
- *BLAST*. Contact: University of Illinois. Web site: <http://www.bso.uiuc.edu/>.

Anatomy of a Guideline

Each guideline in Volume II follows the format outlined below. Information relevant to multiple guidelines is typically discussed in the Overview for that chapter.

- **Recommendation:** A brief description of how to apply the high performance design concept to the building feature.
- **Description:** More detailed information on the technology or design strategy.
- **Applicability chart:** Indicates the applicability of the guideline to particular spaces, climate zones, and design process steps. (See the end of this section for more information on the climate zones covered in this manual.) In the example below, the black areas indicate the guideline's strong applicability and the gray areas represent limited applicability. Unshaded areas indicate that the guideline is not applicable.

Applicable Spaces	Climates	When to Consider
Classrooms	South Coast	Programming
Library	North Coast	Schematic
Multi-Purpose / Cafeteria	Central Valley	Design Dev.
Gym	Mountains	Contract Docs.
Corridors	Desert	Construction
Administration		Commissioning
Toilets		Operation
Other		



- **Applicable Codes:** Lists the codes and regulations that apply to the building feature described in the guideline. Although not listed in this document, local ordinances may also apply in some jurisdictions.
- **Integrated Design Implications:** Describes the implications that the design strategy or technology might have on other building systems, e.g., if cooling load is significantly reduced by high performance fenestration, the HVAC system might be made smaller and natural ventilation might become more viable. Discusses the phase of design when the strategy or technology might best be implemented.
- **Cost Effectiveness:** Describes the benefits and costs of the strategy/technology on both a system basis and an overall project basis. The chart below shows construction costs on the vertical scale, ranging from low to medium to high. The horizontal scale represents benefits, also categorized from low to medium to high. A black mark shows the overall project impact and a gray mark represents the system impact. In the diagram below, the system benefits are medium and the system costs are low, while the overall cost is high and benefits are low.

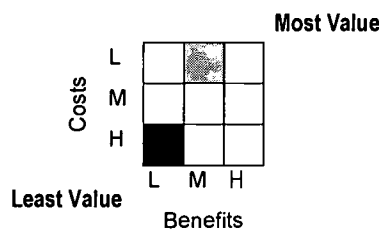

- For ranking the *system* benefits and costs:
 - Low represents an increase in costs or benefits of 0% to 20% over the basecase system.
 - Medium is a cost or benefit increase of 20% to 50% over the basecase system.
 - High is an increase in costs or benefits of more than 50% over the basecase system.
- For ranking the *overall* benefits and costs:
 - Low represents an increase in costs or benefits of 0% to 2% over the basecase system.
 - Medium is a cost or benefit increase of 2% to 8% over the basecase system.
 - High is an increase in costs or benefits of more than 8% over the basecase system.
- The cost scale refers only to the initial construction cost, which is a significant issue for schools and their architects. On an overall basis, low means that the incremental construction cost is small or even negligible and that the district should be able to afford the strategy/technology with the normal school construction budget. Medium cost means that the strategy/technology will cost a little more and the school construction budget will need to be supplemented or will need to realize savings from other systems, e.g., HVAC downsizing.

This section also presents general information on construction costs on a \$/ft² or \$/classroom basis, when possible. It identifies and quantifies operation and maintenance costs if applicable and/or possible. The section describes environmental costs or externalities that cannot be given a dollar value.

- **Benefits:** Outlines the benefits expected from the implementation of the measure including energy savings, improvements in indoor environmental quality, productivity benefits, and possible impact on average daily attendance.
- **Design Tools:** Lists any applicable design tools, including software that can be used to optimize the design, quantify the benefits, or estimate construction costs. In some cases, the section will



describe a technique for using a general-purpose tool such as DOE-2 to evaluate and analyze the design.

- **Design Details:** Contains more thorough details on the design, such as rules of thumb, specific recommendations, sample specifications, or schematic diagrams.
- **Operation and Maintenance Issues:** Outlines potential operation and maintenance concerns and requirements for keeping the strategy/technology operating at optimal performance.
- **Commissioning:** Discusses the need for calibration, functional tests, static tests, commissioning plan requirements, statement of design intent, post-occupancy tests, and other issues and requirements related to ensuring that the strategy/technology was implemented as the designer intended.
- **References / Additional Information:** Provides as sampling of documents, websites, etc. where additional information about the strategy/technology can be found.
- **Related Volume III CHPS Criteria:** Lists the CHPS prerequisites and credits that are applicable to the guideline. These criteria address all aspects of high performance design. Points are assigned to each credit. A "CHPS School" must meet all the prerequisites and earn at least 28 out of the total 81 points.



Climates



California Climate Regions

The guidelines are developed for the five California climate regions shown here. Many of the recommendations vary depending on the climate where the school is constructed. In these cases, the recommendations, and their applicable climate zones, will be indicated in both the guideline text and the applicability chart described in the previous section.

BEST COPY AVAILABLE



GENERAL CONDITIONS

This chapter provides guidelines for preparing the general conditions portion of the construction specification. These guidelines mostly address requirements for the general contractor including:

Sustainable Job-Site Management ([Guideline GC1](#))

Construction and Demolition (C&D) Waste Management ([Guideline GC2](#))

Indoor Air Quality During Construction ([Guideline GC3](#))

Site Protection During Construction ([Guideline GC4](#))

Contractor's Commissioning Activities ([Guideline GC5](#))

Overview

This chapter's guidelines aim to ensure that the methods used to build the school and operate the construction site are environmentally sound. It is not only important to end up with a high performing school; the means to get there should be consistent with that end.

During construction, literally hundreds of opportunities exist to work toward fulfilling the environmental goals of a high performance school or, alternatively, to compromise them. To ensure the construction process is consistent with these goals, contractors should be made aware of them upfront, as part of the bidding process. Ideally, the selected contractor should have experience with some of the practices recommended in this Best Practices Manual. At a minimum, they should be aware of, and responsive to, the goals set for the project. The clearer the expectation that contractors will play an important role in achieving these goals, the more likely the construction process will go smoothly in this regard.

Using Environmentally Preferable Methods During Construction

During construction, general and trade contractors have a significant role to play in making efficient use of materials, preventing future indoor air quality problems, and protecting the site from degradation. Several of the guidelines will help designers direct contractors in this capacity.

In practice, requiring the contractor produce and implement a job-site operations plan has proven to be *the* most effective way to ensure that environmental goals will be given equal treatment along with other project goals.

Sustainable job-site operational costs are generally minimal, and cost benefits can be significant. Planning helps minimize costs and liabilities, including expensive delays, stoppages, and callbacks due to mistakes made during construction. Savings resulting from job-site waste reduction practices are well documented. Contractors familiar with sustainable job-site operations will know the benefits and understand that these are not complicated practices. Contractors unfamiliar with them, however, will assume they cost more and bid accordingly. Bid packages should contain references to existing

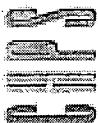

resources to help contractors familiarize themselves with these types of plans as well as provide tools to estimate costs and benefits more accurately.

A sustainable job-site operation will use a combination of contract language, signage, weekly job-site meetings, and incentives/rewards to educate and motivate field personnel to ensure everyone works towards this goal. Brief presentations, signage that both informs and motivates by reporting progress on environmental goals, and contractor's field guides can be helpful communication aids. On most construction sites, signage and other printed instructions will need to be written so individuals for whom English is a second language can easily understand.

In addition, the most successful contractors identify an individual (often the safety officer) who can enforce the sustainable job-site operations plan on a day-to-day basis. With many recommended job-site practices, it is difficult to determine whether they actually occur without regular in-the-field monitoring. Ideally, the same individual monitoring compliance would take an active role in training and other on-site educational efforts.

Achieving the Design Intent of a High Performance School

Perhaps the most important contribution the contractor can provide in achieving high performance goals for the school is in participating in the commissioning process. The entire point of this process is to demonstrate that the installed components of building systems meet the original design intent. (See the Commissioning chapter for more detailed discussions of the process.) Contractors can play a key role in effective commissioning by providing timely documentation, understanding the importance of thorough testing and tuning, paying attention to detail when correcting problems, and being responsive to the commissioning agent's recommendations and requests.

Installation schedules of a high performance school may be different from a conventional school. For example, the California Department of Health Services' "Reducing Occupant Exposure to Volatile Organic Compounds (VOCs) from Office Building Construction Materials Non-Binding Guidelines" recommends that "porous materials, such as carpets and fabric-covered office dividers...be installed last." This practice prevents the porous materials from acting as a "sink" for VOCs being emitted by wet products (paints and other finishes, for example). Proper sequencing can be spelled out in execution articles of pertinent specification sections, but may also be called out under general conditions. In addition, ventilation and flush-out requirements during and after installation will need to be specified in appropriate sections.

In addition, product substitutions (especially those made in the field due to last-minute availability problems) can contribute to losing sight of the original design intent. When substitutions in the field occur, submittals must show that these substitutions possess the environmentally preferable characteristics of the original product or material specified. A sustainable job-site operations plan should specify a method to providing documentation for substituted products, so that, in the event of replacement or repair, the information is available to the custodial staff. In addition, when dealing with non-conventional or innovative materials, it can be helpful to note information in a field log about how a product behaves during installation and pre-occupancy maintenance (such as during cleanup), as well as any other "lessons learned."



Guideline GC1: Sustainable Job-Site Operations Plan

Recommendation

Require a job-site operations plan that includes protocols for Job-Site Waste Reduction (Guideline GC2), Indoor Air Quality (IAQ) (Guideline GC3), and Site Protection (Guideline GC4).

Description

A sustainable job-site operations plan will describe goals, construction practices to achieve those goals, methods to train or otherwise communicate these goals to field personnel, and methods to track and assess progress towards those goals. For each component of the plan (waste reduction, IAQ, and site protection), these elements will be specified. In addition, the plan will specify the method of documenting compliance with these goals, including in the case of product substitutions.

Applicability

Job-site management is applicable to all spaces in schools and to all climates. While it is carried out in the construction phase, the contract documents must clearly specify the expectations of the general contractor.

Applicable Codes

There are many jurisdictions in California (at the county and city level) that have developed, or are developing, ordinances that require job-site waste management planning. (See GC2 for more information.) In addition, local school districts are beginning to develop IAQ policies that incorporate some operational requirements for construction. (See GC3 for more information.) The U.S. Green Building Council's LEED Green Building Rating System (Commercial, Version 2) includes a provision for an IAQ construction plan as well. All jurisdictions include some requirements related to water quality protection, in particular stormwater management during construction. More communities are adopting "green building ordinances" that capture some elements of sustainable job-site operations.

Integrated Design Implications

A sustainable job-site operations plan protects the integrity of design goals to reduce waste, improve air quality, and protect the site and surrounding waterways from degradation.

Cost Effectiveness

Costs for implementing the plan will include labor for overseeing and documenting compliance, and should not be significant.

Benefits

Having a plan in place helps minimize costs and liabilities, including delays, stoppages,

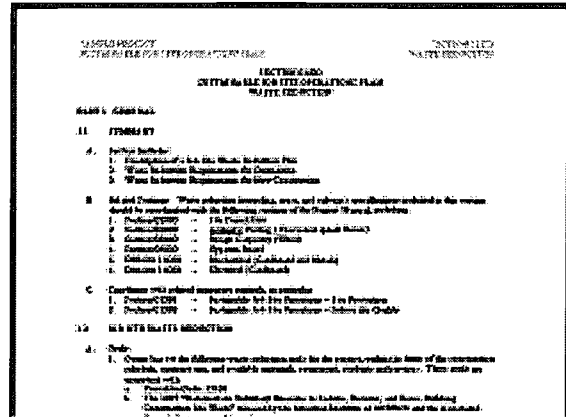

Sample Sustainable Job Site Operations Plan

Applicable Spaces	Climates	When to Consider
Classrooms	South Coast	Programming
Library	North Coast	Schematic
Multi-Purpose / Cafeteria	Central Valley	Design Dev.
Gym	Mountains	Contract Docs.
Corridors	Desert	Construction
Administration		Commissioning
Toilets		Operation
Other		

Costs	L	■	
	M	□	
	H	□	
	L	M	H
	Benefits		

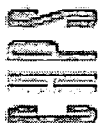

and residual problems in the completed school building. Proper planning is always more cost-effective than cleaning up after a mistake.

Design Tools

None.

Design Details

The requirement for a sustainable job-site operations plan would appear in the "Temporary Controls" section(s) of specifications. The more clearly a plan allocates responsibilities and expectations, the less likely the project will generate unpleasant surprises during and after construction. Ideally, the plan should specify a time requirement for when a plan must be submitted, such as within 14 days of Notice of Award and prior to applicable construction activities. In addition, it can include sample forms, references, or other resources for the contractor to help facilitate development of an effective plan. Sample specifications for the three plan components recommended in this guideline — job-site waste reduction, IAQ, and site protection — can be found in the electronic Appendix A⁴.

Operation and Maintenance Issues

The plan should specify a method of providing documentation for products substituted in the field, so that information is available to custodial staff should a replacement or repair be required. In addition, when dealing with non-conventional or innovative materials, information about how a product behaves during installation and pre-occupancy maintenance (such as during cleanup), as well as other "lessons learned" noted in a field log can be helpful.

Commissioning

None.

References/Additional Information

Please see the References listed for individual components of the plan in the following guidelines: GC2, GC3, GC4. Also see electronic Appendix A for sample specifications language.

Related Volume III CHPS Criteria

Site Prerequisite 2: Construction Erosion.

Materials Credit 1: Site Waste Management.

IEQ Credit 4: Construction IAQ Management Plan.

⁴ The electronic appendices are located on-line at <http://www.eley.com/chps/manual> or on the CD-ROM version the Manual.



Guideline GC2: Construction and Demolition (C&D) Waste Management

Recommendation

Require waste reduction planning and job-site practices. These guidelines recommend that a sustainable job-site operations plan (Guideline GC1) be developed that incorporates a job-site waste reduction component. An alternative is to develop a stand-alone Construction and Demolition (C&D) Waste Management Plan.



Conducting a Construction Site Waste Audit. Photo courtesy of O'Brien & Company.

Description

Effective job-site waste management will reduce the amount of C&D waste generated, as well as divert materials generated through C&D processes from disposal through reuse (salvage) and recycling. This effort can be combined with a concerted use of salvaged or recycled-content building materials throughout the building project; specific materials would be called out in appropriate sections of project specifications.

C&D waste management will include the development of a waste reduction plan, identification of personnel responsible for implementing and monitoring the plan, and an outline of consequences for non-compliance. Waste management should reflect the prioritized hierarchy of "Reduce, Reuse, and Recycle" with recycling efforts occurring in concert with *source reduction* and applying only to materials that *cannot be reused*. The concept of source reduction eliminates or reduces potential waste prior to generation. By reducing waste and using materials efficiently, money will be saved on purchasing and avoided disposal costs. If materials are not generated in the first place, recycling efforts should only apply to materials that cannot first be reused.

Applicable Spaces	Climates	When to Consider
Classrooms	South Coast	Programming
Library	North Coast	Schematic
Multi-Purpose / Cafeteria	Central Valley	Design Dev.
Gym	Mountains	Contract Docs.
Corridors	Desert	Construction
Administration		Commissioning
Toilets		Operation
Other		

Applicability

Construction waste management is applicable in all climates and in all types of school spaces. While carried out during the construction phase, the contract documents must clearly layout the responsibilities of the general contractor.

Applicable Codes

Because local jurisdictions in California faced fines for not meeting the state goal of diverting 50% of waste from landfills by December 31, 2000, many jurisdictions at the county and city level have developed, or are developing, ordinances related to C&D waste management. In some cases, these ordinances apply only to municipally owned projects. Some ordinances exempt C&D projects below a specified dollar value or size.

These ordinances generally require a C&D waste management plan and implementation documentation for permitting, often providing a sample form for this purpose. In some cases, the ordinances require a minimum level of C&D materials diversion from landfills, or at the very least, a "good faith effort." In



addition, at least two ordinances require deposits be held until proof of compliance with waste reduction requirements has been provided.

Whether developing a stand-alone C&D waste management plan or a job-site waste reduction plan as part of an overall sustainable job-site operations plan, it will be important to be familiar with relevant ordinances to ensure the project specifications are in compliance. For a sample of C&D waste related ordinances, see <http://www.ciwmb.ca.gov/ConDemo/SampleDocs>.

Integrated Design Implications

Some waste reduction can be designed into the building project, such as standardized dimensioning, modular or panelized building units, and layout of openings (see the Building Enclosure Chapter). Specifying the use of mechanical fasteners (screws, Velcro) rather than chemical adhesives and solvents will allow components to be easily disassembled and reused.

It will be important that intent of these design details be made clear to avoid in-the-field decisions that waste materials. Contractors are excellent problem solvers, and should be encouraged to find cost-effective substitutes that they know will meet or exceed the environmental goals.

Improper handling of materials on the job site can add to construction waste. Materials contaminated by mildew and mold due to moisture exposure have to be discarded and replaced.

Cost Effectiveness

Costs include labor for overseeing and implementing the C&D waste reduction (or waste management) plan, rental for additional bins or other containers used for recycling or salvage, and transportation. Research indicates labor costs decrease significantly as contractors become more familiar with job-site waste reduction techniques. Some contractors keep costs down by utilizing temporary lay down areas with plywood barriers to hold recyclables, rather than renting bins or containers. Alternatively, planning ahead and ordering bins only when needed can keep down costs, since C&D materials are typically generated at predictable phases of the project.

Costs	L			
	M			
	H			
		L	M	H
		Benefits		

Waste disposal/management is generally budgeted as a very small portion of overall job costs. However, the cost of purchasing materials to replace materials that are wasted is rarely taken into account. The tendency is to assume that effective waste reduction takes more time and results in higher costs, but case studies show that, if labor crews are adequately trained and a good plan is in place, costs do not increase.

Benefits

In general, C&D waste reduction should also reduce overall construction costs, especially as the practice becomes a part of every job, and the C&D recycling/reuse infrastructure matures. If revenues from waste reduction, reuse/salvage, and recycling are allocated to the contractor, the responsibility (and the incentive) for waste reduction clearly lies in the contractor’s domain. Most contractors report that having a good waste reduction program in place results in a cleaner, safer site, resulting in less lost time and delay.

Environmentally, less waste means better use of limited raw materials and of the energy required to produce, transport, and dispose of building products used in the project. Also, recycling provides “stock” for new materials to be manufactured.

Design Tools

See the sample specifications included in *Green Spec: The Environmental Building News Product Directory and Guideline Specifications*. Also see the electronic Appendix A for sample specification language.



Design Details

Scheduling should permit salvaging and deconstruction activities, as appropriate.

Waste reduction goals (as with all other sustainable building goals) should be outlined in the Instructions to Bidders section of the Project Summary. The California Integrated Waste Management Board (CIWMB) recommends a goal of 75% diversion of C&D materials by weight. In addition, waste reduction specifications should be included in the Temporary Controls sections of General Conditions. A 13-step construction and demolition site recycling process can be found on pages 132-134 in the CIWMB publication, "Designing With Vision...A Technical Manual for Material Choices in Sustainable Construction."

As part of identifying those materials that should be targeted for recycling or reuse in a particular project, contact the local waste authority for information about building materials that can be cost-effectively recycled or salvaged in the project area. These materials, an example being gypsum drywall, should be called out for recycling in the General Conditions specifications section pertaining to waste reduction and in other pertinent sections.

Waste reduction specifications should reflect local jurisdictional requirements, but should be organized using typical CSI convention. The specifications should describe what is included in the job-site waste reduction plan, outline submittal and documentation requirements; indicate ownership of revenues resulting from waste reduction efforts; and include performance goals like minimum levels of waste reduction. The specifications should also outline remedies in the event those levels cannot be met.

If the contractor is required by ordinance or specification to be responsible for achieving waste reduction, it is not necessary to detail methods by which the contractor can achieve it. However, it is informative to contractors to include a list of proven waste reduction strategies, such as:

- A pre-C&D waste management meeting to discuss procedures, schedules, coordination, and special requirements for materials.
- A waste reduction provision in supply agreements specifying a preference for reduced, U-turn, and/or recyclable packaging.
- Detailed take-offs that identify location and use in the structure to reduce risk of unplanned and potentially wasteful cuts.
- Proper storage for materials to avoid water or other damage as well as outdating. Materials that become wet or damp due to improper storage shall be replaced at contractor's expense.
- Safety meetings, signage, and subcontractor agreements that communicate the goals of the waste reduction plan. Signage should be clear and easy to understand for multiple languages, through the use of graphic symbols.
- On-site instruction regarding appropriate separation, handling, recycling, salvage, reuse, and return methods to be used to achieve waste reduction goals.
- Discussion of C&D waste management during regular job meetings and safety meetings.
- Contamination protection for materials to be recycled.

Operation and Maintenance Issues

Contractors should be required to provide sufficient information on product substitutions to enable the operation and maintenance staff to properly maintain, repair, and replace all products.

Commissioning

None.



References/Additional Information

- California Integrated Waste Management Board web site. In particular, see "Job Site Source Separation," a fact sheet located at <http://www.ciwmb.ca.gov/ConDemo/factsheets/JobSite.htm>. Also see the Clean Washington Center's *Recycling Plus Manual* at <http://www.ciwmb.ca.gov/ConDemo/Links.htm>. Use this resource to produce a step-by-step construction waste management and recovery plan. *Designing with Vision: A Technical Manual for Material Choices in Sustainable Construction*. Chapter 9, Managing Job-Site Waste addresses C&D waste and is located at <http://www.ciwmb.ca.gov/ConDemo/Pubs.htm>.
- U.S. Environmental Protection Agency, *Characterization of Building-Related Construction and Demolition Debris in the United States*, June 1998 at <http://www.epa.gov/epaoswer/hazwaste/sqg/demol.htm>. Provides national data that a builder may find helpful to estimate and characterize his own waste generation.
- U.S. Green Building Council's *Reference Manual for LEED Green Building Rating System* (Commercial, Version 2) at <http://www.usgbc.org>.
- For product substitutions, refer contractors to the CIWMB web site. Also refer to Green Spec: The Environmental Building News Product Directory and Guideline Specifications (<http://www.buildinggreen.com/>), and the OIKOS web site (<http://www.data.oikos.com/products>).

Related Volume III CHPS Criteria

Materials Credit 1: Site Waste Management.



Guideline GC3: Indoor Air Quality During Construction

Recommendation

Require indoor air quality (IAQ) planning and preventive job-site practices.

Description

Preventive job-site practices can reduce residual problems with IAQ in the completed building and eliminate undue health risks for workers. "Healthy" job-site planning will adequately address problem substances, including construction dust, chemical fumes, off-gassing materials, and moisture. It will make sure these problems are not introduced during construction, or, if they must be, eliminates or reduces their impact. Areas of planning will include product substitutions and materials storage, safe installation, proper sequencing, regular monitoring, as well as safe and thorough cleanup.

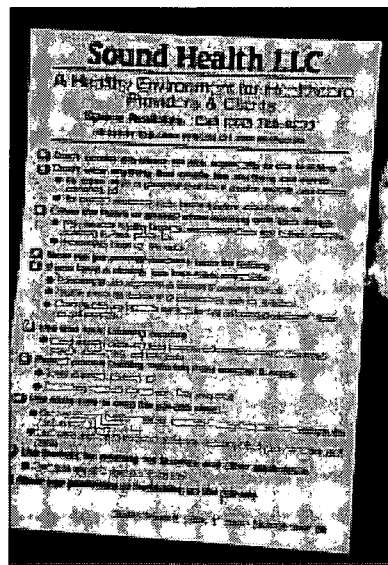

Healthy Job Site Signage. Photo courtesy of O'Brien & Company.

Applicability

Maintaining healthy job-site conditions is important for all spaces and all climates. The activity is carried out in the construction phase, but must be planned in the design development and contract documents phases.

Applicable Spaces	Climates	When to Consider
Classrooms	South Coast	Programming
Library	North Coast	Schematic
Multi-Purpose / Cafeteria	Central Valley	Design Dev.
Gym	Mountains	Contract Docs.
Corridors	Desert	Construction
Administration		Commissioning
Toilets		Operation
Other		

Applicable Codes

Local school districts are beginning to develop IAQ policies that incorporate construction operational requirements. See for example, the **Materials/Indoor Air Quality Policy for School District Buildings, 1994-1995**. Berkeley Unified School District, Berkeley, CA. Check with local jurisdiction to see if a similar policy is in place. In addition, the U.S. Green Building Council's LEED Green Building Rating System (Commercial, Version 2) includes a provision for an IAQ construction plan. This provision requires that the project contractor "meet or exceed the minimum requirements of the Sheet Metal and Air Conditioning National Contractors Association (SMACNA) IAQ Guidelines for Occupied Buildings Under Construction, 1995."

Integrated Design Implications

When identifying "healthy" materials for use in buildings, the focus is generally on preventing problems during occupancy. This guideline implies some responsibility for air quality falls during installation, which may impact the choice of material and/or the method of installation. Also, since substitutions may happen in the field, it is important to outline the approval process for these substitutions clearly. For materials with off-gassing potential, require specific ingredient information about the product itself (as well as any adhesives, solvents, or other products that might be used during installation or maintenance). Designing to use mechanical fasteners (screws, Velcro) rather than chemical adhesives and solvents can reduce potential problems with IAQ during construction.

BEST COPY AVAILABLE



Cost Effectiveness

Implementing this guideline should not necessarily add cost to the project. The one area it might add cost is in the form of potential delays due to sequencing and ventilation requirements. However, this cost can be avoided by proper planning.

Costs	L			
	M			
	H			
		L	M	H
		Benefits		

Risk managers will be reluctant to take on the added responsibility of requiring IAQ planning and preventive job-site practices. However, school districts and project architects across the country have experienced litigation related to poor IAQ resulting from construction activities. Addressing these issues before and during construction will reduce exposure of the district and designers to potentially expensive litigation in the future.

Benefits

The costs of poor IAQ are difficult to quantify, but considerable. They include the sum of illness and decreased student productivity paid by students and teachers, along with the district's cost of equipment replacement, workers' compensation claims, and in the most severe cases, potential litigation. Unfortunately, serious health complaints have resulted from careless acts during construction projects, such as failure to clean up spilled adhesives or neglecting to properly ventilate during and after applying sealants in an occupied building. These mistakes have led to school closures, unpleasant headlines, and costly lawsuits. Good IAQ strategies during construction will help eliminate these potential liabilities.

Design Tools

See electronic Appendix A for sample specification language.

Design Details

IAQ goals (as with all other sustainable building goals) should be outlined in the Instructions to Bidders as part of the Project Summary addition. IAQ specifications should be included in the Temporary Controls sections of General Conditions.

The specifications should describe what is included in an IAQ construction plan, outline submittal requirements, and reference the SMACNA IAQ Guidelines for Occupied Buildings Under Construction 1995, with the goals of:

- Protect the ventilation system components from contamination, or provide cleaning of the ventilation components exposed to contamination during construction prior to occupancy.
- Provide a minimum continuous ventilation rate of one air change per hour during construction, or conduct a building flush-out with new filtration media at 100% outside air after construction ends (following issuance of Occupancy Certificate) and prior to occupancy for seven days (one week). Provide a minimum of 85% filtration (as determined by ASHRAE Standard 52.1-1992) on any return air systems operational during construction, and replace filtration media prior to occupancy. Note that seven days is considered a minimum. IAQ specialists recommend flushing the building with 100% outside air for 30 days prior to substantial completion.

If the contractor is required by the specification to be responsible for protecting IAQ during construction, it is not necessary to detail methods by which the contractor can achieve it. However, it is informative for contractors to include a list of proven air quality protection strategies, such as:

- Use supplemental (temporary) ventilation during the installation of carpet, paints, furnishings, and other volatile organic compound (VOC)-emitting products, for at least 72 hours after work is completed. Preferred HVAC system operation uses supply air fans and ducts only, with windows providing exhaust. Use exhaust fans to pull air from deep interior locations. Stair towers and other paths to the exterior can be useful during this process.
- Perform regular inspection and maintenance of IAQ measures, including ventilation system protection and ventilation rate.

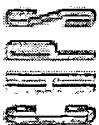

- Provide VOC-safe masks for workers installing VOC-emitting products (interior and exterior), which are defined as products that emit 150 grams per liter (gpl) or more. If local jurisdiction's requirements are stricter, the strictest requirement should be followed for use of VOC-safe masks.
- Provide low-toxic cleaning supplies for surfaces, equipment, and worker's personal use. Options include several soybean-based solvents and cleaning options (SoySolv), and citrus-based cleaners.
- Wet sand gypsum board assemblies. Exceptions should be clearly defined and include full isolation of space undergoing finishing or closure of all air system devices and ductwork. Additional conditions can be set.
- Use safety meetings, signage, and subcontractor agreements to communicate the goals of the construction IAQ plan.

The IAQ construction plan is also a good opportunity to proscribe unacceptable behaviors that represent a potentially negative impact on long term IAQ such as smoking, using chew tobacco, or wearing contaminated work clothes.

Operation and Maintenance Issues

Contractors should be required to provide information on product substitutions sufficient to enable operation and maintenance staff to properly maintain and repair low-emitting or otherwise "healthy" materials.

Commissioning

None.

References/Additional Information

U.S. Green Building Council's *Reference Manual* for LEED Green Building Rating System (Commercial, Version 2) at <http://www.usgbc.org>. Also see Carpet and Rug Institute (CRI) guidelines for carpet installation. The Painting Contractors Union (New York City local) has reportedly developed guidelines for ventilation during painting.

U.S. Environmental Protection Agency. <http://www.epa.gov/iaq/schools/tfs/renovate.html>. A checklist for IAQ issues at all stages of construction.

For product substitutions, refer contractors to the CIWMB web site. Also refer to Green Spec: The Environmental Building News Product Directory and Guideline Specifications (<http://www.buildinggreen.com/>), and the OIKOS web site (<http://www.data.oikos.com/products>).

Related Volume III CHPS Criteria

IEQ Credit 4: Construction IAQ Management Plan.



Guideline GC4: Site Protection During Construction

Recommendation

Require best management practices for site protection during construction.

Description

An effective job-site protection plan will describe construction practices that eliminate unnecessary site disturbance, minimize impact on the site's natural (soil and water) functions, and eliminate water pollution and water quality degradation.

Primarily it will include protocols for:

- Construction equipment operation and parking.
- Topsoil and vegetation protection and reuse.
- Hazardous materials management.
- Installation and maintenance of erosion control and stormwater management measures.

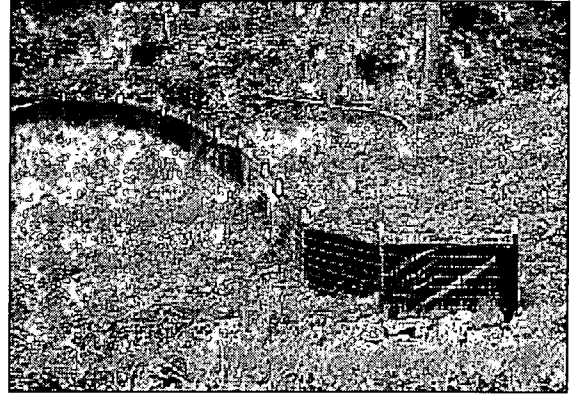

Silt Fencing for Sedimentation Control. Photo courtesy of O'Brien & Company.

Applicability

This guideline applies to all climates and spaces.

Applicable Spaces	Climates	When to Consider
Classrooms	South Coast	Programming
Library	North Coast	Schematic
Multi-Purpose / Cafeteria	Central Valley	Design Dev.
Gym	Mountains	Contract Docs.
Corridors	Desert	Construction
Administration		Commissioning
Toilets		Operation
Other		

Applicable Codes

All jurisdictions include some requirements related to water quality protection, in particular stormwater management and erosion control during construction. Local policies may govern other construction activities covered in this guideline. Please check with the local jurisdiction.

Integrated Design Implications

The plan should be integrated with stormwater management and erosion control measures (see the Site Planning chapter). In addition, a requirement to submit ingredient information about in-field product substitutions to avoid degradation of water quality on the site is important.

Cost Effectiveness

This guideline recommends going beyond typical site practices. The project architect needs to evaluate the risk of erosion problems to determine whether redundant erosion control measures are cost effective. Least-toxic pest and weed control is quite cost effective, as it can provide savings and an increased level of safety for students who will be using the school grounds.

Costs	L			
	M			
	H			
		L	M	H
		Benefits		

Benefits

Construction delays and work stoppages due to erosion control failure are avoided. Water quality in surrounding waterways and groundwater supplies are protected. Health risks to students due to residual toxicity on the site can be reduced.



Design Tools

See electronic Appendix A for sample specification language.

Design Details

Site protection (as with all other sustainable building goals) should be outlined in the Instructions to Bidders as part of the Project Summary. In addition, site protection specifications should be included in the Temporary Controls sections of General Conditions. The specifications should describe what is included in a site protection plan, outline submittal requirements, and recommend strategies, including:

- Regular inspection and maintenance of site protection measures. At a minimum, inspection of all erosion and sedimentation measures after a heavy rainfall, which is defined as 0.5 in. in less than 24 hours.
- Redundant mechanisms for site protection of any critical or sensitive areas, as identified in the site plan. Silt fencing fabric and other temporary site protection measures should be selected to last for the life of the project.
- Measures to ensure that detergent does not get into soil and sediment separators.
- Posted protocol for construction vehicles regarding parking and access on the site.
- Rocked heavy construction vehicle entrance and tire wash.
- Posted clean-up procedures for spills to prevent illicit discharges.
- Measures to minimize risk of the toxic release of hazardous wastes, including paints and other finish products, solvents, adhesives, and oils as follows:
 - Avoid overstocking.
 - Adopt a first-in, first-out policy.
 - Label containers properly.
 - Control access to storage areas and routinely inspect containers.
 - Inspect all containers upon receipt. Reject leaking or damaged containers.
- Topsoil preparation, planting, and maintenance using Integrated Pest Management (least-toxic) protocol. Least-toxic products for controlling pests and insects in detention ponds and for soil prep. No chemical weed eradication.
- Safety meetings, signage, and subcontractor agreements that communicate the goals of the site protection plan.

Operation and Maintenance Issues

Operation and maintenance staff should be informed that least-toxic products have been used for soil preparation and for controlling pests and insects in detention ponds. Also, contractors should be required to provide information on product substitutions sufficient to enable operation and maintenance staff to properly maintain site protection measures.

Commissioning

None.

References/Additional Information

Ross Middle School. Ross School District, CA. Completed in 1999. For more information contact Dana Papke, DPapke@CIWMB.ca.gov.

U.S. Green Building Council's *Reference Manual* for LEED Green Building Rating System (Commercial, Version 2) at <http://www.usgbc.org>. Also see the Environmental Protection Agency (EPA) publication: Stormwater Management for Construction Activities, Chapter 3.

For product substitutions, refer contractors to the CIWMB web site. Also refer to Green Spec: The Environmental Building News Product Directory and Guideline Specifications (<http://www.buildinggreen.com/>), and the OIKOS web site (<http://www.data.oikos.com/products>).

Related Volume III CHPS Criteria

Site Prerequisite 2: Construction Erosion.



Guideline GC5: Contractor's Commissioning Responsibilities

Recommendation

Require that the contractor provide the commissioning agent (CA) with information needed to facilitate the commissioning process and to coordinate activities with the CA as needed.

Description

Commissioning is a systematic, documented process including visual examination and functional performance testing to demonstrate that installed components or systems, as well as the building overall, meet the intent of the original design. A CA is someone qualified to provide an independent inspection of the building or site/landscape component or system being commissioned. This guideline recommends that the contractor be required to coordinate with the CA and provide information as needed to optimize commissioning results. Contractors will be involved in fine-tuning and correcting systems when commissioning indicates this is needed. See the Commissioning chapter for more information.

Applicability

This requirement is applicable to all climates and spaces. It is implemented in the construction phase, but needs to be considered in both the design development and contract documents phase.

Applicable Codes

None.

Integrated Design Implications

None.

Cost Effectiveness

Costs for this aspect of commissioning are minimal. Overall, commissioning has the potential for producing savings in avoided delays and other startup problems.

Benefits

Requiring contractor coordination will facilitate effective commissioning. Commissioning can provide tremendous economic benefits as well as improve building performance.

Design Tools

None.

The Five Phases of Building Commissioning

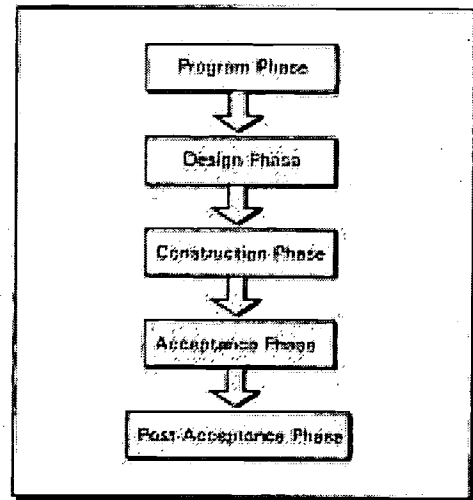

Figure 2-1 from Building Commissioning Guide (See References/Additional Information).

Applicable Spaces	Climates	When to Consider
Classrooms	South Coast	Programming
Library	North Coast	Schematic
Multi-Purpose / Cafeteria	Central Valley	Design Dev.
Gym	Mountains	Contract Docs.
Corridors	Desert	Construction
Administration		Commissioning
Toilets		Operation
Other		

Costs	L			
	M			
	H			
		L	M	H
		Benefits		

BEST COPY AVAILABLE

Design Details

Commissioning goals (in addition to all high performance building goals) should be outlined in the Instructions to Bidders as part of the Project Summary. A requirement that the contractor coordinate with the CA should be included in General Conditions. (A separate commissioning agreement will be drawn up between the district and the CA.) Other commissioning requirements for the contractor will appear in pertinent sections, including mechanical and electrical. (If the contractor is responsible for hiring the CA, a special section incorporating commissioning requirements should be written, and the "coordination" aspect of this guideline would be part of the agreement between the contractor and the CA.)

The contractor should be informed of the types of systems that will be commissioned, the types of information that may be required, and his responsibilities in terms of correcting problems that are identified. Types of systems to be commissioned may include:

- HVAC plant.
- Air and water delivery system.
- Energy management system.
- Electrical and lighting system.
- Fire/life safety system.
- Data networks/communications.
- Security system.
- Irrigation system.
- Kitchen equipment.
- Building envelope.
- Renewable energy system.
- Fume hoods.
- Science lab gas delivery system.
- Emergency power supply.
- Plumbing.

Frequently it is difficult to enforce the requirement that the contractor finish all commissioning tasks prior to Substantial Completion. A practical solution is to provide an incentive to complete the work, by applying a penalty if such tasks are not performed by "functional" completion. Exceptions would be seasonal or "approved deferred" testing and controls training. Functional and substantial completion should be defined in the general conditions of the construction contract.

During construction, building systems are installed, undergo pre-functional performance tests, and are placed into operation. Once construction is completed, all building systems should be operating as designed, both individually and collectively, and are ready for functional performance testing. The contractor assists in all aspects of the commissioning process, including documentation; pre-functional testing; start-up and initial checkout; initial controls checkout; testing; adjusting and balancing (TAB); functional testing for individual systems and integrated systems; verification; training of operation and maintenance personnel; and operation and maintenance manual development and review. In practice, some of the system checks included in full commissioning are performed, but rarely documented.

Operation and Maintenance Issues

The contractor will be required to provide documentation and information for the commissioning process that will be incorporated into an operation and maintenance plan or manual.

Commissioning

None.

References/Additional Information

U. S. Department of Energy's Federal Energy Management Program (FEMP), in cooperation with the General Services Administration (GSA), developed the *Building Commissioning Guide* as part of GSA's facility commissioning program to ensure that construction of new facilities meets the requirements. Chapter 10 of this document includes an extensive list of additional resources related to building commissioning. Version 2.2 of the Guide, along with *Model Commissioning Plan*



and *Guide Specifications* and sample functional tests and checklists can be downloaded from FEMP's web site at: <http://www.eren.doe.gov/femp/techassist/bldgcomqd.html>.

A web site dedicated to providing access to documents dealing with the Guidelines for Total Building Commissioning is being developed under the auspices of the National Institute of Building Sciences. The site is maintained by the Florida Design Initiative and is organized around the individual technical guidelines that will comprise the complete set of Guidelines for Total Building Commissioning. <http://sustainable.state.fl.us/fdi/edesign/resource/totalbcx>.

Implement Building Commissioning, published by U.S. Department of Energy, Rebuild America, EnergySmart Schools program (Washington, DC, 2000); available at http://www.eren.doe.gov/energysmartschools/om_implement.html. Defines building commissioning; discusses the selection of a commissioning agent; the benefits, approaches, and components of commissioning; and lists resources.

Sustainable Building Technical Manual: Green Building Design, Construction, and Operations, produced by Public Technology, Inc., U.S. Green Building Council (USGBC), and U.S. Department of Energy, with support from EPA, 1996. See Chapter 15, "Building Commissioning." Available from USGBC, San Francisco, CA; Phone: (415) 445-9500 or download at <http://www.sustainable.doe.gov/pdf/sbt>

The University of Washington offers a commissioning guide in its Facility Design Information Manual, much of which can be applied to K-12 schools. <http://depts.washington.edu/fsesweb/fdi>.

Related Volume III CHPS Criteria

Energy Prerequisite 2: System Testing & Training.

Energy Credit 4: Commissioning.

District Credit 2: IAQ Management Plan.

District Credit 3: Maintenance Plan.



SITE PLANNING

This chapter provides guidelines for:

Optimum Building Orientation (Guideline SP1)

Landscaping to Provide Shade to HVAC Equipment, Buildings, and Paved Areas (Guideline SP2)

Safe and Energy-Efficient Transportation (Guideline SP3)

Landscape Design and Management (Guideline SP4)

Impervious Surfaces (Guideline SP5)

Native and Drought-Tolerant Plants (Guideline SP6)

Landscaping Soil, Amendments, and Mulch (Guideline SP7)

Water-efficient Irrigation Systems (Guideline SP8)

Stormwater Management, Groundwater Management, and Drainage Materials (Guideline SP9)

Rainwater Collection Systems (Guideline SP10)

Gray Water Systems (Guideline SP11)

Integrated Weed, Disease, and Pest Management (Guideline SP12)

Overview

Site planning is a fundamentally important aspect of high performance design. The choices made during site selection and site planning reverberate throughout the entire school. All aspects of high performance design — from energy and water efficiency, to acoustic comfort and environmental impacts — are affected. Furthermore, every site and district will face unique constraints.

Some districts have the luxury of choosing between several options while other districts have known for years the precise site that must be used. It is

important to remember that regardless of what site is chosen, and whether it is in an urban or rural landscape, the site can be developed wisely to incorporate ideas that support the high performance goals of the entire project.



Berkeley, CA. Good separation between growth and high-use play areas have created a complex and vibrant playground. Photo courtesy Wolfe Mason Associates.



Open spaces at schools typically fall into two categories: hard surfaces and lawn. Districts can and should move beyond this approach to create more vibrant and environmentally responsive site designs. Even if the opportunities for a particular site seem modest, there are better ways to pave a parking lot, water a soccer field, and manage stormwater than are typically practiced.

Site selection and design can either support or detract from the overall performance of the building. Table 2 summarizes some of the benefits associated with wise site planning.

Table 2 – Site Planning Considerations

Goal	Site Planning Considerations
Energy Efficiency	Energy efficiency is improved with effective building location, orientation and massing, and the placement of vegetation for shade or wind protection.
Water Efficiency	Standard irrigation practices typically waste significant amounts of water. Using native plants and water-efficient irrigation technologies are two straightforward methods of reducing demand. More sustainable water management might include captured water, green roofs, and natural stormwater management strategies like vegetated swales and ponds.
Protection of the Natural Ecosystem	The majority of site planning decisions will directly affect the overall level of impact to the natural environment: water conservation, treatment of surface water, building orientation, preservation and restoration of natural habitats, use of native plants and appropriate landscaping materials, etc.
Material Efficiency	The site should incorporate salvaged landscaping materials or those made from recycled materials. Vegetation waste should be composted.
Acoustic, Thermal and Visual Comfort	Comfort is heavily dependent upon orientation and building envelope. Glazing type, size, and orientation are particularly important. The relationship of buildings, especially classrooms, to sources of exterior noise such as roadways must be taken into account to achieve adequate background noise levels. Double glazed windows will reduce excessive exterior noise. Conversely, the relationship of HVAC equipment, recreation areas, and other noise producers will impact the surrounding neighborhood. Reducing the "heat island effect" decreases air conditioning loads during the summer by minimizing hard surfaces and using trees or shade structures.
Health and Indoor Air Quality	Sites cannot contain hazardous chemicals or airborne pollutants that endanger student health. Well-designed sites improve opportunities for natural ventilation and reduce carbon dioxide levels.
Security and Safety	Building placement, landscaping, protected courtyards, and well-situated access and circulation points all heavily impact safety and security.
Connection to Neighborhood and Surrounding Community	Consider community gardens, school parks, meeting rooms, multi-use facilities such as day care, laundry, café, etc. to connect the school to the community. Joint-use partnerships with local nonprofit organizations are an excellent way to fund and share facilities or park space, and improve security.
Learning	Use nature as a teaching tool for science, math, history, art, and health programs; use gardens to connect students to natural concepts. Consider the potential opportunities for real-life lessons in business and economics through on-site programs involving growing and selling or trading products.
Playing	Install creative play areas utilizing a wide variety of natural elements. Consider a schoolyard landscape rich with soil, water, and "critters," rather than simply formal, planted hedges and groomed turf.

Sustainable Site Planning Process

Sustainable site planning is adaptable to all school sites. It balances ecological, social, and economic needs and emphasizes long-term, cost-effective strategies over immediate short-term results. It should be an open process and include the input of the school staff and local community.

Site selection is crucial in the sustainability of school design, and districts must balance cost, student demographics, and environmental concerns during the site selection process. In some cases, school sites have been determined years in advance, eliminating some options for districts and designers when the school is being built. However, when the district can select sites, being conscious of



ecosystem protection, careful building orientation, and a design that controls urban heat islands can significantly lower the school's environmental impact.

When selecting a site, maintaining the health of students should be the first concern. Sites must not contain toxins, pollutants, or safety hazards that will impact student health, such as:

- Hazardous agents, including industrial, agricultural, and naturally occurring pollutants such as asbestos and heavy metals.
- Nearby facilities which might emit hazardous air emissions, or handle hazardous or acutely hazardous materials.
- Other objects that are potentially harmful near a school, such as hazardous pipelines, high voltage power-line easements, railroad tracks, adverse levels of traffic noise, and airports.



Berkeley, CA. Boulders add interest and alternative play areas for these children. Mulch filled cutouts protect tree roots from mowing damage. Photo courtesy Wolfe Mason Associates.

The district should also address issues of land use and open space, including:

- Developing sites that are centrally located for the student population. Both schools and parents spend significant time, energy, and money transporting students to and from school. Cars driven by parents, guardians, or the students themselves are the largest resource users and producers of transportation-related pollution. Centrally located sites mean that cars do not have to travel as far and encourage more students to walk or bike to school.
- Develop joint-use agreements with community organizations to share parts of the school buildings, parks, or recreation space. As part of a growing trend, schools are being integrated with a variety of organizations, from laundromats and coffee shops, to police stations and park districts. Benefits include better campus security, improved community relationships, and reduced site acquisition and construction costs.
- Avoiding development on prime farmland, public parkland, flood zones, and on habitats for threatened or endangered species.
- Preserve undeveloped lands. By not developing on greenfields, which are sites that have not been previously developed, or have been restored to park or farm use, urban redevelopment can reduce environmental impacts.
- Promoting alternative transportation, by locating the school close to public transportation and creating bike facilities.

Once a site is selected, use educational specifications and the schematic design to address areas of the site targeted for conservation, development, or natural enhancement. Select and specify environmentally preferable site materials — building products that use raw materials efficiently and do not introduce pollutants or degradation to the project site or atmosphere, and building systems that conserve water and energy. (For additional information about materials, see the Interior Surfaces chapter.) All stakeholders should meet to review the baseline data and discuss the opportunities and constraints based upon the initial site analysis and program. These stakeholders help define the



project's "vision," which guides development of the plan. Their involvement is essential throughout the planning and design process. The plan, developed by the design team and approved by the community, might include many, or all, of these principles:

- Identify and protect existing natural features and ecosystems.
- Repair and restore damaged natural areas and create habitat to promote biodiversity.
- Respect and incorporate historic, cultural, and artistic resources.
- Stormwater management to reduce pollution and the load on local infrastructure.
- Create healthy landscapes that evolve over time and survive intensive use.
- Develop a responsible maintenance and management program that incorporates an objective monitoring and evaluation strategy.
- Provide a strong link to the surrounding neighborhood and become an active part of the community.

Design Goals and Guidelines

Site planning activities for a high performance school seek to achieve one or more of the following three primary goals:

- Protect and/or restore the site.
- Incorporate the site's natural features to achieve high performance.
- Select environmentally preferable products.

Protect and Restore the Site

The natural functions of a site (hydrologic, geologic, and micro-climatic) can be seriously disrupted by the construction and operation of a building. The design of a high performance school will consider ways that natural site features can be protected — perhaps even restored — through the design, development, and construction processes. For example, preserving natural vegetation reduces overall disturbance to the site. Soil amendments help restore the health of disturbed soils. And designing to reduce impervious surfaces mitigates stormwater runoff caused by construction and protects the hydrologic functions of the site.

Site protection and restoration objectives include:

- Minimizing disturbance to the site.
- Mimicking (or restoring) natural processes in disturbed areas.
- Protecting water quality.

Incorporate the Site's Natural Features to Achieve High Performance

A high performance school responds to the site. Building placement, orientation, massing, and layout decisions made early in the school design process can profoundly affect the energy impacts of the building. These decisions also bear on the resulting indoor environment since they either capture or lose opportunities for daylighting and natural ventilation. Other implications include acoustic comfort, safety, and visual quality. The design of a high performance school incorporates the site's natural advantages and features to achieve the school's high performance goals.



In addition, the high performance school site and building should “teach” environmental protection concepts. Site design will take into consideration opportunities for outdoor classrooms and environmental learning projects. With careful planning and coordination with school staff, such projects can be identified and then facilitated during construction. For example, stream restoration by students and staff can take place more easily if a culvert has been removed during construction. Or a wetland graded during construction can be planted as part of lessons about the natural ecosystems.

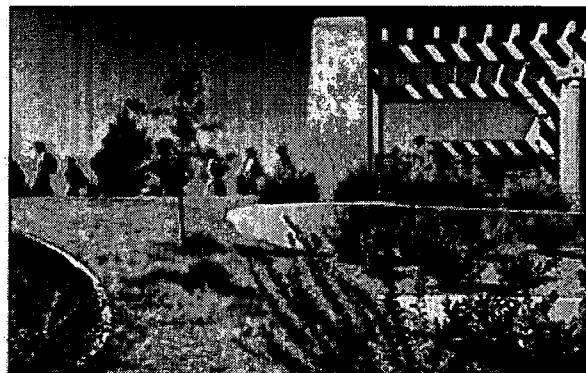

Bloomington, MN. Natural landscaping materials separate landscaping zones of local plants, including native grasses that do not require mowing. Photo courtesy Wolfe Mason Associates.

Site planning objectives that fall into this category include:

- Reduce the demand for water.
- Reduce energy demand.
- Select environmentally preferable materials.

A steadily increasing number and variety of environmentally preferable products are available for sitework and landscaping. Salvaged materials, originating from both on-site and off-site, should also be used where possible. These products include landscaping accessories made with post-consumer and post-industrial recycled materials (parking stops, bike racks, tree cuffs, grates, landscaping ties, planters, outdoor furniture, and lighting and sign posts), recycled concrete asphalt aggregate for fill or road base, concrete made with flyash, and recycled content soil amendments.

Specific examples include:

- Synthetic surfacing for exterior sports surfaces, playgrounds, and other surfaces. Made from 84% to 98% post-consumer rubber from used tires.
- Fencing with made with recycled plastic or salvaged wood or metal.
- Running track surfaces made with 100% recycled rubber/tires.

While maintenance will vary by product, in most cases, maintenance needs are reduced compared to conventional products. For example, plastic lumber is more durable and requires less ongoing maintenance than wood.

In addition, the selection of environmentally preferable materials has an added benefit as a teaching tool. Prominent interpretive signage can inform students, staff, parents, and the community about environmentally preferable materials and their attributes.

Table 3 summarizes the site planning goals and objectives described above, and shows the correspondence of these objectives to the guidelines provided in this chapter.



Table 3 – Site Planning Goals and Relationship to Guidelines

	SP1: Optimum Building Orientation	SP2: Landscaping to Provide Shade to HVAC Equipment, Buildings, and Paved Areas	SP3: Safe and Energy-Efficient Transportation	SP4: Landscape Design and Management	SP5: Impervious Surfaces	SP6: Native and Drought-Tolerant Plants	SP7: Landscaping Soil Amendment and Mulch	SP8: Water-Efficient Irrigation Systems	SP9: Stormwater Management, Groundwater Management, and Drainage Material	SP10: Rainwater Collection Systems	SP11: Gray Water System	SP12: Integrated Weed, Disease, and Pest Management
Goals												
Protect and Restore the Site												
<i>Minimize disturbance to the site</i>						●			●			
<i>Mimic natural process.</i>					●		●		●			
<i>Protect water quality</i>							●		●			●
Incorporate the Site's Natural Features to Achieve High Performance												
<i>Reduce water demand</i>				●		●	●	●		●	●	●
<i>Reduce energy demand</i>	●	●	●									
Select Environmentally Preferable Materials				●	●		●		●			

Resources

Architects, Designers and Planners for Social Responsibility (ADPSR) West Coast. 1998. *Architectural Resource Guide*. Contact: ADPSR, PO Box 9126, Berkeley CA. Tel: (510) 273-2428. Resources and information on green and healthy buildings, including many sources for materials in California.

Barnett, D.L. 1995. *A Primer on Sustainable Building*. Snowmass, CO: Rocky Mountain Institute. An excellent overview of issues and benefits of sustainable building. <http://www.rmi.org>.

Center of Excellence for Sustainable Development, U.S. Department of Energy, Energy Efficiency and Renewable Energy Network (EREN). Provides web pages on green building and green development. <http://www.sustainable.doe.gov>.

Crowther, R.L. 1992. *Ecological Architecture*. Boston: Butterworth Architecture. Primer on ecological design, emphasizing the importance of holistic building design and its integration with natural systems. Includes design guidelines for design, landscaping and planning.

King County, Washington. *Construction and Landscaping Materials Specifications*. <http://www.metrokc.gov/procure/green/const.htm>.

Los Angeles, City of. *Sustainable Building Reference Manual*. Contact: Nady Maechling. Tel: (213) 473-8226. Contains local information and resources.

Lyle, J.T. 1994. *Regenerative Design for Sustainable Development*. New York: John Wiley & Sons. One of the seminal books on the theory, design and construction of regenerative systems and the practical application of ecological design.



- Marsh, W. M. 1991. *Landscape Planning: Environmental Applications*. New York: John Wiley & Sons. A definitive reference for landscape architects, planners and designers on the definition and application of environmental design principles to landscape and site planning.
- Maryland State Department of Education. *Conserving and Enhancing the Natural Environment, A Guide for Planning, Design, Construction, and Maintenance on New & Existing School Sites and Building Ecology and School Design*. 1999. To order, contact the Maryland State Department of Education, Division of Business Services, School Facilities Branch, 200 W. Baltimore St., Baltimore, MD 21201. Phone for Capital Projects Assistant Manager: (410) 767-0097
- Mason, Gary et al; *An Ecosystem-based Approach to Planning Communities: An Ecosystem Manager's Workbook*, USDA Forest Service, Center for Urban Forestry, 1994, 1996, 1998.
- Moore, Robin C. and Wong, Herb H. 1997. *Natural Learning: Creating Environments for Rediscovering Nature's Way of Teaching*, MIG Communications.
- Rocky Mountain Institute. 1998. *Green Development: Integrating Ecology and Real Estate*. New York: John Wiley & Sons.
- Second Nature: Adapting Los Angeles's Landscape for Sustainable Living*. 1999. Published by TreePeople.
- Sorvig, K. 1996. *Sustainable Building Technical Manual*. Washington DC: Public Technologies Inc. Chapter 7, Site Materials and Equipment, offers a concise, valuable overview that highlights design considerations for soil amendments, plant materials and management, paving materials and materials for site construction and furnishings.
- Spurgeon, Richard. 1988. *Ecology: A Practical Introduction with Projects & Activities*. Osborne Publishing Ltd.

For additional information about environmentally preferable materials, see the Material Selection and Research section in the Introduction to Volume II.

Acknowledgments

The following resources were particularly useful for developing this chapter on site planning:

- Sustainable Building Task Force. The Sustainable Building Task Force was formed by a number of California agencies to institutionalize sustainable building practices into state construction projects. The task force meets on a monthly basis to discuss strategies for implementing sustainable building practices in all future and current state buildings, including those leased by the State. See <http://www.ciwmb.ca.gov/GreenBuilding/TaskForce/> for more information and links to member agencies.
- Santa Monica, City of. 1999. *Santa Monica Green Building Design and Construction Guidelines*. Available on-line at <http://greenbuildings.santa-monica.org/main.htm>.
- Partnership for Resource-Efficient Schools. 1998. *Recommended Best Management Practices Promoting Energy Efficiency, Resource Conservation, and Environmental Quality*. A publication of the Seattle Public Schools Building Excellence Program and the City of Seattle (Solid Waste Utility, Water Department and Seattle City Light). The following web site provides information about the Partnership for Resource-Efficient Schools project and a link to download the Best Management Practices manual: <http://www.cityofseattle.net/util/rescons/susbuild/partnership.htm>
- BUILT GREEN™ Handbook. 1999. BUILT GREEN is a program of the Master Builders Association of King and Snohomish Counties (MBA) in partnership with King County, Washington and Snohomish County, Washington. <http://www.builtgreen.net/>.

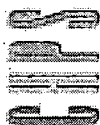

Guideline SP1: Optimum Building Orientation

Recommendation

When site conditions permit, orient buildings so that major windows face either north or south. Position classrooms so that light and air can be introduced from two sides. Solar orientation should guide the placement of building and site features. Reduce the impact of exterior noise sources by locating noise sensitive areas, such as classrooms, away from noise producers, like roadways, train tracks, etc.



Oakland, CA. Orientation plays a key role in the landscaping and daylighting design; low walls, building materials, and varied landscaping create a rich and inviting entrance. Photo courtesy Wolfe Mason Associates.

Description

Space heating and cooling accounts for nearly 20% of all energy consumption in the U.S. Optimal orientation of the building creates opportunities to utilize the potential contributions of the sun, topography, and existing vegetation for increased energy efficiency by maximizing heat gain (or minimizing heat loss) in winter and minimizing heat gain in summer. In the case of existing buildings, arrangement of interior spaces, strategic landscaping, and modifications to the building envelope can mitigate unfavorable orientation.

Applicable Spaces	Climates	When to Consider
Classrooms	South Coast	Programming
Library	North Coast	Schematic
Multi-Purpose / Cafeteria	Central Valley	Design Dev.
Gym	Mountains	Contract Docs.
Corridors	Desert	Construction
Administration		Commissioning
Toilets		Operation
Other		

Applicability

All climates. Primarily for new buildings and site planning, with some applicability to retrofitting existing buildings for greater efficiency.

Applicable Codes

None.

Integrated Design Implications

Knowledge of the existing site soils, vegetation, and microclimate are critical to understanding how to best arrange site elements to create the least disruption to the site and orient structures and spaces appropriately. Integrate existing site features; proposed landscape design; orientation, height and finish of walls; architectural design; impervious surfaces; location of heating and cooling equipment. Refer to guideline: SP2: Landscaping to Provide Shade to HVAC Systems, Buildings, and Paved Areas and SP3: Safe and Energy-Efficient Transportation.

Cost Effectiveness

Cost implications exist mainly in the design phase. Resulting cost savings will be demonstrated during building operation with lowered heating and cooling requirements.

Costs	L			
	M			
	H			
		L	M	H
		Benefits		

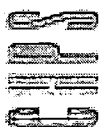

Benefits

Reduced energy consumption will result in cost savings for year-round heating and cooling. The arrangement of interior and outdoor spaces with thoughtful solar orientation allows optimal natural lighting and user-friendly spaces. Studies have shown that students in classrooms with the most daylighting have a 21% improvement in learning rates over students in classrooms with poor natural light.⁵ See the Daylighting and Fenestration Design chapter for more information on this research.

Design Tools

Pacific Gas & Electric and Southern California Edison offer use of heliodons for accurate modeling of daylighting effects. Contact their energy centers for more information. A physical model is mounted on the heliodon and a simulated sun shows shadows and solar exposure for different times of the day and the year. Most are coupled with a video camera for recording the test.

A sun angle calculator is a handy tool for studying sun position for different times of the day and year. It can be used to determine the required distance between buildings needed for adequate solar exposure and for determining the effect of shading obstructions such as adjacent buildings.

Design Details

Consider east-west orientation to maximize north-south daylighting opportunities. Single-story designs offer toplighting daylight strategies for all spaces. Keep width of building to less than 60 ft to increase daylight and ventilation opportunities.

Timesaver Standards for Landscape Architects presents the following site planning and building orientation information:

- Plan site clearing and planting to take advantage of solar access. Solar orientation, cloud cover, and topography create unique site attributes. A site's latitude determines the sun's altitude and associated azimuth for a given time or day. Orient the building to take advantage of solar energy for passive and active solar systems. The building should take advantage of shade and airflows to maximize summer cooling and to optimize passive solar energy for heating and wind protection during winter months. Orient solar collectors for maximum sun exposure.
- Orient building entrances and outdoor gathering spaces to maximize safety, ease of access, and protection from elements.

Solar angles, soils, and topography determine plant species and distribution, as well as vulnerability of the land to erosion by runoff. The extent of disruption to the site during construction can be minimized with careful orientation of buildings and site elements. Align long buildings and parking areas parallel to landscape contours.

Building orientation can have a significant impact on the acoustical performance of a building. Locating noise producers away from noise sensitive areas is the primary goal. Barriers of solid walls or berms of earth, which break the line-of-site between the noise source and the receiver (e.g. classroom), can be effective in reducing sound intrusion. A single row of trees or shrubs will be ineffective in reducing unwanted sound. Since windows are frequently the "weakest link" acoustically in a building structure, double glazed windows are often the only alternative to controlling exterior noise. Normal therma-pane double paned windows with ¼ in. or ½ in. airspace are not effective acoustically. The small airspace, and the two panes of similar glass severely limit its acoustical performance. To be effective acoustically, at least the outer pane should be laminated glass. Additional airspace between the two panes of glass is also very important. It is not uncommon to require 2 in. to 4 in. airspace, and thicker laminated glass to control exterior traffic and/or aircraft noise, which contain substantial low frequency energy.

⁵ Heshong Mahone Group and New Building Institute. "Re-Analysis Summary: Daylighting in Schools, Additional Analysis." On behalf of the California Energy Commission Public Interest Energy Research (PIER) Program, February 2002.



Operation and Maintenance Issues

None.

Commissioning

None.

References/Additional Information

American Institute of Architects Research Corporation. *Solar Dwelling Design Concepts*. Washington, DC: U.S. Department of Housing and Urban Development, 1976.

Baccomb, John Douglas. "Using Energy-10 to Design Low Energy Buildings." National Renewable Energy Laboratory, 1999. A summary report that describes Energy-10 and presents a detailed worked example carrying a particular building from pre-design through preliminary design. <http://www.nrel.gov/buildings/energy10/resources.html>.

Buffo, John, et al. "Direct Solar Radiation on Various Slopes from 0 to 60 Degrees North Latitude." U.S. Department of Agriculture Forest Service Research Paper PNW-142, 1972, 74pp.

DeChiara, Joseph. *Site Planning Standards*. McGraw-Hill, Inc. 1978.

Harris, Charles. *Timesaver Standard for Landscape Architecture: Design and Construction Data*. McGraw-Hill, Inc. 1998.

Land Design/Research, Inc. *Energy Conserving Site Design Case Study*, Burke Center, Virginia. Washington, DC: U.S. Department of Energy, 1979, 60pp.

Marsh, W.M. *Landscape Planning: Environmental Applications*. John Wiley & Sons, New York. 1991.

Marsh, William M., and Dozier, Jeff. "The Radiation Balance." *Landscape: An Introduction to Physical Geography*. Reading, MA: Addison-Wesley, 1981, pp. 21-35.

Sizemore and Associates. *Methodology for Energy Management Plans for Small Communities*. Washington, DC: U.S. Department of Energy, 1978.

Sterling, Raymond, et al. *Earth Sheltered Community Design*. New York: Van Nostrand Reinhold, 1981, 270 pp.

Durant Road Middle School, Wake County, NC utilized many recommendations from this guideline.

Related Volume III CHPS Criteria

Site Credit 1: Sustainable Site Selection.

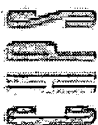

Guideline SP2: Landscaping to Provide Shade to HVAC Equipment, Buildings, and Paved Areas

Recommendation

Shade HVAC equipment from direct sun. Ensure landscaping does not block air circulation to or from the building. Use landscaping to shade windows on the east- and west-facing building facades. Use landscaping or shade structures to shade paved areas to reduce the heat island effect.



Berkeley, CA. Arbors and trellises provide shade to ground and building surfaces for this daycare center. Photo courtesy of Wolfe Mason Associates

Description

Shading HVAC equipment from direct sunlight can significantly lower the cooling demand. Landscaping can greatly reduce the impacts of heavy radiation loads on the roof, and east and west exposure in summer. In temperate regions, site planning and design should seek to promote shade and evaporative cooling in warm periods, and block winds and promote heat gain in cool periods, without disrupting favorable summer wind patterns. In hot, arid regions, plan to balance daily temperature extremes by storing energy, increasing humidity, and diverting desiccating winds.

Applicable Spaces	Climates	When to Consider
Classrooms	South Coast	Programming
Library	North Coast	Schematic
Multi-Purpose / Cafeteria	Central Valley	Design Dev.
Gym	Mountains	Contract Docs.
Corridors	Desert	Construction
Administration		Commissioning
Toilets		Operation
Other		

Applicability

All climates.

Applicable Codes

Some communities in California have a 51% shade canopy requirement for parking lots.

Integrated Design Implications

Integrate landscaping, HVAC design, parking lot design, lighting design, irrigation, and preservation of existing plants with building design and orientation. Wind and moisture patterns should be considered during site planning in conjunction with goals to provide building shade. Design coordination will be needed so that trees and lighting are placed without conflicting with the shade or footcandle requirements. Refer to Guideline SP1: Optimum Building Orientation; SP3: Safe and Energy-Efficient Transportation; SP5: Impervious Surfaces; HVAC guidelines; as well as guidelines in the Building Enclosure and Insulation chapter.

Cost Effectiveness

Costs will vary depending on the type and extent of vegetation or shading structures used. Costs are minimal for HVAC shading, particularly if incorporated into overall HVAC system and landscaping design. Consult with a qualified HVAC engineer regarding opportunities for downsizing systems due to decreased system load.

Costs	L			
	M			
	H			
		L	M	H
		Benefits		



Benefits

Lower energy costs from reduced solar loads on building. Shading HVAC equipment lowers demand for electricity and reduces heat islands.

Design Tools

Charts illustrating distance required between buildings or landscaping to avoid shadows and minimum spacing required to assure adequate light penetration. Solar path, latitude, and altitude charts should also be utilized.

Design Details

Building orientation should be closely integrated with landscape design. Planting deciduous trees on the southeast, southwest, and west side of the building will reduce solar gain in summer during the morning and afternoon. Deciduous vines on arbor structures will provide shade, particularly when used adjacent to the building on the south or west face, sheltering the interior from summer midday sun while allowing solar penetration in winter. Plant low branching deciduous trees on the west side to keep low afternoon sun off west and north walls in summer.

Consider the use of vines against south- and west-facing walls to reduce reflected and absorbed heat and light. This can reduce the temperatures in courtyards and outdoor spaces as well as adjacent buildings and interior spaces.

In urban environments, the site context may include solar windows (gaps between buildings) and shadow corridors (elongated zones which block the sun), which should be considered during site design to maintain sunlight to structures.

Parking lots and paved areas can reflect sunlight and absorb heat that raises temperatures. Shading with trees, shade structures or structures with vines can help lower temperatures.

Locate HVAC equipment so that it is shaded from afternoon sun during the cooling season. Plant trees so that at maturity their canopies shade the unit and the adjacent area during the entire cooling season.

Operation and Maintenance Issues

Design criteria and maintenance guidelines will be needed so that trees shading parking lots and other paved areas can grow to full maturity without excessive pruning. However, care must be taken to avoid contaminating HVAC equipment with leaves or other organic debris. Maintenance must keep plantings from growing too dense and preventing the proper circulation of air around the unit.

Commissioning

None.

References/Additional Information

DeChiara, Joseph. *Site Planning Standards*. McGraw-Hill, Inc. 1978.

Harris, Charles. *Timesaver Standard for Landscape Architecture: Design and Construction Data*. McGraw-Hill, Inc. 1998.

Marsh, W.M. *Landscape Planning: Environmental Applications*. John Wiley & Sons, New York. 1991.

Parker, D.S. "Measured Impacts of Air Conditioner Condensor Shading." The Tenth Symposium on Improving Building Systems in Hot and Humid Climates. Fort Worth, TX, 1996. Archived at <http://www.fsec.ucf.edu/~bdac/pubs/PF302/PF302.htm>, 12/15/2000.

Parker, J.H. "The Impact of Vegetation on Air Conditioning Consumption." Proceedings of the Workshop on Saving Energy and Reducing Atmospheric Pollution by Controlling Summer Heat Islands, Berkeley, CA, pp. 45-52, 1989.

Related Volume III CHPS Criteria

Site Credit 4: Design to Reduce Heat Islands.

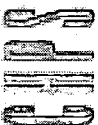

Guideline SP3: Safe and Energy-Efficient Transportation

Recommendation

Locate schools and design school sites to encourage use of safe, energy efficient transit alternatives and to discourage single-use automobile transportation.

Incorporate safe and effective parking and storage for bicycles, skateboards, rollerblades, and scooters, if applicable.

Description

Strategies for encouraging the use of safe, energy-efficient transportation alternatives include providing safe bike and pedestrian paths, and providing facilities for shared vehicle transportation (carpools, vanpools, mass transit).



Designing bike and pedestrian paths and facilities for shared vehicle transportation helps to reduce morning traffic.

NREL/PIX 09075

Applicability

All climates.

Applicable Codes

Applicable municipal codes.

Integrated Design Implications

This guideline should be addressed in the site selection and site planning stage. Also incorporate these strategies into the building and site design stages, especially when looking at access, circulation, and parking lot design. Be sure to locate parking lots and other sources of pollution away from fresh air intake ducts to preserve indoor air quality.

Applicable Spaces	Climates	When to Consider
Classrooms	South Coast	Programming
Library	North Coast	Schematic
Multi-Purpose / Cafeteria	Central Valley	Design Dev.
Gym	Mountains	Contract Docs.
Corridors	Desert	Construction
Administration		Commissioning
Toilets		Operation
Other		

Cost Effectiveness

Costs will vary with strategies selected. In most cases, additional costs are minimized when integrated early into site/building design. Added costs will be offset by reduction in parking lot size.

Costs	L			
	M			
	H			
		L	M	H
		Benefits		

Benefits

Reduced automobile use, reduced traffic congestion, improved urban air quality, improved sense of community, and more efficient use of site (if parking lot size is reduced).

Design Tools

IESNA. 1980. RP-8 Roadway Lighting, Chapter 4, Pedestrian Walkway and Bikeway Lighting Design, Illuminating Engineering Society of North America (IESNA), New York. This document contains guidelines for the design of fixed lighting for roadways, bikeways, and pedestrian paths.

Design Details

- Pedestrian- and bike-friendly features include pedestrian paths and walkways, bike paths, safe and accessible bike storage, and showers/changing facilities.

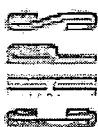

- Good lighting is critical for safe walkways in the early morning and at night. Provide effective lighting onto walkways in accordance with illuminance levels and cut-off angles as specified by IESNA RP8.
- Although cyclists and joggers can change in washrooms and store a change of clothes in the workplace, dedicated facilities are more likely to encourage regular human-powered commuting. Provide changing rooms, lockers, and showers for employees. Connect changing room, shower, and locker facilities with bicycle storage, washroom facilities, or pools. Provide sufficient showers to avoid waits at peak times, and to accommodate growing use. Provide separate change/shower rooms for males and females, if possible. Caution: Facilities must be accessible to building occupants, but not to the general public or visitors.
- Building design can encourage carpooling and vanpooling by giving priority to shared transportation, and by making waiting areas convenient and safe.
- Locate carpool and vanpool parking spaces closer to the building entrance than other single-use automobile parking.
- Post prominent signage to identify the location of carpool and vanpool parking and pick-up areas.
- Provide safe and comfortable waiting areas to encourage carpool and vanpool commuters. Consider amenities such as sunshades, rain canopies, seating, and bulletin boards.

Safety Cautions

- Ensure commuter safety with building lobbies that view waiting, pick-up, and drop-off areas, occupied windows that overlook them, good lighting, and if necessary, prominent surveillance cameras. Eliminate potential hiding places for potential criminals.
- Ensure that sheltered areas are visible from the street and/or parking areas, sidewalk, and school building.
- Avoid creating small, dark courtyards that winter sun never reaches.
- Heavy and massive arcades and other features can obscure visibility and affect pedestrian safety.

Note: The cost premium for providing for environmentally safe and energy-efficient transportation may be offset by grants offered by various agencies.

Operation and Maintenance Issues

None.

Commissioning

None.

References/Additional Information

Bicycle Federation of America. Comprehensive coverage of a host of policy, planning and design guidelines supporting bicycle use. Internet Resource Center. <http://www.bikefed.org/>. April 1999

Cox, E. (April 1999). Long Term Bike Parking. Useful overview of design considerations for long-term bicycle storage offering essential and optional features for caged facilities, bike rooms, bike lockers and shower and clothes locker rooms. <http://www.ips.net/cbc/longbikepark.html>.

Woodhull, J. 1992. *How Alternative Forms of Development Can Reduce Traffic Congestion.* Sustainable Cities; Concepts and Strategies for Eco-City Development, Ed. Bob Walter et al., Eco-Home Media, Los Angeles. Offers alternative approaches to traffic planning concentrating on "access" rather than mobility. Covers densification, parking, and development patterns, and offers solutions for pedestrian-friendly, transit-oriented development.

Related Volume III CHPS Criteria

Site Credit 1: Sustainable Site Selection.

Site Credit 2: Transportation.

District Credit 6: Buses and Alternative Fueled Vehicles.

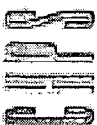

Guideline SP4: Landscape Design and Management

Recommendation

Develop a landscape plan based on an ecological approach, emphasizing plant diversity, natural lawn care, and resource conservation. Use this plan to guide site preparation, site design, and ongoing care of the site. Include objective plans, tasks, standards, and requirements that provide information about how to create a healthy and attractive landscape.

Description

Every site has an ecological dynamism that involves all the physical elements of the landscape. A high performance approach to landscape design and management should be guided by four basic principles that respect this dynamism: resource conservation, diversity, connectivity, and environmental responsibility.

- **Resource Conservation.** Identify, use, and recycle available natural and physical resources that do not degrade the ecosystem. This principle should also be applied to site and landscape accessories.
- **Diversity.** Maintain a healthy natural system that gives primary consideration to habitat, species, and genetic diversity.
- **Connectivity.** Maintain networks of natural resources and interconnecting habitats to maximize healthy ecological functions.
- **Environmental Responsibility.** Protect, restore, and manage resources to maintain a healthy ecosystem in perpetuity.

To apply these principles to landscape care, it's important to understand the difference between landscape *maintenance* and landscape *management*.

Maintaining a landscape implies that the landscape deteriorates and needs to be returned to a "correct" condition by the maintenance crew. This static vision belies the natural dynamism of the landscape. Seeking to simply maintain landscapes works against the dynamic tendencies of nature, resulting in great expense of time, energy, and money.

Management, on the other hand, acknowledges the constant change of nature. To manage a landscape is to work with the basic tendency of nature to change. Management based on ecological principles does not try to always return the landscape to a single, static state. Management — as opposed to maintenance — recognizes the dynamic qualities of landscapes and takes advantage of interconnected elements such as water, soil, and pests.



Castro Valley, CA. Creeping red fescue covers this difficult to maintain site and does not require mowing. Grass is also appropriate for pedestrian traffic and general use. Photo courtesy of Wolfe Mason Associates.

Applicable Spaces	Climates	When to Consider
Classrooms	South Coast	Programming
Library	North Coast	Schematic
Multi-Purpose / Cafeteria	Central Valley	Design Dev.
Gym	Mountains	Contract Docs.
Corridors	Desert	Construction
Administration		Commissioning
Toilets		Operation
Other		



Applicability

All climate regions.

Applicable Codes

Model Water Efficient Landscape Ordinance, Division 2, Title 23, California Code of Regulations, Chapter 2.7, Sections 490 through 495
(<http://www.dpla.water.ca.gov/cgi-bin/urban/conservation/landscape/ordinance/index>), or applicable local ordinances.

Integrated Design Implications

Planning for landscape management should be integrated and coordinated with Guideline SD5: Native and Drought-Tolerant Plants; Guideline SP7: Landscaping Soil, Amendments, and Mulch, and Guideline SP12: Integrated Weed, Disease, and Pest Management. All landscape planning should also take into account irrigation system parameters to help maximize water efficiency (see Guideline SP8: Water-Efficient Irrigation Systems).

Cost Effectiveness

Costs will vary depending on the extent of the site and scope of management plan. Native grasses save money on maintenance with reduced or eliminated mowing schedules. Recycled-content landscaping products are comparable in cost to conventional options.

Costs	L	■	■	
	M	□	□	
	H	□	□	
		L	M	H
		Benefits		

Benefits

High performance landscape design and management, which seeks to bring the designed landscape into a closer adherence with the region's natural systems, provides a high level of benefit. A well-designed and implemented landscape management plan results in water conservation, soil improvement, the use of less intensive practices to manage plants, and the preservation, enhancement, or creation of habitat. The use of recycled content products helps alleviate waste disposal problems, and reduces energy use and consumption of natural resources during manufacturing.

Landscape management, including natural lawn care practices, can help make the school grounds healthier for students and staff, protect beneficial soil organisms, and protect the environment through reduced use of water, pesticides, fertilizers, and pollution-producing mowers and maintenance equipment.

Properly designed earth berms can shield the school from nearby roadways, train tracks, etc. However, landscaping, trees, and shrubs cannot be used to reduce the level of exterior noise at the building façade.

Design Tools

To identify high performance landscape and site planning strategies, consider consulting with a landscape professional that has expertise in ecological approaches to vegetation management.

Design Details

Key Elements of a Landscape Management Plan

A landscape management plan needs to take into account three different functions: management of the vegetation, including lawn care; management of the site's infrastructure; and management of those responsible for its care. A landscape management plan should contain the following components:

- *Management vs. Maintenance:* Briefly discuss the basis of an ecological approach, the concept of maintenance vs. management, and the principles of ecosystem-based management.
- *Vegetation Types and Locations:* Discuss the concept of vegetation types, including diversity of vegetation. Also describe the landscape management zones, and list and describe the types of



vegetation to be included in each zone. Provide standards that describe the desired condition of each vegetation type. Vegetation types include trees (young, street, native, ornamental, naturalized, riparian); shrubs (ornamental, naturalized, riparian, native); perennials; vegetables; meadow; lawn; groundcover; vines; and weeds and undesirable plants.

- *Infrastructure Standards:* Discuss standards for infrastructure care to achieve the desired condition.
- *Designating Responsibility:* Discuss who is responsible for each aspect of the landscape management, and delineate responsibility on a site map.
- *Sustaining the Landscape:* Describe the general tasks necessary to implement the landscape management specifications, including a yearly calendar of tasks as well as monthly task checklists to monitor the work and the health of the landscape.

Establishing Landscape Management Zones

A high performance design should divide a landscape into management zones based on each zone's differing design intents and maintenance requirements. In general, three landscape management zones exist:

- *Ornamental Zone:* The more traditional landscape areas next to buildings, parking areas, streets, and other public use facilities. This zone creates strong identity and focus for the schools. The landscape in this zone is typically designed to be organized, attractive, and lush. This zone requires the highest level of management to maintain a visually pleasing and healthy appearance.
- *Natural or Native Zone:* Existing natural areas on, or adjacent to, the site that are to be preserved, enhanced, or expanded.
- *Buffer Zone:* The interface areas between the other two zones. The management goal is to provide a visually pleasing landscape that bridges the ornamental zone and the native, or more natural, areas.

Natural Lawn Care

Lawns are typically the most intensively managed type of vegetation on a school site. A high performance approach to lawn care starts with lawn placement at the site. Lawn can be divided into different zones, based on how it will be used and how it needs to be cared for. Typically, three standards of care should be considered:





Figure 2 – Landscape Management Zones

- **High Intensity:** Requires uniform species composition, high irrigation demands, high synthetic fertilizer use, and regular pesticide and herbicide use. Used when primarily concerned with having uniform green grass year round with no weed, pest, or soil organisms.
- **Medium Intensity:** Allows for more diverse species composition, less demanding irrigation, moderate organic fertilizer use, and integrated pest management approach. Green is important, but not essential year round. Building soil structure over time is an important goal.
- **Low Intensity:** Diverse species composition and/or sparse coverage is tolerable. Alternatives to lawn are considered, with other vegetation taking precedence over lawn.

Plants depend on soil organisms to recycle nutrients, protect them from disease, and build loose fertile soil. Overuse of soluble fertilizers and pesticides can disrupt this ecosystem and contribute to landscape and lawn problems like thatch buildup and soil compaction. Ecological approaches to landscape management and natural lawn care practices can help make lawns healthier for students and staff, protect beneficial soil organisms, and protect the environment.

A natural approach to lawn care produces lawns that stay healthy and are easier on the environment. Strategies include soil preparation/amendment, choosing groundcovers or no-mow lawn varieties; minimizing turf areas; "grass cycling" (leaving clippings to decompose quickly, releasing valuable nutrients back into the soil); mowing at the proper height, minimal use of pesticides; applying smaller amounts of fertilizers at regular intervals; appropriate watering; and accepting an appropriate threshold for some weeds.

Operation and Maintenance Issues

Consider a variety of alternatives to traditional school staff for maintenance. For example, Conservation Corps or job training programs for restoration and habitat areas.

Landscape management is a different approach from conventional landscape maintenance. Planning, education, and training are key to a program's success. Each school district should develop and implement a written landscape management policy and program.



Commissioning

None.

References/Additional Information

California Department of Water Resources. 1416 - 9th Street, Room 1104-1, Sacramento, CA 95814.
Tel: (916) 653-6192. Fax (916) 653-4684. Web site: <http://www.dwr.water.ca.gov/>.

California Integrated Waste Management Board. Database of Recycled-Content Providers:
<http://www.ciwmb.ca.gov/rcp>

Clean Air Lawn Care, South Coast Air Quality Management District. Available on-line at
<http://www.aqmd.gov/monthly/garden.html>.

Cook, Tom and Roy L. Goss. *Construction and Maintenance of Natural Grass Athletic Fields*.
Washington State University Cooperative Extension, Publication PNW0240. This bulletin provides
the basis for development and maintenance of high quality fields for different purposes under
different conditions. It is well illustrated with line drawings and color photographs plus data tables
specific to different areas of the Pacific Northwest. Explains construction, establishment, drainage,
irrigation, maintenance, and some troubleshooting. Rev. 1992. 28 pages. \$2.25. To order, call
(800) 723-1763.

Craul, Phillip J. *Urban Soil in Landscape Design*. John Wiley & Sons, Inc. 1992.

Hunter, Charles D. *Suppliers of Beneficial Organisms in North America*. California Environmental
Protection Agency, Department of Pesticide Regulation, Environmental Monitoring and Pest
Management Branch. 1997.

Los Angeles County Department of Public Works. *The Natural Approach to Lawn Care*. Available on-
line at <http://www.smartgardening.com/grassrecycling.htm>.

Olkowski, William et al. *Common Sense Pest Control*. The Taunton Press. 1991.

People's Park Landscape Management: Vegetation and Infrastructure Program. A program developed
for the University of California, City of Berkeley and the Park/Community Advisory Group. This
program uses an ecological approach to the renovation and care of the landscape. Information
available from Wolfe Mason Associates at <http://www.wolfemason.com>.

Profiles: A Special Report on Grounds Care. A report of grounds maintenance challenges at
Georgetown University, Washington, DC, the University of Texas Southwestern Medical Center in
Dallas, and the Orange County Public School District in Orlando, Florida. Available on-line at
<http://www.facilitiesnet.com/fn/NS/NS3m9li.html>.

Ross Middle School, Ross, CA (Marin County) — Uses recycled content landscaping products. Sun
shades and landscape benches are made from certified sustainably harvested Ipe or Angico.
Concrete mix design replaces 50% of cement with flyash.

Santa Barbara County Waste Management Board: Recycled Content Providers:
http://www.lessismore.org/htdocs/text_only/important_info/recycled_products.html.

Related Volume III CHPS Criteria

Site Credit 1: Sustainable Site Selection.

Water Prerequisite 1: Create Water Use Budget.



Guideline SP5: Impervious Surfaces

Recommendation

Minimize impervious surface areas to reduce stormwater runoff. Use material-efficient products for installed pervious and impervious surfaces.

Description

Impervious areas, such as roofs, driveways, sidewalks, and streets, increase stormwater runoff by preventing the infiltration of surface water into the ground. This increased stormwater runoff results in increased erosion, higher flow rates, higher ambient temperatures, and increased sediment in nearby waterways. Additionally, as stormwater flows over buildings, parking lots, and play fields, it collects pollutants, such as oil, litter, and dirt. These waterborne pollutants often discharge directly into waterways. Conversely, pervious surfaces reduce peak stormwater runoff and treat stormwater pollutants. In addition, impervious surfaces create higher ambient temperatures on the site compared to pervious or vegetated alternatives.

Strategies to limit impervious surfaces on the building site include:

- Using pervious (or porous) pavement systems in lieu of impervious asphalt or concrete.
Examples:
 - Porous asphalt, paver blocks, or large aggregate concrete for parking and high use bicycle and pedestrian areas.
 - Lattice blocks that permit grass growth for fire lanes and overflow parking.
 - Crushed stone or brick for lightly used pedestrian paths.
- Minimizing the amount of paving by designing for multiple uses. Uses can include access, parking, pathways, meeting places and game courts. Surfacing materials can vary depending on intensity of use, e.g., access roads paved and parking gravel; turf block for emergency access; decomposed granite for secondary paths. All surfacing materials can utilize porous paving techniques.
- Retaining or substituting vegetation in lieu of hard surfaces.
- Designing to distribute runoff from impervious surfaces over large vegetated areas prior to reaching a stormwater conveyance system. This reduces the flow velocity, removes pollutants, and promotes groundwater infiltration.
- Installing a vegetated roof.
- Using natural or constructed wetlands to provide on-site retention and treatment of stormwater.



Student and Staff Parking at Dominican University, River Forest, Illinois. Made with Gravelpave porous paving, manufactured by Invisible Structures, Inc., Aurora, CO (<http://www.invisiblestructures.com>). A porous base course was constructed on top of existing site soils to leave tree roots undisturbed. 15" deep concrete curbs were installed with forms to curve around tree bases. The final top 1" of rings, grid and fabric were anchored in place to receive the gravel. Photo reprinted with permission from Invisible Structures, Inc.

Applicable Spaces	Climates	When to Consider
Classrooms	South Coast	Programming
Library	North Coast	Schematic
Multi-Purpose / Cafeteria	Central Valley	Design Dev.
Gym	Mountains	Contract Docs.
Corridors	Desert	Construction
Administration		Commissioning
Toilets		Operation
Other		



- Minimizing the building footprint through design. (Note: Minimizing building footprint usually means building “up” rather than “out.” For schools, this may not be desirable because of conflicts with higher priority goals, such as daylighting and natural ventilation.)

Where impervious surfaces are necessary, use materials efficient materials. Examples include:

- Rubber modified asphalt or recycled concrete asphalt.
- Recycled aggregate for base coarse of new parking lots and roadways.
- Concrete made using flyash, a byproduct of coal combustion, to replace a portion of the Portland cement, a high-embodied energy material.

Note: One limitation of porous pavement is its tendency to clog if improperly maintained. Once it is clogged, it is difficult and costly to rehabilitate and often must be completely replaced. Clogging can be prevented most easily by not installing it in areas where erosion is a concern and by waiting until all other phases of construction are complete and vegetation is stabilized to install the pavement. Other concerns include the lack of expertise of pavement engineers and pavement contractors. Also, some studies indicate that porous systems have slightly higher deformation in porous pavement compared to conventional.

Applicability

All climates.

Applicable Codes

State Water Resources Control Board, Storm Water Program, PO Box 1977, 1001 “I” Street 15th Floor, Sacramento, CA 95814-1977, phone (916) 341-5536 for general inquiries, (916) 341-5537 for construction related issues, stormwater@dwq.swrcb.ca.gov, or <http://www.swrcb.ca.gov/stormwtr/index.htm>.

The California Environmental Resources Evaluation System (CERES) web site, <http://www.ceres.ca.gov/index.html>, features the California Land Use Planning Network with a broad array of data types from diverse sources, including selected, but fully scanned and searchable, county and city zoning ordinances.

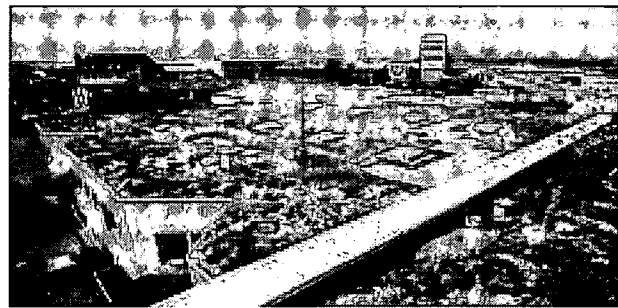

Vegetated Roof. Reprinted with permission from Sarnafil (Source: <http://www.sarnafilus.com/GreenRoofs.htm>)

Applicable landscaping codes.

Setting up a new concrete and asphalt recycling plant requires certain state and local permits, such as air, water, and zoning.

Integrated Design Implications

Strategies to minimize impervious surfaces should be integrated with decisions about landscaping design; shading of the building, site, and heat rejection equipment; building orientation and design (footprint); roofing selection; stormwater management; parking lot and paving design; building layout; vegetated roof design; and parking lot design.

Cost Effectiveness

Minimizing paved areas means less paving material overall, which translates into lower initial cost.

The cost of pervious paving systems will vary depending on the system used. For example, porous (no fines) concrete may be comparable to conventional pavement. (This material requires a contractor familiar with the process, however.) Grid types, pavers, and brick systems have a cost premium. Cost is offset by its dual purpose as a stormwater system. Less land is needed for this type of system, as area for detention, retention, or infiltration is not necessary.

Costs	L			
	M			
	H			
		L	M	H
		Benefits		



Benefits

Minimizing impervious surfaces helps preserve the hydrological and geological functions of a developed site by maximizing the area available for soils and vegetation to receive and treat surface water and facilitates groundwater recharge. The flow, velocity, and quantity of surface water is decreased overall, reducing the sediment and pollutant load on local waterways as well as the burden on municipal water management systems.

Ancillary benefits include reduced heat local heat build-up (heat islands) from the shading and cooling effects of vegetation, vegetated roofing, and whitetopping. These translate into reduced cooling loads and energy consumption. Several pervious pavement systems are manufactured with recycled content and so are also material efficient. Impervious paving that uses recycled concrete aggregate for base or flyash in concrete is also material efficient.

Design Tools

Applicable state and local stormwater and surface water management design manuals.

Pervious Paving

As of this writing, no California guidelines or specifications for porous pavement exist. Guidance documents used in Washington State include:

Interim Guidelines for the Construction of Portland Cement Pervious Pavement or "No Fines" Concrete, a working document of the Washington State Aggregates and Concrete Association, soon to be updated. Contact the California Cement Promotion Council for more information.

BMP T3.40, Porous Pavement, from the *Final Draft, Stormwater Management Manual for Western Washington, Volume V, Runoff Treatment BMPs*. Washington State Department of Ecology, Water Division. August 1999, revised August 2000. This document can be downloaded at <http://www.ecy.wa.gov/biblio/9915.html> or call (360) 407-6614.

Recycled Concrete Asphalt for Base

Many local jurisdictions use California Department of Transportation (Caltrans) Standard Specifications. In Southern California, the Greenbook is commonly used for road projects. Where recycled aggregate is allowed, it must also, of course, meet the same grading and quality specifications as virgin aggregate.

Caltrans Standard Specifications, July 1995, covers aggregate base and aggregate subbase in Sections 25 and 26. These sections do not mention recycled aggregate. However, Caltrans SSPs do allow "reclaimed asphalt concrete, Portland cement concrete, lean concrete base, cement treated base," or "glass" in Class 2 and 3 aggregate base, and also in Class 1, 2, and 3 aggregate subbases.

The Greenbook is a public works specification book commonly used in the Los Angeles area. The Greenbook includes standardized specifications for crushed concrete and asphalt in three of its four aggregate base categories in Section 200-2, "Untreated Base Materials":

- Crushed aggregate base (CAB) does NOT include recycled aggregate. CAB may sometimes be specified where recycled base (CMB or PMB) would also meet requirements.
- Crushed miscellaneous base (CMB) allows recycled aggregate. The Greenbook states that CMB "shall consist of broken and crushed AC or PCC and may contain crushed aggregate base or other rock."
- Processed miscellaneous base (PMB) also allows recycled aggregate. The Greenbook states that PMB "shall consist of broken or crushed AC, PCC, railroad ballast, glass, crushed rock, rock dust, or natural material."
- Select subbase is the Greenbook's only aggregate subbase category. It allows recycled aggregate.

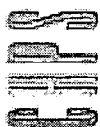

Whitotopping

American Concrete Paving Association (ACPA), Whitotopping, State of the Practice. Publication EB210P. This engineering bulletin covers all aspects of concrete overlays on existing asphalt pavement. Its five chapters include: Introduction (uses and benefits), History and Performance, Design Practices (conventional whitotopping), Construction Practices, and Ultra-Thin Whitotopping (UTW). The last chapter presents the interim procedure for determining the load-carrying capacity of UTW based on research and performance surveys. 1998. \$25.00. Order from the ACPA, <http://www.pavement.com/>.

Design Details

Effective surfaces are those, pervious or impervious, that are connected via sheet flow (shallow or concentrated surface flow) or discrete conveyance (such as drainage ditch) to a drainage system. *Effective impervious surface* is a measure of the performance of the lot with respect to stormwater flows, which provides a way of monitoring impact due to construction. Methods to minimize runoff can be expressed: (1) prescriptively, such as using pervious surfaces, or (2) performance-based, such as providing zero effective impervious surface (no net increase in runoff). Specific strategies will depend upon the specific site and local requirements.

Where impervious pavement must be used, specify the use of recycled asphalt, concrete manufactured with flyash for paving, and/or rubberized asphalt pavement. In hot climates, look for opportunities to whitetop asphalt surfaces with heat-reflecting white concrete.

For concrete work, use reusable steel forms, expansion joint filler with recycled content, and least toxic release methods.

When using porous paving or on-site bio-filtration swales, it is critical that sub-base soils are tested so that designs are sufficient to process the stormwater flow.

Utilize surface stormwater flow wherever possible. Introduce oil/water separators at catch basins.

Note that design considerations should assume a minor loss in porosity in the first four to six years.

Avoid compaction of site soils in adjacent areas during construction to retain infiltration and water holding capacity of existing soils.

Operation and Maintenance Issues

For bio-swales and constructed wetlands, the design intent is to create a self-sustaining system that requires little maintenance. Monitoring and maintenance as the landscape matures provide educational opportunities. As bio-swales and constructed wetlands provide wildlife habitat, mowing and thinning plants should be minimal unless soils testing shows that impurities from runoff are high. In that case, mowing and thinning will aid in removal of toxins that may accumulate in the vegetation.

In parking areas, prune plants as needed to maintain sight lines and the desired aesthetic. If storm drains are used, clear as needed to prevent blockages. Avoid soil compaction in vegetated areas.

For porous asphalt and concrete, vacuum with a hydrovac to maintain or restore porosity by removing sediment from the paving surface. If areas become deformed by traffic, drill compacted areas to restore porosity. Keep underdrains, overflow drains, and edge drains clear.

Grassed paving systems need to be mowed. Tall grasses create a less-permeable surface. If this type of system is perceived as unmaintained, it may discourage potential users. The durability of the system depends on soil type and climate, however maintenance is decreased with the use of appropriate groundcover plants in lieu of lawn. Some groundcovers can take foot traffic but lawn, in turf block or grids, is best used where there is auto traffic.

Unit pavers on a permeable subgrade settle after the initial installation, and therefore require that a joint-filler material be swept in. Permeability decreases over time as the joints become compacted.



The systems mentioned above are conducive to "spot fixes", should replacement of small areas be required due to damage. It should also be noted that maintenance is reduced where snow removal is significant, as snow melts faster on permeable surfaces.

Longevity of the system depends on the type of system used, the amount of use it receives, and the appropriate match of system to site.

Commissioning

None.

References/Additional Information

California Cement Promotion Council, Dave Holman, phone (925) 838-0701 or dholman@best.com.

California Integrated Waste Management Board. *Designing with Vision: A Technical Manual for Material Choices in Sustainable Construction*. See Chapter 8, "Strategies to Reuse Materials and Reduce Material Use in Construction," Appendix E sample specifications for: Section 02145, Erosion Control; Section 02230, Base Course; Section 02513, Asphaltic Concrete Paving. *Designing with Vision* can be downloaded in four parts from <http://www.ciwmb.ca.gov/GreenBuilding>. Chapter 8 is in Part D. Revised July 2000.

California Integrated Waste Management Board. Database of Recycled-Content Providers: <http://www.ciwmb.ca.gov/rcp>.

California Integrated Waste Management Board. Recycled Aggregate, A CIWMB Fact Sheet, CIWMB publication #431-95-052. Also available to download from <http://www.ciwmb.ca.gov/publications/condemo/43195052.doc>.

California Stormwater Best Management Practice Handbook: *Construction Activities*. Prepared for Stormwater Quality Task Force. Camp Dresser and McKee, Larry Walker Associates, Uribe and Associates and Resources Planning Associates. 183p. 1993.

International Erosion Control Association. Provides technical assistance and an annual Erosion Control Products and Services Directory. (800) 455-4322. <http://www.ieca.org/>.

Richman, T. et al. *Start at the Source: Residential Site Planning and Design Guidelines: Manual for Stormwater Quality Protection*. Bay Area Stormwater Management Agencies San Francisco. Brief, information-dense design guide to stormwater runoff reduction and treatment, oriented toward biological and landscaping methods. Many illustrations and diagrams. 1997.

Ross Middle School, Ross, CA (Marin County). Most rain leaders empty into landscaped areas: this allows percolation back to water table, reduces peak storm flows and flooding, and filters pollutants out of stormwater; site design includes pervious surfaces where possible.

Southern California Rock Products Association | Southern California Ready Mixed Concrete Association, <http://www.scrpa.com/>.

State Water Resources Control Board, Water Recycling Programs, PO Box 1977, 1001 "I" Street 15th Floor, Sacramento, CA 95814-1977, phone (916) 341-5536 for general inquiries, (916)341-5537 for construction related issues, stormwater@dwq.swrcb.ca.gov, web site: <http://www.swrcb.ca.gov/stormwtr/index.html>.

Stormwater and Urban Runoff Seminars — Guide for Builders and Developers, NAHB, Edited by Susan Asmus, Washington DC, (800) 368-5242 x538 or <http://www.nahb.com/>.

Stockdale, E.C. *Freshwater Wetlands, Urban Stormwater, and Nonpoint Pollution Control: A Literature Review and Annotated Bibliography*. 2nd Ed. WA Dept. of Ecology, Olympia, WA. 1991.

Strecker, E.W., J.M. Kersnar, E.D. Driscoll & R.R. Horner. *The Use of Wetlands for Controlling Stormwater Pollution*. The Terrene Institute, Washington, DC. April 1992.

U.S. Environmental Protection Agency. *Natural Wetlands and Urban Stormwater: Potential Impacts and Management*. EPA843-R-001. Office of Wetlands, Oceans and Watersheds, Washington, DC. February 1993.

U.S. Environmental Protection Agency. *Stormwater Management For Construction Activities: Developing Pollution Prevention Plans And Best Management Practices: Summary Guidance*. EPA#833-R-92-001, Office of Wastewater Management, 401 M St. SW, Mail Code EN-336,



Washington DC, 20460. October 1992. (800) 245-6510, (202) 260-7786 or
<http://www.epa.gov/owm/sw/construction/>.

Related Volume III CHPS Criteria

Site Credit 3: Post-Construction Management.

Site Credit 4: Design to Reduce Heat Islands.

Materials Credit 4: Recycled Content.



Guideline SP6: Native and Drought-Tolerant Plants

Recommendation

Use vegetation that is drought-tolerant and native to the school's climate area. Preserve existing vegetation, especially groups of plants or significant specimens wherever possible. Design for plant survival since many landscape areas in schools can be destroyed by intensive use. Design landscapes with a minimal water-use budget, using low-flow irrigation systems.

Description

Native vegetation is adapted to regional climate conditions. They are easy to establish, are drought-tolerant (require little or no irrigation once established), and are naturally disease-resistant and pest-resistant. Planting for minimal water use is also referred to as "xeriscaping" or "drought-tolerant" landscaping. Existing vegetation is the easiest and most cost-effective way to landscape the site. It also provides historical connection to the surrounding neighborhood.

Plant survival can be increased by using tough plants that can take foot traffic such as plants grown from corms or bulbs. Good examples include *Dietes vegeta*, *Acanthus mollis*, *Phorium sp.*, and many of the grasses, reeds and sedges. These tough plants should anchor corners and edges of planted areas.

Also raised beds, curbs, and temporary but artistic barriers can help protect plants into maturity. Preparing designs and management programs that layer plant types, use a mixture of sizes at initial plantings, and plan for plant succession will also help.

Applicability

This guideline applies to all climates, but is especially important in the central valley, southern coastal, and desert climates.

Applicable Codes

Model Water Efficient Landscape Ordinance, Division 2, Title 23, California Code of Regulations, Chapter 2.7, Sections 490 through 495 (<http://www.dpla.water.ca.gov/cgi-bin/urban/conservation/landscape/ordinance/index>).

Integrated Design Implications

Drought-tolerant landscaping should be integrated/coordinated with Guideline SP2: Landscaping to Provide Shade to HVAC Systems, Buildings, and Paved Areas; Guideline SP4: Landscape Design and Management; and Guideline SP12: Integrated Weed, Disease, and Pest Management. All landscape planning should also take into account irrigation system parameters to assist in the goal of maximum efficiency. See Guideline SP8: Water-Efficient Irrigation Systems.



Davis, CA. These groupings of native, quick growing perennial grasses require little irrigation and thrive in high use areas. Photo courtesy of Wolfe Mason Associates.

Applicable Spaces	Climates	When to Consider
Classrooms	South Coast	Programming
Library	North Coast	Schematic
Multi-Purpose / Cafeteria	Central Valley	Design Dev.
Gym	Mountains	Contract Docs.
Corridors	Desert	Construction
Administration		Commissioning
Toilets		Operation
Other		



Cost Effectiveness

Costs are competitive with, or only slightly higher than, conventional landscape design. Additional cost benefit occurs if reusing existing vegetation.

Costs	L		H
	M		
	H		
		L M H	Benefits

Benefits

The use of drought-tolerant, native species conserves water (thereby reducing water costs), provides lots of attractive planting options, presents minimal disease and pest problems, thrives with little fertilization, requires low pruning and maintenance, provides wildlife habitat, and saves valuable landfill space. If retaining native vegetation in a landscape (rather than removing them and then replanting), added benefits include excellent erosion, sediment, dust, and pollution control.

Design Tools

Landscaping for minimal irrigation also requires careful planning of plant groupings, the "right plant, right place" concept, soil considerations, and other landscape design practices. The use of landscape professional with expertise in native and drought-tolerant vegetation for the school's climate region is recommended.

Irrigation Water Needs of Landscape Plants in California,
<http://www.dpla.water.ca.gov/urban/conservation/landscape/wucols/index.html>

Landscape Auditors certified by the Irrigation Association (703) 536-7080, web site:
<http://www.irrigation.org/>.

Design Details

Add language into construction specs to protect existing plants, especially trees and root systems.

Soils are often disturbed during construction activities, and native vegetation may not thrive in degraded soils. Unless soil amendments are used to restore disturbed soil, it may be more appropriate to use water-efficient, non-native vegetation. See Guideline SP7 for using soil amendments.

Clearly define planting zones by intended use, e.g., lawns for play; tree groves for shade and habitat; shrub masses for buffering and screening; etc.

Introduce plants to increase habitat, e.g., butterflies and hummingbirds.

Create a diversity of landscape areas, e.g., ponds, meadows and groves; community gardens; vines and perennials, etc.

Operation and Maintenance Issues

Native, drought-tolerant plants are usually hardier and more pest-resistant, requiring less fertilizer and pesticide use. Use organic, slow release fertilizers and integrated pest management for pest control. See Guideline SP12 on integrated pest management.

Recommend that the landscape contractor specify in the maintenance contract that new landscaped areas be maintained for a two to three year plant establishment period. Monthly findings on plant establishment should be reported to owner.

Commissioning

None.

References/Additional Information

California Department of Water Resources. 1416 - 9th Street, Room 1104-1, Sacramento, CA 95814,
Phone: (916) 653-6192, fax: (916) 653-4684, <http://www.dwr.water.ca.gov/>.



California Landscape Contractors Association (CLCA). Phone: (916) 448-2522, fax: (916) 446-7692, or web site (with an on-line contractor search) at <http://www.clca.org/index.html>.

California Native Plants Society, <http://www.cnps.org/index.htm>.

City of Fort Collins. (March 1999). Xeriscape: a New Kind of Landscaping.

A summary of environmentally responsive landscaping resources, including a list of very low, low and moderate water consumption. <http://www.ci.fort-collins.co.us/utilities/water/conserv/xeriscap.htm>.

City of Santa Barbara. (March 1999). Water Conservation Program: Landscaping.

An excellent and visual orientation to water-conserving landscaping on the Southern California coast. http://www.ci.santa-barbara.ca.us/departments/public_works/water_resources.

Managing a Waste-Efficient Landscape, and on-line publication of the California Integrated Waste Management Board, web site:

<http://www.ciwmb.ca.gov/organics/Landscaping/KeepGreen/Manage.htm>.

Marsh, W. M. 1991. *Landscape Planning: Environmental Applications*. John Wiley & Sons, New York.

A definitive reference for landscape architects, planners and designers on the definition and application of environmental design principles to landscape and site planning.

Peterson Nature Area, Peterson Middle School, Sunnyvale, California. Contact: Bryan Osborne, Peterson Middle School, bryosborne@mail.telis.org, Santa Clara Unified School District, (408) 720-8540. Web site: <http://www.peterson.scu.k12.ca.us/~bosborne>.

WaterWiser — a program of the American Water Works Association operated in cooperation with the U.S. Bureau of Reclamation. The web site provides information and resources including links for all aspects of outdoor and indoor water conservation, recycled water collection and reuse, irrigation, landscaping, and efficient fixtures and appliances. AWWA number is (202) 628-8303. <http://www.waterwiser.org/>.

Related Volume III CHPS Criteria

Water Credit 1: Reduce Potable Water for Landscaping.



Guideline SP7: Landscaping Soil, Amendments, and Mulch

Recommendation

Use organic soil amendments to help restore the health of disturbed soils. Where feasible and appropriate, use soil amendments and mulch with recycled content.

Description

The appropriate use of organic soil amendment will offset degradation in soil health due to construction activities, reduce runoff, help treat stormwater pollutants, and help ensure establishment of vegetation. Where feasible, use soil amendments from composted green waste and mulch from shredded bark, which adheres better to the soil.

Applicability

All climates.

Applicable Codes

Model Water Efficient Landscape Ordinance, Division 2, Title 23, California Code of Regulations, Chapter 2.7, Sections 490 through 495
<http://www.dpla.water.ca.gov/cqi-bin/urban/conservation/landscape/ordinance/index>.

Applicable local ordinances (for example, City of Palo Alto, Landscape Water Efficiency Standards, March 15, 1993).

Integrated Design Implications

Soil amending should be integrated/coordinated with Guideline SP2: Landscaping to Provide Shade to HVAC Systems, Buildings, and Paved Areas; Guideline SP4: Landscape Design and Management; and Guideline SP6: Native and Drought-Tolerant Plants.

Cost Effectiveness

Medium.

Benefits

Research at the University of Washington has shown that, compared to traditional lawn installations, landscape grown on composted-amended soils:

- Uses less water for irrigation.
- Requires less fertilizer and pesticide.
- Covers and "greens up" more quickly.
- Has improved appearance.



Davis, CA. Mulch areas 3-4" deep prevent weed growth, protect soil, and prevent irrigation from washing it into other areas. Mulch can be walked on and used to replenish the soils of high use areas. Photo courtesy of Wolfe Mason Associates.

Applicable Spaces	Climates	When to Consider
Classrooms	South Coast	Programming
Library	North Coast	Schematic
Multi-Purpose / Cafeteria	Central Valley	Design Dev.
Gym	Mountains	Contract Docs.
Corridors	Desert	Construction
Administration		Commissioning
Toilets		Operation
Other		

Costs	L			
	M		■	■
	H			
		L	M	H
		Benefits		



- Reduces stormwater runoff.

Design Tools

Appropriate use of soil amendments requires site soil testing and analysis to determine type and amount of amendment.

Design Details

Key steps in creating and maintaining healthy soil and amendments include:

- Minimize disturbance of existing soil.
- Test the horticultural suitability of existing soil.
- Strip and save suitable existing soil for re-use in landscape areas.
- All existing soil in areas to be planted that have been degraded and compacted from building construction must be scarified before planting. In general and depending on soil type, planting soils can not be compacted more than 80% so that air and water can percolate through the soil cross section.
- Incorporate organic soil amendments from composted green waste to help restore the health of disturbed soils.
- Use a minimum 3 in. to 4 in. layer of mulch at all planting areas to help retain soil moisture and discourage weed growth. Some types of mulch can also take foot traffic.

Urban development often involves clearing, removing topsoil, cuts, and fills. Once the work is done, the remaining soil is often much less healthy than the original, native soil.

Table 4 – Characteristics of Healthy vs. Disturbed Urban Soil

Healthy Native Soil	Disturbed Urban Soil
<ul style="list-style-type: none"> • Stores water and nutrients — Contains a rich, diverse makeup of organisms, organic matter, and pores. Healthy soil acts like a giant sponge, storing and slowly releasing water, oxygen, and nutrients to plants as needed. • Regulates water flow — Maintains the natural water cycle by slowly discharging to streams and lakes and recharging aquifers. • Neutralizes pollutants — Soil rich in organic matter contains microorganisms that can immobilize or degrade pollutants. 	<ul style="list-style-type: none"> • Compacted — The removal of topsoil exposes subsoil that is often compacted. Heavy construction equipment can further compact soils. These dense layers resist plant root penetration and lack pores needed for adequate aeration. As a result, the soil is less able to absorb, retain, and filter (purify) groundwater. • Reduced storage capacity — Because subsoil are less able to retain water, more stormwater ends up as runoff, disrupting the natural water cycle and degrading the health of nearby streams and waterways. • Poorer quality — The subsoil layer generally contains less organic matter and fewer nutrients than rich topsoil. This soil is less able to immobilize or degrade pollutants.

The result is increased erosion and stormwater runoff, as well as higher flow rates, higher temperatures, and increased sediment in nearby streams result from disturbed urban soil. In addition, developed sites with poor soil typically require more irrigation, pesticides, and fertilizers to establish and maintain landscaping. Increased water usage as well as pesticide/fertilizer runoff causes further habitat damage.

Operation and Maintenance Issues

Vegetation grown on amended soils establishes more quickly and requires less ongoing maintenance compared to vegetation grown on un-amended, disturbed urban soil.

Commissioning

None.



References/Additional Information

The California Compost Quality Council (CCQC). A collaboration of compost producers, scientists, farmers, landscape contractors, and recycling advocates formed to administer compost quality guidelines in California. The CCQC operates an independent verification program through which compost producers can assure consumers that quality claims have been verified. CCQC, 584 Castro Street, San Francisco, CA 94114, phone (415) 863-1048 or web site: <http://www.crra.com/ccqc/ccqchome.htm>.

Compost and Mulch Sources List from the California Integrated Waste Management Board. Listings for Northern, Central, and Southern California. Web site: <http://www.ciwmb.ca.gov/organics/SupplierList/ListCent.htm>.

Landscape Architects Technical Committee (LATC). Under the purview of the California Architects Board, the LATC was created by the California Legislature to protect the health, safety, and welfare of the public by establishing standards of licensure and the enforcing of laws and regulations which govern the profession of landscape architecture. It is one of the numerous boards, bureaus, commissions, and committees within the Department of Consumer Affairs responsible for consumer protection and the regulation of licensed professions. State of California, Department of Consumer Affairs, California Architects Board, Landscape Architects Technical Committee, 400 R Street Suite 4000 Sacramento, Ca 95814, phone (916) 445-4954, fax (916) 324-2333, web site: <http://www.latc.dca.ca.gov/index.htm>.

U.S. Composting Council. This non-profit organization is involved in research, public education, composting and compost standards. Their website has links to composting resources throughout the country. Web site: <http://www.compostingcouncil.org/>.

Related Volume III CHPS Criteria

Water Credit 1: Reduce Potable Water for Landscaping.



Guideline SP8: Water-Efficient Irrigation Systems

Recommendation

Install drip or other low-volume, water-efficient irrigation and/or systems connected to humidity sensors, where appropriate.

Description

Supplemental irrigation accounts for most water use at schools during the summer and a significant amount during the spring and fall. Maximizing the water efficiency of irrigation systems supports healthy and attractive landscapes and sports fields.

Applicability

All climates.



Photo reprinted with permission from Rain Bird Sprinkler Mfg. Corp.
<http://www.rainbird.com/rbturf/products/xeri/xeri.htm>

Applicable Codes

Model Water Efficient Landscape Ordinance, Division 2, Title 23, California Code of Regulations, Chapter 2.7, Sections 490 through 495
www.dpla.water.ca.gov/cgi-bin/urban/conservation/landscape/ordinance/index,
 or applicable local ordinances.

Integrated Design Implications

Irrigation system design and installation should be closely coordinated with other landscape planning and water management activities. See Guideline SP4: Landscape Design and Management; Guideline SP6: Native and Drought-Tolerant Plants; Guideline SP7: Landscaping Soil, Amendments, and Mulch; Guideline SP12: Integrated Weed, Disease, and Pest Management; and Guideline SP10: Rainwater Collection Systems. Note: The soil should be amended and blended prior to installing the irrigation systems to avoid damage to the system.

Applicable Spaces	Climates	When to Consider
Classrooms	South Coast	Programming
Library	North Coast	Schematic
Multi-Purpose / Cafeteria	Central Valley	Design Dev.
Gym	Mountains	Contract Docs.
Corridors	Desert	Construction
Administration		Commissioning
Toilets		Operation
Other		

Cost Effectiveness

Drip systems and micro-emitters have become very cost effective when evaluated against water restrictions and rising water costs.

Costs	L			
	M			
	H			
		L	M	H
		Benefits		

Benefits

Benefits include significantly reduced irrigation water consumption, reduced utility costs and increased water conservation. Conventional spray heads deliver only 55% to 65% of the water to the ground; the rest is blown away or evaporates, depending on weather conditions. In contrast, drip irrigation is up to 95% efficient. Plants establish and thrive better with drip irrigation since water is delivered to the root zone, where it is needed. Water-efficient irrigation systems are also waste-efficient — water and fertilizer are used only where needed, preventing nutrient-consuming and waste-generating weed growth in other areas and reducing costs associated with managing and disposing of undesired plant growth.



Design Tools

None.

Design Details

- First, aim to eliminate the need for an irrigation system entirely. An effective stewardship program combined with drought-tolerant plants (Guideline SP6) might eliminate the need for an in-ground system.
- Where an in-ground system is required, the design and installation should be completed by a certified irrigation specialist and should conform to local ordinances. The ordinances include specifics about efficient irrigation.
- Systems should be installed to avoid runoff, low-head drainage, overspray, or other similar conditions where irrigation water flows onto adjacent property, non-irrigated areas, or impervious surfaces. Some irrigation systems can be connected to humidity sensors to keep from operating when humidity is high or when it is raining.
- Consider special problems posed by irrigation on slopes, in median strips, and in narrow hydrozones. Installation should provide easy access to sprinkler heads for inspection and maintenance.
- Use irrigation zones to group plants with similar water needs close to a water source, which limits the scope and impact of an in-ground irrigation system.
- Where possible, use the minimum amount of polyvinyl chloride (PVC) products. PVC is highly toxic during manufacture and disposal. Unfortunately the alternatives, such as copper or clay piping, tend to be more expensive. If substitution for virgin PVC is not an option, the system should be designed to use the minimum length of piping possible.
- Consider using irrigation systems made with recycled-content plastic, tire-derived rubber, and other recycled-content materials. See the California Integrated Waste Management Board's Recycled Content Product Database at <http://www.ciwmb.ca.gov/rcp/>.
- Preserve established vegetation to minimize irrigation needs. Avoid killing existing vegetation with too much water from new irrigation systems.

Operation and Maintenance Issues

Requires regular monitoring to ensure system is operating properly. Develop a monthly schedule to visually inspect and monitor irrigation system(s) performance during irrigation season. Performance evaluation should be based upon original design intent, irrigation audit report, and water budget goals.

Commissioning

Work with the commissioning agent and certified irrigation auditor to ensure compliance with the design documents. In addition to checking for proper irrigation equipment and installation, check the system for adherence to specified performance criteria and operation parameters as designed. Verify that maintenance personnel are trained and proficient in the ongoing programming and adjustments for the irrigation system.

References/Additional Information

California Department of Water Resources. 1416 - 9th Street, Room 1104-1, Sacramento, CA 95814, Phone (916) 653-6192, fax (916) 653-4684, <http://www.dwr.water.ca.gov/>

Costello, L. R. and K. S. Jones, A Guide to Irrigation Water Needs of Landscape Plants in California, University Of California Cooperative Extension. 1999 Edition. On-line at <http://www.dpla.water.ca.gov/urban/conservation/landscape/wucols/index.html>.

Drip Irrigation for Every Landscape and All Climates, by Robert Kourik, Metamorphic Press, PO Box 1841, Santa Rosa, CA 95402.



Hawn, Joellyn. "Process Changes to Improve Commercial Landscape Viability." *New England Real Estate Journal*, May 31-June 6, 1996.

Irrigation Association, various publications, including *Common Obstacles to Irrigation Efficiency* and *Drip Irrigation Technology*. Available on-line at <http://www.igin.com/irrigation/irrigation.html>.

Landscape Water Management Principles, Version 1.01. Cal Poly ITRC, San Luis Obispo, CA, 1994.

Netdim Irrigation Inc. 1998. *Techline Design Manual*. Netafim Irrigation, Inc. Landscape Division. Fresno, CA. A technical primer for designing drip irrigation systems.

WaterWiser is a program of the American Water Works Association operated in cooperation with the U.S. Bureau of Reclamation. The website provides information and resources including links for all aspects of outdoor and indoor water conservation, recycled water collection and reuse, irrigation, landscaping, and efficient fixtures and appliances. Web site: <http://www.waterwiser.org/>. AWWA number is (202) 628-8303.

Related Volume III CHPS Criteria

Water Credit 1: Reduce Potable Water for Landscaping.

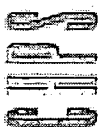

Guideline SP9: Stormwater Management, Groundwater Management, and Drainage Materials

Recommendation

Manage stormwater with systems that slow water velocity, maximize its use for irrigation, and filter pollutants. Use material-efficient options for on-site drainage systems. Groundwater should be managed separately from surface water.

Description

Stormwater management is vital to the safety and ecological health of a school site. Site planning and design should strive to balance water on the site and make effective use of the water for water supply and irrigation.

Water should always be absorbed and captured with the remainder moved slowly across the site into natural features wherever possible. Trying to move water quickly to gutters, downspouts, catch basins, and pipes increases water quantity and velocity, which requires the design of large and expensive drainage infrastructure. Options for material-efficient drainage include:

For fill

- Recycled concrete aggregate.
- Crushed concrete.
- Glass.

For pipes

- EPS with recycled content.

In areas where the water table is high, construction can cause groundwater to seep to the surface. In these cases, level spreaders should be used to pipe the discharge from curtain drains to trickle discharge onto fields or wetlands, in lieu of the stormwater system. It is important to manage groundwater separately from stormwater to prevent possible contaminants from destroying groundwater quality.

Applicability

All climates.

Applicable Codes

State Water Resources Control Board, Storm Water Program, PO Box 1977, 1001 "I" Street 15th Floor, Sacramento, CA 95814-1977, phone (916) 341-5536 for general inquiries, (916) 341-5537 for construction related issues, e-mail: stormwater@dwq.swrcb.ca.gov, or <http://www.swrcb.ca.gov/stormwtr/index.htm>.



Berkeley, CA. A boulder bridge spans a surface swale in the edible garden at King Middle School. The swale allows water to percolate back into the soil and eliminates the need for pipes. Students grow produce and sell it at local markets to raise funds for schools groups. Photo courtesy of Wolfe Mason Associates.

Applicable Spaces	Climates	When to Consider
Classrooms <input type="checkbox"/>	South Coast <input checked="" type="checkbox"/>	Programming <input type="checkbox"/>
Library <input type="checkbox"/>	North Coast <input checked="" type="checkbox"/>	Schematic <input type="checkbox"/>
Multi-Purpose / Cafeteria <input type="checkbox"/>	Central Valley <input checked="" type="checkbox"/>	Design Dev. <input type="checkbox"/>
Gym <input type="checkbox"/>	Mountains <input checked="" type="checkbox"/>	Contract Docs. <input type="checkbox"/>
Corridors <input type="checkbox"/>	Desert <input checked="" type="checkbox"/>	Construction <input type="checkbox"/>
Administration <input type="checkbox"/>		Commissioning <input type="checkbox"/>
Toilets <input type="checkbox"/>		Operation <input checked="" type="checkbox"/>
Other <input checked="" type="checkbox"/>		



The California Environmental Resources Evaluation System www.ceres.ca.gov/index.html features the California Land Use Planning Network with a broad array of data types from diverse sources, including selected, but fully scanned and searchable, county and city zoning ordinances.
<http://www.ceres.ca.gov/index.html>

Applicable specifications for fill and drainage materials.

Integrated Design Implications

Building design (especially roofs), site grading, erosion control, and bank stabilization need to be considered. Where applicable, the groundwater management system design should be integrated with the design of site built stormwater system for greatest cost savings.

Cost Effectiveness

On-site capture, absorption, and slowing of surface runoff usually has a lower first cost and ongoing maintenance expense. By managing groundwater separately from stormwater, the complexity and size of site-built stormwater systems can potentially be reduced, decreasing overall construction costs. Drainage material costs are comparable to, or less than, conventional materials. For example, recycled aggregate base is less expensive than virgin aggregate in the Los Angeles area. There also may be an economic advantage to crushing concrete and asphalt demolition debris on-site, where the material can be used as base or sub-base. The economy of on-site crushing depends on several variables including the amount of rubble stockpiled, the capacity of the crushing equipment available (tons per hour), local tipping fees for the inert materials, the haul distance to local inert landfills, and the total cost of importing virgin or recycled aggregate base to the construction site.

Costs	L			
	M			
	H			
		L	M	H
		Benefits		

Benefits

Capturing and absorbing stormwater is good water conservation. It also can improve the health of on site soils, vegetation, and habitat areas. Use of recycled-content products helps alleviate waste disposal problems, reduces energy use, and lowers consumption of natural resources during manufacturing.

Design Tools

None.

Design Details

Stormwater management should begin with capture in cisterns, ponds, etc. and absorption into groundwater aquifers, landscape areas, etc. Excess percolated water from green roofs and pervious paving should be filtered through vegetated areas or filters.

Any remaining water to runoff should be slowed down and spread slowly over the entire surface of roofs and paved areas before entering bioswales and surface runoff channels, such as brooks and creeks.

If pipes and catch basins are used, use perforated pipe and filters wherever possible.



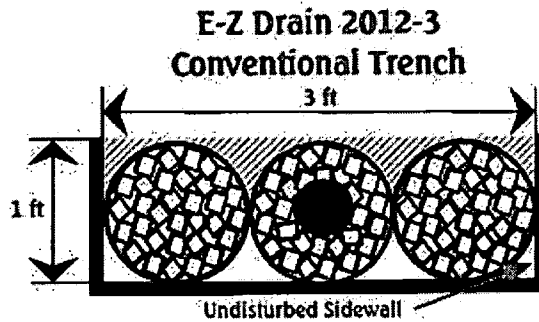

Figure 3 – Cross-Section of Trench

The basic unit of E-Z Drain is a 10 foot length of 4-inch perforated corrugated plastic pipe surrounded by EPS aggregate held in place by a cylindrical shaped polyethylene netting either 10 or 12 inches in diameter. Made from 60% to 100% recycled EPS. Illustration reprinted with permission from E-Z Drain Company. www.ezdrain.com

Natural boulders can be effective as energy dissipaters or as checkdams, creating riffles and pools in the channels.

Use green roofs and bioswales at buildings. Use site grading with bioengineered banks and channels, energy dissipaters, and check dams. Broken and excess masonry and concrete are good inert fill materials under sidewalks and driveways. If space permits, excess concrete can be crushed on-site and used as aggregate on another part of the site or on another construction job.

Operation and Maintenance Issues

Most traditional site maintenance programs at schools are limited trash pickup and “mow and blow” cleanup. Local conservation corps, youth job training programs, community and experienced gardeners, and neighborhood groups are good sources to help augment the school maintenance staff. They can help nurture a variety of landscapes, especially natural waterways and riparian corridors, ponds, meadows, and native planting beds.

If using level spreaders for groundwater management, they should be inspected after every runoff event to ensure proper function.

BEST COPY AVAILABLE



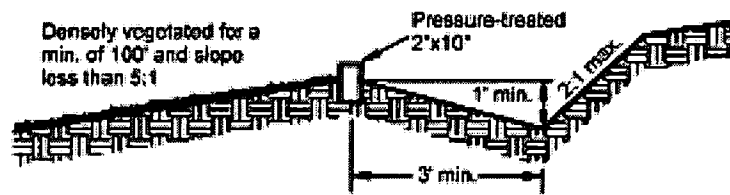

Cross Section of Level Spreader

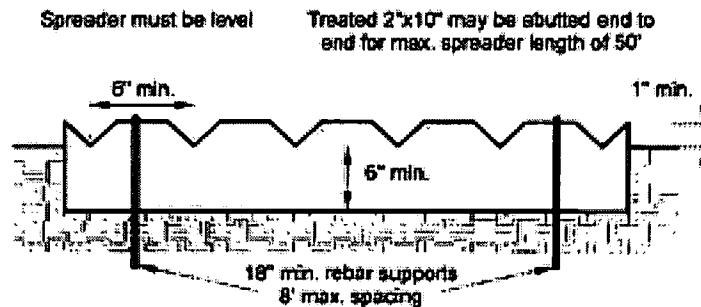

Detail of Level Spreader

Figure 4 – Level Spreader, Cross Section & Detail

(Source: Washington State Department of Ecology, Stormwater Management Manual for Western Washington, Volume II, Construction Stormwater Pollution Prevention)

Commissioning

None.

References/Additional Information

Blackberry Creek Restoration at Thousand Oaks School, Berkeley, CA. Designed by Wolfe Mason Associates with the Waterways Restoration Institute, Oakland and Berkeley, CA.

California Integrated Waste Management Board. Designing with Vision: A Technical Manual for Material Choices in Sustainable Construction. See Chapter 8, "Strategies to Reuse Materials and Reduce Material Use in Construction," Appendix E sample specifications for: Section 02045, Rock Crushing Operations. Chapter 8 is in Part D. Revised July 2000. Designing with Vision can be downloaded in four parts from <http://www.ciwmb.ca.gov/GreenBuilding>.

California Integrated Waste Management Board. Database of Recycled-Content Providers: <http://www.ciwmb.ca.gov/rcp>.

California Integrated Waste Management Board. *Recycled Aggregate* Fact Sheet, CIWMB publication #431-95-052. Also available to download from: <http://www.ciwmb.ca.gov/publications/condemo/43195052.doc>.

International Erosion Control Association. Provides technical assistance and an annual Erosion Control Products and Services Directory. (800) 455-4322 or <http://www.ieca.org/>.

Kids in Creeks Program for School Teachers. Aquatic Outreach Institute, Richmond, CA.

Sonoji Sakai Intermediate School, Bainbridge Island School District, Bainbridge Island, Washington uses level spreaders to slowly distribute groundwater to the adjacent field and wetlands.



BEST COPY AVAILABLE

Stream Corridor Restoration: Principles, Processes and Practices developed by 14 Federal Agencies. Available at <http://www.usda.gov/streamrestoration/>.

State Water Resources Control Board, PO Box 1977, 1001 "I" Street 15th Floor, Sacramento, CA 95814-1977, phone (916) 341-5536 for general inquiries, (916) 341-5537 for construction related issues, e-mail stormwater@dwq.swrcb.ca.gov, or <http://www.swrcb.ca.gov/index.html>.

Stormwater and Urban Runoff Seminars — Guide for Builders and Developers, NAHB, Edited by Susan Asmus, Washington DC, (800) 368-5242 x538 or <http://www.nahb.com/>.

Stormwater Management For Construction Activities: Developing Pollution Prevention Plans And Best Management Practices: Summary Guidance. EPA#833-R-92-001, October 1992, U.S. Environmental Protection Agency Office of Wastewater Management, 401 M St. SW, Mail Code EN-336, Washington DC, 20460. (800) 245-6510, (202) 260-7786 or <http://www.epa.gov/owm/sw/construction/>.

Related Volume III CHPS Criteria

Site Credit 3: Post-Construction Management.



Guideline SP10: Rainwater Collection Systems

Recommendation

Use rainwater-harvesting systems for supplying year-round, dependable potable or non-potable water.

Description

Drawing of excessive water and paving of all available open lands have considerably hindered natural ground water recharge. Rainwater harvesting is merely "putting back rain water into the soil." Rainwater is collected from roof or ground level surfaces and stored in a cistern. The water is then filtered and delivered to terminals through pumps. Rainwater is used for showers, sinks, laundries, dishwashers, and flushes. The components of a rain water system include:

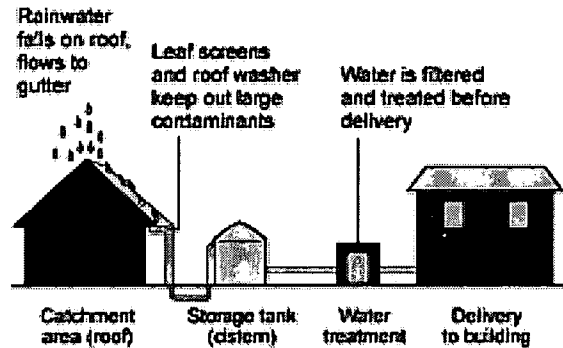

Schematic of a rainwater collection system

- Catchment area/roof is the surface upon which the rain falls. Roofs are most commonly used as catchment areas although channeled gullies or other ground level features can serve the purpose equally well.
- Gutters and downspouts are the transport channels from catchment surface to storage. Water collected by the catchment area is delivered to the storage tank (or cistern) via gutters and downspouts. These need to be appropriately sized and sloped. Standard designs for these "transport systems" are readily available in the market.
- Leaf screens and roof washers remove contaminants and debris.
- Cisterns or storage tanks store the collected rainwater. Cisterns are the most expensive component of the rainwater system.
- Conveying or delivery system for the treated rainwater is accomplished through pumps or gravity. The water pressure for a gravity system depends on the difference in elevation between the storage tank and the faucet. Water gains 1 psi of pressure for every 2.31 ft of rise or lift. Many plumbing fixtures and appliances require 20 psi for proper operation, while standard municipal water supply pressures are typically in the 40 psi to 60 psi range. To achieve comparable pressure, a cistern would have to be 92.4 ft (2.31 ft X 40 psi = 92.4 ft) above the highest plumbing fixture of the facility. This means pumps are essential to convey the filtered water from cisterns to terminal devices.
- Water treatment, filters and equipment, and additives to settle, filter, and disinfect the collected water are important components of this system. It is essential that a professional decide the water treatment method to use for a given facility after conducting appropriate water tests in a laboratory to determine whether this water will be applicable to potable or non-potable uses. Types of treatment include filtration, disinfection, and buffering for pH control. Dirt, rust, scale, silt and other suspended particles, bird and rodent feces, airborne bacteria, and cysts will inadvertently find their way into the cistern or storage tank even when design features such as roof washers, screens, and tight-fitting lids are properly installed. Water can be unsatisfactory without being unsafe; therefore, filtration and some form of disinfection is the minimum recommended treatment if the water is to be used for human consumption.

Applicable Spaces	Climates	When to Consider
Classrooms	South Coast	Programming
Library	North Coast	Schematic
Multi-Purpose / Cafeteria	Central Valley	Design Dev.
Gym	Mountains	Contract Docs.
Corridors	Desert	Construction
Administration		Commissioning
Toilets		Operation
Other		



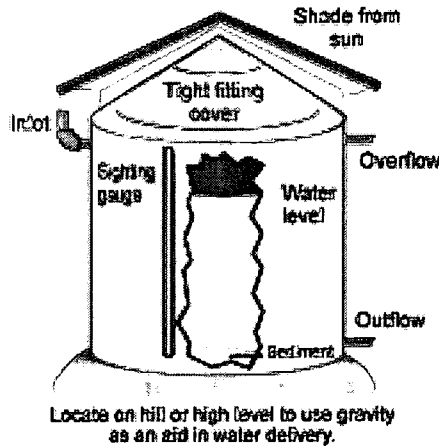

Figure 5 – Cistern for Rainwater Collection

The catchment area is the surface on which the rain that will be collected falls. While this guideline focuses on roofs as catchment areas, channeled gullies along driveways or yard swales can also serve as catchment areas, collecting and then directing the rain to a French drain or bermed detention area. Because composite asphalt, asbestos, chemically-treated wood shingles, and some painted roofs could leach toxic materials into the rainwater as it touches the roof surface, they are recommended only for non-potable water uses.

Gutters and downspouts are the components that catch the rain from the roof catchment surface and transport it to the cistern. Standard shapes and sizes are easily obtained and maintained, although custom fabricated profiles are also available to maximize the total amount of harvested rainfall. Gutters and downspouts must be properly sized, sloped, and installed in order to maximize the quantity of harvested rain.

Other than the roof, which is an assumed cost in most building projects, the storage tank represents the largest investment in a rainwater harvesting system. To maximize the system's efficiency, the building plan should reflect decisions about optimal placement, capacity, and material selection for the cistern.

Applicability

Rainwater systems are appropriate for most climates, although their application may be limited for severely cold climates. In dry climates, enough rainwater is available to meet 75% of the total water requirement of a facility.

Rainwater harvesting should be considered early in the design phase for best (and safest) results.

Applicable Codes

State Department of Health codes will apply to potable water. The Texas Rainwater Guide recommends that the following practices be observed (although regulations will vary locally):

- A cistern should not be located closer than 50 ft from a source of contamination, such as a septic tank.
- A rainwater system must include installation of an overflow pipe that empties into a non-flooding area.
- An above-ground roof washer or filtering device shall be provided on all cisterns.
- The water intake for a pump in a cistern shall be attached to a flotation device and be located a minimum of 4 in. below the surface of the water.
- Overflow from rainwater systems cannot flow into wastewater systems.
- Cisterns shall be accessible for cleaning.
- All openings into the cistern shall be screened.



- Cisterns cannot be relied upon to provide potable water without adequate treatment consisting of roofwashing and continuous disinfection.

Integrated Design Implications

- Site planning is an important consideration in designing rainwater systems. Decisions regarding placing the cistern, creating natural slopes or gullies for channeling rainwater, and creating a pressure difference between the gutter spout and the cistern inlet should be made at the site planning stage.
- Building aesthetics will also be impacted depending on the choice of rainwater collecting element.

Cost Effectiveness

A rainwater harvesting system designed as an integrated component of a new construction project is generally more cost-effective than retrofitting a system onto an existing building. Many of the shared costs of roof and gutters can be designed to optimize system performance, and the investment can be amortized over time.

Costs	L			
	M	■		
	H			
		L	M	H
		Benefits		

Generally rainwater systems cost about \$1/gallon to \$1.50/gallon of collection capacity although factors like design, topography, and climate can significantly alter these numbers.

City-supplied water is relatively inexpensive, although it must be added that municipal water cost is a simple number and does not include hidden environmental costs. Consequently, the pay back period for a full-service rainwater harvesting system where city water is available is rarely less than 30 years and can be as high as 90 years, assuming about present values for municipal water and approximate construction costs of \$1/gallon of collection capacity for a rainwater harvesting system.

Benefits

- It is an environmentally benign system.
- Rainwater quality is excellent.
- The concept is simple and easy to build. Operation and maintenance of systems are easy.
- Water and sewer costs are reduced.

Design Tools

For sizing catchment areas, it is reasonable to assume that 600 gallons is collected per inch of rain per 1,000 ft²:

$$\text{Catchment Area (ft}^2\text{)} = \frac{\text{Average Rainfall (inches)} \times 600}{1,000}$$

Basic Method Using Annual Data⁶

1. Calculate roof catchment area.

2. Multiply the collection area in ft² by 0.6 gallons/ft²/in. of rain times the collection factor times the average annual rainfall and half of the average annual rainfall.

For example, if you have 2,500 ft² of collection area and live in Austin, where the average annual rainfall is 32 in. a year and the collection efficiency factor is 80%, the average amount of rain you can collect is:

$$2,500 \times 0.6 \times 32 = 38,400 \text{ gallons/year}$$

3. Dividing this by 365 days a year, the supply would be 105 gallons/day.

4. Using the rule-of-thumb that half of the average rainfall will provide a close estimate of the low expected rainfall for the area, in an extremely severe drought year, approximately 19,700 gallons could be collected. This would result in a supply of only 53 gallons/day.

⁶ Texas Rainwater Guide.

BEST COPY AVAILABLE



A number of computer software programs are available for sizing purposes. Rainwater System Simulator (RainSim) is a spreadsheet program developed by Rain Harvest, Inc. (now Sustainable Homesteads), that simulates the performance of a rainwater collection system. For every month of the simulation, it subtracts the water that is used and adds in any rainwater that was collected. The amount of water remaining in the cistern at the end of the month is output to a graph. A total of 100 years' rainfall data may be added to the program. The following values are manipulated for simulation:

- Size of the collection area in ft².
- Number of gallons that will be used each month.
- Total size of storage capacity in gallons.
- Amount of water in storage at the beginning of the simulation, in gallons.
- Amount, if any, of water that will be put into storage if it is empty.

A companion program, RainCalc, calculates waste production and peak flow rate based on the collection area and peak design rainfall rates to be expected in this area once every 10 years. RainCalc is used to properly design the collection plumbing system to catch all rainfall flowing off the roof without losing any to system backup.

Design Details

- Collection area should be completely exposed and should not be shaded by trees. Rainwater yield and quality depends on the size and nature of the catchment area. Use smooth, impervious, and clean roofing for good quality yield. Textured roofing slows down water flow and is responsible for

Cistern Types⁷		
Material	Feature	Caution
PLASTICS		
Garbage Cans (20-50 Gallon)	Commercially available, inexpensive.	Use only new cans.
Fiberglass	Commercially available, alterable, and moveable.	Degradable, requires interior coating.
Polyethylene/Polypropylene	Commercially available, alterable, and moveable.	Degradable, requires exterior coating.
METALS		
Steel Drums (55 gallon)	Commercially available, alterable, and moveable.	Verify prior use for toxics, corrodes and rusts, small capacity.
Galvanized Steel Tanks	Commercially available, alterable, and moveable.	Possible corrosion and rust.
CONCRETE AND MASONRY		
Ferrocement	Durable, immovable.	Potential to crack and fail.
Stone, Concrete Block	Durable, immovable.	Difficult to maintain.
Monolithic/Poured in Place	Durable, immovable.	Potential to crack.
WOOD		
Redwood, Douglas Fir, Cypress	Attractive, durable.	Expensive.

⁷ Texas Rainwater Guide.

BEST COPY AVAILABLE

evaporative losses.

- Use pitched metal roofs to minimize losses. Metal roofs are also safe for potable water. Concrete or asphalt roof increase losses to 10%. Further loss in volume could occur if built up tar and gravel roofs are used. Clay and slate are also appropriate roofing choices for collecting potable water. Avoid roofing materials like asphalt, chemically treated wood, or asbestos for collecting potable water as they may introduce toxic matter in the rainwater.
- Surfaces like clay and slate should be treated with a special painted coating to discourage bacterial growth.
- Use aluminum or galvanized iron gutters and downspouts.
- Existing buildings should be fully examined for any lead content in the planning stages of any rainwater collection project.
- Locate cisterns below ground to benefit from cooler year-round ground temperatures. However, this may involve extra excavation and maintenance costs. Above-ground cisterns also work well and may be installed if excavation costs are a major issue. Also placing the cistern at the highest workable level will reduce pumping costs.
- Use durable cisterns (ferrocement or wood) with watertight exteriors. All joints should be sealed with a non-toxic joint sealant. The tank needs to be approved by the Food and Drug Administration if the water is intended for potable use. Use tight fitting covers to avoid losses due to evaporation and the entry of pollutants into the tanks.
- To maximize efficiency and minimize piping costs, locate cisterns close to both the rainwater collectors and the demand terminals.
- It is a good practice to shield cisterns from direct sunlight to prevent algae growth in the stored water.
- Site cisterns at least 50 ft away from sources of pollution like septic tanks.
- Cisterns should have vehicular access if the need to replenish the water through an auxiliary source arises.
- A settling compartment, which encourages any roof run-off sediment that may enter the tank to settle rather than be suspended in the tank, is an option that can be designed into the bottom of the cistern.

Operation and Maintenance Issues

- All tanks intended for storing potable water should be continually shaded from sunlight.
- Tanks should be regularly inspected and cleaned. The roof terrace (or rainwater collection system) should be regularly and thoroughly cleaned. Filters attached to rainwater conveying systems should be frequently cleaned to ensure maximum yield.
- Water from the first rains of the season should not be collected as it may contain atmospheric impurities and pollutants.

Commissioning

Buy durable cisterns with good warranties.

References/Additional Information

American Rainwater Catchment Systems Association, P.O.Box 685283, Austin, TX 78768-5283.

Center for Maximum Potential Building Systems, 8604 F.M. 969, Austin, Texas 78724. (512) 928-4786.

American Water Works Association, 6666 West Quincy Avenue, Denver, CO, 80235.

Water Quality Association, 4151 Naperville Road, Lisle, IL 60532.

<http://www.greenbuilder.com/sourcebook/Rainwater.html>

<http://www.waterwiser.org/>.

<http://www.webcom.com/h2o/>

Related Volume III CHPS Criteria

Water Credit 1: Reduce Potable Water for Landscaping.



Guideline SP11: Gray Water Systems

Recommendation

Use gray water systems for drought-resistant landscape irrigation and for flushing toilets.

Description

Gray water is untreated "used" water that is not contaminated by toilet waste. The California Gray Water Standards define it to include used water from showers, bathroom washbasins, and water from washing machines. It does not include wastewater from dishwashers, kitchen sinks, or laundry water from soiled diapers. Gray water systems filter, sterilize, deodorize, and recycle this used water to be used for irrigating landscapes or flushing toilets.

Gray water systems have three major components: the drain-line plumbing, the surge tank and other equipment associated with it, and the delivery system. Surge tanks allow quicker inflow of water from the source than outflow to drainfields. The example schematic shown here from Appendix J of the California Plumbing Code identifies the components of a gray water system where gray water is delivered to the landscape.

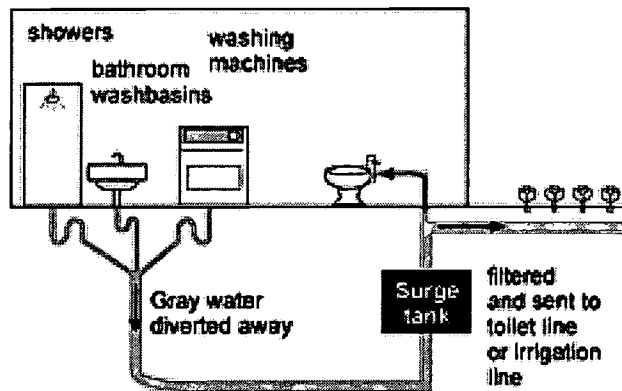

Gray water systems can recycle up to 50% of the selected waste water from a school to use for irrigation and/or flushing toilets.

Applicable Spaces	Climates	When to Consider
Classrooms	South Coast	Programming
Library	North Coast	Schematic
Multi-Purpose / Cafeteria	Central Valley	Design Dev.
Gym	Mountains	Contract Docs.
Corridors	Desert	Construction
Administration		Commissioning
Toilets		Operation
Other		

Plumbing work is required to divert the gray water from the existing drain lines. All drain lines from gray water sources should link to a common channel that connects to the surge tank. The surge tank contains filters, vents, valves, and pumps. Sand and settling (sedimentation) filters are most commonly used in large applications. Pumps deliver the gray water to toilets and the landscape (if drip irrigation is used).

Gray water composition varies depending on the water source, plumbing system, and user-specific variables (like cleaning products). At regular concentration levels, few components in gray water will damage trees and shrubs. Few detrimental soil changes will occur from well-managed gray water systems. Gray water contains high levels of grease, fibers, and particles (like dry skin), and is 5°F to 10°F warmer than non-gray water. Gray water does increase the number of soil organisms, but only slightly. Most harmful soil effects actually result from over-watering and prolonged saturation of the soil.

BEST COPY AVAILABLE



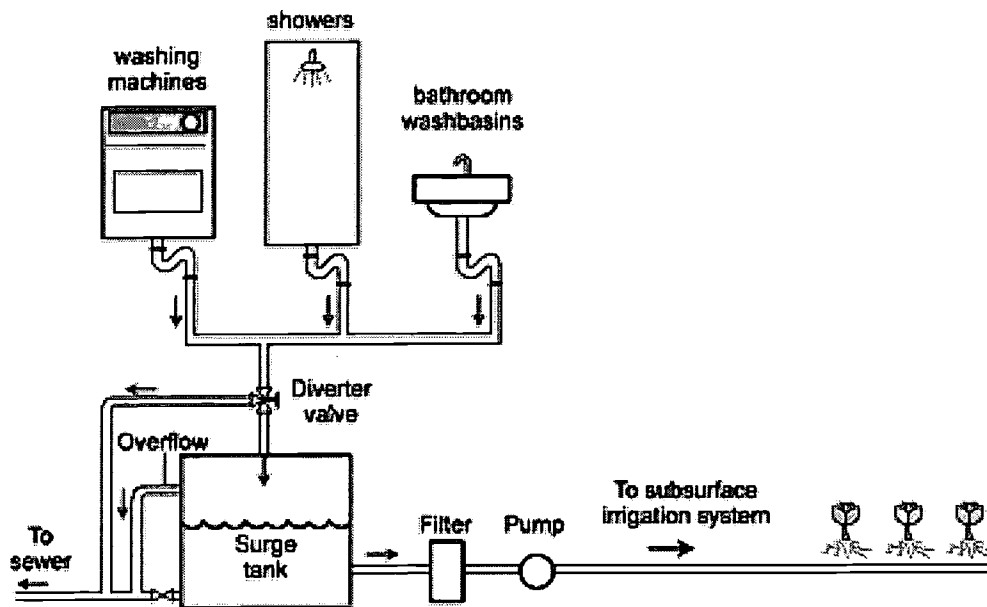

Figure 6 – Example Schematic of Gray Water System

Applicability

- They are appropriate wherever supplemental irrigation is normally required.
- They are applicable for all climate types, although their uses may be limited in severely cold climates. However, in colder weather conditions, graywater can be drained into leaching trenches that are deep enough to resist freezing, but shallow enough to keep the nutrients within the root zones of surface plants. Freezing can be prevented by applying a mulch over the subsurface leaching trenches. Drought-prone climates will especially benefit from a reliable, year-round source for irrigation.
- Do *not* use gray water for plants with limited root areas or on hydroponic plants. Acid-loving trees and shrubs (azaleas, begonias, and rhododendrons) may be affected because gray water is alkaline. Do *not* use gray water on edible plant parts.

Applicable Codes

In 1992, a law legalizing gray water use in the cities and counties of California was passed. The California Department of Water Resources (CDWR) was directed to adopt standards for gray water use. The CDWR standards define gray water as “untreated single-family residential wastewater from all sources, excluding toilet, kitchen sink, and dishwasher.” It also restricts the use of gray water to subsurface (varies between 8 in. to 12 in. depending on the soil type) applications. California does not require gray water sampling, monitoring, and treatment.

However, cities and counties in California can accept or reject the state's gray water standards or establish their own, using the state's standards as a base. They even can decide to ban gray water use altogether.

- All sub-surface drip irrigation must take place at least 9 in. below the soil surface.
- All piping, pumps, and fixtures associated with gray water systems should be clearly labeled along the entire length of the installation.

BEST COPY AVAILABLE



Integrated Design Implications

Integrated gray water systems for new constructions are cost effective, although retrofitting is not a major issue either. Plumbing installation and surge tank location require consideration early in the design process.

Cost Effectiveness

Installation costs for gray water systems can range from several hundred dollars to more than \$5,000 for small systems. Generally, systems will have an initial cost between \$8/gallon to \$15/gallon of stored gray water. The annual operating costs are between \$0.15/gallon and \$0.25/gallon of capacity.

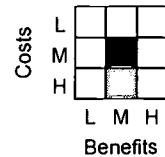

Table 5 – Types of Systems Currently Available

System Type	Source of Gray water	Features	Cost
Low-Tech Owner or Professional Installation	Washing machine only.	200 micron mesh filter. 55-gallon garbage can with locking lid.	\$400-\$800
Medium-Tech	Uses all gray water sources.	Sump pump to PVC tubing. Subsurface drip irrigation. 200-micron mesh filter. (2) 55-gallon storage tanks.	\$1,000- \$1,500
Fully Automated Professional Installation	Uses all gray water sources.	Automatically back-washed sand filter. 250-gallon storage tanks. Pumps at both source and tank/filter. Three-way valve, backflow preventers. Microprocessor controls all flows. Backed by potable water.	\$2,500- \$5,000

Benefits

- Promotes conservation and reduces water bills by reusing water from baths and sinks that would have otherwise gone down the drain. At least 30% of total "used" water is reutilized by such systems.
- Drought-proof landscaping. More than half the indoor water can be recycled, ensuring a constant source of water even during shortages. Also the nutrients in the gray water may benefit plants. Valuable plant nutrients, such as phosphorous and potassium, are often found in gray water that can result in healthier plants and in the reduced application of fertilizers. By leaving the soil surface drier, it may also make for a healthier landscape by reducing disease and pests.
- Using gray water improves the efficiency of applied water because it is delivered to the plants underground, eliminating runoff, over spray, and evaporation.
- The community benefits from gray water use because it reduces the amount of wastewater that is discharged to the local treatment facility. This has the potential to reduce wastewater treatment costs, and may even postpone or avoid the need for flow-related expansions of the facility. Local water and wastewater agencies also experience reduced pumping costs.

Design Tools

One of the toughest challenges in designing the gray water system is laying out the irrigation system and determining the size of the area to be irrigated. The homeowner or designer must decide which plants can be irrigated with gray water. The size of the irrigated area is determined by the soil type, volume of gray water produced, and by the summer water requirements of the plants. A good rule of thumb is to expect 2 gallons to 2.5 gallons of water to effectively irrigate 1 ft²/day. Estimate the total daily water requirement and assume that only 50% of this estimate will make it into the gray water storage.

Design Details

- Plumb "used" water from bathroom sinks, showers, and clothes washers separately from other wastewater. Kitchen sinks may be included if there are no in-sink garbage disposals. This water should drain by gravity into a surge tank.

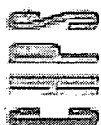

- Surge tanks should have tightly fitted covers, vent stacks, and overflow drains attached. It should also have a one-way valve to prevent backflow. Install the tank such that the outflow can be gravity driven. If this is not possible, use pumps for delivering water for irrigation. Overflow pipes that redirect water to septic tanks or sewer lines are very important when the field gets saturated.
- The water in the surge tank should be filtered.
- Locate the distribution piping 9 in. below the soil surface to provide adequate decomposition and minimize health risks. Use dual pipes that consist of 1 in.-perforated pipes with 5/16 in. holes at 6 in. intervals lodged in pipes of larger diameters with slits at the bottom.
- Provide several independent drain areas with valves for alternate distribution.
- Use a check valve between the pump and outflow piping to restrict the gray water flow in one direction.
- It is a good practice to label and mark all piping, fixtures, and pumps that comprise a gray water system.

Operation and Maintenance Issues

The success of gray water systems is completely dependent on careful operation and periodic maintenance. The following guidelines should be strictly followed for health and safety reasons.

- Paint thinners, paints, or pesticides should never be washed down the drain, and substances such as ammonia and chlorine should find their way into gray water plumbing in very limited quantities only. Drains in schools must be clearly labeled with bilingual signs.
- While most detergents can be used with gray water systems, there are several important exceptions and several cautions. Products that contain boron should not be used. Boron has been shown to be very toxic to most plants. Use biodegradable soaps as much as possible.
- If salt buildup in the landscape is a concern (it should be in most cases), it is better to use liquid detergents than powdered detergents. Powdered detergents contain excessive amounts of sodium.
- Chlorine is extremely toxic to plants, but it has not generally been a problem in gray water irrigation. This may be because chlorine breaks down fairly rapidly and its effects may also be dissipated or diluted in the soil. Having some residual chlorine present in the surge tank to minimize bacteria buildup also appears to be a benefit. Chlorine bleach may damage plants if it touches the foliage.
- Gray water should not be sprayed, allowed to puddle, or run off property.
- Gray water should be rotated with fresh water to leach out any harmful build-up. Biodegradable soaps appear to have the least harmful effects.

Commissioning

For safety reasons, involve a soil engineer (or other experts) to assess available soil and the feasibility of the system based on soil quality. All purchased equipment should be accompanied by detailed installation information and all equipment should be professionally installed.

References/Additional Information

WaterWiser — The Water Efficiency Clearinghouse. <http://www.waterwiser.org/>.

Guiding Principles of Sustainable Design (Chapter 8), National Park Service.
<http://www.nps.gov/dsc/dsqncnstr/qpsd>.

U. S. Environmental Protection Agency, Office of Water, <http://www.epa.gov/OW/>.

Water Alliance for Voluntary Efficiency (WAVE), <http://www.es.epa.gov/partners/wave/wave.html>.

Related Volume III CHPS Criteria

Water Credit 1: Reduce Potable Water for Landscaping.

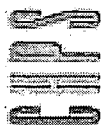

Guideline SP12: Integrated Weed, Disease, and Pest Management

Recommendation

Control and manage weeds, disease, and pests within tolerable limits to maintain the landscape in a manner that achieves attractive and healthy growth for plants, animals, and people while conserving energy and water.

Description

The most effective weed, pest, and disease control measure is to keep plants healthy. When a problem is caused by an adverse environmental condition, chemically treating the problem will not prevent its recurrence, but will only treat the symptoms. Control of disease and pests includes, but is not limited to, rust, scale, aphids, mealy bugs, pine shoot moth, snails, rodents, etc.

Once viewed as safe and effective for insect control, chemical pesticides and herbicides are now recognized poisons that can contaminate the soil and harm wildlife and humans — especially children. Some of this poison finds its way into lakes, streams, and groundwater supplies, where it disrupts the balance of life. Reducing the use of pesticides protects lakes and contributes to a healthier environment for fish, wildlife, and people.

Integrated pest management (IPM) is a horticultural practice that stresses the application of biological and cultural pest control techniques with selective pesticides, when necessary, to achieve acceptable levels of control with the least possible harm to human health and safety, non-target organisms, and the environment.

IPM encompasses various environmentally sound strategies, including:

- Use of appropriate, adapted plant varieties.
- Installation of a compatible, supportive landscape/site design (such as incorporating concrete mow strips near fencing to eliminate the need for herbicide use in these areas).
- Providing the necessary nutrients and moisture.
- Following through with good maintenance practices.

Applicability

All climates.

Applicable Codes

Healthy Schools Act (AB 2260). Signed into law September 2000, this new legislation contains requirements for least toxic pest management practices and notification and documentation of pesticide use.



Integrated pest management is used to maintain this varied landscape. Photo courtesy of Wolfe Mason Associates.

Applicable Spaces	Climates	When to Consider
Classrooms <input type="checkbox"/>	South Coast <input type="checkbox"/>	Programming <input type="checkbox"/>
Library <input type="checkbox"/>	North Coast <input type="checkbox"/>	Schematic <input type="checkbox"/>
Multi-Purpose / Cafeteria <input type="checkbox"/>	Central Valley <input type="checkbox"/>	Design Dev. <input type="checkbox"/>
Gym <input type="checkbox"/>	Mountains <input type="checkbox"/>	Contract Docs. <input type="checkbox"/>
Corridors <input type="checkbox"/>	Desert <input type="checkbox"/>	Construction <input type="checkbox"/>
Administration <input type="checkbox"/>		Commissioning <input type="checkbox"/>
Toilets <input type="checkbox"/>		Operation <input type="checkbox"/>
Other <input type="checkbox"/>		

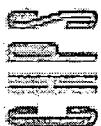

Integrated Design Implications

Planning for IPM should be integrated/coordinated with Guideline SP2: Landscaping to Provide Shade to HVAC Systems, Buildings, and Paved Areas; Guideline SP4: Landscape Design and Management; Guideline SP6: Native and Drought-Tolerant Plants; and Guideline SP7: Landscaping Soil, Amendments, and Mulch

Landscape design that employs IPM will help limit the release of potential stormwater pollutants.

Cost Effectiveness

Medium. IPM may have a higher initial cost than pesticide programs, but it is cost effective over the life of the building and produces safer school grounds, healthier vegetation, and lower spraying costs. Frequent pesticide use can result in a chemical dependent situation, where an insect comes back stronger than it was before. Increasing doses and frequency of application are then needed for attempted control of the pest. For example, pesticides that kill aphids also kill aphid predators. Since aphids reproduce more quickly than their predators, when they return to the plant, their natural enemies will be gone, and they may also become resistant to the pesticide. IPM means less pesticide/herbicide use, but may entail additional ongoing labor for maintenance as well as additional training, documentation, and policy development costs.

Costs	L			
	M	■	■	
	H			
		L	M	H
		Benefits		

Benefits

Decreased pesticide use means less health risk to students and staff, and lower maintenance costs associated with the purchase of pesticides.

Design Tools

None.

Design Details

There are four key issues for weeds, disease, and pests:

- The planting of appropriate species and their maintenance in a healthy condition since most weeds and pests are more attracted to weak or over-fertilized plants than to those in good health.
- Determining what really is a weed or pest. A plant is a weed only if it is in an undesirable location or is out-competing more desired species. Many "bugs" are essential to plant propagation and are beneficial to the health of plant.
- Maintaining weeds and pests on vegetation (grass, groundcover and shrubs, grasses and turf, gardens and perennials) within tolerable levels using the IPM approach.
- The control of damage from water fowl, gophers, and other rodents by the replacement of inappropriate plants with those that are less susceptible, and the addition of mechanical protection devices (cages, mesh, etc.) during the early growth period of the new plants, as needed.

Consulting a landscape professional with expertise in IPM to identify landscape and site design strategies that will support ongoing IPM. Select plant species less prone to disease.

Perform weed control by hand, pulling and hoeing whenever possible. It is important to do this frequently enough so that weeds do not have a chance to go to seed. Remove weeds from pavement and all vegetative areas. If there is a persistent problem, a pre-emergent herbicide may be considered for the large or particularly troublesome areas *only* after review and approval.

IPM requires a proactive management program with a good system of monitoring and record keeping as the first line of defense. Contractors' monthly reports shall include all weed, pest, or disease observations and actions taken for review by the management team. Mechanical and biological control measures, such as hand picking, water jets, safer soap, barriers (e.g., Tree Tanglefoot or poly mesh), biological controls (e.g., *Bacillus thuringiensis*), and less toxic sprays (e.g., dormant/summer oil, sulfur fungicides,



pyrethrum, or rotenone) are first considered for use, often in combination. Less toxic chemicals such as Round-Up will be considered before stronger chemicals.

The control of pests is the subject of numerous recent research, particularly in grass areas. Herbicides and sprays used to eliminate broadleaf weeds or fungus have caused numerous injuries, studies, and debates. If grass areas are properly located and receive proper care, weeds and disease should not be a major problem. If problems do arise, they are to be reviewed with the consulting architect, and physical or biological solutions explored before chemicals are requested. Broadleaf weeds are to be kept to a minimum but multiple grass varieties are acceptable. The use of green dyes in particularly noticeable brown spots is an option.

Operation and Maintenance Issues

IPM is a different approach, and requires planning, education, and training to succeed. Each school district should develop and implement a written pest management policy.

Commissioning

None.

References/Additional Information

California Department of Pesticide Regulation. The web site provides information about the new Healthy Schools Act and CPR's school IPM program. <http://www.cdpr.ca.gov/>.

Overview of Pest Management Policies, Programs, and Practices in Selected California Public School Districts. This is a report of a study conducted by the Environmental Monitoring and Pest Management Branch of the Department of Pesticide Regulation (DPR) of pest management programs in California's public school districts. The study was conducted in cooperation with the California Department of Education (CDE) to: (1) obtain an overview of district pest management policies, programs, and practices, (2) identify policy and program constraints, and (3) identify ways that DPR can work cooperatively with CDE to assist school districts in implementing pest management programs based on the principles of IPM. The report is available on-line at <http://www.cdpr.ca.gov/docs/dprdocs/schools/schools.htm>.

Reducing Pesticides in Schools: How Two Elementary Schools Control Common Pests Using Integrated Pest Management Strategies. The Pesticides Reduction in Schools (PRI-School) Project explored the potential for reducing risks associated with unnecessary pesticide use by implementing IPM programs in schools throughout Santa Barbara County. The main goals of the project were to identify the local administrative, technical and social barriers to implementing effective IPM programs and to explore ways to overcome these barriers. Funding for the PRI-School Project was provided by the U.S. Environmental Protection Agency and the Santa Barbara Foundation. The project was managed jointly by the Community Environmental Council and Organic Consulting Services, both from Santa Barbara. The report is available on-line at http://www.grc.org/cec/pubs/IPM_report2.html.

University of California's Statewide Integrated Pest Management Project, web site: <http://www.ipm.ucdavis.edu/default.html>.

Related Volume III CHPS Criteria

None.



INTERIOR SURFACES AND FURNISHINGS

This chapter provides guidelines for:

Guideline

Carpeting ([Guideline IS1](#))

Resilient Flooring ([Guideline IS2](#))

Ceramic Tile/Terrazzo ([Guideline IS3](#))

Concrete Flooring ([Guideline IS4](#))

Wood Flooring ([Guideline IS5](#))

Bamboo Flooring ([Guideline IS6](#))

Gypsum Board ([Guideline IS7](#))

Acoustical Wall Panels, and Ceilings ([Guideline IS9](#))

Paints and Coatings ([Guideline IS10](#))

Casework and Trim ([Guideline IS11](#))

Interior Doors ([Guideline IS12](#))

Toilet Partitions ([Guideline IS13](#))

Overview

The guidelines in this chapter provide advice on the selection of flooring, wall and ceiling finishes, other interior surfaces, and their associated coatings and adhesives. When selecting interior surfaces for high performance schools, designers should consider two questions:

- Does this product introduce chemical compounds into the space that will affect indoor air quality (IAQ)?
- Is this a material efficient product?

While many other characteristics, including acoustical performance and visual appearance, factor into product decisions, selecting material efficient products that do not degrade indoor air quality are the main goals addressed in these guidelines. Evaluating resource efficiency and volatile organic compound (VOC) emissions is an emerging science with many uncertainties. No material or product is

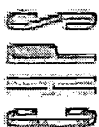

going to be optimum with regard to all the criteria. Choosing materials and products requires some professional judgment as to which of the criteria should be given the greatest weight.

Indoor Air Quality

Since most of the occupants in schools are children or adolescents with still-developing respiratory systems, the importance of IAQ is heightened. The metabolic rates of children are significantly greater than adults causing them to breathe more air and as result absorb and retain more toxins. In addition children's immune systems are less effective.

The U.S. Environmental Protection Agency (EPA) documents that Americans spend more than 90% of their lives indoors, and that pollutant concentrations inside buildings are two to five times greater than those outdoors. News reports and scientific inquiries have brought increased attention to the symptoms and causes of poor IAQ. Symptoms range from mild discomfort (sick building syndrome) to more severe illness and permanent injury (building related illnesses and multiple chemical sensitivity). Health effects include headaches, fatigue, memory problems, eye irritation, and coughs.

Providing improved IAQ over the life of the building a fundamental goal in the design of high performance schools.

There are four principles in designing good IAQ and they all need to be implemented as a whole:

1. **Source control:** Reduce and/or eliminate the source of contaminants in buildings.
2. **Ventilation control:** Provide adequate ventilation to dissipate the contaminants in buildings. Contaminants emanate from the building contents, equipment, occupants, and outside air.
3. **Building commissioning:** Building commissioning is a process used during the design, construction, and post-occupancy phases of a project to ensure that the project is built and performed as designed, and that the systems and equipment function as intended.
4. **Building maintenance:** Buildings require regular scheduled maintenance and cleaning to ensure that they perform throughout their life as they did when first constructed. Using environmentally friendly cleaning agents will reduce the opportunity for air contamination during the building's life.

Designers have a large impact on the selection for building materials, and therefore should seek to reduce or eliminate potential sources of indoor air pollution by selecting the lowest odor, least toxic, lowest emitting, most moisture-resistant, and most durable materials that can be safely installed and maintained.

Indoor pollutants include volatile organic compounds (VOCs), microbial volatile organic compounds (MVOCs), particulates, inorganic compounds (such as CO₂, CO, and ozone), and semi-volatile organic compounds (SVOCs) such as pesticides and fire retardants. Pollutant sources include the outside air, construction materials, furnishings, the building envelope, equipment, maintenance, and the occupants themselves. VOCs are of special concern because they can damage the natural environment during building material production and disposal, create hazards for installers and manufacturers, as well as cause health problems for building occupants.



VOCs are some of the most commonly discussed chemical emissions that affect IAQ. VOCs can occur in the air at normal environmental conditions and are emitted from interior materials such as paints, adhesives, sealants, sealers, carpets, resilient flooring, furniture, and ceiling panels. Materials and products emit ("off-gas") VOCs during and after installation, which can cause health problems for construction workers and building occupants.

Concentrations of a number of VOCs and formaldehyde are currently found in indoor air. In the indoor environment, formaldehyde can cause several health problems for occupants, including skin and eye irritation, upper respiratory system irritation, and symptoms of sick building syndrome. Formaldehyde is a known carcinogen so human exposure should be minimized, and indoor air concentrations should be kept as low as is reasonable to achieve.

In many cases, the best products, with the lowest VOC emissions, are made from water-based constituents. This said, it is also important to select materials that are easy to clean and maintain without the use of odorous, irritating, or toxic cleaning supplies.

Designers should also be aware that a product can be labeled as "low-VOC" or even zero-VOC and still emit VOCs that are odorous, toxic, or otherwise undesirable. Even small quantities of some chemicals can create problems indoors. The EPA VOC labeling requirements do not provide a straightforward way to compare VOC content since labels are required to only list chemicals classified as reactive, with the potential to create smog. Unlabeled non-reactive VOCs may react with oxidants to form odorous, irritating, or toxic chemicals in the indoor environment. While some VOC emissions may not cause an *air quality* problem for occupants, they may still be hazardous to installers and manufacturers.

VOC emissions are generally highest immediately after a new product is installed or a finish is applied, but emissions may continue for days, weeks, or months, and actual emission rates will be impacted by the ventilation conditions, indoor temperature, and humidity conditions. Even with low-VOC emitting materials, it is important to provide temporary ventilation during and after installation. However, the length of the required venting period depends on the amount of surface covered, as well as the volatility and toxicity of the finish. In addition, it is recommended that, prior to substantial completion, each school be flushed out with 100% outside air for about 15 calendar days, or as long as possible, to remove any remaining odor and VOCs.

Fleecy and absorbent surfaces such as carpets, wall coverings, window coverings, and ceiling tiles should be protected from exposure to the air during periods of high VOC emissions. Even better, construction work should be sequenced so that soft and/or porous materials are installed after VOC-emitting materials, finishes, or sealants have had a chance to "off-gas." Otherwise, emitted chemicals will be absorbed by porous surfaces, increasing the time required to clear the chemicals from the building.

Understanding chemical emissions adds to the complexity of reviewing contractor-initiated material and product substitution requests. Construction specifications should require that product ingredients and VOC emissions be reported, as well as information about any adhesives or solvents that are required



during installation or maintenance. However, substitutions should be welcomed when contractors and subcontractors can provide information about new and improved product alternatives.

To assist in understanding and limiting indoor VOC emissions, CHPS provides a model Special Environmental Requirements Specification (Section 01350) that establishes modeled indoor air concentration limits for 75 chemical compounds. It also provides testing protocols and reporting requirements for building materials.

In addition to product selection, the designer should also look for other ways to mitigate potential IAQ problems during construction. Dust and mold are two common construction by-products that can compromise IAQ. Construction activities such as wood sanding and drywall finishing generate large amounts of dust and debris, which can become an IAQ problem. Thoughtful work practices and thorough cleaning before occupancy will mitigate this potential problem.

Mold growth requires moisture and warmth, and a material on which to grow. Excess humidity, caused by moisture intrusion or condensation, will promote the growth of mold and other biological contaminants within building materials that impact human health. Mold growth is commonly found on ceiling tiles, gypsum board, carpet, and other finishes. Special care should be taken during the delivery, storage, and handling of these materials to prevent moisture contamination on the construction site. If any moisture damage occurs, the materials must be removed and replaced as soon as reasonably possible.

In summary, objectives and strategies used to protect IAQ include selecting interior surfaces that are:

- Made with water-based coatings and adhesives.
- Nontoxic and non-polluting during installation and use (low-VOC emitting).
- Resistant to moisture or inhibit the growth of biological contaminants.
- Easy to clean with non-polluting maintenance products.

Promoting Material Efficiency

Selecting material efficient interior building products is another high performance goal. Product material efficiency can be evaluated using a number of different factors including recycled content, product recyclability and reusability, embodied energy, durability, and location of mining and manufacture. The material efficiency calculations are complex and involve making professional decisions about the efficiency of one material versus another with a slightly different performance. For example, one type of flooring may be made from rapidly renewable resources, but is not very durable. Another flooring type is highly durable, but cannot be recycled. Which product is the better choice? Every product has tradeoffs. Weighing these pros and cons of products can make it difficult to determine which products are most environmentally preferable. It is anticipated that at some time in the future, a life-cycle assessment tool will be developed to assist designers with this analysis.

To promote the use of material efficient products in California schools, several new state laws with program requirements for environmental education were enacted (having been mandated by SB 373 in the 2001-2002 session). An "environmentally preferable product" is defined by Public Resources Code (PRC) 42635 as a product that promotes healthy indoor environments for children and uses



environmentally preferable materials and systems (e.g., uses less energy during manufacture and use; contains more recycled content; results in less potential waste; poses less harm to indoor air quality; consumes less water; can be recycled or reused) relative to similar products with similar functions. PRC section 42642 requires the Division of the State Architect (DSA) to create an environmentally preferable products database and a list of recycled products that may be used in the construction and modernization of school facilities. When complete, this database will be housed and maintained on the DSA's website.

In the meantime, designers should evaluate the material efficient product options available and select materials based on the environmental priorities of their project.

What Makes a Product Material Efficient?

To be considered material efficient, products should meet one or more of the following criteria.

- Durable.
- Reused, salvaged, and refurbished material or structure.
- Movable, refinishable, and reusable.
- Made with recycled content. The use of recycled content materials (preferably post-consumer content rather than post-industrial content) helps address problems of solid waste disposal, and the consumption of virgin resources.
- Recyclable.
- Made from or use resources that are sustainable.
- Preferably manufactured within 500 miles of the project site to reduce transportation energy use.
- Packaged in minimal, reusable, recycled content and recyclable containers.
- Purchased from a manufacturing source that embraces sustainability as corporate policy, which is reflected in the operation of the production plant.

Reduce, Reuse, Recycle

Interior finishes are important from a resource conservation perspective because they are used in large amounts and because they wear, requiring periodic maintenance or replacement. Material efficiency for building products should be approached in high performance school design according to the hierarchy of "Reduce, Reuse, Recycle."

Reduce. Waste prevention is the highest priority within the material efficient hierarchy and encompasses several components, including:

- *Dimensional Planning.* Techniques like dimensional planning reduce the amount of waste generated at the construction site. This form of waste prevention includes designing a building using: standard dimensions, a minimal structural footprint, and modular or preconstructed panels and elements. Standard dimensions take into account the standard sizes of major building materials, such as wallboard and carpet, when designing the size of a space. For example, wallboard is generally manufactured in 4 ft by 8 ft sheets, and a standard carpet roll measures 12 ft wide. One potential standard dimension for a space would be 8 ft by 12 ft, because that would reduce the number of cut-offs and scraps produced when installing these major building materials. Reducing the size of a structural footprint in addition to building multiple stories rather than one level with the same square footage conserves resources and uses less material in the foundation and roof structure. Including

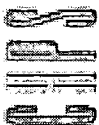

preconstructed panels and elements into plans is also known as designing for flexibility and adaptability, which prevents waste when remodeling spaces. For more details on dimensional planning, See 8.3 of the CIWMB publication, "Designing with Vision...A Technical Manual for Material Choices in Sustainable Construction" (July 2000).

- *Design for Disassembly.* This concept factors in the possibility for a product and its parts to be reused, remanufactured, or recycled at the end of their "useful life," reducing the amount of demolition waste generated. Additionally, these materials, which are typically considered a "waste," can be another building's raw material/resource.
- *Avoiding Unneeded Materials.* Material reduction can also be achieved by avoiding unneeded materials as a means to conserve raw resources. An example of this concept is the elimination of finish materials such as ceilings, or staining and sealing concrete instead of applying a second layer of resilient flooring over concrete slab. It is also important to select products that contain minimal packaging.
- *Durability.* Specifying products with high durability (which includes low maintenance requirements) can reduce waste, since building materials that have been discarded after a short service life account for much of the content in landfills.

Reuse is defined as using a material over again in its current form without breaking it down into a raw material. Designs can promote the reuse of materials by specifying salvaged and refurbished materials and structures. Commonly salvaged materials include lumber, pipes, steel, fencing, wood flooring, doors, windows, stone flooring and wall panels, appliances, lighting fixtures, and decorative accessories.

Recycle. Since it can be quantified, recycled content is one of the most common indicators of material efficiency. Recycled content products create markets for the tons of materials that people recycle. However, it is important to understand the distinction between recycled content products and those that are recyclable. Preferred products are those that both contain recycled content and are also recyclable at the end of their service life. However, when choosing between specifying a product that contains recycled content and one that could be recycled, the recycled content product should always take precedence. While recyclability of a product is important, it does not reduce the consumption of raw materials, nor does it promote completion of the cycle for existing materials that have already been diverted from the waste stream. The designer, in collaboration with the client, should set recycled content goals for all building materials. Some guidance is already available to help the designer with these goals, as described in the State Agency Buy Recycled Campaign (SABRC) section below.

The term "recycled content" can refer to two types of recycled materials: post-consumer and secondary (also known as post-industrial). Post-consumer recycled content is "a finished material which would have been disposed of as a solid waste, having completed its life-cycle as a consumer item."⁸ Secondary, or post-industrial, recycled content is defined as "fragments of finished products or finished products of a manufacturing process, which has converted a resource into a commodity of real economic value, but does not include excess virgin resources of the manufacturing process."⁹

⁸ California Integrated Waste Management Board. "Manufacturer Identification of Recycled Content." <http://www.ciwmb.ca.gov/publications/buyrecycled/43301018.doc>.

⁹ Ibid.

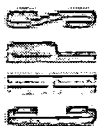

Designers should set a minimum recycled content rate of 25% for the project. Materials Credit 4 of the CHPS Criteria (Vol. III) awards points for using recycled content products. Points may be earned under this credit in a variety of ways. A weighted average is used in Option 1 of the Performance Approach. The calculation gives greater weight to products that exceed 20% post-consumer recycled content. This method is designed for projects that utilize recycled content products with high amounts of post-consumer recycled content. If most products contain at least 50% percent recycled content with a minimum of 10% post-consumer content, Option 2 of the Performance Approach is preferable. This option is consistent with SABRC and does not weigh post-consumer content above post-industrial content in determining the recycled content rate. Only products containing at least 50% total recycled content with a minimum of 10% post-consumer recycled content are included in the calculation.

The final option for achieving the recycled content rate is through the Prescriptive Approach. Under this approach, four to eight major materials from the EPA Comprehensive Procurement Guidelines 2000 Buy Recycled Series must be specified for the project. A "major" material is defined as those covering more than 50% of a building's surface or serving a structural function throughout the majority of the building. While this option may be the easiest to follow, the finite list of materials from which to select can be limiting.

When selecting products to meet the recycled content rate, always maximize the amount of post-consumer recycled content. For instance, if the project has a goal to achieve a recycled content rate of 50%, a product that contains 50% post-consumer recycled content and one with 30% post-consumer and 20% post-industrial content would both satisfy this goal. But, the product with 50% recycled-content would be the preferred choice.

State Agency Buy Recycled Campaign (SABRC)

The State Agency Buy Recycled Campaign is a good starting point for setting recycled content goals. The State Agency Buy Recycled Campaign is a joint effort between the Department of General Services (DGS) and the California Integrated Waste Management Board (CIWMB) to implement state law requiring California agencies to purchase products with recycled content. It compliments the efforts of the 1989 California Integrated Waste Management Act (AB 939 by Senator Byron Sher), which put California at the forefront of environmental protection and solid waste reduction with an ambitious agenda to reduce the amount of trash going to landfills by 50% in 2000. While the SABRC is not directly applicable to California schools, significant effort went into developing the program, and as such, it is a useful tool for school designers to avoid having to reinvent the wheel. For further information, refer to the CIWMB web site: <http://www.ciwmb.ca.gov/BuyRecycled/StateAgency/>.

Within SABRC, there are 11 product categories of recycled content materials. State agencies are required to report on the procurement and levels of recycled content in each category to keep a record of each item's recycled content certification. While this law does not apply to California's schools, it can provide a model for recycled content goals.

Of the eleven reportable recycled content categories, only six are applicable to building materials:



Table 6 – Recycled Content Categories Applicable to Construction Projects

Product Category	Minimum Total Recycled Content Requirement (%)	Minimum Post-Consumer Recycled Content Requirement (%)
Paper products (building insulation)	50%	10%
Plastic products (plastic lumber, carpet, entry mats, signage, and other building products)	50%	10%
Compost/co-compost (landscaping materials)	50%	10%
Glass products (windows, fiberglass insulation, tile)	50%	10%
Paint	50%	10%
Tire-derived products (rubber flooring, mats, ramps, parking and traffic control equipment, loading docks, tree ties)	50%	10%
Steel products (steel furniture, structural steel framing and decking, plumbing piping, sheet metal, reinforcing bars, miscellaneous metals)	25%	10%

The SABRC Training Manual includes a recycled content certification form that can be included in the project specifications so that contractors can obtain certification from manufacturers that products meet these or other desired levels of recycled content.

Material Efficient Examples

Many building products that are material efficient in one or more ways are now available. Examples of material efficient wood use include engineered lumber and composite wood products (Forest Stewardship Council-certified), which can be used for casework and trim as well as for framing. Engineered lumber is manufactured by combining wood fibers with plastic resins to produce high quality, structural products such as I-joists, laminated veneer lumber (LVL), parallel strand lumber (PSL), and glue-laminated beams. Sheathing products manufactured in this manner, such as oriented strand board (OSB), wafer board, medium density fiberboard (MDF) and particleboard, are made primarily of sawmill waste. While these products may be a potential source of indoor formaldehyde concentrations (see information below under Flooring), they promote source reduction. Likewise, finger-jointed lumber made from wood scraps makes use of material that would otherwise be wasted. And composite lumber composed of particleboard with a veneer of hardwood makes efficient use of fine hardwood for uses such as paneling and doors.

The design process also offers opportunity to maximize material efficiency through the use of dimensional planning to reduce waste during construction. Toward this end, the use of modular systems such as carpet tile instead of carpet greatly minimizes this particular construction waste. Develop a Construction Waste Management Plan to target specific materials from construction that should be diverted from landfill to recycling facilities. A standard divergence goal is 75%, with an aim for 80% in the coming years.

Special Environmental Requirements (Section 01350) for the Construction Document Specifications

Reducing chemical emissions and providing for resource efficiency is relatively new to building design and construction. To assist owners, designers, and contractors, CHPS has made available a model specification at <http://www.chps.net/> (To download, click on "Publications and Resources"). This specification section, Special Environmental Requirements (Section 01350), has been used on several California state projects and is intended to be included in Division 1 of the Construction Document

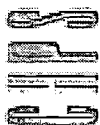

Specifications to lay out special environmental requirements related to IAQ, durability, recycled content and recyclability, wood from sustainably harvested sources, and product packaging. The intent of providing this sample specification is to give designers a base environmental specification from which to work. It is expected that each designer will customize this specification section for their specific project and coordinate with the other specification sections and the other parts of their project manual. Specification Section 01350 is intended to be placed into Division 1 of the project manual, so that it will govern all the other divisions (as is the case with submittal requirements and substitution requests, etc.).

Specification Section 01350 sets out environmental goals (specifically needed by the contractor if they are considering substitution requests), product emission testing methods, test protocols, sample procedures and reporting requirements. The specification section also identifies the chronic reference exposure levels (REL)¹⁰ for 76 hazardous airborne substances and uses these California Environmental Protection Agency Office of Environmental Health Hazard Assessment (OEHHA) RELs to establish acceptable modeled indoor VOC concentrations for these substances. (Since OEHHA will update their chemical lists on an unannounced basis, it is recommended that the designer check the websites referenced in this specification section for the latest list. The OEHHA REL list can be found at http://www.oehha.org/air/chronic_rels/AllChrels.html.) Recycled content and recyclability requirements for building materials are also provided in Specification Section 01350.

CHPS recommends that all interior materials that potentially emit VOCs (including adhesives, sealants, sealers, coatings, carpets, resilient flooring, ceiling materials, wall materials and coverings, architectural wood products, composite wood products, and furniture) meet the emissions criteria outlined in Specification Section 01350. The emissions data and modeled chemical concentration information required by Specification Section 01350 should be provided by the manufacturers to the general contractor, who in turn submits it to the designer for review. For a product to be compliant with Specification Section 01350, the modeled VOC concentrations for its chemical components must be no greater than half the RELs provided on the OEHHA website, other than for formaldehyde. The formaldehyde concentration provided in the OEHHA list is not achievable in reality and a recommendation for this concentration is provided in the specification. These recommendations apply to all products, whether they are standard products used in school construction or environmentally preferable products made with recycled or rapidly renewable content.

However, chemical testing alone cannot fully evaluate the potential for *odor* from VOC emissions. Relying on experience, and even ad hoc experiments such as carefully controlled clean glass jar “sniff” tests to determine the odor acceptability of a product, may also be necessary if there is a concern regarding the VOC emissions.

Other Material Efficiency Considerations

Embodied energy is the energy consumed during the entire life cycle of a product, including resource extraction, manufacturing, packaging, transportation, installation, use, maintenance, and when

¹⁰ According to California's Office of Environmental Health Hazard Assessment website, "Chronic RELs are designed to protect the individuals who live or work in the vicinity of emissions of these substances. A chronic REL is an airborne level that would pose no significant health risk to individuals indefinitely exposed to that level. RELs are based solely on health considerations, and are developed from the best available data in the scientific literature." http://www.oehha.org/air/chronic_rels/Jan2001ChREL.html.



appropriate, even disposal. Products with low embodied energy are environmentally preferable. Since transportation is a component of embodied energy, give preference to products that are locally available.

Products produced in a way that protects the eco-system are also environmentally preferable. One example is certified wood products, which are produced from trees grown and harvested from Forest Stewardship Council (FSC)-certified, sustainably managed forests. FSC is the accrediting agency for organizations such as Smart Wood and Scientific Certification Systems, which in turn oversee forestry practices and certify their sustainability.

Other Considerations When Selecting Interior Surfaces

Acoustical benefits can also factor into a product selection. For instance, consider carpet for areas when noise control is a concern. Also, be aware of how the acoustical properties of certain products can be impacted by other interior materials. For example, most ceiling tiles will lose their acoustical benefits if painted.

A product's color can also influence the decision-making process. While color is always a factor for visual appeal, it can also have a functional impact. Consider light colored paints and coatings to enhance daylighting.

In summary, when selecting materials, including interior building materials, for a high performance school, designers should look for cost-effective, durable, and material efficient products that protect indoor air quality and provide the desired acoustical performance and aesthetic qualities. In addition, high performance school designers should attempt to minimize the impact on the natural environment by selecting locally produced materials, as well as those produced in an environmentally benign manner, preferably using suppliers and manufacturers that practice "sustainable" or environmentally conscious management principles. Look for manufacturers that have a corporate policy incorporating sustainability. The selection process should consider installation and maintenance requirements as well as how the material or furnishing performs during its service life.

Because of their high visibility, interior surfaces and furnishings provide an excellent opportunity to highlight the high performance approach. Environmentally preferable choices teach the importance of caring for the health of occupants, as well as the health of the natural environment.

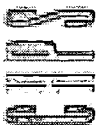

Table 7 summarizes the interior surfaces goals and objectives described above and presents the predominant relationship between them and the guidelines that follow.

Table 7 – Interior Surfaces Goals and Relationship to Guidelines

	IS1: Carpeting	IS2: Resilient Flooring	IS3: Ceramic Tile/Terrazzo	IS4: Concrete Flooring	IS5: Wood Flooring	IS6: Bamboo Flooring	IS7: Gypsum Board	IS8: Acoustical Wall Panels and Ceilings	IS9: Paints and Coatings	IS10: Casework and Trim	IS11: Interior Doors	IS12: Toilet Partitions
Goals												
Protect Indoor Environmental Quality												
<i>Use low-VOC emitting coatings and adhesives.</i>	●	●	●	●	●	●	●	●	●	●	●	●
<i>Use low-VOC emitting materials.</i>	●	●	●	●	●	●	●	●	●	●	●	●
<i>Use moisture-resistant materials.</i>			●	●								
<i>Use low-VOC emitting maintenance products</i>	●	●	●	●	●	●				●		●
<i>Use sound-absorbing materials</i>	●							●				
Materials Efficiency												
<i>Made from sustainable resources</i>		●			●	●				●	●	
<i>Made with recycled content</i>	●	●	●	●			●	●				●
<i>Recyclable</i>	●	●	●	●	●		●	●		●		
<i>Movable, refinishable, and reusable</i>					●					●	●	●
Other Environmental Considerations												
<i>Locally available</i>	●	●	●*	●	●		●	●	●	●	●	●*
<i>Durable</i>	●	●	●	●	●	●	●					
<i>Low in embodied energy</i>					●							
<i>Eco-system protective</i>		●			●					●	●	

* Note: No manufacturers for the recycled content versions of these products currently exist in California.

The discussions below provide a summary of the specific considerations, advantages, and disadvantages of materials choices addressed in these guidelines.

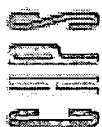

The Vinyl Debate

Few building materials have generated more debate over material efficiency and the environment than those containing polyvinyl chloride (PVC). PVC is a highly versatile, stable compound used in numerous building products, including pipes, siding, wire and cable coatings, resilient flooring, carpets, wall coverings, and furniture. In fact, construction materials account for the largest percentage of PVC use.

Commonly referred to as "vinyl," PVC products are highly durable and require low maintenance, which have made them a popular choice in schools. For instance, vinyl composition tile (VCT) is the most commonly used flooring material for non-carpeted areas in schools due to its long life, low maintenance requirement, and moisture-resistant properties. First cost for PVC products appears to be low.

Much of the debate focuses on environmental concerns with the production of PVC. PVC is derived from petroleum, which is a non-renewable resource and can be highly polluting during extraction, refinement, and manufacturing.¹¹ It should also be noted, however, that because many PVC products are manufactured in the U.S., they can have lower embodied energy than other materials that are manufactured overseas.¹²

Vinyl chloride (VC), a colorless, flammable gas that serves as the building blocks for PVC, is a known human carcinogen. Studies of PVC factory workers have shown that long-term exposure (365 days or more) to high levels of VC can cause liver cancer, nerve damage, and immune system problems.¹³ In response to these findings, the Occupational Safety and Health Administration in 1974 reduced the occupational exposure standard for VC gas in the air from 500 parts per million (ppm) to 1 ppm.¹⁴ These tighter restrictions, in combination with a closed-loop polymerization process adopted by the industry in the U.S., have reduced the high-risk exposure for workers.¹⁵ While most of the studies on VC exposure have focused on long-term exposure in factory workers, breathing high levels of VC gas for short periods of time can cause dizziness and unconsciousness, while breathing extremely high levels in a short period of time can cause death.¹⁶

Concerns also exist surrounding the disposal of PVC products. PVC products are not biodegradable, and since recycling options for PVC are currently limited, most products are not recycled. PVC can

¹¹ U.S. Environmental Protection Agency, Environmentally Preferable Purchasing Program. "Leading by Example: Two Case Studies Documenting how the Environmental Protection Agency Incorporated Environmental Features into New Buildings." December 1997. <http://www.epa.gov/opptintr/epp/pubs/qrnblgq.pdf>.

¹² Ibid.

¹³ U.S. Department of Health and Human Services, Agency for Toxic Substances and Disease Registry. "Vinyl Chloride Fact Sheet." September 1997, CAS #75-01-04. <http://www.atsdr.cdc.gov/tfacts20.html>.

¹⁴ Centers for Disease Control, Morbidity and Mortality Weekly Report. "Epidemiologic Notes and Reports: Angiosarcoma of the Liver Among Polyvinyl Chloride Workers – Kentucky." 1974, update 1997. <http://www.cdc.gov/epo/mmwr/preview/mmwrhtml/00046136.htm>.

¹⁵ Ibid.

¹⁶ U.S. Department of Health and Human Services. "Vinyl Chloride Fact Sheet."



also cause air quality problems due to dioxins emitted during combustion in improper waste incineration¹⁷ and building fires.

While some environmental organizations have serious concerns about its environmental impact, PVC also has some beneficial properties that have made it a widely used material in schools traditionally. CHPS has chosen to remain neutral on the use of vinyl products in schools. The guidelines in this chapter discuss the pros and cons of using PVC products for various building surfaces, but neither recommends nor discourages their use.

Flooring

Flooring should be durable to withstand heavy use without requiring frequent replacement, be easy to maintain, contain recycled content, be recyclable, contribute to a comfortable indoor environment, and not adversely affect human health. Based on life-cycle costs, highly durable materials are justified, especially for high-use areas.

Floor choices include resilient flooring, concrete, tile, wood, and carpet. When selecting these surfaces, review the cleaning products that might be used throughout the life of the flooring.

Carpet systems require maintenance, as do other flooring materials, and their need for more frequent replacement makes them materials- and energy-intensive over their lifetime. If selecting a carpet, select those carpets with a longer warranty to increase the service life and reduce the need for replacement. However, carpeting offers acoustical and comfort benefits that are generally not available with other flooring choices. For these reasons, carpeting is often used in classrooms and administrative areas.

Hard surfaces are often selected for use in high traffic areas not requiring the acoustical benefits of carpet.

Walk-off mats are recommended for all school entrances to help minimize cross-contamination by pollutants brought into the building on occupants' shoes. Using walk-off mats to trap dirt, dust, grit, and moisture can also reduce maintenance costs, improve safety, and protect the life and appearance of the flooring.

Table 8 summarizes advantages and disadvantages of the flooring choices addressed in these guidelines.

¹⁷ U.S. Environmental Protection Agency, Environmentally Preferable Purchasing Program. "Leading by Example: Two Case Studies Documenting how the Environmental Protection Agency Incorporated Environmental Features into New Buildings." December 1997.

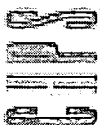

Table 8 – Environmental Criteria for Floors

Flooring Type	Advantages	Disadvantages
Carpet Guideline IS1	<p>Material efficient options available: minimum recycled content guideline of 50%, with at least 10% post-consumer recycled content. (In the CHPS Criteria, Materials Credit 4: Recycled Content gives priority to products with high post-consumer recycled content.)</p> <p>Thermal comfort.</p> <p>Physical comfort (cushion).</p> <p>Provides safety for small children.</p> <p>Noise control.</p> <p>Some recycling options are available.</p>	<p>May emit some VOCs during and after installation.</p> <p>Can harbor dust and other allergy-causing particles.</p> <p>Requires regular maintenance. Requires frequent vacuuming, which stirs up dust.</p> <p>Can adsorb VOCs and re-emit (desorb) later.</p> <p>Adhesives and maintenance products can add to indoor pollution load (but low-toxic/low-VOC options are available).</p> <p>Potentially need to allow time to air out carpet (precondition off site) before occupancy.</p> <p>Less durable and stains easier than other flooring options.</p> <p>Significant debris generated when it must be replaced.</p> <p>Can be a source of mold/mildew if placed in contact with moisture.</p>
Resilient Flooring Guideline IS2	<p>First cost can vary from low to high, depending on product, but due to its high durability, this flooring type tends to cost less per year of use than carpet.</p> <p>Easy to clean.</p> <p>High reflectivity can enhance daylighting.</p>	<p>Flooring adhesives and maintenance products can add to indoor pollution load (but low-toxic/low-VOC options may be available).</p> <p>Most are not recyclable or biodegradable.</p>
Ceramic Tile / Terrazzo Guideline IS3	<p>Recycled content options available: minimum recycled content guideline of 55-77%.</p> <p>Easy to clean and stain-resistant (some tile may need to be sealed first).</p> <p>Highly durable.</p> <p>High reflectivity can augment daylighting.</p>	<p>High cost.</p> <p>High embodied energy.</p> <p>Made from nonrenewable resources. Some ceramic tile is recycled as clean construction waste. When contaminated by bonding and setting agents, recycling is not feasible.</p> <p>Tile installation materials (mortar and grout) are sources of VOCs and toxic materials. (Portland cement-based mortar and grout appear to have less significant environmental impact than latex or solvent-based systems.)</p> <p>Terrazzo poses installation risks, depending upon type. (Cementitious type appears to have less significant environmental impacts than epoxy systems.)</p> <p>Hard finished surface can compromise physical comfort.</p> <p>Adhesives and maintenance products can add to indoor pollution load (but low-toxic/low-VOC options are available).</p>
Concrete Flooring Guideline IS4	<p>Material efficient if manufactured with high fly ash content.</p> <p>Highly durable.</p> <p>Low maintenance and low cost.</p>	<p>Sealers and wax products can add to indoor pollution load (but low-toxic/low-VOC options are available).</p>
Wood Flooring Guideline IS5	<p>Renewable resource, if properly managed (FSC-certified forests).</p> <p>Low embodied energy.</p> <p>Wood flooring is recyclable and the market for recycled wood flooring is expanding.</p> <p>Biodegradable.</p> <p>Easy to clean.</p> <p>"Warm," comfortable surface.</p> <p>Durable and can be refinished to prolong its life.</p> <p>Good aesthetics.</p>	<p>High cost.</p> <p>Adhesives, sealants, and maintenance products can add to indoor pollution load (but low-toxic/low-VOC options are available).</p> <p>Requires special moisture-prevention care in handling and installation to prevent later IAQ problems.</p> <p>On-site sanding requires special measures.</p>
Bamboo Flooring Guideline IS6	<p>Material efficient.</p> <p>Durable and hard.</p> <p>Easy to clean.</p> <p>"Warm," comfortable surface.</p>	<p>High cost.</p> <p>Adhesives, sealants, and maintenance products can add to indoor pollution load (but low-toxic/low-VOC options are available).</p>



Walls and Ceilings

Walls and ceilings should be durable, be easy to clean, contain recycled content, and be recyclable, as well as contribute to a healthy and comfortable indoor environment. Classrooms and other rooms require plenty of tackable wall space for teaching aids and displaying student projects. The type and color of surfaces on teaching walls should also be visually comfortable and not detract from teacher presentations.

Drywall is potentially recyclable and can be composted. Recycled content gypsum board core is available, but it is important to explicitly specify recycled content to ensure its use. Although they may not advertise it as recycled, many manufacturers already use post-industrial recycled content in their drywall product, and virtually all make the facing paper component from post-consumer recycled content paper. To protect indoor air quality, it is recommended that all drywall products meet the emissions requirements outlined in Specification Section 01350. See the discussion on Special Environmental Requirements (Section 01350) above.

When using wall coverings, use biodegradable papers that contain recycled paper or fiber content. Vinyl wall coverings are widely used but have raised concerns since they contain polyvinyl chloride (PVC). (For further discussion of vinyl, see the Vinyl Debate section above.) Installation of wall coverings using traditional wallpaper paste is preferable to using self-stick wall coverings, due to the levels of VOC content in the adhesive.

Avoid using ceiling tile and sprayed-on ceiling finishes containing asbestos, formaldehyde, or crystalline silica, as these items are possible cancer and respiratory tract hazards. Table 9 summarizes advantages and disadvantages of the wall and ceiling choices addressed in these guidelines.



Table 9 – Environmental Criteria for Walls and Ceilings

Type	Advantages	Disadvantages
Gypsum Board Guideline IS7	<p>Gypsum is highly recyclable if not contaminated (with paint, tape, compound, adhesives or other coatings).</p> <p>Recycled content gypsum is readily available at no cost premium, and the paper facing is typically made with recycled paper.</p> <p>Durable, high impact drywall contains up to 15% post-consumer recycled content.</p> <p>Recycled gypsum is more durable than conventional wallboard.</p> <p>Easy to repair.</p> <p>Low cost.</p>	<p>Dust generated during sanding (can specify "wet sanding" process).</p> <p>Gypsum surfaces are potent "sinks" for odors, which they can later re-release.</p> <p>Requires periodic painting. Paints and primers can add to indoor pollution load (but low-toxic/low-VOC options are available).</p> <p>Low durability compared to concrete block.</p>
Ceramic Tile Guideline IS3	See Table 8, Ceramic Tile/Terrazzo Flooring.	See Table 8, Ceramic Tile/Terrazzo Flooring.
Acoustical Wall Panels and Ceilings Guideline IS8	<p>Recycled content materials readily available: minimum recycled content guidelines for ceiling tile is 79-85%, for suspension system is 25%.</p> <p>Formaldehyde-free products available.</p> <p>Reclamation programs available (though limited).</p> <p>Easy installation.</p> <p>Acoustical ceiling tiles often cost less than wallboard ceilings.</p> <p>Do not require painting or other finish materials to complete the installation.</p> <p>Easy to reuse.</p> <p>Provides for easy relocation of fixtures, if required.</p>	<p>Tile collects dust and adsorbs odors. Tile and plenum requires periodic maintenance.</p> <p>Due to the grid organization, acoustical tile ceilings may not be as adaptable to renovations as a gypsum board ceiling.</p> <p>If the T-bar ceiling space has a return air plenum, as is common, this type of air handling design is difficult to clean. Many materials are used in the space above the T-bar ceiling. Material off-gassing, odors and microorganisms in the plenum area can spread and be distributed to other areas. (Avoid this by installing return air systems using dedicated metal ductwork with access hatches for inspection and cleaning.)</p>

Coatings

Paints and other coatings affect indoor air quality and may produce hazardous waste. Most conventional products off-gas VOCs, formaldehyde and other chemicals that are added to enhance product performance and shelf life. These chemicals, especially in combination, may pose health concerns. Fortunately, high quality, low-toxicity and low-VOC substitutions are now available for all these products.

Adhesives and Sealants

Many conventional construction adhesives, sealants, caulking, grouts, and mortars used to bond structural components are solvent-based, toxic and may off-gas large amounts of toxic VOCs (including solvents and aromatic hydrocarbons). Avoid using products, which include butyls and urethanes, indoors. Low VOC, low-toxic, water-based formulations are now available for many more applications.

Specify the least toxic/lowest VOC product suitable for the application and require installer to use the smallest amount of adhesive necessary to fulfill the manufacturer's performance specifications for that product.

Non-solvent adhesives have 99% less hazardous emissions than solvent adhesives, although their emissions may last much longer. When used to adhere dense floor coverings, emissions will be low, but prolonged. Yellow and white glues are recommended. When specifying sealants, consider using only silicone sealants in interior areas. However, some silicone sealants do contain acetic acid, which has an unpleasant odor that may be irritating. Other environmentally preferable alternatives include

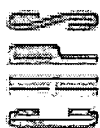

acrylics and siliconized acrylics. They are typically the safest to handle and have the lowest solvent content. All other sealant types, especially butyl sealants, emit VOCs and other toxic compounds, and emission test data should be requested and reviewed prior to including the product in a specification.

Applicable Codes

Applicable state and local school district design and materials standards.

California State Ventilation and Indoor Air Quality Code.

State of California, South Coast Air Quality Management District Rule #1168 for adhesives and sealants.

State of California, South Coast Air Quality Management District Rule #1113 for coatings (Note: Recently amended to adopt new, stricter VOC limits paint and other coatings.)

American Concrete Institute ACI 530, *Building Code Requirements for Masonry Structures*. The 1999 Building Code Requirements for Masonry Structures, Specifications for Masonry Structures and Related Commentaries. Will be referenced by the International Building Code (IBC 2000) for the design and construction of masonry structures. This publication is a joint effort of the American Concrete Institute, the American Society of Civil Engineers, and The Masonry Society.

American Concrete Institute ACI's 318-99, *Building Code Requirements for Structural Concrete and Commentary*. Provides engineers, designers, contractors, and other professionals with the latest design and construction requirements. Will be referenced by IBC 2000.

Design Tools

Alevantis, Leon. 1996. *Reducing Occupant Exposure to Volatile Organic Compounds from Office Building construction Materials: Non Binding Guidelines*. Published by the CA Department of Health Services. Available on-line at <http://www.cal-iaq.org/VOC>.

American Society of Heating, Refrigerating and Air-conditioning Engineers (ASHRAE). *ASHRAE Standard 62, Indoor Air Quality*. <http://www.ashrae.org>.

American Society for Testing and Materials (ASTM) Standard D5116-90, Small Scale Environmental Determination of Organic Emissions from Indoor Materials/Products.

California Integrated Waste Management Board (CIWMB). "Designing with Vision...A Technical Manual for Material Choices in Sustainable Construction." Available on-line at <http://www.ciwmb.ca.gov/greenbuilding/Pubs.htm>.

King County, Washington. *Construction and Landscaping Materials Specifications*. Available on-line at <http://www.metrokc.gov/procure/green/const.htm>.

National Institute of Standards and Technology. Building for Environmental and Economic Sustainability (BEES) 2.0. BEES measures the environmental performance of building products by using the environmental life-cycle assessment approach specified in ISO 14000 standards. Download the program at: <http://www.bfrl.nist.gov/oe/software/bees.html>.

U.S. Environmental Protection Agency (EPA). *Tools for Schools Program and Tool Kit*. Available on-line at <http://www.epa.gov/region01/eco/iaq/index.html>.

U.S. Environmental Protection Agency (EPA). *Building Air Quality: A Guide for Building Owners and Facility Managers*. Ordering information: Tel: (800) 490-9198, order number EPA402F91102, or view at <http://www.epa.gov/iedweb00/base/baqtoc.html>.

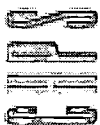

References/Additional Information

- Architects, Designers and Planners for Social Responsibility (ADPSR) West Coast. 1998. *Architectural Resource Guide*. Contact: ADPSR, P.O. Box 9126, Berkeley, CA. Tel: (510) 273-2428. Resources and information on green and healthy buildings, including many sources for materials in California.
- Berkeley Unified School District. 1994. *Materials/Indoor Air Quality Policy* (1994).
- Bernheim, Anthony, "Indoor Air Quality," *Sustainable Building Technical Manual*, Green Design, Construction and Operations, Public Technology, Inc., DOE, USEPA, 1995.
- Bernheim, Anthony, "Saving Resources," *Urban Land Institute*, pp. 76-81, 94-95, June 2001.
- Bernheim, Anthony, "Measure and Cost of Green Building", AIA Convention 2000 Seminar S76. Download handout at <http://www.aiaconvention2000.com/conted/schedule.asp?HandOut=1>.
- Building Ecology Research Group/Hal Levin & Associates. 1999. *Indoor Air Bulletin*. Contact: PO Box 8446, Santa Cruz, CA, 95061-8446. Tel: (831) 426-6624. A newsletter for architects and building professionals on indoor air quality.
- California Integrated Waste Management Board (CIWMB) Database of Recycled Content Products. <http://www.ciwmb.ca.gov/rcp>.
- Center of Excellence for Sustainable Development, U.S. Department of Energy, Energy Efficiency and Renewable Energy Network (EREN). Provides web pages on green building and green development. <http://www.sustainable.doe.gov>.
- Los Angeles, City of. *Sustainable Building Reference Manual*. Contact: Nady Maechling. (213) 473-8226. Contains detailed local information and many resources.
- Maryland State Department of Education. *Building Ecology & School Design; Technical Bulletin: Carpet and Indoor Air Quality in Schools*; and *Interior Painting and Indoor Air Quality in Schools*. To order, contact the Maryland State Department of Education, Division of Business Services, School Facilities Branch, 200 W. Baltimore St., Baltimore, MD 21201. Phone for Capital Projects Assistant Manager, (410) 767-0097.
- National Clearinghouse for Educational Facilities (NCEF). *Managing Indoor Air Quality in Schools*. Available on-line at <http://www.edfacilities.org>. Spiegel, Ross and Dru Meadows. *Green Building Materials, A Guide to Product Selection and Specification*. John Wiley & Sons, Inc. 1999. ISBN 0-471-29133-1.

Acknowledgments

The following resources were particularly useful for developing this chapter:

- Sustainable Building Task Force. The Sustainable Building Task Force was formed by a number of state agencies to institutionalize sustainable building practices into state construction projects. The task force meets on a monthly basis to discuss strategies for implementing sustainable building practices in all future and current state buildings, including those leased by the State. Visit <http://www.ciwmb.ca.gov/GreenBuilding/TaskForce/> for more information and links to member agencies.
- Santa Monica, City of. 1999. *Santa Monica Green Building Design and Construction Guidelines*. Available on-line at <http://greenbuildings.santa-monica.org/main.htm>.
- Partnership for Resource-Efficient Schools. 1998. *Recommended Best Management Practices Promoting: Energy Efficiency, Resource Conservation, and Environmental Quality*. A publication of the Seattle Public Schools Building Excellence Program and the City of Seattle (Solid Waste Utility, Water Department, and Seattle City Light). The following web site provides information about the Partnership for Resource-Efficient Schools project and a link to download the Best Management Practices manual: <http://www.cityofseattle.net/util/rescons/susbuild/partnership.htm>.
- BUILT GREEN™ Handbook*. 1999. BUILT GREEN™ is a program of the Master Builders Association of King and Snohomish Counties (MBA) in partnership with King County and Snohomish County, Washington. <http://www.builtgreen.net/>.
- Maryland State Department of Education. *Building Ecology & School Design; Technical Bulletin: Carpet and Indoor Air Quality in Schools*; and *Interior Painting and Indoor Air Quality in Schools*. To order, contact the Maryland State Department of Education, Division of Business Services, School Facilities Branch, 200 W. Baltimore St., Baltimore, MD 21201, (410) 767-0097.

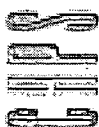

Guideline IS1: Carpeting

Recommendation

Select a carpet, carpet tile, cushion, pad, and adhesives that:

- Cause minimal pollution (low-volatile organic compound emissions).
- Are durable. Compare warranties.
- Are made with recycled-content.
- Can be easily cleaned and maintained.
- Are constructed so as to prevent liquids from penetrating the backing layer where moisture under the carpet can result in mold growth.
- Can be easily removed without the use of toxic chemicals.
- Can be easily replaced.
- Absorb sound.

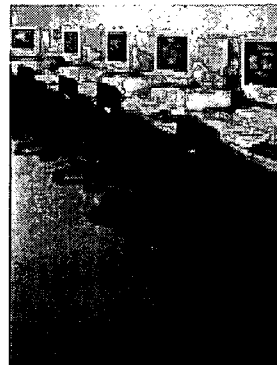

Carpeting in a school computer lab. Photo reprinted with permission from the Carpet and Rug Institute, <http://www.carpet-rug.com>.

To reduce waste during construction and installation consider the use of carpet tile instead of broadloom carpet, if applicable.

Where practicable, select a carpet and pad that is recyclable at the end of its life. Even when made from recycled materials and/or with potential for recycling at the end of their useful lives, carpet service life is relatively short compared to other flooring alternatives. Energy and other resources are consumed in the recycling process. Also, some carpet recycling does not re-use the material as carpet but rather in a lower form of carpet materials. Due to these factors, carpet should be used only when its performance characteristics outweigh its environmental costs.

Follow recommendations from the Carpet & Rug Institute (CRI) for installation and maintenance.

Applicable Spaces	Climates	When to Consider
Classrooms	South Coast	Programming
Library	North Coast	Schematic
Multi-Purpose / Cafeteria	Central	Design Dev.
Gym	Mountains	Contract Docs.
Corridors	Desert	Construction
Administration		Commissioning
Toilets		Operation
Other		

Description

Because carpet systems off-gas when new, carpet is a potential source of indoor air pollution. Typically, most volatile organic compounds (VOCs) are emitted from the backing, adhesive, and seam sealer rather than from the wear layer. The specifications listed under the Design Details section below provide guidelines for procurement of low-emissions carpeting and adhesives.

Particles and debris accumulate on carpets, exposing occupants who regularly use the room. Easy and effective cleaning of carpets is critical to reduce long-term exposure to pollutants. Cleaning requirements include both vacuum use and wet-extraction processes.

Moisture trapped below a carpet can result in mold growth and the release of mold spores and mold metabolic products (microbial VOCs) into the air. Concrete must be sufficiently cured, dried, and/or sealed before carpet is installed over it.



Applicability

Most suitable for classrooms, libraries, and administrative areas.

Applicable Codes

See the Applicable Codes section in this chapter's Overview.

Integrated Design Implications

Flooring type selection affects thermal comfort (carpeting retains heat longer than most resilient flooring, for example) and lighting (floor finishes with high reflectivity enhance daylighting). Recycle clean construction/installation waste carpet, if possible (require subcontractor to take back for recycling). Research carpet reclamation programs if the project involves disposing of an existing carpet. Flooring type also affects acoustics, noise control, safety, and maintenance. Complete all painting and other adhesive use prior to the installation of carpets to prevent VOC "sinks."

Cost Effectiveness

A typical nylon carpet installation costs between \$2.20/ft² and \$3/ft². Recycled content padding and carpeting are priced competitively, with a life expectancy between 10 and 15 years.

Costs	L	■	■	■
	M	■	■	■
	H	■	■	■
		L	M	H
		Benefits		

Benefits

Although not as material efficient as durable flooring, recycled content and recyclable flooring are material efficient. Carpeting provides acoustic benefits not available with other flooring types. Emissions specifications for carpeting in schools provides indoor air quality (IAQ) performance guidelines for school environments. Low-toxic adhesives minimize the indoor air pollution load and health risks to both installers and occupants.

Design Tools

See the Overview at the beginning of this chapter.

Design Details

If regular, effective maintenance and cleaning cannot be assured (due to budget constraints, inadequately trained staff, or other reasons), carpeting should not be used. (See the Operations and Maintenance discussion below).

Emissions Criteria

The adhesives used to attach face fibers to backing materials and the adhesives used to install carpets usually contain VOCs. These compounds may not be listed on the container or on manufacturer's literature if they are considered exempt under the definition of VOCs in the Clean Air Act regulating reactive chemicals known to be precursors of photochemical smog. However, many of the exempt VOCs are of concern for indoor air quality. Depending on the strength, type, and duration of emissions from these chemicals, carpet can be a significant source of indoor air contamination.

The CRI has developed a program known as the CRI Indoor Air Quality Carpet Testing Program (CRI Green Label). This label identifies carpets that, after 24 hours of testing, have VOC emissions below levels established by the CRI. At the time the CRI program was established, many carpets exceeded these emissions levels. Currently, almost all carpets qualify for the CRI Green Label. While the CRI label should be a bare minimum requirement for carpet selection, it is not a sufficient indicator of carpet emissions into indoor air. A Maryland State Department of Education Technical Bulletin, Carpet and Indoor Air Quality in Schools, cautions that CRI certification "does not provide information on comfort and health effects of specific VOC emissions, and should not be misunderstood to assure a safe product."



It is recommended that all carpet products (virgin and recycled-content) meet the emissions criteria outlined in Specification Section 01350 to ensure improved IAQ benefits required for a high performance school. Additionally, the specific criterion for 4-PC emissions applies to carpets.

- Under a test over a 96-hour time period after 10 days of conditioning (as described in Specification Section 01350), the carpet should emit less than 10 $\mu\text{g}/\text{m}^2\text{-hr}$ of 4-PC.
- The proposed specifications should require that the contractor submit a compliance table, which documents the required performance criteria (as provided in the specifications) and actual test results.

School designers should also require manufacturers to submit the following information for each product making up the carpet system:

- The ingredients, including identification and quantified amounts of substances that are listed on either: (a) the International Agency for Research on Cancer List of Chemical Carcinogens; (b) the Carcinogen List of the National Toxicology Program; or (c) the Reproductive Toxin List of the Catalog of Teratogenic Agents.
- Emission factors for VOCs contained in the product, in $\text{mg}/\text{m}^2\text{-hr}$.
- Product TVOC emission factor (after 10 days of conditioning in clean air at 1 air change per hour then tested at 24, 48, and 96 hours ($\text{mg}/\text{m}^2\text{-hr}$)).
- Emissions test protocol used.
- Organization evaluating the product.

Type of Carpet

When selecting carpet, space classification, desired design life, and desired aesthetics are the traditional considerations.

Look for low pile, dense loop, and needle-punch carpet types, which trap the least soil and show the least wear. One good choice for schools is a low-nap, all-nylon carpet, which is less attractive to dust mites and mold.

Natural carpets are made from grasses, cotton, and wool with minimal treatment. However, natural carpet materials can harbor insects and support mold growth, as well as being more difficult to maintain. For these reasons, natural carpet is not recommended for schools.

Recycled Content

Select a carpet with a minimum of 50% total (yarn and backing) recycled content (minimum 10% post-consumer recycled content). The manufacturer's warranty period should be reserved for such carpets, and those with a shorter life span should be used in low-traffic areas. Type One Commercial Carpet is available, either a tile or a broadloom, with backing made with post-consumer plastic (typically nylon, polypropylene or a mix of these two plastics). Some manufacturers offer product lines that contain 50% or more recycled content plastic by weight and above. Generally commercial carpet made from nylon 6 or 6,6 is the most durable type of carpet. At this writing, at least two manufacturers supply products made with 100% recycled nylon. Many manufacturers will offer a surface wear warranty of 15 years or more (e.g., 10% surface wear by weight). Some carpet manufacturers also offer reclamation programs to facilitate carpet recycling at the end of its useful life.

The life expectancy of recycled content carpet is between 10 and 15 years.

Carpet Tiles

Carpet tile systems save money and resources. They generate less waste during installation. They are also easily removed and replaced during renovation, and individual tiles can be easily replaced as needed, considerably extending the average service life of the carpet. A few disadvantages to carpet



tiles are that they may be more subject to vandalism by students who discover the system is modular. Also, flooding or spills may cause moisture to infiltrate the joints, creating potential IAQ hazards.

Refurbished Carpet

At least one manufacturer refurbishes commercial carpet for reapplication as modular carpet tiles. The manufacturer super-cleans, re-textures and overprints new colors and patterns to previously used carpet. The end product has a warranty and costs about half of new. Refurbished carpet is considered a 100% post-consumer recycled content product. However, in some instances, manufacturers will add new backing to the refurbished product, which would reduce the amount of post-consumer recycled content.

Pad

Specify carpet pad with the highest percentage of recycled content (and is compatible with selected carpet product). Fibrous pad is also available in commercial grades made from recycled synthetic and natural fiber from textile mill waste.

Recyclability

Carpet recycling is a priority because of the large volumes being disposed and its resistance to decomposition. A national agreement for carpet stewardship called the Memorandum of Understanding for Carpet Stewardship (MOU) was signed on January 8, 2002. The MOU states that, "the amount of carpet that is reaching the end of its useful life and entering the waste stream is ever-increasing: estimated total discards for 2002 are **4.7 billion pounds**." Fully recyclable carpets are just newly available. Many manufacturers now take the carpet and carpet tile at the end of its useful life and will recycle it back into new carpet backing (i.e., closed loop system).

Installation

Where new carpet odor is a concern, require suppliers to unroll and air out carpets in a warehouse before bringing them into the building. Tests indicate that carpet emissions will decrease significantly within 48 to 72 hours with proper ventilation.

When installing carpet over concrete floors, ensure that the concrete is sufficiently dry prior to installation. If water vapor emissions from the concrete floor are greater than 5 lb/1,000 ft², a vapor emission control treatment should be applied to the floor until emissions meet the maximum levels allowed by the carpet manufacturer.

Specify the least toxic carpet adhesive system compatible with selected carpet products. Require installer to use the smallest amount of adhesive necessary to fulfill the manufacturer's performance specifications for that product. Alternately, specify tack-down carpet to eliminate gluing, while taking precautions to prevent potential mold and mildew growth under the carpet.

If covering a large surface area, carpet and other fabrics can act as "sinks" for the adsorption of VOCs from other sources (during application of paint and other finish coatings, for example) and re-emit them later. To minimize this "sink" effect and subsequent extended re-emitting of VOCs, install soft surfaces as late as possible and/or remove or cover all soft surfaces and use direct ventilation until the offensive coating dries.

Air out space(s) where carpet has been installed for a minimum of 72 hours. With a central HVAC system, the ventilation supply should be on, the return grille(s) sealed, and windows open.

In renovations, carpet installation should occur only when the school building is not in use. An exception would be for small installations in which the space can be exhausted directly to the outdoors, causing the room to be under negative pressure relative to adjacent spaces in the building. Extra ventilation should continue for a minimum of 72 hours after installation.

To reduce the risk of mold growth on carpet, do not install carpet near water fountains, sinks, showers, pools, or other locations where it may get wet.

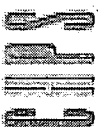

Operation and Maintenance Issues

Carpeting acts as a highly-effective reservoir for allergens such as dirt, pollen, mold spores, pesticides and other toxins, which are present outdoors and often introduced into the indoor environment in dirt from occupants' shoes. Old carpeting may pose more health risks to its occupants than new. Microbial contamination resulting from water infiltration or inadequate cleaning procedures is a potential problem. The presence of fungi and dust mites can exacerbate allergies. To help ensure longer life, maintain appearance, and help protect indoor air quality, carpet requires regular vacuuming with a well-functioning vacuum cleaner equipped with strong suction and a high-performance filtration bag. Walk-off mats should also be provided at all entrances.

Spills must be cleaned up immediately and thoroughly. If carpet becomes saturated and water is not quickly removed (less than 24 hours), experience suggests that carpeting will have to be discarded.

Commissioning

Airing out the space during and after carpet installation is essential and is recommended by the CRI, the U.S. Environmental Protection Agency, and the U.S. Consumer Product Safety Commission. The typical recommendation is to continuously operate the building ventilation system at normal temperature and maximum outdoor air during installation and for 72 hours after installation is completed. A longer flush out of the entire building should also be considered. The CRI *Standard for Installation of Commercial Textile Floor Covering Materials* (CRI 104) addresses the topic of airing and other installation procedures.

References/Additional Information

California Integrated Waste Management Board (CIWMB) Database of Recycled Content Products:
<http://www.ciwmb.ca.gov/rcp>.

Carpet and Indoor Air Quality in Schools. Published by the School Facility Branch of the Maryland State Department of Education. To order, contact the Maryland State Department of Education, Division of Business Services, School Facilities Branch, 200 W. Baltimore St., Baltimore, MD 21201, phone for Capital Projects Assistant Manager, (410) 767-0097.

Carpet & Rug Institute (CRI) website, <http://www.carpet-rug.com>. Provides information on selection, installation, and maintenance.

Comprehensive Procurement Guidelines. The recommended recovered material content for polyester face carpet fiber is listed as 25% to 100% PET resin (recycled plastic soda bottles). Envirotech (Image) and Enviroton (Talisman) lines meet this standard. The Environmental Protection Agency is expanding its definition of environmentally preferred carpet by including nylon fiber with recycled content backing (i.e., Collins and Aikman, Shaw, Interface). These new standards will soon be reflected in the CPGs. For more information on carpet manufacturers and suppliers and a GSA link, visit EPA's web site: <http://www.epa.gov/epaoswer/non-hw/procure/products/carpet.htm>.

Environmentally Responsible Carpet Choices, Sustainable Practices and Opportunities Plan. A project of the Department of Interior, National Park Services. <http://www.nps.gov/sustain/spop/carpet.htm>.

Standard for Installation of Commercial Carpet, CRI 104. An industry minimum commercial installation standard published by the CRI. Contains detailed outlines of technique, procedure, and terminology used in specification writing, planning, layout, and installation. Includes accepted tools and materials, floor preparation, installation in special areas, diagrams and charts. (800) 882-8846.

Related Volume III CHPS Criteria

Materials Credit 2: Building Reuse.

Materials Credit 4: Recycled Content.

IEQ Credit 2: Low-Emitting Materials.

IEQ Credit 3: Pollutant Source Control.

IEQ Credit 2: Minimum Acoustical Performance.

IEQ Credit 5: Improved Acoustical Performance.

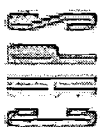

Guideline IS2: Resilient Flooring

Recommendation

Select resilient flooring and adhesives that are material efficient and non-polluting.

Description

Vinyl composition tile (VCT) has been the finish of choice for uncarpeted areas in schools, due to its durability and low maintenance. However, VCT is made of non-renewable resources and there is concern about environmental degradation associated with its production (see the Vinyl Debate section in this chapter's Overview).

Linoleum, often the choice of environmentally conscious designers, is durable as well and is produced from minimally processed, renewable materials. However, it also poses some risks, including offensive odor during its early months and, sometimes, much longer.

Chlorine-free resilient flooring and recycled content rubber (tire-derived) tile/sheet flooring are also becoming available. The compositions of these products differ from VCT in that they do not contain vinyl.

With respect to materials efficiency and air quality, there are important distinctions between material types, installation methods, and maintenance requirements. Final selection will depend upon the application and cost constraints.

Applicability

Most suitable for high traffic areas not requiring the acoustic benefits of carpet, such as hallways, kitchens, cafeterias, art rooms, toilets or anywhere that liquid spills are likely.

Applicable Codes

See Applicable Codes section in this chapter's Overview.

Integrated Design Implications

Flooring type selection affects thermal comfort (carpeting reduces heat loss slightly more than resilient flooring, for example) and lighting (floor finishes with high reflectivity enhance daylighting). Resilient flooring does not generally provide the acoustic benefits of carpeting. Teacher preferences should also be considered, if feasible. Resilient flooring is more easily cleaned than carpeting and may last considerably longer. Some resilient flooring requires application of sealants and waxes, which result in periodic increases in occupant exposure to the chemicals emitted from these products. Recycle waste flooring, if possible (require subcontractor to take back for recycling).

While often considered environmentally preferable, linoleum contains linseed oil, which does off-gas. The oxidation products when the emissions occur are odorous compounds that may affect the acceptability of



"Linorette" linoleum from Armstrong. Photo reprinted with permission. <http://www.armstrong.com/commflooringna/>.

Applicable Spaces	Climates	When to Consider
Classrooms	South Coast	Programming
Library	North Coast	Schematic
Multi-Purpose / Cafeteria	Central Valley	Design Dev.
Gym	Mountains	Contract Docs.
Corridors	Desert	Construction
Administration		Commissioning
Toilets		Operation
Other		

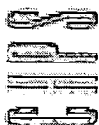

linoleum as a floor covering. It is recommended that designers obtain emissions test data from the producers of linoleum and other resilient floor products prior to specifying such products. Comparisons of emissions should be done prior to selection.

Cost Effectiveness

Costs will vary with type of product chosen. Cork and vinyl-free resilient flooring products have recently entered the marketplace and may be more expensive than VCT products. The designer should obtain cost data.

Costs	L	■	□	□
	M	□	■	□
	H	□	□	■
		L	M	H
		Benefits		

Benefits

Resilient flooring is highly durable.

Recycled content flooring and recyclable flooring are material efficient.

True linoleum is made with renewable materials (linseed oil, cork, wood dust and jute). Its known ingredients are minimally processed, commonly available, and biodegradable. Linoleum is durable.

Low-toxic adhesives and coatings minimize the indoor air pollution load and health risks to both installers and occupants.

Design Tools

See the Overview at the beginning of this chapter.

Design Details

Most resilient flooring products produce some air pollutant emissions; so do their setting and maintenance products. It is recommended that all resilient flooring products meet the emissions criteria outlined in Specification Section 01350.

Natural linoleum is another chlorine-free product, made out of all nearly natural ingredients. At present, linoleum is produced only in Europe. Linoleum emits a fairly strong smell when the flooring is newly installed. The smell comes from linseed oil's oxidation products, which are primarily fatty acids — compounds that react with oxidants to produce new chemicals that have a strong smell even at very low concentrations. Emissions of odors have been measured and observed on aged linoleum as well.

Resilient textile flooring is a newly formulated product that comes in 1-m² (39 in. x 39 in.) tiles, comprising a sandwich of very different materials that is designed to come apart for recycling. Developed as part of the specific manufacturer's corporate sustainability policy and initiative, resilient textile flooring is recyclable, durable, and manufactured using renewable energy. Acoustically it performs like carpet, according to the company. The manufacturer has targeted schools and hospitals as its primary markets, because both those settings benefit from the comfort and acoustic qualities of carpet but struggle with the maintenance and cleanliness issues.

Cork is a natural material and harvested from trees in a sustainable manner. Cork flooring is durable, fairly easy to clean, thermally insulating, and naturally moisture-, mold-, and rot-resistant. Drawbacks are its high cost and high-embodied energy (because it is imported and is energy intensive to ship to North America). Also, some flooring manufacturers use hazardous materials as binders and in installation. It is recommended that binders, adhesives, and coatings meet Specification Section 01350 specifications. If Specification Section 01350 has not been used to test particular products, request and carefully review the MSDS and ASTM emissions test data for these materials. Emissions tests of cork flooring have shown that some of the binder elements are emitted. Some chemicals emitted from cork flooring are toxic at elevated concentrations.

Recycled rubber tile and sheet goods made with waste tires are also available. These are material efficient choices for heavy traffic and utility areas, but may be strong volatile organic compound (VOC) emitters and odor sources.

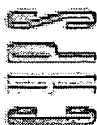

Specifications should require the installer to use the smallest amount of adhesive necessary to fulfill the manufacturer's performance specifications for that product. (In some applications, interlocked rubber tiles and heavy linoleum can be laid without adhesive.)

When installing resilient flooring over concrete floors, ensure that the concrete is sufficiently dry prior to installation. If water vapor emissions from the concrete floor are greater than 3 lb/1,000 ft², a vapor emission control treatment should be applied to the floor until emissions meet the maximum levels allowed by the flooring manufacturer.

Specify adequate ventilation during installation and flush out the building for a minimum of 72 hours after installation.

Operation and Maintenance Issues

Maintenance products are also significant pollution sources. Flooring with sealed "low maintenance" surfaces should be preferred, both for reducing maintenance costs and the use of cleaners and waxes. It may be possible to require manufacturers to provide cleaning and maintenance product specifications and application procedures. In these cases, the chemicals in these products should be evaluated along with the emissions from the flooring itself.

Low-VOC cleaners and sealers are available. Be sure to consult with the manufacturer when specifying sealers and other maintenance products. Use of the wrong products can cause problems, especially with natural linoleum. To help ensure longer life, maintain appearance, and help protect indoor air quality, resilient flooring requires proper cleaning/vacuuming. Walk-off mats should also be provided at all entrances.

Commissioning

None.

References/Additional Information

See resources listed in this chapter's Overview.

Also see the following articles from *Environmental Building News*:

"A New Chlorine-free Competitor to Vinyl Flooring," Volume 7, No. 10, November 1998. (About Amtico Stratica flooring.)

"Solenium — The First Resilient Textile Flooring," Volume 8, Number 5, May 1999.

"Cork Flooring," Volume 5, No. 1, January/February 1996.

Related Volume III CHPS Criteria

Materials Credit 5: Rapidly Renewable Materials.

IEQ Credit 2: Low-Emitting Materials.



Guideline IS3: Ceramic Tile / Terrazzo

Recommendation

Select locally available, recycled content ceramic or clay tile. If installing terrazzo, avoid the epoxy type; substitute cementitious terrazzo where appropriate. Specify low-toxic adhesives, grouts, caulks, sealants, and setting materials.

Description

Recycled content ceramics, clay tiles, and terrazzo (made with cement and crushed stone) are durable and low-emission interior finishes.

Terrazzo is a family of flooring materials that incorporates natural marble chips and other aggregates in a cementitious or epoxy mixture, which is usually applied wet and allowed to cure in place.



TerraTraffic from Terra Green Ceramics is made in the USA from over 55% recycled glass and select ceramic materials. Photo reprinted with permission from Terra Green Ceramics. <http://www.terragreenceramics.com/>

Applicability

Tile is most suitable for traffic areas requiring high durability and low maintenance, but not requiring the acoustic benefits of carpet, such as entryways and toilets.

Applicable Codes

See the Applicable Codes section in this chapter's Overview.

Integrated Design Implications

Flooring type selection affects thermal comfort (carpeting retains heat longer than resilient flooring, for example) and lighting (floor finishes with high reflectivity enhance daylighting). Tile/terrazzo flooring does not provide the acoustic benefits (tile flooring does not absorb sound and does not reduce impact noise transmission to spaces below) of carpeting, so this, along with teacher preferences, should be considered. As part of the C&D plan, recommend that the subcontractor take back waste tile for recycling.

Cost Effectiveness

Terrazzo costs between \$5/ft² and \$10/ft² to install, and will last the life of the building. Ceramic tile costs between \$6/ft² and \$12/ft² installed, and will last 40 to 80 years. Recycled-content tile can be higher priced than average tile products. Low-toxic adhesives used with tile and terrazzo are generally available locally and at competitive prices.

Though costly to purchase and install, the ceramic tile/terrazzo *life-cycle* cost is among the lowest of all finishes for some applications, due to its long life and minimal maintenance. Ceramic tile with recycled content may cost 1.5 to 2 times more than conventional.

Benefits

Use of local or regionally manufactured ceramics reduces the high transportation consumption/cost associated importing with this heavy building material. Ceramics and terrazzo (made with cement and

Applicable Spaces	Climates	When to Consider
Classrooms	South Coast	Programming
Library	North Coast	Schematic
Multi-Purpose / Cafeteria	Central Valley	Design Dev.
Gym	Mountains	Contract Docs.
Corridors	Desert	Construction
Administration		Commissioning
Toilets		Operation
Other		

Costs	L	■	□	□
	M	□	■	□
	H	□	□	■
		L	M	H
		Benefits		

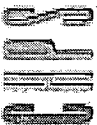

crushed stone) are durable and low emitting. Some tile is available with recycled content (up to 70%), such as scrap glass and feldspar waste from mining, which is material efficient, durable, and low- to non-emitting. Some manufacturers also have added heat recovery, water recovery, and clay mine restoration measures to their operations that exceed industry norms, which is ecosystem-protective.

Low toxic adhesives and coatings minimize the indoor pollution load and health risks to both installers and occupants.

Design Tools

See the Overview at the beginning of this chapter.

Design Details

Tile is a packaging-intensive product. Specify recyclable packaging. Check with the manufacturer to see if there is a collection program in place at no cost to owner or contractor.

Terrazzo

The two types of binders used in terrazzo flooring raise different environmental issues during installation. Cementitious terrazzo is composed of inert ingredients mixed with water. The primary installation hazard is dust during mixing and grinding. The installation of epoxy terrazzo, however, requires the use of OSHA-approved respirators, protective gloves, and safety glasses, as well as ventilation with 100% fresh air. The epoxy matrix contains a number of toxic materials. For these reasons, use of the epoxy type terrazzo should be avoided.

Tile

Avoid the use of imported tile. The glazing used on imported tiles can contain lead, which is toxic and a potential health threat. Another disadvantage is that imported tiles have high-embodied energy.

Mortar, Adhesives, Caulking, and Sealants

Cement mortars, usually modified with acrylic additives, are the safest to handle for tile setting and offer the best performance for most applications. All plastic adhesives contain some solvents and will contribute to indoor air pollution. Where adhesives and caulking must be used, such as for cove bases and flexible joints, choose a low-solvent content product such as an acrylic. Cement-based, cellulose-based and acrylic-modified grouts are safe and have low emissions. Glazed tile and high-fired tile usually do not require sealers. If a porous tile is chosen, the safest sealers are the low-volatile organic compound, acrylic, or water-based silicone types. Check with the tile manufacturer to select the lowest VOC, low-toxic mortars, sealers, caulks, and adhesives that will provide the desired performance. Review MSDS and emission test data for sealers, caulks, and other adhesives to understand their impact on indoor air quality.

Installation

Specify adequate ventilation during installation.

Tile is a non-porous surface and should be installed prior to porous, fleecy, and absorbent materials, which can act as "sinks", absorbing VOCs from other materials and later re-emitting them.

Require the installer to use the smallest amount of adhesive and sealant necessary to fulfill the manufacturer's performance specifications for that product.

Perform building flush out after floor installation.

Operation and Maintenance Issues

Terrazzo flooring should be sealed to prevent absorption of dirt and stains. Water-based sealers are available. Maintenance for ceramic tile varies with the type of surface and grout. Most unglazed tile is sealed after installation. Once floors are sealed, they may require re-sealing throughout their lives, in



which the process may impact indoor air quality. Walk-off mats should also be provided at all entrances to help ensure longer life, maintain appearance, and help protect indoor air quality.

Commissioning

None.

References/Additional Information

See the Overview section of this chapter.

Related Volume III CHPS Criteria

Materials Credit 2: Building Reuse.

Materials Credit 3: Resource Reuse.

Materials Credit 4: Recycled Content.

IEQ Credit 2: Low-Emitting Materials.

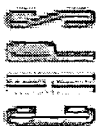

Guideline IS4: Concrete Flooring

Recommendation

Select concrete flooring, made with fly ash. Use low-toxic adhesives, sealers, and wax.

Description

Finished concrete flooring is an integral system of slab and finish, produced by adding colorants and a sealer to the topping concrete (colorized cement) either before or after it cures. The concrete is often stamped with tile patterns and grid lines that also control cracking.

Applying a colorized stain to a cured concrete surface produces stained concrete flooring.

Both types of concrete flooring provide a durable and low maintenance finish. Saw-cut and other designs and colors can add interest and educational value.

Fly ash is a byproduct of the coal burning industry. (Refer to: <http://www.flyash.com/> and <http://www.geocities.com/CapeCanaveral/Launchpad/2095/>.)

Applicability

Especially suitable for high traffic areas, such as hallways, cafeterias, and gathering areas. Staining existing concrete flooring is generally appropriate for renovation. Finished concrete flooring with integral colorants is generally applicable to new installations. Concrete may be used for other building surfaces.

Applicable Codes

See the Applicable Codes section in this chapter's Overview.

Integrated Design Implications

Flooring type selection affects thermal comfort (carpeting retains heat longer than resilient flooring, for example) and lighting (floor finishes with high reflectivity enhance daylighting). Concrete flooring adds thermal mass. Concrete floors do not absorb sound or reduce impact noise transmission to spaces below.

Cost Effectiveness

Medium (\$3/ft²) to high first cost, depending upon complexity of the installation/design.

Benefits

Concrete flooring is highly durable and low maintenance, which conserves materials and reduces potential indoor air quality (IAQ) problems due to maintenance products.



Installation of finished concrete flooring. Photo reprinted with permission from Davis Colors, Inc. <http://www.daviscolors.com/>.

Applicable Spaces	Climates	When to Consider
Classrooms	South Coast	Programming
Library	North Coast	Schematic
Multi-Purpose / Cafeteria	Central Valley	Design Dev.
Gym	Mountains	Contract Docs.
Corridors	Desert	Construction
Administration		Commissioning
Toilets		Operation
Other		

Costs	L	■	■	■
	M	■	■	■
	H	■	■	■
		L	M	H
		Benefits		



Concrete with fly ash is material efficient. Low-toxic coatings minimize the indoor air pollution load and health risks to both installers and occupants.

Design Tools

See Design Tools listed in this chapter's Overview.

Design Details

Selection

Finished systems with integral color added to the entire topping layer are more resistant to damage, and less likely to require re-coloring than systems that are dyed after placing the concrete.

Ask supplier to recommend least toxic, volatile organic compound (VOC)-compliant sealers and wax that will fulfill performance requirements.

Concrete staining is a technique often used in renovation of existing buildings with existing concrete sub-floors.

A variety of techniques are available to add designs — for example, cultural, school, community symbols — for use as teaching tools. Such artistic/educational amenities, however, will increase the cost.

Installation

Specify adequate ventilation during installation and flush out the building in accordance with project specifications.

Require installer to use the smallest amount of sealers and wax necessary to fulfill the manufacturer's performance specifications for that product.

Operation and Maintenance Issues

Proper sealing and re-waxing of stained concrete floors will ensure a long service life. Stained concrete flooring requires periodic re-waxing. Maintenance materials should be reviewed for low-VOC emissions.

Walk-off mats should also be provided at all entrances to help ensure longer life, maintain floor appearance, and help protect IAQ.

Commissioning

None.

References/Additional Information

See the Overview section of this chapter:

Lick Wilmerding High School, San Francisco, CA — stained concrete flooring in the corridors of a new library.

Ross Middle School, Ross, CA (Marin County) — Installed stained concrete floors, eliminating all carpet, resilient flooring, and related adhesives. Used low-VOC sealers.

Related Volume III CHPS Criteria

Materials Credit 4: Recycled Content.

IEQ Credit 2: Low-Emitting Materials.

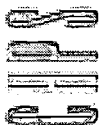

Guideline IS5: Wood Flooring

Recommendation

Select environmentally preferable products for wood flooring. Specify low-toxic adhesives, sealers, and finishes.

Description

Environmentally preferable wood flooring types include Forest Stewardship Council (FSC)-certified hardwood, salvaged wood, and laminated or veneered wood products. When permitted by the school district, other environmentally preferable choices include salvaged or reclaimed wood, sources of which are locally available in California. Salvaged flooring is material efficient and considered a 100% post-consumer recycled content product.

If using hardwood, specify products certified by the FSC. FSC is the accrediting agency for organizations that certify forests as well managed. Other environmentally preferable alternatives to conventional hardwood flooring include a wide range of veneered and laminated products that have a hardwood surface with plywood, MDF, or other materials in the core.



Trademark reproduced with permission. FSC Trademark © 1998 Forest Stewardship Council A.C.

Applicable Spaces	Climates	When to Consider
Classrooms	South Coast	Programming
Library	North Coast	Schematic
Multi-Purpose / Cafeteria	Central Valley	Design Dev.
Gym	Mountains	Contract Docs.
Corridors	Desert	Construction
Administration		Commissioning
Toilets		Operation
Other		

Applicability

Wood flooring is typically now specified for schools only where its performance characteristics make it uniquely desirable: gymnasiums, stages, and dance studios. However, some studies suggest that wood flooring from sustainable forests may be an appropriate flooring material for more functions, including classrooms, especially in regions where desirable species are native.

Applicable Codes

See the Applicable Codes section in this chapter's Overview.

Integrated Design Implications

Flooring type selection affects thermal comfort (carpeting retains heat longer than resilient flooring, for example) and lighting (floor finishes with higher reflectivity enhance daylighting). Wood floors do not absorb sound or reduce impact noise transmission to spaces below.

Cost Effectiveness

Wood flooring costs between \$6/ft² and \$10/ft². The life expectancy averages 38 years. The cost premium for certified wood ranges from modest to significant, depending upon quantity, type, and current availability.

Costs	L	■	□	□
	M	□	□	□
	H	□	□	■
		L	M	H
		Benefits		

Benefits

FSC-certified wood is eco-system protective. Low-toxic adhesives and coatings minimize the indoor air pollution load and health risks to both installers and occupants. The factory pre-finished products have

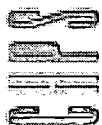

substantial air quality benefits because no sealer is applied, no sanding is performed, and no finishing is done on site.

Design Tools

See the Design Tools listed in this chapter's Overview, and:

Certified Forest Products Database, Certified Forest Products Council. Web site:
<http://www.certifiedwood.org>. Contact: 14780 SW Osprey Dr., Suite 285, Beaverton, OR 97007.
Tel: (503) 590-6600. Industry information on suppliers and standards.

Design Details

Selection

Several FSC-certified hardwood-flooring products are available. Look for woods grown in regional forests, which reduce the energy consumption involved in transportation. Woods common to the western area include pine, aspen, spruce, fir, and hemlock.

Veneered and laminated products that have plywood, composite wood products, or MDF cores are material efficient, but are less easily repaired than solid wood. These are usually pre-finished at the factory with a very durable, low-maintenance finish.

Low-toxic, clear sealers are also available to use as finishes for woodwork. Water-based varnishes, polyurethane, and other finishes for hardwood floors are very durable and much safer to handle than traditional products. Low-toxic solvents, water-based strippers, and all-natural thinners are also locally available.

A word of caution: not all water-based products are low emitters and, in fact, some emissions continue far longer than those from traditional, oil-based sealers. For example, acid cured lacquers can be strong emitters of formaldehyde while they are curing, and for considerable time afterwards. Formaldehyde-free alternatives should be specified for schools. It is recommended that all veneered and laminated products should meet the emissions requirements outlined in Specification Section 01350.

Handling

Specify that woodwork be protected from water damage during transit, delivery, storage, and handling. In addition to saving materials, this helps prevent future moisture/indoor air quality (IAQ) problems.

Installation

A steel track system using wedges to hold the flooring in place, or a "floating system," using edge gluing where necessary, makes wood floors easy to remove. A nail down system is also salvageable, but with some loss of material. Avoid parquet systems, which require a glue-down system and are therefore the least salvageable. Eliminating the use of adhesives reduces the impact on IAQ.

If sanding is done on the premises, the area must be carefully isolated, including sealing off the doors and HVAC system, and using temporary fans. Specify final cleanup with a HEPA filter-equipped vacuum.

Require installer to use the smallest amount of adhesive/coating necessary to fulfill the manufacturer's performance specifications for that product.

For finishing on site, use low-VOC emitting finishes. Hardening oils, varnishes, and acid cured varnishes have prolonged emissions. If edge gluing is required, specify a low toxicity product such as white carpenter's or woodworker's glue. If glue-down methods are required, such as for parquet, specify a low-VOC emitting flooring adhesive.

Specify adequate ventilation during installation and for 72 hours afterwards.

Woods naturally emit formaldehyde.

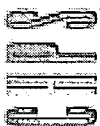

Operation and Maintenance Issues

After being finished with a synthetic topcoat, maintenance requirements for wood floors are similar to VCT and terrazzo. A typical hardwood floor might need re-sanding (which generates airborne dust) every eight to 10 years and can be re-sanded up to five times. Annual screening and re-coating maintains the protective wear layers. Wood flooring is easier to repair than most other materials.

Commissioning

None.

References/Additional Information

See the Overview section of this chapter:

For general information on certified lumber, contact: Certified Forest Stewardship Council, Jeff Wartelle. Tel: (503) 590-6600. Refer also to: <http://fscus.org/html/index.html>. Industry group provides information on distribution and other assistance.

Certified Forest Products Database, Certified Forest Products Council, <http://www.certifiedwood.org>. Contact: 14780 SW Osprey Dr., Suite 285, Beaverton, OR 97007. Phone: (503) 590-6600. Industry information on suppliers and standards.

Two private companies in the U.S. are authorized to issue the FSC stamp of approval: Scientific Certification Systems (SCS) in Oakland, CA (<http://www.scs1.com/forestry1.shtml>), and SmartWood Certified Forestry, based in Richmond, VT, with an affiliate in Oregon (<http://www.isf-sw.org/cert.htm>).

Related Volume III CHPS Criteria

Materials Credit 2: Building Reuse.

Materials Credit 3: Resource Reuse.

Materials Credit 4: Recycled Content.

Materials Credit 5: Rapidly Renewable Materials.

Materials Credit 6: Certified Wood.

IEQ Credit 2: Low-Emitting Materials.



Guideline IS6: Bamboo Flooring

Recommendation

Specify domestically produced flooring made from rapidly renewable bamboo (it matures in less than five years). Install and finish with a low toxic, water-based sealer and wax.

Description

Bamboo is a natural material, technically a grass that can reach timber height of 100 ft. It is a renewable resource, requiring no pesticides, fertilizers or irrigation, so it is not labor intensive to farm. Some manufacturers source their bamboo from managed forests using a harvesting method done by hand. This reduces the impact on the local environment in terms of erosion and habitat destruction. Most bamboo used in flooring production is grown in, and imported from, China. Boric acid is sometimes added during the manufacturing process. Bamboo flooring is harder than most common wood flooring, very durable, fast-growing, and dimensionally stable.

Applicability

Suitable wherever wood flooring would be used. Bamboo may also be used as plywood, paneling, and veneer.

Applicable Codes

See the Applicable Codes section in this chapter's Overview.

Integrated Design Implications

Flooring type selection affects thermal comfort (carpeting retains heat longer than other flooring does, for example) and lighting (floor finishes with high reflectivity enhance daylighting). Bamboo floors do not absorb sound or reduce impact noise transmission to spaces below.

Cost Effectiveness

Costs range from \$4/ft² to \$8/ft², which is slightly more than domestic hardwoods. However, bamboo is more durable than wood (25% harder than oak, 12% harder than maple, and 2.5 times more dimensionally stable than maple, according to one manufacturer).

Benefits

Bamboo flooring is aesthetically pleasing, low emitting, durable, and produced from a renewable, harvested resource. Low-toxic adhesives and coatings minimize the indoor air pollution load and health risks to both installers and occupants.



Bamboo flooring in a residence, copyright TimberGrass LLC. Photo by Art Grice. Photo reprinted with permission from TimberGrass, LLC. <http://www.timbergrass.com>

Applicable Spaces	Climates	When to Consider
Classrooms	South Coast	Programming
Library	North Coast	Schematic
Multi-Purpose / Cafeteria	Central Valley	Design Dev.
Gym	Mountains	Contract Docs.
Corridors	Desert	Construction
Administration		Commissioning
Toilets		Operation
Other		

Costs	Benefits		
	L	M	H
L	■	□	□
M	□	□	□
H	□	□	■

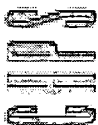

Design Tools

See the Design Tools listed in this chapter's Overview.

Design Details

Specify use of adequate ventilation during installation. Flooring is best applied by nailing, stapling, or gluing to a wood sub-floor, but can be glued to concrete at or above grade. If installing over concrete, moisture testing is recommended prior to installation.

Operation and Maintenance Issues

Place mats at entrances and exits to trap dirt from incoming traffic. Bamboo floors must be vacuumed or swept regularly with a nylon broom. Use non-alkaline cleaning solutions. Do not mop with water, since excess water can damage the floor.

Commissioning

None.

References/Additional Information

See the Overview section of this chapter, and:

The American Bamboo Society. Web site: <http://www.bamboo.org/abs>.

West Coast suppliers include:

Timbergrass, LLC, 9790 NE Murden Cove Drive, Bainbridge Island, (206) 842-9477 or (800) 929-6333.
Email info@timbergrass.com or web site <http://www.timbergrass.com/>

Bamboo Hardwoods, 3834 4th Ave. South, Seattle, (206) 264-2414. Web site:
<http://www.bamboohardwoods.com/>.

Smith & Fong Company, San Francisco, CA., Web site: <http://www.plyboo.com/>.

Bamboo Hardwoods Mfg. Co, Seattle, WA. Web site: <http://www.bamboohardwoods.com/>.

Bamboo Flooring International Corp., Walnut, CA. Web site: <http://www.bamboo-flooring.com/>.

Related Volume III CHPS Criteria

Materials Credit 5: Rapidly Renewable Materials.

IEQ Credit 2: Low-Emitting Materials.



Guideline IS7: Gypsum Board

Recommendation

Specify gypsum wallboard with a minimum 100% recycled content paper facing. Post-consumer recycled content gypsum board core is also available.

Gypsum used for recycling should be clean construction waste, uncontaminated by paint, tape, compounds, adhesives, or other coatings.

Description

Gypsum products are the most common interior panels used due to their fire retardant characteristics and low cost.

Applicability

Suitable for all spaces. High impact gypsum is appropriate for spaces requiring higher than normal durability.

Applicable Codes

See the Applicable Codes section in this chapter's Overview.



Photo courtesy of O'Brien & Company, Inc.

Integrated Design Implications

Wallboard installation should be coordinated with the job-site waste reduction plan. Recycle clean construction waste drywall (require subcontractor to take back to the manufacturer for recycling). Several manufacturing facilities in California will accept clean gypsum board construction waste by the ton. Contributing this material back into the manufacturing process increases the amount of post-consumer recycled content in the core of gypsum board products available in the marketplace.

When recycling gypsum board from a demolition site, check to see if the joint or topping compounds contained asbestos fibers. Sanding such material will result in the release of fibers into the air. State and federal laws regulate disposal of asbestos-containing materials.

Applicable Spaces	Climates	When to Consider
Classrooms	South Coast	Programming
Library	North Coast	Schematic
Multi-Purpose / Cafeteria	Central Valley	Design Dev.
Gym	Mountains	Contract Docs.
Corridors	Desert	Construction
Administration		Commissioning
Toilets		Operation
Other		

Cost Effectiveness

Gypsum board is the lowest cost option for walls. However, for ceilings, it is competitively priced with drop-in ceilings.

Costs	L	M	H
	M		
	H		
	L	M	H
	Benefits		

Benefits

Gypsum is highly recyclable if not contaminated (with paint or adhesives) and the paper facing is generally made with recycled paper. Use of recycled-content gypsum is material efficient. High impact gypsum is more durable than conventional wallboard and has higher recycled content.



Design Tools

See the Design Tools listed in this chapter's Overview, and:

Designing with Vision: A Technical Manual for Material Choices in Sustainable Construction. Revised July 2000. A publication of the California Integrated Waste Management Board. See Chapter 8, "Strategies to Reuse Materials and Reduce Material Use in Construction," Appendix F sample specifications for: Section 09250 Gypsum Board. Designing with Vision can be downloaded in four parts from <http://www.ciwmb.ca.gov/GreenBuilding/>. Chapter 8 is in Part D.

Design Details

Selection

Specify a minimum 10% recycled content gypsum board core with 100% recycled content facing paper. (Recycled content board must be specified, since recycled content is not automatically provided).

Consider gypsum produced by a recent innovation, the fibergypsum process. This board, now available in the U.S., has no paper facing but contains recycled wood, paper fiber, and perlite. It is very strong and scratch-resistant, and appropriate for high-wear areas such as schools. Fiberbond from Louisiana Pacific Corporation is an example of this type of gypsum.

Another environmentally preferable option is the use of gypsum board made with synthetic gypsum. Synthetic gypsum is produced with flue-gas desulfurization (FGD) gypsum, fluorogypsum, citrogypsum, and titanogypsum. This technology is not widely available in plants on the west coast, so embodied energy loads should be considered when selecting synthetic gypsum. Also, synthetic gypsum can have a negative environmental impact on agricultural land if it is ever applied as a soil amendment, due to its heavy metal content.

It is recommended that all gypsum board products (virgin, recycled content, synthetic) meet the emissions standards outlined in Specification Section 01350.

Installation

Special care should be taken during the delivery, storage, and handling of gypsum board to prevent accumulation of moisture on the material or within its packaging. Exposure to moisture can cause mold growth in the gypsum paper facing. To prevent possible interior mold problems, any stored or installed gypsum board showing evidence of moisture damage, including moisture stains, mildew, and mold, should be immediately removed from the site and disposed of properly. Replace contaminated gypsum board with new, undamaged materials.

Specify wet sanding processes during finishing. An exception is that dry sanding may be allowed subject to full isolation of the affected space(s), installation of protective plastic sheeting to provide air sealing during the sanding; closure of all air system devices and ductwork, sequencing of construction to prevent contaminating other spaces with gypsum dust, use of proper worker protection, and owner approval of these measures. Using vacuums during dry sanding to reduce dust can also help protect the health of installers.

Unpainted gypsum surfaces are potent "sinks" — they absorb volatile organic compounds (VOCs) and then re-emit them. Require adequate ventilation during installation of adhesives and other materials that emit indoor pollutants. Where feasible, sequence work to avoid applying VOC-containing materials in spaces with exposed, unpainted gypsum surfaces.

"The Nailer" is a wallboard installation hardware product made by The Millenium Group, Inc. of Estes Park, CO ((800) 280-2304) that replaces wood backing used in traditional gypsum board installation. Besides saving wood, the product is material efficient (contains 25% post-consumer plastic and 75% post-industrial waste) and laborsaving.

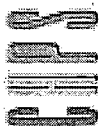

Operation and Maintenance Issues

Requires periodic painting for aesthetic purposes. Type of paint determines cleanability. Wallboard is easy to repair.

Commissioning

None.

References/Additional Information

See the Overview section of this chapter, and:

Information on synthetic gypsum may be obtained from manufacturers' web sites and the following gypsum trade sites: <http://www.gypsum.org/environmental.html> and [http://www.gypsum.org/topical.html - synthetic](http://www.gypsum.org/topical.html-synthetic).

Ross Middle School, Ross, CA (Marin County) — Used recycled content gypsum board.

Related Volume III CHPS Criteria

Materials Credit 4: Recycled Content.

IEQ Credit 2: Low-Emitting Materials.

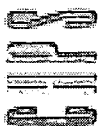

Guideline IS8: Acoustical Wall Panels and Ceilings

Recommendation

Select formaldehyde-free acoustical ceiling and wall systems with recycled content.

Description

Acoustical wall and ceiling systems are widely used in school for sound absorption. A variety of products are available including modular wall panels (textile and metal-covered), suspended ceiling tiles (t-bar ceilings), and surface mounted ceiling and wall panels.

Ceiling tile (usually in a T-bar ceiling) is the most common ceiling finish in schools. Because of the large ceiling surface area, the likelihood of its being disturbed during modifications/renovations, and its contact with HVAC systems, it is an important product to consider for air quality and materials efficiency.

Types currently available include recycled content ceiling tiles made of recycled newspaper, mineral wool, perlite, glass fiber, and clay. Look for a minimum recycled content of 79%. (A recent informal survey conducted by the California Integrated Waste Management Board indicates that the recycled content of acoustical ceiling tiles varies between 18% and 82%). New products on the market can attain 85% recycled content, but with some diminished noise reduction value. Natural fiber acoustic ceiling panels are also available, for both walls and ceilings.

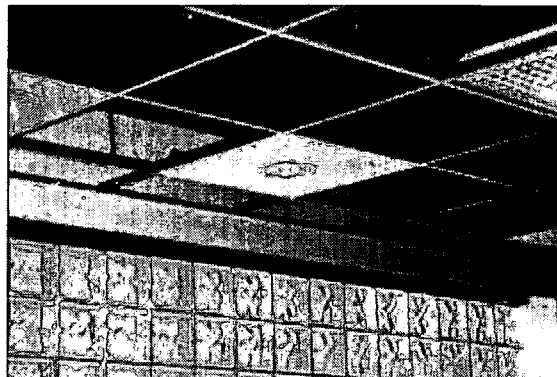

Acoustical ceiling tile/T-bar ceiling installation at the Central Market, a recycled content products demonstration project, Poulsbo, Washington. Photo reprinted with permission from O'Brien & Company, Inc.

Applicability

Use anywhere sound absorption and easy ceiling plenum access is desired.

Applicable Codes

See the Applicable Codes section in this chapter's Overview.

Integrated Design Implications

The T-bar ceiling system integrates with HVAC system ducting layout and operation. Do not use the space above the T-bar ceiling as a return air plenum because it is difficult to clean, and, if there is any off-gassing, odors, or microorganisms from any material in this area, contaminants can spread throughout the air space and be distributed to other areas. Instead, install return air systems using dedicated metal ductwork with access hatches for inspection and cleaning. Recycle construction waste (require subcontractor to take back for recycling).

Make sure insulation is not installed directly over drop-in ceilings. Lighting fixtures, diffusers, and other equipment interrupt the insulating barrier, leading to poor insulating performance. (Often the space above the ceiling is considered an attic space, requiring outside air ventilation.)

Applicable Spaces	Climates	When to Consider
Classrooms	South Coast	Programming
Library	North Coast	Schematic
Multi-Purpose / Cafeteria	Central Valley	Design Dev.
Gym	Mountains	Contract Docs.
Corridors	Desert	Construction
Administration		Commissioning
Toilets		Operation
Other		

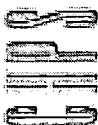

Make sure no fiberglass is exposed in the plenum.

Cost Effectiveness

Costs are low.

Costs	L	■	■	■
	M	■	■	■
	H	■	■	■
		L	M	H
		Benefits		

Benefits

Formaldehyde-free acoustical panels with recycled content are available. These panels are considered a material efficient, low-volatile organic compound (VOC) product that promotes healthy indoor environmental air quality. At least one manufacturer offers a reclamation program (see References below for more information).

Acoustical products from wood fiber and other sustainable raw materials are highly durable.

Ceiling tile waste, either from construction or demolition, is non-toxic (as long as lead paint and asbestos were not used on older ceiling installations). One company claims that its panels can be ground up successfully and composted to produce a soil amendment.

Design Tools

See the Design Tools listed in this chapter's Overview.

Design Details

General

It is recommended that ceiling tiles meet the emissions standards outlined in Specification Section 01350. Emission test data and MSDSs for ceiling tile materials should also be obtained and reviewed.

Acoustical materials, including acoustical ceiling tiles, can act as "sinks" for the adsorption of odorous or irritating VOCs from other sources (during application of paint and other finish coatings, for example, or from occupant activities) and re-emit them later. Where feasible, sequence work to avoid exposing acoustical ceiling and wall systems while applying VOC-containing materials in spaces with exposed acoustical surfaces. Require adequate ventilation during installation of finish materials that emit pollutants.

Consult with the manufacturer before painting/coating any acoustical material. For example, with most ceiling tiles, the material loses its acoustical properties once it has been painted. Exceptions include several product lines from Tectum, which they certify for up to 10 applications of a non-bridging paint.

Sound absorbing materials such as acoustical wall panels and ceiling tiles should have their sound absorbing properties measured in a laboratory environment. Sound absorption is typically rated in terms of NRC (Noise Reduction Coefficient). The NRC scale ranges from 0.00 (totally reflective) to 1.00 (totally absorptive). Materials with "good" sound absorbing capabilities should have a minimum rating of NRC 0.65. Another acoustical parameter to be considered is the Ceiling Attenuation Class (CAC). Ceiling tiles typically range from CAC 25 to 40. Ceiling tiles with higher CAC ratings allow less sound to pass through and tend to absorb less sound than those with lower CAC ratings. In areas that have noise-producing elements (i.e., Variable Air Volume (VAV) or Fan Powered Boxes (FPB)) in the ceiling space and also have a need for low background noise levels, a high CAC ceiling tile may want to be considered to help reduce background noise from terminal air devices or other noise sources.

Acoustical Wall Panels

Low-density fiberboard is made from paper and wood fiber, and is available made from 100% recycled newsprint. Most processes use no glue. They are suitable for use as acoustic panels. Fiber-free foam panels are also available from some manufacturers.

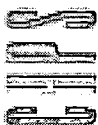

Ceilings

Coordinate placement of lighting fixtures and other equipment in ceilings to provide clear access for inspection and servicing of HVAC system air filters and other components.

Where daylighting has been incorporated as a design strategy, consider using ceiling tiles with high light reflectance as specified in ASTM Standard E1477 (0.83lr).

Special care should be taken during the delivery, storage, and handling of ceiling tiles to prevent to accumulation of moisture on the material or within its packaging. To prevent possible interior mold problems, any stored or installed ceiling tiles showing evidence of moisture damage, including moisture stains, mildew, and mold, should be immediately removed from the site and disposed of properly. Replace contaminated tiles with new, undamaged materials.

Lights should be chosen to maximize the total area of the exposed acoustical ceiling.

Operation and Maintenance Issues

Ceiling tiles and other acoustical materials collect dust as well as adsorb and re-emit VOCs. Tile with mineral fiber content may also begin to shed hazardous fiber if disturbed or as it deteriorates. Both problems are a particular concern where the ceiling is used for a return plenum to carry air back to the HVAC air handlers. If this type of return system is used, the tile should be checked for damage and the plenum space occasionally cleaned with a high performance vacuum. If possible, in new and renovation design, HVAC returns should be ducted instead of risking contamination by debris in suspended ceilings (See the Integrated Design Implications discussion above.)

Commissioning

None.

References/Additional Information

See the Overview section of this chapter, and:

Armstrong World Industries has a program for recycling old ceiling tiles, which it collects from building owners and uses as raw materials in the manufacture of new acoustical ceilings. For more information: Phone: (888) CEILINGS. Armstrong ceilings web site: <http://www.ceilings.com/>, (From Newsbriefs, Environmental Building News, Oct 00, p. 6). Armstrong also provides software for analyzing and comparing the acoustical performance of acoustical products.

"Natural-fiber Acoustic Ceiling Panels," Environmental Building News, Volume 7, No. 4 (April 1998).

Ross Middle School, Ross, CA (Marin County) — Acoustic ceiling tile has 75% recycled content.

Tectum web site, <http://www.tectum.com/>. According to a Tectum rep, their biggest users are schools. For certain applications (e.g., gymnasiums), their product is lowest cost option. In its 1-in. form, it costs about \$2/ft² to the installing contractor.

Related Volume III CHPS Criteria

Materials Credit 4: Recycled Content.

IEQ Credit 2: Low-Emitting Materials.

IEQ Prerequisite 2: Minimum Acoustical Performance.

IEQ Credit 5: Improved Acoustical Performance.

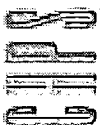

Guideline IS9: Paints and Coatings

Recommendation

Specify the least toxic, low-formaldehyde, low- or zero-volatile organic compound (VOC) paint that meets durability and other high performance requirements.



Description

Emissions from paints and coatings are primarily from evaporating solvents, other VOCs and by-products released after oxidation. Water-based paints acrylic latex paints are lower in VOCs (<250 mg/L) than solvent-based paints. Low-VOC is generally accepted to mean paint with a VOC content less than 100 mg/L.

Low-VOC paints are usually those in the lighter color ranges. Tinting may increase VOC emissions.

Formaldehyde-free paint is not yet available, but several low-formaldehyde options exist. Select paint with the lowest formaldehyde concentrations possible.

While a variety of low-VOC and zero-VOC paints are now available to choose from, they vary in cost, potential toxicity, and performance. Therefore, paint selection should consider VOC content as well as overall composition and required performance characteristics, including cleanability, hideability (i.e., how well a product conceals a surface), and durability.

Recycled content paint is now available and may be considered for interior and exterior use.

Applicable Spaces	Climates	When to Consider
Classrooms	South Coast	Programming
Library	North Coast	Schematic
Multi-Purpose / Cafeteria	Central Valley	Design Dev.
Gym	Mountains	Contract Docs.
Corridors	Desert	Construction
Administration		Commissioning
Toilets		Operation
Other		

Applicability

All interior painted surfaces.

Applicable Codes

See the Applicable Codes section in this chapter's Overview, as well as OSHA and local regulations for lead-containing paint (for renovation work).

Integrated Design Implications

Light colors enhance daylighting. Integrate with ventilation system installation/operation to provide proper ventilation during application, curing, and occupancy. Change out HVAC filters following application and before occupancy.

Cost Effectiveness

Costs vary widely with paint type and application. Low-VOC and zero-VOC paints have tended to cost 10% to 30% more than conventional paint, but prices are becoming more comparable as demand/production increases. Many low-VOC paints are now comparable in price to conventional paint.

Costs	L			
	M			
	H			
		L	M	H
		Benefits		

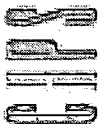

Benefits

Zero-VOC or low-VOC paints minimize the indoor air pollution load, odors, and health risks to both workers and occupants. Water-based paints are generally safer to handle and can be cleaned up with water, reducing health risks to workers and minimizing/avoiding hazardous waste. Leftover latex paint may be recyclable, thus reducing waste.

Design Tools

See the Design Tools listed in this chapter's Overview.

Design Details

Where practicable, leave surfaces of exposed structure unpainted.

A paint can be labeled low-VOC yet still contain odorous, irritating, toxic, or otherwise undesirable ingredients such as ammonia, formaldehyde, crystalline silica (a known carcinogen in dust form)¹⁸, acetone, odor-masking agents, glycols, and many other compounds, including fungicides and bactericides. Some of these may not be an *air quality* problem for occupants, but they may be hazardous to painters and those involved in manufacture of the paint. In addition, hazardous ingredients can degrade the natural environment during production and after disposal. Look for water-based paints that are low-formaldehyde, zero- or low-VOC, *and* low toxic. While information supplied on manufacturers' data sheets may make certain claims about VOC content or toxicity, speak with technical staff at the manufacturers' headquarters or manufacturing facility to obtain detailed information on product performance and environmental hazards. It is recommended that all paints meet the emissions testing standards outlined in Specification Section 01350.

Specify products containing no lead, mercury, hexavalent chromium, or cadmium. Though regulations have eliminated many toxic components from consumer paint lines, industrial and commercial paints may still contain them. Check the MSDSs; all hazardous contents present at 1% of total weight and listed by OSHA as hazardous must be disclosed. Besides using Specification Section 01350 and the MSDS review, more detailed information can be obtained from the manufacturer and by reviewing emissions test results to determine the type of biocides used as well as the presence of other potentially hazardous ingredients.

High-traffic areas or areas vulnerable to graffiti may call for a more durable and smoother (enamel) finish. These paints typically have a higher VOC content. While there is little test data comparing "high durability" and low-VOC paints, anecdotal information suggests that "high durability" (usually alkyd paint) products would be expected to show roughly twice the performance of low-VOC paints.

If possible, the selection process should include a side-by-side paint comparison of the various products being considered, and should include comparison of abrasion resistance (durability), hideability, volume solids, odor, and overall appearance. Final paint selection should consider the following elements:

1. What is the allowable drying cycle for initial painting and subsequent maintenance cycles? Is the paint locally available? (An important consideration for future maintenance.)
2. What is the expected durability or life expectancy required? Requirements will likely vary with the space. For example, one manufacturer had specific and different recommendations for gymnasiums, cafeterias, restrooms, general classrooms, and hallways.
3. What is the method of application? Choices, such as in-house versus contractor and spray versus roller, have a bearing on paint choice.
4. What are the budget constraints, including first-time and maintenance? Budget analysis should consider not just cost per gallon, but also evaluate area coverage per gallon and projected time between re-painting, which can vary greatly with conditions of use.

¹⁸ Some low-VOC paints contain crystalline silica, a known carcinogen. One manufacturer's representative stressed that this ingredient is not a hazard in the wet paint — it is an issue only when dried paint is sanded, and dust is generated.

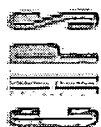

Installation

Paint should be installed prior to soft surfaces such as carpeting to prevent absorption of VOCs. Specify isolation requirements (isolation of construction zones from completed zones to prevent cross-contamination; removal, coverage, or isolation of porous materials to avoid their adsorption and subsequent re-emission of solvents; maintaining negative pressure by exhaust ventilation in construction areas). Low-VOC paints may require a longer airing out time than other paints, so be certain to specify appropriate ventilation. When sanding dried paint, a dust mask should be worn.

Operation and Maintenance Issues

Review recommended duration between paint application and occupancy and review for compatibility with maintenance schedules/requirements. Ideally, work should be scheduled during unoccupied periods or periods of least occupancy. Large projects should be scheduled during the summer vacation months or other breaks. The maintenance schedule should also factor in manufacturer recommended air temperatures for application.

Caution

In jobs that require removal of old paint and may require chemical strippers, closely observe manufacturers recommendations for use, including ventilation and personal protective equipment.

If performing renovation at a school constructed prior to 1980, do not begin work until testing paint samples for possible lead contamination. If lead-containing paint is present, observe appropriate abatement controls.

Where possible, perform painting and stripping off-site or select materials with factory-applied finishes. For on-site interior painting, cover surfaces, such as fabric-covered furnishings, to which VOCs may adsorb. Consider constructing barriers (for example, walls or curtains of plastic sheeting) to help isolate portions of larger areas and minimize the distribution of dust and other pollutants.

Wipe down all surfaces with a wet cloth as soon as practical after completing all dust-generating work typically associated with surface preparation.

Carefully observe manufacturers recommendation for cleanup, storage, and disposal, for paints, primers, and thinners. Some products are classified as "flammable liquids" under federal regulations and must be stored in a specifically constructed safety cabinet. Keep paint containers covered as much as possible during and following use to protect against VOC release. For excess paint, consider recycle/reuse options.

All paint containers with residual liquid must be disposed of as hazardous waste per U.S. Environmental Protection Agency regulations. Only dry containers can be placed in municipal landfills.

Commissioning

None.

References/Additional Information

See the Overview section of this chapter, and:

Bainbridge Island High School (Bainbridge Island, Washington) — As part of a major renovation at the existing high school, Capital Works personnel, with assistance from an environmental consultant, conducted an investigation of locally available, low-VOC paint options.

Interior Painting and Indoor Air Quality in Schools. To order, contact the Maryland State Department of Education, Division of Business Services, School Facilities Branch, 200 W. Baltimore St., Baltimore, MD 21201. Phone for Capital Projects Assistant Manager: (410) 767-0097.

Ross Middle School, Ross, CA (Marin County) — Interior wall & ceiling paint is "zero" VOC formulation.

Related Volume III – CHPS Criteria

Materials Credit 4: Recycled Content.

IEQ Credit 2: Low-Emitting Materials.

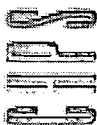

Guideline IS10: Casework and Trim

Recommendation

Specify casework and trim constructed from formaldehyde-free binders and other environmentally preferable materials. Design for easy future disassembly and reuse. Specify assembly off-site where major off-gassing can occur before products are brought into the building. Install with least hazardous, low-volatile organic compound (VOC) content adhesives and coatings.



Description

Conventional particleboard is made with bonding agents including urea-formaldehyde, which can off-gas for years after application. (Please refer to the discussion of formaldehyde-related indoor air quality problems in the Overview.) Authorities recommend fully covering all six sides of each surface with plastic laminate, or coating the particle board with a sealer to prevent off-gassing of formaldehyde and other volatiles (see Caution callout, below). However, unless a product's particleboard is fully-covered, CHPS recommends using only products that use formaldehyde-free binders for interior use in high performance schools.

Applicable Spaces	Climates	When to Consider
Classrooms	South Coast	Programming
Library	North Coast	Schematic
Multi-Purpose / Cafeteria	Central Valley	Design Dev.
Gym	Mountains	Contract Docs.
Corridors	Desert	Construction
Administration		Commissioning
Toilets		Operation
Other		

Environmentally preferable product alternatives for interior casework and/or trim include exterior grade plywood with phenolic formaldehyde resin, formaldehyde-free medium density fiberboard (MDF), oriented strand board (OSB), certified wood, salvaged lumber, bamboo, recycled plastic, metal, biocomposites (only for areas not subject to frequent wetting), and engineered wood. Certified MDF and plywoods also exist. Pre-assembled cabinets made with low-toxic materials and finishes, solid wood, engineered wood, and enameled metal are also available.

OSB, MDF, and other composite wood products can be strong sources of VOCs. Some of the emitted VOCs are terpenes which, when oxidized, form formaldehyde, higher molecular weight aldehydes, and acidic aerosols. Some of these oxidation products are more irritating or toxic than the chemicals emitted from the wood products. For instance, composite wood is the leading contributor to indoor formaldehyde levels, so reducing the amount of composite wood used is crucial to protecting indoor air quality. Some composite wood products manufactured with urban waste wood can contain wood preservatives, lead-containing paint, and other toxic compounds.

Acid-cured lacquers applied as finishes to wood products can be long-lasting sources of formaldehyde emissions.

Applicability

All interior casework and trim.

Applicable Codes

See the Applicable Codes section in this chapter's Overview.

Integrated Design Implications

None.

BEST COPY AVAILABLE

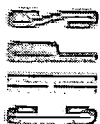

Cost Effectiveness

There is a cost premium for certified wood, ranging from modest to significant, depending upon quantity, type, and current availability. Engineered wood often costs less than virgin lumber. MDF made with formaldehyde-free binders may also cost more.

Costs	L	■	□	□
	M	■	■	□
	H	□	□	□
	L	M	H	
	Benefits			

Benefits

Formaldehyde-free products and low toxic glues/adhesives and coatings minimize the indoor air pollution load and health risks to both installers and occupants. Certified wood is produced in a way that is ecosystem-protective. Products made from certified hardwoods are durable and reusable.

Engineered lumber makes use of wood waste that would otherwise be discarded. Products made with engineered wood have low moisture content and are warp-resistant and shrink-resistant, adding to their durability. The products are strong, and their predictable qualities lead to less rework.

Bio-composite materials are made from natural, renewable resources including straw, recycled paper products, and a soy-based resin systems. These products have reduced emissions and are material efficient.

When plastic laminates are selected, look for options made from recycled laminating manufacturing wastes, which are material efficient and recyclable.

Design Tools

See the Design Tools listed in this chapter's Overview, and:

Certified Forest Products Database, Certified Forest Products Council, <http://www.certifiedwood.org>, 14780 SW Osprey Dr., Suite 285, Beaverton, OR 97007. (503) 590-6600. Industry information on suppliers and standards.

Design Details

Design interior building components for future disassembly, reuse, and recycling.

Selection

Environmentally preferable alternatives include:

- Using certified hardboards with woods grown in regional forests, which reduces the energy consumption involved in transportation. Woods common to the western area include pine, aspen, spruce, fir, and hemlock.
- For casework, consider urea formaldehyde-free MDF, or equal, exterior grade plywood (made with phenolic formaldehyde, which emits far less formaldehyde than the urea formaldehyde in traditional interior grade products).
- Consider veneered wood panels, such as OSB with hardwood facing, for cabinets and millwork. If installed for easy removal, they are reusable.
- Bamboo can be used for countertops. Also consider biocomposites for countertops in reception or other high profile (but not wet) areas.
- Low-density fiberboard is made from paper and wood fiber, available made from 100% recycled newsprint. Most processes use no glue. They are suitable for uses such as underlayment and tackboards.

Caution

Many of the engineered lumber products contain formaldehyde or other chemicals that are detrimental to the environment and to indoor air quality. Some types of particleboard are now being manufactured with resin binders that do not contain formaldehyde. If formaldehyde-free particleboard or plywood products are not available, select exterior grade plywood in lieu of interior grade products. Exterior grade contains phenol formaldehyde, which is less harmful than the urea formaldehyde in interior grade plywood.

Note: Some practitioners recommend coating conventional particleboard with an impermeable sealant to prevent out-gassing of formaldehyde and other volatiles. However, others disagree that this is effective mitigation.

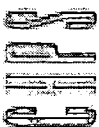

- Recycled plastic panels made from consumer product waste are available for functional worktops. If installed for easy removal, they are reusable.
- Vegetable oil-based plastics are available in both flexible and rigid types. They can be colored and filled with minerals, metal shavings, or other plastic waste and wood fiber giving them a large range of texture and color possibilities. If installed for easy removal, these also have good reuse potential.
- Fiber reinforced cement boards made with recycled fiber are a durable, material efficient choice for use as substrates for tile and decorative finishes. If installed for easy removal, these also have good reuse potential.
- It is recommended that all casework assemblies and wood furnishes meet the emissions standards outlined in Specification Section 01350. It may also be beneficial to obtain and review MSDS and emission test data. Wood naturally emits formaldehyde, so test data should be carefully reviewed.

Installation

Dust from cutting and emissions from glues used for installation are indoor air quality issues during and after installation. Specify work to be performed in a shop off the premises where practicable. Require installer to use the smallest amount of adhesive/sealant necessary to fulfill the manufacturer's performance specifications for that product. Specify use of adequate ventilation and VOC-safe worker masks. Where appropriate, specify installation to permit easy removal and reuse, for example, screwed assembly instead of glued.

Operation and Maintenance Issues

Issues will vary with type of material selected, but are similar to requirements for traditional materials.

Commissioning

None.

References/Additional Information

See the Overview section of this chapter, and:

For general information on certified lumber, contact: Certified Forest Stewardship Council, Jeff Wartelle. Phone: (503) 590-6600. Industry group provides information on distribution and other assistance.

Certified Forest Products Database, Certified Forest Products Council. Web site: <http://www.certifiedwood.org>. Contact: 14780 SW Osprey Dr., Suite 285, Beaverton, OR 97007. Phone: (503) 590-6600. Industry information on suppliers and standards.

Two private companies in the U.S. are authorized to issue the FSC stamp of approval: Scientific Certification Systems (SCS) in Oakland, CA (<http://www.scs1.com/forestry1.shtml>), and SmartWood Certified Forestry, based in Richmond, VT, with an affiliate in Oregon (<http://www.isf-sw.org/cert.htm>).

The American Bamboo Society. Web site: <http://www.bamboo.org/abs>.

APA -The Engineered Wood Association. Phone: (206) 565-6600. Web site: <http://www.apawood.org>. Email: product.support@apawood.org

American Institute of Timber Construction. Phone: (303) 792-9559. Fax: (303) 792-0669. Web site: <http://www.aitc-glulam.org>. Email: webmaster@aitc-glulam.org.

American Wood Council. Phone: (202) 463-2700. Web site: <http://www.awc.org/>. Email: AWCINFO@afandpa.ccompuserve.com.

National Particleboard Association. Phone: (301) 670-0604. Web site: <http://www.pbmdf.com>. Email: info@pbmdf.com.

Western Wood Products Association. Phone: (503) 224-3930. Web site: <http://www.wwpa.org>. Email: info@wwpa.org.



Phenix Biocomposites, LLC. Makes a variety of engineered panel products using agricultural byproducts and other renewable, sustainable and recycled resources. Phone: (800) 324-8187. Web site: <http://www.phenixbiocomposites.com>.

Related Volume III CHPS Criteria

Materials Credit 2: Building Reuse.

Materials Credit 3: Resource Reuse.

Materials Credit 4: Recycled Content.

Materials Credit 5: Rapidly Renewable Materials.

Materials Credit 6: Certified Wood.

IEQ Credit 2: Low-Emitting Materials.

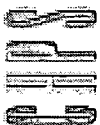

Guideline IS11: Interior Doors

Recommendation

Select formaldehyde-free interior doors constructed with recycled content or from certified wood. Avoid particleboard core board doors, which contain urea-formaldehyde and luan doors, which are made from wood harvested from rain forests. Select pre-finished products, if possible. If finishing on-site, select low-toxic, low-volatile organic compound coatings.

Description

Interior doors are usually wood, molded hardboard, or hollow core. Luan plywood is harvested from rain forests, so it should be avoided unless it has a Forest Stewardship Council (FSC) or other certification. Molded hardboard is often made with recycled material and pressed into shape, but some is made with urea-formaldehyde and should be avoided.

If using solid wood doors, select products with FSC or other certification (clear stock is becoming rare and if uncertified, often comes from old-growth forests).

Applicability

All spaces.

Applicable Codes

See the Applicable Codes section in this chapter's Overview.

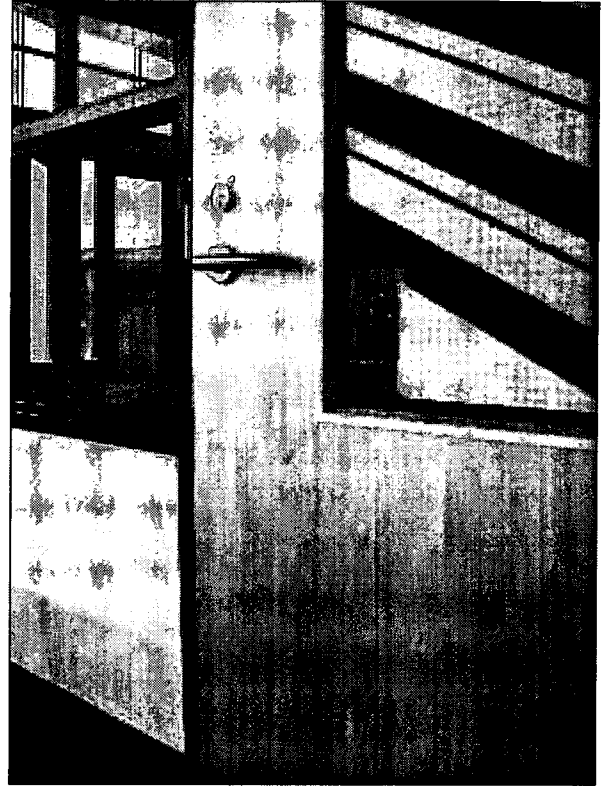

Randy Karels, photographer.

Integrated Design Implications

In areas where a high degree of speech privacy and/or sound isolation is required, doors should be solid core wood or hollow metal with acoustic fill. Full perimeter gaskets should also be included to reduce sound leaks around the edge of the door. Standard weather stripping with a door bottom sweep will minimize sound leaks, but wears down with use. Doors in areas that require a high degree of sound isolation should have heavy-duty adjustable sponge neoprene gaskets at the head and jamb. Automatic door bottoms with a neoprene element should also be used.

Cost Effectiveness

Costs are low.

Benefits

Avoiding luan and solid wood doors help protect limited forest resources. Formaldehyde-

Applicable Spaces	Climates	When to Consider
Classrooms <input type="checkbox"/>	South Coast <input type="checkbox"/>	Programming <input type="checkbox"/>
Library <input type="checkbox"/>	North Coast <input type="checkbox"/>	Schematic <input type="checkbox"/>
Multi-Purpose / Cafeteria <input type="checkbox"/>	Central Valley <input type="checkbox"/>	Design Dev. <input type="checkbox"/>
Gym <input type="checkbox"/>	Mountains <input type="checkbox"/>	Contract Docs. <input type="checkbox"/>
Corridors <input type="checkbox"/>	Desert <input type="checkbox"/>	Construction <input type="checkbox"/>
Administration <input type="checkbox"/>		Commissioning <input type="checkbox"/>
Toilets <input type="checkbox"/>		Operation <input type="checkbox"/>
Other <input type="checkbox"/>		

Costs	L	<input type="checkbox"/>	<input type="checkbox"/>	<input type="checkbox"/>
	M	<input type="checkbox"/>	<input type="checkbox"/>	<input type="checkbox"/>
	H	<input type="checkbox"/>	<input type="checkbox"/>	<input type="checkbox"/>
		L	M	H
		Benefits		



free materials protect indoor air quality and contribute to a more healthful environment. Low-toxic finish coatings minimize indoor air pollution load and health risks to both installers and occupants.

Design Tools

See the Design Tools listed in this chapter's Overview.

Design Details

Review emissions data and MSDS prior to specification of a recycled content molded hardboard product to ensure that it is urea-formaldehyde-free. It is recommended that all hardboard products meet the emissions specifications outlined in Specification Section 01350.

Operation and Maintenance Issues

May require periodic re-coating for aesthetic purposes. Type of paint determines the ability to clean the surface.

Commissioning

None.

References/Additional Information

See the Overview section of this chapter.

Related Volume III – CHPS Criteria

Materials Credit 3: Resource Reuse.

Materials Credit 4: Recycled Content.

Materials Credit 5: Rapidly Renewable Materials.

Materials Credit 6: Certified Wood.

IEQ Credit 2: Low-Emitting Materials.

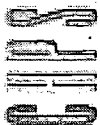

Guideline IS12: Toilet Partitions

Recommendation

Select high durability, solid plastic toilet and shower partitions with recycled content.

Description

Several styles of toilet partitions are available, including baked enamel over metal, plastic laminate over particleboard, and solid plastic panel. Solid plastic toilet/shower partitions are the most durable type overall. Recycled content products are made with a post-consumer, high-density polyethylene (HDPE) content between 20% and 35%, depending on the manufacturer. In addition, some brands contain postindustrial plastic material. Look for purified HDPE, as it contains a predominant amount of post-consumer waste.

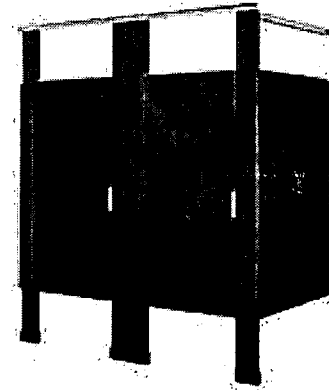

High-density polyethylene (HDPE) restroom partitions are maintenance-friendly and durable. Photo reprinted with permission from Santana Solid Plastic Products. <http://www.santanaproducts.com>

Applicability

All toilet/shower partitions.

Applicable Codes

See the Applicable Codes section in this chapter's Overview.

Integrated Design Implications

None.

Cost Effectiveness

Recycled content units cost 20% more than conventional units, but are more durable, require less maintenance, and can be reused. In addition, recycled content toilet partitions generally have a 15-year warranty versus the standard five-year warranty of other partition products.

Benefits

Recycled content partitions are material efficient, low maintenance, rot resistant, and graffiti/vandal resistant.

Design Tools

See the Design Tools listed in this chapter's Overview.

See also Santana Solid Plastics Products, <http://www.santanaproducts.com/html/toiletpartitions.html>, for sample specifications for solid plastic, recycled content toilet partitions, floor-mounted, ceiling mounted, and floor-to-ceiling models.

Applicable Spaces	Climates	When to Consider
Classrooms	South Coast	Programming
Library	North Coast	Schematic
Multi-Purpose / Cafeteria	Central Valley	Design Dev.
Gym	Mountains	Contract Docs.
Corridors	Desert	Construction
Administration		Commissioning
Toilets		Operation
Other		

Costs	Benefits		
	L	M	H
L	■	□	□
M	□	□	□
H	□	□	□

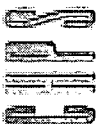

Design Details

None.

Operation and Maintenance Issues

None.

Commissioning

None.

References/Additional Information

See the Overview section of this chapter, and:

Cold Spring Elementary School, Santa Barbara, CA. Used recycled content toilet partitions.

Designing with Vision: A Technical Manual for Material Choices in Sustainable Construction. Revised July 2000. A publication of the California Integrated Waste Management Board. See Chapter 8, "Strategies to Reuse Materials and Reduce Material Use in Construction," Appendix E sample specifications for: Section 10160; Solid Plastic Partitions. Designing with Vision can be downloaded in four parts from <http://www.ciwmb.ca.gov/GreenBuilding/>. Chapter 8 is in Part D.

Related Volume III CHPS Criteria

Materials Credit 3: Resource Reuse.

Materials Credit 4: Recycled Content.

IEQ Credit 2: Low-Emitting Materials.



(This page intentionally left blank.)

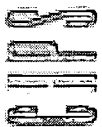

ELECTRIC LIGHTING AND CONTROLS

Electric lighting is one of the major energy consumers in schools. Enormous energy savings are possible through the use of efficient equipment, effective controls, and careful design. Less electric lighting use reduces heat gain, thus saving air conditioning energy, increasing the potential for natural ventilation, and reducing the space's radiant temperature (improving thermal comfort). Electric lighting design also strongly affects visual performance and visual comfort, by aiming to maintain adequate, appropriate illumination, while controlling reflectance and glare. Finally, visual and accessible light and power meters can educate students and faculty about how lighting systems and energy controls work.

This chapter provides guidelines for:

Pendant-Mounted Lighting ([Guideline EL1](#))

Troffer Lighting ([Guideline EL2](#))

Industrial-Style Classrooms ([Guideline EL3](#))

Lighting Controls for Classrooms ([Guideline EL4](#))

Gym Lighting ([Guideline EL5](#))

Corridor Lighting ([Guideline EL6](#))

Lighting for a Multi-Purpose Room ([Guideline EL7](#))

Lighting for a Library or Media Center ([Guideline EL8](#))

Lighting for Offices and Teacher Support Rooms ([Guideline EL9](#))

Lighting for Locker and Toilet Rooms ([Guideline EL10](#))

Outdoor Lighting ([Guideline EL11](#))

Overview

This section outlines lighting quality, lighting technology, lighting energy use, and other important lighting issues such as design criteria, maintenance, and commissioning. These factors all affect the design, installation, and maintenance of lighting systems in different school building spaces.

Visual Tasks in Schools

Common Visual Tasks

School visual tasks vary in terms of size, contrast, viewing angle, and distance. Many of these activities require close attention for prolonged periods of time. Critical visual tasks common to all school environments include:

- Writing.



- Reading printed material.
- Reading material on visual display terminals (VDTs).
- Reading from blackboards, whiteboards, overhead and video projections, and bulletin boards.

Additional School Tasks

In addition to the reading and writing visual tasks common to all school environments, a number of more specialized activities may occur in specific circumstances, which require specialized lighting equipment and design. Examples include:

- Drawing, painting, and other artwork.
- Laboratory work.
- Food preparation.
- Performance activities, such as dramatic productions and debates.
- Sports.
- Home economics activities, including sewing and cooking.
- Industrial education activities, such as metal shop and wood shop.

One notable difference between schools and other environments is that students must constantly adapt their vision between “heads-up” and “heads-down” reading conditions. Copying a homework assignment from the blackboard into a notebook, for instance, requires the eyes to adjust for differences in visual target size, distance, contrast, and viewing angle. To create comfortable and productive spaces, the lighting design must address the quality of the entire visual environment, instead of merely accounting for horizontal illuminance, as is too often the case.

Lighting Quality Issues

Lighting in schools should provide a visual environment that enhances the learning process for both students and teachers, allowing them to perform their visual tasks quickly and comfortably. Several lighting quality issues important in school lighting are outlined below. Table 10 provides information about the relative importance of various lighting quality issues for specific school spaces.

Table 10 – Lighting Quality Issues for Sample School Building Spaces

	General Classroom	Computer Classroom	Multipurpose Classroom	Corridor
Control of Direct and Reflected Glare	●	●	●	○
Light on Walls and Ceiling	●	●	●	●
Fixture Location Related to People	●	●	●	○
Light Patterns – Uniformity vs. Shadows	●	●	●	○
Daylight	●	○	●	●
Color Rendering and Color Temperature	●	●	●	●
Lighting Controls, Flexibility	●	●	●	○

● Very Important ● Important ○ Somewhat Important

Quantity of Light

In design, the quantity of light is measured in footcandles, taken in the horizontal plane at the task. The Illuminating Engineering Society of North America (IESNA) publishes illumination level

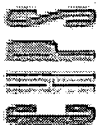

recommendations. With the ninth edition of the *IESNA Lighting Handbook (2000)*, IESNA revised its recommended lighting design procedure and issued the latest recommendations for horizontal illuminance. For most typical classroom and office reading tasks, the current recommended light level is 30 footcandles, as shown in Table 11. However, because some classroom tasks may justify up to 50 footcandles, choosing a level between 30 and 50 is an excellent compromise. Exceptions include art classrooms, shops, laboratories, and other spaces where tasks may require light levels as high as 70 to 100 footcandles.

Even if designing electric light levels for 30 to 50 footcandles of electric illumination, higher light levels – up to about 150 to 200 footcandles under peak solar conditions – can be provided by properly designed daylighting systems in most classrooms. (Computer labs and similar spaces are the exception – high daylight levels cause visual difficulties, so daylight, if introduced at all, should be done carefully and at very low light levels.) To take advantage of natural light, electric lighting systems should be dimmed or extinguished to fully harvest the energy and maintenance savings.

Previously, many published school lighting design guides recommended much higher levels, but the combination of better visual materials and other media, such as video and computer, permit current light level standards. Designers taking advantage of the latest light level recommendations can specify lighting systems that use less energy and require less maintenance than designs performed to older standards.

Note that lower lighting levels (15 to 30 footcandles) are suggested for computer classrooms. Moreover, providing a low ambient light level (5 to 10 footcandles) and task lighting is often preferred for computer spaces.

Table 11 – IESNA Recommended Illuminance Levels

Category	Description	Recommended Illuminance (fc)
Orientation and Simple Visits	Public spaces	3 fc
	Simple orientation for short visits	5 fc
	Working spaces where simple visual tasks are performed	10 fc
Common Visual Tasks	Performance of visual tasks of high contrast and large size	30 fc
	Performance of visual tasks of high contrast and small size, or visual tasks of low contrast and large size	50 fc
	Performance of visual tasks of low contrast and small size	100 fc
	Performance of visual tasks near threshold	300 – 1,000 fc

Source: *IESNA Lighting Handbook, 9th ed. (2000), p. 10-13*

Lighting Quality

IESNA's current lighting design procedure consists of a six-step process that emphasizes the relative importance of numerous design issues for specific applications. In addition to issues such as color appearance, daylighting integration and control, luminances of room surfaces, and many others, topics addressed include vertical illumination, glare control, uniformity, and color rendering. For more information about IESNA's new lighting design procedure, refer to the on-line Appendix of the Best Practices Manual.

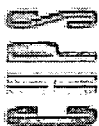

Vertical illumination. Vertical illumination is one of the more critical design issues in school lighting. With the exception of desktop reading, many school visual tasks are “heads-up” type activities, requiring proper vertical illumination of chalkboards and other displays. In addition, the perception of what comprises lighting quality is strongly influenced by vertical illumination. For example, wall illumination is a critical factor in the sense of brightness and cheerfulness of a room. In nighttime environments, vertical illumination that promotes facial recognition is important in creating a sense of safety and security. Appealing vertical illumination promotes the important school activity of social communication.

Glare Control. Light sources that are too bright create uncomfortable glare. In extreme cases, direct or reflected glare can also impair visual performance by reducing task visibility. In such a case, fatigue results from the eye having to work much harder to perform. All sources of light, including daylight, must be carefully controlled to avoid causing discomfort or disabling glare. Common glare problems in classrooms include uncomfortable overhead glare from direct distribution luminaires, reflected luminaire imaging on VDTs and whiteboards, and direct glare from uncontrolled windows or skylights. Very bright sources, such as T-5 straight, twin tube, and T-5HO straight lamps, should only be used in high spaces like gyms, or in cove lighting and indirect luminaires in ordinary classrooms and other spaces. Indirect and direct/indirect lighting systems tend to provide superior glare control as compared to more conventional, direct lighting systems.

Uniformity. For the most part, building spaces should be as uniformly illuminated as possible, avoiding shadows or sharp patterns of light and dark. For classrooms, luminance contrast ratios between the visual task and its immediate surround should not exceed 3:1, and contrast between the brightest surfaces in the visual field and the visual task should not exceed 10:1. Higher ratios contribute to fatigue, because the eye is constantly adapting to differing light levels. Recessed or surface-mounted parabolic fixtures should be avoided in most spaces, as they block light from reaching the upper portion of the wall and create a shadowy, cave-like environment. Exceptions might include lighting systems for theaters and social spaces in the school, where a downlighting system might be used to create a dramatic atmosphere.

Maximize overall lighting uniformity by following guidelines for maximum spacing of luminaires. The best method of maximizing uniformity is to make a concerted effort to light vertical surfaces, as well as the ceiling (using indirect or indirect/direct luminaires) whenever possible. Using light-colored, diffuse surface materials also optimizes lighting uniformity.

Color Rendering. Light sources that render color well enhance the visual environment. Light sources should have a minimum color-rendering index (CRI) of 80 for most interior spaces. Ceramic metal halide lamps, the latest “second generation” T-8 lamps, T-5 lamps, and most compact fluorescent lamps have a CRI in the range of 82 to 86.

Lighting Control Flexibility

Lighting controls should be designed for flexibility to accommodate the varying nature of many school spaces. In addition to saving energy, bi-level or multiple-level switching enables different light levels to respond to changing requirements. Separate circuiting of luminaires in daylight zones also enhances



space flexibility and energy savings. Control flexibility improves lighting energy performance by encouraging the use of lights that are only needed for the activity at hand.

Control flexibility is especially important in classrooms, which typically must be responsive to varying illumination schemes due to a wide variety of conditions and activities that occur. It is critical that teachers have the ability to override any automatic dimming and/or occupancy sensor controls, so that they can switch the lights off manually when necessary.

In multi-purpose spaces, several different lighting control schemes may need to be designed to account for all the different activities. In these cases, it may make sense to specify a preset dimming or switching system, allowing one-button scene changing.

Lighting control systems must also be easy to understand and operate. Non-intuitive control interfaces are likely to be ignored at best, and disabled in more extreme cases.

Integration with Daylight

Properly controlled daylight promotes comfort and productivity. To achieve energy savings, electric lights must be turned off (either manually or automatically) when sufficient daylight is available. Many teachers and students are quite conscientious in manually turning off the lights when not needed, but automatic systems tend to result in greater energy savings over the long run.

The first and most important step in integrating electric lighting with daylighting is to make sure that the electric lights are circuited so they can be logically switched off or dimmed in proportion to the presence of daylight in the room. This generally means that the electric lights should be circuited in lines parallel to the daylighting contours in the space. The areas of the room with the most daylight, the space adjacent to windows or skylights for example, should be turned off or dimmed first. A good rule of thumb for daylighting integration: control electric lights with a minimum of three separate circuits in daylighted spaces.

The electric lighting should be designed to provide balanced and sufficient illumination under nighttime conditions, but it should also be circuited to supplement partial daylight when needed on dark days. The electric lighting designer should thoroughly understand the patterns of daylight illumination expected during different times of the day and year, so that the electric lighting design can supplement the daylight, filling in darker areas of the room or highlighting a wall when needed.

The choices of switching versus dimming, and manual versus automatic photosensor controls, are partly a cost issues, but also operational issues. The pros and cons of each are discussed in Guideline EL4: Lighting Controls for Classrooms. Issues of daylighting design are discussed in the following chapter.

Light Sources

A wide variety of light sources are available for schools. Light source selection critically affects building space appearance, visual performance, and comfort. This section outlines the different types of sources available to the designer. For more detailed information about these technologies, refer to the on-line Appendix that supports the Best Practices Manual.



Incandescent and Halogen Lamps

Incandescent lamps represent the oldest of electric lighting technologies. Advantages of incandescent technology include point source control, high color performance, instant starting, and easy and inexpensive dimming. Disadvantages range from low efficacy and short lamp life to high maintenance costs.

Incandescent sources should not be used in new schools except in very limited and special accent lighting circumstances. Examples might include dimming applications where color performance, beam control, and/or dramatic effect is critical, such as teleconferencing rooms, theaters, and the highlighting of artwork. In most of these cases, halogen sources, which offer longer life, better point source control, and crisper color performance, are superior to standard incandescent lamps. The most efficient halogen technology is "infrared reflecting" or "IR", which should be used whenever possible. T-5 or compact fluorescent lamps can also be considered for many accent lighting applications.

Fluorescent Lamps

Fluorescent lamps can and should be used to light nearly all types of school building spaces. They offer long life, high efficacy, good color performance, and low operating and maintenance costs. Fluorescent lamps are typically straight or bent tubes, which limit their use somewhat. Dimming fluorescent lamps require special electronic ballasts that cost more than standard high frequency ballasts.

Several different types of fluorescent lamps are worth noting, as described in Table 12.

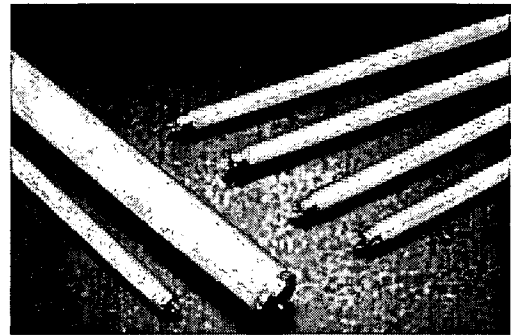

Smaller is better: out-dated T-12 fluorescent lamps shown next to the latest small diameter T-5 lamps



Table 12 – Summary of Fluorescent Lamp Technology

Type of Lamp	Advantages/Disadvantages	Applications
T-12	Antiquated technology. Relatively low efficacy. Supplanted by newer technologies such as T-8 and T-5.	Should not be used in new school construction.
Standard T-8 (7xx and 8xx color)	Smaller diameter standard lamps now in general use throughout the world. Offer 10% to 20% higher energy efficiency than T-12 lamps and other performance improvements when used with electronic ballasts. Low-cost lamps and ballasts.	Most general lighting applications in schools, including classrooms, offices, multipurpose rooms, and libraries.
Premium and Super T-8 (8xx color only)	So-called "super" and other "premium" T-8 lamps offer higher color rendition, higher maintained lumens, and a 20% to 50% increase in lamp life over standard T-8s. Energy efficiency can be 10% to 20% greater than standard T-8 lamps depending on brand and type.	Same.
T-5	Similar performance to "super" T-8 lamps, but a more compact lamp envelope (5/8 in. vs. 1 in. diameter). T-5 luminaires should be well-shielded to minimize glare. More expensive than the T-8 lamp and ballast system.	Smaller profile luminaires. Especially effective in indirect luminaires, cove lighting systems, and wall washers.
T-5 High Output (T-5HO)	Light generation per unit length is the highest. Very good energy efficiency, long lamp life, and high optical efficiency. Currently more expensive than T-8 lamp and ballast system.	Smaller profile suspended luminaires for offices and classrooms. Also, for direct "high bay" applications such as gyms.

For schools, the best choices are T-8 premium and super lamps, T-5, and T-5HO lamps. If taken into account during design, the added energy efficiency and longer life of these slightly more expensive lamps more than pay for the initial cost difference.

Fluorescent Ballasts

All fluorescent lamps require a ballast, which is an electric device that starts and regulates power to the lamp. Electronic high frequency ballasts are now standard equipment for most fluorescent sources. In addition to their efficiency advantages, electronic ballasts have minimal flicker and ambient noise, and are available in a variety of *ballast factor* configurations, allowing the designer to "tune" light levels based on the ballast specification.

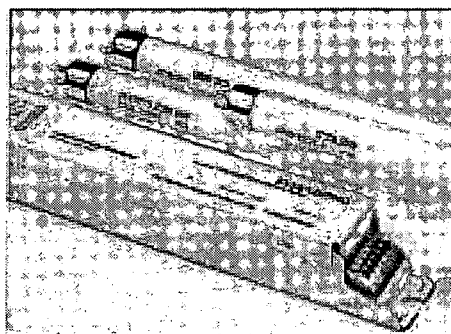

Electronic Ballast with lamps.

Consider the following recommendations for fluorescent ballasts. Refer to the on-line Appendix for more information about fluorescent ballast technology.

There are four different ballast types:

- Instant start ballasts, which have high energy efficiency but may reduce lamp life. A standard T-8 lamp operated for more than three hours per start on an instant start ballast will last about 15,000 hours. However, if the lamp is operated a short time each start (such as when controlled by a motion sensor), lamp life can drop to less than 5,000 hours. Choose instant start ballasts for locations with constant operation of lights.
- Rapid start ballasts, which are increasingly rare because they are less energy efficient and offer no significant lamp life advantages.
- Program start ballasts, which are both energy efficient and significantly reduce the effect of controls and operating cycle. A standard T-8 lamp operated on a program start ballast will last 24,000 hours at three hours per start, and premium or "super" lamps can last as long as 30,000 hours at three hours per start. Equally important, a "super" lamp operated on a motion sensor will still last over 20,000 hours. Note that all T-5 ballasts are program start. Choose program start for all applications, especially those with short-cycle lamp operation.



- Dimming ballasts will be discussed later.
- The “ballast factor” of the ballast, which describes the percentage of rated lamp lumens generated and power used, is variable and can be used to tune lighting systems, especially T-8 lighting systems.
- The standard or “normal light output” (NLO) system produces 87% of the rated light output of the lamp. This is the most common ballast system and it is normally furnished unless otherwise requested.
- Use reduced light output (RLO) electronic ballasts in building spaces lighted with fluorescent lamps where slightly lower light levels will suffice. RLO ballasts produce approximately 75% of rated light output and use 12% to 20% less power than standard NLO ballasts. Applicable spaces might include corridors, rest rooms, and storage areas.
- Use high light output (HLO) electronic ballasts where a modest increase in light output is required. A typical HLO ballast produces 115% to 120% of the lamp’s rated light output for a 15% to 20% increase in power, but does not materially affect lamp life. Clever designs can sometimes employ two lamps and an HLO ballast rather than three lamps and an NLO or RLO ballast, permitting the use of a smaller luminaire or simply fewer lamps.

Table 13 – Fluorescent Lamp/Ballast Power and Light Level (Based on Mean Lamp Lumens) Using Generic T-8 Lamp and Ballast as the Reference

For the numbers in parentheses following the lamp name, the first digit represents the Color Rendering Index (CRI) and the final two digits indicate the color temperature.

** Lamps rated 3000 initial lumens and high lumen maintenance*

*** Lamps rated 3200 initial lumens and high lumen maintenance*

Lamps	Type of Ballast	Relative Light	Relative Power
Standard T-8 (735)	Normal light output (NLO) instant start	100%	100%
Standard T-8 (735)	Reduced light output (RLO) instant start	89%	87%
Standard T-8 (735)	High light output (HLO) instant start	135%	134%
Standard T-8 (835)	NLO instant start	106%	100%
Standard T-8 (835)	Reduced light output (RLO) instant start	94%	87%
Standard T-8 (835)	High light output (HLO) instant start	141%	134%
Premium* T-8 (835)	NLO instant start	111%	100%
Premium* T-8 (835)	Reduced light output (RLO) instant start	99%	87%
Premium* T-8 (835)	High light output (HLO) instant start	149%	134%
Super** T-8 (835)	NLO instant start	119%	100%
Super** T-8 (835)	Reduced light output (RLO) instant start	106%	87%
Super** T-8 (835)	High light output (HLO) instant start	158%	134%
Super** T-8 (835)	RLO program start	100%	80%
T-5 (835)	Program start	125%	100%
T-5HO (835)	Program start	214%	200%

Dimming ballasts for fluorescent lamps require an additional investment, but increase lighting system performance by optimizing space appearance, occupant satisfaction, system flexibility, and energy efficiency. Dimming fluorescent ballasts should be considered in all cases requiring maximum energy performance and light level flexibility. They are particularly effective in daylit classrooms, computer classrooms, audio video rooms, and similar spaces.

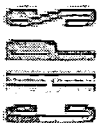

Compact Fluorescent Lamps

Compact fluorescent lamps (CFLs) can be used in nearly all applications that traditionally have employed incandescent sources. CFLs offer excellent color rendition, rapid starting, and dimmability. A large palette of different lamp configurations enhances design flexibility. Principal advantages of CFLs over incandescent sources include higher efficacy and longer lamp life. They can be dimmed, though dimming CFL ballasts are expensive. In colder outdoor environments, CFLs can be slow to start and to come to full light output.

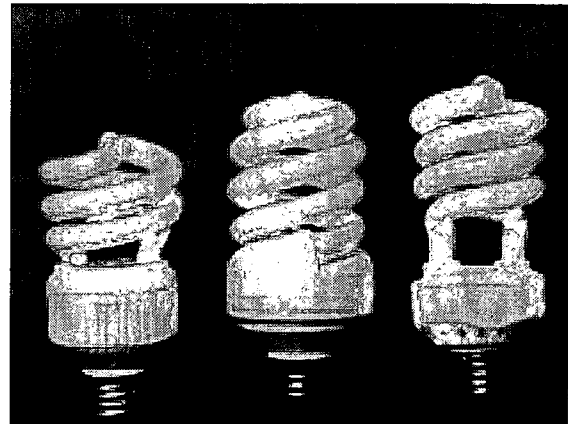

Compact Fluorescent Lamps. NREL/PIX06244

Use CFL lamps extensively in task and accent lighting applications, including wall washing, supplementary lighting for visual tasks requiring additional task illumination above ambient levels, and portable task lighting in computer environments. They are also valuable for medium-to-low level general illumination in spaces such as lobbies, corridors, restrooms, storage rooms, and closets. In most non-mountain California climates, they are quite suitable for outdoor corridors, step lighting, and lighting over doorways. High wattage BIAx-type CFLs can be used for general space illumination in recessed lay-in troffers (see Luminaires section below), as well as in more decorative direct/indirect luminaires for office lobbies, libraries, and other spaces requiring a more "high-end" look.

High Intensity Discharge (HID) Lamps

HID lamps provide the highest light levels of any commercially available light source and come in a wide variety of lamp wattages and configurations. In addition, they offer medium-to-high efficacy and relatively long lamp life. The principal disadvantage to HID sources is that they start slowly and take time to warm up before coming to full brilliance, making them difficult to use in many automatic lighting control scenarios without expensive two-level switching systems. As a result, these lamps may not work well in daylit interior spaces where lights may be turned on and off. In some applications, such as warehouses and vehicle maintenance areas, this may be cost effective when evaluated from a life-cycle cost perspective, but be prepared for reduced color performance and lamp life if used with metal halide lamps. Dimming HID lamps are expensive and unreliable, and, therefore, not recommended.

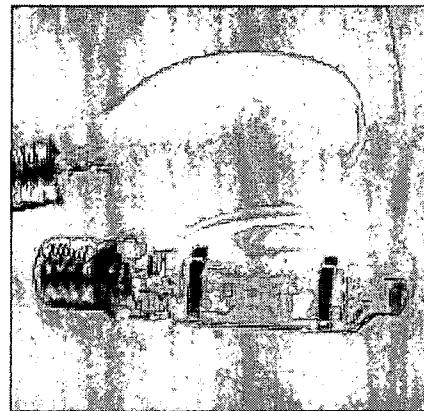

High Intensity Discharge Lamps

For more about HID lamps and ballasts, see the on-line Appendix that supports the Best Practices Manual.

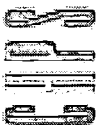

Low Mercury Lamps

Rising concern over mercury disposal has in turn increased the importance of using low mercury content lamps. Low mercury versions of all fluorescent and compact fluorescent lamps, as well as some HID lamps, are available from most manufacturers and should be used. See the section below on Mercury and Lamp Recycling.

Light Emitting Diodes (LEDs)

LEDs are semiconductor devices that generate an intensely directional, monochromatic light. Research today is directed at producing a commercially viable white LED source. Because selection is mainly limited to red, blue, or green products at this time, use of LED as a light source in schools is generally limited to exit and other signs. The principal advantage of LEDs over other sources is their extremely long life. In addition, a two-sided LED exit sign can usually be illuminated with less than 5W.

LEDs are highly recommended for use in school exit signs. They offer high efficacy and very low maintenance costs when compared with either incandescent or fluorescent products, and are available in most of the popular exit sign configurations.

Energy Efficient Choices

Lamps convert electricity (Watts) to light energy (lumens), and most modern lamps require a ballast to regulate the power flow into the lamp. The efficacy of the conversion is measured in lumens of light output divided by Watts of electric power input. The input Watts includes both the lamp and the ballast. **In general, it is best to use the system with the highest possible efficacy that is suited for the project.**

Some electric lamps emit less light as they age, called *lumen depreciation*. Significant improvements in certain lamps make lumen depreciation a very important consideration. Lamps are now rated in *mean lumens per Watt (MLPW)*, which better represents the efficacy of the lamp over its life.

Table 14 gives the MLPW for a variety of lamp/ballast systems and may be used to select light sources. Follow it closely to get the best efficacy. For instance, "premium" T-8 lamps are the best overall choice for most applications, and you can use 835 (neutral color), 830 (warm color) or 841 lamps (cool color) and get the same efficacy. But by substituting 735 color (which is cheaper), the MLPW drops to less than 80.

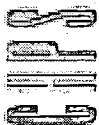

Table 14 – Lamp Application Guidelines

MLPW*	Lamp Type	CRI	Ballast	Good Applications	Limitations
93	T-8 "super" lamps (F32T8/835)	86	Electronic program start	General lighting. The most energy efficient lighting and longest life system available for most uses.	Not for general exterior lighting; not for very high spaces (20 feet or above).
92	T-5 standard 4' lamps (F28T5/835)	86	Electronic program start	Specialty lighting such as valences, undercabinet, coves, and wallwash.	Not for troffers; produce a limited amount of light.
90	T-8 premium 4' lamps (F32T8/835)	86	Electronic instant start (IS)	General lighting. The lowest cost and most efficient system available. Dimmable.	Not for general exterior lighting; not for very high spaces.
87	T-8 premium 8' lamps (F96T8/835)	86	Electronic IS	General commercial and institutional lighting. Dimmable.	8' long lamps generally best in large spaces only.
81	T-5HO high output 4' lamps (F54T5/835)	86	Electronic program start	Indirect office lighting; high ceiling industrial lighting and specialty applications such as coves and wallwash. Gyms. Dimmable.	Very bright lamps should not be used in open fixtures unless mounted very high.
80	Metal halide lamps, pulse start, M141 (1000 watt class)	65	Magnetic CWA	Very high bay spaces such as sports arenas, stadiums, and other locations above 30'.	Very long warm up and restrike times prevent rapid switching and dimming.
79	T-8 premium "U"-bent lamps (F32T8/U/835)	86	Electronic IS	Recessed commercial lighting. Dimmable.	More expensive than straight lamps.
78	T-5 twin tube ("biax") 40-50 watt (FT40T5/835)	82	Electronic IS	General commercial and institutional lighting; track mounted wallwash and display lighting. Dimmable.	More expensive than straight lamps – can be too bright in open fixtures.
78	Metal halide lamps, pulse start, 450 watt class	65	Magnetic CWA	General high bay lighting for gyms, stores, and other applications to about 30'; parking lots.	Very long warm up and restrike times prevent rapid switching and dimming.
76	Standard T-8 generic lamps (F32T8/735)	75	Electronic IS	General commercial lighting. Dimmable.	Not for general exterior lighting; not for very high spaces.
75	T-8 premium 2' lamps (F17T8/835)	86	Electronic IS	General commercial lighting. Dimmable.	Not for general exterior lighting; not for very high spaces.
67	Metal halide lamps, pulse start, M137 (175 watt class)	65	Magnetic CWA	Parking lots and site roadway lighting.	Very long warm up and restrike times prevent rapid switching and dimming.
64	Metal halide lamps, pulse start, M142 (150 watt class) compact T-6 high CRI	85	Electronic (CWA magnetic <60 MLPW)	Track and recessed mounted display lighting.	May not be suitable for general illumination due to lamp cost; very long warm up and restrike times prevent rapid switching and dimming.
63	Metal halide lamps, pulse start, ED-17 M140 (100 watt class) high CRI	85	Electronic or magnetic HX or CWA	Recessed and track mounted display lighting.	May not be suitable for general illumination due to lamp cost; very long warm up and restrike times prevent rapid switching and dimming.
62	Compact fluorescent 18-42 watt triple	82	Electronic	Downlights, sconces, wallwashers, pendants and other compact lamp locations; can also be used outdoors in most climates. Dimmable.	Modest efficacy is still far better than incandescent.
30	Halogen infrared reflecting lamps in PAR-30, PAR-38, MR16 and T-3 shapes	100	None required	Localized accent lighting and where full range, color consistent dimming is absolutely required such as fine restaurants, hotels, high end retail, etc	Cost effective technology must be used in limited amounts.

*Mean lumens per watt vary depending on specific ballast. Values given are optimum lamp-ballast combinations, and other combinations may be lower.



Luminaires

Luminaires (light fixtures) generally consist of lamps, lamp holders or sockets, ballasts or transformers (where applicable), reflectors to direct light into the task area, and/or shielding or diffusing media to reduce glare and distribute the light uniformly. An enormous variety of luminaire configurations exist. This section briefly outlines some of the more important types for school lighting design. For more information about these luminaire types, refer to the on-line Appendix that supports the Best Practices Manual.

Recessed Luminaires

Recessed luminaires represent a large segment of the overall luminaire market. There are two basic variations, lay-in troffers and downlights. The primary use of lay-in troffers is as a direct general light source. Downlights are relatively compact luminaires used for wall washing, accent lighting, supplemental general or task illumination, as well as for lower levels of ambient illumination.

A relatively new type of recessed luminaire is the indirect troffer. It is meant to soften the distribution pattern of a direct distribution luminaire without losing lighting uniformity. However, in many cases the surface brightness of the exposed reflector is actually higher than that of a standard troffer. Use them with caution, and do not use them in larger building spaces such as classrooms and open offices.

Suspended Classroom Luminaires

Suspended indirect or direct/indirect luminaires are the preferred luminaires for lighting classrooms. They are also appropriate for offices, administrative areas, library reading areas, and other spaces. Typically these luminaires employ T-8, T-5, or T-5HO lamps, and mount in continuous row configurations. See [Guideline EL1: Pendant-mounted Lighting](#).

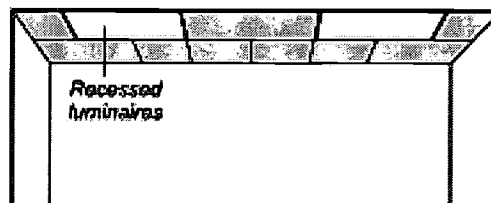

Recessed luminaires are direct general light source.

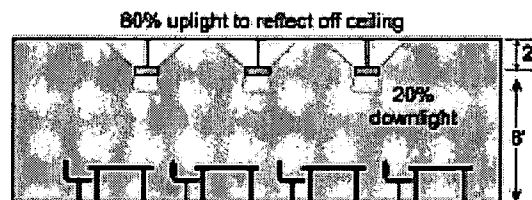

Suspended luminaires are preferred for classroom lighting.

Figure 7 – Recessed vs. Suspended Luminaires

Suspended High Ceiling Luminaires

Both fluorescent and HID suspended luminaires are useful for illuminating building spaces such as gymnasiums and other high-ceilinged spaces. HID luminaires can be classified as either high bay (>25 ft mounting height) or low bay, depending on the configuration. Compact fluorescent, high bay luminaires are also available to light high ceiling spaces. They employ up to eight compact fluorescent lamps to approximate the light output of an HID luminaire, while allowing for additional control flexibility. See [Guideline EL5: Gym Lighting](#) for more information. Linear hooded industrial fluorescent luminaires can be extremely effective at lighting high ceiling spaces.

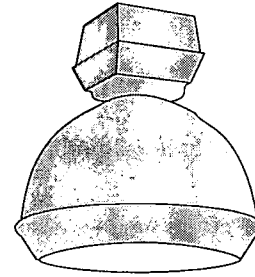

Figure 8 – Low-bay HID Luminaire

Surface-mounted Luminaires

Surface-mounted fluorescent, compact fluorescent, and HID luminaires are valuable for wall and ceiling mounting situations, particularly when ceiling access is a problem.

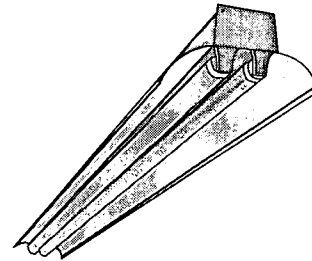

Figure 9 – Hooded Industrial Fluorescent Luminaire

Specialty Luminaires

Several specialty luminaires are available for specific school lighting applications, including specialty wall wash luminaires to illuminate blackboards, task lighting luminaires to supplement general illumination, wet location luminaires for exterior areas open to the elements, and high-abuse luminaires designed to withstand vandalism in school and other institutional environments.

Exit Signs

Numerous exit sign configurations are available for schools. LED exit signs offer the best alternatives for minimizing energy use and maintenance. Avoid self-luminous atomic exit signs because they are difficult to dispose of and may not provide adequate surface luminance.

Lighting Controls

Lighting controls are critical for minimizing lighting energy use and maximizing space functionality and user satisfaction. Control techniques range from simple to extremely sophisticated. Lighting control strategies are most successful when people can easily understand their operating characteristics. Another critical factor is the proper commissioning of lighting control systems so that they operate according to design intent. Finally, regularly scheduled maintenance of control equipment will improve the long-term success of the system. Poorly designed, commissioned, or maintained automatic lighting controls can actually increase lighting energy use, and cause user dissatisfaction.

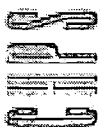

This section provides a brief overview of lighting control hardware available for school applications. For more detailed information, as well as application tips for effective use of lighting controls, see the on-line Appendix that supports the Best Practices Manual.

Switches

Manual switches are the simplest form of user-accessible lighting control. Minimal compliance with Title 24 requires individual manual switching for each separate building space. Bi-level switching is now required in almost every space, i.e. any room larger than 100 ft² with a connected load greater than 0.8 W/ft². The use of occupancy sensors can no longer be substituted for bi-level switching. In addition, areas next to windows or under skylights are required to be switched separately. Manual switches are especially valuable in daylit building spaces because they allow people to turn off electric lights when daylight is adequate. Manual switches should also be installed in spaces with occupancy sensors to increase the energy savings by allowing people to turn off the lights when they are not needed.

Occupancy Sensors

Occupancy sensors employ motion detectors to shut lights off in unoccupied spaces. The primary detection technology can be either passive infrared (PIR) or ultrasonic. Some sensors employ both passive infrared and either ultrasonic or microphonic detection. Mounting configurations include simple wall box sensors appropriate for small spaces such as private offices, and ceiling- or wall-mounted sensors that provide detection of areas up to 2,000 ft².

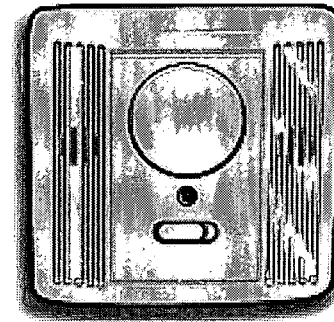
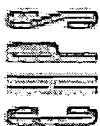

Figure 10 – Occupancy Sensor

Occupancy sensors are most effective in spaces that are intermittently occupied, or where the lights are likely to be left on when unoccupied. The best school applications include classrooms, private offices, restrooms, and storage areas. Use occupancy sensors in combination with manual overrides whenever possible to maximize energy savings, space flexibility, and occupant satisfaction. Including manual off override to the control scheme allows the teacher to turn the lights off for video presentations or other situations requiring the lights to be off. See [Guideline EL4: Lighting Controls for Classrooms](#).



Time Controls

Time controls save energy by reducing lighting time of use through preprogrammed scheduling. Time clocks comply with the California Building Code requirements for whole building shut-off. Time control equipment ranges from simple devices designed to control a single electrical load to sophisticated systems that control several lighting zones.

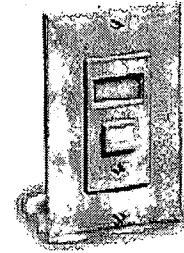

Figure 11 – Digital Time Switch

Time controls make sense in applications where the occupancy hours are predictable, and where occupancy sensor automatic control is either impractical or undesirable. Candidate building spaces include classrooms, offices, library stacks (local digital time switches), auditoriums, and exteriors. Keep in mind that Title 24 requires manual override of time clock control whenever they are installed to comply with whole building shut off.

Energy Management Systems (EMS)

Typically an EMS controls lighting via a time clock. However, many building operators take advantage of the built-in EMS functions to monitor lighting usage on a space-by-space basis. EMS control of lighting systems may also allow building operators to shed non-essential lighting loads during peak demand periods.

Manual Dimmers

Next to standard wall switches, manual dimmers are the simplest of lighting control devices. Manual dimmers serve two important functions. First, dimming lights reduce lighting demand and energy usage. With incandescent and halogen sources, there is the additional benefit of extended lamp life. However, more importantly, dimmers allow people to tune the lights to optimum levels for visual performance and comfort.

Consider manual dimmers (combined with dimming ballasts, where applicable) for many school building spaces, including classrooms, computer classrooms, and office spaces. Audio/visual rooms *require* manual dimming to function properly.

Photosensor controls

Photosensor control systems are used to control electric illumination levels in daylit spaces. A photosensor detects the daylight illumination level and sends a signal to a logic controller to switch off or dim the electric lights in response. In *open-loop* systems, the sensor is placed so that it “sees” a representative daylight level, such as looking up into a skylight or out a window. In a *closed-loop* system, the sensor is placed so that it “sees” both the daylight and electric illumination level combined. Closed-loop systems tend to be more difficult to calibrate since they are partially responding to the light source that they are also controlling. Different photosensors are designed to be used as open- or closed-loop systems, and should be selected specifically by their intended use and location. Compatibility between photosensor, logic controller, and ballasts should also be carefully reviewed. Finally, calibration is important and should be done after the space is painted and furnished with carpets, blinds, and furniture, so that illumination levels are as the occupants will experience them.



Occupant Education

It is extremely helpful to educate the building occupants in how lighting controls work, so that they are less likely to be surprised or annoyed by their operation. A brief tutorial for teachers on occupancy, a one-page explanation taped to the light switch, or best yet, some type of permanent explanation affixed to the classroom wall will greatly aid in the acceptance and appropriate use of the controls. Even manual switches benefit from some education, as teachers often do not realize they have control of more than one light level in their rooms.

Analysis and Design Tools

Several high quality analysis tools can help professionals design lighting systems. The simplest of these programs provide rudimentary zonal cavity calculations to predict average horizontal footcandles, while the most sophisticated tools can handle extensive calculations and produce realistic renderings.

Many of the major luminaire manufacturers offer standard computational software that can predict the performance of their (or other's) luminaires in typical lighting designs. Typically, these programs can calculate horizontal and vertical illuminance for a number of points within the space. Some can produce rudimentary renderings as well. Most can export output to CAD software.

Companies that specialize in lighting software offer the most sophisticated lighting software packages. These products are typically much more robust than the manufacturer-provided packages, and can handle more complex problems, such as surface luminances, daylight effects, irregularly shaped rooms, and high resolution rendering.

Sample manufacturers and products:

- AGI
- LCA (LitePro)
- Lightolier (Genesys)
- Lightscape
- Lithonia (Visual)
- LumenMicro

However, minimally acceptable results may be obtained using lumen method or Watts/ft² methods.

Applicable Codes

Several codes or standards affect the design and installation of lighting equipment. Some of the relevant considerations are outlined below.

Americans with Disabilities Act (ADA)

The ADA affects the selection and installation of lighting equipment. For the most part, ADA only affects wall-mounted luminaires, which cannot protrude more than 4 in. when mounted less than 80 in. above the finished floor.

Egress and Emergency Lighting

Emergency egress and exit lighting requirements are mandated in the Universal Building Code (UBC), National Electric Code (NEC), and National Fire Prevention Association (NFPA) codes. Lighting design must address the minimum lighting levels for egress, as well as include the necessary exit signage.

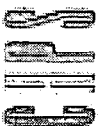

Most counties and municipalities require at least minimal compliance with NEC, and some may require additional measures.

UL Listing

According to the NEC, all luminaires used in construction must be listed by an approved testing agency, such as Underwriters Laboratory (UL). The designer must be sure that all luminaires specified are properly listed by a testing agency recognized by the local electrical inspector. In addition, there are distinctions that need to be made for special applications, such damp, wet, and hazardous locations.

California Building Code

All school buildings must comply with the State of California’s Energy Efficiency Standards for Nonresidential Buildings (Title 24). A significant portion of Title 24 is devoted to lighting systems. The standards require several mandatory measures for lighting systems including:

- Area controls.
- Bi-level switching.
- Separate switching in daylight zones.
- Certification of ballasts and luminaries.
- Automatic shut-off for buildings larger than 5,000 ft².
- Automatic control for exterior lighting.
- Certification of controls.

Title 24 also has prescriptive requirements for lighting power. As of 2001, the lighting power limits for applicable school building spaces (Area Category Approach) are as follows:

Table 15 – California Lighting Power Limits for Schools, Whole Area Method

Area Type	Allowed Lighting Power (W/ft ²)
Classrooms, Lecture Halls, Vocational Rooms	1.6
Offices	1.3
Corridors, Restrooms, Stairs, and Support Areas	0.6
Library Reading Areas	1.2
Library Stacks	1.5
Multi-purpose Centers	1.5
Auditoriums	2.0
Gymnasiums	1.0
Locker Rooms	0.8
Kitchens, Food Preparation Areas	1.7
Reception Lobbies, Waiting Areas	1.1
Electrical and Mechanical Rooms	0.7
Storage Rooms, Closets	0.6

Resource Efficiency

The overall value of energy-efficient lighting systems is reduced energy use, less air pollution, lower maintenance costs, and reduced material requirements. Properly designed lighting systems minimize



lighting demand and energy use. In addition, effective use of lighting controls can extend the service life of lighting equipment, reducing maintenance costs and replacement equipment inventories.

Although lighting's environmental impacts primarily relate to energy performance and enhanced indoor environmental quality, other environmental considerations include materials efficiency and pollution prevention during manufacturing:

- *Materials efficiency:* Metal components of lighting fixtures can be recycled, and whole fixtures can be salvaged during building deconstruction. These fixtures can be refurbished and reused. The metal components of fixtures may include recycled content, although data is not readily available as to the amount.
- *Pollution prevention:* Powder finishes on luminaires may pose a problem during manufacture, but information about these finishes is not readily available.

Mercury and Lamp Recycling

Mercury in fluorescent lamps is a serious issue that has been documented and is being addressed by the lighting industry. Mercury is a toxic element and there are significant concerns about mercury being emitted into the atmosphere or released into groundwater when fluorescent lamps are discarded.

Fluorescent lamps use electricity to excite mercury gas so that it emits ultraviolet light, which in turn causes the phosphor coating to fluoresce and emit light. On average, fluorescent lamps contain approximately 23 mg of mercury per 4-ft lamp. Recent developments in lamp coating technology have resulted in low mercury lamps that contain about 10 milligrams per lamp. However, lamp life and mercury content are related.

The U.S. Environmental Protection Agency (EPA) has declared that lamps containing mercury are hazardous materials requiring special handling. This mandate applies to all fluorescent lamps, and in some cases may also be defined to include HID lamps. Spent lamps may be disposed of in special landfills; however, it is much more ecologically responsible to recycle them. Most lamps used in schools can be completely recycled by a number of different recycling companies. Current costs for recycling lamps average about \$0.06/lin ft. When preparing a maintenance plan for a lighting system, include a lamp recycling procedure.

School districts should be good environmental stewards and engage in recycling programs for fluorescent lamps. For demolition and renovation projects, recycling of lamps should be required where local recycling options are available.

Maintenance

Maintaining lighting systems is critical to the sustainable performance, lighting quality, and energy efficiency of lighting systems. Establishing proper maintenance procedures is as much a responsibility of the designer as it is of the custodian who changes lamps. A good lighting maintenance plan should be included within the building specifications.

Luminaire Cleaning and Troubleshooting

Luminaires need to be cleaned at regular intervals. Consistent maintenance ensures that the lighting system will continue to perform as designed, thereby maximizing lighting quality and space



appearance. When cleaning luminaires, maintenance personnel should also check for and replace any broken or malfunctioning equipment, such as lenses, louvers, and ballasts.

Group Relamping

Lighting systems perform best when they are maintained at regular intervals. Group relamping is a maintenance strategy aimed at maximizing lighting system performance and maintenance economy by changing out all lamps at regular intervals, as opposed to relamping only when lamps have burned out. In the long run, group relamping reduces the cost of maintaining lighting systems through simple economy of scale. Furthermore, relamping luminaires at regular intervals maintains light levels and lighting quality according to design intent, and establishes good lighting maintenance procedures. For cost effectiveness, group relamping should be combined with luminaire cleaning and troubleshooting. Lamps using with dimming ballasts should be properly seasoned prior to being dimmed. See discussion under Commissioning below.

Specifications

Designers of school lighting systems have a number of specification tools available to promote proper maintenance and reduce maintenance costs. For example:

- Specify premium or super T-8 lamps whenever possible to extend lamp life by 20% (lamps rated 24,000 hours) or up to 30,000 hours with specific program start ballasts.
- Try to limit the number of different lamp types specified, which will simplify maintenance and allow for reduced lamp backup stocks.
- Include specification language that requires the contractor to supply the school district with manuals for occupancy sensors and other automatic control hardware.
- Include a maintenance manual in the lighting specification (see below).

Maintenance Manual

Include a detailed maintenance package with the building specifications. At a minimum the package should contain the following:

- As-built plans showing the installed lighting systems.
- Luminaire schedule that includes detailed lamp and ballast information.
- Luminaire cut sheets.
- Lamp inventory list, including recommended stocking quantities.
- Manufacturer data for all lighting controls, including operating documentation and tuning procedures.
- Procedures for maintaining lighting controls.
- Luminaire cleaning and troubleshooting procedures.
- Group relamping procedure.
- Lamp recycling plan and contacts.

Commissioning

All automatic lighting control systems must be tuned after installation to ensure optimal performance and energy efficiency. Malfunctioning automatic control systems waste energy and will disturb

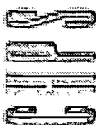

students, teachers, and staff. Building specifications should include a commissioning plan that identifies the commissioning agent and details the required procedures. The commissioning plan should include the following items:

Dimmed Fluorescent Lamps. Manufacturers recommend that fluorescent lamps be fully seasoned prior to being dimmed. Dimming the lamps without this “burn-in” period can result in unstable light output and/or shorter lamp life. Recommendations vary from 10 to 100 hours, depending on the manufacturer. Eventually this requirement may become unnecessary by the use of “smart” ballasts that can sense a lamp’s status. Until such ballasts are available, both new and replacement lamps should be seasoned before dimming.

Occupancy Sensor Sensitivity/Time Delay. Motion sensors must be adjusted to ensure that they only sense motion in the controlled space. Motion in adjoining spaces can cause false triggering or cause the lights to remain on needlessly, thereby wasting energy. Similarly, sensors must not turn lights off when spaces are occupied. An additional adjustment to the sensors can control the time delay period between last detection and lights off. In most cases, this period can be set to 10 minutes for good results.

Photosensors. Photosensors designed for use in open-loop daylighting control systems must be mounted so that they cannot detect the lights they control. This may require some tweaking or relocation of the unit after installation. Consult the manufacturer’s recommendations for proper commissioning procedures for photosensor devices.

Dimming Controllers: Dimming controllers for lighting systems should be tuned so that illuminance at the high dimming range will not exceed design parameters. Only a simple adjustment is required on most dimming boards. Similarly, the commissioning agent can also set the minimum light level.

Stepped or Relay Controllers. If a stepped lighting control system is employed for daylight harvesting, it is important to adjust the deadband between the on and off switching thresholds so that the system does not cycle on cloudy days. Continuous on-off cycling is annoying to building occupants and reduces lamp life.

References/Additional Information

Advanced Lighting Guidelines: 2001 Edition, New Buildings Institute. <http://www.newbuildings.org/>.

IESNA Lighting Handbook. Illuminating Engineering Society of North America. <http://www.iesna.org/>.

IESNA RP-3-00: Lighting for Educational Facilities. Illuminating Engineering Society of North America. <http://www.iesna.org/>.

Related Volume III CHPS Criteria

Energy Prerequisite 1: Minimum Energy Performance.

Energy Credit 1: Superior Energy Performance.

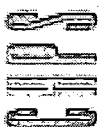

Guideline EL1: Pendant-Mounted Lighting

Recommendation

Classrooms should have ceilings at least 10 ft above the finished floor, which permits the use of either:

- Luminaires with a semi-indirect or indirect distribution and at least 85% luminaire efficiency, using T-5HO, T-5 or T-8 premium lamps, and electronic ballasts; or
- Luminaires with direct/indirect distribution and at least 75% luminaire efficiency, using T-8 premium lamps and electronic ballasts.

In either case, the design should usually operate at between 0.9 W/ft² and 1.1 W/ft², and it will generate 40 to 50 footcandles, maintained throughout the student desk area.

Description

There are two primary, appropriate types of suspended fluorescent luminaires, which are classified according to the fraction of uplight and downlight.

- Direct/indirect luminaires designed for general classroom use. Ceiling, walls, and floor are all illuminated relatively evenly.
- Indirect and semi-indirect luminaires originally designed for office lighting. The ceiling and upper walls are brightest, reflecting light downward onto tasks.

Most direct/indirect luminaires are rated according to the percentages of uplight and downlight. In a direct/indirect luminaire, the amount of uplight and downlight is roughly the same. The type of luminaire shown here is 60% uplight and 40% downlight. While a light colored ceiling is preferred to take advantage of the uplight, a direct/indirect lighting system can be used with light colored wood or other materials. Darker colored ceilings reduce the efficiency of the lighting system. The suspension length of direct/indirect lighting is less critical than for indirect lighting.

In an indirect luminaire, the amount of uplight is at least 90%. If there is any downlight from the luminaire, it is only intended to create a sense of brilliance. Most of the illumination in the room is caused by reflected light from the ceiling. Indirect lighting requires a white ceiling and a minimum suspension length of 18 in., with 21 in. or greater strongly preferred. A semi-indirect luminaire has between 10% and 40% downlight, and suspension length is less critical.

In all cases, affordable luminaires are made of steel bodies, and steel or plastic louvers. More sophisticated luminaires employ extruded aluminum housings, but this generally incurs significant cost increases.

INDIRECT LUMINAIRE
At least 90% uplight

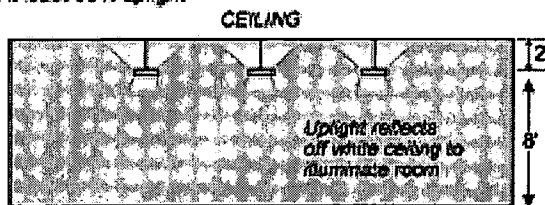

DIRECT LUMINAIRE
Roughly half downlight, half uplight

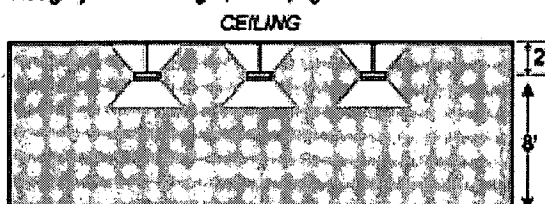

The two primary types of suspended fluorescent luminaires.

Applicable Spaces	Climates	When to Consider
Classrooms	South Coast	Programming
Library	North Coast	Schematic
Multi-Purpose / Cafeteria	Central Valley	Design Dev.
Gym	Mountains	Contract Docs.
Corridors	Desert	Construction
Administration		Commissioning
Toilets		Operation
Other		

BEST COPY AVAILABLE



Applicability

Pendant mounted lighting is appropriate for all classrooms, libraries, multi-purpose spaces, and administration spaces.

Applicable Codes

See the Applicable Codes section in this chapter's Overview. The California Energy Code (2001) limits the amount of lighting power per classroom to 1.6 W/ft², and this guideline recommends a much more efficient solution. Even with supplemental blackboard lighting, the connected load is still under 1.3 W/ft². Title 24 also requires switching (see Guideline EL4: Lighting Controls for Classrooms).

Integrated Design Implications

Suspended lighting systems can work well with almost all ceiling systems that are at least 9 ft-6 in. high. However, ceilings with dark stained wood or dark colored paint must be avoided. For direct/indirect luminaires, ceilings should be light colored; for indirect fixtures, ceilings must be white or off-white, as should upper walls. A direct/indirect luminaire with a greater percentage of downlight (50% or more) should be used for rooms with extremely high ceilings, such as above 14 ft. Note that for maximum efficiency with indirect and semi-indirect lighting systems, it is best to employ ceiling systems with very high reflectivity. Modern white paints and certain ceiling tiles with reflectance of 90% or greater can dramatically increase system performance.

Pendant indirect or direct/indirect lighting systems are particularly well suited for integration with daylight systems, since both approaches require higher ceilings and the use of secondary reflective surfaces. In daylight rooms, pendant systems should be run parallel to the primary windows or daylight source, so that they can be switched or dimmed in response to daylight gradients. In a classroom, three rows of pendants will allow a more gradual response to daylight than just two rows. Daylight controls can then switch or dim each row separately.

Cost Effectiveness

Suspended lighting systems costs are shown in Table 16. Suspended lighting systems provide a high degree of cost effectiveness in most applications. Non-dimming, indirect steel luminaires are the lowest cost, but optimum solutions are generally steel luminaires with steel or plastic louvers providing 35% to 50% downlight.

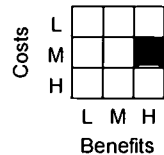

Table 16 – Indirect/Direct Lighting Costs

Lighting System Type	Cost per Lineal Foot, Installed*
Steel Indirect Luminaires, 90%+ Uplight, T-8 Lamps, Non-dimming	\$35
Steel Direct/Indirect Luminaires, Plastic Louvers, 65% Uplight, T-8 Lamps, Non-dimming	\$40
Steel Direct/Indirect Luminaires, Steel Louvers, 50% Uplight, T-8 Lamps, Non-dimming	\$45
Extruded Aluminum Luminaires, Parabolic Louvers, 75% Uplight, T-8 Lamps, Non-dimming	\$50
Add for Dimming Ballasts Using Standard 0-10 volt type	\$12-15

*Approximate cost to owner, including labor, materials, overhead, profit, and costs of construction for lighting, including luminaires, lamps, and suspension hardware. Includes connecting luminaire to branch circuit. Controls and branch circuit costs not included. Based on July 2000 prices. Costs can vary depending on market conditions.

Benefits

Direct/indirect lighting systems generally offer an optimum combination of efficiency and visual comfort, and make excellent use of the low-cost, widely used T-8 lamp system. Systems operating at about 0.9 W/ft² to 1.0 W/ft² will generate between 40 and 50 footcandles on average, with excellent uniformity. Indirect lighting systems are generally less efficient, requiring 1.0 W/ft² to 1.1 W/ft² to achieve 40 to 50 footcandles.

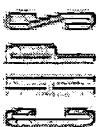

Design Tools

See the Overview section of this chapter.

Design Details

This type of lighting provides good, general lighting throughout the room and is suitable for most types of classroom work. Some types of direct/indirect lighting are optimized for computer CRT work, although they tend to be expensive. It may be necessary to provide separate chalkboard illumination, especially if the suspended lighting system is manually dimmed. Be certain to employ premium T-8 lamps with 835 or 841 color, rated 24,000 hours. For non-dimming applications, luminaire light and power can be varied through choice of ballast factor. Use Table 13 and specify ballasts accordingly.

A typical classroom is shown in the figure below with three rows of two lamp suspended luminaires. Not including daylight contribution, most of the room is between 40 and 60 footcandles at 0.9 W/ft². A slight increase in power will result in a proportional increase in light level; at 1.1 W/ft², the light levels will range between 49 and 73 footcandles.

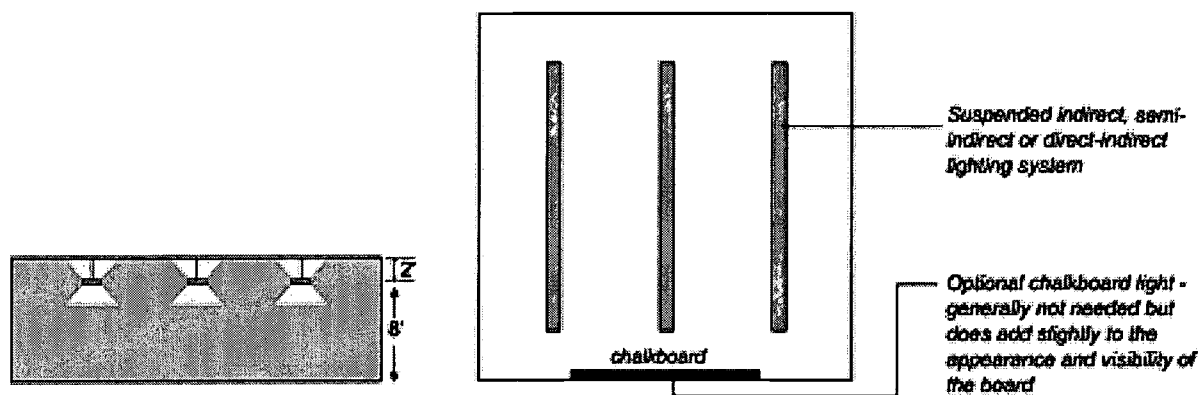

Figure 12 – Classroom Pendant Mounted Lighting Design

*This classroom design uses three rows of suspended fluorescent luminaires.
An optional blackboard light can be mounted at the teaching wall.*

Operation and Maintenance Issues

These lighting systems rarely need maintenance. As with all fluorescent systems, lamps should be replaced at approximately 12,000 to 16,000 hours of operation, which, with normal school use, could be as seldom as every six years. (Use of certain lamps and ballasts can extend this period to 20,000 to 22,000 hours). Luminaires should be cleaned annually. Open louvered luminaires, especially using plastic louvers, require less cleaning and are the most tolerant of poor maintenance and abuse. Indirect fixtures require more regular cleaning and dusting.

Commissioning

No commissioning is needed, other than pre-seasoning of lamps in dimming applications.

References/Additional Information

See the Overview section of this chapter, and:

Windsor High School, Windsor CA. Windsor Unified School District. Quattrocchi / Kwok Architects.

Related Volume III CHPS Criteria

See the Overview section of this chapter.



Guideline EL2: Troffer Lighting

Recommendation

This recommendation is **only** for spaces having no ceiling or a low ceiling (less than 9 ft-6 in.) where pendant mounted lighting is inappropriate. In these cases, use surface or recessed fluorescent troffers having at least 78% luminaire efficiency, T-8 premium lamps and electronic ballasts, and a connected lighting power of 0.9 W/ft² to 1.1 W/ft².

Description

Fluorescent troffers are designed to replace an acoustical tile in grid tee-bar ceiling systems. The most common and cost effective size is 2 ft x 4 ft; less common sizes include 2 ft x 2 ft and 1 ft x 4 ft. Two (or more) T-8 lamps are inside.

The three common troffer types are:

- *Lens troffers*, in which the down-facing side of the luminaire is covered with a plastic lens.
- *Parabolic troffers*, in which the down-facing side of the luminaire is enclosed by a metal louver having aluminum blades.
- *Basket troffers*, in which the down facing side of the luminaire is partially covered by a perforated basket to hide the lamps.

While parabolic troffers and basket troffers may be used in schools, lens troffers generally should be used because of their specific light distribution and economy. Parabolics tend to create a cave-like appearance that may be suitable for some types of spaces, but typically, should be avoided for general use in schools. Basket luminaires are relatively expensive and have poor light distribution qualities for classrooms, although they might be used in other spaces, especially corridors.

In a modern lens troffer, the interior reflector should be either high-reflectance white paint or highly-polished ("specular") silvered coating or aluminum. Silvered coating increases the cost considerably but also increases efficiency to over 85%. The lens should be an industry standard "Pattern 12" prismatic acrylic lens, with a minimum lens thickness of 0.125 in. for durability and appearance.

The luminaires can be laid-out in rows or in a grid pattern, although many architects prefer a doughnut configuration for classrooms. See the examples, below.

Applicability

Lens troffers have a distinctly inexpensive and institutional appearance. Also, the light quality is marginal. Nonetheless, under correct circumstances, troffer lighting is appropriate for classrooms, libraries, multipurpose spaces, and administration spaces.

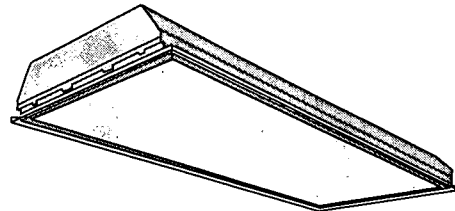

Modern lens recessed troffer (above); surface troffer (below)

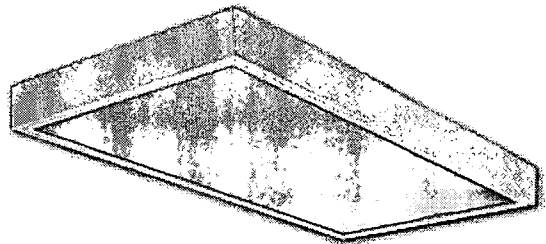

Applicable Spaces	Climates	When to Consider
Classrooms	South Coast	Programming
Library	North Coast	Schematic
Multi-Purpose / Cafeteria	Central Valley	Design Dev.
Gym	Mountains	Contract Docs.
Corridors	Desert	Construction
Administration		Commissioning
Toilets		Operation
Other		



Applicable Codes

The National Electric Code (NEC) usually governs the electrical portion of lighting installations. Some cities have unique electrical codes, but most adopt the NEC. The energy considerations of lighting fall under California Title 24 (or similar codes in other states). Title 24 limits the amount of lighting power per classroom to 1.6 W/ft² (1999), so this recommendation exceeds code limits by a considerable amount. Title 24 also requires switching (see Guideline EL4).

Integrated Design Implications

This type of lighting should only be used in flat acoustic tile ceilings, and then only when ceiling height and/or budget prevents consideration of other options.

In daylit classrooms, three circuits for switching or dimming are recommended. The troffers should be circuited into zones that respond to the daylight gradients in the space, such as defining an outer zone along a window wall, a central zone, and an inner wall zone.

Cost Effectiveness

Recessed lighting systems cost about \$120 per luminaire¹⁹ for basic, white interior luminaires with .125 in. lens, two premium T-8 lamps, and electronic ballast. A dimming ballast will add about \$40 to \$50 to each luminaire. Although lens troffer lighting systems are extremely low cost, their inexpensive appearance can be a drawback.

Costs	L	■	■	
	M	□	□	
	H	□	□	
		L	M	H
		Benefits		

Benefits

Troffer lighting systems generally offer excellent efficiency, but with some loss of visual comfort. They make excellent use of the low-cost, widely used T-8 lamp system. Systems operating at about 1 W/ft² will generate between 50 and 60 footcandles maintained average, with very good uniformity.

Design Tools

See the Overview section of this chapter.

Design Details

There are a number of troffer variations. These include:

- *Quality or price class.* A "specification grade" troffer is generally deeper, heavier gauge metal and costs more. A basic troffer works just as well, but is flimsier.
- *Door type.* A flat steel door with butt joints costs the least; a regressed aluminum door with mitered corners costs quite a bit more, but looks better.
- *Lens.* In addition to the industry standard "Pattern 12" lens, there are other lens designs that can provide increased efficiency and other benefits, but at greater cost.
- *Air Handling.* "Static" troffers are enclosed boxes that do not interface with HVAC equipment. "Heat extraction" troffers serve as a return path for HVAC systems using the ceiling plenum for return, and they cool lamps in the process (not necessary with two-lamp systems). "Air handling" troffers are connected to special HVAC supply or return devices. The cost of HVAC attachments is high, and they do not fully eliminate the need for conventional HVAC diffusers and grilles.

While this type of lighting is suitable for most types of classroom work, lens troffers are not recommended for computer workspaces. Separate chalkboard illumination is usually not required. It is best to employ

¹⁹ Approximate cost to owner, including labor, materials, overhead, profit, and costs of construction for lighting, including luminaires, lamps, and suspension hardware. Includes connecting luminaire to branch circuit. Controls and branch circuit costs not included. Based on July 2000 prices. Costs can vary depending on market conditions.

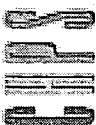

premium or super T-8 lamps with 835 or 841 color. For non-dimming applications, luminaire light and power can be varied through choice of ballast factor. Use Table 13 and specify ballasts accordingly.

Luminaires need to be restrained in case of an earthquake or other natural disaster. In general, this means that each luminaire must be hung from the structure with hanger wires independent of the ceiling system.

There are two common designs:

- A typical classroom with a "modified doughnut" pattern of two lamp troffers (see Figure 13 below). By orienting luminaires parallel to all walls, superior upper wall lighting occurs, although this pattern may cause slightly more glare than by simply using a grid layout.
- A conventional layout of troffers in a simple grid. Upper wall illumination of the end walls is not as good, but the lighting system will produce less glare.

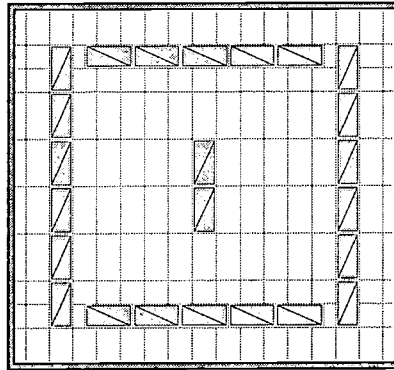

Figure 13 – "Modified Doughnut" Classroom Recessed Lighting Design

Operation and Maintenance Issues

These lighting systems rarely need maintenance. As with all fluorescent systems, lamps should be replaced at approximately 12,000 to 16,000 hours of operation, which, with normal school use, could be as seldom as every six years (consider premium lamps and specific lamp/ballast systems for even longer life and less maintenance). Luminaires should be cleaned annually. Lensed luminaires require periodic cleaning and are occasionally abused. Lens replacement is relatively inexpensive.

Commissioning

No commissioning is needed, other than pre-seasoning of lamps in dimming applications.

References/Additional Information

See the Overview section of this chapter.

Related Volume III CHPS Criteria

See the Overview section of this chapter.

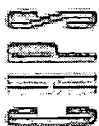

Guideline EL3: Industrial-Style Classrooms

Recommendation

This recommendation applies to rooms without a finished ceiling and to classroom and office spaces designed to have an industrial, exposed construction style.

Use direct or semi-direct fluorescent industrial luminaires that have T-5HO or T-8 premium lamps and electronic ballasts, and have at least 70% efficiency. Lighting power should be approximately 1 W/ft² to 1.4 W/ft².

Description

In rooms without finished ceilings, some creativity may be needed to implement a lighting solution that is both attractive and performs as well as those designed for more finished spaces. Depending on budget and architectural requirements, designs may employ strip lights with reflectors, true industrial-style fluorescent luminaires, or styled industrial-like luminaires.

In general, the following strategies should be employed:

- Use either direct lighting systems (up to 10% uplight), or semi-direct lighting systems (up to 40% uplight). The majority of the light needs to be directed downward since the ceiling of the space, often a metal deck or other unfinished surface, can not be relied on to efficiently reflect light.
- Include some form of glare shielding for the downlight component, although this can often be ignored if the lighting systems are mounted relatively high in the space.
- Have an uplight component to produce balancing luminance and comfortable light, but without being wasteful.
- Use simple ideas to make the luminaires visually appealing.

Applicability

This type of lighting should only be used in very specific applications, such as high bay industrial spaces like industrial arts rooms and art studios. Rooms with unusual architecture, especially if the school is within an existing building or structure, may also benefit from this type of lighting system. This type of lighting system has gained wider acceptance recently as architects explore more "industrial" and constructed forms of design. However, it is best reserved for spaces where it truly suits the aesthetic.

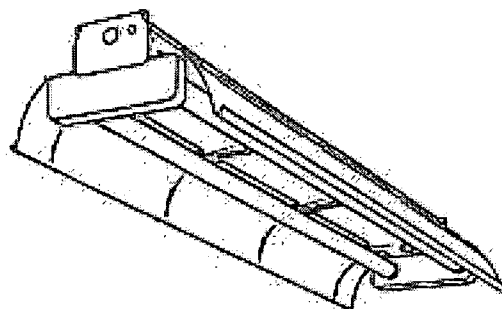

(Above) Industrial fluorescent with uplight (Lithonia Lighting)

(Below) Styled direct luminaire in the industrial motif with louvers and cable suspension (Prudential Lighting)

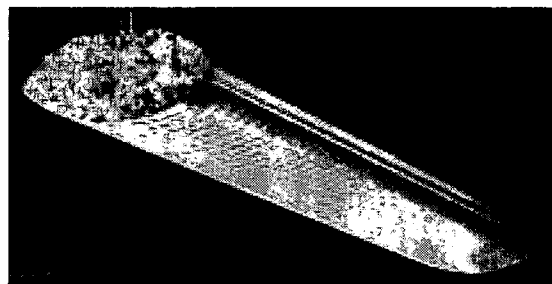

Applicable Spaces	Climates	When to Consider
Classrooms	South Coast	Programming
Library	North Coast	Schematic
Multi-Purpose / Cafeteria	Central Valley	Design Dev.
Gym	Mountains	Contract Docs.
Corridors	Desert	Construction
Administration		Commissioning
Toilets		Operation
Other		

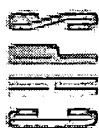

Applicable Codes

The National Electric Code (NEC) usually governs the electrical portion of lighting installations. Some cities have unique electrical codes, but most adopt the NEC. The energy considerations of lighting fall under California Title 24. Title 24 limits the amount of lighting power per classroom to 1.6 W/ft² (2001), so this guideline meets or exceeds code limits. Title 24 also requires switching (see Guideline EL4).

Suspended luminaires need to be restrained in case of an earthquake. With rigid stems, "earthquake" ball joints that permit controlled movement are recommended. Luminaires suspended by aircraft cable or chain may require lateral restraining cables.

Integrated Design Implications

Designing spaces with unfinished ceilings should be carefully contemplated, since ceilings tend to improve the efficiency of light utilization.

Cost Effectiveness²⁰

An industrial lighting system can be very cost effective, even in unusually high open spaces. Industrial-style lighting systems will cost about \$35/ft to \$75/ft of luminaire depending on the quality and style aspects of the chosen product. To minimize costs, consider using HLO ballasts or T-5HO lamps to increase the power of each luminaire and reduce the number of lights required. If the space is sufficiently high, mounting luminaires in continuous rows reduces mounting and wiring costs.

Costs	L			
	M	■		
	H	■		
		L	M	H
		Benefits		

Benefits

Industrial lighting systems generally offer excellent efficiency, but with varying degrees of visual comfort. For instance, the strip light, the most basic industrial lighting system, is very efficient but also produces glare. Industrial luminaires make excellent use of the low-cost, widely used 4-ft T-8 lamp system, as well as the less common but equally efficient 8-ft lamp system. For most situations, installations operating at less than 1.5 W/ft² will generate appropriate lighting with very good uniformity.

Power use will be affected by the system's mounting height. The efficiency of a luminaire decreases as the luminaire's mounting height increases. Many spaces without finished ceilings may have a roof structure 20 ft or more in the air, but the luminaires may be suspended as low as 12 ft above floor. In general, power use will range from 1 W/ft² to 1.2 W/ft² with luminaires at 12 ft, and between 1.2 W/ft² to 1.4 W/ft² at 16 ft.

Design Tools

See the Overview section of this chapter.

Design Details

- A reflector directing the light downward is necessary, which means strip lights without reflectors are probably not an acceptable choice. Determining the amount of uplight needed is a balance between comfort (more uplight) and efficiency (less uplight). The reflectivity of the ceiling cavity affects this decision a little; the more reflective (such as white painted roof deck), the more benefit will be gained from uplighting.
- Contemplate shielding. Most ordinary industrial lighting systems are open, exposing the lamps to view. However, shielding with louvers or lenses decreases overall efficiency. As a rule of thumb, the need for shielding tends to decrease with ceiling height.
- Choose luminaires with an appropriate distribution of light. As the luminaire is mounted higher, the distribution pattern should become narrower and the spacing to mounting height (S/MH) of the luminaire should become smaller. At lower mounting heights, luminaires rated 1.2 S/MH or more are

²⁰ Approximate cost to owner, including labor, materials, overhead, profit, and costs of construction for lighting including luminaires, lamps, and suspension hardware. Includes connecting luminaire to branch circuit. Controls and branch circuit costs not included. Based on July 2000 prices. Costs can vary depending on market conditions.



generally acceptable, but at 15 ft or more, a fluorescent luminaire with S/MH of 1 or less may be the best choice. Avoid wide throw luminaires such as wraparounds.

- Evaluate lamp and ballast options. If the lighting system can be mounted above 12 ft, the use of high light output ballasts on T-8 lamps (up to 1,025 initial lumens per lamp-foot), or even T-5HO lamps (up to 1,250 initial lumens per lamp-foot), can reduce the number of lamps – and luminaires – needed to light the space, which saves costs and complexity. Use Table 13 in this chapter's Overview and specify ballasts accordingly.
- Fluorescent luminaires are strongly encouraged over HID sources due to superior color rendering, energy efficiency, immediate starting and restarting, long lamp life, low flicker, and other qualities. Fluorescent luminaires designed specifically for high bay spaces like gyms can also be used in high bay industrial spaces, such as industrial arts and shops. In some extreme situations, metal halide high bay or low bay luminaires may be used, although fluorescent solutions should always be considered first.
- Some spaces, such as precision industrial arts and art studios, may benefit from higher light levels. Provide up to 1.6 W/ft² in these spaces.
- Consider using 8 ft lamps if enough space exists to warrant the introduction of this less-common lamp type.
- If luminaires are mounted sufficiently high in the space, they may be best installed in rows (see Figure 14 below) which in turn permits luminaires to be wired end-to-end, minimizing electrical construction and reducing the number of points where structural support or seismic bracing are required. Luminaires may be suspended on aircraft cables, chains, rigid stems, or may be attached to the surface of the roof or structure above. The lighting system should be mounted to maintain clearances for equipment, overhead doors, etc.
- See Guidelines EL1 and EL2 for examples on using indirect, semi-indirect and direct luminaires in classrooms with ceilings. These lighting systems can often be applied to spaces with relatively high ceilings as well.

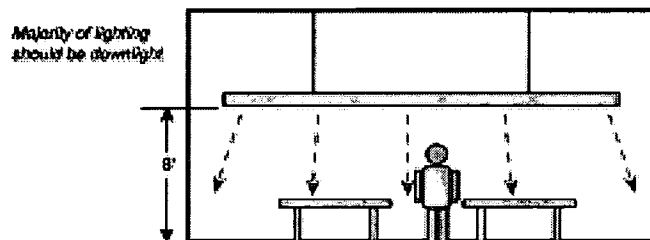

Figure 14 – Industrial Classroom Suspended Lighting Design

Operations and Maintenance

These lighting systems rarely need maintenance. As with all fluorescent systems, lamps should be replaced at approximately 12,000 to 16,000 hours of operation (longer with certain lamps and lamp ballast systems), which with normal school use could be as seldom as every six years. Luminaires should be cleaned annually. Lensed luminaires require periodic cleaning and are occasionally abused. Open luminaires tend to require less maintenance.

Commissioning

No commissioning is needed.

References/Additional Information

See the Overview section of this chapter.

Related Volume III CHPS Criteria

See the Overview section of this chapter.

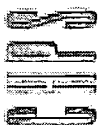

Guideline EL4: Lighting Controls for Classrooms

Recommendation

All lighting systems should be circuited so that lighting can be turned off to respond to daylighting availability. Depending on daylight availability and the audio/visual needs of the classroom (including extensive computer work), the following recommendations should be followed:

Daylit classroom: To meet the classroom's audio/visual needs, the lighting system should include dimming ballasts, automatic daylight sensing, manual dimming, and manual override. If the classroom has no special audio/visual needs, dimming ballasts and automatic daylight sensing should still be included, as well as motion sensing with manual override.

Classroom with minimum daylighting: If the classroom has audio/visual needs, the lighting system should include dimming ballasts, automatic daylight sensing, manual dimming, and manual override. If the room has no special audio/visual requirements, a motion sensing system with manual override should be used.

Description

Lighting controls can dramatically affect both the energy use of a lighting system and the usability of the lighting when the classroom is being used for audio/visual or computer education.

As a minimum, all classrooms should employ motion sensors, preferably in conjunction with a switch that can turn lights off regardless of sensor "state." Most sensors are passive infrared and respond to the movement of warm bodies. Upper wall and corner sensors are the best choice, and dual mode sensors employing ultrasonic, microphonic, or another form of backup sensing are strongly recommended. These types of sensors generally require a power pack (transformer-relay) that actually switches the circuit.

Wallbox sensors that replace wall switches are not a good choice for classrooms. For maximum flexibility, manual switches should be wired in series with the motion sensor relay so that lights can be turned off manually, regardless of whether there is motion in the room.

The falling cost of dimming ballasts for T-8 lamps makes dimming possible for many projects. Dimming ballasts permit both manual dimming, allowing the teacher to adjust lighting levels, and automatic dimming, especially to respond to daylight. Ballasts should be specified in conjunction with an overall dimming system to ensure compatibility.

Spaces with audio/visual needs that require manual dimming should use a wall-mounted dimmer controller.

Applicability

These lighting control strategies are appropriate for classrooms and some areas in administration spaces and libraries.



Photo courtesy: Evan Lesley

Applicable Spaces	Climates	When to Consider
Classrooms	South Coast	Programming
Library	North Coast	Schematic
Multi-Purpose / Cafeteria	Central Valley	Design Dev.
Gym	Mountains	Contract Docs.
Corridors	Desert	Construction
Administration		Commissioning
Toilets		Operation
Other		

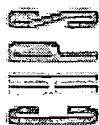

Applicable Codes

The National Electric Code (NEC) usually governs the electrical portion of lighting installations. Some cities have unique electrical codes, but most adopt the NEC. The energy considerations of lighting fall under California Title 24. Title 24 requires that all spaces have a switch with automatic shutoff. Installing a motion sensor meets this requirement.

Title 24 also requires that luminaires in a daylight zone (area near window or skylight) have separate switching or dimming. If automatic daylight dimming is not used, it will be necessary to switch the lights near the windows separately from the interior lights.

Title 24 provides a controls credit for automatic controls like motion sensors and daylight dimming. While no credit exists for small windows, a power credit of up to 40% is given for daylight dimming in rooms with effective windows and skylights. In other words, a lighting system of 1,000 W is considered only 600 W if controlled by a daylight dimming system.

Integrated Design Implications

Controls are essential in achieving the overall goal of reduced energy consumption. The mechanical engineer should be informed of expected changes in the lighting system's pattern of operation due to automatic controls. Reduction in the hours of operation or the power of the lighting system will lower the internal heat gain in the space, changing the needs for supplemental heat, cooling, and ventilation.

For spaces with daylight, automatic daylight sensors are recommended for lights near the window wall or underneath skylights. Lighting control circuits should be designed to parallel daylight contours. Two switches should be located close to the room entrance, one enabling the lighting fixtures near the window and the other controlling the lighting fixtures away from the window. The lighting circuit next to the window should also be controlled by an "open loop" photosensor. "Open loop" sensors that are not affected by room light are strongly recommended since they are more reliable and easier to calibrate. A third "energy management" switch is recommended to toggle the central row of fixtures so that they can be grouped either on the photosensor circuit or the non-daylighted circuit, depending on the season of the year and other factors that affect daylight availability. See Figure 15 below.

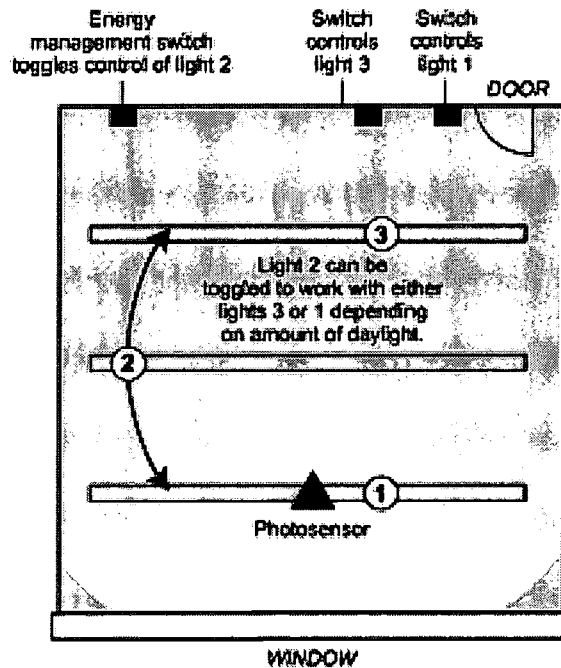

Figure 15 – Simple Windowed Classroom Control

Cost Effectiveness

For motion sensing, cost effectiveness varies depending on the overall energy management skills of teachers and staff. People who are personally careful with energy outperform motion sensors, but for less well managed spaces, motion sensors are worthwhile.

Daylight sensors and dimming ballasts are worthwhile if the daylighting is designed correctly. Systems employing manual dimming, daylighting, and motion sensing are presently only cost effective if audio/visual or computer requirements of the building use need to be met.

Controls are an evolving area of lighting technology for buildings. While cost effectiveness is good at present, costs remain relatively high.

A pair of motion sensors and one power pack adds about \$200 per classroom. Dimming ballasts add approximately \$40 to \$50 per ballast, or up to \$1,200 per classroom. Automatic daylighting control without manual dimming adds about \$200 per classroom, in addition to the costs of ballasts.

A control system that permits manual dimming in conjunction with motion sensing and daylighting will cost about \$1,000 per classroom,²¹ in addition to the costs of the dimming ballasts.

Benefits

Each added control element saves energy. Depending on the school's operating months, the quality of daylight, the climatic zone, and other factors, energy cost savings can vary from good to dramatic.

Costs	L			
	M			
	H	■	■	
		L	M	H
		Benefits		

Design Tools

Very few useful design tools exist for this evolving field. The best information is usually obtained from controls manufacturers and their representatives.

Design Details

- Use two dual-technology motion sensors, set in the corners of the classroom opposite the door. Wire the power for the lights in series with the sensors' transformer-relay and wall switches. Use one switch if automatic daylight controls are being used, and two switches if not.
- Use 0-10 volt dimming ballasts unless employing a complete manufacturer-integrated system of control. 0-10 volt controls are the most universal at present and there is more competition in the market.
- Use "open loop" daylight sensors located within 5 ft of the window.

²¹ Approximate cost to owner, including labor, materials, overhead, profit, and costs of construction for lighting including luminaires, lamps, and suspension hardware. Includes connecting luminaire to branch circuit. Controls and branch circuit costs not included. Based on July 2000 prices. Costs can vary depending on market conditions.



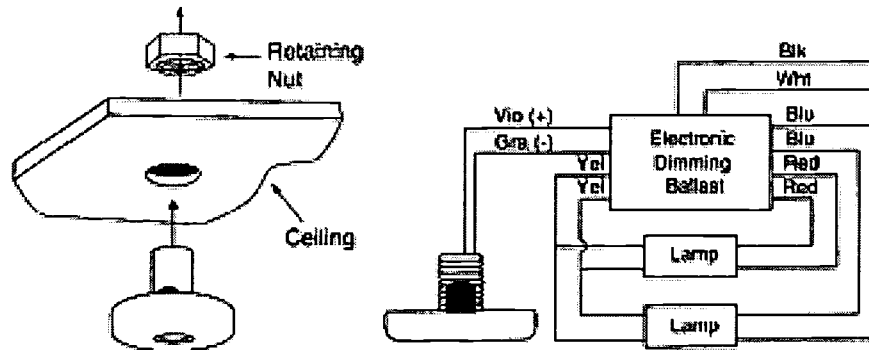

Figure 16 – Wiring for a Ceiling Mounted Light Sensor

Sensor connects directly to the violet and gray terminals of industry standard 0-10 volt ballasts. Courtesy Wattstopper.

Operation and Maintenance Issues

In operation, a properly commissioned system needs only periodic maintenance to ensure optimum performance. Refer to the manufacturer's recommended recalibration and cleaning cycle for sensors.

Commissioning

Commissioning of motion sensor systems and daylighting controls is critical to their success. Systems that work properly will be left alone; systems that have false tripping and other unwanted behavior will be disconnected or bypassed by occupants.

Good rules of thumb:

- The sensitivity of motion sensors should be set according to the manufacturer's instructions. A proper setting will minimize false tripping and unwanted cycling. Because sensors are both physically and electronically adjustable, care should be taken to ensure the sensors are working as intended.
- The time-out setting of motion sensors is also critical. A setting too short may cause false tripping; a setting too long fails to save energy as well. A preliminary time-out setting of 15 minutes is usually the right balance.
- Daylight sensor settings should be made and checked several times. Use a good light meter (Minolta TL-1 or better).

References/Additional Information

See the Overview section of this chapter, and:

Controls: Patterns for Design. Electric Power Research Institute. <http://www.epri.com/>.

Related Volume III CHPS Criteria

See the Overview section of this chapter, and:

Energy Credit 5: Energy Management Systems.

BEST COPY AVAILABLE

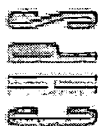

Guideline EL5: Gym Lighting

Recommendation

Over basketball courts, volleyball areas, gymnastics areas, and other portions of the gymnasium with a high ceiling and structure, three choices for lighting exist:

- 1. T-5HO High-Bay Fluorescent.** Use industrial high bay luminaires with T-5HO or T-8 lamps. Each luminaire should have symmetric reflectors for downlight distribution and a wire cage or lens should be used to protect the lamps from flying balls. Four-ft luminaires with four or six lamps and two-lamp ballasts produce similar results as a like number of metal halide luminaires, but with fewer watts and greater versatility.
- 2. Compact Fluorescents.** Employ industrial-style luminaires having multiple compact fluorescent lamps in a single housing. Each luminaire should use eight 32-W or 42-W compact fluorescent triple-tube lamps, with electronic ballasts. The fixture should not have a lens, but consider adding a wire cage to open luminaires that may be exposed to flying balls or other damage.
- 3. Metal Halide.** Use metal halide industrial-style "high bay" luminaires. The metal halide luminaires should employ 320-W to 450-W "pulse-start" lamps and 277-volt reactor ballasts, if possible. They will provide at least 50 footcandles of general lighting. Use a protected lamp suitable for open luminaires, not a lensed or enclosed lamp. Slightly higher light levels may be provided for the main basketball court in middle schools and high schools. Consider adding a wire cage to open luminaires that may be exposed to flying balls or other damage.



Metal halide gym lighting. Windsor High School Gym, Photo courtesy Quattrocchi / Kwok Architects

Applicable Spaces	Climates	When to Consider
Classrooms <input type="checkbox"/>	South Coast <input type="checkbox"/>	Programming <input type="checkbox"/>
Library <input type="checkbox"/>	North Coast <input type="checkbox"/>	Schematic <input type="checkbox"/>
Multi-Purpose / Cafeteria <input type="checkbox"/>	Central Valley <input type="checkbox"/>	Design Dev. <input type="checkbox"/>
Gym <input checked="" type="checkbox"/>	Mountains <input type="checkbox"/>	Contract Docs. <input type="checkbox"/>
Corridors <input type="checkbox"/>	Desert <input type="checkbox"/>	Construction <input type="checkbox"/>
Administration <input type="checkbox"/>		Commissioning <input type="checkbox"/>
Toilets <input type="checkbox"/>		Operation <input type="checkbox"/>
Other <input type="checkbox"/>		

Whichever system is used, it will probably be necessary to design at about the Title 24 limit of 1 W/ft² to meet modern expectations for gym lighting. Gyms where significant television broadcasts occur may also employ a separate television lighting system that is exempt from Title 24 limits.

It will also be necessary to provide an *emergency lighting system*. In addition to self-illuminated exit signs, provide either:

- Some luminaires powered by batteries or a generator, in a high bay fluorescent system or compact fluorescent system.
- Use quartz auxiliary lamps powered from batteries or an emergency generator, in a metal halide system.

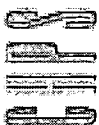

Also consider providing a separate halogen downlight system for "house" lighting during dramatic and social uses of the gym. This system may also be powered in-full or in-part from an emergency generator or battery backup power source. As a basic design, use suspended cylinder downlights with halogen IR PAR-38 flood lamps. Design the system to provide at least two footcandles of illumination with normal power and one footcandle from an emergency source. This system provides both egress lighting and serves other uses (see below). It must be controlled to prevent concurrent operation with the general lighting system.

Description

The height of the gym space's ceiling plays a major role in choosing gym lighting systems. This can be partly assessed by examining the coefficient of utilization (CU) at Room Cavity Ratio (RCR) =2.5 of candidate systems. It is also useful to examine their spacing to mounting height (S/MH) as well.

Fluorescent systems using multiple T-5HO or T-8 lamps are preferred for ordinary gyms and other high ceiling spaces. Superior color, elimination of flicker, and the ability to turn lights on and off as needed are major advantages over HID systems.

The added cost of the fluorescent system is offset by much lower energy use, estimated to be as much as 50% less if the multiple light level capability of a fluorescent system is utilized. Systems using multiple compact fluorescent lamps also provide these benefits, although without the high efficacy of the linear fluorescent lamps.

In general, metal halide high bay lighting systems tend to be more appropriate when ceilings are especially tall, such as in a field house. Long lamp life and a minimum number of luminaires keep costs down. The color of metal halide is suitable for television as well as everyday use. The long warm-up and restrike periods of metal halide lighting are a drawback since switching lights off regularly is not recommended for these systems. Be certain to use pulse-start lamps. These systems are, however, compatible with daylight gyms if they have switched lighting levels.

Multiple compact fluorescent "high bay" lights are a distant third choice. These systems are less energy efficient and require more costly and frequent maintenance than the other choices.

A separate downlight system using halogen lamps is highly recommended for two reasons:

- It is an instant-on, instant-off system that can be dimmed inexpensively. This feature is especially important if metal halide lights are accidentally extinguished, as they will require a five to 10 minute cool-off and restrike delay.
- A dimmable tungsten downlighting system can make the gym more appealing for social events, and can also serve as a "house" lighting system for many of the gym's performance and entertainment uses.

Lighting quality is a crucial issue in gym spaces. Avoiding direct view of an extra bright light source, such as a metal halide lamp, high output lamp, or skylight, can be especially critical in a gymnasium where athletes must scan for the ball and react quickly. Even though a luminaire may normally be out of the line of sight, it can still create a devastating glare source to a volleyball or basketball player.

Applicability

This guideline can be used in most schools, including colleges and universities, public K-12, private, and parochial schools, and similar facilities such as churches, sports clubs, and private institutions.

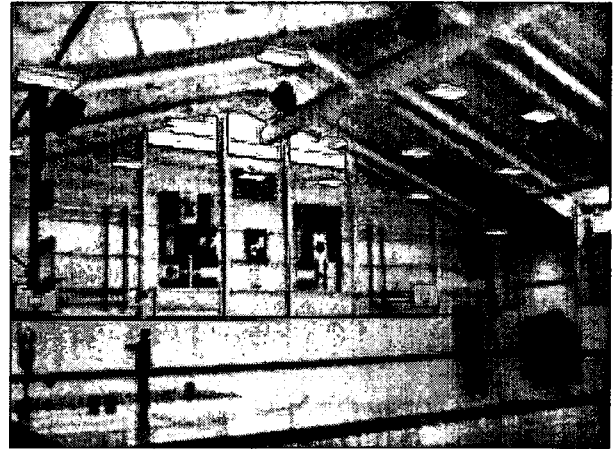

T-5HO Systems are very energy efficient and flexible. Photo Courtesy James K. Rogers

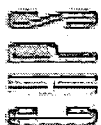

Applicable Codes

Electrical

The electrical portion of lighting installations is usually governed by the National Electric Code (NEC). Some cities have unique electrical codes, but most adopt the NEC. The energy considerations of lighting fall under California Title 24. Title 24 limits the amount of lighting power in a gym to 1 W/ft² (2001), so this recommendation meets the code. Title 24 also requires switching (see Design Details below).

Life Safety

As a place of assembly, the gym needs to be equipped with an emergency lighting system capable of producing at least 1 footcandle, average, along the path of egress. The emergency lighting system must be powered from an emergency generator or from a battery backup system capable of providing egress lighting for at least 90 minutes. In addition, exit signs must be provided and they, too, must be powered for at least 90 minutes after a power outage.

Seismic

Luminaires need to be restrained in case of an earthquake. In general, this means that each luminaire must be secured to the structure with an additional safety cable independent of the fixture's ordinary support system.

Integrated Design Implications

High bay luminaires are easily attached to most structures. It is recommended that the luminaires be suspended within the "truss space" or in other words, with the bottom of the luminaire not lower than the lowest beam or truss member. In the rare instance where the gym has a finished ceiling, recessed lighting should be considered.

Daylighting design is especially well suited to the high ceilings and large open space of gymnasiums. Gentle diffuse systems, which avoid creating excessive bright spots within the athletes' critical viewing directions, are especially appropriate. For example, side lighting should be placed perpendicular to the primary basketball walls. Wall wash top lighting or high sidelighting with light shelves or louvers can be effective techniques for gyms, since both involve secondary reflections on room surfaces that prevent direct view of the window or skylight. Direct sun penetration into gyms should be prevented at all times.

Cost Effectiveness²²

Each metal halide luminaire costs about \$325, or about 79 mean lumens/dollar. A multiple compact fluorescent luminaire costs about \$425, or about 52 mean lumens/ dollar. A T-5HO 6-lamp luminaire costs about \$375, or about 76 mean lumens/dollar. Each PAR38 downlight costs about \$150. Dimming, switching, and emergency power costs vary and are in addition to the luminaire costs.

Costs	L			
	M			
	H			
		L	M	H
		Benefits		

Benefits

The best solution for a particular gym depends on hours of use and other variables.

- A metal halide lighting system has the lowest first cost. There is no less expensive way to provide the necessary quantity of light from this mounting height. The use of high Watt metal halide lamps minimizes the number of luminaires (first costs) and the number of lamps (maintenance costs).
- A system employing multiple T-5HO or T-8 lamps offers the least energy use and longest life lamps (lowest maintenance costs). Multiple light level capabilities save additional energy and extend maintenance periods.

²² Approximate cost to owner, including labor, materials, overhead, profit, and costs of construction for lighting including luminaires, lamps, and suspension hardware. Includes connecting luminaire to branch circuit. Controls and branch circuit costs not included. Based on July 2000 prices. Costs can vary depending on market conditions.

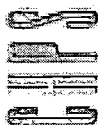

- A system using multiple compact fluorescent lamps combines the flexibility of fluorescent systems with the appearance of HID. While most costly to build and to operate, this approach results in a flexible design that can be energy effective if multiple light levels are used, and the system looks like a metal halide system.

Design Tools

See the Overview section of this chapter.

Design Details

- Fluorescent high bay lighting is a relatively new solution. Consider both T-8 and T-5HO systems. This choice requires specific considerations for reflector shape, photometry, and lamp protection. Products are available from some major fluorescent manufacturers and several specialty fluorescent makers. Careful study to ensure proper lighting levels is recommended.
- Any fluorescent choice permits the use of multiple level switching, including automatic daylight control. Take advantage of this feature in gyms with skylights and clerestories.
- Metal halide “high bay” luminaires are commonly available in a number of reflector types including aluminum, ribbed acrylic, and ribbed glass. Among these, ribbed acrylic offers the best combination of efficiency and uplight, and is sufficiently durable for the application.
- It is critical to specify the 320-W to 450-W, pulse-start, 277-volt reactor ballast system. If 277-volt (three-phase) power is not available, then use a 120-volt CWA ballast, although it is less energy efficient. Do not use the standard (probe-start) 400-W metal halide system, as it produces less maintained light than the 320 pulse-start system.
- In gyms with skylights (highly recommended), the use of a two-level controller for the metal halide lamps should be considered. A photoelectric switch, sensing when adequate daylight is present to turn lights down to the low setting, should control the action.
- Switches for metal halide lamps should NOT be readily accessible. They should be in a controlled location such as an electric room, press box, teacher/coach’s office, or other location where inadvertent operation of the lights will not occur. This adds support to the concept of a separate halogen system in which the switch is quite accessible. It would be a good idea to interlock the two systems so that the halogen system can not operate once the metal halides are at, or near, full light.

Operations and Maintenance

This design should be easy to operate and manage. Dimming on the halogen system (if used) will extend lamp life, and a metal halide system will require relamping every 12,000 to 14,000 hours (depending on hours of operation, this could be three to five years). System cleaning should be simple. Linear fluorescent systems require relamping every 15,000 to 20,000 hours, but compact fluorescent systems require relamping every 8,000 to 10,000 hours. However, if both fluorescent lamp systems rotate lamp operation at reduced light levels, relamping cycles can be very long.

The control system should be designed for easy use. Automatic time of day control with manual override is an acceptable means to control the metal halide lamps, but make certain that the controller is easily programmed for days on and off, holiday schedules, etc.

Commissioning

These systems are relatively easy to commission. Perhaps the most critical step is ensuring that automatic lighting controls, such as a photoelectric controller for a high-low system or an automatic time of day controller, are properly set up.

References/Additional Information

See the Overview section of this chapter, and:

Windsor High School (Model), Windsor CA, Windsor Unified School District. Quattrocchi / Kwok Architects.

Related Volume III CHPS Criteria

See the Overview section of this chapter.



Guideline EL6: Corridor Lighting

Recommendation

There are two principal choices for illuminating corridors in schools:

- Employ recessed fluorescent luminaires that have a means to both protect the lamp and create relatively high angle light perpendicular to the corridor axis.
- Employ surface mounted corridor “wrap-around” fluorescent luminaires designed for rough service applications.

In either case, luminaires should use T-5 or T-8 lamps and electronic ballasts. Caution should be employed to ensure that the luminaires are not overly “institutional” in appearance. Align luminaires parallel to corridor walls to provide good quality of light and to make light useful for lockers.

Outdoor corridors and corridors with plentiful daylight should employ automatic daylight switching or dimming to reduce electric lighting by day.

It will be necessary to provide emergency lighting with this lighting system. Some of these luminaires must be powered from an emergency generator or battery backup power source.



Anzar High School, Photo courtesy Quattrocchi / Kwok Architects

Description

It is important to minimize downlighting so that the walls of the corridor will be better illuminated. Lights that emit very well to the sides should be chosen. Choose from among the following types of products:

- Interior corridors may employ “recessed indirect” luminaires. Luminaires should be oriented with the lamp long axis along the corridor long axis. This design is suited for all ceiling types.
- As an alternative, especially for schools where vandalism is a concern, use surface ceiling wrap-around luminaires, preferably vandal-resistant or high abuse types.
- Exterior corridors should employ surface-mounted wrap-arounds or ceiling-mounted, high abuse luminaires. In some cases, wall-mounted, high abuse luminaires may be acceptable.

Applicable Spaces	Climates	When to Consider
Classrooms	South Coast	Programming
Library	North Coast	Schematic
Multi-Purpose / Cafeteria	Central Valley	Design Dev.
Gym	Mountains	Contract Docs.
Corridors	Desert	Construction
Administration		Commissioning
Toilets		Operation
Other		

Applicability

This guideline can be used in most schools, including colleges and universities, public K-12, private, and parochial schools, and similar facilities such as churches, sports clubs and private institutions.



Applicable Codes

Electrical

The National Electric Code (NEC) usually governs the electrical portion of lighting installations. Some cities have unique electrical codes, but most adopt the NEC. The energy considerations of lighting fall under California Title 24. Title 24 limits the amount of lighting power in a corridor to 0.6 W/ft² (1999), so this recommendation exceeds the code limits. Title 24 also requires switching (see Design Details below).

Life Safety

As a path of egress, the corridor needs to be equipped with an emergency lighting system capable of producing at least 1 footcandle, average, along the path of egress. In general, the best way to do this is to power every third or fourth luminaire from an emergency source, which must be either an emergency generator or a battery backup system capable of providing egress lighting for at least 90 minutes. In addition, exit signs must be provided and they, too, must be powered for at least 90 minutes after a power outage.

Seismic

Luminaires need to be restrained in case of an earthquake. In general, this means that each luminaire must be secured to the structure with an additional hanger wire or support independent of the ceiling's support system.

Integrated Design Implications

Given the choices of luminaires that are available, it should be possible to find an attractive solution that is suitable for any type of corridor ceiling construction, including indoor and outdoor corridors, acoustical tile or wallboard ceilings, etc.

Corridors are generally excellent spaces for daylighting. Furthermore, daylight in corridors provides an important safety feature of guaranteed lighting during any daytime emergencies. For single story or top floor corridors, linear toplighting is especially appropriate. For corridors not directly under a roof or adjacent to an exterior wall, pools of light from intermittent sidelighting or toplighting borrowed from the floor above can create important social spaces, with higher levels of illumination than that provided by the electric lighting system. Daylight introduced at the end of a long corridor can have a glaring effect, making the corridor feel more like a tunnel. Daylight introduced from the side or above is generally more effective with less glaring. As with electric lighting, illuminating the corridor walls should be the primary objective.

Cost Effectiveness

The corridor lighting systems recommended here are very cost effective. Each corridor luminaire costs about \$200²³. Dimming, switching, and emergency power costs vary and are in addition to the luminaire costs.

Costs	L			
	M			
	H			
		L	M	H
		Benefits		

Benefits

Fluorescent corridor lighting systems provide solid results for a modest investment. Long product life will result from carefully choosing a rough service grade luminaire.

Design Tools

See the Overview section of this chapter.

²³ Approximate cost to owner, including labor, materials, overhead, profit, and costs of construction for lighting including luminaires, lamps, and suspension hardware. Includes connecting luminaire to branch circuit. Controls and branch circuit costs not included. Based on July 2000 prices. Costs can vary depending on market conditions.

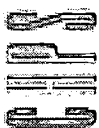

Design Details

The following are typical lighting layouts for corridors:

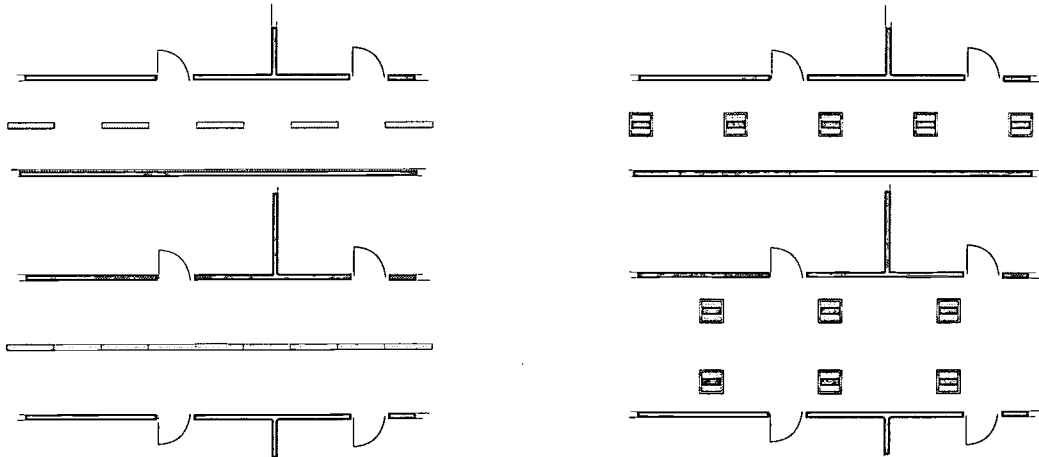

Figure 17 – Corridor Lighting Designs

- If required by the application, choose one of many modern “rough-service” luminaires that are attractive as well as durable.
- In general, recessed downlights generally have insufficient vertical illumination to provide good service in corridors. However, recessed downlights using compact fluorescent lamps may be preferred for lobbies and similar applications where a dressier appearance is desired.
- Switching of the lighting system should NOT be readily accessible. In general, switching should utilize an automatic time of day control system with motion sensor override during normally “off” hours.
- In addition, provide automatic daylighting controls, including dimming or switching off lights in corridors having windows, skylights, or other forms of natural lighting.

Operation and Maintenance Issues

This design should be easy to operate and manage. As with most fluorescent lighting systems, relamping every 12,000 to 14,000 hours is recommended. Ballast life extends 10 years or more. System cleaning should be simple.

The control system should be designed for easy management. Automatic time of day control with override is an acceptable means to control corridor lights, but make certain that the controller is easily programmed for days on and off, holiday schedules, etc.

Commissioning

These systems are relatively easy to commission. Perhaps the most critical step is ensuring that automatic lighting controls, such as a photoelectric controller for a high-low system or an automatic time of day controller, are properly set up.

References/Additional Information

See the Overview section of this chapter.

Related Volume III CHPS Criteria

See the Overview section of this chapter.



Guideline EL7: Lighting for a Multi-purpose Room

Recommendation

As a minimum, a multi-purpose room should have at least two independent lighting systems:

- A general lighting system providing 20 to 30 footcandles of uniform illumination using standard T-8 lamps; and
- A dimmable "house lighting" system supporting audio visual and social uses of the room, producing no more than 5 footcandles.

In addition, theatrical lighting may be added to illuminate specific stage or performance locations.

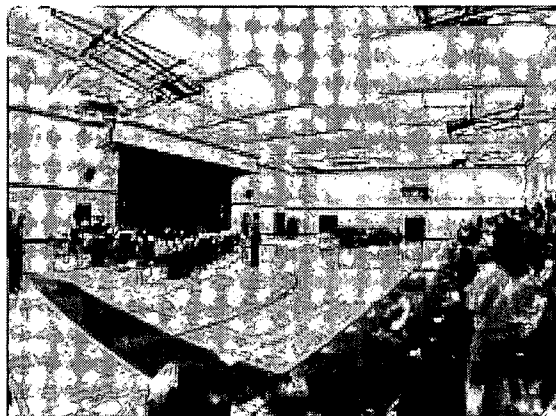

Photo courtesy: SunOptics Prismatic Skylights

Description

The general lighting system should probably be one of the types previously suggested for classroom lighting in Guidelines EL1 through EL3. If suspended luminaires are chosen, be careful to locate luminaires so as not to interfere with audio-visual and other uses of the room. If the room's uses include any sports or games, all lighting systems should be recessed or otherwise protected from damage.

The house lighting system should probably employ recessed or surface downlights. Narrow beam downlights should be chosen, and halogen lighting is recommended due to the superior color, inexpensive dimming, and good light control. Luminaires should use standard IR halogen PAR lamps. Black baffles or black alzak cone trims are recommended for audio/visual applications. The house lighting system should be laid-out to prevent light from striking walls or screens. Note that some general lighting systems might also serve as the house lighting system if properly laid out and equipped with electronic dimming ballasts, but most general lighting systems generate too much diffuse light, even when dimmed, for audio/visual use.

As with corridors and other common spaces, a control system that activates the general lighting system according to a calendar program and employs motion sensing for "off" hours should be used. Rooms with plentiful daylight should employ automatic daylight switching or dimming to reduce electric lighting by day. A manual override switch should be provided. Manual dimming of the house lighting system should be provided along with an interlock switch preventing simultaneous operation of both general and house lighting.

It will be necessary to provide emergency lighting with this lighting system. Some of these luminaires must be powered from an emergency generator or battery backup power source.

Applicability

This guideline can be used in most schools, including colleges and universities, public K-12, private and parochial schools, and similar facilities such as churches, sports clubs, and private institutions.

Applicable Spaces	Climates	When to Consider
Classrooms	South Coast	Programming
Library	North Coast	Schematic
Multi-Purpose / Cafeteria	Central Valley	Design Dev.
Gym	Mountains	Contract Docs.
Corridors	Desert	Construction
Administration		Commissioning
Toilets		Operation
Other		



Applicable Codes

Electrical

The National Electrical Code (NEC) usually governs the electrical portion of lighting installations. Some cities have unique electrical codes, but most adopt the NEC. The energy considerations of lighting fall under California Title 24. Title 24 limits the amount of lighting power in a cafeteria or multi-purpose room to 1.6 W/ft² (1999), so this recommendation is within the code limits. Title 24 also requires switching. Keep in mind that if the two lighting systems are interlocked as described above, only the higher wattage system is counted in energy code calculations.

Life Safety

As a place of assembly, the room needs to be equipped with an emergency lighting system capable of producing at least 1 footcandle, on average, along the path of egress. In general, the best way to do this is to power some of the lighting from an emergency source, which must be either an emergency generator or a battery backup system capable of providing egress lighting for at least 90 minutes. In addition, exit signs must be provided and they, too, must be powered for at least 90 minutes after a power outage.

The controls must be designed such that, if a power emergency occurs, the proper lights are illuminated regardless of setting. This often requires use of automatic transfer relay or other mechanism that bypasses room controls during a power emergency. Transfer relays must be listed for use in emergency circuits.

Seismic

Luminaires need to be restrained in case of an earthquake. In general, this means that each luminaire must be secured to the structure with an additional hanger wire or support independent of the ceiling's support system.

Integrated Design Implications

Because multi-purpose rooms often serve as a cafeteria, study hall, social gathering spot, special event space, community meeting hall, and audio-visual facility, it is extremely important to ensure that the lighting and controls provide proper operation for every intended use of the room. Moreover, this room may benefit from greater architectural design than other spaces, and lighting designers should be prepared to creatively provide the functions of the lighting described here, but use other types of equipment better suited to the specific architecture.

Multipurpose rooms can be successfully daylit, either from high clerestories or toplighting approaches. However, near-blackout capability for the daylight system is probably most important in this type of space, so operable louvers or blinds are highly recommended. If the daylight system can be reduced to a minimum of one to three footcandles, most reduced light functions, including stage performances, can operate effectively. A small amount of sunlight can be a cheerful presence in multipurpose rooms used as a cafeteria, as long as it can be blocked when needed.

Cost Effectiveness²⁴

In general, two separate lighting systems, with one being a dimmed halogen system, is the most cost effective. A single fluorescent lighting system with dimming system is usually more costly and less flexible.

Each downlight costs about \$175 (see the other guidelines in this chapter for general lighting costs). Dimming, switching, and emergency power costs vary and are in addition

Costs	L			
	M			
	H			
		L	M	H
		Benefits		

²⁴ Approximate cost to owner, including labor, materials, overhead, profit, and costs of construction for lighting including luminaires, lamps, and suspension hardware. Includes connecting luminaire to branch circuit. Controls and branch circuit costs not included. Based on July 2000 prices. Costs can vary depending on market conditions.



to the luminaire costs.

Benefits

This "two component" lighting design approach, when combined with effective controls, permits a wide range of uses of the multipurpose room, exactly what these rooms are designed for.

Design Tools

See the Overview section of this chapter.

Design Details

The figure below shows a typical multipurpose room with two lighting schemes. The left side uses pendant-mounted luminaires, and the right side shows recessed troffers.

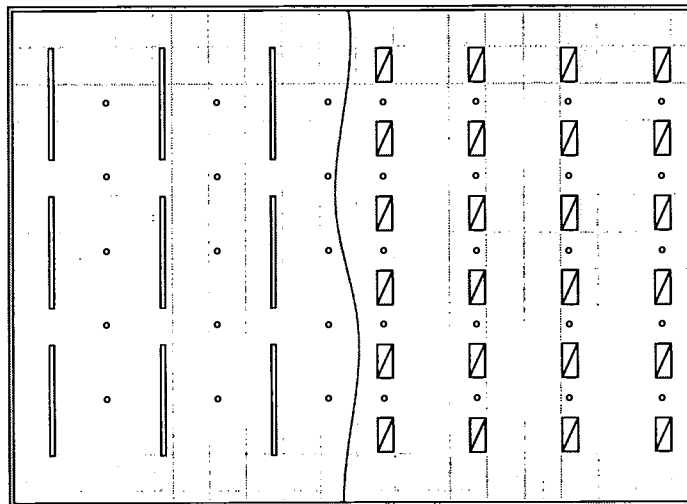

Figure 18 – Multipurpose Lighting Designs

This figure shows two approaches to lighting multipurpose rooms. Both schemes have a separate system of downlights to serve as "house" lights for social and A/V use.

- In this room, self-contained emergency ballast/battery units should be avoided unless specially designed to employ an external voltage sense connection. Leaving any general lighting luminaire operating in the dimmed mode is usually not acceptable.
- Consider placing the lighting in zones that have individual manual override switches to permit deactivating a zone when not occupied.
- Switching and dimming of the lighting system should NOT be readily accessible. Locate controls in a supervised location.
- Consider a modern preset dimming or control system, especially if touch-screen control and other modern audio-video interfaces are planned.

Operation and Maintenance Issues

This design should be easy to operate and manage. As with most fluorescent lighting systems, the general lighting system should be relamped every 12,000 to 14,000 hours. Ballast life should cover 10 years or more. Spot relamping is recommended for the house lighting system. Cleaning of both systems should be simple.

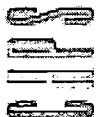

The control system should be designed for easy management. Automatic time of day control with override is an acceptable means to control corridor lights, but make certain that the controller is easily programmed for days on and off, holiday schedules, etc.

Commissioning

These systems are relatively easy to commission. Perhaps the most critical step is ensuring that automatic lighting controls, such as a photoelectric controller for a high-low system or an automatic time of day controller, are properly set up. Also, if fluorescent dimming is used, make sure that lamps are pre-seasoned, i.e., operated at full light for 100 hours prior to dimming them.

References/Additional Information

See the Overview section of this chapter.

Related Volume III CHPS Criteria

See the Overview section of this chapter.

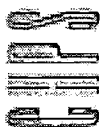

Guideline EL8: Lighting for a Library or Media Center

Recommendation

Provide lighting for a library as follows:

- A lighting system providing 20 to 50 footcandles of general illumination in casual reading, circulation and seating areas using standard T-8 lamps.
- Overhead task lighting at locations such as conventional card files, circulation desks, etc.
- Task lighting at carrels and other obvious task locations, using compact fluorescent or T-8 lamps.
- Stack lights using T-8 or T-5 lamps in areas where stack locations are fixed, and general overhead lighting in areas employing high density stack systems.
- Special lighting for media rooms, as required.



*Austin Creek Elementary School,
Photo courtesy: Quattrocchi / Kwok Architects*

Description

The general lighting system may be one of the types previously suggested for classroom lighting (Guidelines EL 1-3 and EL9). As long as adequate ceiling height is present, suspended lighting systems are preferable. Overhead lighting systems for task locations should also be selected from among choices suitable for classrooms or offices.

Task lighting at carrels and other spots should be selected according to architecture and finish details. Two common options include:

- Under-shelf task lights using T-8 or modern T-5 lamps (e.g., F14T5/8xx, F21T5/8xx, or F28T5/8xx).
- Table or floor lamp equipped with a compact fluorescent lamp up to 40 W.

Stack lighting should utilize luminaires specifically designed for lighting stacks. A number of choices exist, but generally, a single continuous T-8 or T-5 lamp system will provide adequate illumination.

Media rooms, such as video monitoring and editing, sound monitoring and editing, distance learning, and video teleconferencing all have special requirements. It is important that lighting be designed to meet those specific needs and that lighting controls be provided to enable room use. No specific recommendations for those spaces are made here, but depending on the room, professional lighting design services may be needed to assist the standard design team.

A control system that activates the general lighting system according to a calendar program and employs motion sensing for "off" hours should be used. In areas with plentiful daylight, employ automatic daylight switching or dimming to reduce electric lighting by day. In addition, in areas of the library that are less frequently used, such as reference stacks, consider providing individual motion sensors or digital time switches for stack aisles that are connected to dimming ballasts, producing low light levels (but not completely off) until the aisle is occupied. Individual reading and study rooms should employ motion

Applicable Spaces	Climates	When to Consider
Classrooms	South Coast	Programming
Library	North Coast	Schematic
Multi-Purpose / Cafeteria	Central Valley	Design Dev.
Gym	Mountains	Contract Docs.
Corridors	Desert	Construction
Administration		Commissioning
Toilets		Operation
Other		

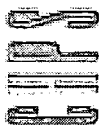

sensors, with “personal” motion sensors and plug strips used at study carrels, especially those with fixed computers.

It will be necessary to provide emergency lighting with this system. Some of the general lighting luminaires must be powered from an emergency generator or backup battery power source.

Applicability

This guideline can be used in most schools, including colleges and universities, public K-12, private and parochial schools, and similar facilities containing libraries, such as churches and private institutions.

Applicable Codes

Electrical

The National Electrical Code (NEC) usually governs the electrical portion of lighting installations. Some cities have unique electrical codes, but most adopt the NEC. The energy considerations of lighting fall under California Title 24. Title 24 limits the amount of lighting power in a library reading area to 1.2 W/ft² and a stack area to 1.5 W/ft² (1999), so this recommendation is within code limits. Title 24 also requires switching.

Life Safety

As a place of assembly, libraries must be equipped with an emergency lighting system capable of producing at least 1 footcandle, average, along the path of egress. In general, the best way to do this is to power some of the lighting from an emergency source, which must be either an emergency generator or a battery backup system capable of providing egress lighting for at least 90 minutes. In addition, exit signs must be provided and they, too, must be powered for at least 90 minutes after a power outage.

Seismic

Luminaires need to be restrained in case of an earthquake. In general, this means that each luminaire must be secured to the structure with an additional hanger wire or support independent of the ceiling’s support system.

Integrated Design Implications

Libraries are often more highly designed than other spaces. In some designs, other lighting systems that integrate better with the architecture should be considered.

Daylight is an excellent choice for providing basic ambient light in a library. Reading areas and storytelling niches especially benefit from the presence of gentle daylight and view windows. With thoughtful daylight design, only the task lighting at checkout desks or stack areas needs to be on during the day. And these can be connected to occupancy sensors to reduce their hours of operation.

If the library has computers for research or card catalog searches, special care should be taken to avoid glare sources on the computer monitors from light fixtures or windows.

Cost Effectiveness²⁵

Library spaces will tend to be among the most expensive to light. These recommendations provide a good balance between cost, energy efficiency, and good lighting practice.

A 4-ft long stack light is approximately \$200. A 3-ft long undercabinet task light costs about \$175. A high-quality compact fluorescent desk lamp falls in the \$300 price range. Dimming, switching, and emergency power costs vary and are in addition to the luminaire costs.

²⁵ Ibid.

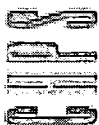

Benefits

These recommendations provide proper light for a library and media center. Task light levels are provided only at task locations, while ambient and general light levels are lower to ensure energy efficient operation.

Costs	L		
	M		■
	H		
	L	M	H

Benefits

Design Tools

See the Overview section of this chapter.

Design Details

Below is a lighting design for a typical library:

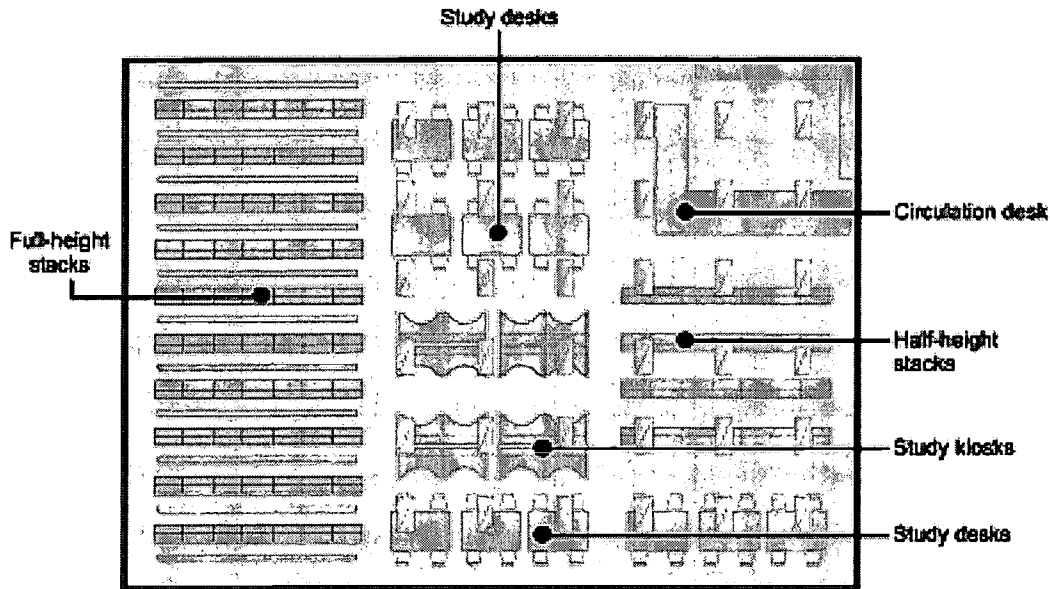

Figure 19 – Library Lighting Design

This design illustrates general lighting using troffers, table lights for study desks, task lights at kiosks, and stack lights. Using high ballast factor 2-lamp troffers, this design works at an overall power density of 1.27 W/ft². Increasing stack lights to high ballast factor increases overall connected power to 1.38 W/ft². Note that the stacks to the right on the plan are half height.

- The general lighting system can be designed to become more “dense” in task areas such as circulation desks, thus minimizing the number of different lighting types.
- Undercabinet task lights should be specified carefully. Avoid traditional “inch light” systems with magnetic ballasts that use twin tube compact fluorescent lamps and old-style linear lamps like the F6T5 (9 in.), F8T5 (12 in.), and F13T5 (21 in.). Use task lights employing modern F14T5 (22 in.), F21T5 (34 in.), F28T5 (46 in.), F17T8, F25T8, or F32T8 lamps. Always use electronic ballasts, and consider dimming for all task lights.
- Desk lamps and table lamps with compact fluorescent hardwired lamps should be used. Relatively few products exist. Medium based screw-in compact fluorescent lamps are not a good choice for new projects.
- Switching and dimming of the lighting system should NOT be readily accessible. Locate controls in a supervised location.
- In media rooms, consider a modern preset dimming or control system, especially if touch-screen control and other modern audio-video interfaces are planned.

BEST COPY AVAILABLE

Operation and Maintenance Issues

This design should be easy to operate and manage. As with most fluorescent lighting systems, the general lighting system should be relamped every 12,000 to 14,000 hours. Ballast life lasts 10 years or more. Spot relamping is recommended for the house lighting system. Cleaning of both systems should be simple.

Commissioning

These systems are relatively easy to commission. Perhaps the most critical step is ensuring that automatic lighting controls, such as a photoelectric controller for a high-low system or an automatic time of day controller, are properly set up. Also, if fluorescent dimming is used, make sure that lamps are pre-seasoned, i.e., operated at full light for 100 hours prior to dimming them.

References/Additional Information

See the Overview section of this chapter.

Related Volume III CHPS Criteria

See the Overview section of this chapter.

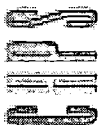

Guideline EL9: Lighting for Offices and Teacher Support Rooms

Recommendation

This recommendation is for offices and teacher support rooms having a ceiling no more than 12 ft high and a flat suspended acoustical tile ceiling. There are three choices:

1. Use recessed fluorescent lens troffers having at least 78% luminaire efficiency, using T-8 premium lamps and electronic ballasts. The connected lighting power should be 0.9 W/ft² to 1.1 W/ft².
2. Use suspended indirect lighting to produce an ambient level of 15 to 20 footcandles (about 0.6 W/ft²) and task lighting where required.

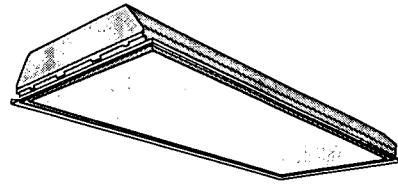

Recessed Fluorescent Lens Troffer

Description

See Guidelines EL1 and 2.

Applicability

This guideline can be used in most schools, including colleges and universities, public K-12, private and parochial schools, and similar facilities such as churches, sports clubs, and private institutions.

Applicable Spaces	Climates	When to Consider
Classrooms	South Coast	Programming
Library	North Coast	Schematic
Multi-Purpose / Cafeteria	Central Valley	Design Dev.
Gym	Mountains	Contract Docs.
Corridors	Desert	Construction
Administration		Commissioning
Toilets		Operation
Other		

Applicable Codes

The National Electric Code (NEC) usually governs the electrical portion of lighting installations. Some cities have unique electrical codes, but most adopt the NEC. The energy considerations of lighting fall under California Title 24. Title 24 limits the amount of lighting power in offices to 1.3 W/ft² (1999), so this recommendation meets code limits by a considerable amount. Title 24 also requires switching (see Guideline EL4).

Luminaires need to be restrained in case of an earthquake. In general, this means that each luminaire must be hung from the structure with hanger wires independent of the ceiling system.

Integrated Design Implications

This type of lighting should only be used in flat acoustic tile ceilings, and then only when ceiling height and/or budget prevents consideration of other options.

Cost Effectiveness

Lens troffer lighting systems are low in cost, but their inexpensive appearance can be a drawback. Suspended lighting systems provide a high degree of cost effectiveness and improved appearance in most applications.

Costs	L	■	■	■
	M	■	■	■
	H	■	■	■
		L	M	H
		Benefits		

Benefits

Troffer lighting systems generally offer excellent efficiency, but with some loss of visual comfort. They make excellent use of the low-cost, widely used T-8 lamp system. Systems operating at about 1 W/ft² will



generate between 50 and 60 footcandles maintained average, with very good uniformity. Separate task and ambient systems may create a more comfortable atmosphere.

Design Tools

See the Overview section of this chapter.

Design Details

See Guidelines EL1 and 2.

For non-dimming applications, luminaire light and power can be varied through choice of ballast factor. Use Table 13 in this chapter's Overview and specify ballasts accordingly.

Operation and Maintenance Issues

These lighting systems rarely need maintenance. As with all fluorescent systems, lamps should be replaced at approximately 12,000 to 16,000 hours of operation, which with normal school use could be as seldom as every six years. Luminaires should be cleaned annually. Lensed luminaires require periodic cleaning and are occasionally abused. Lens replacement is relatively inexpensive.

Commissioning

No commissioning is needed, other than pre-seasoning of lamps in dimming applications.

References/Additional Information

See the Overview section of this chapter.

Related Volume III CHPS Criteria

See the Overview section of this chapter.

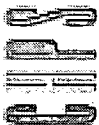

Guideline EL10: Lighting for Locker and Toilet Rooms

Recommendation

Over mirrors and vanities, employ rough service grade fluorescent wall-mounted lights. Over stalls and locker areas, use recessed or surface-mounted rough service area fluorescent lights. In showers, employ ceiling-mounted, watertight, rough-service grade fluorescent lights.

In general, choose luminaires that are attractively styled to prevent an overly institutional appearance.



Description

This guideline generally recommends fluorescent luminaires using standard T-8 or compact fluorescent lamps. These luminaires are part of a relatively new generation of "vandal-resistant" or "rough-service" lights that are considerably more attractive than previous products. These luminaires should be specified with UV-stabilized, prismatic polycarbonate lenses for maximum efficiency and resistance to abuse. The use of tamper resistant hardware is also recommended.

Wall mounted rough-service lights include:

- Linear lights using T-8 lamps and electronic ballasts.
- Rectangular, oval, and round lights that can be equipped with compact fluorescent lamps (low Watt HID lamps can also be used in these luminaries, but are not recommended).

Recessed ceiling lights are generally troffers (see Guideline EL2) that employ the polycarbonate lens and tamper-resistant hardware, as well as more robust components. These luminaires are available in 1 ft x 4 ft, 2 ft x 2 ft, and 2 ft x 4 ft versions with standard T-8 lamps and electronic ballasts.

For showers, employ either surface or recessed luminaires designed for compact fluorescent lights. Due to the long warm-up and restrike times, HID lamps should not be used. In either case, luminaires should be listed for wet applications.

Applicability

This guideline can be used in most schools, including colleges and universities, public K-12, private and parochial schools, and similar facilities such as churches, sports clubs, and private institutions.

Applicable Codes

Electrical

The National Electrical Code (NEC) usually governs the installation of lighting installations. Some cities have unique electrical codes, but most adopt the NEC. The energy considerations of lighting fall under California Title 24. Title 24 limits lighting power to 0.9 W/ft² in a locker or dressing room to 0.9 W/ft²,

Applicable Spaces	Climates	When to Consider
Classrooms <input type="checkbox"/>	South Coast <input type="checkbox"/>	Programming <input type="checkbox"/>
Library <input type="checkbox"/>	North Coast <input type="checkbox"/>	Schematic <input type="checkbox"/>
Multi-Purpose / Cafeteria <input type="checkbox"/>	Central Valley <input type="checkbox"/>	Design Dev. <input type="checkbox"/>
Gym <input type="checkbox"/>	Mountains <input type="checkbox"/>	Contract Docs. <input type="checkbox"/>
Corridors <input type="checkbox"/>	Desert <input type="checkbox"/>	Construction <input type="checkbox"/>
Administration <input type="checkbox"/>		Commissioning <input type="checkbox"/>
Toilets <input type="checkbox"/>		Operation <input type="checkbox"/>
Other <input type="checkbox"/>		

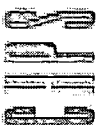

and to 0.6 W/ft² in rest rooms (1999). Title 24 also requires switching in these spaces (see Guideline EL4).

Life Safety

The room needs to be equipped with an emergency lighting system capable of producing at least 1.0 footcandle, average, along the path of egress. In general, the best way to do this is to power some of the lighting from an emergency source, which must be either an emergency generator or a battery backup system capable of providing egress lighting for at least 90 minutes. In addition, exit signs must be provided and they, too, must be powered for at least 90 minutes after a power outage.

Seismic

Luminaires need to be restrained in case of an earthquake. In general, this means that each suspended luminaire must be hung from the structure with hanger wires independent of the ceiling system.

Integrated Design Implications

These types of spaces are historically the most abused interior portions of school buildings. Durable lighting is unfortunately less attractive and less integrated than other lighting types.

Daylight is a welcome addition to any locker or toilet room. The high light levels from daylight promote good maintenance and sunlight can actually help sanitize the spaces by killing bacteria. For privacy and security reasons, daylight is often best provided in these spaces via diffusing skylights. Often these spaces can be designed to need no additional electric light during the day.

Cost Effectiveness²⁶

The investment in rough-service equipment is paid back over time. In high schools and colleges, the payback can be rapid, especially if the students are particularly rough or abusive.

Rough-service lighting systems will cost about \$200 to \$300 per luminaire for the types listed above, with compact fluorescent or T-8 lamps and an electronic ballast.

Costs	L			
	M			
	H			
		L	M	H
		Benefits		

Benefits

Rough service lighting will last longer in these applications while continuing to look good and not suffer from cracks and other signs of abuse.

Design Tools

See the Overview section of this chapter.

Design Details

Be certain to employ premium T-8 lamps with 835 or 841 color, rated at 24,000 hours. For non-dimming applications, luminaire light and power can be varied through choice of ballast factor. Use Table 13 in this chapter's Overview and specify ballasts accordingly.

Controls should perform in one of the following ways:

- Continuously on during normal school hours, with a night/emergency light on all the time; or
- Continuously on during normal school hours, with both a night/emergency light on at all times and a motion sensor override for full lighting during "off" hours.

²⁶ Ibid.

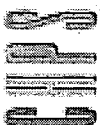

Operation and Maintenance Issues

These lighting systems rarely need maintenance. As with all fluorescent systems, lamps should be replaced at approximately 12,000 to 16,000 hours of operation, which with normal school use could be as seldom as every six years. Luminaires should be cleaned annually. Lensed luminaires require periodic cleaning and are occasionally abused. Lens replacement is relatively cheap.

Commissioning

No commissioning is needed, other than pre-seasoning of lamps in dimming applications.

References/Additional Information

See the Overview section of this chapter.

Related Volume III CHPS Criteria

See the Overview section of this chapter.

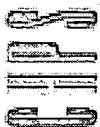

Guideline EL11: Outdoor Lighting

Recommendation

As a minimum, provide the following exterior lighting systems:

- At every door, place canopy or wall-mounted lights to illuminate the general area.
- For parking lots, use pole-mounted, full cut-off lights to illuminate the lot as well as surrounding walks and other areas.
- For driveways intended for night use, have pole-mounted, full cut-off lights for the drive and associated sidewalks.
- For walkways intended for night use, use suitable walkway lighting systems, such as pedestrian light poles or bollards.
- Other lighting as called for by the site, local requirements, etc.

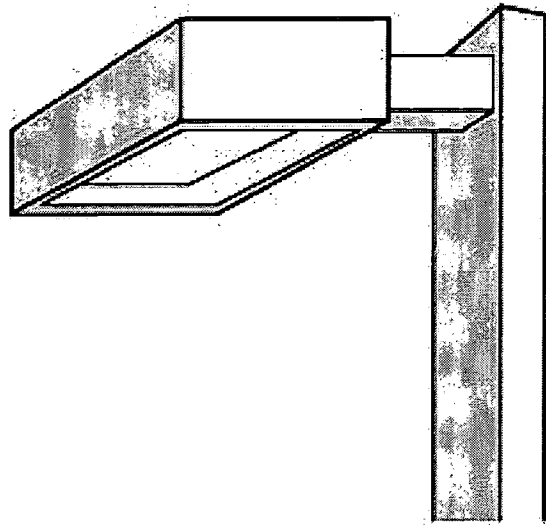

Description

Lights under canopies or mounted to walls should be attractive, rough-service, semi-recessed, or surface luminaires with lens. The lens should be an UV-stabilized polycarbonate prismatic lens. If mounted to walls, employ designs that direct light downward and minimize light trespass and light pollution.

Parking lots and driveways should be illuminated using pole-mounted full-cutoff luminaires. Luminaires should be at least 17 ft above grade; actual pole height depends on the type of pole and base. Direct burial, color-impregnated composition or fiberglass poles are recommended if soil and other site conditions are acceptable; if used in the center of a large parking area, however, consider steel or aluminum poles that are anchor-bolt mounted to foundations. Typically, luminaires will employ 150-W or 175-W pulse start metal halide lamps, and in parking lots, two luminaires may be mounted to a single pole.

Lower level lights may be used for walkways, especially if located away from buildings and parking lots. Choose between short poles (8 ft to 12 ft) using compact fluorescent or low Watt HID lamps, or bollards using compact fluorescent lamps.

A control system that activates the exterior lighting system according to an astronomic clock, instead of a photocell, should be used. The system should permit activation at sunset and deactivation at a programmable time, allowing the school to be "dark" and save energy as much of the night as possible. Separate "off" times programmed for parking lot, driveway, and building lighting are highly desirable. This system should be located where accessible to administration personnel; it must be easy to set and permit manual override.

Applicable Spaces	Climates	When to Consider
Classrooms	South Coast	Programming
Library	North Coast	Schematic
Multi-Purpose / Cafeteria	Central Valley	Design Dev.
Gym	Mountains	Contract Docs.
Corridors	Desert	Construction
Administration		Commissioning
Toilets		Operation
Other		

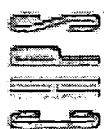

In many cases, a "dark" school after hours is highly desirable. Carefully located motion sensors can be used to activate low-cost compact fluorescent or quartz lights that serve as both safety lighting and as a deterrent against vandalism.

It may be necessary to provide emergency lighting with this system. Some of these luminaires must be powered from an emergency generator or battery backup power source.

All lights should be chosen with consideration of the weather conditions under which they will operate. In most cases, the primary consideration is lamp-starting temperature, which is a function of both lamp and ballast. In most of California, a minimum starting temperature of -5°F is acceptable and can be obtained with certain compact fluorescent lamps as well as HID.

Photovoltaic-powered lights should be considered for locations where grid power is not easily available.

Applicability

This guideline can be used in most schools, including colleges and universities, public K-12, private and parochial schools, and similar facilities such as churches, sports clubs, and private institutions.

Applicable Codes

Electrical

The National Electrical Code (NEC) usually governs the electrical portion of lighting installations. Some cities have unique electrical codes, but most adopt the NEC. The energy considerations of lighting fall under California Title 24. Presently, there are no significant energy code limits to exterior lighting systems.

Life Safety

Because building codes now consider the path of egress to continue outside the building, some exterior lighting, especially in exterior corridors, may need to be equipped with emergency backup power. The design requirement for the backup system is at least 1.0 footcandle, average, along the path of egress. In general, the best approach is to power some of the lighting from an emergency source, which must be either an emergency generator or a battery backup system capable of providing egress lighting for at least 90 minutes. Exterior exit signs may also be required and they, too, must be powered for at least 90 minutes after a power outage.

Lighting controls must be designed such that, regardless of setting, if a power emergency occurs, the proper lights are illuminated. This often requires use of automatic transfer relay or other mechanism that bypasses room controls during a power emergency. Transfer relays must be listed for use in emergency circuits.

Seismic

Building-mounted luminaires need to be restrained in case of an earthquake. In general, this means that each luminaire in a canopy must be secured to the structure with an additional hanger wire or support independent of the ceiling's support system.

Integrated Design Implications

Exterior lights should be chosen with the architectural impact to the building's exterior in mind. Select the proper color, shape, and style to reinforce architectural themes of the building.

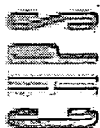

Cost Effectiveness²⁷

The cost of exterior lighting tends to be relatively high. However, compromising on costs, such as using lower quality products, will result in needing to replace the lighting system sooner, thus making it a poor choice when considering life-cycle cost.

Costs	L		
	M		■
	H		
	L	M	H
	Benefits		

- A typical pole luminaire, 17 ft high, 175 W, type III distribution, with steel pole and anchor base, costs approximately \$1,500.
- A bollard, contemporary, with 42-W compact fluorescent and concrete anchor base costs \$600.
- A canopy-mounted, rough-service luminaire, with two 32-W compact fluorescent, contemporary styled costs \$300.
- A high quality motion sensor floodlight, 350-W quartz costs \$250.

Switching and emergency power costs vary and are in addition to the luminaire costs.

Benefits

Properly designed exterior lighting systems permit the extended use of the facility, promoting increased personal safety and security and reduced vandalism.

Design Tools

See the Overview section of this chapter.

Design Details

- Pole lights should use a variation of the classic "shoebox" full cutoff lights. Avoid traditional lights or contemporary lights that do not produce full shielding to help prevent light trespass and light pollution.
- Many choices in wall lights exist, and this is one situation where aesthetics may be critical. Be certain to choose die-cast aluminum bodies, rough-service polycarbonate lenses or diffusers, and/or other heavy-duty construction. A number of look-alike products made of lightweight and inferior materials are on the market, so be especially wary of imitations and substitutes.
- If choosing a "dark" school approach to security, use of motion sensors and quartz floodlights may be warranted. Either separate or integrated units may be used. Quality is especially important in choosing exterior motion sensors, since a faulty sensor will give false indications and activate lights (and concerned neighbors) needlessly.
- Lighting layouts for parking lots and the direct pedestrian access should be performed using an outdoor lighting analysis computer program. Design criteria should be at least 0.5 footcandle in parking lots, with an average light level of 2.0 footcandles and average minimum uniformity of 4:1 or better.
- Consider zoning exterior lighting so that the parking lot zone nearest the building can be activated separately from the majority of the lot.
- Manual override switching of the lighting system should NOT be readily accessible. Locate controls in a supervised location. Use a digital controller, not a mechanical "time clock."

Operation and Maintenance Issues

This design should be easy to operate and manage. As with most HID and compact fluorescent lighting systems, the lighting system should be group relamped every 8,000 hours, or about every two years. Ballast life should cover 10 years or more. Spot relamping is recommended to ensure security and safety. The design should make cleaning of systems simple.

²⁷ Ibid.

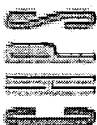

Commissioning

These systems are relatively easy to commission. Perhaps the most critical step is ensuring that the lighting controls are properly set.

References/Additional Information

See the Overview section of this chapter.

Related Volume III CHPS Criteria

Site Credit 5: Light Pollution Reduction.

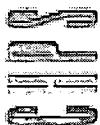

DAYLIGHTING AND FENESTRATION DESIGN

Daylighting forms the cornerstone of sustainable, high performance design for schools. Affecting individuals on both conscious and subconscious levels, it provides light to see the work environment, a natural rhythm that determines the cycles of days and seasons, and biological stimulation for hormones that regulate body systems and moods. In addition, it offers opportunities for natural ventilation and, if properly integrated with the electric lighting system, can provide tremendous energy savings. These advantages of daylighting translate to higher performance in schools. Recent research has shown that children achieve significantly higher test scores in classrooms that are daylit than in those that are not,²⁸ making daylighting one of the best building-related investments for the learning environment.



Gentle, diffuse daylight permeates a classroom with both sidelight and toplight. Note that all surfaces are painted white to distribute light more efficiently and reduce contrast glare. Photo courtesy Barbara Erwine.

This chapter provides an overview of daylighting and fenestration design. It also presents eight daylighting guidelines for specific sidelighting and toplighting schemes. The on-line Appendix that supports the Best Practices Manual provides additional detailed information.

View Windows (Guideline DL1)

High Sidelighting—Clerestory (Guideline DL2)

High Sidelighting—Clerestory with Light Shelf or Louvers (Guideline DL3)

Classroom Daylighting—Wall Wash Toplighting (Guideline DL4)

Central Toplighting (Guideline DL5)

Patterned Toplighting (Guideline DL6)

Linear Toplighting (Guideline DL7)

Tubular Skylights (Guideline DL8)

To fully daylight most spaces, the guidelines should be combined with each other or repeated as a pattern across the space. For example, Wall Wash Toplighting (Guideline DL4) on an interior wall could be combined with High Clerestory Sidelighting (Guideline DL2) and View Windows (Guideline DL1) on an exterior wall to fully daylight a classroom. Since daylight is additive, the total amount of daylight in the

²⁸ Heschong Mahone Group, "Daylighting in Schools—An Investigation into the Relationship between Daylighting and Human Performance," prepared for Pacific Gas & Electric Company and funded by California utility customers, 1999. Heschong Mahone Group and New Buildings Institute, "Re-Analysis Summary: Daylighting in Schools, Additional Analysis." February, 2002.

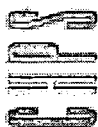

space is the sum of the daylight available from each individual pattern. Each guideline represents a daylight delivery system with inherent advantages and disadvantages, which are summarized below in Table 17.



Guideline DL5: Central Toplighting from a sawtooth monitor with sun baffles is combined with DL1: View Windows to provide balanced illumination in a classroom. Photos courtesy Barbara Erwine.

Table 17 – Selection Criteria for Daylighting Strategies

Design Criteria	View Windows (DL1)	High Sidelight w/ Light Shelf (DL2 & DL3)	Wall Wash Toplighting (DL4)	Central & Patterned Toplighting (DL5 & DL6)	Linear Toplighting (DL7)	Tubular Skylights (DL8)
Uniform Light Distribution	○ ○	● / ○	●	● ●	○	○
Low Glare	○	●	●	●	●	● / ○
Reduced Energy Costs	○	●	●	● ●	●	●
Cost Effectiveness	●	●	●	●	●	● ●
Safety/Security Concerns	○	● / ○	●	●	●	● ●
Low Maintenance	○	●	●	●	●	●

●● Extremely good application ● Good application ○ Poor application ○○ Extremely poor application ● Depends on space layout and number and distribution of daylight apertures ●/○ Mixed benefits

Overview

Daylight can be provided via windows and glazed doors, as well as via skylights and other forms of toplighting. These glazed openings are collectively referred to as "fenestration." The placement, design, and selection of materials for fenestration are extremely important and can tip the balance between a high performance and low performance building. Fenestration impacts building energy efficiency by affecting cooling loads, heating loads, and lighting loads. Visual comfort is strongly affected by the window location, shading, and glazing materials. Well-designed windows can be a visual delight. But poorly designed windows can create a major source of glare. Thermal comfort can also be compromised by poor fenestration design. Poorly insulated windows add to a winter chill or summer sweat, while windows with low U-values keep glass surface temperatures closer to the interior air temperature, improving thermal comfort. In addition, east-west windows and unshaded south windows can cause excessive cooling loads. And although windows and skylights provide opportunities for natural ventilation, they must be designed to ensure a safe, secure, and easily maintained facility.

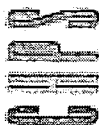

Benefits of Daylighting

There are several advantages to the use of daylight in schools:

Academic Performance

Studies indicate that well-designed daylighting is associated with enhanced student performance, evidenced by 13% to 26% higher scores on standardized tests, while poor daylighting design has been shown to correlate with reduced student performance.²⁹ It makes sense that students and teachers perform better in stimulating, well-lit environments. Daylighting can provide high quality light, stimulating views, and an important communication link between the classroom and adjacent spaces.

Energy Savings

Daylighting can save energy and reduce peak electricity demand if electric lights are turned off or dimmed when daylight is abundant. Nationally, K-12 schools spend more than \$6 billion a year on energy. For most school buildings, electric lights are the largest energy consumer. For instance, in California, about 40% of school building energy use is attributable to just electric lighting. Daylighting per se, however, saves no energy unless the electric lighting system is appropriately controlled. To be effective, daylighting must be thoughtfully designed, avoiding glare and overheating, and must include dimming or switching of the electric lighting system, preferably with automatic photocell control. The design of systems for supplementary electric lighting and controls is addressed in the chapter on electric lighting.

Better Light

Daylight provides the highest quality light source for visual tasks. It enhances the color and visual appearance of objects, and helps students to see small details better.

Connection to Nature

Daylight provides a connection to the natural world by supplying information on time of day, season, and weather conditions. In doing so, it enriches the learning environment and may also help to make lessons more memorable. The constant variety in the quality and quantity of daylight also helps keep students and staff more alert.

Improved Health

Views provided by windows contribute to eye health by providing frequent changes in focal distance, which helps to relax eye muscles. Daylight, whether associated with a view or not, may also reduce stress for both students and teachers. Research in Sweden showed that work in classrooms without daylight "may upset the basic hormone pattern, and this in turn may influence the children's ability to concentrate or co-operate, and also eventually have an impact on annual body growth and sick leave."³⁰

²⁹ Ibid.

³⁰ Kuller and Lindsten. 1992. *Journal of Environmental Psychology* 12:305-317.



Environmental Education

Windows and solar gain through windows can present opportunities to teach how the sun moves through the sky and how daylight can be controlled by carefully designed overhangs and other shading devices. These observations can form part of an experiential learning unit for environmental education as students plot the movement of the sun on a sundial or across a schoolyard wall. Control of electric light in response to daylight may also be one of the "treasures" found in the Energy Treasure Hunt, a pilot program (sponsored by the U.S. Department of Energy's Rebuild America, the U.S. Environmental Protection Agency, Pacific Gas & Electric Company, and others) in several Northern California schools to educate students about issues pertaining to energy and efficiency.



Cameron Park Library, Peter Wolfe Architect. A skylit library provides a stimulating yet peaceful environment. Colorful banners enliven the space while blocking glare from the skylights and helping to diffuse the daylight. Photo courtesy Lisa Heschang.

Basic Daylighting Principles

The following six principles, described in more detail below, provide fundamental guidance in designing daylit schools.

- Prevent direct sunlight penetration into space.
- Provide gentle, uniform light throughout space.
- Avoid creating sources of glare.
- Allow teachers to control the daylight with operable louvers or blinds.
- Design the electric lighting system to complement the daylighting design, and encourage maximum energy savings through the use of lighting controls
- Plan the layout of interior spaces to take advantage of daylight conditions.

1. Prevent Direct Sunlight Penetration

One of the delights of daylight is that it changes in quality throughout the day and with each season. The daily and seasonal path of the sun is the prime determinate of sunlight availability, while the presence of clouds and moisture in the air affect the quality and intensity of light from the sky. It is essential that designers understand the basic principles of solar orientation, climate conditions, and shading systems to design successful daylit buildings.

Sunlight Versus Daylight

Direct beam *sunlight* is an extremely strong source of light, providing up to 10,000 footcandles of illumination. It is so bright, and so hot, that it can create great visual and thermal discomfort. *Daylight*, on the other hand, which comes from the blue sky, from clouds, or from diffused or reflected sunlight, is much more gentle and can efficiently provide excellent illumination without the negative impacts of direct sunlight. Good daylighting design typically relies on maximizing the use of gentle, diffuse daylight, and minimizing the penetration of direct beam sunlight. In general, sunlight should only be



allowed to enter a space in small quantities, as dappled light, and only in areas where people are not required to do work.

The best daylighting designs are initiated early in the design process of new buildings. The first step in good daylighting design is the thoughtful orientation of the buildings on the site and orientation of the fenestration openings. A carefully oriented building design will allow maximum daylight while minimizing unwanted solar gains. It is easiest to provide excellent daylight conditions using north-facing windows, since the sun only strikes a north-facing window in early morning and late evening during midsummer. South-facing windows are the next best option because the high angle of the south sun can be easily shaded with a horizontal overhang. East- and west-facing windows are more problematic because when the sun is low in the sky, overhangs or other fixed shading devices are of limited utility. Any window orientation more than 15° off of true north or south requires careful assessment to avoid unwanted sun penetration.



North versus south windows. South windows are shaded from direct sun, but receive daylight reflected off of concrete walk and white painted overhangs. North windows are large and unshaded. Photo courtesy Lisa Heschong.

For sidelighting, carefully designed shading devices both inside and outside the building can limit direct sun penetration while allowing diffuse daylight. For toplighting, avoid direct sun by using glazing that diffuses the sunlight, or by reflecting it off baffles, louvers, or light well walls. The sections on Sidelighting and Toplighting below give strategies for the design of shading devices for optimum performance.

2. Provide Gentle, Uniform Illumination

Daylight is most successful when it provides gentle, even illumination throughout a space. Evenly diffused daylight will provide the most energy savings and the best visual quality. Achieving this balanced diffuse daylight throughout a space is one of the greatest achievements of a good daylight designer.

It is easiest to achieve uniform daylight illumination from toplighting strategies that distribute light evenly across a large area. The next best approach is to provide daylight from two sides of a space with a combination of view windows and high windows, preferably no more than 30 ft to 50 ft apart. Combinations of sidelighting with toplighting can also be successful in providing uniform illumination levels. The most challenging condition is a room with windows on only one side. There, daylight illumination levels will be very high right next to the window and drop off quickly. Various strategies to distribute light deeper into the space are available, but require more design skill and construction cost.

Daylight can most easily be used to provide a base level of illumination throughout a space, referred to as the ambient illumination, which is often on the order of 20 to 30 footcandles. Individual work areas can then be highlighted with electric task lights to bring the illumination levels in specific areas to higher task level requirements, such as 50 or 75 footcandles. Alternatively, if the daylighting fenestration area is increased to provide the higher task illumination for most of the day, the electric lighting energy



savings will be maximized while heating and cooling costs may increase. The best daylighting designs balance these energy costs with the desired lighting quality.

Walls, Ceilings And Other Reflective Surfaces

The arrangement of reflective surfaces that help to distribute the light are just as important as the arrangement of daylight openings for providing gentle, uniform illumination. Whenever possible, place daylight apertures next to a sloped or perpendicular surface so the daylight washes either a ceiling or a wall plane, and is reflected deeper into the space. It is essential to recognize that walls and ceilings are part of the daylighting design. For greatest efficiency and visual comfort, they should be painted white, or a very light color. Even pastel-colored paint absorbs 50% of the light that strikes it, correspondingly reducing daylight levels. Saturated colors should be used only in small areas, for accents or special effects.

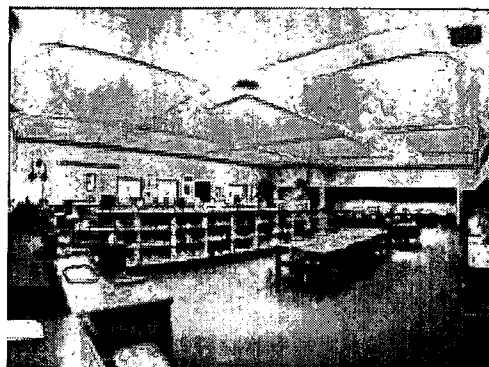

*Deeply coffered ceiling helps to diffuse light from four skylights. There are no electric lights on in this photo.
Photo courtesy SunOptics.*

Advanced daylighting designs take advantage of additional exterior and interior reflecting surfaces to shape the distribution of daylight in the space. Light-colored walkways and overhangs can help reflect daylight. Light shelves can be used to bounce daylight deeper in the space (see Guideline DL3), or a series of reflective or refractive surfaces built into the glazing itself can redirect sunlight onto the space's ceiling. These approaches are integral to the architecture of the building and are designed differently for each cardinal orientation. For example, classrooms may have light shelves on the south side of the building, but none on the north. In this way, the design is "fine tuned" to optimize the daylight delivery for each orientation.

3. Avoid Glare

Excessively high contrast causes glare. Direct glare is the presence of a bright surface relative to the surroundings (for example, a bright diffusing glazing or direct view of the sun) in the field of view that causes discomfort or loss in visual performance. This glare can have negative effects on student and staff performance. A recent study showed that skylights admitting direct sun (and presumably glare) into classrooms correlated with a *decrease* in student performance on standardized tests³¹. Eliminate glare by obscuring the view of bright sources and surfaces with blinds, louvers, overhangs, reflectors, and similar devices.

Placing daylight apertures next to reflective surfaces reduces glare in addition to distributing the daylight more evenly. It brightens interior surfaces to reduce their contrast with the bright glazing surface. If washing a wall with daylight is not possible, some glare reduction can be achieved by splaying window reveals and skylight wells. Blinds or drapes can also reduce contrast by controlling

³¹ Heschong Mahone Group, "Daylighting in Schools—An Investigation into the Relationship between Daylighting and Human Performance," prepared for Pacific Gas & Electric Company and funded by California utility customers, 1999. Heschong Mahone Group and New Buildings Institute, "Re-Analysis Summary: Daylighting in Schools, Additional Analysis." February, 2002.



the amount of brightness at the windows, and diffusing the light. Punched windows (simple holes in the middle of a wall) represent the worst scenario for glare and are not recommended.

Glare can also occur when daylight strikes a reflective surface, like a computer screen or a whiteboard, and produces shiny reflections that make it difficult or impossible to see. You can predict when these reflections will be a problem by placing an imaginary (or real) mirror on the screen or whiteboard and seeing if any bright light sources or surfaces are visible in the mirror. If they are visible, reorient the screen/whiteboard or redesign the apertures to eliminate their reflection in the surface.

VDT Screens

When video display terminals (VDTs) are located in daylight spaces, the designer must take great care to minimize daylight reflections from the VDT screen. This problem is especially acute when the computer screen is oriented so that the screen is facing the daylighting aperture (that is, the student's back is to the window or skylight). Under these conditions, reflected glare may completely wash out the screen, making work impossible without completely closing window blinds or drapes. If the VDT screen is located so that the screen viewing orientation is parallel to or 45° to the windows (see figure on left), reflected glare poses less of a problem and, if present, can usually be reduced by using polarizing filters or meshes attached directly to the screen. Flat screen monitors have fewer glare problems.

4. Provide Control of Daylight

Daylight is highly variable throughout the day and the year, requiring careful design to provide adequate illumination for the maximum number of hours while contributing the least amount possible to the cooling load. The ideal daylighting design would have variable apertures that respond

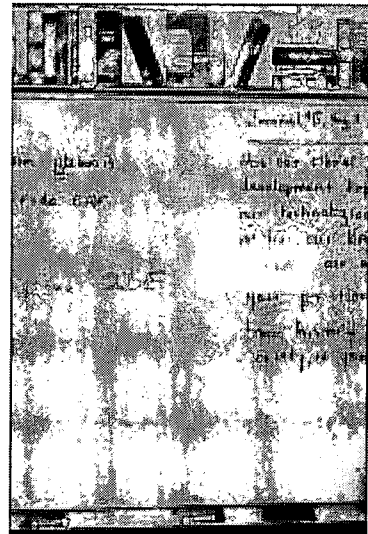

Glare from windows or light fixtures reflecting off of shiny surfaces, such as computer screens or whiteboards, can reduce student performance. Photo courtesy Lisa Heschang.



Horizontal blinds allow control of brightness from lower view windows. Note that high clerestory windows have no blinds so that daylight can reach deep into classroom. Most classrooms do not need complete black out capability for viewing of modern video equipment. Photo courtesy Barbara Erwine.



Reflections of luminaires in computer screens can cause veiling glare. Careful lighting and daylighting design avoids these problems. Photo courtesy Lisa Heschang.

BEST COPY AVAILABLE

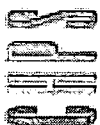

to changes in the availability of daylight. The apertures would become smaller when daylighting is abundant and larger on cloudy days or at times when daylight is less available. While electrochromic glazing may permit variable daylighting apertures in the future, with today's technology the size of the aperture and its transmission are fixed. The principal means of control is through the use of shades or blinds located inside or outside the window.

Teachers should have easy access to controls for these shades or blinds to adjust light levels as needed throughout the day. These systems should be reliable, as well as easy and economical to clean and repair. Manually operated controls are slightly less convenient but also less expensive and less likely to need repair. Avoid the use of moveable exterior shades; they are exposed to weather conditions that may degrade their performance. Ensure that fixed exterior shading devices are sloped slightly so they drain water.

5. Integrate with Electric Lighting Design

The daylight and the electric light systems must be designed together so they complement each other to create high quality lighting and produce energy savings. This requires an understanding of how both systems deliver light to the space. For example, if daylight lights the two sidewalls, electric light may be used to highlight the teaching wall. The Design and Analysis Tools section later in this chapter discusses tools to help visualize the overall light distribution in the space.

Color

Daylight is a "bluer" light source than most electric lighting. Fluorescent lights that are designed to match the color of incandescent light will appear yellow in comparison with daylight. The color temperature of a light source is a number that describes its relative blueness or yellowness. When mixing daylight and electric light, most designers choose fluorescent lamps in the blues range, with a color temperature of 3500°K to 4100°K or even higher.

Controls

Daylighting is also more thermally efficient than electric lighting, meaning that the cooling load created by daylighting illumination is much lower than that created by electric lighting providing the same light level. Since electric lighting is a major contributor to the cooling load in schools, substituting daylight for electric lighting reduces cooling costs as well as lighting costs. But these energy savings will only be achieved if the electric lights are turned off or dimmed in response to the daylight.

The electric lighting should be laid out, circuited, and controlled to coincide with the patterns of daylight in the space, so that the lights can be turned off in areas where daylight is abundant and left on where it is deficient. Controls can either be manual or automatic. Automatic controls use a small photosensor that



Lighting Controls, Oakridge High School: Automatic photosensor controls turn off first bank of lights next to skylight well. The light fixtures are arranged parallel to skylights to left and windows (out of picture) to right, while whiteboard is located perpendicular to windows and skylights. Photo courtesy Lisa Heschong



monitors light levels in the space. Manual controls are substantially less expensive, but need to be convenient and well labeled to ensure their use. Automatic controls guarantee savings, but are more expensive and must have overrides so the teacher can darken the room for audio/visual use. Lighting controls are discussed in more detail in the chapter on Electric Lighting and Controls.

6. Plan the Layout of Interior Spaces

Successful daylighting designs must include careful consideration of interior space planning. Since daylighting illuminance can vary considerably within the space, especially with sidelighting, it is important to locate work areas where appropriate daylighting exists. Perhaps more importantly, visual tasks (especially the teaching wall) should be located to reduce the probability of discomfort or disabling glare. In general, work areas should be oriented so that daylighting is available from the side or from above. Facing a window may introduce direct glare into the visual field, while facing away from a window may produce shadows or reflected glare.

Sidelighting vs. Toplighting

The location, orientation, and size of the daylighting apertures are of paramount importance, as is the selection of the glazing materials used and how they are shaded from direct sun. When possible, it is always better to locate daylighting apertures in the ceiling plane — a strategy known as toplighting. This reduces the likelihood of glare and allows for a more even distribution of daylight within the space. Toplighting, of course, can only be provided for one-story buildings or for the top floor of multi-story buildings. The other basic strategy, sidelighting, allows daylight to enter through windows in vertical walls. With windows, uniform illuminance is more difficult to provide, as there is always more light next to the window. Glare is also more difficult to control. But there are design techniques that can substantially reduce problems associated with sidelighting.



Sidelighting: Library receives daylight from two sidelighting strategies: 1) view windows at perimeter, and 2) high clerestories that bring daylight into the center of the space.

The basic sidelighting pattern provides windows on one or more walls of the space. The depth of daylighting penetration from vertical windows is largely dependent on the height of the window head (that is, the top of the window). For a simple sidelighting scheme, a rough rule of thumb is that useable daylight will be available about 1.5 times the window head height. So for good daylight delivery, sidelighting windows should be located as high as possible in the wall. However, to provide exterior views, windows need to be at eye level. Since these requirements clearly conflict, advanced daylighting designs differentiate between the functions of view and task daylighting, frequently providing separate windows for each of these.

The orientation of a sidelighting aperture strongly affects the quantity, quality, and distribution of daylight. For sidelighting and no shading, north-facing windows provide the most even illuminance. The



quantity of light is diminished, but a larger aperture will compensate, providing adequate and more even illumination.

Exterior Shading Strategies

Shading devices for sidelighting strategies minimize solar gains and glare, and can also be designed to increase illumination levels. Shading devices — both overhangs and fins — can be either opaque or translucent, and solid or louvered. It is best to place shading devices outside the glazing to stop solar gains before they hit the window and to reduce potential glare from bright window views. Exterior overhangs should be deep enough to minimize direct sun on the window for the hottest hours of the day during the cooling season. For south-facing windows in sunny (clear sky) climates with very high air conditioning loads, a good rule of thumb is to design the overhang with a shading cutoff angle about equal to 90° minus the site latitude. This provides full shading between March 21 and September 21. Many areas are likely to experience their hottest weather in September, and still need full shading that time of year. Overhangs for climates with lower air conditioning loads and/or more summer overcast can increase this angle by 5° to 15° . Overhangs or fins for windows facing east or west do not lend themselves to simple rules of thumb and should be carefully designed for the specific site, climate, and space. North-facing windows usually do not need exterior overhangs or fins, but may occasionally require interior blinds or louvers to control glare.

Interior Shading Strategies

Interior shading devices for windows reduce solar heat gain somewhat (by reflecting solar gain back out through the glazing) but are most effective at controlling glare. The most common interior glare control devices are horizontal mini-blinds, vertical blinds, shade screens, and curtains. Mini-blinds positioned between the panes of glass in double-glazed fenestration do not have to be cleaned and may have the lowest maintenance costs, but their initial cost is substantially higher. They can also pose replacement problems if a window is broken. Interior shading devices can also be used for security purposes to obscure the view of room contents when a space is unoccupied. Many school spaces will also require blackout shades. All these operable devices should have robust, reliable controls that are easily accessible to the teacher. However, operable louvers, blinds, and drapes are frequently left in a non-optimal daylighting setting — either fully closed or fully open. Systems that have fixed louvers or settings for the daylight glazing and operable glare control for view glazing will be more likely to deliver dependable daylight throughout the year.

Landscaping

Daylight is also affected by obstructions on the site, such as trees and other buildings. Landscaping can serve an important shading and sun control function if it is strategically placed or incorporated into a trellis device. Deciduous trees and vines positioned to the south of a window are extremely useful for providing shade during overheated summer months while admitting more sun in areas with cold or overcast winters. Evergreens provide shade year-round in consistently overheated climates. They are also useful for blocking low east and west sun.



Toplighting

Providing daylight from above, generically referred to as “toplighting”, can generally provide the most uniform illumination throughout a space. Examples of toplighting strategies include roof monitors, unit skylights, and tubular skylights. The vast majority of schools are one or two stories, and so a large proportion of school spaces can easily be lit from above. Toplighting schemes have many other advantages, including freeing up walls for tack space or storage, and increasing security by reducing access to fenestration.

Toplighting schemes can provide much more useful illumination from smaller apertures than sidelighting when they capture and diffuse sunlight. Sunlight is roughly 10 times brighter than light from the sky or clouds. If the sunlight is diffused through the use of lenses, baffles, or reflecting surfaces, it can be diffused and spread over a large area. Thus, one ft² of a diffusing skylight can provide illumination to about 10 times the area of one ft² of equivalent window glazing.

As with any lighting design, it is important to strive for good lighting quality with toplighting, which is best done in two ways. First, design openings so that they maximize illumination on vertical surfaces. Skylights or roof monitors should be placed preferentially adjacent to important walls that should be highlighted. Be careful that ceiling returns or structural members do not create shadows on important vertical surfaces. Secondly, design for uniform illumination by using many openings spread out uniformly across the space. The higher the daylight aperture, the more broadly the light will diffuse in the space. Thus, it is easier to successfully toplight spaces with high ceilings. As a rule of thumb, skylights should be spaced apart no more than one-and-a-half times the ceiling height. (When the skylight well is broadly splayed, the vertical distance can be measured to the top of the splay.) This means that spaces with low ceilings will require more small skylights spaced closer together than the spaces with the same floor area but a higher ceiling. The Excel tool SkyCalc™ has a calculator that helps to figure out appropriate skylight spacing relative to ceiling heights and structural grids.

Glare is also an issue with skylights. Diffuse glazing, such as fiberglass or white acrylic, can become extremely bright in direct sunlight, and should be kept out of direct view of the occupants. Recessing skylight diffusers behind other elements, such as structural members, banners, or splayed wells, all help prevent glare. Lensed glazing can also help to break sunlight up into smaller bits, reducing glare potential. The designer should assess glare potential of any toplighting product and design in direct sunlight conditions.

Horizontal vs. Vertical Glazing

Toplighting designs can have either horizontal or vertical glazing. Because the sun is higher in the sky during the summer than in the winter, toplighting schemes with horizontal glazing receive more direct

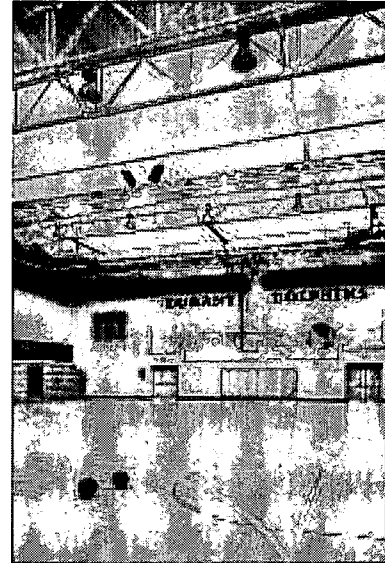

Monitors provide diffuse light into gymnasium at the Durant Middle School gym. Photo courtesy Innovative Design.

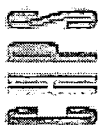

sun in the summer (when it is generally not needed) and less in the winter (when it is needed). The opposite is true with south-facing vertical glazing schemes. So in terms of optimizing yearly heating and cooling balance, south-facing vertical glazing tends to be most efficient. North facing glazing will receive much lower and more uniform levels of diffuse daylight, and thus need to be sized significantly larger than south-facing apertures to achieve equivalent illumination levels. East and west orientations show large variations in light levels throughout the day and the greatest solar gains in the summertime, and therefore are not recommended.

However, horizontal glazing or skylights have a number of other advantages. First of all, skylights' energy performance on a flat roof is fairly independent of orientation, allowing more architectural freedom on other issues. Skylights actually deliver more daylight into a space over the course of a year than comparable vertically oriented glazing. Pyramid, bubble, or arched-shaped diffusing skylights are effective at collecting daylight during the very low sun angles of early morning or late afternoon when it is most needed. And during overcast days, the sky is brightest straight up, so horizontal glazing will deliver the most light under these conditions. Solar heat gains in skylights tend to be less than expected due to stratification of heated air in the skylight wells. The advantages of skylights in collecting daylight throughout the year allow them to have a smaller aperture than vertical glazing for the same amount of illumination delivered, which also reduces relative heat loss and heat gain.

Another consideration in the decision between vertical versus horizontal glazing is cost. Prefabricated skylights, which are inserted into a roofing system, can be much less expensive than custom-built roof monitors requiring extensive structural modifications and flashing. Integration of the toplighting scheme with the HVAC, ceiling, and lighting systems is also an important concern. The final decision for horizontal or vertical glazing is a balance of these concerns for the specific building and climate, as well as the ability to integrate into the architecture.

Toplighting Shading Strategies

Shading for monitors may not be needed if the light well design prevents direct sun from entering the space. Exterior shading devices for skylights are available, but are not recommended due to maintenance problems. Rooftop devices are usually exposed to more severe weather, dust, and debris but have less maintenance supervision than windows. Sturdy, dependable performance is an essential criterion. Thus, it is a good idea to protect any shading or operable equipment for skylights below at least the first layer of skylight glazing. Some skylight manufactures offer fixed or operable louver options for sun and daylight control, to reduce solar gain and excessive daylight. Others offer movable insulation devices that can be operated, either manually or automatically, to reduce both solar gain and nighttime heat losses.

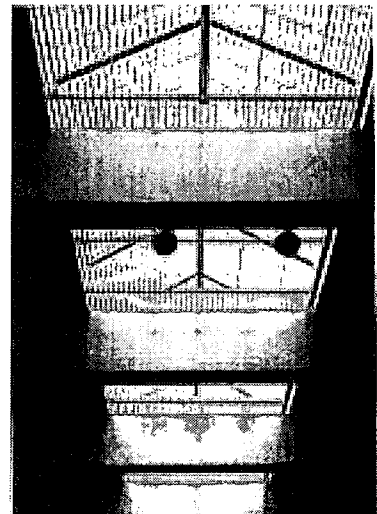

Linear skylight in multipurpose room includes electrically operated louvers to reduce brightness when needed. Photo courtesy Lisa Heschang.

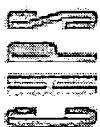

Structural Considerations

All toplighting schemes represent penetrations through the roof diaphragm, which is often a critical part of the building's structural system, designed to stiffen the building and resist forces that tend to twist the structural frame. This structural diaphragm can have various numbers and sizes of holes in it and still continue to function. But at some point, additional holes will weaken its strength, limiting the size and location of toplighting apertures. However, if more toplighting apertures are desired than allowed by the structural system, the project's structural engineer may be able to devise ways to strengthen the diaphragm to allow additional penetrations.

The light well connecting the toplighting aperture with the space below may also intersect HVAC ducting, electric lighting layouts, and fire sprinkler systems. Careful coordination of the structural and mechanical designs will ensure compatibility among these systems.

Fenestration Products

High performance fenestration features include double glazing, low-emissivity coatings, and blue/green tints. These have become a very important means of energy conservation in modern construction to reduce both thermal losses and solar gains. Fenestration has three principal energy performance characteristics, which have been identified by the National Fenestration Rating Council (NFRC) to be tested and labeled on manufactured windows: Visible light transmittance, solar heat gain coefficient, and U-factor. Site-built windows and skylights may or may not have such tested information available.

- *Visible light transmittance (VLT)* is the fraction of light that is transmitted through the glazing. Light is that portion of solar radiation that is visible, meaning it has a wavelength between about 380 and 780 nanometers. Single clear glass has a VLT of about 0.9, while highly reflective glass can have a VLT as low as 0.05. The quantity of daylight that enters a window or skylight is directly proportional to the VLT. In general, VLT should be as high as possible, provided it does not create glare or other visibility problems.
- *Solar heat gain coefficient (SHGC)* measures the solar heat gain through a window. A window that has no solar gain would have a SHGC value of zero, while a perfectly transmissive glazing would have a SHGC of 1.0. These extremes are both theoretical concepts that are not possible in the real world. Except in passive solar applications where solar heat gain is desired, everything else being equal, glazing materials should be selected with the lowest possible SHGC. However, glazing materials with a low SHGC (like dark gray and bronze tints) may also have a low VLT, so the challenge is to identify specialized "selective" low-e products and blue/green tints that combine the lowest SHGC with the highest VLT.
- *U-factor* measures the heat flow through a window assembly due to the temperature difference between the inside and outside. The lower the U-factor, the lower the rate of heat loss and of heating energy consumption. Everything else being equal, the U-factor should be as low as possible. The fenestration frame and glazing edge spacers degrade the U-factor of an insulated glass assembly. So two U-factors are frequently specified: the center of glass (COG) value, which is the U-factor measured at the center of the assembly, and the whole-window value, which is the overall U-factor of the glazing plus the spacer and frame system. (The whole-unit value will be higher than the COG value.) Single pane windows typically have a U-factor in the range of 1.0 to 1.2 COG; double pane windows range from 0.65 to 0.45 COG. With low-e coatings, inert gas fills, and multiple glazings, the U-factor can be as low as 0.1 COG.

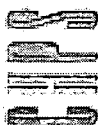

Other glazing considerations include diffusion, transparency, and durability:

- **Diffusion and Transparency.** Transparent glazing materials provide views, but diffuse materials can spread daylight better in the space. Diffusion is one of the most important characteristics in selecting a skylight. Good diffusing glazings maximize the spread of light in the space and minimize “hot spots” and glare. Diffusion may be accomplished by using a white pigment, a prismatic surface, or embedded fibers. Unfortunately, specifications on diffusion properties are rarely available for fenestration products. Thus, samples of diffusing glazing materials should be visually evaluated to see how well they diffuse direct sunlight. A simple test is to place the product in the sun and see if it allows your hand to cast a shadow. A fully diffusing material will blur the shadow beyond recognition and will not concentrate the sunlight into local hot spots. Note that diffusing glazing placed in direct sunlight can be glaringly bright if it is within the field of view. It should be placed above the direct line of sight or be obscured by baffles.
- **Durability.** Characteristics such as UV degradation (yellowing and other aging effects), structural strength, scratch resistance, breaking and fire resistance, along with replacement cost and availability, should be considered in selecting a glazing material.



Pyramid skylights on experimental portable classroom design integrates skylights into a high efficiency modular design. Photo courtesy Lisa Hescong.

The fenestration frame holds the glazing material in place and forms the structural link with the building envelope. The frame and the spacer between the glazing panes in multiple glazed units form a thermal short circuit in the insulating value of the fenestration. This degradation of the U-factor at the fenestration perimeter can be minimized with high performance frame and spacer technologies now available. This is important both for energy conservation and the potential for condensation on the frame.

Frames are available in metal, wood, vinyl, composite, and fiberglass. Metal frames conduct the most heat and must have a thermal break for good performance. Insulated vinyl and fiberglass frames have the lowest U-factor. The NFRC has established a rating system to evaluate the whole window performance including the frame, spacer, and glazing. More information can be found at their website, <http://www.nfrc.org>. The whole-window U-factor, VLT, and SHGC is shown on a label attached to all rated windows. Rated windows should be purchased for all school projects and frame/spacer performance should be compared based on these overall ratings. Site-built windows and skylights will not have these ratings available.

Design and Analysis Tools

There are three general categories of tools for evaluating daylighting and fenestration: physical models, lighting computer simulation programs, and whole-building energy simulation programs.

Physical Models

Physical scale models are probably the easiest and most intuitive way to understand daylighting design options. Scale models can be easily built that quickly and accurately illustrate the daylighting conditions created by any given design. They also help non-professionals, such as teachers and parents, to see



lighting quality issues directly, and understand why one design might work better than another. Photographs of the interior of scale models are an easy way to record the impacts of various design options. Many daylighting textbooks include a chapter on the construction and testing of daylight models. An excellent training video — Daylight Models, available from the Lighting Design Lab in Seattle — also describes how to build and test these models. (See the References section below for more information.)

Daylighting models can also be used for numerical analysis. The models may be tested either outside under real sky conditions or in artificially constructed overcast sky and direct sun simulators. Small light measuring devices (photocells) can be used to record light levels within the model. Sun simulators (heliiodons) can be set to represent the correct sun angle for the site latitude and hour of day, and are used to visualize the movement of light during a typical day. Measurements in a simulated sun or sky are more reproducible than in the real sky, which is constantly changing. Several California universities and electric utilities, including the Pacific Energy Center in San Francisco, have sun and overcast sky simulators, associated video equipment, and photocell arrays.

Lighting and Daylighting Computer Simulations

Electric lighting and daylighting computer simulations such as Radiance, Superlite, LumenMicro, and Lightscape give information about the distribution of lighting in spaces with contributions from windows and skylights as well as electric lighting systems. Unlike the energy simulation programs described below, these programs produce results for a single instant in time. Multiple calculations are needed to study varying sky and solar conditions. These computer-based tools give light level values and gradients for both daylight and electric light across the space. Some of these tools also produce realistic renderings of lighting within the space, which may be linked to generate an automated "walkthrough" of the space for a particular day and time or to simulate the daylight variations through the hours of the day. The programs that are easiest to use may be constrained by the complexity of shapes they can simulate. The more complex programs can simulate almost any room shape or material, but require significantly more expertise and modeling time.

Whole Building Energy Simulations

Whole building energy simulation tools, such as DOE-2, EnergyPlus, BLAST, and spreadsheet estimating programs like SkyCalc consider all aspects of the fenestration's impact on building energy use, including solar gains, impact on HVAC equipment sizes, and reduction of electric lighting energy. Many of the energy simulation programs have user-friendly interfaces to make it easier to construct models and evaluate results. Most of these tools have simplified daylighting simulation algorithms that may not accurately represent daylight levels from complex designs (like light shelves). For these designs, daylight predictions from one of the computer simulations mentioned above may need to be input to the energy program to accurately predict daylight's potential to save energy by turning off or dimming electric lights.

Other Design Considerations

The on-line Appendix that supports the Best Practices Manual has details of additional design considerations, including the following:



- Natural ventilation
- Noise control
- Radiant comfort
- Safety and security
- Air and water leakage
- Condensation
- Replacement
- Maintenance
- Fire resistance

Applicable Codes

The California Energy-Efficiency Standards for Nonresidential Buildings (Title 24) limit the window-wall ratio to 40% of the exterior wall. Since mid-2001, the code requires high performance glazing, including thermal break frames and low-e coated double glass, although the requirements vary somewhat with climate. The standard does not require daylighting or daylighting controls, but it does offer credits when automatic controls are installed.

Resource Efficiency

In terms of energy performance, windows and skylights are two of the most important considerations in building design. They also provide an opportunity to address other environmental objectives, including material efficiency, indoor air quality (IAQ), and pollution prevention during manufacturing.

To achieve material efficiency, windows are now being manufactured with durable alternatives to wood frames and sashes, including options made with post-industrial waste. Unfortunately, many of these products can contribute to pollution during manufacture, and possibly even to IAQ problems. For now, the best environmental performance strategy is to select durable frame and sash options that enhance energy performance as well as meet programming and daylighting needs. Table 18 lists currently available options that are environmentally preferable from a material efficiency perspective.



Table 18 – Strategies for Constructing Resource Efficient Fenestration Systems

Window Frame and Sash	Strategies	Environmental Benefits & Considerations
Wood	Select windows produced with wood certified by Forest Stewardship Council (FSC), Scientific Certification Service (SCS). Specify factory-applied finish.	Prevents degradation to forest and wildlife habitat; wood can be high maintenance. Good energy performance. Typically more durable than field-applied. More controlled finishing environment prevents pollution.
Wood and Plastic Composite	Durable options combine wood fiber and post-consumer waste plastic, and combine recycled PVC scrap, virgin PVC, and fiber from recycled wood scrap.	Utilizes industrial waste, stretching the wood supply. Very durable and low maintenance. Manufacture of PVC can contribute to pollution, however. Good energy performance
Vinyl	Vinyl frames include foamed PVC insulating core.	Low maintenance. Needs no paint. Manufacture of PVC can contribute to pollution, however and high coefficient of thermal expansion can lead to premature failure of seal. Excellent energy performance.
ABS Plastic		Low maintenance. Needs no paint. Manufacture can contribute to pollution however, and high coefficient of thermal expansion can lead to premature failure of seal. Moderately good energy performance.
PVC Plastic		Low maintenance. Manufacture can contribute to pollution, however, and high coefficient of thermal expansion can lead to premature failure of seal.
Fiberglass	Pultruded fiberglass frame members have a hollow profile usually insulated with fiberglass or polyurethane foam.	Promotes durability. However, difficult to recycle. Emissions contribute to IAQ problems and manufacture contributes to air pollution. Moderately good energy performance.
Metal	Specify durable, factory-applied finishes, anodized, polyvinylidene fluoride, and siliconized polyester.	Promotes durability and reduces potential pollution on-site. Energy-intensive production, however. Not the best energy performance. Do not use metal frames that lack thermal break.

Source: GreenSpec: The Environmental Building News Product Directory and Guideline Specifications.

For specific product recommendations, see GreenSpec: The Environmental Building News Product Directory and Guideline Specifications, <http://www.buildinggreen.com> and OIKOS's Redi Guide (Resources for Environmental Design Index). Iris Communications, 800-346-0104, <http://www.oikos.com>.

References/Additional Information

- Ander, Gregg D. *Daylighting Performance and Design*. New York: New York: John Wiley and Sons, 1995.
- Eley, Charles, ed. *The Advanced Lighting Guidelines 2001*. New Buildings Institute, 2001. Available at <http://www.newbuildings.org/>.
- Heschong, Lisa et al. *The Skylighting Guidelines*. Southern California Edison, 1998. Available at <http://www.energydesignresources.com/Heschong> Mahone Group. "Daylighting in Schools: An Investigation in the Relationship Between Daylighting and Human Performance" for Pacific Gas and Electric, 1999. Available at <http://www.h-m-g.com/William, M.C. Sunlighting as Formgiver for Architecture>. New York: Van Nostrand Reinhold, 1986.
- Lighting Design Lab. *Daylighting Models* (video). Seattle, WA: Lighting Design Lab, 1998. 400 E. Pine St., Suite 100, Seattle, Washington 98122. (800) 354-3894.
- Moore, Fuller. "Chapter 1: Historical Response." In *Concepts and Practice of Architectural Daylighting*. New York: Van Nostrand Reinhold, 1991, pp. 3-16.
- National Renewable Energy Laboratory. Energy-10 website. <http://www.nrel.gov/buildings/energy10/>.
- O'Conner, Jennifer et al. *Tips for Daylighting with Windows*. Lawrence Berkeley National Labs, 1997. Available at <http://windows.lbl.gov/daylighting/designguide/download.html>.
- Rea, Mark S., ed. *The IESNA Lighting Handbook*. Ninth Edition. Illuminating Engineering Society of North America, 2000.
- Robbins, Claude. *Daylighting Design and Analysis*. New York: Van Nostrand Reinhold, 1986.

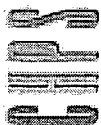

Millett, Marietta S. *Light Revealing Architecture*. New York: Van Nostrand Reinhold, 1996.

Related Volume III CHPS Criteria

Energy Prerequisite 1: Minimum Energy Performance.

Energy Credit 1: Superior Energy Performance.

IEQ Credit 1: Daylighting in Classrooms.

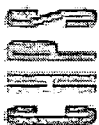

Guideline DL1: View Windows

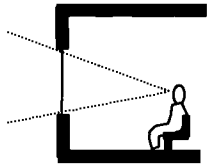

Recommendation

Provide access to exterior views through view windows for all interior spaces where students or staff will be working for extended periods of time.

Description

A view window is vertical glazing at eye level, which provides a view to the exterior or interior adjacent spaces.

Applicability

View windows are essential in all school spaces (except spaces requiring visual privacy) to provide relaxing views and information about exterior natural conditions, and also to allow people outside of a space to view and connect with activities inside. They are applicable to all climate regions and should be planned in the schematic design phase.

Applicable Codes

The California Energy Code does not require that view windows be installed. However, the code does specify the minimum performance of fenestration products and it limits window area to a maximum of 40% of the exterior wall area.

Integrated Design Implications

- **Balance with other program needs.** View windows serve a broad range of important functions for view, social communication, egress, ventilation, and energy conservation (see Benefits below). However, view windows are often inefficient at supplying working daylight to the space. The square footage of view windows will reduce the allowable area for windows and skylights placed higher in the wall and ceiling that can be designed to deliver more useful daylight across the space. View windows also decrease valuable classroom wall space and pose potential acoustic and vandalism problems. A balance should be achieved among these conflicting needs.
- **Integration with mechanical ventilation.** Operable view windows should be used to naturally ventilate the space and reduce mechanical ventilation needs. Evaluate prevailing wind conditions to assess the feasibility. A statistical analysis of 650 schools by the Florida Solar Energy Center found a strong correlation between the presence of operable windows and a decrease in indoor air quality complaints.³²



View windows at Camaron Library expand the space outward and connect the reading area with the natural landscape. Lisa Heschong, photographer.

Applicable Spaces	Climates	When to Consider
Classrooms	South Coast	Programming
Library	North Coast	Schematic
Multi-Purpose / Cafeteria	Central Valley	Design Dev.
Gym	Mountains	Contract Docs.
Corridors	Desert	Construction
Administration		Commissioning
Toilets		Operation
Other		

³² M. Callahan et. al. Energy Efficiency for Florida Educational Facilities: 1996 Energy Survey of Florida Schools Final Report. Report # FSEC-CR-951-97. Florida Solar Energy Center. Submitted to Florida department of Education, July 1997.



- **Integration with HVAC.** View windows should decrease overall seasonal heating and cooling loads on the building if they are oriented, glazed, and shaded correctly. This can reduce the initial size of the HVAC system and annual energy costs. The analysis of Florida schools noted above also found that the presence of windows strongly correlated with an overall reduction in total building energy use.
- **Thermal Comfort.** Window surfaces that are considerably above or below the mean radiant temperature of other room surfaces will be uncomfortable for occupants adjacent to them. Shade the windows, use high performance glazing, and design HVAC to minimize radiant thermal discomfort.
- **Space Planning.** View windows should be oriented relative to the location of stationary tasks, such as desks, teaching wall, computer locations, and reading areas. Avoid reflected glare from windows in computer screens or on whiteboard surfaces. The best classroom location for view windows is perpendicular to the teaching wall.
- **Design Phase.** To function well, view windows must be at eye level, glare-free, oriented toward views that will not distract occupants, and designed to reduce building energy loads. A requirement for view windows should be identified in the building program; their location and design objectives should be determined in the early phases of schematic design.

Cost Effectiveness

Costs for view windows are typically low. View windows are (or should be!) standard practice for classrooms. The incremental cost of energy-efficient glazing ranges from \$0.75/ft² to \$2.50/ft² of glass. Daylight energy savings from view windows are negligible because the shading elements required to minimize glare usually render them unreliable for reducing electric light consumption.

Costs	L			
	M			
	H			
		L	M	H
		Benefits		

Benefits

View windows provide numerous benefits, serving a broad range of important functions for view, social communication, egress, ventilation, and energy conservation

The outward views they provide are essential for mental stimulation and relaxation for eye muscles. Optometrists recommend access to long views for any sedentary workers (such as students) for frequent shifting of eye focal length, which promotes eye health and good vision. This may be especially important for young children while their eyes are still developing.

View windows provide occupants a connection with nature, weather, cardinal orientation, and some natural light (though not evenly distributed across the space). Occupant productivity and connection with place may increase through the associated views. Studies have shown that the primary reason people prefer having a window is view, preferably a view of nature. Research suggests that natural views elicit positive feelings, hold interest, and reduce fear and stress.³³ Teachers have reported a reduction in stress levels when they have access to a relaxing view from their classroom.³⁴

View windows, especially on the first floor of school buildings, also provide an important social communication function, allowing teachers, administrators, and parents to quickly assess what is going on inside a classroom. When installed with clear glass, they are often used to display art work and current student projects, contributing to both pride and awareness of other's efforts.

Operable view windows provide emergency egress and natural ventilation. A recent study has shown that natural ventilation in classrooms correlates with higher student test scores.³⁵

³³ Norris and Tillett. 1997. "Daylight and productivity: Is there a causal link?". Glass Processing Days Conference, Tampere, Finland (Sept.).

³⁴ Hescong Mahone Group, "Daylighting in Schools—An Investigation into the Relationship between Daylighting and Human Performance," prepared for Pacific Gas & Electric Company and funded by California utility customers, 1999.

³⁵ Ibid.



Well-designed view windows can reduce the overall building heating and cooling loads and north-facing view windows can also deliver enough dependable daylight to reduce electric lighting loads with manual or photocontrols. Other orientations, however, often have blinds or curtains drawn. Thus, unless a view window faces north or has a head height over 8 ft, and separate glare control for at least 2 ft of the top glazed area, it should not be counted on to provide sufficient daylight to merit the installation of automatic photocontrols and reap predictable savings from reduced electric lighting use.

Design Tools

The physical models and daylight simulation tools noted in the Overview can be used to evaluate potential daylight levels, and energy programs can be used to understand building energy implications.

For critical view areas, access to views and view angles from various positions in the space can be evaluated graphically with scaled drawings or with the use of a scale physical model. For a physical model analysis, it is helpful to have a "lipstick" video camera head, which can be moved around inside the model to record the views available at each location.



View windows at RI library are separated from the daylight feature overhead and use lower transmission glass to reduce glare. Lisa Heschong, photographer.

Design Details

- **Orientation.** Orient view windows toward the north or south to avoid low angle east/west sun. Up to 15° variance from true north or south is acceptable, but will reduce performance.
- **Shading devices.** Since view windows are within the occupants' normal field of view, the contrast between the bright window view and other interior surfaces is an important glare consideration. Use exterior shading devices (overhangs, fins, etc.) or landscaping to eliminate direct sun and reduce brightness. If this is not possible, use a lower transmission glazing adjusted for the window orientation (about 40% transmission for south windows, 30% for east/west windows and 60% to 85% for north windows). On south, east, and west orientations, add an interior shade (shade screen, blinds, or drapes) so the teacher can adjust brightness and sun penetration as needed. In general, visible transmission of view glazing should not be reduced below 30% in clear sky climates or below 50% in heavily overcast climates. If tinted glazing is used, evaluate its effect on distortion of colors (for example, the graying of greens and blues in the landscape) in both overcast and clear skies. Provide blackout capability for view windows as needed.
- **Reflectance.** Deep splayed walls or mullions will also reduce glare. Paint all surfaces near windows white or off-white to further reduce contrast between the brightness of the window and its surrounding wall. Place view windows adjacent to a perpendicular surface to reflect daylight onto adjacent surfaces. Placing view windows adjacent to walls is best. Avoid punched holes in walls, as they create the worst glare conditions.



View windows promote communication between interior and exterior spaces. Lisa Heschong, photographer.



- **Outside reflective surfaces.** Be aware of bright reflective surfaces outside the view window that may create glare when they are in sunlight. Reflected sun off a car windshield can be especially troublesome. Light-colored walls within view can also create glare sources when they are in direct sun. Plant hedges or trees to reduce the glare potential from these exterior sources.
- **Thermal comfort.** Window surfaces that are considerably above or below the mean radiant temperature of other room surfaces will feel uncomfortably cold or hot for occupants sitting next to them. In very cold or hot climates (desert, mountain and Central Valley), use double glazing with a low-e coating to maximize comfort and energy efficiency. Single glazing is sufficient for coastal climates in California.
- **Views.** In classrooms, orient views toward "passive" nature scenes. In administration areas, views may be oriented toward the school entry or other security concerns.
- **Teaching surface.** In classrooms, the teaching wall should be perpendicular to the window wall for best illumination.
- **Computer screen location.** Orient computers at a 45° angle from view windows to avoid glare from reflections of the window in the VDT screen. Flat screen computers and adjustable-angle LED screens also help to reduce glare.
- **Security.** Provide operable interior shades and/or laminated glass for security in ground level rooms that contain computers or other valuables.
- **Durability and accessibility.** Use sturdy mechanisms for all operable ventilation and shading devices. Make them easily accessible to the teacher and easily repairable.
- **Noise transmission.** Since windows are frequently the "weakest link" acoustically in a building structure, double glazed windows are often the only alternative to controlling exterior noise. Normal thermal-pane double paned windows with ¼ in. or ½ in. airspace are not acoustically effective. For better acoustic performance, windows should have laminated glass on at least one pane, as well as significant airspace between the two panes. In high noise areas (from exterior traffic and/or aircraft), it is not uncommon to require thicker laminated glass and 2 in. to 4 in. of airspace between the panes.
- **Balancing with electric light.** If view windows are the only daylight apertures in the room, and they appear on only one wall of the space, balance their brightness in the room by washing other interior walls with electric light.

Operation and Maintenance Issues

View windows should be washed on a schedule. Elements provided to reduce glare and allow blackout conditions (blinds, drapes, blackout shades, etc.) need to be cleaned and replaced over time. Give consideration to the robustness of operable shade mechanisms that are accessible to students. Coordinate selection of glazing materials with the maintenance staff to ensure ease of cleaning and replacement. Districts may have district-wide standards to ensure quick replacement of broken glass, but ensure that it is replaced with the same type of glass.

Design ventilation devices to prevent physical entry as well as any rain or maintenance water penetration.

Commissioning

None.

References/Additional Information

See the Overview section of this chapter.

Related Volume III CHPS Criteria

See the Overview section of this chapter, and:

Energy Credit 2: Natural Ventilation.

IEQ Credit 6: Controllability of Systems.



Guideline DL2: High Sidelighting—Clerestory

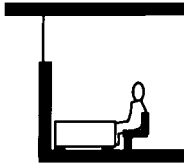

Recommendation

Use high clerestories in perimeter walls to increase daylight delivery deeper in classrooms, offices, libraries, multipurpose rooms, gymnasiums, and administrative areas.

Description

High sidelighting clerestories are vertical glazing in an exterior wall above eye level (usually above 7 ft). Since the penetration of daylight from vertical glazing is about two times the window head height, moving the window higher in the wall increases daylight penetration in the space.

Applicability

High clerestory windows can be used in all school spaces to provide deep penetration of daylight.

They are applicable to all climate regions and should be planned in the schematic design phase.

Applicable Codes

The California Energy Efficiency Code does not require that high clerestories be installed. However, the code does specify the minimum performance of fenestration products and it limits window area to a maximum of 40% of the exterior wall area.

Integrated Design Implications

- Design phase.** High sidelighting requires high ceilings and perimeter walls. North and (shaded) south orientations are preferable, although east, and west orientations can be acceptable if diffusing glazing is used, or if low-angle sun penetration will not be bothersome in the space. High sidelighting is most appropriate for open plan interior layouts that allow unobstructed daylight penetration. It should be considered in the early schematic design phase.
- Balance with other daylight needs.** Applied to one wall, this approach creates a decreasing gradient of useable daylight about two times the clerestory head height into the space. For spaces of 20 ft to 40 ft in width (classrooms, etc.), it can be balanced with a daylighting scheme on the opposite wall to provide even lighting across the entire space. View windows should also be provided. The total glazing area should be apportioned among these needs.



Classroom with high clerestory window. Lisa Hescong, photographer.

Applicable Spaces	Climates	When to Consider
Classrooms	South Coast	Programming
Library	North Coast	Schematic
Multi-Purpose / Cafeteria	Central Valley	Design Dev.
Gym	Mountains	Contract Docs.
Corridors	Desert	Construction
Administration		Commissioning
Toilets		Operation
Other		



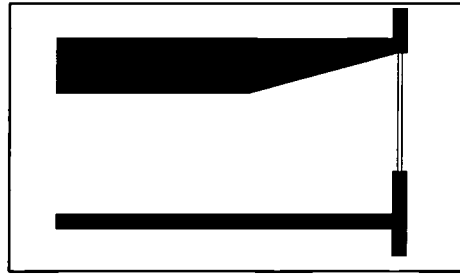

Figure 20 -- Sloped Ceiling

Sloped ceiling at perimeter increases window head height by reducing plenum space

- **Reduced plenum space.** Clerestory sidelighting requires ceiling heights of 9.5 ft or more at the window wall. This extra ceiling height may be accomplished with minimal increase of the floor-to-floor height by careful integration of the structural system, HVAC ducts and electric lighting in the plenum space. Sloping (or stepping) the ceiling upward at the perimeter (see figure) — essentially reducing the plenum space there — can also yield additional perimeter ceiling height. For ceiling-ducted HVAC systems, this requires routing ducts away from perimeter walls.
- **Natural ventilation.** High windows can be especially beneficial for natural ventilation, by allowing heated air to escape out near the ceiling. The ideal location for high operable windows is on the leeward side of a building.
- **Integration with HVAC.** High sidelighting glazing impacts HVAC loads by its vulnerability to solar gains during the cooling season and heat loss in the heating season. Good design (appropriate glazing orientation, size, glazing materials, shading and photocontrol of electric lights) can reduce the overall HVAC loads and potentially reduce HVAC system size and first costs.
- **Duct work.** Keep ductwork away from high windows to avoid blocking daylight.
- **Integration with electric lighting.** High sidelighting creates linear zones of daylight that run parallel to the clerestory windows. Electric lighting should be circuited parallel to this and photocontrolled (or manually controlled) in response to available daylight.

Cost Effectiveness

Costs for high sidelighting are low to moderate. Windows are standard practice for classrooms. A balance of view and clerestory windows can be provided for each classroom with minimal increase to the overall glazed area. The incremental cost of energy efficient glazing ranges from \$0.75/ft² to \$2.50/ft².

Costs	L	■	■	■
	M	■	■	■
	H	■	■	■
		L	M	H
		Benefits		

Benefits

High sidelighting provides a moderate level of benefits. The general energy saving, productivity and visual comfort benefits of daylighting are discussed in the Overview section to this chapter. Clerestory sidelighting both saves energy and improves lighting quality. Energy savings come from reduced electric lighting energy use. Lighting quality is improved by a more uniform distribution of daylight across the space.

Design Tools

Computer simulation programs and scale models as outlined in the Overview can be used to demonstrate daylight distribution. If the design includes sloped surfaces, check to ensure the simulation program can accommodate these. Check for daylight levels across the space under both clear sky and overcast sky conditions and check direct sun penetration through the clerestory glazing for the lowest expected sun angles. Even occasional penetration of low sun angles can be extremely bothersome to occupants and may lead to blocking a window.



Energy savings from minimized HVAC loads and control of electric lighting in response to daylight can be estimated with the DOE-2, EnergyPlus, and Energy-10 programs available.

Design Details

- **Ceiling height.** High sidelighting glazing works best in spaces with high ceilings. A minimum perimeter ceiling height of 9.5 ft is recommended. Generally, the higher the ceiling height, the better.
- **Balancing with view windows.** Lower view windows are frequently coupled with high sidelighting schemes, but they do not have to coincide for the whole perimeter. The high glazing should be continuous along the whole area to be daylit. View windows can be selectively spaced beneath these high windows as needed. This balance between high clerestories and view windows can leave lower perimeter wall space available for other uses.
- **Shading devices.** Design high sidelighting clerestories with exterior shading, diffusing glazing, operable blinds, or light shelves to eliminate direct sun penetration. Mini-blinds positioned between the panes of glass in a double glazed window accomplish this with minimal maintenance. (A light shelf or louver system may also be used; see Guideline DL3.) Dedicated blinds or shades for the upper clerestory glazing can allow lower view windows to be controlled separately for glare. Blackout shades may need to be provided.
- **Glazing materials.** New glazing materials (prismatic, lensed, holographic, or laser cut acrylic) may be available to redirect daylight to the ceiling from the clerestory. These can deliver daylight deeper in the space but may cause very bright glazed areas and should be tested to see if they produce glare.
- **Orientation.** Clerestories are most effective on south and north orientations, but should be carefully evaluated on east and west orientations to assure that low sun angle penetration and direct solar gain into the space is minimized. Shade exterior glazing with an overhang on east-, west-, and south-facing glazing to minimize solar gain or use a selective low-e coating (SHGC less than .45).
- **Visible transmission.** Use high transmission, clear glazing (visible transmission 60% to 90%) on the upper window to admit the maximum daylight to the space. Double clear low-e glazing is recommended in the desert, mountain and Central Valley climates; single clear glass is recommended in coastal climates.
- **Stepped ceiling.** Clerestories may create a comparatively dark area along the wall directly beneath them. An interior stepped ceiling in a multi-story building can create a clerestory that reflects daylight back onto the wall to brighten it and deliver reflected daylight to the space.

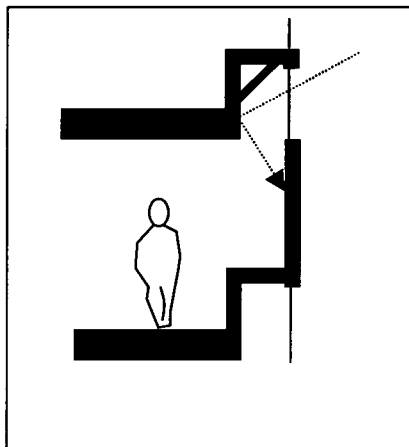
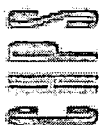

Figure 21 – Clerestories in Multistory Buildings

Clerestories in multistory buildings can redirect daylight onto the perimeter wall to brighten it.

- **Reflectance.** Paint all surfaces near the clerestories white or off-white to reduce contrast between the brightness of the clerestory and its surrounding wall. The adjacent ceiling should also have a



highly reflective (>70%) white or off-white surface to help diffuse a maximum amount of daylight into the space. Use specially designed “high reflectance” ceiling tiles if the budget allows.

- **Teaching surface.** In classrooms, the teaching surface should be perpendicular to the window wall for best illumination. Avoid orientations that will put students’ or teachers’ faces in silhouette or cause reflected glare on whiteboards or computer screens.

Operation and Maintenance Issues

For operable louvers, it is best to have preset angles that are seasonally adjusted by maintenance staff so the louvers are not inadvertently closed and forgotten or left at a non-optimal angle.

For shades or blinds that are operated by teachers, ensure that their control mechanisms are accessible, robust, and easily repaired.

Clerestory windows should be washed on a regular schedule.

Commissioning

Set adjustable louvers at their correct seasonal angle to eliminate direct sun penetration.

References/Additional Information

See the Overview section of this chapter.

Related Volume III CHPS Criteria

See the Overview section of this chapter, and:

Energy Credit 2: Natural Ventilation.

IEQ Credit 6: Controllability of Systems.

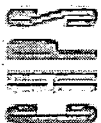

Guideline DL3: High Sidelighting—Clerestory with Light Shelf or Louvers

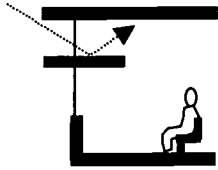

Recommendation

Use light shelves or louvers with high clerestory glazing in perimeter walls to improve daylight distribution, block direct sun penetration, and minimize glare in classrooms, offices, libraries, multipurpose rooms, gymnasiums, and administrative areas.

Description

A light shelf is a horizontal panel placed below high clerestory glazing (with a view window generally below it) to bounce daylight deeper into the space. Light distribution is improved as daylight reflects off the top surface of the light shelf or louver onto the ceiling. A series of smaller horizontal louvers (6 in. to 24 in. wide) can replace a single large light shelf with a slight sacrifice in performance. The larger the louver, the deeper it will deliver daylight into the space. Light shelves and louvers can be located on the exterior, interior, or both. Exterior shelves shade the lower window from solar heat gain and reflect high angle summer sun into the room. Interior shelves reflect lower angle winter sun while blocking the penetration of direct sun and reducing glare from the upper glazing.

Applicability

High clerestory windows can be used in most school spaces to provide deep penetration of daylight. They are applicable to all climate regions and should be planned in the schematic design phase.

Applicable Codes

The California Energy Efficiency Code does not require that high side lighting with light shelves be installed. However, the code does specify the minimum performance of fenestration products and it limits window area to a maximum of 40% of the exterior wall area.

Integrated Design Implications

- **Design Phase.** Clerestories with light shelves require perimeter access to south-facing (+/- 15°) sidelighting and impact many aspects of building massing. They also benefit from open plan interior

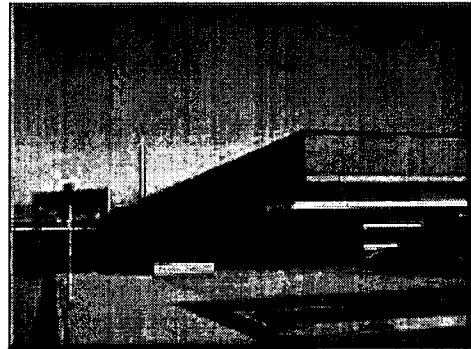
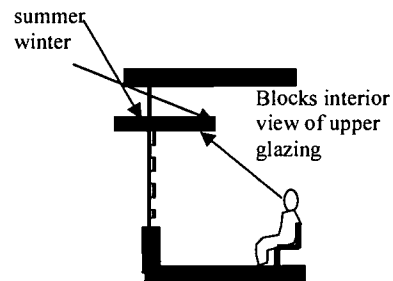

Photo of Liberty Elementary School with exterior lightshelves to reflect sunlight onto classroom ceilings. Photo courtesy of Liberty Elementary, Boise School District, Boise, ID



Exterior light shelves shade lower window and reflect summer sun into room. Interior shelves reflect winter sun while reducing glare.

Applicable Spaces	Climates	When to Consider
Classrooms	South Coast	Programming
Library	North Coast	Schematic
Multi-Purpose / Cafeteria	Central Valley	Design Dev.
Gym	Mountains	Contract Docs.
Corridors	Desert	Construction
Administration		Commissioning
Toilets		Operation
Other		



layouts that allow unobstructed daylight penetration. They should be considered in the early schematic design phase. Calculation of the size and cutoff angles of the light shelf or louver system is critical.

- **Balance with Other Daylight Needs.** Applied to one wall, this approach creates a decreasing gradient of useable daylight about 2.5 times the clerestory head height into the space. For spaces of 20 ft to 50 ft in width (such as classrooms), it can be balanced with a daylighting scheme on the opposite wall to provide even lighting across the entire space. Lower view windows are frequently coupled with light shelf schemes, but they do not have to coincide for the whole length of the light shelf. The high glazing with light shelf should be continuous along the whole area to be daylight. View windows can be selectively spaced beneath the light shelf as needed. This balance between high sidelighting and view windows leaves some lower perimeter wall space available for other uses. Total glazing area should be apportioned among these needs.
- **Integration with Ceiling Plenum.** Clerestories with light shelves require ceiling heights of 9.5 ft or more at the window wall. This extra ceiling height may be accomplished with minimal increase of the floor-to-floor height by careful integration of the structural system, HVAC ducts, and electric lighting in the plenum space. Sloping (or stepping) the ceiling upward at the perimeter — essentially reducing the plenum space there — can also yield additional perimeter ceiling height. For ceiling-ducted HVAC systems, this requires routing ducts away from perimeter walls.
- **Integration with HVAC.** Glazing above a light shelf impacts HVAC loads by its vulnerability to solar gains during the cooling season and heat loss in the heating season. Good design (appropriate glazing orientation, size, performance, shading, and photocontrol of electric lights) can reduce the overall HVAC loads and potentially reduce HVAC system size and first costs. Light shelves also must be designed so as not to interfere with circulation of air from the HVAC system.
- **Integration with Electric Lighting.** Clerestories with light shelves create linear zones of daylight that run parallel to the clerestory windows. Electric lighting should be circuited parallel to this and photocontrolled (or manually controlled) in response to available daylight. Light shelves and louvers deliver daylight indirectly to the space; they work well when coupled with direct/indirect pendant electric lighting. Sometimes the first row of electric lighting is incorporated into the light shelf itself.
- **Integration with Other Mechanical Systems.** Design light shelves so they do not interfere with the operation of a fire sprinkler system.

Cost Effectiveness

Clerestories with light shelves or louvers are relatively expensive, but downsizing cooling systems may offset some cost (if electric lights are automatically switched or dimmed in response to daylight). Energy savings from reduced lighting and cooling energy are adequate to recover the initial investment in about eight to 12 years.

Costs	L			
	M			
	H			
		L	M	H
		Benefits		

Benefits

Clerestories with light shelves or louvers produce a high level of benefits. The general energy saving, productivity, and visual comfort benefits of daylighting are discussed in the Overview section to this chapter. Clerestories with light shelves or louvers both save energy and improve lighting quality. Energy savings come from reduced solar gains (when an exterior light shelf shades lower glazing) and reduced lighting energy use.

Lighting quality is improved because daylight is delivered deeper in the space, creating a more even distribution of daylight. Interior light shelves and louvers restrict the view of the bright upper glazing, eliminating glare.

Design Tools

Computer simulation programs and scale models as outlined in the Overview can be used to demonstrate daylight distribution. If the design includes sloped surfaces, check to ensure the simulation program can



accommodate these. Check for daylight levels across the space under both clear sky and overcast sky conditions, and check direct sun penetration through the upper glazing for the lowest expected sun angles.

Most whole-building energy simulation programs (like DOE-2 and EnergyPlus) do not accurately represent the increased daylight distribution from a light shelf or louver system. For more accurate simulations of electric lighting energy savings, the daylight distribution should be simulated with a physical scale model or daylight simulation program and then input to the energy program.

Design Details

- **Ceiling height.** Provide a minimum perimeter ceiling height of 9.5 ft (the higher, the better). Position the light shelf at 7 ft or more above the floor. Coordinate shelf position with pendant electric lighting, door headers, shelving, fire sprinklers, and other interior features.
- **Orientation.** Light shelves are most effective on south orientations, and occasionally on the north (to reduce glare from the upper glazing). They should be avoided on east and west orientations.

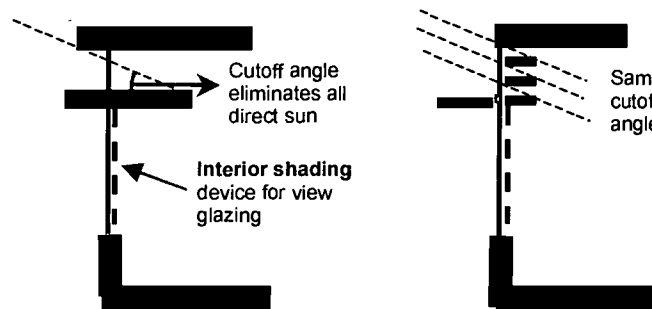

Figure 22 – Cutoff Angle of Light Shelves

Set the cutoff angle of light shelves or louvers to eliminate direct sun penetration during normal school hours.

- **Cutoff angle.** Set the cutoff angle of the light shelf or louvers (see the figure above) to eliminate direct sun penetration during normal school hours. (Use a cutoff angle of 27° for latitudes north of Chico. Use a cutoff angle of 23° for latitudes between Chico and Bakersfield. Use a cutoff angle of 20° for latitudes south of Bakersfield.) Cutoff angle can be increased by 10° if there are operable shades on the upper glazing, and increased by 20° if operable louvers will be seasonally adjusted.
- **Visible transmission.** Use high transmission, clear glazing (visible transmission 60% to 90%) on the upper window to admit the maximum daylight to the space. Double glazing with low-e is recommended in the desert, mountain and Central Valley climates. Single clear glass is acceptable in coastal climates.
- **Reflectance.** The top surface of the light shelf or louvers should be highly reflective (greater than 80% reflectance and with a diffuse, not mirrored, surface). Paint all surfaces near the clerestories white or off-white to reduce contrast between the brightness of the clerestory and its surrounding wall. The adjacent ceiling should also have a highly reflective (>70%) white or off-white surface to help diffuse a maximum amount of daylight into the space. Use specially designed "high reflectance" ceiling tiles if the budget allows.



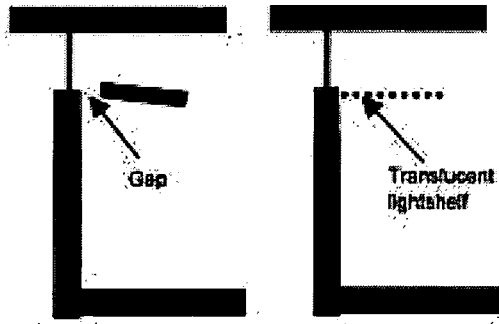

Figure 23 – Creating a Wall Wash

If opaque light shelves aren't coupled with view windows, consider leaving a gap between the light shelf and the wall to create a wall wash. Translucent shelves provide a soft light under them.

- **Materials.** Light shelves and louvers may be opaque or translucent and constructed of wood, metal panels, GFRC (glass fiber reinforced concrete), plastic, fabric, or acoustic ceiling materials. Choice of material should include consideration of reflectivity, structural strength, cost, ease of maintenance, and durability. Some curtain wall or window manufacturers can assist in developing details for light shelves and offer add-on products as part of their service. Fabric "shelves" can be suspended from the ceiling at their interior edge.
- **Top surface.** The top surface of a row of lockers or casework that lines a perimeter wall can also be used as a light shelf if its reflectivity and dimensions are appropriate. Slope the top surface so it will not be used for storage.
- **Opaque vs. translucent shelves.** Opaque shelves may create a dark space along the wall directly under them if they are not coupled with a view window. Leave a gap between the light shelf and the wall to create a wall wash or use electric lighting to brighten this wall. Translucent shelves provide a soft light under them but must be carefully evaluated so the direct view of the under side does not create glare. See Figure 23 above.
- **Dirt accumulation.** To reduce accumulation of dirt, exterior shelves should be sloped at least 0.25 in./ft so that rain can help keep it clean and not pool on the shelf. Also slope interior shelves so they are not used for storage. Fabric construction is another way of preventing this.
- **Accessibility.** Both exterior and interior light shelves can be an "attractive nuisance" in school buildings, inviting students to climb or hang on them. Minimize access to the shelf or use a series of louvers instead.
- **Access for cleaning.** Detail the light shelf or louver system so it is easy to clean the glass above it, both inside and out. Large light shelves may need to be moved away from the window by six inches to allow for window cleaning equipment to be inserted from below the shelf.
- **Teaching surface.** In classrooms, the teaching surface should be perpendicular to the window wall for best illumination.

Operation and Maintenance Issues

The glazing and light shelf/louver system forms a light delivery system that must be kept clean to ensure maximum delivery of daylight to the space. The top surface of the shelf or louvers should be cleaned each time the windows are washed. Make sure light shelves or louvers are detailed correctly to allow easy window cleaning. For operable louvers, it is best to have preset angles that are seasonally adjusted by maintenance staff so the louvers are not inadvertently closed and forgotten or left at a non-optimal angle.



Commissioning

Unless the light shelf or louvers are moveable, commissioning should not be necessary. Set adjustable louvers at their correct seasonal angle to eliminate direct sun penetration.

References/Additional Information

See the Overview section of this chapter.

Related Volume III CHPS Criteria

See the Overview section of this chapter.



Guideline DL4: Classroom Daylighting—Wall Wash Toplighting

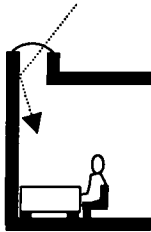

Recommendation

Use wall wash toplighting for interior classroom walls to balance daylight from window walls, brighten interior classrooms, and make them seem more spacious.

Description

Wall wash toplighting provides daylight from above through a linear skylight or monitor to wash an interior wall. The glazing is obscured from direct view by the skylight or monitor well. Daylight is diffused with diffusing glazing, baffles or reflections off of matte reflective light well and interior walls.

Applicability

A toplighting scheme applies to single-story buildings or the top floor only of a multistory building. Appropriate spaces for wall wash toplighting may include classrooms, libraries, multipurpose spaces, gyms, corridors, and administration offices. It is applicable to all climate regions, and must be planned for in schematic design.

Applicable Codes

The California Energy Code specifies the minimum performance of fenestration products and it limits window area to a maximum of 5% of the exterior roof area.

Integrated Design Implications

- **Balance with other daylight.** Applied to one wall, this approach creates even daylight across approximately two-thirds of a classroom. It should be balanced with a daylighting scheme on the opposite wall to provide even lighting across the entire classroom. View windows should also be provided. The total glazing area should be apportioned among these needs.
- **Skylights vs. vertical glazing.** The glazing for this wall wash toplighting scheme may be either horizontal or vertical (facing north, east, south, or west). See Daylighting Design Considerations in the electronic Appendix for a discussion of the energy performance of sidelighting versus toplighting facing in different orientations for all of the California climate zones. Skylights can offer an advantage of lower construction costs.

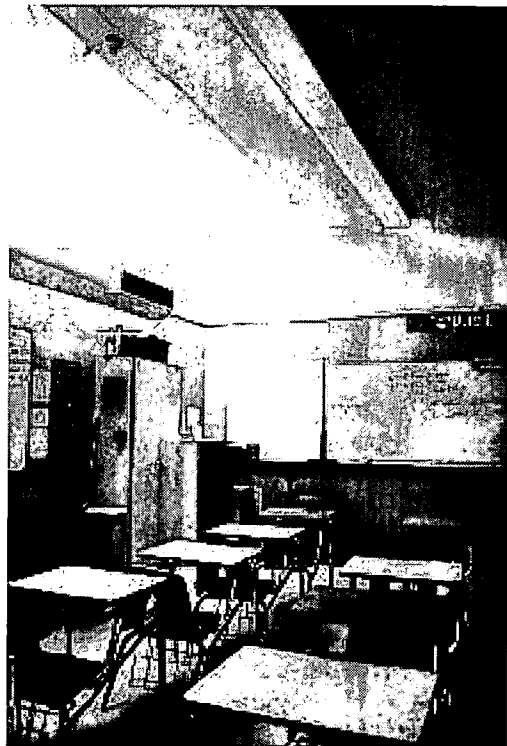

Skylit wall wash delivers daylight across two-thirds of this classroom. Lisa Hescong, photographer.

Applicable Spaces	Climates	When to Consider
Classrooms	South Coast	Programming
Library	North Coast	Schematic
Multi-Purpose / Cafeteria	Central Valley	Design Dev.
Gym	Mountains	Contract Docs.
Corridors	Desert	Construction
Administration		Commissioning
Toilets		Operation
Other		

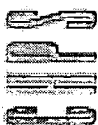

- **Integration with HVAC.** Placement of skylights and monitors and their associated light wells must be coordinated with the location of rooftop HVAC equipment and interior duct runs. If it is oriented, glazed, shaded, and integrated with electric lighting controls, toplighting should decrease overall seasonal heating and cooling loads on the building. This can reduce the initial size of the HVAC system and annual energy costs.
- **Integration with mechanical ventilation.** Operable rooftop fenestration can be used to naturally ventilate the space. Evaluate thermal stratification of air in the space and prevailing wind conditions to assess the feasibility.
- **Integration with structural system.** Skylights and monitors interrupt the roof diaphragm and structural system. Their size and location may be limited by this and must be coordinated with the structural system to maintain its strength and integrity. See Daylighting Design Considerations in the electronic Appendix for more details.
- **Safety and security.** Toplighting scenarios on relatively flat roofs have liabilities for both safety and security. Refer to Daylighting Design Considerations in electronic Appendix for more details.

Cost Effectiveness

Costs for wall wash toplighting are moderate to high, depending on design. Commercial, single glazed skylights are usually the least expensive approach.

Costs	L			
	M		■	
	H		■	
		L	M	H
		Benefits		

Benefits

Wall wash toplighting provides a moderate to high level of benefits. This approach washes a wall with light, and bounces glare-free daylight into the classroom. It will make the space appear larger and brighter. The uniform light from this approach can easily light the inner two-thirds of a classroom. It is excellent when combined with another wall wash or a sidelighting technique that increases daylight on the opposite side of the room (for example, a perimeter window) to create even, balanced daylight across the whole room.

This approach saves electric lighting energy if the first row or two of lights adjacent to the wall wash are switched off or dimmed in response to the daylight. Savings for controlled fixtures may be 40% to 80% during daylight hours.

If this scheme is used to provide natural ventilation, it may increase student performance. Natural ventilation has been correlated with higher student scores on standardized tests and lower overall building energy use.

Design Tools

The computer simulation programs and scale models described in this chapter's Overview can be used to demonstrate daylight distribution. If the design includes sloped surfaces, check to ensure the simulation program can handle this situation.

Design Details

General

- **Orientation.** Optimize the toplighting design for the climate, orientation, and budget. A skylight will perform better in a predominantly overcast sky condition and for non-north/south orientations. A well-designed monitor with north- or south-facing glazing will be more expensive, but may perform better than a skylight in sunny climates with high air conditioning loads.
- **Diffusion.** Diffuse the daylight before it washes the wall. Eliminate direct sun patches with diffusing glazing, baffles, or a deep well. For skylights, use a high performance diffusing material, such as prismatic acrylic, to maximize light transmission while minimizing hot spots. For clear glazed, baffled systems, design fixed baffles to cut off all expected sun angles or provide adjustable baffles.
- **Visible transmittance.** Use glazing with the highest visible transmittance to bring in the most daylight relative to the glazed area. For vertical glass, use a low-e coating to minimize heat loss; use a selective low-e coating to minimize solar gain on solar orientations.



- **Light wells.** A light well connects the upper aperture with the ceiling plane of the classroom. Light well walls should be highly reflective (>80% reflectance). Diffusely reflecting light wells should be less than 8 ft deep; mirrored reflecting wells can be used for deeper wells when necessary.
- **Surface colors.** The top of the wall that is washed should be light in color (>70% reflectance) so it can reflect daylight into the space. It should not have protrusions that will cast objectionable shadows.
- **Balancing daylight.** Combine wall wash toplighting approach with another linear approach on the opposite wall to balance daylight in the space.
- **Insulation.** Insulate light well walls to minimize thermal losses and reduce condensation.
- **Task and accent lighting.** In addition to ambient lighting, this approach can be used for task lighting on the wall (lighting lockers) or accent lighting (lighting artwork). It is excellent for corridors and other circulation spaces.
- **Blackout capability.** The aperture will need blackout capability for most classrooms.
- **Integrating with electric light.** Consider an electric lighting wall wash luminaire to illuminate the wall at night, or during heavily overcast conditions. Photoswitch this light in response to daylight levels.
- **Safety and security.** Operable mechanisms should prevent any physical entry. A safety/security grating can be placed in the light well under the glazing for this toplighting scheme. (Light control louvers and baffles may also serve this function.) Make sure this grating does not create a shadow pattern on the wall. See Daylighting Design Considerations in the electronic Appendix for more discussion of safety and security issues with toplighting.
- **Leakage.** All roof penetrations have leakage liabilities. Use well-tested curb design details and flashing kits provided by the manufacturer. Any operable opening should prevent rain penetration.

Monitors

Monitors with glazing oriented north/south (elongated east/west) will exhibit the least variation of daylight levels throughout the day and will be easiest to design for good energy performance. South-facing vertical glazing should have an overhang, or spectrally selective low-e coating (SHGC less than .45) to reduce solar gains during the cooling season combined with baffles or diffusing glazing to eliminate direct sun. Monitors with glazing oriented east or west are more likely to show variations in light level and quality from morning to afternoon. If the east-west orientation is required, a skylight may perform better than a monitor.

Operation and Maintenance Issues

- Educate teachers about how wall wash toplighting delivers daylight to the space; discourage them from placing dark colored artwork and posters high on the washed wall.
- Clean glazing on a schedule. Horizontal glazing needs more frequent cleaning in climates with low rainfall.
- The mechanisms for operable louvers and blackout shades should be robust, accessible to the instructor and easily repaired.
- The janitorial service should check all operable windows or skylights for closure daily.

Commissioning

Check to ascertain that operable louvers and shades are working. Set angles of adjustable louvers to eliminate direct sun penetration.

References/Additional Information

See the Overview section of this chapter.

Related Volume III CHPS Criteria

See the Overview section of this chapter.

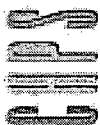

Guideline DL5: Central Toplighting

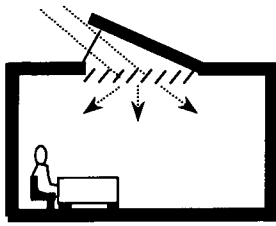

Recommendation

Use central toplighting in single-story classrooms to provide high levels of even, balanced daylight across the entire room.

Description

Central toplighting uses a central monitor or skylight (or cluster of skylights) to distribute daylight evenly across the room. Daylight is diffused with diffusing glazing or baffles that can be fixed or operable. Daylight levels are highest directly under the aperture and gradually reduce toward the perimeter of the space.

Applicability

Central toplighting is applicable in single-story or top floor spaces including classrooms, libraries, multipurpose spaces, and administrative offices. It is appropriate for all climate regions, and should be considered during the programmatic, schematic, and design development phases of a school building project.

Applicable Codes

The California Energy Code specifies the minimum performance of fenestration products and it limits window area to a maximum of 5% of the exterior roof area.

Integrated Design Implications

- **Integration with site plan.** This toplighting scheme applies to single-story buildings or the top floor only of a multi-story building. It must be planned for in the schematic design.
- **Skylight vs. vertical glazing.** The glazing for a central toplighting scheme may be either horizontal or vertical (facing north, east, south, or west). See Daylighting Design Considerations in the on-line Appendix for a discussion of the energy performance of horizontal versus vertical glazing facing in different orientations and an evaluation of the relative HVAC loads.
- **Balance with other daylight.** This scheme may be combined with view windows in perimeter walls. Since the toplighting aperture provides most of the ambient daylight, smaller windows can be judiciously spaced in exterior walls to optimize views and valuable wall space can be relinquished for other needs. The total glazing area should be apportioned among these needs.
- **Integration with HVAC.** Placement of skylights and monitors, and their associated light wells, must be coordinated with the location of rooftop HVAC equipment and interior ducts.

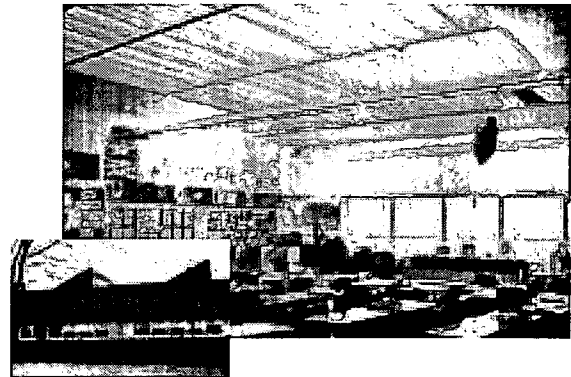

Central sawtooth monitor provides even illumination across desktops in this classroom. Photo courtesy: Barbara Erwine.

Applicable Spaces	Climates	When to Consider
Classrooms	South Coast	Programming
Library	North Coast	Schematic
Multi-Purpose / Cafeteria	Central Valley	Design Dev.
Gym	Mountains	Contract Docs.
Corridors	Desert	Construction
Administration		Commissioning
Toilets		Operation
Other		



- **Integration with electric lighting.** Central daylighting schemes often fail to provide bright illumination on interior walls. Electric lighting wall wash fixtures may be needed to supplement the daylight.
- **Integration with mechanical ventilation.** If the toplighting fenestration is operable, it can be used to naturally ventilate the space. Evaluate the thermal stratification of air in the space and the prevailing wind conditions to assess the feasibility.
- **Safety and security.** Toplighting scenarios on relatively flat roofs have both safety and security issues that should be considered. The Daylighting Design Considerations in the on-line Appendix discusses these concerns in more detail.



*Classroom with central skylight and splayed light well walls.
Photo courtesy PJHM Architects*

Cost Effectiveness

Costs for central toplighting are medium to high, depending on design. Commercial, double glazed skylights or a diffusing, double wall panel system with a sheetrocked well will be the least expensive. Site-built monitors with vertical or sloped glazing will cost more.

Costs	L			
	M			
	H			
		L	M	H
		Benefits		

Benefits

Central toplighting provides a high level of benefits. With good diffusion, this approach creates even, balanced daylight across the classroom, which has been correlated with higher standardized test scores. (However, uncontrolled direct sun toplighting in classrooms has been associated with lower standardized test scores. See this chapter's Overview for details.)

This approach saves electric lighting energy if the electric lights are switched off or dimmed in response to the daylight. Savings may be 40% to 80% during daylight hours.

Operable louvers can provide variable amounts of daylight for different classroom activities.

Operable skylights or monitor glazing can provide the top outlet for a natural ventilation scheme that draws fresh air in through a lower aperture. Natural ventilation may improve student performance, having been positively correlated with higher student scores on standardized tests.

Design Tools

The computer simulation programs and scale models described in this chapter's Overview can be used to demonstrate daylight distribution and resultant daylight levels. If the design includes sloped surfaces, check that the simulation program can handle this. The SkyCalc program can be used to optimize the size and energy performance of a central skylight scheme.

Design Details

General

- **Visible transmittance.** Use high visible transmission glazing materials (greater than 60%) to maximize daylight while minimizing the size of the glazed area with its relatively low U-factor. Single glazing is adequate for most California climates. Double glazing is recommended for mountain regions. Alternatively, larger areas of low-transmission glazing with high insulation levels, such as insulated fiberglass panels, may be used successfully. The balance between visible transmittance and insulation levels is best studied with an hourly climate simulation software tool.



- **Orientation.** Optimize the toplighting design for the climate and budget. A skylight will perform better in a predominantly overcast sky condition or non-optimum orientation. A well-designed, north- or south-facing monitor will be more expensive, but may perform better than a skylight for sunny climates with high air conditioning loads.
- **Reflective materials.** A light well connects the upper aperture with the ceiling plane of the classroom. Light well walls should be highly reflective (>80% reflectance). Bright white, flat paint works best. Diffusely reflecting light wells should be less than 8 ft deep; specular reflecting wells can be used for deeper wells when necessary.
- **Diffusion.** Diffuse the daylight with diffusing glazing or baffles. Design baffles to cut off all expected sun angles or to be adjustable. Avoid placing diffusing glazing within the normal field of view, as it will cause excessive glare.
- **Splayed light wells.** Splay light well walls to spread the daylight more effectively in the space and reduce glare. A 45° to 60° angle works best.
- **Insulation.** Insulate light well walls to an R-value at least equivalent to the code requirement for wall insulation to minimize thermal losses and reduce condensation.
- **Blackout capability.** Add blackout capability, as needed, and louvers to modulate the daylight levels.
- **Integration with electric lighting.** If the light well is visible (not obscured by baffles), provide some electric light so it does not become a “dark hole” at night. Pendant upright fixtures work well. Photoswitch these lights in response to daylight levels. See the Electric Lighting and Controls chapter for information about control of electric lights in response to available daylight.
- **Safety and security.** A safety/security grating can be placed in the light well under the glazing for this toplighting scheme. (Light control louvers and baffles can also serve this function.) Make sure this grating does not create a shadow pattern on the wall. See Daylighting Design Considerations in the on-line Appendix for more information about safety and security issues with toplighting.
- **Leakage.** All roof penetrations have leakage liabilities. Use well-tested curb design details and flashing kits provided by the manufacturer.
- **Reflectors.** A reflecting device may be placed below the light well to redirect daylight onto the ceiling or walls of the space. This ceiling/wall wash will make the space appear larger and brighter, even though horizontal footcandles measured at desk height may be reduced. The reflector may consist of flat or curved mirrored or matte reflective surfaces. It may also be partially translucent (fabric, plastic, or perforated metal). This device will require extra floor to ceiling height and should be studied with a physical scale model to evaluate daylight distribution.

Skylights

Use a glazed area of about 3% to 12% of the floor area. Use the lower end of this range for spaces with high air conditioning or heating loads, and the higher end for temperate climates with more overcast skies. In cold climates, consider south-facing clerestories instead of skylights.

Monitors

A sawtooth monitor with glazing oriented north will exhibit the least variation of daylight levels throughout the day and will have better energy performance than east or west glazing. South-facing vertical glazing should have an overhang or spectrally selective low-e (SHGC less than .45) to reduce solar gains during the cooling season. Avoid sawtooth monitors with glazing oriented east or west; they will show large variations in light level and quality from morning to afternoon, and will have poor thermal performance.

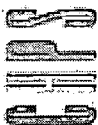

Operation and Maintenance

- Clean glazing on a regular schedule. Horizontal glazing needs more frequent cleaning in climates with low rainfall.
- Mechanisms for operable louvers and blackout shades should be robust, accessible to the teacher, and easily repaired.

Commissioning

Check that operable louvers and shades are working. Set angles of adjustable louvers to eliminate direct sun penetration.

References/Additional Information

See the Overview section of this chapter.

Related Volume III CHPS Criteria

See the Overview section of this chapter.



Guideline DL6: Patterned Toplighting

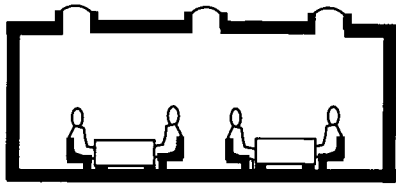

Recommendation

Use patterned toplighting in interior spaces that need even, low glare illumination across a large area.

Description

Patterned toplighting provides daylight through a two-dimensional grid of skylights or rows of linear monitors (sawtooth or square). It provides even, glare-free daylight across large areas. Spacing of the pattern is largely a function of the ceiling height.

Applicability

This daylighting pattern is useful for any large area that needs even daylight levels. It is especially good for gymnasium, library, multipurpose, or cafeteria spaces. For gymnasium ball courts, add baffles or high light well cutoff angles to minimize direct views of bright glazing surfaces during ball games (See Design Details below). Patterned toplighting is appropriate for all climate regions, and should be considered during the programmatic, schematic, and design development phases.

Applicable Codes

The California Energy Code specifies the minimum performance of fenestration products and it limits window area to a maximum of 5% of the exterior roof area.

Integrated Design Implications

- **Integration with site plan.** This toplighting scheme applies to single-story buildings or the top floor only of a multi-story building. It must be planned for in the schematic design.
- **Skylight vs. vertical glazing.** The glazing for these patterned toplighting schemes may be either horizontal or vertical (preferably facing north or south). See Daylighting Design Considerations in the on-line Appendix for a discussion of the energy performance of horizontal versus vertical glazing facing in different orientations and an evaluation of the relative HVAC loads.
- **Balance with other daylight.** This scheme may be combined with view windows in perimeter walls. Since the toplighting aperture provides most of the ambient daylight, smaller windows can be judiciously spaced in exterior walls to optimize views, and valuable wall space can be relinquished for other needs. The total glazing area should be apportioned among these needs.

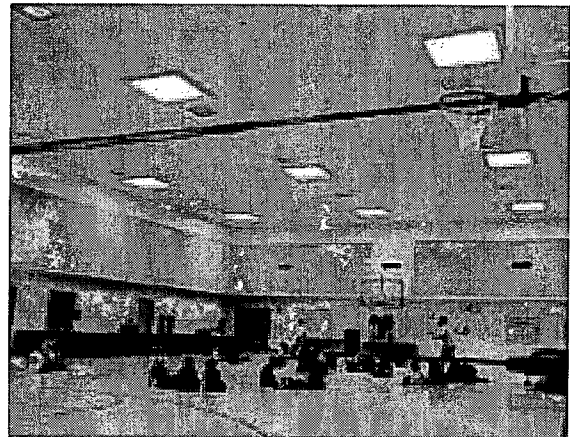

Grid of skylights in Peoria Gymnasium provide even illumination across the space. Photo courtesy Natural Lighting Co., Inc.

Applicable Spaces	Climates	When to Consider
Classrooms	South Coast	Programming
Library	North Coast	Schematic
Multi-Purpose / Cafeteria	Central Valley	Design Dev.
Gym	Mountains	Contract Docs.
Corridors	Desert	Construction
Administration		Commissioning
Toilets		Operation
Other		



- **Integration with HVAC.** Placement of skylights and monitors and their associated light wells must be coordinated with the location of rooftop HVAC equipment and interior duct runs.
- **Integration with mechanical ventilation.** If the toplighting fenestration is operable, it could be used to naturally ventilate the space. Evaluate the thermal stratification of air in the space and prevailing wind conditions to assess the feasibility.
- **Integration with structural system.** Skylights and monitors interrupt the roof diaphragm and structural system. Their size and location may be limited by this and must be coordinated with the structural system to maintain its strength and integrity. See Daylighting Design Considerations in the on-line Appendix for more information about integrating toplighting with structural systems.
- **Safety and security.** Toplighting scenarios on relatively flat roofs have both safety and security issues that should be considered. Check the Daylighting Design Considerations in the on-line Appendix for further discussion of these.

Cost Effectiveness

Costs for patterned toplighting range from low to high, depending on design. A grid of skylights with unfinished wells will be the least expensive; monitors with reflecting devices will be much more expensive. Costs include the expense of the skylight or monitor device; rooftop installation; curbs and waterproofing; interior well construction and finish; and electric lighting controls to switch or dim in response to daylight.

Costs	L			
	M			
	H			
		L	M	H
		Benefits		

Benefits

Patterned toplighting provides a high level of benefits. This approach creates even, balanced, low-glare daylight across the space. This approach saves electric lighting energy if the electric lights are switched off or dimmed in response to the daylight. Savings may be 40% to 80% during daylight hours.

Operable louvers can provide variable amounts of daylight for different activities. Operable skylights or monitor glazing can provide the top outlet for a natural ventilation scheme that draws fresh air in through a lower aperture. Natural ventilation may improve student performance, having been positively correlated with higher student scores on standardized tests.

Design Tools

The computer simulation programs and scale models described in this chapter's Overview can be used to demonstrate daylight distribution and resultant daylight levels. If the design includes sloped surfaces, check to ensure the simulation program can handle this. The SkyCalc program can be used to optimize the size of skylight schemes.

Design Details

General

- **Optimize for climate and budget:** A grid of skylights will perform better in a predominantly overcast sky condition. A series of well-designed monitors will be more expensive, but will perform better than a skylight for sunny climates with high air conditioning loads.
- **Visible transmittance:** Use high visible transmission glazing materials (greater than 60%) to maximize daylight while minimizing the size of the glazed area with its relatively low U-factor. Single glazing is adequate for most California climates. Double glazing is recommended for mountain regions. **Diffusion:** Diffuse the daylight with diffusing glazing or baffles. Design baffles to cut off all expected sun angles or to be adjustable. Avoid placing vertical diffusing glazing within the normal field of view.
- **Splayed light wells:** For deeper, narrow light wells, splay the light well walls to spread the daylight more effectively in the space and reduce glare. A 45° to 60° angle works best.
- **Reflectance:** A light well connects the upper aperture with the ceiling plane of the classroom. Light well walls should be highly reflective (>80% reflectance). Bright white flat paint works best. Diffusely



reflecting light wells should be a maximum of 6 ft to 8 ft deep; specular reflecting wells can be used for deeper wells when necessary.

- **Insulation:** Insulate light well walls to minimize thermal losses and reduce condensation. Use an R-value at least equivalent to the code requirement for wall insulation.
- **Blackout capability:** Add blackout capability, as needed, and louvers to modulate the daylight levels.
- **Safety and security:** A safety/security grating can be placed in light wells under the glazing for this toplighting scheme. (Light control louvers and baffles can also serve this function.)
- **Leakage:** All roof penetrations have leakage liabilities. Use well-tested curb design details and flashing kits provided by the manufacturer.

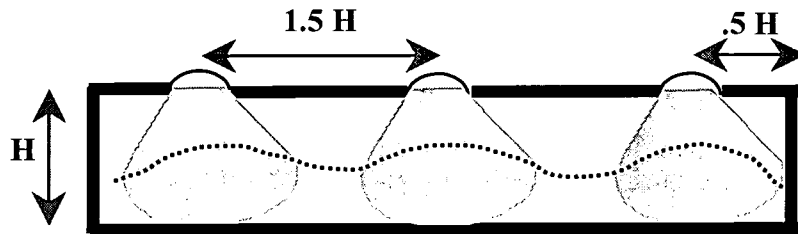

Figure 24 – Skylight Grid Spacing

Skylight Grid

As a rough rule of thumb, skylights should be spaced about one-and-a-half times the floor-to-ceiling height (H in Figure 24 above). Their glazing should be about 3% to 12% of the floor area to be lighted. (Use SkyCalc to optimize the design.)

Series of Monitors

Sawtooth monitors with glazing oriented north will exhibit the least variation of daylight levels throughout the day and will have better energy performance than east or west glazing. South-facing vertical glazing should be smaller and should have an overhang or spectrally selective low-e coating (SHGC less than .45) to reduce solar gains during the cooling season. Avoid sawtooth monitors with glazing oriented east or west; they will show large variations in light level and quality from morning to afternoon, and poor energy performance.

Operation and Maintenance

- Clean glazing on a regular schedule. Horizontal glazing needs more frequent cleaning in climates with low rainfall.
- Mechanisms for operable louvers and blackout shades should be robust, accessible to the instructor, and easily repaired.

Commissioning

Check that operable louvers and shades are working. Set angles of adjustable louvers to eliminate direct sun penetration.

References/Additional Information

See the Overview section of this chapter.

Related Volume III CHPS Criteria

See the Overview section of this chapter.

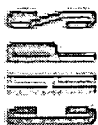

Guideline DL7: Linear Toplighting

Recommendation

Use linear toplighting as a single downlighting element in a long, linear space (such as a corridor) to direct movement or establish a visual orientation. Use it on two sides of a space to define separate functions or activities, to define edges in a larger space, and/or to downlight the space from two directions.

Description

Linear toplighting is a downlighting scheme that provides a line of high intensity daylight directly under it, which diminishes as an individual moves perpendicularly away from it. It establishes a strong longitudinal orientation in the space and is best coupled with a corresponding circulation pattern or linear visual cue. Used bilaterally (from two sides), it can frame a larger space.

Applicability

This daylighting pattern is useful for enclosed hallways and linear walkways within a larger space, or for use bilaterally to frame centrally focused areas like gymnasiums, libraries, and multipurpose areas. Linear toplighting may also be used in covered exterior walkways to minimize their shadow, especially in covered walkways adjacent to rooms with sidelighting.

Applicable Codes

The California Energy Code specifies the minimum performance of fenestration products and it limits window area to a maximum of 5% of the exterior roof area.



Linear skylight in this library spreads daylight to adjacent spaces and organizes the circulation

Applicable Spaces	Climates	When to Consider
Classrooms	South Coast	Programming
Library	North Coast	Schematic
Multi-Purpose / Cafeteria	Central Valley	Design Dev.
Gym	Mountains	Contract Docs.
Corridors	Desert	Construction
Administration		Commissioning
Toilets		Operation
Other		

Integrated Design Implications

- **Design Phase.** This toplighting scheme applies to single-story buildings or the top floor only of a multistory building. It must be integrated with the site plan and building massing and should be planned for in the schematic design phase.
- **Balance with other daylight.** Since overall glazing area is limited, the amount of glazing in a linear toplighting scheme must be balanced with the need for view windows and other apertures in the space.
- **Integration with electric lighting.** Electric lighting should be aligned with the toplighting without blocking it and causing shadows on the floor.
- **Integration with structural system.** Skylights and monitors interrupt the roof diaphragm and structural system. Their size and location may be limited by this and must be coordinated with the

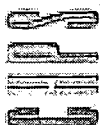

structural system to maintain its strength and integrity. See Daylighting Design Considerations in the on-line Appendix for more about integrating toplighting with structural systems.

- **Integration with HVAC.** Placement of the linear toplight and its associated light well must be coordinated with the location of rooftop HVAC equipment and interior duct runs. Interruptions in the linear run of this toplight may be required to accommodate these other needs. The interruptions should be sequenced in a regular manner to prevent a random pattern of light and dark.
- **Integration with mechanical ventilation.** If the toplighting fenestration is operable, it could be used to naturally ventilate the space. Evaluate thermal stratification of air in the space and prevailing wind conditions to assess the feasibility.
- **Safety and security.** Toplighting scenarios on relatively flat roofs have both safety and security issues that should be considered. Check Daylighting Design Considerations in the on-line Appendix for further discussion.

Cost Effectiveness

Costs for linear toplighting range from moderate to high, depending on design. A linear row of skylights will be the least expensive; monitors with reflecting devices will be more expensive. Costs include the expense of the skylight or monitor device; rooftop installation; curbs and waterproofing; interior well construction and finish; and electric lighting controls to switch or dim in response to daylight.

Costs	L			
	M		■	
	H		■	
		L	M	H
		Benefits		

Benefits

Linear toplighting provides a high level of benefits. This approach creates bright, welcoming corridors that link important functions in the building. It can provide a strong visual cue for circulation that guarantees daytime egress lighting independent of electric power. In a bilateral scenario, it can provide balanced daylighting that graduates from high at the perimeter to moderate between the two linear toplights.

This approach saves electric lighting energy if the electric lights are switched off or dimmed in response to the daylight. Savings may be 40% to 80% during daylight hours.

Operable skylights or monitor glazing can provide the top outlet for a natural ventilation scheme that draws fresh air in through a lower aperture. Natural ventilation may improve student performance, having been positively correlated with higher student scores on standardized tests.

Design Tools

The computer simulation programs and scale models described in this chapter's Overview can be used to demonstrate daylight distribution and resultant daylight levels. If the design includes sloped surfaces, check to ensure the simulation program can handle this. The SkyCalc program can be used to optimize the size of a skylight scheme.

Design Details

- **Visible transmittance.** Use high visible transmission glazing materials (greater than 60%) to maximize daylight while minimizing the size of the glazed area with its relatively low U-factor. Single glazing is adequate for most California climates. Double glazing is recommended for mountain regions. Alternatively, larger areas of low-transmission glazing with high insulation levels, such as insulated fiberglass panels, may be used successfully. The balance between visible transmittance and insulation levels is best studied with an hourly climate simulation software tool.
- **Glazing area vs. floor area.** Use a glazed area of about 3% to 12% of the floor area. Use the lower end of this range for spaces with high air conditioning or heating loads, and the higher end for temperate climates with more overcast weather.
- **Circulation.** When applicable, coordinate linear toplighting with major circulation areas in the school. Increase light levels at major intersections and hallway ends to draw students in that direction.

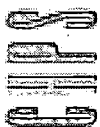

- **Diffusion.** Either diffuse daylight or direct sun may be used in circulation and transition areas. Daylight diffused with translucent glazing or baffles will spread the daylight evenly in the space, making the most effective use of the light. Occasional patches of direct sun can create a vibrant splash of light to emphasize major intersections and circulation spines. Some designs have successfully combined patterns of diffusing glazing with smaller areas of transparent glazing to animate a circulation space.
- **Shared daylighting.** Consider sharing diffuse corridor daylight with adjacent spaces by glazing the upper portion of the wall. Avoid this in areas where acoustic separation is important. In multistory buildings, consider sharing daylight from the top floor corridor with the lower floor by periodically cutting light wells to the lower level.
- **Splayed light wells.** For diffusing skylights with deeper, narrow light wells, splay the light well walls to spread the daylight more effectively in the space and reduce glare. A 45° to 60° angle works best.
- **Insulation.** Insulate light well walls to an R-value at least equivalent to the code requirement for wall insulation to minimize thermal losses and reduce condensation.
- **Safety and security.** A safety/security grating can be placed in the light well under the glazing for this toplighting scheme. (Light control louvers and baffles can also serve this function.) Make sure this grating does not create a shadow pattern on the wall.
- **Leakage.** All roof penetrations have leakage liabilities. Use well-tested curb design details and flashing kits provided by the manufacturer.

Operation and Maintenance

Clean glazing on a schedule. Horizontal glazing (and clear glazing) needs more frequent cleaning in climates with low rainfall.

Commissioning

Check that operable louvers and shades are working. Set angles of adjustable louvers to eliminate direct sun penetration.

References/Additional Information

See the Overview section of this chapter.

Related Volume III CHPS Criteria

See the Overview section of this chapter.

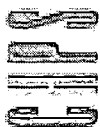

Guideline DL8: Tubular Skylights

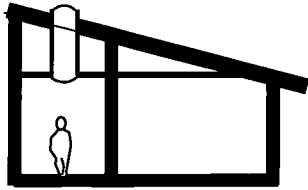

Recommendation

Use tubular skylights for toplighting in areas with relatively deep roof cavities and for low-cost retrofits to existing spaces.

Description

Tubular skylights are small clear-domed skylights with mirrored reflective ducts connecting them to the ceiling plane of the space. They have an interior diffuser at the ceiling plane to spread daylight in the space. They may have electric lighting within the duct or diffuser that is switched or dimmed in response to the available daylight. Since they depend on multiple reflections to deliver daylight to the space, they perform better under direct sun than overcast sky conditions.

Applicability

Tubular skylights are especially good for small spaces, such as toilet rooms, locker rooms, kitchens, interior corridors, enclosed staff work areas, and other interior spaces that are sporadically occupied and would benefit from a low-cost toplighting solution. They are also good for retrofit into any existing school space that needs extra daylight or needs to balance an existing asymmetric daylight distribution.

These units will work significantly better in clear sky climates than in overcast climates. As the duct gets longer, less daylight is delivered; so they are limited to spaces with roof cavities of 8 ft or less.

Applicable Codes

The California Energy Code specifies the minimum performance of fenestration products and it limits window area to a maximum of 5% of the exterior roof area.

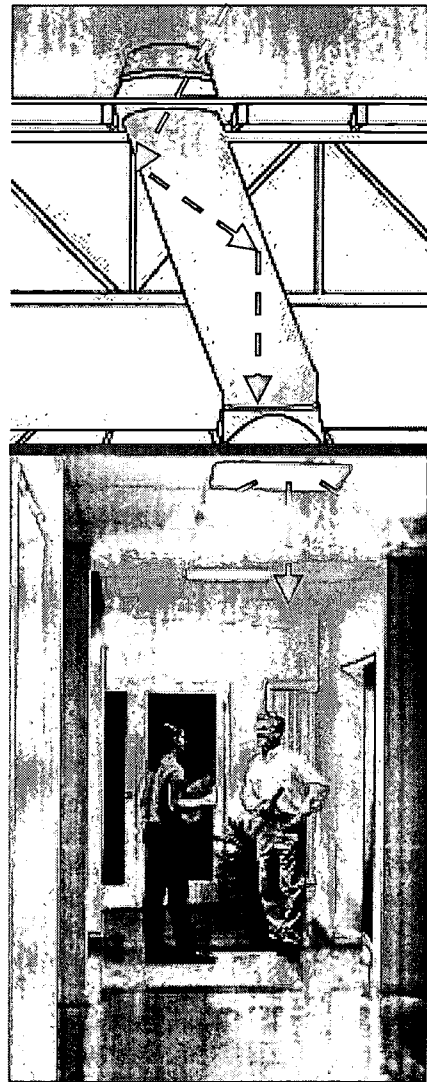

Tubular skylight. Photo courtesy Solatube, Inc.

Applicable Spaces	Climates	When to Consider
Classrooms	South Coast	Programming
Library	North Coast	Schematic
Multi-Purpose Cafeteria	Central Valley	Design Dev.
Gym	Mountains	Contract Docs.
Corridors	Desert	Construction
Administration		Commissioning
Toilets		Operation
Other		

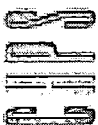

Integrated Design Implications

- **Integration with site plan.** This toplighting scheme applies to single-story buildings or the top floor only of a multistory building. It must be planned for in schematic design.
- **Balance with other daylight.** This scheme may be combined with view windows in perimeter walls. Since the toplighting aperture provides most of the ambient daylight, smaller windows can be judiciously spaced in exterior walls to optimize views and valuable wall space can be relinquished for other needs. The total glazing area should be apportioned among these needs.
- **Integration with HVAC.** Placement of tubular skylights must be coordinated with the location of rooftop HVAC equipment and interior duct runs. Although the reflective ducts can jog to avoid barriers in the ceiling plenum space (within reason), efficiency of daylight delivery is reduced with each change in direction.
- **Integration with structural system.** Skylights interrupt the roof diaphragm and structural system. Their size and location may be limited by this and must be coordinated with the structural system to maintain its strength and integrity. The small diameter of these units reduces their impact on the structural system relative to larger framed skylights. See Daylighting Design Considerations in the on-line Appendix for more on integrating toplighting with structural systems.
- **Integration with electric lighting.** Some tubular skylights come equipped with compact fluorescent (or incandescent) electric lights within the duct or ceiling plane diffuser that can be switched or dimmed in response to daylight. Ascertain that any included electric light not block the daylight delivered through the device.
- **Safety and security.** Unless these skylights are larger than 16 in.², they should not pose a safety or security liability.

Cost Effectiveness

Costs for tubular skylights are low. For smaller spaces like hallways and offices, 10 in. and 14 in. tubular skylights cost approximately \$300 and \$400 (not including installation costs), respectively.

Costs	L			
	M			
	H			
		L	M	H
		Benefits		

Benefits

Tubular skylights provide a moderate level of benefits. This approach provides daylight "fixtures" that deliver daylight through a ceiling plenum to an interior space. Arranged in a grid, they can provide even, balanced daylight across the space, though daylight levels will fluctuate widely between direct sun and overcast sky conditions. Daylight in classrooms has been correlated with higher standardized test scores. See this chapter's Overview for details.

This approach saves electric lighting energy if the electric lights are switched off or dimmed in response to the daylight. Savings may be 20% to 60% during daylight hours.

Design Tools

The specular reflective tube makes it difficult to simulate the performance of these skylights with physical scale models and computer tools. Local case studies, test installations, and estimating tools from the manufacturers are the best tools for evaluating performance. Designers should take note that many manufacturers of tubular skylights have made exaggerated claims about both daylight delivery and R-value of their products.

Energy performance of these skylights is also handicapped by the lack of U-factor and SHGC data. As this information becomes available, hourly building energy evaluation programs like DOE-2, EnergyPlus, and Energy-10 can be used to evaluate the energy impacts.

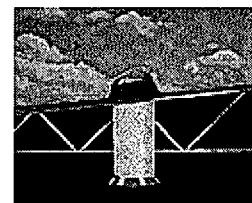

Cross section of tubular skylight.
Courtesy of Solatube, Inc.



Design Details

- **Length and bends.** Minimize the overall length and minimize bends in the reflective duct running from the skylight to the ceiling plane.
- **Reflective ducts.** Use a product with a highly reflective cylindrical duct. Do not use a corrugated duct; the corrugations trap light.
- **Half dome vs. full dome.** In predominantly sunny climates, use a tubular skylight with a south-facing, reflective half-dome under the skylight "bubble" to increase the reflection of low angle winter sun into the skylight (see Figure 25 below). In predominantly overcast climates, use a full clear dome. Special lenses or geometric shapes can also help to catch low angle sun and direct it downward.

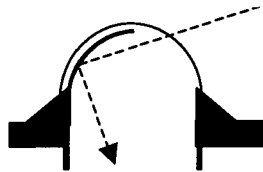

Figure 25 -- Section of Reflective Half Dome

- **Diffusers.** Some products have a flat bottom diffuser that fits into a standard 2 ft x 2 ft or 2 ft x 4 ft dropped ceiling grid. These may incorporate the electric lighting in them or may alternate in a grid with recessed fluorescent electric lighting fixtures.



Tubular skylights in interior administrative office provide high lighting levels even when electric lights are off. Skylight diffuser panel fits into a standard suspended ceiling system. Photo courtesy of Solatube.

- **Insulation.** For ducts installed in uninsulated ceiling or attic spaces, insulate the duct to an R-level at least equivalent to the code requirement for air ducts to minimize thermal losses and reduce condensation.
- **Leakage:** All roof penetrations have leakage liabilities. Use well-tested curb design details and flashing kits provided by the manufacturer.

Operation and Maintenance

Clean glazing on a schedule. Horizontal glazing needs more frequent cleaning in climates with low rainfall.

Commissioning

None.

References/Additional Information

See the Overview section of this chapter.

Related Volume III CHPS Criteria

See the Overview section of this chapter.

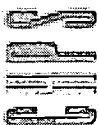

(This page intentionally left blank.)

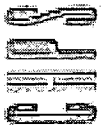

BUILDING ENCLOSURE AND INSULATION

The design of the school building enclosure — or envelope — entails many considerations. The materials — both indoors and out — must be durable, resistant to vandalism, easy to clean, and inexpensive. They must be strong enough to meet seismic codes, yet appear inviting. Add energy efficiency and sustainability to this list and the job of the design team is even more complex.

This chapter provides technical guidelines for the school building enclosure, including:

Wall Insulation (Guideline IN1)

Roof Insulation (Guideline IN2)

Cool Roofs (Guideline IN3)

Radiant Barriers (Guideline IN4)

Reduce Infiltration (Guideline IN5)

Concrete Masonry (Guideline IN6)

Fenestration (windows and skylights) is addressed in the chapter on Daylighting and Fenestration Design.

The construction of the building enclosure, especially its color, levels of insulation and thermal mass, has a significant effect on energy efficiency and occupant comfort. The building enclosure also affects acoustic comfort as it can attenuate site and traffic noise. The selection of materials for the construction of the building enclosure affects school resource efficiency, including transport energy, the volume and type of raw materials that must be extracted from the earth, the energy required for manufacturing, and packaging. Building shell construction also affects thermal comfort. Even when heating and cooling systems are large enough to make up for poorly insulated components, the building's surface temperature may be cold or hot (depending on season), and this affects the radiant temperature of the space.

Overview

Heat Transfer through the Building Enclosure

Heat transfer through envelope components is quite complex and dynamic. The direction and magnitude of heat flow is affected by solar gains from the sun, outdoor temperature, and indoor temperature. Building envelope components have three important characteristics that affect their performance: their U-factor or thermal resistance (R-value); their thermal mass or ability to store heat, measured as heat capacity (HC); and their exterior surface condition/finish (for example, are they light in color to reflect the sun or dark to absorb solar heat?). These concepts are explained in greater detail below. Also discussed below is the use of radiant barriers to reduce heat transfer in certain situations.



U-factor

The U-factor is the rate of steady-state heat flow. It is the amount of heat in British thermal units (Btu) that flows each hour through 1 ft² of surface area when there is a 1°F temperature difference between the inside and outside air. Heat flow can be in either direction, as heat will flow from the warmer side to the cooler side. Insulation and most other building materials affect heat flow equally in both directions, but some construction elements such as radiant barriers may reduce heat flow entering the building, but have little impact on heat leaving the building.

Steady-state heat flow assumes that temperatures on both sides of the building envelope element (while different) are held constant for a sufficient period so that heat leaving one side of the assembly is equal to heat entering the opposite side. The concept of steady-state heat flow is a simplification, because in the real world, temperatures change constantly. However, U-factor can predict average heat flow rates over time and is commonly used to explain the thermal performance of construction assemblies. Because they are easy to understand and use, the terms for steady-state heat flow (R-values and U-factors) are part of the basic vocabulary of building energy performance.

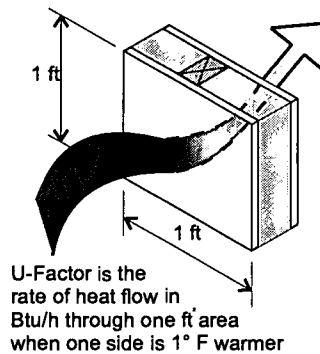
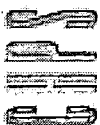

Figure 26 – Concept of U-factor

With metal framing, thermal bridges have a significant impact on the performance of the overall assembly, sometimes reducing the insulation effectiveness to less than half. The U-factor accounts for thermal bridges and the conductance of every element of the construction assembly, including the air film conductances on the interior and exterior surfaces. The air film conductances quantify the rate at which heat is transferred between the surface of the construction assembly and the surrounding environment. This conductance depends on the orientation and roughness of the surface and the wind speed across the surface.

For light frame walls, U-factors provide an adequate description of heat transfer. For heavy concrete and masonry walls, however, this is only true under constant temperature conditions. The dynamic heat storage properties of concrete and masonry alter the thermal behavior of the wall, and the U-factor becomes less accurate as a predictor of heat flow (see discussion of HC below).



R-values

R-values are also used to describe steady-state heat flow but in a slightly different way. The R-value is a material property that is proportional to resistance to heat flow. A larger R-value has greater thermal resistance, or more insulating ability, than a smaller R-value. The opposite is true with U-factors, that is, the lower the better.

R-values are widely recognized in the building industry and are used to describe insulation effectiveness. The insulation R-value does not describe the overall performance of the complete assembly, however. It only describes the thermal resistance of the insulation material. The performance of the entire wall assembly can be significantly lower when metal framing or other elements penetrate the insulation.

Most construction assemblies include more than one material in the same layer. For example, a wood stud wall includes cavity areas where the insulation is located and other areas where there are solid wood framing members. The wood areas have a lower R-value and conduct heat more readily than the insulated areas. Framing members must be considered when calculating the U-factor of a wall, roof, or floor assembly. See the Design and Analysis Tools section below for more details.

Thermal Mass

Thermal mass is another important characteristic that affects the thermal performance of construction assemblies. Heavy walls, roofs, and floors have more thermal mass than light ones. Thermal mass both delays and dampens heat transfer (see Figure 27). The time lag between peak outdoor temperature and interior heat transfer is between four and 12 hours depending on the heat capacity of the construction and other characteristics.

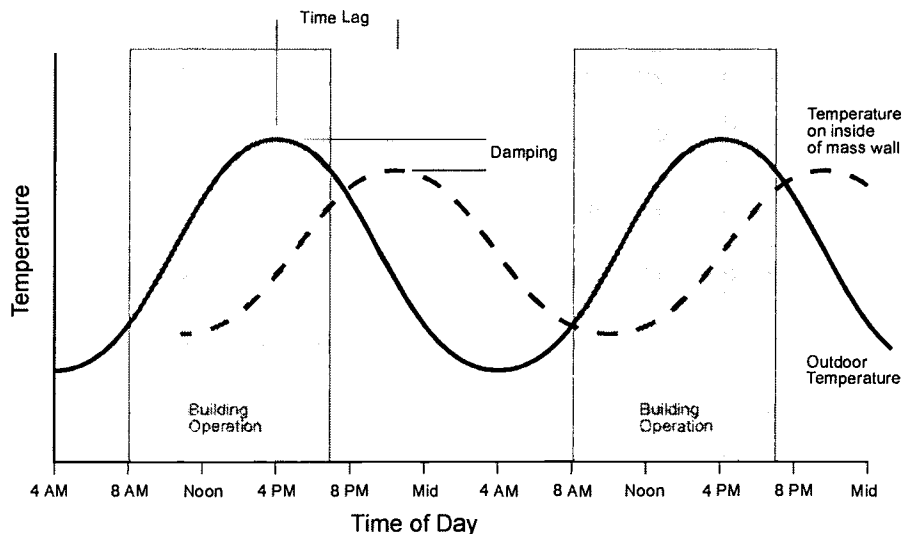

Figure 27 – Temperature Swing

Thermal mass that is exposed to interior air has other benefits as well. If the mass is allowed to cool at night, it will absorb heat during the morning and reduce the cooling load. If the interior thermal mass is exposed to sunlight, it will warm during the day and release the heat at night. Thermal mass used this



way is a basic principal of passive solar design and may be appropriate in the mountain climates of California.

Figure 28 shows examples of mass walls commonly used in school construction.

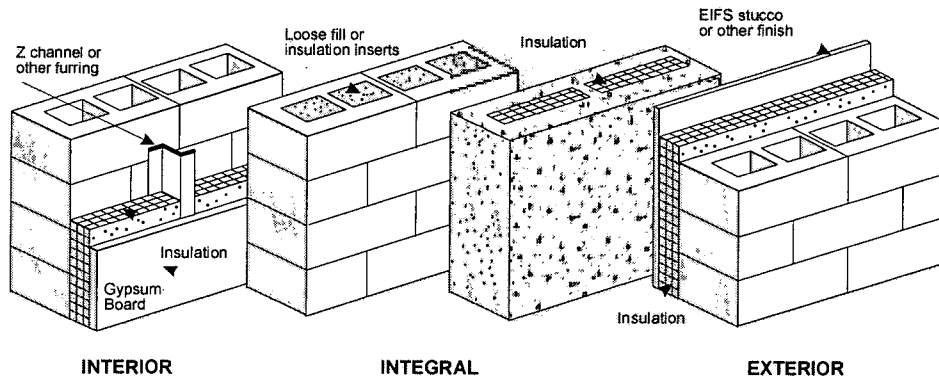

Figure 28 – Mass Wall Constructions

Heat Capacity

HC is the metric used to quantify thermal mass. HC is the amount of heat in Btu that must be added to 1 ft² of surface area in order to uniformly elevate the temperature of the construction by 1°F. The units are Btu/ft²·°F. HC is the sum of the heat capacity of each individual layer in the wall. The heat capacity of each layer is the density of the material times its thickness times its specific heat (all in consistent units). HC can be approximated by multiplying the weight of a ft² of wall, roof, or floor by 0.2. For example, a wall with a weight of 100 lb/ft² has an HC of approximately 20 Btu/ft²·°F.

Many energy standards (including California Title 24) consider HC as a factor in the overall performance of a building envelope component. The California nonresidential standards, for instance, have separate U-factor criteria for different HC ranges.

Concrete is not a very good insulating material. However, some varieties are better than others. There is a class of materials called aerated concrete that has air bubbles entrained in the concrete, which makes the concrete lighter and also improve its insulating ability. Low-density aggregates such as perlite or vermiculite can be used to produce lightweight concrete.

Cool Roofs

Heat transfer is also affected by the exterior surface. This is especially important for roofs. In fact, the term “cool roof” is used to describe those with favorable surface characteristics. Cool roofs have two key features. First, they have a high solar reflectance, which usually means that they are light in color. The high reflectance means that solar radiation is reflected rather than absorbed by the roof surface, keeping the surface temperature lower and reducing heat gain. Second, cool roofs have a high or normal emittance. Emittance is a little harder to understand than reflectance, but it can be just as important to energy performance. Emittance is that percentage of energy that would be radiated to the



sky from a surface. Galvanized metal and other metallic finishes have a low emittance, which means that when they warm up, they can not easily release their heat by radiating it back to the sky.

Radiant Barriers

One last feature of construction assemblies that deserves some discussion is radiant barriers. Many construction assemblies have a large cavity. An attic, for instance, is a cavity separating the roof from the ceiling. Radiant barriers are not typically installed in walls. In construction assemblies that have a cavity, much of the heat transfer from the warmer surface to the colder surface is due to radiation. A radiant barrier can reduce this component of heat transfer. A radiant barrier is a shiny metallic surface on one or more sides of the cavity that has a low emittance. Radiant barriers are commonly installed in attics.

Applicable Codes

The California Nonresidential Energy Efficiency Standards (Title 24) apply to schools, and these standards require that roofs, walls, and floors have a minimum level of insulation. The criteria are expressed both in terms of a minimum R-value and a maximum U-factor. If the prescribed level of insulation is installed, then it is not necessary to make U-factor calculations. For unusual constructions, the maximum U-factor criteria offers more design flexibility.

The requirements vary by climate region and are summarized in Table 19. Roofs must be insulated with at least R-11 insulation in the south coast region, while a minimum of R-19 is required in the other California climate regions. Walls require R-11 along the coast, but R-13 for the valley, desert, and mountains. R-19 floor insulation is required in the mountains and R-11 in the other climate regions.

Table 19 – Title 24 Standards for Building Envelope

		South Coast	North Coast	Central Valley	Desert	Mountains
Roofs	R-value	11	19	19	19	19
	U-value	0.078	0.057	0.057	0.057	0.057
Walls	R-value	11	11	13	13	13
	Wood frame	0.092	0.092	0.084	0.084	0.084
	Metal frame	0.189	0.189	0.182	0.182	0.182
	Mass ($7 \leq HC < 15$)	0.430	0.430	0.430	0.430	0.340
	Mass ($15 \leq HC$)	0.690	0.650	0.650	0.400	0.360
	Other	0.092	0.092	0.084	0.084	0.084
Floors	R-value	11	11	11	11	19
	Mass ($7.0 \leq HC$)	0.158	0.158	0.097	0.158	0.097
	Other	0.076	0.076	0.076	0.076	0.050

Source: California 1998 Nonresidential Energy Efficiency Standards (Title 24)

Design Tools

The thermal performance of construction assemblies can be calculated in many ways. The appropriate method depends on the type and complexity of construction. The basic calculation methods include:

- *Series Calculation Method.* This is the easiest way of calculating U-factor, but its use is limited to constructions that have no framing and are made of homogenous materials.



- *Parallel Path Calculation Method.* This simple extension of the series calculation method can be used for wood-framed assemblies.
- *Effective R-value (Isothermal Planes).* This method uses principles similar to the series and parallel path calculation methods, and is appropriate for construction assemblies such as concrete masonry and metal-framed walls/roofs where highly conductive materials are used in conjunction with insulated or hollow cavities.
- *Two-Dimensional Calculation Method.* Two dimensional heat flow analysis may be used to accurately predict the U-factor of a complex construction assembly. Calculating two-dimensional heat flow involves advanced mathematics and is best performed with a computer.
- *Testing.* This is the most accurate way to determine the U-factor for all types of construction, except slabs-on-grade. But it is costly and time consuming, and because a large variety of possible construction assemblies exist, it is impractical to test them all. Calculation methods are usually more cost-effective.

Table 20 provides guidelines on which method can be used with different types of construction assemblies. These methods are described in greater detail in the electronic Appendix to the Best Practices Manual.

Table 20 – Procedures for Determining U-factors for Opaque Assemblies

	Series Calculation Method	Parallel Path Calculation Method	Effective R-value (Isothermal Planes)	Two-dimensional Calculation Method	Testing
Roofs					
Insulation above Deck	✓			✓	✓
Attic (wood joists)		✓		✓	✓
Attic (steel joists)			✓	✓	✓
Other				✓	✓
Walls					
Mass			✓	✓	✓
Wood Framed		✓		✓	✓
Steel Framed			✓	✓	✓
Other				✓	✓
Below-Grade Walls					
Mass			✓	✓	✓
Other				✓	✓
Floors					
Mass	✓		✓	✓	✓
Steel Joist			✓	✓	✓
Wood Framed		✓	✓	✓	✓
Other				✓	✓

Computer Programs

The calculation methods described above are implemented in a number of design tools and computer programs.

- The EZFrame program, available from the California Energy Commission (CEC), can be used to calculate the U-factor of metal framed wall and roof constructions and accounts for many features such as the gauge of the steel used for framing members, the percent of knockouts in the web, and insulating tape between the framing members and the sheathing. The cost is \$14. For more



BEST COPY AVAILABLE

information, contact the CEC. Tel: (916) 654-5106 or (800) 772-3300. Web site:
http://www.energy.ca.gov/efficiency/computer_prog_list.html

- The Therm program available from Lawrence Berkeley National Laboratory is designed primarily to analyze window frames, but can be used for any type of two-dimensional heat transfer analysis. This program can be downloaded from http://windows.lbl.gov/software/therm/therm_getacopy.htm.
- General-purpose energy simulation programs such as DOE-2 and EnergyPlus can be used to calculate the energy savings of various construction assemblies. With these programs, the dynamics of heat transfer are modeled. In fact, EnergyPlus models the temperature gradient in constructions. DOE-2, on the other hand, uses a more simple response factor method.

Pre-calculated Data

The U-factor of common constructions has been calculated and values are published in a number of sources.

- Appendix B of the 1998 California Nonresidential Manual has a wealth of useful data, including R-values of common materials, pre-calculated U-factors, and other data. The manual can be downloaded from http://www.energy.ca.gov/title24/nonresidential_manual/index.html
- Appendix A of ANSI/ASHRAE/IESNA Standard 90.1-2001 has published values in both inch-pound and metric (SI) units. Constructions include walls, roofs, floors, slabs, and below-grade walls. These values are also contained in the EnvStd 4.0 computer program, which can be downloaded from <http://www.eley.com>.

Indoor Air Quality and Moisture

It is extremely important to provide an exterior weather barrier with drainage plane to prevent moisture from entering construction cavities. Wet or damp construction cavities, attics, and plenums are a major source of mold and can contribute significantly to indoor air quality (IAQ) problems. In addition, moisture can damage the structure and degrade the performance of insulation, increasing energy and operating costs. For example, the California Air Resources Board reports that most of the IAQ complaints that they receive with regard to schools are related to leaky roofs that have resulted in the growth of mold in a plenum or attic space.

Water vapor can also enter construction cavities through a process of moisture migration. Moisture migrates from the warm and humid side of the construction assembly to the cold dry side of the construction assembly. The vapor cools as it moves through the wall may condense into water molecules that can accumulate to cause damage and create mold. To prevent water vapor migration, framed walls, floors, and roofs should have a vapor barrier on the warm moist side. For California climates, this means that the vapor barrier should be on the interior side. Vapor barriers also are available as part of most insulation products and consist of an asphalt-impregnated paper or metal foil. Care should be taken during construction to ensure that this vapor barrier is continuous, tightly secured at the framing members, and not damaged. Special care should be taken in lockers, showers, food preparation areas, and other spaces that are likely to have high humidity.

In addition to correctly installing a vapor retarder, it is important to provide adequate ventilation to dry spaces where moisture can build up. Most building codes require that attics and crawl spaces be ventilated, and some require a minimum one-inch clear airspace above the insulation for ventilation of vaulted ceilings. Even the wall cavity may need to be ventilated in extreme climates. An infiltration

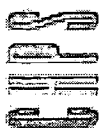

barrier should be installed under slabs with ventilated gravel in areas with soil gas contaminants like radon or methane.

Insulation Protection

Insulation should be protected from sunlight, moisture, landscaping equipment, wind, and other physical damage. Rigid insulation used at the slab perimeter of the building should be covered to prevent damage from gardening or landscaping equipment. Rigid insulation used on the exterior of walls and roofs should be protected by a permanent waterproof membrane or exterior finish. In cold climates, mechanical or other equipment should not be installed in attics, since it can generate heat and cause uneven snow melting and ice dams. For moderate climates, access to equipment installed in attic spaces should be provided in a way that will not cause compression or damage to the insulation, which may mean using walking boards, access panels, and other techniques to prevent damage to the insulation.

In situations where insulation is left exposed (including return air plenums), fiberglass insulation products should be encapsulated in a manner that prevents fibers from becoming airborne. To maintain a continuous vapor barrier, all seams should be sealed with tape or mastic. In this application, simply stapling the insulation is not adequate.

Material Efficiency and Other Environmental Considerations

One of the most effective ways to achieve material efficiency in a building is to reuse all or part of an existing building enclosure. This reduces solid waste produced by a project and avoids the environmental burdens associated with production and delivery of materials for a new building enclosure. Saving the building enclosure, however, may not be appropriate if the existing structure is not energy efficient and cannot be adequately upgraded to meet high performance objectives.

When designing a new building enclosure, material efficiency can be achieved by:

- Using panelized, pre-cut, and engineered construction products.
- Designing with standard dimensions to reduce on-site waste.
- Designing a compact building (this also reduces impervious surface on the site, but may conflict with daylighting objectives).
- Planning for future adaptability to extend the life of the building.
- Choosing durable materials and systems.

In addition, building enclosure and insulation materials exist that are recyclable, include recycled or resource-efficient content, or have other environmentally preferred characteristics. The materials may, for example, avoid introducing toxics into the building or natural environment, or they may be produced using sustainable methods. In addition to the design strategies above, refer to Table 21 below for some easily achievable strategies that will improve the sustainability of the building enclosure and insulation.

For specific product recommendations, see GreenSpec: The Environmental Building News Product Directory and Guideline Specifications, available at <http://www.buildinggreen.com/>, and OIKOS's Redi

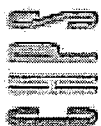

Guide (Resources for Environmental Design Index), available from Iris Communications, (800) 346-0104, <http://www.oikos.com/>.

Table 21 – Strategies for Constructing Resource-efficient Building Enclosures

Building Component	Strategies	Environmental Benefits & Considerations
Foundation and Concrete Work	For concrete materials, specify flyash as replacement, not addition. 10–25% replacement is commonly specified, but higher percentages are possible, depending on application.	Formerly landfilled as industrial waste, flyash is now used to replace energy-intensive Portland cement in concrete mix. Flyash adds workability and strength. Consider using "high volume" flyash concrete (with 50% flyash).
	Use autoclaved and/or aerated concrete for appropriate concrete applications.	Aerated concrete is lighter and has better insulating properties than standard concrete.
	Prohibit dumping concrete waste anywhere intended to be pervious.	Prevents degradation of the site and permits infiltration.
	Use steel rather than wood forms.	Although energy intensive, steel is reusable, contains recycled content and can be recycled at the end of service life.
	If wood forms are used, reuse wood in framing and sheathing.	Reduces resources used. Reduces waste.
	Use low and non-toxic form releases. Bio-based products are available.	Prevents soil contamination, and reduces human health risk. Promotes worker safety. Water-based products should be protected from freezing during storage.
	Use expansion joint fillers with recycled content.	Appropriate use of recycled, relatively low-strength materials, such as waste cellulose from recycled newspapers.
	Use rebar supports with recycled content. DOT-approved products are available with 100% recycled content, including engineered plastics and fiberglass.	Rebar supports in concrete form-work have minimal structural requirements; appropriate use of recycled waste plastic.
	If using ICFs, use options with ozone-friendly foam ingredients. (ICFs are permanent forms with integral insulation that are not disassembled after the concrete is cured. Note: not all ICFs are alike; field R-values can differ significantly so rely on results from completed projects.)	ICFs can provide significant improvements in energy efficiency and can reduce the use of energy-intensive Portland cement. Using ozone-friendly options (with EPS foam) eliminates a source of global warming.
	Use sill sealers to limit infiltration at the foundation.	Increases energy efficiency.
	Use sub-slab ventilation in areas with radon or potential soil gas submissions.	Improves indoor air quality.

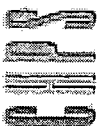

Table 21 – Strategies for Constructing Resource Efficient Building Enclosures (Continued)

Building Component	Strategies	Environmental Benefits & Considerations
Masonry Walls	Use mortar dropping control product to prevent blocking of weep holes. Product available with 100% recycled polyethylene.	Maintains air flow and allows moisture migration from behind masonry veneer facades. Improves building durability.
	For CMUs: maximize recycled content. Typically available with 10% recycled content.	Reduces resources used to produce new CMU material. No difference in product performance or application. Products are high strength, high fire resistance, and highly durable.
	For CMUs: use CMUs containing flyash.	Formerly landfilled as industrial waste, flyash is now used to replace energy-intensive Portland cement in concrete mix. Flyash adds workability and strength.
	For CMUs: consider using lightweight CMUs.	Reduces transportation-related impacts.
	For CMUs: pull watermark line down below window framing to eliminate finishing details. For CMUs: do not paint, order with color.	Reduces maintenance over the life of the building. Avoids resources used to produce paint. Avoids use of VOC-emitting paints generally used to finish CMUs. The pigments typically used in colored CMU are nontoxic and contain none of the solvents associated with painting and re-painting. Products are low maintenance.
Steel Framing	Use systems with highest level of recycled content. Although steel may have as little as 25% recycled content, most structural steel framing has as much as 90% or more. Many load-bearing stud systems include up to 60% recycled content.	High recycled-content steel uses less embodied energy, and minimizes mining waste and pollution associated with virgin steel production. Also generally reduces job site waste, as waste steel is highly recyclable. Transportation of steel uses less energy and creates less pollution compared to dimensional lumber due to weight. Steel conducts heat efficiently. When using light-gauge steel, ensure that insulation is adequate to prevent thermal bridging and heat loss.
	Use fireproofing available with recycled EPS foam and recycled newsprint.	Traditionally, products contained fiberglass and asbestos for this use. More benign products that make efficient use of recycled materials are preferable.
Wood Framing	Use advanced or intermediate framing systems where applicable and accounting for seismic requirements for building site. Example framing elements include 24 in. on-center framing, insulated headers, two stud corners with drywall clips, ladder partitions. References: <i>Builder's Guide</i> – Building Science Corporation, and <i>Efficient Wood Use in Residential Construction</i> – Natural Resources Defense Council.	This both allows for more insulation, less "cold" spots, and increased wood efficiency, thus improving both energy and materials efficiency.
	Use engineered wood products in place of dimensional lumber such as floor joists and roof joists.	Engineered wood products are lighter weight and use fewer resources for the same function as dimensional timbers.
	Use wood certified with Forest Stewardship Council (FSC) or Scientific Certification Service (SCS). A variety of certified dimensional and engineered wood products are available.	Prevents degradation to forest and wildlife habitat.



Table 21 – Strategies for Constructing Resource Efficient Building Enclosures (Continued)

Building Component	Strategies	Environmental Benefits & Considerations
Siding	Use fiber cement siding. Most available factory primed; suggest back priming. Proper painting is important for the siding's long-term durability.	Reduces virgin wood use and can be a durable option.
Roofing	Use metal roofing.	Includes recycled content, is durable, and can be recycled at the end of service life.
	Use non-PVC options for membrane roofing.	Avoids the environmental impacts of PVC manufacturing.
	Consider a green or vegetated roof system for low-slope roofs. These roofs contain plants in a lightweight soil to absorb and slow runoff that would otherwise pour from rooftops. These roof systems typically consist of drainage, soil, and vegetation layers. Be sure to use native plants and grasses in green roof systems.	Can absorb and slow rainwater runoff to reduce peak loads on sewer systems. Helps reduce building heat gain and prevents urban heat islands. Plantings also absorb carbon dioxide. Helps conserve energy in the winter by insulating rooftops. Green roofs, however, require structural steel to support their weight. Because steel has high-embodied energy, this may offset some of the environmental benefits of using green roofs.
Moisture and Waterproofing	Sealants and repellants: Limit use of sealants through proper detailing. Use least-toxic options. Avoid products containing methylene chloride, chlorinated hydrocarbons, aromatic and aliphatic solvents, styrene butadiene, or products containing bactericides and fungicides classified as phenol mercury acetates, phenol phenates, or phenol formaldehyde.	Combining good detailing and low toxicity will prevent air quality problems while promoting long service life of the building.
	Do not rely on caulking for waterproofing. Proper flashing will prevent water from entering the building.	In addition to adding durability to shell, proper flashing prevents mold and mildew build up, reducing health risk.
	If using a vapor retarder, select film available with up to 100% LDPE (plastic).	Utilizes plastic waste that would otherwise be landfilled. Reduces resources required to produce virgin-based material.
Insulation	Use fiberglass insulation with up to 30% verified (SCS) recycled content. California plants use glass collected in CA recycling programs. Formaldehyde-free fiberglass option also available (price premium).	Uses glass collected at curbside recycling programs. Formaldehyde-free option promotes good indoor air quality and promotes worker safety.
	Use cellulose insulation produced with 100% recycled newsprint.	Utilizes paper waste that would otherwise be put in landfills.
	If using rigid insulation with polyisocyanurate foam, use ozone-friendly option.	Prevents further degradation of the earth's atmosphere through global warming.
Exterior Doors (for window recommendations, see Daylighting chapter)	Use doors produced with reclaimed lumber.	Reduces pressure on timber supply, as well as degradation of forest habitat.

Source: Adapted from *GreenSpec: The Environmental Building News Product Directory and Guideline Specifications*

Related Volume III CHPS Criteria

Energy Prerequisite 1: Minimum Energy Performance.

Energy Credit 1: Superior Energy Performance.



Guideline IN1: Wall Insulation

Recommendation

Insulate exterior walls at a level appropriate for each class of construction and climate.

Class of Wall	South Coast, North Coast Climates	Central Valley, Desert, Mountain
Wood-Framed Walls	Insulate 2x4 wood-framed walls with R-13 fiberglass batt insulation or use other insulating materials with a similar thermal resistance. When 2x6 wood framing is needed for structural (or other) reasons, insulate with at least R-19 fiberglass insulation.	Use 2x6 wood studs and advanced framing techniques to increase the percent of insulated cavity in walls. Insulate the cavities with R-19 batt insulation or other materials with a similar thermal resistance.
Steel-Framed Walls	Insulate 2x4 steel-framed walls with R-13 fiberglass batt insulation or other materials with a similar thermal resistance. When 2x6 framing is needed for structural (or other) reasons, insulate the cavities with at least R-19 fiberglass insulation.	Provide a continuous thermal barrier by installing a layer of continuous insulation on either the exterior or interior surface of the wall. Protect the insulation from physical damage and from moisture penetration.
Mass Walls	Shade mass walls from exposure to direct sun. Insulation is marginally cost effective in coastal climates.	Insulate mass walls either by furring on the interior surface, with an Exterior Insulation Finish System (EIFS), or with an integral insulation system.

Description

The construction of exterior walls affects comfort, operating costs, acoustic separation, and the size of heating and cooling systems. The class of construction (wood-framed, steel-framed, or mass) is usually determined by requirements for fire separation between spaces, durability, or other issues. The recommended insulation levels for these classes are based on life-cycle cost analysis and are presented separately for each class and climate region. More insulation is justified in colder climates and less in more temperate climates.

Concepts of thermal heat transfer are presented in this chapter's Overview and should be reviewed, since they apply to walls as well as other building enclosure components.

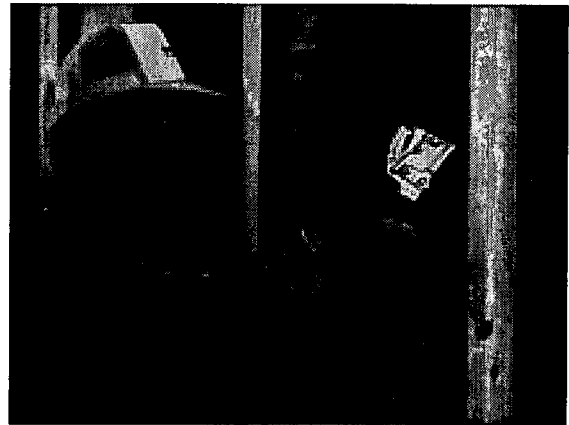

Photo Courtesy: CertainTeed.

Applicability

These recommendations apply to all exterior walls in all spaces that are heated or cooled. Design decisions that affect wall thickness must be considered in the schematic design phase of the project.

Applicable Spaces	Climates	When to Consider
Classrooms	South Coast	Programming
Library	North Coast	Schematic
Multi-Purpose / Cafeteria	Central Valley	Design Dev.
Gym	Mountains	Contract Docs.
Corridors	Desert	Construction
Administration		Commissioning
Toilets		Operation
Other		

Applicable Codes

- For both metal- and wood-framed walls, the California Building Code requires R-11 insulation in the north and south coast climates, and R-13 insulation in the other climate zones. Criteria for framed walls are provided as both a minimum R-value and a maximum U-factor. Only U-factor criteria are provided for mass walls and less insulation is required than for framed walls. See the Overview to this chapter.
- Fire protection codes (the California Building Code) require noncombustible construction for certain classes of schools, which prohibits wood framing. In some instances, walls must provide a four-hour fire separation near property lines and in other applications, which generally requires mass walls.

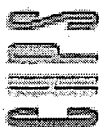

- Structural and seismic safety requirements often dictate the thickness and spacing of framing members. For masonry walls, they usually require at least partial grouting of all exterior walls.

Integrated Design Implications

Well-insulated and sealed walls can reduce drafts and thermal loads in buildings, which can result in smaller HVAC equipment and reduced costs.

Cost Effectiveness

The cost of insulating the cavity of wood- and steel-framed walls is low. However, insulating mass walls is more difficult and expensive. Insulating the cavity of mass walls is not very effective because of thermal bridges across the concrete webs and seismic safety requires that most of the hollow cells be grouted and reinforced. The most effective way to insulate mass walls is to use an Exterior Insulation Finish System (EIFS), which costs \$7/ft² for 1-in. insulation and \$8/ft² for 2-in. insulation. If budget permits, this is the preferred method, since the benefits of the thermal mass are maximized. As an alternative, steel or wood furring can be used on the interior of the wall, batt insulation can be placed in the cavities between the furring strips, and gypsum board can be used as the interior finish.



Rigid Insulation is the most effective way to insulate metal studs. Photo Courtesy: CertainTeed.

Benefits

Insulating walls has several important benefits for high performance schools:

- Energy use is reduced.
- Natural ventilation can be used for a greater number of hours.
- Smaller HVAC equipment can be purchased, which can reduce initial cost.
- Greater acoustic separation is provided from the outdoors.
- Spaces are more comfortable because the interior surface temperature will be closer to room temperature, which provides more uniform interior temperatures and can reduce drafts.

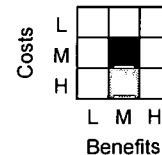

Design Tools

The Overview section of this chapter has a discussion of methods and procedures for calculating U-factors. Energy simulation programs are recommended for analyzing insulation options for mass walls, because of the time delays and dynamic effects inherent with this type of construction.

Design Details

- For framed walls, provide a continuous vapor barrier on the inside surface of walls. If the vapor barrier that comes with batt insulation is used, then the paper or foil should be stapled to the face of the studs, not the inside. This will provide



Masonry walls can be insulated on the interior, but the benefits of thermal mass are mostly lost. Photo Courtesy: CertainTeed.

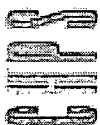

a more secure and continuous vapor barrier and will reduce compression of insulation.

- For wood framing in the central valley, desert, and cold climates, use 2x6 framing. The studs should be spaced at 24 in. o. c., the headers over doors and windows should be insulated with rigid insulation, and minimum wood framing should be used at corners, wall intersections and openings.
- EIFS systems used with mass walls should be installed according to manufacturers' instructions. Make sure that the exterior finish is durable and weather resistant.
- Electrical and mechanical equipment should be minimized for exterior walls. Equipment such as electrical outlets and other recessed equipment can create thermal bridges and increase infiltration.
- For wood framed walls, use wood products that are produced through sustainable forest practices. Require that framing members be certified by the Forrest Stewardship Council.
- For metal-framed walls, specify that the steel used for manufacturing have 30% recycled content.

Operation and Maintenance Issues

Exterior and interior wall finishes must be maintained. The interior finish should be maintained for aesthetic reasons, but also light colors should be maintained to enhance the performance of the electric lighting and daylighting systems. Exterior surfaces should be maintained to be waterproof or water resistant, and secure. This is important to prevent water from entering construction cavities, which can cause the growth of mold, damage the structure, and deteriorate the performance of thermal insulation. Mold can be a major source of indoor air quality problems and needs to be avoided.

Commissioning

No commissioning of exterior walls is needed other than normal construction administration.

References/Additional Information

See the Overview section of this chapter.

Related Volume III CHPS Criteria

See the Overview section of this chapter.

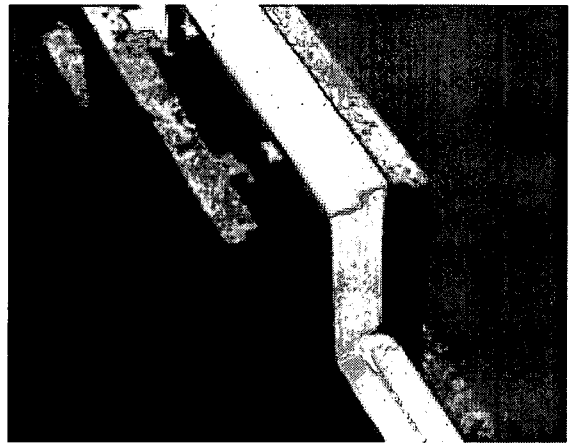
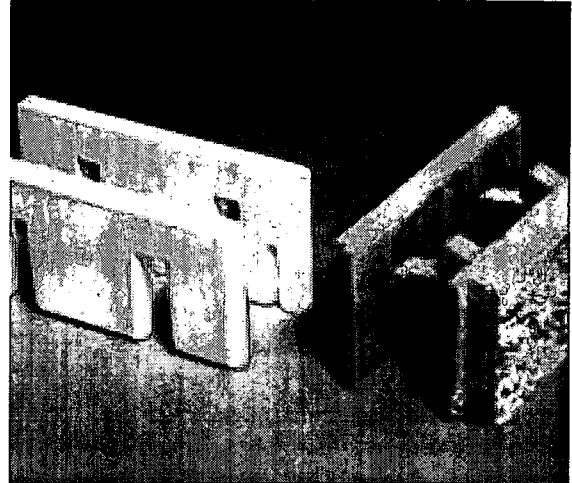

Integral Mass Wall Insulation Techniques. Photo Courtesy: Korfil CBIS.



Guideline IN2: Roof Insulation

Recommendations

Insulate roofs at a level appropriate for each class of construction and climate. The recommended roof insulation depends on the class of construction and the climate. See also the guidelines for cool roofs and radiant barriers.

Roof Class	South Coast, North Coast	Central Valley, Desert, Mountain
Insulation above Deck Including Mass	Provide a continuous layer of R-7 rigid insulation over the structural deck and protect this with a durable weatherproof membrane.	Provide a continuous layer of R-14 rigid insulation over the structural deck and protect this with a durable weatherproof membrane.
Wood Framed, Attics and Other	Install R-30 blown in insulation in ventilated attics. Use R-30 batt insulation in other framed cavities.	Install R-38 blown-in insulation in ventilated attics. Use R-38 batt insulation in other framed cavities.

Description

The construction of roof assemblies affects comfort, operating costs, acoustic separation, and the size of heating and cooling systems. The class of construction (wood-framed, steel-framed, or mass) is usually determined by requirements for fire separation between spaces, durability, or other issues. The recommended insulation levels for these classes are based on life-cycle cost analysis and are presented separately for each class and climate region. More insulation is justified in colder climates, with less in more temperate climates.

Concepts of thermal heat transfer are presented in the Overview to this chapter and should be reviewed, since they apply to roofs as well as other building enclosure components.



Photo courtesy: CertainTeed.

Applicability

This roof insulation guideline is applicable for all spaces in schools that are heated or cooled. The class of construction is usually determined in schematic design, but the insulation level can be set in design development or even contract documents.

Applicable Spaces	Climates	When to Consider
Classrooms	South Coast	Programming
Library	North Coast	Schematic
Multi-Purpose / Cafeteria	Central Valley	Design Dev.
Gym	Mountains	Contract Docs.
Corridors	Desert	Construction
Administration		Commissioning
Toilets		Operation
Other		

Applicable Codes

- The California Building Code requires R-11 in the south coast climates and R-19 insulation in the other climate zones. Criteria are provided as both a minimum R-value and a maximum U-factor. See the Overview to this chapter for a more comprehensive discussion of the codes applicable in California.
- Fire protection codes (the California Building Code) require noncombustible construction for certain classes of schools, which may prohibit wood framing in roof assemblies.
- Structural and seismic safety requirements often result in the roof being used as a structural diaphragm to resist twisting or buckling during earthquakes or extreme wind.

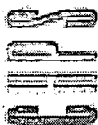

Integrated Design Implications

Well-insulated roofs and roof cavities can reduce drafts and thermal loads in buildings. HVAC ducts located in ceiling cavities can be leaky and can be a significant component of thermal loads. These losses are far less significant when ducts are located in sealed and insulated ceiling cavities. Reduced loads can result in smaller HVAC equipment and reduced costs.

Cost Effectiveness

The cost of roof insulation varies with the class of construction. Insulating attics and the cavity of wood- and steel-framed roof assemblies is low since labor is minimal and the roof cavity is readily accessible during construction. Rigid insulation installed over structural decks is more expensive due to construction details and added insulation cost.

Costs	L			
	M	■		
	H	■	■	
		L	M	H
		Benefits		

Benefits

Insulating roofs and ceilings has several important benefits for high performance schools:

- Energy use is reduced.
- Natural ventilation can be used for a greater number of hours.
- Smaller HVAC equipment can be purchased, which can reduce initial cost.
- Spaces are more comfortable because the interior surface temperature will be closer to room temperature, which provides more uniform interior temperatures and can reduce drafts.

Design Tools

This chapter's Overview has a discussion of methods and procedures for calculating U-factors. Energy simulation programs are recommended for analyzing insulation options for mass roofs, because of the time delays and dynamic effects inherent with this type of construction.

Design Details

- Insulation installed in exposed applications or in return air plenums should be either encapsulated or otherwise sealed from contact with moving air.
- Make sure that insulation is dry before walls or other cavities are enclosed. Moisture in building cavities can be a source of mold, which can cause building damage and indoor air contamination.
- Do not install insulation over suspended ceilings, because the insulation's continuity is likely to be disturbed by maintenance workers. Also, a suspended ceiling is a poor barrier to infiltration. If the insulation is located at the ceiling, many building codes will consider the space above the ceiling to be an attic and require that it be ventilated to the exterior. If vented to the exterior, air in the attic could be quite cold (or hot) and the impact of the leaky suspended ceiling would be worsened.
- Use type IC light fixtures in insulated gypsum board ceilings.
- Consider recycled insulation materials for attics and other places where loose-fill insulation is used. If cellulose (recycled paper) is used, make sure that the chemicals used as a fire retardant contain no volatile organic compounds and are not a possible source of pollution.

Operation and Maintenance Issues

The roof membrane must be maintained to prevent moisture from entering the roof cavity. Moisture in ceiling/roof constructions is a common source of mildew, which can cause serious indoor air quality problems. Insulation materials themselves require no maintenance.

Commissioning

No commissioning is needed for roof insulation systems.

References/Additional Information

See the Overview section of this chapter.

Related Volume III CHPS Criteria

See the Overview section of this chapter.



Guideline IN3: Cool Roofs

Recommendation

In air conditioned buildings, use a roof surface that is light in color (high reflectance), yet has a non-metallic finish (high emissivity). Asphalt roofs with a cap sheet and modified bitumen roofs should be coated with a material having an initial reflectance greater than 0.7 and an emittance³⁶ greater than 0.8. Single-ply roofing material should be selected with the same surface properties.

Description

Solar gain on roofs is a significant component of heat gain and using materials that have a high reflectance and a high emittance can significantly reduce the load. The high reflectance keeps much of the sun's energy from being absorbed. The high emittance allows radiation to the sky. Cool roofs are typically white and have a smooth texture. Commercial roofing products that qualify as cool roofs fall in two categories: single-ply and liquid-applied. Examples of single-ply products include:

- White PVC (polyvinyl chloride).
- White CPE (chlorinated polyethylene).
- White CPSE (chlorosulfonated polyethylene, e.g. Hypalon).
- White TPO (thermoplastic polyolefin).

Liquid-applied products may be used to coat asphalt cap sheets, modified bitumen, and other substrates. Products include:

- White elastomeric coatings.
- White polyurethane coatings.
- White acrylic coatings.
- White paint (on metal or concrete).

Cool roofs are becoming available in different colors. Table 22 shows reflectance and emittance for some typical roofing products.



A white single ply membrane with heat-welded seams is being installed on this roof surface. Photo courtesy: BondCote Roofing Systems.

Applicable Spaces	Climates	When to Consider
Classrooms	South Coast	Programming
Library	North Coast	Schematic
Multi-Purpose / Cafeteria	Central Valley	Design Dev.
Gym	Mountains	Contract Docs.
Corridors	Desert	Construction
Administration		Commissioning
Toilets		Operation
Other		

³⁶ Heat radiated from a roof surface is proportional to the 4th power of the absolute temperature and depends on emittance. Emittance is the ratio of radiant heat flux emitted by a specimen to that emitted by a black body at the same temperature and under the same conditions.



Table 22 – Solar Reflectance and Emittance of Different Roofing Materials.

Source: Berdahl and Bretz 1995, Akbari 1990, Parker et al. 1993, LBNL Cool Roofing Materials Database.

	Material	Total Solar Reflectance	Emittance
Reflective Coatings	Kool seal elastomeric coating over asphalt shingle	0.71	0.91
	Aged elastomeric on plywood	0.73	0.86
	Flex-tec elastomeric coating on shingle	0.65	0.89
	Insultec on metal swatch	0.78	0.90
	Enerchon on metal swatch	0.77	0.91
	Aluminum pigmented roof coating	0.30 - 0.55	0.42 - 0.67
White Metal Roofing	Lo-mit on asphalt shingle	0.54	0.42
	MBCI siliconized white	0.59	0.85
White Metal Roofing	Atlanta Metal products Kynar Snow White	0.67	0.85
	Black EPDM	0.06	0.86
Single-ply Roof Membrane	Grey EPDM	0.23	0.87
	White EPDM	0.69	0.87
	White T-EPDM	0.81	0.92
	Hypalon	0.76	0.91
	White	0.85	0.96
Paint	Aluminum paint	0.80	0.40
	Black	0.03 - 0.05	0.91
Asphalt Shingles	Dark brown	0.08 - 0.10	0.91
	Medium brown	0.12	0.91
	Light brown	0.19 - 0.20	0.91
	Green	0.16 - 0.19	0.91
	Grey	0.08 - 0.12	0.91
	Light grey	0.18 - 0.22	0.91
	White	0.21 - 0.31	0.91

Note: Shaded products all have a reflectivity greater than 0.70 and an emittance greater than 0.80.

Applicability

Cool roofs are applicable to all spaces in schools and to all California climates. The benefits are less, however, in the cold regions. In order to take advantage of equipment downsizing, cool roofs should be considered in the schematic design phase.

Applicable Codes

The California Building Code offers credits for cool roofs. Cool roofs are also considered in ANSI/ASHRAE/IESNA Standard 90.1-2001 and state energy codes in Georgia, Florida, and Hawaii. The California credit can be used through either the building envelope trade-off option or the whole building compliance method.

Integrated Design Implications

Cool roofs can significantly reduce cooling loads, resulting in smaller air conditioning equipment or in some cases, eliminating air conditioning entirely in favor of natural ventilation. Like all roofing systems, skylights and other roof penetrations, as well as the roof top equipment mounts, should be considered in the design of the roof. Equipment access should be provided in a manner that does not create undue wear or damage to the roof membrane.



Cost Effectiveness

The additional cost for coating an asphalt cap sheet or modified bitumen roof is about \$1/ft² to \$2/ft². The cost premium between a conventional single-ply roof membrane and one with a high reflectance (all have high emittance) is negligible.

Costs	L	M	H
	L	M	H
	L	M	H
	Benefits		

Benefits

Cool roofs can save demand charges and energy charges. They are highly cost effective, especially in the desert and central valley climates. However, there are other benefits as well. Since solar radiation (especially ultraviolet light) is a major cause of roof deterioration, cool roof coatings can significantly increase the life of the roof membrane. Cool roofs also can help make the whole community cooler by reducing the "heat island" effect.

Design Tools

Cool roofs are effective for a number of complex reasons. They reflect heat from the sun, and assessing this benefit requires a model that accounts for the position and intensity of the sun. Sun that is absorbed by the roof (that which is not reflected) increases the surface temperature of the roof and induces heat gain in addition to that driven by temperature differences. At night and at other times, hot roof surfaces radiate heat to the night cool sky. This is a valuable benefit that requires knowledge of the roof surface temperature and the sky temperature. Because of the complexity of heat transfer related to cool roofs, energy simulation programs are necessary to accurately assess their benefits.

Oak Ridge National Laboratory's Radiation Control Calculator can be used to estimate energy savings. See <http://www.ornl.gov/roofs+walls>.



This building uses a standing seam metal roof with a white coating. Photo courtesy: Snap-Clad Metal Roofing and Boarman Kroos Phister Rudin & Associates.

Design Details

- The performance of cool roofs is affected by the accumulation of dirt. Dirt accumulation can be reduced if roof surfaces slope at least 0.25 in./ft.
- When liquid applied coatings are used, carefully select coatings that are compatible with the underlying substrate.
- Liquid applied cool roof coatings should comply with ASTM Standard 6083-97 for durability and elongation and have a minimum thickness of 20 mils.

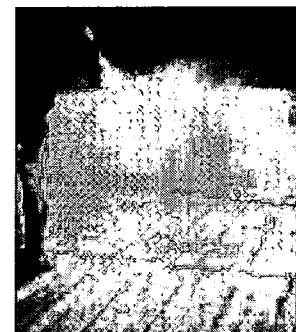

Elastomeric or other coating can be field applied to many roof substrates. Photo courtesy: Dow Corning roofing products.

Operation and Maintenance Issues

To assure continued performance of cool roofs, they will need to be cleaned each year with a high-pressure water spray. (Verify that doing this does not void the product warranty.) Liquid-applied coatings may need to be refinished every five years or so.

Commissioning

No commissioning is needed.



References/Additional Information

- Akbari H., et al. 1997. "Peak Power and Cool Energy Savings of High-Albedo Roofs". *Energy and Buildings*, Berkeley, CA. Vol. 25, pp. 117 - 126.
- Akbari H. and S. Bretz. 1997. "Long Term Performance Of High-Albedo Roof Coatings". *Energy and Buildings*, Berkeley, CA. Vol. 25, pp. 159 - 167.
- Akbari H., et al. 1995. "Mitigation of Urban Heat Islands: Materials, Utility Programs and Updates." *Energy and Buildings*, Berkeley, CA, Vol. 22, pp. 255 - 265. Also Lawrence Berkeley National Laboratory Report LBL-36587, Berkeley, CA.
- Berdahl, P. and S. Bretz. 1997. "Preliminary Survey of the Solar Reflectance of Cool Roofing Materials," *Energy and Buildings - Special Issue on Urban Heat Islands and Cool Communities*, 25(2), pp. 149-158. Also, Lawrence Berkeley National Laboratory Report LBL-36020, Berkeley, CA.
- Berdahl, 2000. Cool Roofing Materials Database. Lawrence Berkeley National Laboratory, Berkeley, CA. <http://eetd.lbl.gov/coolroof/>.
- Gartland, L. 1999. "Cool Coatings Heat Up Savings". Trade Press Publishing Corporation. <http://www.facilitiesnet.com/NS/NS3m9ai.html>.
- Parker D. S. et al. 1993. "Laboratory Testing of The Reflectance Properties of Roofing Materials". Florida Solar Energy Center Report FSEC-CR-670-93, Cocoa FL.
- Parker D.S. and S.F. Barkazi. 1997. "Roof Solar Reflectance and Cooling Energy Use: Field Results from Florida." *Energy and Buildings*, Berkeley, CA, Vol. 25, pp. 105 - 115.
- Simpson, J. R., and E. G. McPherson. 1997. "The Effects of Roof Albedo Modification on Cooling Loads of Scale Model Residences in Tucson, Arizona". *Energy and Buildings*, Berkeley, CA. Vol. 25, pp. 127 - 137.
- Taha, H. 1997. "Urban Climates and Heat Islands: Albedo, Evapo-transpiration, and Anthropogenic Heat". *Energy and Buildings*, Berkeley, CA. Vol. 25, pp. 99 - 103.
- U.S. Environmental Protection Agency. 1998. Roof Products MOU - Version 1.0.

Related Volume III CHPS Criteria

See the Overview section of this chapter, and:

Site Credit 4: Design to Reduce Heat Islands.



Guideline IN4: Radiant Barriers

Recommendation

Use a radiant barrier in conjunction with attic construction in schools in all climates.

Description

A radiant barrier is a surface with a low emittance that is installed at the ceiling of attics. The radiant barrier surface is usually aluminum foil or another shiny metallic finish that has a low emittance. A couple of installation methods exist. The least costly method is to use plywood or composition board with a film that is pre-applied to the board. An alternate, but more effective method, is to drape foil over the rafters before the sheathing is installed (see photo).

Radiant barriers are effective because they reduce one of the major components of heat gain, which is radiation from the hot attic ceiling to the cooler attic floor. The amount of heat that is radiated from the attic ceiling to the floor is directly proportional to the emissivity of the surfaces. Uncoated plywood and most other conventional building materials have an emittance of about 0.8, while the surface of a radiant barrier has an emittance of around 0.1. The radiation component of heat transfer can, therefore, be as much as eight times lower than without a radiant barrier.

Radiant barriers are effective in reducing cooling loads, but not heating loads. Radiant barriers can also improve the system efficiency of HVAC air distribution ducts are located in attics. Duct losses during cooling mode are proportional to the temperature difference between air inside the duct and the temperature of the attic. Radiant barriers reduce the temperature of the attic during cooling conditions, and therefore, duct system efficiency is improved.

Applicability

Radiant barriers are highly recommended in the central valley and desert climates of California. They can also be effective in coastal climates. They are recommended for attics over any spaces that are cooled by air conditioners or natural ventilation. Radiant barriers should be considered no later than the design development phase so that the HVAC equipment may be appropriately downsized.

Applicable Codes

The California Building Code, which applies to schools, does not recognize radiant barriers. However, the California standards for low-rise residential buildings require radiant barriers in central valley and desert climates.



Photo courtesy: PARSEC Thermo-Brite

Applicable Spaces	Climates	When to Consider
Classrooms	South Coast	Programming
Library	North Coast	Schematic
Multi-Purpose / Cafeteria	Central Valley	Design Dev.
Gym	Mountains	Contract Docs.
Corridors	Desert	Construction
Administration		Commissioning
Toilets		Operation
Other		



Integrated Design Implications

Radiant barriers directly reduce cooling loads, which can result in smaller air conditioners. HVAC air duct efficiency is also improved when air distribution ducts are located in attics.

Cost Effectiveness

When applied to sheathing, the cost premium for radiant barriers is on the order of \$0.10/ft² to \$0.15/ft². Cost is a little higher for draped installation, mainly because additional labor is required.

Costs	L	■		
	M			
	H			
		L	M	H
		Benefits		

Benefits

Radiant barriers reduce cooling loads and energy costs. They can also result in smaller air conditioners, which can more than compensate for the added cost of the radiant barrier. Attics where radiant barriers are installed have a lower temperature, which results in improved HVAC duct efficiency and other benefits.

Design Tools

Estimating the benefits of radiant barriers can be approximated by making an adjustment to the U-factor of the ceiling/roof construction. The problem with this approach is that radiant barriers only have a benefit in reducing cooling loads. In fact, they can have a slightly negative effect on heating loads, since solar gains are reduced which might be useful when schools are in a heating mode. The most accurate way to evaluate radiant barriers in attics is to use an hourly simulation model where the attic itself is modeled as a separate, unconditioned thermal zone, and where radiation transfer can be explicitly modeled. The only models with these capabilities are for research purposes and are difficult for practitioners to use. However, the U.S. Department of Energy released a tool called EnergyPlus, which has these capabilities. Version 1.0 was released in April 2001.

Design Details

- Choose radiant barrier surfaces that have an emittance less than 0.1, when tested in accordance with ASTM E408. When comparing products, select a product with the lowest emittance. Some have an emittance as low as 0.05.
- Install radiant barriers so that the shiny surface faces down to prevent dirt from accumulating on the surface. Dirt can depreciate performance.
- When using radiant barriers that are pre-applied to sheathing, make sure that care is taken to not damage the surface during shipping and installation.
- When using the draped method of installation, let the radiant barrier sag about an inch from the sheathing, creating an additional air gap. This accounts for the improved performance of the draped method of installation.

Operation and Maintenance Issues

Radiant barriers rarely require any maintenance, unless they are damaged while other maintenance work is being performed in an attic.

Commissioning

No commissioning is necessary.

References/Additional Information

Ross Middle School, Ross, CA. Architect: Esherick Homsey Dodge & Davis.

U.S. Department of Energy, Radiant Barrier Fact Sheet, June 1991. Prepared by Oak Ridge National Laboratory.

The California Bureau of Home Furnishings (as part of insulation certification) certifies radiant barriers with an initial product emissivity of 0.05 or less.

The California ACM Approval Manual for low-rise residential buildings has detailed installation requirements in Section 4.24. This document is available at <http://www.energy.ca.gov/>

Related Volume III CHPS Criteria

See the Overview section of this chapter.



Guideline IN5: Reduce Infiltration

Recommendation

Design and construct the building envelope to limit the uncontrolled entry of outside air into the building. This is achieved through building envelope sealing (caulking and weather stripping), specifying windows and doors that have been tested to have low rates of infiltration, and by using air lock entries in cold climates.

Description

Controlling infiltration is very important to achieving energy-efficient buildings. Air leakage introduces sensible heat into conditioned and semi-heated spaces. In climates with moist outdoor conditions, it is also a major source of latent heat. Latent heat must be removed by the air conditioning system at considerable expense. The ANSI/ASHRAE/IESNA 90.1-2001 Standard has requirements for the sealing of building envelope elements, infiltration through doors and windows, air seals at loading dock doors, and vestibules to limit infiltration at main entrance doors to buildings.

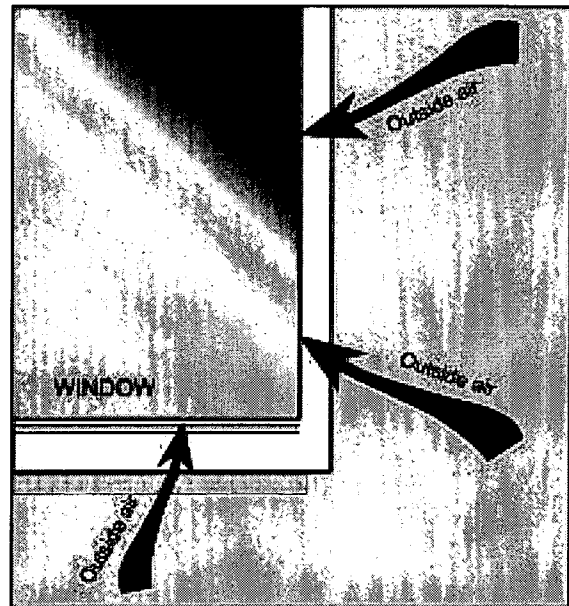

Reducing entry of outside air into a building can be beneficial in preventing energy loss.

Applicability

Schools in all climates should be sealed to reduce infiltration, but it is especially important in the more harsh climates such as the cold, central valley and desert climates. The recommendations apply to all spaces in schools. Sealing and infiltration control should be first considered in the design development phase, but details should be specified in the contract documents. Tight construction is mainly a matter of care during construction and should be verified during construction and verified in the commissioning phase.

Applicable Spaces	Climates	When to Consider
Classrooms	South Coast	Programming
Library	North Coast	Schematic
Multi-Purpose / Cafeteria	Central Valley	Design Dev.
Gym	Mountains	Contract Docs.
Corridors	Desert	Construction
Administration		Commissioning
Toilets		Operation
Other		

Applicable Codes

The California Building Code specifies minimum infiltration rates for fenestration products and requires that the building envelope be sealed to reduce unwanted infiltration.

Integrated Design Implications

Poorly sealed buildings can cause problems for maintaining comfort conditions when additional infiltration loads exceed the HVAC design assumptions.

Cost Effectiveness

The cost of controlling infiltration is minimal. Mainly it is a standard of care that must be exercised during the construction phase.

Costs	L			
	M			
	H			
		L	M	H
		Benefits		

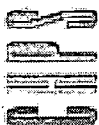

Benefits

Controlling infiltration makes it easier to balance and maintain HVAC systems. Energy costs are also reduced in a cost-effective manner.

Design Tools

All energy calculation methods are capable of accounting for infiltration in some manner. Some use an air-changes-per-hour method, while others are based on the concept of an effective leakage area. Many hourly simulation methods are capable of modeling infiltration using either calculation method. During construction, air leaks can be detected and repaired through pressurization tests, often called blower door tests. With this procedure, a building or space is pressurized with a large fan that is usually mounted in the door (thus, blower door). The space is pressurized to about 50 Pascals of pressure and leakage is measured. The location of leaks can be identified using smoke sticks.

Design Details

Building Envelope Sealing

Exterior joints, cracks, and holes in the building envelope shall be caulked, gasketsed, weather stripped, or otherwise sealed. The construction drawings and specifications should require the sealing, but special attention is needed in the construction administration phase to assure proper workmanship. A tightly constructed building envelope is largely achieved through careful construction practices and attention to detail. Special attention should be paid to several areas of the building envelope including:

- Joints around fenestration and door frames.
- Junctions between walls and foundations, between walls at building corners, between walls and structural floors or roofs, and between walls and roof or wall panels.
- Openings at penetrations of utility services through roofs, walls, and floors.
- Site-built fenestration and doors.
- Building assemblies used as ducts or plenums.
- Joints, seams, and penetrations of vapor retarders.
- All other openings in the building envelope.

ANSI/ASHRAE/IESNA Standard 90.1 also has requirements for limiting infiltration through mechanical air intakes and exhausts. These requirements are addressed in the mechanical section (§ 6) of the Standard, not in the building envelope section.

Fenestration and Doors

Fenestration products, including doors, can significantly contribute to infiltration. Most fenestration products should have an infiltration rate less than 0.4 cfm/ft². For glazed entrance doors that open with a swinging mechanism and for revolving doors, the infiltration should be limited to 1.0 cfm/ft². Infiltration rates should be verified with National Fenestration Rating Council (NFRC) 400. A laboratory accredited by the NFRC or other nationally recognized accreditation organizations must perform the ratings.

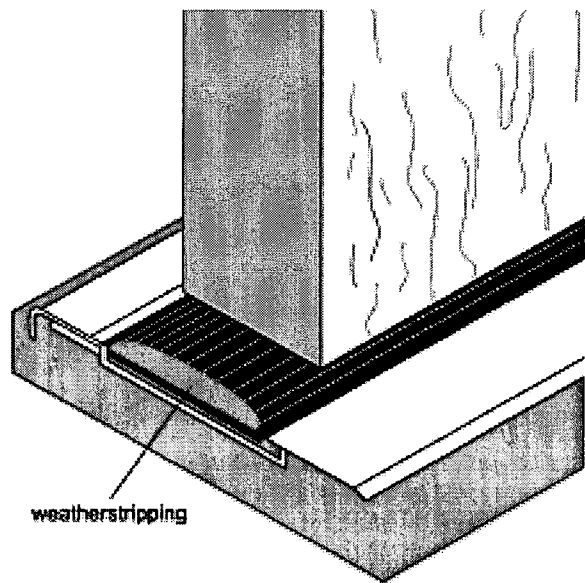

Door weatherstripping is one method for reducing infiltration.



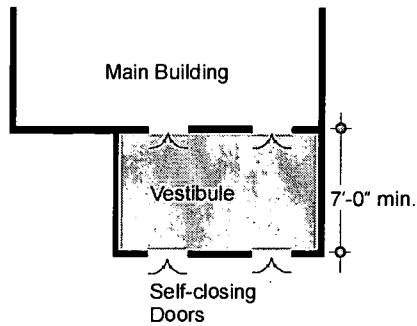

Figure 29 – Vestibule Diagram

Vestibules

In cold California climates, vestibules should be created at the main entrance to schools. All the doors entering and leaving the vestibule must be equipped with self-closing devices and the distance between the doors should be at least 7 ft.

Operation and Maintenance Issues

Weatherstripping around doors and other openings must be maintained and replaced every five to 10 years. Caulking in exposed locations will need to be replaced or touched up each time the exterior of the school is painted.

Commissioning

The commissioning agent should verify that weather stripping and caulking is properly installed. Fenestration products should be labeled by NFRC to enable easy field verification of the infiltration requirements.

References/Additional Information

Nonresidential Manual for Compliance with the 1998 Energy Efficiency Standards, California Energy Commission, available from <http://www.energy.ca.gov/>

Installing Caulking and Weatherstripping, http://www.weservehomes.com/diy/ha_diy.html

Weatherstripping to Reduce Heating and Cooling Bills, <http://www.doityourself.com/energy/weatherstripping.htm>

Related Volume III CHPS Criteria

See the Overview section of this chapter.

BEST COPY AVAILABLE



Guideline IN6: Concrete Masonry

Recommendation

Specify colored concrete masonry for concrete masonry unit (CMU) wall applications.

Description

CMU construction is high-strength, fire-resistant, durable, and economical. Improvements in manufacturing and quality control of colored concrete masonry assure greater CMU uniformity and color consistency, reduced porosity, and reduced shrinkage. In addition, high-performance water repellents can be applied to walls or added to the concrete and mortar mixes so that it is unnecessary to paint or coat the units with block-filler to avoid water penetration.



CMU Construction at the Central Market, Poulsbo, Washington. Photo courtesy of O'Brien and Co, Inc.

Applicability

All climates.

Applicable Codes

See Applicable Codes in this chapter's Overview.

Integrated Design Implications

Recycle waste CMUs, if possible, and require the supplier/subcontractor to take them back for recycling.

Cost Effectiveness

The first cost of masonry walls is considerably more than for traditional, framed walls. In cold climates, masonry walls exposed to the exterior must be insulated, entailing additional cost in materials and labor. However, not having to paint or coat a colored CMU wall saves time and money during construction, and additional savings accrue throughout the lifetime of the building since colored concrete is a permanent material that requires little or no maintenance.

Applicable Spaces	Climates	When to Consider
Classrooms	South Coast	Programming
Library	North Coast	Schematic
Multi-Purpose Cafeteria	Central Valley	Design Dev.
Gym	Mountains	Contract Docs.
Corridors	Desert	Construction
Administration		Commissioning
Toilets		Operation
Other		

Benefits

Masonry is a material efficient, high-strength, durable material with high fire resistance and low maintenance requirements. The integral color pigments typically used in colored CMU are non-toxic and contain none of the solvents associated with painting and re-painting.

Costs	L	M	H
	M	M	M
	H	M	M
Benefits			

Design Tools

See Design Tools listed in this chapter's Overview and:

American Concrete Institute ACI 530.1, *Specifications for Masonry Structures*.

ASTM C90, *Specification for Loadbearing Concrete Masonry Units*.



ASTM C270, *Specification for Mortar for Unit Masonry*.
ASTM C979, *Pigments for Integrally Colored Concrete*.

Design Details

In general, colored CMU is specified and installed in the same way as other high-quality masonry construction.

To assure uniform colors, all CMU used on a particular project should be produced with consistent manufacturing and curing techniques and with cement and aggregates from a single source. Pigments should comply with ASTM C979 Pigments for Integrally Colored Concrete, which establishes criteria for the pigment's resistance to weather and light and its compatibility with concrete. Mortar can be tinted with the same pigments used in the CMU to match or complement the hue of the masonry units. Some variation in appearance is a normal design feature of CMU and mortar, whether colored or not. Mortar lightens as it cures; allow up to 28 days for this process.

Specify the submittal of samples showing the range of each CMU to be used on the job. On jobs with critical appearance tolerances or unique requirements, specify a mock-up to demonstrate that the materials and workmanship to be used will produce the desired results.

Efflorescence, a white crystalline deposit that can form on concrete surfaces, can be especially visible on colored CMU surfaces. To minimize the potential for efflorescence, detail and build the wall to avoid penetration of water into the masonry, and keep the top of the wall covered when work is stopped.

Efflorescence is easiest to remove if it is cleaned promptly after it appears. A water-repellent or clear glaze coating also can help reduce water penetration; test any surface-applied treatment or coating before proceeding with the application to determine the effect on masonry appearance. Caulking materials used to seal joints can be specified in colors to match the masonry.

Operation and Maintenance Issues

Colored concrete is a permanent material that normally requires little or no maintenance. Sandblasting will remove graffiti.

Commissioning

None.

References/Additional Information

American Concrete Institute (ACI), PO Box 9094, Farmington Hills, MI 48333-9094. Tel: (248) 848-3800. Fax: (248) 848-3801. Web site: <http://www.aci-int.org/>.

National Concrete Masonry Association (NCMA), 2302 Horse Pen Road, Herndon, VA 20171-3499. Tel: (703) 713-1900. Fax: (703) 713-1910. Web site: <http://www.ncma.org/>. The web site provides a list of certified masonry consultants.

Related Volume III CHPS Criteria

Materials Credit 3: Resource Reuse.

Materials Credit 4: Recycled Content.



(This page intentionally left blank.)

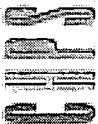

HVAC

This chapter presents guidelines for natural ventilation as well as mechanical heating and cooling systems. Presented together in one chapter, the organization emphasizes the interrelationship between these systems. Guidelines are provided for the following technologies and design strategies:

Cross Ventilation (Guideline TC1)	Gas-Fired Radiant Heating System (Guideline TC14)
Stack Ventilation (Guideline TC2)	Ground Source Heat Pump System (Guideline TC15)
Ceiling Fans (Guideline TC3)	Evaporatively Precooled Condenser (Guideline TC16)
Gas/Electric Split System (Guideline TC4)	Dedicated Outside Air System (Guideline TC17)
Packaged Rooftop System (Guideline TC5)	Economizers (Guideline TC18)
Displacement Ventilation System (Guideline TC6)	Air Distribution Design Guidelines (Guideline TC19)
Hydronic Ceiling Panel System (Guideline TC7)	Duct Sealing and Insulation (Guideline TC20)
Unit Ventilator System (Guideline TC8)	Hydronic Distribution (Guideline TC21)
Ductless Split System (Guideline TC9)	Chilled Water Plants (Guideline TC22)
Evaporative Cooling System (Guideline TC10)	Hot Water Supply (Guideline TC23)
VAV Reheat System (Guideline TC11)	Adjustable Thermostats (Guideline TC24)
Radiant Slab System (Guideline TC12)	EMS/DDC (Guideline TC25)
Baseboard Heating System (Guideline TC13)	Demand Controlled Ventilation (Guideline TC26)
CO Sensors for Garage Exhaust Fans (Guideline TC27)	

Overview

The main purposes of HVAC systems are to provide thermal comfort and to maintain good indoor air quality (IAQ). These conditions are essential for a quality, high performance learning environment. HVAC systems are also one of the largest energy consumers in schools, and relatively small improvements in design or equipment selection can mean large long-term savings in energy expenditures over the life cycle of the system.

The choice and design of HVAC systems can affect many other high performance goals as well. Water-cooled air conditioning equipment is generally more efficient than air-cooled equipment, but increases water consumption and maintenance. HVAC systems are also the major source of outside air ventilation in many schools, making their operation and maintenance mission critical for IAQ. The acoustic environment of classrooms, libraries, and other school spaces can be adversely affected by noise created by the movement of air through ducts and air diffusers and from the operation of HVAC



equipment. Properly designed, installed, and operated HVAC systems and controls minimize these issues as well as provide a key component of the “buildings that teach” theme.

Integrated Design

To achieve a high performance design, it is very important to integrate the HVAC systems with the building envelope and lighting system. Integrated design creates opportunities for greater comfort, lower first costs, easier equipment maintenance, and lower operating costs. Some of the ways in which high performance can be achieved through integrated design are:

- Careful attention to shading, the locations of windows and glazing types, roof colors, building thermal mass, and enhanced natural ventilation may eliminate the need for cooling in many parts of California.
- Natural ventilation can eliminate the need for ductwork, allowing higher ceilings and more opportunities for daylighting savings.
- Under-floor air distribution allows access for future power and communication needs. The system can also be designed to work in harmony with natural ventilation.
- Attention to the radiant temperature of surfaces through careful envelope design reduces heating and cooling energy requirements. This is especially true of windows.
- Using a central heating and chilled water plant can allow for future installation of a thermal solar or geo-exchange source for heating or cooling energy, or for the use of a thermal energy storage system or other peak electric demand reducing measures.
- Integration of HVAC, multiple light switches, and lighting occupancy sensor controls can reduce operating costs for both systems.

Thermal Comfort

Thermal comfort is affected by air temperature, humidity, air velocity, and mean radiant temperature (MRT).³⁷ Non-environmental factors such as clothing, gender,³⁸ age,³⁹ and metabolic activity also affect thermal comfort.

- Air temperature is measured with a normal thermometer, and most people are comfortable between about 70°F and 76°F. However, an individual's preferred temperature is higher in the summer and lower in the winter, mostly because of differences between summer and winter wardrobes.
- The relative humidity range for human comfort is between about 20% and 60%. The moisture content of air can also be expressed as the wetbulb temperature, humidity ratio, or dew point temperature.
- Ceiling fans, circulation fans, or operable windows can provide air movement, and such air movement increases the upper temperature limit of comfort by about two degrees.
- The temperature of the surfaces surrounding a person (walls, ceiling, floor, and windows) affects the MRT, especially during hot and cold days. Caves have a low MRT, which makes them comfortable

³⁷ MRT is the temperature of an imaginary enclosure where the radiant heat transfer from a human body equals the radiant heat transfer to the actual non-uniform temperature surfaces of an enclosure.

³⁸ Women generally prefer temperatures about 1° warmer.

³⁹ Persons over 40 generally prefer temperatures about 1° warmer.



even when the air temperature is high. Likewise, rooms with heated floors are comfortable, although the air temperature may be cooler.

The most accepted definition of thermal comfort is ASHRAE Standard 55, but recent research is resulting in a reevaluation of this definition. Standard 55 currently defines comfort in terms of operative temperature and humidity, and represents the range of thermal conditions when 80% of sedentary, or slightly active, people find the environment thermally acceptable (see Figure 30). Operative temperature is the average of the mean radiant and ambient air temperatures, weighted by their respective heat transfer coefficients. The Standard 55 definition of comfort does not consider air movement or velocity. Most occupants do not feel comfortable when it is drafty and cold.

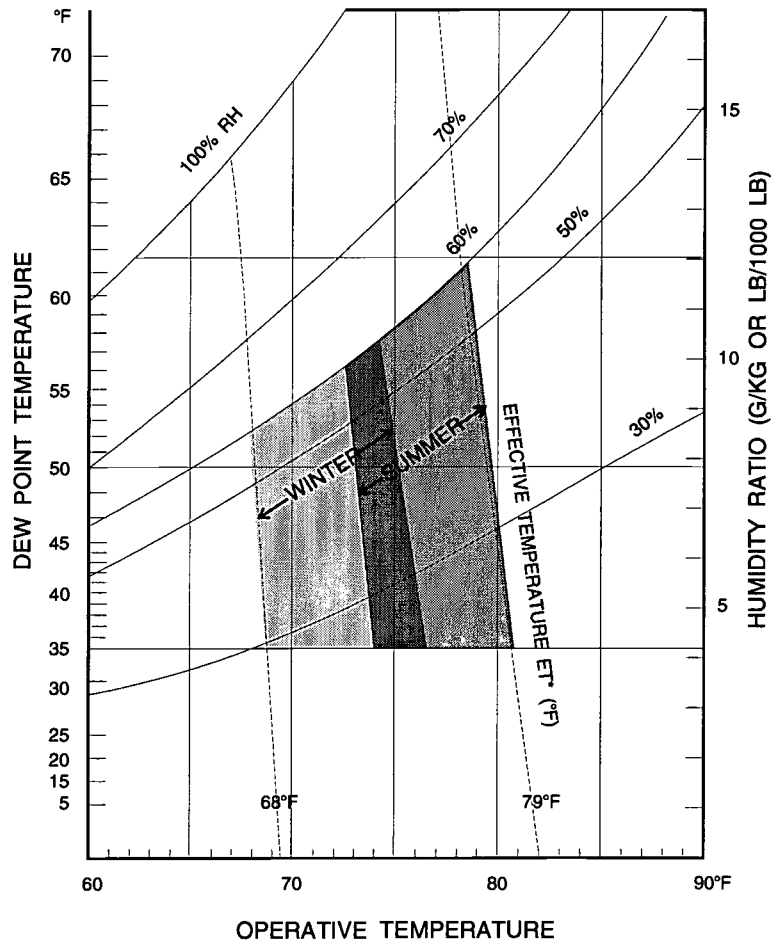

Figure 30 – ASHRAE Standard 55 Comfort Envelope

Source: 2001 ASHRAE Handbook – Fundamentals. This figure shows the temperature and humidity ranges within which about 80% of the population will be comfortable while wearing typical summer and winter clothing and being in a sedentary or slightly active state.

Much of the research on thermal comfort is based on asking people if they are hot or cold, and correlating their response to measurements of air temperature, humidity, air velocity, and MRT. The ASHRAE thermal sensation scale is commonly used for such surveys (see Table 23). Some of this research has been conducted in test environments where temperature and humidity can be tightly controlled. Other research has been conducted in workplaces.

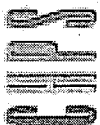

Table 23 – ASHRAE Thermal Sensation Scale

Cold	Cool	Slightly cool	Neutral	Slightly warm	Warm	Hot
-3	-2	-1	0	+1	+2	+3

Since thermal comfort is not an absolute condition but varies with each individual, statistical measures of thermal comfort are sometimes used. One statistical measure is the predicted mean vote (PMV). PMV predicts the mean response of a large population on the ASHRAE thermal sensation scale (see Table 23). A PMV of +1 means that on average people are slightly warm. PMV can be calculated if information is known about the metabolic rate, typical clothing, and environmental conditions such as temperature and humidity. Once PMV is known, it can be translated to another statistical factor called percent of population dissatisfied (PPD).

Air movement also affects comfort. Operable windows, ceiling fans or circulation fans create or enable air movement. Too much air movement is uncomfortable, especially when it is cold. When it is hot, air velocities up to about 200 ft/minute are pleasant and enable most occupants to be equally comfortable at 2°F higher temperatures. Air speeds higher than about 200 ft/minute should be avoided because they can create drafts and be annoying (see Table 24).

Table 24 – Effect of Air Movement on Occupants

Source: Victor Olgay, *Design with Climate*, Princeton University Press, 1963

Air Velocity	Probably Impact
Up to 50 ft/minute	Unnoticed.
50 to 100 ft/minute	Pleasant.
100 to 200 ft/minute	Generally pleasant, but causes a constant awareness of air movement.
200 to 300 ft/minute	From slightly drafty to annoyingly drafty.
Above 300 ft/minute	Requires corrective measures if work and health are to be kept in high efficiency.

Research by Gail Brager and others at the University of California, Berkeley, shows that students and teachers in naturally ventilated schools are comfortable for a wider range of thermal conditions than in schools that have continuous mechanical cooling. Occupants of air-conditioned schools develop high expectations for even and cool temperatures, and are quickly critical if thermal conditions drift from these expectations. Occupants in naturally ventilated schools adapt to seasonal changes in mean outdoor temperature and are comfortable for a wider range of conditions. They even prefer a broader range of thermal conditions. The comfort range for naturally ventilated buildings is considerably larger than common definition of comfort published in ASHRAE Standard 55-1992.

Research shows that part of the difference in comfort expectations is due to behavioral adaptations: occupants in naturally ventilated schools wear appropriate clothing and open windows to adjust air speeds. However, some of the difference is due to physiological factors. The human body's thermal expectations actually change through the course of a year, possibly because of a combination of higher levels of perceived control (occupants can open and close windows) and a greater diversity of thermal experiences in the building.

Using an adaptive model of thermal comfort, instead of ASHRAE Standard 55, allows schools to be designed and operated to both optimize thermal comfort and reduce energy use. In many climates, maintaining a narrowly defined, constant temperature range is unnecessary and expensive. Brager's



research is the foundation of changes currently being considered to ASHRAE Standard 55. See the electronic Appendix for more information on this research.

Potential for Natural Ventilation

Natural ventilation is an effective and energy efficient way to provide outside air for ventilation and to provide cooling in many California schools. Historically, most schools in California have not been air conditioned and natural ventilation has been the only means of cooling. The classic classroom has high windows to provide both natural ventilation and daylighting. In most California climates, natural ventilation is still a solid strategy, but windows must be designed to maintain a safe and secure facility while allowing air to enter and escape, even at night and on weekends.

The potential for natural ventilation varies with climate. Figure 31 through Figure 34 show the potential for maintaining thermal comfort in classrooms for four California climate regions. These diagrams have time of the day on the vertical axis and months of the year on the horizontal axis. The shades of gray in the diagrams represent the ASHRAE thermal sensitivity scale from neutral to slightly warm, to warm to hot.

The period of time when schools are typically operated is also shown. If a school is operated in the summer or for extended hours, adjustments can be made to these figures.

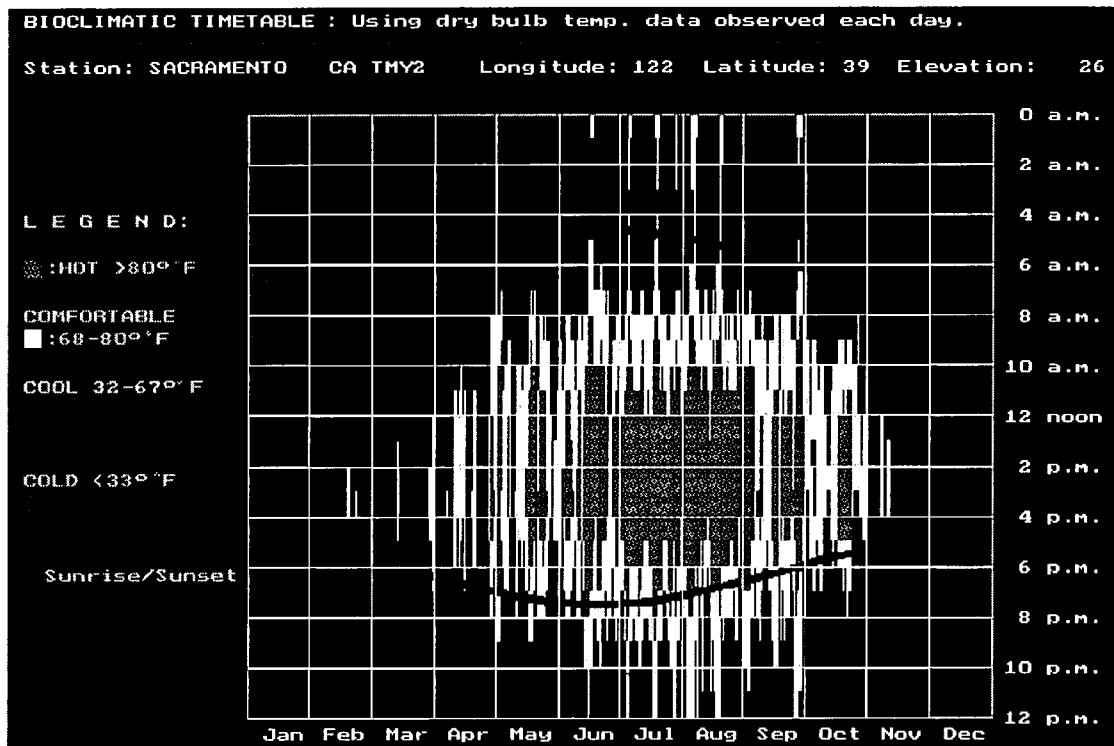
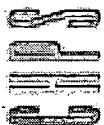

Figure 31 – Natural Ventilation Potential, California Central Valley (Sacramento)



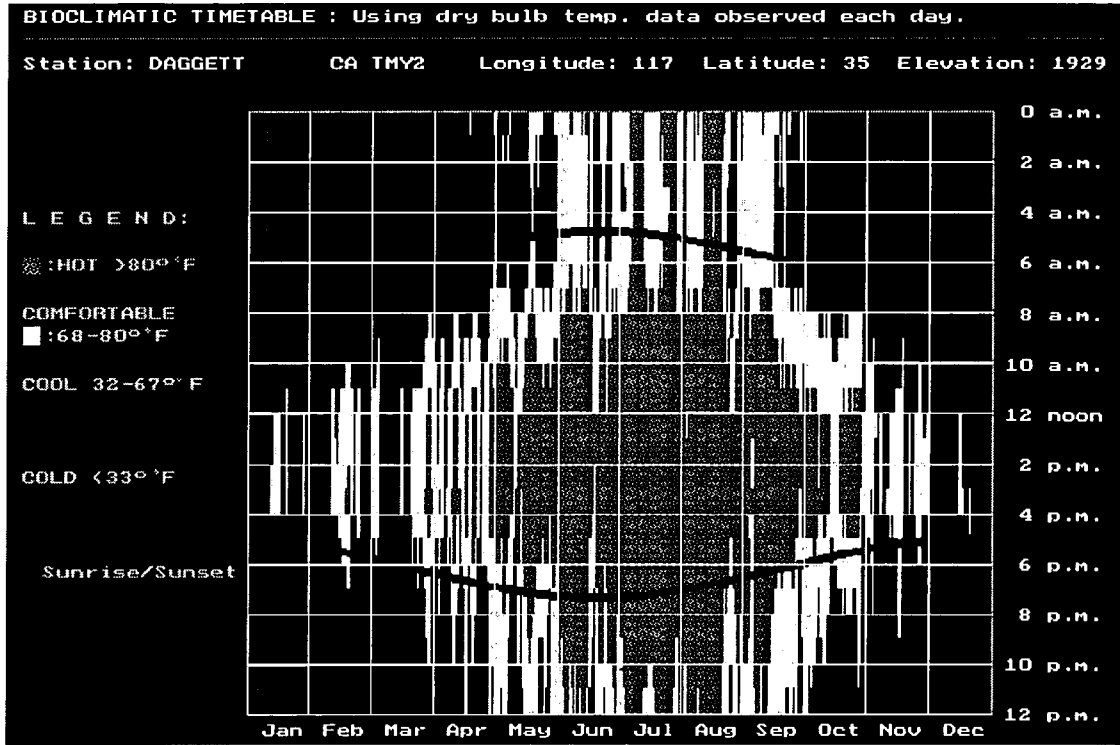

Figure 32 – Natural Ventilation Potential, California Desert (Daggett)

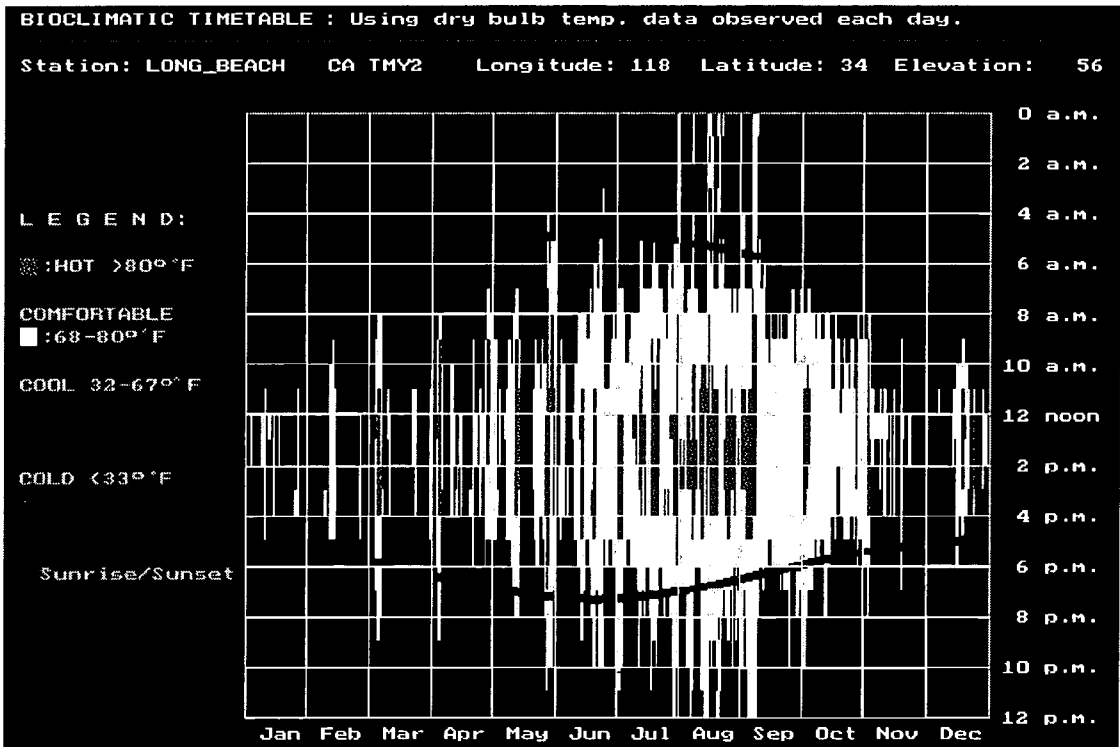

Figure 33 – Natural Ventilation Potential, California South Coast (Long Beach)



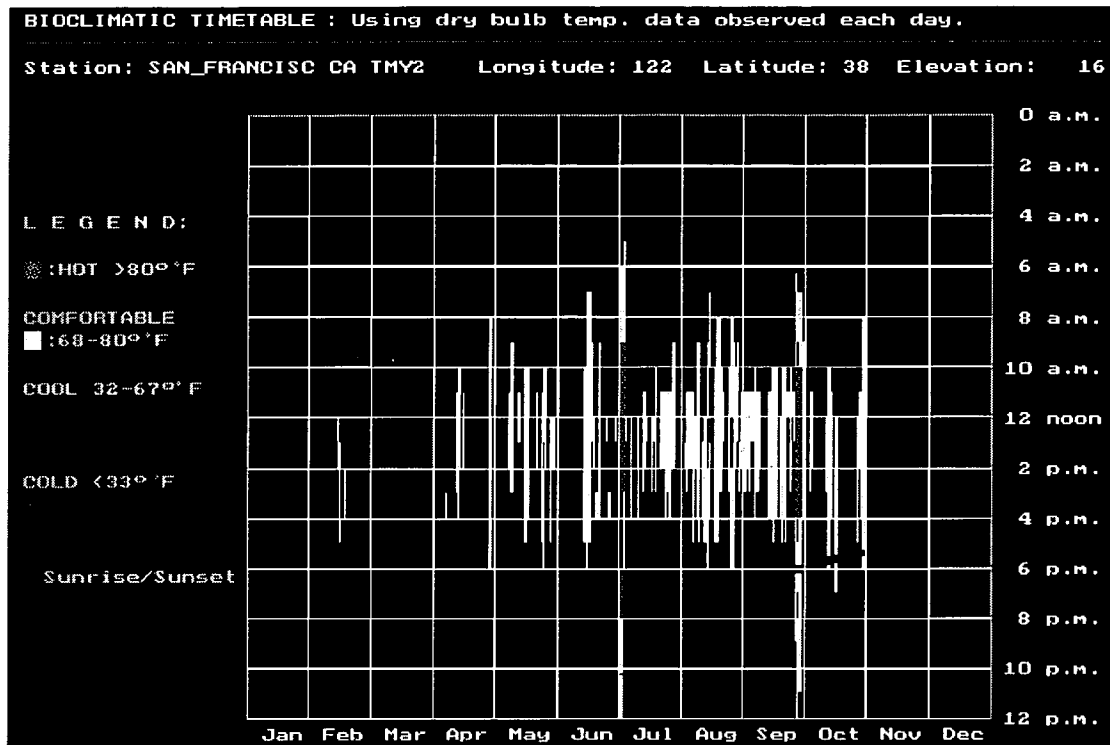

Figure 34 – Natural Ventilation Potential, California North Coast (San Francisco)

Outside Air Ventilation

Classrooms and other school spaces must be ventilated to remove carbon dioxide and other pollutants from exhaled breathing air, body odors, cleaning chemical odors, and other pollutants that are generated inside the building by occupant activities. The national consensus standard for outside air ventilation is ASHRAE Standard 62. This standard is the basis of requirements in Title 24 of the California Building Code. Title 24 requires that outside air ventilation be provided through either natural ventilation or mechanical means.

If outside air is provided through natural ventilation, then all spaces within the room must be within 20 ft of a window, door, or other ventilation opening, and the total area of ventilation openings must be greater than 5% of the floor area. For a typical 960-ft² (30 ft x 32 ft) classroom, the minimum free ventilation area must be at least 48 ft². The 20 ft rule would also require that ventilation openings be provided on two sides of the room; otherwise some portions of the classroom would be further than 20 ft from a window.

If outside air is provided through a mechanical system, then at least 15 cubic feet per minute (cfm) of outside air must be provided for each occupant. A typical classroom with 30 people requires a minimum of 15 x 30 or 450 cfm per occupant. However, the actual code minimum ventilation rate for a typical classroom is 360 cfm.⁴⁰ Other spaces in schools require differing levels of outside air ventilation,

⁴⁰ Title 24 specifies 15 cfm per person and sets the occupant density at one half the code-specified occupant density for fire egress, which is 20 ft²/occupant. This works out to 24 occupants for a typical 960 ft² classroom [(960 ft² / 20 ft²/occupant)/2], and 24 occupants times 15 cfm per occupant is 360 cfm of outside air ventilation per classroom.



based on the expected occupant density of the space and the recommended ventilation rate of 15 cfm/occupant.

The number of occupants is highly variable in some school spaces such as gyms, auditoriums, and multi-purpose rooms. Title 24 requires systems to vary the quantity of outside air ventilation in these spaces based on the number of occupants. One technique for addressing this issue is to install carbon dioxide (CO₂) sensors that measure concentrations and vary the volume of outside air accordingly. If an auditorium fills up for a school assembly, CO₂ concentrations will increase, the HVAC system will be signaled, and outside air volumes will be increased accordingly. This type of control can both save energy and significantly improve IAQ. This type of technique combined with variable rate fans can significantly reduce electrical energy consumptions in large volume areas.

Title 24 not only specifies the minimum volume of outside air that needs to be provided to spaces, but also requires that this amount of air be provided during all hours when the spaces are normally occupied. Systems must also be designed to provide at least three air changes per hour, or the required ventilation rate indicated above for the hour prior to normal occupancy of the building. This requirement ensures building-related contaminants that may have built up overnight while the system was shut down are flushed out.

The location of ventilation air intakes and exhausts is a critical aspect of integrated building design and sometimes difficult to coordinate or optimize. Outside air intake dampers must be carefully located to avoid pollution from sources such as parking lots, loading docks, adjacent roadways, sewer vents, or boiler exhaust fumes. Patterns of air movement around buildings can be quite complex and dynamic. Designers are advised to consult ASHRAE Fundamentals Chapter 15 airflow analysis models for exhaust stack reentrainment modeling. If major sources of industrial pollution exist nearby, more sophisticated models are often used for predicting down wind concentrations of pollutants. In the extreme case of urban settings with multiple building heights, designers should consider building scale models for testing in wind tunnels..

IAQ is also affected by the selection of interior finishes and materials. These issues are discussed in the Interior Surfaces and Furnishings chapter. The design of air distribution ducts and fan systems can also have a significant effect on IAQ. Exposed fiberglass and other porous or flaking materials should never be used on the interior of ducts, unless they are encapsulated with a surface finish that is robust, will not break down from atmospheric ozone exposure (smog), and can be cleaned with a mechanical brush without releasing particles.

Load Calculations

Properly sizing HVAC systems in schools is critical to both energy efficiency and cost effectiveness. The compressors in oversized packaged air conditioners or heat pumps cycle frequently and overall efficiency drops with each cycle. Frequent cycling also reduces the efficiency of boilers, furnaces, and many other types of equipment. Properly sized equipment, with multiple firing rates and stages of cooling, reduces cycling and helps maintain efficient operation, but smaller, properly sized equipment that is matched to the building load is also often less expensive and can reduce initial construction costs.

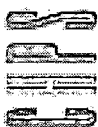

Many computer programs and calculation methodologies can be used for load calculations. Title 24 of the California Building Code has requirements on the types of load calculation methods that are allowed and the assumptions to include in the analysis. The code also requires selecting equipment that is no larger than necessary to satisfy the calculated load. However, this requirement has a number of important exceptions. For instance, if a particular manufacturer's product line is selected for use, the smallest unit available within that product line can be chosen, even though it may be larger than required. Larger equipment can be used if it is shown that energy use does not increase, as in case of oversized fans with variable speed control and other equipment that "unloads" intelligently. Exceptions also exist for redundant units and multiple units that are sequenced to come on only as needed.

Title 24 requires that the calculation procedure used be consistent with the 1993 ASHRAE Handbook – Fundamentals. Indoor design conditions must be consistent with ASHRAE Standard 55. Cooling systems must be designed for outdoor conditions that are exceeded for only 0.5% of the time. Exterior conditions for heating are also specified. Assumptions on outside air ventilation, occupant loads, envelope loads, and lighting loads must be based on a building that complies with Title 24. Internal loads may be ignored for heating calculations since the school may be unoccupied, with lights and equipment off, when it is being warmed up in the morning. The calculated cooling loads may be increased by 1.43 (33%) and heating loads may be increased by 1.21 (11%) to account for warm-up loads, cool-down loads, and safety factors.

While many requirements for load calculations are specified in Title 24, much is left to the judgment of the mechanical engineer. The engineer should be careful to make choices and assumptions that are realistic and appropriate for each school design.

Applicable Codes

The requirements of Title 24 related to outside air ventilation and system sizing (load calculations) are described in the section above. In addition, Title 24 has many other requirements that affect the selection and design of school's HVAC systems. Some of the requirements are highlighted here:

- Most equipment must meet minimum energy-efficiency requirements. Air conditioner efficiency is expressed as a minimum energy-efficiency ratio (EER), while gas-fired heating equipment efficiency is expressed as an annual fuel utilization efficiency (AFUE). Water heater efficiency is communicated as an energy factor (EF).
- Systems that reheat or re-cool air are prohibited, including constant volume reheat systems and most multi-zone systems. (Triple deck multi-zone systems do not mix heated and cooled air, but rather mix heated and outside air, or cooled and outside air.) Variable air volume (VAV) systems with reheat are permitted as long as air volume is reduced to the minimum before reheating occurs.
- Pipes and ducts must be insulated and sealed.
- Appropriate HVAC controls must be installed. Every classroom or other thermal zone must have its own thermostat to control the supply of heating and cooling to the space. Systems must also have a means to automatically shut down during off hours. A time clock would be needed with programmable schedules, one for a school day and one for a non-school day, as well as a timed override for system operation after hours.
- Large systems (over approximately 6 tons and more than 2,500 cfm) require that economizers be installed. Economizers are available and recommended for smaller systems as well, provided they are maintained and operated correctly.

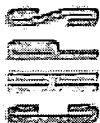

- Large fan systems (25 hp or larger) have a maximum fan power limit of 0.8 W/cfm for constant volume systems and 1.25 W/cfm for variable volume systems.
- Restrictions exist on the use of electric resistance heating systems when other alternatives are available.

Environmental Considerations

In terms of environmental performance, the HVAC system primarily affects energy usage, acoustic comfort, the life of building materials, and indoor environmental quality. Proper HVAC performance will enhance the learning environment and the health of the occupants. However, poor design or installation will detract from the learning environment and could contribute to illness. Other environmental considerations are relevant, such as efficient use of materials, employing energy recovery devices for heating or cooling, conservation of water, use of materials that can be readily recycled, and avoidance of ozone-depleting refrigerants. The following specific measures can be used to reduce the environmental impact of HVAC systems.

- A well-designed building with integrated building systems will significantly reduce the requirements for heat and cooled air distribution. In addition to energy savings, significantly less equipment, or smaller equipment, is needed.
- A well-designed HVAC system always provides easy access for cleaning and repair, enhancing long-term ability to provide good IAQ and thermal comfort.
- Selection of equipment and materials play a part as well.⁴¹
- Strategies and considerations include:
 - Specifying low-toxic (water-based) mastic to seal ducts, or in cases where round ducts are utilized, specify internal gasketed duct joint systems so that duct sealants are not needed.
 - Selecting durable long-life equipment with hinged access doors that allow for equipment service and that can be easily refurbished.
 - Limiting the use of equipment that uses CFC or HCFC refrigerants.
 - Consider alternatives to cooling towers and evaporative equipment, which use significant amounts of water.
 - Metal components of HVAC systems can be recycled. Suggest recycling equipment at the end of its life cycle. In addition, metal components of HVAC equipment typically include recycled content, although data is not readily available as to the amount.
 - Energy recovery equipment should always be considered for the ventilation system since heating and cooling the ventilation air accounts for the majority of the load that is placed on the systems in a well-designed facility. Payback periods for energy recovery are often 10 years; however the school systems are designed to last 30 to 50 years.
 - Consideration needs to be given to renewable energy heating and cooling sources such as geothermal standing column wells.

⁴¹ For specific product recommendations, see GreenSpec: The Environmental Building News Product Directory and Guideline Specifications, <http://www.buildinggreen.com/>, and OIKOS's Redi Guide (Resources for Environmental Design Index), available from Iris Communications, (800) 346-0104, <http://www.oikos.com/>



Commissioning

Commissioning is the process of ensuring that the intent of the project program is properly reflected in the design and that the design intent is properly executed during construction and operation.

Commissioning tasks start at the very beginning and continue throughout the project, even into the occupancy period. Experience has shown that most energy efficient designs do not achieve intended savings without the oversight and performance acceptance testing provided by a commissioning process.

For larger facilities, the project manager should consider including an independent commissioning agent in the early planning process. A commissioning plan should be developed during schematic design and updated at each project phase. Typical elements of a commissioning process include:

- Commissioning plan development.
- Documentation of design intent.
- Design review.
- Submittals review.
- Inspections and system functional performance testing.
- Enhanced operating and maintenance documentation, including hands-on training of the staff operating and maintaining the equipment.
- Post-occupancy testing and operation evaluation.

For small schools with relatively simple mechanical systems, a detailed commissioning process may not be feasible. However, some form of a performance acceptance testing of the equipment and controls is essential to ensure systems are operating properly and at peak efficiency before, or soon after, occupancy.

Specific commissioning issues are discussed in each of the guidelines below. A number of sample commissioning plans and guidelines are also available. A good source is the Portland Energy Conservation Inc. at <http://www.peci.org/>. Other resources include the U.S. Department of Energy at <http://www.energy.gov/>, the American Society of Heating, Refrigerating and Air-Conditioning Engineers at <http://www.ashrae.org/>, and the Sheet Metal and Air Conditioning Contractors' National Association at <http://www.smacna.org/>.

Design Tools

In addition to general energy simulation programs, many useful tools for optimizing mechanical design exist. Heating and cooling load calculation programs that are widely available from equipment manufacturers and commercial vendors are most commonly used. Other programs integrate with CAD software and aid the design of piping and duct systems. Many of these tools also have cost estimating capabilities, which are very helpful in design optimization and budget review.

Computational fluid dynamics (CFD) software can help in studies of natural and mechanical ventilation and is very useful in creative integration of mechanical and architectural design. Historically, this type of analysis is expensive. Many manufacturers of air distribution equipment can now provide CFD graphic representation of the air distribution delivered by their products.



Controls

HVAC, lighting, water heating, signal/communication wiring, and other systems need to be operated and controlled efficiently and effectively. With integrated design, the effective control of one system may depend on how another system is being operated. Building management systems offer integrated control of HVAC, lighting, outside air ventilation, natural ventilation, building security, and water heating systems. Energy can be saved through efficient control that turns off or slows down systems when they are not needed. In general, slowing down most fans by 25% cuts the electric energy the fan uses by 50%. Building management systems can also provide information for students and faculty to understand how the building is working and how much energy it is using. Building management systems should always be equipped with easy-to-use graphic interfaces to facilitate their proper use.

System Selection

Figure 35 illustrates a few important questions that help narrow the choice of HVAC system for each space. This decision tree leads to one of several categories of system types. There are three main questions:

- Can natural ventilation meet all reasonable cooling needs? For many locations in California this is possible, especially with careful attention to architectural design. If cooling is unnecessary, then a number of heating-only options exist.
- Can outdoor air ventilation be provided naturally or is mechanical ventilation required? This affects the system choice regardless of whether it is heating only, or heating and cooling. If fans are not required for ventilation, the design should allow them to be off for much of the year, saving fan energy.
- If cooling is required, can an efficient evaporative cooling system be used? If not, compressor cooling, either with a direct expansion or chilled water system is required.

There are, of course, many other considerations in system selection. This chapter provides guidelines for most of the common HVAC system types used in California schools. The choice of optimal system type for a specific school is a complex decision based on many factors. Many tradeoffs are involved, especially price versus performance. Other important considerations are:

- Noise and vibration.
- IAQ ventilation performance.
- Thermal comfort performance.
- Operating costs and energy efficiency.
- Maintenance access, costs, and needs.
- HVAC equipment space requirements (in the classroom, on the roof, in mechanical rooms).
- Durability and longevity.
- The ability to provide individual control for classrooms and other spaces.
- The type of refrigerant used and its currently understood ozone-depleting potential.

Table 25 compares system types using these criteria and others. More information regarding the applicability of each system type is discussed in the individual guidelines.



Phasing of construction projects also influences the decision between central systems and distributed systems. If a large facility is to be constructed in several phases, then it may be difficult to afford the upfront investment in the central plant option.

Related Volume III CHPS Criteria

Energy Prerequisite 1: Minimum Energy Performance.

Energy Credit 1: Superior Energy Performance.

Energy Credit 2: Natural Ventilation.

Energy Credit 5: Energy Management Systems.

IEQ Prerequisite 1: Minimum Requirements.

IEQ Credit 3: Pollutant Source Control.

IEQ Prerequisite 2: Minimum Acoustic Performance.

IEQ Credit 3: Improved Acoustic Performance.

IEQ Prerequisite 3: ASHRAE 55 Code Compliance.

IEQ Credit 6: Controllability of Systems.



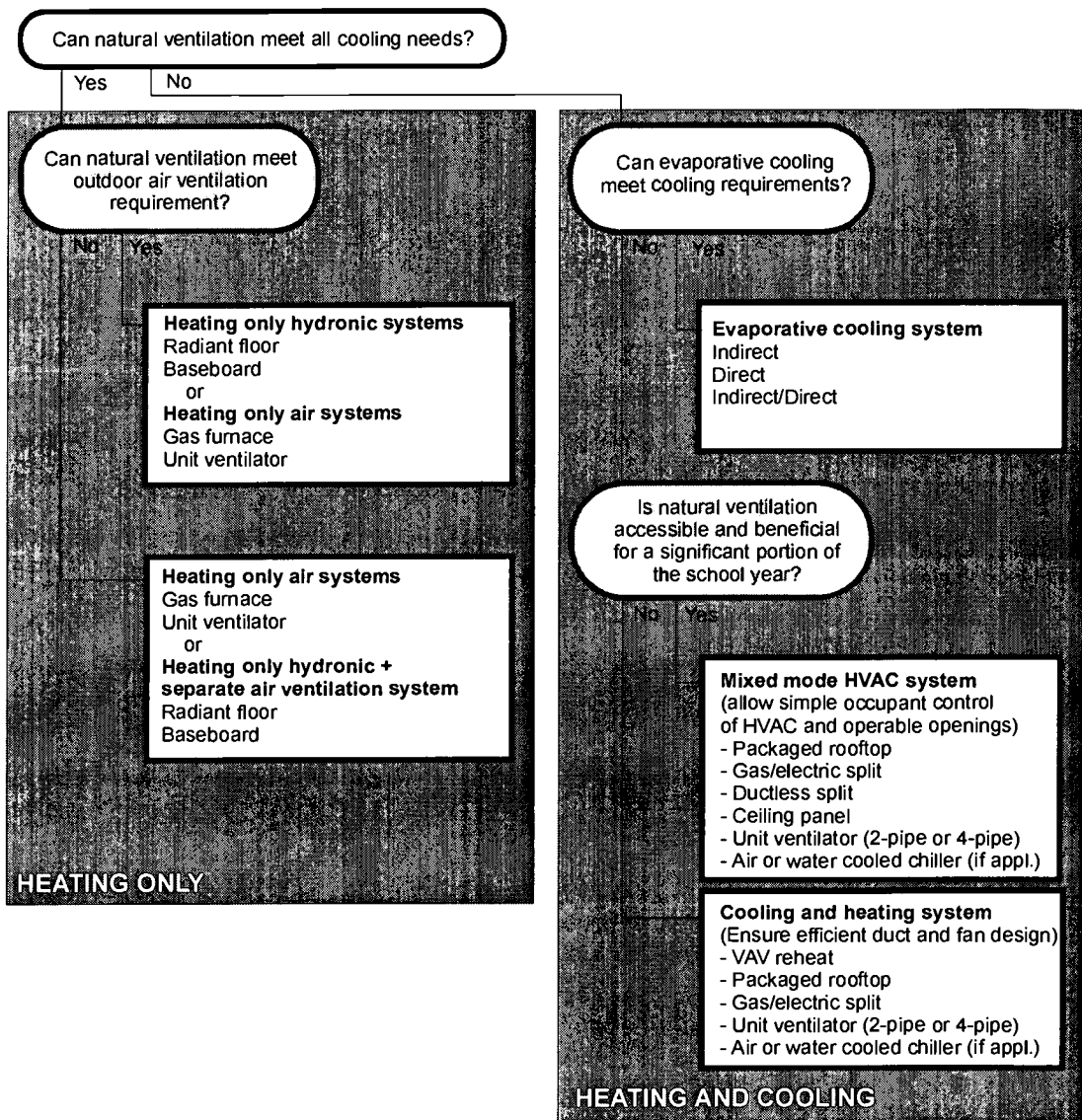

Figure 35 – HVAC System Selection Decision Tree

Table 25 – HVAC Selection Criteria

Selection Criteria		Gas/Electric Split system	Rooftop packaged system	Displacement ventilation	Ceiling Panels	Unit ventilator (4-pipe)	Unit ventilator (2-pipe)	Ductless Split System	Evaporative cooler	VAV/reheat.	Radiant floor	Baseboards	Gas-Fired Radiant system for gyms	Chiller – Water Cooled	Chiller – Air Cooled
First Cost		●	●	○	○	○	●	●	●	●	○	●	●	○	●
Maintenance Cost		●	●	●	●	●	●	●	●	●	●	●	●	●	●
Cooling Effectiveness		●	●	●	●	●	●	○	●	●	N/A	N/A	N/A	●	●
Heating Effectiveness		●	●	○	○	●	○	○	N/A	●	●	●	●	N/A	N/A
Energy Operating Cost		●	●	●	●	●	●	●	●	●	●	●	●	●	●
Durability		●	●	●	●	●	●	●	●	●	●	●	●	●	●
Life-Cycle Cost		●	○	●	●	○	○	●	●	●	●	●	●	●	●
Noise (Acoustic Environment)		●	●	●	●	○	○	○	●	●	●	●	●	○	○
Roof Space Required		●	○	●	●	●	●	●	○	○	●	●	●	N/A	N/A
Water Consumption		●	●	●	●	●	●	●	○	●	●	●	●	●	●
Classroom Control		●	●	●	●	●	●	●	●	●	●	●	●	N/A	N/A
Multi-zone Capability		○	○	○	●	○	○	○	○	●	●	●	●	N/A	N/A
Ozone Depletion		○	○	●	●	●	●	○	●	●	●	●	●	●	●
Outside Air Ventilation		●	●	●	○	●	●	○	●	●	○	○	○	N/A	N/A
Thermal Comfort		●	●	●	●	○	○	○	●	●	●	●	●	N/A	N/A
Natural Ventilation (Mixed Mode Method)	Compatibility (poor/fair/good)	●	●	●	●	●	●	●	●	○	●	●	●	N/A	N/A
	Change-Over (yes/no)	●	●	●	○	●	●	●	●	●	○	○	○	N/A	N/A
	Concurrent (yes/no)	○	○	○	●	○	○	○	○	○	●	●	●	N/A	N/A
Indoor Air Quality		●	●	●	●	●	●	●	●	●	●	●	●	N/A	N/A

Legend: ● Better than average (better performance or lower cost) ● Average ○ Worse than average (lower performance or higher cost)



Selection Criteria		Gas/Electric Split system	Rooftop packaged system	Displacement ventilation	Ceiling Panels	Unit ventilator (4-pipe)	Unit ventilator (2-pipe)	Ductless Split System	Evaporative cooler	VAV/reheat.	Radiant floor	Baseboards	Gas-Fired Radiant system for gyms
Spaces Applicability (black, gray or clear)	Classrooms	●	●	●	●	●	●	○	●	●	●	●	○
	Library	●	●	●	○	○	○	○	●	●	●	●	○
	Multi-purpose	●	●	●	○	○	○	○	●	●	●	●	●
	Gym	●	●	○	○	○	○	○	●	●	●	○	●
	Corridors	●	●	○	○	○	○	○	●	●	●	●	○
	Admin	●	●	●	●	○	○	●	●	●	●	●	○
	Toilets	●	●	○	●	○	○	●	●	●	●	●	○
	Other	●	●	●	●	●	●	●	●	●	●	●	●
Climate Applicability (black, gray or clear)	South Coast	●	●	●	●	●	○	●	●	●	●	●	●
	North Coast	●	●	●	●	●	●	●	●	●	●	●	●
	Central Valley	●	●	●	●	●	○	●	●	●	●	●	●
	Desert	●	●	●	●	●	○	●	●	●	●	●	●
	Mountains	●	●	●	●	●	●	●	●	●	●	●	●
Possible Cooling Sources	DX	●	●	●	○	●	●	●	○	●	N/A	N/A	N/A
	CHW	○	○	●	●	●	●	○	○	●	N/A	N/A	N/A
Possible Heating Sources	HP	○	●	●	○	●	●	●	○	○	○	○	○
	HW	○	●	●	●	●	●	○	●	●	●	●	○
	Furnace	●	●	●	○	○	○	○	●	●	○	○	○
Optional Energy Efficient Features	Air Economizer	●	●	●	○	●	●	●	●	●	○	○	○
	Evaporative Precooler	●	●	●	○	○	○	●	○	●	○	○	○
	Variable Speed Fan	●	●	●	○	●	●	●	●	●	○	○	○
	High Efficiency Motors	●	●	●	●	●	●	●	●	●	●	●	○

Legend: ● Better than average (better performance or lower cost) ● Average ○ Worse than average (lower performance or higher cost)



Guideline TC1: Cross Ventilation

Recommendation

Provide equal area of operable openings on the windward and leeward side. Ensure that the windward side is well shaded to provide cool air intake. Locate the openings on the windward side at the occupied level.

Description

Wind driven ventilation is one of two methods of providing natural ventilation. All natural ventilation strategies rely on the movement of air through space to equalize pressure. When wind blows against a barrier, it is deflected around and above the barrier (in this case, a building). The air pressure on the windward side rises above atmospheric pressure (called the pressure zone). The pressure on the leeward side drops (suction zone), creating pressure stratification across the building. To equalize pressure, outdoor air will enter through available openings on the windward side and eventually be exhausted through the leeward side.

Pressure is not uniformly distributed over the entire windward face, but diminishes outwards from the pressure zone. The pressure difference between any two points on the building envelope will determine the potential for ventilation if openings were provided at these two points. The airflow is directly proportional to the effective area of inlet openings, wind speed, and wind direction.

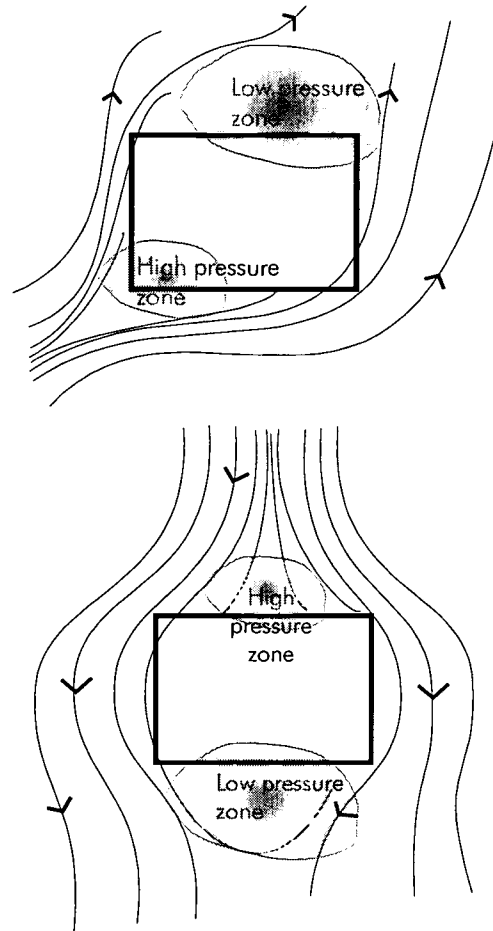

Applicability

Cross ventilation is a very effective strategy for heat removal and providing airflow in mild climates. In coastal climates, the need for a cooling system may be eliminated by a carefully designed natural ventilation system. In most other climates, it can alter interior conditions only modestly. Hybrid systems work best in such situations. In humid climates,

natural ventilation cannot replace the moisture removing capabilities of air-conditioning (although desiccant systems that remove moisture from the space can be used for more effective natural ventilation). Introducing humid air (even if it is relatively cool) into a space will add a substantial load on the cooling system in hybrid systems. However, even extreme climates experience moderate conditions during spring and fall, and natural ventilation should be designed to take full advantage of these conditions.

This strategy relies heavily on two parameters that may change continuously: wind availability and wind direction. Consequently, it is a somewhat unreliable source for thermal comfort. Spaces, like computer rooms and laboratories, that need strict maintenance of indoor temperature and humidity should definitely use hybrid systems for both cooling and ventilation. Introducing natural ventilation in a building may

Applicable Spaces	Climates	When to Consider
Classrooms	South Coast	Programming
Library	North Coast	Schematic
Multi-Purpose / Cafeteria	Central Valley	Design Dev.
Gym	Mountains	Contract Docs.
Corridors	Desert	Construction
Administration		Commissioning
Toilets		Operation
Other		



BEST COPY AVAILABLE

cause increased levels of dirt, dust, and noise, which could also be a serious limitation for certain types of spaces.

Cross ventilation has to be an integral part of the design schematic and design development phases. An effective natural ventilation design starts with limiting space sizes to facilitate inward flow of air from one face and outward flow from the other — architectural elements can be used to harness prevailing winds. This may alter building aesthetics and needs to be addressed early in the design phase.

Applicable Codes

"Section 121-Requirements for Ventilation" of Title 24 only apply to spaces that are ventilated naturally (i.e., without mechanical means). These requirements include:

- The total area of the openings should be at least 5% of the total floor area (based on classroom dimensions of 30 ft x 32 ft x 9 ft-6 in., a minimum openable area of 48 ft² should be provided for each classroom).
- All spaces should be within 20 ft of an operable opening in the wall or roof.
- All openings provided for natural ventilation should be readily accessible to occupants of the space at all times when the space is occupied.
- All naturally ventilated spaces should have direct outdoor air flow from openings in the wall or roof. This airflow should remain unobstructed by walls or doors.

Codes related to fenestration performance and maximum allowable window area are also relevant:

- Maximum-allowable window wall ratio limits the area of openings to 40% of the gross wall area. The code also specifies minimum performance levels for fenestrations. See Daylighting Guidelines for more information on performance levels for glazing.

Integrated Design Implications

- **Design Phase.** Cross ventilation can (or should) very strongly influence building aesthetics and site planning. Natural ventilation codes will dictate space widths and minimum opening sizes. To maximize the effectiveness of openings, the long façade of a building should be perpendicular to the prevailing wind direction. Narrow and woven plans with more surfaces exposed to the outside will work better than bulky plans with concentrated volumes. Singly loaded corridors will provide better airflow than doubly loaded ones. An open building plan with plenty of surface area exposed to the outside will work well for cross ventilation. Architectural elements like fins, wing walls, parapets, and balconies will enhance wind speeds and should be an integral part of cross ventilation design.
- **Thermal Mass.** Cross ventilation should be combined with thermal mass to take advantage of large diurnal temperature swings. Mass walls can act as heat reservoirs, absorbing heat through the day and dissipating it at night. At night, natural ventilation can be used to increase the quantum of dissipated heat as well as to accelerate the process of dissipation (see section on Building Envelope for details). This will reduce the load on the cooling system by pre-cooling the building. A large diurnal temperature swing (as in desert areas) will ensure that the building is more effectively "flushed."
- **Integration with Daylighting and View Windows.** The apertures for cross ventilation will also serve as view windows and luminaires for side lighting. All architectural elements intended to enhance one strategy should also work for the other. Orientation that works for ventilation (openings on the windward side) may not be the ideal direction for bringing in daylight. West orientation for windows will increase heat gain and cause glare, but may be the best orientation for bringing in outside air in the coastal areas. Prioritize the needs of the space based on function and climate. For instance, benefits of daylighting in a cold climate outweigh those of cross ventilation, therefore orient the building based on daylighting considerations.
- **Integration with HVAC.** Natural ventilation may be intended to replace air conditioning entirely or, as is more often the case, to coexist with mechanical systems in a "hybrid mode." Also, natural ventilation may occur in "change-over" (windows are shut when mechanical system is on) or

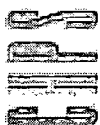

"concurrent" modes. Fewer systems are compatible with the concurrent mode. These factors need to be carefully considered before selecting a system (for more information on system selection see this chapter's Overview).

Cost Effectiveness

Low to moderate. Buildings that use natural ventilation may have higher initial costs, due to the higher cost of operable windows. Operable windows typically cost 5% to 10% more than fixed glazing. Based on average installed cost for metal frame, double glazed, fixed windows of \$20/ft² to \$30/ft², the operable window should cost \$48 to \$72 more per classroom for buildings that meet their ventilation needs through natural ventilation only (based on code prescribed minimum area of operable glazing per classroom). For "hybrid" buildings, the cost will be more modest because the operable window area can be less than the code prescribed minimum (5% of floor area). In buildings where natural ventilation is designed to occur concurrently, the initial costs may be higher due to limitations in system selection.

Benefits

Moderate to high. This varies significantly depending on climatic conditions and natural ventilation design.

- In a moderate climate like that of the north coast, wind-driven ventilation can meet the cooling loads most of the time. In such climates, the simple payback period will vary between eight to 12 years. At times, a good natural ventilation design may completely eliminate the need for a cooling system. This design will result in huge savings that offsets the cost of installing operable windows and lowers the simple payback period to one to four years.
- Buildings located in harsher climates will use "mixed-mode" systems. In such climates, natural ventilation may have limited application resulting in higher payback periods of 12 to 15 years.
- Cross ventilation alleviates odors and quickly exhausts contaminants from a space.
- Increased airflow in a space results in higher thermal comfort levels and increased productivity.
- Operable openings at the occupied level instill the occupants with a sense of individual control over the indoor environment.
- An intangible benefit of natural ventilation is the establishment of a connection with the outdoors (both visual and tactile), weather patterns, and seasonal changes. This results in higher tolerances for variations in temperature and humidity levels.
- Natural ventilation systems are simple to install and require little maintenance.

Costs	L			
	M			
	H			
		L	M	H
		Benefits		

Design Tools

Opening areas may be derived using spreadsheet-based calculations. These estimates use approximation techniques but are good numbers to start with. The following algorithm shows the rate of wind-induced airflow through inlet openings:

$$Q = C_4 C_v A V$$

where,

Q =airflow rate, cfm

C_v =effectiveness of openings (C_v is assumed to be 0.5-0.6 for perpendicular winds and 0.25 to 0.35 for diagonal winds)

A =free area of inlet openings

V =wind speed, mph

C₄ =unit conversion factor= 88.0

The following algorithm calculates the required airflow rate for removal of a given amount of heat from a space (see section on Load Calculations for estimating the amount of heat to be removed):



$$Q = \frac{60q}{c_p \rho (t_i - t_o)} \quad Q = \frac{\text{Btu/h}}{1.08 \Delta T}$$

where,

Q =airflow rate required to remove heat, cfm

q =rate of heat removal, Btu/h

C_p =specific heat of air Btu/lb°F (about 0.24)

ρ =air density, lb_m/cf (about 0.075)

t_i-t_o =indoor-outdoor temperature difference, °F

Many computer programs are available for predicting ventilation patterns. Some that use the “zonal” method may be used to predict ventilation rate (mechanical and natural), magnitude and direction of air flow through openings, air infiltration rates as a function of climate and building air leakage, pattern of air flow between zones, internal room pressures, pollutant concentration, and back drafting and cross-contamination risks. These models take the form of a flow network in which zones or rooms of differing pressure are interconnected by a set of flow paths. This network is approximated by a series of equations representing the flow characteristics of each opening and the forces driving the air flow process. Widely available codes include BREEZE and COMIS.

A computational fluid dynamics (CFD) program is a more accurate and complex tool for modeling airflow through a space based on pressure and temperature differentials. These programs can simulate and predict room airflow, airflow in large enclosures (atria, shopping malls, airports, exhibitions centers, etc.), air change efficiency, pollutant removal effectiveness, temperature distribution, air velocity distribution, turbulence distribution, pressure distribution, and airflow around buildings. Fluent, Inc. is the largest provider of CFD code. FLUENT is a sophisticated analysis technique that can, among other things, model and/or predict fluid flow behavior, transfer of heat, and behavior of mass. Flomerics authors FLOVENT software, designed to calculate airflow, heat transfer, and contamination distribution for built environments. This software is particularly geared towards ventilation calculations including natural and forced convection currents. It also accurately calculates air density as a function of temperature and predicts the resulting buoyancy forces that can give rise to important thermal stratification effects. Important outputs from FLOVENT are user variables, such as the comfort indices of predicted mean vote, percentage of people dissatisfied, mean radiant temperature, dry resultant temperature, and percentage saturation, including a visualization of their variation through space. A summary of minimum, maximum, mean, and standard deviation for all calculated variables is also available.

Design Details

- Orient the building to maximize surface exposure to prevailing winds.
- Provide the inlets on the windward side (pressure zone) and the outlets on the leeward side (suction zone). Use architectural features like wing walls and parapets to create positive and negative pressure areas to induce cross ventilation. Air speed inside a space varies significantly depending on the location of openings (see table below). As far as possible, provide openings on opposite walls. Using singly loaded corridors will facilitate provision of openings on opposite walls. Limit room widths to 15 ft to 20 ft if openings cannot be provided on two walls. Windows placed on adjacent walls also perform very well due to the wall-jet phenomenon wherein the inflowing air moves along the nearest wall surfaces. This positioning should be limited to smaller spaces (less than 15 ft x 15 ft).
- Air inlet and outlets should be designed to minimize noise transfer from the exterior to the interior and to adjacent occupied spaces.

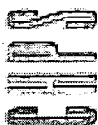

Table 26— Average Indoor Air Velocity as a Percentage of the Exterior Wind Velocity for Wind Direction Perpendicular to and 45° to the Opening

Window Height as a Fraction of Wall Height	1/3	1/3	1/3
Window Width as a Fraction of Wall Height	1/3	2/3	3/3
Single Opening	12-14%	13-17%	16-23%
Two Openings on Same Wall	-	22%	23%
Two Openings in Adjacent Walls	37-45%	-	-
Two Openings on Opposite Walls	35-42%	37-51%	46-65%

Source: Givoni, Baruch; Man, Climate, and Architecture, London: Applied Science, 1976.

- A free ventilation area of 1.5% to 2% (of the floor area), which is the recommended minimum area for operable windows only, will meet the ventilation requirements. Daylighting considerations will require a larger window area. Also, if the space is solely dependent on natural ventilation then code requirements will set the minimum operable window area to 5% of the floor area. Although this area will meet the ventilation requirements of a space during mild climatic conditions, larger window areas should be provided for occupant cooling through increased air movement. For cooling purposes provide 5% to 8% of the floor area as free ventilation area. Equal inlet and outlet areas maximize airflow whereas outlets that are 2% to 5% larger than inlets produce higher air velocities. The inlet location affects airflow patterns far more significantly than outlet location. Inlet location should be a higher priority (if faced with a choice) as a high inlet will direct air towards the ceiling and will almost bypass the occupied level. Locate inlets at a low or medium height. For natural ventilation to function properly, solar gains should be minimized. Direct sunlight penetrating into the space during periods of natural ventilation may make it difficult or impossible to achieve comfortable conditions with natural ventilation alone. Use shading devices to like overhangs, awnings, and fins to control solar gains.
- The incoming air may be cooled through good site planning, landscaping, and planting strategies. If a water body is planned for the site, place it on the windward side to pre-cool the incoming air through evaporative cooling. Planting tall deciduous trees on the windward side will lower the temperature of the inflow and shade the openings.
- Provide windows with shutters that can be opened or shut in increments. This allows the occupants to vary the inlet and outlet areas according to seasonal variations.
- Use features like overhangs, awning windows, eaves, and porches to protect the openings from rain and to minimize excess heat gain from direct sunlight. Awning windows work very well for cross ventilation because they provide more airflow than double hung windows (for the same glazed area) and also provide protection from rain. Casement windows provide maximum airflow in both perpendicular and oblique wind conditions. Ensure that vents and windows are accessible and easy to use. Avoid blocking windows with exterior objects such as shrubs and fences, but do not eliminate shading.
- Provide inlets for cross ventilation openings at the occupied level. Stagger the outlet openings both vertically and horizontally by a few feet to achieve longer air paths. Concentrate ventilation openings in spaces most likely to require cooling.
- Use overhangs, porches, and eaves to protect windows and vents from rain to extend the amount of time that natural ventilation can be used.
- Ensure that openings can be tightly sealed in winter or when using air conditioning.
- HVAC systems should be designed to work in harmony with natural ventilation. The objective of a concurrent natural ventilation system is to meet the outside air requirement using the least possible opening area. The objective of a changeover natural ventilation system is to meet the outside air requirement as well as provide cooling. The HVAC and natural ventilation system are mutually dependent. See the Overview for a detailed discussion.



Operation and Maintenance Issues

This strategy is largely dependent on manual operation for its success. Automated operation may make sense for very large commercial buildings, but not for schools.

- Encourage students and teachers to open/close openings regularly.
- The mechanisms for operable inlets and outlets should be well maintained and clean.
- Periodically clean windowsills, panes, fins, screens, and louvers to ensure healthy air intake for the space.
- Assign responsibility of ensuring that openings are shut during cold weather and the hours of operation of the mechanical system. Also ensure adequate opening area is available for nighttime ventilation in hot dry climates.

Commissioning

None.

References/Additional Information

Passive Cooling by Jeffrey Cook (Ed.), MIT Press, Cambridge, USA, 1989.

Sun, Wind, and Light by G.Z. Brown, John Wiley & Sons, New York, 1986.

Related Volume III CHPS Criteria

See the Overview section of this chapter.

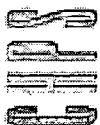

Guideline TC2: Stack Ventilation

Recommendation

Use inlets and outlets of equal area and maximize the vertical distance between these two sets of apertures. Place inlets close to the floor or at the occupied level. Locate the outlets closer to the ceiling on the opposite wall. To facilitate varying summer and winter strategies, provide incrementally operable shutters.

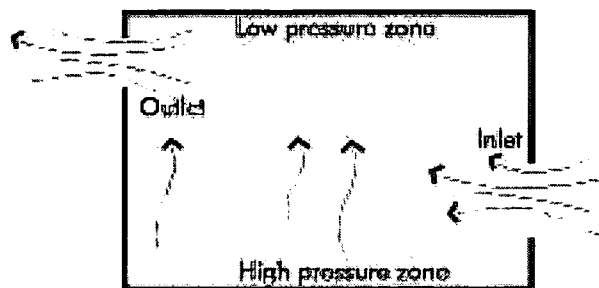

Description

Stack ventilation is one of two methods of providing natural ventilation. Stack ventilation utilizes the difference in air densities to provide air movement across a space. At least two ventilation apertures need to be provided; one closer to the floor and the other high in the space. Warmed by internal loads (people, lights, equipment), the indoor air rises. This creates a vertical pressure gradient within the enclosed space. If an aperture is available near the ceiling, the warmer air at the upper levels will escape as the lower aperture draws in the cool outside air.

Higher indoor temperatures are essential for causing a pressure difference such that the upper openings act as the outlet and cool air intake is induced at the lower opening.

The airflow induced by thermal force is directly proportional to the inlet-outlet height differential, the effective area of the aperture, and the inside-outside temperature differential.

Applicable Spaces	Climates	When to Consider
Classrooms	South Coast	Programming
Library	North Coast	Schematic
Multi-Purpose / Cafeteria	Central Valley	Design Dev.
Gym	Mountains	Contract Docs.
Corridors	Desert	Construction
Administration		Commissioning
Toilets		Operation
Other		

Applicability

Pressure differential driven natural ventilation is an effective strategy for meeting minimum airflow requirements, especially during winter, when the inside-outside temperature differential is at a maximum. It is also appropriate for providing cooling during mild weather conditions.

Applicable Codes

"Section 121-Requirements for Ventilation" of Title 24 apply only to spaces that are ventilated naturally (without mechanical means). These requirements include:

- The total area of the openings should be at least 5% of the total floor area (based on classroom dimensions of 30 ft x 32 ft x 9 ft-6 in., a minimum openable area of 48 ft² should be provided for each classroom).
- All spaces should be within 20 ft of an operable opening in the wall or roof.
- All openings provided for natural ventilation should be readily accessible to occupants of the space at all times when the space is occupied.
- All naturally ventilated spaces should have direct outdoor airflow from openings in the wall or roof. This airflow should remain unobstructed by walls or doors.

Codes related to fenestration performance and maximum allowable window area are also relevant:



- Maximum-allowable window wall ratio limits the area of openings to 40% of the gross wall area. The code also specifies minimum performance levels for fenestrations. See Daylighting Guidelines for more information on performance levels for glazing.

Integrated Design Implications

- Design Phase.** Using the stack effect for ventilation requires an integrated design approach. Stack ventilation will affect building mass and aesthetics. Vertical airshafts for providing stack ventilation also need to be considered early in the design phase.
- Thermal Mass.** Nighttime ventilation coupled with thermal mass is a very effective strategy for heat removal from space, in hot, dry climates.
- Integration with Daylighting and View Windows.** Apertures for stack ventilation need to be located close to the floor and ceiling for best results. The high apertures can couple as clerestories or side lighting luminaries. Benefits of daylighting and natural ventilation need to be considered in conjunction with each other to arrive at the ideal location and size for openings.
- Integration with HVAC.** Stack ventilation will be used for meeting the outside air requirement in most climates other than hot and dry ones (where stack ventilation will also be used for nighttime cooling). Carefully integrating this strategy with HVAC system selection and operation will maximize its benefits. For details, see the Overview section.

Cost Effectiveness

Low to moderate. Stack ventilation may not add to overall costs significantly if integrated with view windows, high side lighting, and other daylighting strategies. However, an additional cost of \$2/ft² may be associated with ensuring that all openings are operable. Adjustable frame intake louvers may cost up to \$25/ft² (this includes installation costs). Additional cost of installing windows high in the space will range from \$15/ft² to \$30/ft².

Costs	L	M	H
	L	M	H
	L	M	H
Benefits			

Benefits

Low to moderate. The benefits depend largely on weather conditions (indoor-outdoor temperature differential), and the design of openings.

- In a moderate climate like that of the north coast, a combination of wind-driven and stack ventilation strategies can meet the cooling loads most of the time. In more extreme climates (with a large diurnal range of temperature), stack ventilation can operate in "mixed-mode" systems and reduce the peak demand through nighttime flushing, resulting in lower utility bills and first costs. In such climates, the simple payback period will be eight to 12 years. For most other climates, the simple payback period will be 10 to 14 years.
- Stack ventilation apertures can also double as side and high side lighting strategies.
- Stack ventilation effectively removes contaminants and pollutants from space.

Design Tools

The airflow (cfm) required can be reasonably estimated using spreadsheet-based calculations. The following algorithm defines the airflow as it varies with the area of openings, indoor temperature, outdoor temperature, and location of the inlet and outlet:

$$Q = 60C_D A \sqrt{2g \Delta H_{NPL} (T_i - T_o) / T_i}$$

Q = airflow rate, cfm

C_D = discharge coefficient for opening

ΔH_{NPL} = height from mid-point of lower opening to Neutral Pressure Level (NPL) ft

T_i = indoor temperature, °F

T_o = outdoor temperature, °F



Use this algorithm to estimate the aperture area for a particular hour of a day (with Q equal to 15 cfm).

A number of computer tools are available for simulating pressure driven airflow. Refer to Guideline TC1: Cross Ventilation for details.

Design Details

- Provide equal inlet and outlet areas to maximize airflow. Airflow will be dictated by the smaller of the inlet and outlet areas.
- The width to height ratio of openings should be more than one as far as possible, i.e., orient openings horizontally.
- The free ventilation area of the inlet and outlet should be at least 1% of the total floor area of the room (4.8 ft² each per classroom, based on 32 ft x 30 ft x 9 ft-6 in. classrooms). This is adequate to meet outdoor air requirements with perpendicular wind speeds as low as 2 mph and low temperature differentials that occur during summer months. Lowering the air intake of these openings during winter or completely shutting some of these openings may avoid uncomfortable winter conditions. For extreme climates, all the available operable openings may remain open only for limited periods.
- Allow for at least a 5 ft center-to-center height difference between the inlet and the outlet. Increasing the height differential further will produce better airflow.
- Use stairwells or other continuous vertical elements as stack wells by providing adequate apertures. Such spaces may be used to ventilate adjacent spaces because of their ability to displace large volumes of air (because of greater stack height).
- Carefully control and minimize solar gains. For details see Guideline TC1: Cross Ventilation.
- Combine stack ventilation with cross ventilation elements. Set the inlet openings for cross ventilation lower in the wall so that they can double as inlets for stack ventilation.
- Use louvers on inlets to channel air intake. Use architectural features like wind towers and wind channels to effectively exhaust the hot indoor air.
- HVAC systems should be designed to work in harmony with stack ventilation (see the Overview section for a discussion).
- Air inlet and outlets should be located or designed to minimize noise transfer from the exterior to the interior and to adjacent occupied spaces.
- Large openings may require installation of security grills to limit potential points of entry.

Operation and Maintenance Issues

This strategy is largely dependent on manual operation for its success:

- Openings should be appropriately operated according to indoor-outdoor temperature differentials.
- The mechanisms for operable inlets and outlets should be well maintained and clean.
- Windowsills, fins, screens, and louvers should be periodically cleaned to ensure healthy air intake for the space.
- Assign responsibility of ensuring that openings remain shut during the mechanical system's hours of operation unless the ventilation is designed to work concurrently.
- Ensure that adequate opening area is available for nighttime ventilation in hot, dry climates.

Commissioning

None.

References/Additional Information

Cook, Jeffrey. *Passive Cooling*. MIT Press, Cambridge, USA, 1989.

Brown, G.Z. *Sun, Wind, and Light*. John Wiley & Sons, New York, 1986.

Related Volume III CHPS Criteria

See the Overview section of this chapter.

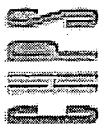

Guideline TC3: Ceiling Fans

Recommendation

Use ceiling fans in classrooms to provide enhanced thermal comfort for occupants through higher air velocity. Use the ceiling fans instead of air conditioners in mild coastal climates. In more extreme climates, use ceiling fans as a supplement to cooling systems.

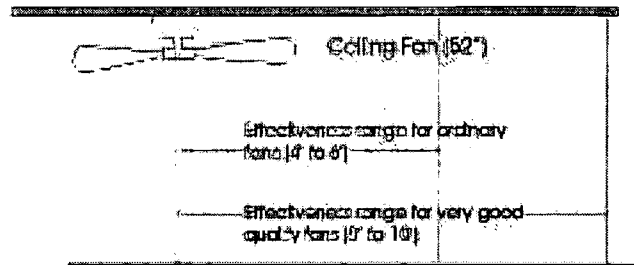

Description

A ceiling fan is a device for creating interior air motion. It is a permanent fixture operated by a switch or a pull string. Acceptable comfort levels can be maintained above the customary comfort zone for air speeds exceeding 50 fpm by using a ceiling fan. Generally, for speeds above 30 fpm, most people will perceive a 15 fpm increase in air to be equal to 1°F decrease

in temperature. This phenomenon is commonly called "chill factor." Outside air can be introduced into a space through openings using a fan when outside air cannot enter the space on its own, because it is either too humid or too hot. A fan can also re-circulate air within a space. Fans also cool by increasing evaporation of moisture from the skin (skin moisture vaporizes using body heat to change phase).

In a high ceiling space, ceiling fans can help "destratify" the warm air layer, which collects near the ceiling, and distribute it to the lower part of the space for thermal comfort. As a result, heating thermostats need not be set as high.

The interior air motion caused by ceiling fans varies as a function of fan position, power, blade speed (measured in rpm), blade size, and the number of fans within the space. Moreover, air speeds within a space vary significantly at different distances from the fan.

The normal current draw will range from approximately 15 W at low speed to 115 W at high speed.

Applicability

Ceiling fans are appropriate for classrooms and administration areas. They may not be suitable for gyms because of the potential for rapid skin cooling (more skin moisture is secreted during intense physical activities). Nor are they appropriate for toilets as the space may be too small for a ceiling hung fan. Noise produced by ceiling fans may be an issue in auditoriums or classrooms if fans turn at too high a velocity.

Ceiling fans are suitable for most climates that require cooling. Combined with other passive strategies they may eliminate the need for air conditioning in the north coast region. They are not very useful in humid climates.

Ceiling fans should be considered in the design development stage due to electrical wiring and ceiling height issues, although adding fans to existing spaces is feasible too.

Applicable Codes

Electrical codes apply.

Applicable Spaces	Climates	When to Consider
Classrooms	South Coast	Programming
Library	North Coast	Schematic
Multi-Purpose / Cafeteria	Central Valley	Design Dev.
Gym	Mountains	Contract Docs.
Corridors	Desert	Construction
Administration		Commissioning
Toilets		Operation
Other		



Integrated Design Implications

Using ceiling fans does not significantly impact other design decisions, except when a displacement airflow design is being considered.

- A minimum ceiling height of 9 ft must be provided to accommodate a fan such that its blades are at a distance of 8 ft from the floor and 1 ft from the ceiling.
- Ceiling fans should be combined with natural ventilation strategies for best results.

Cost Effectiveness

Ceiling fans cost between \$75 and \$200. The typical cost of a professionally installed fan is about \$250. Fans with features such as light fixtures, reverse or multiple speed settings, and extended warranties may cost more. Some ceiling fans are very economical to operate as they consume very little energy. Others have very inefficient motors and add considerable heat to the room. Careful selection should be made.

Costs	L			
	M			
	H			
		L	M	H
		Benefits		

Benefits

- Moving air extends the comfort range and allows occupants to feel comfortable at higher temperatures. It also helps occupants feel dry. Wind speed is one of the six factors that affect thermal comfort indices like the predicted mean vote (PMV). Increasing air speeds results in PMVs that fall in the comfort zone (for detailed discussion, see this chapter's Overview section).
- Temperature settings for mechanical cooling equipment can be higher and an energy savings greater than the energy consumption of the fans can be realized. According to the Texas Energy Extension Service, for a 3-ton cooling system costing \$550 per season, raising the thermostat from 75°F to 80°F can reduce the operating cost by \$151. Operating a ceiling fan 10 or more hours a day may cost less than \$3/month. For example, a typical fan operating at high speed uses approximately 100 W of power. Assuming that the fan is operated five hours/day with an energy cost of \$0.08/kWh, the cost of operation will be \$0.04/day. At lower speeds this operating cost will be even less. This low operating cost and the potential reduction in cooling and heating cost make the ceiling fan one of the better energy saving devices on the market. As a rule of thumb — each degree rise in a thermostat setting (beyond 78°F) results in a 3% to 5% saving on cooling energy. If the ceiling fan is supplementing air conditioning, the thermostat of the air conditioning unit may be raised a full 4°F above the standard 78°F setting while still maintaining comfortable space conditions.
- In the heating season, ceiling fans can help bring the warmer air that stratifies near the ceiling down to where the occupants are located. A low speed that does not create a significant breeze is best for this heating season application. Again, the thermostat set point may be lowered by nearly 2°F.

Design Tools

Use the following charts to size ceiling fans according to largest room dimension and room area:

Table 27 — Fan Diameter Selection Based on Space Dimensions

Largest Dimension of Room	Minimum Fan Diameter
12 ft or less	36 in.
12 - 16 ft	48 in.
16 - 17.5 ft	52 in.
17.5 - 18.5 ft	56 in.
18.5 ft or more	2 fans needed



Table 28 — Fan Diameter Selection Based on Space Area

Room Area	Minimum Fan Diameter
100 ft ²	36 in.
150 ft ²	42 in.
225 ft ²	48 in.
375 ft ²	52 in.
400+ ft ²	2 fans needed

Sources: *Consumer Guide to Home Energy Saving (1995) by the American Council for an Energy Efficient Economy.*

Design Details

- Use ceiling fans in frequently occupied spaces.
- Use "Quiet Type" energy-efficient fan and motor assemblies.
- A larger fan provides a greater range of airflow settings and ventilates a larger area at lower velocities, with less noise, and only slightly more power than similar smaller units. Use two 48 in. fans in classrooms (based on 30 ft x 32 ft classrooms). These will move air most effectively in a 4 ft to 6 ft radius, and somewhat less effectively for another 3 ft to 4 ft radius. At the level of seated occupants, this will achieve air speeds ranging from 50 fpm to 200 fpm. Beyond 30 fpm, every additional 15 fpm results in a perceived 1°F drop in temperature. The more blade surface, the more air it will catch.
- Ceiling fans work best when the blades are 8 ft to 9 ft above the floor and 10 in. to 12 in. below the ceiling. Placing fans so the blades are closer than 8 in. to the ceiling can decrease the efficiency by 40%. Fans also require at least 18 in. of clearance between the blade tips and walls. Two types of mountings are available for ceiling fans — rod and hugger. In rod fans, the motor housing is suspended from the mounting bracket by a rod. With hugger fans, the motor housing is mounted directly to the ceiling box. Hugger fans are not as efficient as rod fans in the down motion, especially at higher speeds. The blades will starve themselves for air when they are too close to the ceiling.
- Use ceiling fans to supplement air movement in natural ventilation strategies.
- Select a fan with at least a two-speed control for better regulation of air movement. Variable-speed fans are preferable so that the lowest speed can be used in the heating season to accomplish destratification without causing excessive draft. If using a reversible fan, ensure that the fan has a setting low enough to circulate the air without creating too much of a breeze. These fans are best for rooms that tend to build up heat.
- Fans should be on only when the space is occupied; otherwise the movement of the motor is also introducing some heat in the room without any cooling benefits. Remember that ceiling fans cool people, not spaces. Consider using an occupancy sensor.

Operation and Maintenance Issues

- Ceiling fans should be operated only when the rooms are occupied. A motion sensor or a clear policy of operating ceiling fans only when using the room is needed.
- Ensure that all blades are screwed firmly into the blade holder and that all blade holders are tightly secured at the fan. This should be checked at least once a year.
- It is important to periodically clean the fan, as the blades tend to accumulate dust on the upper side. An anti-static agent can be used for cleaning, but do not use any cleaning agents that can damage the finish. Never saturate a cloth with water to clean the ceiling fan.
- For a fan to perform efficiently, it is very important that the blade be aerodynamically shaped to increase its efficiency, similar to an airplane propeller. "Balanced" blades; that is, blades that are electronically matched at the factory; are sold as balanced four- or five-blade sets, depending on the design of the fan. For this reason, never interchange blades between fans.



Commissioning

- Use durable fans with longer warranties. Use fans with metal motor housings — these may require annual oiling (while plastic motor housings will not), but may have better warranties and be worth the added maintenance.

References/Additional Information

AIRBASE (database of over 7,000 abstracts of international papers on infiltration and ventilation), Air Infiltration and Ventilation Centre, Sovereign Court, University of Warwick Science Park, Sir William Lyons Road, Coventry, CV4 7EZ, U.K. Tel: 44-203-692050, Fax: 44-203-416306.

American Society of Heating, Refrigerating and Air Conditioning Engineers. *ASHRAE 62-Ventilation for Acceptable Indoor Air Quality*. 1791 Tullie Circle NE, Atlanta, GA, 30329-2305. Tel:(404) 636-8400; Fax:(404) 321-5478.

Bower, John. *Understanding Ventilation: How to Design, Select, and Install Residential Ventilation Systems*. The Healthy House Institute, 430 N. Sewell Rd., Bloomington, IN 47408.

The Home Ventilating Institute. *The Certified Home Ventilating Products Directory*. 30 West University Dr., Arlington Heights, IL 60004-1893. Tel:(708) 394-0150.

Oikos/Green Construction Source (Features REDI 96, an online directory of products, including ventilation fans, devices, and controls.) Iris Communications, P.O. Box 5920, Eugene, OR, 97405-0911, Tel:(541) 484-9353. Web site: <http://www.irisinc.com/oikos>

Related Volume III CHPS Criteria

See the Overview section of this chapter.



Guideline TC4: Gas/Electric Split System

Recommendation

When specifying a gas/electric split system, consider an add-on economizer, two-speed blower/furnace/compressor, high-efficiency furnace (AFUE 90+), and high-efficiency cooling (SEER 14+).

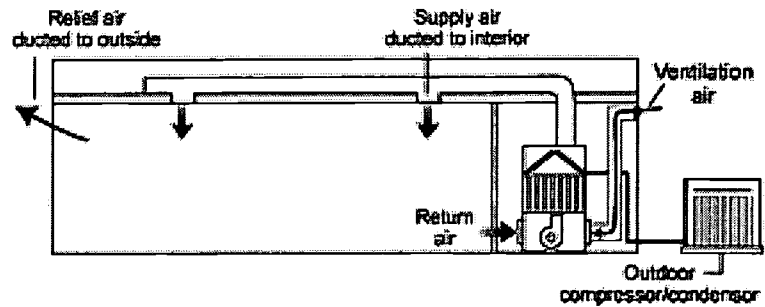

Description

This system is similar to a typical residential heating and cooling system. The components include an indoor fan unit and outdoor compressor and condenser package. The indoor unit usually includes a cooling coil and furnace section, although the furnace can be omitted if the compressor is also used for heating in heat pump mode. The indoor and outdoor sections are connected via refrigerant tubing and control wires.

Gas/Electric Split System

Applicable Spaces	Climates	When to Consider
Classrooms	South Coast	Programming
Library	North Coast	Schematic
Multi-Purpose / Cafeteria	Central Valley	Design Dev.
Gym	Mountains	Contract Docs.
Corridors	Desert	Construction
Administration		Commissioning
Toilets		Operation
Other		

Supply air from the indoor unit is typically ducted to several supply diffusers in the ceiling. Return air may be ducted or returned directly to the unit through a grill.

While most residential systems recirculate indoor air only, an outside air duct is essential to supply ventilation air that is mixed with return air for schools.

Variations and Options

An economizer is not standard with split systems but is available as an aftermarket option. The additional equipment includes a mixing box with outdoor and return air dampers and the associated controls. Check with split system manufacturer for control compatibility.

For climates where cooling is unnecessary, then the system can be used for heating only, or for heating and ventilating. Eliminating the cooling coil and outdoor compressor unit reduces the cost significantly. An economizer may be installed to provide free cooling if the space design does not allow for convenient natural ventilation cooling (due to drafts, outdoor noise, dust, or similar problems).

Indoor units are available for either horizontal or vertical installation. Horizontal units are typically installed above the ceiling. Vertical units may be installed in a mechanical closet with flow direction either upwards or downwards.

A high-efficiency, condensing furnace is available as an option for most split systems. Annualized fuel utilization efficiency (AFUE) is 90% to 96%, compared to about 80% for standard units.

High-efficiency cooling is also an option provided by most manufacturers. Systems are available with efficiencies greater than seasonal energy efficiency ratio (SEER) 14, compared to typical units with SEER 10 to 11.

A two-speed blower and variable output furnace is an option that can provide significant fan energy savings and improve comfort through less on-off cycling.



BEST COPY AVAILABLE

Two-speed compressors are available that can be controlled together with a two-speed indoor fan for better comfort and humidity control.

Heat pump heating is an option for locations without convenient natural gas access. In cool climates, a supplementary electric resistance heating element may be necessary, especially to handle relatively high ventilation air requirements for classrooms.

Natural gas engine-driven heat pumps are available, however they are more expensive. These units use a reciprocating natural gas engine rather than an electric motor to drive the compressor and provide heating and cooling.

Applicability

This system type is appropriate for classrooms or other single zone spaces up to about 2,500 ft².

Applicable Codes

Minimum cooling efficiency is SEER 10.0 for split systems smaller than 65,000 Btu/h of cooling capacity. Minimum heating efficiency is 78% AFUE for gas furnaces smaller than 225,000 Btu/h. These efficiency requirements are federal regulations.

Outdoor air ventilation (see the topic in this chapter's Overview section).

Temperature control.

Integrated Design Implications

Location of the indoor and outdoor units needs to be considered early in the architectural design to ensure optimal performance. See Design Details below for important considerations. Similarly, the location of ducts and supply registers should be considered when making structural and lighting system decisions.

System controls should be specified so they integrate with natural ventilation design. Use automatic interlock controls to shutoff the system when windows are opened or allow manual fan shutoff. If the space is designed for good natural ventilation, then an economizer may not be necessary.

Try to place ducts within the conditioned envelope to minimize the impact of leakage and conduction losses, which can be very significant. Insulate under the roof deck rather than on top of a suspended ceiling. If possible, place the indoor unit within the conditioned envelope as well. Ensure, however, that combustion air is properly vented.

Cost Effectiveness

Overall system cost for a gas/electric split system ranges from \$10/ft² to \$12/ft².

A high-efficiency (condensing) furnace adds roughly \$700, compared to a standard efficiency unit with a base installed cost of about \$550. However, the extra cost may also cover multi-speed fan control and variable furnace output, in addition to better efficiency.

An efficient 3-ton air conditioner with 13 SEER costs roughly \$2,500, compared to \$1,700 for a SEER 10. The incremental cost is roughly \$800.

An outside air economizer adds about \$300 to \$500.

For a 960-ft² classroom, the incremental cost for combined measures is roughly \$2,000, or \$2/ft² of floor area.

High-efficiency cooling is generally cost effective in warm regions. A high efficiency, condensing furnace should be cost effective in cool climates, especially considering construction cost savings due to more flexibility in locating the low temperature flue vent.

Costs	L			
	M			
	H			
		L	M	H
		Benefits		

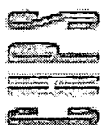

Benefits

Advantages

- High heating and cooling efficiencies are available. (By contrast, efficient heating options are seldom available for packaged rooftop units.)
- Two-speed fan and compressor options improve partial load efficiency, comfort, and humidity control.
- Numerous system capacities are possible with combinations of furnace units, cooling coils, and compressors.
- An economizer can be added to take advantage of outdoor air for free cooling.
- Outdoor unit is relatively small.
- It is possible to keep all ducts within the insulated building shell to minimize impact of duct losses.
- Moderate initial cost.
- This can be installed as a heating-only system at a lower cost. A cooling coil and outdoor condensing unit can be added later if desired. However, their ductwork and air distribution system would need to be sized for greater cooling airflow requirements.

Disadvantages

- Space within the building shell is required for the indoor unit, either above the ceiling or in a closet.
- An indoor unit may create noise in the space if not carefully designed and installed.
- Air ducts are required, which can be leaky and inefficient if not installed properly.
- High-efficiency units have a significant cost premium.
- Limited multi-zone capability.
- Poor dehumidification control (better with two-speed compressor and fan).
- Higher maintenance cost for large facilities compared to central variable air volume systems.

Design Details

Indoor unit location considerations:

- To reduce noise, isolate the unit from the occupied space, as well as provide appropriate noise control measures at the intake and discharge and adequately sized ducts and registers to avoid excessive air velocity.
- Make sure that filters and coils are easily accessible for maintenance.
- Provide easy access for the outdoor air inlet, minimizing length of ducts and eliminating turns from ductwork if possible.
- Allow access to outdoors for furnace combustion air and provide a vent for flue gas as recommended by the manufacturer.
- Minimize the number of duct turns necessary to reach supply diffusers and return grilles, and minimize length of ducts (second priority compared to number of turns). At the same time, however, ensure that noise transmission through the ducts is controlled.
- Consider that cooling coil condensate must drain to a proper receptacle and condensate pan overflow should drain to a visible location.
- Provide adequate vibration isolation. Manufacturer may provide standard vibration isolation package.
- See also TC19: Air Distribution Design Guidelines for information about choosing locations for supply and return registers to minimize noise and maximize performance.



Outdoor unit location considerations:

- Typically, the unit is placed on a concrete pad alongside the building. However, rooftop installation is possible as well.
- To reduce noise, keep the unit away from operable windows and doors.
- Remember that outdoor units face the potential for vandalism and design accordingly.
- Provide access for maintenance.
- Try to choose a shaded location with the lowest possible ambient air temperature to improve cooling efficiency. Be especially careful to avoid direct exposure to afternoon sun.
- Provide adequate clearance around the outdoor unit to prevent airflow obstructions.
- If the outdoor unit is mounted on the rooftop, then consider using a reflective white roof membrane to reduce temperature and improve system performance. Standard roofs exceed 150°F on a sunny day, while white roofs can be 50°F cooler.

Match the compressor and indoor fan units for proper performance. See manufacturers' literature for combinations and their efficiency ratings.

Be sure to allow for furnace condensate drainage for high efficiency units, and provide condensate drainage for cooling coils.

Design the air distribution system to minimize pressure drop and set blower fan motor to low or medium speed to reduce fan energy consumption and minimize noise (see TC19: Air Distribution Design Guidelines).

Do not oversize heating and cooling capacities (see the topic Load Calculations in this chapter's Overview section).

If choosing a system with a multiple-speed fan as well as variable heating and cooling capacity, then specify a thermostat with those control capabilities.

Operation and Maintenance Issues

Maintenance requirements for a gas/electric split system are very similar to other system types. However, all compressor-cooling systems require additional maintenance skills and cost more to maintain compared to heating-only systems.

Recommended maintenance tasks include:

- Replacing filters regularly.
- Cleaning indoor and outdoor coils regularly.
- Checking refrigerant charge.
- Cleaning the cooling coil condensate pan and drain.
- Lubricating and adjusting the fan as recommended by manufacturer.

Commissioning

Measure total supply airflow with a flow hood or comparable measuring device. Make sure that airflow is within 10% of design value. If airflow is low, then check ducts for leaks and constrictions, and check that filters and coils are free of obstructions. Larger ducts, or shorter duct runs, may be necessary. Reduce the number of duct turns to a minimum. If airflow is high, then reduce fan speed if possible according to manufacturer's instructions.

If an economizer is installed, then verify proper operation (see TC18: Economizers).

References/Additional Information

TC18: Economizers; TC19: Air Distribution Design Guidelines.

Related Volume III CHPS Criteria

See the Overview section of this chapter.

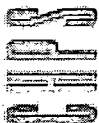

Guideline TC5: Packaged Rooftop System

Recommendation

If choosing a packaged rooftop system, specify a high-efficiency unit with an integrated economizer (depends on the space's natural ventilation design), and design the duct system to allow proper airflow at low or medium fan speed.

Description

A packaged rooftop system is fully self-contained, and most consist of a constant volume supply fan, direct expansion cooling coil, heating (when required) with gas furnace, filters, compressors, condenser coils, and condenser fans. Units are typically mounted on roof curbs but can be also mounted on structural supports or on grade. Packaged rooftop single zone units are typically controlled from a single space thermostat with one unit provided for each zone. Supply air and return air ducts connect to the bottom (vertical discharge) or side (horizontal discharge) of the unit.

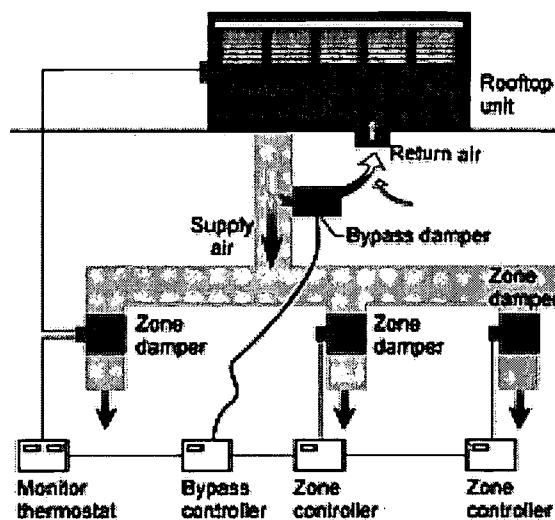

Packaged Rooftop System.

Variations and Options

Economizers are often standard, cost-effective options for rooftop units (see TC18: Economizers).

High-efficiency cooling with seasonal energy efficiency ratios in the range of 12 to 13 is commonly available.

Units can be purchased as heat pumps for use in areas without convenient access to natural gas for heating.

An evaporative precoolers can be added to the condenser to increase capacity and efficiency during hot weather.

A "single zone" rooftop unit can condition multiple zones when equipped with special controls and hardware. This type of system includes an automatic damper in the ductwork for each zone, which modulates to control temperature. If some zones require cooling while others need heating, then the controller switches the rooftop unit between both modes and the zone dampers will open or close as appropriate. This system also includes a bypass damper between the supply and return that is opened to maintain constant airflow through the rooftop unit when one or more zone dampers are closed.

Applicability

A packaged rooftop unit is applicable for spaces that require heating and cooling. However, due to their relatively low cost and expected short life (less than 30 years), they are sometimes installed where only heating is required.

Applicable Spaces	Climates	When to Consider
Classrooms	South Coast	Programming
Library	North Coast	Schematic
Multi-Purpose / Cafeteria	Central Valley	Design Dev.
Gym	Mountains	Contract Docs.
Corridors	Desert	Construction
Administration		Commissioning
Toilets		Operation
Other		

BEST COPY AVAILABLE

Due to the constant volume fan, this system is most applicable where loads and ventilation requirements are relatively constant, such as in classrooms, administration areas, and libraries. The system is less applicable for intermittent occupancies such as assembly areas.

Packaged rooftop units are available in capacities from 2 tons to more than 100 tons, and can be used for single zones from 600 ft² to more than 30,000 ft².

Multiple zones where the zone loads are not too different can be handled with special controls. There is no theoretical limit to the number of zones possible, and commercially available controllers will serve 32 or more. However, in practice, these controls should be used for no more than a handful of zones. For larger systems, variable air volume (VAV) controls will be more effective and efficient.

Applicable Codes

See Table 29 for minimum cooling efficiency requirements. For units smaller than 65,000 Btu/h, these efficiency requirements are federal regulations.

Outdoor air ventilation (see this chapter's Overview section)

Temperature control.

Title 24 requires an integrated economizer for systems with cooling capacity greater than 75,000 Btu/h and supply airflow greater than 2,500 cfm.

Integrated Design Implications

Rooftop units can have a significant visual impact and can create concern regarding noise level at adjacent properties. Their location should be considered early in the architectural design process to allow for efficient duct layout. In addition, location of ducts and supply registers should be considered when making lighting system decisions.

System controls should be specified so they integrate with natural ventilation design. Use automatic interlock controls to shut off the system when windows are opened or allow manual fan shutoff. If the space is designed for good natural ventilation, an economizer may not be necessary.

Try to place ducts within the conditioned envelope as much as possible to minimize the impact of leakage and conduction losses, which can be very significant). This is only recommended, however, where approximately the first 20 ft of duct runs above spaces that are not sensitive to noise. Insulate under the roof deck rather than on top of a suspended ceiling.

Cost Effectiveness

The overall cost for a packaged rooftop system can be as low as \$15/ft² to \$20/ft² (installed cost, including ductwork and controls).

Cost of the unit alone ranges from about \$1,500 for a two-ton unit to around \$2,000 for a five-ton unit. High-efficiency package units (when available) cost about 10% more than standard efficiency models and have paybacks of around three to four years in warm climates.

Costs	L			
	M			
	H			
		L	M	H
		Benefits		

Packaged rooftop systems are often the lowest first cost alternative when both heating and cooling are required. However, they are relatively costly to maintain, energy costs are higher than average, and life expectancy is less than 30 years.

Benefits

Advantages

- Low initial cost.
- No inside mechanical equipment space is used.

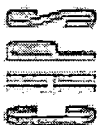

- An added economizer can take advantage of outdoor air for free cooling (see TC18: Economizers).
- Systems are widely available.

Disadvantages

- Fewer efficiency options exist compared to gas/electric split systems (e.g. condensing furnace, two-speed fan, high efficiency cooling).
- Systems are relatively large and require roof space.
- Air ducts, which can be leaky and inefficient if not installed properly, are required.
- Systems have limited multi-zone capability.
- Poor dehumidification control can occur compared to VAV systems (due to compressor cycling).
- Higher maintenance costs occur for large facilities compared to central VAV systems.
- Systems have typically shorter lifetimes than central VAV systems.

Design Details

Most packaged systems have several fan speed options that can be selected in the field when the unit is installed. Careful design of the air distribution system can reduce pressure drop and provide significant savings if the fan is wired for low or medium speed (see TC19: Air Distribution Design Guidelines).

The incremental equipment cost for packaged rooftop equipment is not too large to increase size from say, two to four tons. Therefore, the temptation is strong to specify the larger unit for safety's sake. However, there are performance penalties for oversized systems. Bigger is not always better. Do not rely on rules of thumb to select airflow, cooling capacity, or heating capacity. See this chapter's Overview section for a discussion of load calculations and the impact of cooling capacity oversizing.

Table 29 lists recommended minimum efficiencies for packaged rooftop equipment.

Vibration isolation is often provided internally. Internal isolation should be reviewed for proper spring type and static deflection. If internal isolation is not provided, or is unacceptable, external spring isolators should be utilized. Refer to 1995 ASHRAE Handbook Chapter 43 for recommended vibration isolation. If external isolation is used, all internal spring isolators should not be released from their restraining bolt.

The unit should be located above unoccupied spaces (i.e., storage, stairwells, etc.).

Provide appropriate intake and discharge noise control consistent with meeting the Noise Criteria.

Table 29 – Recommended Minimum Efficiencies for Air-Cooled Packaged Rooftop Equipment

Capacity	Title 24 (after 10/29/01)	Recommendation
< 65,000 Btuh	10.0 SEER	12.0 SEER
65,000 – 135,000 Btuh	10.3 EER	11.0 EER
135,000 – 240,000 Btuh	9.7 EER	10.5 EER
> 240,000 Btuh	9.5 EER	10.0 EER

Operation and Maintenance Issues

Maintenance requirements for a packaged rooftop system are very similar to other system types. However, all compressor-cooling systems require additional maintenance skills and cost more to maintain compared to heating-only systems.

Recommended maintenance tasks include:

- Replacing filters regularly.
- Cleaning indoor and outdoor coils regularly.



- Checking refrigerant charge.
- Cleaning and draining cooling coil condensate pan, and specify pans that are pitched to drain continuously under all operating conditions.
- Pitch and properly trap drain pan and drain condensate to a roof drain, not over the side of a building.
- Lubricating and adjusting fan as recommended by the manufacturer.

Commissioning

Measure total supply airflow with a flow hood or comparable measuring device. Make sure that airflow is within 10% of design value. If airflow is low, then check ducts for constrictions and check that filters and coils are free of obstructions. Larger ducts or shorter duct runs may be necessary. Reduce the number of duct turns to a minimum. If airflow is high, then reduce fan speed if possible, according to manufacturers' instructions.

If an economizer is installed, then verify proper operation (see TC18: Economizers).

References/Additional Information

Guideline TC18: Economizers; Guideline TC19: Air Distribution Design Guidelines.

Related Volume III CHPS Criteria

See the Overview section of this chapter.



Guideline TC6: Displacement Ventilation System

Description

Displacement ventilation systems are different from most other HVAC systems for schools and offer a number of advantages. With displacement systems, air is delivered near the floor, at a low velocity, and at a temperature from 63°F to 65°F (compared to around 55°F). The goal of displacement systems is not to cool the space, but to cool the occupants. Cool air flows along the floor until it finds warm bodies. As the air is warmed, it rises around occupants, bathing them in cool fresh air. Air quality improves because contaminants from occupants and other sources tend to rise out of the breathing zone rather than being mixed in the space. Similarly, cooling loads decrease significantly because much of the heat generated by occupants, lights, and computer equipment rises directly out of the occupied zone and is exhausted from the space. This is especially true in classrooms designed for 100% outside air with total energy recovery.

Variations and Options

There are several supply air distribution options:

- Access floor.
- Low wall outlets.
- Infloor outlets.

The best cooling source for a displacement ventilation system is a chilled water coil. The control valve in a hydronic system allows supply of constant 63°F to 65°F air. A typical direct exchange (DX) system is designed to provide colder 50°F to 55°F air while the compressor is running and cycles on and off to meet space loads. This lower temperature and temperature fluctuations would create a comfort problem in displacement ventilation when it comes in contact with occupants. However, larger DX systems with several compressors and temperature-reset capabilities can be used as an alternative to a chilled water system. For example, a packaged rooftop variable air volume (VAV) system serving 10 or more classrooms should be able to provide the necessary supply air temperature control.

Evaporative cooling is also a potential source because it typically produces higher air temperature than a DX system.

Applicability

Displacement ventilation is most appropriate for spaces with ceiling height of at least 10 ft to permit stratification. Systems that utilize 100% outside air design with enthalpy energy recovery are very suitable for high occupant density areas like classrooms and auditoriums. This distribution type is also a great choice where raised access floors are desired for flexibility of power and communication wiring (although access floors are not required for displacement ventilation).

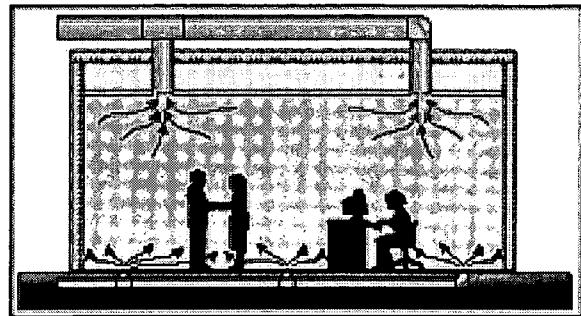

Displacement ventilation.

Ventilation System.

Source: <http://www.advancedbuildings.org>

Applicable Spaces	Climates	When to Consider
Classrooms	South Coast	Programming
Library	North Coast	Schematic
Multi-Purpose / Cafeteria	Central Valley	Design Dev.
Gym	Mountains	Contract Docs.
Corridors	Desert	Construction
Administration		Commissioning
Toilets		Operation
Other		



Applicable Codes

Displacement ventilation systems face the same fan power limits and equipment-efficiency requirements as other system types.

Integrated Design Implications

Supply air outlets must be coordinated with the location of furnishings and space usage. The outlets may be integrated with cabinets or seating.

There is an excellent opportunity to integrate electrical and communication wiring with the air distribution either under the floor or along the baseboard.

A displacement system can eliminate the need for a suspended ceiling and allow the ceiling to be clear of supply diffusers.

If the ceiling is high enough, displacement ventilation can be integrated into portable classroom design, where space for ducting exists in the crawlspace beneath the floor.

Slab floors may be designed with integral ducts or troughs for air distribution.

Consider using variable-speed heating and cooling sources to minimize the on-off cycling and variations in supply air temperature.

Ceiling fans are not recommended with displacement ventilation because they are designed to mix air in a space and will disrupt the stratification created by the displacement ventilation system.

Cost Effectiveness

There is not a great deal of experience with displacement ventilation in California classrooms, but it is growing in popularity for new commercial buildings. For the near future, costs are likely to be higher than standard overhead air distribution.

A displacement ventilation system will probably not provide a short payback based on energy savings alone. However, the system provides additional comfort and air quality benefits.

Costs	L			
	M			
	H		■	
		L	M	H
		Benefits		

Benefits

Advantages

- Significantly lower cooling loads (1/3 lower) result from thermal stratification.
- Significantly low system capacities will be needed if enthalpy energy recovery is used in combination with this vertical displacement approach.
- Air quality will improve per cfm moved compared to systems that mix space air.
- Can provide equal or better air quality with less outdoor air due to stratification.
- Lower fan energy with lower static pressure may result (depends on distribution type and outlet type).
- Ceiling remains clear of supply registers, except for exhaust/return grills.
- Raised access floor systems are typically made up of 1-in. to 1.5-in. thick concrete sections. This provides advantages from the standpoint of controlling duct noise breakout and/or radiated noise from VAV or fan powered boxes.

Disadvantages

- Heating performance may be worse than systems providing air at greater velocities. Mixing (i.e., destratification) is desirable for heating.



- First cost may be higher with raised floor systems.
- Some floor area or low wall area is required for supply air outlets.

Design Tools

All manufacturers of sidewall displacement diffuser and floor systems offer design assistance and computational fluid dynamics (CFD)-generated graphics that depict air supply patterns with defined supply air temperatures and airflows.

CFD software that now runs on personal computers can help predict airflow patterns within a room, as well as help with the selection and location of supply outlets.

Design Details

Provide 20 cfm to 30 cfm per occupant (0.6 cfm/ft² to 0.9 cfm/ft²) for classrooms depending on cooling loads. At this relatively low airflow rate, 100% outside air may be necessary.

Deliver supply air at 63°F to 65°F.

Design for air velocity at supply outlets no greater than 25 ft/minute to 50 ft/minute. Therefore, displacement ventilation requires significantly larger supply outlets than an overhead distribution system. However, the system would be typically delivering close to half the airflow rate of a conventional mixed air system.

Try to place sidewall outlets at the corners of the room. Try to avoid situations where occupants are more than 15 ft from the nearest supply outlet.

Use barometric relief dampers to exhaust the 100% outside air.

Minimum ceiling height is about 10 ft for adequate stratification.

In choosing cooling capacity, consider that loads from lighting, computers, and occupants will be reduced by about 1/3 compared to a system type that mixes indoor air.

Higher air velocity is desirable in heating mode, so consider a design that reduces supply air outlet area (either manually or automatically) when the system provides heating, or that uses VAV in cooling and full airflow in heating. This is especially important in large halls, such as a gymnasium with sidewall supply. Consider demand control and variable frequency drive (VFD) in gyms, auditoriums, and cafeterias.

Operation and Maintenance Issues

Operating and maintenance requirements are similar to overhead air distribution systems.

Commissioning

Check for proper supply air temperatures. Ensure that air velocity at supply outlets is not too high for comfort. Verify that total airflow meets design requirement. Verify proper control operation and temperature reset for heating or cooling. Verify VAV or VFD operation if demand control is incorporated into an area such as a gym.

References/Additional Information

Boscawen School, NH implemented this type of system. H. L. Turner Group, Architects.

Related Volume III CHPS Criteria

See the Overview section of this chapter.

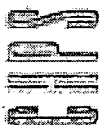

Guideline TC7: Hydronic Ceiling Panel System

Recommendation

Install radiant cooling ceiling panels in arid areas needing significant cooling.

Description

A hydronic ceiling panel system provides thermal comfort predominately through radiation heat transfer with objects and occupants. Basic ceiling panel design consists of a metal sheet with copper tubing attached to the upper side and covered with insulation/acoustical inlay material. Applications can take the form of modular panels or wall-to-wall linear design. The system can be suspended, recessed, or placed in a grid configuration. A ceiling panel heating/cooling system involves the following:

- Ceiling panels.
- Support system.
- Control system.
- Hydronic distribution system.
- Hot/cold water source.

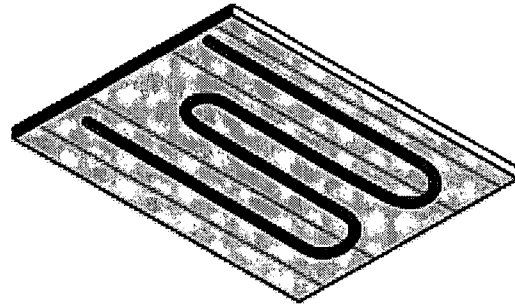

Applicable Spaces	Climates	When to Consider
Classrooms	South Coast	Programming
Library	North Coast	Schematic
Multi-Purpose / Cafeteria	Central Valley	Design Dev.
Gym	Mountains	Contract Docs.
Corridors	Desert	Construction
Administration		Commissioning
Toilets		Operation
Other		

Applicability

Most applicable in areas with low latent heat load, but can also work in more humid climates with a proper dehumidifying system. Panels can also be used for heating, generally as a substitution for radiators around building perimeter.

Applicable Codes

There are no requirements specific to hydronic ceiling panels in Title 24. A supplemental ventilation system (mechanical or natural) must be used to meet indoor air quality standards. Exposed piping must be insulated in accordance with Section 123 of Title 24. If the system is cooling-only, the insulation requirement will be minimal. Insulation is not required for water temperatures greater than 60°F, and inlet water temperatures for ceiling panel systems are typically between 58°F and 65°F.



Integrated Design Implications

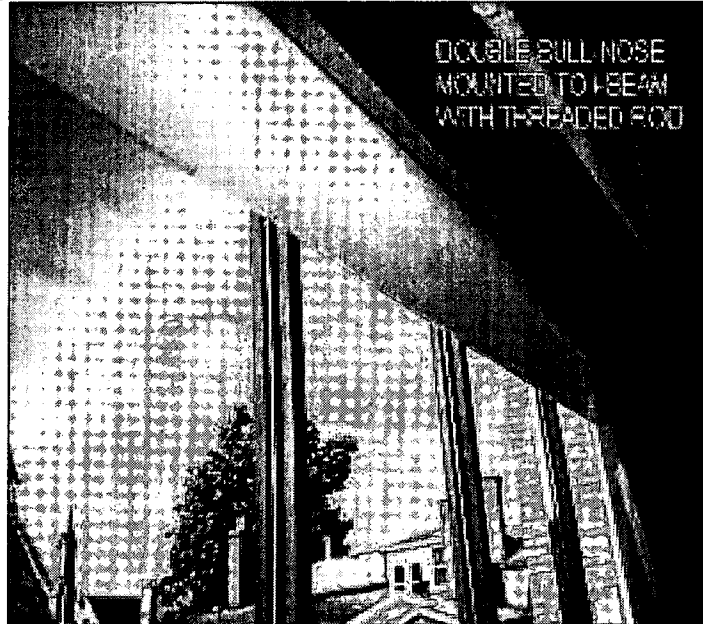

Extruded Aluminum Linear Panel. Source: Sun-EI Corporation

- Hydronic ceiling panel systems provide no outside air ventilation and thus fresh air must be supplied with either operable windows or an air handling system.
- Choosing any hydronic cooling system affects hot and chilled water decisions (solar thermal, chiller, boiler, etc.).
- Placement of system components affects requirements of the hydronic distribution system. Try to make these decisions early in order to create a hydronic distribution layout that minimizes piping materials (pipes, bends, etc.) and head loss.
- Depending on regional weather characteristics and required panel water temperature, an air conditioning system may be required to remove excess latent heat load and avoid condensation.
- Possibly integrate the system with building sprinkler systems to lower installation costs. Check with the fire marshal to ensure this does not violate fire code regulations.
- Use a heat pump or possibly a cooling tower to attain required temperatures.
- Acoustic properties of the panels need to be considered.
- If the system is to be used for both heating and cooling, a choice between a two-pipe and four-pipe system must be made. This decision will affect the hydronic distribution system.
- Use heavy-duty ceiling grid and provide space in plenum for hangar support.
- System can be integrated into a facility-wide hydronic heating and cooling system, including baseboards and radiant slabs.
- Effectiveness of panels relates to architectural and daylighting decisions regarding ceiling height. Performance of panel system degrades with increasing ceiling height.

BEST COPY AVAILABLE



Cost Effectiveness

Price for installed panels is roughly \$18/ft² of active ceiling area. This does not include costs for control system, hot/cold water supply, or hydronic distribution. Installed cost for modular and linear panels is roughly equal.

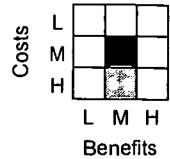

- Suppliers report that 10-year savings are substantial. Operation and maintenance costs are low. Fuel costs are lower due to increased efficiency compared to air handling systems. The system is generally most cost effective when part of a facility-wide hydronic heating and cooling system.

Benefits

- Hydronic systems can decrease or eliminate the need for mechanical air handling systems. This can provide a duct credit under Title 24.
- The water pumping system does not create as much internal heat as air fans do.
- Aluminum panels present the possibility for high recycled-content material use.
- Added cooling comfort results from lower perceived temperature.
- The system's low noise makes them good choices for classrooms.
- Energy demand is significantly lower than that for air systems due mostly to savings in fluid transport systems.
- Quick response time.

Design Tools

- Invensys/REDEC provides an AutoCAD-based program for layout design and Microsoft Excel-based spreadsheets for sizing calculations.
- RADCOOL is a software program developed by the Lawrence Berkeley National Laboratory for modeling buildings with radiant cooling systems.
- EZ-Radiant software from Radiant Tech in New York covers design for floor, ceiling, and baseboard radiant systems.
- Design and sizing procedure is documented in Chapter 6 of the 2000 ASHRAE Systems and Equipment Handbook.

Design Details

- If the panels are to be used for heating and cooling, a two- or four-pipe system can be used. A two-pipe system is less expensive and will work for applications with infrequent changeover from one mode of operation to another. If frequent changeovers occur, it is best to use a four-pipe system.
- Panel performance is dependent upon room air, panel water temperatures, and thermal resistance of the panel. Cooling performance for modular panels is generally around 27 Btu/h ft² with an 18°F temperature difference between room air temperature and mean water temperature. Extruded linear panels absorb from 40 Btu/h ft² to 50 Btu/h ft² with the same temperature difference. In either case, performance degrades with increasing ceiling height. Heating performance ranges from 40 Btu/h ft² to 200 Btu/h ft² for mean water temperatures of 120°F and 180°F and a 70°F room temperature.
- Cooling water temperatures are generally between 58°F and 65°F depending on dewpoint.
- Heating water temperatures are usually between 120°F and 180°F.
- Panels located above occupants should not exceed a 95°F surface temperature for comfort reasons. Higher temperatures may be used for panels that do not extend more than 3 ft into the room. These high temperature panels can be used in lieu of baseboard radiators to heat glass surfaces and exterior walls to decrease downdrafts.

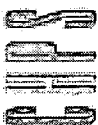

- Water temperature should be kept at least 1°F higher than the dewpoint temperature at all times.
- Temperature rise for cooling systems should be less than 5°F and temperature drop for heating systems less than 20°F.
- Be sure the water flow rate is in the proper range. Rates too high can cause noise and those too low can result in a significant decrease in heat transfer rate due to laminar flow.
- Panels can be perforated and installed with a special inlay material to improve acoustical properties.
- In order to avoid condensation, a control system must be used. The system can either use flow control or temperature control. A flow control system uses humidity sensors, temperature sensors, and control valves. It is an on-off system; as soon as the water temperature reaches the dew point temperature, the control valve closes. This system is cheap and simple, but can make the system useless for extended periods. A temperature control system uses similar sensors and a two- or three-way valve to adjust water temperature and avoid condensation. This system is more complex, but it allows for system operation when humid conditions exist.

Operation and Maintenance Issues

Normal hydronic operation and maintenance issues include checking pumps, valves, pipe leaks, chemical water treatment, and water quality/pipe fouling (important for sustaining maximum heat transfer and minimum pressure drop in open systems). Significant maintenance does not appear to be an issue. Ceiling panel suppliers Redec and Sun-El state that repair business is minimal. The ceiling panels have a life expectancy in excess of 30 years.

Commissioning

Commissioning should be performed throughout planning, design, construction, and operation to ensure proper installation, set-up, and integration with other facility components. The ceiling panel array(s) should be documented with an infrared camera during testing, adjusting, and balancing work to guarantee even cooling and/or heating.

References/Additional Information

American Society of Heating, Refrigerating and Air Conditioning Engineers. *ASHRAE Systems and Equipment Handbook*. 2000.

Invensys/REDEC's call center in Illinois is being built with both a VAV system, a radiant panel system, and an extensive array of sensors. Data will be taken using each system separately and the results posted on the web in the near future.

Lawrence Berkeley National Laboratory, Berkeley, California, Operated by the University of California for the U.S. Department of Energy.

Preparation room in the Challenger Learning Center, Phoenix, AZ, uses 2 ft x 4 ft REDEC CBA-C modular panels for 15/16 in. T-Grid with micro perforation and sound absorbing mats.

REDEC. George Hoekstra, Product and Marketing Manager, 1354 Clifford Avenue, P.O. Box 2940, Loves Park, IL 61132-2940. Phone: 815-637-3712. Fax: 815-637-5312. Email: ghoekstra@redec.com. Web site: <http://www.redec.com/>.

Sun-El. Bob Pruet, 2223 Dailey Avenue, P. O. Box 488, Latrobe, PA.15650. Phone: (724) 537-3600. Fax: (724) 537-8002. Email: SUNELPRU@AOL.COM. Web site: <http://www.sun-el.com>.

Related Volume III CHPS Criteria

See the Overview section of this chapter.

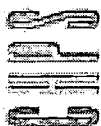

Guideline TC8: Unit Ventilator System

Recommendation

If choosing a unit ventilator system, specify units with multiple-speed fans, two-way control valves and economizer controls. Also specify variable-flow chilled water and hot water distribution systems. Assure that buses will not be staged in areas with unit ventilators. Do not plant scrubs at unit ventilator air intakes.

Description

Unit ventilators, sometimes called classroom ventilators, provide heating, cooling and ventilation for a single space. The units consist of constant volume fans, chilled water and hot water coils (typical), filters, and outdoor and return air dampers all enclosed in a heavy gage metal housing. Ventilation and/or economizer air is drawn from adjacent openings in the outside wall. Relief is either by gravity or powered exhaust remote from the unit.

A unit ventilator can be mounted in a vertical or horizontal position. A typical installation is a vertical discharge unit on the floor against an exterior wall. However, horizontal discharge units may be suspended from the ceiling or hidden above the ceiling.

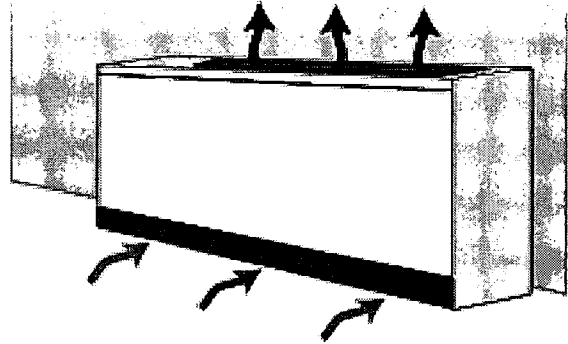

Unit Ventilator, a.k.a. Classroom Ventilator.

Applicable Spaces	Climates	When to Consider
Classrooms	South Coast	Programming
Library	North Coast	Schematic
Multi-Purpose / Cafeteria	Central Valley	Design Dev.
Gym	Mountains	Contract Docs.
Corridors	Desert	Construction
Administration		Commissioning
Toilets		Operation
Other		

Variations and Options

A unit ventilator may be part of a two-pipe or four-pipe hydronic distribution system.

A two-pipe system (i.e., one supply pipe and one return pipe) is also known as a changeover system, if it provides both heating and cooling. The same piping is used for both hot water and chilled water, and the central plant produces either one or the other. During mild weather periods, the system may be required to switch from heating to cooling as the day warms up. Therefore, two-pipe systems must be designed to account for the potential thermal shock to the equipment. Two-pipe systems likely need supplemental natural ventilation to accommodate swing seasons.

Four-pipe systems can circulate hot water and chilled water throughout the facility simultaneously. The advantage is better zone control because some zones may be heating while others are cooling. The main disadvantage is higher initial cost.

The control valve within a unit ventilator may be a two-way or three-way valve. In both cases, the valve modulates the flow of water through the coil. The difference is how the valve affects flow in the rest of the distribution system. A three-way valve provides a bypass so total flow through the unit ventilator is constant even though flow through the coil changes. A two-way valve modulates the total flow through the unit ventilator. A distribution system with two-way valves will have variable flow and potentially lower pumping energy consumption, especially if pumps are controlled with variable-speed drives.

Economizer controls are an option for some units. An actuator controls the integral outdoor air and return air dampers to take advantage of free cooling when it is available.

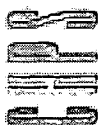

Direct expansion cooling may be an option in place of a chilled water-cooling coil.

Alternatives to hot water heating include steam coils and heat pumps.

Some unit ventilators offer a heat recovery option that uses exhaust air to either preheat or precool the outdoor ventilation air. Options for this heat recovery function include an air-to-air heat exchanger and a heat pipe.

Some manufacturers offer matched cabinetry to make the unit ventilator look like part of the furnishings.

Applicability

Systems are applicable for classrooms and other spaces with exterior wall access.

The systems should also be used in facilities with central chilled water and hot water distribution. These are typically large schools that are fairly centralized (to minimize length of chilled water and hot water distribution piping).

In spaces where ceiling height is restricted, these systems can be useful because ducts are unnecessary.

Applicable Codes

No unit ventilator efficiency requirements for hydronic systems exist. However, chillers, boilers, and piping face requirements

An economizer is not required for unit ventilators smaller than 2,500 cfm, which includes typical classroom units.

Integrated Design Implications

A unit ventilator requires more coordination with classroom space planning than most other system types. It is a high maintenance item and the system layout must be planned for easy access. Casework systems are available to integrate the unit with classroom fixtures. An exterior wall with clean outdoor air must be available for unit ventilator installation.

Hydronic distribution may free up space normally reserved for ducts, permitting lower floor-to-floor heights or enabling higher ceilings and better daylighting performance. Hydronic piping should not be run in floor trenches as they are impossible to clean and often grow mold, which can impact indoor air quality since the unit ventilator always pulls some air from the trench.

With unit ventilators as well as other hydronic system types, pay attention to site planning and building layout to minimize the length and complexity of piping between the central plant (chiller and/or boiler) and the terminal units.

As with other system types, controls should be designed to allow simple manual or automatic interlock with natural ventilation systems. In addition, economizer controls may be unnecessary if the space is designed to encourage occupants to use operable ventilation openings during mild weather.

Cost Effectiveness

A system consisting of unit ventilators, a chiller, boiler, and two-pipe distribution costs roughly \$14/ft² to \$16/ft² of floor area served. Cost for a four-pipe system is \$17/ft² to \$18/ft².

A unit ventilator system may be cost effective in specific cases, but in most cases other system types will be either lower cost and/or higher performance.

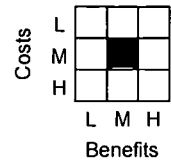

Benefits

Advantages

- Fan energy savings increase, as duct friction losses are avoided.
- Cooling can be very efficient if water-cooled chillers and a well-designed pumping system are installed.
- Constant, or slowly varying, supply air temperature (through modulation of control valves).
- Multiple-speed fans are available in some units.
- Provides flexibility for heating or cooling different parts of the building.

Disadvantages

- Poor air distribution, subject to drafts.
- Noise, particularly for student sitting adjacent to unit.
- Vulnerable to student abuse.
- Subject to turning-off or blocking air output by teachers.
- Air intakes can gather pollutants from mowing, rain intrusion, and vehicle exhaust.
- Relatively high first cost.
- Relatively inefficient fans.
- Console units take up floor space within the room.
- Significant maintenance needed in each classroom.
- Typically limited to poor air filtration.
- Energy recovery difficult or expensive.
- Multiple controls and valves located in every classroom.

Design Details

Ensure that the outdoor air intake area is free from potential pollution sources. Also make sure to locate the unit to minimize drafts indoors. Air from the units must not be discharged on the occupants, and seating should never be immediately adjacent to the unit. The top of the unit should not be used for storage.

Specify the lowest possible noise levels. If possible, specify a unit with multiple-speed fan control so that normal ventilation occurs at low fan speed. For chiller, boiler, and hydronic distribution system design details, see those individual guidelines. Specify two-way valves in all unit ventilators and variable-flow chilled water and hot water systems.

Load calculations are important, but oversizing of cooling and heating capacity, as long as it is not excessive, is less of a concern with unit ventilators (and with most other hydronic system terminal units) because control valves can modulate output rate. On/off cycling and partial load efficiency degradation is less of a concern, especially with variable-speed fan control. Note, however, that overall facility load calculations are still very important for central plant equipment sizing, where oversizing penalties do occur.

Two-pipe systems should be avoided where heating and cooling may be needed on the same day (or even the same week). The switch from heating to cooling wastes energy and can take a long time. In some cases, the cooling tower and a heat exchanger are used at switchover to cool the loop. The chillers are engaged once the loop has dropped to a tolerable temperature.



Operation and Maintenance Issues

Unit ventilator maintenance is significant, and requires a high skill level for all the controls that are involved in keeping discharge temperatures correct. They can difficult to access due to classroom arrangements. Furniture should not be pushed up against the unit. Chiller and boiler maintenance requires a relatively high skill level.

Maintenance tasks include:

- Cleaning cooling coil condensate pans to prevent mold growth.
- Replacing filters at least three times a year.
- Cleaning coils to prevent mold growth.
- Cleaning outdoor air intake louvers.
- Lubricating fans if required by manufacturers.
- Lubricating and adjusting outdoor air and return air dampers.

Commissioning

Check fan speed setting and airflow. Check control valve operation and thermostat operation. Confirm staging of fan speed if applicable. Check coil connections for proper water flow direction. Check outdoor air supply, economizer operation, and economizer airflow. Make sure the outside air duct boot is sealed to the building shell and that water will not enter into it.

References/Additional Information

Guideline TC18: Economizers; Guideline TC21: Hydronic Distribution; Guideline TC22: Chilled Water Plants; Guideline TC23: Hot Water Supply.

Related Volume III CHPS Criteria

See the Overview section of this chapter.



Guideline TC9: Ductless Split System

Recommendation

For ductless split systems, specify high efficiency, multiple fan speed, and low noise.

Description

A ductless split system consists of two matched pieces of equipment: an indoor fan coil unit and an outdoor condenser and compressor unit connected by refrigerant tubing and control wiring run through the wall or roof. The indoor unit contains a cooling coil, fan, and filter. The outdoor unit includes compressor(s), condenser coil, and condenser fans.

In its simplest form, a ductless split system recycles 100% indoor air. However, on many units, ventilation air can be supplied with an optional duct attachment that passes through the wall.

Variations and Options

The indoor unit is available in several forms: high wall mount, ceiling mount, and above-ceiling mount. The high wall mount may be least costly but is usually limited in peak capacity to about 2 tons. Capacities up to 5 tons are available with suspended ceiling units. The above-ceiling units typical fit in a 2x2 suspended ceiling system and resemble a typical supply diffuser from below.

Many of these systems can be supplied with a heat pump option to provide heating as well as cooling. Alternatively, heating can be provided through a separate system such as a radiant floor.

Variable-speed fans are common and desirable to minimize cycling and reduce noise.

Economizers are typically not available for most ductless split systems.

Systems are available that allow two indoor units to be connected to a single outdoor unit, which can increase system capacity up to 4 tons.

Applicability

A ductless split system can serve spaces up to about 1,000 ft², or perhaps 2,000 ft² if multiple units are installed. They are most useful for buildings with indoor and/or outdoor space constraints, where rooftop space is unavailable or space for ducts is limited.

Ductless split systems are good choices when integrated with natural ventilation that can provide free cooling. For sealed spaces without operable openings, a split system is less desirable because it does not typically have capability to provide 100% outdoor air for free cooling.

This system is also applicable for retrofits where ducts do not currently exist.

Applicable Codes

Efficiency, outdoor air, and economizer requirements are the same as for gas/electric split systems.

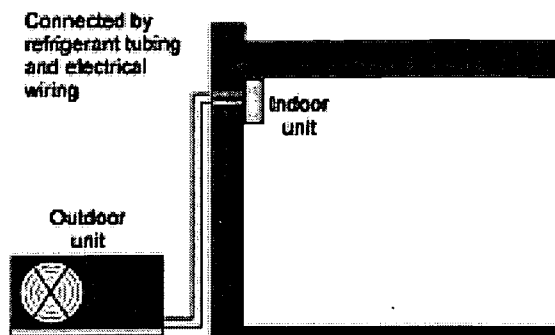

Ductless Split System.

Applicable Spaces	Climates	When to Consider
Classrooms	South Coast	Programming
Library	North Coast	Schematic
Multi-Purpose / Cafeteria	Central Valley	Design Dev.
Gym	Mountains	Contract Docs.
Corridors	Desert	Construction
Administration		Commissioning
Toilets		Operation
Other		



Integrated Design Implications

A ductless split system is a good complement to radiant heating for spaces where cooling is also necessary but infrequent.

Cost Effectiveness

In North America, ductless split systems are usually more expensive than packaged rooftop systems due to higher equipment cost. The unit price for a typical 2-ton unit is \$4,000 to \$5,000.

Due to the extra cost, a ductless split system will probably be cost effective only where space constraints prohibit the use of ducted system types.

Costs	L			
	M	■		
	H			
		L	M	H
		Benefits		

Benefits

Advantages

- Systems can be utilized where outdoor space is limited. Equipment is compact.
- No duct losses.
- Simple installation.
- Multiple-speed fans are commonly available.

Disadvantages

- Does not provide good outside air ventilation.
- Relatively poor indoor air distribution and higher potential for drafts.
- Systems have limited capacity to handle ventilation air.
- Heating option is limited to heat pump.
- System use is less common in North America, where equipment cost is relatively high.

Design Details

Place the indoor unit on an external wall for ventilation air access and for minimum distance to the outdoor unit. Follow manufacturers' recommendations for positioning the indoor unit to provide maximum air distribution and to avoid drafts.

Pay attention to security, noise, and ambient temperature when positioning the outdoor unit.

Specify high efficiency units if they are available. Specify low-noise units.

- Fan coils should be isolated from occupied spaces. Locate rooftop units above unoccupied spaces.
- Provide appropriate intake and discharge noise control consistent with meeting the Noise Criteria.

Outdoor units should be located away from noise sensitive areas and windows.

Be very careful not to oversize the unit to avoid excessive cycling, which reduces humidity control and irritates occupants. Manufacturers even recommend choosing a system slightly smaller than peak load for these reasons.

Insulate suction and liquid refrigerant lines separately during installation. Otherwise, one heats the other causing capacity and efficiency loss.

Water may condense on the indoor cooling coil. Therefore, a condensate pump may be required to remove water from the condensate drain pan to an approved receptacle. Overflow from the drain pan must be routed to a visible location.

Operation and Maintenance Issues

Maintenance requirements and operator skills are similar to gas/electric split systems and rooftop packaged systems.



Commissioning

Verify proper multiple fan speed control operation and thermostat operation.

References/Additional Information

None.

Related Volume III CHPS Criteria

See the Overview section of this chapter.



Guideline TC10: Evaporative Cooling System

Recommendation

Consider evaporative cooling for spaces with high outside air ventilation requirements.

Description

Evaporative cooling is an alternative way to provide air conditioning. Lower energy costs result because no compressor is needed, only a fan and pump.

Evaporative cooling can be "direct" or "indirect." In a direct evaporative cooling system the water is exposed to the supply air stream. Usually the water flows over a special medium designed to maximize the surface area of water in contact with air, and the air is cooled by the evaporation. The effectiveness can reach 80% to 90%, meaning that the drybulb temperature drops by 80% to 90% of the difference

temperature of the entering air. For example, if entering air temperature is 80°F drybulb and 50°F wetbulb, then the leaving air is cooled to 53°F to 76°F drybulb.

Indirect evaporative cooling is not as effective as direct evaporative cooling, but adds no moisture to the supply air. In some systems, the air passes through a heat exchanger that is wetted on the outside, where cooling takes place in a secondary air stream. In other systems, air passes through a cooling coil supplied with water from a remote cooling tower. Indirect evaporative cooling can be approximately 60% effective in reducing the dry bulb temperature of the entering air to its wet bulb temperature. While direct cooling provides 72°F to 74°F air in the example above, indirect cooling could provide 78°F air.

Combining indirect and direct evaporative cooling (as shown in the figure above) further reduces the supply air temperature. When air passes through the indirect cooler first, then drybulb and wetbulb temperature is reduced through sensible cooling. Due to the lower wetbulb temperature, the direct cooler can achieve even cooler temperature for the supply air.

Variations and Options

Packaged evaporative coolers are available in a wide range of sizes, approximately 3,000 cfm to 20,000 cfm. They are typically roof mounted to supply outside air for the indirect cooling stage.

Packaged air handlers are available that incorporate both indirect and direct evaporative cooling. The evaporative cooling system has an economizer that uses 100% outside airflow during cooling mode, and minimum outside airflow during heating mode. This allows the use of return air during the heating season to keep heating costs equivalent to a standard system. These package units can have hot water coils or duct furnaces installed to provide heating.

If evaporative cooling alone does not satisfy cooling loads, then it can be combined with packaged rooftop cooling by adding direct and/or indirect coolers onto the outside air intake of the packaged unit or it can be integrated directly into the mixed air stream (outside + return) of the packaged unit.

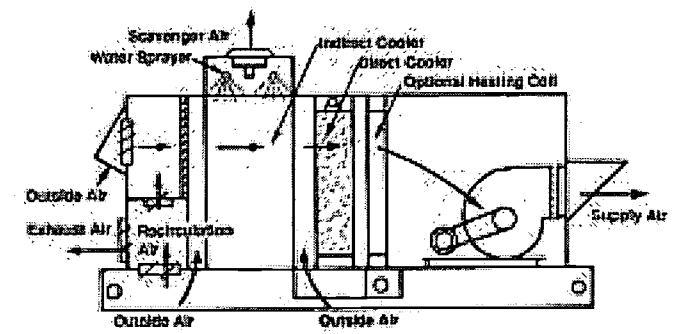

Evaporative Cooling System

Applicable Spaces	Climates	When to Consider
Classrooms	South Coast	Programming
Library	North Coast	Schematic
Multi-Purpose / Cafeteria	Central Valley	Design Dev.
Gym	Mountains	Contract Docs.
Corridors	Desert	Construction
Administration		Commissioning
Toilets		Operation
Other		



Evaporative cooling reduces the load on the direct expansion (DX) cooling coil, allowing the compressor size to be reduced, and peak power to be reduced.

Alternatively, a combination of cooling tower and heat exchanger could be used with cooling coils and standard air handlers.

Some indirect evaporative cooling systems are designed to use exhaust air rather than outside air as the secondary air stream, providing heat recovery.

Other systems combine evaporative cooling with a desiccant wheel and/or enthalpy wheel as a method of precooling the outdoor air and increasing cooling capacity.

Applicability

Evaporative cooling is most effective in hot, dry climates but it can also be used to completely replace compressor cooling in cold and coastal areas. For areas with higher design wet bulb temperatures, such as Sacramento, CA (100°F/70°F), evaporative cooling can produce most of the space cooling needs. However, if evaporative cooling is used exclusively, space temperatures may rise above 80°F during design conditions a few hours each year.

Evaporative cooling is especially appropriate for spaces with high outside air ventilation requirements such as showers, locker rooms, kitchens, or shops. Compressor cooling is often too expensive to operate for these applications.

Combination evaporative and DX cooling only makes economic sense in certain climates and for packaged units over a certain size. Direct and/or indirect evaporative cooling should be considered for packaged units over:

- 20 tons in South Coast (Climate Zones 6 through 10).
- 15 tons in Central Valley (Climate Zones 11 through 13).
- 10 tons in Desert (Climate Zones 14, 15).

Applicable Codes

Evaporative cooling systems face no efficiency requirement except for fan system efficiency and heating efficiency.

Integrated Design Implications

Evaporative cooling is a good match for displacement ventilation systems, which are designed for higher supply air temperature than a typical overhead air distribution system. However, the design will need to accommodate higher airflow that could disrupt stratification. Therefore, careful attention is necessary in locating and sizing supply outlets.

Larger ducts are required compared to a typical compressor cooling system, and duct size may be a consideration in the architectural and structural design.

Direct evaporative cooling may not be appropriate for spaces with materials such as wood floors that might be damaged by high humidity.

These systems require regular maintenance and are difficult to seal against air infiltration in cold climates.

Cost Effectiveness

Installed costs are typically greater than for typical packaged air conditioning equipment.

Evaporative cooling is usually cost effective in warm and dry climates as long as somewhat higher indoor temperatures are acceptable during hot periods.

Costs	L			
	M			
	H			
		L	M	H
		Benefits		

Benefits

Advantages

- Lower electricity consumption and lower peak electric demand result.



- Systems typically use 100% outside air in cooling mode, providing better air quality.
- Smaller electrical supply.

Disadvantages

- Regular maintenance is more critical than for compressor cooling systems.
- Higher airflow requirements lead to increased fan energy.
- Cooling unit requires water supply.
- On-site water consumption increases.
- Cooling requirements in some climates may not be completely satisfied.
- Direct evaporative cooling increases space humidity.
- First cost is higher.

Design Details

An evaporative cooling system requires higher airflow due to higher supply air temperature. Therefore, special attention to duct design and sizing is required to avoid high fan energy costs. The appropriate airflow depends on design conditions for the school's location.

A variable-speed or two-speed fan is a good idea to allow lower airflow in heating mode.

In warm climates, try to use exhaust air as the secondary air stream for indirect evaporative cooling systems.

Vibration isolation is often provided internally. Internal isolation should be reviewed for proper spring type and static deflection. If internal isolation is not provided, or is unacceptable, external spring isolators should be utilized. Refer to 1995 ASHRAE Handbook Chapter 43 for recommended vibration isolation. If external isolation is used, all internal spring isolators should not be released from their restraining bolt.

- Locate rooftop units above unoccupied spaces.
- Provide appropriate intake and discharge noise control consistent with meeting the noise criteria.

Operation and Maintenance Issues

Evaporative coolers demand more maintenance than a typical compressor-based system, so they should be specified only for facilities with qualified maintenance staff or with a qualified outside service company.

To minimize maintenance requirements, specify adequate bleed-off rates to prevent mineral buildup (without causing excessive water consumption). Also specify controls that periodically flush the evaporative medium with water to remove dirt and scale. Finally, specify materials to minimize potential for corrosion.

Commissioning

Check for correct airflow.

Check for correct water flow rate over the evaporative media.

Check the bleed-off rate of water from the evaporative system to ensure that it is adequate to prevent mineral buildup but not too large to cause excessive water consumption.

Verify all modes of operation.

References/Additional Information

None.

Related Volume III CHPS Criteria

See the Overview section of this chapter.



Guideline TC11: VAV Reheat System

Recommendation

Choose a variable air volume (VAV) reheat system for large administration or classroom facilities, especially multi-story buildings. Specify variable-speed fan control, low face velocity cooling coil, bypass damper, supply air temperature reset control and supply duct pressure reset control-direct digital (DCC).

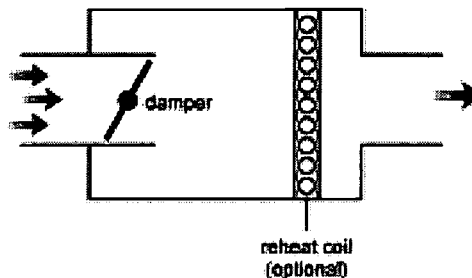

VAV Box.

Description

VAV is a general term for a type of HVAC system that supplies only the amount of air needed to satisfy the load requirements of a building zone and can supply different volumes to different zones at the same time. The result is that the total supply of cool air changes over the course of the day, depending on the heat gains in different building areas at different times.

In a VAV system, a central supply fan sends air through medium pressure ductwork to terminal units (VAV boxes) throughout the building. The airflow to each zone — a space or group of similar spaces — is controlled by the VAV box (a “smart damper”), which varies the airflow in response to the space temperature. As cooling loads in the zone drop, the damper continues to close until it reaches a minimum position. The minimum position provides the occupants of the zone with adequate ventilation air. Some VAV boxes, especially those in perimeter zones, contain a reheat coil for times when the minimum airflow provides too much cooling. The reheat coil — typically hot water — prevents zones from being overcooled. The reheat coil also provides winter heating, typically during a morning warm-up period prior to occupancy when the outdoor air dampers are closed.

A duct-mounted pressure sensor that decreases the fan output as the VAV box dampers close controls the main system fan.

Applicable Spaces	Climates	When to Consider
Classrooms	South Coast	Programming
Library	North Coast	Schematic
Multi-Purpose / Cafeteria	Central Valley	Design Dev.
Gym	Mountains	Contract Docs.
Corridors	Desert	Construction
Administration		Commissioning
Toilets		Operation
Other		

Variations and Options

VAV air handlers may be purchased as factory fabricated units or may be assembled from components in the field (built-up). In either case, cooling can be provided with a chilled water coil or a direct expansion refrigerant coil.

- A common choice for schools is the packaged rooftop VAV air conditioning system. The self-contained unit consists of a variable-volume supply fan; direct-expansion cooling coil; heating (when required) with gas furnace, hot water, or steam; filters; compressors; condenser coils; and condenser fans.
- Facilities with a central chilled water plant often use factory-fabricated air handlers with chilled water coils. In this case, the unit includes a supply fan, cooling coil, filters, and perhaps a heating coil.

VAV systems usually include economizer controls. Several VAV box types are available and some can be combined within the same system:

- Most common for new buildings are pressure-independent boxes with DDC-controlled actuators.



- Fan-powered mixing boxes recirculate room or plenum air and are available in two types: series fan or parallel fan. The series fan box requires the fan to operate at all times. The parallel fan box fan activates only when reheat is required.
- Dual-duct VAV boxes contain two dampers controlling a cool duct inlet and warm duct inlet. Typically the warm duct damper is closed during cooling periods. When cooling load drops and the cool duct damper reaches its minimum position, then the warm duct damper begins to open to prevent overcooling in the space.

A dual-fan, dual-duct VAV system is an alternative to VAV reheat and requires less reheat energy. The warm duct recirculates indoor air and adds heat if necessary. The cool duct provides ventilation air and cooling. Rather than using a reheat coil to avoid overcooling at minimum ventilation position, the dual duct system mixes warm return air to offset cooling.

Applicability

VAV systems are appropriate for administration buildings or large classroom buildings with peak cooling load greater than 20 tons. The minimum size for a packaged VAV system is about 20 tons.

The overall efficiency of VAV systems depends on the diversity of zone heating and cooling loads. If a particular building has very similar zones and constant loads (such as classrooms with identical occupancy schedules in an extremely well-insulated building), the potential for savings from a VAV system are reduced.

Applicable Codes

Title 24 restricts simultaneous heating and cooling (e.g., reheat) unless certain conditions are met. Either the system must be capable of reducing airflow to 30% before reheating, or reducing to 0.4 cfm/ft², or to 300 cfm, whichever is larger.

Supply air temperature reset controls are required.

Integrated Design Implications

VAV systems require space for ductwork and should be considered early in the design process.

Requirements for fire separations can affect duct layout and architectural design. Fire separation is less of an issue with single zone systems because all the ductwork is typically within a single fire zone.

Shaft space may be required in multi-story buildings to deliver air to the lower floors.

Cost Effectiveness

A typical VAV reheat system costs \$16/ft² to \$18/ft² of floor area. This cost is greater than packaged single zone systems and roughly equal to a unit ventilator system, but offers far greater performance and control.

A VAV system is usually cost effective for larger buildings. It is the most common system type for new multi-story commercial facilities.

	L	M	H
L			
M		■	
H			
	L	M	H

Costs

Benefits

Benefits

Advantages

- Better comfort control results from steady supply air temperature (vs. single zone systems that are constant volume and variable temperature).
- Moderate initial cost for buildings that require multiple zones.
- Better dehumidification control than packaged single zones.



- Energy efficiency of variable air volume.
- Larger and more efficient fans than single zone systems.
- Centralized maintenance for coil cleaning and filter replacement.
- Relatively simple to add or rearrange zones.

Disadvantages

- Sometimes higher fan pressure occurs than with variable-speed single zone systems, depending on load matching of design. This may lead to higher energy consumption.
- Requires more sophisticated controls than single zone systems.
- VAV box can generate noise that radiates out of the sheet metal walls (radiated noise), and travels down the supply duct (discharge noise).

Design Details

A variable-speed fan is the recommended approach to control duct air pressure in a VAV system although several methods are possible. Variable-speed drives are the most efficient and have the added advantage of limiting current inrush for startup of large motors ("soft-start" feature). Other less effective duct pressure control devices are variable inlet vanes, inlet cones, sliding covers, and discharge air dampers.

For direct-expansion VAV systems, multiple-step unloading or variable speed compressors should be specified, which prevents frosting of the evaporator coil at low cooling loads (particularly important for units equipped with economizers). Greater numbers of unloading steps also improves supply air temperature control by allowing a smaller throttling range.

Supply air temperature reset. Specify controls that will adjust the supply air temperature according to demand for cooling. As cooling demand drops, supply air temperature may be increased so that compressors operate more efficiently, and outside air can provide a larger fraction of cooling. However, more airflow is required with higher supply air temperature and at some point, the extra fan energy exceeds the cooling energy savings. Carefully consider the characteristics of a specific building when choosing a supply air reset schedule. Computer simulations can help to determine optimal settings.

Supply air pressure reset. Consider controls that will also minimize the supply air pressure required to meet all zone loads. Typically the supply fan is controlled to maintain a constant static pressure of around 1.5 inches water column in the duct upstream of the VAV boxes. However, lower pressure may satisfy airflow demands at many times of the year and can save fan energy. Automatic reset controls can monitor damper position in all VAV boxes and lower the supply duct pressure when all dampers are partially closed.

Ventilation air control can be tricky in a VAV system due to varying supply airflow. One option is to modulate the outdoor air damper based on measurement of outdoor airflow. This modulating damper method can also allow demand ventilation control to reduce airflow when spaces have low occupancy (see Guideline TC26: Demand Controlled Ventilation). Another option is a separate outdoor air fan that injects a constant volume of ventilation air into the supply air stream when the system is not in economizer mode.

To minimize reheat energy consumption, set the minimum flow on each VAV box as low as possible. In many cases, reheat would be unnecessary if the minimum flow were zero. However, the need for ventilation air usually requires some minimum damper position. In some systems, heating occurs at minimum airflow. Therefore, heating load can also be a constraint on the minimum flow. In these situations, reverse acting damper control is recommended. As heating load increases, the damper reopens. Title 24 requires that the minimum zone airflow be not greater than 30% peak flow.



The zone thermostats should have separate setpoints for heating and cooling with a deadband in between (as required by Title 24). This control also helps to minimize reheat energy.

Zone controls should also be tied to a central energy management and control system (EMCS). An EMCS reduces operation and maintenance cost by allowing remote monitoring and control.

To minimize air pressure drop across the cooling coils, limit the face velocity to 300 fpm, which requires a larger coil as well as larger equipment and floorspace. Also consider specifying a bypass damper that opens when the cooling coil is not needed, such as in economizer mode. Both these measures help reduce fan energy consumption.

Rather than installing a return air fan, consider using a relief fan or barometric relief dampers to minimize fan energy.

Design duct systems to minimize pressure drop and leakage. For recommendations on duct design, see Guideline TC19: Air Distribution Design Guidelines.

VAV boxes should not be located over noise sensitive areas (i.e., classrooms) when an acoustical tile ceiling system is being used. A gypsum board ceiling will do a better job of reducing VAV radiated noise than a typical ceiling tile system. For this reason most VAV boxes can be located above noise-sensitive areas where a gypsum board ceiling, which has all penetrations and joints well sealed, is installed.

Oversizing VAV boxes is one way to reduce radiated and discharge noise levels. This has to do with the velocity of air as it enters the box and passes by the damper.

Static pressure drop across the VAV box also has an impact on the amount of noise generated.

Designing the system so that the damper does not produce more than 0.5 in. of static pressure drop will minimize noise.

Operation and Maintenance Issues

VAV system operation requires a skilled commissioning staff to ensure that controls operate efficiently. However, maintenance is relatively simple once the system is operating. Maintenance is centralized for boilers and chillers rather than being distributed to individual units. Many tasks are centralized and take less time than for a system with single zone units.

VAV boxes typically have DDC interfaces allowing space conditions to be monitored from a central building management system. The information and remote control capability helps reduce maintenance costs.

Commissioning

Calibrate zone airflow sensors, and confirm minimum and maximum flow for each VAV box.

Calibrate all system temperature and pressure sensors. Confirm supply air temperature, reset supply pressure, and reset control operation.

Calibrate outside airflow measurement (if one is installed) and ensure that minimum ventilation airflow is provided under varying conditions.

Confirm proper functioning of all valves and dampers.

References/Additional Information

None.

Related Volume III CHPS Criteria

See the Overview section of this chapter.

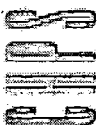

Guideline TC12: Radiant Slab System

Recommendation

Install radiant slab-on-grade systems in rooms with heating demand. When conditions permit, use a solar thermal, geothermal system, and/or recovered thermal energy for the hot water supply.

Description

A radiant slab heating system consists of the following:

- Hydronic distribution.
- Hot water source (boiler, solar, geothermal heat pump, etc.).
- Control system.

Like all radiant heating systems, radiant slab systems provide thermal comfort to building occupants predominantly through radiation heat transfer. In other words, the system heats or cools room objects and occupants, rather than the surrounding air. Two basic configurations exist for hydronic radiant slab heating and/or cooling. The first option involves the placement of pipes in the foundation slab itself, referred to as slab-on-grade. The second, called thin-slab, consists of piping placed in a thinner slab layer that is situated on top of the foundation slab or on suspended floors. Each consists of a loop of tubing (normally cross-linking polyethylene, PEX) that is imbedded in concrete or a similar material, such as gyp-crete. Hot water is passed through the tubing, which heats the slab, and in turn, the room.

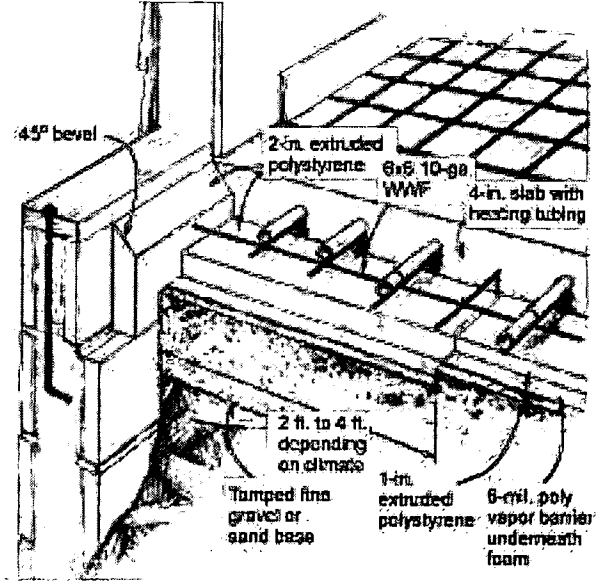

Radiant Slab.

Applicable Spaces	Climates	When to Consider
Classrooms	South Coast	Programming
Library	North Coast	Schematic
Multi-Purpose / Cafeteria	Central Valley	Design Dev.
Gym	Mountains	Contract Docs.
Corridors	Desert	Construction
Administration		Commissioning
Toilets		Operation
Other		

Applicability

The use of radiant slabs for heating is applicable in all regions with a heating demand. However, due to condensation concerns, the use of radiant slabs for cooling should be limited to areas with a low latent cooling load.

Applicable Codes

- There are no requirements specific to radiant slab systems in nonresidential sections of Title 24. (Residential code requires R-10 edge insulation.)
- A supplemental ventilation system (mechanical or natural) must be used to meet indoor air quality standards.
- Title 24 Section 123 details pipe insulation requirements.

Integrated Design Implications

- Choosing any hydronic heating system affects boiler decisions (heat pump, solar, etc.).



- All radiant hydronic systems provide an alternative to large-scale air handling systems. This impacts many aspects of the building design including the required plenum sizing, boiler/chiller sizing, ducting, etc.
- The slab system is a low temperature application and is complemented well by alternative water heating methods including geothermal heat pumps and solar thermal systems. Typical hydronic heating systems such as baseboard radiators use water temperatures of 140°F to 200°F, whereas radiant floor heating uses temperatures between 90°F and 120°F.
- Consider framing strength when installing suspended floor thin slab systems. It is much more cost effective to consider this during design rather than reinforcing the framing during construction.
- This system can be integrated into a facility-wide hydronic heating and cooling system including baseboards and ceiling panels.
- Placement of system components affects requirements of the hydronic distribution system. Try to make these decisions early to create a hydronic distribution layout that minimizes piping materials (pipes, bends, etc.) and head loss.

Cost Effectiveness

- The installed cost of the slab only ranges from \$2/ft² to \$20/ft² depending upon application. PEX tubing costs around \$0.65/lin ft retail.
- Operation and maintenance costs are low. Fuel costs are lower due to increased efficiency compared to air handling systems.
- The system is generally most cost effective when part of a facility-wide hydronic heating and cooling system.

Costs	L			
	M			
	H			
		L	M	H
		Benefits		

Benefits

Advantages

- Hydronic systems can decrease or eliminate the need for mechanical air handling systems. This can provide a duct credit under Title 24.
- Quiet operation.
- Better perceived comfort. Radiant slabs heat occupants from the bottom up and are purported to increase comfort. Allows for lower thermostat settings.
- Lower boiler temperatures of 90°F to 120°F compared to 140°F to 200°F for other heating systems. These temperatures can be accomplished by a geothermal heat pump or solar thermal system.
- Can provide fuel savings when compared to forced-air systems.
- Aesthetically pleasing; no heat registers or visible radiators.

Disadvantages

- Hard to set back temperatures because of lag.
- Ground losses can reduce efficiency if insulation is not properly installed.

Design Tools

- Use of a CAD-based program to design the layout of the tubing is key to save time, materials, and money.
- EZ-Radiant software from Radiant Tech in New York covers design for floor, ceiling, and baseboard radiant systems.



Design Details

- Install edge insulation around radiant slab.
- Older installations used copper or other metal tubing, but these materials can react with the concrete and corrode if not properly treated. Copper has excellent heat transfer characteristics, but its short coil length and incomplete compatibility with concrete has caused a switch to polymer or synthetic rubber tubing. Most modern installations use cross-linked polyethylene (PEX) tubing. PEX tubing is usually layered with an oxygen diffusion barrier to extend the life of system components. Some installers use stainless steel components in lieu of the diffusion barrier. Another option is PEX-aluminum (PEX-Al-PEX) composite tubing, where the aluminum acts as a nearly perfect diffusion barrier. PEX-Al-PEX is also easier to bend than standard PEX.
- Any PEX tubing outside of the slab should be protected from sunlight to prevent corrosion.
- Tubing must be routed through the sub-soil or in a protective sleeve when passing through expansion joints.
- Before pouring the concrete, tubing should be laid out and pressurized to 100 psi for 24 hours to ensure no leakage. The tubing should remain pressurized throughout the pouring and curing process.
- Water should be delivered to the slab at a temperature that can maintain surface temperatures between 80°F and 85°F. The required inlet water temperature is dependent upon the thermal resistance of the slab and any floor finishing material.
- Tubes should be spaced between 6 in. and 15 in. apart, depending on application.
- Use tighter spacing for slabs with wood floor finishing. Even temperatures are critical in order to avoid varying levels of expansion and contraction in wood floors.
- Early planning, including an accurate estimate of the load requirements in the rooms to be heated and cooled, is key for these systems. Due to the nature of the system (in the foundation slab), the earlier the decision is made the better.
- High quality control systems should be used that monitor both indoor and outdoor temperatures. The slab is a large thermal mass and care must be taken to avoid under or over shooting the prescribed temperature.

Operation and Maintenance Issues

- The slab system consists of a large thermal mass and thus takes a significant amount of time to respond to changes in control settings. The response time of the system can be through proper operation and maintenance practices that serve to avoid severely over and/or under shooting the desired temperature.
- Modern radiant slab systems require little maintenance and do not have the leakage concerns of earlier systems.

Commissioning

Commissioning should be performed throughout planning, design, construction, and operation to ensure proper installation, set-up, and integration with other facility components. Proper installation and management of the control system for a radiant slab are of particular importance. Be sure indoor and outdoor sensors are sited correctly and functioning properly.

References/Additional Information

Hydronic Specialties Company. 1051 Folger Street, Berkeley, CA 94710. Phone: (800) 786-6847. Fax: (510) 548-7962. Email: info@2hsc.com. Web site: <http://www.h-s-c.com/>

Radiant Tech. 11A Farber Drive, Bellport, NY 11713.
Phone: (631) 286-0900 or (800) 784-0234. Fax (631) 286-0947. Email: info@radiant-tech.com.
Web site: <http://www.radiant-tech.com/>.



Warm Floors. 211 Gateway Road West, Suite 208, Napa, CA 94558-6279.
Phone: (707) 257-0880. Fax: (707) 257-0119. Email: inquiry@warmfloors.com. Web site:
<http://www.warmfloors.com/>.

Wirsbo Co. 5925 148th St West, Apple Valley, MN 55124. Phone: 800-321-4739. Web site:
<http://www.wirsbo.com/>.

Related Volume III CHPS Criteria

See the Overview section of this chapter.

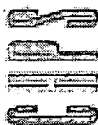

Guideline TC13: Baseboard Heating System

Recommendation

Use baseboard heating in areas experiencing periods of near-freezing temperatures.

Description

Hydronic radiant baseboard heating is a common application that has been used for over 50 years in the U.S. The most common types are the finned-tube convector and radiant convector both of which heat cold air at the floor of the room and induce an upward convective current. This is extremely effective in reducing downdrafts at cold facades and under windows. These models provide heat through a combination of convection and radiation. Another model is the panel, or flat pipe, radiator. Panel radiators are common in Europe and provide thermal comfort predominately through radiation heat transfer. A baseboard heating system requires the following:

- Baseboard heaters (convector or panel).
- Hydronic distribution system (piping, pumps, valves, etc.).
- Control system (sensors, thermostats, etc.).
- Hot water source (boiler, solar thermal, recovered thermal energy, geothermal heat pump, etc.).

Applicability

These systems are applicable in all areas experiencing extreme cold, and are especially effective in areas of significant heat loss, such as entryways or under windows.

Applicable Codes

- There are no requirements specific to baseboard heaters in Title 24. A supplemental ventilation system (mechanical or natural) must be used to meet indoor air quality standards.
- Title 24 Section 123 details pipe insulation requirements.

Integrated Design Implications

- Baseboards are a good compliment for displacement ventilation systems. They can operate independently to maintain space temperature and to recover from night cool down.
- Choosing any hydronic heating system affects boiler decisions (heat pump, solar, etc.).

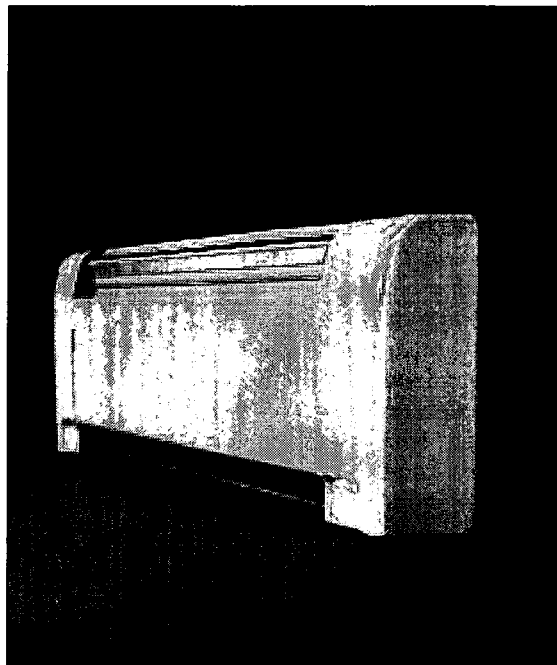

Baseboard Heater.

Source: Embassy Industries Incorporated.

Applicable Spaces	Climates	When to Consider
Classrooms	South Coast	Programming
Library	North Coast	Schematic
Multi-Purpose / Cafeteria	Central Valley	Design Dev.
Gym	Mountains	Contract Docs.
Corridors	Desert	Construction
Administration		Commissioning
Toilets		Operation
Other		



- All radiant hydronic systems provide an alternative to large-scale air handling systems. This impacts many aspects of the building design including the required plenum sizing, boiler/chiller sizing, ducting, etc.
- The systems can be integrated into a facility-wide hydronic heating and cooling system including radiant slabs and ceiling panels.
- They can be the main heat source, or integrated with another system and used primarily to reduce downdrafts at cold walls or glass, and can provide off-hours heating without running fans.
- Placement of system components affects requirements of the hydronic distribution system. Try to make these decisions early in order to create a hydronic distribution layout that minimizes piping materials (pipes, bends, etc.) and head loss.

Cost Effectiveness

Baseboard heaters cost \$10/lin ft to \$25/lin ft.

- Operation and maintenance costs are low. Fuel costs in a well-designed system are lower due to increased efficiency compared to air handling systems.
- The system is generally most cost effective when part of a facility-wide hydronic heating and cooling system.

Costs	L			
	M			
	H			
		L	M	H
		Benefits		

Benefits

- Hydronic systems can decrease or eliminate the need for mechanical air handling systems. This can provide a duct credit under Title 24.
- These well-understood systems have been used for over 50 years.
- The systems are low maintenance.
- They can be more fuel-efficient than air systems and use less power to move heat through the facility.
- Since they are quiet, these systems are good for classrooms.
- Cold downdrafts at outside walls and windows are stopped.
- Systems should be configured to allow for individual room control.

Design Tools

- The *Advanced Installation Guide for Hydronic Heating Systems*, available from the Hydronics Institute, includes a design and sizing procedure for baseboard heating.
- *Hydronics Design Toolkit* software is available from the Radiant Panel Association.
- EZ-Radiant software from Radiant Tech in New York covers design for floor, ceiling, and baseboard radiant systems.

Design Details

- Baseboard systems can use zone control or individual room control. Zone control uses one thermostat to regulate several spaces in a single hydronic loop. This system is simple and cheap, but often involves large temperature drops and can be difficult to balance. Individual room control uses thermostatic radiator valves (TRV) to independently control baseboard elements in each space. The TRV allows educators to control the thermal environment of their own classroom.
- Flow rate must be controlled to ensure turbulent flow. If the flow rate is in the laminar regime, the heat transfer rate will be dramatically lower and more sensitive to flow rate changes causing difficulties in maintaining intended thermal conditions. Too high a flow rate can cause pipe noise.
- Increases in altitude can decrease the performance of finned-tube and radiant convectors.



- Painting panel radiators can affect performance. Aluminum and bronze paint can reduce total heat output by up to 10%.
- Make allowances for pipe expansion during installation in order to decrease audible disturbances.
- Water should be delivered to baseboard radiators between 140°F and 200°F.
- Care should be taken to ensure baseboard surface temperatures do not reach levels dangerous to young children.
- Output ranges from 300 Btu/hr/ft to 800 Btu/hr/ft depending on inlet/outlet temp and flow rate.
- Temperature drop across heater should not exceed 20°F to insure uniform heating.
- Be sure not to inhibit convective flow patterns when arranging furniture near baseboard heating elements.
- "Quiet Type" baseboard heaters (ie., heaters designed to produce less operating noise) should be specified for occupied areas.

Operation and Maintenance Issues

Operation and maintenance issues for baseboard heating systems are minimal. Heat transfer surfaces should be kept clean and free of dust. If the system is open to the potable water supply some internal cleaning may be necessary to avoid fouling. Pipe fouling can lower efficiency by decreasing the heat transfer rate and increasing the pressure drop.

Commissioning

Commissioning should be performed throughout planning, design, construction, and operation to ensure proper installation, set-up, and integration with other facility components.

References/Additional Information

"Advanced Installation Guide for Hydronic Heating Systems." Available from Hydronics Institute. Berkeley Heights, NJ 07922.

Anderson Hot Water Heating, 2866 Julio Ave, San Jose, CA 95124. Phone: (408) 378-3868. Fax: (408) 984-5854. Email: info@radiantheat.net. Web site: <http://www.radiantheat.net>.

Embassy Industries Inc. 300 Smith St. Farmingdale, NY 11735. Phone: (631) 694-1800. Fax: (631) 694-1834. Email: sales@embassyind.com. Web site: <http://www.embassyind.com/>

Hydronic Specialties Company, 1051 Folger Street, Berkeley, CA 94710. Phone: (800) 786-6847. Fax: (510) 548-7962. Email: info@h-s-c.com

MYSON, INC. 948 Hercules Drive, Suite 4, Colchester, VT 05446. Phone: (800) 698-9690. Fax: (802) 654-7022. Web site: <http://www.mysoninc.com/>

Panel Radiator, Inc., Division of Hydro-Air Components, Inc. 4950 Camp Road, Hamburg, NY 14075. Phone: (716) 648-3801 or (800) 346-8823. Fax: (716) 648-3203.

Radiant Panel Association, PO Box 717, Loveland, CO 80539-0717. Phone: (800) 660-7187 or (970) 613-0100. Fax: (970) 613-0098. Email: info@rpa-info.com.

SLANT/FIN CORPORATION. 100 Forest Drive, Greenvale, NY 11548. Phone: (516) 484-2600. Fax: (516) 484-5921. E-Mail: info@slantfin.com. Web site: <http://www.slantfin.com/>.

Related Volume III CHPS Criteria

See the Overview section of this chapter.



Guideline TC14: Gas-Fired Radiant Heating System

Recommendation

Consider gas-fired radiant heating for spaces with high ceilings and potentially high infiltration, or in large spaces with spot heating needs such as workshops or gymnasiums.

Description

This class of radiant heaters burns gas to heat a steel tube or a ceramic surface. The heated surface emits infrared radiation that is absorbed by occupants, furniture, floor, and elements of the building in view of the heating element. Those objects then heat the air in the space through convection. An advantage to this type of radiant heating in high traffic areas is that the objects in the space remain warm even if cool air is introduced.

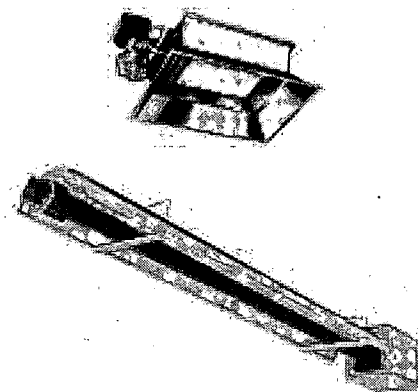

Radiant Heaters

Variations and Options

Several configurations of gas-fired radiant heaters are available. Some are linear units consisting of a long steel pipe with a reflector above. Another option is a smaller unit with heated ceramic surface design to cover a rectangular area of floor.

Applicable Spaces	Climates	When to Consider
Classrooms	South Coast	Programming
Library	North Coast	Schematic
Multi-Purpose / Cafeteria	Central Valley	Design Dev.
Gym	Mountains	Contract Docs.
Corridors	Desert	Construction
Administration		Commissioning
Toilets		Operation
Other		

Applicability

Radiant heating is appropriate in spaces with high ceilings because it helps to overcome thermal stratification. Much of the heat is delivered directly to objects and occupants at floor level.

As mentioned earlier, radiant heating is also useful in areas with high traffic where infiltration can be a problem.

Appropriate spaces include gyms, shops, greenhouses, and high-traffic entrances or lobbies.

Radiant heaters can provide spot heating in large open spaces such as workshops or warehouses.

Applicable Codes

Codes may require an outdoor source for combustion air and/or venting for the products of combustion.

Integrated Design Implications

Consider the need for combustion air and flue gas venting when choosing the location for a gas-fired radiant heater. Also allow for adequate clearance around the unit, as recommended by the manufacturer.

Cost Effectiveness

Gas-fired radiant heaters are usually a cost-effective choice for spot heating in large open spaces. They may also be cost effective for general heating in spaces like gymnasiums when energy savings are considered.

Costs	L			
	M		■	
	H			
		L	M	H
		Benefits		



Benefits

Advantages

- Equal comfort with lower indoor air temperatures results in lower heating energy consumption.
- Fan energy and/or pumping energy required for heating distribution is eliminated.

Disadvantages

Occupants may experience some discomfort due to warm heads and cool feet.

Design Tools

None.

Design Details

Provide protection for units installed in gymnasiums to prevent contact with sports equipment.

Follow the manufacturers guidelines for clearance above and to sides.

Provide an outdoor combustion air source and vent flue gas to outdoors.

"Quiet Type" unit should be specified.

Operation and Maintenance Issues

Gas-fired radiant heaters are relatively low maintenance systems.

Commissioning

None.

References/Additional Information

None.

Related Volume III CHPS Criteria

See the Overview section of this chapter.



Guideline TC15: Ground Source Heat Pump (GSHP) System

Recommendation

Consider ground source heat pump (GSHP) systems in locations with considerable heating and/or cooling loads, or when heating fuel is expensive.

Description

GSHP systems are known by many names, including geothermal, earth-coupled, geoexchange, water-coupled, groundwater, ground-coupled, closed-loop, coiled, open and water-source heat pump systems.

GSHP systems use a refrigeration cycle to extract and transfer heat. A ground source heat pump uses the earth as a source of heat in the winter and as tool for heat removal from the building space in the summer.

GSHP systems can be grouped into two types: closed-loop and open systems, such as standing wells. The selection of the type of system depends on many factors, including the availability of groundwater and surface water, soil type, energy requirements, size of lot, and the experience of the designer and contractor.

An open-loop system takes water directly from a well, a lake, a stream, or other source; filters it and passes it directly through the condenser loop of the heat pump system. When in a cooling mode the water is warmed, and in a heating mode the water is cooled. The heated or cooled water is then released into another well or stream. Open systems are not permitted in most areas.

The closed-loop systems circulate a fluid (usually an antifreeze solution) through a subsurface loop of pipe to a heat pump. The system uses a subsurface loop and a refrigerant loop. The subsurface loop typically consists of polyethylene pipe, which is placed horizontally in a trench or vertically in a bore hole. This thin-walled pipe is a heat exchanger, transferring heat to and from the earth. Fluids inside the pipe circulate to the heat exchanger of an indoor heat pump where they exchange heat with the refrigerant. The refrigerant loop typically consists of copper pipes that contain a refrigerant.

Applicability

These systems are applicable to all interior school spaces, including classrooms and administration facilities. The systems can also be used to heat water for the facility.

Applicable Codes

Although Title 24 does not address GSHPs, the high efficiency credit can be obtained through compliance option process.

Integrated Design Implications

With a good design that includes elements like daylighting, thermal mass, and photovoltaic systems, GSHP systems can help a building become a "net-zero" facility, where all energy needs are supported on-site.

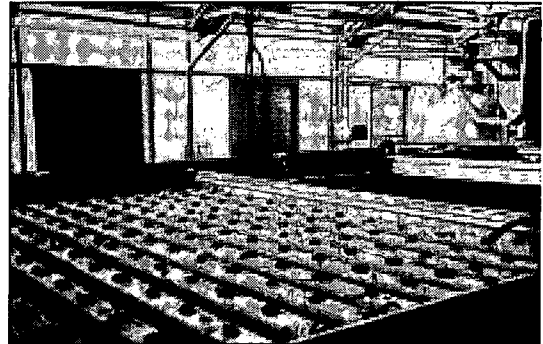

Mountain City, TN. A geothermal heat pump system heats Johnson County High School's greenhouse. Photo courtesy National Renewable Energy Laboratory/PIX07191

Applicable Spaces	Climates	When to Consider
Classrooms	South Coast	Programming
Library	North Coast	Schematic
Multi-Purpose / Cafeteria	Central Valley	Design Dev.
Gym	Mountains	Contract Docs.
Corridors	Desert	Construction
Administration		Commissioning
Toilets		Operation
Other		



Cost Effectiveness

Large systems tend to have first costs that are similar, or slightly higher, to other high quality HVAC systems with conventional energy sources. However, when compared to traditional HVAC systems, the energy savings offsets the initial higher cost. GSHP systems can have 20% to 50% energy cost savings over conventional systems, with maintenance savings of approximately 30%.

Costs	L		
	M		■
	H		
	L	M	H
	Benefits		

Also, the payback period for the GSHP systems generally falls between five to 10 years. Some utilities offer incentives that make the systems more affordable.

Benefits

Energy use and fossil fuel consumption in GSHP systems is reduced by 40% to 70% percent compared to systems that use air instead of the Earth to provide temperature control. Water consumption is also reduced since no cooling towers or water-cooled condensers are needed.

The systems reduce peak energy demand and reduce heat island effect, since waste heat is returned to the ground, not the outside air.

The seasonal energy efficiency ratio (SEER) compares rejected heat to energy consumed to rate cooling efficiency. Higher numbers indicate more efficiency; values greater than eight are preferred. According to the Pennsylvania Ground Source Heat Pump Manual, advanced GSHPs are reaching SEER values of greater than 17.

Waste heat from the system can be used to heat water when the system is cooling the building..

Systems can be designed to use multiple heat pumps with dual speed controls to improve part-load performance. Teachers can control the temperature in each classroom. Also, facilities staff can shut off unused zones during peak demand periods while allowing critical zones to operate normally without any decreased performance.

Since piping and pumps are buried or enclosed in the building, damage caused by inclement weather, insects, and vandalism can be greatly reduced.

Systems promote better aesthetics since no equipment needs to be placed on rooftops or outside the building envelope. They can be used with sloped roofs and work well with historic buildings, since the equipment is easily hidden from view.

Design Tools

Design tools available for GSHP systems include:

- HEATMAP© Geo, Washington State University Energy Program.
- GchpCalc Design Software for vertical ground coupled heat pump systems design for commercial and institutional buildings, Version 3.1, Energy Information Services, Tuscaloosa, AL.
- Cycle Analysis Software Tool, National Renewable Energy Laboratory.
- Geocrack2D, Kansas State University.
- GEOCALC, Design Software, Developed by Ferris State University, Released by Thermal Works Software, Grand Rapids, Michigan.
- Wright Soft Geothermal Heat Pump Software, Lexington, MA.
- GL/GW-Source, Design Software, Kansas Electric Utilities Research Program.
- Geothermal Heat Pump Pipe and Fitting Program, Geothermal Heat Pump Consortium.
- Energy-Smart Choice for Schools, HVAC comparison tool, Geothermal Heat Pump Consortium.
- BuilderGuide, National Renewable Energy Laboratory, Golden, CO.



- However, none of these tools are approved for use with Title 24.

Design Details

In addition to the details below, it is recommended that the standards established by the International Ground Source Heat Pump Association (IGSHPA) for GSHP systems be followed.

Closed-loop systems

The heat transfer between the loop and the surrounding soil or rock depends on thermal conductivity, which is an important consideration when designing closed-loop systems. Consult a geological expert to evaluate the soil conditions at the site.

Non-toxic, biodegradable circulating fluids, such as food-grade propylene glycol or potassium acetate, are recommended for use in GSHP systems.

Loops should be at least 25 ft from any septic systems.

Configuration of subsurface loops can be almost any shape, including long trenches, parallel shorter trenches, radiating, coiled, and vertical borings.

Backfilling or grouting must be done at the end of the installation process to help provide good thermal contact and to protect the pipes.

Open ground systems

For standing column wells, the largest quantities of water will be produced during the coldest part of the winter, so the system must be sized to accommodate such a volume as well as handle extreme temperatures.

Selecting the appropriate groundwater pump size is important for open systems. The pump must be large enough to overcome the friction in the piping and to supply enough water for the heat pump and other uses. However, the pump must be small enough to be efficient in energy usage.

Subsurface disposal and recycling of water in a standing column well conserves groundwater and limits environmental problems.

At least 100 ft should separate wells from contamination sources such as septic tanks and livestock pens. Landfills should be separated by an even a greater distance.

Acceptable drilling methods for wells include rotary, cable tool, and auger. The driller's method should be environmentally sound and prevent the introduction of any contamination.

Casing should be used when necessary to prevent collapse of the hole and the migration of surface pollutants into the drill hole.

Grout should be placed in the entire annular space between the surface casing and the drill hole.

Operation and Maintenance Issues

GSHP systems require little maintenance aside from require regular cleanings of heat exchanger coils and strainers that filter the ground water, as well as regular air filter changes. These systems generally have an expected 25 to 30 year life cycle.

If a closed system is properly designed and installed, soil-freezing conditions do not create any system problems. At a soil temperature of 30°F, latent heat moisture in the soil adds considerably to the capacity of the system, allowing for very successful performance in northern climates.

However, aging, poorly installed, or improperly operated GSHP systems have a greater risk for system failure.



Commissioning

Closed loop

Flushing the loops will help to ensure the system is in good operating order. This process consists of debris flushing, air purging, pressure testing, and final charging of the system with antifreeze.

Also, the system "heat of extraction" and/or "heat of rejection" needs to be calculated, which can be done by non-technical staff using a probe thermometer and a probe pressure gauge. By measuring the temperature and pressure across the source heat exchanger and performing some basic calculations, the operating capacity of the system is determined. This capacity value is then compared with the manufacturer's printed capacity value.

References/Additional Information

American Society of Heating, Refrigerating and Air-Conditioning Engineers. *Design of Geothermal Systems for Commercial and Institutional Buildings*. 1997.
<http://www.ashrae.org/BOOK/bookshop.htm>.

Ankeny Elementary School, Ankeny, IA.

Carlson, Steven. "Ground Source Heat Pumps" presentation. CDH Energy Corp.
<http://www.cdhenergy.com/>.

Commonwealth of Pennsylvania Department of Environmental Protection. Ground Source Heat Pump Manual, August 2000. <http://www.dep.state.pa.us/>.

Energy Center of Wisconsin. "Report Summary: Market Assessment of New Heat Pump Technologies." 1999. www.ecw.org.

Geothermal Heat Pump Consortium. Earth Comfort Update, Vol. 8, Issue 5. September/October 2001.
<http://www.geoexchange.org/>.

Geothermal Heat Pump Consortium and The Association for Efficient Environmental Energy Systems. Proposal for the California Building Energy Efficiency Standards – Revisions for July 2003 Adoption. November 2001.

International Ground Source Heat Pump Association, Oklahoma State University, Stillwater, OK.
<http://www.igshpa.okstate.edu/>.

Manheim Township School District, Lancaster, PA.

National Renewable Energy Laboratory's Geothermal Technologies Program.
<http://www.nrel.gov/geothermal/>.

Oak Ridge National Laboratory. "Geothermal Heat Pumps in K-12 Schools: A Case Study of the Lincoln, Nebraska, Schools." <http://www.ornl.gov/femp/pdfs/ghpsinschools.pdf>.

Paint Lick Elementary School, Lancaster, KY.

West Central Secondary School, Barrett, MN.

U.S. Department of Energy's Federal Energy Management Program. Geothermal Heat Pump Technical Resources. <http://www.eren.doe.gov/femp/financing/ghpresources.html>.

U.S. Department of Energy's Geothermal Energy Program. <http://www.eren.doe.gov/geothermal/>.

Related Volume III CHPS Criteria

See the Overview section of this chapter.

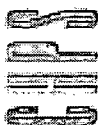

Guideline TC16: Evaporatively Precooled Condenser

Recommendation

Specify an evaporatively precooled condenser for larger packaged units (10 tons or greater) in warm climates.

Description

An evaporative precooling is an option available for some packaged air conditioners that cools the air entering the unit's condenser coils. The precooling reduces the temperature at which the condenser operates and increases the efficiency and capacity of the packaged unit.

The evaporative precooling consists of an evaporative medium several inches thick that replaces the inlet grill that typically protects the condenser coils. The medium is wetted using a recirculating system or a "once-through" system. Air drawn over the medium by the condenser fan is evaporatively cooled to a point close to the wetbulb temperature of outside air.

Precoolers are also available for outdoor units of some split systems.

Applicability

These condensers are applicable for larger units, especially those serving spaces used in summer. They should be used in facilities with skilled maintenance staff.

Applicable Codes

An evaporative precooling adds no code requirements compared to a standard packaged rooftop system.

Integrated Design Implications

An evaporative precooling increases the capacity of air conditioners under hot conditions. Therefore, a smaller unit can be installed which will run more efficiently under normal partial load conditions. Water supply piping is required.

Cost Effectiveness

Evaporative precooled condensers add about 10% to the cost of the equipment and can pay for themselves in two to three years.

An evaporatively precooled condenser is generally cost effective for units over 10 tons in Valley and Desert climates (Zones 11-15).

Benefits

Condensers increase capacity and efficiency of packaged direct exchange air conditioners. They can also reduce summer demand peaks.

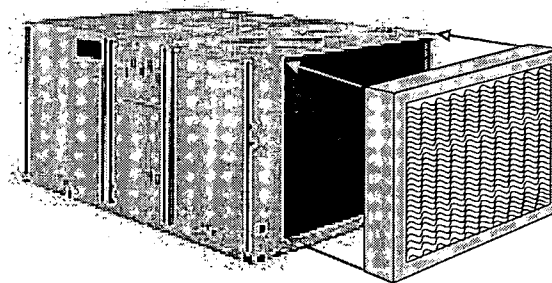

Evaporatively Precooled Condenser.

Applicable Spaces	Climates	When to Consider
Classrooms	South Coast	Programming
Library	North Coast	Schematic
Multi-Purpose / Cafeteria	Central Valley	Design Dev.
Gym	Mountains	Contract Docs.
Corridors	Desert	Construction
Administration		Commissioning
Toilets		Operation
Other		

Costs	L			
	M			
	H			
		L	M	H
		Benefits		



Design Tools

None.

Design Details

Evaporative precoolers are typically controlled to operate only at higher outdoor air temperatures, approximately 80°F and above. At lower temperatures, less benefit occurs.

When sizing the packaged rooftop system, reduce the design outdoor drybulb temperature assuming that the evaporative precooler is about 50% effective. For example, in a climate with summer design conditions of 100°F drybulb and 70°F wetbulb, use an outdoor drybulb of 85°F for selecting the system capacity. This smaller system will run more efficiently at part load and have a smaller peak electric demand.

The addition of the evaporative precooler will reduce condenser airflow due to extra pressure drop. Check with the unit's manufacturer to make sure that airflow will be adequate.

Ensure that the precooler medium is properly designed and sized to prevent carry-over of water onto the condenser coils.

Operation and Maintenance Issues

To minimize maintenance requirements, specify adequate bleed-off rates to prevent mineral buildup (without causing excessive water consumption). Also specify controls that periodically flush the evaporative medium with water to remove dirt and scale. Finally, specify materials to minimize potential for corrosion.

Specify periodic cleaning of evaporative medium, and periodic inspections of water circulation rate and bleed-off rate.

Commissioning

Check that the precooler is activated when system runs and outdoor air exceeds the minimum setpoint (typically 80°F).

References/Additional Information

None.

Related Volume III CHPS Criteria

See the Overview section of this chapter.



Guideline TC17: Dedicated Outside Air Systems

Recommendation

Install dedicated outside air ventilation systems to supplement or replace natural ventilation.

Description

Dedicated outside air systems typically provide 100% outside air and deliver approximately 450 cfm to each classroom. The ventilation rate to other types of spaces should be provided according to the requirements of Title 24.

Outside air systems can be designed with ducted return or with relief dampers to outdoors. Systems with ducted return air can recover exhaust heat with an air-to-air heat exchanger. Systems without a heat exchanger usually need some means to temper the outside air, especially during winter.

Small systems are available that can serve individual rooms, while larger systems can serve an entire building. With larger centralized ventilation systems, evaporative cooling or waste heat recovery may be economical for tempering outdoor air.

Applicability

This design strategy applies mainly to classrooms, or other areas with expected high occupant density, but can be used for other spaces where hydronic heating systems and natural ventilation are appropriate. This design strategy is not as applicable for spaces that have conventional air conditioning, since outside air ventilation would be provided by the air conditioning system.

Dedicated outside air ventilation is especially appropriate in combination with baseboard or radiant heating systems, where a fan is not required for heating. However, even with forced air heating systems, a separate ventilation system may be appropriate if access to clean outdoor air is difficult from each individual room. In these cases, a central air handler can supply tempered ventilation air to each room, while each space heater recirculates indoor air and runs only when there is a demand for heating.

A dedicated ventilation system may also be appropriate where natural ventilation access is difficult due noise, extreme temperatures, dust, security, or lack of physical access to outdoors.

Applicable Codes

Ventilation requirements can be satisfied by either mechanical or natural ventilation. See the Ventilation section of this chapter's Overview for more details.

Integrated Design Implications

Special attention to controls is important to make sure that the ventilation system works together with the heating and/or cooling system. As with any ducted HVAC system, architectural coordination is important in locating relief dampers and in routing ventilation ducts.

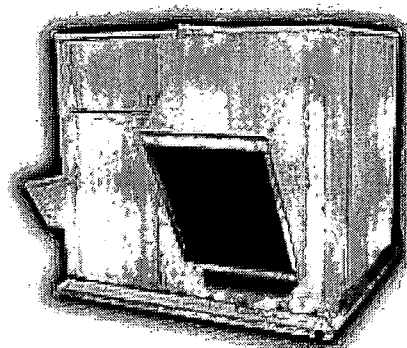

Rooftop Air-to-Air Heat Exchanger.
Source: Lennox.

Applicable Spaces	Climates	When to Consider
Classrooms	South Coast	Programming
Library	North Coast	Schematic
Multi-Purpose / Cafeteria	Central Valley	Design Dev.
Gym	Mountains	Contract Docs.
Corridors	Desert	Construction
Administration		Commissioning
Toilets		Operation
Other		



Cost Effectiveness

A dedicated outside air system may add cost to the overall HVAC system, but when combined with a well-designed displacement system in a coordinated building, it would be expected to be competitive with a well-designed, high-quality conventional HVAC system.

The U.S. Environmental Protection Agency has created the School Advanced Ventilation Equipment Software that uses DOE-2 and code by the Florida Solar Energy Center and others to show that dedicated outdoor air supply systems utilizing energy recovery ventilation components have a payback of under seven years in most parts of the country.

Benefits

These systems will reduce energy costs in most regions. In addition, they ensure proper ventilation, improving air quality and occupant well-being.

Design Tools

Most popular energy simulation programs, such as DOE-2, do not have the capability to directly model dedicated outside air distribution systems. However, there are some tricks that can give an approximation of the energy use.

Design Details

- In both hot and cold climates, consider using an enthalpy air-to-air heat exchanger to precondition outside air that is brought into the building. This will also reduce winter dryness.
- Provide dampers that can automatically minimize and shutoff ventilation air to each classroom, if it is not occupied. Consider using a motion sensor already installed for lighting as a control.
- Consider variable-speed controls for central ventilation fans, so that airflow can be reduced when some rooms are unoccupied.
- Use gravity type or automatic relief dampers in each classroom, unless exhaust air is ducted to a central unit for heat recovery.
- Size the system to provide at least 15 cfm per person in classrooms and other spaces. If a classroom is expected to have 30 students, 450 cfm should be delivered. If a classroom is expected to have 24 students, 360 cfm is appropriate.
- Use filters to remove dust and other particles from outside air.
- Isolate unit from occupied spaces. Provide appropriate intake and discharge noise control consistent with meeting the Noise Criteria.
- Locate rooftop units above unoccupied spaces and away from pollution sources on the roof.

Operation and Maintenance Issues

Replace filters on a regular basis.

Commissioning

Provide documentation regarding the design intent to contractors and building operators to ensure that the system gets implemented properly.

Systems should be balanced and controls commissioned so that adequate air is delivered to each classroom.

References/Additional Information

None.

Related Volume III CHPS Criteria

See the Overview section of this chapter.



Guideline TC18: Economizers

Recommendation

Incorporate integrated economizer dampers and controls on HVAC systems that utilize return air. For units under 5 tons, use non-integrated economizers with two-stage cooling controls

Description

Economizers consist of three sets of dampers with interlinked controls: an exhaust damper which relieves space return air to offset ventilation air brought in; an outside air damper which controls the amount of ventilation air brought into the system; and a return damper which balances the return and outside air portions of the economizers. At low outside air temperature (below 65°F), the economizer dampers modulate to minimum ventilation position unless more outside air is needed for cooling. This minimizes the heating load and protects the cooling coils from frosting at low loads. At high outside air temperature (above about 75°F), the economizer dampers return to this low ventilation position. At these temperatures, the recirculated space air takes less energy to cool. Between these points, the economizer dampers modulate from minimum ventilation to 100% outside air, acting as a first stage of cooling in attempt to maintain the desired supply air temperature.

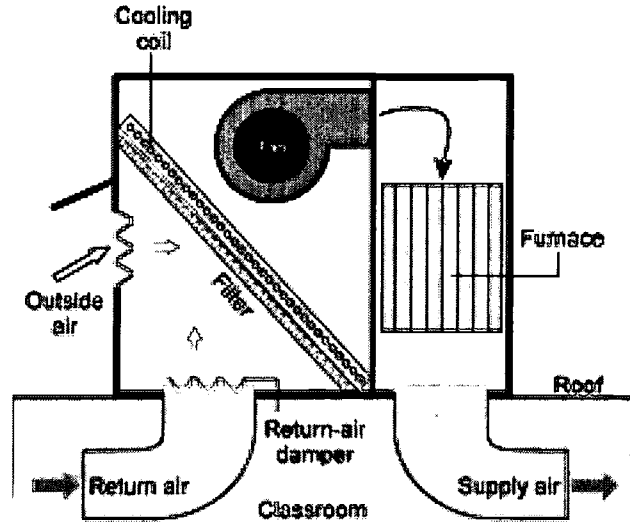

Components of an Economizer.

Applicable Spaces	Climates	When to Consider
Classrooms	South Coast	Programming
Library	North Coast	Schematic
Multi-Purpose / Cafeteria	Central Valley	Design Dev.
Gym	Mountains	Contract Docs.
Coridors	Desert	Construction
Administration		Commissioning
Toilets		Operation
Other		

Integrated economizers allow simultaneous economizer and mechanical cooling. Non-integrated economizers first attempt to cool with outside air; if that does not satisfy the load, the economizer dampers return to minimum position and mechanical cooling is initiated.

There are three common control methods:

- **Fixed temperature setpoint** economizers close to minimum position when outdoor air exceeds a fixed temperature setpoint, typically 72° to 74°F.
- **Differential temperature** economizers will operate whenever the temperature of the outside air is below the temperature of the return air.
- **Differential enthalpy** economizers compare the enthalpy of the outside air and return air streams and operate whenever the outside air has less heat content. Enthalpy economizers are most important in humid climates.

For moderate climates like much of California, economizers can be a significant means of minimizing space-conditioning costs, because outside air will be within the comfort range for much of the school day throughout the year.

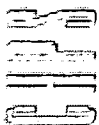

Applicability

Economizers make the most difference for systems serving spaces with low occupant density, such as libraries, administration, and other areas. In those spaces, the normal ventilator rate is fairly low and little free cooling occurs without an economizer. In classrooms and assembly areas, where high occupant density will dictate a large minimum position on the outside air damper (30% or above), economizers controls will have less impact. However, they will still be cost effective due to higher cooling loads in these spaces.

On many existing systems, economizers can be added as a retrofit.

Economizers will not be as useful for spaces designed to use natural ventilation for cooling. In those cases, the cooling system may run only during hot periods when an economizer would be at minimum position anyway.

Economizers should not be installed in facilities do not receive maintenance because a failure can increase energy consumption.

Applicable Codes

Title 24 requires integrated economizers on all systems providing more than 2,500 cfm of supply air and 75,000 Btu/hour of cooling capacity. No economizer is required for smaller units.

Integrated Design Implications

Economizers are especially valuable with displacement ventilation systems because the higher supply air temperature may allow an economizer to provide 100% of the cooling demand for a greater number of hours each year.

An economizer may be unnecessary in spaces with good natural ventilation design.

Cost Effectiveness

The cost premium is \$200 to \$500 to add an economizer to a small packaged rooftop system.

Economizers are very cost effective for spaces without natural ventilation.

Costs	L			
	M			
	H			
		L	M	H
		Benefits		

Design Tools

None.

Design Details

Economizers should be factory-installed or specified to be factory-designed, if they are to be field-assembled. Misapplication may cause coil and/or compressor damage.

Differential temperature control is recommended for most areas in California. However, in humid climates a differential temperature economizer could actually increase the system energy use by imposing a latent cooling load during economizer operation. A differential enthalpy economizer is ideal for humid areas, but enthalpy sensors require maintenance and can be unreliable. Therefore, a fixed temperature economizer with a setpoint around 72°F is a good choice for coastal areas where mild temperatures are accompanied by fairly high humidity.

For retrofit applications, care must be taken to protect the direct exchange coil and compressor from damage during low loads. With existing direct exchange systems, either non-integrated economizers should be installed or controls should be added to prevent compressor cycling and cutout on low evaporator temperatures. Economizer retrofits are likely to be cost effective only for larger systems (above 7.5 tons).



Operation and Maintenance Issues

Clean and lubricate dampers and control linkages. Maintenance is critical to ensure that economizers work properly for the lifetime of the system.

Commissioning

A functional test is critical to ensure that economizer controls are operating properly. With the system running during mild weather (outdoor cooler than indoor air), set the space thermostat to a low value to call for cooling and check that the outside air dampers are completely open. Then use a heat source, such as a hot-air gun, to warm the outside air temperature sensor and check that the outside air damper closes to its minimum position. Remove the heat source and check that the damper reopens (after the sensor has cooled).

For integrated economizers, also check that the outside air dampers remain completely open when the compressor is running and outdoor air is cool.

References/Additional Information

None.

Related Volume III CHPS Criteria

See the Overview section of this chapter.

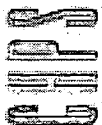

Guideline TC19: Air Distribution Design Guidelines

Recommendation

Design the air distribution system to minimize pressure drop and noise by increasing duct size, eliminating duct turns and specifying low-loss duct transitions and plenums. Use lowest possible fan speed that maintains adequate airflow. Pay special attention to the longest or most restricted duct branch. (See Guideline TC11: VAV Reheat System for information on variable volume systems.)

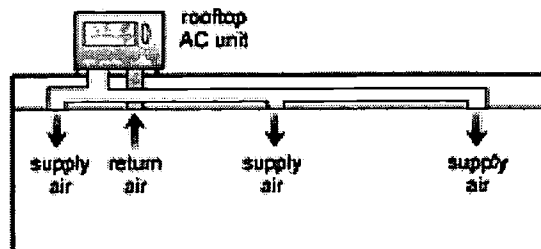

Basic Air Distribution System.

Description

Optimal air distribution system design is fairly complicated. An optimal design balances the need for comfort and low noise with overall HVAC system cost, energy cost, and long-term maintenance and replacement costs. Many factors affect performance: diffuser type, number of diffusers, diffuser size, duct size, duct material, plenum type and size, fitting types, length of ducts, number of turns, type of turns, location of duct system (e.g., unconditioned attic or within conditioned space), priority for heating performance vs. cooling performance, and fan characteristics (pressure vs. airflow).

Applicable Spaces	Climates	When to Consider
Classrooms	South Coast	Programming
Library	North Coast	Schematic
Multi-Purpose / Cafeteria	Central Valley	Design Dev.
Gym	Mountains	Contract Docs.
Corridors	Desert	Construction
Administration		Commissioning
Toilets		Operation
Other		

Due to the complexity of design, a detailed analysis is common for small systems. Typically, contractors rely on experience or rules of thumb in choosing system components. Even if design calculations are performed, however, decisions are not always the best, in terms of energy efficiency and acoustic performance.

This guideline addresses small, constant volume duct systems that are common in California schools. It covers design targets for air velocities and pressure loss that help ensure an efficient and quiet system.

Applicability

All ducted air systems.

Applicable Codes

Title 24 requires that most ducts be insulated (depending on duct location).

In addition, individual HVAC systems with more than 25 hp of fans face efficiency limits of 0.8 W/cfm for constant volume systems and 1.25 W/cfm for variable volume systems.

Integrated Design Implications

Air distribution design options are closely tied to the architectural design. The choice of duct type is often limited by space availability, but acoustics should be considered. Round ducts with no internal glass fiber lining tend to keep noise inside and not let it be reduced as it travels away from the noise source (i.e., fan). Rectangular ducts with no internal glass fiber lining allow more sound to escape than circular ducts, but can be problematic if the level noise traveling through the sheet metal walls of the duct is too high.



Ducts may be located outside, in unconditioned space, or within the conditioned space. The most energy efficient option is usually within conditioned space, but excessive noise may require that the first section of duct be run on the roof or over unoccupied areas for a considerable distance. More expensive sheet metal ducts are usually required, but they need not be insulated. If ducts are located in an unconditioned attic, then the roof must be insulated and/or equipped with a radiant barrier to reduce heat gain to the ducts. Outdoor ducts should not be used unless no other option is feasible, as they almost always get wet and become mold sites.

Location of supply air outlets must be coordinated with lighting design (if located in ceiling) or space plan and furniture (for wall or floor outlets).

Cost Effectiveness

Sometimes extra costs for low-loss fittings or larger ducts are necessary to achieve a high performance design. However, these costs can often be offset by carefully sizing the heating and cooling system to reduce overall system size. In addition, many air distribution improvements have little or no extra cost, such as proper installation of flex duct that should be limited to the last 5 ft to 6 ft due to higher internal pressure drop.

Design Tools

Numerous duct sizing computer programs are commercially available.

A common tool is a "Ductulator" by the Trane Company, which is a manual device used to calculate pressure loss for different types of ducts.

Design Details

These guidelines are intended to cover typical, small, single zone systems. Additional criteria appropriate for multi-zone air distribution systems are not covered here.

Airflow

System cooling airflow. Total system airflow should generally fall between 350 cfm/ton and 450 cfm/ton for systems with cooling. If airflow is greater, condensation might blow off the cooling coil. If airflow is less than 350 cfm/ton, the cooling capacity and efficiency drop. The capacity loss due to low airflow is worst in dry climates where latent cooling loads are low.

System heating airflow. For heating-only systems, a good target is 25 cfm per kBtu/h of heating capacity, providing about 105°F supply air. Heating airflow should not be lower than 15 cfm per kBtu/h because supply air temperature will exceed 135°F. If the airflow is low, supply air will be too warm and air velocity too low, and poor mixing occurs in the room. Excessive airflow during heating creates more noise and can cause uncomfortable drafts.

Airflow adjustment. After system installation, airflow can be adjusted by either changing the fan speed or altering the duct system. To reduce airflow, lower the speed of the fan rather than install dampers. Try to use the lowest fan speed possible because fan energy consumption drops rapidly as fan speed decreases. If possible, specify a variable-speed fan or multiple-speed fan. To increase airflow, try to modify the duct system rather than increase the fan speed. Possible measures include replacing the most restrictive ducts with larger sizes, improving duct transitions to reduce pressure loss, and eliminating duct turns or constrictions (especially in flex duct).

Supply diffuser. Most diffusers also have a minimum velocity both for proper mixing and to avoid dumping cool air on occupants. Refer to manufacturers' guidelines for specific types of supply diffusers. When choosing diffusers based on Noise Criteria (NC), remember that manufacturers' data are usually at ideal conditions (long, straight duct attached to diffuser) and actual noise level is likely to be higher. To account for this, diffusers should be selected for five to 10 NC points below the NC criteria of the room. Refer to table below for suggested air velocities.



Table 30 – Air Velocities for Supply Outlet and Return Inlet

	Design Criterion NC or RC(N)	Neck Air Velocity (fpm)
Supply Outlet	45	625
	40	560
	35	500
	30	425
	25	350
	20	300
Return Inlet	45	750
	40	675
	35	600
	30	500
	25	425
	20	375

(Source: 1999 ASHRAE APPLICATION HANDBOOK)

Return grille. The return air grille(s) must be larger than the total supply air diffuser area to avoid excessive noise. Refer to table above for suggested air velocities.

Duct. Air velocity should not exceed 700 fpm in flex ducts and 1,200 fpm in sheet metal ducts above occupied areas. Higher flow creates excessive turbulence and noise. There is usually a practical lower limit to duct air velocity, where the duct becomes too large and expensive.

Cooling coil. Air velocity through the cooling coils should be minimized to reduce pressure loss. A good target is 300 fpm. However, designers seldom have a choice of coil area in small packaged HVAC units, though it is possible to compare airflow and fan power data from different manufacturers to identify units with lower internal pressure loss.

Duct type

Flex duct. Flexible ducts are widely used. They offer a number of advantages when properly installed but also have some disadvantages.

Flex ducts are most popular for their low cost and ease of installation. In addition, they attenuate noise much better than sheet metal ducts, but allow noise to escape into the ceiling plenum, which may not be acceptable if noise levels at the flex duct are excessive. Flex duct also offers lower air leakage, are usually pre-insulated, and provide some flexibility for future changes.

On the down side, pressure loss is greater in flex ducts, even when they are properly installed. They are also prone to kinking, sagging, and compression, which are problems that further reduce airflow and create noise. And since they are flexible, flex ducts are usually installed with more turns than sheet metal ducts. Actual performance of flex ducts in the field is often poor due to these installation problems. As a final disadvantage, flexible ducts are typically warranted for only about 10 years and will need replacement more often than a sheet metal equivalent.

If flex duct is used, several important points to consider are:

- The duct must be large enough for the desired airflow (see table below).
- The ducts must be properly suspended according to manufacturer guidelines without compression or sagging.
- All ducts must be stretched to full length (see table notes below).
- Keep flexible duct bends as gentle as possible; allow no turns of more than 45°.
- Fasten all flex ducts securely to rigid sheet metal boots and seal with mastic (see Guideline TC20: Duct Sealing and Insulation).
- Limit duct lengths to no longer than about 20 feet (otherwise pressure loss may be too high).



Table 31 -- Minimum and Maximum Airflow Values

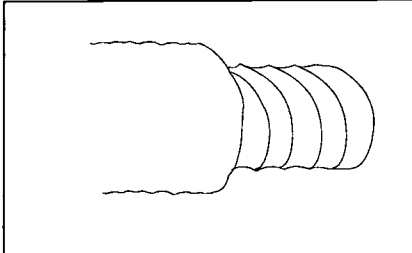

Flex Duct Diameter (in.)	Minimum Airflow (cfm)	Maximum Airflow (cfm)
4	20	60
5	40	100
6	60	140
7	90	190
8	130	240
9	175	310
10	230	380
12	380	550

Table Notes:

- Maximum airflow limits correspond to velocity of 700 fpm. Higher flows create turbulence and noise in flex ducts.
- Minimum airflow corresponds to a design friction rate of 0.06 in./100 ft.
- The airflow values in the table assume that the flex duct is stretched to its full length. Airflow resistance increases dramatically if flex duct is compressed in length. Pressure loss doubles if the duct is compressed to 90% of its full length and triples if it is 80% compressed.

Sheet metal duct. The advantages to sheet metal ducts are lower pressure loss, longer life, greater durability, and the potential for reuse or recycling at the end of the system's life. They are the only option for long duct runs or medium-to-high pressure duct systems. In addition, sheet metal ducts may remain exposed in conditioned spaces.

Disadvantages to sheet metal ducts are higher cost, higher sound transmission (sometimes they require noise attenuation measures that offset some of the pressure loss advantage), insulation requirement, and potentially greater leakage (though leakage is not an issue if they are properly sealed).

From a pressure loss standpoint round sheet metal ducts are preferred over rectangular when adequate space is available. Round sheet metal ducts keep noise inside better than rectangular ducts. This may be preferred if the ducts are running over a noise sensitive space, and duct noise breakout is a concern. However, because round ducts do not allow noise to escape as easily as rectangular ducts, noise will not be reduce as quickly as the noise travels down the duct system. When ducts cannot be lined with internal glass fiber, rectangular ducts are preferred to allow low frequency noise to escape the duct before reaching the diffuser. Rectangular ducts are susceptible to noisy drumming at high airflow.

Reducing pressure loss

A number of measures may be taken to reduce pressure loss and improve airflow. Knowledge of the following simple principles may help the designer improve airflow:

- **Air resists changing direction.** The pressure drop of a turn can be reduced dramatically by smoothing the inside and outside radius. When possible, avoid sharp turns in ducts and never allow kinks in flexible ducts. Turning vanes are another option to reduce the pressure drop in a sharp turn.

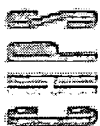

				
	BEST	GOOD	FAIR	POOR
Relative Pressure Loss	1.0	X 1.3	X 4.7	X 13.0

Figure 36 – Pressure Loss for Duct Turns

Note: Total pressure loss calculated at 800 fpm air velocity.

- Airflow into branch ducts will be improved by using angled transitions (or conical taps) rather than typical straight connections. The angled transition is especially useful for critical branches that are not getting enough air.

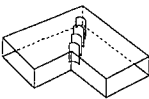
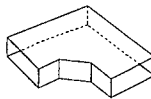
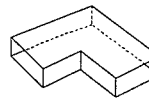
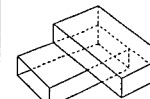
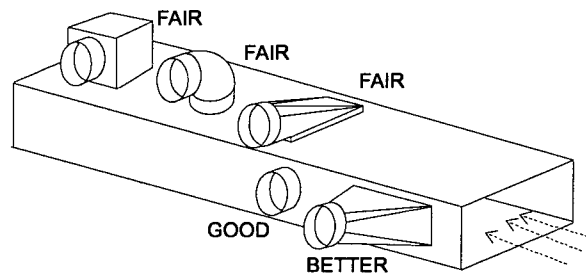

Figure 37 – Various Connections for Branch Ducts

From a pressure loss standpoint, the fewer turns the better. However, turns help to reduce noise, particularly at high frequencies, as it travels through the duct system. For example, a side branch takeoff provides less flow resistance than a top branch takeoff because the top takeoff requires the air to turn twice.

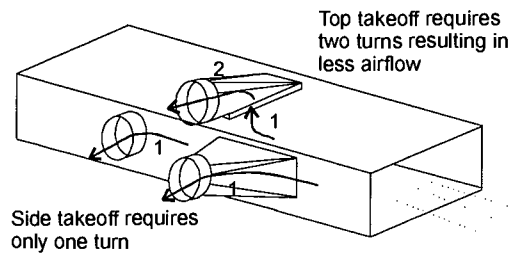
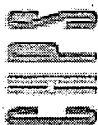

Figure 38 – Side Takeoff Vs. Top Takeoff

Reducing noise

Noise reaching the space via the duct system is either transmitted from the air conditioning unit or generated by air turbulence within the air distribution system.

There are several measures available to reduce noise as it travels through the duct system, such as sound absorbing duct liner, flex duct, duct turns, and sound attenuators (silencers). Each of these elements has different noise reduction characteristics that need to be considered when analyzing the system for noise. Duct lining thickness and duct dimensions controls the amount of noise reduction per linear foot of duct. Thicker glass fiber lining will reduce noise faster. Length and diameter controls the amount of noise reduction across flex duct. Duct dimensions and the way in which the duct turns (i.e., turning vanes, radiused elbow, etc.) impacts the amount of noise reduction. Please bear in mind that noise reduction is frequency dependant. Noise reducing elements (i.e., elbows, flex duct, etc.) may



reduce noise effectively at high or low frequencies, but seldom have the same amount of noise reduction across the audible frequency range.

The first three measures mentioned above are the most feasible for small, single zone systems because they are not prohibitively expensive and do not necessarily cause excessive pressure loss (small packaged systems usually do not have a lot of pressure to spare). Careful design is important to balance noise attenuation benefits vs. additional pressure loss.

Limiting air velocity as described earlier in this guideline controls noise generation with the ducts, or at grilles and diffusers.

Other Design Issues

Pay special attention to the duct branch with the greatest pressure drop, either the longest branch or the one with the most constricted turns. For longer branches, either larger duct size or low loss duct transitions will be required to achieve proper airflow.

- Do not place balancing dampers directly behind diffusers. If they are necessary, then dampers should be located as close to the fan as possible to minimize noise and air leakage in the supply duct.

Connections to ceiling diffusers should have two diameters of straight duct leading into the diffuser. Otherwise noise and pressure drop can increase significantly.

Avoid placing ducts in a hot attic. The roof can reach 150°F on a sunny day and the radiant heat load on the duct is significant. If ducts are above the ceiling, insulation must be installed on or under the roof or a radiant barrier must be installed under the roof deck.

In many cases, if the pressure loss in the air distribution system can be reduced by as little as 0.15 in. SP, fan speed can be reduced and fan power decreases significantly. In the case of a 3-ton rooftop packaged unit, energy savings can be \$200 to \$300 over a 10-year period. Manufacturer's data for a typical 3-ton unit shows that the fan can supply 1,100 cfm at 0.8 in. w.c. external static pressure, if the fan is set to high speed. The fan can provide the same airflow at 0.65 in. w.c. at medium speed. Therefore, if the duct system is carefully designed and installed it may be possible to run at medium speed. The fan power then drops from 590 W to 445 W. For typical operating hours and electricity rates, the savings are about \$30/year.

Operation and Maintenance Issues

Filters must be replaced regularly to maintain airflow. Fans and drives must be lubricated to maintain proper operation.

Commissioning

Measure supply airflow and external static pressure to compare with design values. If airflow is low, take measures to reduce restrictions in duct system rather than increasing fan speed.

References/Additional Information

American Society of Heating, Refrigeration and Air Conditioning Engineers. *ASHRAE Handbook - 2001 Fundamentals*. Atlanta, Georgia.

Sheet Metal and Air Conditioning Contractors National Association. *HVAC Systems Duct Design*. Chantilly, Virginia.

Related Volume III CHPS Criteria

See the Overview section of this chapter.



Guideline TC20: Duct Sealing and Insulation

Recommendation

Create strong and long-lasting connections by mechanically fastening all duct connections and using mastic to seal connections and transverse joints (those perpendicular to airflow). If choosing pressure-sensitive tape as a sealant, then specify foil-backed tape with 15-mil butyl adhesive.

Description

Duct leakage has a big impact on system efficiency and capacity. Studies of residential systems conducted by the Lawrence Berkeley National Laboratory show that 20% loss is common.⁴² Similar problems exist in commercial duct systems.

Other studies have shown that some types of pressure-sensitive tape fail quickly in the field. Therefore, duct-sealing systems must be specified carefully for longevity as well as strength and airtightness.

Depending on duct location, insulation also plays a critical role in ensuring system efficiency and capacity.

Supply and return air plenums must be sealed as well. These are usually the areas of greatest pressure in the air distribution system, and small holes create significant leaks.

Applicability

All ducted air systems.

Applicable Codes

Title 24 requires R-4.2 duct insulation unless the duct is completely within conditioned space. The code also requires mechanical connections; tape or mastic alone is not allowed. In addition, sealing is required using mastic, tape, aerosol sealant, or other system that meets UL 181. (However, an UL 181 rating should not be the only consideration in choosing a duct sealing material. UL 181 does not test longevity of the sealing system.)

Integrated Design Implications

Duct leakage problems can be avoided by placing ducts within the conditioned envelope or by eliminating them altogether (e.g., hydronic heating and cooling).

Do this (in all cases):
Mechanically fasten connections.

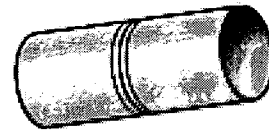

then do one of these:

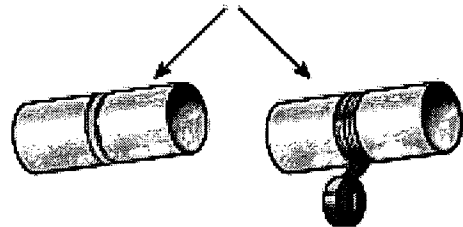

Seal with mastic and glass fiber tape.

Seal with foil backed 15 mil butyl adhesive tape.

Applicable Spaces	Climates	When to Consider
Classrooms	South Coast	Programming
Library	North Coast	Schematic
Multi-Purpose / Cafeteria	Central Valley	Design Dev.
Gym	Mountains	Contract Docs.
Corridors	Desert	Construction
Administration		Commissioning
Toilets		Operation
Other		

⁴² http://www.lbl.gov/Science-Articles/Research-Review/Highlights/1998/v3/EES_duct.html.

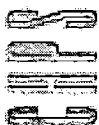

Cost Effectiveness

Using mastic for duct sealing may increase material costs, but many find that labor costs drop compared to sealing with tape. Therefore, good duct sealing should not have a significant cost impact.

Costs	L			
	M			
	H			
		L	M	H
		Benefits		

Benefits

Careful duct-sealing and insulation application will allow use of smaller cooling and heating equipment or at least allow the use of smaller safety margins in sizing calculations. Lower equipment cost may be a result.

Lower cooling and heating costs result. Other benefits include improved system performance, potentially better comfort, and reduction in infiltration and potential moisture problems within envelope components.

Design Tools

None.

Design Details

Do not rely on sealants, such as tape or mastic, to provide a mechanical connection. Specify screws, draw bands, or other mechanical fastening devices as appropriate for the duct type.

As a first choice, use mastic to seal all connections and transverse joints. Mastic is a liquid applied sealant that can also be used together with a mesh or glass fiber tape to provide added strength or to span gaps of up to about 1/4 in. Specify mastic in a water-based solvent with a base material of polyester/synthetic resins free of volatile organic content.

If choosing pressure-sensitive tape as a sealant, specify foil-backed tape with 15-mil butyl adhesive. Butyl tape has been found to have greater longevity in the field. Use of tape with rubber or acrylic adhesive should be avoided.

Flexible ducts must be mechanically fastened with draw bands securing the inner and outer plastic layers to the terminal boot. Specify that the draw bands be tightened as recommended by the manufacturer using an adjustable tensioning tool.

Seal both supply and return ducts and plenums.

Commissioning

Inspect duct connections.

Test duct leakage with smoke testing or pressure testing.

References/Additional Information

None.

Related Volume III CHPS Criteria

See the Overview section of this chapter.



Guideline TC21: Hydronic Distribution

Recommendation

Consider using a variable flow system with variable-speed drive (VSD) pumps, but be careful to keep turbulent flow in the fin tube during cold weather. Insulate exposed hydronic heating/cooling piping. Make early decisions regarding the placement of heating/cooling components (radiators, ceiling panels, slab floors, boilers, chillers, etc.). Use this information to create a system layout that minimizes piping material (pipes, bends, etc.) and head loss. When possible, use larger pipe diameters and smaller pumping equipment to conserve energy.

Description

Significant amounts of energy must be used to distribute water for heating and cooling. Proper design can result in substantial economic and energy savings. Unfortunately, hydronic distribution design is often governed by *past* practices and not necessarily *best* practices. This factor makes the design process quick and easy, but not always the most economical or energy efficient. A hydronic distribution system consists of pipes, fittings, tanks, pumps, and valves.

Applicability

Applicable in all areas.

Applicable Codes

- Title 24 Section 123 details pipe insulation requirements.
- ANSI/ASHRAE/IESNA Standard 90.1 details requirements for various pump sizes.
- Consult Title 24 Mechanical Code regarding seismic support.

Integrated Design Implications

Hydronic distribution is related to nearly all aspects of building design and construction. It is crucial that the HVAC piping contractor be involved throughout the design and construction process in order to maximize the efficiency and cost effectiveness of the hydronic distribution system. Simply laying out heating and cooling elements (baseboards, ceiling panels, chillers, boilers, etc.) in such a way that minimizes the required pipe material and maximizes straight-running pipe can save significant amounts of energy. Maximizing the amount of straight-running pipe also simplifies the insulating process.

Cost Effectiveness

Initial cost for hydronic distribution depends on the quantity, size, and type of piping, valves, and pumps. Initial cost can be minimized through proper planning, sizing, and placement of each.



These loop water pumps and piping are part of a geothermal heat pump system being used by Nebraska schools to save money and energy on heating and cooling. NREL/PIX07415

Applicable Spaces	Climates	When to Consider
Classrooms	South Coast	Programming
Library	North Coast	Schematic
Multi-Purpose / Cafeteria	Central Valley	Design Dev.
Gym	Mountains	Contract Docs.
Corridors	Desert	Construction
Administration		Commissioning
Toilets		Operation

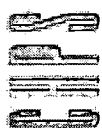

When doing life-cycle cost analysis, compare incremental cost of increased pipe diameter to energy savings, and savings from decreased size and cost of pumping system.

Benefits

- A properly sized and installed system will provide quiet, efficient, and virtually maintenance-free operation at minimal cost.
- Properly insulating all exposed piping will save energy and money, which can be cost effective at levels beyond code requirements.
- Increasing piping diameter significantly decreases the pumping power required. Pressure head loss due to friction is the fifth power with pipe diameter.
- Oversized piping allows for increases in load requirements from add-ons or renovations without complete system overhaul.

Design Tools

- Use a CAD-based program to design pumping layout.
- ASHRAE Handbook - Fundamentals outlines the process for determining pressure drop through piping layout.
- Pipe diameter selection involves balancing the following:
 - Location of pipe in the system.
 - First costs of installed piping.
 - Pump costs (capital and energy).
 - Erosion considerations.
 - Noise considerations.
 - Architectural constraints.
 - Budget constraints.

Design Details

Piping Circuits

There are four general types of piping circuits: series, diverting series, parallel direct-return, and parallel reverse-return. The series circuits are one-pipe circuits, and are the simplest and lowest-cost design. Both the series and diverting series involve large temperature drops; however, only the latter allows for control of individual load elements.

The advantage of parallel piping circuits is that they supply the same temperature water to all loads. Direct-return networks are sometimes hard to balance due to sub-circuits of varying length. Reverse-return networks are designed with sub-circuits of nearly equal length. Parallel circuits are two-pipe systems.

Piping attached to vibration-isolated equipment (typically with the first 25 ft to 30 ft from the equipment) should be supported with vibration isolators, similar in type and static deflection to the vibration isolation being used for the associated equipment.

Fluid flow should be limited to 4 fps in 2-in. diameter pipes and below. For larger pipes a flow velocity of 6 fps is recommended.

Maintain a maximum of 50 psig water pressure at plumbing fixtures.



Valves

In general, either two-way or three-way control valves are used to manage flow to the load. A two-way valve controls flow rate to the load through throttling, which causes a variable flow load response. Three-way valves are used in conjunction with a bypass line to vary flow to the load. Because the water that does not go to the load simply passes through the bypass line, three-way valves provide a constant flow load response. Significant energy savings can be realized when two-way control valves are used in conjunction with VSD pumps.

It is recommended that ball valves or butterfly valves be used for all isolation and balancing valves. These valves are reliable and offer a low-pressure drop at a low cost.

Pumps

Centrifugal pumps are most commonly used in hydronic distribution systems. The use of VSD pumps can save significant amounts of energy and simplify the distribution system. Pump power falls at a cubed rate with speed and thus a VSD pump can be extremely cost effective for systems with significant load variations. Also, variable flow networks with VSD pumps use a simple two-way valve and do not require balancing valves. For systems that use supply air temperature reset controls, specify a clamp on the speed of the pump in order to avoid excessive energy use during system startup.

Refer to 1995 ASHRAE Handbook Chapter 43 for recommended vibration isolation.

Dual-Temperature Systems

When a space requires both heating and cooling, either a two-pipe system or four-pipe system can be used. In a two-pipe system, all the loads must be either heating or cooling congruently. Two-pipe systems cannot be used when some spaces on the piping network need cooling, while others need heating. Switching from one mode of operation to the other increases overall energy usage and can be a fairly time consuming process. A four-pipe system is more complex, but it allows for heating and cooling on the same network and is more convenient than a two-pipe system when frequent changeovers are required.

Expansion Chamber

- Closed systems should have only one expansion chamber.
- Expansion tanks open to the atmosphere must be located above the highest point in the circuit.

Air Elimination

Measures such as manual vents and air elimination valves should be taken to purge any gases from the flow circuit. Failure to do so can lead to corrosion, noise, and reduced pumping capacity.

Insulation

The insulation process becomes significantly easier when the piping network is laid out properly. Install all valves with extended bonnets to allow for the full insulation thickness without interference with valve operators. It may be cost effective to insulate pipes beyond code requirements.

Water Treatment

Care should be taken to avoid scaling and biological growth within the distribution system. Significant fouling resulting from either source is detrimental to system performance. The degree to which scaling can occur is dependent upon temperature, pH level, and the amount of soluble material present in the water. Scale formation can be controlled through several means including filtration and chemical treatments.

Biological growth is generally a larger problem for cooling systems. Heating systems typically operate at temperatures high enough to prohibit substantial biological growth. Chemical treatments with biocides such as chlorine and bromine have traditionally been used to control this growth. Alternatives

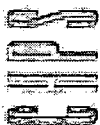

to these chemicals include ozone and UV radiation. Ozone itself is toxic; however it readily breaks down into non-toxic compounds in the environment. UV radiation is completely non-toxic, but is only effective when turbidity levels are low. Mechanical methods such as blow downs can also be utilized to control fouling and decrease chemical use, but these methods increase water usage.

Operation and Maintenance Issues

- Water quality should be checked on a regular basis to ensure fouling due to scaling or biological growth is not occurring.
- Periodically check piping insulation. Insulation adhesive can fail and expose piping.
- Check pressures, pumps, and valves on regular basis to ensure system is performing as intended.

Commissioning

Commissioning should be performed throughout planning, design, construction, and operation to ensure proper installation, set-up, and integration with other facility components. Water flow should be measured and adjusted accordingly. System head should be measured and compared to design system head.

References/Additional Information

American Society of Heating, Refrigerating and Air Conditioning Engineers. *ASHRAE Handbook - HVAC Systems and Equipment*. 2000.

CoolTools: Chilled Water plant Design Guide. Available from Pacific Gas and Electric, P.O. Box 770000, B32. San Francisco, CA 94177.

Hydronics Institute, Berkeley Heights, NJ 07922. Phone: (908) 464-8200.

Related Volume III CHPS Criteria

See the Overview section of this chapter.



Guideline TC22: Chilled Water Plants

Recommendation

Use high-efficiency, water-cooled, variable speed chillers. Use chiller heat recovery if there is a reliable hot water demand. Install oversized induced draft cooling towers with axial propeller fans. Use low approach temperatures and variable speed fan control.

Description

Chillers

There are two basic chiller classifications, air-cooled and water-cooled. Water-cooled cost more (when considering the cooling tower and condenser water loop), but are more energy efficient. Several chiller types exist within the classifications, including electric (centrifugal, reciprocating, screw or scroll), gas-fired (engine-driven or double effect absorption), and steam absorption.

Towers

The purpose of a cooling tower is to provide heat rejection for a water-cooled chiller by exposing as much water surface area to air as possible to promote the evaporation of the water and thus cooling. Cooling towers come in a variety of shapes and configurations. A "direct" tower, also known as an "open" tower, is one in which the fluid being cooled is in direct contact with the air. An "indirect" tower, or "closed-circuit fluid cooler," is one in which the fluid being cooled is contained within a heat exchanger or coil, and the evaporating water cascades over the outside of the tubes. The tower airflow can be driven by a fan (mechanical draft) or can be induced by a high-pressure water spray. The mechanical draft units can blow the air through the tower (forced draft) or can pull the air through the tower (induced draft). The water invariably flows vertically from the top down, but the air can be moved horizontally through the water (cross flow) or can be drawn vertically upward against the flow (counterblow).

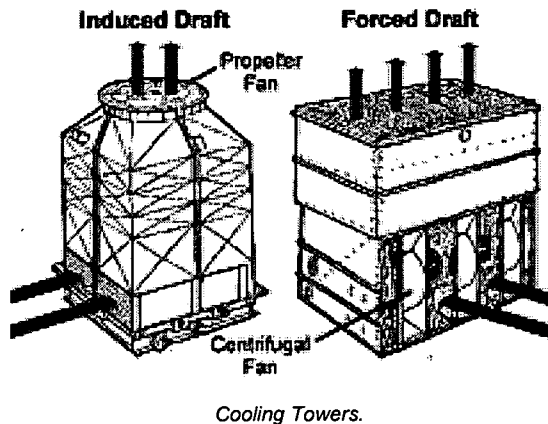

Applicable Spaces	Climates	When to Consider
Classrooms	South Coast	Programming
Library	North Coast	Schematic
Multi-Purpose / Cafeteria	Central Valley	Design Dev.
Gym	Mountains	Contract Docs.
Corridors	Desert	Construction
Administration		Commissioning
Toilets		Operation
Other		

Applicability

These towers are applicable for a small percentage of schools in areas needing significant amounts of chilled water and space cooling.

Applicable Codes

Equipment should perform in accordance with efficiency guidelines in Title 24 and ANSI/ASHRAE/IESNA Standard 90.1-2001. The energy performance requirements set forth by ANSI/ASHRAE/IESNA Standard 90.1-2001 state that heat rejection devices must supply ≥ 38.2 gpm/hp for axial fan towers and ≥ 20.0 gpm/hp for centrifugal fan towers. The U.S. Environmental Protection Agency codes chemicals (usually chlorine) used for cleaning. Methods using ozone for cleaning are also an option, but this can lead to increased corrosion of internal systems.

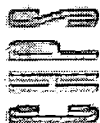

Integrated Design Implications

Chiller and tower decisions are related to many aspects of building design and construction including space considerations, cooling/heating choices, and the hydronic distribution system layout. Tower performance is related to facility layout and orientation. The tower should be sited properly to minimize recirculation of saturated air.

The placement of chilled water plant components affects requirements of the hydronic distribution system. Try to make these decisions early to create a hydronic distribution layout that minimizes piping materials (pipes, bends, etc.) and head loss.

Cost Effectiveness

Installed estimates for chillers fall between \$575/ton and \$781/ton, depending on efficiency and drive choice. Installed tower cost estimates are between \$133/ton and \$178/ton.

Costs	L			
	M	■		
	H	■		
		L	M	H
		Benefits		

As a general rule, air-cooled chillers are more cost effective if the chiller plant is less than 300 tons. Water-cooled are more cost effective above 300 tons. However, many factors affect operating costs for a chilled water plant, and the best choice of type, size, efficiency, and controls is difficult to generalize. Most California facilities experience varying cooling loads over the course of the year, and a variable-speed chiller will be cost effective. First cost premium when improving from an efficiency of 0.7 kW/ton to 0.6 kW/ton is \$70/ton. This number increases to \$136/ton for variable speed chillers. Simple payback periods vary from three to 11 years.

Increasing size and efficiency of cooling tower is generally cost effective with a four to seven year payback. Annual energy savings are between \$0.01/ft² and \$0.04/ft². Incremental costs are between \$0.08/ft² and \$0.12/ft², depending upon climate.

Design Tools

- CoolTools: Chilled Water Plant Design Guide available from Pacific Gas and Electric.
- Gas Cooling Guide available from InterEnergy Software.
- The use of chillers with various efficiencies can be modeled using DOE-2 and VisualDOE.

Design Details

Vibration Isolation

Refer to 1995 ASHRAE Handbook Chapter 43 for recommended chiller and cooling tower vibration isolation.

Chiller Type

The best choice among electric, gas, and steam chillers (or some combination thereof) is largely site specific. If a reliable source of free or very low cost steam is available on-site, then steam absorption makes the most sense.

Gas versus electric or hybrid gas/electric will depend on utility rates. Gas-fired chillers can cost two times more than electrically-driven machines and will require a larger cooling tower and condenser water pump. Gas engine chillers are more energy efficient than absorption machines and have high temperature heat readily available for recovery but are more maintenance intensive than absorption machines.

Chiller type has a significant impact on the level and quality of noise produced. Historically, rotary screw compressors produce very high levels of noise, which typically contains an annoying tonal component. Centrifugal compressors are usually quieter than screw chillers and do not contain a tonal component. Scroll compressors are the most quiet of the three, but are usually air-cooled. The predominant source of noise from air-cooled scroll compressor chillers is the generated by the cooling



fans. Variable-speed drives (VSD) can reduce the amount of noise being generated by slowing the flow of refrigerant through the compressor.

The most cost effective type of electric chiller is primarily a function of chiller size. General decision guidelines are listed in Table 32.

Table 32 -- Recommended Electric Chiller Types

Chiller Size	Recommendation
<= 100 tons	1 st choice: reciprocating 2 nd choice: scroll 3 rd choice: screw
100 – 300 tons	1 st choice: screw 2 nd choice: scroll 3 rd choice: centrifugal
> 300 tons	1 st choice: centrifugal 2 nd choice: screw

Number of Chillers

As a general rule:

- If the peak chilled water load is less than 300 tons, then a single chiller is usually most economical.
- If the load is greater than 300 tons, use two chillers. This offers better low load capability and operating efficiency, and offers some redundancy should one of the chillers fail.

Having one smaller or pony chiller (as opposed to two or more equally-sized chillers) can improve part-load efficiency of the plant. However, some operators prefer if all the machines are the same size due to familiarity and parts interchangeability.

Unloading Mechanism

Centrifugal chillers typically use inlet vanes to control the chiller output at part-load. The use of hot gas bypass as a means to control the chiller at very low loads should be avoided, if at all feasible, as this strategy results in significant energy penalties. Using a VSD instead of inlet vanes allows the compressor to run at lower speed at part-load conditions, thereby reducing the chiller kW/ton more than inlet vanes. The energy savings from a VSD chiller can be quite significant if the chiller operates many hours at low load. In order to capture the potential savings of VSD chillers, it is important that the condenser water temperature is reset when ambient conditions are below design conditions. This can be accomplished either by using a fixed setpoint (e.g., 70°F) that is below the design condenser water temperature (e.g., 85°F) or using wet bulb reset control, which produces the coldest condenser water the tower is capable of producing at a particular time. A gas engine chiller is also capable of unloading by decreasing engine speed.

Chiller Efficiency

The ratings in Table 33 should be considered as upper bounds. Lower efficiencies are available and are often the lowest lifecycle cost option.



Table 33 -- Recommended Chiller Rated Efficiency

Condenser Type	Compressor Type	Min Tons	Max Tons	Recommended kW/Ton	Recommended IPLV	Recommended C.O.P.
Water-Cooled	Scroll	1	80	0.79	0.78	
Water-Cooled	Screw	1	150	0.76	0.70	
Water-Cooled	Screw	151	300	0.72	0.70	
Water-Cooled	Screw	301	& up	0.64	0.61	
Water-Cooled	Reciprocating	1	80	0.84	0.75	
Water-Cooled	Reciprocating	81	& up	0.82	0.75	
Water-Cooled	Gas Engine	501	2000			1.80
Water-Cooled	Absorption (SE)	150	1000			0.65
Water-Cooled	Absorption (DE)	150	1000			1.00
Water-Cooled	Centrifugal	1	150	0.62	0.62	
Water-Cooled	Centrifugal	151	300	0.60	0.61	
Water-Cooled	Centrifugal	301	& up	0.56	0.56	
Air-Cooled	Scroll	1	80	1.25	1.10	
Air-Cooled	Absorption (SE)	1	& up			0.60
Air-Cooled	Screw	1	& up	1.21	1.00	
Air-Cooled	Reciprocating	1	& up	1.15	1.15	
Air-Cooled	Centrifugal	1	& up	1.30	1.30	

Heat Recovery Chiller

Heat rejected from the condenser of a chiller can be recovered and used to drive a desiccant system or for preheating domestic hot water by routing the condenser water through a double-wall heat exchanger that is either an integral part of a storage tank or is remotely located with a circulation pump to the storage tank. Heat recovery chillers are typically used only for a portion of the total cooling load, because of the need for to match hot water load and cooling load and because of the lower efficiency of heat recovery chillers. Heat recovery chillers are not typically piped in parallel with other chillers but rather are either piped for "preferential" loading or in series with other chillers, allowing the cooling load on the heat recovery chiller to be matched to the hot water load. Waste heat can also be recovered from the engine jacket and exhaust of gas engine driven chillers.

The energy savings from chiller heat recovery are reduced when using economizers (air-side or water-side) because chillers are often not needed when the weather is mild or cold. Chiller heat recovery cannot eliminate the need for a DHW boiler but it can eliminate the need for some of the cooling towers at a site.

Chiller Staging

For a plant composed of single-speed chillers, control systems should be designed to operate no more chillers than required to meet the load. A plant composed of variable-speed chillers should attempt to keep as many chillers running as possible, provided they are all operating at above approximately 20% to 35% load. For example, for the typical variable-speed chiller plant, it is more efficient to run three chillers at 30% load than to run one chiller at 90% load. The use of hot gas bypass at very low loads should be avoided, if at all feasible, as this strategy results in significant energy penalties.

Tower Fan Speed Control

Two-speed (1,800 rpm/900 rpm) or variable-speed fan control is always more cost effective than single-speed fan control. For plants with multiple towers or multiple cells, provide two- or variable-speed control on all cells, not just the "lead" cells. The towers are most efficient when all cells are running at low speed rather than some at full speed and some off. For instance, two cells operating at half speed will use about 15% of full power compared to 50% of full power when one cell is on and the other is off.



Tower Oversizing

The tower and fill can be oversized to reduce pressure drop, thereby allowing the fan to be slowed down, which reduces motor power and noise. Tower heat transfer area should be oversized to improve efficiency to at least 60 gpm/hp to 80 gpm/hp at CTI conditions.⁴³ The energy savings should outweigh the added cost to oversize the tower and to accommodate the larger tower footprint and weight.

A larger tower can also produce cooler water, allowing chillers to run more efficiently. Selecting towers for a 4% or 5% approach will generally be cost effective relative to a more typical 10%. Cooling towers are available with as low as 3% approach temperature, but the tower cost increases as the degree of approach drops. A life-cycle cost analysis should be performed to compare the extra cost to the energy impact on the tower, chiller, and pumps.

Tower Performance

The performance of a cooling tower is a function of the ambient wet bulb temperature, entering water temperature, airflow and water flow. The dry bulb temperature has an insignificant effect on the performance of a cooling tower. "Nominal" cooling tower tons are the capacity based on a 3 gpm flow, 95°F entering water temperature, 85°F leaving water temperature, and 78°F entering wet bulb temperature. For these conditions, the range is 10°F (95°F-85°F) and the approach is 7°F (85°F-78°F).

Table 34 -- Cooling Tower Design Considerations

	Energy	Noise	Height	Chiller Fouling	Cost	Application
Packaged Induced Draft, Axial Fan	Lower	Higher	Higher	Higher	Medium	Best for most plants.
Field-Erected Induced Draft, Axial Fan	Lowest	Higher	Higher	Higher	Higher	Very large plants.
Forced Draft, Centrifugal Fan	Higher	Lower	Lower	Higher	Lower	Best if noise or height constrained or large external static pressure (e.g., tower located indoors).
Closed Circuit Evaporative Cooler, Axial Fan	Higher	Higher	Higher	Lower	Highest	Appropriate for heat pumps, not most chillers.
Closed Circuit Evaporative Cooler, Centrifugal Fan	Highest	Lower	Lower	Lower	Highest	Appropriate for heat pumps, not most chillers.
Spray Towers	Lowest	Lowest	Higher	Higher	Lowest	Seldom used due to high maintenance and variable condenser water flow.

Operation and Maintenance Issues

Periodic blow downs and scrubbing of cooling towers must be performed to avoid scaling of internal systems and biological growth. The condition of cooling tower fill is critical to performance. It should be inspected every year and the chemistry of the tower water should be maintained to minimize fouling.

⁴³ Tower efficiency (as defined in ANSI/ASHRAE/IESNA Standard 90.1-2001) is the ratio of the maximum tower flow rate (gpm) to the fan motor horsepower (hp) at standard CTI rating conditions (95°F to 85°F at 78°F wet bulb). Standard efficiency is about 35 gpm/hp to 40 gpm/hp efficiency.

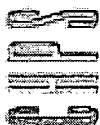

Commissioning

In order for chillers to operate efficiently, they must be properly commissioned. Part of this process is making sure that sensors (such as chilled water flow, chilled water supply and return temperatures, and chiller electric demand), are specified and properly calibrated. Sensor data should be permanently stored by the energy management system and easily visualized graphically. Not only is this data valuable for insuring that the design intent is met in the construction process, but also for maintaining energy efficiency over the life of the chiller. For example, by monitoring the approach temperatures in the condenser and evaporator heat exchangers (as the heat exchanger surface becomes fouled, the approach temperature increases) maintenance can be scheduled when needed, as opposed to too often, which wastes maintenance resources, or too infrequently, which wastes energy. A detailed account of commissioning issues specific to chilled water plants can be found in the CoolTools design guide (see the References section below).

References/Additional Information

CoolTools: Chilled Water Plant Design Guide. Available from Pacific Gas and Electric, P.O. Box 770000, B32, San Francisco, CA 94177.

InterEnergy Software, <http://www.interenergysoftware.com/>

Santa Ana Police Facility utilizes condenser water from a small chiller to preheat water using a plate and frame heat exchanger that replaces the cooling tower. The system provides about 10° of heating. (714) 245-8061.

STD-201 (November 1996) Certification Standard for Commercial Water Cooling Towers. Available from Cooling Tower Institute, Post Office Box 73383, Houston, Texas 77273. Phone: (281) 583-4087.

Todd Road Jail in Ventura County uses an energy efficient electric chiller rated at 0.55 kW/ton. Ventura County. (805) 654-3091.

Related Volume III CHPS Criteria

See the Overview section of this chapter.



Guideline TC23: Hot Water Supply

Recommendation

Consider high-efficiency, gas-fired boilers for space heating and domestic hot water. If demand is large and variable, install several smaller modular boilers instead of one large unit. If conditions permit, augment boiler with solar thermal system and/or recovered thermal energy.

Description

Boilers

Boilers are pressure vessels that transfer heat to a fluid. They are constructed of cast-iron, steel, aluminum, or copper. There are two basic types: fire-tube and water-tube. Fire-tube configurations heat water by passing heated combustion gases through a conduit that is submerged in the water. This system generally uses natural gas or oil as the combustion fuel. Water-tube configurations pass water in pipes through the heated combustion gases and can use natural gas, oil, coal, wood, or other biomass. The air needed for combustion can be supplied by either mechanical or natural means. Hot water boilers are generally classified as either low temperature (less than 250°F) or high temperature (250°F to 430°F), and are rated by their maximum working pressure. All boilers systems have the following components in common:

- **Fuel supply:** natural gas, oil, wood, or other biomass.
- **Burner:** The burner injects a fuel-air mixture in the combustion chamber.
- **Combustion chamber:** Location in boiler where combustion occurs.
- **Heat exchange tubes:** Tubes within the boiler that contain water for a water-tube model and combustion gases in a fire-tube unit.
- **Stack:** The stack is the chimney through which combustion gases pass into the atmosphere.
- **Hydronic distribution system:** Supplies feed water to the boiler and distributes hot water to the facility.

Solar Thermal

A solar thermal system can be either direct or indirect and classified as either active or passive. A direct system heats water directly in solar collectors. An indirect system uses a working fluid (usually a glycol-water mixture) in conjunction with a heat exchanger to increase the water temperature. Direct systems contain fewer elements and are less expensive, but they are prone to freezing and cannot be used in all climate zones without drain back systems. Indirect systems use an antifreeze mixture and can be used in any climate zone. Active and passive refers to the method by which fluid reaches the

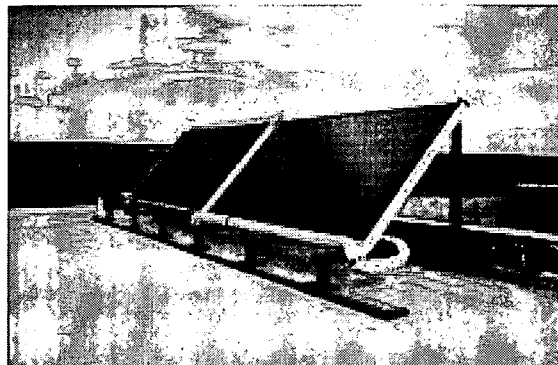

Photo courtesy National Renewable Energy Laboratory/ PIX05183.

BOILER Applicable Spaces	Climates	When to Consider
Classrooms	South Coast	Programming
Library	North Coast	Schematic
Multi-Purpose / Cafeteria	Central Valley	Design Dev.
Gym	Mountains	Contract Docs.
Corridors	Desert	Construction
Administration		Commissioning
Toilets		Operation
Other		

SOLAR Applicable Spaces	Climates	When to Consider
Classrooms	South Coast	Programming
Library	North Coast	Schematic
Multi-Purpose / Cafeteria	Central Valley	Design Dev.
Gym	Mountains	Contract Docs.
Corridors	Desert	Construction
Administration		Commissioning
Toilets		Operation
Other		



collector. If the fluid moves through natural convection, the system is termed passive, and if pumps are used, it is active. Solar thermal systems consist of the following elements:

- **Solar radiation collector:** Collects solar radiation for heating.
- **Heat exchanger:** A heat exchanger is used in an indirect system to pass heat from the working fluid to the water supply.
- **Hydronic distribution system:** Supplies water to the collector for direct systems and to the facility for both direct and indirect systems.
- **Storage tank:** Stores heated water for facility use or for boiler feed water supply.

Applicability

Applicable in any situation where a significant amount of space heating and/or water heating are required. A solar thermal water heating system has the potential to be the main hot water source in some situations. For example, an elementary school in the desert could easily meet most of its hot water needs through solar energy utilization. In most areas it could at least augment the boiler system.

Applicable Codes

- Title 24 Section 123 details pipe insulation requirements.
- Title 24 Section 113 requires the following regarding hot water storage tanks:
 - At least R-12 external insulation; or
 - Combined external and internal insulation of R-16; or
 - Less than 6.5 Btu/h ft² of heat loss based on a water-air temperature difference of 80°F.

Boilers

- Title 24 Section 112 specifies the minimum efficiency requirement for boilers to be 80% to 83% depending upon combustion fuel and size.
- The boiler should comply with the American Society of Mechanical Engineers Boiler and Pressure Vessel Code. This includes codes regarding suggested maintenance.
- Stack placement should adhere to ASHRAE 62 Standards. Stack emissions must conform to requirements set forth by the Clean Air Act under jurisdiction of the applicable air quality district.
- The stack will transmit vibration and noise if the stack is not decoupled from the building structure. Ensuring that the stack is isolated from the building structure is particularly important when the stack is close to occupied areas.

Solar Thermal

- Solar specific components should be certified by the Solar Rating and Certification Corporation.

Integrated Design Implications

A certain amount of hot service water will always be needed for restroom facilities. Any additional need is dependent upon the choice of space heating system (air or hydronic) and whether or not the building design includes a swimming pool and/or commercial sanitation and food preparation equipment. The actual heating load is dependent upon climate and decisions regarding fenestration, hydronic distribution, building envelope, indoor equipment, and building orientation. The placement of boiler or solar thermal components affects requirements of the hydronic distribution system. Try to make these decisions early in order to create a hydronic distribution layout that minimizes piping materials (pipes, bends, etc.) and head loss.



If a central cooling plant is being considered for the facility the possibility of using recovered thermal energy should be considered. Using this technique could affect many aspects of design including chiller choice.

Solar Thermal

A radiant slab heating system works extremely well with solar thermal water heating. Solar thermal systems can generally achieve the low inlet temperatures (90°F to 120°F) required by a radiant slab system.

Because the performance of a solar thermal system is dependent upon the weather, it works best when used in conjunction with another heating system. Depending upon the situation, the solar system can be the primary heat source or can be used to augment and increase the efficiency of a boiler system. The increased efficiency is accomplished by preheating boiler feed water with solar thermal energy.

The use of a solar thermal system must be addressed early in the planning stages, as its viability is highly dependent upon available roof space and building orientation. It is also important to plan the placement of any other roof systems to avoid shading by packaged HVAC systems, stacks, walls, etc.

Cost Effectiveness

Boilers

Total installed costs between \$35/kBtu/h and \$52/kBtu/h depending on efficiency. Some maintenance costs exist, but they can help prevent huge repair costs in the future.

Condensing boilers cost from 30% to 60% more than standard units up to 500 kBtu/h. Incremental costs for more efficient boilers range from \$0.23/ft² to \$0.35/ft² depending on climate. The more efficient boilers realize simple payback period of five to 10 years.

Solar Thermal

Initial costs are higher than that for a boiler system. Most systems cost between \$30/ft² and \$90/ft² of collector area. Maintenance costs are low, and fuel expenses are zero.

The initial cost for solar thermal systems is somewhat more than boilers. However, the fuel is free and thus the system will eventually pay for itself. For a slab system it may be the more cost effective option since it is heating to its maximum while a boiler would need to be run at a lower, less efficient setting. The cost effectiveness of a solar system varies from site to site, as the payback period is dependent upon climate and available solar radiation. Solar thermal systems will be most cost effective in schools with substantial summer occupancy, as this is the time of greatest available solar radiation.

Benefits

Boiler

- Longer life span than standard storage water heaters.
- Can be more efficient than a furnace, but not always.
- Gas boilers burn significantly cleaner than oil, coal, and wood fired units.

Solar

- Free fuel.
- Do not have to worry about changing fuel prices.
- Non-polluting. No fumes means healthier for students and teachers. No operational greenhouse gas emissions.
- Great for teaching. The system itself can be a topic in science classes.

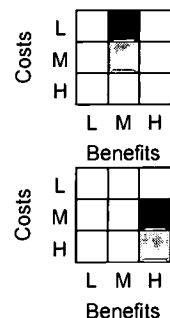

Design Tools

Boiler

The use of boilers with various efficiencies can be modeled using DOE-2 and VisualDOE.

Solar Thermal

- The Transient System Simulation Program developed by the University of Wisconsin-Madison Solar Energy Lab is capable of modeling entire solar water heating systems.
- The National Renewable Energy Lab has extensive data regarding annual totals of solar radiation for different cities in California.
- *Solar Engineering of Thermal Processes* by John Duffie and William Beckman is a great resource for solar energy applications.

Design Details

Boiler

- Large systems are between 75% and 85% efficient.
- New condensing gas-fired boilers are up to 96% efficient.

Boiler energy saving add-ons:

- Economizers preheat feed water with energy from stack gases before it goes to the boiler.
- Air preheaters preheat the air that is mixed with the fuel for combustion, leaving more energy to heat the water.
- Turbulators increase the convective heat transfer rates in fire-tube boilers by inducing higher levels of turbulence.
- Oxygen trim controls measure and adjust oxygen levels in the inlet air before combustion.
- Boiler reset controls automatically change the high-limit set point based on changes in outdoor temperatures.
- Since boilers are generally most efficient at their rated capacity, it is better to have several smaller boilers rather than one large unit that is rarely used at its most efficient setting.
- Condensing boilers produce acidic condensate that is corrosive to some materials such as steel or iron. Make sure to account for proper condensate drainage and follow manufacturers specifications for exhaust flue design if specifying a condensing boiler.
- Refer to 1995 ASHRAE Handbook Chapter 43 for recommended boiler vibration isolation.

Solar Thermal

The system requires use of a differential thermostat to ensure heat is not being dumped to the collectors. The most important element of a solar thermal system is the solar collector. Solar collectors can be either fixed or track the sun. The latter is generally more expensive and is saved for high-temperature applications. Fixed collectors should be oriented facing south and tilted based on seasonal load. A good rule of thumb is to use the location's latitude as the tilt angle with respect to the horizontal.

- Flat-plate collectors consist of a metal frame box containing a layer of edge and backing insulation, an absorber plate with parallel piping, and glazing. The absorber plate is generally constructed of copper or aluminum with a high absorbance coating. The glazing layer reduces convective and radiation heat loss and involves one or more sheets of glass. Solar thermal systems with flat-plate collectors are very common.



- Integral collector storage (ICS) systems use the storage tanks themselves as solar collectors. The tanks are painted black and are set on the roof alone or in insulating boxes with transparent covers angled south. ICS systems are applicable only in mild climates, as freezing and significant heat loss become issues in colder regions. This system is very simple and cost effective.
- The evacuated tube collector is a long and thin version of a flat-plate collector where the box has been substituted by a glass tube and the insulation by a vacuum. These collectors are extremely efficient but are fragile and expensive.
- Concentrating collectors use a curved surface to reflect and concentrate the solar radiation onto a pipe containing fluid. These collectors are generally used for high-temperature applications and are almost always configured to track the movement of the sun.

Operation and Maintenance Issues

Boiler

Performing basic operating and maintenance practices on boilers is very important. Regular inspection of boiler system components ensures safe and efficient operation. Proper maintenance can lead to energy savings of 10% to 20%, reduce harmful emissions, and increase the lifespan of the system.

Fire-side maintenance:

- Minimize excess combustion air and monitor stack gas O_2 and CO_2 to ensure proper percentages. Too little air can cause increased CO and particulate emission, while too much can lower efficiency.
- Clean heat transfer surfaces.

Water-side maintenance:

- Perform regular 'blow downs' to reduce the level of total dissolved solids (TDS) in the system. High TDS levels cause pipe fouling that reduces the heat transfer rate and increases the pressure drop.
- Insulate boiler walls and piping.

Solar Thermal

- Collector glass should be cleaned regularly to ensure maximum efficiency.
- Direct systems must be drained when freezing conditions exist.

Commissioning

Boiler

Commissioning should be performed to ensure proper installation and operation. It is particularly important to properly train maintenance operators. The safety and efficiency of a boiler system is highly dependent upon the duties performed by boiler personnel.

Solar Thermal

Commissioning is important for solar thermal systems because the general contractor may not be familiar with them. Solar systems must be considered whenever rooftop decisions are made. The efficiency of the system is wholly dependent upon collector orientation and minimizing shading. It is important to have a solar expert on hand whenever the system is being considered, even for such things as storing collectors before installation. (Some collectors can be damaged if stored in the sun without fluid passing through them.)

References/Additional Information

Boiler

American Society of Mechanical Engineers. *Boiler and Pressure Vessel Codes*. New York: ASME. 1998.



DONLEE Technologies Inc. 693 North Hills Road, York, PA 17402-2211.

The Fulton Companies. 3981 Port Street, Box 257, Pulaski, NY 13142-0257.
Phone: (315) 298-5121. Fax: (315) 298-6390. Web site: <http://www.fulton.com/>

Rio Consumnes Correctional Facility in Sacramento County, CA uses a natural gas fired pulse boiler.
(916) 874-7469.

Todd Road Jail in Ventura County, CA installed a 90% efficient pulse boiler to provide space conditioning and hot water for a laundry facility. (805) 654-3091.

Solar Thermal

Albion Elementary School, Near Mendocino, CA. Hot water supplied by 22 panel solar thermal system.

American Society of Heating, Refrigerating and Air-Conditioning Engineers. *ASHRAE Handbook: HVAC Applications*, 2000.

American Society of Heating, Refrigerating and Air-Conditioning Engineers. *ASHRAE Handbook: HVAC System and Equipment*, 2000.

Beckman, J.A. and Beckman, W.A., *Solar Engineering of Thermal Processes*. Wiley-Interscience: New York. 1991.

Heliodyne, Inc. 4910 Seaport Ave. Richmond, CA 94804. Phone: (510) 237-9614. Fax: (510) 237-7018. Email: info@heliodyne.com. Web site: <http://www.heliodyne.com/> Real Goods Trading Corporation. 3440 Airway Drive, Suite E, Santa Rosa, CA 95403. (707).542-2600. Web site: <http://www.realgoods.com/>

Solar Engineering Laboratory. University of Wisconsin-Madison, 1500 Engineering Drive, Madison, WI 53706. Phone: (608) 263-1589. Fax: (608) 262-8464. Email: trnsys@sel.me.wisc.edu. Web site: <http://sel.me.wisc.edu/trnsys>.

UC-Santa Cruz Student Housing, Santa Cruz, CA.

U.S. Department of Energy. Energy Efficiency and Renewable Energy Network.
<http://www.eren.doe.gov>.

U.S. Department of Energy. Federal Energy Management Program. <http://www.eren.doe.gov/femp/>.

Related Volume III CHPS Criteria

See the Overview section of this chapter.



Guideline TC24: Adjustable Thermostats

Recommendation

Specify thermostats or temperature sensors that will allow classroom teachers control over comfort conditions in their classroom including temperature (within limits) and noise.

Description

Teachers find it helpful to have control over conditions in their classrooms because different conditions may be appropriate at different times. For example, cooler temperatures may be appropriate after recess or for a more active group. It may be appropriate to turn off mechanical ventilation for certain activities requiring acute hearing or when windows are open. Where an energy management system is not used for temperature control, programmable thermostats can allow implementation of energy saving and comfort enhancing measures, but only if programmed and maintained properly. Care should be taken to select a model that is very easy to program. Otherwise, it is likely to be overridden or set for continuous operation.

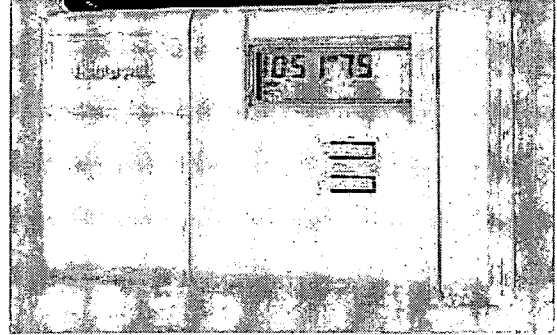

Adjustable thermostats allow the user to have control over the conditions of the room, which can improve overall comfort and create a better learning environment.

NREL/PIX04899

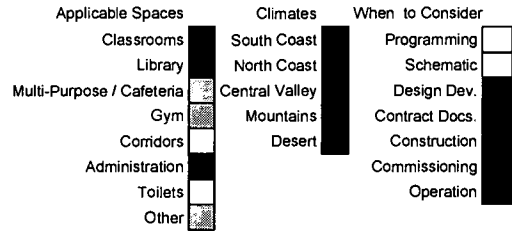

Applicable Codes

Title 24 requires set back thermostat, time of day control, and override. A programmable thermostat is a cost effective way to satisfy these requirements.

Cost Effectiveness

\$50 to \$200 premium for programmable thermostat.

Programmable thermostats are highly cost effective. For a relatively small incremental increase over conventional thermostats, a carefully selected and programmed model will provide teachers with control over their classroom environment while combining time of day and override functions. Direct digital control (DDC) system sensors with adjustable set point have a greater incremental cost impact over plain sensors, but the benefits of giving teachers control should not be underestimated.

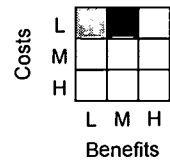

Benefits

Improved comfort and sense of control may foster a better attitude and teaching environment. Some energy savings may be realized due to stopping mechanical ventilation when windows are open. Service requests may be reduced compared to situations where teachers must request a set point change from operations and maintenance personnel. Programmable thermostats replace time clocks, eliminating associated first and maintenance costs.

Design Tools

None.

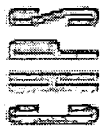

Design Details

- Specify programmable thermostats for control, adjustment, time clock, and override functions when no DDC system will be used for temperature control.
- Sensors with set point control and fan/unit on-off control should be specified for temperature control of classrooms using a DDC system. Also specify limits within which the set point may be varied and the time period after which an overridden value or state will revert to the standard "automatic" (default) value or state.
- If it is necessary to have thermostat covers that lock, provide a means for faculty access.
- Place the thermostat on an interior wall in a location out of direct sun and away from heat sources such as copiers or computers. A point close to the return air or exhaust air inlet is often a good choice.

Operation and Maintenance Issues

Faculty may require repeated training on programmable thermostat operation. Unlike DDC system temperature sensors with adjustable set point, which can be programmed to revert to standard operation after a specified period, programmable thermostats may allow the HVAC system to be switched off, rather than overridden. This can defeat morning warm-up, resulting in comfort problems and complaints. Specify that simplified one-page instructions be provided by the installing contractor and kept on file at school office with copies distributed to teachers for adjustable sensors or programmable thermostats. Programmable thermostats may require periodic replacement of back-up battery.

Commissioning

Proper functioning of any thermostat or temperature sensor must be verified prior to acceptance of the installation. Programmable thermostats and temperature sensors with adjustable set point necessitate a slightly more involved verification procedure.

References/Additional Information

New Orchard Elementary School, San Jose, CA.

Related Volume III CHPS Criteria

See the Overview section of this chapter.



Guideline TC25: EMS/DDC

Recommendation

Use a graphic-interfaced, direct digital control (DDC) system to integrate multiple components of HVAC and other building systems and manage them from a single (local and/or remote) location.

Description

Automatic control of multiple pieces of HVAC equipment and other systems may be integrated using computerized systems known variously as DDC, energy management systems (EMS), energy management and control systems (EMCS), building management systems (BMS), building automation systems (BAS), etc. The added expense and complexity may be justified by the equipment optimization and increased convenience of maintenance possible with such a system.

DDC systems generally perform three functions: equipment on/off control, space temperature control, and equipment status monitoring. A single system can control lighting, security, central plant equipment, and space conditioning equipment. Systems may be specified to allow local override and temperature adjustment at selected space temperature sensors. Graphical user interfaces may be custom configured with different levels of access to allow limited adjustment of schedules and other system parameters by various personnel. While a DDC system will permit the implementation of energy and cost saving measures not otherwise possible, the advantages will only be realized if the system is initially programmed correctly and checked periodically by adequately trained personnel.

DDC systems consist of individual controllers that communicate with one another over a network linked by two-conductor cable or other means. Each controller is wired directly to relays, valve and damper motors, temperature sensors, etc., in order to control and monitor specific equipment. Controllers generally require line voltage power to control panels containing one or more controllers. All other wiring is generally low voltage. The systems may connect directly, via a local-area network (LAN) or modem to a desktop or laptop computer for monitoring and adjustment. A "user-friendly" graphical interface is desired. Systems may be programmed to retain and plot temperature and other status data for performance analysis over limited periods, but retention of historical data requires optional software and additional storage media.

Applicability

DDC systems may not be appropriate for small schools with very simple HVAC systems. Their applicability increases with the size of the facility, the complexity of the HVAC system, and the size of the district.

Applicable Codes

Title 24 requires a seven-day time clock with a manual override as a minimum level of automatic control over HVAC systems.

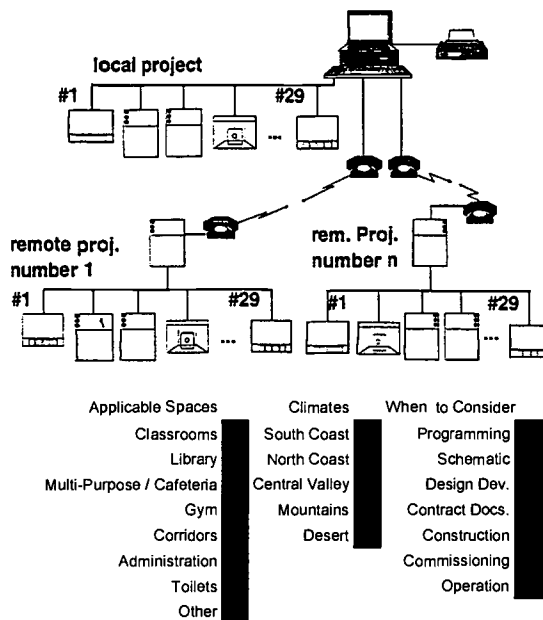

BEST COPY AVAILABLE

Integrated Design Implications

Coordination between mechanical and electrical consultants is necessary for supplying power to a DDC system. If the system is to integrate control of lighting and other building systems, significantly greater coordination will be required. It may also be desirable to have the DDC system use the building (or district-wide, if available) LAN for communications between controllers and with users. These decisions must be made early in the design phase to allow for coordination throughout the design.

Cost Effectiveness

\$0.50/ft² to \$1.50/ft². \$300 to \$500 per input or output "point". Special operation and maintenance training is required to operate, maintain, and troubleshoot DDC systems. Periodic recalibration of sensors may be required for precise control. Software upgrades are periodically required, and life expectancy of major system components may be as low as eight to 10 years due to the rapid pace of development of computer technologies.

Costs	L			
	M			
	H			
		L	M	H
		Benefits		

Cost effectiveness can be very high, with simple paybacks commonly estimated at four to 15 years. However, benefits will only be realized when certain conditions are met: the system must be programmed carefully, checked out thoroughly, and maintained actively. If operation and maintenance personnel are not comfortable with the system, it is likely to be bypassed, so good training is critical. Many school districts find that the greatest benefit of a DDC system is as a maintenance tool, allowing remote adjustment and troubleshooting of equipment.

Benefits

Energy savings may be realized from a DDC system that is correctly installed and actively maintained. Additionally, comfort conditions may be more easily and consistently attainable, and improvements can be made in operation and maintenance resource utilization, through the use of the DDC system for fine tuning, analysis, and trouble shooting.

Peak electric demand savings are possible through load management controls. A DDC system can be programmed to shutoff or reduce power to specific loads during times of high peak demand charges. The savings can be significant, especially if implemented throughout a district.

Comfort improvements and energy savings may be achieved through such features as adaptive optimum start programs that learn when to start morning warm-up to achieve comfort at occupancy time for different operating conditions such as Monday mornings (when the building may have cooled off more than on other mornings).

DDC systems can also offer remote monitoring of system status from a central office and help reduce time spent on maintenance and trouble calls.

DDC systems have the added benefit of eliminating the air compressors required for pneumatic control systems, together with associated maintenance costs, failures, etc.

Design Tools

Control system manufacturers and their representatives are usually eager to assist with the design process (or take it over, if possible). This resource should be used with care, so as to not overlook the design engineer's responsibility to specify a well-engineered system. Close attention to the development of operation sequence is always worthwhile. Software is available, both commercially and from control manufacturers, to chart sequences of operation in block diagrams or flow charts.

Design Details

- Keep controls as simple as possible for a particular function. They will generally be operated (or bypassed) to the lowest level of understanding of any of the operation and maintenance personnel responsible for the HVAC system.
- Rooftop units are often available with optional factory-installed control modules that will interface with the DDC system as an independent "node," allowing a high level of monitoring and control.

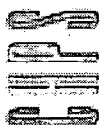

- Discharge air temperature sensors are necessary for troubleshooting, even if not required for control.
- Specify temperature sensors with adjustable set point to give teachers control.
- Specify training. Since operation and maintenance personnel will “inherit” the system, and its performance will ultimately depend on them, involve them as much as possible in design decisions.
- Specify at least a one-year warranty, including all programming changes.
- By specifying the configuration of specific data trend logs (not just the capability to collect them) and their submittal for review and approval at system completion, some system commissioning may be accomplished by the design engineer and/or other owner’s representatives.
- Specify all software necessary for efficient system operation by operation and maintenance personnel to be provided as part of the system installation.
- Local DDC contractors will usually be willing to provide design assistance or even a “complete” design package. Great care should be taken in such collaboration, for it is unlikely that thorough engineering will be applied to the design. The control system should be carefully specified by the design engineer, and details left up to the installing contractor only after careful consideration.
- Control algorithms that may be specified to increase energy efficiency include: optimal start time calculation based on learned building behavior; operation of central equipment based on zone demand, including supply temperature or pressure reset; night purge ventilation to cool building interiors with cool nighttime air in hot climates; heating and cooling system lockouts based on current or predicted outside air temperature; or heating and cooling lockout when windows or doors are opened for natural ventilation (using security system sensor switches).
- Automatic alternation of redundant and lead/lag equipment based on runtime should be accomplished by the DDC system, with provision for operator override.

Operation and Maintenance Issues

Calibration of critical points is required annually or semi-annually. Alternation of redundant or lead/lag equipment for even wear may be triggered automatically or manually. Operation and maintenance requires special training, particularly in the case of software, and therefore consistency with existing systems may be desirable. Permanent software changes should be carefully limited. Periodic checkout is necessary.

Commissioning

Careful commissioning is critical for success of DDC system installations, and proper control operation is necessary for proper equipment operation. Since DDC software may be somewhat esoteric, lack of commissioning may mean that this important aspect of the contractor’s work may never be inspected and may never be finished to the desired level. Therefore, it is a very good idea to provide for some commissioning of the control system by an independent party or organization representing the owner’s interests. Submittal and review of contractor’s input and output point verification test documentation should be required. Field calibration of any temperature sensors that must be accurate for proper control is necessary. (Factory calibration is adequate only for non-critical sensors, such as room temperatures with adjustable set points.) One minimal but effective commissioning method is to specify submittal of trend data logs showing system operation in specified modes, for review by the design engineer. User interfaces including graphics (when specified) should also be reviewed.

References/Additional Information

- New Orchard Elementary School, San Jose, CA.
- Henry J. Kaiser High School, Fontana, CA.
- Arroyo Valley High School, San Bernadino, CA.

Related Volume III CHPS Criteria

See the Overview section of this chapter.

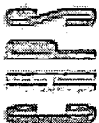

Guideline TC26: Demand Controlled Ventilation

Recommendation

Specify controls to adjust ventilation rate for spaces with varying occupancy to prevent unnecessary cooling or heating of large quantities of outside air, and insure that adequate ventilation *is* provided when needed.

Description

Many spaces in schools require high ventilation rates due to dense “design” occupancy, but experience this occupancy level sporadically or occasionally. The outdoor air required may represent a very large heating or cooling load, depending on the season and climate. Therefore reducing the amount of ventilation during those times the space is partly occupied or unoccupied may save substantial amounts of energy and wear on equipment, but temperature needs to be maintained. This may be accomplished using occupancy sensors or air quality (CO₂ concentration) sensors to control the quantity of ventilation air. This may be done either in conjunction with a direct digital control system or by independent controls.

Applicability

For variable air volume, variable airflow with constant volume, multi-zone or small packaged unit zones, occupancy sensors may be applied but must be enabled/disabled to meet Title 24 pre-occupancy ventilation requirements. For larger intermittently occupied spaces such as multi-purpose rooms, auditoriums, cafeterias and gyms, the energy savings may justify the added first cost, maintenance cost and complexity of a CO₂ sensing system that modulates the outside air quantity down from the design level when interior air CO₂ levels indicate partial occupancy.

Applicable Codes

Title 24 minimum ventilation rates, including baseline for area (0.15 cfm/ft²). Title 24 establishes a “floor” for ventilation, regardless of CO₂ concentration, and specifically addresses demand controlled ventilation.

Cost Effectiveness

Each CO₂ sensor costs approximately \$400. Installation, testing, and adjustment ranges from \$500 to \$1,500 per system. Hand-held CO₂ sensor for calibration costs \$500.

Generally, cost effectiveness for occupancy sensor-based controls will be very high for larger systems. For CO₂ sensor-based control, it will depend on the climate being “severe” enough, and the required ventilation rate being large enough, so that the heating and cooling load reduction saves enough energy costs to offset the first cost of the CO₂

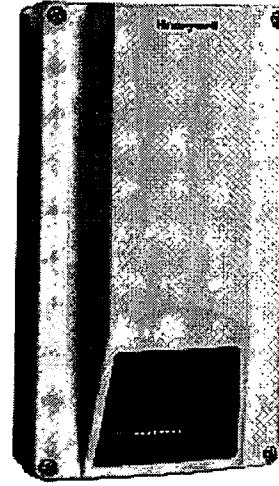

CO₂ Sensor.

Source: Honeywell.

Applicable Spaces	Climates	When to Consider
Classrooms	South Coast	Programming
Library	North Coast	Schematic
Multi-Purpose / Cafeteria	Central Valley	Design Dev.
Gym	Mountains	Contract Docs.
Corridors	Desert	Construction
Administration		Commissioning
Toilets		Operation
Other		

Costs	L	M	H
	L	M	H
	Benefits		



sensing equipment.

Benefits

- Reduced energy consumption.
- Reduced wear on equipment.
- Confirmed/documentated interior air quality.

Design Details

None.

Design Details

- Demand controlled ventilation responds to human occupancy only. Other sources of internal pollutants must be addressed with per-area baseline ventilation, targeted ventilation, etc. This should be considered very carefully before applying this type of control, especially to classrooms, where various odor sources may be used. Demand controlled ventilation always results in worse interior air quality than a properly adjusted system constantly delivering ventilation for rated occupancy.
- CO₂ sensor-based ventilation control uses the measured CO₂ level as an indicator of the current occupancy level, so the ventilation rate may be adjusted accordingly. This is an important difference from using the CO₂ sensor as a direct indication of air quality.
- In areas where outdoor air CO₂ concentration is relatively constant, ventilation may be controlled by a single return air sensor to maintain a fixed CO₂ limit. Otherwise, outdoor and return air sensors should be used.
- The setpoint must be calculated based on occupancy and activity level. For example, the CO₂ concentration for an office space designed at 15 cfm per person (sedentary adult) can be calculated at 700 ppm above ambient.

Operation and Maintenance Issues

Calibration is required.

Commissioning

Review system operation under varying occupancy. Correlate with balance report data for minimum and maximum outdoor air damper positions. Verify acceptable levels of CO₂ concentration in space when occupied using hand-held sensor. Perform all testing in non-economizer mode.

References/Additional Information

American Society of Heating, Refrigerating and Air Conditioning Engineers. *ASHRAE Journal*, April 1997. Interpretation of ventilation standard IC-62-1989-27.

American Society of Heating, Refrigerating and Air Conditioning Engineers. *ASHRAE Standard 62-99*.

Related Volume III CHPS Criteria

See the Overview section of this chapter.



Guideline TC27: CO Sensors for Garage Exhaust Fans

Recommendation

Use carbon monoxide (CO) sensors to prevent parking garage exhaust fans operating when they are not needed.

Description

Parking garage ventilation is often provided by an exhaust fan operated during normal occupancy hours. However, the high ventilation rate required when traffic is present need not be maintained most of the time, when no vehicles are operating. Substantial energy savings may be realized by limiting fan operation to only those periods during normal occupancy when carbon monoxide concentration in the garage rises above acceptable levels. Carbon monoxide concentration sensor technology has advanced substantially in recent years, reducing cost and improving reliability.

Applicability

School buildings with enclosed parking garages requiring mechanical ventilation.

Applicable Codes

UMC

Cost Effectiveness

\$0.20/ft² to \$0.40/ft² of garage. \$1,000 to \$2,000 per sensor installation.

Benefits

Benefits include energy savings, wear reduction, and noise reduction.

Design Tools

None.

Design Details

- Diesel exhaust does not contain high levels of CO. Consider nitrogen dioxide (NO₂) sensors if substantial traffic or idling of diesel vehicles is anticipated.
- Include time of day control in addition to CO concentration control.
- Sensor coverage area is limited, so multiple sensors may be required.
- Specify calibration tools provided to operation and maintenance personnel at time of training.

Operation and Maintenance Issues

Annual calibration of sensors is required.

Commissioning

Verify threshold adjustment and function. Also verify training of operation and maintenance personnel, including calibration.

References/Additional Information

Jean Parker Elementary School, San Francisco Unified School District, San Francisco, CA.

Related Volume III CHPS Criteria

See the Overview section of this chapter.

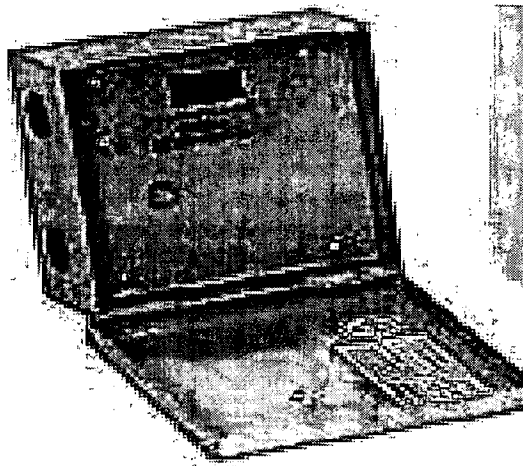

Applicable Spaces	Climates	When to Consider
Classrooms	South Coast	Programming
Library	North Coast	Schematic
Multi-Purpose / Cafeteria	Central Valley	Design Dev.
Gym	Mountains	Contract Docs.
Corridors	Desert	Construction
Administration		Commissioning
Toilets		Operation
Other		

Costs	Benefits		
	L	M	H
L	■	□	□
M	□	■	□
H	□	□	■



OTHER EQUIPMENT AND SYSTEMS

This chapter discusses systems that significantly improve the resource efficiency and performance of existing services, mechanisms, and equipment. These systems also improve energy management by reducing energy use and peak loads, as well as using abundantly available solar radiation. In particular, this chapter provides technical guidelines for the use of:

Photovoltaics (Guideline OS1)

Solar Pool Heating (Guideline OS2)

Timers for Recirculating Hot Water Systems (Guideline OS3)

Efficient Terminal Devices (Guideline OS4)

Waterless Urinals (Guideline OS5)

Relocatable Classrooms (Guideline OS6)

Overview

The equipment and systems described in this chapter can all be used to emphasize that high performance schools are "buildings that teach." Some of these systems are highly visible, making them ideal teaching tools. A photovoltaic array on a school building, for example, lends itself more readily to teaching opportunities than a remote power station does. Teachers can show students how photovoltaics produce on-site electricity, and can encourage students to think about the energy source that powers the systems that keep them comfortable. Such systems also require a higher level of involvement from the people who benefit from them, as their maintenance and functioning is the direct responsibility of the school staff.

Introducing these systems in schools promotes their acceptance on a broader community level. For instance, some people who are not familiar with waterless urinals may be concerned about unpleasant odors or unhygienic conditions. But in fact the special liquid used in the traps for these urinals does not allow odors to escape the trap. And the no-touch system actually enhances hygiene and prevents overflow. Getting used to the system is the key to acceptance.

The main characteristics of the equipment and systems described here are that they utilize sustainable practices and require little or no fossil fuel-generated energy to operate. Photovoltaics and pool heaters, for example, use radiant and thermal energy from the sun. Waterless urinals conserve clean water and reduce the load on water treatment plants.

Due to the way energy cost is typically defined, many of these systems tend to have high payback periods. But the price in dollars and cents for 1 kWh of electricity does not include many environmental costs, such as adding greenhouse gases to the atmosphere, using fuels that are not abundantly available or not replenished, or damaging ecosystems. Only an environmentally balanced life-cycle

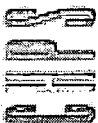

cost assessment will ascertain the real payback period for these systems. Such systems may also have high first costs because they do not benefit from the economies of scale that mass-produced systems do. Because these systems are emerging technologies, they have not yet achieved critical manufacturing volume. But using these systems in high performance schools will make valuable contributions toward their gaining greater market share and acceptance.

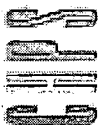

Guideline OS1: Photovoltaics

Recommendation

Install photovoltaic (PV) arrays to convert radiant energy from the sun to electricity. PVs are ideal for isolated or stand-alone tasks, and can serve as an excellent teaching tool.

Description

PVs convert radiant energy from the sun into direct current electricity, without any environmental costs (greenhouse or acid gas emissions) associated with other methods of electricity generation.

PVs produce electricity from an abundant, reliable, and clean source. In fact, the amount of solar energy striking the earth is greater than the worldwide energy demand each year.

The basic component of a PV system is a solar cell. Most solar cells are made of specially treated silicon semiconductor materials. Sunlight striking the cells generates a flow of electrons. This flow is directly proportional to the surface area of the cells and the intensity of the radiation (a cell of area 6.25 in.² will produce 3.5 amperes in bright sunlight). Each solar cell produces approximately 0.5 volts. Higher voltages are obtained by connecting the solar cells in series. Solar cells are laminated; most have a tempered glass cover and a soft plastic backing sheet. This sealing protects the lodged electrical circuits from the outside elements and makes solar cells durable. Modules may be connected in series for higher voltages and in parallel for higher currents.

The typical photovoltaic module uses 36 silicon solar cells, connected in series to provide enough voltage to charge a 12-volt battery. However, most schools do not require battery storage and can use grid-tied PV systems. A grid-tie system can provide electricity savings as well as provide additional shading or cooling benefit. Most schools can switch to a net metering rate schedule where utilities give credit to surplus electricity produced by PV systems.

Individual modules may be further combined into panels, sub arrays, and arrays. PV arrays with storage batteries are sources for uninterrupted power supply. Schools requiring emergency backup for communication systems in the case of an earthquake or rolling blackout can use this type of stand-alone system with batteries. Batteries store energy collected during the day for nighttime use. A battery charger controller may be included to avoid overcharging the battery. In addition, all systems include wire, connectors, switches, and electrical protective components. If the load requires alternating current (AC), an inverter is used to convert the direct current (DC) power to AC power. The energy collected during the day is stored for use during the night.



Photovoltaics are most cost effective in remote locations that are a distance from an electrical grid, but they have zero environmental costs. NREL/PIX07631.

Applicable Spaces	Climates	When to Consider
Classrooms	South Coast	Programming
Library	North Coast	Schematic
Multi-Purpose / Cafeteria	Central Valley	Design Dev.
Gym	Mountains	Contract Docs.
Corridors	Desert	Construction
Administration		Commissioning
Toilets		Operation
Other		



Applicability

- PVs are very suitable for remote facilities that are more than one-third of a mile away from the electrical grid.
- PVs are ideal for climates where plenty of sunlight is available. PVs are also suitable for climates that may experience cloudy days periodically but have sunlight available on most other days. However, availability of sunlight will influence the size and cost of the system. For example, a very small PV system designed to operate a 72-W load for eight hours/day would require a 120-W PV module in southern Arizona, as compared to a 240-W module in Wisconsin. This difference results from the fact that the daily solar insolation levels in southern Arizona are roughly twice the insolation levels in Wisconsin. Although applicable to a whole range of climates, PVs are more feasible in climates with high insolation levels. The Solar Radiation Data Manual for Flat-Plate and Concentrating Collectors, published by the National Renewable Energy Laboratory, provides an accurate assessment of available insolation for 239 U.S. locations.
- PVs are ideal for providing power to exterior and parking lot lighting, and for school zone flashers.

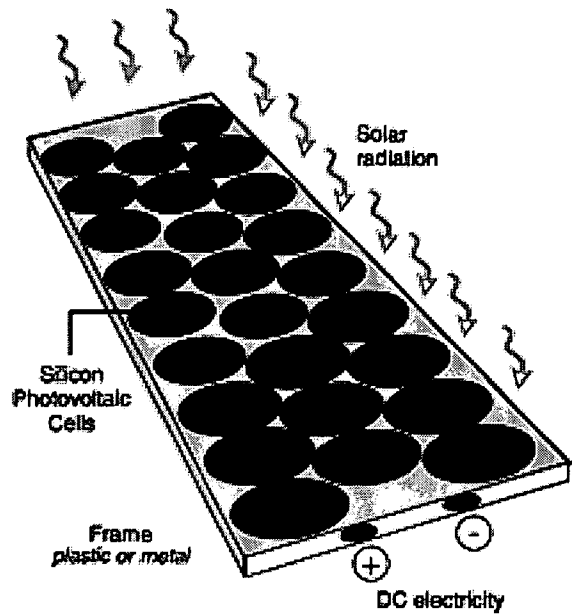

Figure 39 – Photovoltaic Module

Applicable Codes

The National Electric Code (NEC) applies to all systems that generate, store, transport, and consume electricity. With PV systems, it is important to follow the equipment requirements of NEC so that local electric code officials can approve the system. Also, many states require all electrical equipment to be installed by a licensed electrician.

Integrated Design Implications

Building aesthetics. In the early design stage, consider mounting PVs on rooftops for best results.

System integration. Since PVs are most likely to be used in hybrid systems, the mechanical engineer needs to perform detailed planning in the early design stages.

Cost Effectiveness

Photovoltaic panels typically cost anywhere between \$3.50/W to \$6/W for modules and \$5/W to \$20/W for the system depending on the size and capacity of the installation (each W of PV array will produce 2 Wh to 6 Wh of energy depending on availability of sunlight). 100 W installations will cost between \$10/W to \$12/W. Using typical borrowing costs and equipment life, the life cycle cost of PV-generated energy generally ranges from \$0.25/kWh to \$1/kWh. Before rebates, the simple payback period for this system in California is 25 to 30 years.

Costs	L			
	M			
	H			
		L	M	H
		Benefits		

The California Energy Commission (CEC)'s Emerging Renewables Buydown Program offers incentives to Pacific Gas and Electric, Southern California Edison, San Diego Gas and Electric, and Bear Valley Electric customers for PV systems. Customers can receive \$4.50/W or 50% of system costs. This program is due to expire in 2004. To obtain the rebate, the PV system must be certified by the CEC.

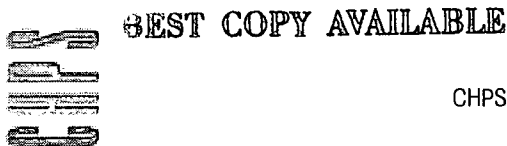

Benefits

- PVs are most cost effective in remote locations that are at a distance from an electrical grid. PVs are typically three to six times more expensive than utility-supplied electricity. However, this figure does not take into account the “real” or environmental cost of utility-generated electricity or local rebates.
- PVs are environmentally benign during use and do not produce any greenhouse gases or acid gas emissions associated with other methods of generating electricity. They have zero environmental costs.
- PVs produce electricity from an abundant and reliable “fuel” — sunlight. Coupled with storage batteries, PVs are capable of supplying uninterrupted power.
- PVs are available in modular building blocks; more arrays may be added as the demand for power increases.
- Wear and tear is minimized for PVs, since they have no moving parts and produce power silently.
- Although they may be combined with other power sources in hybrid systems to increase system reliability, PVs themselves require no connection to an existing power source or fuel supply.
- For grid-tie PV systems, net metering allows schools to receive utility credits for surplus electricity generated by PV systems.
- PVs can withstand severe weather conditions including snow and ice.
- PVs can be combined with other types of electric generators (wind, hydro, and diesel, for example) to charge batteries and provide power on demand.
- By putting power back into the electrical grid and shaving peak loads, PVs can have far-reaching implications.

Design Tools

Most PV dealers will work with designers to engineer the best-customized system for the school. System requirements are determined by:

- Estimating the daily load demand.
- Determining the solar resource in the location.
- Calculating the battery size. (Note: A lead-acid battery is not a viable option.)
- Calculating the number of PV modules required.

For first estimates of the array size needed, consider the following variables that effect the production of power in an array:

- Outside air temperature. Use average annual temperatures.
- Amount of sunlight received, or Incident Solar Radiation, which depends on latitude, cloud cover, and angle of the array.
- Efficiency of the photovoltaic cells. This information should be available from the manufacturer and varies between 13% at unfavorable conditions to 30% under lab conditions.

$$P = (\text{Sol}_{\text{ins}} + \Delta t) \times A \times \text{Eff}$$

where,

P = Power generated, W

Sol_{ins} = Incident solar radiation, Wh/ft²

Δt = Difference between the control and design temperatures (use zero if the design temperature is between 50°F and 60°F, for control temperature use 50°F for colder weather and 60°F for warm weather)



A = Area of the array, ft²
 Eff = Efficiency of the system (multiply cell efficiency by efficiency of the storage unit)

A Macintosh software program is available for PV design and sizing, wherein designers can specify appliances and AC/DC loads, inverter efficiency, and site location. Based on these variables, the software recommends the number of solar modules and batteries. The software costs about \$15.

PVWatts is another PV software program. Researchers at the National Renewable Energy Laboratory developed PVWatts to allow non-experts to quickly obtain performance estimates for grid-connected PV systems at no cost.

Trnsys, a program developed at the University of Wisconsin, also helps size and locate PVs. See the References section at the end of this guideline for more information.

Design Details

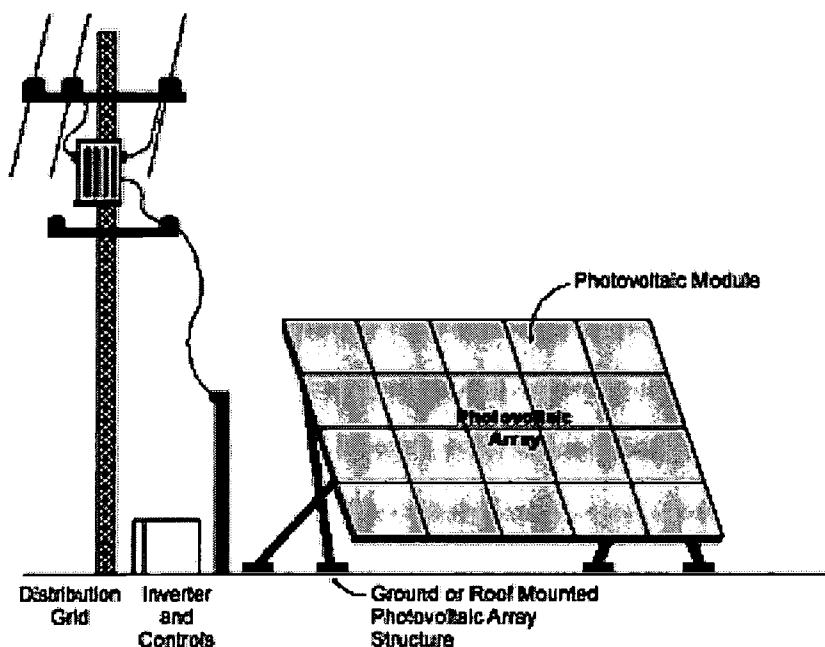

Figure 40 – PV Siting, Elevated

Source: Renewable Energy Project Analysis Software

- The most important aspect of installing PVs is siting. Shading can significantly reduce the output of solar cells. Mount PVs at an elevation or on roof tops. Consider both summer and winter sun paths and ensure that trees, neighboring buildings, or other obstructions do not shade any portion of the array between 10:00 AM and 3:00 PM.
- Mount PVs for maximum southern exposure. The exact mounting angle will differ from site to site.
- Flat, grassy sites work better than steep, rocky sites.
- Use arrays as building components to economize on building materials and for unobtrusive design solutions. Arrays can be used as a finishing material on structures to create attractive roofs or skylights. Arrays can be used to break up and add interest to a large, uniform roof surface. They can double as shading devices, which not only block the sun but also capture it. Transparent arrays can be used as structural glazing instead of glass. Arrays can also be part of a curtain wall system.



Operation and Maintenance Issues

- PVs require occasional cleaning to remove dust and debris. In cold, snowy climates, care must be taken to keep the array surface clear of snow.
- Some PV systems contain storage batteries that may require some watering and maintenance similar to that required by batteries in automobiles.
- PV modules are the longest living components of a PV system (20 to 30 years) and will likely outlive the batteries. Batteries may need replacement every six or seven years.
- No PV system is maintenance-free. Schedule regular inspections of the system to ensure that the wiring and contacts are free from corrosion, the modules are clear of debris, and the mounting equipment has tight fasteners. Roof-integrated systems should be designed to facilitate regular inspection and maintenance.
- Monitor the power output of PV modules, the state-of-charge and electrolyte level of the batteries, and the actual amount of power that building loads use. Writing this information in a notebook helps to track the system's performance and determine whether the system is operating as designed. Monitoring will also help understand the relationships between the system's power production, storage capability, and load requirements.
- Roof-integrated systems should be designed to allow easy removal if roof replacement is required.

Commissioning

- Do not compromise on the initial module cost of PV systems. Skimping on first costs results in having to pay later, in terms of higher operation (\$/kWh) costs that amount to a much higher figure over the lifespan of a system.
- Purchase PV systems from established and knowledgeable dealers who can help determine requirements specific to the site. Look for warranties of 20 years or more. Thoroughly check the rating system that the dealer/manufacturer is using for reliability.
- Always engage a professional to design and install PV systems. A preliminary design is a necessity in order to determine the size, layout, and potential energy output of the PV modules. This design can be performed with computer simulation tools using estimated hourly weather, solar resource, and load data. The time required to prepare the preliminary design and detailed cost estimate typically falls between 30 and 60 hours, with fees ranging from \$40/hour to \$100/hour. Smaller scale projects with simple structural requirements fall at the low end of this time range. Larger scale projects requiring more difficult structural integration into existing buildings will be at the high end of this time range.
- Fully commission panels and the entire array to confirm rated power is achieved.

References/Additional Information

Energy Efficiency and Renewable Energy Network, U.S. Department of Energy.

Maryland Solar Schools Program Plan. <http://www.energy.state.md.us/executiv.htm>.

Solar Engineering Laboratory, University of Wisconsin-Madison, 1500 Engineering Drive, Madison, WI 53706, Phone: (608) 263-1589; Fax: (608) 262-8464, Email: trnsys@sel.me.wisc.edu, Web site: <http://sel.me.wisc.edu/trnsys>.

Solar Schoolhouse. Developed by the Raus Institute, this web site contains information on PV systems, a database on schools using solar power, DSA approval checklists, lesson plans, etc. Site is expected to launch in June 2002. Web site: <http://www.solarschoolhouse.org/>.

Stand-Alone Photovoltaic Systems: Handbook of Recommended Design Practices, Sandia National Laboratory.

Related Volume III CHPS Criteria

Energy Credit 3: Renewable Energy.

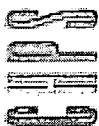

Guideline OS2: Solar Pool Heating

Recommendation

Use solar heaters for swimming pools as an environmentally friendly and cost-effective solution to pool heating requirements.

Description

Most solar pool heating systems consist of three basic components: a collector, a pump, and a controller. Unlike domestic solar water heating systems, which raise a small amount of water to a high temperature of about 140°F, pool heaters raise the temperature of several thousand gallons of water to about 80°F by circulating the water at a relatively fast rate through the collectors. This circulation allows most of the solar energy falling on the collectors to transfer to the pool water.

The collector consists of a large area of pipes that absorb solar energy in the form of heat. They are made from plastic or rubber compounds that can withstand continuous exposure to sunlight. The collector is positioned for maximum access to sunlight. The pump circulates water through the collector to continually absorb heat. The hot water is then pumped back into the pool. This pump may be separate (especially in retrofit situations) from the regular pool pump that circulates pool water through a filter. The pump is automatically switched off when the temperatures of the water in the pool and the collector approach each other. The controller regulates the flow of water within the collector based on the temperature of the outgoing water using a diverting valve, the only moving part in a solar pool heating system. This valve controls whether or not the water circulates through the collector loop. When the collector temperature is sufficiently greater than the pool temperature, the water is diverted from the filter systems through the collector loop. The water bypasses the solar collectors during nighttime or cloudy periods. Some smaller systems are operated manually or with timers, but larger systems may be operated through electronic sensors.

Strip, panel, and tube systems are the three major types of solar collectors available. All three perform to a more or less equal standard, although strip systems are the most commonly used type.

Applicability

Solar heating for swimming pools is feasible for all climate types, even those that experience sub-freezing temperatures. Waterways on strip systems can expand to accommodate the increased volume of frozen water.

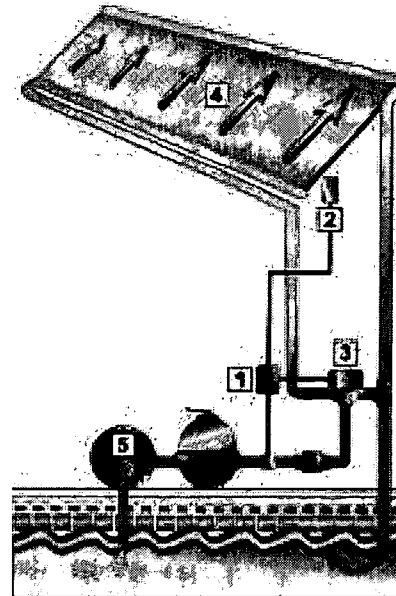

Source: Solar-Tec Systems Solar Pool Heating

With an automatic system, simply set the desired temperature on the control panel (1). When the solar sensor (2) finds that there is enough solar energy to heat the pool, water is automatically sent to the solar collectors (4) by the valve (3). The pump (5) sends pool water to the solar collectors. As the water flows through the many tubes in each solar collector, the sun's energy heats it. The solar-heated water then flows back to the pool. This simple cycle continues until the pool reaches the desired temperature.

Applicable Spaces	Climates	When to Consider
Classrooms	South Coast	Programming
Library	North Coast	Schematic
Multi-Purpose / Cafeteria	Central Valley	Design Dev.
Gym	Mountains	Contract Docs.
Corridors	Desert	Construction
Administration		Commissioning
Toilets		Operation
Other		

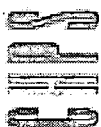

Most sloping roofs can be fitted with solar collectors. Relatively lightweight strip systems are suitable for sloping roofs. Strip collectors can be fitted to follow the roof contours and can be curved around obstructions, such as chimneys and skylights. Panel collectors are limited by their rigid sheet design and can be applied to flat or plane roofs only.

Applicable Codes

Title 24 allows for exceptions to Section 114 (a) 4 (that prohibits electric resistance heating) and Section 114 (b) 2 (that requires pool covers) for pools deriving at least 60% of the annual heating energy from site solar energy. Other codes may apply.

Integrated Design Implications

Although solar heated swimming pools can easily be accommodated later in the design or construction phases, the following issues should be considered beforehand:

- **Building aesthetics.** Installation of solar collectors on rooftops may conflict with building aesthetics. Consider placement and orientation of the collectors early in the design phase to avoid this conflict.
- **Space availability.** Solar collectors may occupy an area equivalent to 75% of the pool's surface area. This roof area must be available near the location of the swimming pool for unobstructed access to sunlight (although it's possible to mount the collectors at ground level).

Cost Effectiveness

Collectors made of copper are more expensive than those made of plastic, although they last longer. Plastic collectors are less conductive than copper, but are inert to chemicals and have about a 10-year lifespan. On an average, solar heating systems for pools cost around \$7.50/ft² to \$10/ft² (installed). An unglazed solar heating system for an average 600-ft² pool, including separate pump and automatic controller, costs around \$4,500 fully installed. The operating energy is practically free, as all the heating energy is solar.

Costs	L			
	M			
	H			
		L	M	H
		Benefits		

Pool covers for an average size 600 ft²-pool costs around \$400 to \$500 (not including the roller, which has a starting cost of around \$300). Using the above figures for the cost of running a gas heater, heating the pool with solar energy can save from 3.8 tons to 5.1 tons of greenhouse gas emissions (CO₂) per year.

Benefits

- Since solar pool heating collectors operate just slightly above the ambient air temperature (80°F), such systems typically use inexpensive, unglazed, low temperature collectors made from especially formulated plastic materials.
- The alternative system — a gas pool heater — has a starting price of around \$2,000, plus additional heating costs varying from \$600 to \$900 per year. The solar heating system will therefore repay the extra cost in less than three to four years, and will have much lower running costs thereafter.
- A solar heating system requires very little or no maintenance since it has no burners or moving parts. A gas heater or heat pump requires far more maintenance and typically lasts only one-third the life span of a solar system.
- Solar heating systems' warranties are typically more inclusive and much longer (12 to 15 years) than warranties for gas heaters (five years) and heat pumps (typically 10 years).
- A good solar pool heating system can generally be expected to increase pool water temperature by 9°F to 18°F above the unheated water temperature from October through March. However, temperatures will vary depending on local climate conditions. The graphs below shows the temperature differences claimed by one manufacturer in two climate extremes.



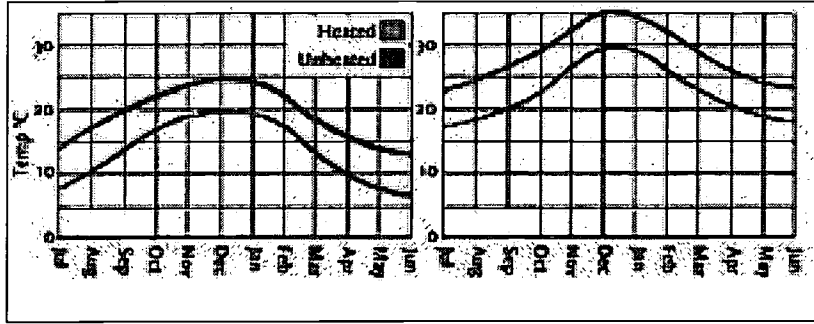

Figure 41 – Solar Heating vs. No Heating in Extreme Climates

- Attic insulation gets saturated with radiant heat from roof decks that increases air conditioning bills. Collectors mounted on the roof will considerably lower air conditioning costs for that space.

Table 35-- Cost comparison for gas and solar pool heaters in a heating-dominated climate

Gas Pool Heater	Solar Pool Heater
Initial cost \$2,400	Initial cost \$3,495
Five year operating cost \$6,000	Five year operating cost \$0
Total five year cost \$8,400	Total five year cost \$3,495

Design Tools

Use the following simplified algorithm for arriving at the required collector area:

$$A = A_p \times O \times S \times Sol_{ins}$$

where,

- A = Area of solar collector, ft²
- A_p = Effective area of pool (multiply the surface area of the pool with the shape multiplier from Table 36), ft²
- O = Orientation multiplier (from Table 37)
- S = Shading multiplier (from Table 38)
- Sol_{ins} = Solar insolation (from figure below)

BEST COPY AVAILABLE

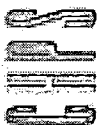

Table 36 – Shape Multiplier

Shape	Multiplier
Rectangle	1.00
Kidney/Freeform	0.85
Oval	0.90
Round	0.79

Table 37 – Orientation Multiplier

Orientation	Multiplier
South facing	1.00
East or west facing	1.25
Flat	1.10

Table 38 – Shading Multiplier

Shading (from 9 a.m. to 5 p.m.)	Multiplier
No shade	1.00
25% shade	1.10
50% shade	1.25
75% shade	1.50
100% shade	1.75

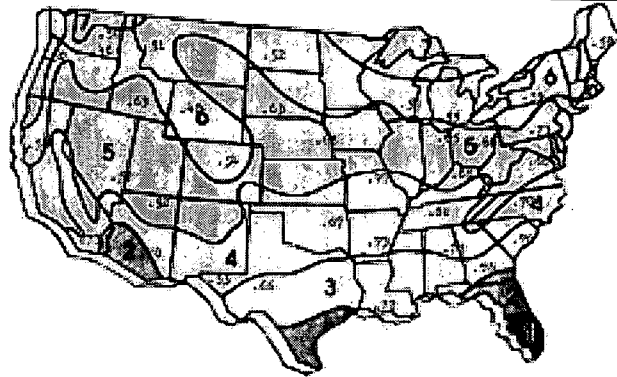

Figure 42 – Solar Insolation Levels in the U.S.

Free software is available from U.S. Department of Energy to analyze current energy consumption and project savings when implementing a variety of energy management systems from pool covers to solar systems. The *Energy Smart Pools* software uses hourly temperature and humidity data along with solar data to provide an accurate simulation of the heat losses and gains of a pool. Over 50 U.S. weather sites are currently available in the software. The program is intended to provide annualized simulation of annual energy costs, other costs, savings, and payback of adding a pool cover system, as well as costs, savings, and payback of adding a solar heating system.

Design Details

As in all solar heating, the primary factor in determining the effectiveness of the system is exposure to the sun. The size and the location of the collector, controller efficiency, local climate, wind protection, and roof orientation all influence the functioning of solar pool heating systems.

- Use a minimum collector area that is 60% of the pool's surface area. This applies only for ideal conditions (see the Design Tools section for simplified sizing). Whenever conditions are unfavorable, for example in colder climates, the size of the collector will need to be increased, with a minimum area of 80% recommended for such installations. Increase collector area to 75% of the pool surface area if collectors are laid flat or if collectors face west. Other orientations are not recommended. In general, for every 20% of the pool surface area that is installed as solar collector, a 3°F rise in water temperature can be expected (based on collector rating at 1,000 Btu/ft² of collector area).
- A south-facing roof is the best location for these systems. Use a west orientation or a flat roof if south orientation is unavailable.
- Ideally, tilt the south-facing collectors by 30° to 32°.
- Consider installing pool covers. They are the most cost effective measure for reducing heat loss, water evaporation, and chemical use.
- Manual operation or a simple timer may be substituted for expensive automatic controls.
- Indoor pools that are used year round require glazed flat plate collectors, which should slope between 35° and 45°.

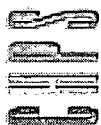

Operation and Maintenance Issues

Ensure that pools are manually and seasonally drained. In areas subject to winter freezing, the collectors and plumbing should be installed to allow all water to drain when the system is off.

Paint all exposed PVC plumbing to protect it from damage due to solar energy.

Commissioning

Carefully check how long the manufacturer has been in business and what warranty services are available. Use the Florida Solar Energy Center rating system (see References for more information).

References/Additional Information

American Solar Energy Society, Inc. (ASES). 2400 Central Avenue, G-1, Boulder, CO 80301. Phone: (303) 443-3130; Fax: (303) 443-3212, Email: ases@ases.org. Web site: <http://www.ases.org>.

National Spa & Pool Institute (NSPI). Phone: (800) 323-3996. Web site: <http://www.nspi.org/>.

The Energy Efficiency and Renewable Energy Clearinghouse (EREC).. P.O. Box 3048, Merrifield, VA 22116. Phone: (800) DOE-EREC (800-363-3732). Email: doe.erec@nciinc.com. Florida Solar Energy Center. 1679 Clearlake Rd., Cocoa, FL 32922. Phone: (407) 638-1000, Fax: (407) 638-1010, Pamphlets available by mail - call for costs, Collector Thermal Performance Ratings (publication FSEC-GP-16), Design and Installation Manual (publication FSEC-IN-21-82), System Sizing (publication FSEC GP-13). Web site: <http://www.eren.doe.gov/consumerinfo>.

Solar Energy Industries Association (SEIA). 1616 H Street, NW, 8th Floor, Washington, DC 20006. Phone: (202) 628-7979, Fax: (202) 628-7779. <http://www.seia.org/>.

Related Volume III CHPS Criteria

Energy Credit 3: Renewable Energy.



Guideline OS3: Timers for Recirculating Hot Water Systems

Recommendation

Use recirculation timers to control circulation of hot water based on demand. Use separate hot water systems for areas with significantly different demand patterns.

Description

Recirculating hot water systems connect to the hot water pipe and constantly circulate hot water through the pipes, from the heater to the furthest fixture and then back to the heater, making warm water immediately available upon turning the tap. Large facilities use recirculating hot water systems, which result in heat losses through the distribution piping. Installing timers ensures that hot water circulates only during times of need, which greatly reduces the heat loss through the distribution piping as well as the daily pumping load.

Applicability

Timers are applicable for large facilities where hot water is recirculated. Timers will work effectively only when the hot water demand for a facility can be predicted accurately, as in the case of classrooms and school administrative areas.

Applicable Codes

The service hot water system should meet all the requirements of Title 24 Section 113 — Mandatory Requirements for Service Water Heating Systems and Equipment. Section 113 (b) 2 also states that all pumps for circulating systems should have a control capable of automatically turning off the circulating pump when hot water is not required, with the exception of residential occupancies.

Cost Effectiveness

Timers are very cost effective and have a two to five year payback period.

Prices for recirculating system timers range between \$40 and \$50.

Benefits

Timers greatly reduce heat losses through distribution piping. Daily pumping loads are also reduced considerably.

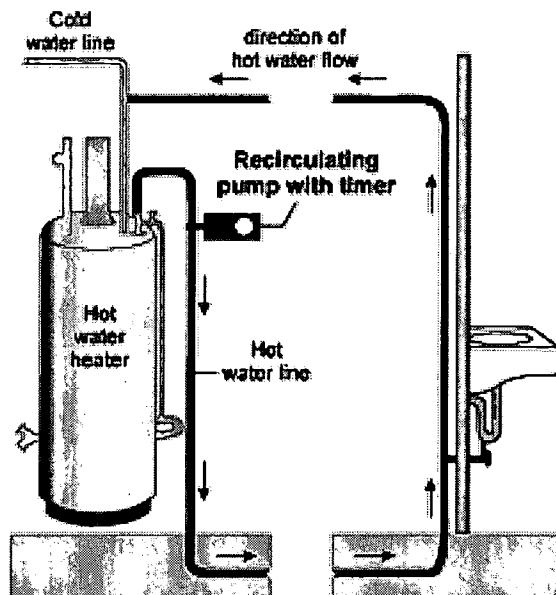

Applicable Spaces	Climates	When to Consider
Classrooms	South	Programming
Library	North Coast	Schematic
Multi-Purpose	Central	Design Dev.
Gym	Mountains	Contract Docs.
Corridors	Desert	Construction
Administration		Commissioning
Toilets		Operation
Other		

Costs	L	M	H
	L		
M			
H			
	L	M	H
	Benefits		

BEST COPY AVAILABLE



Design Tools

None.

Design Details

Most schools are ideal candidates for using timers because of the predictability of classroom schedules. Set the system to operate only between classes, just before and after the school day, and during lunch periods.

Administrative areas, locker rooms, and other areas may have a demand schedule different from that of the classroom facility. Separate hot water systems or gas-powered, instantaneous water heaters can be used to accommodate these areas. Avoid using timers for areas with random and intermittent schedules.

Consider using thermostats connected in series with the timers. The thermostat turns off the pump when the water in the pipes reaches a certain temperature. Once the water in the pipe is hot, the pump turns off. If the timer and thermostatic controls are installed together in series, the circulator operates only at the preset clock times and only when the temperature conditions of the thermostat are met. That is, if either the timer control or the thermostatic control switch is open (off), the circulator will not operate, which results in additional savings.

Operation and Maintenance Issues

- Adjust the initial timer schedule based on observed or monitored demand data. Schedules may vary from school to school, and it is important to fine-tune the timer settings based on specific demand patterns.
- Check the hot water supply every six months to ensure that the timer is functioning as expected.
- Always set the timer switch to the actual time by turning the programming ring in the direction of the arrow until the timing arrow points to the actual time on the ring.
- In a power outage, the timer will not keep time. After power has been restored, the correct time of day must be reset by rotating the programming ring in the direction of the arrow until the timing arrow points to the actual time on the ring.

Commissioning

If installing a thermostat along with the timer, ensure that the two devices are installed in series.

After wiring is completed and checked, install the timer control unit onto the terminal box bracket of the pump and reinsert the terminal box screw. Be careful not to bind or leave any terminal box wires exposed.



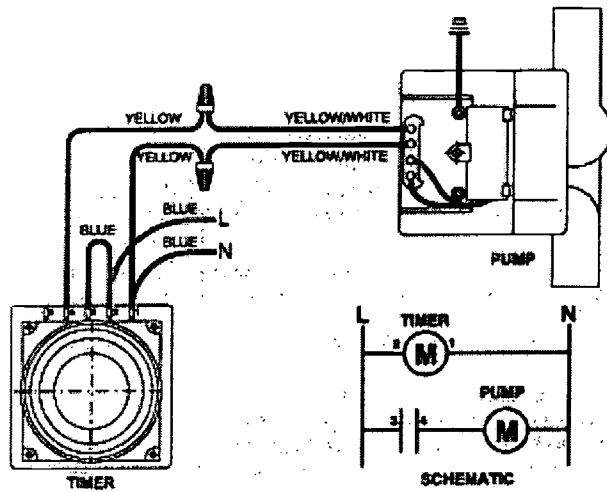

WIRING DIAGRAM FOR TIMER CONTROL ONLY

Figure 43 – Wiring Diagram

Source: <http://www.plumbingsupply.com/grundtimer.html>

References/Additional Information

http://www.eren.doe.gov/buildings/consumer_information/water/waterques.html#13.

<http://www.lainginc.com/instant.htm>.

<http://www.plumbingstore.com/circpump.html> - faq.

Related Volume III CHPS Criteria

Energy Credit 5: Energy Management Systems.

BEST COPY AVAILABLE



Guideline OS4: Efficient Terminal Devices

Recommendation

Use low-flow toilets and low-flow devices on all terminals like faucets and showerheads. Use automatic faucets for controlling wastage of clean water.

Description

Installing low-flow devices is simple and cost effective. In 1995, the National Energy Policy Act mandated the use of toilets that use no more than 1.6 gallons of water per flush (gpf), reduced from 3.5 gpf. Low-flow toilets use various technologies like large drain passages, redesigned bowls, and tanks for increased functionality and easier wash-downs.

Older showerheads typically deliver 4 to 5 gallons per minute (gpm) of water. Newer showerheads are more efficient and follow the National Energy Policy Act of 1992 that allows a maximum water flow rate of 2.5 gpm (at standard water pressure of 80 lb/in²). Showerheads should use aerator technology and multiple flow settings to save water. Conventional bathroom faucets use 3 gpm to 7 gpm. New faucets, designed to meet federal codes, use a maximum of 2.5 gpm (at 80 psi), although some are being designed to use 1.5 gpm or less.

The new low-flow faucets essentially operate in one of two ways: aeration or laminar flow. In laminar flow faucets, the water travels in parallel streams producing a clear flow of water without being mixed with air (as in aeration) that produces superior wetting ability over aerating faucets. Laminar flow faucets are somewhat more expensive than aerating types. Conventional faucet aerators do not compensate for changes in inlet pressure, so with greater water pressure, more water is used. New technology compensates for this occurrence and provides the same flow regardless of pressure. Aerators are also available that allow water to be turned off at the aerator itself.

Some low-flow faucets are metered-valve type; they deliver a fixed quantity of water and then shut off automatically. Other automatic faucets include self-closing and sensed. Sensed faucets, either infrared or ultrasonic, are designed to turn on when a user's hands are placed under the faucet, and turn off when the hands are removed.

Applicability

Low-flow technology is applicable to all terminal devices that deliver water.

Applicable Codes

Low-flow plumbing fixtures must meet the appropriate American National Standards Institute (ANSI) standards listed by the International Association of Plumbing and Mechanical Officials (IAPMO).



Low-flow devices will reduce water consumption by 15% to 20% resulting in lower environmental costs and reduced load on wastewater treatment plants. NREL/PIX00653

Applicable Spaces	Climates	When to Consider
Classrooms <input type="checkbox"/>	South Coast <input type="checkbox"/>	Programming <input type="checkbox"/>
Library <input type="checkbox"/>	North Coast <input type="checkbox"/>	Schematic <input type="checkbox"/>
Multi-Purpose / Cafeteria <input checked="" type="checkbox"/>	Central Valley <input type="checkbox"/>	Design Dev. <input type="checkbox"/>
Gym <input type="checkbox"/>	Mountains <input type="checkbox"/>	Contract Docs. <input type="checkbox"/>
Corridors <input type="checkbox"/>	Desert <input checked="" type="checkbox"/>	Construction <input checked="" type="checkbox"/>
Administration <input type="checkbox"/>		Commissioning <input type="checkbox"/>
Toilets <input checked="" type="checkbox"/>		Operation <input type="checkbox"/>
Other <input type="checkbox"/>		



Cost Effectiveness

A good quality, low-flow showerhead will cost \$10 to \$20. Low-flow faucet aerators cost \$4.50 to \$8. A sensed faucet is expensive and may cost up to \$160 per fixture more than the regular faucets.

Costs	L	M	H
	M	M	M
	H	H	H
	L	M	H
	Benefits		

Benefits

A low-flow device will pay for itself in energy saved within four to eight months.

Installing low-flow showerheads and faucet aerators can save significant amounts of hot water. Low-flow showerheads can reduce hot-water consumption for bathing by 30% while still providing a strong, invigorating spray.

Water consumption is reduced by 15% to 20%, resulting in lower environmental costs and reduced load on wastewater plants. Easy installation procedures make low-flow plumbing fixtures feasible for retrofitting. It is estimated that low-flow toilets alone could save up to 2,000 gallons of water per person.

Design Tools

None.

Design Details

Use aerators that deliver 0.5 gpm to 1 gpm of water for bathroom faucets.

Use aerators with higher flow rates (2 gpm to 3 gpm) for sink faucets that will be used for intensive washing purposes.

Operation and Maintenance Issues

Faucets should be periodically checked for leaks and repaired as needed. Leaky faucets can waste enormous amounts of water (up to tens of gallons in a single day).

Faucet aerators need to be checked periodically for clogging, some models clog more easily than others and may need to be cleaned too often to be effective. Some aerators may cause unacceptable performance or the perception of poor performance, resulting in an increase in water use.

Commissioning

Installation of low-flow plumbing fixtures is similar to that of conventional fixtures. Most of these fixtures require no special connections or fittings. Low quality showerheads may simply restrict water flow, which often results in poor performance.

References/Additional Information

American Water Works Association. 1401 New York Ave. NW, Suite 640, Washington, DC 20005.
Phone: (202) 628-8303. Web site: <http://www.awwa.org>.

Plumbing Manufacturers Institute (PMI). 800 Roosevelt Road, Building C, Suite 20, Glen Ellyn, IL, 60137. Phone: (708) 858-9172. Web site: <http://www.pmihome.org>.

Related Volume III CHPS Criteria

Water Credit 2: Water Use Reduction.



Guideline OS5: Waterless Urinals

Recommendation

Install waterless urinals wherever applicable.

Description

Waterless urinal systems have been used in schools since 1993, and have some innovative features that distinguish the product from the conventional urinal systems available today. The products look, feel, and work like a conventional urinal system except for one difference: they do not require water to operate.

The system has three main components: a polypropylene trap insert, a sealant liquid, and a reinforced fiberglass urinal body.

The primary component of the product is the trap cartridge. This cartridge "traps" the biodegradable sealant liquid, which is lighter than other liquids. It floats on and seals the contents from the atmosphere. This special liquid allows urine to sink through its layer, creating a pleasant and odor-free environment. Since urine is 90% water, it readily flows down and falls through the trap. This trap design allows immersed urine to be discharged into the drain without using any mechanical parts.

The system requires only about three ounces of sealant liquid per charge to operate and will last for about 1,500 sanitary uses. Then, the liquid is simply replenished. The trap needs to be replaced three to four times a year, depending on frequency of use.

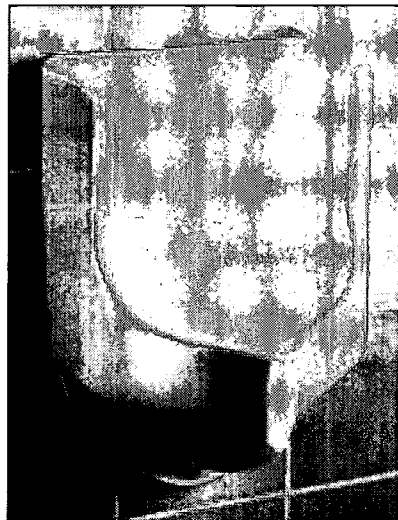

Source: Waterless Co.

Applicable Spaces	Climates	When to Consider
Classrooms <input type="checkbox"/>	South Coast <input checked="" type="checkbox"/>	Programming <input type="checkbox"/>
Library <input type="checkbox"/>	North Coast <input type="checkbox"/>	Schematic <input type="checkbox"/>
Multi-Purpose / Cafeteria <input type="checkbox"/>	Central Valley <input type="checkbox"/>	Design Dev. <input type="checkbox"/>
Gym <input type="checkbox"/>	Mountains <input type="checkbox"/>	Contract Docs. <input type="checkbox"/>
Corridors <input type="checkbox"/>	Desert <input checked="" type="checkbox"/>	Construction <input checked="" type="checkbox"/>
Administration <input type="checkbox"/>		Commissioning <input type="checkbox"/>
Toilets <input checked="" type="checkbox"/>		Operation <input type="checkbox"/>
Other <input type="checkbox"/>		

Cross - Section of the Patented Vertical Eco Trap®

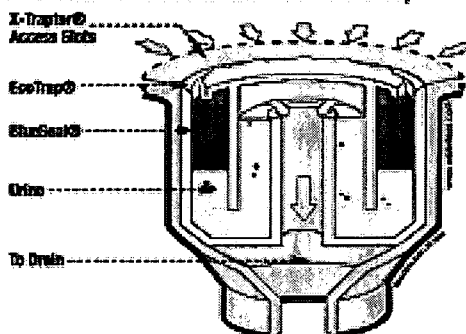

Figure 44 – Cross-section of Waterless Urinal

Source: Waterless Co.

BEST COPY AVAILABLE

Applicability

Waterless urinals are applicable to all restroom modernizations and new construction.

Applicable Codes

American National Standards Institute (ANSI) Z124.9, UPC®, CSA®

Cost Effectiveness

Costs for waterless urinals are comparable to regular manual flushed urinals, but are less than automatic-sensor flushed urinals.

The payback period for the system is one to four years. Savings due to waterless urinals are estimated between \$150/urinal/year and \$330/urinal/year depending on factors like number of users, cost of water, cost of sewer, volume of water use, and maintenance.

Costs	L	■	■	
	M	■	■	
	H	■	■	
		L	M	H
		Benefits		

Benefits

Some benefits of waterless urinals include:

- Easy maintenance since it has durable, break-resistant fiberglass construction with no moving parts. This reduces operating costs by eliminating the problem of broken flush valves.
- Flushometer and valve replacements are common problems for flush urinals. Such repairs are not an issue for waterless urinals.
- Waterless urinals are simple to install and use. Replacing existing conventional urinals with waterless products is also relatively simple to accomplish, since they easily adapt to existing two-inch plumbing waste lines.
- They have a short payback period of one to four years.
- Fresh water supply will be preserved and can be applied in a more effective and meaningful way. In addition to saving water, they reduce the amount of water needing to be treated. Less water released into the treatment process lowers pollution and benefits the environment.
- Waterless urinals significantly reduce clogging and prevent overflows.

Design Tools

None.

Design Details

None.

Operation and Maintenance Issues

The smooth, simple design of the waterless system is easy to clean and maintain. Also, there are no costly repairs usually associated with the mechanical components of flush valves.

The trap cartridge should be replaced two or four times per year, depending on the frequency of use.

The sealant liquid is biodegradable and the trap cartridge should be recycled.

Commissioning

The drain line should be clear before installation, which may require snaking the drain line.

References/Additional Information

Falcon Waterfree Technologies, 10900 Wilshire Blvd., 15th Floor, Los Angeles, CA 90024. Web site: <http://www.waterlessurinals.com/>.

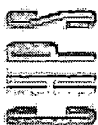

Waterless Co., 1223 Camino Del Mar, Del Mar, CA 92014. E-mail: klaus@waterless.com,
Web site: <http://www.waterless.com/>.

School districts using waterless urinals include:

San Dieguito Unified High School District, Encinitas, CA.

San Diego City Schools, San Diego, CA.

Carlsbad Unified School District, Carlsbad, CA.

Alameda Unified School District, Alameda, CA.

Related Volume III CHPS Criteria

Water Credit 2: Water Use Reduction.

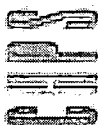

Guideline OS6: Relocatable Classrooms

Recommendation

Use high performance school concepts to increase the indoor environmental quality of school portables.

Description

Portables should contain appropriate building and indoor surface materials, as well as properly designed ventilation systems to minimize the presence of indoor pollutants. Commissioning and regular maintenance should be conducted to ensure the quality of the indoor environment.



This relocatable structure is a prototype designed by Southern California Edison and contains high performance features such as daylighting, high indoor air quality, significant energy savings, and resource efficient materials.

Photo courtesy of Southern California Edison.

Applicability

This guideline applies to all climate areas where relocatable or portable classrooms are used.

Applicable Spaces	Climates	When to Consider
Classrooms	South Coast	Programming
Library	North Coast	Schematic
Multi-Purpose / Cafeteria	Central Valley	Design Dev.
Gym	Mountains	Contract Docs.
Corridors	Desert	Construction
Administration		Commissioning
Toilets		Operation
Other		

Applicable Codes

The California Department of General Services (DGS) issues specifications on "Building, Classroom, Prefabricated, Relocatable General Requirements", which outlines the DGS requirements for the State Portable Classroom Program. The demand generated by the Class Size Reduction Program exhausted the available inventory of California lease program relocatable classrooms. Many school districts will instead obtain relocatable classrooms directly from manufacturers. Although all classroom units manufactured for California must conform to the Title 24 Building Standard Code, these standards are not specific for "portables." Hence these relocatable units may not adhere to the DGS specifications, and their design and quality can vary.

Integrated Design Implications

Portables are self-contained units. The choices of fenestration and HVAC will affect the indoor environment in the same way as permanent buildings.

Cost Effectiveness

Cost figures for high performance relocatable classrooms are still being collected based on prototypes developed by Southern California Edison and Pacific Gas and Electric.

Costs	L			
	M			
	H			
		L	M	H
		Benefits		

Benefits

High performance relocatable classrooms are treated as little buildings, and therefore have the same benefits of complete schools.

Design Tools

The design tools discussed in previous guidelines may be applied here as well.



Design Details

- When specifying a new relocatable classroom, ensure that the HVAC system can: (a) provide minimum outdoor air of 480 cfm; and (b) heat and cool this outdoor air at design outdoor temperatures for the specific geographic location where each classroom is installed. Some manufacturers of relocatable units do not include outdoor air intakes in their standard classroom models. It is important that an additional "outdoor air kit" be ordered for this purpose. Further, installation of an outdoor intake must be specified as part of the exhaust system. Lack of an exhaust in the HVAC system with an outdoor air intake will result in room pressurization, reduced outdoor air flow rates, and lower efficiency of removal of pollutants from the room.
- Outdoor air should be supplied continuously when a classroom is occupied. Demand-controlled HVAC package systems often used in relocatable classrooms typically operate only when the temperature of a space is different from the thermostat's set point. In order to provide a continuous outdoor air supply, it is important to ensure that the HVAC thermostats are set to the "on" or continuous mode when occupied.
- Avoid package wall-mounted HVAC systems because of their excessive noise. Split systems are recommended.
- Particle filters are needed for protection of HVAC components and reduction of airborne dust, pollens, and microorganism from recirculated and outdoor air streams. For relocatable classrooms, the DGS requires installation of a replaceable filter in the HVAC system. ASHRAE Standard 62-1989R requires filters with a minimum of 25% to 30% dust spot efficiency (ASHRAE Standard 52.1) or >60% efficiency (ASHRAE Standard 52.2 for 3 micron particles). Where system design can accommodate them, filters with >65% efficiency for 1 to 3 micron particles will improve indoor air quality with respect to particles.
- The DGS State Portable Classroom Program requires that units be carpeted except in certain areas, such as bathrooms. When carpets are specified, use products that have been certified under the Carpet and Rug Institute's Indoor Air Quality Labeling Program.
- Do not use carpet in entryways to classrooms with direct outdoor access. Otherwise, supply waterproof mats over carpeted entryways for drying of clothing and umbrellas.
- Site classroom away from locations where vehicles idle, water accumulates after rains, and electric/magnetic fields (EMF) are high.
- Ensure that at least one supply air outlet and return air inlet are located in each enclosed area.
- Locate building air intakes away from any exhaust outlets or other contaminant sources.
- Specify operable windows to provide user-controlled ventilation when needed.
- Check that special-use classrooms (e.g., for chemistry, biology, fine arts, etc.) have local exhaust ventilation (e.g., hoods or window fans).
- Locate HVAC and air handler units as far away as possible from teaching areas.
- Have insulation installed only on the outside surfaces (not inside) of air ducts.
- Ensure that HVAC ducts and plenums have easy access for inspection and cleaning.
- Specify that building materials used in construction are certified as "low-emitting" for volatile organic compounds (VOCs).

Operation and Maintenance Issues

- Provide training on operation and maintenance of new HVAC equipment to appropriate staff.
- Be certain that operation and maintenance documentation is kept readily accessible for staff servicing the system.
- Maintain documentation of completed tasks.
- Allocate sufficient staff time and funds for maintenance.



- Instruct teachers and staff on proper use and settings of thermostat and ventilation controls — provide each classroom with hardcopy (plastic-covered) instruction sheets

Establish a regular and timely plan for testing, inspecting, and performing specific maintenance tasks:

- Inspect roofs, ceilings, walls, floor, and carpeting for evidence of water leakage or infiltrations, and for mold and mildew growth or odor. Replace water damaged materials.
- Inspect air supply outlets and return air inlets, to ensure that they are open, operable and unobstructed.
- Check airflows rates at the outlets and inlets periodically.
- Inspect air plenums for mold growth, excess dirt, etc.
- Establish a periodic air filter replacement schedule.
- Clean condensate pans (monthly) and do not allow freestanding water to accumulate.
- When carpets are cleaned, ensure that they dry thoroughly as soon as possible after the process is complete.
- Provide for the proper storage of cleaning/janitorial supplies.
- Maintain documentation of completed tasks.

Commissioning

Prior to occupancy of any new relocatable units by staff or students, continuously operate HVAC systems at their maximum outdoor air intake rate for several days. Start the flush-out as soon as the HVAC system is operational, and continue after furniture installation. During this period, do not recirculate return air.

Do not "bake-out" the unit. "Baking-out" is defined as increasing temperatures up to 100°F in order to artificially age building materials. The effectiveness of this method has not been proven and may in fact damage parts of the HVAC system or building components.

Continue the flush-out ventilation during the first periods of use. Efforts to minimize student and staff exposure should continue in the weeks following construction. Emissions of VOCs are highest during this period. Flush-out periods of one to two weeks are recommended, although longer periods may be required. For the first weeks of occupant use, continue to operate HVAC systems at the maximum outdoor air setting. Finally, monitor occupants' comfort and follow-up complaints to identify problems early.

Establish an Integrated Pesticide Management plan. For a quick reference guide, see *Pest Control in the School Environment: Adopting Integrated Pest Management*, Report IPA 735-f-93-012.

References/Additional Information

Building Air Quality: A Guide for Building Owners and Facility Managers. Superintendent of Documents. Phone: (202) 512-2250.

IAQ Tools for Schools Action Kit. U.S. Environmental Protection Agency Indoor Air Quality Information Clearinghouse. Phone: (800) 438-4318.

Indoor Air Quality: A guide for Educators. California Department of Education, School Facilities Planning Division. Phone: (916) 322-2470.

Indoor Air Quality/School Facilities Documents. (A set of 15 documents, such as "Maintaining Acceptable IAQ During the Renovation of a School," "Maintenance of HVAC systems and IAQ in Schools"). Maryland State Department of Educations, Schools Facilities Branch. Phone: (410) 767-010.

Rethinking the Portable Classroom. A demonstration project of Southern California Edison, Design & Engineering Services.

Related Volume III CHPS Criteria

None.



COMMISSIONING AND MAINTENANCE

Introduction

Building owners spend more on complex building systems than ever before, yet many find they are not getting the performance they expect. A 1994 study of 60 commercial buildings found that more than half suffered from control problems. In addition, 40% had problems with HVAC equipment and one-third had sensors that were not operating properly.⁴⁴ An astonishing 15% of the buildings studied were actually missing specified equipment. And approximately one-quarter of them had energy management control systems, economizers, and/or variable speed drives that did not run properly. Problems also frequently occur on the envelope, structural, and electrical systems of many new buildings.

Schools are investments, and every new school is unique. In essence, each school design is a prototype expected to perform as if it were something that had been built before. Combining a new school design with modern technology, a tight construction schedule, and a fixed budget can lead to a building that does not perform as anticipated.

Building commissioning is one way to improve the outcome of a construction project. Neither the design team nor the district desires a poorly performing school. Unfortunately, school districts frequently are the ones left to deal with the resulting financial implications, including excessive repair and replacement costs, student absenteeism, indoor air quality problems, and construction team liability. Building commissioning can ensure that a new school begins its life cycle at optimal productivity, and improves the likelihood that it will maintain this level of performance.

Commissioning is a quality-assurance process that increases the likelihood that a newly constructed building will meet district expectations. Commissioning can optimize the energy-efficient design features and improve overall building performance. Districts can use this proven, systematic approach to reduce change orders and liability exposure, and to ensure that they receive buildings that function according to their original project requirements (design intent).

What Exactly Is Building Commissioning?

Commissioning is a systematic process of ensuring that all building systems perform interactively according to the contract documents, the design intent and the school's operational needs. This is achieved ideally by beginning in the pre-design phase with design intent development and documentation, and continuing through design, construction, and the warranty period with actual verification through review, testing, and documentation of performance. The commissioning process

⁴⁴ Piette, Mary Ann. Quantifying Energy Savings from Commissioning: Preliminary Results from the Northwest, in Proceedings of the National Conference on Building Commissioning, 1996.



integrates and enhances the traditionally separate functions of design peer review, equipment startup, control system calibration, testing, adjusting and balancing, equipment documentation, and facility staff training, as well as adds the activities of documented functional testing and verification.

Commissioning is occasionally confused with testing, adjusting, and balancing. Testing, adjusting, and balancing measures building air and water flows, but commissioning encompasses a much broader scope of work. Commissioning typically involves four distinct "phases" in which specific tasks are performed by the various team members throughout the construction process. The four phases are pre-design, design, construction, and warranty. As part of the construction phase, commissioning involves functional testing to determine how well mechanical and electrical systems meet the operational goals established during the design process. Although commissioning can begin during the construction phase, districts receive the most cost-effective benefits when the process begins during the pre-design phase at the time the project team is assembled.

A properly commissioned school can result in fewer change orders during the construction process, fewer callbacks, long-term occupant satisfaction, lower energy bills, and avoided equipment replacement costs. Commissioning also assures that the building's operational staff is properly trained, with correctly compiled operation and maintenance manuals delivered at project turn-over.

Commissioning Approaches

In recent California focus group studies, building owners and their representatives repeatedly stressed lack of communication between the design team and construction team as a major problem. This lack of communication means that the original design intent of a project is unlikely to be carried through to project completion. (Documenting design intent — the expectations for building performance — is a critical component of commissioning and is discussed in more detail later.) Commissioning provides a means of linking the traditionally fragmented phases of the design and construction process, because it encourages the project team to view the process holistically. The commissioning process encourages parties to communicate and solve problems earlier in the construction process. Beginning proper commissioning during the design phase can help identify and solve problems that later may turn into performance problems, occupant comfort complaints, indoor air quality issues, and decreased equipment life.

Although commissioning works best when it begins during design, projects already under construction can still benefit from commissioning. Bringing a commissioning provider into a project during the construction phase can be invaluable in helping solve start-up problems that have stumped both designers and contractors. The commissioning provider can also document the start-up and functional testing results, thereby reducing future liability exposure for the designers and district. The provider also oversees operation/maintenance staff members training, thus improving the operating procedures of the facility.



Benefits of Commissioning

Until recently, the most frequently mentioned benefit of commissioning was its energy-related value: building commissioning ensures that the energy savings expected from the design intent are implemented correctly. While these benefits are significant, the non-energy related benefits of commissioning far outweigh them. Examples include:

- Proper and efficient equipment operation.
- Improved coordination between design, construction, and occupancy.
- Improved indoor air quality, occupant comfort, and productivity.
- Decreased potential for liability related to indoor air quality, or other HVAC problems.
- Reduced operation and maintenance costs.

Proper and Efficient Equipment Operation

Commissioning verifies that equipment is installed and operating properly. Equipment that operates as intended lasts longer, works more reliably, and needs fewer repairs during its lifetime. By promoting equipment reliability, commissioning can reduce service, energy, and maintenance costs. Equipment that operates properly tends to use less energy, require fewer service calls and replacement parts, and demands less "crisis maintenance" from onsite staff (or expensive outside contractors), allowing them to concentrate on their normal duties.

Improved Coordination Between Design, Construction, and Occupancy

Commissioning can result in greater cooperation among the professionals involved in the project and provides a platform for cross-checking the performance of a building's equipment and combined systems, which ultimately leads to fewer callbacks and litigation problems.

A good design includes systems that are sized correctly, rather than the oversized mechanical systems found in many commercial buildings.⁴⁵ On many projects, a lack of understanding and coordination between the design, installation, and/or operational team members can lead to systems that function inefficiently. Commissioning allows for a broad perspective and consistent focus throughout the design and construction process on whether the building will function as intended and identifies the best long-term solutions for problems that arise during the project. Commissioning can facilitate improved integration and communication among team members throughout these phases and can also ensure that correctly sized systems function as intended and specified.

Many districts mistakenly believe that adding commissioning quality assurance procedures to their design process will lead to delays of their project's schedule and increase costs. Many who have incorporated commissioning into the design phase of their projects have discovered that commissioning can significantly reduce change orders,⁴⁶ which in turn reduces the requests for project delays and decreases the use of contingency funds for change orders. Thus, beginning commissioning

⁴⁵ York, Dan. "Commissioning Green Buildings" in Proceedings of the National Conference on Building Commissioning, 1998.

⁴⁶ Savage, Jerry. Commissioning a Materials Research Laboratory, in the Proceedings of the National Conference on Building Commissioning, 2000.



during design can actually contribute to the on-time and on-budget completion of projects. It should be noted that these benefits will not be realized if the commissioning process begins during the equipment start-up phase of a project.

Improved Indoor Air Quality, Comfort, and Productivity

The benefits of high performance schools are all dependent on how well the building performs.

Surveys indicate that comfort problems are common in many U.S. buildings. A recent Occupational Safety and Health Administration (OSHA) report noted that 20% to 30% of commercial buildings suffer from indoor air quality problems. Building occupants complain of symptoms ranging from headaches and fatigue to severe allergic reactions. In the most severe cases, occupants have developed Legionnaire's disease, a potentially fatal bacterial illness. The National Institute of Occupational Safety and Health surveyed 350 buildings with deficient indoor air quality and found that more than half of the complaints stemmed from HVAC systems that were not operating properly.

Building commissioning is a tool districts can use to avoid the expenses and productivity losses associated with poor indoor air quality and student/teacher discomfort. Because commissioning assures that HVAC and other building systems are installed and operating properly, commissioned buildings tend to have fewer comfort-related problems.

Liability Related to Indoor Air Quality

Building commissioning protects schools in more than one way. First, it provides documented verification of a building's performance and operation. Ventilation rates are a good example of a primary factor that affects indoor air quality. HVAC commissioning typically includes testing these flow rates under varying load conditions to assure that the ventilation systems are operating properly. If a school has deficiencies, the commissioning provider documents the original condition and records the repairs made. Commissioning should be repeated throughout the life of the school, and performance documentation should be updated regularly. This documentation provides districts with a record of building performance that can be used as evidence in the event of a lawsuit.

Commissioning also helps prevent many indoor air quality problems through its focus on training the teachers and staff in the proper maintenance of building systems. Properly run and maintained HVAC systems, with clean coils and air intakes as well as regularly changed filters, are less likely to contribute to indoor air quality problems. In addition, trained school staff can spot potential air quality and ventilation problems before they develop.

Both local and state government agencies in California have begun using commissioning as a tool to ensure that indoor air quality standards are being met when a building is constructed.



Reduced Operation, Maintenance, and Equipment Replacement Costs

Operation, maintenance, and equipment replacement costs will always consume a portion of building budgets. However, more operation and maintenance departments are realizing they minimize life-cycle costs by changing their practices. That is, proper operation and maintenance can actually save money compared to poor practices, and many businesses are reinvesting their operation and maintenance savings in more efficient building systems. The commissioning process establishes sound building operation and maintenance practices, and trains operators in carrying out these practices. (Some of these practices are discussed in more detail in the Operation and Maintenance for Persistence section of this chapter.)

The Bottom Line

Commissioning improves a building's value. Properly functioning buildings with reliable equipment kept in good condition are worth more than their non-commissioned counterparts. Commissioned systems and equipment retain their value longer. Additionally, an ongoing demand exists for comfortable, healthy working space. Finally, systems that function properly use less energy, experience less down time, and require less maintenance, thereby saving money for districts.

Kern High School District - Liberty High School Commissioning

The Kern High School District, like many other districts in California, has been constructing new schools to satisfy its increasing student population. On many of its new construction projects, equipment did not function properly at turnover, resulting in numerous contractor callbacks. Projects with 100 or more callbacks were the rule, rather than the exception. In 1994, as it began the planning for the construction of the new 200,00-ft² Liberty High School campus, the school district decided to incorporate commissioning as a quality assurance process. The commissioning goal was to improve the outcome of this project, and to reduce or eliminate this callback problem. The commissioning budget was set at \$40,000 of the total construction budget of \$28 Million. The district wrote their own request for proposal for commissioning services and hired a commissioning provider to conduct construction phase commissioning on the mechanical systems and verify proper electrical phasing. After the provider was selected and hired, he began development of the commissioning plan. As construction commenced, regular meetings were held between the commissioning provider and the construction team. When construction was completed, the district maintenance staff worked with the commissioning provider and contractors to functionally test each system and verify proper operation. Although no "major" deficiencies were found, numerous minor adjustments and system integration issues were identified and rectified as part of this commissioning process. The net result was a 75% reduction in contractor callbacks after the turnover of the new facility. This reduction also resulted in significant labor and maintenance budget savings for the district. Resources normally used to address these turnover problems were now being redirected elsewhere.

The district learned many lessons on its first commissioning project. They now recognize that if budget will allow for it on their next commissioning project, they would like to include analysis of the systems, specification review, and possibly design review, as part of the commissioning provider's scope of work.

Costs of Building Commissioning

Currently, no standard method of reporting the costs and savings associated with commissioning exists. For many projects, commissioning costs are not separated from other project costs. For projects where these costs have been tracked separately, various methods have been used to report both the costs and associated benefits. The table below lists some of the most common cost estimation methods. No matter which estimation method is used, however, commissioning accounts for only a very small portion of overall construction and retrofit budgets.

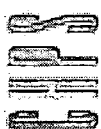

Table 39 – Estimated Commissioning Costs for New Equipment⁴⁷

Commissioning Scope	Estimated Cost Range
Whole building (controls; electrical; mechanical) Commissioning from design through warranty.	0.5% to 3% of total construction cost.
HVAC and automated controls system, only.	1.5% to 2.5% of mechanical contract.
Electrical system, only.	1% to 1.5% of electrical contract.

Savings from Building Commissioning

Districts and their servicing utilities are interested in the energy (kWh) savings achieved from commissioning energy systems and equipment. Additionally, they are also interested in how much the commissioning will save them in operation and maintenance costs. Just as commissioning costs can vary from project to project, so do commissioning savings. Savings will depend on the scope of the commissioning. Table 40 shows the reported savings for three different types of commercial buildings commissioned during the past few years. When commissioning is done properly, the savings can be quite substantial for schools as well.

Table 40 – The Savings from Commissioning New Equipment (Mechanical Systems)⁴⁸

Building Type	Annual \$ Savings	Annual Energy Savings
110,000-ft ² Office	\$22,320	279,000 kWh
22,000-ft ² Office	\$13,080	130,800 kWh
60,000-ft ² High Tech Manufacturer	\$26,880	336,000 kWh

Many districts question how they can pay for commissioning with a limited design and construction budget. Because commissioning can identify potential problems earlier in the design or construction process, the result is a lower overall construction budget, fewer contractor callbacks, and lower operating costs during the first year of operation. By transferring those potential savings to the design and commissioning team budgets, the total project costs can be equivalent to a project that is not commissioned, as illustrated in Figure 45 below.

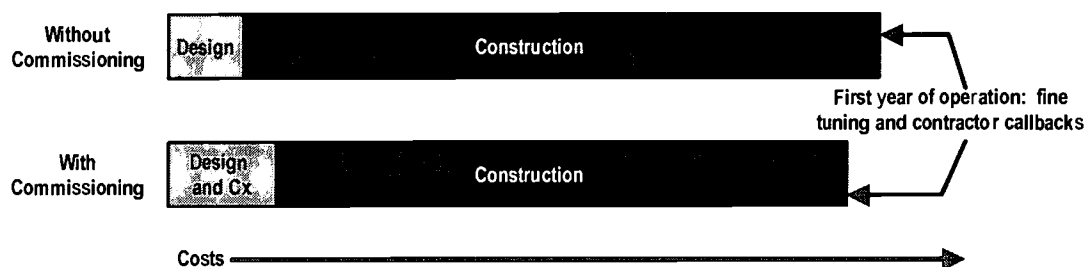

Figure 45 – How to Pay for Commissioning-One Option.

Shift 2% of total project costs to the commissioning provider and 3% to the design team⁴⁹

⁴⁷ Estimated costs adopted from PEI Data and Ron Wilkinson's article Establishing Commissioning Fees, ASHRAE Journal-February, 2000.

⁴⁸ Annual energy savings calculated from three Northwestern United States commissioning projects. Cost savings estimates based on a blended 2000 California kWh rate of \$0.10 for smaller office buildings and \$0.08 for larger offices and industrial facilities.



Selecting a Commissioning Provider

One of the most important commissioning decisions is selecting the commissioning provider and determining who will hold the commissioning provider's contract. Two primary methods exist for selecting a commissioning provider: competitive bid and selection by qualification. The Building Commissioning Association (BCA) can provide a list of commissioning providers. Contact information for the BCA can be found in the resources section at the end of this chapter. In the Request for Qualifications, be sure to ask for details on previous, relevant commissioning experience, including the depth of commissioning experience (what some call commissioning is no more than traditional equipment startup⁵⁰). Make sure that the provider's definition of commissioning corresponds to the one at the beginning of this chapter. Recommended commissioning provider qualifications are discussed in more detail in the following pages. Based on the responses, develop a list of firms to receive a Request for Proposal that details exactly what services the construction project will need to be properly commissioned. A sample RFP/RFQ is included in the appendix of the CHPS manual. Districts can also select a commissioning provider based on qualifications and rate schedules, rather than by competitive bid. This process warrants careful interviewing and contact with the providers' current or past clients.

Any of the following parties can be selected to manage the commissioning provider's contract:

- Project Manager.
- Architect/Design Engineer.
- Contractor.

Each option has its advantages and disadvantages. The final choice will depend on the complexity and the specific needs of the particular project. As building commissioning has evolved and more practitioners with different ideas have entered the field, a group of interested parties worked to form the BCA in 1998. According to the BCA website (<http://www.bcxa.org/>), "The BCA's goal is to achieve high professional standards, while allowing for diverse and creative approaches to building commissioning that benefit our profession and its clients. For this reason, their focus is on identifying critical commissioning attributes and elements, rather than attempting to dictate a rigid commissioning process". The association believes that "the basic purpose of building commissioning is to provide documented confirmation that building systems function in compliance with criteria set forth in the project documents to satisfy the owner's operational needs." Paramount to this is the understanding that if the commissioning provider is not an independent party under contract directly with the district/owner then he or she must develop a formal plan for managing the potential conflict of interest. One method that has been used successfully to manage, but not eliminate these potential conflicts of interest, is parallel and simultaneous reporting of all findings to the district's representative and contract manager for the commissioning services.

⁴⁹ The Farnsworth Group, as presented in *How to Achieve Top Performance in Your Building: Commissioning Benefits, Process and Performance*, a workshop series by the Association of State Energy Research and Technical Transfer Institutes, 1998.

⁵⁰ "Start up" refers to the process of starting up equipment to determine whether it operates. Commissioning goes beyond start up to ensure that new equipment performs in conformance with design expectations in all modes and conditions of operation.



Independent Third Party Under Contract to the District/Owner

Many districts/owners who have commissioned their buildings recommend using an independent third party as the commissioning provider. An independent commissioning provider can play an objective role and ensure that the district will truly get the building performance expected. For large and/or complex projects, especially in buildings with highly integrated, sophisticated systems, future savings from commissioning outweigh the slightly higher costs with an additional contract. Independent third party commissioning providers bring a fresh perspective to the project as they collaborate with the design team. By joining the project team during the design, the commissioning provider can identify more opportunities for improvements and savings early on when changes can be made on paper. This approach is preferable to waiting to fix the problems through the change order process as the building is being constructed.

Independent commissioning providers, who are often trained as design engineers, should have the qualifications listed under "Commissioning Provider Qualifications," plus they should be able to write commissioning specifications for bid documents. Hands-on experience with building systems is especially critical. It is important to involve the independent authority as early in the project as possible. This allows the authority the opportunity to review the design intent for the project, begin scheduling commissioning activities, and begin writing commissioning specifications into bid documents for other contractors.

Architect or Engineer Overseeing the Commissioning Process

If commissioning requirements in the project specifications are rigorous and detailed, districts may consider having the architect manage the contract of a commissioning provider. When the architect or the mechanical designer has qualified field engineers on staff and those engineers do not have responsibility for the design of the project, the architect or engineer may be considered for directly overseeing the commissioning process. One advantage of using the architect or mechanical designer is that he or she is already familiar with the design intent of the project. Districts considering this option should bear in mind that commissioning is not included in a design professionals basic fees. Districts should require that all findings of the commissioning process be directly reported to both the designer and to the district as they occur to manage the potential conflict of interest created by having the commissioning services under the designer. Districts must also recognize that even if this option is not chosen and an independent third party is used, designers might increase their fees slightly to offset the additional time requirements to coordinate their work with the commissioning provider.

Contractor

It used to be standard practice for many contracting firms to conduct performance tests and systematic checkout procedures for equipment they installed. As construction budgets became tighter, this service was dropped from most projects. Although contractors may have the knowledge and capability to test the equipment they install, they may not be skilled at testing or diagnosing system integration problems. In addition, some contend that it is difficult for contractors to objectively test and assess their own work, especially since repairing deficiencies found through commissioning may increase their costs. For districts that only wish to have the commissioning process begin during the construction



phase, it may be appropriate to use the installing contractor as the commissioning provider in cases where:

- The building size is less than 20,000 ft².
- The project specifications clearly detail the commissioning requirements.
- The district has skilled staff that can review the contractor's commissioning work.

Another option for districts that have a good relationship with the general contractor is to require that the general contractor hire a test engineer to commission the equipment. This scenario can work well when specifications and contract documents clearly detail the commissioning requirements and when the district has technical staff that is qualified to oversee the test engineer. Still, many general contractors welcome the opportunity to work with an independent commissioning provider, because of the objectivity they bring and because they assist in ensuring that the subcontractors perform their work properly, improving client satisfaction and ultimately reducing callbacks.

Commissioning Provider Qualifications

Currently there is no broadly recognized and approved certification or licensing process for commissioning providers. It is therefore up to each district to determine the commissioning provider's qualifications appropriate for a given project. See the sidebar for guidelines on selecting a qualified commissioning provider.

Regardless who is chosen to act as the commissioning provider, there are certain minimum qualifications any commissioning provider ought to have, and the following list is by no means all-inclusive. Certain projects may require more or less experience, depending on size, complexity, and specific building characteristics. Direct the commissioning provider to subcontract work in which he or she lacks sufficient experience.

Commissioning Provider Qualifications Checklist

In general, for complex projects, a commissioning provider who will personally develop the commissioning test plans and directly supervise the commissioning work should meet these qualifications. These qualifications are focused on HVAC and control systems. Where electrical and other systems will be commissioned, the firm's experience in these areas should also be considered. However, often the prime commissioning provider will team with other subconsultants to provide a team that can expertly address all the systems being commissioned. In such cases, the management skill of the prime commissioning provider is also important.

Recommended Minimum Qualifications

Experience in design, specification, or installation of commercial building mechanical and control systems, as well as other systems being commissioned.

Experience commissioning projects within the last three years with similar size building systems.

History of responsiveness and proper references.

Meet district's liability requirements.

Experience working with project teams, project management, conducting scoping meetings, and good communication skills.

At least two projects involving commissioning of buildings of similar size and of similar equipment to the current project. This experience includes the writing of functional performance test plans.

Optional Qualifications

Direct responsibility for project management of at least two commercial construction or installation projects with mechanical costs greater than or equal to current project costs.

Experience in design installation and/or troubleshooting of direct digital controls and energy management systems, if applicable.

Demonstrated familiarity with metering and monitoring procedures.

Knowledge and familiarity with air/water testing and balancing.

Experience in planning and delivering operation and maintenance training.

Building contracting background.

Overall understanding by the commissioning team of all building systems including building envelope, structural, and fire/life safety components.



The Commissioning Team

Members of a design-construction project team, like components of integrated building systems, need to interact in order to perform their tasks successfully. Commissioning actually facilitates this interaction, because it sets clear performance expectations and requires communication among all team members.

Any project involving commissioning should begin with a commissioning scoping meeting, which all team members are required to attend. At this meeting, the roles of each team member are outlined, and the commissioning process and schedule are described.

Commissioning team members most often include the district representative or project manager, commissioning provider, design professionals, installing contractors, and manufacturer's representatives. The team may also include facility staff and possibly testing or diagnostic specialists and utility representatives. The commissioning team does not manage the design and construction of the project. Its purpose is to promote communication among team members and to identify and resolve problems early in the process. To that end, the design professional and district representative are key members of the commissioning team.

Of course, few situations are ideal. Budget considerations and special project characteristics may expand or minimize the commissioning roles and responsibilities described below. Districts should consult with their commissioning providers about potentially combining some of the following roles. The commissioning provider can review the scope of commissioning and advise the district on how to consolidate roles and tasks to best fit the size and complexity of the project.

District Representative

The district's most significant responsibility is to clearly communicate expectations about the project outcome. The district's expectations are used by the designer to establish the design intent of the project and by the commissioning provider to evaluate whether this intent is met. Other responsibilities of the district representative include:

- Determining the objectives and focus of the project.
- Hiring the commissioning provider (if using an independent third party) and other members of the project team.
- Determining the project's budget, schedule, and operating requirements.
- Working with the commissioning provider to determine commissioning goals.
- Facilitating communication between the commissioning provider and other project team members.
- Approving start-up and functional test completion (or delegating this task to a construction or project manager).
- Attending building training sessions when appropriate.

Commissioning Provider

The commissioning provider's primary tasks include:

- Ensuring the completion of adequate design intent documentation.



- Providing input on design features that facilitate commissioning and future operation and maintenance.
- Assisting in developing commissioning specifications for the bid documents.
- Developing a commissioning plan that includes equipment and systems to be commissioned.
- Ensuring that team members understand their specified commissioning responsibilities; work to promote a positive, solutions-based team approach; and facilitate bringing a quality project to completion.
- Developing diagnostic and/or test plans for systems to be commissioned.
- Writing construction, functional, and performance tests.
- Submitting regular reports to the district representative.
- Witnessing selected contractor start-up tests, air and water testing and balancing, and duct pressure testing.
- Overseeing all functional and performance testing of systems.
- Reviewing and commenting on technical considerations from design through installation, in order to facilitate sound operation and maintenance of the building.
- Reviewing contractor and manufacturer training plans prior to delivery to facility staff.
- Reviewing operation and maintenance manuals documentation for completeness.
- Writing a final commissioning report documenting the final evaluation of the systems' capabilities to meet design intent and district needs.
- Developing a systems concepts and operations manual that details the most important operation parameters and equipment instructions.

Design Professionals

The responsibilities of the design professionals will vary with the interests of the designers and the needs of the project. The primary commissioning-related responsibilities of design professionals are to document the design intent for all systems, if this was not completed in pre-design, to write system descriptions and record design basis information, answer questions and issues brought up by the commissioning provider during design, and to make sure that commissioning is included in the bid specifications. If the design professional is hiring the commissioning provider, he or she should do so as early in the design process as possible. During construction, the designers are tasked with clarifying design issues related to system operation and design intent and to assist in resolving construction and operational deficiencies illuminated by the commissioning process. For complex projects, the designer may review commissioning plans, functional performance test plans, and may witness select functional testing. If this is the case, the design professional's proposal should include funds to cover these activities. As mentioned before, the design firm may be responsible for hiring and overseeing the commissioning provider.

Installing Contractors and Manufacturer Representatives

Contractors and manufacturer representatives are responsible for performing commissioning functions described in the specifications. These may include assisting with developing the commissioning schedule, conducting performance tests (under the supervision of the commissioning provider or facilities staff) of the systems they install, adjusting systems when commissioning indicates this is



needed, and documenting system startup. Contractors and manufacturer representatives are also responsible for training building staff in the proper operation and maintenance of systems, and providing operation and maintenance manuals on the equipment they install.

Facility Manager/Building Operator

The building operator should assist with (or at least observe) as much of the functional testing as possible. To achieve even greater impact on the commissioning process as early as possible, the district should try to hire its new operator or assign an existing operator who will be responsible for this building to become closely involved with the construction commissioning team. The insights of an operator in the final phases of design can be quite beneficial. Often times there are details of the design that can be adjusted and modified at no cost yet will provide significant benefits to the ongoing operation of the building. Specific examples might include point naming conventions, alarm messages, and graphic layouts of the energy management system. The operator can also help in interfacing any existing facilities management software, district standards, and equipment preferences into the project. As this employee observes the commissioning tests, the operator's understanding of the equipment and control strategies will improve. It also trains the employee to be able to retest systems periodically as part of their ongoing operation and maintenance. The operator should also attend training sessions provided by manufacturer's representatives and or contractors.

Testing Specialists

If the complexity of the project requires special testing, the specialists performing these tests should also be involved in commissioning. Test results and recommendations from these specialists should be submitted to the commissioning provider for review. They may also be required to review documentation relating to the systems they test and to train operators on the proper use of this equipment.⁵¹

Commissioning Phases

The commissioning process helps facilitate and connect each step of the construction process. Commissioning enhances communication among project team members and ensures that they all understand the project goals. This allows the project team to identify problems early, before they can affect later phases of the project and cause delays.

Predesign Phase

The predesign phase is the ideal time for the district to select a commissioning provider. Early selection allows the commissioning provider to play an advisory role during the conceptual process, suggesting ways to make the overall building more energy efficient and identify key design strategies that can facilitate operation and maintenance. Involving the provider early can also increase buy-in for commissioning from other team members because the provider is involved from the beginning. Otherwise, the team may view the commissioning provider as an outsider who does not really

⁵¹ Dunn, Wayne. Roles and Responsibilities, in Proceedings of the National Conference on Building Commissioning, 1995.



understand the project. During this phase, the commissioning provider may assist in developing the district's goals, or at minimum, ensuring that these goals are clearly documented and distilled into a design intent narrative.

The design intent narrative, typically developed by the district, is an explanation of the ideas, concepts, and criteria that are important. It should generally describe the project both physically and functionally, and it should set the performance requirements for the design, construction, and operation. The level of detail will vary with the size and complexity of the project, the district demands, and the experience of the design team. The design intent should describe how the project will be used and operated, and should present known goals and objectives as measurable metrics when possible. It may also state specific contractual performance requirements or energy consumption targets, if the district establishes them. The design intent sets the criteria for all subsequent design decisions.

Expected Deliverables

Districts who decide to commission their buildings should expect to receive the following written deliverables:

Commissioning plan and schedule detailing each step of the commissioning process and each team member's role and responsibilities.

A diagnostic and functional test plan detailing the objective of each test, how each test will be accomplished, and noting expected performance parameters.

A list of findings and potential improvements identified by the commissioning provider for design phase and construction phase activities.

A training plan recommending specific topics and training schedules.

At the completion of the project, a final commissioning report detailing all of the commissioning provider's findings and recommendations including copies of all functional performance testing data.

A systems concepts and operations manual which gives a description of each system with specific information about how to optimally operate and control the system during all modes of operation such as during fire, power outage, shutdown; etc., including special instructions for energy efficient operation and recommissioning.

Energy savings and implementation cost estimates for recommendations developed in the process are also deliverables in retrocommissioning projects.

Design Phase

The goal of commissioning during the design phase is to ensure that the efficiency and operational concepts for building systems that were developed during programming are included in the final design. The main commissioning tasks during this phase are compiling and reviewing design intent documents if not already developed, incorporating commissioning into bid specifications, and reviewing bid documents. During the beginning of design, the designer develops their design concepts that he or she proposes to use to meet the district's program and intent. They also document the assumptions (design basis) used in their design for sizing and selection of systems, i.e., codes followed, temperature parameters, occupancy loads, etc. The design concepts and design basis are compiled into a design narrative document that the commissioning provider reviews for clarity, completeness, and compliance with the design intent. As the design progresses, the design narrative is updated and compared against the design intent.

The bid specifications developed during the design phase include commissioning requirements for the contractors. Specifications should include any special equipment or instrumentation that must be installed for obtaining measurements during performance testing. They should also describe the responsibility that contractors will have for preparing operation and maintenance manuals and for



training facility staff. The commissioning provider reviews these bid documents, updated design narratives, and all other design intent and contract documents.

The optimum time to hold the commissioning scoping meeting is during the design phase. At this meeting, the commissioning provider outlines the roles and responsibilities of the project team members with respect to commissioning and reviews the commissioning plan outline and schedule. Team members provide comment on the plan and schedule, and the commissioning provider uses these suggestions to complete the final commissioning plan. The final plan will include:

- The scope or level of commissioning.
- Commissioning schedule.
- Team member responsibilities.
- Communication, reporting, and management protocols.
- Documentation requirements of each team member.
- Detailed scope of testing.
- Detailed scope of monitoring.
- Recommended training format.

The commissioning provider attends selected design team meetings and formally reviews and comments on the design at various stages of development. They note potential system performance problems, and may provide input on energy efficiency, indoor environmental quality, maintainability, commissionability, sustainability, life cycle cost, etc., depending on the skills of the commissioning provider and design team and interests of the district. Making these changes during the design phase, rather than after construction begins, reduces costly change orders, which saves money in the long run. It is important for the district to understand that the commissioning provider does not approve the design. He or she makes recommendations to facilitate commissioning and improve building performance in a collegial manner in concert with the designated design team.

During this phase, the commissioning provider can also play a significant role in developing a building's operation and maintenance program or suggesting improvements for a program already in place. The provider interviews the facility manager to determine operating staff ability and availability to operate and maintain building equipment and systems. Careful consideration is given to whether the proper level of staffing resources is available to fully implement a successful long-term operation and maintenance system to ensure continued building performance. The commissioning provider also reviews the design documents and drawings to ensure that equipment is accessible for maintenance.

Construction Phase

During this phase, the commissioning provider reviews contractor submittals of commissioned equipment and the operation and maintenance manuals and may write test plans for each system and piece of equipment to be commissioned. The provider also visits the construction site periodically and notes any conditions that might affect system performance or operation.

During the construction phase, construction checklists — sometimes referred to as “pre-functional tests” and usually completed by the contractors — are used to ensure that equipment is properly

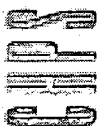

installed and ready for functional testing. The commissioning provider approves and may oversee start-up and the use of construction checklists, as well as making sure that any deficiencies are remedied before functional testing begins.

The commissioning provider should involve the building operation staff in the construction checklist procedures and functional testing as much as possible. Doing so improves staff understanding of the proper operation of equipment and systems. It also provides operators with valuable hands-on training in running and troubleshooting the equipment they will manage.

The commissioning provider may write various progress reports during construction that document testing progress as well as deficiencies that may affect future building performance. These reports may be submitted to the district, design engineer, project manager or contractors, depending on the contract arrangements for the project. (Establishing a clear process prior to the construction phase for delivering correction orders to the responsible contractors and tracking their responses is critical to the success of commissioning.)

The commissioning provider uses the functional tests to document and verify the proper operation of equipment and systems according to the building specification plans and change orders, as well as the architect's instructions. Most often, the commissioning provider directs the tests, but the subcontractors, particularly the controls contractor, perform the actual equipment operation during the tests. If corrective measures are required, the commissioning provider ensures they meet the district's criteria and the design intent, involving the owner and architect for resolution of responsibility or strategy when necessary. Acceptable performance is reached when equipment or systems meet specified design parameters under full-load and part-load conditions during all modes of operation, as outlined in the commissioning test plan.

After completing functional testing, the provider writes a final commissioning report and submits it to the district for review. In addition to the final report, some commissioning projects include a more comprehensive documentation package to assist the district in understanding, operating and maintaining their systems. The American Society of Heating, Refrigerating, and Air Conditioning Engineers (ASHRAE) calls this package a systems manual and recommends that it include:⁵²

- Index of all commissioning documents with notations as to their storage locations.
- Commissioning report.
- Initial and final design intent documents.
- As-built documents.
- Description of systems, including capabilities and limitations.
- Operating procedures for all normal, abnormal, and emergency modes of operation.
- Sequence of operation as actually implemented, with control systems data including all set points, calibration data, etc.
- Location of all control sensors and test ports.
- Seasonal start-up and shutdown procedures.

⁵² ASHRAE Guideline 1-1996-*American Society of Heating Refrigerating and Air-Conditioning Engineers*, Atlanta Georgia, 1996.



- Control schematics and computer graphics.
- Complete terminal interface procedures and capabilities of the Direct Digital Control (DDC) system.
- A list of recommended operation record keeping procedures, including sample forms, trend logs, etc.
- Maintenance procedures.

The construction phase is complete when the facility has moved from the static construction state to the dynamic operating state essentially free of deficiencies. Control of the building may have been transferred from the design/construction team to the district and building operators prior to the completion of this phase. Part of this transfer involves training building operators in the operation and maintenance of equipment and systems. Preferably this training begins during the construction/installation phase, as discussed above.

The commissioning provider is responsible for interviewing the project manager and operation and maintenance staff to determine their training needs. With the district representative, the provider then selects the appropriate topics, level of detail, sequence of training, and training methods. Training may include both classroom sessions and hands-on site demonstrations of proper equipment operation and maintenance.

In addition, the commissioning provider oversees training sessions as specified in the bid documents that installing contractors, designers and manufacturers representatives will conduct. The provider also verifies that operation and maintenance manuals are complete and available for use during the training sessions. The commissioning provider may arrange for videotaping of the training and coordinate this videotaping with vendors. Videotaping training sessions often provides an extra incentive for vendors to ensure the quality of the sessions.

Warranty Phase

Upon turnover the building is in the hands of the owner and operators. Even though the project is considered complete, some commissioning tasks from the initial commissioning contract continue throughout the typical one-year warranty period to ensure that full operation of building systems is achieved.

Any testing that was delayed because of site or equipment conditions or inclement weather, will be completed during warranty. Although some testing of heating and cooling systems can be performed under simulated conditions during the off-season, natural conditions usually provide more reliable results. Seasonal testing is conducted to verify proper operation during, at minimum, both winter and summer.

When performing testing during post-occupancy, the commissioning provider or test engineer must be careful not to void any equipment warranties. The district should require that contractors provide the commissioning provider with a full set of warranty conditions for each piece of equipment to be commissioned. Some warranty provisions may require that the installing contractor actually perform the testing, under the supervision of the commissioning provider.



The commissioning provider may also be tasked with returning a few months prior to the expiration of the contractor's one-year warranty to review system operation and interview facility staff. Acting as the district's technical resource, he or she assists the facility staff in addressing any performance problems or warranty issues.

It is a good idea for districts to consider recommissioning their facilities periodically to ensure that equipment performance levels continue to meet design intent. If school staff has been involved in the original commissioning effort, and if they received training that included the components listed in the Suggested Training Topics sidebar, they may be able to conduct the recommissioning process themselves.

When Does Commissioning End?

Commissioning ensures that a building is performing as intended at the time that commissioning occurs. This means that to maintain this level of performance, commissioning, in a sense, never ends. Certainly no one could reasonably expect building operation staff to perform functional tests on equipment and systems daily. However, operation and management staff should be encouraged to recommission selected building systems on a regular basis, perhaps every two to three years depending on building usage, equipment complexity, and operating experience. The commissioning provider can recommend an appropriate interval for the building and systems. In the meantime, implementing regular, sound operation and maintenance practices ensures that the savings from commissioning last.

Operation and Maintenance for Persistence

Sound operation and maintenance practices can help keep the school operating at commissioning levels. Some of these practices include:

- Establishing and implementing a preventive maintenance program for all building equipment and systems.
- Using commissioning documentation such as commissioning checklists and functional tests as a basis for periodic testing of equipment.
- Reviewing monthly utility bills for unexpected changes in building energy use.
- Using energy accounting software to track building energy use.
- Tracking all maintenance, scheduled or unscheduled, for each piece of equipment. Periodic reviews of these documents will often indicate whether certain pieces of equipment require tuning up.
- Updating building documentation to reflect current building usage and any equipment change-outs.
- Establishing an indoor air quality program for the building.
- Assessing operator training needs annually.

Good Operation and Maintenance Begins During Design

Like commissioning, successful operation and maintenance begins in the design phase of a project. Soliciting input from operation and maintenance staff during the early stages of building design can



facilitate good operation and maintenance practices. The more convenient it is for staff to perform regular checks and maintenance on building systems, the better building performance needs can be met and costly maintenance can be avoided. In addition, the installing contractor's responsibilities concerning operation and maintenance should be clearly detailed in the project contract specifications during the design stage, so that the contractor can adjust the bid price accordingly. For instance, specifications should explicitly state that contractors will be required to provide information needed to facilitate the commissioning process and to coordinate activities with the commissioning provider as needed. The specifications should also require the contractor to provide comprehensive operation and maintenance manuals for equipment and provide training for staff.

Operation and Maintenance Manuals

The contractor prepares operation and maintenance manuals for each piece of equipment. The commissioning provider reviews each manual for compliance with the specifications as part of the commissioning process. Operation and maintenance manuals should contain:

- Name, address, and telephone number of installing contractor.
- Product data.
- Test data.
- Performance curves (for pumps, fans, chillers, etc.).
- Installation instructions.
- Operation requirements.
- Preventive maintenance requirements.
- Parts lists.
- Troubleshooting procedures specific to the equipment design and application.

If the provider believes it would be beneficial, additional information, already gathered during the commissioning process, can also be included in the operation and maintenance manuals. This information may include equipment submittals, design intent documents including control strategies and sequence of operations (normal and emergency), and copies of the commissioning tests (pre-functional checklists and functional performance test forms).

Operation and maintenance manuals are useful reference tools for current facilities staff and can also be used as a training resource for new staff members. The operation and maintenance manuals should be placed in three-ring binders. Contractors should be required to provide at least three copies of each manual to the district. Typically, one copy becomes the master copy, and remains in the facility manager's office. "Hard binding" the master copy, so that pages cannot be removed and misplaced, is recommended. The second copy functions as a field copy, and selected pages from it may be removed for use during site work. The third copy resides at district offices. If building equipment will be maintained and operated by an outside firm, a fourth copy should be requested and provided to them as a reference. Because manuals lose their usefulness if they are not kept up to date, any pages added to them, such as checklists or preventive maintenance work orders, must be included in each copy.



Training

Perhaps the most essential component of operation and maintenance is training. Unless building operators and managers are given the skills to perform quality operation and maintenance practices, there is no hope that a building will continue to perform optimally.

As with all training, instruction should be structured to meet the needs of building operator staff. Training session topics should ideally be specified in the bid documents.

By videotaping each training session, including the hands-on start-up and shutdown procedures for equipment, building operation staff gains a permanent and inexpensive onsite training aid. When new staff is hired, they can view the videos as part of their training.

For buildings where a facility manager without a technical background provides maintenance, the commissioning provider can still coordinate with contractors to ensure that the manager is educated about the capabilities, intended function, and required maintenance of the building systems. This education should enable the facility manager to respond to occupant complaints in a manner that does not circumvent the systems' design intent. It is important to provide a list of resources for the manager to call for maintenance assistance when necessary.

Once a building is operating and occupied, problems occasionally develop that were not apparent during the commissioning process. These problems often occur during the first year of operation after construction or renovation. Sometimes the service contractor or operating staff can effectively troubleshoot and solve the problem. However, if a problem becomes chronic (for example, repeated comfort complaints), or if operating staff is unable to solve a problem in a reasonable amount of time, the district should request expert troubleshooting assistance.

Because the commissioning provider and design engineer are very familiar with the building systems, the district may want to consider contracting with one and/or both of them for the first year of operation to provide troubleshooting assistance on an as-needed basis. In traditional construction projects, the mechanical engineer is only responsible to help correct problems if their contract stipulates a warranty period and the problems are "design" related. The district may find that it is more cost-effective to

Suggested Training Topics

Descriptions of equipment and systems installed and their warranties or guarantees.

Equipment start-up and shutdown procedures, operation in normal and emergency modes, seasonal changeover, and manual/automatic control.

Requirements and schedules for maintenance on all operation and maintenance-sensitive equipment.

Indoor air quality, health, visual comfort, acoustic comfort, and safety issues.

Recommendations for special tools and spare parts inventory.

Emergency procedures.

Operation and adjustment of dampers, valves, and controls.

Hands-on operation of equipment and systems.

Common troubleshooting problems, their causes, and corrective actions.

Review of operation and maintenance manuals, and their location onsite.

Building walk-through.

Review of related design intent documents.

Energy management control system operation and programming.

Control sequences and strategies.

Thermostat programming.

Relevant commissioning reports and documents.

When and how to recommission building systems.

The maintenance work order management system.

Sound energy management practices.

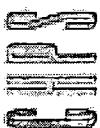

purchase troubleshooting services from the commissioning provider or engineer, because their knowledge of the building systems and design saves them time in diagnosing problems. This contract could be written in a "fee-for-service" or an "amount-not-to-exceed" manner.

In the long run, districts may also find it beneficial to train operation and maintenance staff in energy accounting. In addition to tracking the building's energy use, energy accounting can also indicate problems or potential problems with equipment operation.

Preventive Maintenance

Another important operation and maintenance practice is preventive maintenance. Preventive maintenance can save school districts time and money by:

- Maintaining facility operation.
- Extending equipment life.
- Identifying equipment degradation.
- Preventing losses of equipment, time, productivity, and resulting revenue.

Effective maintenance and operations procedures are fundamentally important to sustaining the performance of all building systems. Student health and productivity can be affected when building systems fail to operate as designed. Sub-standard maintenance or incorrect operation of building systems usually results from a combination of factors. First, maintenance budgets are often the first to be reduced or eliminated when money becomes tight. Second, designers and contractors typically provide the building staff minimal or no training about how the building systems are supposed to operate or be maintained. Finally, schools eventually lose their institutional knowledge of the building systems because of staff turnover and lack of communication.

When estimating service life, manufacturers usually assume regular preventive maintenance of the equipment and system components. Many preventive maintenance procedures recommended by manufacturers are intended to extend the life of the component and the system as a whole. Lack of preventive maintenance reduces equipment life.

Identifying degradation of the system's components is another benefit of preventive maintenance. A proper facility operation and maintenance system that includes reporting and documentation reduces the incidence of failure. For example, if a component of the system is identified as potentially failing to operate as intended, a work order for replacement parts can be set up immediately and work scheduled during unoccupied hours. Preventive maintenance can reduce the number and cost of emergency corrective maintenance bills.

Preventive Maintenance Software Modules

Many major controls contractors also offer preventative maintenance modules for their software that will track and automatically advise operation and maintenance staff when equipment maintenance needs to occur. These systems can offer good value because the controls system already knows a lot about many of the building systems. To set these systems up properly to be operational when the building is first occupied, the district should allow some extra budget for a facilities operator to assist in set-up during construction. This will also allow the operator to become familiar with the system and maximize its benefits once the building is occupied.

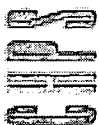

Performing regular preventive maintenance can result in energy and cost savings. For example, simply replacing worn fan belts on a regular basis can save 2% to 4% of the energy used to run the fans. Cleaning air filters and cooling coils regularly can save 1% to 3% of the building's energy use for cooling. These basic activities cost very little to perform, but can add up to dramatic savings.

Preventive maintenance also makes buildings safer and can reduce potential district liability. Increasingly, building ventilation systems function as part of an engineered smoke control system and therefore proper maintenance can decrease liability.

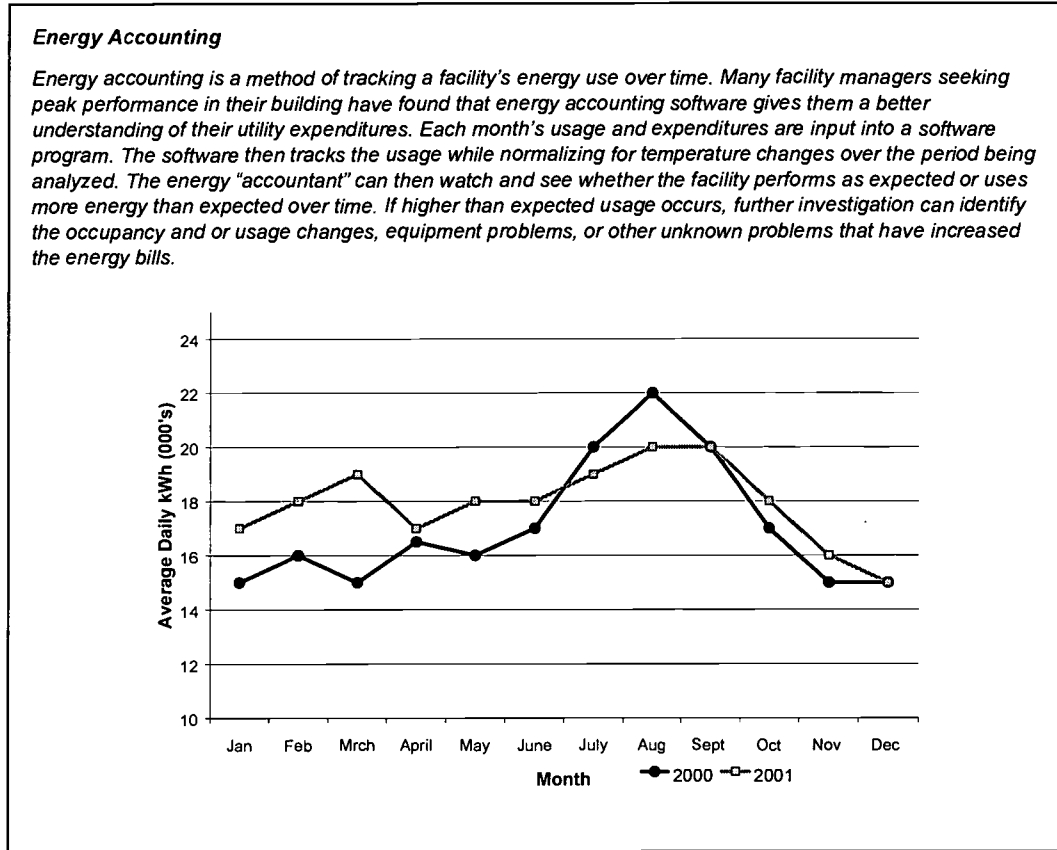

Developing a Preventive Maintenance Plan

The commissioning provider can assist the district or facility manager in developing a preventive maintenance plan for a building's HVAC and electrical systems. Most of the information required for developing a preventive maintenance plan is gathered as part of the commissioning process or can be obtained from the operation and maintenance manuals.

A preventive maintenance plan consists of a checklist of tasks that are performed at manufacturer-recommended intervals (usually measured in hours of equipment run time). This checklist is usually kept in the form of a log and updated manually when tasks are performed. In buildings that use computerized maintenance management systems, the equipment that requires preventive maintenance should be entered into the system. If the computerized system is used for generating



preventive maintenance work orders, update the system when work is performed and keep hard copies of completed work orders in a file or notebook. Another low cost measure to consider is programming the energy management system to track and archive equipment run times. This option is easy and inexpensive if done when the initial system programming takes place, and it should be outlined in the original equipment specification in the contract.

The preventive maintenance plan for each piece of equipment should include the following fundamental information, gathered during the commissioning process:

- Unique equipment identification number.
- Name plate information.
- Manufacturer's name.
- Vendor's name and telephone number.
- Equipment location.
- Date installed.
- Expected equipment life.
- Expected annual energy use.

Preventive maintenance should be performed according to manufacturer requirements. Consult the manufacturer's operation and maintenance manual for each piece of equipment for requirements such as frequency, chemical treatments, proper lubricants, special tools, etc. This information should also become a part of the preventive maintenance plan.

The preventive maintenance work order form or task list for each piece of equipment should have a verification section with at least two signature lines: one for the technician performing the preventive maintenance and one for the supervisor verifying that the maintenance was performed.

Outsourcing Preventive Maintenance

If a new piece of equipment does not require frequent maintenance, and current staff time is committed, a contract for outside help may be less costly than hiring and training full-time staff. If a sophisticated new piece of equipment is purchased, compare the cost of training in-house staff to the cost of hiring a trained outside contractor to perform maintenance on the equipment to determine the best option.

In buildings where operating staff is not available or trained to perform the required preventive equipment maintenance, districts may obtain a service contract from the vendor, installing contractor, or a maintenance service contractor. Ensure that the service contract covers all of the manufacturer's recommended preventive maintenance procedures as described in the operation and maintenance manuals. After each site visit, require the contractor to provide an invoice or preventive maintenance form stating clearly which preventive maintenance activities or repairs were performed. Keep these forms onsite in a file or three-ring binder for future reference. Regardless of who actually performs the preventive maintenance, the district is responsible for making sure that the preventive maintenance plans are complete.

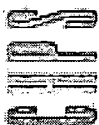

Maintenance contracts tend to be site-specific, but in general, there are two basic types of services.

- **Preventive maintenance contract.** Normally, this variety of contract does not cover the cost of replacement parts, but does include labor and supplies. The equipment owner is responsible for parts replacement. The duration of a preventive maintenance contract is usually one year. Frequency of site visits may depend on the equipment being serviced. Corrective maintenance may or may not be included.
- **Guaranteed service and repair contract.** Large maintenance contractors usually offer this type of contract. Under this arrangement, the contracting firm not only maintains but also replaces failed components. It is essentially an insurance policy with a low deductible, and typically is a multi-year contract. The cost for this type of contract is comparatively high.

Regardless of the type of contract used, it is important to carefully evaluate the cost for the service, quality of service, and the existing contractor's familiarization with the facility's equipment and operating procedures when the contract is up for renewal. Because any new contractor will face a learning curve when taking over a facility, it might not be a wise decision to choose a new contractor just because they offer a lower price. Careful consideration of the quality service already received and successful renegotiations with the existing service contractor might provide better long-term value.



List of Commissioning References and Resources

Procedural Guidelines, Specifications and Functional Tests Last Updated: 10/25/01

*Denotes documents available on electronic disk.

Legend: ● Comprehensive Information ● Average Information/Partial Information ○ No Information

Source	Design		Construction		Sample Tests
	Guidelines	Specs	Guidelines	Specs	
<i>Appendix VII Idaho New Building Commissioning Guidelines</i> , State of Idaho, 2000. Available at: http://www2.state.id.us/adm/pubworks/archengr/app7nbcq.pdf	○	○	○	○	○
<i>Building Commissioning Assistance Handbook Appendices</i> . Seattle City Light, 1999. Standardized functional test procedures. http://www.ci.seattle.wa.us/seattle/light/conserves/business/bdgc.coma/cv6_bc.com.htm	○	○	○	○	*●
<i>Procedural Standards for Building Systems Commissioning</i> , National Environmental Balancing Bureau (NEBB), 1999. (301) 977-3698.	●	●	●	●	●
<i>A Practical Guide for Commissioning Existing Buildings</i> , PECl and Oak Ridge National Labs (ORNL), 1999. NTIS (800) 553-6847.	●	○	○	○	○
<i>Model Commissioning Plan and Guide Commissioning Specifications</i> , USDOE/PECl, 1997. NTIS: # DE 97004564 (800) 553-6847. Or download from: http://www.peci.org/cx/mcpgs.html .	*●	*●	●	●	*●
<i>Building Commissioning Guide</i> , U.S. GSA. & USDOE, 1995, revised in 1998 (Ver. 2.2). Ver. 1 by Enviro-Management & Research, Inc. Version 2.2 available on the web: http://www.eren.doe.gov/femp/techassist/bldguide.pdf .	*●	○	●	○	○
<i>The HVAC Commissioning Process</i> , ASHRAE Guideline 1-1996, 1996. ASHRAE Publications Dept., 1791 Tullie Circle, NE, Atlanta, GA 30329. (404) 636-8400. http://www.ashrae.org .	●	●	●	●	○
<i>Functional Test Protocol Library</i> , Pacific Gas & Electric Company, 2001. Available on the EDR Commissioning Resources CD-ROM. For ordering information visit: http://www.energydesignresources.com/ or by call 925-866-5329.	○	○	○	○	●
<i>The Building Commissioning Handbook</i> , The Association of Higher Education Facilities Officers (APPA), written by John Heinz and Rick Casault, 1996. APPA, 1643 Prince Street, Alexandria, VA 22314. (703) 684-1446. http://www.appa.org .	●	○	●	●	○
<i>Beyond Lighting DSM: Life After Green Lights</i> , Montgomery Co., MD, 1995. Existing building commissioning case study with sample process and detailed procedures. 70 pgs. (301) 217-6000.	●	○	○	○	●
<i>Engineering and Design Systems Commissioning Procedures</i> , U.S. Army Corps of Engineers, 1995 (ER 1110-345-723). Dept. of the Army, U.S. Army Corps of Engineers, Washington, DC 20314-1000.	●	●	●	●	○
<i>Commissioning Specifications</i> , C-2000 Program, Canada, 1995. C-2000 Program, Energy Mines & Resources, Energy Efficiency Division, 7th Floor, 580 Booth St., Ottawa, Ontario, Canada K1A 0E4.	○	○	○	*●	○
<i>Model Construction Document Specifications and A/E Services Contract Clauses</i> , Bonneville Power Administration/John Heinz, U. of WA, 1995. 503-230-7334. Also available on the Univ. of Washington web site at: http://www.depts.washington.edu/fsesweb/fdi2001/15_mech/doc/19-15t.doc .	○	○	○	*●	●
<i>Commissioning Guidelines, Instructions for Architects & Engineers</i> , State of WA., 1995. Dept. of General Admin., Div. of Engin. & Arch., (360) 902-7272.	●	○	●	○	○
<i>Commissioning of HVAC Systems</i> , seminar/workshop training materials, Univ. of Wisconsin, Madison, 1994. (800) 462-0876 or (608) 262-2061.	○	○	●	●	●



Source	Design		Construction		Sample Tests
	Guidelines	Specs	Guidelines	Specs	
<i>Laboratory HVAC Systems: Design, Validation and Commissioning</i> , ASHRAE collection of 11 papers, 1994. ASHRAE Publications Dept., 1791 Tullie Circle, NE, Atlanta, GA 30329. (404) 636-8400. http://www.ashrae.org/	○	○	●	○	○
<i>Commissioning Smoke Management Systems, ASHRAE Guideline 5-1994</i> . ASHRAE Publications Dept., 1791 Tullie Circle, NE, Atlanta, GA 30329. (404) 636-8400. http://www.ashrae.org/	●	○	●	○	○
<i>Standard HVAC Control Systems Commissioning and Quality Verification User Guide</i> , U.S. Army Const. Engineering Research Labs, 1994. Facilities Engineering Applications Program, U.S. Army Engineering and Housing Support Center, Ft. Belvoir, VA 22060-5516. FEAP-UG-GE-94/20.	○	○	○	○	●
<i>Contractor Quality Control and Commissioning Program—Guidelines and Specification</i> , Montgomery Co. Gov., St of Maryland, 1993. (301) 217-6071.	○	○	*●	*●	*●
<i>HVAC Systems Commissioning Manual</i> , Sheet Metal and Air Conditioning Contractors' National Association (SMACNA), 1993. SMACNA, 4201 Lafayette Center Dr., Chantilly, VA 22021.	○	○	●	●	●
<i>Commissioning Guide</i> , Public Works Canada, Western Region, 1993. (403) 497-3770.	●	●	●	●	○
<i>Guide Specification for Military Construction—Commissioning of HVAC Systems</i> , Dept. of the Army, U.S. Army Corps of Engineers, 1993. Washington, DC 20314-1000.	○	○	○	*●	*●
<i>Building Commissioning Guidelines</i> , Bonneville Power Administration/PECI, 1992. (503) 230-7334.	●	○	●	●	●
<i>HVAC Functional Inspection and Testing Guide</i> , U.S. Dept. of Commerce and the General Services Administration, 1992. NTIS: (800) 553-6847.	○	○	○	○	●
<i>AABC Master Specification</i> , Associated Air Balance Council. (Primarily for how the TAB fits into the commissioning process) AABC National Hdqrs, (202) 737-0202.	○	*●	○	●	○

Commissioning Overviews and Case Studies

Building Commissioning: The Key to Quality Assurance. U.S. DOE Rebuild America/PECI, 1998.

Commissioning retrofits and existing buildings: overview, process and case studies. Dedicated solely to retrocommissioning. 68 pgs. (800) 363-3736.

Beyond Lighting DSM: Life After Green Lights, Urban Consortium Energy Task Force of Public Technologies, Submitted by Montgomery County Government, MD, Div. of Facilities and Services, 1998. Existing building commissioning case study with sample process and detailed procedures. 70 pgs. (301) 217-6000.

Commissioning For Better Buildings in Oregon. Oregon Office of Energy/PECI, 1997.

New construction overview, benefits, process and case studies. Contains some data on recommissioning. 44pgs. (503) 378-4040 or download at: <http://www.energy.state.or.us/bus/comm/bldgqcx.htm>

What Can Commissioning Do For Your Building? PECI, 1997.

Commissioning overview and report of 175 building case studies. Contains some data on recommissioning. 12pgs. (503) 248-4636.

Commissioning Four New Science Laboratory Buildings (U. of WA). Bonneville Power Admin./Phoebe Caner, 1997. Commissioning case studies with detailed "lessons learned" information in all sections. ~70 pgs. (503) 230-7334.

Commissioning the Physics/Astronomy Building Control System (U. of WA). Bonneville Power/Phoebe Caner, 1996. Commissioning case study and report with lessons learned. ~110 pgs. (503) 230-7334.

A web site dedicated to providing access to documents dealing with the Guidelines for Total Building Commissioning is being developed under the auspices of the National Institute of Building Sciences. The site is maintained by the Florida Design Initiative and is organized around the



individual technical guidelines that will comprise the complete set of Guidelines for Total Building Commissioning. <http://www.sustainable.state.fl.us/fdi/edesign/resource/totalbcx>.

Implement Building Commissioning, published by U.S. Department of Energy, Rebuild America, EnergySmart Schools program (Washington, DC, 2000); available at: http://www.eren.doe.gov/energysmartschools/om_implement.html. Defines building commissioning; discusses the selection of a commissioning agent; the benefits, approaches, and components of commissioning; and lists resources.

Sustainable Building Technical Manual: Green Building Design, Construction, and Operations, produced by Public Technology, Inc., U.S. Green Building Council (USGBC), and U.S. Department of Energy, with support from EPA, 1996. See Chapter 15, "Building Commissioning." Available from USGBC, San Francisco, CA; Phone: (415) 445-9500 or download at: <http://www.sustainable.doe.gov/pdf/sbt>.

Four case studies. Seattle City Light. http://www.ci.seattle.wa.us/seattle/light/consERVE/business/bdqcoma/cv6_bcam.html.

Web Sites Containing Commissioning Documents

Building Commissioning Association	http://www.bcxa.org/
Florida Design Initiative	http://www.state.fl.us/fdi/index.html . Ongoing articles & forum.
National Institute of Health Model Commissioning Guide	http://www.des.od.nih.gov/farhad2/Commissioning/nih_cx_guide/ComGuideTitle.htm
NEBB	http://www.nebb.org/ . Certification program and manuals.
Oregon Office of Energy	http://www.energy.state.or.us/bus/comm/bldgcx.htm Benefits of Cx, case study, the full text of <i>Commissioning for Better Buildings in Oregon</i> . Contains some data on recommissioning.
PECI	http://www.peci.org/ NCBC information, downloadable <i>Model Cx Plan and Guide Specifications</i> , Cx and O&M resources.
Seattle City Light	http://www.ci.seattle.wa.us/seattle/light/consERVE/business/bdqcoma/cv6_bcam.htm Standardized test procedures and case studies.
Texas A&M Energy Systems Lab	http://www-esl.tamu.edu/ . Retrocommissioning process and software, for purchase. Dedicated solely to retrocommissioning.
University of Washington	http://www.depts.washington.edu/fsesweb/fdi2001/15_mech/doc/19-15t.doc . University Cx guide specs distributed throughout the specs. Vols 1-4.
USDOE / FEMP	http://www.eren.doe.gov/femp/techassist/bldgcomgd.html . Full text of GSA/USDOE <i>Building Commissioning Guide</i> ; early version of <i>Model Cx Plan and Guide Specifications</i> .
USDOE	http://www.eren.doe.gov/ . Links to commissioning documents. Search on "commissioning."
Whole Building Design Guide (NIBS)	http://www.wbdg.org/ . National Institute of Building Sciences. Find commissioning information by searching on "commissioning."

Related Volume III CHPS Criteria

Energy Prerequisite 2: System Testing & Training.

Energy Credit 4: Commissioning.

District Credit 2: IAQ Management Plan.

District Credit 3: Maintenance Plan.



the

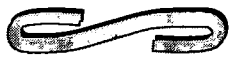

collaborative



for high



performance



schools

Best Practices Manual

VOLUME III

CRITERIA

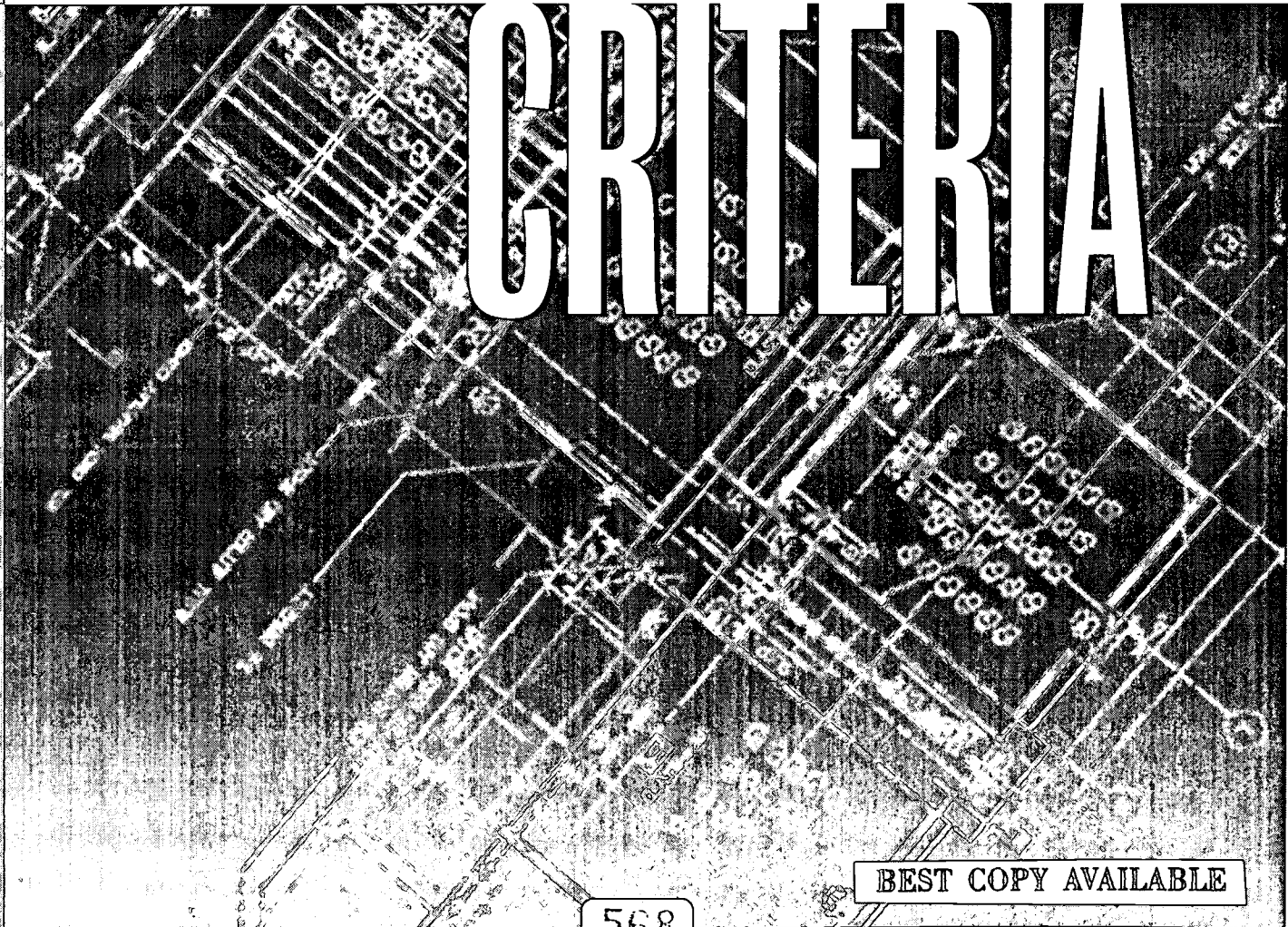

Volume III – Criteria

High Performance Schools Best Practices Manual

Version 1.0

November 1, 2001

A Project of:

the

collaborative

for high

performance

schools

The Collaborative for High
Performance Schools
(877) 642-CHPS
www.chps.net

Copyright 2001 CHPS Inc.

CHPS Criteria

The CHPS Criteria explicitly defines a high performance school. The criteria are most useful as a goal-setting and planning tool. Districts can use it to simply and clearly communicate their design goals. At the same time, the criteria's flexibility allows designers to deliver a CHPS school while managing the regional, district, and site-specific constraints of the school design.

Eligibility Levels and Documentation

The criteria are flexible and address all aspects of high performance schools such as energy efficiency, water efficiency, site planning, materials and indoor environmental quality. In each area, the system is composed of both prerequisites and optional credits. Points are assigned to each credit. To be eligible, a school must meet all of the prerequisites and earn at least 28 points (at least two points must be from the Energy category). The more credits a building earns, the better it is, but the CHPS criteria are a pass/fail system.

As documentation, design teams must complete a report that identifies with a brief narrative the approach used to earn each point. Each design team or building owner will document compliance with the criteria through a process of self-evaluation.

Documentation reports must be sent to CHPS. CHPS will make spot checks of documentation reports, but not check every one. However, CHPS stakeholders or other government agencies may sponsor programs where meeting these criteria is required for participation. In these cases, the program administrators may require that documentation be submitted for a thorough review. Example programs include financial incentives (such as Savings By Design), accelerated plan review, and/or bonus points for state funding.



A Criteria Scorecard has been included at the end of this document. The scorecard summarizes the requirements and applicable points for each credit.

CHPS and LEED™

The CHPS Criteria is similar to the US Green Building Council's (USGBC) LEED™ 2.0 Rating System. However, no interchangeability between the two systems is expressed or implied. A school qualifying for CHPS may contain many of the elements needed for LEED™ certification, but there is *no interchangeability* between the two systems. Schools qualifying for CHPS may or may not qualify for LEED and vice versa. Teams wishing to pursue a LEED™ rating must do so independently. However, the USGBC has developed excellent support materials, which are referenced by CHPS. In particular, the LEED™ 2.0 Reference Manual is referenced as a resource in a number of CHPS Criteria Credits. See the USGBC's web site at <http://www.usgbc.org> for more information on how to join the organization and obtain the referenced materials.

Priorities

Sustainability and high performance are broad topics. The CHPS Criteria span a wide variety of areas, from site planning and energy use, to material specifications and district resolutions. The prerequisites in the criteria are typically design issues required by state law. However, the design must move beyond the prerequisites to ensure that the CHPS school is healthy, operates efficiently, increases student productivity, and reduces environmental impact. Listed below are the design areas and credits that are recommended by CHPS to maximize the performance of the school.

- **Daylighting.** Quality daylighting designs have been proven to improve student productivity. When integrated properly with the electric lighting system, daylighting saves significant amounts of energy.
See IEQ Credit 1: Daylighting in Classrooms (1-4 points)
- **Energy Efficiency.** Energy Efficiency should be a cornerstone of the CHPS school to reduce operational expenses, conserve natural resources, and reduce local and global pollution.
Energy Credit 1: Superior Energy Performance (2-10 points)
Energy Credit 2: Natural Ventilation (1-4 points)
- **Indoor Air Quality.** Schools must protect student health, and good indoor air quality is essential for healthy schools. Because a wide variety of design issues affect indoor air, each of the credits below must be addressed to protect indoor air quality.
IEQ Credit 2: Low-Emitting Materials (1-4 points)
IEQ Credit 3: Pollutant Source Control (1-3 points)
IEQ Credit 4: Construction IAQ Management Plan (1-2 points)
- **Maintenance.** Without regular preventative maintenance over the lifetime of the building, a school will not perform at the level it was designed. Inadequate maintenance can cause a litany of problems from poor indoor air quality and increased energy expenses, to visually, thermally, and acoustically inadequate teaching



environments. The costs of fixing these problems often dwarf the investments to prevent them.

District Credit 3: Maintenance Plan (1-2 points)

- **Commissioning and Training.** All schools should be commissioned to ensure that the design meets the expectations of the district, and that the school is built as it was designed. Modern schools are complex buildings. Commissioning ensures that all building systems are working properly, and that the school staff knows how to operate and maintain them.

Energy Credit 4: Commissioning (2-3 points)

- **Acoustics.** If not controlled to appropriate levels, noise from loud ventilation systems, outdoor sources, and neighboring rooms can significantly impede communication between teachers and students. Young learners, students with hearing difficulties, and those learning English as a second language are particularly vulnerable. Classrooms should be designed to be accessible for all students.

IEQ Credit 5: Improved Acoustical Performance (2 points)

- **Sustainable Materials.** Hidden within all materials are the resources, energy, chemicals, and environmental damage involved in their production. More sustainable alternatives exist and should be used as much as possible.

Materials Credit 4: Recycled Content (1-2 points)

Materials Credit 6: Certified Wood (1 point)

- **Waste Reduction.** It is now possible to recycle, compost, or salvage a majority of construction and demolition waste instead of disposing it in landfills.

Materials Credit 1: Site Waste Management (1-2 points)

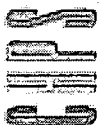

CRITERIA OVERVIEW

Category	Group	Credit Name	Points	Page
Site 14 points	Site Selection	Prereq 1 <u>Code Compliance</u>	R	6
		Credit 1 <u>Sustainable Site Selection</u>	1-6	7
	Transportation	Credit 2 <u>Transportation</u>	1-3	9
	Stormwater Management	Prereq 2 <u>Construction Erosion</u>	R	10
		Credit 3 <u>Post-construction Management</u>	1-2	11
	Outdoor Surfaces	Credit 4 <u>Design to Reduce Heat Islands</u>	1-2	12
Outdoor Lighting	Credit 5 <u>Light Pollution Reduction</u>	1	13	
Water 5 points	Outdoor Systems	Prereq 1 <u>Create Water Use Budget</u>	R	14
		Credit 1 <u>Reduce Potable Water for Landscaping</u>	1-2	16
	Indoor Systems	Credit 2 <u>Water Use Reduction</u>	1-3	17
Energy 24 points	Energy Efficiency	Prereq 1 <u>Minimum Energy Performance</u>	R	20
		Credit 1 <u>Superior Energy Performance</u>	2-10	22
		Credit 2 <u>Natural Ventilation</u>	1-4	24
	Alternative Energy Sources	Credit 3 <u>Renewable Energy</u>	2-6	25
	Commissioning and Training	Prereq 2 <u>System Testing & Training</u>	R	27
		Credit 4 <u>Commissioning</u>	2-3	29
Credit 5 <u>Energy Management Systems</u>	1	31		
Materials 11 points	Waste Reduction and Efficient Material Use	Prereq 1 <u>Storage and Collection of Recyclables</u>	R	32
		Credit 1 <u>Site Waste Management</u>	1-2	33
		Credit 2 <u>Building Reuse</u>	1-3	34
	Sustainable Materials	Credit 3 <u>Resource Reuse</u>	1-2	35
		Credit 4 <u>Recycled Content</u>	1-2	36
		Credit 5 <u>Rapidly Renewable Materials</u>	1	39
Credit 6 <u>Certified Wood</u>	1	40		
Indoor Environmental Quality 17 points	Daylighting	Credit 1 <u>Daylighting in Classrooms</u>	1-4	41
	Indoor Air Quality	Prereq 1 <u>Minimum Requirements</u>	R	42
		Credit 2 <u>Low-Emitting Materials</u>	1-4	44
		Credit 3 <u>Pollutant Source Control</u>	1-3	45
		Credit 4 <u>Construction IAQ Management Plan</u>	1-2	46
	Acoustics	Prereq 2 <u>Minimum Acoustic Performance</u>	R	47
		Credit 5 <u>Improved Acoustical Performance</u>	1-2	48
	Thermal Comfort	Prereq 3 <u>ASHRAE 55 Code Compliance</u>	R	49
Credit 6 <u>Controllability of Systems</u>		1-2	50	
District Resolutions 10 points	High Performance Policies	Credit 1 <u>District Resolutions</u>	1	51
	Indoor Air Quality	Credit 2 <u>IAQ Management Plan</u>	1	52
	Maintenance	Credit 3 <u>Maintenance Plan</u>	1-2	53
	Energy	Credit 4 <u>Equipment Performance</u>	1-2	54
		Credit 5 <u>Green Power</u>	2	55
	Transportation	Credit 6 <u>Buses and Alternative Fueled Vehicles</u>	1-2	56

Credits in bold font = CHPS-recommended credits.

Total Points 81

Minimum required for CHPS School (Two points must be in Energy category) **28**



SITE

Site Selection

Purpose: Choose sites that protect students and staff from outdoor pollution and minimally impact the environment. Channel development to centrally located areas, with existing infrastructure, to protect greenfields, minimize transportation requirements, and preserve habitat and natural resources.

Site Prerequisite 1: Code Compliance

<i>Required</i>	<p>P1.1. Title 5 compliance. Comply with all siting and environmental impact study requirements of the School Facilities Planning Division as defined in Title 5, Division 1, Chapter 13 of the California Code of Regulations, including:</p> <ul style="list-style-type: none">▪ DTSC site review for hazardous agents, including industrial, agricultural, and naturally occurring pollutants such as asbestos and heavy metals.▪ The air pollution control district or air quality management district having jurisdiction in the area must identify nearby facilities which might reasonably be anticipated to emit hazardous air emissions, or to handle hazardous or acutely hazardous materials, substances, or waste and determine that they will not adversely affect student, staff, or teacher health.▪ All other siting requirements, including separation from power-line easements, railroad tracks, hazardous pipelines, adverse levels of traffic noise, and avoiding construction on active earthquake faults or fault traces.
-----------------	---

Protecting student health is the most important issue during site selection. The state of California's Title 5 siting and environmental impact study requirements were created to eliminate sites containing pollutants known to be hazardous to student and staff health. A variety of factors, from hazardous materials in the soil to airborne pollutants from nearby sources, are included in the site review process.

All schools receiving state funding are required by law to follow the Title 5 requirements. Under the CHPS criteria, privately funded schools must also engage the SFPD and DTSC to validate that their site complies with the Title 5 requirements.

Resources

California Department of Education, School Facilities Planning Division. School Site Selection and Approval Guide. Available from <http://www.cde.ca.gov/facilities/>

BEST COPY AVAILABLE



Site Credit 1: Sustainable Site Selection

1 point	<p>1.1. Do not develop buildings on portions of sites that meet any one of the following criteria:</p> <ul style="list-style-type: none"> ▪ Important farmland as defined by the US Department of Agriculture. ▪ Land whose elevation is lower than five feet above the elevation of the 100-year flood as defined by FEMA. ▪ Land that provides habitat for any species on the federal or state threatened or endangered list. ▪ Within 100 feet of any wetland as defined by 40 CFR, Parts 230-233 and Part 22, OR as defined by local or state rule or law, whichever is more stringent. ▪ Land which prior to acquisition for the project was public parkland, unless land of equal or greater value as parkland is accepted in trade by the public landowner. (Park Authority projects and joint use arrangements with parkland are exempt.)
1 point	<p>1.2. Do not build on greenfields. Greenfields are defined as those sites that have not been previously developed, or have been restored to agricultural, forestry, or park use.</p>
1 point	<p>1.3. Centrally located sites. Create centrally located sites in which 50% of students are located within the distances below:</p> <ul style="list-style-type: none"> ▪ Elementary: 1 mile. ▪ Middle School: 2 miles. ▪ High School: 4 miles.
1 point	<p>1.4. Joint use of facilities. Dedicate part of the school building for use by community or other appropriate organizations.</p>
1 point	<p>1.5. Joint use of parks. Share park or recreation space with local park boards or other organizations.</p>
1 point	<p>1.6. Reduced footprint. Increase the Floor Area Ratio (FAR) of the school to be at least 1.2 to reduce the development footprint and preserve openspace. The FAR is the quotient of a building's total square footage and its footprint.</p>

A district faces many issues during site selection. Cost, student demographics, and environmental concerns all influence when sites are acquired and how the district uses them. The site is a crucial element in determining the overall sustainability of the school design. Sites are sometimes purchased years in advance, and some of these credits may be out of the control of the districts and/or designers at the time the school is being built. However, districts that are considering multiple sites can substantially lower the environmental impact of the school by choosing centrally located sites, sharing parks or facilities with community organizations, preserving openspace, and protecting environmentally sensitive areas.

Credit 1.1. Environmentally sensitive or important spaces should be avoided.

Important Soils: The Natural Resources Conservation Services division of the Department of Agriculture maintains the definitions and soil surveys that designate areas as "important farmland". Lists of Prime and Statewide Important Farmland Soils are maintained for each soil survey area and may be obtained from the Field Office Technical Guide (FOTG) located in each



NRCS field office. County and state offices of the NRCS keep maps showing the status of maps within their jurisdiction. County offices can be located at http://offices.usda.gov/scripts/ndISAPI.dll/oip_public/USA_map

100-Year Flood Plains: California is in FEMA's region IX (<http://www.fema.gov/Reg-IX/index.htm>). To find a map showing the 100-year flood elevations, contact your community representative on the Region IX Community Status List (http://www.fema.gov/Reg-IX/r9_nfip.htm), or call 877-336-2627 to talk to a map specialist. Unofficial maps by ESRI are available online at <http://www.geographynetwork.com>.

Wetlands: The term wetlands is defined in Title 40 as "those areas that are inundated or saturated by surface or ground water at a frequency and duration sufficient to support, and that under normal circumstances do support, a prevalence of vegetation typically adapted for life in saturated soil conditions. Wetlands generally include swamps, marshes, bogs and similar areas." [Source: CFR: Title 40. 330.4]. Any coastal development is regulated by the California Coastal Commission in parallel with the U.S. Army Corps of Engineers and the California Regional Water Quality Control Board. In addition, joint consultation that includes the California Dept of Fish and Game is necessary for any projects in or adjacent to any waterway, tidal creek, wetland, or seasonal stream.

Credit 1.2. During the site selection process, use previously developed sites instead of greenfields. Urban redevelopment reduces environmental impacts by utilizing established infrastructure and preserving the openspace of undeveloped lands. If the site already contains a building, additional points may be earned with Materials Credit 2: Building Reuse.

Credit 1.3. Over the lifetime of the building, schools and parents invest significant amounts of time, energy, and money transporting students to and from school. Cars driven by parents, guardians, or the students themselves are the largest resource users and sources of transportation-related pollution. Centrally located sites allow more students to walk or bike to school, while reducing the distance cars must travel. To earn this point, calculations must be based on the estimated school population when the school opens. Additional transportation-related points are covered in Site Credit 2: Alternative Transportation.

Credits 1.4 and 1.5. Joint use of facilities and parks is a growing trend across the country and state. Schools are being integrated with a variety of organizations, from laundromats and coffee shops to police stations and park districts. Joint use can have a variety of benefits, including increasing campus security, improving community integration, and reducing site acquisition and construction costs.

Credit 1.6. Building multi-story schools reduces the amount of land used in construction. Said another way, achieving a FAR of 1.2 requires at least 20% of a school's square footage to be on a second floor.

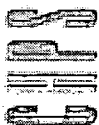

Transportation

Purpose: Reduce pollution and land development impacts from automobile use.

Site Credit 2: Transportation

1 point	<u>2.1.</u> Public Transportation. Locate building within 1/4 mile of a commuter rail, light rail or subway station, or within 1/8 mile of one or more bus lines.
1 point	<u>2.2.</u> Bicycles. Provide suitable means for securing bicycles for 15% or more of building occupants; AND provide bike lanes and sidewalks that extend at least to the end of the school zone.
1 point	<u>2.3.</u> Minimize Parking. Provide preferred parking totaling 5% of total parking spaces for carpools or vanpools and size parking capacity not to exceed High schools: 2.25 spaces per classroom plus parking for 20% of students Elementary and Middle: Three spaces per classroom OR , add no new parking for rehabilitation projects and provide preferred parking totaling 5% of total parking spaces for carpools or vanpools.

The energy-use and pollution associated with transportation often dwarfs the total lifetime energy used by the school itself. Locating the site close to public transportation, creating bike facilities and safe access, and offering bus service, all reduce the automobile-related pollution.

Credit 2.1. When available, public transportation is a very efficient method of transportation. Some school districts offer reduced or subsidized fares for students and staff using public transportation. If sufficient capacity exists, schools can use public transportation to replace district provided bus service. Schools located near high traffic areas must ensure safe student access. In addition, all transportation-related pollution must be considered when investigating site air quality and potential for natural ventilation.

Credit 2.2. Bicycles are a popular and pollution-free form of transportation. To protect pedestrians and bicyclists, bike lanes and sidewalks must extend to the end of the school zone.

Credit 2.3. Excess parking spaces encourage increased automobile use, contribute to urban heat island effects, and can increase pollution from stormwater runoff. Design parking so as not to exceed listed amounts and include clearly marked, preferred parking areas for carpools.

Resources

CHPS Best Practices Manual, Volume II: Guideline SP3: Safe and Energy Efficient Transportation.

LEED™ Reference Guide: Site Credit 4.

BEST COPY AVAILABLE



Stormwater Management

Purpose: Manage stormwater during and after construction to control erosion and runoff, reducing the negative impacts on water and air quality.

Site Prerequisite 2: Construction Erosion and Sedimentation Control

<i>Required</i>	<p>P2.1. Design to a site sediment and erosion control plan that follows the best management practices outlined by the state Water Resources Control Board (WRCB) to comply with the Stormwater Construction Activities General Permit. The plan shall meet the following objectives:</p> <ul style="list-style-type: none"> ▪ Prevent loss of soil during construction by storm water runoff and/or wind erosion, including protecting topsoil by stockpiling for reuse. ▪ Prevent sedimentation of storm sewer or receiving streams and/or air pollution with dust and particulate matter.
-----------------	---

The state WRCB is responsible for administering water-related construction permit activities. Construction projects must file a permit and develop a Stormwater Pollution Prevention Plan (SWPPP) to comply.

Individual county zoning ordinances may further delimit the Development Standards for Wetland Habitats. At the same time, any projects that result in discharge of water into a wetland require a permit from the California Regional Water Quality Control Board. Note that each local zoning ordinance may give exception to that requirement for a particular waterway.

A variety of best practices address this prerequisite, including:

Runoff Control	<p>Minimize clearing: land grading, permanent diversions, preserving natural vegetation.</p> <p>Stabilize drainage ways: check dams, filter berms, grass-lined channel, riprap.</p>
Erosion Control	<p>Stabilize exposed soils: chemical stabilization, mulching, permanent seeding, sodding, soil roughening.</p> <p>Protect steep slopes: geotextiles, gradient terraces, soil retention, temporary slope drain.</p> <p>Protect waterways: temporary stream crossings, vegetated buffer.</p> <p>Phase construction: construction sequencing, dust control.</p>
Sediment Control	<p>Install perimeter controls: temporary diversion dikes, wind fences and sand fences, brush barrier, silt fence.</p> <p>Install sediment-trapping devices: sediment basins and rock dams, sediment filters and sediment chambers, sediment trap.</p> <p>Storm drain inlet protection.</p>

Resources

CHPS Best Practices Manual, Volume II: Guideline GC4: Site Protection During Construction.

LEED™ Reference Guide: Site Prerequisite 1 Erosion and Sedimentation Control.

California Best Practices Handbooks from WRCB: <http://www.swrcb.ca.gov/stormwtr/bmp.pdf>.

EPA Storm Water Management for Construction Activities, EPA Document No. EPA-833-R-92-001.

EPA On-line Best Practices Information: <http://www.tetrattech-test.com/bmpmanual/htmfolder/menu.htm>.

California WRCB: <http://www.swrcb.ca.gov/stormwtr/index.html>.

BEST COPY AVAILABLE



Site Credit 3: Post-construction Stormwater Management

1 point	<p><u>3.1.</u> Limit stormwater runoff. No net increase in the rate or quantity of stormwater runoff shall occur from existing to developed conditions.</p> <p>OR if existing imperviousness is greater than 50%, implement a stormwater management plan that results in a 25% decrease in the rate and quantity of stormwater runoff.</p>
1 point	<p><u>3.2.</u> Treat runoff. Install treatment systems designed to remove 80% of the average annual post-development total suspended solids (TSS), and 40% of the average annual post-development total phosphorous (TP), by implementing best management practices outlined by Regional Water Resources Control Boards or in EPA's Guidance Specifying Management Measures for Sources of Nonpoint Pollution in Coastal Waters (EPA 840-B-92- 002 1/93).</p>

Stormwater runoff is precipitation that flows over surfaces on the site and enters either the sewage system or receiving waters. Stormwater carries sediment and pollutants from the site into the sewage system and/or local bodies of water. In addition, the cumulative runoff throughout the local area requires significant investments in municipal infrastructure to handle peak runoff loads.

Post-construction stormwater management is not covered under the Stormwater Pollution Prevention Plan. Post-construction stormwater management is regulated by the Regional Water Resources Control Boards with Standard Urban Stormwater Mitigation Plans (SUSMP) Region 4 (LA), Region 9 (San Diego). Some local jurisdictions, such as Alameda's Countywide Clean Water Program, have other stormwater control plans.

Credit 3.1. Reducing the amount of runoff is the most effective way to minimize its negative impacts. Many strategies exist to limit stormwater runoff:

- Significantly reduce impervious surfaces, maximize on-site stormwater infiltration, and retain pervious and vegetated areas.
- Capture rainwater from impervious areas of the building for groundwater recharge or reuse within the building.
- Use green/vegetated roofs.

Credit 3.2. Total suspended solids (TSS) are particles that are too small or light to be removed from stormwater by gravity settling alone, and must typically be removed with filtration methods. Total phosphorous (TP) consists of organically bound phosphates, poly-phosphates, and orthophosphates in stormwater, and usually originate from fertilizers. Common treatment systems include infiltration basins and trenches, porous pavement, vegetated filter strips, grassy swales, filtration basins, and constructed wetlands.

Resources:

CHPS Best Practices Manual, Volume II: Guideline SP11: Stormwater Management and Drainage Materials.

LEED™ Reference Guide: Site Credit 6: Stormwater Management.

EPA On-line Best Practices information: <http://www.tetrattech-test.com/bmpmanual/htmlfolder/menu.htm>.

LA Stormwater Management Division: <http://www.lacity.org/san/swmd/>.

Regional California Water Resources Control Boards: <http://www.swrcb.ca.gov/regions.html>.

BEST COPY AVAILABLE



Outdoor Surfaces

Purpose: Reduce heat islands to minimize impact on microclimate, and human and wildlife habitat.

Site Credit 4: Landscape and Exterior Design to Reduce Heat Islands

1 point	<p>4.1. Landscaping Issues. Provide shade (within five years) on at least 30% of non-roof, impervious surfaces on the site, including parking lots, walkways, plazas, etc.</p> <p>OR use light-colored/ high-albedo materials (reflectance of at least 0.3) for 30% of the site's non-roof, impervious surfaces.</p> <p>OR use an open-grid pavement system (net impervious area of LESS than 50%) for a minimum of 50% of the parking lot area.</p>
1 point	<p>4.2. Cool Roofs. Use ENERGY STAR® roof-compliant roofing, with an initial reflectance of at least 0.7 and initial emissivity of at least 0.75 for a minimum of 75% of the roof surface.</p> <p>OR install a "green" (vegetated) roof for at least 50% of the roof area.</p>

Credit 4.1. Employ design strategies, materials, and landscaping designs that reduce heat absorption of exterior materials. Note albedo/reflectance requirements in the drawings and specifications. Provide shade using native or climate-tolerant trees and large shrubs, vegetated trellises, or other exterior structures supporting vegetation. Substitute vegetated surfaces for hard surfaces. Explore elimination of blacktop and the use of new coatings and integral colorants for asphalt to achieve light colored surfaces.

Credit 4.2. Cool roofs can significantly reduce school cooling loads and urban heat island effects by reflecting the sun's energy, instead of absorbing, retaining, and radiating it into the occupied spaces below. With cool roofs, both the reflectivity and emissivity are important. Solar reflectance is the ratio of the electromagnetic energy reflected by a surface to the total amount incident upon it. A solar reflectance of 0.0 means all the solar energy hitting the surface is absorbed and none is reflected. Emissivity is the ability of a material to shed infrared radiation. In other words, surfaces with high emissivities lower their surface temperatures by shedding infrared radiation. Bare metals, for example, have low emissivities and stay hotter for longer periods than materials with high emissivity. The EPA's ENERGY STAR program includes a database of high-reflectance roofing materials. To ensure high emissivity, do not use bare metal roofing products.

Resources

CHPS Best Practices Manual, Volume II: SP2: Landscaping to Provide Shade to Buildings and Paved Areas; SP5: Impervious Surfaces; IN3: Cool Roofs.

LEED™ Reference Guide: Credit 7: Landscape and Exterior Design to Reduce Heat Islands.

BEST COPY AVAILABLE



Outdoor Lighting

Purpose: Eliminate light trespass from the building site, improve night sky access, and reduce development impact on nocturnal environments.

Site Credit 5: Light Pollution Reduction

1 point	5.1. Do not exceed Illuminating Engineering Society of North America (IESNA) footcandle level requirements as stated in the IESNA RP-33 Recommended Practice for Exterior Environmental Lighting or applicable sections of the IESNA Lighting Handbook, Ninth Edition; AND design interior and exterior lighting (excluding sports fields) such that zero direct-beam illumination leaves the building site.
---------	---

Consult IESNA Recommended Practice Manual: Lighting for Exterior Environments for CIE zone and pre- and post-curfew hour descriptions and associated ambient lighting level requirements. Ambient lighting for pre-curfew hours for CIE zones range between 0.01 footcandles for areas with dark landscapes such as parks, rural, and residential areas, and 1.5 footcandles for areas with high ambient brightness such as urban areas with high levels of nighttime activity. Design site lighting and select lighting styles and technologies to have minimal impact off-site and minimal contribution to sky glow. Minimize lighting of architectural and landscape features.

Resources

CHPS Best Practices Manual, Volume II: EL11: Outdoor Lighting.

LEED™ Reference Guide: Site Credit 8: Light Pollution Reduction.

The International Dark Sky Association: <http://www.darksky.org/ida/index.html>. The California Chapter (www.skykeepers.org) maintains state-focused information. The International Dark Sky Association Lighting Handbook is available on line at http://www.nofs.navy.mil/about_NOFS/staff/cbl/LC_Handbook.html

BEST COPY AVAILABLE



WATER

Outdoor Systems

Purpose: Limit excess water use for landscaping and ornamentation.

Water Prerequisite 1: Create Water Use Budget

<i>Required</i>	P1.1. Design landscape and ornamental water use budget to conform to local Water Efficient Landscape Ordinance. If no local ordinance is applicable, then use the landscape and ornamental budget outlined by the California Department of Water Resources.
-----------------	--

California's Model Water Efficient Landscape Ordinance requires that landscapes be given a water budget or "water allowance." A water budget is usually expressed in terms of a percentage of amount of water that evaporates from vegetation and from the underlying soil (reference evapotranspiration) for the size of the area permitted to be landscaped. Local governments may have a different ordinance from the state model.

The California Model Landscape Ordinance requires that estimated applied water use cannot exceed the Maximum Applied Water Allowance. Maximum Applied Water Allowance means, for design purposes, the upper limit of annual applied water for the established landscaped area as specified by the equation below. It is based upon the area's reference evapotranspiration, the ET Adjustment Factor, and the size of the landscaped area. Estimated applied water use may be the sum of the water recommended through the irrigation schedule.

A project's Maximum Applied Water Allowance can be calculated using the following formula:

$$\text{MAWA} = (\text{ETo})(0.8)(\text{LA})(0.62)$$

where:

MAWA = Maximum Applied Water Allowance (gallons per year).

ETo = Reference Evapotranspiration (inches per year). Evapotranspiration means the quantity of water evaporated from adjacent soil surfaces and transpired by plants during a specific time. California has a directory of evapotranspiration tables from around the state. See the Resources section of this guideline.

0.8 = ET Adjustment Factor. This factor, when applied to evapotranspiration, adjusts for plant factors and irrigation efficiency, two major influences upon the amount of water that needs to be applied to the landscape.

LA = Landscaped Area (ft²).

0.62 = Conversion Factor (to gallons per ft²). This converts the maximum applied water allowance from acre-inches per acre per year to gallons per square foot per year.

So, for a landscaped area of 50,000 ft² in Fresno:

$$\begin{aligned}\text{MAWA} &= (\text{ETo})(.8)(\text{LA})(.62) \\ &= (51 \text{ inches})(.8)(50,000 \text{ ft}^2)(.62) \\ &= 1,264,800 \text{ gallons per year (or } 1,691 \text{ hundred-cubic-feet per year: } 1,264,800/748 = 1,691)\end{aligned}$$

Portions of landscaped areas such as parks, playgrounds, sports fields, or schoolyards where turf provides a playing surface or serves other recreational purposes, are considered recreational areas and may require water in addition to the Maximum Applied Water Allowance. A statement should be included



with the landscape design plan, designating recreational areas to be used for such purposes and specifying any needed amount of additional water above the Maximum Applied Water Allowance.

Resources

California Department of Water Resources Model Ordinance is described at:

<http://www.dpla.water.ca.gov/cgi-bin/urban/conservation/landscape/ordinance/index>.

Model reference evapotranspiration: http://www.dpla.water.ca.gov/cgi-bin/urban/conservation/landscape/ordinance/section_495.

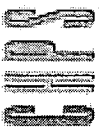

Water Credit 1: Reduce Potable Water for Landscaping

1 point	1.1. Reduce potable water consumption for irrigation by 50% over landscape budget baselines with the use of water-efficient native (or adapted) climate-tolerant plantings, high-efficiency irrigation technologies, or using captured rain or municipally provided reclaimed water.
2 points	1.2. Reduce potable water for site irrigation by additional 50% (100% total reduction). OR do not install permanent landscape irrigation systems.

Significant amounts of potable water are used to irrigate landscaping and playing fields even though non-potable water is equally effective. Water use is a growing issue in California, as expanding populations increase the demand for limited supplies of water. Patterns of precipitation in most of California make it difficult to store enough rainwater for irrigation through the long dry summers. High efficiency irrigation technologies such as micro irrigation, moisture sensors, or weather data-based controllers save water by reducing evaporation and operating only when needed. In urban areas, especially in Southern California, municipally supplied, reclaimed water is an available, less-expensive, and equally effective source for irrigation.

References

CHPS Best Practices Manual, Volume II: Guideline SP6: Drought Tolerant and Pest-Resistant Plants, Guideline SP10: Water-Efficient Irrigation Systems; Guideline SP12: Reclaimed Water for Irrigation.

LEED™ Reference Manual: Water Credit 1: Water Efficient Landscaping.

BEST COPY AVAILABLE



Indoor Systems

Purpose: Maximize water efficiency within buildings to reduce the burden on municipal water supply and wastewater systems.

Water Credit 2: Water Use Reduction

1 point	<u>2.1.</u> Reduce the use of municipally provided potable water for building sewage conveyance by a minimum of 50% through the utilization of water-efficient fixtures and/or using municipally supplied reclaimed water systems.
1 point	<u>2.2.</u> Employ strategies that, in aggregate, reduce potable water use by 20% beyond the baseline calculated for the building (not including irrigation) after meeting the Energy Policy Act of 1992's fixture performance requirements.
2 points	<u>2.3.</u> Exceed the potable water use reduction by 30% beyond the baseline.

The growing value of potable water in California underlines the importance of lowering demand. Water efficiency naturally reduces the amount of water pumped from the ground or transported around the city or state. In addition, water efficiency reduces the cost and amount of sewage needing treatment after use. Because water-efficient devices can vary in quality and performance, specify only durable, high performance fixtures.

A maximum of three points can be earned with this credit. Well designed, water efficient systems may earn points by reducing the amount of potable water used for sewage conveyance (Credit 2.1), and up to two points by reducing the overall amount of potable water used in the schools (Credits 2.2 and 2.3).

Develop a water use baseline including all water consuming fixtures, equipment, and seasonal conditions according to methodology outlined below. Specify water conserving plumbing fixtures that exceed the Energy Policy Act of 1992's fixture requirements in combination with ultra high efficiency or dry fixture and control technologies. Specify high water efficiency equipment (dishwashers, laundry, cooling towers).

Credit 2.1. Use water-efficient fixtures and/or municipally supplied reclaimed water to reduce the amount of potable water used for sewage conveyance. Only those sources that produce blackwater, such as toilets and urinals, are included in this credit. Reclaimed water is suitable for flushing toilets and urinals, which typically produce the largest amounts of wastewater in a school.

To quantify water use reductions, create spreadsheets showing baseline and design water uses. List each fixture that produces blackwater, the amount of daily uses, number of occupants, and total water use. A water-efficient design for a 1,000-student school is shown below. The example assumes the use of low-flow toilets and waterless urinals, all using reclaimed water.

Fixture Type	Flow-rate	Duration	Occupants	Daily Uses	Water Use (gal)
Low-flow Toilet (male)	1.1 gal/flush	1 flush	500	1	550
Waterless Urinal (male)	0.0 gal/flush	1 flush	500	2	0
Low flow Toilet (female)	1.1 gal/flush	1 flush	500	3	1650
Total Daily Volume					2200
Number of School Days					180
Design Total Annual Volume					396,000
Minus Reclaimed Water Use					(396,000)
Total Potable Water Used for Sewage Conveyance					0



1. Calculate Daily Water Use per fixture using the following equation:

$$\text{Daily Water Use} = (\text{Flow-rate}) (\text{Duration})(\text{Occupants})(\text{Daily Uses})$$
2. Sum Daily Water Volumes for each fixture to find Total Daily Volume
3. Multiply the Total Daily Volume by the number of school days for Total Annual Volume.
4. Subtract the amount of reclaimed water used to find Total Potable Water Used for Sewage Conveyance

For the baseline calculation, create a similar spreadsheet but change only the type of fixture and its associated design details. For baseline calculations, assume flow rates outlined by the Energy Policy Act of 1992's fixture performance requirements:

Fixture	EPA Requirements
Toilets	1.6 gal/flush
Urinals	1.0 gal/flush
Showerheads	2.5 gal/min
Faucets	2.5 gal/min
Replacement Aerators	2.5 gal/min
Metering Faucets	0.25 gal/cy

The baseline calculation for this example would therefore be:

Fixture Type	Flow-rate	Duration	Occupants	Daily uses	Water use (gal)
Conventional Toilet (male)	1.6 gal/flush	1 flush	500	1	800
Conventional Urinal (male)	1.0 gal/flush	1 flush	500	2	1000
Conventional Toilet (female)	1.6 gal/flush	1 flush	500	3	2400
Total Daily Volume					4200
Number of School Days					180
Baseline Total Annual Volume					756,000

Comparing the two spreadsheets, the water-efficient fixtures reduced potable water use for sewage conveyance by:

$$\begin{aligned} \% \text{ Savings} &= 1 - (\text{Design Total Annual Volume} / \text{Baseline Total Annual Volume}) \\ &= 1 - (0/756,000) = 1.00 = 100\% \end{aligned}$$

Therefore, this design would earn one point because potable water used for sewage conveyance has been reduced by 100% through using reclaimed water in the toilets and urinals. Note that the low-flow fixtures by themselves were not enough to earn this credit.

Credits 2.2 and 2.3. These credits award reductions in total water use, therefore all water uses are included in the calculations. To quantify water use reductions, create spreadsheets showing baseline and design water uses. List each water-using appliance or fixture, the amount of daily uses, number of occupants, and total water use. Note that to determine the net amount of water used in the calculations, the amount of reclaimed water used for sewage conveyance is subtracted from the total amount of water used. A water-efficient design for the school shown in the previous example is shown below.



Fixture Type	Flow-rate	Duration	Automatic Controls	Occupants	Daily uses	Water use
Low-flow Toilet (male)	1.1 gal/flush	1 flush	-	500	1	550
Waterless Urinal (male)	0.0 gal/flush	1 flush	-	500	2	0
Low-flow Toilet (female)	1.1 gal/flush	1 flush	-	500	3	1650
Bathroom Sink	2.5 gal/min	.25 min	20% saved	1000	3	1500
Low-flow Shower	1.8 gal/min	5 min	-	100	1	900
Low-flow Kitchen Sink	1.8 gal/min	45 min	-	2	2	324
Efficient Washing Machine	20 gal/load	1 load	-	-	10	200
Total Daily Volume						5124
Number of -School Days						180
Subtotal						922,320
Minus amount of reclaimed water used						(396,000)
Design Total Annual Volume						526,320

For the baseline calculation, create a similar spreadsheet but change only the type of fixture and its associated design details. The baseline calculation for this example would therefore be:

Fixture Type	Flow-rate	Duration	Automatic Controls	Occupants	Daily uses	Water use
Conventional Toilet (male)	1.6 gal/flush	1 flush	-	500	1	800
Conventional Urinal (male)	1.0 gal/flush	1 flush	-	500	2	1000
Conventional Toilet (female)	1.6 gal/flush	1 flush	-	500	3	2400
Bathroom Sink	2.5 gal/min	.25 min	-	1000	3	1875
Conventional Shower	2.5 gal/min	5 min	-	100	1	1250
Kitchen Sink	2.5 gal/min	45 min	-	2	2	450
Clothes Washer	40 gal/load	1 load	-	-	10	400
Total Daily Volume						8175
Number of School Days						180
Baseline Total Annual Volume						1,471,500

Comparing the two spreadsheets, the water-efficient fixtures reduced potable water use by:

$$\begin{aligned} \% \text{ Savings} &= 1 - (\text{Design Total Annual Volume} / \text{Baseline Total Annual Volume}) \\ &= 1 - (526,320 / 1,471,500) = 0.64 = 64\% \end{aligned}$$

Therefore, this design would earn two points because overall potable water use has been reduced by over 30%.

Resources

CHPS Best Practices Manual, Volume II: OS6: Efficient Terminal Devices; OS7: Waterless Urinals.

LEED™ Reference Guide: Water Credit 2: Innovative Waste Water Technologies; Water Credit 3: Water Use Reduction.

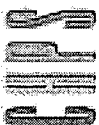

ENERGY

Energy Efficiency

Purpose: Reduce environmental impacts and increased operational costs associated with excessive energy use.

Energy Prerequisite 1: Minimum Energy Performance

<i>Required</i>	<p>P1.1. The school design must exceed the Title 24-2001 California energy efficiency standards by 10%.</p> <p>OR the following prescriptive package energy conservation measures must be included in the design:</p> <ol style="list-style-type: none">1. Energy efficient lighting with occupancy controls.2. Economizers on packaged equipment.
-----------------	---

Energy-efficient schools save money while conserving non-renewable energy resources and reducing atmospheric emissions of pollutants and greenhouse gases. Since its inception in the late 1970s, the state energy code, Title 24, has been very effective in reducing energy use: Californians are the second smallest energy user per capita in the nation. Title 24 was last updated in 2001, and although the code was made more stringent, there are numerous cost-effective, practical, and straightforward measures that can reduce energy use by over 30% from Title 24-2001. Note that Title 24-2001 currently covers only *regulated* energy, and does not include plug loads (including kitchen and lab equipment). School designs may comply with this credit by using performance or prescriptive approaches.

Energy efficiency will not happen in a vacuum. Commissioning, maintenance, and training are vitally important to the performance of the school and its systems. Commissioning involves a rigorous quality assurance program that ensures the building is designed appropriately and built as it is designed. No building can perform optimally without maintenance. Training is critically important to ensure that the teachers and maintenance staff understand how to maintain and operate the building systems. When turnover occurs, appropriate documentation must be on-hand to ensure that new team members are properly trained.

Performance Approach. The school must use 10% less source energy than the Title 24 baseline building. These calculations must be modeled in compliance with all the rules outlined in the California Alternative Compliance Manual (ACM). It provides guidance for establishing building base case development and analysis.

Prescriptive Approach. Alternatively, schools that incorporate the prescriptive package of energy conservation measures listed below are assumed to be at least 10% more efficient than Title 24-2001:

1. Use energy-efficient lighting and occupancy sensors to achieve an average adjusted lighting power density (LPD) of 0.95 W/ft² for the entire school. Energy-efficient lighting reduces the LPD directly by using less energy to deliver the same amount of light to the space. The CHPS Best Practices Manual dedicates an entire chapter to efficient lighting, including three classroom designs. The recommended approach is to install three rows of two-lamp suspended direct/indirect luminaries. Additional guidelines are provided for gyms, corridors, restrooms, libraries, and other spaces.



BEST COPY AVAILABLE

Occupancy sensors employ motion detectors to shut lights off in unoccupied spaces; they should be used in all classrooms, storage spaces, and offices where appropriate. Occupancy sensors are “control credits” in Title 24 that lower the adjusted LPD by 10-60% depending on the space type. Consult Title 24-2001 and the associated Non-Residential Manual and ACM Manual for more information.

To comply with this pre-requisite, use a weighted average of LPD by space type to calculate the average adjusted LPD for the entire school:

$$\text{Average Adjusted LPD} = \sum_{i=1}^n a_i \text{LPD}_i$$

Where:

n = number of spaces within the school with similar lighting and control designs.

a = the percent (expressed as a decimal) of the school square footage used by a particular space type, lighting design, and controls.

LPD = the lighting power density, adjusted appropriately for occupancy sensor “control credits” of a particular space type within the building.

2. Specify and install economizers on all package HVAC systems that utilize return air. Economizers save energy by using outside air instead of return air when it is more economical to do so. For example, if the outside air is closer to the desired thermostat setting than the return air, more outside air is used because less energy is needed to cool it. The moderate California climates allow economizers to be used frequently throughout the year, saving significant amounts of energy.

Integrated economizers should be used whenever feasible. They are more energy efficient and require less maintenance than non-integrated economizers. Care must be taken to train the maintenance staff to ensure that the economizers are not disabled unnecessarily.

Resources

CHPS Best Practices Manual, Volume II. Energy efficiency is affected by most of the guidelines. In particular, consult the Daylighting, Electric Lighting, HVAC, Building Envelope, and Site Planning Chapters.

Three documents from the California Energy Commission give detailed descriptions of the state energy code. Access them all at <http://www.energy.ca.gov>.

- Title 24-2001 Regulations is the actual energy code text.
- The Nonresidential Manual thoroughly explains the nonresidential requirements of Title 24-2001. This is the reference for interpreting the code language.
- The Nonresidential Alternative Calculation Method (ACM) Approval Manual is primarily intended for those persons who want to design a calculation computer program for use with the energy standards. Because it describes all of the underlying computer baseline and modeling assumptions, it is also used as a resource for those preparing energy models. The Nonresidential ACM Manual itself is not used for compliance with the Energy Efficiency Standards.



Energy Credit 1: Superior Energy Performance

1.1. By integrating the design of system components to increase energy efficiency, reduce the source energy of the proposed design to be below what is required by the California energy efficiency standards (Title 24).

2 points	15% reduction in total net energy use compared to Title 24-2001 baseline.
4 points	20% reduction in total net energy use compared to Title 24-2001 baseline.
6 points	25% reduction in total net energy use compared to Title 24-2001 baseline.
8 points	30% reduction in total net energy use compared to Title 24-2001 baseline.
10 points	35% reduction in total net energy use compared to Title 24-2001 baseline.

OR

4 points	Incorporating the following design elements into the school: <ol style="list-style-type: none">1. All of the prescriptive measures detailed in Energy Prerequisite 1.2. Daylighting, with daylighting controls installed on 40% of lights.3. Radiant barrier or increased roof insulation.
----------	--

Investments in energy efficiency measures are cost-effective, and net reductions of 20% to 30% are feasible. A wide array of measures can reduce energy use, with the amount of energy saved depending on local climate, the quality of the design, whether the interactions between the building systems have been optimized, the extent of commissioning, and the amount of training given to teachers and staff. Consider opportunities throughout the school in the following areas:

- Daylighting: optimize the daylighting design to minimize glare and eliminate direct beam light in the classroom, use daylighting controls designed to dim or turn-off electric lights when sufficient daylight is available.
- HVAC systems: use high efficiency equipment, correctly size for the estimated demands of the facility, use economizers and other controls that optimize system performance.
- Electric lighting: use high efficiency products, optimize the number of light fixtures in each room, use occupant sensors and other control devices that ensure peak system performance, successfully integrate electric lighting and daylighting strategies.
- Enclosure: Ensure that walls, floors, roofs, and windows of the school are as energy efficient as cost-effectively possible.
- Commissioning. Commissioning is increasingly important as more savings are expected through energy conservation measures. It ensures that the school is built as designed, and operates as expected. See Credit 4: Commissioning for more information.

Performance Approach. Include additional integrated design measures to increase the energy efficiency of the school. Perform energy analysis for selected design elements that affect energy performance and document compliance. Follow the requirements and guidelines outlined in the Title 24 ACM manual. The unit of measure for performance is source energy. The design earns from two to 10 points, based on the level of savings achieved. Interpolation to whole number point levels is allowed. For example, 22.5% savings would earn five points. Extrapolation is not allowed.

Prescriptive Approach. Alternatively, designs that incorporate the following measures are assumed to save 20% of baseline energy and therefore earn four points:

1. All measures detailed in the prescriptive approach of Energy Prerequisite 1.



BEST COPY AVAILABLE

2. Use daylighting and dimming controls. Incorporate daylighting throughout the school so that 40% of the installed electrical lighting is dimmed or turned off when sufficient natural light is present. Lighting controls can be “dimming” or “stepping” technologies. All school spaces can be designed to utilize natural daylight, but classrooms should be prioritized due to the proven correlations between quality daylighting design and improved student performance. Daylighting is encouraged throughout all spaces in the school.
3. Use a radiant barrier in the attic following the guideline in the CHPS Best Practices Manual (Guideline IN4: Radiant Barriers). Radiant barriers lower cooling loads by reflecting solar radiation before it can penetrate and heat building interiors.

Resources

CHPS Best Practices Manual, Volume II. Much of Volume II is dedicated to energy efficient design strategies including the chapters on Daylighting, Electric Lighting, HVAC, and Building Envelope.

LEED™ Reference Guide: Energy and Atmosphere Credit 1: Optimize Energy Performance.

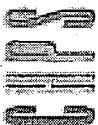

Energy Credit 2: Natural Ventilation

1 point	<u>2.1.</u> Install interlocks to turn off HVAC systems if operable windows or doors are opened.
3 points	<u>2.2.</u> Design 90% of permanent classrooms without air conditioning.

Credit 2.1. It is recommended that each classroom have an operable window. IEQ Credit 1 (Daylighting) has one point for view windows in classrooms and IEQ Credit 6 (Teacher Control) offers another credit if the window is operable. However, care must be taken to properly control the operable windows with interlocked controls.

Each year, significant amounts of energy are lost when teachers or staff members open exterior doors or windows while HVAC systems are operating. Interlocks should be installed to stop HVAC systems when windows and doors are opened for extended periods. Controls must be included so that normal use of the doors does not cause the HVAC systems to cycle on and off unnecessarily, and teachers must be educated on how the system works and why it is needed. In addition, the interlocks should not turn off the ventilation fans, only the mechanical compressors. Adequate amounts of ventilation must be supplied to the classroom at all times.

However, with proper design and adequate maintenance, teachers should have no *reason* to open the doors. If the ventilation system cannot remove stale air and odors, teachers are often forced to open exterior doors or windows to improve comfort. Portables are particularly susceptible to this problem, especially if the HVAC systems are not ducted. Other times, in spaces with small or no windows, teachers and staff open the doors for a connection to the outdoors. Both of these issues can, and should, be addressed with better design and adequate maintenance. Insufficient ventilation can have serious health effects on the students, teachers, and other staff members.

Credit 2.2. Natural ventilation is a comfortable, effective, and efficient option for some climate zones in California. It is critically important to verify that required ventilation levels can be maintained through natural ventilation, and that no outdoor pollutants (from traffic, industrial sources, or the potential for air quality emergencies) eliminate its feasibility. To meet Title 24 ventilation standards, all occupants must be within 20 feet of an operable window. For a standard classroom, this would require that operable windows be installed on both sides. If this design is not possible, ventilation systems with exhaust fans would need to be installed to provide the minimum required ventilation levels. In-line fans designed for radon removal provide one low-power option.

Air conditioning systems prohibited by this credit include all air- and water-source packaged air conditioners or heat pumps. Direct/indirect evaporative systems without compressed refrigerant can be used and still receive this credit.

Resources

CHPS Best Practices Manual, Volume II: Guideline TC1: Cross Ventilation; Guideline TC2: Stack Ventilation; Guideline TC3: Ceiling Fans.

BEST COPY AVAILABLE



Alternative Energy Sources

Purpose: Reduce environmental impacts and increased operational costs associated with excessive energy use.

Energy Credit 3: Renewable Energy and Distributed Generation

3.1. Use on-site renewable energy and distributed generation for a portion of a school's energy use. The table below shows the point levels corresponding to the percentage of net energy use supplied by alternative sources.

For Renewable Energy Sources	For On-site Distributed Generation	% of Net Energy Supplied from Alternative Sources
2 points	1 point	5%
3 points	1 point	7.5%
4 points	2 points	10%
5 points	3 points	20%
6 points	4 points	50%

Employ on-site renewable energy technologies or distributed generation to supply part of the building energy. Systems include:

Renewable Energy Sources	Distributed Generation
Photovoltaics	Fuels cells utilizing non-renewable fuels and waste heat recovery.
Wind	Microturbine utilizing waste heat recovery.
Geothermal (not including ground source heat pumps)	
Fuel cells utilizing biogas	

On-site renewable energy and distributed generation have many benefits. Renewable sources, such as photovoltaics, wind turbines, and geothermal sources, use the sun, air, and earth instead of non-renewable, polluting sources, such as coal or natural gas. The distributed generation systems listed in the table above all use non-renewable fuels. However, their improved efficiencies and technologies produce less air pollutants than traditional, centrally-located coal or natural gas plants. Fuel cells can be powered by either renewable (biogas) or non-renewable (natural gas) sources, and are included in both categories.

Sources covered under this credit must be located at the school site, eliminating the environmental impacts and transmission losses associated with remote sources. On-site sources can become very effective components of school curriculums, educating students on a wide variety of energy and science issues. Off-site renewables are covered under District Credit 5 Green Power.

The costs and feasibility of on-site renewables and distributed generation vary significantly with location, technology, site-specific constraints, and maintenance concerns. Typical school installations supply less than 5% of total energy. Renewable systems generally reach a point of diminishing returns before they supply 100% of total energy. Incentive or "buy-down" programs from state or local energy providers can substantially reduce first-costs.

Sources should be installed using net metering. Net metering attaches the on-site system to the electrical power grid. When the school produces more energy than it is uses, the excess energy is traded back to the local energy provider. In essence, this "spins the meter backwards" and is vital to the cost-effectiveness of the system. At the time of this writing (Fall 2001), facilities with on-site renewables and



net metering could only receive credit up to the amount of energy they used. In other words, buildings could only “zero-out” their utility bill and not make a profit from selling their excess energy.

To earn points with this credit:

1. Model the school building to estimate the amount of energy used annually (Q_{school}). Employ figures from Energy Prerequisite 1 or Energy Credit 1 if the performance approach is used.
2. Calculate the amount of energy the particular on-site renewable or distributed generation system can supply annually ($Q_{\text{alternative}}$).
3. Calculate the net amount of energy provided by renewables ($Q_{\text{alternative}}/Q_{\text{school}}$).

Resources

CHPS Best Practices Manual, Volume II: Guideline OS1: Photovoltaics.

LEED™ Reference Guide: Energy and Atmosphere Credit 2: Renewable Energy.



Commissioning and Training

Purpose: Verify that fundamental building elements and systems are designed, installed, and calibrated to operate as intended, and provide for the ongoing accountability and optimization of building energy performance over time.

Energy Prerequisite 2: Fundamental Building Systems Testing and Training

<i>Required</i>	<p>P2.1. A third party or district official must verify that the following critical building systems have been tested prior to occupancy:</p> <ul style="list-style-type: none"> ▪ Controls (daylight, occupancy, light switching). ▪ HVAC (ducts, economizers, timeclocks, air balance, airflow, refrigerant charge). ▪ Energy Management System.
<i>Required</i>	<p>P2.2. Effective and complete training and documentation must be provided, including a complete guide for staff, short operations briefs for all classrooms, and facilitation of training programs for school administrators, teachers, and staff. Training is an essential step to protect indoor air quality and maintain superior energy performance. Maintenance and record keeping must meet the requirements of the Cal/OSHA Minimum Building Ventilation Standard, Title 8, Sec. 5142.</p>

Prerequisite P2.1. Verification of system performance and training of staff is typically included in current practice. However, this prerequisite requires a third party or district official to perform, monitor, or verify the testing. Training the teachers and staff is essential to performance of the building, but often it is either not performed or hastily completed.

Prerequisite P2.2. The design and construction of the school may incorporate all the latest high performance features, yet problems can occur simply because important information was not transferred from the design and construction teams to the teachers and other school staff. The following required actions help ensure that the facilities staff, teachers, and others understand their role.

- **Operations & Maintenance Manual:** Provides detailed operations and maintenance information for all equipment and products in use in the school. A short, classroom "user's guide" must be created for teachers explaining how to operate their room lighting and HVAC systems.
- **O&M Training:** Provides a short introduction for all school staff, and then features a special hands-on workshop for facility personnel.
- **Cal/OSHA requirements** are available online at: <http://www.dir.ca.gov/title8/5142.html>. The regulations include:
 1. The HVAC system shall be inspected at least annually, and problems found during these inspections shall be corrected within a reasonable time.
 2. Inspections and maintenance of the HVAC system shall be documented in writing. The employer shall record the name of the individual(s) inspecting and/or maintaining the system, the date of the inspection and/or maintenance, and the specific findings and actions taken. The employer shall ensure that such records are retained for at least five years.



3. The employer shall make all records required by this section available for examination and copying, within 48 hours of a request, to any authorized representative of the Division (as defined in Section 3207), to any employee of the employer affected by this section, and to any designated representative of said employee of the employer affected by this section.

Resources

CHPS Best Practices Manual, Volume II: Guideline GC5: Contractor's Commissioning Responsibilities.

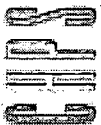

Energy Credit 4: Commissioning

2 points	<p>4.1. Implement ALL of the following fundamental best practice commissioning procedures:</p> <ol style="list-style-type: none"> 1. Engage a commissioning agent. 2. Develop design intent and basis of design documentation. 3. Include commissioning requirements in the construction documents. 4. Develop and utilize a commissioning plan. 5. Verify installation, functional performance, training, and documentation. 6. Complete a commissioning report.
1 point	<p>4.2. In addition to Credit 4.1 above, implement the following commissioning tasks:</p> <ol style="list-style-type: none"> 1. Conduct a focused review of the design prior to the construction documents phase. 2. Conduct a focused review of the construction documents when close to completion. 3. Conduct a selective review of contractor submittals of commissioned equipment. 4. Develop a system and energy management manual. 5. Have a contract in place for a near-warranty end, or post-occupancy, review. <p>Note: The design firm cannot perform items 1, 2, and 3.</p>

Do not underestimate the value of commissioning.

Buildings, even simple structures, are complex systems of electrical, mechanical, and structural components. High performance buildings are healthy, efficient, environmentally sensitive structures whose performance can be significantly affected if the building has not been designed following the district's intent or constructed according to the designers' specifications. Commissioning is a rigorous quality assurance program administered by a knowledgeable third party that ensures the building performs as expected.

The requirements of this credit are split into two levels of commissioning. The first credit (4.1) should be a part of all school construction programs. The second credit (4.2) expands the scope to include design, construction documentation, and submittal review.

Credit 4.1. Worth two points, this credit requires the following commissioning procedures. For a more thorough discussion of the requirements, see the LEED™ Reference Guide: -Energy Prerequisite 1.

1. **Engage a commissioning agent.** The commissioning agent (CA) directs the commissioning process and should be engaged as early in the design as possible. CHPS recommends that the CA be an independent third party. If this is not possible, a member of the design firm may be designated for this role as long as he or she is not responsible for project design, construction management, or supervision.



2. **Develop design intent and basis of design documentation.** The CA must write a list of the owner's requirements and design intent for each of the systems or features to be commissioned.
3. **Develop commissioning plan.** The commissioning plan includes a list of all equipment to be commissioned, delineation of roles for each of the primary commissioning participants, and details on the scope, timeline, and deliverables throughout the commissioning process.
4. **Include commissioning requirements in the construction documents.** All commissioning requirements must be integrated into the construction documents to clearly specify the responsibilities and tasks to be performed. Of particular importance are the delineation of the contractors' responsibilities and the creation of the Operations and Maintenance Manuals.
5. **Verify installation, functional performance, training, and documentation for each commissioned system and feature.**
6. **Complete a commissioning report.** The report must show that the building's systems have met the design intent and specifications, have been properly installed, are performing as expected, and that proper O&M documentation and training have been provided.

Credit 4.2. This credit expands the role of the CA to include review of the design, construction documents, and submittals beyond the tasks required by Credit 4.1. In addition, the CA must develop an indexed Recommissioning Management Manual and return for a post-occupancy review of the school. For a more thorough discussion of the requirements, see the LEED™ Reference Guide: Energy and Atmosphere Credit 3.

Resources

CHPS Best Practices Manual, Volume II: Guideline GC5: Contractor Commissioning Responsibilities.

LEED™ Reference Manual: Energy and Atmosphere Prerequisite 1: Energy and Atmosphere Credit 3.

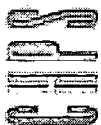

Energy Credit 5: Energy Management Systems

1 point	<p>5.1. Install an Energy Management System to monitor the energy use of the following systems throughout the school (including all portables):</p> <ul style="list-style-type: none">▪ Lighting (Internal and external)▪ Equipment (plug loads)▪ HVAC (heating, cooling, fans)▪ Hot water; <p>AND either the Energy Management System or other devices (e.g. occupancy sensors) must control all lighting and HVAC systems to Title 24 minimum standards in all spaces, including portables used on the school site.</p>
---------	--

Energy management systems (EMS) are typically installed in new schools. However, care must be taken to specify and install an appropriate system for the district and maintenance staff. An appropriate EMS is the simplest system that still addresses the school's needs. Increased complexity does not always mean increased value for the district. EMS systems can potentially save significant energy, but only if the staff understands how to operate it. Proper training of district staff is critical, and high turnover rates continue to challenge school districts.

Monitoring capabilities should allow for comparison between various types of building loads throughout all spaces of the school (including portables). This information is valuable and can be used to manage and optimize energy use. Minimum control capabilities are necessary to implement Title 24 requirements.

Resources

CHPS Best Practices Manual, Volume II: Guideline TC23: Adjustable Thermostats; Guideline TC24: EMS/DDC; Guideline EL4: Lighting Controls for Classrooms.

BEST COPY AVAILABLE



MATERIALS

Waste Reduction and Efficient Material Use

Purpose: Reduce the amount of construction and occupant waste entering the landfill and promote the efficient reuse of materials and buildings.

Materials Prerequisite 1: Storage and Collection of Recyclables

<i>Required</i>	<p>P1.1. The building/school shall meet local ordinance requirements for recycling space;</p> <p>AND provide an easily accessible area serving the entire school that is dedicated to the separation, collection, and storage of materials for recycling including—at a minimum—paper (white ledger, mixed, and cardboard), glass, plastics, and metals.</p>
-----------------	--

In California, many local governments have developed ordinances relating to adequate areas for collection and loading of recyclable materials in development projects. Areas without local ordinances should use the model ordinance developed by the California Integrated Waste Management Board and detailed in Appendix A of the Recycling Space Allocation Guide. (<http://www.ciwmb.ca.gov/publications/localasst/31000012.doc>).

Reserve space for recycling functions early in the building occupancy programming process and show areas dedicated to the collection of recycled materials on space utilization plans. Broader recycling space considerations should allow for collection and storage of the required elements, as well as the recycling of newspaper, organic waste (food and soiled paper), and dry waste. When collection bins are used, they should be able to accommodate a 75% diversion rate and be easily accessible to custodial staff and recycling collection workers. Consider bin designs that allow for easy cleaning to avoid health issues. Ensure that the spaces are synergistic with the policies of local waste handling companies.

Resources

California Integrated Waste Management Board Recycling Space Allocation Guide (<http://www.ciwmb.ca.gov/publications/localasst/31000012.doc>).

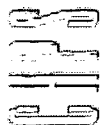

Materials Credit 1: Site Waste Management

Meet local ordinance requirements concerning construction and demolition materials at construction sites, if applicable;

AND develop and implement a waste management plan, quantifying material diversion by weight to:

1 point	1.1. Recycle, compost, and/or salvage at least 50% (by weight) of construction, demolition, and land clearing waste.
2 points	1.2. Recycle, compost, and/or salvage at least 75% (by weight) of the construction, demolition, and land clearing debris.

Develop and specify a waste management plan that identifies licensed haulers and processors of recyclables; identifies markets for salvaged materials; employs deconstruction, salvage, and recycling strategies and processes; includes waste auditing; and documents the cost for recycling, salvaging, and reusing materials. Source reduction on the job site should be an integral part of the plan.

The plan should address recycling of corrugated cardboard, metals, concrete brick, asphalt, land clearing debris (if applicable), beverage containers, clean dimensional wood, plastic, glass, gypsum board, and carpet. It must also evaluate the cost-effectiveness of recycling rigid insulation, engineered wood products, and other materials.

Compliance calculations for this credit must be based on weight. Many recycling and landfill facilities weigh incoming materials. Shipments that cannot be weighed can be estimated based on their volume and density.

$$\text{Recycle Rate (\%)} = \frac{\text{Recycled Waste [Tons]}}{\text{Recycled Waste [Tons] + Garbage [Tons]}} \times 100$$

Resources

CHPS Best Practices Manual, Volume II: Guideline GC2: Construction and Demolition Waste Management.

LEED™ Reference Guide: Materials Credit 2: Construction Waste Management.



Materials Credit 2: Building Reuse

Earn one of the following credits.

1 point	<u>2.1.</u> Reuse large portions of existing structures during renovation or redevelopment projects. Maintain at least 75% of existing building structure and shell (exterior skin and framing, excluding window assemblies).
2 points	<u>2.2.</u> Maintain an additional 25% (100% total) of existing building structure and shell (exterior skin and framing, excluding window assemblies).
3 points	<u>2.3.</u> Maintain 100% of existing building structure and shell; AND 50% non-shell (walls, floor coverings, and ceiling systems).

Reusing parts of the building can save significant money and resources, while greatly reducing the amount of construction waste. When materials are re-used, the environmental benefits start with resource savings and extend down through the entire lifecycle of the material: less energy is spent extracting, processing, and shipping the materials to the site. Depending on the amount of building re-used, school districts can significantly reduce their construction and material costs. However, the building envelope will significantly affect many important high performance areas, such as space programming, energy performance, opportunities for daylighting, and indoor air quality. In addition, care must be taken to ensure that any environmental hazards such as toxins, lead, and asbestos have been identified and addressed. Develop a list of benefits and tradeoffs, and make the decision based upon the overall, integrated design tradeoffs.

Credits 2.1 and 2.2. Percentage of reused structures materials (foundation, slab on grade, beams, floor and roof decks, etc) should be approximated in terms of cubic feet, while shell materials (roof and exterior walls) should be estimated in square feet. Average together the structural and shell reuse percentages for an approximated building reuse factor.

$$\text{Building Reuse (\%)} = \frac{\frac{\text{Reused Structural Elements[cf]} + \frac{\text{Reused Shell Elements[ft}^2\text{]}}{2}}{\text{Total Structural Elements[cf]} + \frac{\text{Total Shell Elements[ft}^2\text{]}}{2}}}{2}$$

Credit 2.3. Percentage of reused, non-shell building portions will be calculated as the total area (ft²) of reused walls, floor covering, and ceiling systems, divided by the existing total area (ft²) of walls, floor covering, and ceiling systems.

Resources

LEED™ Reference Guide: Materials Credit 1: Building Reuse.



Materials Credit 3: Resource Reuse

1 point	<u>3.1.</u> Specify salvaged or refurbished materials for 5% of building materials.
2 points	<u>3.2.</u> Specify salvaged or refurbished materials for 10% of building materials.

Re-used materials or products are salvaged from a previous use or application and then used in a new use or application with only superficial modification, finishing, or repair. Commonly salvaged building materials include wood flooring/paneling/cabinets, doors and frames, mantels, ironwork and decorative lighting fixtures, brick, masonry, heavy timbers, and on-site concrete used as aggregate. Ensure the salvaged materials, especially structural elements, comply with all applicable codes.

Base percentage calculations in terms of dollar value:

$$\text{Salvage Rate [\%]} = \frac{\text{Salvaged Material Cost[\$]}}{\text{Total Material Cost[\$]}} \times 100$$

Exclude all labor costs, all mechanical and electrical material costs, and project overhead and fees. If the cost of the salvaged or refurbished material is below market value, use replacement cost to estimate the material value; otherwise use actual cost to the project. Total material cost is used as the basis of the sustainable material credits.

Resources

CHPS Best Practices Manual, Volume II: Material Selection and Research Section; Interior Surfaces and Furnishings Chapter.

LEED™ Reference Guide: Materials Credit 3: Resource Reuse.



Sustainable Materials

Purpose: Increase demand for building products that have incorporated recycled-content material, reducing the impacts resulting from extraction of new material; reduce the use and depletion of finite raw and long-cycle renewable materials by replacing them with rapidly renewable materials; encourage environmentally-responsible forest management.

Materials Credit 4: Recycled Content

1 point	<p>4.1. Performance Approach: Achieve a minimum recycled content rate of 25% following either:</p> <ul style="list-style-type: none"> ▪ Option1: A weighted average postconsumer recycled-content calculation that rewards products that exceed 20% postconsumer recycled-content material. ▪ Option 2: A summation of all recycled-content materials that each contain a minimum of 50% total recycled content with at least 10% postconsumer recycled content. <p>OR Prescriptive Approach: Specify at least four major materials from the Construction Products category of the EPA Comprehensive Procurement Guidelines 2000 Buy-Recycled Series.</p>
2 points	<p>4.2. Performance Approach: Achieve a minimum recycled content rate of 50% following either:</p> <ul style="list-style-type: none"> ▪ Option1: A weighted average postconsumer recycled-content calculation that rewards products that exceed 20% postconsumer recycled-content material, ▪ Option 2: A summation of all recycled-content materials that each contain a minimum of 50% total recycled content with at least 10% postconsumer recycled content <p>OR Prescriptive Approach: Specify at least eight major materials from the EPA Comprehensive Procurement Guidelines. At least six building materials must be from the Construction Products Category.</p>

The number and variety of products using recycled-content materials expands every year. Using these materials closes the recycling loop by creating markets for materials collected through recycling programs across the country. It also reduces the use of virgin materials and landfill waste. Recycled-content alternatives exist for all major building materials and surfaces. Recycled content is either a postconsumer (collected from end users) or secondary material. Secondary material (also known as post-industrial or pre-consumer) is collected from manufacturers and industry. The objective is to maximize postconsumer recycled content.

The US EPA's Comprehensive Procurement Guideline (CPG) program provides fact sheets for various product categories as well as a list of materials with recommended recycled-content levels. The California Integrated Waste Management Board (CIWMB) Recycled-content Products Database allows you to search for a recycled-content product by product/brand name, company, or keyword. Each product in the database has information on the total recycled content as well as the postconsumer recycled content.



Performance Approach. Chose either option below to earn points in this credit.

Option 1: This option only considers postconsumer recycled content. The weighted average calculation methodology outlined below rewards materials that contain at least 20% postconsumer material by weighting them more heavily. Products with less than 20% are penalized.

1. Sum the Material Cost for all products used in the school to find the **Total Project Material Cost**. Material cost is the construction cost of a material excluding all labor and equipment (mechanical and electrical materials) costs, project overhead, and fees.
2. For each material, calculate the **Postconsumer Recycled-content Value**.

$$\text{Postconsumer Recycled-content Value [\$]} = \text{Material Cost} \times \frac{\text{Post - consumer Recycled - content [\%]}}{20\%}$$

3. Sum these values to obtain the **Total Postconsumer Recycled Content Value**.
4. Calculate the **Recycled-content Rate (%)**.

$$\text{Recycled-content Rate [\%]} = \frac{\text{Total Postconsumer Recycled - content Value [\$]}}{\text{Total Project Material Cost [\$]}}$$

Earn 1 point if: Recycled-content Rate (%) = 25%.

Earn 2 point if: Recycled-content Rate (%) = 50%.

Option 2: This option is consistent with California's State Agency Buy Recycled Campaign (SABRC). Only products with at least 50% total recycled content with a minimum of 10% postconsumer recycled content are included in the calculation.

1. Create a table of all materials used in the project including information on total recycled content and postconsumer recycled content. Sum the cost of all materials used to come up with the **Total Project Material Cost**.
2. Sum the cost of all materials that each have at least 50% total recycled content with a minimum of 10% postconsumer recycled content to find the **Total Recycled-content Material Cost**.
3. Divide the **Total Recycled-content Material Cost** by the **Total Project Material Cost** and multiply by 100 to come up with the total recycled-content rate.

$$\text{Recycled-content Rate [\%]} = \frac{\text{Total Recycled - content Material Cost [\$]}}{\text{Total Project Material Cost [\$]}}$$

Earn 1 point if: Recycled-content Rate (%) = 25%.

Earn 2 point if: Recycled-content Rate (%) = 50%.

Prescriptive Approach. Credit 4.1. Specify at least four major materials from the Construction Products category of the EPA Comprehensive Procurement Guidelines 2000 Buy-Recycled Series. A "major" material is defined as those materials covering more than 50% of a major building surface (such as parking areas, floor, roof, partitions, walls), or serving a structural function throughout the majority of the building. EPA's Comprehensive Procurement Guidelines are available at: <http://www.epa.gov/cpg>. For the purposes of these prescriptive points, nylon carpeting with at least 50% recycled-content materials can be used in addition to the carpet with recycled polyester (PET resin) materials listed on the EPA's site. Some PET carpets do not have enough durability for commercial applications.

Credit 4.2. Eight major materials must be specified from the EPA's Comprehensive Procurement Guidelines, and at least six must be from the construction products category.

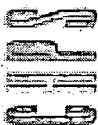

Resources

CHPS Best Practices Manual, Volume II: Interior Surfaces and Finishes Chapter.

LEED™ Reference Guide: Materials Credit 4: Recycled Content.

State Agency Buy Recycled Campaign (SABRC) at <http://www.ciwmb.ca.gov/BuyRecycled/StateAgency/>

California Integrated Waste Management Board (CIWMB) Recycled-content Products Database:
<http://www.ciwmb.ca.gov/rcp>

EPA's Comprehensive Procurement Guideline (CPG) Program: <http://www.epa.gov/cpg>

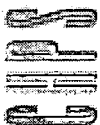

Materials Credit 5: Rapidly Renewable Materials

1 point	5.1. Specify rapidly renewable building materials for 5% of total building materials.
---------	---

Rapidly renewable resources are those materials that substantially replenish themselves faster than traditional extraction demand (e.g. planted and harvested in less than a 10 year cycle); do not result in significant biodiversity loss, increased erosion, and air quality impacts; and that are sustainably managed. Products in this category include, but are not limited to, bamboo products, wheat grass cabinetry, oriented strand board and other wood products made from fast-growing poplar and Monterey pine trees, and linoleum. Ensure that the products protect indoor air quality and are durable.

To earn this credit, determine the percentage of total building materials from rapidly renewable sources. Exclude all labor costs, all mechanical and electrical material costs, and project overhead and fees.

$$\text{Rapidly Renewable Material Portion [\%]} = \frac{\text{Rapidly Renewable material cost[\$]}}{\text{Total material cost[\$]}} \times 100$$

Resources

CHPS Best Practices Manual: Volume II: Interior Surfaces and Finishes Chapter.

LEED™ Reference Guide: Materials Credit 6: Rapidly Renewable Materials.



Materials Credit 6: Certified Wood

1 point	6.1. Use a minimum of 50% of wood-based materials certified in accordance with the Forest Stewardship Council guidelines for wood building components. This includes, but is not limited to, framing, flooring, finishes, furnishings, and non-rented temporary construction applications such as bracing, concrete form work, and pedestrian barriers.
---------	---

Refer to the Forest Stewardship Council guidelines for wood building components that qualify for compliance to the requirements and incorporate them into the material selection for the project.

For earn this credit, determine the percentage of total new wood based products that are FSC-certified. Exclude all labor costs, all mechanical and electrical material costs, and project overhead and fees.

$$\text{Certified Wood Material Portion [\%]} = \frac{\text{FSC Certified Wood Products Cost cost [\$]}}{\text{Total New Wood Based Products cost[\$]}} \times 100$$

Resources

CHPS Best Practices Manual, Volume II: Guideline IS5: Wood Flooring; Guideline IS11: Casework and Trim; Guideline IS12: Interior Doors.

LEED™ Reference Guide: Materials Credit 7: Certified Wood.



INDOOR ENVIRONMENTAL QUALITY

Daylighting

Purpose: Improve student productivity through quality daylighting designs that minimize glare and direct sunlight penetration. Provide a connection between indoor spaces and the outdoor environment through the introduction of sunlight and views into the occupied areas of the building.

IEQ Credit 1: Daylighting in Classrooms

3 points	1.1. Achieve a 2% minimum Daylight Factor of uniformly distributed daylighting with no direct sunlight penetration in 75% of all classroom space, not including copy rooms, storage areas, mechanical, laundry, and other low occupancy support areas.
1 point	1.2. Direct line of sight to vision glazing from 90% of classrooms, administration areas, and all regularly occupied spaces, not including copy rooms, storage areas, mechanical, laundry, and other low occupancy support areas.

Credit 1.1. Daylighting is fundamentally important to high performance design, and should be the primary source of light in classrooms.

To earn this credit, 75% of the classrooms in the school must have a minimum Daylight Factor of 2%. The Daylight Factor is simply the ratio of exterior to interior illumination:

$$\text{Daylight Factor [\%]} = \frac{\text{Light at Task Levels in Classroom [fc or lux]}}{\text{Outdoor Daylight [fc or lux]}} \times 100$$

Follow the guidelines in the Daylighting Chapter of the CHPS Best Practices Manual to create a suitable daylighting strategy. Daylighting in classrooms must be uniformly distributed, with no direct-beam, sunlight penetration and minimized glare. The guidelines thoroughly discuss several different approaches to classroom daylighting, including the use of clerestories, light shelves, and toplighting.

Always orient the school to maximize daylighting options. Do not overglaze the space. Daylighting in classrooms should not exceed 200 footcandles during peak periods.

Credit 1.2. To earn this credit, 90% of all classroom, administration areas, and other regularly occupied spaces must contain direct line of sight glazing to the outdoors. Windows below 2.5' or above 7.5' do not qualify.

Resources

CHPS Best Practices Manual: Volume II: Daylighting and Fenestration Design Chapter.

LEED™ Reference Guide: Indoor Environmental Quality Credit 8: Daylighting.



Indoor Air Quality

Purpose: Achieve good indoor air quality to protect student and staff health, performance, and attendance.

IEQ Prerequisite 1: Minimum Requirements

<i>Required</i>	<p>P1.1. Meet the performance requirements of Cal/OSHA Minimum Ventilation Standard, Title 8, Sec. 5142, including:</p> <ul style="list-style-type: none"> (a) Design building ventilation systems to ensure that the continuous delivery of outside air is no less than the governing design standard (currently CEC Title 24: 15 cfm per person); (b) AND will occur at all times rooms are occupied. The design must ensure that the supply operates in continuous mode and is not readily defeated (i.e., blocked registers or windows) during occupancy periods.
<i>Required</i>	<p>P1.2. Meet the minimum requirements of voluntary consensus standard ASHRAE 62-1999, Ventilation for Acceptable Indoor Air Quality for areas not covered by Cal/OSHA Minimum Ventilation Standard.</p>
<i>Required</i>	<p>P1.3. All surface grades, drainage systems, and HVAC condensate must be designed to prevent the accumulation of water under, in, or near buildings (especially portables).</p>
<i>Required</i>	<p>P1.4. Irrigation systems must not spray on buildings.</p>
<i>Required</i>	<p>P1.5. During construction, meet or exceed all of the following minimum requirements:</p> <ul style="list-style-type: none"> ▪ Mold protection: Building materials, especially those like wood, porous insulation, paper, and fabric, should be kept dry to prevent the growth of mold and bacteria. Cover these materials with plastic to prevent rain damage, and if resting on the ground, use spacers to allow air to circulate between the ground and the materials. Water damaged materials should be dried within 24 hours. Due to the possibility of mold and bacteria growth, materials that are damp or wet for more than 72 hours may need to be discarded. Immediately remove materials showing signs of mold and mildew, including any with moisture stains, from the site and properly dispose of them. Replace moldy materials with new, undamaged materials. ▪ Filters: Replace all filtration media immediately prior to occupancy. Filtration media shall have a Minimum Efficiency Reporting Value (MERV) of 13 as determined by ASHRAE 52.2-1999.

Supplying non-polluted outdoor air ventilation to classroom areas is critical to the protection of good indoor air quality. Ensure that the ventilation system's outdoor air capacity can meet standards in all modes of operation. Locate building outdoor air intakes away from loading areas, building exhaust fans, cooling towers, and other sources of contamination.

Note that compliance with code minimums will not ensure good indoor air quality. Minimizing emissions from materials (IEQ Credit 2), controlling point sources of pollution (Credit 3), performing measures during



construction (IEQ Credit 4), commissioning (Energy Credit 4), and regular maintenance (District Credit 3) are all critically important to protecting indoor air quality.

For intake sitings, consider both current and future traffic and development patterns and consult the local Air Pollution Control Officer to locate nearby emission sources. Local air quality may impact decisions to use natural ventilation or may justify improved air filtration.

P1.1. All regularly occupied spaces must be ventilated. Cal/OSHA requires that the HVAC shall be operated continuously during working hours except:

- during scheduled maintenance and emergency repairs.
- during periods not exceeding a total of 90 hours per calendar year when a serving electric utility by contractual arrangement requests its customers to decrease electrical power demand.
- during periods for which the employer can demonstrate that the quantity of outdoor air supplied by non-mechanical means meets the outdoor air supply rate required by Title 24.

The Cal/OSHA requirements are available at: <http://www.dir.ca.gov/title8/5142.html>.

P1.2. For areas not covered by Cal/OSHA, ventilation systems must meet the minimum requirements of voluntary consensus standard ASHRAE 62-1999, Ventilation for Acceptable Indoor Air Quality.

P1.3. Due to extreme health risks that can be caused by mold and microbial growth, all surface grades, drainage systems, and HVAC condensate must be designed to prevent the accumulation of water under, in, or near buildings. Portables are particularly vulnerable, and must be placed on properly drained surfaces.

P1.4. Permanent irrigation systems that spray on buildings can cause major structural damage and mold growth. Do not install irrigation systems in locations where they spray directly on buildings.

P1.5. Construction activities affect indoor air quality. Mold protection and changing filters are prerequisites; additional measures are covered under IEQ Credit 4.



IEQ Credit 2: Low-Emitting Materials

1 to 4 points	<p>2.1. Receive one point (with a maximum of four) for each of the following products tested with the protocols detailed in the CHPS Material Specifications Section 1350 and found to have chemical concentration under the specified limits:</p> <ul style="list-style-type: none">▪ Adhesives, sealants, and concrete sealers.▪ Carpet, resilient flooring.▪ Paint.▪ Building insulation.▪ Gypsum board.▪ Acoustical ceilings or wall panels.▪ Wood flooring, composite wood boards.
---------------	--

Many common indoor building and surfacing materials contain a variety of carcinogenic and/or toxic chemicals. These chemicals are released into the air and can cause a variety of health problems, from irritating odors to major health problems. Because a single material can off-gas enough toxins to cause health problems, it is important to evaluate and specify materials that are low emitting, non-irritating, nontoxic, and chemically inert. This is especially important in schools because children are more susceptible than adults to indoor air pollutants.

CHPS has developed sample material specifications to identify materials that will not compromise the health of students and staff. The CHPS material specifications (available from www.chps.net) identify over 60 specific chemicals that have been found to impact human health and the maximum emission levels for each. Designers should request emissions test data from manufacturers to ensure that the chemical emissions are within safe exposure levels.



IEQ Credit 3: Pollutant Source Control

1 point	<p>3.1. Design to minimize cross-contamination of regularly occupied areas by chemical pollutants:</p> <p>Control surface dust by covering all exposed dirt, providing walk-off mats at all entrances, and not installing deep-pile carpets;</p> <p>AND where chemical use occurs (including housekeeping areas, chemical mixing areas, copying/print rooms), use structural deck-to-deck partitions with separate outside exhausting, no air recirculation, and negative pressure;</p> <p>AND install low-noise, vented range hoods for all cooking appliances (such as stoves, ovens) and chemical mixing areas in lab or prep spaces;</p> <p>AND provide drains with plumbing appropriate for disposal of liquid waste in spaces where water and chemical concentrate mixing occurs.</p>
1 point	<p>3.2. Install ducted HVAC returns to avoid the dust and microbial growth issues associated with plenum returns.</p>
1 point	<p>3.3. Use particle arrestance filtration rated at greater than 65% in all mechanical ventilation systems.</p>

Credit 3.1. Design to physically isolate activities associated with chemical contaminants from other locations in the building, and provide dedicated systems to contain and remove chemical pollutants from source emitters at source locations. Eliminate or isolate high hazard areas and design all housekeeping chemical storage and mixing areas (central storage facilities and janitors closets) to allow for secure product storage. Design copy/fax/printer/printing rooms with structural deck-to-deck partitions and dedicated exhaust ventilation systems.

Credit 3.2. Plenum returns are easily contaminated with dust and microbial growth. Ducted returns, though more expensive, will help prevent such problems and reduce maintenance and repairs.

Credit 3.3. Filters rated at greater than 65% will remove more pollutants from the air used to ventilate the school.

BEST COPY AVAILABLE



IEQ Credit 4: Construction IAQ Management Plan

<p>1 point</p>	<p>4.1. During construction, meet or exceed all of the following minimum requirements: Temporary construction ventilation: Continuously ventilate during installation of materials that emit Volatile Organic Compounds (VOC) and after installation until emissions dissipate. Follow the recommended ventilation times in the CHPS Specification Section 1350, or ventilate for 72 hours, if not specified. Ventilate areas directly to outside areas; do not ventilate to other enclosed spaces. If continuous ventilation is not possible via the building’s HVAC system(s), then ventilate via open windows and temporary fans that sufficiently provide no less than three air changes per hour.</p> <ul style="list-style-type: none"> ▪ Dust protection: Turn the ventilation system off, and protect HVAC supply and return openings from dust infiltration during dust producing activities (e.g. drywall installation and finishing). Provide temporary ventilation as required. ▪ Preconditioning: Allow products that have odors and significant VOC emissions to off-gas in dry, well-ventilated space for a sufficient period to dissipate odors and emissions prior to delivery to the construction site. Condition products without containers and packaging to maximize off-gassing of VOCs. Condition products in a ventilated warehouse or other building. Comply with substitution requirements for consideration of other locations. ▪ Sequencing: Where odorous and/or high VOC-emitting products are applied on-site, apply them prior to installation of porous and fibrous materials. Where this is not possible, protect porous materials with polyethylene vapor retarders. . ▪ HEPA vacuuming and duct cleaning: Vacuum carpeted and soft surfaces with a high-efficiency particulate arrestor (HEPA) vacuum. If ducts contain dust and dirt, clean them using a HEPA vacuum immediately prior to substantial completion and prior to using the ducts to circulate air. Oil film on sheet metal should be removed before shipment to site. However, ducts will be inspected to confirm that no oil film is present. Remove any oil.
<p>1 point</p>	<p>4.2. Building shall be flushed-out continuously for at least 30 days prior to substantial completion. When the contractor is required to perform touch-up work, provide temporary construction ventilation during installation and extend the building flush-out by a minimum of four days after touch-up installation, with 100% tempered outside air for 24 hours each day.</p>

Credit 4.1. Each of the listed construction practices will improve indoor air quality by minimizing the amount of indoor pollutants that are distributed and retained by the surface materials and ventilation systems during construction.

Credit 4.2. Flushing out the building with 100% outside air will help remove indoor pollutants prior to occupancy. Do not “bake out” the building by increasing the temperature of the space.

Resources

CHPS Best Practices Manual, Volume II: Guideline GC3: Indoor Air Quality During Construction.



Acoustics

Purpose: Design HVAC systems and classrooms to provide acoustic levels that do not interfere with student and teacher productivity.

IEQ Prerequisite 2: Minimum Acoustical Performance

<i>Required</i>	P2.1. Classrooms must have: <ul style="list-style-type: none">▪ Maximum unoccupied background noise levels of 45 dBA.▪ 0.6-second maximum (unoccupied) reverberation times.
-----------------	---

Student learning suffers in acoustically poor environments. Excess noise from exterior sources, loud HVAC systems, or other nearby rooms can make it difficult, and sometimes impossible, for students and teachers to communicate.

The purpose of this prerequisite is to eliminate the worst performing acoustical environments. Background noise levels of 45 dBA are not sufficient for classrooms with young children, students with limited English proficiency, and those with hearing impairments or language disorders. **Districts and designers are strongly encouraged to move beyond these prerequisites and achieve background noise levels of 35 dBA for all classrooms.**

Important aspects of classroom acoustical design include isolation from exterior noise (wind loads, traffic, and other loud outdoor activities), elimination of interior noise (from HVAC systems, foot traffic, and other classrooms), and the use of appropriate wall assembly and interior surface materials to minimize sound propagation and reduce reverberation times in the classrooms. The most common sources of interior mechanical noise are the air conditioning and air-handling systems, including ducts, fans, condensers, and dampers.

Architects and engineers must design to these levels. Verification should be integrated with building commissioning.

Resources

National Clearinghouse for Educational Facilities: <http://www.edfacilities.org/>.



IEQ Credit 5: Improved Acoustical Performance

1 point	<p><u>5.1.</u> Classrooms must have:</p> <ul style="list-style-type: none">▪ 40 dBA maximum (unoccupied) background noise levels.▪ 0.6-second maximum (unoccupied) reverberation times.
2 points	<p><u>5.2.</u> Classrooms must have:</p> <ul style="list-style-type: none">▪ 35 dBA maximum (unoccupied) background noise levels.▪ 0.6-second maximum (unoccupied) reverberation times.

Acousticians recommend 35 dBA as the minimum background levels for school classrooms. Strategies for improving the background noise levels include using centralized HVAC systems and acoustically isolating mechanical equipment from classrooms.

Resources

National Clearinghouse for Educational Facilities: <http://www.edfacilities.org/>.



Thermal Comfort

Purpose: Provide a high level thermal comfort with individual teacher control of thermal, ventilation, and lighting systems to support optimum health, productivity, and comfort conditions.

IEQ Prerequisite 3: ASHRAE 55 Code Compliance

<i>Required</i>	<p>P3.1. Comply with ASHRAE Standard 55-1992, Addenda 1995 for thermal comfort standards, including humidity control within established ranges per climate zone. Indoor design temperature and humidity conditions for general comfort applications shall be determined in accordance with ANSI/ASHRAE 55-1992 or Chapter 8 of the ASHRAE Handbook, 1993, Fundamentals volume. Note that winter humidification and summer dehumidification shall not be required. The upper limit may be ignored for naturally ventilated buildings.</p>
-----------------	---

Resources

CHPS Best Practices Manual, Volume II: HVAC Chapter.



IEQ Credit 6: Controllability of Systems

1 point	<u>6.1.</u> Provide a minimum of one operable window in each classroom.
1 point	<u>6.2.</u> Provide temperature and lighting controls for each classroom.

Credit 6.1. Operable windows are important for personal comfort, and have been shown to improve student performance. Provide at least one operable window in each classroom. It is recommended to interlock controls with the HVAC system to optimize energy efficiency. Train teachers on how to properly use the HVAC controls in their rooms and how opening door and windows affect ventilation and comfort.

Credit 6.2. Individual classrooms will vary in temperature depending on their orientation and other building conditions, as well as occupant preferences. Provide individual or integrated controls systems to allow teachers to regulate the lighting and temperature of their classrooms.

BEST COPY AVAILABLE



DISTRICT RESOLUTIONS

High Performance Policies

Purpose: Integrate high performance goals into district planning.

District Credit 1: District Resolutions

1 point	<u>1.1.</u> Districts must pass board-level resolutions that integrate high performance standards in the preparation and revision of district educational specifications and building programs, i.e. requiring all new facilities to be high performance schools or prioritizing CHPS high performance schools in local bond funding.
---------	---

Districts leaders who institutionalize high performance are not just building better schools; they are protecting student health, improving test scores, and lowering the district's operating expenses. To earn this credit, the district must pass board-level resolutions that reference compliance with the CHPS Eligibility Criteria. The district is free to decide the most appropriate way to integrate the criteria into their specifications and building program. Some districts may take an aggressive leadership role and require that all new schools comply with the CHPS Eligibility Criteria. Others may use a tiered approach: starting with several pilot schools and gradually requiring all schools to comply. Other options include offering additional funds or priority funding in local bond elections. Adding requirements for only specific issues (such as daylighting or energy efficiency) are valuable but do not qualify for this point.

BEST COPY AVAILABLE



Indoor Air Quality

Purpose: Protect student and staff health during occupancy.

District Credit 2: IAQ Management Plan

1 point	<u>3.1.</u> Implement the EPA's Tools for Schools Program or an alternative, equivalent in scope and effectiveness. Include the IAQ Management Plan in the Facility Maintenance and Commissioning Plans. Designate a trained staff person with clear responsibility to implement and update the plan.
---------	---

The Tools for Schools Kit provides the basic set of operations and maintenance actions that will help prevent IAQ problems in schools. Protecting indoor air quality requires a knowledgeable and responsive staff. Tools for Schools establishes responsibilities and clear communication channels so that indoor air problems can be prevented and problems can be quickly identified and solved.

Failure to respond promptly and effectively to poor indoor air quality in schools can cause severe consequences. These include an increase in short- and long-term health problems (leading to more absenteeism), a greater risk that classrooms or buildings will have to be closed with students and staff temporarily relocated, and potential liability problems.

Resources

EPA: <http://www.epa.gov/iaq/schools>.

BEST COPY AVAILABLE



Maintenance

Purpose: Ensure the school continues to perform as it was designed.

District Credit 3: Maintenance Plan

1 point	3.1. In addition to full participation in state deferred maintenance programs, the district must create a school maintenance plan that includes an inventory of all equipment in the school and their preventative maintenance needs.
1 point	3.2. The school district has allocated an annual budget to fund the maintenance plan at 100%

Regular maintenance is critically important to the operation and performance of schools. Every district has unique maintenance needs, but districts should invest sufficient staff and resources to ensure that the school's building systems continue to operate as they were designed.

High performance schools are not maintenance-intensive. However, all buildings and building systems require preventative—not just deferred—maintenance. This credit aims to incent districts to proactively plan for preventative maintenance tasks, and invest adequate funds in the maintenance of their school facilities. If cost-effective and appropriate, outsourcing some, or all, of the maintenance tasks may be an option for some districts.

Credit 3.1. The maintenance plan goes beyond deferred maintenance to include all regularly scheduled preventative maintenance tasks over the lifetime of the building system or equipment. These tasks include cleanings, calibrations, component replacements, and general inspections. The commissioning plan and maintenance documentation is an excellent starting point and reference for developing the maintenance plan. The plan must include staff time and materials costs for each maintenance task and clearly define who is responsible for performing the task, as well as the overall management of maintenance activities.

Credit 3.2. Maintenance plans have limited value if they are not implemented. To earn this point, the plan created in Credit 3.1 must be funded at 100%. This may mean the expansion of current staff and/or increases in the amount spent on preventative maintenance tasks.

BEST COPY AVAILABLE



Energy

Purpose: Specify energy efficient equipment to minimize energy loads and operational costs.
Encourage the development and use of grid-source, renewable energy technologies on a net-zero pollution basis.

District Credit 4: Equipment Performance

Choose **ONE** of the following credits:

1 point	<u>4.1.</u> Districts must pass a resolution to require ENERGY STAR® equipment and appliances for all new purchases, and to prohibit the purchase of low efficiency products, including halogen torchieres and portable electrical resistance heaters.
2 points	<u>4.2.</u> Districts must pass a resolution to require new equipment and appliances that are within 20% of the EPA's ENERGY STAR® "best available" for the category, and to prohibit the purchase of low efficiency products including halogen torchieres and portable electrical resistance heaters.

Credits 4.1 and 4.2. The ENERGY STAR® program maintains a database of compliant manufacturers and products. To earn this credit, the district must pass a board-level resolution requiring that all new equipment or appliances be ENERGY STAR® -compliant. Products not currently covered under the ENERGY STAR® program are excluded from the scope of this credit. A partial list of equipment covered by ENERGY STAR® includes computers, monitors, copy machines, water coolers, printers, scanners, refrigerators, and washing machines.

In addition, the resolution must state that the district cannot purchase halogen torchieres and portable electrical resistance heaters.

Resources:

ENERGY STAR®: www.energystar.org.

BEST COPY AVAILABLE



District Credit 5: Green Power

2 points	5.1. Engage in a two-year contract to purchase power generated from renewable sources approved by the California Energy Commission.
----------	---

Purchase power from a provider that guarantees a fraction of its delivered electric power is from net nonpolluting renewable technologies. The California Energy Commission approves sources for consumers in California. Grid power that qualifies for this credit originates from solar, wind, geothermal, biomass, or low-impact hydro sources. Low-impact hydro complies with the Low Impact Hydropower Certification Program.

Resources

California Energy Commission: <http://www.energy.ca.gov/greenpower/index.html>.

Toll Free: 800-555-7794.

E-mail: renewable@energy.state.ca.us

BEST COPY AVAILABLE



Transportation

Purpose: Lower the environmental impact of district bus and maintenance vehicle fleets.

District Credit 6: Buses and Alternative Fueled Vehicles

1 point	<u>6.1.</u> Provide bus service for students.
1 point	<u>6.2.</u> Alternative fueling. At least 20% of the district-owned buses and maintenance vehicles serving the school must use alternative fuels. If district bus service is provided under contract from a third party, then 20% of the buses used to service the school must use alternative fuels.

Transporting children to and from school requires significant energy, time, and money, and causes a considerable amount of pollution. Intelligent transportation strategies for bus and maintenance fleets save resources, lower pollution, and protect student health.

Credit 6.1. This credit aims to reduce the number of parents independently driving their children to school. When designed appropriately, district-provided bus services are large investments that can greatly reduce reliance on automobiles while increasing convenience to parents. However, buses should not be encouraged if they are not needed. School-provided busing is less sustainable than walking, biking, or using municipal transit.

Credit 6.2. When used, buses should operate on alternative fuels. Most school buses are old and emit 60 to 70 times more smog-forming pollutants, and hundreds of times more toxic air contaminants, than today's passenger cars. In addition, new research has shown that pollutants, including carcinogens and particulates, *inside* the buses can be alarmingly high. These pollutants can have direct and significant effects on student health.

Replacing older school buses will improve public health and safety. Currently, propane, natural gas and other alternative fuels are used in less than 1 % of school buses nationwide. There are funds available from the California Energy Commission and Air Resources Board to help districts retrofit or replace old vehicles.

BEST COPY AVAILABLE



CRITERIA SCORECARD

Credits in bold font = CHPS-recommended credits

Site 14 points

Site Selection	Prereq 1	Code Compliance	R	P1.1. Comply with all requirements of Title 5.	
	Credit 1	Sustainable Site Selection	1	1.1. No development on sites that are: prime agricultural land, in flood zone, habitat for endangered species, parkland.	
			1	1.2. Do not develop on greenfields.	
			1	1.3. Create centrally located sites with in which 50% of students are located within minimum distances of the school.	
			1	1.4. Joint use of facilities.	
			1	1.5. Joint use of parks.	
			1	1.6. Reduce building foot print.	
Transportation	Credit 2	Transportation	1	2.1. Near public transit.	
			1	2.2. Provide bike racks and bike lanes for 15% of school population.	
			1	2.3. Minimize parking lot and create preferred parking for carpools.	
Stormwater Management	Prereq 2	Construction Erosion	R	P2.1. Control erosion and sedimentation to reduce negative impacts on water and air quality.	
	Credit 3	Post-construction Management	1	3.1. Minimize runoff.	
1			3.2. Treat runoff.		
Outdoor Surfaces	Credit 4	Design to Reduce Heat Islands	1	4.1. Shade or lighten impervious areas, or reduce impervious parking.	
			1	4.2. Install cool roof.	
Outdoor Lighting	Credit 5	Light Pollution Reduction	1	5.5. Minimize outdoor illumination with no direct beam leaving site.	

Water 5 points

Outdoor Systems	Prereq 1	Create Water Use Budget	R	P1.1. Establish and comply with water use budget.	
	Credit 1	Reduce Potable Water for Landscaping	1-2	1.1. Use high efficiency irrigation technology, OR, reduce potable water consumption for irrigation by 50%. <i>(2 points = 100% or no irrigation installed)</i>	
Indoor Systems	Credit 2	Water Use Reduction	1	2.1. 50% reduction in potable water use for sewage conveyance with reclaimed water.	
			1-2	2.2. Decrease water use by 20% after meeting Energy Policy Act. <i>(2 points = 30% reduction)</i>	

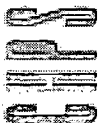

Energy 24 points

Energy Efficiency	Prereq 1	Minimum Energy Performance	R	P1.1. Design building to exceed Title 24-2001 by 10%, or include prescriptive package of measures.	
	Credit 1	Superior Energy Performance	2-10	1.1. 15% to 35% reduction in total net energy use from Title 24-2001 baseline, or include prescriptive package of measures.	
	Credit 2	Natural Ventilation	1	2.1. HVAC Interconnect controls with operable windows & doors. 3 2.2. Design 90% of classrooms without air conditioning.	
Alternative Energy Sources	Credit 3	Renewable Energy	2-6	3.1. 5% to 50% of net energy use supplied by renewable energy or distributed generation.	
Commissioning and Verification	Prereq 2	System Testing & Training	R	P2.2. Third party or district verification of building systems & training.	
	Credit 4	Commissioning	2-3	4.1. Basic commissioning tasks. <i>(2 points = advanced building commissioning)</i>	
	Credit 5	Energy Management Systems	1	5.1. Install an Energy Management System to measure and control loads.	

Materials 11 points

Waste Reduction and Efficient Material Use	Prereq 1	Storage and Collection of Recyclables	R	P1.1. Meet local standards or recycling space and have spaces dedicated to recycling.	
	Credit 1	Site Waste Management	1-2	1.1. Meet local ordinances, develop waste management plan, and recycle/salvage 50% construction waste. <i>(2 points = 75% reduction)</i>	
	Credit 2	Building Reuse	1-3	2.1. Reuse 75% of previous structure. <i>(2 points = reuse of 100% of previous structure)</i> <i>(3 points = reuse of 100% of previous structure and 50% of non-shell systems)</i>	
Sustainable Materials	Credit 3	Resource Reuse	1-2	3.1. Specify salvaged or refurbished materials for 5% of building. <i>(2 points = specification of 10%)</i>	
	Credit 4	Recycled Content	1-2	4.1. 25% of building materials meet requirements. <i>(2 points = 50% of building materials meet requirements)</i>	
	Credit 5	Rapidly Renewable Materials	1	5.1. 5% of materials are rapidly renewable.	
	Credit 6	Certified Wood	1	6.1. 50% of wood must be certified.	



IEQ 17 points

Daylighting	Credit 1	Daylighting in Classrooms	3	1.1. Minimum 2% daylight factor in 75% of classrooms.			
			1	1.2. Direct line of site glazing for 90% of classrooms.			
Indoor Air Quality	Prereq 1	Minimum Requirements	R	P1.1. HVAC must meet Title 24 ventilation requirements, Cal/OSHA performance requirements, and satisfy ASHRAE 62 requirements for outdoor air supply.			
			Credit 2	Low-Emitting Materials	1-4	2.1. Building materials (paints, ceiling tiles, carpet, adhesives, etc) meet chemical emission rates detailed in CHPS material specifications.	
	Credit 3	Pollutant Source Control			1	3.1. Control dust, segregate pollutant sources, local exhaust in kitchens, appropriately plumbed drains in chemical storage areas.	
					1	3.2. Install ducted HVAC returns.	
	1	3.3. Use high efficiency filters.					
Credit 4	Construction IAQ Management Plan	1	4.1. Create and implement specified construction IAQ plan.				
		1	4.2. Flush out building or conduct IAQ testing.				
Acoustics	Prereq 2	Minimum Acoustical Performance	R	P2.1. Classrooms must have a maximum (unoccupied) noise level of 45dba, with maximum (unoccupied) reverberation times of 0.6 sec.			
			Credit 5	Improved Acoustical Performance	1	5.1. Classrooms must have a maximum (unoccupied) noise level of 40dba, with maximum (unoccupied) reverberation times of 0.6 sec.	
2	5.2. Classrooms must have a maximum (unoccupied) noise level of 35dba, with maximum (unoccupied) reverberation times of 0.6 sec.						
Thermal Comfort	Prereq 3	ASHRAE 55 Code Compliance	R	P3.1. Comply with Title 24 required ASHRAE 55-1992 thermal comfort standard.			
			Credit 6	Controllability of Systems	1	5.1. Operable windows in classrooms.	
1	5.2. Temperature and lighting controls in all classrooms.						

District Resolutions 10 points

Institutionalize High Performance	Credit 1	District Resolutions	1	1.1. Institutionalize High Performance Goals on a district level.	
Indoor Air Quality	Credit 2	IAQ Management Plan	1	2.1. Create IAQ Management Plan and include in Facility Maintenance and Commissioning Plans. Designate a trained staff person with clear responsibility to implement and update the plan.	
Maintenance	Credit 3	Maintenance Plan	1	3.1. Create a maintenance plan that includes an inventory of all equipment in the school and their preventative maintenance needs.	
			1	3.2. District allocates budget to fund plan at 100%.	
Energy	Credit 4	Equipment Performance	1	4.1. Require EnergyStar equipment and prohibit wasteful technologies.	
			2	4.2. Require new equipment to be within 20% of the EPA ENERGY STAR® "best available" for the category.	
	Credit 5	Green Power	2	5.1. Engage in a two-year contract to purchase power generated from renewable sources approved by the CEC.	
Transportation	Credit 6	Buses and Alternative Fueled Vehicles	1	6.1. Provide busing service.	
			1	6.2. Alternative Fueled Vehicles. 20% of bus and maintenance vehicle fleet serving the school must use alternative fuels.	

Minimum total required for CHPS School (Two points must be in Energy category)

28



Appendix

High Performance Schools Best Practices Manual

2002 Edition

A Project of:

the
collaborative
for high
performance
schools

The Collaborative for High
Performance Schools
(877) 642-CHPS
www.chps.net

Copyright 2002 CHPS Inc.

Preface

Background

This is a unique period in California history. The state, already educating one out of every eight students in the U.S., has seen historical enrollment rates four times higher than national averages. Hundreds of schools a year are being built to house the 100,000 new students per year moving into the system and to accommodate state-mandated class-size reductions. The current infrastructure is aging and over 30% of existing facilities are in need of major renovation. At the same time, California schools are spending nearly \$450 million per year on energy¹ in a time of rising concern over energy supplies and tight school budgets. These figures illustrate an enormous opportunity for our state's school districts to build the next generation of school facilities that improve the learning environment while saving energy, resources, and money.

The goal of this Best Practices Manual is to create a new generation of high performance school facilities in California. The focus is on public schools and levels K-12, although many of the design principals apply to private schools and higher education facilities as well. High performance schools are healthy, comfortable, energy efficient, resource efficient, water efficient, safe, secure, adaptable, and easy to operate and maintain. They help school districts achieve higher test scores, retain quality teachers and staff, reduce operating cost, increase average daily attendance (ADA), reduce liability, while at the same time being friendly to the environment.

¹ These costs are based on data prior to the California energy crisis, which began during the winter of 2000-2001. During this period, wholesale energy costs rose by a factor of eight. Eventually, some or all of these costs will be passed on to schools and other utility customers.



Best Practices Manual Organization

This Best Practices Manual is split into three volumes:

- Volume I addresses the needs of school districts, including superintendents, parents, teachers, school board members, administrators, and those persons in the school district that are responsible for facilities. These may include the assistant superintendent for facilities (in large districts), buildings and grounds committees, energy managers, and new construction project managers. Volume I describes why high performance schools are important, what components are involved in their design, and how to navigate the design and construction process to ensure that they are built.
- Volume II contains design guidelines for high performance schools. These are tailored for California climates and are written for the architects and engineers who are responsible for designing schools as well as the project managers who work with the design teams. Volume II is organized by design disciplines and addresses specific design strategies for high performance schools.
- Volume III is the CHPS Criteria. These criteria are a flexible yardstick that precisely defines a high performance school so that it may qualify for supplemental funding, priority processing, and perhaps bonus points in the state funding procedure. School districts can also include the criteria in their educational specifications to assure that new facilities qualify as high performance.

The Best Practices Manual is supported by the Collaborative for High Performance Schools' website (<http://www.chps.net/>) which contains research papers, support documents, databases and other information that support the manual.

Who is CHPS

CHPS began in November 1999, when the California Energy Commission called together Pacific Gas and Electric Company, San Diego Gas and Electric, and Southern California Edison to discuss the best way to improve the performance of California's schools. Out of this partnership, CHPS grew to include a diverse range of government, utility, and non-profit organizations with a unifying goal to improve the quality of education for California's children. With the successful launch of the Best Practices Manual in 2001, interest in high performance design grew, and CHPS expanded its focus beyond California, developing a national version of the manuals as well as other state-specific versions. In early 2002, CHPS incorporated as a non-profit organization, further solidifying its commitment to environmentally-sound design that enhances the educational environment for all schoolchildren.

Acknowledgements

A great number of people have contributed to the development of the Best Practices Manual and this 2002 update. Charles Eley is the executive director of CHPS, Inc. and served as the technical editor.

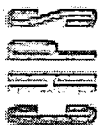

For Volume I: Deane Evans (Sustainable Buildings Industries Council) and Randy Karels (Eley Associates). Donald Simon (Wendel, Rosen, Black & Dean) wrote the section on construction contracts. The Newport Coast Elementary case study was adapted from the paper *Mainstreaming the Sustainably Designed School* by Deborah Weintraub and Tony Pierce of Southern California Edison.

For Volume II: Jim Benya (Benya Lighting Design); Anthony Bernheim (SMWM), Barbara Erwine (Cascadia Conservation); Lisa Heschong (Heschong Mahone Group); Erik Kolderup, Joe Kastner, and Anamika (Eley Associates); Hal Levin (Building Ecology Research Group); Kathleen O'Brien (O'Brien and Company); Kerry Parker (TMAD Engineers); Jane Simmons (O'Brien and Company); Kerry Parker (TMAD Engineers); and Adam Wheeler (Control Group).

The commissioning section of this manual is a modified version of the *Building Commissioning Guidelines* prepared for Pacific Gas & Electric Company by Portland Energy Conservation, Inc. (PECI) for the Energy Design Resources program. Certain sections of this document were excerpted and modified from *Commissioning for Better Buildings in Oregon*, written by PEGI for the Oregon Office of Energy, and *Building Commissioning: The Key to Quality Assurance*, written by PEGI for the U.S. Department of Energy's Rebuild America program.

From Eley Associates, Kimberly Got edited and coordinated production on Volumes I and II. Debra Janis developed additional graphics and provided layout assistance. Randy Karels and Arman Shehabi provided assistance with coordination and technical content review. Patricia Adamos worked to secure graphic permissions.

The CHPS Best Practices Manual 2002 Update Task Force contributed countless hours reviewing the document and providing valuable direction and input. Special thanks to Panama Bartholomy (Division of the State Architect), Gary Flamm (California Energy Commission), Bill Orr and Dana Papke (California Integrated Waste Management Board), Tom Phillips (California Air Resources Board), and Jed Waldman (Department of Health Services).

Beginning with the first edition, many people contributed to the development of the manual through their technical content review: Tor Allen (Rahus Institute); Dennis Dunston (HMC Architects), Wael El-Sharif (Geothermal Heat Pump Consortium), Andrew Gorton and Dennis Paoletti (Shen Milsom & Wilke / Paoletti), John Guill (Quattrocchi / Kwok Architects), Gary Mason (Wolfe Mason Associates), Lynn N. Simon (Simon & Associates), and George Wiens (WLC Architects).

The following individuals contributed significantly to this project, particularly in the early development of the manuals: Manuel Alvarez, Jan Johnson and Lisa Stoddard (Southern California Edison), Richard Conrad and Chip Smith (Division of the State Architect), Don Cunningham (Los Angeles Department of Water and Power), Julia Curtis, Ray Darby, Grant Duhon (Pacific Gas & Electric), Lisa Fabula and Chip Fox (San Diego Gas &

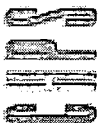

Electric), Kathy Frevert (California Integrated Waste Management Board), Greg Golick (Coalition for Adequate School Housing), Tony Hesch (California Department of Education), Bill Jones, Kathleen McElroy (Xenergy), Daryl Mills and Mike Sloss (California Energy Commission), Jim Parks (Sacramento Municipal Utility District), and Richard Sheffield (Office for Public School Construction).

Finally, the CHPS Board of Directors deserves special acknowledgement for their continued guidance and funding support. Robert Pernell (California Energy Commission), Gregg Ander (Southern California Edison), Stephan Castellanos (Division of the State Architect), Randall Higa (Southern California Gas), Chuck Angyl (San Diego Gas & Electric), Jim Barnett (Sacramento Municipal Utility District), Duwayne Brooks (California Department of Education), Oliver Kesting (Pacific Gas & Electric), and Bill Orr (California Integrated Waste Management Board).



Table of Contents

Preface	ii
Background.....	ii
Best Practices Manual Organization	iii
Who is CHPS.....	iii
Acknowledgements.....	iii
Table of Contents.....	vi
Appendix A – Job Site Specifications.....	1
Section 01501 – Indoor Air Quality Construction Plan	1
Section 01500 – Waste Reduction	4
Section 01503 – Site Protection Plan	9
Waste Reduction Plan	11
Appendix B – Calculating Cost-Effectiveness	12
Introduction	12
Other Issues.....	14
Appendix C – A Field-Based Thermal Comfort Standard for Naturally Ventilated Buildings.....	18
Introduction	18
Adaptation In Buildings	19
Research Methods.....	20
Thermal Comfort In Air-Conditioned Vs. Naturally Ventilated Buildings	21
An Adaptive Comfort Standard For Naturally Ventilated Buildings	24
Conclusions	26
References.....	27
Appendix D – Energy Cost and IAQ Performance of Ventilation Systems and Controls.....	29
Executive Summary.....	29
Purpose And Scope of this Report	29
Methodology	32
Limitations.....	33
Issues Addressed in the Project	33
Key Results.....	35
Discussion.....	37
Summary.....	44
Bibliography	44
Appendix E – Lighting Design Supplement.....	58
IESNA Lighting Design Process	58
Design Issues	59
Light Sources.....	60
Luminaires	64
Lighting Controls.....	68
Appendix F – Daylighting and Fenestration Design Supplement.....	71
Optimizing the Aperture Size	71
Glazing Products.....	72
Links with Other High Performance Design Measures.....	76
Other Design Considerations for Daylighting and Fenestration Design.....	77



APPENDIX A – JOB SITE SPECIFICATIONS

Section 01501 – Indoor Air Quality Construction Plan

GENERAL

SUMMARY

Section Includes:

- Description of an Indoor Air Quality (IAQ) Construction Plan
- IAQ Construction Requirements

Related Sections: Site protection specifications included in this section should be coordinated with the following sections of the Project Manual, including:

- Division 9: Finishes
- Division 15: Mechanicals

Coordinate with related temporary controls, in particular:

- Section 01572: Sustainable Job Site Operations – Waste Reduction
- Section 01573: Sustainable Job Site Operations – Site Protection

INDOOR AIR QUALITY

Goals: The owner has set the following indoor air quality goals for jobsite operations on project, within the limits of the construction schedule, contract sum, and available materials, equipment, products and services. Goals include:

- Prevent residual problems with indoor air quality in the completed building.
- Protect workers on the site from undue health risks during construction.

INDOOR AIR QUALITY PLAN

Within fourteen (14) days after receipt of Notice of Award and prior to any waste removal by the Contractor from the Project, the Contractor shall develop and submit to the Owner for review a healthy indoor air quality plan. This plan shall be Part II of a “Sustainable Job Site Operations Plan.”

- List of IAQ protective measures to be instituted on the site
- Schedule for inspection and maintenance of IAQ measures

SUBSTITUTIONS

Should the Contractor desire to use procedures, materials, equipment, or products that are not specified but meet the intent of these specifications to protect air quality on the



site, the Contractor shall propose these substitutions in accordance with Substitutions and "Or Equal" in General Requirements.

PRODUCTS

MATERIALS

Low emitting products have been specified in appropriate sections.

EXECUTION

ALL PHASES

- The Contractor is minimally required to meet or exceed minimally the minimum requirements of the Sheet Metal and Air Conditioning National Contractors Association (SMACNA) IAQ Guidelines for Occupied Buildings Under Construction, 1995 to:
- Protect the ventilation system components from contamination, OR provide cleaning of the ventilation components exposed to contamination during construction prior to occupancy.
- Provide a continuous ventilation rate of one air change per hour minimum during construction, OR, conduct a building flush-out with new filtration media at 100% outside air after construction ends (following issuance of Occupancy Certificate) and prior to occupancy for seven days (one week). Provide a minimum of 85% filtration (as determined by ASHRAE Standard 52.1-1992) on any return air systems operational during construction, and replace filtration media prior to occupancy.
- During installation of carpet, paints, furnishings, and other VOC-emitting products, provide supplemental (spot) ventilation for at least 72 hours after work is completed. Preferred HVAC system operation uses supply air fans and ducts only; exhaust provided through windows. Use exhaust fans to pull exhaust air from deep interior locations. Stair towers and other paths to exterior can be useful during this process.
- Conduct regular inspection and maintenance of indoor air quality measures including ventilation system protection, and ventilation rate.
- Require VOC-safe masks for workers installing VOC-emitting products (interior and exterior) defined as products that emit 150 gpl or more UNLESS local jurisdiction's requirements (Canadian or US) are stricter, in which case the strictest requirement shall be followed for use of VOC-safe masks.
- Use low-toxic cleaning supplies for surfaces, equipment, and worker's personal use. Options include several soybean-based solvents and cleaning options (SoySolv) and citrus-based cleaners.
- Use wet sanding for gypsum board assemblies. Exception: Dry sanding allowed subject to owner approval of the following measures:

Full isolation of space under finishing.

Plastic protection sheeting is installed to provide air sealing during the sanding.

Closure of all air system devices and ductwork.

Sequencing of construction precludes the possibility of contamination of other spaces with gypsum dust.

Worker protection is provided.



Use safety meetings, signage, and subcontractor agreements to communicate the goals of the construction indoor air quality plan.

END OF SECTION



Section 01500 – Waste Reduction

SECTION 01500
SUSTAINABLE JOB SITE OPERATIONS PLAN
WASTE REDUCTION

GENERAL

SUMMARY

Section Includes:

- Description of a Job-Site Waste Reduction Plan
- Waste Reduction Requirements for Demolition
- Waste Reduction Requirements for New Construction

Related Sections: Waste reduction (recycling, reuse, and salvage) specifications included in this section should be coordinated with the following sections of the Project Manual, including:

- Section 02000 - Site Demolition
- Section 02000 - Asphaltic Paving, (Concrete/Asphalt Reuse)
- Section 06000 - Rough Carpentry (Wood)
- Section 09000 - Gypsum Board
- Division 15000 - Mechanical (Cardboard and Metals)
- Division 16000 - Electrical (Cardboard)

Coordinate with related temporary controls, in particular:

- Section 01501 - Sustainable Job Site Operations – Site Protection
- Section 01502 - Sustainable Job Site Operations – Indoor Air Quality

JOB SITE WASTE REDUCTION

Goals:

Owner has set the following waste reduction goals for the project, within the limits of the construction schedule, contract sum, and available materials, equipment, products and services. These goals are consistent with:

- Executive Order 13101
- The 1997 “Statement on Voluntary Measures to Reduce, Recover, and Reuse Building Construction Site Waste” released by the American Institute of Architects and the Associated General Contractors of America.
- The California Integrated Waste Management Board (CIWMB)’s market development plan “Meeting the 50 Percent Challenge: Market Development Strategies Through the Year 2000,” in which reducing C&D debris is identified as a priority means of achieving the State’s mandated diversion goal of 50% by 2000.



- Sample County Ordinance #000, which requires that projects over 10,000 square feet involving construction, remodeling or demolition, must submit a "Solid Waste Management and Recycling Plan" to the Public Works Staff for review and approval.
- The waste reduction goals for this project include:
 - Minimizing the amount of construction and demolition (C&D) waste generated.
 - Diverting waste created through C&D processes from disposal through reuse (salvage) and recycling. A minimum of 75% by weight of total project demolition waste, and a minimum of 50% by weight of total project new construction waste shall be diverted from landfill.
- Use recycled-content or salvaged building materials.

DEFINITIONS

- **Waste:** For the purpose of this section, the term applies to all excess materials, including materials that can be recycled, unless otherwise indicated.
- **Construction and Demolition Waste (C&D):** Includes all non-hazardous solid wastes resulting from construction, remodeling, alterations, repair, and demolition.
- **Proper Disposal:** As defined by the jurisdiction receiving the waste. Rules for the Sample County Central Landfill for disposal of construction and demolition material/debris are available from Jane Doe, Department of Public Works at (000-000-0000).
- **Hazardous Waste:** As defined by local jurisdictions, California Department of Toxic Substances Control, and the California Integrated Waste Management Board.
- **Recycling:** The process of sorting, cleaning, treating, and reconstituting materials for the purpose of using the material in the manufacture of a new product. Can be conducted on site (as in the case of concrete ground on site for use on the site or elsewhere).
- **Recycling facility:** An operation that can legally accept materials for the purpose of processing the materials into an altered form for the manufacture of a new product. Recycling facilities have their own specifications for accepting materials.
- **Reuse:** Making use of a material without altering its form.
- **Salvage:** Recovery of materials for on-site reuse or donation to a third party.
- **Source-separated materials:** Materials that are sorted at the site for the purpose of reuse or recycling.

WASTE REDUCTION PLAN

- Within fourteen (14) days after receipt of Notice of Award and prior to any waste removal by the Contractor from the Project, the Contractor shall develop and submit to the Owner for review a waste reduction plan. A sample form is attached. This plan shall be Part I of a "Sustainable Job Site Operations Plan." Once approved by the owner, the Contractor shall provide copies of the waste reduction plan to the owner's representative, the project architect, the job site foreman, and all subcontractors. In addition, the plan shall be posted on the site in a prominent location.
- The waste reduction plan shall include:
 - Estimate of total project waste to be generated, landfills where waste would normally be disposed, tipping fees, and estimated cost of disposal.



- Types and estimated quantities of salvageable materials that are expected to be generated during demolition.
- The method to be used to salvage or reuse these material on-site. Methods shall include one or more of the following options: contracting with a deconstruction specialist to salvage all or most materials generated, selective salvage as part of demolition contractor's work, and reuse of materials on site or in the new structure.
- Types and estimated quantities of recyclable materials expected to be generated during demolition and construction in significant amounts, in particular, wood, concrete, metals, cardboard, and drywall. Other recyclable materials to be generated should be listed as well.
- The method to be used to recycle these materials. Methods shall include one or more of the following options: requiring subcontractors to take materials back for recycling (new construction), contracting with a full service recycling service to recycle all or most materials on site, process or reuse materials on-site (demolition and new construction).

DOCUMENTATION

- To each application for progress payment submitted to the owner or its representative, the Contractor shall attach a record of the amount of material disposed (in tons) and the amount of each material recycled or salvaged by type (in tons or cubic yards, whichever is available). Manifests, weight ticket, receipts, and/or invoices can be used as documentation.
- The Contractor shall be responsible for providing such information whether directly involved in recycling the materials or not (whether the Contractor performs recycling tasks or hires or requires others, such as subcontractors, to do so).
- In the event the Contractor cannot fulfill the specified diversion rate for C&D waste generated by the project, the Contractor shall notify the Owner prior to submitting the final progress report. The Contractor must provide documentation showing a good faith effort was made to achieve the diversion rate. Such proof will include a record of contacts with C&D recycling businesses and shall include: date and time of contacts, name of business and contact, telephone, and results of contact.

REFERENCES

- C&D Recycling Businesses: California Integrated Waste Management Board (CIWMB) lists C&D recyclers and processors (Pub #431-96-017) sorted by County (Pub#431-96-017). CIWMB also offers a searchable database of recyclers on its web site (<http://www.ciwmb.ca.gov/ConDemo>).
- Case Studies and Other Technical Assistance: See CIWMB website and links.

SUBSTITUTIONS

Should the Contractor desire to use procedures, materials, equipment, or products that are not specified but meet the intent of these specifications to reduce materials waste, the Contractor shall propose these substitutions in accordance with Substitutions and "Or Equal" in General Requirements.

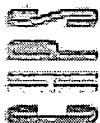

REVENUES

Revenues or other savings obtained from recycled, reused, or salvaged materials shall accrue to Contractor unless otherwise noted in the Contract Documents.

PRODUCTS

MATERIALS

Recycled-content, salvaged, or otherwise resource-efficient products are specified in appropriate sections.

EXECUTION

DEMOLITION

See Section 02### for a list of items targeted for demolition. Plans identify specific items to be reused, salvaged, or left in place.

Recycle the items listed below (on or offsite).

- Concrete and asphalt
- Metals
- Wood
- Job-Shack wastes, including office paper, pop cans and bottles, and office cardboard.

Recycle other items as cost-effective. Possible additional items include: carpet and carpet pad.

NEW CONSTRUCTION

Recycle the items listed below.

- Landclearing debris (rock and dirt)
- Concrete
- Asphalt
- Metals
- Wood
- Drywall
- Job-Shack wastes, including office paper, pop cans and bottles, and office cardboard.

Recycle other items as cost-effective. Possible additional items include: packaging

- Include in supply agreements a waste reduction provision specifying a preference for reduced, U-turn, and/or recyclable packaging.
- Use detailed take-offs and use to identify location and use in structure to reduce risk of unplanned and potentially wasteful cuts.
- Store materials properly to avoid wetting or other damage to materials as well as outdating. Materials that become wet or damp due to improper storage shall be replaced at contractor's expense.



Use safety meetings, signage, and subcontractor agreements to communicate the goals of the waste reduction plan. At a minimum, waste reduction goals will be discussed at the following meetings.

- Project Kick-Off Meeting
- Pre-Construction Meeting
- Regularly scheduled progress meetings (safety meetings).

Provide on-site instruction regarding appropriate separation, handling, recycling, salvage, reuse, and return methods to be used to achieve waste reduction goals.

Protect materials to be recycled from contamination. As part of regular clean-up, schedule visual inspections of dumpsters and recycling bins to identify potential contamination of materials.

END OF SECTION

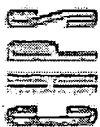

Section 01503 – Site Protection Plan

GENERAL

SUMMARY

Section Includes:

- Description of a Site Protection Plan
- Site Protection Requirements

Related Sections: Site protection specifications included in this section should be coordinated with the following sections of the Project Manual, including:

- Division 2: Site

Coordinate with related temporary controls, in particular:

- Section 015## - Stormwater management
- Section 01501 - Sustainable Job Site Operations – Waste Reduction
- Section 01502 - Sustainable Job Site Operations – Indoor Air Quality

SITE PROTECTION

Goals: The owner has set the following site protection goals for jobsite operations on the project, within the limits of the construction schedule, contract sum, and available materials, equipment, products and services. The goals assume that all jurisdictional requirements are met as a *minimum* for stormwater management and erosion control.

Goals include:

- Eliminate unnecessary site disturbance.
- Minimize impact on the site's natural (soil and water) functions.
- Eliminate water pollution and water quality degradation.

SITE PROTECTION PLAN

Within fourteen (14) days after receipt of Notice of Award and prior to any waste removal by the Contractor from the Project, the Contractor shall develop and submit to the Owner for review a site protection plan. This plan shall be Part II of a "Sustainable Job Site Operations Plan."

The site protection plan shall include:

- Site protection materials list and documentation
- Maintenance/inspection schedule for site protection measures
- Construction vehicles protocol, including parking, project access, maintenance, and tire wash.

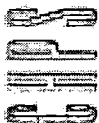

REFERENCES

Reference best management practices in *EPA's Storm Water Management for Construction Activities*, Chapter 3 and relevant local jurisdiction publications.

SUBSTITUTIONS

Should the Contractor desire to use procedures, materials, equipment, or products that are not specified but meet the intent of these specifications to protect the site, the Contractor shall propose these substitutions in accordance with Substitutions and "Or Equal" in General Requirements.

PRODUCTS

MATERIALS

- Least-toxic products for use on the site are specified in Division 2.

EXECUTION

ALL PHASES

- Conduct regular inspection and maintenance of site protection measures. Minimally, inspect all erosion and sedimentation measures after a heavy rainfall, defined as ½ inches in less than 24 hours.
- Provide redundant mechanisms for site protection of any critical or sensitive areas on site, as identified in Site Plan. Silt fencing fabric and other temporary site protection measures shall last for the life of the project.
- For oil and sediment separators, ensure detergent does not get into separator.
- Establish and post construction vehicles protocol for parking and access on the site. Provide a rocked heavy construction vehicle entrance and tire wash.
- Establish and post clean-up procedures for spills to prevent illicit discharges. To minimize risk, reduce hazardous wastes, including paints and other finish products, solvents, adhesives, and oils as follows:

Avoid overstocking

Adopt a first-in, first out policy

Label containers properly

Control access to storage areas and routinely inspect containers

Inspect all containers upon receipt. Reject leaking or damaged containers.

Coordinate topsoil preparation, planting, and maintenance using Integrated Pest Management (least toxic) protocol. Use least-toxic products for controlling pests and insects in detention ponds and for soil prep. Chemical weed eradication prohibited.

Use safety meetings, signage, and subcontractor agreements to communicate the goals of the site protection plan.

END OF SECTION



Waste Reduction Plan

Project: _____

Waste Reduction Plan

Salvaged Materials

Materials	Estimated Quantities	Expected Condition	Hauler	Destination

Recycling

Materials	Estimated Quantities	Expected Condition	Hauler	Destination
Concrete				
Asphalt Rubble				
Ferrous Metals				
Non-Ferrous Metals				
Wood				
Cardboard				
Other				

Other Waste Reduction Actions Planned:



APPENDIX B – CALCULATING COST-EFFECTIVENESS

Introduction

Once you have identified initial costs and operating costs over the time horizon of the building, you must then decide if the proposed design is cost-effective. In some cases, you may want to consider more than one design alternative, in which case you will want to know which of the alternatives is the most cost-effective. This appendix provides the technical information you will need to make these assessments.

Payback Period

The most common measure of economic performance is the payback period—the period of time it takes for the savings to equal the initial investment. Payback period is based on the construction cost difference between two competing lighting systems and the resulting savings due to the more efficient system. As a result, it can only be used to compare *two* competing alternatives. If multiple alternatives are to be evaluated, they must all be compared to a single base case.

While easy to understand, payback period is inadequate in comparing many design alternatives, in particular systems with different lives or maintenance costs. Consider for instance two options: one with a cost of \$10,000 and annual savings of \$2,000 per year and a second with a cost of \$5,000 and annual savings of \$1,000 per year. Both have a payback period of 5 years, but which is the better investment? The inadequacies of payback period are further exposed if the two retrofit options have different lives and varying maintenance or replacement costs. While the payback calculation can be adjusted to consider utility rebates and annualized maintenance costs, more detailed economic analysis based on net present value or internal rate of return is recommended.

Cash Flow

Net Present Value (Life-Cycle Cost)

Net present value is the sum of the initial costs and all future benefits and costs over the life of the building, discounted to present value. Benefits are generally assigned a positive value while costs are assigned a negative value. In comparing alternatives, the one with the highest net present value is the best investment. Net present value can be used to compare several different systems and is especially useful in comparing design alternatives with different or irregular cash flows, or design alternatives with different lives.



Expenses or costs that occur in the future have a smaller value in current dollars. The rate at which future expenses or costs are discounted is the *discount rate*. It is the percent reduction in future benefits or costs for each year in the future. An understanding of discount rate is necessary in order to understand other measures of economic performance such as net present value, annualized cost, benefit to cost ratio, or internal rate of return.

The discount rate can be "real" or "nominal." The real discount rate is the rate at which future benefits or costs are discounted without consideration for inflation. If future expenses and costs are quantified in current dollars, a real discount rate is used. It is generally easier to quantify future benefits and costs in current dollars, so a real discount rate is commonly used in economic analysis. If future expenses and costs are quantified in inflated dollars, then a nominal discount rate should be used. The nominal discount rate is the real discount rate plus the inflation rate.

The *discount rate* is the rate of return that an investor typically makes or expects to make from other investment opportunities with a similar risk. It also indicates whether an investor has a short-term or long-term perspective. Investors with a short-term perspective generally have a higher discount rate, while investors with a long-term perspective have a lower discount rate. Risk must also be considered in selecting a discount rate. Since investments in sustainable buildings involve little risk, the discount rate should be based on consideration of other low-risk investments such as government securities. Using this logic, if the return on investment for government securities is 8% and the general inflation rate is 5%, then an appropriate *real* discount rate is 3%.

A discount rate may be used to calculate the present value of future costs. The present value of a cost occurring "n" years in the future with a discount rate of "i" is obtained by multiplying the cost by a present worth factor. The present worth factor or PWF is given by the following equation:

$$PWF = \frac{1}{(1+i)^n}$$

Tables of present worth factors may be calculated for a variety of discount rates and years into the future so that the above equation does not have to be evaluated for every case. Such a table is included as Table A-1. To calculate the present worth of a future benefit or cost, select a value from the table based on the discount rate and the number of years into the future and multiply the selected value times the future cost or benefit. Keep in mind that if the future cost or benefit is quantified in today's dollars, a real discount rate should be used. Otherwise, a nominal discount rate should be used.

Energy costs or savings (like maintenance costs) also occur in the future and may need to be discounted to present value. The values in Table B-1 could be used to discount each annual energy cost, but there are easier ways. If a cost or benefit occurs as a time series, that is, the same cost or benefit occurs each year for some period of time, then the net present value of this series of costs or benefits can be determined by multiplying the first year cost times a series present worth factor (SPWF).



The SPWF for "n" years or periods and a discount rate of "i," can be calculated with the following equation.

$$SPWF = \frac{(1+i)^n - 1}{i(1+i)^n}$$

Table B-2 contains pre-calculated series present worth factors for a variety of discount rates and years into the future. To calculate the net present value of a time series of future benefits or costs, select a value from the table based on the discount rate and the number of years into the future and multiply the selected value times the first year cost or benefit.

Benefit-to-Cost Ratio

Benefit-to-cost ratio is another way of evaluating investments. This is the ratio of the net present value of all benefits to the net present value of all costs. All investments with a ratio greater than one may be considered cost-effective. In comparing multiple investment alternatives, all would have to be compared to a base case. The one with the highest benefit-to-cost ratio is the best investment opportunity.

Internal Rate of Return

The internal rate of return (IRR) is the discount rate at which the present value of future benefits in energy savings and maintenance cost savings is equal to the initial cost premium. Put another way, it is the return on investment with all future costs and savings considered. The IRR of an investment can be viewed as the amount of annual interest (in percent) paid on the investment over the life of the project. The internal rate of return must be calculated through a process of iteration, but many spreadsheet programs have built in functions that are capable of calculating the IRR.

Annualized Cost

Annualized cost is a useful method of comparing lighting alternatives. The initial costs and periodic maintenance costs are converted to an equivalent annual payment and added to the annual energy costs. The design alternative with the lowest annual cost is the one that is most cost-effective. Annualized cost is especially useful when initial costs are financed. Like IRR, annualized cost can be calculated with spreadsheet programs.

Other Issues

Inflation and Energy Cost Escalation Rates

The price of all goods and services increases over time at the general inflation rate. As long as all future costs increase at the same rate, inflation may be ignored in evaluating the economic performance of investments in energy efficiency. With this approach, commonly used in economic analysis, all future costs are quantified in current dollars and discounted at a real discount rate.



If there is reason to believe that energy costs will increase at a rate different from the general inflation rate, each future energy cost should be quantified in inflated dollars and discounted to present value using a nominal discount rate.

Tax Considerations

Investments in energy efficiency have tax implications that need to be considered in detailed economic analysis. Energy costs are an expense; so when energy costs are reduced, taxable income is increased and potentially some of the energy savings are paid to the government as additional taxes. On the other hand, investments in energy efficiency can be depreciated over the life of the equipment, offering a tax benefit. For many businesses, these offset each other, but they must be considered on a case-by-case basis.

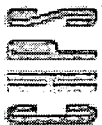

Table B-1 – Present Worth Factors

Number of Years	Discount Rate												
	1%	2%	3%	4%	5%	6%	7%	8%	10%	12%	14%	16%	18%
1	0.99	0.98	0.97	0.96	0.95	0.94	0.93	0.93	0.91	0.89	0.88	0.86	0.85
2	0.98	0.96	0.94	0.92	0.91	0.89	0.87	0.86	0.83	0.80	0.77	0.74	0.72
3	0.97	0.94	0.92	0.89	0.86	0.84	0.82	0.79	0.75	0.71	0.67	0.64	0.61
4	0.96	0.92	0.89	0.85	0.82	0.79	0.76	0.74	0.68	0.64	0.59	0.55	0.52
5	0.95	0.91	0.86	0.82	0.78	0.75	0.71	0.68	0.62	0.57	0.52	0.48	0.44
6	0.94	0.89	0.84	0.79	0.75	0.70	0.67	0.63	0.56	0.51	0.46	0.41	0.37
7	0.93	0.87	0.81	0.76	0.71	0.67	0.62	0.58	0.51	0.45	0.40	0.35	0.31
8	0.92	0.85	0.79	0.73	0.68	0.63	0.58	0.54	0.47	0.40	0.35	0.31	0.27
9	0.91	0.84	0.77	0.70	0.64	0.59	0.54	0.50	0.42	0.36	0.31	0.26	0.23
10	0.91	0.82	0.74	0.68	0.61	0.56	0.51	0.46	0.39	0.32	0.27	0.23	0.19
11	0.90	0.80	0.72	0.65	0.58	0.53	0.48	0.43	0.35	0.29	0.24	0.20	0.16
12	0.89	0.79	0.70	0.62	0.56	0.50	0.44	0.40	0.32	0.26	0.21	0.17	0.14
13	0.88	0.77	0.68	0.60	0.53	0.47	0.41	0.37	0.29	0.23	0.18	0.15	0.12
14	0.87	0.76	0.66	0.58	0.51	0.44	0.39	0.34	0.26	0.20	0.16	0.13	0.10
15	0.86	0.74	0.64	0.56	0.48	0.42	0.36	0.32	0.24	0.18	0.14	0.11	0.08
16	0.85	0.73	0.62	0.53	0.46	0.39	0.34	0.29	0.22	0.16	0.12	0.09	0.07
17	0.84	0.71	0.61	0.51	0.44	0.37	0.32	0.27	0.20	0.15	0.11	0.08	0.06
18	0.84	0.70	0.59	0.49	0.42	0.35	0.30	0.25	0.18	0.13	0.09	0.07	0.05
19	0.83	0.69	0.57	0.47	0.40	0.33	0.28	0.23	0.16	0.12	0.08	0.06	0.04
20	0.82	0.67	0.55	0.46	0.38	0.31	0.26	0.21	0.15	0.10	0.07	0.05	0.04
21	0.81	0.66	0.54	0.44	0.36	0.29	0.24	0.20	0.14	0.09	0.06	0.04	0.03
22	0.80	0.65	0.52	0.42	0.34	0.28	0.23	0.18	0.12	0.08	0.06	0.04	0.03
23	0.80	0.63	0.51	0.41	0.33	0.26	0.21	0.17	0.11	0.07	0.05	0.03	0.02
24	0.79	0.62	0.49	0.39	0.31	0.25	0.20	0.16	0.10	0.07	0.04	0.03	0.02
25	0.78	0.61	0.48	0.38	0.30	0.23	0.18	0.15	0.09	0.06	0.04	0.02	0.02
26	0.77	0.60	0.46	0.36	0.28	0.22	0.17	0.14	0.08	0.05	0.03	0.02	0.01
27	0.76	0.59	0.45	0.35	0.27	0.21	0.16	0.13	0.08	0.05	0.03	0.02	0.01
28	0.76	0.57	0.44	0.33	0.26	0.20	0.15	0.12	0.07	0.04	0.03	0.02	0.01
29	0.75	0.56	0.42	0.32	0.24	0.18	0.14	0.11	0.06	0.04	0.02	0.01	0.01
30	0.74	0.55	0.41	0.31	0.23	0.17	0.13	0.10	0.06	0.03	0.02	0.01	0.01



Table B-2 – Series Present Worth Factors

Number of Years	Discount Rate												
	1%	2%	3%	4%	5%	6%	7%	8%	10%	12%	14%	16%	18%
1	0.99	0.98	0.97	0.96	0.95	0.94	0.93	0.93	0.91	0.89	0.88	0.86	0.85
2	1.97	1.94	1.91	1.89	1.86	1.83	1.81	1.78	1.74	1.69	1.65	1.61	1.57
3	2.94	2.88	2.83	2.78	2.72	2.67	2.62	2.58	2.49	2.40	2.32	2.25	2.17
4	3.90	3.81	3.72	3.63	3.55	3.47	3.39	3.31	3.17	3.04	2.91	2.80	2.69
5	4.85	4.71	4.58	4.45	4.33	4.21	4.10	3.99	3.79	3.60	3.43	3.27	3.13
6	5.80	5.60	5.42	5.24	5.08	4.92	4.77	4.62	4.36	4.11	3.89	3.68	3.50
7	6.73	6.47	6.23	6.00	5.79	5.58	5.39	5.21	4.87	4.56	4.29	4.04	3.81
8	7.65	7.33	7.02	6.73	6.46	6.21	5.97	5.75	5.33	4.97	4.64	4.34	4.08
9	8.57	8.16	7.79	7.44	7.11	6.80	6.52	6.25	5.76	5.33	4.95	4.61	4.30
10	9.47	8.98	8.53	8.11	7.72	7.36	7.02	6.71	6.14	5.65	5.22	4.83	4.49
11	10.37	9.79	9.25	8.76	8.31	7.89	7.50	7.14	6.50	5.94	5.45	5.03	4.66
12	11.26	10.58	9.95	9.39	8.86	8.38	7.94	7.54	6.81	6.19	5.66	5.20	4.79
13	12.13	11.35	10.63	9.99	9.39	8.85	8.36	7.90	7.10	6.42	5.84	5.34	4.91
14	13.00	12.11	11.30	10.56	9.90	9.29	8.75	8.24	7.37	6.63	6.00	5.47	5.01
15	13.87	12.85	11.94	11.12	10.38	9.71	9.11	8.56	7.61	6.81	6.14	5.58	5.09
16	14.72	13.58	12.56	11.65	10.84	10.11	9.45	8.85	7.82	6.97	6.27	5.67	5.16
17	15.56	14.29	13.17	12.17	11.27	10.48	9.76	9.12	8.02	7.12	6.37	5.75	5.22
18	16.40	14.99	13.75	12.66	11.69	10.83	10.06	9.37	8.20	7.25	6.47	5.82	5.27
19	17.23	15.68	14.32	13.13	12.09	11.16	10.34	9.60	8.36	7.37	6.55	5.88	5.32
20	18.05	16.35	14.88	13.59	12.46	11.47	10.59	9.82	8.51	7.47	6.62	5.93	5.35
21	18.86	17.01	15.42	14.03	12.82	11.76	10.84	10.02	8.65	7.56	6.69	5.97	5.38
22	19.66	17.66	15.94	14.45	13.16	12.04	11.06	10.20	8.77	7.64	6.74	6.01	5.41
23	20.46	18.29	16.44	14.86	13.49	12.30	11.27	10.37	8.88	7.72	6.79	6.04	5.43
24	21.24	18.91	16.94	15.25	13.80	12.55	11.47	10.53	8.98	7.78	6.84	6.07	5.45
25	22.02	19.52	17.41	15.62	14.09	12.78	11.65	10.67	9.08	7.84	6.87	6.10	5.47
26	22.80	20.12	17.88	15.98	14.38	13.00	11.83	10.81	9.16	7.90	6.91	6.12	5.48
27	23.56	20.71	18.33	16.33	14.64	13.21	11.99	10.94	9.24	7.94	6.94	6.14	5.49
28	24.32	21.28	18.76	16.66	14.90	13.41	12.14	11.05	9.31	7.98	6.96	6.15	5.50
29	25.07	21.84	19.19	16.98	15.14	13.59	12.28	11.16	9.37	8.02	6.98	6.17	5.51
30	25.81	22.40	19.60	17.29	15.37	13.76	12.41	11.26	9.43	8.06	7.00	6.18	5.52



APPENDIX C – A FIELD-BASED THERMAL COMFORT STANDARD FOR NATURALLY VENTILATED BUILDINGS

Gail Schiller Brager, Ph.D. and Richard de Dear, Ph.D.

Introduction

Architecture and engineering journals have been paying increasing attention to innovative non-residential buildings designed with operable windows. Such buildings may rely exclusively on natural ventilation for cooling, or may operate as mixed-mode, or “hybrid” buildings that integrate both natural and mechanical cooling. Architects who want to incorporate natural ventilation as an energy-efficient feature need to collaborate closely with mechanical engineers. Unfortunately, engineers often need to veto such natural approaches, citing their professional obligation to adhere to thermal comfort standards such as ASHRAE Standard 55 or ISO 7730. In their current form, these standards establish relatively tight limits on recommended indoor thermal environments, and do not distinguish between what would be considered thermally acceptable in buildings conditioned with natural ventilation vs. air-conditioning. In other words, engineers have not been given a suitable tool to help them decide when and where full HVAC is required in a building, and under what circumstances they can incorporate more energy-conserving strategies without sacrificing comfort.

ASHRAE Standard 55¹, “Thermal environmental conditions for human occupancy”, was initially released in 1966. Since then, it has been revised once a decade, incorporating the latest technical advances in our understanding of thermal comfort. Derived from laboratory experiments using a thermal-balance model of the human body, this standard has attempted to provide an objective criterion for thermal comfort — in particular, specifying combinations of personal and environmental factors that will produce interior thermal environments acceptable to at least 80% of a building’s occupants. While ASHRAE Standard 55 was originally intended to provide guidelines for centrally-controlled HVAC, its broad application in practice is hindering innovative efforts to develop more person-centered strategies for climate control in naturally ventilated or mixed-mode buildings. Such strategies may hold great social and environmental benefits, reducing energy consumption and increasing occupant satisfaction, especially in office buildings.

Based on research funded by ASHRAE, this article argues that adequate scientific basis now exists to amend Standard 55 to include a more “adaptive” field-based alternative for application to naturally ventilated buildings. Such a proposal reflects findings that thermal



preference in such buildings varies widely from predictions made by the present laboratory-based standard. The article suggests that one possible reason for this discrepancy may be that the heat-balance model of thermal comfort underlying the present standard cannot account for the complex ways people interact with their environments, modify their behaviors, or gradually adapt their expectations to match their surroundings.

Adaptation In Buildings

Advocates for a more flexible thermal-comfort standard have long argued that the primary limitation of Standard 55 is its "one-size-fits-all" approach, where clothing and activity are the only modifications one can make to reflect seasonal differences in occupant requirements. The standard was originally developed through laboratory tests of perceived thermal comfort, with the limited intent to establish optimum HVAC levels for fully climate-controlled buildings. However, today, in the absence of any credible alternative, Standard 55 is being applied universally across all building types, climates and populations.

As a consequence, even in relatively mild climatic zones, it is hard to meet the standard's narrow definition of thermal comfort without mechanical systems. Many researchers and designers have argued, for example, that reliance on Standard 55 has allowed important cultural, social and contextual factors to be ignored, leading to an exaggeration of the "need" for air conditioning². Others have argued that allowing people greater control of indoor environments, and allowing temperatures to more closely track patterns in the outdoor climate, could improve levels of occupant satisfaction with indoor environments and reduce energy consumption.³

Such issues have particular relevance with regard to naturally ventilated buildings, where occupants are able to open windows, creating indoor conditions that are inherently more variable than buildings with centralized HVAC systems. In such settings, an alternative thermal comfort standard based on field measurements might be able to account for contextual and perceptual factors absent in the laboratory setting. Toward this end, the research began by focusing on three primary modes of adaptation: physiological, behavioral, and psychological.

Physiological adaptation, also known as acclimatization, refers to biological responses that result from prolonged exposure to characteristic and relatively extreme thermal conditions. One example in hot climates is a fall in the setpoint body temperature at which sweating is triggered, leading to an increased tolerance for warmer temperatures. Laboratory evidence suggests, however, that such acclimatization does not play much of a role in subjective preferences across the moderate range of activities and thermal conditions present in most buildings⁴.

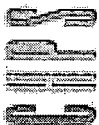

Behavioral adaptation refers to any conscious or unconscious action a person might make to alter their body's thermal balance.⁵ Examples include changing clothes or activity levels, turning on a fan or heater, or adjusting a diffuser or thermostat. Behavioral adjustments offer the best opportunity for people to participate in maintaining their own thermal comfort. Affording ample opportunities for people to interact with and control the indoor climate is an essential strategy in the design of naturally ventilated buildings.

The psychological dimension of thermal adaptation refers to an altered perception of, and reaction to, physical conditions due to past experience and expectations. It is premised on the generalization, true across all sensory modalities (not just thermal), that that repeated exposure to a new stimulus leads to a diminution of the evoked response. It also includes the idea that a person's reaction to a temperature that is less than perfect will depend on expectations and on what that person is doing at the time⁶.

Research Methods

The research described in this paper involved assembling a quality-controlled database containing 21,000 sets of raw data compiled from previous thermal-comfort field experiments inside 160 different office buildings located on four continents and covering a broad spectrum of climatic zones.⁷ The gender and age distribution of the subjects was typical of office building populations and the large size of the sample reduced the risk of bias that might occur in relatively smaller samples used in climate chamber experiments. The data included a full range of both subjective and physical measurements, including thermal questionnaire responses, clothing and metabolic estimates, concurrent indoor climate measurements, a variety of calculated thermal indices, and outdoor meteorological observations. Analysis of data was performed separately for buildings with centralized HVAC systems and naturally ventilated buildings (i.e., where occupants had access to operable windows). The analysis examined thermal comfort responses in terms of both thermal neutrality and preference, as functions of both indoor and outdoor temperatures. Observed responses were also compared to predictions of thermal sensation made using the heat-balance-based PMV model.⁸ The PMV model is the basis for ISO Standard 7730⁹, and for the next version of Standard 55.

The following sections present select aspects of the research that directly relate to the proposal for an "adaptive" thermal-comfort standard to be used as an alternate to PMV for naturally ventilated buildings in the next revision of ASHRAE Standard 55. A more detailed description of the research methods, statistical analysis techniques, and results can be found in ASHRAE Transactions papers.^{7,10}

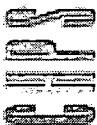

Thermal Comfort In Air-Conditioned Vs. Naturally Ventilated Buildings

To what extent do people behaviorally adapt in the two building types?

Behavioral adaptation was analyzed by examining how changes in clothing, metabolic rate, and air velocity varied as functions of indoor temperature. Mean metabolic rates in both building types stayed fairly constant at about 1.2 met units regardless of indoor temperature, ranging within a fairly tight cluster of 1.1-1.4 met units. In contrast, changes in clothing and air velocity were both significantly related to changes in mean indoor operative temperatures in all buildings. The relationships were stronger, however, in the case of the naturally ventilated buildings. Mean clothing insulation values (including the incremental insulation of the chairs) varied seasonally in the HVAC vs. naturally-ventilated buildings, respectfully, from 0.70/0.66 clo in the summer, to 0.92/0.93 clo in the winter. Although the differences between the mean clothing values were not significantly different between the two building types, there was a much wider range of clothing worn in the naturally ventilated buildings, and a stronger relationship between clothing and indoor temperature. In the naturally ventilated buildings, mean thermal insulation decreased by an average of 0.1 clo units for every 2°C (3.6°F) increase in mean indoor temperature.

Air velocity is considered a form of behavioral adaptation when people are able to make the environmental adjustments themselves, such as opening or closing a window, turning on a local fan, or adjusting an air diffuser. Mean air speeds recorded in the HVAC buildings were generally confined to the region below 0.2 m/s (39.4 ft/min), as prescribed in ASHRAE Standard 55-1992. In naturally ventilated building, on the other hand, speeds above this limit were recorded when indoor temperatures extended beyond the upper temperature limit of 26°C (78.8°F) in ASHRAE Standard 55-1992. As will be shown below, however, these forms of behavioral adaptation could account for only part of people's acceptance of higher temperatures in the naturally ventilated buildings.

How do people react as conditions deviate from the optimum?

A weighted linear regression model of the relationship between mean thermal sensation (TS) and mean indoor operative temperature (T_{op}) was used to judge how quickly people felt too warm or too cool as temperatures deviated from the optimum:

$$\begin{aligned} \text{(centralized HVAC buildings)} \quad TS &= 0.51 * T_{op} - 11.96 \quad (T_{op} \text{ in } ^\circ\text{C}) \quad (1) \\ TS &= 0.28 * T_{op} - 21.03 \quad (T_{op} \text{ in } ^\circ\text{F}) \end{aligned}$$

$$\begin{aligned} \text{(naturally ventilated buildings)} \quad TS &= 0.27 * T_{op} - 6.65 \quad (T_{op} \text{ in } ^\circ\text{C}) \quad (2) \\ TS &= 0.15 * T_{op} - 11.45 \quad (T_{op} \text{ in } ^\circ\text{F}) \end{aligned}$$

In these equations, TS represents a vote on the familiar ASHRAE 7-point thermal sensation scale, where TS=0 is "neutral". This analysis revealed that occupants of centralized HVAC buildings were twice as sensitive to such deviation as were occupants of naturally ventilated buildings. Such a finding suggests that people in air-conditioned



buildings have higher expectations for thermal consistency, and quickly became critical if thermal conditions diverge from these expectations. In contrast, people in naturally ventilated buildings seem to demonstrate a preference for a wider range of thermal conditions, perhaps due to their ability to exert control over their environment, or because their expectations match the more variable conditions they are used to experiencing in such buildings.

How does one define a “comfort temperature”? Does everyone always prefer to feel “neutral”?

The traditional method of defining a comfortable temperature is to assume that a “neutral thermal sensation” represents ideal conditions, and then solve a linear regression equation such as those given above for the “neutral temperature” at which $TS=0$. However, when surveys include a question about preference (usually expressed as “do you prefer to feel warmer, no change, or cooler?”), one can also calculate a “preferred temperature” in a similar way, assuming that a preference for “no change” represents ideal conditions.

Both types of analyses were conducted in the present project, with the result being that there was generally no difference in these measures for occupants of naturally ventilated buildings. However, in the HVAC buildings, the analysis revealed that people preferred slightly warmer-than-neutral temperatures in cold climates, and cooler-than-neutral temperatures in warmer climates (the difference being up to 1°C at either extreme end). Since we viewed “preference” as being a more appropriate indicator of optimum thermal conditions than the traditional assumption of “neutral thermal sensation,” we developed a correction factor to modify calculations of neutral temperatures in HVAC buildings to more accurately reflect preference.

Do indoor comfort temperatures change in relation to outdoor weather and climate?

Adaptive theory suggests that the thermal expectations of building occupants, and their subsequent expectations for indoor comfort, will be dependent on outdoor temperature. This relation may vary, however, based on the extent to which the indoor environment is connected to natural seasonal swings in outdoor climate. Figure 1 shows a regression of indoor comfort temperatures as defined above against an outdoor temperature index for centralized HVAC (left graph) and naturally ventilated (right graph) buildings. The outdoor temperature index used was mean effective temperature (ET^*). Each graph shows the regressions based on both observed responses in the database and the PMV predictions.

Looking first at observed responses (dotted lines), the gradient for the naturally ventilated buildings was more than twice that found in buildings with centralized HVAC systems. One possible interpretation of this finding is that occupants of the HVAC buildings become more finely adapted to mechanically conditioned, static indoor climates. In comparison, the range in thermal comfort levels in naturally ventilated buildings showed a much larger variation, suggesting that occupants of these buildings preferred conditions that more closely reflected outdoor climate patterns.



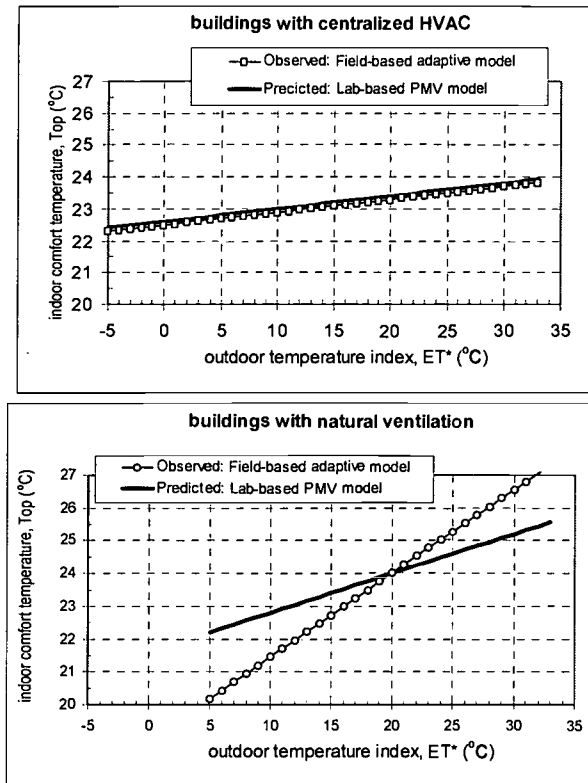

Figure C-1 -- Observed and predicted comfort temperatures

How do field-based measurements compare to lab-based predictions, and what does this say about adaptation?

Looking next at the observed and predicted lines within each graph in Figure 1 provides insight into how adaptation may influence the relationship between indoor comfort and outdoor climate in the two building types. Recall that clothing insulation and air velocity both had a statistical dependence on mean indoor temperatures (and are probably related to outdoor temperature as well). Both are included as inputs to the PMV model. Therefore, one would expect to see that the indoor comfort levels predicted by the PMV model might also show some dependence on outdoor climate. In fact, as seen in Figure 1, they do.

In the HVAC buildings (left-hand panel of Figure 1), the observed (dotted) and predicted (solid) lines appear very close together, demonstrating that PMV was remarkably successful at predicting comfort temperatures in these buildings. A corollary of this finding is that, in HVAC buildings, behavioral adjustments to clothing and room air speeds fully explain the relationship between indoor comfort temperature and outdoor climatic variation, and that these adaptive behaviors are, in fact, adequately accounted for by the PMV model.

However, the remarkable agreement between PMV and adaptive models in the HVAC buildings clearly breaks down in the context of naturally ventilated buildings (right-hand panel of Figure 1), where the observed responses show a gradient almost twice as steep

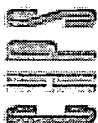

as the PMV model's predicted comfort levels. By logical extension therefore, it appears that behavioral adjustments (clothing and air velocity changes) may account for only half of the climatic dependence of comfort temperatures within naturally ventilated buildings.

What explains the rest? Having accounted for the effects of behavioral adaptations, physiological (acclimatization) and psychological components of adaptation are left to explain the divergence. But, as noted previously, existing literature suggests that acclimatization is unlikely to be a significant factor. This leaves psychological adaptation as the most likely explanation for the difference between field observations and PMV predictions in naturally ventilated buildings. This means the physics governing a body's heat balance must be inadequate to fully explain the relationship between perceived thermal comfort in naturally ventilated buildings and exterior climatic conditions.

An Adaptive Comfort Standard For Naturally Ventilated Buildings

Using Standard 55 to determine acceptable indoor temperature ranges requires one to know, or at least anticipate, the average metabolic rate and amount of clothing worn by people in a building, regardless of whether that building is already built or occupied. In contrast, an adaptive model relates acceptable indoor temperature ranges to mean monthly outdoor temperature (in this case, defined as the arithmetic average of mean monthly minimum and maximum air temperature). This is a parameter already familiar to engineers and can be easily found by examining readily available climate data, such as that published by the U.S. National Atmospheric and Oceanographic Administration (www.ncdc.noaa.gov). Because the adaptive model is based on extensive field measurements, the relationship between expected clothing and outdoor climate is already built into the empirical statistical relationship.

Although both laboratory and field studies typically collect subjective data in terms of thermal sensation, Standard 55 presents temperature limits in terms of acceptability (with the goal of achieving 80 percent acceptability in the field). To create the link between 80% acceptability and measured thermal sensation, we accepted one of the underlying assumptions of Fanger's PMV/PPD indices: namely, that a group mean thermal sensation (PMV) between the limits of ± 0.85 corresponds with 20 percent of the group being dissatisfied (PPD). If one wanted to apply a more stringent level of acceptability to the adaptive model, or if one expected a building to present greater than normal thermal asymmetries, one might choose to use an acceptability criteria of 90 %, corresponding to a mean thermal sensation falling within the limits of ± 0.5 .

For comparison, it should be noted that the 80% acceptability comfort zone in Standard 55 is actually based on a 10% general dissatisfaction criteria for the body as a whole, corresponding to tests performed in the laboratory under uniform conditions. It then allows for an additional average of 10% dissatisfaction that might occur because of local thermal



discomfort. Since the adaptive model is based on field measurements, where people are naturally integrating whole body plus local sensations, field votes already account for both sources of discomfort.

The adaptive model for naturally ventilated buildings is shown in Figure 2. To make it easier for engineers to use, the regressions in Figure 1 (originally using ET*) have been recalculated based on mean monthly outdoor air temperature. This comfort standard would be applicable to buildings in which occupants control operable windows, where there is no mechanical cooling, and where activity levels are < 1.2 met. As the outdoor temperature extends beyond the outdoor temperature limits that were included in the RP-884 database, the acceptable indoor temperature limits would remain constant at the maximum and minimum levels. To use this standard, engineers would simply calculate the average of the mean minimum and maximum air temperatures for a given month, and then use Figure 2 to determine the acceptable range of indoor operative temperatures for a naturally ventilated building. During the design phase of a building, these numbers could be compared to the output of a thermal simulation model of the proposed building to determine whether the predicted indoor temperatures are likely to be comfortable using natural ventilation, or if air-conditioning would be required. The figure could also be used to evaluate the acceptability of thermal conditions in an existing building by comparing the acceptable temperature range obtained from Figure 2 to indoor temperatures measured in the building.

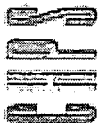

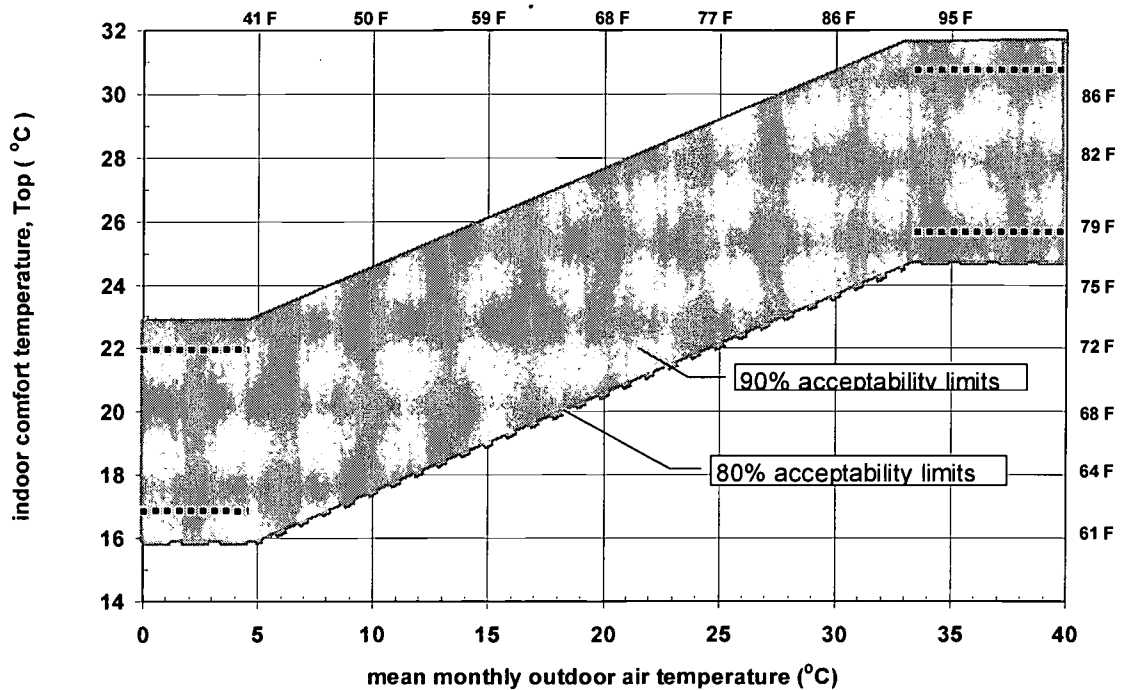

Figure C-2 – Proposed adaptive comfort standard for naturally ventilated buildings.

Conclusions

The research has demonstrated that occupants of buildings with centralized HVAC systems become finely tuned to the very narrow range of indoor temperatures presented by current HVAC practice. They develop high expectations for homogeneity and cool temperatures, and soon became critical if thermal conditions do not match these expectations. In contrast, occupants of naturally ventilated buildings appear tolerant of – and, in fact, prefer – a wider range of temperatures. This range may extend well beyond the comfort zones published in ASHRAE Standard 55-92, and may more closely reflect the local patterns of outdoor climate change.

Further analysis of research findings established that behavioral adaptations, such as changes in clothing insulation or indoor air speeds, could account for only half the observed variance in thermal preferences of people in naturally ventilated buildings. Since it has been established that physiological adaptation is unlikely to play much of a role in relation to indoor office environments, this suggested the rest of the variance was attributable to psychological factors. Chief among these was a relaxation of thermal expectations possibly because of a combination of higher levels of perceived control and a greater diversity of thermal experiences in the building.

Such research suggests that accounting for these broader adaptive mechanisms allows mechanical engineers to design and operate buildings in ways that both optimize thermal



comfort and reduce energy use. In many climatic settings, the practice of maintaining a narrowly defined, constant range of temperatures in fully air-conditioned buildings is unnecessary, and carries a very high energy cost. Unfortunately, the thermal comfort standards embodied in Standard 55 do not present alternative approaches to building conditioning. One reason is that the heat-balance models, on which the standard is based, were developed in tightly controlled laboratory conditions. In this process, people were considered passive subjects of climate change in artificial settings, and little consideration was given to the broad ways they might naturally adapt to a more wide-ranging thermal environments in realistic settings.

Along these lines, it may be noted that the laboratory context in which Standard 55 was established is quite similar to that of buildings with fully centralized HVAC systems. In fact, there is a historical connection between the two, since the standard was originally intended for application by the HVAC industry to the creation of "artificial climates" in "controlled spaces" (Fanger 1970). It is therefore not surprising that this research demonstrated that the PMV model could accurately predict people's patterns of thermal preference in fully air-conditioned buildings. However, the research showed that the PMV model could not predict people's thermal preferences in naturally ventilated buildings. This would seem to indicate the PMV model is an unsuitable guide when deciding whether or not to install HVAC systems in a particular building.

On the strength of this research we argue that an adaptive model of thermal comfort may usefully augment laboratory-based predictive models in the setting of thermal comfort standards. Furthermore, it would appear that such an approach is essential in order to account for additional contextual factors and individual experiences that appear to modify people's expectations in naturally ventilated buildings. As part of the next round of revisions to ASHRAE Standard 55, adoption of an alternative "adaptive" standard for naturally ventilated buildings may serve as a practical first step towards allowing engineers to adopt a more complex, socially and environmentally-responsive approach to evaluating and designing indoor climates. It would reflect growing awareness among researchers that factors beyond the mere passive experience of a body's thermal balance may play a significant role in determining human thermal preferences.

References

- ASHRAE. 1992. Standard 55 - Thermal Environmental Conditions for Human Occupancy. Atlanta: ASHRAE Inc.
- Kempton, W.; and Lutzenhiser, L. (Eds) 1992. Energy and Buildings. V.18.
- Milne, G.R. 1995. "The energy implications of a climate-based indoor air temperature standard", Standards for Thermal Comfort, Nicol, Humphreys, Sykes, Roaf (Eds.), E and FN Spon, London, 1995, pp. 182-189.
- Brager, G. S.; and de Dear, R. J. 1998. "Thermal Adaptation in the Built Environment: A Literature Review." Energy and Buildings, 27 (1): 83-96.



- Wohlwill, J.F. 1975. "Behavioral response and adaptation to environmental stimulation", *Physiological Anthropology*, Damon, A. (Ed), Harvard Univ. Press, Cambridge, MA, pp. 295-334.
- McIntyre, D.A. 1980. "Design requirements for a comfortable environment", *Bioengineering: Thermal Physiology and Comfort* Cena, K.; and Clark, J.A. (Eds), Amsterdam: Elsevier. pp.157-168.
- de Dear, R. J. 1998. "A Global Database of Thermal Comfort Field Experiments". *ASHRAE Transactions*. 104 (1).
- Fanger, P.O. 1970. *Thermal Comfort - Analysis and Applications in Environmental Engineering*. Copenhagen: Danish Technical Press.
- ISO. 1994. *International Standard 7730 : Moderate Thermal Environments - Determination of the PMV and PPD Indices and Specification of the conditions of Thermal Comfort*. 2nd ed. (ISO: Geneva).
- de Dear, R. J. and Brager, G. S. 1998. "Developing an adaptive model of thermal comfort and preference". *ASHRAE Transactions*. 104 (1).



APPENDIX D – ENERGY COST AND IAQ PERFORMANCE OF VENTILATION SYSTEMS AND CONTROLS

Indoor Environments Division
Office of Radiation and Indoor Air
Office of Air and Radiation
United States Environmental Protection Agency
Washington, D.C. 20460

April, 1999

Executive Summary

Table 1 – Relationship Between Goals and Technical Chapters

Table 2 – Choosing an Appropriate Daylighting Strategy

Table 3 – Solar Optic Properties of Glazing Materials

Table 4 – Daylighting Analysis Tools

Table 5 – Recommended Daylighting Aperture – Sawtooth Roofs

Table 6 – HVAC Selection Criteria

Exhibit 1: Characteristics of the Base Buildings Modeled in this Study

Exhibit 3: Comparison of Outdoor Air Flows {design = 20 cfm (9 L/s) per person} for a Large Office Building with Alternative HVAC Systems

Exhibit 5: Comparison of Zone Level Outdoor Air Flow Rates {design = 20 cfm (9 L/s) per person} for Three Types of HVAC Systems in Office Buildings in Washington, DC.

Exhibit 6: Comparison of Annual Energy Costs for the Base Office Building with Alternative HVAC Systems and in Different Climates

Exhibit 8: Annual HVAC Energy Costs of Increasing Outdoor Air from 5 to 20 cfm per person for VAV(COA) Systems with Economizers

Exhibit 9: Impacts of Increased Outdoor Air Flows on Peak HVAC Coil Loads for VAV(COA) Systems with Economizers

Exhibit 10: Energy Measures that are Compatible with IEQ

Exhibit 11: Energy Measures that May Degrade IEQ

Exhibit 12: Modeling Parameters for the Office and Education Building

Exhibit 13: Energy Cost for Office Building with Energy and IEQ Modifications

Exhibit 14: Energy Cost for the Education Building with Energy and IEQ Modifications

Exhibit 15: Percent Savings in Total Energy Cost from Energy and IEQ Modifications

Exhibit 16: Energy Costs of Operational Measures that May Have Adverse Effects on IEQ

Exhibit 17: Savings from Reduced Lights and Office Equipment when Unoccupied

Purpose And Scope of this Report

In it's 1989 Report to Congress on Indoor Air Quality, the United States Environmental Protection Agency provided a preliminary assessment of the nature and magnitude of



indoor air quality problems in the United States, the economic costs associated with indoor air pollution, and the types of controls and policies which can be used to improve the air quality in the nation's building stock. In that report, EPA estimated that the economic losses to the nation due to indoor air pollution was in the "tens of billions" of dollars per year, and suggested that because of the relative magnitude of operating costs, labor costs, and rental revenue in most buildings, it is possible that modest investments toward improved indoor air quality would generate substantial returns. Since that time, EPA has attempted to further define the costs and benefits to the building industry of instituting indoor air quality controls.

This project - *Energy Cost and IAQ Performance of Ventilation Systems and Controls* - is part of that effort. Adequate ventilation is a critical component of design and management practices needed for good indoor air quality. Yet, the energy required to run the ventilation system constitutes about half of a building's energy cost. Since energy efficiency can reduce operating costs and because the burning of fossil fuels is a major source of greenhouse gases, energy efficiency has become an important concern to the building industry and the promotion of efficient energy utilization has become a matter of public policy. It is important, therefore, to examine the relationship between energy use and indoor air quality performance of ventilation systems.

This project represents a substantial modeling effort whose purpose is to assess the compatibilities and trade-offs between energy, indoor air quality, and thermal comfort objectives in the design and operation of HVAC systems in commercial buildings, and to shed light on potential strategies which can simultaneously achieve superior performance on each objective.

This project seeks to examine three related fundamental questions:

- How much seasonal and spatial variation in IAQ performance may be expected from commonly used HVAC systems and controls and what are the IAQ implications of these variations?
- What is the energy cost associated with meeting ASHRAE indoor air quality performance standards for HVAC systems?
- How much energy reduction would have to be sacrificed in order to maintain minimum indoor air quality performance of HVAC systems in the course of energy efficiency projects?

The indoor air performance standards for HVAC systems used in this project are indoor air quality flow rates contained in ANSI/ASHRAE Standard 62-1989, *Ventilation for Acceptable Indoor Air Quality*, and temperature and relative humidity requirements for thermal comfort based on ANSI/ASHRAE Standard 55-1992, *Thermal Environmental Conditions for Human Occupancy*. The outdoor air flow rate criteria used were 20 cfm per occupant for office spaces, and 15 cfm per occupant for educational buildings and



auditoriums as per ANSI/ASHRAE Standard 62-1989.² The thermal comfort criteria in ANSI/ASHRAE Standard 55-1992 were considered satisfied if space temperatures were maintained at 70° F - 79° F and relative humidity levels were maintained between 20% and 60%.³ When judging HVAC performance, these criteria were used to set the outdoor air controls and space temperature set points. The actual outdoor air flows, space temperatures, and space relative humidity were then compared with these criteria to judge the performance of the system. Where appropriate, operational changes were undertaken to insure that the criteria were met and the associated changes in energy cost were examined.

While indoor air quality can arguably be controlled by different combinations of source control, ventilation control, and/or air cleaning technologies, no attempt was made in this project to study the potential for maintaining acceptable indoor air quality at reduced ventilation rates through the application of source control and air cleaning methods. In addition, while the impact of polluted outdoor air on the indoor environment is noted in discussions of outdoor air flow rates, no attempt was made to assess the implications of treating the outdoor air prior to entry into the building. In general, this project attempted to examine issues facing HVAC design and operational engineers during the most common applications of the indoor air quality and thermal comfort standards as prescribed by ASHRAE.

In addition, since outdoor air flow rates of 5 cfm per occupant were allowed by ASHRAE Standard 62-1981, energy costs for both 5 cfm per occupant (which were commonly used prior to 1989) as well as the above referenced 15 and 20 cfm per occupant, were estimated in order to determine the cost implications of raising the outdoor air flow rates from the previously allowed to the current ASHRAE outdoor air requirements.

It is hoped that this project will contribute to the body of new data needed by professionals and practitioners who design and operate ventilation systems as they attempt to reduce costs and save energy without sacrificing thermal comfort or outdoor air flow performance. This information should also assist in the development of public policies and strategies directed toward improvements in building performance as it relates to public health, productivity, and the conservation of energy resources.

-
- 2 The outdoor air flow rates specified in ASHRAE 62-1989 are designed to dilute indoor generated contaminants to acceptable levels where no significant indoor sources of pollution are present, and where the outdoor air quality meets applicable pollution standards. Thus, where significant indoor sources of pollution are present, these would have to be controlled. In addition, unacceptable concentrations of contaminants in the outdoor air would have to be removed prior to its entering occupied spaces. These issues were not specifically addressed in this modeling project.
 - 3 ASHRAE Standard 55-1992 describes several factors which affect thermal comfort, including air temperature, radiant temperature, humidity, air speed, temperature cycling and uniformity of temperature, when establishing criteria for thermal comfort. The modeling in this project addresses only the air temperature and relative humidity factors.



Methodology

The process of investigating indoor air quality (IAQ) and energy use can be time-consuming and expensive. In order to streamline the process, this study employed a building simulation computer modeling procedure. The computer modeling approach enabled the investigation of multiple variations of building configurations and climate variations at a scale which would not otherwise be possible with field study investigations.

The methodology used in this project has been to refine and adapt the DOE-2.1E building energy analysis computer program for the specific needs of this study, and to generate a detailed database on the energy use, indoor climate, and outdoor air flow rates of various buildings, ventilation systems and outdoor air control strategies.

Buildings and Climate

One large office building, an education building, and an auditorium formed the basis for most of this study. Summary characteristics of these buildings are presented in Exhibit 1. In addition, however, thirteen variations of the office building were used to examine how these variations impacted the energy costs of increasing outdoor air flow rates from 5 to 20 cfm per occupant, while slight modifications to the education building were made to examine the combined application of energy efficiency and indoor air quality controls.

Each building was modeled with (1) a dual duct constant volume (CV) system with temperature reset; and (2) a single duct variable volume (VAV) system with reheat. Outdoor air controls include a fixed outdoor air fraction (FOAF), and constant outdoor air (COA) flow. The FOAF strategy maintains a constant outdoor air fraction (percent outdoor air) irrespective of the supply air volume. For VAV systems, the FOAF could potentially be approximated in field applications by an outdoor damper in a fixed position (Cohen 1994; Janu 1995; and Solberg 1990), but specific field applications are not addressed in this study. The FOAF strategy was modeled so that the design outdoor air flow rate is met at the design cooling load, and diminishes in proportion to the supply flow during part-load. The COA strategy maintains a constant volume of outdoor air irrespective of the supply air volume. In a CV system, the FOAF and the COA strategies are equivalent, and are referred to in this report as CV (FOAF). In a VAV system, the COA strategy might be represented in field applications by a modulating outdoor air damper which opens wider as the supply air volume is decreased in response to reduced thermal demands. Specific control mechanics which would achieve a VAV (COA) have been addressed by other authors, (Haines 1986, Levenhagen 1992, Solberg 1990) but are not addressed in this modeling project.

In this study two types of air-side economizer strategies were also modeled: one controlled by outdoor air temperature ($ECON_T$) and one controlled by outdoor air enthalpy ($ECON_E$). The economizer is designed to override the minimum outdoor air flow called for by the prevailing strategy (FOAF or the COA) by bringing in additional quantities of outdoor air to provide "free cooling" when the outdoor air temperature (or enthalpy) is



lower than the return air temperature (or enthalpy). In addition, the temperature economizer is prevented from operating when outdoor air temperatures exceed 65°F in order to avoid potential humidity problems. While the enthalpy economizer was modeled for comparison purposes, the temperature economizer was the primary economizer control used in various parts of this study.

Climates and Utility Rates

Each building was modeled using TMY formatted weather data for three different cities, each representing distinctly different climate regions: Minneapolis, MN (cold climate regions), Washington, DC (temperate climate regions), and Miami, FL (hot and humid climate regions). Five different utility rate structures were modeled to determine the extent to which energy cost impacts from various parametric changes were dependent on utility rate structures. The base utility rate structure represents the average of prices taken from utilities in 17 major cities around the country in 1994. The price of electricity was modeled at \$0.05 per kilowatt-hour, and \$8 per kilowatt. Gas for space heating and DHW service was modeled at \$0.50 per therm. The sensitivity of the results in this study to alternative utility rate structures was also tested.

Limitations

Any analysis, however thorough, is inevitably constrained by the state of the art and resource available. Several fundamental limitations to the analysis in this project must be recognized.

- The analysis is ultimately constrained by the extent to which the model used accurately reflects real world performance.
- While a large number of building and ventilation parameters were used, they are limited in comparison to the many and varied building and ventilation characteristics in the nation's building stock. While the parameters were chosen to capture important variations, they are not necessarily representative.
- The model assumes that all equipment functions as it was intended to function. Faulty design, improper installation, and malfunctioning equipment due to poor maintenance, which are not uncommon in existing buildings, were not modeled.

Issues Addressed in the Project

Seven reports, covering the following questions, describe the issues addressed in this project:

Project Report #1: Project Objectives and Methodology

- What is the purpose of the project?
- What modeling tool was used and what modifications were made to meet the needs of this project?



- What buildings, HVAC systems, outdoor air control strategies, and utility rate structures were used, and how were they combined in simulations which constitute the database for this project?

Project Report #2: Assessment of CV and VAV Ventilation Systems and Outdoor Air Control Strategies for Large Office Buildings-- Outdoor Air Flow Rates and Energy Use

- Are there significant differences in outdoor air flow and energy cost among different HVAC systems and outdoor air control strategies?
- What HVAC system/outdoor air control strategy combinations offer the best and the worst results?
- What are the trade-offs and compatibilities between energy cost and outdoor air performance among the combinations studied?

Project Report #3: Assessment of CV and VAV Ventilation Systems and Outdoor Air Control Strategies for Large Office Buildings-- Zonal Distribution of Outdoor Air and Thermal Comfort Control

- How well do HVAC systems and outdoor air control strategies deliver design quantities of outdoor air to individual zones?
- Can shortfalls in particular zones be easily corrected and at what energy cost?

Project Report #4: Energy Impacts of Increasing Outdoor Air Flow Rates from 5 to 20 cfm per Occupant in Large Office Buildings

- What are the energy costs of raising outdoor air flow rates from 5 to 20 cfm per occupant for office buildings?
- How does the cost impact vary among different ventilation systems, outdoor air control strategies, and climates?

Project Report #5: Peak Load Impacts of Increasing Outdoor Air Flow Rates from 5 to 20 cfm per Occupant in Large Office Buildings

- Do HVAC system capacity problems result when outdoor air flow rates are raised in existing buildings (designed for 5 cfm of outdoor air per occupant) to conform with ASHRAE 62-1989?
- How significant are such problems and when are they most likely to occur?
- What implications do peak load impacts have on desires to downsize equipment in order to reduce first costs and save energy?

Project Report #6: Potential Problems in IAQ and Energy Performance of HVAC Systems When Outdoor Air Flow Rates Are Increased from 5 to 15 cfm per Occupant in Education Buildings, Auditoriums, and Other Very High Occupant Density Buildings

- What operational difficulties are presented by the requirement for large quantities of outdoor air for schools, auditoriums and other buildings with high occupant densities and how can these difficulties best be solved?
- What are the energy costs of increasing outdoor air flow from 5 to 15 cfm per occupant as per ASHRAE Standard 62-1989 for schools, auditoriums, and other buildings with high occupant densities, and how much can these costs be mitigated?

Project Report #7: The Impact of Energy Efficiency Strategies on Energy Use, Thermal Comfort, and Outdoor Air Flow Rates in Commercial Buildings

- What energy efficiency measures are compatible and what measures are incompatible with indoor environmental quality?



- What are the energy savings and penalties associated with measures to protect the indoor environments during energy efficiency projects?
- What protections and enhancements to indoor environmental quality can reasonably be employed in energy management and retrofit projects without sacrificing energy efficiency?

Key Results

- **VAV Systems Save Energy:** Variable air volume systems provided \$0.10 - \$0.20 energy savings per square foot over constant volume systems.
- **VAV with Fixed Outdoor Air Fractions Caused Outdoor Air Flow Problems:** VAV systems may require a different outdoor air control strategy at the air handler to maintain adequate outside air for indoor air quality than the constant volume predecessor. If the fixed outdoor damper strategy of the CV system, which is commonly used in the VAV systems, results in a fixed outdoor air fraction, the outdoor air delivery rate at the air handler will be cut to about one half to two thirds the design level during most of the year.
- **Core Zones Received Significantly Less Air than Perimeter Zones and space temperatures tended to be higher:** Both CV and VAV systems provided an unequal distribution of supply air and outdoor air to zones. The south zone received the highest and the core zone received the least outdoor air. The core zone received only about two thirds of the building average outdoor air flow and had higher space temperatures.
- **Core Zones in VAV Systems with a Fixed Outdoor Air Fraction Received Very Little Outdoor Air:** The VAV system with fixed outdoor air fraction diminished the outdoor air delivery to the core zone to only about one third of the design level. With a design level of 20 cfm of outdoor air per occupant, the core zone received only 6-8 cfm per occupant, and only 2-3 cfm per occupant with a design level of 5 cfm per occupant. Along with higher temperatures in the core zone, this shortfall could contribute to higher indoor air quality complaint rates in the core relative to the perimeter zones.
- **VAV with Constant Outdoor Air Control Displayed Improved Indoor Air Performance without any Meaningful Energy Penalty.** A VAV system with an outdoor air control strategy that maintains the design outdoor air flow at the air handler all year round had slightly lower energy cost in the cold climate, and slightly more energy cost in the hot and humid climate. It is therefore comparable in energy cost, but preferred for indoor air quality.
- **Economizers on VAV Systems May Be Advantageous for Both Indoor Air Quality and Energy in Cold and Temperate Climates.** By increasing the outdoor air flow when the outside air temperature (or enthalpy) is less than the return air temperature (or enthalpy), economizers can reduce cooling energy costs. For office buildings, economizers may operate to provide free cooling even at winter temperatures (e.g. at zero degrees Fahrenheit), provided that coils are sufficiently protected from freezing. For the office building, energy savings of about \$0.05 per square foot were experienced by the VAV system economizer over the non-economizer VAV system in cold and temperate climates. The economizer on the CV system was much less advantageous due to increases in heating energy costs for this system, and was actually more expensive under some utility rate structures. The need to control or relative humidity and the potential introduction of outdoor contaminants are potential disadvantages of economizer systems.



- **VAV with Constant Outdoor Air Control and an Economizer Offers Significant Advantages, while VAV with Fixed Outdoor Air Fraction and No Economizer offers Significant Disadvantages:** Of all the ventilation systems and controls studied, the VAV system with constant outdoor air flow, which in cold and temperate climates is combined with an economizer and proper freeze control and humidity control, provided the good overall performance considering outdoor air flow, thermal comfort and energy efficiency. The VAV system with a fixed outdoor air fraction and no economizer provided the poor overall performance because it failed to deliver adequate outdoor air and had no energy benefit.
- **Raising Outdoor Air to Meet ASHRAE Standard 62-1989 in Office Buildings Resulted in Very Modest Increases in Energy Costs.** Raising outdoor air flow from 5-20 cfm per occupant in office buildings typically raised HVAC energy costs by only \$0.02 - \$0.08 per square foot (2% - 10%) depending type of system and climate. Considering the total energy bill, this increase amounted to approximately 1% - 4%. This is much less than is commonly perceived by practitioners. The cooling cost increases in the summer months were counterbalanced by cooling cost savings during cooler weather. Cost increases were higher for economizer systems than systems without economizers because much of the cost savings from higher outdoor air flow rates during cooler weather was already captured by the economizer system. The most significant factor affecting this increase was occupant density.
- **VAV Systems in Education, Auditoriums, and Other Buildings with Very High Occupant Densities May Require Special Adjustments for Meeting the High Outdoor Air Flow Rates of ASHRAE 62-1989.** In the education and auditorium buildings, the higher per occupant outdoor air requirements sometimes exceeded the total supply air needed to control thermal comfort. Even with the constant outdoor air damper control on the VAV system, the VAV box minimum settings had to be raised to what appear to be uncommonly high levels (e.g. 50% - 100% of peak flow), in order to maintain 15 cfm per occupant during part load.
- **Controlling Humidity Can be a Problem for Education Buildings, Auditoriums or Other Buildings with Very High Occupant Densities where HVAC Systems Must Deliver High Outdoor Air Flows to Meet ASHRAE Standard 62-1989.** Relative humidity frequently exceeded 60% and occasionally exceeded 70% in all climates in the education buildings and the auditoriums even though the cooling coils were adequately sized to handle peak loads and the indoor temperatures were well controlled. Problems occurred at part load during mild weather when the outdoor relative humidity was high. The increased dominance of the outdoor air at 15 cfm per occupant meant that the heating and cooling system had to deal with wide ranges in the sensible to latent heat ratio, so that humidity as well as temperature had to be part of the control regime. Controlling humidity may be a subject of special concern in buildings with very high occupant densities which meet the outdoor air flow requirements of ASHRAE Standard 62-1989.
- **The Outdoor Air Requirements of ASHRAE Standard 62-1989 for Education Buildings, Auditoriums and Other Buildings with Very High Occupant Densities Can Create a Significant Energy Burden.** When outdoor air ventilation rates were raised from 5 to 15 cfm per occupant in the education building and the auditorium, and when all adjustments were made to insure adequate outdoor air flow rates at part load, and relative humidity was controlled to 60% or below, HVAC energy costs rose by \$0.13 - \$0.27 per square foot (15%-32%) in the education building, and by \$0.36 - \$0.88 per square foot (26% - 67%) in the auditorium. This was judged to be a significant energy burden.



- **Contrary to Conventional Wisdom, the Impact of Raising Outdoor Air Flow Rates in High Occupant Density Buildings may be Least in Hot Humid Climates.** While raising outdoor air flow rates in the education and auditorium buildings raised cooling costs in Miami more than it did in Minneapolis and Washington, D.C., this was more than offset by the high increase in heating and fan energy these climates which was not experienced in Miami. The net result was much less relative impact in Miami.
- **Peak Loads, and therefore Equipment Capacity Requirements, may be Significantly Impacted when Outdoor Air Ventilation Rates are Raised.** Raising the rate from 5 to 20 cfm per occupant in office buildings often raised peak coil requirements by 15% - 25%, and created preheat requirements where none had previously existed. Raising the outdoor air flow rate from 5 to 15 cfm increased the peak loads by 25%-35% in the education building, and by 35% - 40% in the auditorium. This could provide real limits to downsizing strategies which are often part of an energy efficiency strategy, and calls for specific steps to reduce peak loads without sacrificing outdoor air requirements. It also suggests indoor air consultants advise clients of existing buildings to raise outdoor air flow rates in order to reduce indoor air quality complaints, should first consider the potential need to either increase capacity or reduce peak loads. Buildings without sufficient capacity may find themselves unable to maintain thermal comfort in the face of these higher outdoor ventilation rates, or in the worst scenario, may experience coil damage.
- **Energy Recovery Technologies May Potentially Reduce or Eliminate the Humidity Control, Energy Cost and Sizing Problems Associated with ASHRAE Standard 62-1989 in Education Buildings, Auditoriums, and Other Buildings with Very High Occupant Density.** While DOE-2 has limited capabilities to adequately model energy recovery technologies, some literature suggests that both latent and sensible energy recovery systems may significantly reduce or eliminate the associated problems of controlling thermal comfort, reducing energy costs, and downsizing equipment needs while meeting the outdoor air requirements of ASHRAE Standard 62-1989 in high occupant density buildings. Corroborating research could be of great value.
- **Protecting or Improving Indoor Environmental Quality During Energy Efficiency Projects May Not Hamper Energy Reduction Goals.** Many energy efficiency measures with the potential to degrade indoor environmental quality appear to require only minor adjustments to protect the indoor environment. When energy efficiency retrofit measures (including lighting upgrades), which were adjusted to either enhance or not degrade indoor environmental quality, were combined with measures to meet the outdoor air requirements of ASHRAE Standard 62-1989, total energy costs were cut by 35% - 45%. Operational measures compatible with indoor environmental quality cut total energy costs by 10%-20%. Avoiding operational measures that degrade indoor environmental quality meant that total energy reductions of only 3%-5% in the office building, and 7%-10% in the education building were foregone. There appears to be demonstrable compatibility between indoor environmental goals and energy efficiency goals, when energy saving measures and retrofits are applied wisely.

Discussion

Relative Performance of Alternative HVAC Systems and Outdoor Air Control Strategies

Exhibit 2 presents the outdoor air flow rate by outdoor air temperature for CV and VAV systems. The design outdoor air flow for each system was set at 20 cfm per occupant.



The CV(FOAF) and the VAV(COA) configurations provided 20 cfm of outdoor air per occupant at all times and in all climates. However, the VAV (FOAF) system never provided 20 cfm of outdoor air per person -- except on the design day -- because as the supply air flow rate is throttled back from design conditions, the outdoor air flow into the building is reduced proportionally, to between one third to two thirds the design flow rate most of the time.

Exhibit 3 presents the proportion of occupied hours that each HVAC system in the base office building experiences an outdoor air flow within designated ranges. The outdoor air performance of the VAV (FOAF) systems varied with climate location. The system's outdoor air performance was best in the hot Miami climate, and worst in the cold Minnesota climate. This is because a larger portion of the year is spent at low cooling load conditions in Minneapolis relative to Washington D.C. and Miami. An economizer significantly improved the outdoor air performance of the VAV (FOAF) system for Minneapolis and Washington D.C., but only when the economizer was operational. As expected, the economizer made little difference in the outdoor air performance in the Miami climate.

Variations in outside air distribution due to variations in the thermal loads on the base office building⁴ with VAV (COA) in Washington, D.C. are shown in Exhibit 4. For the VAV (COA) system, the outdoor air flow at the air handler is consistently at the design level of 20 cfm (9.2 L/s) per occupant, but there is wide divergence in the outdoor air flow rate to the zones, with the divergence depending on the outdoor temperature. At all temperatures, the core zone is being consistently under ventilated relative to the building design flow rate and receives the least outdoor air during hot weather, when a large portion of the supply air flows to the south zone because of its high cooling load. The zonal pattern would be similar for the VAV (FOAF) system, except that the outdoor air flow rate for each zone is lower, corresponding to the reduced air flow into the building described above.

Since the ventilation disparity between zones is seasonal, the extent to which each zone is over ventilated or under ventilated over the course of the year depends in part on the proportion of occupied hours the building is experiencing various outdoor air temperatures. Exhibit 5 presents the proportion of occupied hours that each zone experiences various outdoor air ventilation rates for different ventilation systems. This table shows that for a design outdoor air flow rate of 20 cfm (9 L/s) per occupant, the core zone of the CV (FOAF) system consistently receives 11-15 cfm (5 - 7 L/s) per occupant, while the core zone for the VAV (COA) system receives this amount about half the time. However, a striking observation is that the core zone for the VAV (FOAF) system receives only 6 - 10 cfm (2 - 4 L/s) of outdoor air per occupant all year round. While not shown here, patterns for other climates are similar. Also, adjusting VAV box settings (not shown here) did not resolve this problem.

4 The occupant density is the same for each zone.



Operational modifications (not shown here) to improve the performance of the VAV (FOAF) system were also modeled. Raising the outdoor air setting at design to 30 cfm (14 L/s) per occupant in Miami was sufficient to achieve at least 15 cfm (7 L/s) per occupant year round, but raised HVAC energy costs by \$.03 per square foot. For Minneapolis and Washington D.C., raising the design setting to 45 cfm (21 L/s) per occupant was necessary to achieve 15 cfm per occupant year round, raising HVAC energy costs by \$.05 - \$.06 per square foot respectively. A seasonal reset strategy was also modeled with similar results. However, making operational adjustments such as these runs the risk of exceeding capacity during extreme weather conditions and may not be advisable.

Exhibit 6 shows the energy costs for the CV system and the VAV systems with and without economizers. Comparisons of the energy costs of the CV (FOAF) and the VAV (COA) demonstrates the energy advantage of the VAV system over its CV counterpart. Both systems provide 20 cfm (9 L/s) under all operating conditions, but the energy cost for the VAV system is \$0.10 - \$0.20 less than the CV system. Much of this is due to the reduction in fan energy costs.

It is also useful to compare the VAV (FOAF) with the VAV (COA). The VAV (FOAF) system consistently delivers less than 20 cfm (9 L/s) of outdoor air, but offers no energy advantage over the VAV (COA) system which delivers a constant 20 cfm (9 L/s) per occupant. That is, the diminished outdoor air flow of the VAV (FOAF) system does not reduce energy costs over the VAV (COA) system. In fact, for the cold and temperate climates of Minneapolis and Washington D.C., energy costs of the VAV (FOAF) system are marginally greater than the VAV (COA) system, and only marginally less than the VAV (COA) system in Miami. This result is consistent with the fact that additional outside air during cooler weather provides some degree of free cooling, which is the concept underlying the economizer outdoor air control strategy. The added cooling benefit of the additional outdoor air in the VAV (COA) system tends to offset the added cooling burden during the hot summer season. However, when economizers are added to both systems, both systems experience free cooling. Thus, the VAV (FOAF) Econ saves about \$.02 per square foot over the VAV (COA) Econ.

Economizers reduce HVAC energy costs 6% - 10% on VAV systems compared to only 1% to 2% for CV systems. The economizer for the CV system provides significant savings in cooling energy for the core zone, but this is partially counterbalanced by a heating penalty for the perimeter zones. While the economizer brings in sufficient outdoor air to reduce the mixed air temperature to 55° F in both systems, the supply air quantity of the CV system is considerably higher than that of the VAV system, and this results in a substantial heating penalty for the CV system economizer. Since gas is used for space heating, the advantage of the CV economizer is sensitive to the price of gas relative to electricity. In fact, while not shown here, for pricing structures involving high gas and low electricity prices, the CV economizer raised rather than lowered energy costs. As expected, economizers have a meaningful impact on energy costs only in cold and



temperate climates. Because the Miami climate offers little opportunity for economizer operation, energy savings of the economizer in Miami were minimal.

Impacts of Increased Outdoor Air Flows on Annual HVAC Energy Costs

It is commonly held that raising outdoor air flow rates to accommodate indoor air quality needs will dramatically increase energy use because this increased outdoor air must be conditioned. However, this conventional wisdom ignores the dynamics of energy use of different systems during different seasons. Exhibit 7 demonstrates that the annual average change in energy use resulting from increasing the outdoor air flow rate in an office building from 5 - 20 cfm per occupant depends on the relative impact of increases in energy use and decreases in energy use during different seasons. Significant reductions in cooling energy can occur in mild to cold temperatures which offset increases during warm weather, but heating penalties may also occur in CV systems during cold weather periods. The actual impact depends on the nature of the energy impact during each season, the utility rate structure, and the amount of time the system is operating within each seasonal range. Increases in CV systems tend to be higher than VAV systems because of the heating penalty in winter, while economizer systems tend to result in higher energy cost increases because much of the cooling cost savings in the mild to cold weather is already accounted for in the economizer system.

Exhibit 8 presents the HVAC energy cost changes when outdoor air flow rates are raised from 5 cfm (2 L/s) per occupant to 20 cfm (9 L/s) per occupant for the office building, and to 15 cfm (7 L/s) per occupant for the education and assembly buildings. All buildings have economizers. For the office building shown, the outdoor air increase resulted in only a 6% - 10% increase in HVAC energy cost, (or approximately 2% - 4% increase of total energy cost).

Raising outdoor air flow rates resulted in a considerably higher HVAC energy cost increase in the schools, amounting to 15% - 31% (5% - 14% total energy cost), while the auditorium experienced an HVAC energy cost increase of 26% - 67% (9% - 25% total energy cost). This was due to many factors. Because of the high occupant densities in these buildings, the required per occupant outdoor air flows may exceed supply air flow during periods of the year when thermal loads are low. In these cases, supply air flows must be increased to maintain minimum outdoor air flows in the building, increasing annual fan energy costs. This was done by adjusting the VAV box minimum settings. In addition, the large volumes of outdoor air subjected the cooling system to wide ranges in the sensible to latent heat ratio, making it difficult for the system to keep indoor air relative humidity below 60% when controlling only for temperature. Particularly on mild but humid days, indoor relative humidity frequently rose above 60% and occasionally rose above 70%. As a result, cooling coil temperatures had to be lowered when needed to insure that indoor relative humidity did not exceed 65%.

Contrary to conventional wisdom, the total increase in HVAC energy cost from raising the outdoor air flow rate in the education building and auditorium was least in Miami. While



heating energy costs did not increase in the office buildings with a VAV system in any climate, heating cost penalties in the education and assembly buildings were substantial, often accounting for more than half of the increase in total HVAC energy cost in the cold and temperate climates. However, in the hot and humid climate of Miami, heating energy and fan energy penalties were very low. As a result, the total energy cost increase in Miami was less than it was in either Minneapolis or Washington, D.C.

Impacts of Increased Outdoor Air Flows on HVAC System Capacity

Research on the impact of increased outdoor air flows on HVAC system capacity is important because ASHRAE Standard 62-1989 and the IAQ litigation environment may have the effect of forcing building operators to increase outdoor air flow rates in buildings in response to occupant complaints. When these situations occur, the existing cooling and heating systems (designed for 5 cfm of outdoor air per occupant) may not have the capacity to handle the increased load caused by the increased outdoor air flows.

Exhibit 9 presents DOE-2.1E predicted peak load impacts for the 3 types of buildings for VAV (COA) and the CV (FOAF) systems with economizers. While only economizer systems are presented, there were no meaningful differences in the results between systems with and without economizers. Peak cooling load increases tended to be higher for the CV system than the VAV system, and also higher in the education and assembly buildings when compared to the office building. Increases in peak cooling loads ranged from 15% - 21% in the office building, from 20% - 33% in the education building, and from 26% to 45% in the assembly building. Increases tended to be higher in warmer climates.⁵ Since increases in peak cooling loads caused by the increase in outdoor air occurred during the day, capacity limitations on the cooling coil would most likely bring about thermal discomfort of occupants from midday to late afternoon.

Absolute increases in peak heating loads are modest (below 500 kBTU/hr) for all buildings in all climates, but percentage increases can be substantial due to relatively small initial peak loads. Peak preheat coil load increases can be higher (0 - 1100 kBTU/hr) and often occurred in situations where no preheat was required at the lower outdoor air flow rate. The increase in both the peak heating and peak preheat coil load caused by the increase in outdoor air occurred consistently at the first hour of occupancy when the outdoor air damper was first opened. This suggests that heating and preheat coil capacity limitations may therefore prevent the system from maintaining thermal comfort in the morning, and, with high outdoor air flow rates, potentially throughout the day. In the worst scenario, inadequate preheat capacity could result in coil damage if the outdoor dampers are not closed. But closing the outdoor dampers would add indoor air quality problems to the thermal comfort problems.

⁵ Peak cooling load increases show the same climatic pattern in Eto (1988).



The Energy Consequences of Protecting Indoor Environmental Quality in Energy Efficiency Projects

The indoor environmental factors that most influence occupant health and welfare are the thermal conditions, the lighting, and the concentrations of indoor pollutants. Thermal control and lighting are familiar subjects in energy management. Accordingly, energy professionals are in a strong position to affect these two important aspects of indoor environmental quality (IEQ) while they are often less knowledgeable about indoor pollutant concentrations. Energy activities that are compatible with IEQ, either because they are likely to enhance or have little effect on IEQ if properly instituted, are identified in Exhibit 10. In general, the compatibility with IEQ is dependent on the cautions and adjustments which are outlined in this exhibit. In this modeling project, unless otherwise stated, the cautions and limitations described in this exhibit were either directly or implicitly incorporated into the modeling runs when energy efficiency measures were modeled.

Much of the perceived conflict between IEQ and energy efficiency derives from just two elements of an energy strategy – the tendency to minimize outdoor air ventilation rates and the willingness to relax controls on temperature and relative humidity to save energy. Energy reduction activities that are generally recognized as having a significant potential for degrading the indoor environment and causing problems for the building owner (client) and the occupants are identified in Exhibit 11.

A staged energy retrofit on an office building and education building was modeled to quantify the energy gains and losses from energy activities which protect or enhance indoor environmental quality and which avoid measures that compromise it. The office building had a VAV system with fixed outdoor air damper and an economizer, while the education building had a VAV system, constant outdoor air flow control and an economizer. The parameters of these buildings and the energy measures taken are presented in Exhibit 12. The staged retrofit included operational (tune-up) measures in Stage 1, load reduction measures in Stage 2, air distribution system upgrades in Stage 3, central plant upgrades in Stage 4, and selected IEQ upgrades in Stage 5. For analytic convenience, most of the operational measures normally included in Stage 1 were modeled and analyzed separately and not included in Stage 1.

Exhibits 13-14 present the energy cost results from the staged energy activities for the office building (Exhibit 13) and the education building (Exhibit 14). Exhibit 15 presents the percent savings (from the base and from the previous stage) of the total energy cost for both buildings.⁶

Stage 1 included only a simple seasonal supply air temperature reset strategy which increased the supply air temperature from 55^o F to 65^o F from January 1 to March 31 in each climate. Therefore, it does not reflect an optimal control logic for the fans and chiller. As a result, the energy savings for Stage 1 (-2% - 1%) are not substantial and not

⁶ Total energy costs are defined here to include only energy from HVAC, lighting, and office equipment.



uniformly positive, and do not reflect values that would normally be achieved with a more sophisticated control strategy (See discussion of other operational measures below).

A further reduction beyond Stage 1 of 28% - 33% was achieved in this building through a lighting retrofit and increased efficiency of office equipment in Stage 2. The Stage 3 upgrades relied solely on variable speed drives which reduced the energy costs an additional 5% -10%. Finally, in Stage 4, central plant upgrades, including down-sizing the equipment because of reduced loads⁷ added another 13% -15% to the total energy savings, bringing the combined savings to 44% - 45% for the office building. The results for the education building were similar but less dramatic, resulting in a total energy savings of 31% - 40%. While many of these activities implemented in Stages 1 through 4 above could impact IEQ, all the necessary adjustments identified in Exhibit 10 were made or are implicit in the model's algorithms to insure that IEQ would not be degraded.

The base buildings provided only 5 cfm of outdoor air per occupant (i.e. does not meet the current ASHRAE ventilation requirements for indoor air quality (ASHRAE Standard 62-1989)). To meet the requirements of ASHRAE Standard 62-1989, a set of IEQ controls were instituted as part of Stage 5. The first control was to raise the outdoor air setting from 5 cfm per occupant to 20 cfm per occupant in the office building, and 15 cfm per occupant in the education building. The second control was to provide a constant outdoor air control damper to the office building to insure 20 cfm of outdoor air per occupant at all times. In the education building, VAV boxes were adjusted to insure 15 cfm per occupant at all times, and relative humidity was controlled so as not to exceed 60%.

Meeting these indoor environmental requirements raised total energy costs 3% -4% for the office building and 5% - 14% for the education building. Accordingly, the staged energy retrofits which include provisions to protect indoor environmental quality and which provide additional outdoor air to meet ASHRAE Standard 62-1989 achieved total energy savings of 42% - 43% for the office building, and 22% - 37% for the education building. While the modeling capability in DOE-2.1E does not allow adequate representation of energy recovery systems, some literature suggests that the energy burden of providing additional outdoor air can be substantially reduced or eliminated through energy recovery technology (Rengarajan, et al. 1996; Shirey and Rengarajan, 1996). This issue is worthy of further research.

Many energy measures with significant potential to adversely impact IEQ occur in Stage 1, and involve either relaxing temperature (and humidity) controls and/or reducing HVAC operating hours. Exhibit 16 summarizes the results of these modeling runs. Widening the day time temperature dead band from 71 - 77^o F to 68-80^o F reduced energy costs by 2% -3% in the office building, and by 7% - 8% in the education building. Relaxing the night time temperature setback from +/- 10^oF to +/- 15^oF reduced energy costs from 0% - 1% in

⁷ The equipment was downsized, but not below that necessary to accommodate increased outdoor air flow in Stage 5 of 20 cfm/occ for the office building, and 15 cfm per occupant for the education building. as per ASHRAE Standard 62-1989.



the office and from 1% - 2% in the education building. Reducing the HVAC operating time by two hours (including a reduction of startup time from 2 hours to 1 hour), reduced the energy costs by 0% - 1% for the office building and by 2% - 4% in the education building. All of these operational measures are attractive because they are inexpensive to implement. However, the savings are small relative to other operational measures or retrofit measures, and cumulatively amount to savings of only 3%-5% for the office building and to 7% - 10% in the education building.

In contrast, other operational measures for Stage 1 that do not degrade IEQ can provide significant savings. For example, simply commissioning the building to insure that controls and equipment are functioning properly (not modeled) have been shown to typically reduce total energy costs by 5% - 15%, and also tend to improve IEQ (Gregerson, 1997). Reducing lighting and office equipment usage during unoccupied hours can also result in significant savings. The base office building was modeled with lighting during unoccupied hours operated at 20% of daytime use and office equipment operated at 30% of daytime use. Exhibit 17 compares the modeling results for this case (20%/30%) with both greater usage during unoccupied hours (40%/50%) in Stage 1, and reduced usage (10%/15%) after Stage 4 modifications.

As indicated in Exhibit 17, had the usage of the lighting/office equipment during unoccupied hours been at 40%/50% of day time levels and then reduced to the original levels of 20%/30% that was modeled in the office building, 12% savings would have been possible in Stage 1 from this activity. This result is consistent with field data which showed that energy savings of 15% on average are associated with operational controls (mostly lighting) during unoccupied hours (Herzog, et al.1992). In addition, an aggressive program to reduce night time use of lights and office equipment after the building is made energy efficient and IEQ compatible could provide additional reductions of equal magnitude.

Summary

This study contains DOE-2.1E modeling data and analysis which shed light on several important issues related to the performance of ventilation systems in terms of energy use, thermal comfort, and outdoor air flow. The results of this study suggest that some systems perform better than others. Special problems in controlling the indoor climate for very high occupant density buildings such as schools and auditoriums were identified as were the issues of reducing energy costs in solving these problems. Finally, the study suggest certain guidelines for protecting or enhancing indoor environmental quality during energy efficiency projects.

Bibliography

ASHRAE , 1989, *ASHRAE Standard 62-1989: Ventilation for Acceptable Indoor Air Quality*. American Society of Heating, Refrigerating and Air-Conditioning Engineers, Inc., Atlanta.



- ASHRAE. 1995. *ASHRAE Handbook – HVAC Applications*. American Society of Heating, Refrigerating, and Air Conditioning Engineers, Inc. Atlanta.
- ASHRAE. 1996. *ASHRAE handbook – HVAC Systems and Equipment*. American Society of Heating, Refrigerating, and Air Conditioning Engineers, Inc. Atlanta
- ASHRAE. 1997. *ASHRAE handbook – fundamentals*. Atlanta: American Society of Heating, Refrigerating, and Air Conditioning Engineers, Inc.
- Brambley, Michael; Pratt, Robert; Chassin, David; and Cartipamula, Srinivas. 1998. Diagnostics for Outdoor Air Ventilation and Economizers. *ASHRAE Journal* 40(10): 49-55.
- Cohen, T. 1994. Providing constant ventilation in variable air volume systems. *ASHRAE Journal* 34(7): 43-50.
- Curtis, R., Birdsall, B., Buhl, W., Erdem, E., Eto, J., Hirsch, J., Olson, K., and Winkelmann, F. 1984. *DOE-2 Building Energy Use Analysis Program*. Lawrence Berkeley Laboratory. LBL-18046.
- Elovitz, D. M., 1995. Minimum outside air control methods for VAV systems. *ASHRAE Transactions* 101(2): 613-618.
- E Source. 1997. *E Source Technology Atlas Series*. Rocky Mountain Institute Research Associates. Boulder, CO.
- Eto, J., and C. Meyer, 1988. The HVAC costs of fresh air ventilation in office buildings. *ASHRAE Transactions* 94(2): 331-345.
- Eto, J., 1990. The HVAC costs of increased fresh air ventilation rates in office buildings, part 2. *Proc. Of Indoor Air 90: The Fifth International Conference on Indoor Air Quality and Climate*. Toronto
- Filardo, M. J. 1993. Outdoor air - how much is enough? *ASHRAE Journal* 35(1): 34-38.
- Guarneiri, M. 1997. EPA's Energy Star Buildings provides a roadmap to energy efficiency. *Facilities Manager* January/February 1997: 39-43.
- Gregerson, Joan. 1997. Commissioning Existing Buildings. *Tech Update*. E Source, Inc. TU-97-3. March.
- Haines, R., 1986. Outside Air Volume Control in a VAV System. *Heating/Piping/Air Conditioning*. October
- Haines, R. W. 1994. Ventilation air, the economy cycle, and VAV. *Heating/Piping/Air Conditioning* October 1994: 71-73.
- Hall, J.D., Mudarri, D.H. and Werling, E. 1998. Energy Impacts of Indoor Environmental Quality Modifications to Energy Efficiency Projects. In *Proceedings of IAQ 98. Healthy Buildings*. Conference of the American Society of Heating, Refrigerating, and Air Conditioning Engineers Inc. Atlanta.
- Harriman, L. G., Plager, D., Kosar, D. 1997. Dehumidification and cooling loads from ventilation air. *ASHRAE Journal* 39(11): 37-45
- Hathaway, A. 1995. The link between lighting and cooling. *Engineered Systems Maintenance* July 1995: 18-19.
- Henderson, John K.; Hartnett, William J; and Shatkun, Phil. 1981. *The Handbook of HVAC Systems for Commercial Buildings*. Building Owners and Managers Association International. Washington, D.C.
- Herzog, Peter and LaVine, Lance. 1992. Identification and Quantification of the Impact of Improper Operation of Mid-size Minnesota Office Buildings on Energy Use: A Seven Building Case Study. In *Proceedings of the 1992 Summer Study on Energy Efficiency in Buildings*. American Council for an Energy Efficient Economy. Washington, D.C.
- Janu, G. J., Wenger, J. D., Nesler, C. G. 1995. Outdoor air flow control for VAV systems. *ASHRAE Journal* 37(4): 62-68.
- Ke, Y., Mumma, S. A. 1996. A generalized multiple-space equation to accommodate any mix of close off and fan powered VAV boxes. *ASHRAE Transactions* 102(1): 3950

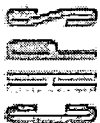

- Ke, Y. P., Mumma, S. A., Stanke, D., 1997. Simulation results and analysis of eight ventilation control strategies in VAV systems. *ASHRAE Transactions* 103(2): 381-392.
- Kettler, J. P. 1998. Controlling minimum ventilation volume in VAV Systems. *ASHRAE Journal* 40(5): 1-7.
- Kosar, D. R., Witte, M. J., Shirey, D. B., Hedrick, R. L. 1998. Dehumidification issues of Standard 62-1989. *ASHRAE Journal* 40(3): 1-10.
- Levenhagen, J. I. 1992. Control systems to comply with ASHRAE Standard 62-1989. *ASHRAE Journal* 34(9):40-44..
- Marshallsay, P. G., Luxton, R. E., Shaw, A. 1993. Ventilation air quantity indoor air quality and energy. CLIMA 2000 Conference, November 1993.
- Meckler, M. 1994. Desiccant-assisted air conditioner improves IAQ and comfort. *Heating/Piping/Air Conditioning* October 1994: 75-84.
- Mudarri, D., and Hall, J. 1993. Increasing Outdoor Air Flow Rates in Existing Buildings. *Proc. of Indoor Air 93. The Sixth International Conference on Indoor Air Quality and Climate*. Toronto.
- Mudarri, D., and Hall, J. 1996. Impacts of Increased Outdoor Air Flow Rates on Annual HVAC Energy Costs. In *Proceedings of the 1996 Summer Study on Energy Efficiency in Buildings*. American Council for an Energy-Efficiency Economy. Washington, D.C.
- Mudarri, D., Hall, J. and Werling C. 1996. Energy costs and IAQ performance of ventilation systems and controls. In *IAQ 96. Paths to Better Building Environments*. Conference of the American Society of Heating, Refrigerating, and Air Conditioning Engineers, Inc. Atlanta.
- Mumma, S. A., Wong, Y. M. 1990. Analytical evaluation of outdoor airflow rate variation vs. Supply airflow rate variation in variable air volume systems when the outdoor air damper position is fixed. *ASHRAE Transactions* 96(1): 1197-1208
- Mumma, S. A., Bolin, R. J. 1995. Real-time, on-line optimization of VAV system control to minimize the energy consumption rate and to satisfy ASHRAE Standard 62-1989 for all occupied zones. *ASHRAE Transactions* 101(1): 3753.
- Mutambara, A., and Hittle, D. 1990. "Energy Effects of Various Control Strategies for Variable Air Volume Systems." *ASHRAE Transactions*. V. 96. Pt. 1. Atlanta.
- Reddy, T. A., Liu, M., Claridge, D. E. 1996. Synergism between energy use and indoor air quality in terminal reheat variable air volume systems. In *Proceedings of the 1996 Summer Study on Energy Efficiency in Buildings*. American Council for an Energy-Efficiency Economy. Washington, D.C.
- Rengarajan, K., Shirey, D. B., Raustad, R. A. 1996. Cost-effective HVAC technologies to meet ASHRAE Standard 62-1989 in hot and humid climates. *ASHRAE Transactions* 102(1): 3949..
- Sauer, H. J., Howell, R. H. 1992. Estimating the indoor air quality and energy performance of VAV systems. *ASHRAE Journal* 34(7): 43-50
- Shirey, D. B., Rengarajan, K. 1996. Impacts of ASHRAE 62-1989 on small Florida offices. *ASHRAE Transactions* 102(1): 3948
- Solberg, D., Dougan, D., and Damiano L. 1990. Measurement for the Control of Fresh Air Intake. *ASHRAE Journal*. January.
- Steele, T., and Brown, M. 1990. *Energy and Cost Implications of ASHRAE Standard 62-1989*. Bonnyville Power Administration. May.
- U.S. DOE. 1990. *DOE 2.1E User's Manual*. United States Department of Energy. Washington, DC
- U.S. EPA. 1993. *ENERGY STAR Buildings Manual*. Washington, DC: United States Environmental Protection Agency.
- Steele, T., and Brown, M. 1990. *Energy and Cost Implications of ASHRAE Standard 62-1989*. Bonnyville Power Administration. May.



- Ventresca, J. 1991. Operation and maintenance for IAQ: implications from energy simulation of increased ventilation. *IAQ '91: Healthy Buildings*. American Society of Heating, Refrigerating, and Air-Conditioning Engineers Inc. Atlanta.
- Warden, D. 1996. Outdoor air: calculation and delivery. *ASHRAE Journal* 37(6): 54-61.

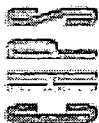

Exhibit 1: Characteristics of the Base Buildings Modeled in this Study

	Office	Education	Assembly
Building Characteristics			
Shape	square	L-shaped	square
Zones/Floor	5	6	5
Floor Area (ft ²)	338,668	50,600	19,600
Number of Floors	12	2	1
Floor Height (ft)	12	15	30
Wall Construction	steel-reinforced concrete, curtain wall	concrete block	concrete block
Net Window Area (%)	42%	34%	7%
Window U-factor (Btu/hr ft ² OF)	0.75	0.59	0.59
Window Shading Coefficient	0.8	0.6	0.6
Wall R-Value (hr ft ² OF/Btu)	R-7	R-8	R-8
Roof R-Value (hr ft ² OF/Btu)	R-8	R-12	R-12
Perimeter/Core Ratio*	0.5	1.0	0.6
Infiltration Rate (ach)	0.25**	0.25	0.25
Occupancy			
Number of Occupants	2,130	1,518	588
Occupant Density (occup/1000ft ²)	7	30	60
HVAC			
Air Distribution System	central (CVor VAV)	central (CVor VAV)	central (CVor VAV)
Heating and DHW	central gas boiler - 70% efficiency	central gas boiler - 80% efficiency	central gas boiler - 80% efficiency
Cooling	chiller - 3 COP w/cooling tower	chiller - 4 COP w/cooling tower	chiller - 4 COP w/cooling tower

* Ratio of perimeter to core floor area, where perimeter space is up to 15 ft. from the exterior walls

**0.5 when HVAC is not operating

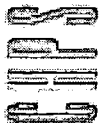

Exhibit 3: Comparison of Outdoor Air Flows {design = 20 cfm (9 L/s) per person} for a Large Office Building with Alternative HVAC Systems

(% of Occupied Hours)

HVAC System Type and Climate Location	Outdoor Air Flow Rates Achieved (cfm per person)				
	<= 5	6-10	11-15	16-19	>= 20
CV(FOAF)					
Minneapolis, MN	0.0%	0.0%	0.0%	0.0%	100.0%
Washington, DC	0.0%	0.0%	0.0%	0.0%	100.0%
Miami, FL	0.0%	0.0%	0.0%	0.0%	100.0%
VAV(COA)					
Minneapolis, MN	0.0%	0.0%	0.0%	0.0%	100.0%
Washington, DC	0.0%	0.0%	0.0%	0.0%	100.0%
Miami, FL	0.0%	0.0%	0.0%	0.0%	100.0%
VAV(FOAF)					
Minneapolis, MN	0.0%	42.0%	56.3%	1.7%	0.0%
Washington, DC	0.0%	16.6%	78.1%	5.3%	0.0%
Miami, FL	0.0%	0.0%	42.5%	57.5%	0.0%
VAV(FOAF) Econ					
Minneapolis, MN	0.0%	0.0%	32.5%	0.0%	67.4%
Washington, DC	0.0%	0.1%	48.6%	0.5%	50.8%
Miami, FL	0.0%	0.0%	62.3%	31.9%	5.8%

BEST COPY AVAILABLE



Exhibit 5: Comparison of Zone Level Outdoor Air Flow Rates {design = 20 cfm (9 L/s) per person} for Three Types of HVAC Systems in Office Buildings in Washington, DC.

(% of Occupied Hours)

System Type and Zone	without Economizer					with Economizer				
	OA Flow Rate Achieved (cfm/person)					OA Flow Rate Achieved (cfm/person)				
	<6	6-10	11-15	16-19	>19	<6	6-10	11-15	16-19	>19
CV(FOAF)										
Core			100.0					49.9	0.6	49.5
East					100.0					100.0
North					100.0					100.0
West					100.0					100.0
South					100.0					100.0
VAV(COA)										
Core		0.2	51.5	48.3	0.0			39.0	10.4	50.6
East					100.0					100.0
North				14.4	85.6				4.1	95.9
West					100.0					100.0
South					100.0					100.0
VAV(FOAF)										
Core	0.7	99.3	0.0	0.0	0.0	49.3	0.1	0.1		50.6
East			46.4	15.3	38.3		6.3	13.5		80.2
North			69.4	24.4	6.2	3.5	19.4	23.8		53.2
West			54.2	15.0	30.8		9.7	14.5		75.7
South			35.2	10.7	54.1		6.1	8.8		85.1

BEST COPY AVAILABLE



Exhibit 6: Comparison of Annual Energy Costs for the Base Office Building with Alternative HVAC Systems and in Different Climates

HVAC System Type and Climate Location	Annual HVAC Energy Use Summary				
	Fan (\$/SF)	Cooling (\$/SF)	Heating (\$/SF)	Total (\$/SF)	(KBtu/sf)
CV(FOAF)					
Minneapolis, MN	0.32	0.52	0.04	0.88	47.4
Washington, DC	0.29	0.56	0.01	0.86	41.1
Miami, FL	0.30	0.72	0.00	1.02	50.6
CV(FOAF) Econ					
Minneapolis, MN	0.32	0.45	0.10	0.87	53.7
Washington, DC	0.29	0.50	0.06	0.85	46.4
Miami, FL	0.30	0.71	0.00	1.01	50.7
VAV(COA)					
Minneapolis, MN	0.19	0.49	0.10	0.78	49.7
Washington, DC	0.17	0.52	0.05	0.74	38.9
Miami, FL	0.18	0.65	0.00	0.83	38.9
VAV(COA) Econ					
Minneapolis, MN	0.19	0.43	0.11	0.73	45.9
Washington, DC	0.17	0.47	0.05	0.69	35.8
Miami, FL	0.18	0.64	0.00	0.83	38.5
VAV(FOAF)					
Minneapolis, MN	0.19	0.49	0.10	0.79	50.6
Washington, DC	0.17	0.52	0.05	0.74	39.5
Miami, FL	0.18	0.62	0.00	0.81	38.3
VAV(FOAF) Econ					
Minneapolis, MN	0.19	0.42	0.11	0.71	45.7
Washington, DC	0.17	0.46	0.05	0.68	35.5
Miami, FL	0.18	0.61	0.00	0.80	37.8

BEST COPY AVAILABLE



Exhibit 8: Annual HVAC Energy Costs of Increasing Outdoor Air from 5 to 20 cfm per person for VAV(COA) Systems with Economizers

Climate	Office Building			Education Building			Assembly Building		
	5 cfm (\$/sf)	Increase (\$/sf)	Percent Increase (%)	5 cfm (\$/sf)	Increase (\$/sf)	Percent Increase (%)	5 cfm (\$/sf)	Increase (\$/sf)	Percent Increase (%)
Minneapolis, MN									
Fan	0.19	0.00	None	0.17	0.01	5%	0.24	0.06	24%
Cooling	0.39	0.04	10%	0.35	0.07	19%	0.49	0.18	37%
Heating	0.10	0.00	None	0.32	0.19	59%	0.58	0.64	111%
Total	0.69	0.04	6%	0.84	0.27	32%	1.31	0.88	67%
Washington, DC									
Fan	0.17	0.00	None	0.16	0.01	6%	0.23	0.06	26%
Cooling	0.42	0.05	12%	0.40	0.10	25%	0.61	0.20	33%
Heating	0.05	0.00	None	0.14	0.11	81%	0.23	0.38	162%
Total	0.65	0.05	8%	0.70	0.22	31%	1.07	0.64	60%
Miami, FL									
Fan	0.18	0.00	None	0.20	0.00	None	0.29	0.03	11%
Cooling	0.57	0.07	13%	0.64	0.12	18%	1.09	0.31	29%
Heating	0.00	0.00	None	0.00	0.00	None	0.00	0.01	786%
Total	0.75	0.08	10%	0.84	0.13	15%	1.39	0.36	26%

BEST COPY AVAILABLE



Exhibit 9: Impacts of Increased Outdoor Air Flows on Peak HVAC Coil Loads for VAV(COA) Systems with Economizers

Climate	Office Building			Education Building			Assembly Building		
	5 cfm (kBTU/Hr)	Increase (kBTU/ Hr)	Percent Increase (%)	5 cfm (kBTU/Hr)	Increase (kBTU/ Hr)	Percent Increase (%)	5 cfm (kBTU/Hr)	Increase (kBTU/ Hr)	Percent Increase (%)
Minneapolis, MN									
Cooling	8688	1336	15%	1841	370	20%	958	271	28%
Heating	6148	444	7%	2819	1	0%	1134	106	9%
Preheat	0	897	Increase	246	1282	521%	330	919	279%
Washington, DC									
Cooling	8517	1659	19%	1951	488	25%	1067	275	26%
Heating	4638	None	None	1935	93	5%	822	177	22%
Preheat	0	None	None	90	750	832%	224	553	247%
Miami, FL									
Cooling	8670	1862	21%	2213	529	24%	1229	349	28%
Heating	1949	None	None	397	271	68%	99	291	293%
Preheat	0	None	None	0	200	Increase	0	151	Increase

BEST COPY AVAILABLE



Exhibit 10: Energy Measures that are Compatible with IEQ

Measure	Comment
Improve building shell	- May reduce infiltration. May need to increase mechanically supplied outdoor air to ensure applicable ventilation standards are met.
Reduce internal loads (e.g. lights, office equipment)	- Reduced loads will reduce supply air requirements in VAV systems. May need to increase outdoor air to meet applicable ventilation standards. - Lighting must be sufficient for general lighting and task lighting needs
Fan/motor/drives	- Negligible impact on IEQ
Chiller/ boiler	- Negligible impact on IEQ
Energy recovery	- May reduce energy burden of outdoor air, especially in extreme climates and/or when high outdoor air volumes are required (e.g. schools, auditoria).
Air-side economizer	- Uses outdoor air to provide free cooling. Potentially improves IEQ when economizer is operating by helping to ensure that the outdoor air ventilation rate meets IEQ requirements. - On/off set points should be calibrated to both the temperature and moisture conditions of outdoor air to avoid indoor humidity problems. May need to disengage economizer during an outdoor air pollution episode.
Night pre-cooling	- Cool outdoor air at night may be used to pre-cool the building while simultaneously exhausting accumulated pollutants. However, to prevent microbiological growth, controls should stop pre-cooling operations if dew point of outdoor air is high enough to cause condensation on equipment.
Preventive Maintenance (PM) of HVAC	- PM will improve IEQ and reduce energy use by removing contaminant sources (e.g. clean coils/drain pans), and insuring proper calibration and efficient operation of mechanical components (e.g. fans, motors, thermostats, controls)..
CO2 controlled ventilation	- CO2 controlled ventilation varies the outdoor air supply in response to CO2 which is used as an indicator of occupancy. May reduce energy use for general meeting rooms, studios, theaters, educational facilities etc. where occupancy is highly variable, and irregular. A typical system will increase outdoor air when CO2 levels rise to 600-800 ppm to ensure that maximum levels do not exceed 1,000 ppm. The system should incorporate a minimum outside air setting to dilute building related contaminants during low occupancy periods.
Reducing demand (KW) charges	- Night pre-cooling and sequential startup of equipment to eliminate demand spikes are examples of strategies that are compatible with IEQ. Caution is advised if load shedding strategies involve changing the space temperature set points or reducing outdoor air ventilation during occupancy.
Supply air temperature reset	- Supply air temperature may sometimes be increased to reduce chiller energy use. However, fan energy will increase. Higher supply air temperatures in a VAV system will increase supply air flow and vice versa.
Equipment down-sizing	- Prudent avoidance of over-sizing equipment reduces first costs and energy costs. However, capacity must be sufficient for thermal and outdoor air requirements during peak loads in both summer and winter. Latent load should not be ignored when sizing equipment in any climate. Inadequate humidity control has resulted in thermal discomfort and mold contamination so great as to render some buildings uninhabitable. - Energy recovery systems may enable chillers and boilers to be further downsized by reducing the thermal loads from outdoor air ventilation.

BEST COPY AVAILABLE



Exhibit 11: Energy Measures that May Degrade IEQ

Measure	Comment
Reducing outdoor air ventilation	- Applicable ventilation standards usually specify a minimum continuous outdoor air flow rate per occupant, and/or per square foot, during occupied hours. They are designed to ensure that pollutants in the occupied space are sufficiently diluted with outdoor air. Reducing outdoor air flow below applicable standards can degrade IEQ and has low energy saving potential relative to other energy saving options.
Variable Air Volume (VAV) Systems with fixed percentage outdoor air	- VAV systems can yield significant energy savings over Constant Volume (CV) systems in many applications. However, many VAV systems provide a fixed percentage of outdoor air (e.g. fixed outdoor air dampers) so that during part load conditions when the supply air is reduced, the outdoor air may also be reduced to levels below applicable standards. - VAV systems should employ controls which maintain a continuous outdoor air flow consistent with applicable standards. Hardware is now available from vendors and involves no significant energy penalty.
Reducing HVAC operating hours	Delayed start-up or premature shutdown of the HVAC can evoke IEQ problems and occupant complaints. - An insufficient lead time prior to occupancy can result in thermal discomfort and pollutant-related health problems for several hours as the HVAC system must overcome the loads from both the night-time setbacks and from current occupancy. This is a particular problem when equipment is downsized. Shutting equipment down prior to occupants leaving may sometimes be acceptable provided that fans are kept operating to ensure adequate ventilation. However, the energy saved may not be worth the risk .
Relaxation of thermal control	Some energy managers may be tempted to allow space temperatures or humidity to go beyond the comfort range established by applicable standards. Occupant health, comfort and productivity are compromised. The lack of overt occupant complaints is NOT an indication of occupant satisfaction.

Exhibit 12: Modeling Parameters for the Office and Education Building

Building Parameter	Office Building		Education Building	
	Base	Modification	Base*	Modification
Stage 1: Operational/Tune-up Measures				
Day Temp. Set Points	71o - 77o F	(68o - 80o F)	71o - 77o F	(68o - 80o F)
Night Set Back	+/- 10o F	(+/- 15o F)	+/- 10o F	(+/- 15o F)
Day HVAC Hours	8am - 6pm	(9am - 5pm)	7am -10pm	(8am - 9pm)
Seasonal Reset	No	Yes	No	Yes
Entries in parentheses were modeled separately—not part of the retrofit project				
Stage 2: Load Reduction Measures				
Lighting	2.5 W/f2	30% reduction	3.0 W/f2 rms 2.0 W/f2 corr	30% reduction
Office Equipment	1.0 W/f2	30% reduction	0.25 W/f2	30% reduction
Stage 3: Air distribution System Upgrades				
VSD	no	yes	no	yes
Stage 4: Central Plant Upgrades				
Chiller COP	3.0	5.5	3.0	5.5
Boiler Efficiency	70%	85%	70%	85%
Stage 5: IEQ Ventilation Modifications Required to meet ASHRAE 62-1989				
Outdoor Air Setting	5 cfm/occ	20 cfm/occ	5 cfm/occ	15 cfm/occ
Outdoor Air Control	fixed damper	constant flow	constant flow	const. flow-VAV box adjustment
Humidity Control	not needed	not needed	not needed	60% RH

*For the base education building used for the energy retrofit: infiltration rate = 0.5ach; window U value = 0.99 (Btui/hr ft² °F); and window shading coeff. = 0.90.

BEST COPY AVAILABLE



Exhibit 13: Energy Cost for Office Building with Energy and IEQ Modifications

Building Parameter	Washington D.C. (\$/sf)						Minneapolis (\$/sf)			Miami (\$/sf)		
	Fan	Cool	Heat	Total HVAC	Light & Off. Equip	Total	Total HVAC	Light & Off. Equip	Total	Total HVAC	Light & Off. Equip	Total
Base Bldg	0.17	0.42	0.05	0.64	0.94	1.58	0.68	0.94	1.62	0.74	0.94	1.68
Stage 1												
Seas. Reset	0.18	0.41	0.04	0.63	0.94	1.57	0.66	0.94	1.60	0.78	0.94	1.72
Stage 2												
Ltng/Off Equip	0.15	0.30	0.08	0.52	0.57	1.08	0.58	0.57	1.16	0.57	0.57	1.15
Stage 3												
VSD	0.09	0.28	0.06	0.43	0.57	1.00	0.47	0.57	1.04	0.52	0.57	1.09
Stage 4												
Chiller/Boiler	0.09	0.16	0.05	0.30	0.57	0.87	0.33	0.57	0.90	0.35	0.57	0.93
Stage 5												
OA Setting	0.09	0.18	0.06	0.32	0.57	0.89	0.36	0.57	0.93	0.38	0.57	0.95
OA Control	0.09	0.19	0.06	0.33	0.57	0.90	0.37	0.57	0.94	0.40	0.57	0.9

Exhibit 14: Energy Cost for the Education Building with Energy and IEQ Modifications

Building Parameter	Washington D.C. (\$/f2)						Minneapolis (\$/f2)			Miami (\$/f2)		
	Fan	Cool	Heat	Total HVAC	Light & Off. Equip	Total	Total HVAC	Light & Off. Equip	Total	Total HVAC	Light & Off. Equip	Total
Base Bldg	0.21	0.62	0.28	1.11	0.97	2.08	1.42	0.97	2.40	1.22	0.97	2.19
Stage 1												
Seasonal Reset	0.21	0.61	0.25	1.07	0.97	2.04	1.38	0.97	2.36	1.23	0.97	2.21
Stage 2												
Lights/off equip	0.19	0.53	0.33	1.04	0.67	1.71	1.42	0.67	2.10	1.08	0.67	1.76
Stage 3												
VSD	0.11	0.50	0.33	0.94	0.67	1.62	1.30	0.67	1.97	0.98	0.67	1.65
Stage 4												
Chiller/boiler	0.11	0.29	0.28	0.67	0.67	1.35	0.98	0.67	1.65	0.64	0.67	1.31
Stage 5*												
OA Setting	0.12	0.35	0.35	0.82	0.67	1.49	1.19	0.67	1.68	0.73	0.67	1.40
OA & RH control	0.13	0.36	0.38	0.87	0.67	1.54	1.20	0.67	1.87	0.71	0.67	1.38

*Only the education building required RH control

BEST COPY AVAILABLE



Exhibit 15: Percent Savings in Total Energy Cost from Energy and IEQ Modifications

(Top figure in each cell is for office building; bottom figure is for education building)

	Washington			Minneapolis			Miami		
	\$/f2	From Base	From Prev. Stage	\$/f2	From Base	From Prev. Stage	\$/f2	From Base	From Prev. Stage
Base Bldg	1.58 2.08			1.62 2.40			1.68 2.19		
Stage 1	1.57	01%	01%	1.60	01%	01%	1.74	-02%	-02%
Seasonal Reset	2.04	02%	02%	2.36	2%	2%	2.21	-01%	-01%
Stage 2	1.08	32%	31%	1.16	28%	28%	1.15	32%	33%
Lights/Off Equip	1.71	18%	16%	2.10	13%	11%	1.76	20%	20%
Stage 3	1.00	37%	07%	1.04	36%	10%	1.09	35%	5%
VSD	1.62	22%	05%	1.97	18%	6%	1.65	25%	6%
Stage 4	0.87	45%	13%	0.90	44%	13%	0.93	45%	15%
Chiller/boiler	1.35	35%	17%	1.65	31%	16%	1.31	40%	21%
Stage 5*	0.90	43%	-03%	0.94	42%	-04%	0.97	42%	-04%
OA setting with OA & RH control	1.54	26%	-14%	1.87	22%	-13%	1.38	37%	-05%

* Only the education building required RH control

Exhibit 16: Energy Costs of Operational Measures that May Have Adverse Effects on IEQ

Building Parameter	Washington D.C.							Minneapolis			Miami		
	\$/sf							\$/sf			\$/sf		
	Fan	Cool	Heat	Total HVAC	Light & Off Equip	Total	% Save	Total HVAC	Total	% Save	Total HVAC	Total	% Save
Base Off. Bldg	0.17	0.42	0.05	0.64	0.94	1.58		0.68	1.62		0.74	1.68	
Day Temp. Set	0.17	0.40	0.04	0.61	0.94	1.56	01%	0.64	1.58	03%	0.71	1.65	02%
Night Set Back	0.16	0.41	0.04	0.62	0.94	1.56	01%	0.66	1.60	01%	0.72	1.66	01%
Day HVAC Hrs.	0.17	0.42	0.04	0.63	0.94	1.57	01%	0.66	1.60	01%	0.75	1.69	00%
Base Edu. Bldg	0.21	0.62	0.28	1.11	0.97	2.08		1.42	2.40		1.22	2.19	
Day Temp. Set	0.18	0.55	0.22	0.95	0.97	1.93	07%	1.25	2.23	07%	1.06	2.03	01%
Night Set Back	0.21	0.62	0.27	1.10	0.97	2.07	00%	1.40	2.38	01%	1.22	2.19	00%
Day HVAC Hrs	0.20	0.61	0.25	1.06	0.97	2.02	03%	1.34	2.31	04%	1.18	2.15	02%

Exhibit 17: Savings from Reduced Lights and Office Equipment when Unoccupied

Operational Control	Office Building in Washington D.C.				
	Energy Cost (\$/f 2)			Saving	
	HVAC	Light/off equip	Total	\$/f2	%
Stage 1					
40% lights/50% office equipment (base case)	0.71	1.08	1.79		
20% lights/30% office equipment	0.64	0.94	1.58	0.21	12%
Stage 4 (retrofitted building)					
20% lights/30% office equipment	0.33	0.57	0.90		
15%lights/20% office equipment	0.29	0.40	0.70	0.20	22%



APPENDIX E – LIGHTING DESIGN SUPPLEMENT

In this manual, the Electric Lighting and Controls chapter and the Daylighting and Fenestration Design chapter both provide general information about designing lighting systems for schools, as well as detailed recommendations in the form of guidelines. This appendix offers supplemental information about lighting and daylighting design lighting practitioners may find useful.

This supplement provides an overview of the new IESNA lighting design process, and technical information about light sources and ballasts, luminaires and controls.

IESNA Lighting Design Process

In the 9th edition of the *Lighting Handbook: Design and Application*, IESNA published a new lighting design procedure for schools and other buildings. Previous design procedures stressed horizontal illumination as the major design criteria, based on the type of visual task being performed. The new procedure comprises a six-step process consisting of the following:

1. Using the Lighting Design Guide found in Chapter 10 of the new *Lighting Handbook*, find the appropriate visual task or location under consideration.
2. Learn about which "design issues" (see below) are important for that visual task or location. Issues are identified as being "very important," "somewhat important," or "somewhat important," wherever applicable.
3. Refer to the appropriate application chapter of the *Handbook*, as directed in the Lighting Design Guide.
4. Go to other chapters of the *Handbook* for discussions of how to apply the relevant design criteria, and for a better understanding of the issues that are not included in the Design Guide.
5. From the Lighting Design Guide, determine the targets for horizontal and vertical illuminance. Use professional judgment as to whether or not these values need to be adjusted for factors such as low reflectances.
6. Document the process.

Admittedly the more proficient designer will find much of this process to be intuitive in nature; however steps 1, 3, and 5 are critical for optimum lighting effectiveness and efficiency.



Design Issues

Design issues found in step 3 of the IESNA lighting design procedure are as follows:

- Appearance of Space & Luminaires
- Color Appearance
- Daylighting Integration and Control
- Direct Glare
- Flicker & Strobe
- Light Distribution on Surfaces
- Light Distribution on Task Plane (Uniformity)
- Luminances of Room Surfaces
- Modeling of Faces or Clients
- Point(s) of Interest
- Reflected Glare
- Shadows
- Source/Task/Eye Geometry
- Sparkle/Desirable Reflected Highlights
- Surface Characteristics
- System Control & Flexibility
- Horizontal Illuminance
- Vertical Illuminance

Each of these design issues is assigned a value based on their importance. Issues that are considered most important in school lighting vary depending on space type. Specific spaces listed for educational facilities include corridors, many different types of classroom, gymnasiums, outdoor sports facilities, cafeterias, and dormitories. In addition, as shown in table E-1, more than 30 separate reading tasks are listed, with differing design issues.



Table E-1: Design Issues for Reading Tasks

Source IESNA, 9th Edition Lighting Handbook, Reference and Applications, Chapter 10

I. INTERIOR LOCATIONS AND TASKS	Very Important <input checked="" type="checkbox"/> Important <input checked="" type="checkbox"/> Somewhat important <input type="checkbox"/> Blank = Not important or not applicable														Design Issues	Notes on Illuminance - see end of section	Reference Chapter(s)							
	Appearance of Space and Luminaires	Color Appearance (and Color Contrast)	Daylighting Integration and Control	Direct Glare	Flicker (and Strobe)	Light Distribution on Surfaces	Light Distribution on Task Plane (Uniformity)	Luminances of Room Surfaces	Modeling of Faces or Objects	Point(s) of Interest	Reflected Glare	Shadows	Source/Task/Eye Geometry	Sparkle/Desirable Reflected Highlights				Surface Characteristics	System Control and Flexibility	Special Considerations	Notes on Special Considerations	Illuminance (Horizontal)	Category or Value (lux)	Illuminance (Vertical)
Reading (16)																								Ch. 11, 12
Copied tasks																								
Microfiche reader																							A	
Photograph, moderate detail																							A	
Thermal copy, poor																								
Photocopies																								
Photocopies, 3 rd generation																								
Data processing tasks																								
VDT screens																							A	A
Impact printer																								
good ribbon																								
2 nd carbon and greater																								
ink jet/laser printer																								
keyboard reading																								
Machine rooms																								
Active operations																								
Tape storage																								B
Machine area																								
Equipment service																								C
Thermal print																								
Handwritten tasks																								
#2 pencil and softer leads																								
#3 pencil																								
#4 pencil and harder leads																								
Ball-point pen																								
Felt-tip pen																								
Handwritten carbon copy																								
White boards																								B
Chalk boards																								E
Printed tasks																								
6-point type																								
8- and 10-point type																								
Glossy magazines																								
Maps																								
Newsprint																								
Typed originals																								
Telephone books																								

Light Sources

A wide variety of light sources are available to light schools. Light source selection critically affects building space appearance, visual performance and comfort. This section outlines the different types of sources available to the designer, describing each technology type and providing appropriate application examples.



Incandescent and Halogen Lamps

Incandescent lamps represent the oldest of electric lighting technologies. In many older schools incandescent lamps illuminate most or all of the building spaces. The advantages of incandescent technology include point source control, high color performance, instant starting, and easy and inexpensive dimming. Disadvantages include low efficacy, short lamp life and high maintenance costs.

Incandescent sources should not be used in new buildings except in very limited and special accent lighting circumstances. Examples might include dimming applications where color performance, beam control, and/or dramatic effect is critical, such as teleconferencing rooms, theaters, and the highlighting of artwork. In most of these cases halogen sources, which offer longer life, better point source control, and crisper color performance, are superior to standard incandescent lamps.

Fluorescent Lamps

Fluorescent lamps can and should be used to light nearly all types of school building spaces. They offer long life, high efficacy, good color performance, and low operating and maintenance costs. There are no inherent disadvantages to fluorescent technology; however, dimming fluorescent lamps requires special electronic ballasts that incur a cost premium over standard high frequency ballasts.

Fluorescent lamps and all other discharge light sources require ballasts to operate. Ballasts perform the starting function for the lamp, and they limit or regulate lamp arc current. To dim discharge lamps, special ballasts designed specifically for that function are required. Ballast selection has a significant impact on building space appearance and lighting system energy use, and should be carefully considered when designing lighting systems.

Several different types of fluorescent lamps are worth noting.

- T-12 lamps are a relatively antiquated technology that has been supplanted by higher quality products. They are still useful in some low temperature applications, such as cafeteria food storage areas.
- T-8 lamps have rapidly become the dominant lamp technology on the commercial and institutional markets. When combined with electronic ballasts, they represent a significant performance improvement over T-12 technology. Advantages include higher efficacy, more design options, better color rendition, reduced flicker and less noise. Newly available "premium" T-8 lamps offer higher color rendition, higher maintained lumens, and a 20% increase in lamp life over standard T-8s. They should be considered for most general lighting applications in schools, including classrooms, offices, multipurpose rooms and libraries.
- T-5 lamps have very similar performance to T-8 lamps, but offer a more compact lamp envelope (5/8 in. vs. 1 in. in diameter). This allows for their use in smaller profile luminaires. They are especially effective in indirect luminaires, cove lighting systems, and wall washers. T-5 luminaires should be well shielded to minimize glare. Note that T-5 lamps are NOT interchangeable with T-8 systems, and they require dedicated sockets, ballasts and luminaire housings.



- T-5 High Output (T-5HO) lamps represent an exciting development in fluorescent lamp technology. One T-5HO lamp produces nearly the equivalent maintained lumens as two standard T-8 lamps. This allows the use of fluorescent technology (and the accompanying control and starting advantages) in some high-bay applications that previously would have required high intensity discharge (HID) sources. In addition, T-5HO luminaires with special optical components may allow a designer to increase the spacing between direct/indirect luminaire rows, as compared to a typical T-8 design. This promotes the use of fewer lamps and/or fewer luminaires, leading to reduced lighting maintenance costs. Currently T-5HO systems carry a fairly significant cost premium when compared to T-8 designs; however, prices are expected to drop as the technology matures. Due to the intense surface luminance of these lamps, they must be used in well-shielded luminaires to avoid unacceptable glare.

Fluorescent Ballasts

Fluorescent lamps and all other discharge light sources require ballasts to operate. Ballasts perform the starting function for the lamp, and they limit or regulate lamp arc current. To dim discharge lamps, special ballasts designed specifically for that function are required. Ballast selection has a significant impact on building space appearance and lighting system energy use, and should be carefully considered when designing lighting systems.

Electronic high frequency ballasts are now standard equipment for most fluorescent sources. Ballast manufacturers are gradually phasing out the production of many older technology electromagnetic ballasts, most of which will be legislated out of existence in 2002. In addition to their efficiency advantages, electronic ballasts reduce flicker and ambient noise, and are available in a variety of ballast factor configurations, allowing the designer to “tune” light levels based on the ballast specification. Normal light output (NLO) ballasts operate lamps at about 88% of rated light output. Reduced light output ballasts (RLO) ballasts reduce light output to approximately 75% of rated light output. High light output (HLO) ballasts are also available to increase light output to as much as 120% of rated levels. In addition there is a nearly linear relationship between ballast factor and system input wattage (see Table E-2).

Table E-2 – Fluorescent Lamp/Ballast Power

Lamps per ballast	Type of Ballast	Input power per ballast
(2) F32T8	Normal (BF=0.87)	58–60
(4) F32T8	Normal (BF =0.87)	110–112
(2) F32T8	Low light (BF=0.78)	50–51
(4) F32T8	Low light (BF=0.76)	99–100
(2) F32T8	High light (BF=1.20)	78–84

Consider using RLO electronic ballasts in building spaces lighted with fluorescent lamps where lower light levels will suffice. Applicable spaces might include corridors, rest rooms, storage areas and similar spaces. The reduction in light output corresponds to lower input wattage, thus reducing lighting demand and energy use.



Electronic ballasts for fluorescent lamps employ one of two methods to start the lamps. Rapid-start ballasts heat the lamp electrodes when starting the lamp, as well as while the lamp is energized. Conversely, instant-start ballasts do not apply any voltage to the lamp electrodes at any time during the operating process. Instead, the ballast initiates a relatively high voltage across the lamp to initiate the arc discharge. Instant-start ballasts are slightly more efficacious than rapid start, but they may adversely affect lamp life, particularly in applications where on-off switching cycles are short, such as in spaces with occupancy sensors.

For maximum energy performance, use instant-start ballasts in areas where the lights are unlikely to be subject to a lot of on-off cycling. In areas with more frequent switching, specify rapid-start ballasts to maximize lamp life. Newer products, known as “programmed rapid-start” ballasts, are optimized for use with occupancy sensors and in spaces where switching is more frequent.

Dimming ballasts for fluorescent lamps require an additional investment, but increase lighting system performance by optimizing space appearance, occupant satisfaction, system flexibility and energy efficiency. Lamps can be dimmed to 10%, 5%, or 1% of full light output, depending on the lamp-ballast combination. For most energy-saving applications, dimming to 5% or 10% is sufficient. However, in spaces requiring maximum dimming capability due to space needs or preferences, 1% dimming will maximize flexibility and energy savings, though at a substantial cost premium.

There are two basic types of dimming ballasts:

- 0–10 volt DC ballasts are offered by most major ballast manufacturers, and in most cases are compatible with industry standard lighting control devices, including manual dimmers, occupancy sensors, and photocell controllers.
- Line voltage dimming ballasts usually require the purchase of proprietary control gear offered by the ballast manufacturer. In some cases an additional conductor is required to handle the dimming signal.

Dimming fluorescent ballasts should be considered in all cases requiring maximum energy performance and light level flexibility. They are particularly effective in daylight classrooms, computer classrooms, audio video rooms and similar spaces.

Compact Fluorescent Lamps

Compact fluorescent lamps (CFLs) can be used in nearly all applications that traditionally have employed incandescent sources. CFLs offer excellent color rendition, rapid starting and dimmability. A large palette of different lamp configurations enhances design flexibility. Principal advantages of CFLs over incandescent sources include higher efficacy and longer lamp life. They can be dimmed, though dimming CFL ballasts are expensive. In colder outdoor environments, they can be slow to start and to come to full light output.

Use CFL lamps extensively in task and accent lighting applications, including wall washing, supplementary lighting for visual tasks requiring additional task illumination above ambient levels, and portable task lighting in computer environments. They are also



valuable for medium to low-level general illumination in spaces such as lobbies, corridors, restrooms, storage rooms and closets. In most non-mountain California climates they are quite suitable for outdoor corridors, step lighting, and lighting over doorways. High wattage biax-type CFLs can be used for general space illumination in recessed lay-in troffers (see Luminaires section below), as well as in more decorative direct/indirect luminaires for office lobbies, libraries and other spaces requiring a more "high end" look.

High Intensity Discharge (HID) Lamps

HID lamps provide the highest light levels of any commercially available light source in a wide variety of lamp wattages and configurations. In addition, they offer medium to high efficacy and relatively long lamp life. The principal disadvantage to HID sources is that they start slowly and take time to warm up before coming to full brilliance. This makes them difficult to use in many automatic lighting control scenarios without the use of expensive two-level switching systems. In some applications, such as warehouses and vehicle maintenance areas, this may be cost effective when evaluated from a life-cycle cost perspective, but be prepared for reduced color performance and lamp life if used with metal halide lamps. Dimming HID lamps is expensive and unreliable, and not recommended.

HID lamps are appropriate for use in exterior and high ceiling interior lighting applications, including gymnasiums, warehouses, parking lots, exterior corridors and building floodlighting. In interior applications, select metal halide HID lamps for good color appearance and rendering. Premium "pulse-start" metal halide lamps offer improved starting, color uniformity and rendition, longer lamp life and higher lumen maintenance than standard metal halide lamps. This is due primarily to advances in arc tube technology. Pulse-start lamps can often be used in place of incandescent or halogen sources in applications requiring point source drama and high color performance. High-pressure sodium HID lamps produce a golden-colored light. Their most appropriate uses are in exterior environments, or in interior applications, such as warehouses and other storage areas, when color performance is secondary to efficacy and maintenance goals.

HID Ballasts

Metal halide and high-pressure sodium lamps also require ballasts to start the lamp and regulate electrical operation. Control of the arc current is particularly critical to the successful operation of HID sources, and ballasts are designed to perform this function within relatively close tolerances.

Pulse-start metal halide and high-pressure sodium ballasts employ an electronic ignition pulse to initiate the arc and start the lamp. In standard metal halide lamps, however, the ballast starts the lamp via a separate starting electrode within the lamp. This method of starting the lamp takes longer than the pulse-start system.

Electronic ballasts do not offer the same magnitude of energy-efficiency benefits to HID lamps as they do to fluorescents, and there is a limited selection of products on the market. The main benefit of electronic HID ballasts is more precise control of the arc's



electrical characteristics. In metal halide lamps this can improve lamp color uniformity and reduce color shift.

Light Emitting Diodes (LEDs)

LEDs are semiconductor devices that generate an intensely directional, monochromatic light. Research today is directed at producing a commercially viable white LED source. At this time, because selection is mainly limited to red, blue or green products, LED use as a light source in schools is generally limited to exit signs and other signs. The principal advantage of LEDs over other sources is their extremely long life. In addition, a two-sided LED exit sign can usually be illuminated with less than 5 watts.

LEDs are highly recommended for use in school exit signs. They offer high efficacy and very low maintenance costs when compared with either incandescent or fluorescent products, and are available in most of the popular exit sign configurations.

Luminaires

Luminaires (light fixtures) generally consist of lamps, lamp holders or sockets, ballasts or transformers (where applicable), reflectors to direct light into the task area, and/or shielding or diffusing media to reduce glare and distribute the light uniformly. There is an enormous variety of luminaire configurations. This section briefly outlines some of the more important types for school lighting design.

Recessed Luminaires

Recessed luminaires represent a large segment of the overall luminaire market. There are two basic variations:

- *Lay-in troffers* recess into an acoustical tile ceiling. The most common types measure 2 ft x 4 ft or 2 ft x 2 ft. With the use of a special flange, they can also be recessed into gypsum board ceilings. They typically consist of a housing, reflector, mounting hardware, lamps, ballast, and a lens or other shielding or diffusing media, such as parabolic louvers. Their primary use is as a direct general light source. They are among the least expensive of light fixtures available. Their primary advantages are their low cost and their ability to produce high levels of uniform horizontal light. They are generally less effective than other types of luminaires at producing the high wall and ceiling illumination levels that are important for visual comfort. This is particularly true of the parabolic troffer.
- *Downlights* can also be recessed into t-bar or hard ceilings. They are relatively compact luminaires used for wall washing, accent lighting, supplemental general or task illumination, as well as for lower levels of ambient illumination. Both square and round configurations are available in nominal overall diameters of 6 in., 7 in., 8 in., 10 in. and 12 in.. They use incandescent, compact fluorescent or HID sources. Specific luminaire components vary depending on application.
- *Other types:* A relatively recent addition to the recessed luminaire family is a modified version of the standard troffer that indirectly reflects light into the space. These are marketed as "indirect troffers", and their intent is to soften the distribution pattern of a



direct distribution luminaire without losing the benefit of lighting uniformity. However, in many cases the surface brightness of the exposed reflector is actually higher than that of a standard troffer. Use them with caution, and don't use them in larger building spaces such as classrooms and open offices.

Suspended Classroom Luminaires

Suspended indirect or direct/indirect luminaires are the preferred luminaires for lighting classrooms. They are also appropriate for offices, administrative areas, library reading areas and other spaces. Typically these luminaires employ T-8, T-5, or T-5HO lamps, and mount in continuous row configurations.

Some people dislike the "cloudy day" effect produced by 100% indirect luminaires, and prefer some direct illumination. However, luminaires with too much of a direct component can produce shadows, glare or reduced uniformity. This is particularly true with T-5HO lamps, which should not be used in suspended luminaires with more than 5–10% direct distribution. Fortunately, luminaire optical system options allow the designer to determine the amount of indirect and/or direct illumination.

By using the ceiling to distribute light into the room, indirect and direct/indirect fixtures efficiently produce soft, uniform illumination throughout the space. They typically require at least a 2-ft extension from a minimum ceiling height of 10 ft for acceptable uniformity and to avoid ceiling "hot spots."

High-end suspended classroom luminaires are constructed of extruded aluminum and cost significantly more; however, steel luminaires are available at prices comparable to recessed troffers, particularly when installation labor costs are factored in. Luminaires can usually be specified to include transparent dust covers, which prevent dirt and refuse (spitballs, paper airplanes, etc.) from accumulating inside the fixture, thereby blocking light and increasing required maintenance.

Suspended High Ceiling Luminaires

Both fluorescent and HID suspended luminaires are useful for illuminating building spaces such as gymnasiums and other high-ceilinged spaces. HID luminaires can be classified as either high bay (>25 ft mounting height) or low bay, depending on the configuration. High-bay luminaires typically consist of either a spun aluminum reflector or prismatic refractor with an open or clear plastic bottom and a very direct distribution pattern. Low-bay luminaires typically employ a lens or diffuser to increase distribution uniformity. Metal halide is preferable to high-pressure sodium in gymnasiums due to its superior color performance.

Compact fluorescent high-bay luminaires are also available to light high ceiling spaces. They employ up to eight compact fluorescent lamps to approximate the light output of an HID luminaire, while allowing for additional control flexibility.

Linear hooded industrial fluorescent luminaires can be extremely effective at lighting high ceiling spaces. T-8 lamps with HLO ballasts or T-5HO lamps will produce adequate

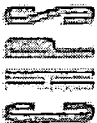

illumination for all but the highest spaces. Using fluorescent lamps allows for sophisticated control schemes and minimizes lighting maintenance costs due to long lamp life. In addition, the color performance of fluorescent is superior to that of metal halide. Be sure to use wire lamp guards for luminaires in gymnasiums or in other areas subject to damage or abuse.

Surface-mounted Luminaires

Surface-mounted fluorescent, compact fluorescent and HID luminaires are valuable for wall and ceiling mounting situations, particularly when ceiling access is a problem. Fluorescent luminaires of this type include straight-sided "modular" fixtures that resemble recessed troffers in shielding media and optical performance, inexpensive, utility "wraparounds" for general lighting purposes; wall-mounted bathroom mirror lights; and many other configurations. Surface-mounted compact fluorescent luminaires include one-lamp, two-lamp, and three-lamp utilitarian drum lights; bathroom vanity lights; exterior wall and ceiling corridor lights; and decorative wall sconces and ceiling fixtures. Ceiling-mounted HID canopy lights can be used to light exterior corridors or gymnasiums and other high ceiling spaces, depending on configuration and lamp size.

Specialty Luminaires

Several specialty luminaires are available for specific school lighting applications. These include specialty wall wash luminaires to illuminate blackboards, task lighting luminaires to supplement general illumination, wet location luminaires for exterior areas open to the elements, and high-abuse luminaires designed to withstand vandalism in school and other institutional environments.

Blackboard lights provide supplemental vertical illumination on the teaching wall. Specially designed recessed or surface-mounted linear fluorescent luminaires provide high levels of uniform illumination when mounted in continuous rows over the vertical surface. To minimize specular reflections from whiteboard surfaces, the aiming angle of the luminaire should not exceed 30 degrees from nadir.

Specialty task lighting luminaires are important in areas such as computer classrooms or offices where ambient illumination levels are kept relatively low. Portable or furniture-mounted task lights can provide supplemental illumination for certain paper tasks and other visual work requiring higher illumination levels. Usually these luminaires employ compact fluorescent or halogen lamps and include local switches or dimmers to allow the user some flexibility.

Wet location luminaires are required in exposed exterior locations. These luminaires carry a wet UL designation and have internal gasketing and heavy-duty fasteners. They are available in numerous configurations of enclosed fluorescent, compact fluorescent and HID luminaires. They cost more than standard luminaires.



High-abuse luminaires are recommended for areas subject to vandalism, including corridors, restrooms, exterior areas and other common areas. These fixtures typically are constructed of more robust materials than standard luminaires and usually include tamper-proof mounting hardware. They cost significantly more than standard fixtures but stand up much better to abuse.

Exit Signs

Numerous exit sign configurations are available for schools. LED exit signs offer the best alternatives for minimizing energy use and maintenance. However, compact fluorescent exit signs may be preferable in some instances when higher surface brightness or an additional downlight component is desired. Avoid self-luminous atomic exit signs because they are difficult to dispose of, and may not provide adequate surface luminance.



Lighting Controls

Lighting controls are critical for minimizing lighting energy use and maximizing space functionality and user satisfaction. Control techniques range from simple to extremely sophisticated. This section outlines lighting control hardware available for school applications, and offers some application tips for effective use of lighting controls.

Switches

Manual switches are the simplest form of user-accessible lighting control. Minimal compliance with Title 24 requires individual manual switching for each separate building space. Bilevel switching is also required in spaces larger than 100 ft² with a connected lighting load greater than 1.0 W/ft². Additional switching requirements are triggered by daylight spaces.

Manual switches are especially valuable in daylight building spaces because they allow people to turn off electric lights when daylight is adequate. Manual switches should also be installed in spaces with occupancy sensors. This increases the energy savings of occupancy sensor controls by allowing people to turn off the lights when they are not needed.

Occupancy Sensors

Occupancy sensors employ motion sensors to shut lights off in unoccupied spaces. The primary detection technology can be either passive infrared (PIR) or ultrasonic. Each type has advantages and disadvantages depending on the building space type, space usage, and configuration. Some sensors employ both passive infrared and either ultrasonic or microphonic detection. Sensors have adjustments to control their overall sensitivity, and to control the "time out" period between last detection and turning off the lights.

There are two basic types of occupancy sensor mounting configurations. The simplest configuration fits in a standard single gang box in place of a standard wall switch. Most of these devices also have an integral manual switch. Wall box sensors are useful in most small building spaces such as private offices, but they are inappropriate in classrooms and other large building spaces, or in areas where they cannot "see" the space occupants due to mounting location or distance.

For larger building spaces, ceiling or wall-mounted sensors provide detection of areas up to 2,000 ft². These devices require a separate relay/transformer unit or "switch pack" to power the sensor and switch the lights. It makes good sense to wire wall switches in series with the sensor to allow manual override capability in many building spaces.

Occupancy sensors are most effective in spaces that are intermittently occupied, or where the lights are likely to be left on when unoccupied. The best school applications include classrooms, private offices, restrooms and storage areas. Use occupancy sensors in



combination with manual overrides whenever possible to maximize energy savings, space flexibility, and occupant satisfaction. Including manual off override to the control scheme allows the teacher to turn the lights off for video presentations or other situations requiring the lights to be off.

Time Controls

Time controls save energy by reducing lighting time of use through preprogrammed scheduling. Time clocks comply with the Title 24 requirements for whole building shut-off in buildings greater than 5,000 ft². Time control equipment for lighting comes in a variety of configurations with varying degrees of complexity. The simplest devices are designed to control a single electrical load, while extremely sophisticated systems typically control several lighting zones. The larger systems employ low-voltage relay switching technology, and can often link up well with energy management controllers.

Time controls make sense in many applications where a predictable schedule of operation can be defined, and where occupancy sensor automatic control is either impractical or undesirable. Candidate building spaces include classrooms, offices, library stacks (local digital time switches), auditoriums, and exteriors. Keep in mind that Title 24 requires manual override of time clock control whenever they are installed to comply with whole building shut off.

Energy Management Systems (EMS)

Energy management systems can be configured to control lighting circuits. Typically when lighting is controlled through an EMS it is via a time clock. However, many building operators take advantage of the built-in EMS functions to monitor lighting usage on a space-by-space basis. EMS control of lighting systems may also allow building operators to shed non-essential lighting loads during peak demand periods.

Manual Dimmers

Next to standard wall switches, manual dimmers are the simplest of lighting control devices. Manual dimmers serve two important functions. First, dimming lights reduces lighting demand and energy usage. With incandescent and halogen sources, there is the additional benefit of extended lamp life. However, more importantly, dimmers allow people to tune the lights to optimum levels for visual performance and comfort.

Consider manual dimmers (combined with dimming ballasts, where applicable) for many school building spaces, including classrooms, computer classrooms and office spaces. A/V rooms *require* manual dimming to function properly.

Photoelectric controls

Photoelectric control systems employ a photosensor and logic controller to control lights in daylit spaces, such as classrooms and corridors. The logic controller processes a signal from the photosensor and sends a dimming or switching signal to the lighting circuit based



on the monitored light level. Open-loop systems “see” only daylight, while closed-loop systems monitor both daylight and the light emitted by the luminaires they control.

Successful employment of photoelectrically controlled lighting systems requires careful design, installation, and commissioning, as well as a commitment to the long-term maintenance of the system. Without these elements, energy savings are rarely sustainable.

General Application Notes for Lighting Controls

Lighting control strategies are most successful when people can easily understand their operating characteristics. Another critical factor is the proper commissioning of lighting control systems so that they operate according to design intent. Finally, regularly scheduled maintenance of control equipment will improve the long-term success of the system. Poorly designed, commissioned or maintained automatic lighting controls can actually increase lighting energy use, and cause user dissatisfaction.

For optimizing lighting control performance, consider the following rules of thumb when designing lighting control systems:

- Provide control interfaces that are easy to understand and operate by building users.
- Always commission automatic lighting controls after installation to ensure compliance with design intent.
- Involve the lighting control equipment manufacturer in the specification, installation and commissioning of lighting controls.
- Include lighting control commissioning plans in bid specifications.
- Provide detailed maintenance procedures for all specified controls.
- Involve building users in the energy-saving process by communicating lighting control design intent.

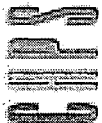

APPENDIX F – DAYLIGHTING AND FENESTRATION DESIGN SUPPLEMENT

The Daylighting and Fenestration Design chapter of this manual provides an overview of design high performance daylighting systems for schools, as well as specific design guidelines. This supplement offers a more in-depth discussion of certain aspects of daylighting design, including:

- Optimizing Aperture Size
- Fenestration Products
- Other Design Criteria for Daylighting Systems

Optimizing the Aperture Size

The optimum size of the daylighting aperture depends on a number of factors, including the pattern (light shelves, sawtooth roof monitor, etc.), the desired illuminance level of the school space that is being daylit, and the type of glazing material selected. Climate and internal loads (heat given off by people and equipment) are also important considerations since the optimum aperture size is the one that minimizes the total operating cost.

For a given daylighting pattern, glazing material, occupancy pattern, lighting level, electric lighting control system, and climate, the total operating costs can be calculated and plotted for various window areas, as shown in Figure F-1 for a window with vertical glazing. As glazing area increases, the energy use for lighting is steadily reduced until the window area is about 25% of the exterior wall. After that, daylight saturation is achieved for much of the time, and lighting energy savings are much smaller with increased window area. However, both cooling load and fan energy increase steadily throughout the entire range of window-wall ratios. Note that cooling energy increases at a more rapid rate after daylighting saturation is achieved at a window-wall ratio of about 25%. Heating energy is relatively flat in this example, but it also increases with window-wall ratio. In cold, sunny climates, heating energy might actually decline for part of the window-wall ratio range, especially for south-facing orientations.

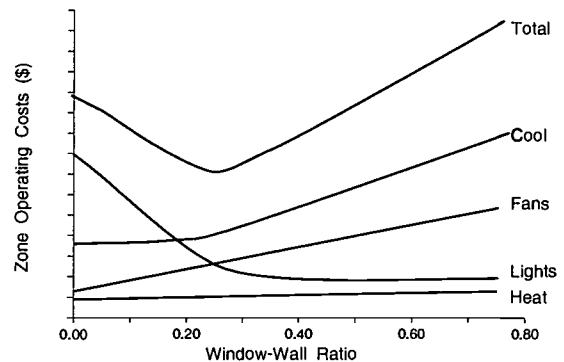

Note: South Orientation, Double Green Glass, Long Beach, CA
Figure F-1 – Optimum Aperture Area



A similar set of graphs can be generated for skylights. Figure F-2 shows the change in energy savings as skylight area becomes a larger percentage of the floor area. This graph indicates that whole building energy savings increase until the skylight area

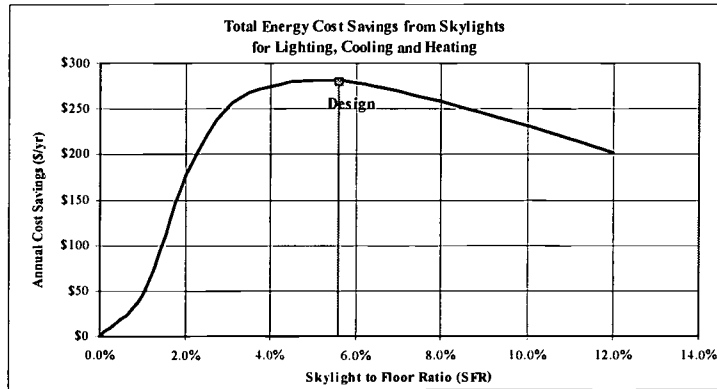

Figure F-2 – Energy Cost Savings from Skylights

represents about 5% of the floor area and then begins to decrease,

SkyCalc graph shows optimum skylight to roof area ratio for classroom skylight design in Los Angeles using high transmission skylights. Results vary by skylight design and climate location.

although the savings are still positive with larger areas. In general, skylights should represent about 4–8% of the floor area for good daylighting with minimal energy costs. In milder climates, larger areas generally make more economic sense. Computer tools such as SkyCalc allow quick analysis of design alternatives.

Remember that optimizing heating and cooling impacts are not the only criteria in sizing windows and skylights. Observations of classrooms have indicated that if daylight levels are high enough in the morning when school starts, then teachers are more likely to use less electric light. Minimum threshold of daylight illumination may also be appropriate for other visual and comfort reasons. Most designs are likely to strike a compromise between desired daylight levels and minimized overall energy use.

Glazing Products

Some of the greatest glazing advances in recent years have been in the area of special low-e coatings applied to the surface of the glazing. Originally developed to lower the U-factor of double glazed windows, low-e coatings have a low "emissivity" value, meaning that they repress radiation of heat between the panes of glass. In cold weather, this saves energy by reducing heat loss from the warm inner pane to the cold outer pane of glass. It also increases thermal comfort considerably by keeping the inner pane of glass warmer, so it does not feel like a large cold surface to occupants. In hot climates, it performs the opposite function for air-conditioned spaces, keeping the "coolness" in.

BEST COPY AVAILABLE

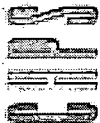

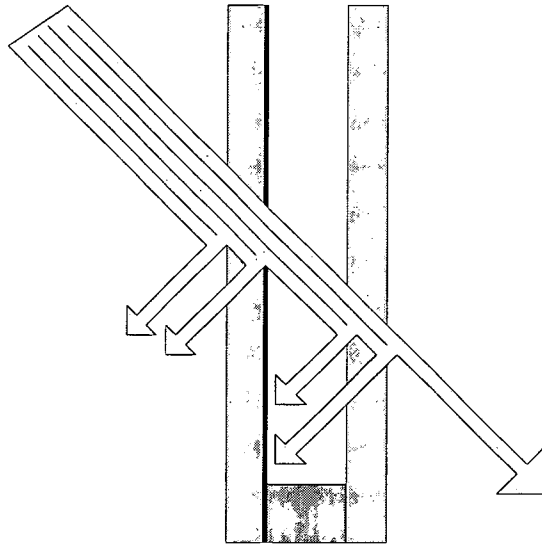

Figure F-3 – Heat Transfer Through Glazing

More important than the U-factor for many of California's milder climates, glazing should also have a low SHGC to minimize solar gains but a high VLT to maximize daylighting potential. The efficacy of fenestration is the ratio of VLT to SHGC. The higher the efficacy, the better the fenestration product is in allowing daylight and reducing solar gains. Glazing materials with a high efficacy are known as "selective" glazing materials because they selectively transmit radiation in the visible portion of the spectrum while blocking solar radiation in the ultraviolet and infrared spectra. Selective products will have a VLT to SHGC ratio > 1.3.

A high glazing efficacy is achieved through several technologies. First, many glazings are tinted by the addition of a rouge added to the silicon when the glass is manufactured. Tints such as bronze or gray are poor performers and actually reduce the glazing efficacy, while green and blue tints typically increase the efficacy. Another approach to increase efficacy is with the use of the new generation of "selective" low-e coatings that have been engineered to minimize solar gains in addition to reducing thermal losses. These selective low-e coatings are virtually clear and colorless, but can block more heat than a heavily tinted gray glazing. However, they are relatively soft and must be located on the second or third surfaces of double glazing so that they are protected from abrasion.



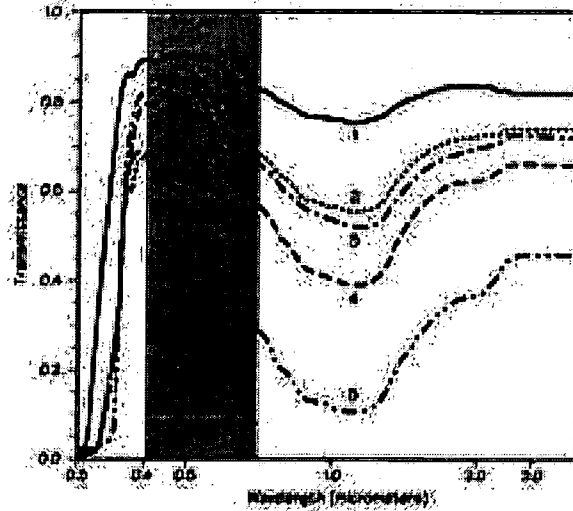

Figure F-4 – Glazing Efficacy

Green tinted glass is a good inexpensive and efficient glazing material for California climates; in either a single or double glazing assembly. When double-glazing can be justified for thermal reasons in colder climates, then a selective low-e coating should be considered on the second or third surface. However, for passive solar designs, which require solar gain, specify the original (SHGC >.6), not selective, low-e coating.

Table F-1 – Solar Optic Properties of Vertical Glass Materials & Coatings

Number of Panes	Tint	Special Coatings or Films	U-factor (COG)	Visible Light Trans. (VLT)	Solar Heat Gain Coefficient (SHGC)	Glazing Efficacy (VLT/SHGC)
Single	Clear	None	1.09	0.88	0.82	1.08
	Green	None	1.09	0.75	0.61	1.23
	Bronze	None	1.09	0.53	0.61	0.87
	Selective tint	None	1.11	0.72	0.52	1.37
Double	Clear	None	0.48	0.78	0.70	1.12
	Green	None	0.48	0.66	0.49	1.35
	Bronze	None	0.48	0.47	0.49	0.96
	Selective tint	None	0.48	0.64	0.40	1.58
Double	Clear	Orig. Low-e	0.31	0.73	0.62	1.18
	Clear	Selective Low-e	0.29	0.70	0.37	1.89
	Clear	Sunbelt Low-e				
	Selective tint	Selective Low-e	0.29	0.56	0.27	2.07
Triple	Clear	Mylar Film	0.27	0.63	0.47	1.34
	Green	Mylar Film	0.27	0.55	0.35	1.57
	Selective tint	Mylar Film	0.27	0.51	0.29	1.76

Notes:
 Values are for standard metal frame construction Center of Glass. Special tint glass refers to tinted products such as Azurlite or Evergreen.
 N/A = Not Available

BEST COPY AVAILABLE



In addition to the glass types mentioned above, there is a large variety of sheet and formed plastic materials used in fenestration, especially skylights. The most common materials used are acrylic and polycarbonate plastics and fiberglass. These products may be in flat sheets, formed domes (or other shapes), or extruded channels (double or triple walled, to decrease the U-factor and provide some diffusion). Their performance specifications are similar to their glass counterparts, but unfortunately, tested values are frequently not available for commercial glazing units. All these products are susceptible to UV degradation and must have a UV inhibitor added to maintain clarity and keep them from yellowing.

Acrylic materials are cheaper than polycarbonates, but polycarbonates are stronger and more scratch resistant. Fiberglass is a highly variable material, since it is frequently not made from a uniform pre-manufactured sheet material, but is made by applying the resin and glass mixture to a form. Thus, exact thickness and composition of the material can vary along with its diffusing characteristics. Since low-e films cannot be adhered to these materials at this time, the low-e performance noted above is not available for the lower cost versions of these plastic fenestration products. Table 3 shows some generic specifications for a range of these products.

These materials may diffuse the light with either an added "white" pigment, a prismatic surface or imbedded fibers (fiberglass). While pigments can successfully diffuse the light, they inevitably also reduce the visible transmittance of the glazing, reducing overall efficiency. Prismatic and fiberglass materials diffuse the light through optics, and can maintain higher visible transmittance. There is, however, no standard language or widely available measurement that accurately describes diffusion properties. There are test standards, such as ASTM E167-96, which measure diffusion; however these results are rarely available. As a result, the specifier should describe a visual inspection procedure to evaluate samples of the glazing material or the skylight assembly for diffusion.



Table F-2 – Solar Optic Properties of Plastic Glazing Materials

Material	Layers	Color	U-factor	Visible Light Trans. (VLT)	Solar Heat Gain Coefficient (SHGC)	Glazing Efficacy (VLT/SHGC)	
Acrylic	Single	Clear		.92	.77	1.19	
		Med. White		.42	.33	1.27	
		Bronze		.27	.46	.59	
	Double	Clear			.86	.77	1.10
		Med. White			.39	.30	1.28
		Bronze			.25	.37	.67
Fiberglass	Single						
	Double Sandwiched w/ batt insulation	White	0.24	.2	.23	.85	
Polycarbonate	Single	Clear		.85	.89	.96	
		Med. White		.37	.50	.73	
		Bronze		.50	.69	.73	
	Double	Clear			.73	.75	.97
		Med. White			.32	.43	.74
		Bronze			.43	.58	.73

Links with Other High Performance Design Measures

Interaction with HVAC

Fenestration impacts the heating and cooling loads on a school because it has a higher U-factor than other portions of the building envelope and because it has the potential to admit solar gain. The U-factor for most windows is about 1.1 for single-glazed windows and 0.4–0.6 for double-glazed windows.

Fenestration oriented toward the sun may admit large amounts of solar gain. Although this may be beneficial for passive solar designs, for most buildings, it is a cooling season liability. Excessive solar gains will overheat spaces without air conditioning and will increase energy costs for air-conditioned spaces. They will even increase the first cost of the HVAC system if a larger system is specified to handle the larger loads. Appropriate sizing of apertures and design of shading and glazing can minimize these loads for each building elevation. The building energy simulation tools mentioned in the section on Whole Building Energy Simulations above can aid in evaluating overall loads and performance.

Although many schools are not intended to operate in the summer, and so may have insignificant cooling energy use, they still should be designed to minimize solar gain. This will ensure comfortable classrooms year round, and, should school operation plans change in the future to include summer operation, will minimize energy liabilities.

HVAC systems that incorporate ceiling ducting will also increase the required ceiling plenum and reduce the allowable window head height unless they are left exposed or the ceiling is sloped at the perimeter.



Interaction with IAQ

Operable fenestration can also provide natural ventilation and improve indoor air quality. The benefits of natural ventilation, and fenestration design strategies to promote natural ventilation, are discussed in the section below.

Other Design Considerations for Daylighting and Fenestration Design

Daylight apertures have impacts on building performance beyond their daylighting functions. Some of these additional impacts are discussed below.

Natural Ventilation

Operable fenestration can provide natural ventilation and improve indoor air quality. Operable windows correlate with higher standardized test scores and are associated with an overall reduction in building energy use, even in a hot, humid climate. Operable windows may be a liability for areas with constant high exterior noise, such as near airports, or exceptionally poor outdoor air quality, such as near agricultural fields with frequent plowing and chemical use. Except for these situations, operable windows should be included in all schools (especially classrooms) and designed to provide natural cross ventilation. Location of operable apertures low in the space on the windward side and high in the space on the leeward side will provide optimum ventilation performance.

Noise Control

Most windows and skylights allow more noise to pass through than walls or roofs do. If noise transmission is a problem, then orient fenestration away from the offending noise or use a glazing system designed to minimize transmission. Reduced noise transmission is an important side benefit to using double glazing for thermal reasons.

In order to be effective, the same acoustic treatment should be used for all glazing materials throughout a building. Noise will always travel through the weakest link in the system. Both double glazing and laminated glass (especially when the laminated pieces are of different thickness) will transmit less noise than single glazing. Use of a specialized gas between the layers of double glazing may further help to dampen noise transmission. Note that the effectiveness of each of these solutions will vary depending on the wavelength (or frequency) of the offending noise. For extreme situations, consult an acoustic engineer.



Radiant Comfort

Even when air temperatures are within a comfortable range, occupants can be cold or hot because of the surface temperature of windows and skylights. This effect is intensified if the glazing surface is large and close to the occupant. The glazing surface temperature is affected by the outdoor temperature, the number of glazing panes, frame construction and low-emissivity (low-e) coatings. In winter, students near a window wall may feel cold while others near the interior are comfortable. Turning up the thermostat to satisfy students at the perimeter will use excess energy and may make students near the interior too warm. This problem is best resolved by using high performance glazing that improves radiant comfort by reducing hot glazing surfaces (in summer) and cold glazing surfaces (in winter). See the section above on Fenestration Products for recommendations on high performance glazing to increase radiant comfort.



Large windows can create overly cold or warm surfaces, reducing thermal comfort. High performance glazing improves thermal comfort. Double glazing improves acoustic performance. Operable windows, which allow natural ventilation, improve student performance. (Photo courtesy Barbara Erwine)

Safety and Security Issues

Fenestration poses safety and security liabilities both because it's breakable and because it allows views into areas that may contain valuables. These increase the risk of vandalism, and potential injury from shattering of glass or accidental falls through unprotected openings (especially skylights).

On the other hand, windows, especially can provide many important safety features for schools. Clear view glass allows supervision between the inside and outside of buildings. It's easy to spot mischief occurring inside a classroom if there's an easy view in from the outside. Operable windows can also provide a safety advantage as a secondary means of egress during any kind of emergency, or for immediate emergency ventilation in case of a chemical spill.

Minimize vulnerability to vandalism by using interior blinds or drapes to shield interior contents from view when the space is not occupied. Making windows or skylights easily observed from the street, or designing the building so that fenestration is difficult to access, can also help reduce vandalism. Some school districts have found that flat roofs tempt children to climb and play on them after hours, while sloped roofs substantially reduce this problem.

Minimize the risk of injury from breakage by carefully selecting the glazing materials, minimizing access to rooftops with toplighting schemes, and providing gratings to prevent

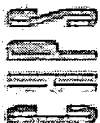

falls through rooftop openings. Glazing materials that resist breakage are both safer and less susceptible to vandalism. Tempering glass quadruples its strength, and changes its breakage pattern from large shards to small "pebbles." Laminated or wired glass keeps glazing intact even when it is broken, minimizing injuries. Some form of safety glass is required for all glass within 18 in. of the floor or associated with an adjacent doorway. Underwriters Lab (UL) Standard 972 covers the strength of the glazing in resisting the efforts of burglars while ASTM Standard F588 reports how well the frame holds up to forced entry.

Most codes require that skylights be designed to withstand a fall from a 300-pound person. Use of laminated or wired glass, fiberglass, or polycarbonate rather than regular glass or acrylic plastics increases strength and eliminates shards on breakage. Most falls through skylights seem to be from people backing into them inadvertently. Use of high curbs or weight-bearing louvers or bars within the skylight well can reduce injury falls through skylights.

Air and Water Leakage

Windows and skylights represent penetrations through the building's weather-tight skin, making it vulnerable to air and water leakage. Air infiltration can cause uncomfortable drafts and increased HVAC energy costs. Water leakage can cause damage to building contents, such as rugs, furniture and equipment. It can also create structural damage and high moisture conditions, promoting the growth of mold and contributing to sick building syndrome.

Leakage is affected both by the construction details (the "tightness" of the seal between the fenestration and the wall or roof rough opening) and, for operable apertures, by the quality of the seals within the window or skylight unit itself. Both windows and skylights need to be properly flashed and sealed to eliminate air and water leakage problems. Skylights should sit on raised curbs, flashed like any other roof penetration. Molded plastic skylights have the advantage over glass assemblages of creating a continuous waterproof surface that is not dependent on sealants.

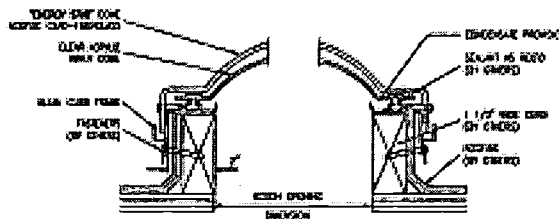

Skylight detailing should include careful attention to flashing and condensation control.

(Graphic courtesy Bristolite Skylights)

Condensation

Since windows and skylights usually have higher U-factors than walls and ceilings, in winter the interior surface of the glass will be colder than the walls and ceilings. This temperature difference makes them a prime target for condensation, which occurs when warm moist air comes in contact with a cooler surface. The colder the interior surface of



the glass or frame, the more likely water will condense. Because of this, single-pane glass and simple metal frames without a thermal break are especially prone to condensation. Condensation can also occur between the panes of a double-glazed window. This indicates that the seal that holds the panes together has failed. The glass often becomes cloudy, a signal that it needs to be replaced.

Small amounts of condensation on very cold days are not a major problem, but larger amounts over a long period of time can cause mold, cosmetic damage to paints and finishes and even structural damage to the wall or roof. Condensation dripping from a skylight is very often mistaken for a leak. To minimize condensation, select windows and skylights with a low overall U-factor, use low-conduction vinyl, wood or thermally broken aluminum frames, and make sure the frame is designed with weep holes to collect and redirect any moisture that accumulates. Skylights should all have a small condensation "gutter" designed to collect any condensation at night and allow it to re-evaporate during the day.

Replacement

Windows and skylights in schools are vulnerable to breakage, so the cost and ease of glazing replacement is important. Using readily available glazing sizes, tints and coatings allows the easiest replacement options. Standardized sizing may be especially important for double-glazed units, which must be constructed as a unit and cannot be "cut to size." When replacing tinted or coated glazing, ensure that the same tint is being used and that the coating is on the same glazing surface. Although there is not a large energy penalty for switching the coating surface (say from the outer pane to the inner pane), the exterior appearance of the glazed unit as compared to others in the building may change noticeably.

Window seals in double-glazed units should carry a warranty; check to see if it is in effect if you have a seal failure. The retrofitting of a tinted film onto a window may add stresses to the glazing and will probably void the warranty.

Maintenance

A window or skylight will deliver less light to a space if it is dirty. Under normal conditions, the accumulation of dirt can reduce the visible light transmission of vertical glass by 10% and horizontal glazing by up to 30%. All glazing should be cleaned on a regular schedule. Wash windows, and hose down skylights occasionally during dry dusty weather. High windows and skylights may also attract spider webs, which should be removed occasionally. When designing windows and skylights, consider the access to the glazing for cleaning, and the ease and cost of cleaning shading and reflecting devices. When light shelves and louvers are placed in front of glazing, accommodation must be made to clean the glass above or behind them.



Fire Resistance

The size of openings for windows or skylights, and the type of glazing allowed, may be restricted by code in a fire-rated construction. Many plastic glazing materials for skylights are combustible and their use is allowed with area limitations and spacing requirements. The use of sprinklers affects these parameters, as does the type of glazing material used. Placement of light shelves or diffusers should be coordinated to avoid interfering with sprinkler performance. Skylights can reduce fire spread by functioning as a smoke hatch which pops open on a fusible link.





U.S. Department of Education
Office of Educational Research and Improvement (OERI)
National Library of Education (NLE)
Educational Resources Information Center (ERIC)



REPRODUCTION RELEASE

(Specific Document)

I. DOCUMENT IDENTIFICATION:

Title: Best Practices Manual	
Author(s):	
Corporate Source: Collaborative for High Performance Schools	Publication Date: 2002

II. REPRODUCTION RELEASE:

In order to disseminate as widely as possible timely and significant materials of interest to the educational community, documents announced in the monthly abstract journal of the ERIC system, *Resources in Education* (RIE), are usually made available to users in microfiche, reproduced paper copy, and electronic media, and sold through the ERIC Document Reproduction Service (EDRS). Credit is given to the source of each document, and, if reproduction release is granted, one of the following notices is affixed to the document.

If permission is granted to reproduce and disseminate the identified document, please CHECK ONE of the following three options and sign at the bottom of the page.

The sample sticker shown below will be affixed to all Level 1 documents

The sample sticker shown below will be affixed to all Level 2A documents

The sample sticker shown below will be affixed to all Level 2B documents

PERMISSION TO REPRODUCE AND DISSEMINATE THIS MATERIAL HAS BEEN GRANTED BY

Sample

TO THE EDUCATIONAL RESOURCES INFORMATION CENTER (ERIC)

1

PERMISSION TO REPRODUCE AND DISSEMINATE THIS MATERIAL IN MICROFICHE, AND IN ELECTRONIC MEDIA FOR ERIC COLLECTION SUBSCRIBERS ONLY, HAS BEEN GRANTED BY

Sample

TO THE EDUCATIONAL RESOURCES INFORMATION CENTER (ERIC)

2A

PERMISSION TO REPRODUCE AND DISSEMINATE THIS MATERIAL IN MICROFICHE ONLY HAS BEEN GRANTED BY

Sample

TO THE EDUCATIONAL RESOURCES INFORMATION CENTER (ERIC)

2B

Level 1

Check here for Level 1 release, permitting reproduction and dissemination in microfiche or other ERIC archival media (e.g., electronic) and paper copy.

Level 2A

Check here for Level 2A release, permitting reproduction and dissemination in microfiche and in electronic media for ERIC archival collection subscribers only

Level 2B

Check here for Level 2B release, permitting reproduction and dissemination in microfiche only

Documents will be processed as indicated provided reproduction quality permits.
If permission to reproduce is granted, but no box is checked, documents will be processed at Level 1.

I hereby grant to the Educational Resources Information Center (ERIC) nonexclusive permission to reproduce and disseminate this document as indicated above. Reproduction from the ERIC microfiche or electronic media by persons other than ERIC employees and its system contractors requires permission from the copyright holder. Exception is made for non-profit reproduction by libraries and other service agencies to satisfy information needs of educators in response to discrete inquiries.

Sign here, → please

Signature: <i>Gregg Anderson</i>	Printed Name/Position/Title: GREGG ANDERSON - CHAIR	
Organization/Address: <i>Southern California Edison</i>	Telephone: <i>626-633-2100</i>	FAX:
	E-Mail Address: <i>ANDER.G@SCE.COM</i>	Date: <i>06/04/03</i>



(Over)

III. DOCUMENT AVAILABILITY INFORMATION (FROM NON-ERIC SOURCE):

If permission to reproduce is not granted to ERIC, or, if you wish ERIC to cite the availability of the document from another source, please provide the following information regarding the availability of the document. (ERIC will not announce a document unless it is publicly available, and a dependable source can be specified. Contributors should also be aware that ERIC selection criteria are significantly more stringent for documents that cannot be made available through EDRS.)

Publisher/Distributor:

Address:

Price:

IV. REFERRAL OF ERIC TO COPYRIGHT/REPRODUCTION RIGHTS HOLDER:

If the right to grant this reproduction release is held by someone other than the addressee, please provide the appropriate name and address:

Name:

Address:

V. WHERE TO SEND THIS FORM:

Send this form to the following ERIC Clearinghouse:

**National Clearinghouse for Educational Facilities
National Institute of Building Sciences
1090 Vermont Ave., NW #700
Washington, DC 20005-4905
or fax to 202-289-1092**

However, if solicited by the ERIC Facility, or if making an unsolicited contribution to ERIC, return this form (and the document being contributed) to:

**ERIC Processing and Reference Facility
4483-A Forbes Boulevard
Lanham, Maryland 20706**

**Telephone: 301-552-4200
Toll Free: 800-799-3742
FAX: 301-552-4700
e-mail: ericfac@inet.ed.gov
WWW: <http://ericfacility.org>**