

## DOCUMENT RESUME

ED 469 344

HE 035 304

AUTHOR Sanaghan, Patrick; Napier, Rod  
TITLE Intentional Design and the Process of Change: Strategies for Successful Change.  
INSTITUTION National Association of Coll. and Univ. Business Officers, Washington, DC.  
ISBN ISBN-1-56972-016-9  
PUB DATE 2002-00-00  
NOTE 257p.; "Made possible through a grant from the Follett Higher Education Group Fund for Financial Management."  
AVAILABLE FROM National Association of College and University Business Officers, 2501 M St. NW, Washington, DC 20037-1308 (\$59.95, members; \$79.95, nonmembers). Tel: 866-348-6300 (Toll Free); 301-362-8198; Web site: <http://www.nacubo.org/shop>.  
PUB TYPE Guides - Non-Classroom (055)  
EDRS PRICE EDRS Price MF01/PC11 Plus Postage.  
DESCRIPTORS Cooperation; \*Educational Change; \*Higher Education; \*Leadership; \*School Culture; \*Strategic Planning

## ABSTRACT

This guide to successful change at colleges and universities has two parts. Part 1 explores the process of change at institutions of higher education, focusing on some of the underlying factors and issues that have proven vital to long-term success. In part 1, the first section discusses collaboration, key to a successful change process at any institution. Section 2 focuses on creating an institutional culture that supports and fosters change, and section 3 discusses developing and using a shared vision of the future as a centerpiece of the change process. Section 4 focuses on leadership, and section 5 contains advice on building trust. Section 6 discusses engaging the various constituencies who have a stake in the change process. Partnerships described in section 7 can provide benefits and cost savings partners may not be able to enjoy separately. Section 8 wraps up part 1 by sharing lessons learned over years of consulting about change in higher education. The designs in part 2 provide detailed instructions for collaborative activities for various groups in these sections: (1) "Data Gathering and Diagnosis"; (2) "Communication"; (3) "Team/Group Effectiveness"; (4) "Learning and Leverage"; (5) "Problem Solving"; and (6) "The Change Leader's Toolkit." An appendix discusses the role of the leader facilitator in planning and implementing a strategic design. Each chapter contains references. (SLD)

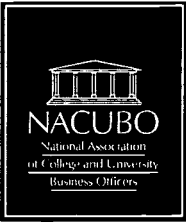

ED 469 344

PERMISSION TO REPRODUCE AND DISSEMINATE THIS MATERIAL HAS BEEN GRANTED BY  
*D. Klinger*  
TO THE EDUCATIONAL RESOURCES INFORMATION CENTER (ERIC)  
1

U.S. DEPARTMENT OF EDUCATION  
Office of Educational Research and Improvement  
EDUCATIONAL RESOURCES INFORMATION CENTER (ERIC)  
 This document has been reproduced as received from the person or organization originating it.  
 Minor changes have been made to improve reproduction quality.  
• Points of view or opinions stated in this document do not necessarily represent official OERI position or policy.

# INTENTIONAL DESIGN



THE

PROCESS OF

CHANGE

*Strategies for Successful Change*

BEST COPY AVAILABLE

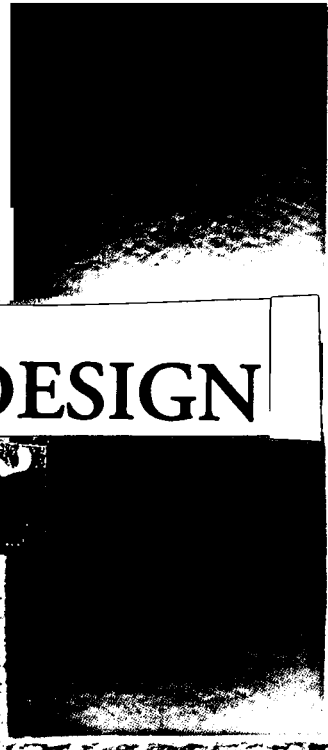

By  
Patrick Sanaghan  
and  
Rod Napier

2

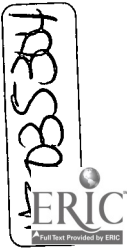

**INTENTIONAL DESIGN AND  
THE PROCESS OF CHANGE**

*Strategies for Successful Change*

by Patrick Sanaghan and Rod Napier



This publication is made possible through a grant from the Follett  
Higher Education Group Fund for Financial Management.

Copyright 2002 by NACUBO

All rights reserved. No part of this book may be reproduced or transmitted in any form or by any means, electronic or mechanical, including photocopying, recording, or by any information storage and retrieval system, without permission in writing from the publisher.

National Association of College and University Business Officers  
Washington, DC  
[www.nacubo.org](http://www.nacubo.org)

Printed in the United States of America

Design: Lynn Riley  
Editors: Donna Klinger, Caroline Grills, and Karen Bandy  
Production Manager: Elissa Fitzgerald

ISBN 1-56972-016-9

# CONTENTS

|                           |      |
|---------------------------|------|
| Foreword . . . . .        | vii  |
| Acknowledgments . . . . . | viii |
| Preface . . . . .         | ix   |

## *PART 1: THE PROCESS OF CHANGE*

|  |             |
|--|-------------|
| <b>Section 1: Collaboration: The Key to Successful Change Management . . . . .</b>   | <b>1.1</b>  |
| Breaking Tradition—Living One’s Values . . . . .                                     | 1.1         |
| The Roots of Collaboration—From Certitude to Pragmatism . . . . .                    | 1.2         |
| Pragmatics and Change . . . . .  | 1.3         |
| Middlebury College and the Building of “True” Consensus . . . . .                    | 1.3         |
| Why Consensus Usually Fails . . . . .  | 1.5         |
| Paradise Valley Community College—Values at the Heart of All Collaboration . . . . . | 1.6         |
| Loyola College of Maryland: Open Books, Open Discussion . . . . .                    | 1.7         |
| Virginia Tech—Everything Begins at the Top . . . . .                                 | 1.9         |
| The Unique Relationship between Collegiality and Collaboration . . . . .             | 1.11        |
| Questions Testing the Principles Underlying Successful Collaboration . . . . .       | 1.13        |
| References . . . . .   | 1.15        |
| <b>Section 2: Creating a Culture of Change . . . . .</b>                             | <b>1.17</b> |
| Culture: The Unique Personality of an Organization . . . . .                         | 1.17        |
| A Historical Context . . . . .   | 1.18        |
| The Splendid Isolation and Independence of Colleges and Universities . . . . .       | 1.18        |
| Culturally Defined Routines and Structures Inhibiting Change . . . . .               | 1.19        |
| The Administration Side of the University or College Enterprise . . . . .            | 1.23        |
| Corporate Culture and Performance . . . . .  | 1.25        |
| Summary . . . . .  | 1.27        |
| A Dozen Questions . . . . .  | 1.27        |
| References . . . . .   | 1.29        |
| Suggested Reading . . . . .  | 1.29        |

|  |             |
|--|-------------|
| <b>Section 3: Values, Vision, and the Learning Organization</b> . . . . .                      | <b>1.31</b> |
| Universities and Colleges—A Paradox and Compelling Danger . . . . .                            | 1.31        |
| The Challenge . . . . .  | 1.32        |
| The Question . . . . .   | 1.32        |
| Changing the Way We Change . . . . .   | 1.32        |
| The Answer . . . . .   | 1.33        |
| The Power of Values and Vision for Reframing Institutional Priorities . . . . .                | 1.33        |
| Values and the Process of Change . . . . .   | 1.35        |
| A Word About Mission or Organizational Purpose . . . . .                                       | 1.37        |
| Motivation and Pride in the Future: Enter the Vision . . . . .                                 | 1.37        |
| The Role of Vision in Colleges and Universities . . . . .                                      | 1.38        |
| Building Idealism and Hope Through the Visioning Process . . . . .                             | 1.39        |
| Conclusion—Envisioning Higher Education . . . . .  | 1.40        |
| References . . . . .   | 1.41        |
| <b>Section 4: Intentional Leadership: Strategic Design and the Process of Change</b> . . . . . | <b>1.43</b> |
| Strategic Design: The Keystone of Intentional Leadership. . . . .                              | 1.44        |
| Tough Questions . . . . .  | 1.44        |
| An Example of Strategic Design . . . . .   | 1.45        |
| Dealing with the Natural Challenges of Many Working Groups . . . . .                           | 1.46        |
| Breaking Predictable Patterns That Block Meeting Effectiveness . . . . .                       | 1.47        |
| The Leadership Imperative and the Role of the Team . . . . .                                   | 1.48        |
| Case in Point: The Value of a Team to a Change Initiative . . . . .                            | 1.49        |
| Looking Under Stones . . . . .   | 1.50        |
| Reduce Costs If You Overspend . . . . .  | 1.51        |
| Developing a Diagnostic Mentality . . . . .  | 1.52        |
| Design as Key to the Diagnostic Process . . . . .  | 1.52        |
| A Diagnostic Design . . . . .  | 1.53        |
| Vision, Values, and Planning . . . . .   | 1.55        |
| From Diagnosis to Current Reality for an Ideal Future . . . . .                                | 1.55        |
| Visioning as a Shared Process . . . . .  | 1.56        |
| Using Core Values to Leverage Change . . . . .   | 1.56        |
| Collaboration Is the Difference . . . . .  | 1.57        |
| The 10-30-60 Rule . . . . .  | 1.57        |
| Performance Management: The Key to Sustainability . . . . .                                    | 1.58        |
| Conclusion . . . . .   | 1.59        |
| References . . . . .   | 1.60        |
| Suggested Reading . . . . .  | 1.60        |

|   |             |
|---|-------------|
| <b>Section 5: Building Trust: A Key Factor in the Process of Institutional Change . . . . .</b> | <b>1.61</b> |
| Fitting Trust into the Equation of Change . . . . .   | 1.61        |
| Reframing Our View of Trust . . . . .   | 1.62        |
| Trust as Outcome . . . . .  | 1.62        |
| Content or Product Knowledge and Skills . . . . .   | 1.63        |
| Management Structure and Discipline . . . . .   | 1.63        |
| Process or Maintenance Skills and Behaviors. . . . .  | 1.65        |
| Trust Is Relative, Not Absolute . . . . .   | 1.68        |
| Summary . . . . .   | 1.69        |
| Trust Survey . . . . .  | 1.70        |
| <b>Section 6: Constituent Engagement in the Change Process. . . . .</b>                         | <b>1.73</b> |
| Operational Excellence . . . . .  | 1.74        |
| Product Leadership. . . . .   | 1.75        |
| Customer Intimacy. . . . .  | 1.75        |
| The Professor's Dilemma. . . . .  | 1.76        |
| Summary . . . . .   | 1.79        |
| References. . . . .   | 1.79        |
| <b>Section 7: The Partnering Revolution in Institutional Change . . . . .</b>                   | <b>1.81</b> |
| Partnering—One Possible Answer. . . . .   | 1.81        |
| Maximizing Unique Abilities and Leveraging Resources . . . . .                                  | 1.83        |
| The Courage to Act . . . . .  | 1.84        |
| Acting to Fill a Need. . . . .  | 1.84        |
| The Shadow Side of Partnerships . . . . .   | 1.85        |
| The Boston/Mellon Consortium. . . . .   | 1.86        |
| Trust—The Universally Agreed Key to Partnering Success . . . . .                                | 1.89        |
| Building a Climate of Trust. . . . .  | 1.89        |
| Implications for Change Management and Partnering . . . . .                                     | 1.90        |
| The Remarkable Five Colleges Consortium . . . . .   | 1.92        |
| Creating a Partnership Diagnostic. . . . .  | 1.93        |
| References. . . . .   | 1.96        |
| Suggested Reading . . . . .   | 1.96        |
| <b>Section 8: Deep Lessons About Change in Higher Education: A Summary. . . . .</b>             | <b>1.97</b> |

*PART 2: INTENTIONAL DESIGN*

|   |              |
|---|--------------|
| Introduction . . . . .  | 2.1          |
| <b>Section 1: Data Gathering and Diagnosis . . . . .</b>  | <b>2.7</b>   |
| Interview Design . . . . .  | 2.9          |
| The Carousel Design . . . . .   | 2.15         |
| Engaged Interviews for Leaders . . . . .  | 2.23         |
| Customer/Stakeholder Feedback . . . . .   | 2.29         |
| <b>Section 2: Communication . . . . .</b>   | <b>2.35</b>  |
| Developing a Communication Plan . . . . .   | 2.37         |
| Change Updates . . . . .  | 2.47         |
| Rumor Mill . . . . .  | 2.51         |
| Senior Management Meeting . . . . .   | 2.55         |
| <b>Section 3: Team/Group Effectiveness . . . . .</b>  | <b>2.59</b>  |
| Establishing Criteria for Chairpersons and Group Leaders . . . . .  | 2.61         |
| Creating Effective Team Ground Rules . . . . .  | 2.65         |
| Bringing Two Working Groups Together . . . . .  | 2.71         |
| Transition Design . . . . .   | 2.75         |
| <b>Section 4: Learning and Leverage . . . . .</b>   | <b>2.81</b>  |
| Future Timeline: Horizon Thinking . . . . .   | 2.83         |
| Lessons Learned . . . . .   | 2.87         |
| Rotating Experts . . . . .  | 2.93         |
| Jigsaw Design . . . . .   | 2.99         |
| <b>Section 5: Problem Solving . . . . .</b>   | <b>2.105</b> |
| Distributed Problem Solving . . . . .   | 2.107        |
| Adapted Fishbowl . . . . .  | 2.111        |
| Organized Brainstorming . . . . .   | 2.117        |
| Group Problem Solving . . . . .   | 2.123        |
| <b>Section 6: The Change Leader's Toolkit . . . . .</b>   | <b>2.131</b> |
| Constructive Feedback . . . . .   | 2.133        |
| Las Vegas Voting . . . . .  | 2.137        |
| Mindmapping . . . . .   | 2.141        |
| Nominal Group Technique . . . . .   | 2.145        |
| Self-Managed Groups . . . . .   | 2.149        |
| Self-Selection . . . . .  | 2.151        |
| Parking Lot . . . . .   | 2.153        |
| <b>Appendix: The Role of the Leader Facilitator When Planning and<br/>    Implementing a Strategic Design . . . . .</b> | <b>2.155</b> |



# FOREWORD

This book is written for campus leaders who are responsible for reshaping how things are done. It is an essential tool for both business/financial administrators and academic administrators such as provosts, deans, or department chairs.

Colleges and universities have been essential elements of the social and economic vitality of this nation from the beginning. That role has become even more critical as the economy and society continues to shift to a knowledge-based economy and global society linked by 24/7 instant communications.

However, future success of colleges and universities is not guaranteed. Numerous aspects of administration and academics need to change. The last 10 years have seen a lot of change; the future is more change at a faster pace. Whether driven by new system installations or curriculum modification, those in positions of leadership on campus must have skills to successfully move the whole or parts of institutions to new states of effectiveness.

Patrick Sanaghan and Rod Napier have written a book that provides guidance to all who must lead campuses to new levels of performance within an environment resistant to change. Based on more than 20 years of successful engagement of consulting on many campuses, they bring their skills of group facilitation and organizational performance improvement to this important book.

The guidance and insights found in Part 1 are important documentation that significant organizational improvement can be achieved on campuses of all types and size. Part 2 is even more important to the campus administrative leader who wants to become a knowledgeable and skilled change agent. The “design” of effective group interactions, whether for gathering data or selling an outcome, is a knowledge base all leaders should have.

Jay Morley  
NACUBO President

# ACKNOWLEDGMENTS

Our personal experience in writing this book has been enriched time and time again by the opportunities to talk at length with thoughtful professional educators from an extraordinary range of colleges and universities. Their dedication to engage in best practices and to experiment with new management strategies in order to strengthen their institutions has provided fertile ground for this endeavor. We personally thank them for their time, their many ideas, and their willingness to continue being creative managers and educators.

These exceptional leaders include Roxanne Bahar Hewartson of Cornell University, Kent John Chabotar of Bowdoin College, Hal Craft of Cornell University, Dennis Dougherty of University of Southern California, Susanne Dumbleton of DePaul University, Keith C. Finan of Williams College, Geoffery Gamble of Montana State University, Gina Kranitz of Paradise Valley Community College, Ronald Liebowitz of Middlebury College, Rebecca Martin of The University of Vermont, Rich McDaniel of Cornell University, Walter McCarthy of The College of New Rochelle, Helen Oellette of Williams College, John Palmucci of Loyola College in Maryland, Gregory S. Prince of Hampshire College, Sister Francis Rafferty of The College of St. Elizabeth, Father Nicholas S. Rashford of Saint Joseph's University, William S. Reed of Wellesley College, Minnis E. Ridenour of Virginia Polytechnic Institute & State University, Eugene Sunshine of Northwestern University, and Robert L. Woodbury of University of Southern Maine.

We are also grateful to the reviewers of this book for challenging us and for affirming our work. The comments of John Palmucci of Loyola College in Maryland, Mary Jo Maydew of Mount Holyoke College, Jerry Schaffer, retired from University of Florida, and Jay Morley of NACUBO are greatly appreciated. Donna Klinger has been a positive and tenacious support over the long period of development of our manuscript. For this we are highly appreciative.

Patrick Sanaghan would also like to acknowledge James "Jim" Frederick Seitz, who was his best friend and a true collaborator, as well as Kim Field, David Baum, and the S.A.P. Implementation Team: Alcee, Ken, Tom, Dan, Ashim, Lena, and Michael.

# PREFACE (HOW TO USE THIS BOOK)

This book has two parts. Part 1 explores the process of change at colleges and universities, focusing on some of the underlying factors and issues that have proven vital to long-term success. It provides the foundation for an intentional leader, one who pays attention to the essential process and task aspects of a change initiative, or even of a meeting.

Part 2 provides specific strategies to enhance collaborative change in a variety of settings. We call these collaborative activities designs, and for each design we give you, the change leader, detailed instructions in the creative process of planning and facilitating a set of activities that move a group successfully toward conscious goals.

In Part 1, the first section discusses collaboration, which is key to a successful change process at any college or university. To be optimally successful, collaboration needs to be part of the institution's way of doing business on a daily basis. Section 1 gives examples of successful collaborations and guides for testing the level of collaboration at your institution.

Section 2 focuses on creating an institutional culture that supports and fosters change. The chapter poses a variety of questions to help frame the nature of change and to help you assess your organization's readiness for change. Change management is about mobilizing available resources and thinking beyond the norm so that change is possible. Section 3 discusses developing and using a shared vision of the future as a centerpiece of the change process.

Section 4 focuses on leadership. Committed leadership is important, but it is not enough. System change processes need intentional leaders, that is, superb strategists with tough-minded skills and specific know-how to orchestrate successful collaborations among critical stakeholders. Section 5 provides advice on building trust among colleagues, stakeholders, and others in the change process; it includes a trust survey to help assess the level of trust in any organization about to begin a change initiative.

Section 6 discusses engaging the various constituencies—faculty, administration, students, parents, alumni, and others—who have a stake in the change process for their college or university. The partnerships described in Section 7 can be established between different colleges and universities or between organizational units in the same institution. In either case, they provide the partners with benefits or cost savings they could not enjoy separately. This chapter includes a set of diagnostic questions to help you determine if a partnership is feasible. Section 8 wraps up Part 1 by sharing a number of deep lessons that we have learned over many years of consulting about change in higher education.

The designs in Part 2 of the book provide detailed instructions for collaborative activities for various groups, large and small. Section 1 includes designs for data gathering and diagnosis—soliciting information from people in engaging and exciting ways. The designs in Section 2 focus on communication, including ways to be sure that stakeholders are well informed and that they are heard, as well.

Section 3 has designs to organize teams and groups in ways that maximize people's skills and

talents. Section 4 presents designs to help leaders and groups learn from the past, look to the future, and leverage people's time in the present.

Section 5 provides different ways to share ideas, develop creative thinking skills, and craft productive solutions to problems. Finally, Section 6 provides a collection of tools and techniques that every change leader can use to complement any of the designs in this book or to enhance the effectiveness of everyday meetings.

INTENTIONAL DESIGN AND  
THE PROCESS OF CHANGE

*Strategies for Successful Change*

**PART I: THE PROCESS OF CHANGE**

by Rod Napier with Patrick Sanaghan

# COLLABORATION: THE KEY TO SUCCESSFUL CHANGE MANAGEMENT

---

*Collaboration—From the Latin word collaborare—meaning to work together in the achievement of an intellectual endeavor.*

In this day and age, most will agree that collaboration is the key to initiating virtually any kind of organizational change. As we shall see, higher education is rooted in a tradition of collegiality, which implies both collaboration and behaving in a civil manner among professional peers pursuing truth and understanding. Collaboration, quite simply, makes sense.

## **Breaking Tradition—Living One’s Values**

Problems in the process of change most often arise when those who must eventually live with the needed changes fail to embrace them because of inadequate training, education, involvement, or ownership of the proposed solution itself. Overcoming resistance, as we shall see, results largely from engaging those involved in activities such as:

- Assessing the need for the proposed change
- Being able to influence the change process itself
- Identifying and evaluating the available choices
- Being privy to current information or being “kept in the loop”
- Assessing best practices and benchmarking other organizations
- Strategizing how to implement the necessary strategies of change
- Monitoring and evaluating the outcomes of the various change initiatives.

This book is dedicated to the underlying assumption that collaboration is good at the diagnostic level, at the idea generation level, and at the implementation level. The variety of strategically designed activities highlighted in the second half of this volume provide proven ways of successfully engaging widely differing types of groups participating in the complexities of the change process itself. We also realize, however, that in order for people to embrace the implications of a collaborative approach, it is essential that the institution models collaboration on a daily basis over time. Collaboration is not something to be thrown on the process as a stand-alone gimmick to simply get people involved and, hopefully, to create instant credibility. To be optimally successful, collaboration needs to be part of how business is done, day after day, month after month. People believe what they experience.

The following are examples of how different types of higher education institutions have mirrored

collaboration over the years. Thus, when the need for dramatic change does occur, it feels familiar, consistent with the institutional values and the collegial way important problems are solved and new initiatives are approached. When leaders rush to get people involved at the time of the change initiative itself, skeptics and supporters alike feel that the process is artificial, a kind of strategic manipulation in the name of openness and participation. In most cases, the success of the collaborative methodologies themselves will be dependent on the level of trust that exists and the degree to which collaborative methods are used in less demanding and stressful times.

## The Roots of Collaboration—From Certitude to Pragmatism

The United States is a country of absolutes and passionate commitments to grand ideas such as freedom of speech, democracy, free enterprise, and equal rights. However, a fundamental shift occurred in how Americans thought about and discussed these and similar truths after the Civil War (Menard 2001). Menard provides an extraordinarily lucid and interesting account of this period in American history and its implications for how people thought and dealt with these challenging events. Such thinking continues to shape how we approach problems and, eventually, create their solutions. Pragmatism is at the root of the current increasing interest in collaboration and is founded on the belief that without compromise lasting solutions cannot be the result.

The brutality and bloodshed of our own countrymen at the hands of each other resulted in the realization that certitude and absolutism rarely prove anything other than that their presence often accelerates differences—eventually to the point of violence. Jack Gibb in his classic 1968 paper identified six factors guaranteed to engender defensiveness among individuals (Gibb 1961). Of the six, certainty, judgment or criticism, superiority, and control most often arise in situations in which absolutes are being argued. (The other two factors—neutrality and strategy—create defensiveness, but they do not have the same visceral effect as the other four noted here.)

It was this awareness—after being wounded three times and watching his best friends die—that changed the great jurist, Oliver Wendell Holmes, Jr. from an absolutist (a unionist in favor of The War) to someone who would explore every alternative and investigate every side of an argument for new and creative solutions. He, John Dewey, and William James helped give birth to a more pragmatic view of thinking, moving away from certitude toward compromise and negotiations as a means of influencing differences. In their eyes, virtually any absolute could eventually give way to another “truth” at another time and in another circumstance. Such relativism demands polling all points of view, openness to alternative thinking, and a position that holds every idea as valuable. Such an attitude tends to promote compromise, reconciliation, and openness to further dialogue. It supports collaboration and the search for what is possible rather than what is absolutely right or correct.

Some would say that in addition to rapid change driving us toward greater relativism, the Vietnam War moved us as a nation from a time of greater absolutism toward one in which there was a greater interest in pragmatism. At some level, the absolutes did not work. For those raised and bred in that period of our country’s discontent, a solution has been to move less rapidly to the brink of absolutism and the tyranny of an idea and more toward rapprochement and greater cooperation.

## Pragmatics and Change

In the world of rapid change, absolutes abound. The all too predictable barriers and resistances to such change have resulted in a period in which we have had to reconsider how to shift from intransigent positions toward compromise. As we move from absolutes to common ground, organizations advance by engaging in consensus building and other strategies designed to involve both large and small groups of participants in workable solutions.

In the past 30 years, the idea of “getting all of the voices in the room” to explore alternatives and their consequences has resulted in new approaches for building solutions. At one time, this would have only been discussed behind closed doors. But, today at the core is the belief that without real participation and greater transparency of ideas and information, most change efforts will be undermined and many will be rendered useless.

However, even in the honest effort to become more transparent and to engage relevant constituencies in the problem solving process, less than satisfactory results are often the result. For example, “consensus” is one of the handles of new management that is blithely used—and abused—in the leader’s arsenal of collaborative management practices. Later, we will discuss why it so often fails and why it tends to generate “false consensus” rather than something that those involved can truly live with. But, for now, we will provide examples of collaboration at work—and we mean work.

What follows are examples from a diverse group of colleges and universities who have intentionally attempted to create a foundation of trust upon which a climate supporting true collaboration could be built. While the methods differ dramatically, the intention in each instance is to broaden the base of participation among those who will be influenced by the actions to be taken. As their involvement increases, so will the trust in the change process itself and the stake of those participating in the eventual initiatives.

## Middlebury College and the Building of “True” Consensus

One senior manager doubted that the historical timing of the situation could have been better. By anyone’s standards, the changes that occurred on this small Vermont campus in the eight years prior to the millennium were astounding. In 1992, the campus had emerged from an extended period of stability—some would say complacency. A long serving and respected president had left, to be replaced by a person who only lasted one year. The result was the choice of an “acting” president from among the faculty ranks—someone who understood the traditions and culture of the institution and, apparently, understood what it would take to mobilize change on a campus that was reluctant to question its past and reassess its future.

In the early years of this period of reassessment and change, the focus was on two critical needs. The first was to explore the guiding principles of the institution, to get the various constituency groups on the same page in relation to what had made Middlebury unique and where it needed to move in the future. On a campus where there is, among many, an unabashed love for the institution, the very act of raising such hard questions was threatening. Yet, over time, faculty, staff, and students revisited all of their assumptions about education and carved out the guiding principles that would drive the second major event—a boldly framed 10-year plan. The plan was sufficiently broad, so that it could focus the attention of the campus, yet not so narrow that it would create divisions even before the necessary re-education of its many stakeholders could occur.



Having listened for months to broad-ranging discussions of values and educational purposes, the president and a few key leaders forged a compelling vision of the future that identified needs more than solutions. It left the larger community with the responsibility to define the specifics and struggle with the details that would or would not change the critical aspects of institutional life. It was the positive outcome of these discussions—the feeling of being truly heard—that provided the trust necessary to move ahead into the more substantive areas of change.

### ***To Grow or Not to Grow***

One of the sacred cows of most small colleges is the belief that growth dilutes quality and, in the process, will pollute the unique learning environment that only small size can provide. To many at Middlebury, the thought of 350 new students being merged into the picturesque campus of 2,000, as proposed in the plan, was not only repugnant, but flew in the face of a vocal minority who actually wanted to reduce the current size.

### ***A True Understanding of Consensus***

What followed was an extraordinary example of living the values of real consensus—the moving of a community toward agreements drawn from thorough discussion; education combined with a demonstrated respect for ideas and new ways of thinking. The college's struggle toward consensus was predicated on the view that individuals are in search of what is best for the institution, rather than the search for justification of individual positions.

The truth is that consensus rarely works, especially among a large number of highly differentiated stakeholders—in this case, faculty, students, administrators, and alumni. Could the campus live its principles, or would the process deteriorate, as is so often the case, into an exhausting struggle, finally resulting in decision by attrition or, worse yet, a stalemate? The positions of the various groups were carefully heard and the benefits of growth weighed against the cost of the status quo or the benefits of reducing the current size.

The effort to build consensus became a learning experience for those involved and demonstrated the meaning of civility and collegiality. People let go of their rigidly held beliefs and demonstrated a willingness to change their long and fervently held positions. This stimulated trust in the process and each other. As individuals put aside their personal interests in favor of what appeared to be best for the college, the community drew together. During the college-wide debate, the faculty vote shifted dramatically until well over 80 percent of the stakeholders supported the notion of growth.

### ***The Next, Even Bigger Test***

An even greater test awaited the community in its desire to build a stronger place for student education. In 1997, the leadership proposed that residential life change from an integrated model to one of small, differentiated learning communities, modeled after Yale and similar institutions. This issue could have blown apart a less committed educational community. There was a clear understanding that any eventual decision of such magnitude would need the support of students, faculty, and staff. The debate lasted 15 months. While it was not pretty, the dedication to learn about the issues remained paramount. Mixed task forces visited campuses utilizing similar approaches. Best practices were sought and experts' advice solicited. In the end, large number of students, faculty, and

staff saw the “sense” of such learning communities and each group, independently, registered support of the proposition at a level of greater than 80 percent.

Would such an elaborate consensus-building process work in higher education institutions where faculty may be less committed to the values and culture of their institution? When time and/or information are lacking, a consensus process in the name of collegiality can be divisive and futile. Add to this the reality that many institutions are conflict averse and the alignment found here does not occur. Middlebury’s case shows that with patience, experience, and good information—along with a desire to put the interest of the institution ahead of individual needs—the result can be powerful change leading toward an even more cohesive community.

## Why Consensus Usually Fails

Building consensus in a large group can be a time-consuming and often trying process. It is our experience, even when working with small groups or teams, that the consensus-building process can be fraught with problems. How many times has a well-intentioned leader said, “Anyone disagree (pause)? Well, I guess we have consensus.” The result is a “false consensus” in which the unspoken disagreements are submerged, only to arise later at the point of implementation. Long gone will be the understanding that the failure to gain true agreement months before would cost the institution heavily later. The following are four demands of an effective consensus process. If they are absent, failure is likely to occur.

- **First, discussions cannot be rushed.** Consensus demands that all voices are heard. However, in an adversarial climate participants are sometimes unwilling to give up the floor so others can be heard. In the rare situation, when collegiality is truly working, there is a search for truth, for the answer or idea that will lead to the “best” solution possible. In a world where everyone is pressed, where time, for some, is the most precious of commodities, there is often impatience—even intolerance for a process that can demand so much from its participants.
- **Second, consensus requires aggressive seeking of all information essential to the decision.** This information gathering necessitates a willingness for opponents to embrace ideas that may be foreign to their position, to weigh them, and, then, to decide their value. In the usual win-lose climate created by the dialectic at many university and colleges, the goal is not to access all relevant information, but, rather, to discount any information that is not supportive of one’s position. Instead of sincerely supporting a discussion of ideas, lines are drawn and combat ensues. As individuals witness the goal of winning overriding the goals that are best for the institution, the battle often results in a loss of trust. This can drive an open discussion of ideas into a win/lose spiral where the common ground so essential in consensus building is thrown out.
- **The third essential ingredient in consensus building is the ability of those participating to conflict—often with passion—while maintaining respect for their colleagues and their positions.** The ability to have “the good fight” in a civil manner, over time, builds respect. Middlebury demonstrates this point. Witnessing people argue with deep conviction and emotions and, then, alter their position to incorporate new information, is at the heart of building the kind of trust essential to consensus building.
- **A final component is building trust around issues rather than egos and personalities.** While egos and politics are always present, the commitment to search out what is best for the institution, as was done at Middlebury, is difficult to achieve.

The good news is that when a group trusts the intentions of its members and has a history of witnessing compromise and changing minds because of creative solutions, consensus building can be an efficient and highly effective use of a group's time. In large groups, where relations are more tenuous, the work, inevitably, is more difficult and the commitments to time and patience must be greater.

## **Paradise Valley Community College—Values at the Heart of All Collaboration**

When queried about what makes Paradise Valley Community College such a strong example of an institution that prizes collaboration, the president, Gina Kranitz, answered unequivocally, “It is our absolute commitment to an understandable and completely supported core value.” The result is an energized, focused campus where “learning” is the centerpiece. Not very original you say? Not so. By focusing on learning as core to everything it does, to virtually all institutional decisions, the campus has experienced a galvanizing of ideas that has brought all constituents together around something that can be important to all of them. “Does what we do foster learning?” is the central question at every budget meeting, every long-range planning meeting, every curriculum development meeting, and whenever the joint task force on faculty and staff development convenes. Months of open debate among students, faculty, and staff led to the conclusion that teaching, while a necessary skill, was rightly subsumed under the notion of “learning.” But, it was agreed that learning is the more important contextual issue representing something that touches virtually everything done at the college. The decision to shift the focus from teaching to learning has the potential of influencing every member of the campus community. Once understood and internalized, it offered a starting point for nearly every discussion. It formed the basis of engagement and a reason for collaboration. Even more important, it provides a context for problem solving and decision making.

### ***Gaining Purpose***

Bringing diverse constituencies together to discuss anything can be risky, especially when differences in education, experience, and status have led to the failure of so many efforts. In many higher education institutions, core values can receive short shrift, with the untested assumptions that they are understood or the belief that they are window-dressing and only good for a place on a placard along with equally non-functional statements of mission and vision.

Let's take an example of how “learning” as the core value is a filter at Paradise Valley Community College and acts as a catalyst for real collaboration. One of the hot topics has been that of dual enrollment. The college was stretched to its capacity providing evening and part-time education to students looking for a way into higher education or to specific career opportunities. Leaders feared that by spreading their resources even more thinly through the support of a parallel system of courses in the afternoon, they would diminish the quality of learning for which they were justly proud. A community meeting involving all of the interested parties was convened to sort through the issues and get all of the voices into the room.

The result was that faculty were convinced that they needed to address a real need and could not easily deny this critical aspect of the college's mission.

Listening to student and community stakeholders, who they seldom had the opportunity to hear, had an important impact on the faculty's willingness to extend their thinking and, ultimately, their resources. While budget considerations were important, they kept returning to their core purpose and what was most critical—providing the learning opportunities to their key constituents.

A pilot project was successfully launched. The eventual outcome was an afternoon college where students could matriculate on a full-time basis. Motivated by the need, the faculty solved the problem with a maximum input from those who would utilize the new service. In the process they demonstrated a part of their core learning value in that they were willing to learn from the experience of the pilot study, using it as the building block for the later, more fully evolved program.

### **Focus, Focus, Focus**

Focusing on a single predominant value has allowed the college to create a better relationship:

- With the larger community who felt the commitment of the college toward meeting their needs. The result has been increased enrollment and signs of increased interest and loyalty toward the college.
- With the staff of the college itself. A joint task force of staff and faculty has actually pooled training and development monies, which for many represents a demonstrable way of breaking down natural barriers between these groups.
- Among the faculty and administrators who, through regular dialogue in relation to the common issues of learning, has forged a greater respect among themselves and an increased sense of community.
- With students, who feel they have a real voice in the destiny of “their” college.

## **Loyola College of Maryland: Open Books, Open Discussions**

John Palmucci, the chief financial officer (CFO) of Loyola College of Maryland said it with a certainty that left little doubt about his commitment to where he believed the truth lies: “The budget is the key to all trust.” And that is where collaboration begins. You can have all the workshops in collaboration, create a mutual vision, have a compelling mission, train people in how to conduct community dialogue. But, the CFO believes it is all dependent on the willingness to be absolutely candid about the budget—what drives it and the sacrifices that need to be made if the institution is to deliver on its agreed-upon goals. And “agree” is the operative word. It is not just knowing what the budget is and being forthcoming about the financials. It is about involving the various stakeholders in determining where the monies go, the priorities, and what can and cannot be accomplished with the limited monies available. Palmucci added, “The values and overall mission of the institution must be reflected in the budget, and the priorities of the institution are the result of serious discussions among all of the key constituents, who must believe that they can influence the process.”

### **Gone Are Smoke Filled Rooms**

It is easy to give the appearance of collaboration. But, it is the realization by the important players that they have a powerful voice in the critical financial decisions of the college that makes collaboration real. It is the shared sense of accountability to students, parents, alumni, and each other

that drives collaboration and makes it real. At Loyola of Maryland, there is a belief that leaders in the college cannot be allowed to disengage from playing a vital role and making a substantial contribution to the running of the institution. Thus, for example, where some colleges allow faculty to turn over their responsibilities to a small band of politically active individuals, this is not acceptable at Loyola. Loyola expects employees to lend their voices to the important decisions of the college. While one cannot force participation, the opportunities are clear, as are the expectations. The expectation is that, perhaps, 20 percent of the faculty will choose not to participate in the governance of the college. It is important to seek the voices of the 50 percent who often sit on the fence so that the quality of institutional problem solving is recognized as a natural and compelling part of their role. Creating the opportunities for this kind of collaboration is seen as an essential part of the role of administration and results in the kind of long-standing loyalty characteristic of Loyola.

### ***Strategic Planning—Making Collaboration Happen***

Fully 65 percent of the faculty is involved rather directly with the strategic planning process either within seven primary areas of concern deemed critical to the institution or in some other closely related area of budgetary oversight or task force involvement. Unless such participation is recognized as meaningful and useful to the functioning of the college, nothing will hold the interest of those participating. Again, the administration's role is to help recruit good people and to be certain that their participation is worth their while and is valued by the college.

### ***The Game Has Changed***

Changes in the informal contract between employees and the college has had a positive influence on building a greater sense of community through collaboration at all levels. While changing financial realities have demanded building a new relationship, in the eyes of many, the changes have spawned new levels of creativity and personal contribution. The following is a comparison between the old and new psychological contract.

| <i>Old Contract</i>              | <i>New Contract</i>                               |
|----------------------------------|---|
| 1. Work Hard                     | 1. Model our agreed upon values                   |
| 2. Do as you're told             | 2. We provide work                                |
| 3. Expect life-long employment   | 3. Develop your skills and potential              |
| 4. Provide a pay raise each year | 4. Rewards will result from quality contributions |

The result is that there is a strategic partnership between the employees and the college that is interdependent and based on good will and honest communication at all levels. Just as there is candor and openness about the state of the college and its direction, so too, there is openness about individual performance, whether the employee is on a tenure track or not. Performance is increasingly the measure of success whether at the intellectual/academic level or within the realm of managing the affairs of the college. Since all are dependent on the good works of others, the contract is one that is open and adjustable. The essence of the collaborative process is centered in honesty and openness. Collaboration at one level becomes synergistic and influences how work is conducted at other levels. Admittedly, the approach is a work in progress, and leaders, faculty, and staff are learning how to do it well together.

### **Montana State—The Principle Holds**

One might imagine that a small college like Loyola and a large, complex system (four separate colleges and extraordinarily diverse constituencies) like Montana State University might have little in common when it comes to building trust and an atmosphere of openness and collaboration. Consider the internal and external politics that are at play in the larger state institution, the difficulty of working with a legislature, and the vested interests of each unique campus. Nevertheless, the lessons learned in one can readily be applied to the other. What was built patiently over a decade at Loyola is attempting to be built by President Geoffery Gamble at Montana State in a short time. He is in a hurry to build a foundation of trust and broad-based participation where information is shared openly and backroom politics are minimized.

A critical attitude voiced clearly is, “By keeping financial issues transparent, it keeps people honest and, at the same time, more honorable. “Herein lies one of the central realities of collaboration. If there is limited money, then priorities must be driven by institutional needs and these, in turn, must be negotiated. Such difficult realities provide a perfect opportunity for building a climate of trust through collaborative problem solving and actions. It is those who represent both their individual constituencies as well as the interests of the larger system who must deal in an increasingly open, honest, and, ultimately, mutually satisfying manner. Such conditions offer collaboration at its most difficult and necessary level. If, during the process, individual self interests and maneuvering are handled with candor and directness by the group involved and decisions are made based on agreed upon criteria, trust and respect will be strengthened.

This president’s most valuable tool has been the use of public meetings and the use of a public Web site to communicate the strategic plan and its progress as well as the results of budget hearings. Almost instantly, the process reduced the amount of behind-the-scenes manipulation as individuals had to stand behind their public statements. The truth acted as a vehicle for leveling the playing field and reducing the political gamesmanship traditionally a part of the process. The same openness was portrayed with the legislature where open meetings, shared financial data, and a transparent presentation of the current state of the university resulted in a more sympathetic and supportive environment instead of what had become an adversarial coming together of antagonists.

### **Virginia Tech—Everything Begins at the Top**

In many colleges and universities, there is a well-defined hierarchy from the top of the system down. Defined roles reflect a status that can shape both how people are treated as well as the respect that they engender. Predictably, in collegial communities, such a stratified system would be heartily denied since egalitarianism is a spoken value. Unfortunately, the reality of a highly differentiated system is apparent to many every day. Virginia Tech has attempted to create a greater sense of equality across the system, beginning at the top. The president, chief financial officer, and chief education officer have worked diligently to establish parity among themselves with the hope that it would be a springboard for greater collaboration at all other levels as a result of the subsequent clarification of roles and at the same time, the minimizing of status differences. It has worked.

### ***The First Step—Defining Roles, Authority, and Responsibilities***

Presidents often assume that since the buck stops at the top, authority is theirs to choose. The result can be an inclination to dip unceremoniously into the territory of any direct report, whether it be human resources, development, curriculum, or finance. The incursion into other's areas of responsibility and authority can undermine trust, respect, and, most certainly, the credibility of those influenced. Since we have seen, time and again, that effective collaboration begins with establishing trust and respect, it would only be natural for those witnessing a transgression to model the same behavior to others reporting to them. Such is the nature of both formal and informal hierarchies.

At Virginia Tech, the three key leaders have struggled, over years, to understand their respective roles and to establish the sense of parity so that each has the ability to concentrate resources on what is his or hers, without having to worry about that of the others. It would be easy to dismiss this focus on role and authority differentiation as natural and unnecessary. If this is the case, the ability of the organization to collaborate successfully may even be jeopardized. But, what makes this well-oiled team successful is the structure, discipline, and diligence used to institutionalize these carefully defined roles, their individual authority, and their relationship to the collaborative process. Other leaders in the organization know what to expect when it comes to management or planning or the implementation of other strategic initiatives. There is never the sense of playing one of the leaders off one another, since they meet so frequently to discuss issues that influence the larger system. They use each other as wise counsel, realizing that any decision they make will influence the others. To do this opens them to hard questions and feedback, as well as alternative ways of thinking. The attitude they modeled is expected at all levels of the university.

### ***Structure, Structure, Structure***

By keeping communications totally open among themselves and working from the assumption of a "transparent" organization, the three leaders meet every Monday at 7:30 a.m. to discuss critical operational issues. This is followed by an executive staff meeting with the vice presidents and later a monthly deans' meeting. A monthly meeting with the deans and vice presidents where the focus is on strategic planning and other system initiatives tends to act as an accountability session. Are they, as leaders of the university, doing what they say, and how can they, working together, help to move things forward? While this sequence of meetings does not sound extraordinary, the regularity of the sessions, the involvement of the top leaders, and the proactive nature of the sessions keeps it from merely being a continuous "show and tell."

The strategic planning process, while time driven, represents an ongoing review of needed changes, actions taken, and new initiatives. It reflects the move toward strategic planning as a process rather than a one-time event that occurs in many higher education institutions. Broad based diagnostic and problem solving teams that relate to selected major areas of university life are reviewed on a monthly basis for two to three hours. The predictability of such collaborative group meetings and the attendant hard questions and scrutiny do not allow complacency or inattention to bog down strategic planning as is so often the case in other organizations.

Prior to presenting the findings of the strategic plan to the board, the three key leaders visit the home or office of each of the board members to review the plan, their concerns, the

implications across each of their offices, and how each is working in support of the others. The common front is crucial to the team and its credibility to the board as they consider the pressing needs of the institution.

### **The Lack of an Academic/Administration Division**

Organizationally, what is known is that:

- The three key leaders trust, respect, and depend on each other.
- Information is free flowing among them.
- The chief financial officer works in service of the chief education officer.
- There is a non-adversarial relationship at the top that builds trust and cooperation and, ultimately, increases the desire for others to collaborate when the opportunities arise.
- Modeling trust and cooperation at the top has fostered faculty respect and the expectation to be more collaborative across the natural silos that occur. This was best reflected in 1990, when the state summarily cut \$30 million from the budget. The Budget and Planning Committee, including representatives of both the students and the faculty, made the necessary cuts with a minimum of rancor.

While there are always problems, the consistency of the leadership team's relationship and the resulting stability over the years has gained the respect of the faculty who value the integrity of the management process.

## **The Unique Relationship between Collegiality and Collaboration**

Collegiality itself is one of those core ideas that is a part of virtually every university or college and, more recently, has been used to describe the climate of many campuses. In its ideal form, its definition has many common elements. In practice, however, collegiality varies from idealistic to dysfunctional, from useful to hypocritical. It can stand beside or opposite the very notion of collaboration depending on the situation. The following are descriptions of collegiality provided by nearly 20 university and college presidents, senior vice presidents, or chief financial officers representing a wide range of higher education institutions.

Some of the ideas as well as the specific examples used in this chapter were drawn from these individuals who had been systematically identified as people who were both highly skilled and successful at using collaborative methods within their institutions. In these representative definitions, collaboration as we have used it throughout the chapter is implied and appears central to any collegial process. The definitions of collegiality are:

**Definition #1.** An academic environment where all parties agree to engage in a mutual dialogue as a means of resolving differences and in the creation of solutions driven by what is best for the institution.

**Definition #2.** The notion that power and authority are vested equally among participants involved in meaningful dialogue. The implication is that good ideas will win out over agreements based on intellectual intimidation and the threat of later negative consequences.

**Definition #3.** A community of scholars who seek the truth through honest dialogue in



order to extend their knowledge and understanding. Through this involvement they will be able to solve problems and create effective solutions that will improve the functioning of the institution.

When asked to describe collegiality at their own institution, two-thirds of those queried agreed that there was a long distance between their definition of the ideal they described and what actually occurs. When asked why, the following responses were generated.

1. Academic communities are often established in relation to a competitive hierarchy among individuals, departments, and smaller units. Success is dependent on the good will and acknowledgement of their peers. However, the mistrust generated in such a competitive climate can result in a lack of honest and open communications.
2. If a point is being argued and an individual does not have the knowledge or skill to win the day, he or she may personalize the issue and attempt to outlast the opponent. Knowing the issue is now personal, the other party may acquiesce, thus reinforcing an argumentative environment.
3. Political realities can render the supposed open discussion moot.
4. Personal intimidation and the fear of reprisals can disarm the process as personal power and personalities take over rationality and clear thinking.
5. Emotional arguments and personal interests can shut down the discussion of new ideas.
6. Personal agendas rather than the good of the institution can rule the day, especially in highly decentralized departmental structures.
7. Because debate is often in terms of absolutes, expressed differences often accelerate conflict.
8. Hidden agendas often waylay the search for truth and the expression of knowledge that will not be confronted in a climate that is ostensibly civil and buttressed by an aversion for conflict.
9. When dealing “as a faculty” there is often an “us” vs. “them” attitude toward others including the administration and board. Instead of seeking collaboration, those looking to compromise may be seen as collaborators with the enemy.
10. In an environment in which success is measured by academic achievements, many may opt out of the governance process. Eventually, internal politics and power are turned over to the few inclined to take the time to lead, thus further removing faculty from participation in issues critical to the organization.
11. Tenure, with its benefits to faculty, can be a detriment to change because of the potential for intransigence and resistance without consequences.

Thus, the distance between the cup of collegiality and the lip of its application can be great. These issues are not suggested to discredit faculty groups. They are intended to detail why the development of a culture of true collaboration is difficult. One of those interviewed in support of this chapter acknowledged that his institution was highly collegial and blessed with a group that lived by the rules of true civility and respect and did not simply give lip service to politeness. When asked how this faculty was able to overcome the many built-in traps that cultivate adversarial attitudes both within and outside of the faculty, he said,

The chair of the faculty senate is a marvelous gentleman of the ‘old school’ who believes with all his heart that we should conduct ourselves with dignity and respect. He believes his role is to be sure that this occurs. As a result, politics are minimized, personal attacks don’t

occur, all voices get heard, people are prepared, and we follow procedures and policies that keep us honest. It's that simple. When he leaves, I'm not sure what will happen.

### **Collaboration and Collegiality**

Clearly, it is not one or the other. Faculty represents the drivers of educational change and reform. Without their support and engagement in the process of healthy change, it will not occur. Yet, their own past experiences and internal structures can isolate them and handicap any change process. The examples and the strategies described in this book are designed to support the ideals of collegiality. At the same time, they emphasize how new approaches to collaboration can act synergistically to build trust, open communications, and establish rich dialogue among various parties.

As the examples revealed, there are many ways that skilled leaders have been able to establish climates that support collaboration on their campuses. Some have been cultivated over a decade or more, while others have been more immediate in their application and success.

### **Questions Testing the Principles Underlying Successful Collaboration**

The following questions state some of these principles. They are intended to help you assess the readiness of your own campus for using many of the approaches we provide in Part 2 of this book. Clearly, the list is not meant to be inclusive. Rather, it provides a useful starting place for measuring the readiness of your campus and steps you might wish to consider as you move toward a more collaborative culture.

**1. Do the top leaders of the organization act collaboratively in dealing with one another and in a manner that provides parity in the eyes of the rest of the campus?**

This suggests they share critical decisions, seek council from each other across lines of authority, and communicate as one on many of the issues critical to the institution. The natural division between academic and administrative is rather seamless, with one acting in support of the other.

**2. Is "transparency" as a concept promoted on an institutional level?**

This has more to do with an attitude of disclosure across units, with special regard for how money is allocated (see question 4), how decision-making criteria are established, and how agreements are monitored, and how accountability is maintained.

**3. Are substantive issues delegated to task forces, committees, and councils for problem solving and decision making?**

It is not uncommon for collaboration to be "window-dressing" used more for the sake of appearance than with the intention of providing participants with real authority. Such charades are easily observed and create distrust and disillusionment.

**4. Are financial decisions given over to decision-making groups?**

If you are interested in how much key leaders trust the collaborative process, determine whether "real" decisions and the accompanying accountability exists in relation to the spending of financial resources.

(continued)

**5. Is “consensus,” as a vehicle for decision-making, real or simply a tool to push through quick decisions in a conflict-averse system?**

The test for whether the trust required for effective consensus exists includes these questions:

- a) Is the group committed to take the necessary time to explore the issue?
- b) Does the consensus-building group have the essential knowledge to understand the issue sufficiently so that individuals are not stuck arguing from their own biases?
- c) Are there skills among the group to deal effectively with the inevitable conflicts that serious consensus building requires?

**6. Has the group or community taken the time to develop a set of core values (no more than four or five) that act as a filter for determining what is important to the organization?**

These provide necessary focus for groups attempting to work collaboratively for the good of the community. Similarly, other core values can establish the structure for how people work together and treat each other.

**7. Similarly, is there a clear mission statement clarifying exactly who the organization is—its real place in the education marketplace?**

Again, this provides essential direction for individuals attempting to work collaboratively.

**8. Is there a compelling vision of where the organization is going and where it wants to be in relation to a number of expansive goals?**

Who one is becoming says a great deal about whom one is in the present and acts as a motivator and provides boundaries through which to filter strategic actions and the utilization of available resources.

**9. Does the reward system clearly reward individuals for active participation in the collaborative domain of the organization’s work?**

Let’s face it, only a small percentage of individuals will actively choose to participate in time consuming collaborative processes. Yet, a truly collaborative enterprise demands participation from a deeper pool of individuals who represent many backgrounds and voices.

**10. Are the use of pilot studies and experimental programs encouraged as a means of testing ideas?**

An experimental mentality within an academic organization not only is consistent with the implied values of a “learning organization,” but it also acts to encourage creative, out-of-the-box thinking. Without the pressure of “forever” and the investment of large amounts of money, such opportunities can neutralize large pockets of resistance to change and provide the institution with real choices.

**11. Are there opportunities for interested stakeholders in large and small open meetings to discuss issues critical to the communities?**

Bringing the issues out into the open, it becomes clear where the hidden agendas lie and who is attempting to influence the process with their own interest ahead of the larger system.

**12. Are efforts made to expand the information available to those engaged in the change effort through a systematic review of best practices as well as carefully constructed benchmarking efforts, either within the organization or outside?**

Few of us have the opportunities, in the normal course of things, to be well informed in areas in which we are suddenly expected to be knowledgeable. Stepping outside of our normal areas of expertise can dramatically stimulate a change process.

## References

- Gibb, J. "Defensive Communication," *Journal of Communications* 11, 1961, pp. 141-148.  
Menard, L. *The Metaphysical Club*. New York: Farrar, Straus, Giroux, 2001.

## CREATING A CULTURE OF CHANGE

---

*“The hyper-speed of change today means that given ‘facts’ become obsolete faster— knowledge built on them becomes less durable. To overcome this ‘transience factor,’ new technological and organizational tools are currently being designed to accelerate scientific research and development. Others are intended to speed up the learning process. The metabolism of knowledge is moving faster.”*

—ALVIN TOFFLER

When considering how to initiate necessary change in an organization, there is an inclination to look for similar organizations and utilize the strategies that have been successful. This tendency is natural and even more easily understood when considering change in colleges and universities where there are so many apparent similarities across institutions. The similarities are such that one can easily imagine the introduction of common or previously used approaches to the change process introduced in a quite rational, stepwise, and linear fashion. Inevitably, we find such an approach will fail.

It is not the many similarities that we must worry about. Rather, it is the myriad large as well as subtle differences that give each higher education institution its unique culture—characteristic strengths and limitations—that effect change. Much of this book is about understanding the similarities while honoring and responding to the unique cultural differences that exist within colleges and universities. We believe the first major question is how do college and university leaders develop the most appropriate strategies for change while thoroughly understanding and respecting these differences?

At another level, we are making a critical assumption. It is our belief that many institutions of higher learning are limiting their choices in a rapidly changing world. The second question we ask is how do we help them shape their cultures to become more adaptable and better able to respond to the demands of a rapidly changing educational landscape?

### **Culture: The Unique Personality of an Organization**

A simple definition of culture is the totality of norms, mores, values, and attitudes, which represent a department, college, university, or nation in the eyes of its members. It reflects the stated and unstated rules, which guide the behaviors and sustain the values that are so essential to the identity of

any organized body of human beings. At a work level, the culture defines how decisions are made, problems are solved, and rewards are distributed.

When a decision is made to change how such an organization does its business—manages its affairs—it is only natural to anticipate periods of confusion as people attempt to conform to the new reality or choose to resist these same changes. Any culture today represents the product of a long evolutionary process. Sudden change, whether positive or negative, is predictably unsettling and may be resisted as individuals attempt to hold onto older, more familiar ways.

For this reason, those leading change require a deep understanding of an organization's culture. Understanding can help in the strategizing and planning of any significant change effort. Only by doing so is it possible to account for the potential consequences the change process will have on strongly held norms, values, and expectations. Indeed, it is the inability to anticipate such consequences that often results in the eventual failure of the most well-intentioned and necessary change initiatives.

## A Historical Context

James D. Clawson notes that for hundreds of years businesses were run on a feudal ownership model in which, like kingdoms, all authority was placed in the hands of a single unquestioned authority. This was followed by the industrial revolution where individual ownership and control slowly gave way to the more complex structures of hierarchical organizations where efficiencies came from centralized and increasingly bureaucratic authority. With the advent of the information age came the need for flatter, leaner, more competitive, and more responsive organizations. At Microsoft Corporation, for example, most communication is via e-mail.

This natural evolution of changing organizational structures found in business and industry, and reflecting changing market realities, has not held true in higher education. Like the organized church and the military, higher education's structure has been used to maintain tradition, power, control, and mission. Theoretically, to threaten the structure is to threaten the culture and the organization's ability to survive. Today, many of these powerful institutions' existence is threatened if they do not open themselves to new ways of doing business—driven by the dramatically changing needs and realities of the larger culture.

## The Splendid Isolation and Independence of Colleges and Universities

Colleges and universities have, traditionally, been very different than most other institutions. Tradition ruled and convention determined roles, methods, and procedures as higher education adhered to protocols, rituals, and structures designed to maintain themselves and resist change. Certainly there have been changes over many centuries, and variations on many themes can be easily found. However, it was not until the rise of the virtual university and of for-profit institutions, such as the University of Phoenix, that a tangible threat of change became serious enough to be embraced and dealt with. Suddenly, words like adaptable and flexible, creative, entrepreneurial, and alternative have become a more acceptable part of the higher education lexicon and its actual working vocabulary.

In this discussion, it is assumed that community colleges are an almost universal exception. Their very existence is by necessity market driven and adaptable to the changing needs and realities of their students. Yet, the resistance to give up the security and comfort of tried and true structures and control remains for many other parts of the higher education world. The old established and quite predictable patterns, rituals, and habits of university and college life are powerful indeed.

Recently, we faced, once again, the hard reality of immovable system norms and practices during one of our consulting assignments. We were asked to facilitate needed and desired system-wide change at a well-established university. What might at first appear to be an almost diabolical and quite intentional resistance to our efforts can just as easily be explained by understanding 150 years of successfully doing business a particular way. Now, faced with a huge financial shortfall, declining enrollments, and a non-responsive governance process, this institution's future is very much in doubt. Letting go of the past appears to many to be an attack at the very fabric of the institution's collective being. Understanding this alone can help lessen the natural impediments to change.

Realizing something needed to give, the faculty and administration made all the right moves—spoke of cooperation and the changing needs of the larger institution along with the need for sacrifice and change. However, when the hard questions were asked, even in light of irrefutable data, the response was chilling. Within eight months the president was gone, and a few months later the faculty had unionized. While mistakes were made on the part of both administrators and faculty, the reluctance of the faculty to own their part of the problem and to give up certain entitlements and old ways of doing business, proved to be the undoing of the change process.

## Culturally Defined Routines and Structures Inhibiting Change

There are various aspects of university and college life that many of us have experienced in our own education that felt natural and acceptable. Today, they are all being addressed and questioned. What follows are some of the traditional norms being tested.

### **Semesters**

Let's begin with something as basic as the yearly academic schedule. More often than not, this is still supported by the trusted semester or quarter course structure, typically consisting of 36 contact hours per course. In quarter systems, the problems of both time and space utilization are similar and spread over four months. These are buttressed at one end by summer vacation and at the other by the long winter break that is often a month or more. During these times, the faculty is often inaccessible. System-wide involvement of faculty in change efforts becomes nearly impossible while faculty are teaching their courses and unworkable if meeting outside the confines of the semester, as this impinges upon their "free" time.

In addition, from a business perspective, the majority of the physical structures on a two-semester campus are underutilized during extended down periods and cost millions of dollars in lost revenues. However, there are ongoing operating expenses such as heating, cooling, lighting, and general maintenance of these buildings. The tension between these realities and the habits, comfort, and entitlements of professors are unmistakable.

### ***The Sanctity of Face-to-face Courses***

An effective teacher can deliver an in-person, memorable lecture in front of 10 or 200 students. Ten thousand students can conceivably participate in the same course over the Internet. How people learn and remember is suddenly under severe scrutiny and the creative utilization of multimedia approaches is being explored. Are costly physical structures for housing traditional lectures really necessary? What are the options? What is the optimal balance between personal contact and one's ability to have a quality education? The answers challenge traditional cultural norms as well as the very way students are learning today and into the future. The implications for the average professor are equally provocative.

### ***Convoluting Governance Structures***

Operating within a culture that values argument, free speech, and democratic principles, faculty councils, assemblies, or houses of representatives become bastions of discourse with interminable ways of blocking progress and few opportunities to advance legislation or new ideas.

Serious-minded and busy faculty members often give up attending such hapless meetings and leave the working of faculty governance in the hands of a few. Thus, the business of the academic side of the university or college can sometimes be dictated by a handful of politically astute individuals who promote the interests of the faculty, establish an adversarial relationship with the administration, and often polarize the faculty themselves. The majority of uninvolved faculty members choose their research, teaching, consulting, or writing interests over the predictable contentiousness of their own governance process. By disengaging from the political process and responding most often when their self-interests are threatened, their role can become increasingly reactive and adversarial.

While there are new methods for engaging large numbers of constituents in stimulating and rewarding governance experiences, few have found their way into the corridors of academia. They could conceivably change how ideas are generated and shared. Ultimately, how decisions are made in both large and small institutions will change. However, the benefits of staying within the narrowly defined traditional governance protocols remain high for those committed to the defense of the status quo. This is truly their comfort zone.

These are only a few of the many cultural routines being challenged by a wide array of new needs, ideas, and innovations. Such changes can be disheartening and threatening. Individual dreams of the ideals represented in academia are suddenly challenged. Nevertheless, change will not wait.

Most banks, utilities, and airlines were not ready for deregulation. Yet, the new reality has changed everything and institutional success is being determined by how readily particular organizations are able to learn and adjust to meet these challenges. Such changes in less than a lifetime have been momentous and are continuing. Colleges and universities face the same level of institutional and cultural change. The question is how and what to change, not whether.



## ***The Split Between the Administrative and Academic Sides of the Educational Enterprise***

In what business is there a separation of the product side and the management side of the organization? Where does the quality of the product and the influence of those delivering the service not relate to the bottom line and the decisions of the larger organization? Where are the generators of the income protected from criticism and where are they not accountable for mediocre performance or for lack of consumer interest? In what business is the administrative side responsible for bottom line success with virtually no control over the amount, quality, or duplication of services on the product side? And, where, without direct control over the production, are administrators vulnerable to the disenchantment of those very producers who indirectly or directly can influence their own careers? Only in a university or college environment do such extraordinary realities exist as part of the day-to-day landscape of doing business. It is a natural response to this reality that increasing amounts of mistrust and suspicion can be expected as the two sides—academic and administrative—continue to thrust and parry while self interests, long-standing methods, and procedures are challenged.

As noted, traditional colleges and universities are anomalies in relation to other organizations. Historically, they have contributed enormously to society, its productivity, and its creative influence in the world. Faculty comprises the single most critical cultural factor within the institution. To understand them is to have a good start at comprehending the institutional culture.

## ***The Arduous Ladder of Academic Advancement***

Few organizations of any kind are as demanding and rigorous as academia. Those who make it into the rarefied air of tenure and later pass through the gauntlet on the way to becoming a professor inevitably feel deserving of their hard-earned status and position.

Often, a by-product of the journey is the internalizing of values and qualities of the college or university, which are to be protected and to which they are now entitled. Such entitlements can become boulders in the road to change. “How much do I have to give up?” becomes a mantra more important than “What is good for the institution and its students?” From beginning to end, the route to success is competitive, and personal. There is no reason to believe that an individual would willingly become focused on a more cooperative and collaborative view. Give up benefits to meet the changing needs of the broader system? After spending nearly a decade of holding one's nose to the grindstone in search of achievements, teaching, recognition, and hard-earned security, should one sacrifice tenure in the name of change? No way!

Nor is it likely that their hard fought experience has readied faculty to spend more time in the arena of collaborative management and solving the problems of the greater university or college. The convoluted and slow moving process of change can be frustrating. Therefore, many faculties choose to focus their skills and energy on the very predictable sources of reward focused in their own academic disciplines.

The traditional higher education culture breeds a desire for autonomy, independence, and freedom. New administrative interests in working across departments and across the system as a whole go against the grain of institutional norms as well as many individual personal survival instincts. In the academic community, if one is not contributing to his or her own resume, there will, more than likely, be no team or group of individuals looking out for the best interests of that individual.

To make matters worse, unlike most good businesses, there is no one to help develop individual faculty members in relation to their own personal goals, their areas of weakness, or future successes. No one is looking at how this might relate to the growth and needs of the institution. Is it any wonder why it is so difficult to pull faculty out of their personal interests and academic stakes to take part in uncertain system change efforts that, at the very least, will probably reduce their perks and entitlements?

They will challenge even the most creative administrations with a desire to maintain positive relationships with even the best-intentioned faculties.

Faculty tends to be:

- Silo based, self-regulating, and self-evaluating units.
- Individual rather than team-based in their relation to the total organization.
- Supportive of a competitive rather than cooperative environment.
- Supportive of personal achievement, length of tenure, and reputation.
- Supportive of tenure as a way of life, which provides security as well as protection from what many would say is normal criticism and accountability.
- Decentralized in terms of departmental structures, which, in turn, create a sense of autonomy and independence from the whole.
- Holders of a sense of entitlement after years of driving the critical decisions of the institution. Such faculty attitudes can create a perception of elitism by others in the community who feel unduly influenced by a minority of college or university personnel with academic rank and the accompanying status and influence.
- Non-practitioners of performance management. This is rarely practiced in academic departments where budgets may be established but historically are not monitored beyond basic agreed upon bottom line numbers. Therefore, efficiencies, individual competence and performance, overlapping courses, or redundancies of other kinds are rarely detailed or addressed.
- Builders of a clear separation of administrators and faculty. Natural suspicions and mistrust result from different institutional goals.

Decision-making administrators increasingly seek ways to circumvent predictable logjams. This course of action inevitably increases mistrust and can reinforce the adversarial nature of the relationship in the eyes of many faculties. The huge shadow cast by faculty needs to be explored at greater length.

### ***The Silo Based, Self-Evaluating, and Monitoring Departmental System***

There are few systems in which departmental units are more self-protected or self-serving than college and university departments. Hospitals are one. Physicians, until recently, were treated as self-possessed entrepreneurs with personal interests blatantly pushing against the needs of the whole. The sense of invincibility held by many physicians came crashing down as administrators and third party payers joined forces to neutralize their unfettered self-interests and power. The traditional unwillingness of physicians to collaborate has had a huge impact on their own morale and, ultimately, on patient care. To many it appeared that physicians were asleep at the wheel and never saw change coming—change that would dramatically alter their own ability to influence their lives. This same reluctance to share power has been attributed to university and college faculties. Even

though some professors maintain their institutional positions as a platform for other entrepreneurial work, they are tied at the hip to their academic institution. Even so, most departments have huge amounts of autonomy and are basically self-regulating.

The question is usually, what is good for our department, our students, and (lastly) the organization? This does not lend itself to a position of negotiation and openness with the administration, which is responsible for the larger financial enterprise. Since departments compete among themselves for shrinking resources, there are virtually no incentives for thinking outside the rigid confines of their own unit. The result is a highly complex system where politics, strongly held norms, and personal interests do not support attention or energy being devoted to the problems of the larger enterprise. Instead of fostering a climate of negotiation and collaboration, the relation between administrators is often seen as adversarial.

## The Administration Side of the University or College Enterprise

We have already made the assumption that most institutions have not one, but, two rather distinct cultures. One is driven by the academics—the faculty that directs the education and research arms of the institution. It is left then for the administration to do everything else—maintenance, grounds, construction, student services, salary, benefits—right down to parking. Without administration there is no institution. Fortunately, the idealistic nature of higher education attracts a motivated and value-driven group of people who dedicate themselves to this work. They usually expect a range of life style benefits reaching far beyond the less than robust salaries typically afforded them. Certainly, if dollar income were the only measure of success, the caliber of higher education employees would drop dramatically.

However, it seems fair to say that the typical administrator has a strong desire to achieve personal goals, which are more often intrinsic in nature than in many other occupational pursuits. Many buy into the goals of the system and add to the luster of the institution by their own love and care for their work. Their idealism of role usually blends well with the idealism of their students and the value-driven nature of most faculties.

What they also bring to the table, more often than not, is an accommodation to institutional norms of politeness and civility. The strong status levels created from tenure and rank (associates, assistants, lecturers, assistant professors, associate professors, and professors) among the academics are mirrored in the development of highly stratified roles in administration. This includes: senior vice presidents, vice presidents, assistant vice presidents, directors, and department heads. There is little inclination toward argument, dissent, or even controversy. Questioning those with higher authority might be encouraged, but responding to the concerns is not the norm. One of the strongest cultural norms that we find among administrators is the fierce aversion to conflict, especially with faculty. The collegial environment reigns supreme.

Role and functions reinforce this. Since many administrative roles are service directed, the result, as one might expect, is an interest in accommodating the requests of those in authority or those being serviced. Thus, downsizing rarely means reduced services or making hard choices. It is simply implied that, “We will do everything as before but with fewer resources.” This attitude of doing one’s best even in the face of adversity fits nicely into the norms of a conflict-averse system. The effort to

keep everyone happy with fewer resources available usually begins at the top with presidents acquiescing to boards, vice presidents acquiescing to the president, and so on down the line. The result can be an overworked staff with low morale where people find themselves not living the values that brought them there in the first place. The end result is that honesty, openness, and living a balanced lifestyle are squeezed by the harsh realities of the institution. Over time, the result can influence decision making, productivity, and morale.

The strong interest in accommodation can, for example, result in administrators mistakenly utilizing consensus as a means of decision making. However, consensus demands trust. Without allowing time for thorough discussion, this results in a false consensus and a lack of buy in on decisions made. Such decisions can easily fall apart at the point of implementation because of a lack of real, underlying support.

The following is how we experience the way that many university and colleges do business:

- First, there is the expectation that people who are hired are competent and quite capable of doing their job. Thus, the norm is, “Just let me alone so I can do the work for which I was hired.”
- Second, as a result, people are rewarded for doing their job without rigorous supervision or performance management. Competence is assumed. In fact, it is rare that performance management is valued or supported.
- Third, employees depend more on self-motivation, which is where real recognition lies, rather than delegating sufficiently to others. This means many leaders are doing more than they should and often feel undervalued and overworked in the process.
- Fourth, since seeking perfection is part of the higher education mentality, there is an inclination to discover exactly what the boss or person in charge has in mind and to do it perfectly. The result is that individuals are prone to be overly dependent on authority and less and less inclined to give away their own authority. As a further consequence, individuals will also be less and less inclined to take risks and speak their minds.
- Fifth, since most cost cutting is initiated on the administrative side, it will come at the expense of people who already tend to be stretched, but who will acquiesce and take on the extra work that is demanded. This is usually performed without overt complaining, but not without resentment.
- Sixth, performance management standards and criteria tend to be weak, at best. Over time there is an increasing tendency to evaluate people based on how much they do, how loyal they are, and how much they will put up with, rather than in relation to defined priorities or criterion-based outcomes—even if previously agreed upon.
- Seventh, over time, standards deteriorate, people are rarely fired, and a few people tend to do more of the work and are increasingly depended upon. Tensions around standards and unfair reward practices within the administration side increase. Faculties are quick to criticize inefficiencies and less than optimal standards.
- Eighth, for those who have worked in this environment over a long time, an implied tenure mentality may develop where work becomes an entitlement along with other implied perks (arriving late, leaving early), which results in increasingly mediocre work among larger numbers of people.
- Ninth, because performance management is valued less than being busy doing work, and

because people avoid conflict, difficult feedback is often avoided as a part of a formal evaluation process, and accountability is less and less relevant. Mediocre or even poor performers may be given good or positive reviews.

- Tenth, because staff often feel exploited by faculty—who they observe working less, being paid more, having better benefits (including long vacations), and sometimes treating staff insensitively—a gulf of disrespect and misunderstanding grows.

While one can discover similar patterns in some corporate settings, the drive for profit—and the threat to survival posed by mediocre performance and bottom line inefficiencies—militate against their presence. The anti-business mentality, which exists in most university and college settings, lessens the possibility of establishing meaningful performance standards so that time in service, loyalty, and institutional habit play an increasing role.

We have witnessed this pattern in different degrees in large research-based institutions, academically oriented universities, top-flight liberal arts institutions, and in the cream of the Ivy League. The pattern is modeled at the top by leaders (who themselves have internalized a powerful work ethic) having difficulty letting go of authority, desiring independence in others, and yet in the end, promoting the very kinds of dependency and attitudes they dislike.

Because there is little time or inclination to supervise or develop individuals, leaders often create fear by their own personal power. Then, they wonder why people acquiesce to their wishes and rarely reveal confronting or risk-taking behaviors. Many extol the virtues of teams and collaboration, yet, as we will see later, few have the tools or skills to create the climate and, ultimately, the culture they say they desire or that is needed.

Clearly, it is extraordinarily difficult to contemplate system change without a thorough understanding of how people within the system are rewarded or held accountable. Thus, how effectively performance management or the supervisory process is conducted can be pivotal.

## Corporate Culture and Performance

In their classic study of corporate America, Kotter and Heskitt studied more than 200 firms from 22 separate industries over an 11-year period (Kotter and Heskitt, 1992). Their question was, “How does the culture of an organization influence its success according to certain measures?” Such measures include increasing revenues, an expanding workforce, growth in stock value, and increased net income. Their findings have relevance for any organization attempting to become more responsive and competitive in a business climate that is increasingly bottom-line driven.

Colleges and universities are now demanding greater accountability on many levels. They are increasingly working from business-driven financial models. Such models can be relevant and have much to say in relation to the cultures of both universities and colleges. Further, the rather well defined sub-cultures of faculties and administrations gain further clarity in their analyses. The following figure is a brief comparison of some of the characteristics of successful corporate cultures and a typical academically driven organization.

Put simply, the most successful organizational cultures in the Kotter and Heskitt study were proactive in the search for problems and their solutions. Risk taking tended to be encouraged and

Figure 1.

## A Comparison of Two Cultures

| <i>Successful Corporate Culture</i>                              | <i>Traditional University/College Culture</i>  |
|--|--|
| Climate encourages experimentation and risk taking.              | Attempt to maintain status quo and traditional ways (outside of research).   |
| Trouble shooting and inquiry is legitimized; feedback supported. | Departments are self contained and often secretive, not feedback driven.   |
| Restructuring of systems and developing new policies common.     | Reluctance to restructure and rarely address problems systemically.  |
| Employee development a high priority; management is valued.      | Performance management minimal or nonexistent among faculty and individual development optional throughout.                      |
| Personnel reluctant to change and model new values are removed.  | Tenure-based system gives protection and rise to mediocrity and resistance to change. Typically, data-based feedback is limited. |
| Change and adapting to new needs a way of organizational life.   | Change of any kind is viewed as a threat and typically resisted.   |
| Client or customer needs highly valued and motivates change.     | Reluctance to even think of students as customers who should influence the product (curriculum) or the educational process.      |

even supported, as was an openness to innovation and change. And, most important, the leaders of these successful organizations focused heavily on both the needs of their customers and the needs of their own employees.

Contrast this to the characteristics of low performing cultures in which leaders tended to be resistant to change and held onto the status quo. As might be expected, data feedback was not actively sought and when it was, the information was often ignored. Little attention was paid to the needs of employees as a group or to customers themselves. A common attitude was often, "We are the experts and are hired to provide the answers required by our customers." The underlying arrogance of this point of view was one of the clear blocks to organizational effectiveness.

When measured against these standards, many colleges and universities come up short. Instead of being customer focused, some faculties resent the very word. They rail against placing education in any kind of a business context. In no other field is the distance between the client who pays and the vendor who delivers the product so distant or, in some cases, unrecognized.

To make matters worse, many faculty members take offense to the idea of asking students to provide feedback in relation to the quality of their performance. Even if they happen to receive such data feedback, there is rarely any relation to even a modest form of institutional accountability. Furthermore, exit polling of disenchanted students who leave early or graduating students rarely has any influence on faculty or their performance. Similarly, recent graduates who are sensitive to the

demands of the job market and are important measures of their own preparedness seldom provide direct feedback to professors. Again, even when they receive such feedback, there is rarely any mechanism that holds them accountable for being responsive to the data. In short, faculty stand alone in the world of work as providers of a product where, only in rare cases, are there formal measures of accountability in relation to the quality of the information being provided or the effectiveness of the presentation itself. Even when data are available, there are rarely consequences for substandard work.

Add to this the feelings institutional employees often have toward their faculty brethren—a low sense of their importance in the overall educational process—and one can anticipate a growing chasm between the two. It is striking how the majority of qualities pointed out by Kotter and Heskitt in relation to low performing corporate cultures appear to be emulated strongly in most university and college systems. The rigidly defined roles, structures, functions, and reward systems make such consequences almost preordained.

This is not to suggest that high quality teaching is not recognized by students and is not reflected in the decisions of those who seek admissions or in the reputation of the school or department itself. Nor is it to suggest that most faculties are not committed to their disciplines and competent in the performance of their roles. It does suggest that in an increasingly competitive marketplace, many universities and colleges are seriously limited in their ability to change by the attitudes of resistant faculties and administrators who have difficulty unblocking the traditional impediments to change.

## Summary

Our purpose in exploring the nature of culture in higher education institutions has been, first, to raise issues surrounding the complexity of any change process and to understand how natural resistance will predictably occur according to how the system is organized, how individuals are rewarded, and how norms support both functional and dysfunctional behaviors. Second, we have posed a variety of questions to help to frame the nature of change. These questions should be considered prior to initiating change within any particular institution. Finally, by understanding the unique qualities of the faculty and administrative sub-cultures, we can grasp the natural tensions that exist and learn how essential it is to address these differences within the context of any change effort.

### A Dozen Questions

The following questions can help determine how responsive a college or university culture is to the challenges of a changing environment. Higher education institutions can differ markedly in their reputations and in the public perceptions of their strengths and limitations.

Answering these questions relating to underlying cultural realities will provide a more definitive picture of how system change initiatives will likely be responded to in a particular higher education institution. The information should also provide clues to the kinds of strategic moves that might be utilized if whole system change efforts are to be successful. Ideally, each of the questions would be asked independently to faculty, administrators, students, and alumni. Then, they should be compared for consistencies and discrepancies.

**1. What specific factors provide individuals within this educational community a sense of affiliation in relation to acceptance, respect, and influence?**

Such information will provide important data relating to the kinds of strategies to be used to break down barriers of communication. By separating faculty and administrative responses, it is possible to

highlight the potential adversarial relations. Opening the flow of communication between the two factions is essential to leading change. This helps to identify issues of trust between the groups and those who feel excluded.

**2. How are decisions made that influence operational effectiveness and the financial viability of the institution?**

Who wields power is reflected in decision making. The perception of such power can have a tremendous effect on morale, personal initiative, and levels of resistance within such a community. In addition, it can determine how willing faculty and others are to engage in solving the problems that directly influence them.

**3. How are academic and non-academic departments held accountable for their productivity and bottom line efficiencies?**

Without standards and processes for holding various constituents accountable, any organization will be increasingly incapable of planning or of making necessary financial decisions that might influence its future. Not every course, service, or activity should relate positively to the bottom line. However, self-interests all too often influence decisions justified by rationalizing that things are different in academia.

**4. What are the rewards that drive performance in this organization and who receives them?**

What is rewarded on an individual or departmental level will inevitably reflect what is valued in an organization. If innovation and entrepreneurship are important, or teaching, or research, or perhaps service, they will rise to the surface through this question. The attention that is paid to system rewards, the kinds of recognition, and celebrations that occur throughout the organization can stimulate change.

**5. What signs, if any, are there in this organization that customer needs (students, parents, alumni) and interests are of primary concern to faculty and administrators?**

In an increasingly competitive marketplace, organizations most responsive to changing customer needs will garner new business. This is also one of the key indicators of the institution's ability to adapt and change.

**6. What are the values most lived by this college or university?**

In theory, values reflect mission and shape the attitudes of students, faculty, administrators, and alumni. Differences among these groups need to be understood and addressed.

**7. What are the values most espoused and yet not lived in the eyes of the institution's critical constituencies?**

Values and beliefs are the building blocks of institutional behavior and tend to shape internal and external attitudes.

**8. How are differences and other sources of conflict handled within the organization?**

An important litmus test for the quality of relationships within an organization has to do with how conflict is resolved and whether it is seen as a legitimate and necessary part of organizational life. If it is feared or if intimidation or threat is a large part of the cultural equation, the implications for problem solving and decision-making can be critical.

**9. How is performance managed in this organization? What is the relationship among responsibility, authority, and accountability?**

Self-initiative, dependency, risk-taking and, ultimately, morale are influenced greatly by how these variables relate to each other.

**10. How is professional development supported on an organizational level?**



In an age of dramatic and fast-paced change, successful organizations encourage, support, and reward the education and general development of employees.

**11. Discuss how well the administrative structure of the organization facilitates getting its work accomplished. What, if anything, would need to change to increase its effectiveness?**

Structure can inhibit change as much as any single factor and can play a large role in defining the nature of organizational culture. In some organizations the structure seems inviolate (such as the army, the university, large colleges, hospitals, and banks). In others (small entrepreneurial firms, high tech organizations) the structures are fluid and adaptable to changing needs and market conditions.

**12. How does planning play a role in determining the future direction of the institution, its priorities, and the allocation of its scarce resources?**

Without planning strategies being part of an organization, they become victims of the status quo. Organizations are vulnerable to a crisis-reactive response to changing needs and conditions.

## References

- Clawson, James D., *Three Levels of Leadership*, New York: Prentice Hall, 1999.  
Kotter, J.P. and Heskitt, J.L. *Corporate Culture and Performance*. New York: The Free Press, 1992.

## Suggested Reading

- Meister, D.H., *Practice What You Preach: What Managers Must do to Create a High Achievement Culture*. New York: The Free Press, 2001.

BEST COPY AVAILABLE

# VALUES, VISION, AND THE LEARNING ORGANIZATION

---

*“When there is a genuine vision (as opposed to the all-to-familiar ‘vision statement’), people excel and learn, not because they are told to, but because they want to.”*

—PETER SENGE

## Universities and Colleges—A Paradox and Compelling Danger

Colleges and universities sell knowledge. Theoretically, our campuses should be the center of the debate over what we teach, how we learn, and the very nature of higher education itself. The kinds of curiosity, creativity, and revolutionary thinking evidenced in the research domain of such institutions should be reflected in questioning every aspect of the teaching/learning process itself. Higher education institutions should epitomize what Peter Senge in 1990 described as “learning organizations.” His major premise was that in an age of instant communications, rapidly changing technologies, and expanding competition in the marketplace, organizations that are not increasingly adept and solicitous of new ideas will eventually flounder and many will fail. For example, one of the features of the most versatile organizations is that they are “feedback driven” with a constant flow of data influencing decisions and behavior at every level. The challenge, and the competitive edge, can be found in being open as leaders to changing realities and in embracing new possibilities.

For a variety of reasons, Senge’s view of such enlightened management is less in evidence within the tradition-bound world of higher education than outside those hallowed ivy walls. To understand this phenomenon in higher education as well as the nature of change in other organizations, it is essential to look at two ingredients of any culture. One is how individuals within the organization are rewarded. The second, and closely associated issue, relates to how such individuals earn and then maintain membership among their peers and professional colleagues.

Professional achievement in the name of scholarly contributions to the professional literature and original research is the primary source of recognition in much of academia. The research/scholarship domain tends to outweigh service and teaching, the other traditional measures of faculty performance. Individual interests and scholarly pursuits are the unstated, but deeply held, values of most four-year institutions—even when the focus of the institution is stated to be teaching.

## The Challenge

The traditional four-year institution of higher education is being challenged by distance learning, new curricular demands, readily available foreign educational experiences, and increasingly flexible and creative work-study programs. Add to these forces the insertion of focused, entrepreneurial programs—such as those offered at Motorola University—and the threat to enrollment and classroom attendance becomes very real. Add a hundred contradictions like the changing reality in which student learners are questioning large classroom lectures and, at the same time, the problem that underutilized classroom buildings are increasingly a drain on institutional resources.

For the beleaguered administrator, there are additional realities. The most significant is that the cost of a four-year education continues to rise beyond the capacity of many to pay, while the choices in an increasingly competitive educational marketplace continue to expand. While faculty members often bridle at the notion that students should be perceived as clients, customers, or consumers, students have more choices than ever. They, along with their parents, are beginning to consider new criteria as they weigh their educational investment in light of attractive alternatives that didn't exist a decade ago. More than ever, the institution of higher education needs to be a “learning organization.”

## The Question

The time for change is at hand. But, how does one engage these remarkable institutions when reward systems, policies, and internal politics have not changed, in many cases, for over 100 years? How does one overcome habit, routine, rituals, and rewards that have driven decisions ranging from course content to scheduling and from governance to facilities utilization? The challenge in any change effort is unlocking new possibilities and generating creative solutions in cultures where inertia is the expected independent variable.

## Changing the Way We Change

In the “old” days, 50, 25, or as little as 15 years ago, organizational change was much simpler. Data would be gathered, those with most influence in the organization would mull things over, short- and long-term goals would be carved out of the ensuing debate by those expected to be ultimately accountable. These decisions would then be communicated to other interested constituents in words that sounded collaborative but, everyone knew, reflected the thinking of those few at the top of the system. Tradition and the hard reality that noncompliance could be dealt with harshly defined a dependent and submissive system. Post World War II free enterprise reflected a changing attitude toward authority, participation, and collaboration. Quality circles, a movement toward team-focused organizations, and a variety of participative management strategies resulted in an erosion of absolutism and the rise of a more cooperative work environment.

Today, authoritarian decisions will almost assuredly be translated into palpable resistance, as those informed of the new mandates have the opportunity to reflect on the implications for themselves and the organization. Often the resistance has as much to do with the “process” as with the actual decisions or actions being ordered. People are more likely to oppose implementation of any change proposition that influences their lives if they are not involved in the process. This reality demands new approaches to faculty, administrators, and staff if meaningful change is to occur.

## The Answer

After years of such predictable passive or active obstruction, institutional leaders began to forge new strategies for overcoming such resistance. “How do we increase the ‘buy in’ of our major constituents in the decisions that influence them?” became the mantra. A first step in altering this predictable and negative dynamic has often been engaging various stakeholders in the exploration of something as basic as the mission of the organization. Here organizational purposes were defined, underlying assumptions explored, values discussed, and, even, the future was considered. The process was inevitably arduous and time consuming. More than likely the result was less than satisfying, with an idealistic, catchall, pie in the sky statement of purpose and direction that would lay fallow on a shelf until the next cycle of planning. Frustrated participants began to resist the notion of collaboration over such ineffective outcomes.

Since those early efforts at system change, there is increasing evidence that change efforts are much more complex than was ever expected (Fullan, 1993; Senge, 1999). We now realize that participation must be carefully choreographed so that each step is built on a solid and understandable foundation where a series of successes rather than a collective frustration is the result. To manage such complexity in a work environment where time and patience are both at a premium is difficult enough. But, add to this equation intelligent, independent thinking and critical stakeholders, such as those found in higher education, and change itself becomes a high stakes enterprise. Any leader willing to engage must be ready for criticism, defensiveness, and open antagonism as participants revile past experiences or protect that which they do not want changed.

The result is that the change process itself must reflect a new way of doing business modeled rigorously each step of the way by the leaders of the organization. In the beginning, most leaders are caught between the rock of legitimate frustration and disillusionment of those supporting change and the hard place of antagonism and overt resistance by those who had never agreed that any change was necessary in the first place. The very notion of change can be interpreted as something is wrong and, thus, must be defended. Managing this quite natural and predictable response is essential during the initial stages of any change effort.

Our intent in this chapter is to focus on two of the three critical aspects of the management equation that include values, purpose or mission, and vision. From a change management perspective, the values provide the foundation upon which to build, while the vision provides the focus, motivation, and stimulus for future growth or critical change.

## The Power of Values and Vision for Reframing Institutional Priorities

Because of the understandable mistrust built over decades between competitive, silo-based units within many colleges and universities, as well the antagonism created by different institutional goals held by faculty and administrators, a new foundation must be created before change efforts can be successful. One area of rather powerful agreement among change theorists during the past 10 years (Covey, 1989; Goulliart and Kelly, 1995; Hammer, 1995; Collins and Parris, 1996; Schein, 1996; Green, 1998; Senge, 1999) lies in the area of core values. Put simply, core values are the keystone for maintaining a consistent, value-driven culture that can be understood by employees at all levels. The

values represent the bricks and mortar that provide the ability to determine whether people within the organization practice what they preach. Core values are simple, direct statements that reflect powerful beliefs in relation to how people act and how the business of the organization is conducted. The difficult part of building such a core set of values is that if the system “buys” them and then fails to live them or be accountable to them, it will inevitably result in declining morale and, ultimately, in less productive performance. Thus, if an organization is to get into the values game, it had better be ready to live them.

For example, in one highly regarded midwestern university, staff complained that faculty and administrators treated them with a lack of dignity. Even more interesting was that more than 40 percent of both staff and administrators indicated that being treated with greater dignity was the single value they felt should be more visible at the university. This was in sharp contrast to only 17 percent of the faculty. The fact that treating people with dignity is one of the deeply held values imbedded in the mission of the university, has led to a serious assessment of the entire management process. Looking deeper, it was found that issues of fairness and favoritism, courtesy, and respect were closely related. Having the value and believing that it should be demonstrable in the life of the institution and not just words on paper, can help, as in this case, to mobilize the necessary will to change.

### **Values Are to Be Lived**

The 1,200 employees of the Division of Facilities Management at Cornell University after a highly engaging process, decided on five values, one of which was to be:

***We are committed to telling the truth.***

It sounds good. Certainly to not tell the truth is unacceptable. But, suddenly, naming truth telling as a value raised the organizational stakes. The truth, they said, dictates that we do and mean what it is we say. Think about it. How many places do you know where people speak the truth about what they experience, what they disagree with, or when people fail to do what they say? Where do employees tell their bosses when they aren't listening? When they are insensitive or too aggressive? When the meeting they are running is not working? And this was just the beginning.

The organization had to alter its norms of compliance and dependency as well as being risk averse. Staff received training in the art of feedback and committed themselves to providing feedback as part of almost everything they did. Truth, they discovered, could not be left in the hands of a courageous few. It had to be supported by skill and structures and norms that reminded people every day that they are committed and believe in what they “say” they value. By owning that single value deeply, the organization changed the way it did business. No longer would ineffective meetings be tolerated because people would and could legitimately evaluate their effectiveness. No longer could individual leaders get away with being patronizing, sexist, unclear, or abusive. Suddenly people would not only talk about it in the “underground,” but the individual would receive feedback from his or her boss and employees alike.

In light of this, the division decided to take the pulse of the organization regularly in relation to whether the chosen core values are truly being lived, whether waste is curtailed, productivity is maintained, and agreed to standards are achieved. Such information is shared openly. This includes periodic client assessments and benchmarking against competitors and recognized leaders in their field.

Finally, all supervisory level personnel periodically receive 360-degree feedback from those they

impact in their work. Based on this information, strategies are developed with each leader to improve their performance over time and to measure those changes. Thus, the giving and receiving of feedback on a regular basis is expected and is seen as critical to how both individuals and the organization continues to stretch and grow. Feedback became a critical operational vehicle for helping to actualize what truth telling meant on a daily basis.

In a college or university, are some protected from such honesty? Does telling the truth mean that professors receive feedback concerning how they treat people further down the food chain? What about how effective their teaching is? At places like De Paul University, The College of New Rochelle, and St. Joseph's University, where teaching excellence remains at the center of their stated values, feedback is key to the maintenance and support of the value. And, of course, an even tougher question is whether those receiving feedback respond to the information? Or is there no accountability and "feedback" is just information and nothing more? We believe that establishing such "to be lived" values is the very beginning and, ultimately, the essence of effective change management.

## Values and the Process of Change

So, how does this relate to organizational change? How can we engage a community of stakeholders with different interests and needs if we cannot begin to talk openly and honestly? If we have concerns about the process of change or its content, do we believe that we can legitimately raise such concerns without the fear of recrimination? If mistrust exists, how do we generate greater credibility if we cannot speak the truth in whatever forum or setting we meet? Does a vice president's title, a Ph.D. in front of a name, tenure, or a professor's rank entitle a person to a different standard of behavior because of such past achievement? If an organization becomes committed to a more participative, inclusive, and democratic approach to problem solving, decision making, or strategic planning, then it must begin using those same methods in the way it does business on a daily basis and not just when it is convenient or practical. Content specialists and award winners can be honored and respected but should not be feared by those whose stake in the organization's future may be just as great as theirs.

In our example, the five values chosen as core by the organization were TRUTH, RESPECT, TRUST, TEAMWORK, and EXCELLENCE. Their belief is that if the members of their organization pay close attention to these beliefs and match them with a few inviolate behaviors, they can raise the level of their organization and it will influence almost everything they do. Thus, in the area of excellence, they agreed to strive to be the best in everything they do. They do this by benchmarking their progress against the highest standards and providing themselves with ongoing feedback to measure their own progress. The relationship between truth and feedback and benchmarking is evident. Eventually, the organization had to reassess its performance management practices since there were huge inconsistencies in skill and actual practices throughout the organization.

This was no longer acceptable. Similarly, in order to become an organization of effective teams, then it would have to establish what the difference was between good and mediocre teams and provide measurable criteria to evaluate against. Once again, truth telling, feedback, and excellence were related. Finally, in the case of trust, it became evident that trust, unlike the other four core

values, was much more an outcome—the result of their commitment to the other four. Thus, if truth saying occurred, if teamwork was measurably high, if excellence in work was increasing, and people were treated with respect regardless of position, then the level of trust within the organization would increase.

### **Can You “Stand” the Truth?**

The measurement process allows leadership to be scrupulous in how business is done every day. Individuals not conforming to agreed-upon values and the accompanying standards will be supported in moving closer to the standards established around each value. This assumes that the norms that reflect acceptable behaviors are clear and consistently mirror the behavioral tenets that support each value. When the majority of those in an organization seriously buy into the described values, and when people are reminded of them in a positive and specific manner, behaviors change.

One way to help an organization take their commitment to a set of core values seriously is to measure them periodically. For example, if we decided to measure the value, “We seek the truth,” the first step would be to define what examples would reveal whether our organization was, in fact, acting on this particular value. We could develop a list of specific behaviors that would measure a number of these agreed upon “truth” linked behaviors. Once identified, scaled items (using a 1 – 10 point scale) could be created. Examples might be: The degree to which people in our community:

|  |              |   |   |                  |   |   |   |                  |   |    |
|--|--------------|---|---|------------------|---|---|---|------------------|---|----|
| 1. Create measurable performance goals   | 1            | 2 | 3 | 4                | 5 | 6 | 7 | 8                | 9 | 10 |
|  | <i>Never</i> |   |   | <i>Sometimes</i> |   |   |   | <i>Always</i>    |   |    |
| 2. Actively seek feedback from their constituents relating to their leadership effectiveness | 1            | 2 | 3 | 4                | 5 | 6 | 7 | 8                | 9 | 10 |
|  | <i>Never</i> |   |   | <i>Sometimes</i> |   |   |   | <i>Regularly</i> |   |    |
| 3. Are free to speak up in meetings even when they question the leader’s point of view       | 1            | 2 | 3 | 4                | 5 | 6 | 7 | 8                | 9 | 10 |
|  | <i>Never</i> |   |   | <i>Sometimes</i> |   |   |   | <i>Always</i>    |   |    |

There could be others that, together, would reflect the essence of the value under consideration. Core values must be defined clearly and evaluated at this level periodically in order to help the institution maintain its own ability to grow and be accountable to itself. Such vigilance helps to hold individuals and organizational units accountable to these beliefs, and is at the heart of a “learning organization.”

## A Word About Mission or Organizational Purpose

Collins and Porras (1996) talk about the “ideology” of an organization being represented by its core working values and a clear statement of purpose. Together they represent to the world the organization’s identity, what it does, how it goes about its business, and what separates it from its competitors. While the core values tend to remain constant over time, institutional purposes can change given new demands, changing demographics, innovation, and a variety of other variables that can result in changing realities which must be addressed. To be insensitive to the changing times can be disastrous even to the best. Nevertheless, the mission or purpose is designed to help keep the organization’s collective eye on the ball, to provide a sense of who the organization is to the world now and in the near future. For some high tech organizations, the present and the future are so closely tied that change is built into the formula of daily work. Yet, for most organizations, including colleges and universities, a clear mission statement provides a sense of direction and focus that helps in decision making and establishing short- and long-term priorities.

## Motivation and Pride in the Future: Enter the Vision

Like core values, the concept of vision was barely in the lexicon of management language a mere 20 years ago. Now it is at least discussed in most organizational circles and can be a driving force in institutional change. Effective visioning can provide new opportunities and real choices in a rapidly changing landscape where change itself has become an independent variable.

### ***Maintaining Will Not Win the Game***

Anyone who has played organized sports realizes that one of the surest ways to lose a game—virtually any game—is to attempt to nurse a comfortable lead. While the opposition is pulling out all the stops, mobilizing its most creative energies to “catch-up,” the leader is holding on, running down the clock, trying not to make mistakes so that it can hold onto the ever-shrinking lead. All too often, the momentum shifts, and, with it, the confidence and energy necessary to win. The drive and intensity that had propelled the team into the lead disappears and erodes its ability to act. The team becomes tentative, further energizing the other team.

Legendary organizations in the world of business and industry that have been unresponsive to their own set of changing realities and have attempted to nurse their leads have included: Montgomery Ward, Apple, Woolworth, Howard Johnson’s, Sears, Kodak, IBM, K-Mart, General Motors, Ford, and hundreds of others. At one time or another, each had to eat the dust of their more agile, hungrier rivals who were less encumbered by the trappings of their own success. Some, like IBM, Apple, and GM, were able to overcome their inefficiencies, complacency, and arrogance and, once again, mobilize their considerable resources to fight their way back. Others never regained their momentum. In the history of management, it is the exception to find organizations that can remain responsive, supple, and creative, as well as continually able to redefine themselves in light of such new realities. We read about the exceptions—Hewlett Packard, Sony, Johnson and Johnson, and 3M. Realistically, dreams, once achieved, rarely stimulate change or support the kinds of creative risks upon which innovation and significant change are built.



It is part of the all too human condition. It happens to marriages, small businesses, and athletic teams alike. They lose their sense of meaning and, at the same time, they lose their dream. They become complacent, self satisfied, and indifferent to the changing world both within and outside of their organization. As we will see, it can happen to colleges and universities in an increasingly competitive and changing landscape.

### ***The Collapse of Physician Power***

Physicians were blind sided by politicians, third party payers, and hospital administrators. In less than a decade, they lost their ability to influence their own realities. In less than a moment in time, their entitlements, authority, and self-interests were threatened. During the good years, there had been little incentive or time to deal with the quite audible sounds of discontent or changing societal needs. Physicians appeared satisfied to hang onto their substantial lead. What risk was there to them? Medical costs would rise and their salaries would increase. Why change? By the time they became fully aware of the threat, it was too late. They had lost their ability to influence the process, had become reactive and less adaptable. In short, they lost many of the choices that had been available to them only a short time before.

The HMO revolution got their attention. Now they are negotiating. But their own unwillingness to adapt their all too narrow view of the future has damaged both their credibility and, ultimately, their capacity to act. Being out of touch with patient needs and other system realities has thrown the profession into disarray. What was once considered “untouchable” has changed forever.

## **The Role of Vision in Colleges and Universities**

Colleges and universities are in a similar predicament. Parent and student consumers are changing. Technology is changing. Boards and alumni are changing. Market needs are changing. Yet, for the most part, faculty lead with the same institutional vision they have carried for decades. Fixed courses, credit hours, tenure, rank, semester or quarter systems, the process of teaching and a system of rewards can feel archaic. In our fast changing, entrepreneurial world, the sanctity of traditions, customs, and deeply held beliefs are being challenged daily. The question is, how do we preserve the best of our traditions and unique programming and still remain open to change? Again, we are not talking about changing underlying values, but rather, the “whats” and the “whys”—the content and process—of how business is accomplished.

One major university witnessed the hiring and firing of four presidents and half a dozen provosts in less than 15 years. The result is a hunkering down into college and departmental silos where the accepted norm is to hang onto what they have and resist anything that would jeopardize the status quo. The apparently idealistic faculty, who talk the value of democratic principles, can be translated into the reality that any loud voice or discontented group can threaten the job of either a president or provost. To openly confront the changes necessary and threaten the self-interests of virtually any campus group is to threaten one's own survival. The result is a totally reactive, shortsighted governance process that is paralyzed when it comes to dealing with the long-term problems and priorities of the university. Until there is an institutional vision that reaches beyond the vested interests of individuals and their silos, there is no opportunity to create a responsive institution capable of dealing with the real challenges being posed.

## **A Legacy of Mistrust and Suspicion**

While faculty can be a major impediment to change, it would be a mistake to label them as the primary reason universities and colleges find system change so difficult. Historically, higher education carries an approach to institutional problem solving /management that, by necessity, was abandoned by many businesses and much of industry many years ago. Until recently, many colleges and universities were not propelled by bottom-line concerns. At wealthy institutions, entitlements were strengthened. As long as these were not threatened, there was little reason to engage the whole system. Faculty remained relatively isolated and disengaged. Poorer colleges and universities remained solvent with large raises in tuition and a favorable stock market. There too, the hierarchical, decentralized approach to management, driven by highly autonomous units where individualism is rewarded, has spawned resistance to attempts to look beyond tried and true ways of doing business.

Nevertheless as faculty governance structures have become increasingly bogged down (AGB, 1996), administrators have become adept at moving around the logjams and making decisions with less and less input by faculty, thus increasing the gulf of mistrust and suspicion. With few methods or precedents for bringing the disparate sides together, the chasm between the faculty and administration has continued to widen. The result is that presidents and their key leaders—regardless of their good intentions—are often looked upon with natural suspicion. The faculty, as a body, tend to avoid engagement, appearing only when they are faced with a threat to their interests or a long-held entitlement. The adversarial climate is exacerbated by the fact that each issue raised is not seen as a part of any organizational plan, thus increasing the tendency toward a crisis-reactive mode of operation.

Finally, there is a tendency to avoid conflict when financial problems have arisen in recent years. Rather than forge a well thought out and comprehensive system-wide plan, the tendency has been to demand sweeping, across-the-board reductions that have tended to appear arbitrary and have avoided the tough questions and, ultimately, the difficult decisions. The consequence has been that the administrative leadership looks weak and nobody is happy. Morale declines as people await the next predictable round of cuts since most realize that the underlying “causes” of most issues have not been addressed.

## **Building Idealism and Hope Through the Visioning Process**

There are many different ways to utilize visioning as the centerpiece for organizational change. Still, there are some principles that seem to govern most successful efforts. First, however, there is a major assumption. That is, whatever the approach utilized, it will generate vocal resistance. It needs to be understood, embraced, and not personalized. Much of it is to be expected and needs to be legitimized.

1. Change management is ongoing (Senge 1999). Visioning by its nature is a long-term process rather than being perceived as a one-time event (Collins and Porras 1996).
2. There is an explicit understanding that an assessment of the “current reality” occurs with an effort to engage broad-ranging stakeholders of the larger academic community.
3. To ensure acceptance of the diagnostic process and the outcomes, a diverse, representative strategy group should be utilized to oversee the process and help in the generation of the

- critical questions, the analysis of the resulting data, and the monitoring of the change process itself. (Napier, Sidle, and Sanaghan, 1998).
4. Data gathering itself should represent the opportunity for dialogue and face-to-face discussions that will, ultimately, prove to be more favorable than impersonal questionnaires that fail to move the respondents beyond superficial commentary. Having the opportunity for members of the organization to witness the data as it evolves lends credibility to the process. (Weisbord, 1995).
  5. Given a thorough assessment of the current reality, opportunities are created to take a hard look at the future needs and opportunities that could face the organization. The opportunity to assess the leading-edge programs in the field, listen to the views of futurists, and explore trends in technology, leads to broad-ranging discussions to engage the imagination of the various campus stakeholders. Adding external information to the system view of the future may offer critical new choices in an insular and tradition bound institution.
  6. Visioning conferences, large gatherings of broad-ranging constituents to explore specific long-term goals, their costs, and benefits, is a major step toward shaping the real, compelling choices for the institution—once a vision has been created. It represents the beginning of the road toward action.

True visioning is the systematic cultivation of possibilities that will motivate the organization and its members to extend themselves and to challenge their potential. Collins and Porras (1996) perceive the visioning process as complementary to the core ideology. Thus, a solid and firmly grounded set of values with a clear purpose sets the stage for building the organizational dream. To us, this represents a five to ten year enlightened picture of a possible future that draws those working within the organization toward it. These goals are dramatic and demanding—extending the organization to accomplish what is challenging or even unlikely. They represent mountains to be climbed by a team or organization willing to undertake an ultimate challenge that can change institutional direction. Such new direction can pose risks and even failure, but the institution views the outcomes as worth the gamble.

In today's fast-paced world, transforming goals can also occur in two or three or five years. The object is to choose visionary goals that will match the unique needs of the institution and mobilize the necessary creativity, interest, and energy essential to achieve success where none was previously imagined. It is the opportunity to forge the future with well-calculated risks that demand that the organization continue to learn and challenge itself, in spite of either success or failure along the way. And, once achieved, more mountains will be created to climb.

## Conclusion—Envisioning Higher Education

Often the dreams of universities and colleges are left to the creative arm of the laboratory, or to the poet or writer, or others striving to break new territory in the world of the mind. What often gets lost is the dream of the institution itself and how it can best meet changing needs and realities. Building mutual trust and cooperation, respect, and collaboration across traditional, silo-based systems that are grounded in self-interest represents a huge challenge. This age of new educational technologies and a changing student consumer presents the opportunity to break old molds, set new standards,

and enrich the teaching/learning experience as never before. Change management is about mobilizing available resources and thinking beyond the norm so that change is possible. To do this, new design strategies for breaking the predictable barriers, as presented in Part 2, will have to be utilized.

## References

- Collins, James and Porras, Jerry I. "Building Your Company's Vision," *Harvard Business Review*, September-October 1996, pp. 65-78.
- Covey, Stephen, *The Seven Habits of Highly Effective People*. New York: Simon and Shuster, 1989.
- Fullan, Michael. *Change Forces*. London: Palmer Press, 1993.
- Gouillart, F.J. and Kelly, James N. *Transforming the Organization*. New York: McGraw-Hill, 1995.
- Hammer, Michael and Stanton, Steven A. *The Reengineering Revolution*. New York: Harper Collins, 1995.
- Napier, Rodney, Sidle, Clint, and Sanaghan, Patrick, *High Impact Tools and Activities for Strategic Planning*. New York, McGraw-Hill, 1997.
- Renewing the Academic Presidency: Report on the Commission on Academic Presidency*. Association of Governing Boards, 1996.
- Schein, Edgar H. "Three Cultures of Management: The Key to Organizational Learning." *Sloan Management Review*, Fall 1996, pp. 9-20.
- Senge, Peter M. *The Fifth Discipline*. New York: Doubleday, 1990.
- Senge, Peter M. *The Dance of Change*. New York: Doubleday, 1999.
- Weisbord, M. and Janoff, S. *Future Search*. San Francisco: Barrett-Koehler, 1995.

## INTENTIONAL LEADERSHIP: STRATEGIC DESIGN AND THE PROCESS OF CHANGE

---

*“Effective leadership depends, I believe, on the leader’s ability to endure feelings, and learn from them, instead of reacting with immediate sentiments.”*

—MIHA POGACNIK

Effective, courageous, and intelligent leadership is vital to any successful change effort. Unfortunately, it isn't enough. We have had the opportunity to work with scores of faculty and administrative leaders over the last 20 years, and found that *intentional leaders* have been the most successful in managing change within their institutions.

In this chapter, we will explore the notion of intentional leadership from the individual to the level of the team. To begin with, intentional leaders are superb strategists. They understand at a deep level what they want to accomplish and have the ability to engage critical constituents meaningfully in accomplishing their goals. These leaders leave little to chance and utilize diverse and creative approaches to facilitate understanding and learning throughout an organization. Practical application of intentional leadership is highlighted in this chapter by sharing actual scenarios from our consulting practice in higher education.

Many people might think that nearly all leadership is intentional, since it is most often goal directed. We feel *intentional* suggests a much more rigorous view of leadership in which tough questions and discipline force a view of consequences and personal impact in a manner rarely considered previously. At the simplest level, presenting ideas can be likened to a carefully choreographed dance. Whether to stand or sit, to use an overhead, multimedia tool or flip chart, to speak with objectivity or attempt to sell an idea with passion and personal conviction. The decision to provide preview materials in advance, break into small groups for questions and discussion, or take questions from the floor, the time of day, the physical setting of the room—all of these and many other variables should be considered. And this doesn't even touch on the impact of personal style, dress, tone of voice, eye contact, use of humor, or level of preparation.

Now, consider system change. Suddenly the variables increase exponentially. The following are some of the dimensions of leadership we believe most influence how successful a change effort will be.

## Strategic Design: The Keystone of Intentional Leadership

Given the usual resistance to administrative led change initiatives, with their control over the facilities and services of the educational enterprise, and given the interest and authority of the faculty over the product or classroom side, there is bound to be a high potential for dissent. And with limitations of time and resources, is it any wonder that many higher education institutions are crisis reactive and filled with discord and tension? Add to this equation the affection and personal interest of its many and varied stakeholders in the well-being of the institution—students, faculty, alumni, parents, staff, and boards. Such organizations are literally overrun with meetings of all shapes and sizes. The consequence is that many of them are understaffed, ill-prepared, unfocused, and, as a result, are frequently unproductive.

### Tough Questions

Effective change management begins with the way business is accomplished every day. Regardless of their level in the organization, peers and associates evaluate leaders by how they conduct themselves. The following “Tough Questions” are designed to measure how effective you are on a daily basis in the meetings for which you are responsible. Theoretically, everything you do in the preparation and execution of these meetings should be intentional, thoughtfully considered, and, ultimately, worth the time of each participant. If the questions are answered affirmatively, there is little question that change management efforts will have a greater likelihood of success.

- Are the outcome or product goals clear and agreed upon by those present? Is the meeting really necessary?
- Do the agenda items reflect these goals? Are adequate time and resources available to accomplish each in the time available?
- Is attention paid to the process of the meeting – not only “how” the task goals are to be achieved, but also how people will feel as a result.
- Are the right people present to accomplish the task(s) at hand?
- Is each agenda item designed in a manner that reflects the unique goal or outcome of that particular item?
- Are there decisions to be made during the meeting and, if so, are the various decisions clear to everyone in advance of any discussion? Who really has authority to decide and will they have the courage to use it?
- Do the same few people dominate every discussion, or is there broad participation—based on one’s knowledge and experience? Is the desired amount of collaboration utilized in relation to each issue?
- Is there a clear sense of accomplishment at the end of each meeting?
- Is communication open and free flowing? Does it reflect positive relations on the part of the various members? If not, is the leader willing to engage members in a review of the “process,” including what needs to be done to improve the quality of interaction in the future?
- Is each meeting evaluated in terms of what worked, what was unsuccessful, and what positive changes should occur to improve the next meeting?
- Is there appropriate follow-up assigned as well as necessary preplanning for the next meeting of the group? Finally, are members accountable to each other? Do they do what they promise?

Strategic design represents both a manner of thinking and acting. Whether it concerns the meeting of a seven-person task force or the meeting of 100 participants in a daylong strategic problem-solving session, these questions remain fairly constant. Regardless of the complexity of the session, the behaviors of the leader or facilitator are intentional and strategically matched to the outcome desired from each chosen intervention or action. Leaders who are disciplined and intentional generate credibility as well as a confidence, which is translated to other situations. This same tough-mindedness creates confidence in any change management effort where participants are concerned with how their efforts will, ultimately, make a difference.

Thus, more specifically, strategic design represents a number of developmental activities that systematically move a group or organization toward some clearly defined result of both a product and process nature. Concern is for the product as well as the process, or, in other words, how the outcome is reached, and how those involved feel about it. We have come to realize that how people “feel” about the various meeting experiences they have during the course of a change management initiative will directly influence their interest and motivation as well as what they tell others about the credibility of the change process itself.

## An Example of Strategic Design

A group of 14 deans and vice presidents were attempting to develop clear criteria for reducing redundancies among a number of varied services offered on a campus-wide basis. Previous discussions had broken down because two of the participants were able to intimidate the others by flexing their considerable influence in the large group discussion and keeping the group from agreeing on the needed criteria. The provost, who had some understanding of strategic design, developed the following activities or actions to move the process along. His stated goal was to agree on criteria for reducing redundancies of service on the campus.

Other goals he personally carried helped frame his intention for himself and the assistant provost who helped design the meeting. These goals included:

- To increase the participation of the group in the discussion and the eventual decision.
- To decide in advance how the decision would be made in relation to the final list of criteria.
- To establish an initial list of three or four organizations that appear to meet the criteria.

The following intentional design strategies were developed to meet the single explicit goal as well as the three secondary goals.

The designers believed it was essential to establish, prior to any discussion, the agreement that it would take a vote of 80 percent of the group to ratify the criteria. Since the group usually made decisions based on a two-thirds vote, this felt fair, even to the predictable dissenters. It would allow a total of three people to dissent and still ensure passage. The final vote would be a blind vote. Groups like this, which are controlled by a few powerful voices, will often be intimidated into reaching a consensus which, then, could be blocked by one, two or three of the naysayers who, in fact, wish to maintain the status quo.

A total of 45-minutes was set aside to develop the criteria. The group of 14 was divided into three groups with the usual two dissenters in the same group. Each group of four or five was to agree on six criteria, which would be considered when evaluating whether a redundant service on campus should be eliminated. This strategic design was intended to “get all of the voices in the room” and

not to curb dissent. By intentionally placing the two strong voices in the same group, it would free the discussion in the other clusters. Again, such strong individuals will often fight the idea of breaking into small groups for discussion, since the very act of doing this will loosen their control over the discussion.

Twenty-minutes would be given for each group to generate their initial list of criteria. It was agreed that there had to be consensus in the small clusters in order to bring any of their criteria forward. Each criterion was to be accompanied by a clear rationale. (It was assumed that because there had been some previous discussion, the allocated time would be sufficient.) By limiting the three clusters to a maximum of six criteria, it was estimated that, given overlap across the three groups, there would be 12-to-14 criteria from which to choose the final selection criteria.

The three clusters came together after the agreed upon 20 minutes. One group had six criteria and the other two clusters were able to agree upon five criteria each. The three lists were each placed on chart paper and posted in front of the large group. One criterion: *No justifiable reason for more than one organization providing the same service on the campus* was agreed to—in a similar form—by all three of the groups. Another three items were agreed to by two of the groups. A member of each group was then allowed a few minutes to provide a rationale for each criterion for which they were advocating. Two of the items, which were advocated by two groups, were on the list of the group with the two difficult members.

At this point, the leader asked for a straw vote—each member voting for four items—so people could see how much strength each criterion had on the surface. Then, people were given one more opportunity to advocate for one or two of the criteria. Then, there was a blind vote. There was agreement across the three groups (at more than 80 percent agreement on five of the items). One of the items argued aggressively by the two problematic members had garnered virtually no support in the other two groups. One item had nine votes. The group negotiated 10-minutes more of discussion and agreed in a voice vote for the sixth criterion.

Open discussions by a group of 14 can be problematic when there has been little formal team building and there remains considerable conflict and unfinished business among the various participants. Consensus is rarely achievable and demands more time and trust than the group had. Because the two dissenters saw they did not have nearly the number of votes in the straw poll to pull their favorite criterion into the final six, they abandoned their effort. Had they been in a group discussion, they might have worn the group down through personal intimidation or bravado.

Such an intentional design reflects the leader's ability to assess the history and dynamics of the group and to intervene appropriately so success can occur. The stonewalling, domination, and manipulation of a few would most likely have derailed a traditional meeting.

## Dealing with the Natural Challenges of Many Working Groups

This effort at intentional leadership influenced no fewer than four of the challenges that often block success. For example, the challenge of dealing with the issue of individual self-interests influencing a particular outcome was reduced by structuring the activity in a manner that minimized the ability of any single individual to control the process.

Another challenge, typically, is how to make the decision making process appear fair and equitable.



We have all experienced how convoluted decision-making can hinder the ability of a group, or the entire organization, from moving forward. By creating a rational and hard to refute decision-making process prior to any discussion, the participants, in this instance, were forced to play by previously agreed upon rules and manipulation was minimized. Often, deciding how to decide is put off until the discussion has become heated and individuals feel their chances of “winning” are slipping away. That is when they will raise the standard or even push for a consensus vote in order to protect their interests.

A third challenge to the success of this meeting, and present in most meetings of this kind, has to do with the limited time available in most meetings and the resentment by participants when they feel their time has been wasted. In our example, by carefully designing the structure of the groups, there was ample opportunity for individuals to share their ideas, within a context of clear boundaries. The participants were able to contribute as many ideas (up to six) as they could work out among themselves in the time available. Using consensus mentality in the clusters and voting in the larger group within limited time frames, the process moved along much faster. Typically, in an open discussion group of approximately 14, a few strong individuals often commandeer the group, thereby negating its ability to succeed. Such a meeting could easily end without a decision after two or more hours.

Finally, another challenge had to do with different goals between the academics (in this case deans) and the administrators (vice presidents). By having to agree on the criteria to reduce redundancies in mixed groups, it was clear that compromise rather than blocking would have to occur. By establishing three groups, there was the realization that if individuals wished to influence the final product, they would have to generate as many ideas as possible, since the other groups probably would. Thus, a healthy climate of competition between groups for the best ideas rather than between individuals in the different groups prevailed.

## Breaking Predictable Patterns that Block Meeting Effectiveness

Strategic design is about unblocking groups. It is also about creating strategies for inclusion and full participation. It takes into consideration the nature of a task, the time available, the history of the working group, and the desire to increase trust rather than sources of contention. In this case, the group actually became more cohesive as it learned that it could complete a necessary task without being waylaid. The leader, realizing the potential for failure, maintained the integrity of the process by intentionally designing the various activities. This kept the group from experiencing failure.

This was not a casual series of acts. They were highly intentional and strategic. They demanded that the leaders planning the intervention took sufficient time to diagnose the situation and to build in the design strategies, which might move the group forward in a positive and successful manner. And that closely represents our definition of leadership—intentional acts to facilitate the group’s ability to solve problems, discuss difficult issues, and, sometimes, to make decisions that will influence the life of the institution.

It probably demanded an hour to design the activities (versus the usual 15-minutes to throw together a typical meeting agenda). Not a bad price for the estimated 42 hours of cumulative work time spent by the 14 participants in their three-hour meeting.

## The Leadership Imperative and the Role of the Team

Committed leaders who communicate a strong belief in what it is they are leading take a giant step toward success. Any doubt or sign that their will or understanding is diminished, will undermine the entire change effort. Imperative is a powerful word with little room for the uncommitted. It suggests that this is where we are going and how we are going to get there. People need to feel the confidence resulting from a stalwart commitment by their leaders to provide the trust to tread on the new ground of change.

This is not the same as the dictatorial commands of bygone years conveyed with mixed messages of zeal and threat, eagerness and fear. Rather, it assumes the soil has been tilled. The ideas and concerns of followers have been solicited in areas that influence them. Alternatives have been explored, and consequences measured. But, once this essential effort has been accomplished, the leadership imperative represents the urgency to act. The commitment to such actions can mobilize the energy and belief of those needed to overcome the sometimes-daunting obstacles to change.

### *The Role of the Leadership Team*

We have found the concept of a high-performing, trusting, and interdependent team is almost an oxymoron at most colleges and universities. True, people talk about teams, but there appears to be an aversion to do what it takes to develop the kind of trust required for teams to act like teams. Perhaps it is the historic stigma to the “touchy feely” approach to team building of bygone years that goes against the grain, or the sense that such anti-intellectual pursuits cannot be justified. Or perhaps it is rooted in the silo mentality of the institutions themselves and the independence of such groups, along with the “back home” allegiances that people feel.

Whatever the reason or reasons, we find that joining a team is often a temporary act. The team spirit ends when the individuals return home to face the praise or ill will of their constituent peers. Their reception is based on how their performance supports their department or unit. The result is that meaningful team building is rarely pursued and seldom achieved.

Existing teams are often used as vehicles of communication, as counsel to provide members with insider information that can be so helpful in the political world of the institution. But without the deeper sense of team and the belief that the work of the team at an institutional level is as important, or even more important, than the back-home silo, one begins any change process in a very precarious position. It is the agreed-upon imperative of the leadership team, as a whole, that can create a strong belief in the potential of the change process itself. Nothing is quite as powerful or eye-opening as participants witnessing their leaders being on open and friendly terms, speaking with passion and a common voice about a new institutional vision or change initiative. On the other hand, nothing is so harmful to the success of a change initiative as individual leaders returning to their constituents and minimizing the importance of the change and, even, discussing how the process can be subverted.

Our definition of such a high-performing team includes the ability to solve organizational problems, to resolve conflicts whether interpersonal or content based, to provide dispassionate feedback about each other's effectiveness, and to communicate ideas and concerns in an open, objective manner. Stepping beyond the boundaries of polite and nice professional roles, and into the more risky and uncertain territory of candor and authenticity, demands levels of trust and security that are unusual on most campuses.

However, the benefits in terms of support are extraordinary once the predictable stresses accompanying any system-wide change effort materialize. For a person to choose to take a team down this path is a clear example of intentional leadership since the payoff is predicated on the individual's own willingness to be open, vulnerable, and a learner along with the rest of the team. The building of the team itself would be based on real work and not on unrelated simulations or games. The one variable that cannot be minimized is the need for extended periods of time to achieve the desired outcomes.

## Case in Point: The Value of a Team to a Change Initiative

A small Midwestern university had, over the years manifested a deep schism between the faculty and the administration. It was thought that one way to rebuild trust between the two factions was to create a highly participative strategic change initiative that would promote long-missing dialogues across the campus and regenerate the respect that had once been present.

However, skepticism was so high after years of less than candid communications, and non-collaborative decision-making, that leaders justifiably feared that no one would participate. The president, a creative, impatient, and manipulative person recognized his part in the evolving problem and decided to engage in a high-risk team-building intervention. He provided a model for the campus of both his good intentions as well as the opportunity to bring the two sides to work together.

A 14-person Steering Team was chosen to guide the change initiative. It was drawn equally from administration and faculty with both skeptics and proponents. The team also included an outspoken board member. One of our "givens" was that the president, provost, and chief financial officer had to be on the Steering Team. The group was candid, conscientious, and carried a high degree of credibility. The strategic design for building the team and moving the change initiative forward was based on a number of strategic assumptions.

On the road to strategic change, it was the responsibility of the Steering Team to challenge the university to open itself to a high degree of self-scrutiny. But, first, it was posited that the team members themselves needed to learn about change management. They could do this by testing the process they planned to use on the larger system on themselves. Thus, they would use data generated on themselves as individuals to assess their own performance as teachers and administrators, leaders, and members of their university community.

Under the umbrella of such shared risk, the team began to understand the nature of institutional change with the threats and fears it posed. Using themselves as a laboratory, the Steering Team tested certain approaches and became increasingly sensitive to the consequences of each. If the process could create openness to new ideas and choices for the future, instead of the predicted resistance, then the challenge was to create the same positive climate for change across the campus. At the same time, it would, hypothetically, increase trust and a greater sense of partnership among long competing groups. The experimental nature of the process caught the imagination of the empiricists within the team.

If the team building did not succeed, the risk was the fact that the message would spread throughout the campus and the change initiative would lose both credibility and the team support. During an initial three-day off-site retreat, the team experienced a variety of strategic designs in

microcosm, using themselves as a replica for the actual initiatives that could be employed on the campus to diagnose critical problems, to open discourse, and to provide feedback. Each strategic design they used provided an opportunity to engage each other in an increasingly open fashion. They explored campus issues as well as the relations among the team itself. Years of frustration were examined in the safety provided by the structured designs.

A post mortem was used at the end of each activity to explore the underlying theoretical assumptions and to determine if such a strategic design—or an adapted version—could be used with larger numbers of campus stakeholders. As the individual members increased their trust in each other and the process, they began taking more personal risks, which generated even greater trust. Enthusiasm and optimism for the proposed campus-wide change initiative grew.

At the end of the initial three days, each of the team members was asked to select a cross section of 15 to 20 individuals from the campus community to provide an anonymous, written feedback on the team member's effectiveness as a leader and member of the community. A protocol of this 360-degree feedback data would then be developed and provided to the individuals at a second three-day retreat a month later. At that time, they would also be asked to scrutinize the strategies used for reporting their data, their positive or negative response to the process, as well as the problem-solving strategies for dealing with issues they felt important to address. Once again, after each initiative, the team was asked to determine what they had learned that could be applied to the proposed change initiative being planned for the university.

Needless to say, by the end of the second three days, the team understood the underlying issues of change management. At the same time, they had become familiar with the concept of strategic design and its role in the arena of intentional leadership. The team returned to campus as advocates for the change initiative. They maintained their role for an entire year, helped to design the change process, and monitored its progress as it unfolded, one step at a time.

The president's own intuitive understanding of the potential of such a team, along with his willingness to model the values of the change process, provided the impetus to overcome the quite legitimate cynicism that initially prevailed. The team itself was a continuous sign to the campus that the process could be trusted, that concerns could be voiced through the Steering Team, and that together all of this was a reflection of more positive changes to come.

## Looking Under Stones

A really skilled fly fisherman will slowly and gently enter a new stream. His or her first task is to discover the stream culture. The problem is, he or she can ascertain only a fraction of what determines the health of the local ecosystem, whether it is a good place to fish, and what it might take to successfully fish the stream. With a trained eye and a view above the water, the fisherman can witness considerable life on the surface. Even more is learned by witnessing tadpoles and small fish underneath the water. Then, the individual stoops down and picks up a rock from beneath the water. There, clinging to the under side, is a world of life hidden from view. To the trained eye, the grubs of this particular stream unlock a world of information about the life of the stream and what the local trout eat. The true experts will then select from their own flies the best bait to use for that particular part of the stream to attract the local fish.

Similarly, each campus must be understood by looking under the stones of that very unique

culture—how the organization makes decisions, how it solves problems, what it rewards, and how it handles differences. Also, it is important to learn how the campus communicates and holds people accountable. These inevitable shades of difference must be understood if system change is to be successful on a particular campus.

## Reduce Costs If You Overspend

Sounds simple enough. On the surface, you look for redundancies, sources of serious cost-income discrepancies, as well as underutilized facilities and programs. This was the case at one mid-sized, Southern state college where excessive spending over income had resulted in a number of shortfalls, which were fast becoming a problem of major proportions. All had apparently agreed that something had to be done. After years of unfocused and ambivalent leadership, indications were that the time was ripe for more decisive and definitive leadership.

Historically, the solution had been painful, but relatively easy. A proportionate, across the board cut was made—where everyone suffered equally. It took little thought and minimum time to implement. This avoided the predictable slings and arrows from those who would be outraged if they had been selected to carry a larger share of the problem than others did. The result was that no one was content, only the symptom was addressed and, predictably, there would soon have to be another just as painful cut required, since nothing at the system level had, in fact, changed. Such a crisis—reactive and unplanned—made no inroads into the mistrust, deteriorating morale, and the general malaise that had taken over both faculty and staff.

On this occasion, the administrative leadership acted courageously. They began to look under stones. They came to the table asking hard questions in attempting to look for lasting solutions. On a campus where departmental territory and historical prerogatives determined influence, they realized their jobs would likely be the price to pay if their strategic initiatives failed to break down the walls built to resist any change in the culture. At the very least, the faculty would have to be engaged and drawn out of their bunkered silos. The dollar issues were systemic in nature and a single change would, quite predictably, force others. Here, as in many places, the loud call for change preceded the understanding that sacrifices would have to be made and major cultural shifts would have to occur.

Once the first change initiatives had occurred, it became evident that for lasting change to result, the college would have to address some long-standing blocks to system health. It is one thing to cut costs but it is quite another to begin questioning sacrosanct ways of doing business. The long held entitlements as well as long denied responsibility for institutional dysfunction were a few of the factors that surfaced in this cold stream of change and had to be addressed if change was to stick.

A highly laissez faire system of performance management existed in which the assumption was that good people will do good work and that they will know what is best for the institution. There were few standards, and fewer consequences for commitments broken. Historically, the promises of change eroded as leaders returned to their isolated silos for business as usual. This major dysfunction had to change if the courageous actions of the new leadership were to succeed. An intentional intervention to fix this system dysfunction would undoubtedly cause additional resistance and hostility at a time when the system was tired from the changes already engaged. It was here that many leaders had been fired or caved into the mounting opposition.

Data showed that a substantial number of students were leaving the college prior to their second

year. This had been all but ignored by faculty. Now, as a result of a rather thorough diagnostic, it became evident that unnecessary courses, ineffective teaching, and a lack of personal contact between faculty and students were among the underlying causes that most likely influenced some of the early departures. Each of these issues either questions a long-held assumption that faculty are good teachers, or an entitlement that faculty have the right to teach courses of their specialty or interest. Building institutional-wide solutions again raises other issues around performance management, the evaluation of both programs and courses, and the nature of institutional rewards. The question then was which of these issues must be addressed in the short run to ensure the greatest gain for the institution?

Once tenure is accomplished, rewards on the faculty side are set. Except in exceptional circumstances, grants and awards can add to the mix. What is known is that one of the few leverage points within a university or college system for altering performance or behavior is through the reward structure. It was realized that until this changed, there would be little incentive for people to risk doing things differently—either as an entrepreneur or by developing new courses and focusing on the fine art of teaching. On the administrative and staff side, a tenure mentality existed that was reinforced by the lack of a standardized set of work principles and methods. The result was widely varying practices, differing supervisory competencies, and differences over the criteria for the distribution of rewards.

Addressing the tenure side of the equation suggested a long, but inevitable road already begun. Increasing part-time employees and reducing the hiring of full time, and tenure track personnel would minimize the problems surrounding tenure.

New ways of maintaining faculty loyalties, ensuring skill levels, and other benefits would change the face of how this college would manage its faculty resources. All agreed that each of these three issues—performance management, faculty development, and rewards—had to be addressed if significant change initiatives were to be effective. All three issues related to issues of accountability, which is weak in most institutions. Coming to grips with this, and a handful of other system causes, became the key to making long-term, hard decisions around cost reduction.

## Developing a Diagnostic Mentality

Because people tend to remain at universities and colleges for the duration, these communities often seethe with political complexity and informal channels of influence. It is important to develop a diagnostic mentality to achieve the intended changes. Bringing facts and measured opinions to the table can help to deter the voices of powerful individuals or departments. Using data can provide positive information to bolster community pride, while less data can be used to stimulate dialogue, to look at long-term trends and consequences, and to help chart a constructive course of action.

## Design as Key to the Diagnostic Process

One of the critical aspects of intentional leadership is the ability to organize the data-gathering process itself into a creative act. People are not inspired by the results of even a well-crafted questionnaire if the resulting return represents only 25 or 30 percent of those polled. Such information usually fails to generate either interest or support. We have learned that the data-

gathering process is of huge importance to the credibility and potential success of any change initiative. Twenty years ago, a questionnaire was distributed; the results tabulated, and sent on to a small group of institutional power brokers to decide what information would be shared and what actions were warranted from the limited information.

Skepticism of such approaches on college and university campuses has been long building. We anticipate that the beginning of nearly any change initiative may be undermined by the belief that solutions are preconceived and data gathering is only a show to support what has already been decided. Therefore, the art of design has become a critical part of the diagnostic process. Increasingly, people engaged in the process of change tend to believe what they see and have had the opportunity to discuss.

## A Diagnostic Design

For example, if we are interested in the opinions of a faculty in relation to issues previously agreed to require change, one design would have a random group of 30 to 40 faculty invited to a three-hour data-gathering meeting. (For a more detailed account of this design, see Interview Design on page 2.9.) Depending on the nature of the problem and its interest, other groups of faculty could be engaged in a similar fashion with the resulting information pooled.

**Step 1** in this process is to have a credible group of faculty develop, perhaps, six powerful questions that are meant to plumb the ideas of the target group in relation to a particular issue. The assumption is that the questions will have been given considerable thought and would, in theory, require minimal background information to answer. If, for example, the issue was distance learning and its future role in the institution, a question might be: “What are the potential advantages to our students utilizing distance learning as part of our curriculum?” A second question could be, “What are several reason that might deter us from implementing distance learning on this campus?” It might be useful for a paper to be distributed to the 36 participants in advance that would explore the expanding field of distance learning for colleges and universities—its potential and its problems.

**Step 2** would be designed so that all of the 36 participants, during the diagnostic workshop, would each be responsible for interviewing six people in relation to one of the six questions. In turn, they would be interviewed on their ideas concerning all six questions by six other individuals—each of whom was provided one of the other questions (including their own). Each one-question interview would take four or five-minutes with the interviewer encouraged to probe for examples concerning their opinions. The idea of not being restricted to a paper and pencil response has proven appealing to many faculty members we have involved in such a process. Further, the stimulus of having someone explore alternatives and seek examples can be challenging. Again, in this particular diagnostic design, each of the faculty members present would have the opportunity to provide information concerning all six questions, while, at the same time, being responsible for interviewing individuals about one of the same six questions. The design allows those participating to provide more than a few sentence response (as would be the case in responding to a questionnaire) to important questions that are felt to require considerably more thought.

**Step 3** has the participants clustered in groups of six with other individuals who have their identical question. Thus, each group of approximately six individuals would represent a 100 percent sample of the data generated in relation to that particular question. In the meantime, other groups of

six would also be organizing their data in relation to another one of the six questions. Armed with this information, the groups of six—each focused on the results of their interviews—are given time to explore the resulting patterns of response. Their task is, first, to identify issues from the participants they interviewed where there is a strong degree of agreement. Another category involves issues of less significant agreement arising from their pooled data that, nevertheless, deserve to be identified and shared with the larger group. A final category focuses the evaluating group of six on individual ideas identified as unique and offering a perspective that should not be lost to the larger group or, for that matter, to the institution, even though only a single person may have registered the idea. Often such good ideas become lost or minimized when the only focus is on popular responses.

**Step 4** has the group of six reporting their summary analysis of their pooled data from their question to the larger body.

**Step 5** might be a further discussion of the results, with the group of 36 being divided into new groups of four or five to allow a full expression of the findings.

**Step 6** has the summarized information from each of the six groups organized and made available for other discussion groups within the larger organization. The summarized information could also be placed on a Web site or summarized in a brief white paper concerning the future of distance learning at the institution. Because of the openness of the process itself, the credibility of the data tends to be high.

**Summary** In a period of three hours, because of the structure of the design, a minimal amount of pre-work, and the focus of some important questions, the result is:

- A 100 percent sample of the faculty present in relation to what has been identified as a critical campus issue.
- The opportunity for a group of critical thinkers to express their ideas freely, to feel heard, and to listen to others as well.
- A well-organized summarization of the data from the participants and a record of the outcomes that can easily be communicated to others.
- A productive, task-driven meeting with tangible outcomes worthy of the participation of the faculty group and reflecting a truly collaborative approach to the assessment.

This is only one of many creative vehicles for generating interest and good information where one of the goals is to establish campus-wide trust in the change process itself. One of the great truths of any kind of therapeutic process is that “until the patient believes there is a problem, there is little hope that it will be solved by the patient.” We have found a fundamental honesty and integrity among campus professionals. They may deny the truth for years, but when faced with a hard question and not intimidated by peers or the loud voices of a few, they will respond with honesty and creativity. Our belief is that change begins with asking hard questions and with the freedom and desire to generate honest opinions. The design discussed here led naturally to more in-depth dialogue and problem solving. This, in turn, resulted in an increased interest in creating other designs that could be utilized with other groups in the diagnosing and solving of other problems.

Intentional leadership has the leader thinking far beyond the relatively simple task of gathering data. He or she considers such things as the level of trust existing in the organization, the need for dialogue, and the strategies for enticing people out of their individual silos. Leaders then consider how to present the resulting data gathered back to the organization in a manner that maximizes its credibility. Employing such a diagnostic mentality gives credibility to the



change process since it suggests assessing every situation in terms of what is needed and the relative consequence of any chosen action.

## Vision, Values, and Planning

Strange as it seems, the concepts of visioning and planning are relatively new to business and certainly are newborns in higher education. Until the mid- to late-1970s, the concept of visioning was not even on the horizon of effective management practices. Planning itself was discredited because of the early communist focus on five and eight-year plans. The post-World War II burgeoning American economy had little room or interest in long-range planning. The hunger for goods and services resulted in a quick turnaround, reactive management environment. Even when planning gained greater favor in the business world, it found little support on most U.S. campuses. Planning was often tied to fund raising, and fund raising was tied to immediate needs or favorite projects, rather than to coherent long-term strategies. While there has been huge institutional growth in higher education over the years, more often than not, it has been reactive in nature and inconsistent in approach.

Historically, leaders frequently pulled a reluctant organization along, based on their legacy, their desire to lead, or their personal passion for a new direction or concept. It is almost built into the role of college and university presidents that they should lead through inspiration. The notion of engaging faculty and other stakeholders in the creation of an institutional vision has demanded a new approach. Intentional leadership, with its focus on strategic design and the utilization of the ideas of many constituents, has come of age at the right time. The day of the enlightened leader having the capacity to move the system forward as a result of brilliance, charisma, and manipulation is fast becoming a deviation from the norm.

## From Diagnosis to Current Reality for an Ideal Future

Once again, we are faced with the understanding that mobilizing the energy and will of an institution to change, demands the engagement of the minds and hearts of those affected. It is necessary to educate or raise the consciousness of the participants beyond the narrow confines of past and present thinking and into complete understanding of what the future holds. The participants' total buy-in is required.

Before a vision of the future is created, the reality of the present condition must be vividly portrayed—often to people who stoutly resist listening. How does one move from contentment (the status quo) to active questioning, to the discovery of what is real, and ultimately to what are the possibilities?

Change is not a stroll through the park. It is much more challenging. Rarely is it easy. A critical role of the intentional leader is crafting ways to help reluctant constituents to hear. This might be conducted by the following means.

- A sharply defined diagnostic intervention
- Introduction of “best practices” applied in other similar colleges and universities
- Learnings from those who have led the way
- A clear sense of possibilities gained by bringing futurists to campus

All of these represent the necessary ingenuity to arrive at any vision and change. Put simply, if the audience isn't interested in the show, it is difficult to keep them in their seats.

## Visioning as a Shared Process

Once members of the institution are thinking differently, asking necessary questions, and facing up to their current reality, a multitude of design strategies are available to help involve the members of the community in developing a compelling vision for the institution.

It is capturing the excitement and motivation behind what could be that will drive the change process. Possibility thinking generates the enthusiasm required to turn the vision into a reality. Shifting from one's vision to "our" vision is one of the most critical aspects of intentional leadership.

## Using Core Values to Leverage Change

Many organizations play at core values. All too often they represent pie in the sky, idealistic window dressing that says to the world, "This is what we believe," regardless if that is the case. When done well, however, core values provide a foundation upon which to build the entire change process. Such lived values are like a giant filter through which pass how the organization does its business, treats its students, relates to each other, and approaches the quality of its work together. It is not a laundry list to be amended over time. Rather, these few values are perceived as timeless: a handful of visible, idealized behaviors, which are memorable and owned by the community—at every level. Furthermore, they are measurable and observable so people know when they are occurring. Above all, leaders model them on a daily basis. Intentional leadership in this case suggests that leaders commit themselves to living the values every day and expect others to do the same.

The 1,200-person division at Cornell University, discussed previously, engaged all of its members in strategic dialogues, and eventually committed to the following five core values. Fearing that the words alone would become meaningless, they anchored each with a memorable statement. Later, they were each cast into a number of behavioral criteria that, when measured, could tell the organization and its various units them whether or not they were actually "living" their values. Such accountability is critical. The core values are:

- **TRUTH**– *Say what we mean and do what we say.*
- **TEAMWORK**– *Together we do more.*
- **RESPECT**– *Treat people as we would be treated.*
- **EXCELLENCE**– *Strive to be the best.*
- **TRUST**– *The outcome of our work together if we practice the other four values.*

Part of intentional leadership is helping to create a more intentional community where people, ideas, and actions are not taken for granted. It is assumed that if individuals abide by these values, then change will be easier. It becomes part of every business day—a part of the fabric of the organization built on a shared awareness and commitment. The result is that it does not result in people feeling vulnerable or resistant. It is their choice of how they wish to conduct themselves in their work environment.

With this in mind, an engaging diagnostic leads most change efforts and creates the framework for any particular change initiative. The feedback part of the truth-saying value and the search for

organizational excellence provide a legitimate starting point for creating a meaningful vision of a more ideal reality. Furthermore, it is assumed that any change at its core demands trust and the ability for individuals to learn together and, in the process, to be vulnerable. It is these agreed-to and lived core values at Cornell that become the natural and expected preamble of any change effort. With them, the other pieces fall into place.

## Collaboration Is the Difference

Colleges and universities have been built upon individual achievements, on the unique contributions of people who, through creativity and hard work, have competed and won. It is not an environment that encourages participating or sharing endeavors. In fact, coming together is often perceived as detracting from the hard work and dedication required to succeed in such a singularly competitive environment.

Most higher education institutions, in our experience, appear to follow a similar pattern whether in the classroom or among the faculty themselves. Except in some labs, a few seminars, and even fewer classes, information flows from the top. It is integrated individually, followed by competitive tests—often curved to reward winners and punish losers. It is within this context of individual rewards and achievement that leaders are now attempting to encourage the use of participatory change strategies, which stress cooperation and shared knowledge.

The more we understand the reasons behind successful change—what it takes to ensure that such change is maintained over time—the more it is apparent that:

- Greater, not less, involvement matters.
- Adversarial and polarized relationships inhibit rather than stimulate change. Such relationships are difficult to resolve unless the parties are willing to come together.
- Participation by those individuals affected by the change correlates strongly with positive outcomes.
- Strong individuals tend to dominate the groups they are in; thereby requiring specially designed strategies to ensure the inclusion of other's ideas and alternative points of view.
- Competition can be stimulating or destructive on the road to effective collaboration. It is the design that can make it a positive aspect of the collaboration process.

## The 10-30-60 Rule

Keep in mind that most higher education leaders have never been trained in the rudiments of group management nor in the strategic designs capable of stimulating creative problem-solving and consensus-building. Therefore, the intentional leader who is willing to confront the suspicions of those unwilling to relinquish their traditional hold on the change process should be aware of the 10-30-60 rule.

In our experience, in almost every group in which turnover is limited and influence is determined either by seniority or a small handful of powerful individuals, one can expect 10 percent of these individuals to actively undermine any effort to become more inclusive and collaborative. They and their allies—perhaps another 30 percent—will lose power and status if their dominant source of control is compromised by new methods of engagement that involve greater participation.

The remaining critical mass of individuals, about 60 percent, have either been disillusioned and opted out of participation in the usual governance process or they represent new voices with little seniority. Many feel they lack the experience necessary to challenge those holding the reigns of traditional power and influence. Also, in this remaining 60 percent are others who are so focused on their own work that they simply disengage themselves from most traditional avenues of involvement.

By increasing the voices in the room and the opportunity to participate, there is often a critical shift in this distribution of 10-30-60. After only a few successful strategic interventions in which greater participation occurs, the 30 percent shrinks, the 10 percent remain the same and may actually grow slightly, as they marshal recruits in the face of the threat to the status quo. Many of the traditionally silent 60 percent become more active as they experience greater success and begin to feel heard. We find that there is a critical shift in involvement, with as many as 30 or 40 percent becoming excited by the opportunities afforded them by their increased ability to influence the problem-solving and decision-making process. As mentioned previously, it helps enormously to have a steering group at the head of the change process. Educated in the methods and benefits of such a collaborative change effort, they act as a buffer when the all too predictable resistance begins and have the ability to “design” corrective action in order to keep the change process on track. Thus, such change is a continuous work in progress that can change as new challenges or resistances arise.

Dozens of large-scale design strategies are now standard operating practice in hundreds of colleges and universities across the country (Brigham, 1996, Weisbord, 1995, 1987). Some are used for as few as 30 or 40 people and some can be utilized effectively with literally hundreds of people coming together to share ideas, set priorities, solve wide-ranging problems, or debate issues. While the methodologies may differ widely, the one strategy selected for a particular event is based on a careful assessment of the needs, goals, past experience, historical attitudes, and physical setting of the gathering. While these approaches are new for some institutions, their track record is now proven over 20 years.

## **Performance Management: The Key to Sustainability**

Good intentions and New Year’s resolutions go hand in hand. They seldom can be counted on, even with all of the new methods, increased skills, and understanding that stand behind many change initiatives. It is the presence or lack of an effective performance management process that will ultimately determine success or failure on campuses.

Once again, we are faced with the now familiar consequence of isolated units determining their own approaches. The result is a lack of consistency throughout many higher education institutions. Even when there is a clearly defined process of performance management in place, it may lack any teeth. Certainly, it is often missing on the academic side of the enterprise. Vulnerable deans are often beholden to faculty whose tenured status and personal reputations make it difficult to provide counsel, let alone real accountability. If one takes on the faculty, it can be career threatening. If deans collude with faculty and derive their power through accommodation, they become resistors to the larger goals of the institution. Some have likened being a dean to the National Football League where star players make more money and wield more power than the beleaguered coaches whose primary job is to hold the egos of the players in check so they can bring their considerable talents to fruition on the playing field.

On the non-academic side, the tenured mentality bleeds into the management process with the underlying assumption that roles are filled by talented, responsible individuals and that competence is assumed. Supervisory personnel who are rewarded for “doing” real work easily reinforce such attitudes, and supervision is perceived as an obligation with few consequences if performed minimally.

Finally, it is highly likely that institutional norms will not support giving negative, critical feedback in a work environment where collegial behavior is the unwritten rule. Management is more apt to give across the board salary increases and to not document ineffective performance.

By the time poor performance in relation to any individual has reached serious proportions, there is little information or patience for providing the kind of development the individual needs to improve performance. In essence, there develops a cadre of wounded, underperforming workers where the system has colluded with mediocre performance over time until, finally, tolerance is exhausted.

Propelled into this situation of limited performance management are the expectations and demands of agreed-upon change initiatives. With little monitoring, minimal adjustments of priorities, and limited time to build necessary new skills, there is little incentive to press the newly developed action plans into service.

Often the result is that even if the ambitious change initiatives are supported during the take off phase, it is not unusual for them to lose favor during the later implementation or maintenance phases. A call from the president, a disgruntled board member, or an irate faculty can derail a change effort.

One role of a steering team can be to help ensure the smooth transition from the idea stage to that of full implementation. Essential in all of this is performance management, structured in such a way that new tasks and programs are built into a clear system of unit and individual accountability. Without this support, the change initiative will flounder and most likely fail.

Such systems are often notoriously resistant to the establishment of firm priorities and commitments. Without them, the system will remain in a crisis reactive mode of operation with the current “hot” priority taking the attention of previously over-committed leaders and their staff.

Performance management means that it is a recognized part of each manager’s review process and their rewards are, in part, a consequence of their own supervisory effectiveness. The essential part of this is defining the role with common expectations, providing the means of measuring individual performance, and developing the skill sets necessary to conduct the work of supervision effectively. Obviously, this cannot be done once a major change initiative is in motion. Having the foresight to establish this at the front end of the process is critical to intentional management.

## Conclusion

Organizations respond to effective leadership. Initiating a serious change effort at an organization wide level provides a marvelous opportunity to lead. Our belief is that such leaders must be superb strategists, continually thinking ahead to remove impediments, to facilitate forward movement, and to anticipate consequences to respond proactively.

Intentional leadership is ultimately strategic. The development of design skills and a diagnostic view of their system fuel such a perspective. Utilizing such strategic interventions will cut off reactionary tendencies before they can take off. Such leadership is tough-minded and works in a

context of both team and large group collaboration. Creating a value driven team that supports necessary changes and brings critical stakeholders to the table are crucial elements of successful change management.

There are no simple prescriptions for successful change management. By its nature, all change is unique. It demands leaders who are flexible and can adapt to the changing moods and current realities of their institution. Nevertheless, the principles outlined here will go a long way in preparing for success and in preempting the elements that might lead to failure. The intentional leader must always look ahead.

## References

- Brigham, S. E. "Large Scale Events." *Change*. November/December 1996, pp. 25-37.  
Weisbord, M. and Janoff, S. *Future Search*. San Francisco: Barrett-Koehler, 1995.  
Weisbord, M. *Productive Workplaces*, San Francisco: Jossey-Bass, 1987.

## Suggested Reading

- Block, Peter. *Stewardship*. San Francisco: Barrett-Koehler, 1993.  
Clawson, J. G. *Level Three Leadership*. Upper Saddle River N.J.: Prentice Hall, 1999.  
Collins, J.C. and Porras, J. "Building Your Company's Vision." *Harvard Business Review*. September/December 1996 pp. 65-78.  
Covey, S. *The Seven Habits of Highly Effective People*. New York: Fireside (Division of Simon and Schuster), 1995.  
Drucker, P.F. *Management Challenges for the 21st Century*. New York: HarperCollins, 1999.  
Gouillart, F.J. and Kelly, J. N. *Transforming the Organization*. New York: McGraw Hill, 1995.  
Greenleaf, R. K. *Servant Leadership*. Mahwah, N.J.: Paulist Press, 1997.  
Hammer, M. and Stanton, S. A. *The Reengineering Revolution*. New York: Harper Collins, 1995.  
Jacobs, R. *Real Time Strategic Change*. San Francisco: Barrett-Koehler. 1994.  
McLagan, P. and Nel, C. *The Age of Participation*. San Francisco: Berrett -Koehler, 1995.  
Napier, R. W. and Gershenfeld, M. K. *Groups: Theory and Experience*. Sixth Edition, Boston: Houghton Mifflin, 1998.  
Napier, R. W. and Gershenfeld, M. K. *Advanced Games for Trainers*. New York: McGraw Hill, 1998.  
Pozner, B. and Kunzes, J. *The Leadership Challenge*. San Francisco: Jossey Bass, 1994.  
Rodin, R. and Hartman, C. *Free, Perfect and Now*. York: Simon and Schuster, 1999.  
Senge, Peter M. *The Dance of Change*. New York: Doubleday, 1999.  
Senge, Peter M. *The Fifth Discipline*. New York: Doubleday, 1990.

## BUILDING TRUST: A KEY FACTOR IN THE PROCESS OF INSTITUTIONAL CHANGE

---

*“Trust can only arise where people have deep, intense interest in each other. They must be able to distinguish one another’s qualities, to know which aspects of one another are special and worth trusting.”*

—PETER SENGE

### Fitting Trust into the Equation of Change

Building trust is indeed a major factor in those leaders involved with initiating change. The impact of trust is reflected in most strategic planning, but implied trust is not enough to get the job done.

Well-intentioned leaders commonly hire qualified experts to help them formulate a well-defined, linear planning process. They build their plans in relation to values, mission statements, and institutional vision—along with defining the goals to reach. Then, data are gathered from broad ranging constituencies. Eventually, an implementation plan is formulated. Finally, more often than not, little happens. Disappointment by the hopeful and skepticism by critics fuel a profound disillusionment that can undermine the morale of an entire institution. Failure to build trust at the front end of a change effort will most likely meet resistance at the point of implementation.

If there is mistrust from years of avoiding conflict, poor communications, political intrigue, and the silo nature of how business is conducted in higher education, then it is predictable that meaningful change will be thwarted. Lacking understanding of how to build trust, one can predict that the mere suggestion of a need to build trust within the planning process will lead to strong denials and the demand, “Let’s just get on with the planning.”

The deterioration of trust brought about by such an ineffective planning effort will only further poison future initiatives of this kind. Who wants to invest additional monies, time, and mental energy in what people will see as another predictable failure?

Even though such failure may be predictable, most will not understand that the lack of trust had anything to do with the concrete and often elegant planning strategy. In fact, most people have difficulty comprehending the concept of trust itself.

## Reframing Our View of Trust

Years ago, Sarah Engel, a former graduate student and now a colleague, came to us excited about an insight she had gained in relation to one of the least understood concepts of management—trust. Like us, she had been perplexed by the fact that almost regardless of the type of organization with whom she worked, trust was nearly always identified as a factor inhibiting both management effectiveness as well as the implementation of various change initiatives. Our experience with colleges and universities of varying types and sizes only reinforced this reality.

Trust is almost a ubiquitous presence. Ask people in an organization whether it is great or small and there is seldom equivocation. People know when it is present and when it is not, even if it has not been carefully defined. It is a litmus test for relationships between faculty, administrators, and other campus groups. What separates trust from other factors is that trust is treated, almost universally as a problem. In fact, it is an outcome of other factors. Until this is grasped, trust will not be understood in a manner that will allow it to be increased.

## Trust as Outcome

Factors such as communications, while complex, can be broken down into identifiable parts. These can then be systematically attacked by a leader or team that is bent on improving communications—either within the team or with other stakeholders. For example, the failure to share information is a particular kind of communication problem that can be solved. The failure to solicit feedback from critical constituents is another difficult, but quite manageable, problem under the communications umbrella. Trust, however, cuts across a wide variety of issues that can prove difficult to solve.

Engel changed trust from being a problem to an outcome. She realized that it was quite possible to identify many of the variables that pose the greatest threat to trust. Then, she began to use them as part of a system diagnosis and later in purposeful problem solving. Thus, by attempting to isolate the most critical factors that reduce trust we can proactively initiate strategies that can bolster it between individuals, within a team, or in an institution.

Our earlier discussion of intentional leadership focused on the ability of the leader to identify the factors that are undermining trust and, then, to intervene strategically to alter the situation. Engel's excitement was about having isolated some of these quite manageable variables that, if addressed, could have a positive effect on morale and even productivity.

Over the years, we have taken these initial ideas and expanded them so that any leader can identify areas that create mistrust and, at the same time, by utilizing specific design interventions, can improve overall trust. We have broken these factors into three main categories:

- Content or product knowledge and skills
- Management structure and discipline
- Process or maintenance skills and behaviors.

Prior to providing a simple instrument for measuring trust, let's briefly explore each of these factors.



## Content or Product Knowledge and Skills

In our culture, bottom-line objectives are predictably determined by the ability of individuals to generate an effective product. It matters little if such an outcome represents completing a complex laboratory experiment, conducting a conference, or carrying out an extensive program evaluation. Therefore, one would expect an inordinate amount of attention to be focused upon the task dimensions of producing that product. This demands two kinds of knowledge and related skills—first is content knowledge and second is technical knowledge. We estimate that 90 percent of leadership energy is focused on these two vital areas. Without competence in them, there is little hope that success will result.

Content knowledge has to do with the intellectual understanding of the product itself and the essential information necessary to create it. Such knowledge separates competitors. This can be vital in determining whether a good idea is translatable into a successful result.

For example, recent competition in the field of biotechnology has only heightened the importance of such intellectual knowledge and the competition surrounding it. Trust in an institution or in a particular department is partly based on the ability to predict the quality and value of the product and to distinguish it from the competition. Without such intellectual capital, and the consistent ability to move from idea to product, both confidence and trust are diminished. This can result in a reduced willingness to invest time, money, or other resources in pursuit of the product, which ultimately influences the relationship.

On an individual management level, the same holds true. A new vice president, dean, or even president must create an impression in an academic community that they have a broad-based understanding of widely varying subject matter in addition to recognized content knowledge within their field of expertise. For many community members, this is the starting point of trust and helps determine whether they will be willing to be led.

Technical knowledge and skills in support of the product represent a wide range of activities and understandings without which even the best ideas would languish. Thus, building efficient production cycles, innovative marketing, and sales strategies, as well as taking advantage of some of the new communication technologies, can all have a positive effect on trust. In the increasingly competitive world of higher education, the capacity to translate technology into efficiencies can provide a competitive edge and increase both confidence and trust.

## Management Structure and Discipline

Whether people within an organization believe that work can be accomplished effectively because of competent organization, decision-making, planning, and the efficient utilization of resources plays heavily on one's ability to trust. Clearly, having great competence in areas of content or technical understanding will only go so far. Without the ability to organize work efficiently, all the skills and knowledge will be to little avail.

As organizations grow, the ability to manage increasing complexities, and at the same time expand capacity to allow growth, becomes the challenge of management. Providing sufficient structure in areas such as roles, goals, levels of authority, and communication can provide members of the organization with a sense of security. Within the category of *Management Structure and Discipline* are some of the following variables that influence trust:

- *Clearly defined goals* represent one of the foundations of organizational trust. They imply what we do, where we're going, and how success will ultimately be measured. Our experience suggests that goals are often unclear and poorly defined at system, group, and individual levels.
- *Role clarity* ties naturally into goal-related issues. When individuals know what it is that they are supposed to do and how that fits into the complexities of the organization, their trust goes up. When roles are unclear and they bleed across areas or between individuals, trust goes down and competition or other dysfunctional behaviors are likely to increase.
- *Well-defined authority* was one of the benefits of a highly structured, hierarchical, and bureaucratic organization. Historically, as organizations grew in complexity, conflict was reduced dramatically. In such bureaucratic organizations, lines of authority were clear and people knew what was theirs and what lay in the hands of others. In the more diffused arena of modern management, with the breaking down of hierarchies, the doing away with rigid silos and the need for greater interdependence, authority can become hazy at best. People accustomed to clear authority and marked territories become confused and, often, agitated.

While colleges and universities differ significantly from corporations, they have some common characteristics in relation to authority. One related problem is the occurrence of building relatively independent colleges within a university, and within those having divisions or departments that act rather autonomously. In many cases, the result has been the emergence of protective silos that have spawned territoriality, and the lessening of open lines of communication.

In increasingly flat-line organizations with overlapping functions and instant communications, authority becomes blurred. Matrix organizations, with all of their difficulties, are one of the natural results. As we will see later, such fluid organizational structures demand interpersonal trust, which allows the benefits of the highly structured system to be less important. In universities and colleges the trend is to think more systemically and to seek out redundancies and inefficiencies. This requires breaking down traditional barriers and previously rigid boundaries.

The problem is that trust becomes a process issue, and it has less to do with structure and definitions of role and authority than it does with the ability of people to cooperate across lines of authority. Because structure in traditional organizations was developed to deal with potential conflict and ambiguity, little attention was paid to the process dimension. The result is that few organizations are equipped with the tools or understanding to build the trust essential to bridge such gaps.

- *Rewards and recognition* can undermine interpersonal and organizational trust. Just as individuals' adjustment to ill-defined authority can influence trust, so, too, can the way rewards are distributed and recognition is applied. In many of the organizations where we serve as consultants, favoritism has appeared as a factor influencing morale. Often it happens unintentionally as a few people are recognized for their successes. However, others that are critical to the organization's success may be left feeling unappreciated. Even worse, financial rewards can be felt to be arbitrarily defined—based on who you know or what you have done lately—rather than as a result of achieving clearly defined goals and agreed-upon outcomes.
- *Measured accountability* is at the heart of any good performance management process. The discipline necessary to build and maintain a fair and equitable system of performance management—especially in organizations that are crisis reactive—is, in our experience, rare. Without the structure and discipline measured accountability ensures, people will feel unprotected and at the whim of their boss. The last 50 years of unions has been more about

unfairness and distrust in this area than in any other. By ensuring clearly defined perimeters and predictability of pay, trust tends to increase. Recognizing individuals for exceptional work on a system or group level can be a minefield unless the criteria and method of selection are absolutely clear. Sadly, this rarely occurs—leaving mistrust and jealousy in its all too familiar wake. Most people wish for nothing more than to believe that they are protected and that fairness will prevail in relation to how they are evaluated and rewarded.

- *Effective communications* is essential to ensure trust across units and the entire system. While new technologies make much more information available than ever before, individuals still have the ability to maintain power and control through the withholding or selective distribution of information. Having effective structures and processes for ensuring access and distribution of information is central to maintaining trust at all levels. Put plainly, if people have information, they are likely to have greater choices than if they don't. In a highly fluid and changing organization, leadership is obliged continually to assess options and to create alternatives for moving the organization forward. In universities and colleges not known for openness or for the transparency of ideas across departments and committees or with their boards, fluidity of communications has not been common. What is communicated often rests in the hands of a few who determine what access others should have. Thus, one would expect high levels of mistrust.

By creating the essential management structures that support safety and security, organizational energies can focus more clearly on the primary issues of improving the quality and efficiencies surrounding work, whether in the form of curriculum change, institutional task forces, or the administrative budget process. In university and college systems where there is often a chasm between the faculty and administration, clarifying the details surrounding these areas can substantially reduce the amount of projection and rumor that often undermine the trust so essential to more effective cooperation and collaboration. Once again, good intentions will not go far when historical realities have all too often created a legacy of mistrust.

## Process or Maintenance Skills and Behaviors

Traditionally, much of the focus of colleges and universities—like most other organizations—has been on the content or task dimensions of work. Little training or time is regularly devoted to the process or maintenance skills that influence organizational life. There is no question that it is easier to scope out the more concrete aspects of intellectual ideas, the clearly achievable goals, or the measurable outcomes of specific projects.

The more ephemeral process domain has traditionally received little attention or training in higher education management, and it is often dismissed as a waste of time. Nevertheless, we have learned that it is feelings that drive morale. In turn, feelings have a direct impact on productivity, absenteeism, and efficiency. At the core of building greater trust is the maintenance of relationships among those who are dependent on each other and who must increasingly rely on shared information and the solution of mutual problems.

At the heart of effective team building are these elements that directly influence how much trust exists. The process or maintenance domain is the mortar that holds together both the intellectual ideas as well as the critical relationships that are necessary for success.

The central goal of the process domain is to define **how** work is accomplished. This demands asking what gets in the way of those working that keeps them from accomplishing organizational task(s) as effectively as possible, while at the same time, maintaining positive relationships, morale, and high levels of productivity? Here is where the human element is factored into the work of the organization. What follows are eight process or behavioral skills that help establish mutual trust.

### **1. Establish a Climate of Collaboration and Participation**

Collaboration and participation is at the heart of trust building within any organization or team. A well-known rule of thumb is that if people are going to be directly affected by an action, then they should have the opportunity to influence the decisions surrounding it.

### **2. Create an Atmosphere of Support**

This is an important step toward reducing the typical adversarial relationships spawned by the natural competition found in most academic settings. At a system level, breaking down the influence of autonomous silos can be a major step. At a very practical level, it is possible to reduce such natural divisiveness by establishing ground rules and working norms that contribute to a positive atmosphere driven by ideas and the search for common ground rather than by criticism and judgments.

### **3. Develop Conflict Resolution Skills**

If people are to begin trusting that they can speak the truth, deal with real differences, and not fear retribution, they need to understand how to resolve conflict. When people fear conflict, the best and most necessary conversations will never reach the table. This is not to say that conflict should be avoided. Rather, it needs to be encouraged and managed through the development of basic tools for effective listening, problem solving, and decision making. People do not wish to be condemned or made to feel stupid. Trust is increased when participants realize they can survive and prosper from a variety of healthy conflicts that are bound to arise when differences surface. In the win/lose climate that prevails in many academic settings, humiliation and intimidation often outweigh thoughtful listening and effective problem solving.

### **4. Improve Listening Skills**

As mentioned previously, listening is often a skill in search of an audience since winning a point is often more important than exploring all the dimensions of a new idea. Listening is a most critical skill. By establishing simple ground rules and structures, trust is almost immediately influenced when all have their say and, equally important, believe what they have said has been heard. Research shows that within a typical group of 10 participants in an open discussion, 3 people will tend to dominate the discussion. Put the same people in another group and they will tend to dominate again, regardless of the change in topic. The result will be a withdrawal from the discussion of the other voices with ideas of value. This, in turn, will lead to a resulting disillusionment about the quality of decisions made by the group or, for that matter, by the organization. The first job of any facilitator wishing to build ideas or open a discussion is to equalize participation and to utilize the brainpower in the room. More often than not, this is a design issue where a little structure can ensure that ineffective group norms or procedures, personal needs, or the overzealousness of an individual or two cannot reduce the possible participation of other resources within the group. The problem, of course, is that the three who have been accustomed to dominating discussions will not give up their control without a fight.

For example, something as simple as the use of a “nominal technique” (see page 2.145 in Part 2) can completely shift the dynamics of a group, ensuring full participation of all individuals. In this design, participants are asked to write down their ideas on a topic in advance of any discussion. Ideas

are then solicited one at a time around the group with each idea being posted. Unlike traditional brainstorming, the quickest thinker doesn't "win," leaving other erstwhile participants in the dust. Once all ideas have been gleaned from the group, an open discussion can be encouraged. Listening becomes one of the important offshoots of the discussion.

A second example of structure that promotes listening is to suggest that individuals cannot express a second idea until every person in the group has had the opportunity to respond to the first idea raised. Such a simple structure requires little facilitation, demands greater listening, and, at the same time, can foster greater involvement. All of this has a direct influence on levels of trust. Once again, the second part of this book is dedicated to specific design strategies for engaging people actively in issues that influence them.

### **5. Develop Effective Feedback Skills**

Without feedback, change is perceptibly more difficult. It is the key to individual and system knowledge of process issues. Effective feedback allows us to determine which issues block organizational effectiveness. Furthermore, it enables us to identify blocks to progress and helps monitor whether progress is in fact occurring. Without it there can be no effective accountability. When members of the organization witness people soliciting and then utilizing feedback, it enhances the credibility of its leadership and expands the trust so essential to any change management effort.

### **6. Understand the Willingness of People to Take Risks**

This is a measure of how open individuals are to engage in new ideas, how concerned they are with the judgements of others, and how willing they are to explore the future. At the heart of risk taking is the degree to which the fear of failure or rejection inhibits the group's ability to engage novel ideas and for individuals to speak their truth even when the idea might not be popular. Risk taking demands that individuals trust themselves sufficiently to test their ideas. It presupposes that they will be judged for their idea, rather than for their person—an assumption often heard verbalized, but one that all too often leaves us disappointed.

### **7. Treat People with Respect**

Mutual respect will determine if people will give feedback, speak the truth, or share their ideas. If individuals can't trust that they will be treated with respect, it will be difficult to solicit information or to explore the kinds of process issues influencing either productivity or morale. Universities and colleges are institutions where great gaps exist in status, pay, degrees earned, perceived contributions, and entitlements. Yet, if treating people with respect is not highly valued, it will, paradoxically, be difficult to explore.

### **8. Be a Likeable Person**

Having affection for the person, the unit, or the institution can be a catalyst for building trust. The old saw "I don't have to like you to work with you" is probably true. However, when we like to be around a person, enjoy their company and their style, and care about them as an individual, there is an increased desire and inclination to trust them. Similarly, having fun, responding to humor, and acknowledging people's good work can create channels through which flows affection and ultimately trust.

Simply said, these eight processes or behavioral skills are among many skills that help higher education managers to establish or build mutual trust. They will go a long way toward achieving lasting change management goals.

## Trust Is Relative, Not Absolute

When we speak of trust being the outcome of a wide variety of independent variables, it implies difficulty in attempting to define its makeup. There are quite literally hundreds of specific factors that can undermine one's personal effort to build trust on a team or within a larger organization. Where does initiating a malicious rumor go, or using sarcasm as a weapon to minimize an individual's contribution, or being unwilling to own a mistake? Our effort here is to increase your awareness of how conscious a leader must be of the influence trust can have on any process of change. The very fact that trust is such a complex concept suggests that you don't suddenly have trust. Instead it is an ever-changing reality that must be nurtured and attended to continuously.

Returning to the example of the university Steering Team (see Section 4, page 1.49), the two, three-day retreats with 14 lay leaders were designed to increase trust among these leaders and across the institution. Trust was facilitated by:

- Learning the content and technical skills of long-term planning together, thus creating a common language of change.
- Establishing clear goals and roles for themselves and others within the context of planning.
- Clarifying the authority that would belong to the steering group and others as the planning effort proceeded.
- Communicating, often through the steering committee itself, information surrounding the planning effort to other interested constituencies.
- Practicing effective collaboration techniques and training the group itself in these very particular skills.
- Increasing support and reducing the adversarial climate that had for so long existed.
- Expanding the skills within the steering group to deal with long-standing conflicts and, at the same time, providing the practice necessary to increase the capacity of the group to deal with conflict in the future.
- Creating a climate where feedback became a normal part of the group work together so that interpersonal issues would not fester.
- Establishing the norm within the group that a language of respect for each person would be demonstrated so that differences of ideas would not be personalized.
- Developing opportunities for the participants to have fun together and get to know each other as people and not stereotypes. The informality and good humor of the program increased the desire for success and provided renewed optimism.

By paying attention to the specific areas where trust could be influenced, it was possible to systematically build trust within the steering group. Trust grew from working on real tasks and building on real successes.

Any group willing to put the time into forging these kinds of positive working relationships can achieve the same results. Our experience suggests that sitting around a table with an agenda being squeezed into a limited period of two- or three-hours virtually never allows a group to deal with its unfinished business or to build trust. The result is that most working groups are fraught with unresolved tensions, frustrations, and little hope of breaking the cycle of normal, unproductive behaviors. Without permission to infuse into the group the skills, tools, and experiences necessary to move the group to another level and to take the time necessary to do it, trust will typically remain low.

## Summary

How often does a committee or a task force undertake a highly charged assignment among a group of individuals where there are long standing differences and unresolved conflicts? How often does a campus begin a planning initiative when there is palpable mistrust among the leaders expected to lead the process? How often do those participating in change efforts not have the content or process skills essential to move the team or group forward? And, how often do individual members of such groups fail to show respect toward each other or other groups on the campus? In our experience, all too often. What we know is that if steps aren't taken to deal with unresolved tensions and to build trust in the group, the work of the group will only act to exacerbate the already existing tensions.

The limited time availability of individuals and the all too predictable rush to perform tasks often negates even the possibility of building trust among those present. The result is the generation of premature solutions (often logically reached) without the "buy in" of the participants themselves. The danger in creating change among intelligent participants is not that good ideas will not be created. It is that the time won't be taken to create the necessary foundation of trust so essential to the effective implementation of these same ideas. Without the skills to create the collaborative strategies for problem solving and the structures necessary to ensure the listening and respect necessary to build the trust, risk taking, candor, and feedback so necessary to any change effort will remain low.

Following is our straightforward *Trust Survey*, which is designed to provide you and your team, or organization with an easy-to-read assessment of how much trust exists in a group or organization. From the survey you will discover what areas need to be bolstered to ensure a more positive climate, which is so essential to support necessary change. The survey should also provide insight into the specific areas of a) content knowledge, b) management structure and discipline, and c) process or maintenance skills and behaviors that need attention as you move forward. Leaders that have the courage to ask these hard questions, and, then to act on the resulting data, will have greater opportunities for success.

## Trust Survey

**Directions:** Each of the following 19 statements reflect an aspect of trust which can directly or indirectly influence efforts at conducting successful change. Please determine the degree to which each is present in your group or organization on the 10-point scale to the right of each statement. In each instance, a **high score (8, 9, or 10)** suggests that there is **ample supply** of the quality described. On the other hand, a score of **1, 2, or 3** indicates that you believe **little of the quality** appears to exist. While any such list can be expanded or reduced based on the unique factors present in a team or the organization, the following questions in this survey have proven to be particularly valuable within settings of higher education. By answering each on a 1 to 10 scale (with 1 being low and 10 being high) it is possible to gain a simple measure of overall trust as well as the particular factors that may be posing problems.

**To what degree does/has the group or organization: [Indicate a number from 1 to 10]**

1. Have the content knowledge necessary to conduct the desired change initiative?
2. Have the technology necessary to conduct the desired change initiative?
3. Clearly defined attainable goals with which to guide the change initiative?
4. Clearly defined roles among individuals leading various aspects of the change process?
5. Established well-defined responsibilities and the requisite authority to carry them out?
6. Reward and recognize participants in the change process appropriately for their efforts?
7. Hold individuals measurably accountable?
8. Accomplish the tasks to which they commit?
9. Communicate effectively to various stakeholders?
10. Communicate the change effort both information and progress?
11. Involve essential constituents through the effective utilization of collaborative strategies?
12. Create a climate of support and cooperation that minimizes self-interests and silo thinking?
13. Have both the skills and will necessary to deal with past and present conflicts influencing trust?
14. Have the skills and inclination to be effective listeners so that participants truly feel heard?
15. Have the ability and desire to utilize feedback?
16. Been effective at both an individual and group level?
17. Have created a climate that promotes risk taking without the fear of retribution?
18. Established a climate that demands that respect is shown to all participants?
19. Provided the opportunity for the kinds of involvement that encourages building affection and care?

### Interpreting the Results of the Survey

The Trust Survey provides a first look at the level of trust that exists in a group or organization as it undertakes a change initiative. It is not meant to be a definitive analysis. Rather, it can isolate particular areas that need addressing. It is not unusual for three or four of the statements to be scored relatively high (suggesting an abundance of those particular qualities) as well as three or four which are, on average, scored low (suggesting a less than desirable amount of those particular qualities). In the case of the low scores, it might be wise to solicit additional information in order to gain a further understanding of each.

For example, imagine the following array of scores from a 30-person division embarking on a process to reorganize their current management structure. In such an effort, one would hope that both listening and the willingness to risk would be high.



**Item # 17.** Have created a climate, which promotes risk taking without the fear of retribution.



If one were to take an average of the scores shown (5.9), the inclination would be not to be very worried. However, looking at the distribution of scores across the line, it is easy to see that more than a third of the participants do not feel heard, while an equal number have registered very high scores. One can only imagine the tension that might exist between the two groups and the repercussion such scores would have for the necessary dialogues that must occur. This pattern is underscored when looking at the array of scores for the question on risk taking. Again, the mean score belies the obvious split among the members of the division. What we don't know is what specific factors are causing the mistrust that must attend such scores. What we see is an even more polarized situation when it comes to the willingness of people to risk. It is our experience that when individuals score below four on a 10-point scale it needs to be taken seriously. Even scores in the 4 to 6 range should be of concern to those initiating the change effort.

Since this diagnostic tool is not meant to provide more than a sense of the factors influencing trust in this particular situation, it would be wise to probe further. Thus, it might be helpful to develop an additional brief questionnaire or consider some straightforward interview questions. For example, the following questions might be on such a questionnaire:

Please suggest three things you would do to increase our ability to listen to each other as we move ahead in our change efforts.

1. \_\_\_\_\_
2. \_\_\_\_\_
3. \_\_\_\_\_

What several factors do you believe hinders people in our division from being willing to take risks. Please be specific.

1. \_\_\_\_\_
2. \_\_\_\_\_

Our point is that an instrument as simple as the Trust Survey may point in the direction of problems that need to be addressed or to the notion that more specific data need to be collected. By soliciting additional, anonymous information, leaders have the opportunity to design tailored interventions to help increase the trust in the specific areas identified.

By utilizing this approach to the exploration of the factors creating or minimizing trust, leaders of change have the opportunity to develop clear, new choices for strengthening the climate of change.

We have found that when averaging the scores over the 19 items, you may wish to consider the following. An average of 1 to 4 suggests a dangerously low level of trust. Symptoms probably include:

*(continued)*

passive behavior on the part of most participants, a few dominant individuals representing the ideas of “their” factions, a lively underground where most meaningful discussions occur, a strong aversion to real conflict, and sharp language among proven adversaries. The organization depends on a few powerful figures.

Average scores of 5 to 7 reveal considerable caution and a limited willingness to risk among most participants with an inclination to “make nice” rather than deal with real differences. The task or goals may be clear and meaningful, but there is little faith that much that is significant will be derived from the change initiatives. While conversations will occur, there will be little faith in a collaborative result. Unlike at lower levels of trust, intransigent, silo-based behaviors can begin to give way to system thinking, although self-interest still dominates.

Average scores of 8 to 10 reveal a healthy interest in shared communication and collaborative problem solving. Individuals freely speak their minds, yet listening and being heard in a climate that minimizes competition is evident—even when differences are strong. Goals are clear and meetings are well designed in order to utilize the value of those present. Time is taken for course corrections and to deal openly with issues arising out of content or process issues. Feedback is given early. Efforts are made to know each other beyond the formality of the group.

#### *Final Note*

We would like to reiterate that, perhaps, the best use of the Trust Survey is for identifying specific areas of mistrust that exist and need to be addressed if your change initiative is to avoid unnecessary problems. All change will engender resistance: it should be expected. However, by reducing as many as possible of the factors that inhibit trust, you can help make the change process less arduous in the long run.

BEST COPY AVAILABLE

## CONSTITUENT ENGAGEMENT IN THE CHANGE PROCESS

---

A review of recent literature in the area of change management and new business strategy leaves the indelible impression that customer service and consumer opinion represent the most significant drivers of change (Hope and Hope 1995, Treacy and Wiersema 1995, Ostroff 1999). The fact that this represents new ground for higher education is both a challenge and a fertile opportunity. Removing the student/consumer stigma should be relatively easy. There is no question as to who is in charge. The faculty expert should be the driving force in the classroom.

Rather, the issue revolves around several questions. Who cares? How do we attract the student to the classroom and, for that matter, the campus, in the first place? Hallowed ivy walls and historical reputation are no longer sufficient. The consumer (parents and students) is doing more comparative shopping for price, for content, for professor competence, and for career relevance. If people don't come to the institution of higher learning or if they choose to leave in the first or second year, an intellectual debate as to whether the student is a "client or customer" is a moot point.

Treacy and Wiersema's business model creates a language that appears to have relevance to this point. It is their contention, after studying 80 market leading organizations in more than three dozen markets, that the most successful organizations were measurably more effective in at least one of three areas—all of which have direct applicability to higher education's way of doing business. They are: 1) operational excellence, 2) product leadership, and 3) customer intimacy.

Treacy and Wiersema found that successful companies need to pay attention to all three elements but usually focus on one at which to excel. The best practices mentality is slowly, but nonetheless inevitably, moving ahead and changing such institutions from being arrogantly complacent and nonresponsive to ones that are increasingly sensitive to the changing nature of the competitive marketplace. In higher education, with the natural separation of the administrative and educational functions, there are opportunities to work in all three areas and to reap real gains in each.

Together the three elements rest on four truths that colleges and universities never had to pay attention to 20 or even 10 years ago.

**Truth #1.** You must be cost conscious, and it is not going to be possible to raise prices every time costs go up. The marketplace will not tolerate a continued escalation of prices. Those institutions with the ability to contain costs will have a market advantage over their competitors. People care about cost whether it relates to generic versus name brands in pharmaceuticals, the cost of a Coke versus a generic supermarket brand, or, the cost of a course of study. A difference of \$10,000 to

\$20,000 over a four-year period will certainly turn the head of many a consumer student or their burdened parents (Levine and Curetin 1998).

**Truth #2.** Students, like consumers of all kinds, are tired of paying top dollar and being treated insensitively as a result of inconvenient, slow, or hassled service in course selection, registration, or other student services. Just as faculty must pay attention to their own excesses that never appeared to matter previously, so too they must watch carefully over all aspects of the student experience that could drive students away.

**Truth #3.** Students are increasingly sophisticated and intelligent consumers (Levine and Curetin 1998). They are conscious of the services available at other institutions. They expect the same at their institution—especially if they are paying the same or more for comparable services. In the past, many colleges and universities could ride for decades on their reputation and their unique ways, but this is not longer possible.

**Truth #4.** Whatever the nature of quality is in the major product—educational courses and programs—it can no longer be compromised for the intelligent consumer at current prices. Current content, exemplary methods, outstanding teacher presentations, and thoughtful, meaningful examinations must be evaluated and accountability established. That can be a new challenge for professors who for hundreds of years were rarely questioned about methods, content, or practices.

By breaking the rules and looking at how corporations think in relation to their customers, there are huge gains to be attained by colleges and universities willing to recognize what makes them truly different and tantalizingly similar in the world of the consumer. Let's look for a moment at how each of the areas—operational excellence, product leadership, and customer intimacy—would work in an educational context.

## Operational Excellence

A focus on operational excellence has helped Dell Computers underprice its rivals. By asking similar questions, colleges and universities can focus their attention on ways of streamlining their operational costs. For example,

- How can we reduce costs in supplying products and other basic internal services to students, parents, and other campus constituents?
- How can operations be more standardized across different colleges, divisions, departments, or units in order to increase quality and efficiencies?
- How can all management systems be increased in relation to the speed, reliability, and measurable efficiencies of transactions?
- How can the system begin to support and reward a culture of waste reduction and other efficiencies?

True, long-standing sacred cows such as departmental or divisional autonomy would have to be questioned. But, since all would ultimately benefit from lower costs and being more competitive in the marketplace, the potential advantages far outweigh the limitations. However, it is normal to expect considerable resistance from those whose methods and procedures have never been questioned. Comfort, habit, and the status quo are difficult to overcome when people doing it “their way” without much accountability has been the norm.

For example, the costly privilege of having campus buildings unused and unavailable to

customers in order to provide convenient office space for professors may have no place in a world where cost efficiencies are increasingly important as long as program quality is not reduced. The very introduction of such an economic point of view is heretical to many faculty and some administrators.

Of course, not all colleges and universities will care to take a highly disciplined and aggressive approach to cost reductions. The key is a committed leadership and a faculty and staff that begins to own a view that lower costs are a shared responsibility and can help ensure the possibility of redirecting internal moneys to improve the quality of other institutional products and services. From a purely business perspective, it can be seen that the larger the margins, the greater the choices available for all members of the educational community.

## Product Leadership

Higher education institutions can utilize product leadership characteristics in a parallel manner to other efforts to improve operational excellence previously mentioned. Relevant questions might include:

- What kind of inventiveness and resulting product development would enhance the quality of the core institutional products (courses, programs, methods) and, at the same time, increase cost effectiveness? This, of course, would have to be accomplished without compromising the quality and content of the educational process itself.
- How can the nature of the business structure change to take greater advantage of new opportunities?
- Are there new management systems that could be implemented across the institution that would allow individuals to take measured risks and develop valuable new ideas without the threat of harsh consequences?
- What steps would have to occur to encourage greater creativity and innovation on an institutional basis?

Many colleges and universities have been stuck in old models of participation. To change these ways of doing business demands leadership of a new kind, rewards for risk taking and inventiveness, and a climate that supports change rather than the status quo (Troutt 1998).

## Customer Intimacy

We have found that the strongest loyalties of students to their colleges or universities are not to fancy buildings or the latest technologies. Rather, they are tied to the quality of the relationships between students and faculty as well as administrators and staff. DePaul University, The College of New Rochelle, and Saint Joseph's University, all tuition dependent, each has maintained high enrollment, retention, and student satisfaction levels because they have paid attention to the quality of student relationships, student services, and teaching. It is part of their core values and essential to their survival.

On the other hand, for years, at many institutions, students were not viewed as customers, and the services outside of the classroom were inefficient, time consuming, and often impersonal. The loss of good will and the building resentments were often translated back to parents or resulted in acting out indirectly or directly against the institution itself. The absence of meaningful core values

results in a lack of ability to focus on acceptable behaviors across the institution and results in an inability to provide measures of accountability. Unless there are consequences and such values become part of the fabric of how business is done, the words will be just that, words. Following are questions that might help focus a college or university on customer intimate behaviors.

- What are the processes for resolving student concerns and problems arising from how services are disbursed?
- Does the business structure encourage employees who interface directly with students to have the opportunity to address problems that arise and influence that relationship through their participation in solutions?
- Is it possible to develop systems that can address the special interests and needs of particular student groups that, in turn, can drive a new income stream for the institution?
- Is the institutional culture sufficiently adaptable to meet changing opportunities and needs as they arise so the institution appears responsive to individual groups of special constituent groups?
- Is there a steady flow of data that measures the satisfaction of student graduates/alumni with the products of the university or college? Is there an avenue that ensures a response in light of changing needs and interest as well as changing realities among competitive institutions?

All of these questions relate to the kinds of personal relations and attention that are provided the student, alumni, parents, and other “paying” constituents who can dramatically influence the future of the institution because of the attitudes and allegiances they develop. The idea is to look for creative ways of adding value to their experiences wherever contact is made and, as a result, providing better service in their eyes. The notion is to develop a long and lasting relationship over time.

In a college setting, the relationship begins the minute the person applies to the institution and ends with the death of the alumnus. In few businesses is the relationship as personal or as long lasting. Knowing these groups as they continue to evolve over time and adapting to their changing needs is crucial at many levels. Developing creative solutions to changing problems demands the best data possible and the best understanding of the “customer” at any point in time. One of the amazing facts is that such a relationship can exist for 50 years after the original four-year educational relationship ends. Is this reality part of the mindset of professors, student counselors, housing directors, and financial officers? Alumni bring in millions of dollars to the university or college and continue to support the institution at many levels. In what other business would these people not be honored as customers of long and honored standing?

## The Professor’s Dilemma

Unquestionably professors have the greatest ability to influence the student’s attitudes and overall educational experience. Students remember their interactions with and attitudes of faculty members for years, decades...a lifetime. Yet, based on the reluctance to address such issues, we must assume that faculty often perceive the student only in the narrow confines of the teaching/learning experience and fail to grasp their significance over the long term. What would happen if faculty and administrators would ask and could answer the following questions?

- What about their educational experience do students most value and care about during their school years?

- What remains alumni's fondest memory over time?
- What could be done to improve the value of the educational experience in students' eyes without jeopardizing educational quality or essential content?
- What do the institutions that most rival ours have in these value-added areas that outshines us and where we could improve?
- What is it about us that keeps us falling short in these identified areas of value?
- What would we have to change to increase our effectiveness in these areas?

By broadening the role of each staff and faculty member to understand the student experience at a deep and abiding level, the opportunity exists to enhance it in many ways. One way to ensure that this occurs is to build some of the attending behaviors and ways into the core values of the institution. In that way it is never theoretically far from the mind of either staff or faculty.

In *The Alchemy of Growth* (1999) M. Baghai, S. Coley, and D. White make a critical assumption. They believe that growth—whether in quality, new products, or actual expansion—cannot occur unless a strong operational base and fiscal health have been established. They talk about “earning the right to grow” as a result of hard-nosed decisions made at the front end that are necessary to clean up inefficiencies, redundancies, and ineffective practices. Until this is accomplished, it is impossible to acknowledge what resources the organization even has to utilize in the move toward a redefined and growing organization. Universities and colleges sometimes look upon growth only in terms of number of students. Instead, they must continually consider developing new programs, new revenue streams, new approaches to teaching or training that accommodate the changing needs of society and consequently of their changing student population. Only by continually assessing the relevance of current programs against such changing needs will the institution be able to maintain its position of excellence and its pertinence to its students and donors.

Adapting a sales perspective to the world of education is risky. Nevertheless, it allows us to turn the academic point of view a few degrees and results in a highly relevant point of reference. Baghai, Coley, and White create a new perspective by asking a variety of questions that, if answered, offer the organization new choices or, in their terms, degrees of freedom. By comparing a market perspective to an educational perspective, a college or university's leaders could dramatically influence the change process.

- Is it possible to take the educational programs in which the college or university currently excels and introduce them to other potential students by packaging them differently, by creating strategic partnerships, or by bundling programs in new and creative ways? Thinking this way means garnering the support of faculty and moving them from strictly a delivery mode to a creative marketing one.
- Are there new programs that could be developed to attract new student groups? Here the notion is to work internally across historically separate departments. This assumes that professors have a keen understanding of shifting trends and interests in education and encourage an entrepreneurial approach to the marketplace. A related assumption is that program acceptance and interest depend on capturing the interest of students and then holding them with outstanding content and presentation.
- Are there new and unique methods that would increase student interest, maximize the use of available technology, or allow other approaches that would influence the interest in the program? Being able to do this, and at the same time save cost and time, could add to the

bottom line of the department and the university, thus improving margins and creating further programmatic choices.

- Are there new geographic areas or special interest groups that might form new populations for course participation?
- Is it possible to attract new personnel to your program who might increase its reputation as well as the variety of programs and new offerings available? Businesses and hospitals have few sacred cows in relation to personnel. As universities and colleges accept a more dynamic view of the educational marketplace, they will inevitably loosen their own boundaries and challenge their restrictive and exclusive view of faculty membership. This approach would be stimulated if rewards were at least partially tied to bottom line numbers based on cost efficiencies, financial margins based on attendance, and other variables. Increased numbers would primarily reflect course or program relevance and market interest.
- Are there nonacademic forums or activities stemming from needs outside the traditional educational enterprise that can generate revenue and allow the meaningful application of theory and practice? Stepping outside the confines of traditional academia can be stimulating for students and faculty and allow internship and practicum experiences for selected students. Such dollar-value based programs can add significantly to the bottom line and further increase the choices available to faculty and administrators alike.

There is no assumption that all professors should or would be interested in a more highly entrepreneurial approach to the educational enterprise. In fact, many people who enter academia approach it from a strictly theoretical rather than from an applied sense. Nevertheless, the capacity to broaden the view of what education is in a marketplace that is not constrained by old paradigms is a challenge. The idea is to take advantage of the resources that are available within the educational institution and be in a position to expand the opportunities that are available to professors, students, and administrators as well as outside interest groups. In doing so the university or college would become a place much more reflective of a real world of interest and needs and less the domain of narrowly defined academic interests sometimes driven as much by self interest as by the needs of a rapidly changing marketplace of rapidly changing jobs, roles, skills, interests, and, in turn, demands.

The University of Phoenix may not be appreciated by many academics (Nelson and Watt 1999). However the for-profit university, with campuses in 36 states, is encroaching on the market share of many colleges and universities. Old rules and models do not encumber it. It uses new technology and new approaches to the business of education. It has warts and flaws. But it also reflects a changing marketplace of consumers where students and parents are treated as customers and their needs and interests are taken seriously; where price drives decisions; where accessibility and convenience match other changes now occurring in the workplace; and where the reputation and cost of a degree means less and less to larger and larger numbers of people. Faculties who are willing to take the best and most relevant pieces of the pie they have cooked will find new opportunities for doing what they do even better. To dismiss the concept out of hand is ludicrous since it represents real needs, interests, and, most of all, real value in the eyes of the consumer. The University of Phoenix is changing the rules of the game—like it or not. Eventually, it will mean a revolution in the way many people are educated, how professors are rewarded, and how business deals with students as products of an educational process that will increasingly reflect rapidly changing needs.

Treacy and Wiersema (1995) showed how Atlantic Richfield capitalized on the Gulf War crisis in



1991 and lowered its prices by 10 cents per gallon below its average competitor at a cost of tens of millions of dollars. Its aggressive response to an immediate situation provided an opportunity to differentiate itself while other competitors were scrambling. The result—five years later—was a stronger organization where its return on equity was three times its competitors. Pricing is increasingly an issue with customers, period.

## Summary

Many faculty and administrators stand behind a myth that has evolved over a hundred years. They say that, “Students are attracted to our school because of our high quality teaching and our relations with our students.” The reality is that many students are being driven away from institutions because faculty/student contact is minimal, graduate students teach large sections of undergraduates, machines score tests, and the educational process feels isolated and disconnected (Levine and Curetin 1998).

The research indicates that students and their parents are most often attracted to a particular institution by the “whole package.” Thus, the physical setting, the relations with other students, the dorms, the food, the quality of teaching, the accessibility of faculty, the quality of student services, and the quality of student involvement in the life of the institution are all key elements of the package.

It is, in short, the total picture of how the system comes together to meet the diverse needs of its students. The consumer is at work weighing every level of student support. Considering how these needs are satisfied is one of the keys to unlocking the door of successful change.

## References

- Baghai M., Coley S., and White D. *Alchemy of Growth*. Cambridge, MA: Perseus Publishing, 1999.
- Hope, T. and Hope, J. *Transforming the Bottom Line*. Boston, MA: Harvard Business School Press, 1995.
- Levine, A. and Curetin, J.S. “Collegiate Life - An Obituary,” *Change*, May/June 1998, pp. 12-18.
- Nelson, C. and Watt, S. *Academic Keywords*. New York: Routledge, 1999.
- Ostroff, F. *The Horizontal Organization*. New York: Oxford University Press, 1999.
- Treacy, M. and Wiersema, F. *The Discipline of Market Leaders*. Cambridge, MA: Perseus Publishing, 1997.
- Troutt, W. “The Incredible Journey.” *NACUBO Business Officer*, January 1998, pp. 30-34.

## THE PARTNERING REVOLUTION IN INSTITUTIONAL CHANGE

---

*“Strengths and weaknesses change over the life of a partnership, and they also change based upon the particular circumstances. The college or university must be aware of these peculiarities within each of its partnerships... Living in a constantly changing environment makes these partnerships and staff interrelationships even more difficult.”*

—MAURICE W. SCHERRENS (from his book *Maximizing Service Provider Relationships*)

Change is imminent for many universities and colleges. Traditionally, higher education institutions have taken great pains to establish their independence from their competition. They have taken pride in the uniqueness of their image, their services, and reputation. Such high-minded isolation has also been mirrored internally with both academic and administrative departments being bastions of independence. The result is an educational world that is now being besieged by new opportunities and challenges. The greatest change is an ever-increasing interest in reaching out, communicating more openly, and engaging in the necessary dialogue of what sort of change must occur.

### Partnering—One Possible Answer

Partnering—either within an institution or with another institution—is a notion that is fast developing among higher education organizations. Colleges and universities are joining resources to create benefits and cost savings not possible by one institution alone. Usually necessity drives such partnerships because, without it, the trouble of overcoming cultural and structural differences can prove daunting.

There have been remarkable examples of successful historical partnerships where financial benefits and proximity drew partners into the same orbit. As early as 1925, the Claremont Colleges of California found that cooperation instead of competition made good sense. Over the years, they have thrived together as they never could have separately. Joint library services, a shared medical clinic, student services, and physical plant management are but a few examples of the benefits of their partnering which now save each institution millions of dollars in expenses—not to mention providing extraordinary conveniences. Additionally, one in four students in the Claremont Colleges, at any given time, is taking advantage of the strength of another school’s curriculum. Yet, in spite of the degree of interdependence, each of the six participating colleges has managed to maintain its own uniqueness and sense of individuality.

Other partnerships in higher education have influenced student diversity, created unique vendor relationships, and joined an ever-increasing number of programs and services in providing service in unique and often profitable ways. Even with such examples, until now, the trend has remained cautious and conservative.

In the meantime, in the non-academic world of business, partnering has moved from the fad of the moment to a critical aspect of management strategy. The mergers of the 1980s and 1990s have given way to the greater flexibility of alliances, consortiums, and partnerships of every conceivable kind. The potential benefits and accompanying difficulties are becoming dramatically clear and have strong implications for higher education. Partnering is increasingly perceived as adding a critical dimension to how business will be accomplished in the future.

Entrenched, silo-based campuses are beginning to open their doors to the possibilities provided by this new perspective. This chapter provides a hard look at how partnerships can help, the traps they hide, and the important questions they raise. Such questions must be considered if partnering is being examined on your campus as an important strategy in change management.

### ***A Broad Definition—A Way of Thinking***

The joining of internal or external resources by two or more parties in an effort to increase productivity, efficiencies, or working relationships is our definition of a partnership. It reflects a commitment to work toward mutual beneficial outcomes for each, and it is based on the assumption that it will continue as long as participants perceive it as advantageous to themselves. By design, partnerships are not adversarial or competitive and demand a new level of cooperation and collaboration. Thus, partnering is increasingly occurring with vendors, among departments within an organization, and with similar and dissimilar external institutions. The measure of effectiveness is whether working together provides measurable benefits and allows each participant to maintain its own autonomy while leveraging its ability to meet its primary mission.

### ***Many Benefits***

Perhaps the most compelling reason to consider partnering was raised by Peter Drucker (1999) in his extended observations concerning the challenges of the 21<sup>st</sup> century. He contended that organizations must become focused on their ability to create and to develop their unique, core competencies. In contrast, the decades of the 1980s and 1990s were all about cutting, saving, and creating efficiencies.

### ***Core Competencies***

Today, in a rapidly changing, highly competitive world, there is a need to differentiate yourself from the competition, to develop core competencies, and pay attention to your unique mission. Vision is the key to success. By necessity, this means doing what you do best as much as possible, and letting others do what they do best. That, consequently, frees individuals and entire organizations to focus diligently on their core competencies. They need to focus on what is required to meet the changing needs of the student, and the changing realities of an increasingly fluid educational marketplace, while saving money and resources in the process.

## **Change of Focus**

For educators, comfortable with the traditions and the rituals of academia, it is often difficult to move outside of the predictable environment offered by particular academic routines. Yet, as with everything else, change will ultimately win out. The question is whether or not those involved will be victims of the change or initiators of it. The most difficult challenge is for an individual or a department to focus less on what they want to do. Instead, they need to ask what is it that they should be doing, given their unique abilities, changing demands, and new realities.

## **Maximizing Unique Abilities and Leveraging Resources**

College bookstores, like many other organizations, are threatened by realities that can totally alter their ways of doing business and, for that matter, their very existence. Of the more than 3,000 college bookstores, the 80 largest represent a billion dollars worth of business. Yet, like many other aspects of higher education, these stores traditionally conducted all of their work independently. There was little sharing of ideas or resources and virtually no synergy in terms of working for greater economies of scale. In spite of large revenues, many of these independent bookstores were going out of business, being bought out by leasing organizations that, with larger economies of scale, could turn unprofitable operations into profitable ones.

The following information was drawn from an in-depth interview with Rich McDaniel, recent president of the National Association of College and University Bookstores. In an effort to ward off their own demise, a group of five leaders, representing five of these large stores, created an alliance based primarily on a core competency they had developed. They all used the same complex information system (Ratex, Legacy System) and began to explore ways of leveraging their knowledge of retail-wholesale relations and electronic servicing. As a result, in a period of two years, business valued at \$120 million per year increased to \$250 million. Their alliance grew to 13 stores.

At one point, feeling increasingly confident in their ability to compete, the group went to the leasing organization, who had cannibalized some of their sister stores, and suggested that there was a third alternative to direct competition or being eaten by the lessor. They asked: "What if they franchised their alliance group and instead of competing, became allies?" The result was that they were able to negotiate a number of significant deals that provided efficiencies of scale large enough to provide the lessor with substantial profits, while saving each of the participating stores significant costs and strengthening their individual bottom lines. Paradoxically, having the ability to view their former enemy as an ally benefited both parties dramatically.

Partnerships work if money can be earned, efficiencies can be gained, new modes of operations can be introduced, markets can be expanded, resources can be shared, or unique competencies can be exploited. There can be external alliances to cut costs and bolster weaknesses, internal collaboration to improve communications and solve mutual problems, supplier partnerships, customer partnerships, student and employee partnerships. There is nothing sentimental about the formation of partnerships, but, as we will explore later in detail, any such relationship depends on trusting your partner. The ability to work together becomes significant. In the previous example, those forming the alliance and eventually the franchise had known each other for years and had built relationships based on observed competence, integrity, and friendship. Real issues of trust arose when dealing with the lessor.

## The Courage to Act

Imagine a campus of 29 buildings, over 500 acres demanding maintenance, landscaping, building renovation, new building development, plumbing, and electricity. What kind of partnership or alliance would it require to allow those running the organization to focus on their core competencies—the world wide supply of sophisticated electronic computer graphics and measurement systems? In this case, the operating company Tektronix, Inc. outsourced all of its maintenance, engineering, construction, and other operations related to facilities to a single international engineering firm. The partnership has saved money, and provided time to manage primary operations. The company reduced aggravation and stress significantly by having the courage and will to simply do what it did best and let others do much of the rest.

By asking the hard question, what is it that we do that adds value to our customers, and what are we doing that detracts from that goal, Tektronix's leaders faced a major challenge. Were they willing to test their belief that the organization would gain value if its leaders did what they did best? Taking the challenge immeasurably improved their ability to do their work and to be successful.

Now imagine if every university or college department—both academic and nonacademic—was willing to take such a test and ask: “What is it that we do that adds value to the educational experience of our students?” A second question to ask is: “What tasks fail to utilize the core competencies of those who work here? How many courses would be dropped and how many new ones would be developed as a result of focusing on core competencies? How many services would be outsourced?” Such questions frame the value of partnering by freeing resources and focusing on the clear intention of the organization itself.

## Acting to Fill a Need

Not long ago, a caller on a national talk show focusing on the increasing influence of distance learning was asked what was important to him in an education? He responded without hesitation, “It's cost, convenience, and access. That's it. I don't want to waste my time or my money.” The person was in the military, on active duty, and planned to be fully degreed when he left the service. He wanted to work at his own pace and level at any time he chose— night or day. A multitude of educational enterprises now attempt to meet this individual's specific need to learn without frills and on his or her own terms. Such a call could not have been made even five years ago. Imagine the possibilities and the opportunities. In order to move quickly and responsibly, higher education organizations are partnering as never before.

For example, AT&T sought out the University of Phoenix to develop a program for adult learners who mirror some of the same qualities of our erstwhile soldier. They see a future in terms of virtual organizations with virtual workers where mobility is expected and where anytime learning will be the norm more than the exception. Building special, made-to-order courses where higher education has specific knowledge integrated into the special training needs and formats of the organization will be one central theme of such collaborations. Institutions wishing to develop creative partnerships will find ample opportunities as long as they have the capacity to open their narrowly defined view of lecture-based classroom learning and deal with the needs of a changing work environment. It means that professors themselves will have to be willing to change their own habits and expectations in order to reframe the educational process in a different, more productive manner.

Similarly, AT&T chose St. John's University to build a made-to-order MBA level program in which emerging distance learning technologies are meeting specific customer needs. In this case, a changing work environment has created a demand for both content and logistical guarantees that differ from the traditional three-credit, lecture-based classroom learning of the past. The partnership will prove to be cost effective for the customer, lucrative for the client, and should be satisfactory for both the parties. When it no longer accomplishes these ends, the partnership will dissolve.

## The Shadow Side of Partnerships

The benefits of partnering can be all too evident. They can become intoxicating, easy to conceive, yet, difficult to put into effect. In truth, there are many obstacles that can prohibit the successful implementation of even the most needed and rationally based partnership. Driven by opportunity and bottom line value, success depends both on the concept and on the process of implementation. It is the latter that inevitably poses the greatest problems on the road to success. Truly effective partnerships pay attention to both sides of the equation. Few will succeed without the willingness of the leaders to scrutinize their own leadership and every aspect of the partnership.

When entering a fluid situation where trust is not a part of the historic relationship, it is understandable that the two (or more) parties will often respond out of self-interest rather than in the interest of both. If there is the possibility that the other partner will be self-serving, then why not take a minimalist role and reduce one's possible downside risk? If both partners have such a minimalist or passive approach, both will lose and the relationship cannot be optimized. Dissolution is inevitable.

Because most partnerships are opportunistic in nature, with partners typically being most interested first in the individual benefits of the alliance, there is a natural tendency to be suspicious of the other. Such attitudes take on a self-fulfilling nature, which, quite predictably, results in increased levels of mistrust between both parties. This inevitably results in a short-term transactional view of the relationship. A positive partnership carefully cultivated over time, focusing on the best interests of both parties, is the more workable.

J. C. Henderson (1990) suggests that in highly competitive environments, self-maximizing, self-serving organizations will have a leg up if they can work independently rather than interdependently. It is just such an approach that breeds mistrust and self-protection, and minimizes the very value of a partnership. Failure rates in organizations are reported, ranging from 50 to 80 percent in partnerships, resulting in dissolution of the relationship or acquisition by one of the partners. Such results are not surprising when built-in competition and suspicion are the starting points.

One way to reduce mistrust quickly is to break the self-protective strategy. One study (Gulati et al. 1994) call this sequential, unilateral commitments, where one party takes a risk that will strengthen the partnership, but without a direct payback to themselves. Other(s) in the alliance see the selfless act, which increases their trust, and a positive self-fulfilling cycle is initiated. This, in turn, leads to reciprocal actions. From this, comes a willingness of all parties to risk and to engage the process more fully and honestly. This is the true essence of both building trust and establishing a workable partnership.

If people believe other members of the partnership are not out to take advantage of the situation, the game changes. Imagine an example of one partner posting a legal bond of \$1 million to be paid to charity if the alliance fails. Such an act is perceived immediately by the other partner as a convincing

sign of commitment and unilateral risk with no expectation of the other. While such a bond may not be realistic, it would be quite possible to promise a partner exclusivity in some areas even though there would be some benefit not to do so. Convincing signs of commitment with no risk to the other partner would include providing important information not normally available, or facilitating something to expedite a particular operation.

A classic example of such a unilateral commitment is the alliance created between United Parcel Service and Hillenbrand, a manufacturer of a wide range of products including hospital equipment (Rackham, 1996). Instead of entering the relationship with a transactional mentality in which the involvement of each partner is restricted by what each feels it can gain from each unfolding transaction, the partners committed themselves to a broader view of the relationship. The result was that each volunteered sensitive information, committed resources beyond what was contractually necessary, and allowed themselves to be vulnerable at various points. They trusted that the outcomes would, over time, justify the risks inherent in such an open relationship. And they did.

## The Boston/Mellon Consortium

This consortium is a perfect example of an alliance that never should have survived and where cautious game theory thinking dominated early negotiations. That they have overcome so many obstacles is to the credit of farsighted leadership, the patience and perseverance of its members, effective design strategies, and perhaps some luck. The potential benefits are still unfolding and continue to grow, as does the trust in each other, and in their understanding of the potential advantages of the alliance. To begin experiencing the benefits was the result of a hard fought journey and a willingness to continually ask a series of tough questions, which provide the basis of an ongoing diagnostic.

Initially, difficulties arose from the fact that some of the original participating colleges had existed for centuries as competitors in the intellectual marketplace. There had been few opportunities and fewer precedents for real cooperation among such competitors until the mid 1990s. While civility and professional courtesy were high, trust and mutual interdependence were low. More difficult were the huge differences among the institutions of the potential alliance. There existed broad-ranging differences in educational philosophy, in fiscal health, in operating budgets—from \$50 million to nearly \$2 billion. They included both institutions of national stature (Harvard, MIT, Tufts, Wellesley, Brandeis) and those with strong regional roots (Northeastern, Babson, Bentley, Wheaton). Five were colleges and six were universities; some were religiously affiliated and others non-denominational. Some had literally built their reputations as unique, stand-alone institutions with personal autonomy and independence being highly valued for their own sake.

In spite of such differences, the challenges of changing financial realities provided a common denominator for all the potential players and drew them to the table. The potential advantages to be gained from reducing costs, creating economies of scale, improving the quality of services provided, as well as the specter of reducing costly redundancies and duplicate programs was incentive enough. The potential leverage gained from more than 130,000 students, 50,000 employees, huge payrolls, and overlapping services were lost to no one.

Clearly, the challenges were formidable and similar to those facing any well-intentioned effort of a group to form a meaningful alliance. Beyond very natural differences among the group, other realities made success problematic.

- The consortium began with the quite practical reality that the chief financial officers (CFOs) represented around the table were hard pressed for time. Many had little interest or time for the details so essential to later success. The reality was that this promising initiative was not part of their own agenda and not on the horizon of those to whom they reported. Lesson learned: *Explaining the benefits of an idea is much more difficult prior to reaching the first success.*
- Early on it became evident that the interest of the CFOs began with problems under their own personal jurisdiction and didn't match the needs of the constituencies on campus that they represented. The result was that they found themselves immediately embroiled with campus politics and threats to other campus stakeholders.
- There proved to be virtually no baseline data or agreed upon reporting categories for comparisons across institutions so that potential areas of collaboration and support could be identified and analyzed.
- All of the issues facing any new group composed of strong leaders, many of whom were not familiar with each other, resulted in responses ranging from competition and skepticism to mistrust and enthusiasm. Lesson learned: *Creating the opportunity for individuals to move beyond hearsay and stereotypes—based on institutional affiliation and personality characteristics—is essential to building trust and confidence in the group.*
- The mixed blessing of such diversity was magnified with the various personal and institutional agendas that came to bear.
- Some of the participants required some sign of the potential of the consortium for back home skeptics and supporters. An early win for these individuals was of crucial importance. Lesson learned: *It became essential that real problems had to be solved as evidence of the consortium's viability.*
- Each campus represented a unique situation in relation to openness to the idea and to the level of threat and resistance it would generate. Thus, the personal risk to each of the CFOs was substantially different depending on this and other historical factors, which were very personal to his or her institution.

These problems were not systematically identified and sorted out prior to the development of the consortium. Instead, they evolved a step at a time and formed a tangle of difficult problems that were dealt with in a very unsystematic manner. Most often it depended on the particular issue that gained the attention of the group at any particular time. The group's success and increasing understanding of its own process, however, has laid the groundwork for many other groups struggling with building a cohesive and smoothly functioning alliance.

In an interview with Will Reed, one of the consortium founders, he answered the question, "After nearly five years, what are recommendations you would make, which if followed might have made the journey easier?"

First, there is the need to create an emotional and intellectual commitment to the notion of the alliance. It needs to be strong enough to overcome competing forces of time and priority. Reed felt that, "Unless there are incentives from the beginning, it is difficult to gain the attention and commitment of potential members." Full plates, daily crises, and the fact that few credits are given



for what might happen, can act as disincentives. Looking back, he would have embraced the notion of a \$500,000 initiation fee to show good faith and to provide sufficient funds to handle initial administrative costs, data gathering, and the search for best practices.

Such a commitment would have provided a real solid foundation and legitimacy for other meetings, along with deeper involvement. It would also have created some degree of buy-in from boards that would have had to underwrite such an initial commitment. This would, ideally, have been followed by as much as \$1 million in additional earnest money once preliminary due diligence had been completed. This clear commitment would have made the generation of additional support monies easier and, in turn, would have increased the alliance's early action choices.

Second, Reed recognized that the single largest issue was the natural and expected caution and distrust that existed among various consortium members. However, he observed that the level of trust rose in response to the knowledge and skill displayed as individuals worked collaboratively to solve mutual problems of significance to the group. It was these observations that worked to undercut the stereotypes and biases that initially accompanied this rather extraordinary group of strong leaders. These positive experiences were further parlayed into deeper levels of trust through important social gatherings where individuals could add important dimension to each individual's work image. Reed was adamant that time for informal, non-agenda based gatherings are essential for reaching the level of trust essential to the success of any such collaboration.

Third, early on it was recognized that involving mid-level managers from the various institutions in solving issues that arose was essential to legitimize the alliance and reduce the implied threat it carried for many. The result was the creation of deeper levels of institutional trust. It was at this level that much of the problem solving was to occur and where the ultimate success of the alliance would result—or not. Just as it took time to resolve issues of trust among the leadership group, it would quite naturally take time and involvement of leaders across the various institutions to experience the benefits to be gained from such collaboration.

For example, one of the bastions of independence in such autonomous institutions has traditionally been among procurement officers. These are the dealmakers that take pride in their skills and experience to gain the best advantage for their particular institution. They see their work as almost an art form. Not only was their image threatened, but many also believed their very role was being jeopardized by such institutional collaboration. True, their role would change. However, their importance to the institution would increase through the establishment of effective negotiations across the larger system. Each would have the capacity to influence greater savings and to be part of large scale, system-wide change. Nevertheless, this example could be multiplied many times as the specter of losing value, personal status, or even job security needed understanding and resolution among many organizational units. According to Reed, such unanticipated issues would be important to ferret out toward the beginning of any system-wide collaboration and not after their fears had been allowed to fester and impede the effort.

Fourth, the alliance had to have the flexibility to deal with real issues, important to the life of the alliance, as they arose. While long-term vision and planning are essential, it is the ability to deal with real-time issues that give the members a deeper sense of the importance and meaning of the alliance. For example, a current issue, which had not been on the alliance's horizon, has provided new and significant opportunities, while at the same time challenging old boundaries in new and unanticipated ways. It has to do with the reality that the health care provider used by most of the

individual members was bankrupted. Suddenly, the group was faced with a wide range of choices, some of which had never been considered. For example, in the ensuing discussions, the possibility of self-insuring, which had never been imagined, was raised. Suddenly, the enormity of the opportunity and its implications for cost savings as well as for the field of higher education was laid squarely on the table. It is the capacity to deal creatively with such spontaneous and very real issues that justifies the time and commitment for many of the partners.

Fifth, the consortium members had to determine whether the rather immediate need to establish legitimate leadership represented the best interests of all the members. Without such support, the details of operating such a complex enterprise would continue to fall between the cracks. And it was learned that with such support, the ability of the alliance to communicate, plan, and execute immediately rose to another level which, in turn, raised member confidence and commitment.

## **Trust—The Universally Agreed Key to Partnering Success**

Whether one deals with internal partnering across departments or units or with external alliances, virtually all our research concludes that trust stands at the center of successful partnering. The problem is not the recognition of the obvious. Rather, it is the apparent difficulty of achieving it, or, perhaps, quite simply, the lack of skill or will in attaining trust. The failure of intelligent people to explore issues of trust is difficult to comprehend.

At five different colleges and universities there was a common malady. All engaged high-priced consultant organizations to partner with them in developing sophisticated, multi-level and cross-functional information technology (IT) programs. The client in each case was inevitably dependent on the knowledge and technical expertise of the contracting vendor. The vendors, rather than entering into the various partnerships as a collaboration, ignored the fears of the client, failed to build a trusting relationship, and provided no effective method for receiving and responding to feedback from their client systems. The result was angry, passive, resistant customers who failed to support the program. In some cases, they actively sabotaged the process. While the vendors were at fault for not responding to the need of the partners, the clients failed to demand the levels of required openness and two-way communication essential for success. Whether it was ignorance or insensitivity, the result was costly overruns, mishandled problems, and an IT product that failed to live up to its promises on many levels. The culprit would be identified differently at the different institutions. However, the common factor missing in each case was a process designed to enhance trust and create a collaborative environment where both partners shared the problems of the whole.

## **Building a Climate of Trust**

The Division of Facilities Management of Cornell University has over 1,200 employees and 250 supervisors. In 1993, the organization could be described as a group of autonomous units that mirrored the larger university's historical tendency toward independent, self-governing, decentralized organizations. Since all rewards were decentralized, most were treated as profit centers and had little reason to work collaboratively.

Hal Craft, a former astrophysicist now senior vice president, had little formal training in management, although intuitively he saw the need for greater cooperation and collaboration at all

levels of the university. In it for the long haul, he was determined to create a climate built on respect and trust. He set out to minimize internal competition and maximize collaborative problem solving where it made sense. He encouraged the sharing of information and resources in order to achieve the best results. Craft's solution was to create a revolution in attitudes. Over a two-year period, every supervisor was committed to nine days of an intensive, off-site training program (three separate three-day modules) that was designed to:

- Create a common language of management
- Develop specific skills for collaborative problem solving, understanding how groups function, and creating inventive design strategies for improving meetings
- Explore the latest leadership models that promoted team work
- Establish core values reflecting these skill sets
- Create a performance management process modeling these same values and create measurable ways of developing a new leadership standard through personal 360-degree feedback and ongoing performance dialogues at all levels
- Develop greater skills in the areas of interpersonal and group conflicts.

So the organization would not be dependent on outside consultants for such intensive, personal, and costly training, Craft committed the organization to the development of state-of-the-art management and group facilitation training under Roxi Bahar, his director of administration. She proceeded to institutionalize a sophisticated program that standardized expectations and, at the same time, incorporated the established skills into the daily operations of the division.

One of the benefits of the program was the cross fertilization of ideas and understanding across the various units and, consequently, the systematic breaking down of long-established stereotypes and barriers. Recognized as the best-managed division on campus, the tenets of the program began to spread into different campus departments where facilities personnel modeled the skills and attitudes that were now part of their culture. Without the training across all levels, there would have been no opportunity to build partnering, since the previous relationship reinforced autonomy, widely varying methods of problem solving, and decision-making.

## Implications for Change Management and Partnering

The methodologies utilized to engage all stakeholders in the change effort have been consistent—either within a particular unit, across departments, or within the larger Cornell community. Eight years ago when Craft initiated the program, designed to build trust and greater interdependence among his key leaders, the general attitude among many of them was, “Just leave us alone to do our work. We’re professionals, dependable and competent.” In other words, stay out of our face and things will be just fine, thank you very much. Today, if we consider the dimensions of trust discussed earlier in this book, they represent the standard of how business is accomplished. Even so, it is difficult to quantify exactly how the investment in training and development has had an impact on partnering as we have defined it. Two examples provide evidence from a perspective of both morale and money.

### *The Case of the Beleaguered Police*

Campus police and security units rarely gain the respect they deserve. Cornell police are no exception. Priorities of nearly every kind take precedence over service organizations in general and

the police specifically. With expanding demand and a facility that no longer served them well, the situation had reached crisis proportions, influencing both morale and the quality of the service the group was able to provide. The problem was that in a tight economy, police requirements receive little attention, and there was little optimism that the situation would change in the near future.

In the past, the situation would have, at best, garnered some sympathy and little else. However, in the evolving partnership climate, four members of the leadership team put their heads together with the police chief to develop a plan to expand facilities and to renovate the current structures. Each individual's unit would provide time and materials and draw against profits earned on other jobs. Profit margins had been one of the measures of competence in the highly individualistic and competitive world of facilities management. Having developed greater trust and respect among each other as well as a system perspective, there was little hesitancy to parlay their experience and resources into a gift to their peer-in-need. The net cost of such services would have easily reached \$600,000.

### **The Case of No Fault, No Blame**

In any large bureaucracy, there are always remnants of old problems that are ignored or denied. Suddenly, one day, a problem or problems from the past appear as a dark hole and become a major concern. The result is that someone is likely to be ascribed blame with predictable finger pointing and recriminations. One of these situations happened at Cornell and offers a good example of how a partnering mentality helped to resolve what could have become a rather ugly problem. A good partnership attempts to create win-win situations even when conditions are not equal. Since the relationship is a long-term one, a positive resolution usually matters far more than any particular event.

For a decade, the construction department at Cornell had used a particular warehouse as a storage facility for excess materials, obsolete merchandise, and other commodities not utilized. A new director discovered what amounted to years of such backlog that had either lost value or had become worthless. It was not a pretty sight. While the origin of the problem lay with construction, the problem now resided with the director of the general stores who, like his colleague, was not the cause of what now looked like a \$1 million problem. In the competitive environment of the past, with the focus on blame and independence, rather than cooperation, it would have been the norm for the construction boss to walk away from the problem and leave it for the general stores to resolve. Instead, on their own, the two leaders developed a strategy to resolve the issue utilizing a cross-unit team. More important, the two decided to split the cost of the operation. What could have been a most rancorous situation was resolved. Again, those utilizing cooperation and collaboration subverted traditional win-lose norms. While the dollar cost to each was considerable, the good will resulting from such a mature resolution was priceless.

One cannot mandate the kinds of cooperation revealed in these examples. Cooperation is an end game, built upon a culmination of experiences where individuals consistently show concern about the problems of others. They begin to grasp the notion that what is good for the larger system will ultimately be good for them as well. At Cornell, such trust was cultivated through years of paying attention to the relationships within the group as leadership actions were predictably filtered through hard-won core values. These values helped leaders align their behaviors with their strongly held beliefs.

One of their core values—*Speaking the truth*—legitimizes feedback on a consistent basis in

relation to virtually everything leaders do, whether it's designing and executing meetings, how supervision is accomplished, or how well they partner with other leaders within the division. That value, of course, supports three other core values: *Teamwork, Excellence, and Respect*. It should be noted that three of the four core values described here reflect *how* the work is accomplished, or the process domain. One focuses on the product dimension or on the nature and quality of the work accomplished. In relation to the attention most organizations give to process versus the product or task domain, it is quite often heavily weighted towards the task. The result of such inattention invariably takes a toll on the amount of trust that results and on the level of cooperation that can be expected.

## The Remarkable Five Colleges Consortium

Imagine the creation of a working consortium among a group that includes: Mount Holyoke, one of the most celebrated and oldest undergraduate schools; the University of Massachusetts at Amherst, the largest state university campus in Massachusetts; Smith, the largest liberal arts college for women in the nation; and Hampshire College, arguably one of the most innovative and experimental-based colleges. In addition, to the remarkable reality that there is completely accessible course selection and facility utilization across the five campuses, perhaps the most unique aspect of this consortium is the philosophy of partnership. It embodies much of the theory and applied understanding expressed in these pages. The approach has been maintained consistently over a 30-year period, even though it was born long before partnering was fashionable and before the theory to guide such practice had been formulated.

### **Cooperation—the Cornerstone**

Although efforts to work collaboratively had been underway for more than 50 years, it was not until 1970 that significant strides were taken to utilize the diverse strengths of the partners. A recent interview with Greg Prince, long-standing president of Hampshire College, underscored the key to the success of The Consortium. There remains a fundamental belief in the concept of cooperation. It is not just an idealistic, high-minded, “make nice” abstraction; rather, cooperation is the bedrock upon which every decision is built. As Prince noted, “Achieving any particular goal is not nearly as important as being certain that the effort will improve the relationship among us.” He gave an example relating to the proposed building of an integrated library automation project a number of years back.

Three of the five members were firmly in the camp of a more aggressive, costly and, in their eyes, necessary, strategy. For a variety of reasons, the other two were taking a considerably more conservative approach. Common ground required that the three accept the less progressive strategy. There were no recriminations, no blame, and only the obvious signs of support and cooperation. Nor was there “I told you so” when the other initiative was finally agreed upon two years later. The belief is that the health of The Consortium is built on trust, good will, and a deep and abiding understanding of what cooperation really means. In this case, it meant patience, not winning, as well as listening and understanding the needs of their partners. There was the essential belief that the good of the whole would be served through agreement and unity.

## **The Ultimate Example of Partnering**

There is a paradox. Success comes when change should be the easiest. But, it is also at the time when many fall prey to self-satisfaction and arrogance. In the late 1960s, by creatively pushing against their own boundaries and resistance, the four presidents at Smith, Mt. Holyoke, University of Massachusetts, and Amherst College were able to look at what was missing from the educational equation being provided for by the joint study program of the four diverse institutions in The Consortium. Supported by the common goal of cooperation, they forged an extraordinary alliance where the ultimate sign of good faith was the birthing of a fifth college, Hampshire. Here would be an enterprise offering what none of the other four could—an alternate type of learning institution anchored in individualized programming and a multi-cultural, multi-disciplined curriculum driven by individual inquiry. In a moment in time, the four, thinking far outside of their individual expertise, were able to create change that would represent a larger good and ultimately, benefit them all. Thirty years later the experiment is thriving and all members draw on the success of each other.

## **The Key**

How has the integrity of The Consortium been sustained for 30 years with dramatic changes in administrations, changing needs and demands of the five-member group, as well as the ever-changing needs of the individual member institutions? Prince's response was telling. He suggested that, as each project arises, the group returns to its basic principle of cooperation and attempts to determine the nature of the challenges waiting behind the current "good idea." What would be the sticking points? Would they be diverging values, opposing traditions, differing needs, operational issues, or differing levels of understanding and education? Their own diagnostic of the issue and current reality would shape the structure, tone, and flavor of the ensuing discussion. Continuity and security comes with the knowledge that truth will be spoken, the trust that there is no risk of confidentiality being broken, and the belief that differences will be resolved based on what is good for the group.

The formula has worked for 30 years. In fact, during one 12-month period, three of the five presidents were new. Some came from backgrounds in which cooperative leadership was minimal, when compared to the strong bias of the five colleges. Yet, the basic values were such, and the benefits were so compelling, that there was no crisis, even with the reality that a totally new alignment had to be created and trust had to be regenerated. And that is the fundamental thesis underlying partnering as a principle of work and collaboration. It is the process that will ultimately support or deny the value of a partnership and will outweigh any short-term gain of a project or deal.

## **Creating a Partnering Diagnostic**

Engaging in partnerships is serious business driven by much more than by financial interests. Whether an alliance is being created with a vendor, a consortium is formed with similar institutions, or greater cooperation is fostered with previously isolated departments—partnering is the goal. Partnerships take time to develop and an ongoing commitment to both time and resources. Then, like a garden, time and attention are required to maintain the quality of the crop. To determine whether partnering is worth the effort, answers to the following questions should prove helpful. While some of these questions will be more useful in relation to certain kinds of partnerships,

together they form a powerful lens through which to view the unique nature of partnerships. They also provide a review of the key principles discussed in this chapter.

## The Partnership Diagnostic

1. Is there evidence that the potential partners are open to change and are prepared to embrace the inconveniences and problems inherent in any change of this nature?  
*Partnerships like marriages represent a series of never-ending negotiations and accommodations. There must be early signs that flexibility and openness to the other's view are considered. It is more than likely that the good intentions and potential benefits of the partnership will be insufficient to maintain the relationship if such give and take is not apparent.*
2. Is there basic information that suggests that partners can contribute what they say to the partnership?
3. Due diligence at the front end can reduce unnecessary disappointment later. Here is where the notion of "desperately seeking synergy" raised by Gould and Campbell is relevant. Therefore, are the apparent or promised benefits real or do they represent unrealistic hopes? Can they be measured?
4. Do the aspirations and ambitions of the two (or more) participants in the partnership reflect sufficient mutuality and common direction? Is the vision of each compatible and complementary to that of the other? What is the common vision that can drive the new partnership? What is the "prize" to be gained?
5. Does the partnership open each organization to new possibilities, choices about how it does its business, and ways that it can best utilize its own resources?
6. In light of question number 2, does the proposed partnership allow each member to do what he or she does best, to contribute their core competencies in a manner that enhances the other members, while best utilizing themselves as a resource?  
*One of the most positive reasons for a partnership is the increased capacity of each organization to exploit its strengths while doing less of those things it does not do well.*
7. Which of the following will have the greatest value added for your involvement in the partnership? Please be as specific as you can in terms of the benefits to be gained if a particular category proves beneficial. This list is not supposed to be inclusive. Nor is each item designed to be independent from the others. The idea is to stimulate your thoughts as you weigh the benefits for joining a partnership. What problems will, hopefully, be resolved through partnering?
  - Will it reduce operational redundancies?
  - Will it allow more focus on the utilization of core strengths and competencies?
  - Will it increase specific efficiencies?
  - Will it markedly increase purchasing power?
  - Will it reduce waste?
  - Will it reduce fixed costs and overhead or other administrative costs?
  - Will it create economies of scale in areas such as training, etc.?
  - Will it increase the ability to expand into new markets or engage in other opportunities?
  - Will it increase profits?
  - Will it stimulate innovation, the utilization of new ideas, methods, and products?
  - Will it provide greater access to critical new information and knowledge?
  - Will it reduce response time?
  - Will it increase internal relationships – trust and the ability to work together?
  - Will it increase the customer and marketing base?

8. In light of these benefits, what will be the quantifiable measures of success?  
*Measurable goals should determine whether the partnership holds sufficient advantages. Thus, standards and criteria for measuring success should be clearly defined and agreed upon.*
9. Has a joint feasibility team been established to guide and monitor the transition into a full partnership?  
*This team explores all of the factors that might facilitate or impede the success of the venture once the initial due diligence has occurred and once the benefits have been perceived as sufficient to warrant further investigation of relevant operational issues. Such a group should include "champions" from both sides (those committed to the success of the venture with the status to influence the process).*
10. What are the barriers that could impede the success of the partnership—structurally, functionally, or operationally?  
*The effort to identify such barriers and to propose solutions as the result of some collaborative problem solving can provide members of both groups the opportunity to determine the levels of interpersonal skills that exist and areas of needed improvement.*
11. How are the two cultures different as well as similar? How do the norms, values, and expectations diverge in ways that could deter success?  
*The failure of a great many mergers, partnerships, alliances, and consortia is the result of relationship and operational issues rather than the quality of the ideas or the technical skills required to reach the desired outcomes. Incompatibilities need to be identified and resolved early in the relationship.*
12. How are decisions made? How is authority distributed? What's the relationship between authority and responsibility?
13. How are problems solved? With whom?
14. How are conflicts—differences ranging from interpersonal conflicts, to value discrepancies, to operational disagreements—managed?  
*The last three questions (12, 13, and 14) are the ones that wreak the most havoc when partnerships are still evolving. They are the ones that demand most leadership skill and sensibilities. Here is where style and norms can conflict and where basic relationship skills often appear to be lacking.*
15. Is there a desire among key leaders involved in the proposed relationship to build a high level of openness and trust as a result of "how" they conduct their business together?  
*Without such a commitment to the "process" or maintenance aspect of the evolving relationship, it will be difficult to ensure that effective conflict resolution will result, that feedback will be established as a positive skill and norm, or that individuals will be willing to deal with issues as they arise.*
16. Will there be a commitment to have middle managers and others in the organization that must work interdependently for the partnership to succeed by having the opportunity to hone their own relationships through training and collaborative problem solving?  
*The failure to strengthen relationships systematically at these operational levels often poses a threat to the long-term existence of the partnership.*
17. Does a system of performance management exist where rewards are related to performance and where those engaged in the partnership are rewarded for their participation in it?  
*Employees realize something is important when it is reflected in their performance goals and there are real consequences for success or failure. Goodwill often loses out to any crisis of the day if expectations are not related to performance outcomes.*

(continued)



18. Are there regularly scheduled reviews of the partnership, its goal, and progress by key leaders?  
*Having a troubleshooting mentality within the context of such regularly held meetings would cut off many problems at the pass before they become game breakers. In addition, such meetings will enable communications to remain open and clear.*
19. Are a number of early successes identified to encourage confidence in the partnership and develop credibility among skeptics and advocates alike?  
*Like any other new enterprise, partnerships can take time to become functional and show clear value added. Yet, it is at the beginning that early progress needs to be shown. Without this part of the intentional transition plan, it probably will not occur.*
20. Is data gathering an integral part of the management procedure with outcome-based data as well as process information a regular part of how progress is being reported?  
*One of the mistakes regarding partnerships is not attempting to objectify the reporting of results. Promises and good intentions can look quite different in the cold light of data.*
21. Have the partners agreed upon a small number of core values to which they are committed and act as a means of guiding both how they perform and their operational decisions?  
*The very act of establishing such operationally focused core values can help establish a common cultural foundation that can secure a common standard relating to how the two parties conduct business.*
22. Lastly, is planning a regular aspect of the organizational relationship with a continual assessment of the mission, goals, and vision, as well as tracking the progress of the partnership initiative?  
*Planning provides a structure and legitimacy to any such enterprise. It also ensures a context for the systematic data gathering and regular review.*

## References

- Drucker, P. F. *Management Challenges of the 21st Century*. New York: Harper Collins, 1999.
- Gould, M. and Campbell, A., "Desperately Seeking Synergy," *Harvard Business Review*, September–October 1998, pp. 131-143.
- Gulati, R., Khanna, T. and Nohria, N., "Unilateral Commitments and the Importance of Process in Alliances," *The Sloan Management Review*, Spring, 1994, pp. 61-69.
- Henderson, J.C., "Plugging into Strategic Partnerships." *The Sloan Management Review*, Spring, 1990.
- Rackham, N., Friedman, L., and Ruff, R. *Getting Partnering Right*, New York: McGraw Hill, 1996.

## Suggested Reading

- Dent, S. M., *Partnering Intelligence*. Palo Alto, CA: Davies-Black Publishing, 1999.
- Greaver II, M. F., *Strategic Outsourcing*. New York: Amacon, 1999.
- Hutt, M.D., Stafford, E. R., Walker, B. A., Reingen, P. H., "Case Study: Defining the Social Network of a Strategic Alliance." *Sloan Management Review*, Winter, 2000, pp. 51- 62.
- Marl, J.P. "Competition and Cooperation—Partnering for Success." *The Business Officer*, National Association of College and University Business Officers, Washington, DC, July, 1996, pp. 53 – 55.
- Robinson, R., and Daigle, S., "Important Lessons from CSU's Failed Strategic Partnership." *Planning for Higher Education*, Winter 1999, pp. 18-30.
- Smith, Carla. "Creating a Composite Culture." *Association Management*, October, 1998, p. 34.
- Spekman, R. E., Isabella, L. A., MacAvoy, T. C. *Alliance Competence*, New York: John Wiley & Sons, 1999.

## DEEP LESSONS ABOUT CHANGE IN HIGHER EDUCATION: A SUMMARY

---

Years of experience, including our fair share of failures, and conversations with hundreds of change leaders at colleges and universities across the country have opened our eyes to some underlying lessons about change, all of which have been shared in Part 1 of this book. These lessons are presented here to provide a summation and to reinforce the lessons. While almost everyone embraces the nostrum of change, its actual process is rarely easy or comfortable. But take heart, the process is manageable, particularly if you bear in mind the following.

**1. Pay attention to the process of change. The way things are done is the critical element for success.** We have witnessed scores of change processes that theoretically should have worked. Their purposes were clear; intelligent people were in charge; they invested tremendous effort. Yet, the results were minimal. Why? The pithiest answer comes from a 1999 American Council on Education (ACE) report, *Taking Charge of Change—A Primer for Colleges and Universities*. “Most of the time, institutional leaders are thinking about *what* to do, rather than *how* to do it. Strategy and process are afterthoughts and too often are simply ignored. At the end of the day, the personal, political, and cultural aspects of change—the process—will make or break a change initiative.”

Change leaders must design and organize a process that fits their institution’s unique culture and purposes. Adopting “off the shelf” change models just does not work. A great deal of thought and effort needs to be invested in thinking through how things will be done. The change leader continually needs to ask: *Who* needs to be involved? *What* voices need to be heard? *How* do I engage the relevant stakeholders?

The change process should build shared understanding and ownership throughout the institution. Stakeholders should be fully informed, understand how decisions will be made, be alerted to the implications of decisions, and, most importantly, be informed as to how the change will be implemented and measured over time. All this takes planning, feedback, communication, and the involvement of people from the inception of the designing of the change effort.

**2. Leaders need a support network during a change effort. Develop a support group you can trust.** Senior leadership is often fraught with overwhelming responsibilities, huge risks, and a great deal of vulnerability. Leaders need safe havens where they can voice their fears, share their ideas, obtain strategic advice, and receive emotional support.

The most successful change leaders have a support network they trust and can call upon—perhaps a senior management team that has developed honest relationships, or a small group of

outsiders who care about the leader as a person and will be honest with him or her. It matter less who the people are than that there is a long-term support system in place.

Support systems are not only effective for leaders on top; any change leader in an institution should build a support system. We have witnessed deans, administrators, and even staff creating support groups to test their ideas, share their concerns, and help them through a challenging change effort. As you undertake a change process, you might ask yourself, “What kind of support system do I currently have? What will I need to sustain my efforts over time? Develop a support network—it works.

**3. Learning is essential. Change can be a bumpy journey. A learning attitude is necessary to manage and master the challenges of change.**

Facilitating and nuturing a learning attitude is very important in a change effort. The change process is often exciting, unpredictable, rewarding, frustrating, and anxiety producing; sometimes all in the same day!

We guarantee there will be unexpected results, mistakes made, tensions, and conflict. You cannot control a change process; however, with a great deal of effort, you can manage it. This takes ingenuity, patience, intelligence, and, most importantly, an experimental mindset. Change leaders see the bumps in the journey as opportunities to learn rather than as signs of failure.

In our consulting work, we have been struck by an unusual paradox. We have found that people in many places of learning are not very open to learning about themselves. Academic and administrative leaders must be committed to a “learner’s attitude” during times of change. This is only possible if they work together in a collaborative partnership, sharing information and perspectives and building trusting relationships throughout the institution. Mistakes are inevitable; how we learn from them defines the quality of life in an institution. Change demands that we become learners.

**4. Be able to handle conflict. Conflict management is necessary and inevitable in any meaningful change process.**

On the whole, institutions tend to be conflict averse. In the collegial atmosphere of most colleges and universities, conflict is avoided at all costs. We know conflict is inevitable in any meaningful change process. You will always encounter differing opinions, loyalties, perspectives, and feelings. How you manage the differences will determine the quality and results of the change process.

In *The Leader of the Future*, Ronald Heifetz offers cogent advice in this regard: “People don’t learn by staring into a mirror; people learn by encountering differences.” The leader is responsible for bringing differences to the surface, creating opportunities for sharing and dialogue as well as preventing the differences from harming the institution. This is not easy to do and will test the mettle of any leader. If stakeholders believe that their leaders can manage conflict and make it work for the betterment of the institution, they will have great confidence in what their leaders say and do. Conflict is inevitable. Know how to manage it.

**5. Change leadership is counter-intuitive. Often you will have to do the unexpected in order to manage the complexities of change.**

The most effective leaders we have worked with reacted to difficult situations in unpredictable ways. They tailored their response, reaction, and initiatives to meet the unique needs of the situation. Often their actions didn’t make sense on the surface, but the results they achieved did.

A colleague who loves to whitewater raft provided us with some insight into this leadership characteristic. He explained that when you are rafting and coming directly at a wall on the side of a

canyon, the normal tendency is to lean away. If you do this, the water rushing under the boat against the canyon wall will then rush back against the raft and capsize you! Paddlers must lean toward the threatening canyon wall, which acts to stabilize—not destabilize—the raft. What seems like an incongruous act actually saves the day.

Going against the natural grain can pay dividends. For example, in times of stress, people need more face-to-face interaction, not less. The “natural” tendency is for top leaders to narrow communication, limit information, and rely heavily on technology as a primary source for communicating. But people need to see their leaders and engage them during change. Accessibility is a critical element in a successful change process. Create opportunities for people to interact during change. Be visible and connect with people.

Although most leaders are verbal and articulate, overusing these skills during a change process can be detrimental. When leaders show that they are truly listening to stakeholders, their credibility is enhanced. When people feel listened to, they feel valued and respected. Leaders don't have to dazzle constituents with their speech; they need to listen to their concerns.

**6. The senior management group (president, provost, and chief financial officer) must be a well-functioning team or the change process will fail.**

The president, provost, and chief financial officer must work together as a collaborative team. If these three individuals are not on the same page, the change process is doomed. We have been in several situations where the president and provost outwardly disliked each other. The impact on the organization was devastating. Problems went unsolved, people took sides, and blamed each other, open communication shut down, and secrecy prevailed. In this situation, as outside agent (e.g., the board of trustees, the state legislature) had to intervene for the well-being of the institution. Whenever this happens, the negative residue remains for years.

We have witnessed excellent intra-departmental or divisional collaboration at many colleges and universities. However, when it is necessary to cooperate across divisions and departments, things often fall apart. In this context, it is particularly important that senior management model collaboration for the institution. People throughout the institution are watching this small group constantly to see if they are “walking the talk.”

When stakeholders see that members of the senior management team support each other and are working from a common agenda, they are focused and confident in the future of the organization. Make sure your senior management team is a real team.

**7. Change leaders are “cultural travelers.” They can go anywhere on campus and participate, learn, and listen. They have access to multiple stakeholder groups and are accessible to others.**

The most successful change leaders we know in higher education are “cultural travelers.” These are individuals who can go almost anywhere on the campus and have access to diverse groups throughout the institution. They have a rare ability to interact with and engage different stakeholders regardless of race, class, gender, or education. Because of who they are, these leaders have tremendous credibility across divisions, academic departments and organizational groups.

Being a “traveler” gives them access to ideas, discussions, and people who are invaluable in a change process. They act as bridge builders and translators across different groups. They are good listeners, open to the ideas of others, are able to keep confidences, and always work toward what is best for the institution. Their agenda is neither personal nor political. They work to serve the

common good. These travelers understand the culture of the institution, can tap the pulse of different stakeholder groups, and enable collaboration to take place.

**8. Resistance is a resource. Listen carefully to what resisters have to say and create ways to bring them into the change process.**

Too often we have seen leaders dismiss resistance as a negative force in a change process. Value judgments are made about “those resisters” and a great deal of effort is devoted to neutralizing their impact, even shutting them down. We believe that resistance can be a rich source of information and, when included, can make your change process more effective. Resistance will let you know what’s missing in the change process. Pay attention to it.

We have found that unprincipled resistance—that which is motivated solely by personal gain or the avoidance of loss—is more the exception than the rule. A change leader must be prepared to deal with “unprincipled” people but must also be capable of hearing and benefiting from the perspectives of principled people who don’t agree with the change process.

**9. Building community is a key factor in any change process. People need to feel connected to others in the institution, for their efforts to be leveraged, and for their commitment to be strong.**

We strongly believe that creating community is an essential leadership skill and needs to be “intentionally” paid attention to during a change effort. One of the greatest assets higher education has, is that people working there often feel a connection to something greater than themselves. It can be a tradition of excellence, national reputation, the student body, a stellar faculty, or even a winning sports team! There are many attractions, few of them monetary. Most employees really enjoy being part of the higher education community.

We realize that many believe that building community is the “soft side” of change management. All change models look great on paper, but if people aren’t engaged or committed to successful outcomes, few change efforts will be implemented.

We recently engaged in a campuswide planning process that looked at issues such as mission, academic excellence, diversity, and the future. One of the processes we utilized involved faculty members of the planning council (about 12 faculty members) interviewing non-planning council faculty outside their own departments about some important questions. Although we employed many collaborative practices throughout the campus, faculty members saw this single intervention as the most significant! Faculty reported that it was wonderful to share perspectives and opinions with faculty with whom they rarely had a chance to interact. After the planning process was over, faculty members established monthly breakfast meetings where they could get together with other faculty members to discuss issues. The need for connection and community is vital.

**10. Truth telling must be rewarded. Change leaders must be committed to creating opportunities for people to share their ideas and concerns honestly.**

If an institution is to undertake a meaningful change process, stakeholders must be encouraged to share their ideas and perspectives. As a change leader, you are responsible for creating opportunities to uncover and understand institutional norms, history, traditions, and power. Some of what you will find out won’t be wonderful; you will still have to manage the difficulties.

About half of the institutions we have worked with have had a real reluctance to look at some of the uncomfortable stuff, (“Let’s not talk about the past, let’s focus on the future.” We have had some problems here, but that leader is gone now.” Sound familiar?) Our goal is never to dig into

old wounds, but to learn how things evolved into the present situation. As a change leader, if you don't deeply understand the complexities about power, conflict, and politics your efforts will be minimally successful. The goal in exploring the "uncomfortable stuff" is to avoid making the same mistakes again.

Recently, we were involved in designing a learning model for a large university with little past success in technology implementations. We were asked to create opportunities for the administration to learn from past mistakes. To that end, we held a series of Interview Design (see page 2.9 of Part 2) meeting with more than 100 stakeholders. What we discovered about previous implementation efforts was invaluable. There had been no real leadership buy-in; the leadership didn't really understand technology and saw it as a necessary evil. The efforts had been too dependent on outside consultants. The training was haphazard and not directly related to the actual use of the technology. The faculty was never engaged in examining the direct impact of technology in the classroom, and felt that something "had been done to them." The president went to the faculty senate to communicate the lessons learned and what he intended to do about these in the upcoming implementation. This presentation was well received by a traditionally critical group. People appreciate hearing the truth even if its content is unwelcome.

One organization we consult with holds a quarterly series of focus groups to get the "pulse" of the place. They intentionally talk to those people who are willing to speak the "truth in the face of power." They find it invaluable. Who are the "truth tellers" on your campus?

#### **11. Trust is essential. Trust is the outcome of a leader's actions and interactions.**

Effective change leaders know how to create trust and nurture its growth. Without trust between different stakeholder groups, very little meaningful change will occur. For a change leader, in fact for every leader, character—who they are as a person—is the critical element of leadership effectiveness. People must believe strongly that they can trust you. They must believe that you are honorable in your intentions and in your interactions with them and that you have the highest interests of the institution in your mind and heart. Very little else really matters.

The aforementioned ACE report on change summarizes our views: "Without trust, stakeholder groups will focus on preserving rights and principles rather than taking risks to create a future with the common good in mind." Bottom line: change leaders are responsible for the level of trust in their institutions.

We make 20 presentations a year to different groups that support higher education. One of the questions we often ask the audience is: "On a scale of 1 to 10 (10 being very high, 5 being average, and 1 being very low) how would you rate the level of trust in your college or university?" Participants never have a difficult time giving their institution a number. If the trust in your organization is above an 8, great things are possible. If it is between 5 and 7, you have some real work to do, but over time you can build trust throughout your place. If it is below 4, your change leaders had better focus on building collaboration, creating open communication, listening to people, establishing transparent decision making, and building community. How do you rate the trust in your institution?

#### **12. The more people who understand the reasons for change and participate in the change process, the more successful you will be.**

Engage early and often. In the past, a small group of people (insiders, consultants, and senior management) met, created a change process, and then tried to "sell" it to stakeholders on campus. In

such situations, stakeholders feel little sense of ownership or commitment to the change process. Engagement speeds implementation.

Too often, we get trapped into thinking we need to present a refined model to stakeholders. We have found that this is not true. Now, there are ways to engage stakeholders throughout the institution at the early stages of the change design. For a university that had identified communication as an institution-wide problem, we designed a meeting for 75 diverse stakeholders. They spent about a day looking at the existing state of communication (both formal and informal), assessing the effectiveness of various communication process, and creating ways to enhance each. The result was an integrated communication process that was implemented within 30 days. The group established quarterly benchmarks so they could measure the effectiveness of communication throughout the academic year. A subsequent survey showed that communication improved greatly (63 percent) over the course of a year. One reason for that success was that we had at least 75 advocates for the communication process, because there was real ownership of it. Involvement creates the commitment to change, persist, and endure over time.

**13. Change and complexity are here to stay. Get used to them. Leaders must develop a special set of skills that will enable them to master the complexity and pace of inevitable change.**

The ability to manage change and complexity will separate the winners from the losers in the next decade. A change leader must be able to manage the inevitability and pace of change in such a way that the institution is not overcome by a myriad of forces but is improved by change. This will not be easy.

Change leaders must be committed to creating a learning agenda for themselves that will develop their skills in managing change and complexity. Change leaders will need to learn how to deal with ambiguity, power, conflict, resistance, paradox, and complexity. The list is long and a leader must invest time, energy, and attention to learn this complex set of skills.

We believe that intentional process design and collaborative leadership are strategic answers to managing organizational complexity and change.

**INTENTIONAL DESIGN AND  
THE PROCESS OF CHANGE:**

*Strategies for Successful Change*

**PART 2: INTENTIONAL DESIGN**

by Patrick Sanaghan with Rod Napier



# INTRODUCTION

## *PART 2*

This section of the book offers a selection of collaborative activities or “designs” that have proven to be highly effective on campuses throughout the country. They have been used in: 1) strategic planning efforts that involved hundreds of stakeholders throughout the institution; 2) technology implementations where campus communication, education, and buy-in were essential to the success of very expensive projects; 3) self-studies in preparation for external accreditation; 4) curriculum reviews and renewal with faculty; 5) communication meetings where an institution wanted to listen to and develop positive relationships with neighbors; and 6) large-scale change processes that affected the entire campus (e.g., establishing a satellite campus redesigning a school or implementing a new financial management system). They work.

This section also provides a user guide to the nature of design so that the reader can become an effective facilitator of change. By design we simply mean: “The creative process of planning and facilitating a set of activities that move a group successfully toward conscious goals.”

We use design in our everyday lives. If you were organizing a birthday party for a close friend you would invite specific guests, have certain kinds of music (upbeat), have fun activities planned so that people enjoyed themselves, possibly decorate your home (balloons, ribbons), and have delicious food, including a birthday cake. Each of these elements would have to be planned very carefully, so that you achieve your desired goal of having fun.

If you were organizing a Fourth of July party, you might use many of the same elements, but they would be designed or organized very differently. The same people might attend, but your music selection would probably be quite different; outdoor activities would be planned with a patriotic theme; you might choose a different menu from the festive birthday food; and the decorations would be red, white, and blue.

You might consider that you are organizing a design event with the same planning elements, but with very different purposes. Therefore, each design has very different sets of activities to help achieve the desired outcomes.

As an “intentional” change leader, you have to develop a “design mentality” when planning and facilitating meetings throughout a change process. There are four key elements that every change leader needs to understand and pay attention to when selecting and using these activities. They are: 1) purpose; 2) stakeholders; 3) design; and 4) logistics.

## Purpose

To define your purpose(s), or what it is you want to accomplish at a particular meeting you are planning, is the most important thing you can do in a change management process. It is often the most difficult thing to define. It is helpful to consistently ask yourself, “What is my hoped for outcome(s)?” For example:

- “Am I deciding something or seeking input?”
- “Do I want to share information or solicit feedback?”
- “Do I have a problem I need help in solving or do I want to provide the solution and test its validity?”
- “Do I want to create the opportunity for people to share their accomplishments or their concerns?”

The answers to each of these questions would determine very different purposes. Each of these purposes would need a different set of activities or “design” in order for them to be accomplished.

Once you have defined your purposes clearly, then you can begin to think about whom (the stakeholders) to invite and what the design needs to be. Without a clearly understood and articulated purpose, everything else will suffer. It is the most important thing to clarify.

Communicate your purpose(s) to the invited participants before they attend the meeting.

It is also important to think of “process” goals along with the task or product outcomes. Thus, asking how you hope participants “feel” about the experience being designed could add to your considerations. Such purposes may not be communicated except among the designers.

## Stakeholders

Once you have defined your purpose, then you need to ask yourself, “Who needs to be at this meeting or series of meetings to accomplish the purpose?” If you want to solve a complex problem on

campus, then you may want to have participants who: 1) have some experience with the problem, 2) could be impacted by the problem, or 3) can provide creative ideas and approaches to the problem. These may be three distinctive stakeholder groups.

We define “stakeholders” as those individuals who have a stake in the institution. On any given campus, you can have scores of potential stakeholders, such as faculty, community members, alumni, legislators, neighborhood activists, staff, parents, etc. The challenge for the change

leader is to define and determine what stakeholders must be involved in a change process or particular meeting.

### **Helpful Hint**

**If the same set of players are always getting together to solve institutional problems, you need to expand your view of stakeholders.**

When determining who should be involved, it is helpful to ask some of the following questions:

- Who has the content expertise to help us with these problem or change management issues?
- Who has institutional memory and can give us a sense of history about the problem or our institutional culture?
- Who has political power or “savvy” and can help us map out the sensitive issues that need to be addressed?
- Who has information that would be helpful to us?
- Who has insight and wisdom?

- Who might be impacted by the decisions we make? (Think both short and long term.)
- Who has creative ideas and approaches to problem solving and change issues?
- Are different levels in the organization represented so that we are not looking at the issue from the same perspective?
- Who could hurt us if they aren't involved in the meeting(s) or decisions?

Don't be afraid of large numbers. With a particular issue, you might find that 20 or 25 people are potential stakeholders. The following designs can easily manage both small and large groups. Choose the right people and then select the right design.

## Design

Now comes the interesting part. Once you have defined your purpose and selected the stakeholders that need to be involved, you must select the right design. Make yourself familiar with the range of designs and activities in this book to determine which one(s) will serve your purpose. We have established three levels of difficulty with these designs:

*EASY:* This means the design is suited for a novice. If you read the descriptions of the activities in these designs, and follow the instructions carefully, you will be successful.

*MODERATE:* This indicates some level of difficulty in the design. You should have some experience in facilitating meetings, giving instructions, providing examples, and managing group dynamics.

*CHALLENGING:* These designs need an experienced facilitator or change leader. If you have several years of experience, then you will be successful in implementing the design. Often these challenging designs deal with large groups (50-100) or have several steps to them. None of the designs are overly complex or complicated, but they do take real experience.

## Logistics

Assuming that you have a clear purpose, the right people coming to the meeting, and an excellent set of activities to achieve your purpose, never forget that the "devil is in the details." This fourth element is as important as the other three, but is often neglected. It can spell disaster or failure if you don't pay attention to it.

Logistics involves all the physical things that need to be carefully planned. It is helpful to have your own "punch list" of items for your meeting. For example: 1) flipcharts and easels; 2) magic markers (plenty of them); 3) masking tape; 4) computer connections; 5) paper and pens; 6) moveable chairs. You get the idea. Think through your design and write down all the physical things that you will need to successfully implement your plans.

Some last advice regarding logistics: 1) Show up early, prior to the appointed meeting time. Then, if anything is wrong, you have time to fix it. 2) Make sure you have seen the room you will be using. A diagram is rarely helpful. By visiting it, you get a feel for the room, understand its strengths and drawbacks. We had a meeting in one faculty dining room. The president bragged about how beautiful and large it was. "You guys are going to love this room," he told us. We didn't visit the room beforehand and when we did show up, six "beautiful" pillars blocked everyone's view in the room. It was a great place to eat, but not to meet.

Wall space is your friend. Because many of these activities utilize flipchart paper, you need adequate space to hang the paper. Many rooms have beautiful pictures, sconces, curtains, and candle

holders every two feet. It is hard to hang up paper in a room like this. Make sure you have plenty of usable wall space.

Lastly, because these activities are designed for maximum interaction and participation, they encourage movement. Make sure you have enough space for people to feel comfortable and move around. People don't like to feel cramped, especially if you have a daylong meeting. Remember, a large room can always be made smaller by rearranging chairs and flipcharts, but a small room can't be enlarged. Bigger is always better.

## Additional Advice

Start small if you are unfamiliar with these types of activities. Use our templates (easy, moderate, or challenging) to choose your activity. Many of these designs work very well with small groups. You don't have to tackle the most complicated design or group at first. Start with the easy ones, gain experience, and build your capacity.

Co-facilitation helps. As you begin to try these activities on your campus, we have found that working with a partner helps. Two sets of eyes, and two heads are usually better than one. Besides, it helps to have someone you trust by your side.

Dry runs are helpful. If there is a group of trusted colleagues you can practice on, it will build your experience and expertise. Most people will find these designs and activities very interesting, so even a practice group will learn something.

Do good planning. Review the design carefully and make sure you have dealt with and determined the four elements: purpose, stakeholders, design, and logistics. These are not magical activities. They work because you do your homework. Watch out for "rabbit ears." This happens when a change leader tries something new, such as using small, mixed groups or using flipcharts to capture information in full view. Sometimes a few curmudgeons start to mumble loudly, "We can all talk together. We don't need these small groups." Or "What is this touchy-feely stuff? What's going on here?"

These types of comments can strike fear in the heart of a change leader. It takes real courage to handle the mumbles and not react quickly (like a rabbit) to appease the curmudgeons. These activities have been tried and proven with thousands of people throughout higher education and plenty of them were curmudgeons!

## Collaborative Principles

Each of the designs in Part 2 embrace certain collaborative principles, which include the following:

**They are open.** Participants can clearly see and understand what is taking place during the activity. You cannot have a hidden agenda with these designs because you cannot control the outcome.

**They are transparent.** Decision making is visible and clearly understood by every participant. People know how a decision will be made before they start the activity. Many of these designs utilize democratic decision-making tools, where everyone can influence the final outcome.

**Participants manage their own work.** These are not expert or leader-driven activities. Participants take responsibility for organizing themselves, sharing information, and distilling

meaning from their work. “Outsiders” don’t try and control them or interpret what they produce. In short, they manage themselves as adults.

**Designs tap the resources within the group.** There is a clear assumption that a great deal of talented people work in higher education. These designs are excellent at utilizing this talent and building organizational capacity. We have had scores of faculty members tell us that they use many of these techniques in their classrooms.

**They are organized for maximum participation and interaction.** These designs utilize small groups, create opportunities for participants to work across institutional boundaries and neutralize the impact of dominating or powerful individuals. Participants will feel energized and well used with these activities.

**Designs create real learning.** They value learning and discovery. When people on campus are given the opportunity to share ideas and perspectives, listen to each other, and solve complex problems, learning is an outcome. Participants often report that each time they are engaged in these activities, they learn more about others, the institution, and the complexities of managing a campus.

**They embrace diversity.** A diversity of ideas and perspectives are needed to manage the pace and complexity of change. We need more ideas, not less. We need creativity, not status quo. We need variety, not the same old players at the table. These activities are organized so that many voices are heard, a variety of perspectives are shared, and differences are tolerated.

**Designs build community and connection.** Although all these designs are task and outcome driven, they pay attention to the process domain, how things are accomplished. By utilizing different group structures, open communication, and democratic principles, positive relationships between participants are built. Participants feel connected to each other when working together to improve the institution. They gain confidence in their and others’ ability to solve complex campus problems. When you have a positive community feeling and talented people, almost anything is possible.

It is important as a change leader to understand and, more importantly, agree with these principles. If they don’t philosophically match your way of doing things, they will not work. Good luck!

## SECTION 1 | **Data Gathering and Diagnosis**

Before and during a change process, the change leader needs to assess progress toward goals, solicit feedback from stakeholders, discover problems and issues, and distill learning. This is not easy to do.

Relying on surveys and questionnaires will rarely give you the quality information you will need to make wise decisions. These traditional vehicles of assessment are usually met with skepticism, “Here we go again with another survey. What do they do with this information anyway?”

The four designs in this section will solicit excellent information from participants and will engage, and even excite them. They help create openness and provide strategic information that is critical to effective change management.

### Interview Design

This activity is one of the most powerful, engaging, and outcomes-based meeting designs in the fields of change management and strategic planning. It can be used as a diagnostic tool to assess institutional progress and issues, or as a vehicle for obtaining feedback, advice, and creative ideas. It works well with small groups (of 10) and with very large groups (of 100). It is a classic design that works very effectively.

### The Carousel Design

This activity is a highly interactive and efficient meeting design. It creates immediate information in full view of everyone who participates. It has high energy and focus, and can be done with groups of 10-40 very effectively.

### “Engaged” Interviews for Leaders Design

This design enables senior leaders to model collaboration and commitment, and develop listening skills. It can indicate to stakeholders throughout the campus that the senior leadership is serious about the change process and open to the ideas of others.

### Customer/Stakeholder Feedback Design

This activity provides a unique way of listening to your stakeholders and builds a positive relationship at the same time. Participants feel valued for their input, and tend to provide honest and strategic information for the institution.

BEST COPY AVAILABLE

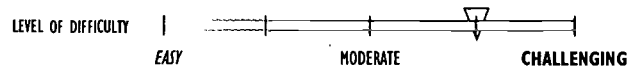

# INTERVIEW DESIGN

## I. Goals/Outcomes

1. To gather information from relevant stakeholders about key issues regarding a change process
2. To ensure the full participation of everyone engaged in the activity
3. To prioritize a large amount of information into “chewable chunks”
4. To begin to identify organizational issues that need to be dealt with effectively during a change process
5. To understand how to generate alternative solutions

## II. Background/Context

This design is one of the most powerful, engaging, and effective meeting designs we know. It is one of the classic designs that has been around for many years, and has stood the test of time. People who have experienced it report that they believe it is one of the most interesting, collaborative, open, and strategic meetings they have ever participated in.

The interview design can be used at the beginning of a change process and during a change process to diagnose or benchmark progress. Or it can be used at the end of a change process to distill lessons learned. As long as you have the right purpose, great questions, and the right people in the room, you will be amazed by the results.

One of the things that makes this design so effective is that you can use it with large groups of 50 to 75, or even 100 participants, and it will take the same amount of time. It is impressive to see 100 people working together collaboratively, sharing ideas and information, and creating prioritized and strategic information in about 2 hours. The interview data is undeniable because it is collected with everyone’s input and in full view of everyone.

This design creates a somewhat difficult logistical challenge (i.e., moving people around) and needs some upfront planning to be successful. It is well worth the effort.

Another key to the effectiveness of this design is the creation of engaging and interesting questions. It is most effective for the change leader to work with a small group of people who know the institution well and craft the right questions. This way you ensure that the quality of the

questions is top notch.

The following are some sample questions you might use at different stages of the change process. These questions are generic, but will yield valuable information.

1. Before starting a change process (seeking advice)
  - A. What is some advice you would like to give the president as we begin this change process?
  - B. How would you like to be kept informed during the change process? Please be specific.
  - C. What are your major concerns regarding this upcoming change process? (What makes you nervous?)
2. Sometime during the change process (diagnostic)
  - A. What is the “word on the street” regarding our change process? (can be positive or negative)
  - B. How can we further improve collaboration throughout our campus?
  - C. How would you rate our communication system? Any suggestions to improve?
3. After a change process (distilling lessons learned)
  - A. As you look back over the change process we have been engaged in, what are three things that went well?
  - B. What are three things that went wrong?
  - C. Was communication effective during our change process? Why/Why not?
  - D. If we were to undergo the same process tomorrow, what would be the most important thing we need to be aware of? Why?
4. Other questions you could use for different purposes
  - A. What are the strengths of our institution? What do we do well?
  - B. If you were to describe the quality of our campus life to a friend, what would you say?
  - C. What are the norms of this institution? (these could be constructive or destructive)
  - D. What are three things that keep us from being excellent?
  - E. What are three suggestions you could make to improve institutional morale?
  - F. If you were the president, what are three things you would change on campus? Why?

One of the key elements of this design is to create engaging, informative, and strategic questions for participants to answer.

### III. Logistics

Materials: Flipcharts, markers, notepads, pens, and moveable chairs

Space needs: Very large, comfortable room

Time frame: Approximately 2 hours

Number of participants: 10 to 100



## IV. Implementation

We will use 50 participants as a model for this design.

1. The room should be arranged in pairs of rows facing one another. In our working example we have five questions and 50 participants. The room should look like this:

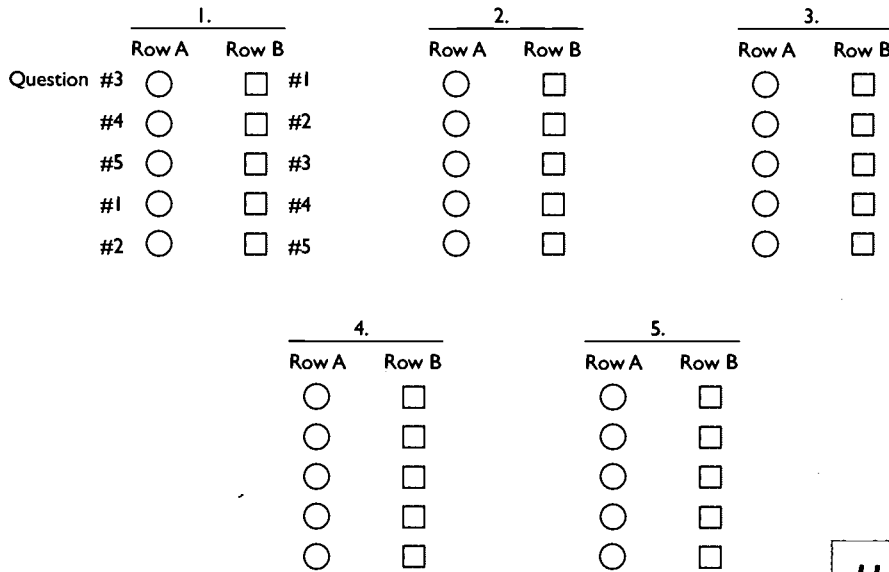

2. The facilitator welcomes participants, explains the purposes of the meeting (e.g., “To diagnose where we are in the change process” or “To seek your advice before we undertake our change project” or “To distill lessons learned from our recent change process”). Each participant should have a pen and note pad.

3. The facilitator then “walks” participants through the logistical directions of the Interview Design. They are:

- A. The participants in Row A will start the interview process. They will ask their “partner” across from them their focus question and record their partner’s responses for 2-1/2 to 3 minutes.

**Helpful Hint**  
 It is important to stagger the questions in Row B so that when you begin the process participants are not asking the same question of each other.

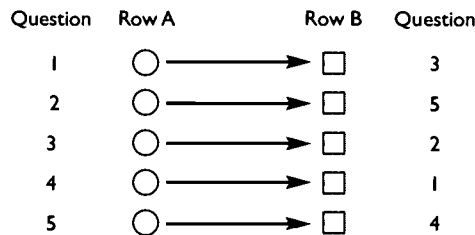

- B. Then participants in Row B will ask their partner their focus question and record their responses for 2-1/2 to 3 minutes.

BEST COPY AVAILABLE

C. After Rows A and B have asked and answered a question, that is the end of a “round.” People in Row B move down one seat, and one person at the end of Row B rotates to the other end seat.

**Helpful Hint**

People in Row B, who move, should remember to bring their question with them.

You now have a new partner with a new question, and the original process continues (i.e., Row A asks their question and records it, then Row B asks their question and records it). You will continue the “rotating” seats until all the questions have been asked and answered. At the end of approximately 30 minutes, every person will have been interviewed five times and they will have interviewed five people.

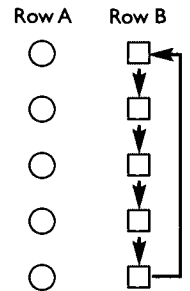

**Helpful Hint**

If you have “extra” participants, (e.g., 52 people instead of 50) put them on the end of one of the Row A’s, the row that does not move.

After you explain the logistics, ask for any questions or clarification and let the first part of the meeting begin.

D. After the initial data gathering/interviewing process, have participants sit quietly (for 15 minutes) by themselves and organize their interview data into the following three categories:

*Facts.* These are the responses or answers expressed by almost every person that was interviewed. They are very strong ideas, and are consistent across participants. They leap off the page.

*Trends.* Those responses given by about half the respondents. If you interviewed five people, and three people expressed a similar idea, it is a trend.

**Helpful Hint**

Use “self-managed” roles (see page 2.149) for this part of the design.

*Unique Ideas.* These are individual ideas that represent a different or unique approach, perspective, or idea. (It is not a laundry list of every idea, just the unique ones.)

4. After individuals have organized their interview data into one of these three categories, have them join with others who have the same question. In our working model, you would have five stations (one for each question) and have 10 participants at each station. The room should look like this:

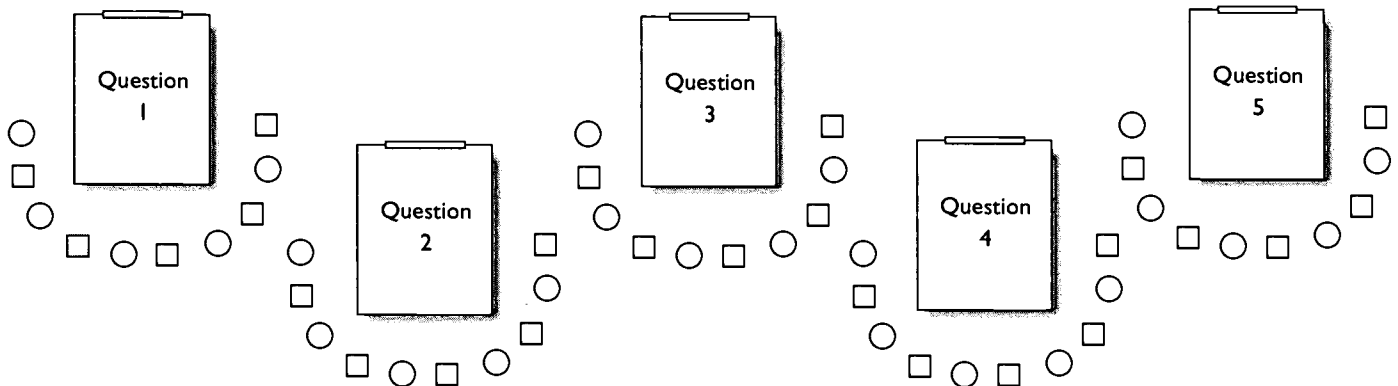

BEST COPY AVAILABLE

5. Instruct the participants to take 30–40 minutes and “pool” the information regarding their focus question and put the facts, trends, and unique ideas for their focus question on flipchart paper. Here’s an example of a possible focus question:

**#1 What must leadership do if they are to be successful with this change process?**

*Facts:*

- They must be visible throughout the process
- They must listen to people
- They must engage as many stakeholders as possible
- They must communicate openly with all stakeholders

*Trends:*

- Look at best practices from other colleges before you begin
- Let us know how decisions will be made
- Measure progress throughout the process and communicate results

*Unique Ideas:*

- Involve the community somehow
- Talk to Byrne College - they did this last year
- Have regular breakfast meetings to keep people informed

After the five focus questions groups have created their facts, trends, and unique idea for their question, have each group present their findings to the larger group. (Have an identified presenter do this for each group.)

After the presentations, the facilitator can lead a brief discussion about participants’ reactions to the shared information. Keep this to about 20 minutes.

6. It is important to let participants know what will happen to their information (e.g., go to the president’s council, change management task force, vice president’s group, etc.).

### **Helpful Hint**

This design can be used to create a focused problem-setting activity later.

## Schedule

- |  |               |
|--|---------------|
| 1. The facilitator welcomes participants, explains the purposes of the meeting, and walks through the directions.  | 10-15 minutes |
| 2. Participants interview each other about the assigned questions.   | 30 minutes    |
| 3. Participants individually organize their interview data into "truths," needs, and unique ideas.                 | 15 minutes    |
| 4. Groups work with "like" questions, pool their information, and create presentations about their interview data. | 30-40 minutes |
| 5. Groups report their findings.   | 10-15 minutes |
| 6. Facilitator conducts a brief discussion about people's responses to the overall data.                           | 15-20 minutes |

*Total time: approximately 2 hours*



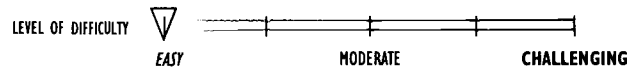

# THE CAROUSEL DESIGN

---

## I. Goals/Outcome

1. To gather information from a number of people in an efficient and interesting manner
2. To fully involve all participants in creating a database about key questions
3. To manage the information efficiently and identify areas of priority

## II. Background/Context

This design is an adaptation of a classic design and has several names: The Gallery Walk, The Walkabout, and The Carousel. All the names indicate movement, which is one of the key elements of this design. During a change process, leaders need to find ways to engage stakeholders and receive information and feedback from them. Because colleges and universities rarely have enough time for discussion and dialogue, different ways to solicit information are needed.

This design is one of the most interesting data-gathering designs we know. It is highly interactive and participative and, most importantly, very time efficient. This design can be used in a variety of ways to gather information about: 1) organizational climate, 2) stakeholder concerns, 3) a Strengths/Weaknesses/Opportunities/Threats (S.W.O.T.'s) analysis, or 4) to get advice about organizational problems.

This design has an adaptation where you disseminate rather than gather information.

## III. Logistics

Materials: Flipcharts, easels, magic markers for all participants, tape, timer, bell, or chimes

Space needs: Large, comfortable room where participants can move around easily

Time frame: 1 to 1-1/4 hours

Number of participants: 10 to 40

### III. Implementation

We will use 20 participants and four questions as a model for this design.

The leader will have to do some upfront homework with this design and be very clear about the purposes of the meeting. If you want to do a S.W.O.T's analysis about the institution or particular division, you would utilize four classic questions:

- What are the strengths of our institution? (What do we do well?)
- What are areas of weaknesses for our institution? (What do we need to improve?)
- What are some opportunities we should be taking advantage of? (What excites you?)
- What are some threats to this institution? (What makes you nervous?)

If you were to use this design to seek advice and information that would help the institution, you might ask the following questions:

- What are the three greatest sources of tension within the college or university?
- What is some advice you can give senior management that would improve institutional morale?
- How can we further improve campus life for our undergraduates?
- How can we further improve communication throughout the campus? Please be specific.

#### Helpful Hint

The ideal number of questions for this design is four. You can use up to six questions for larger groups, but this is the upper limit.

Once you have determined your focus questions, you should create four separate stations throughout the room with an easel and flipchart paper. Each station should have a focus question at the top of the flipchart.

The facilitator should have the group of 20 break into four groups of five participants. Do this by counting off one to four. This will give you randomly selected groups.

Make sure that each participant has a magic marker and have them stand in front of their assigned easel with the question written on the flipchart.

(When the group counts off, and you are number 3, you go to station #3.)

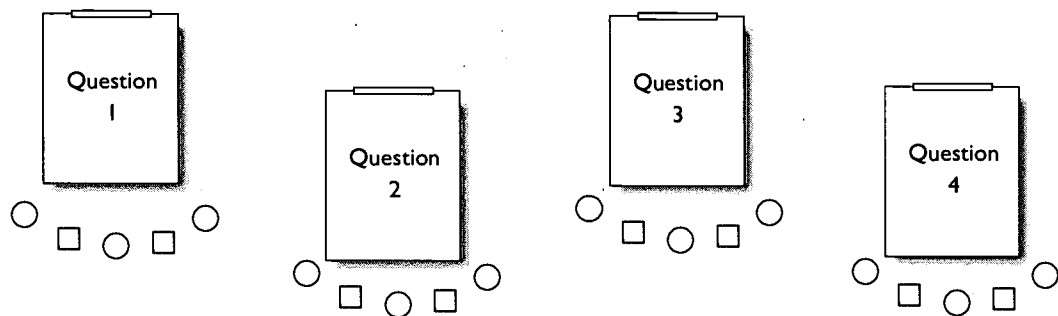

The facilitator should let participants know that their goal is to read the focus question at the top of the flipchart, and individually record their responses to the question. This is not about group agreement. We want individual responses. (This is why everyone has a magic marker.) If participants agree with other people's ideas, they can indicate their agreement by checking off the idea. Each group is given 5 or 6 minutes to read the focus question and individually record responses.

An example:

**#2 How can we further improve communication throughout the campus?**

- The president's office should produce daily e-mails about campus events ✓
- Re-institute the campus newsletter
- Have face-to-face meetings with each division ✓✓✓
- Use the campus Web page to keep people informed ✓✓✓✓
- Have the president visit our staff meetings ✓✓✓
- Hold the convocation twice a year

At the end of 5 or 6 minutes, the facilitator should indicate by ringing a bell or chime that each small group of five should move clockwise to the next station.

Each group then reviews the input from the previous group, individually checks off the ideas with which they agree, and adds their own ideas to the list.

This process continues until all four groups have answered each question individually by rotating to all stations.

Once all questions have been answered, have each group return to the question where they first started. There will be a lot of new information added at this question/station. Give them several minutes to read the new information and indicate agreement by checking off the answers to the focus question.

The last step in this design is to have each original group report on the top four or five answers for their focus question. These will be easily recognized by their check marks. Keep this mini-presentation to about two minutes. The goal is to indicate the most important ideas and gain closure with this culminating activity.

#### **Helpful Hint**

**You do not have each group go back and review all the answers to the focus questions, or do an entire second round. The activity will lose energy and you will have information overload.**

BEST COPY AVAILABLE

## Schedule

- |   |               |
|---|---------------|
| 1. Facilitator welcomes participants, shares purposes, and directions for the activity                              | 10 minutes    |
| 2. Facilitator utilizes a counting off method to create randomly mixed groups                                       | 5 minutes     |
| 3. The four groups answer the focus questions and rotate to all stations  | 20-25 minutes |
| 4. Groups return to their original question and read the information and check off ideas they agree upon            | 10 minutes    |
| 5. Small groups select the top four or five ideas/answers for their focus Question and prepare a brief presentation | 5 minutes     |
| 6. Each small group makes a short presentation about their top four or five answers                                 | 10 minutes    |
| 7. Facilitator thanks participants and explains how the information will be utilized                                | 2-3 minutes   |

*Total time: approximately 1-1/4 hours*



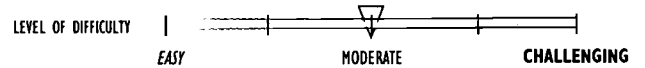

# ADAPTATION OF THE CAROUSEL DESIGN

---

## I. Goals/Outcomes

1. To manage a large amount of information shared with participants
2. To distill key themes and ideas from the information shared
3. To fully engage all participants in digesting important information

## II. Background/Context

In the original design, we showed how to *generate* information. In this adaptation you *distribute* information and distill meaning from it. This design adaptation manages information overload that often occurs when presenting information. People can only handle so much information at a time. Presentations often become “data dumps” and people get lost in the data, overwhelmed, and very frustrated. This design breaks up a large amount of information into “chewable chunks.”

## III. Logistics

Materials: Flipcharts, paper, five easels, magic markers for all participants, timer bell

Space needs: Large, comfortable room where participants can move about easily

Time frame: 2 hours

Number of participants: 10-30

## IV. Implementation

We will use 30 participants as a model for this adaptation. You can use this design in several ways: distributing student or alumni survey feedback, sharing the results of an organizational climate survey, looking at the best practices of competitors, getting educated about the trends and issues impacting higher education, etc.

In our example, we will use the results of an organizational climate survey. You could organize the information by division—financial, student services, academic, administration, support services, etc., or, by organizational levels, such as senior management, middle management, staff, students, alumni, etc. Use what works but have no more than five categories.

The categories will become “information stations” where participants will travel to each station, read the appropriate information, and then distill meaning.

The key to the success of this design is the upfront preparation of the information that is to be distributed and digested. The information has to be clear and to the point. Charts and graphs should be simple and easy to understand. The goal is to create the information so that it can be easily read and digested in a relatively short period of time. This will take real thinking and work upfront, but it is well worth the effort. You want participants to be engaged with the information, feel more informed, and distil key themes.

The leader/facilitator welcomes participants and shares the purposes of the meeting. Ask the participants to count off from one to five. This will give you five mixed groups of six participants each. Make sure everyone has a marker before you begin this activity.

Make sure that there is a flipchart and the appropriate category of information at each “station.” The room should look like this:

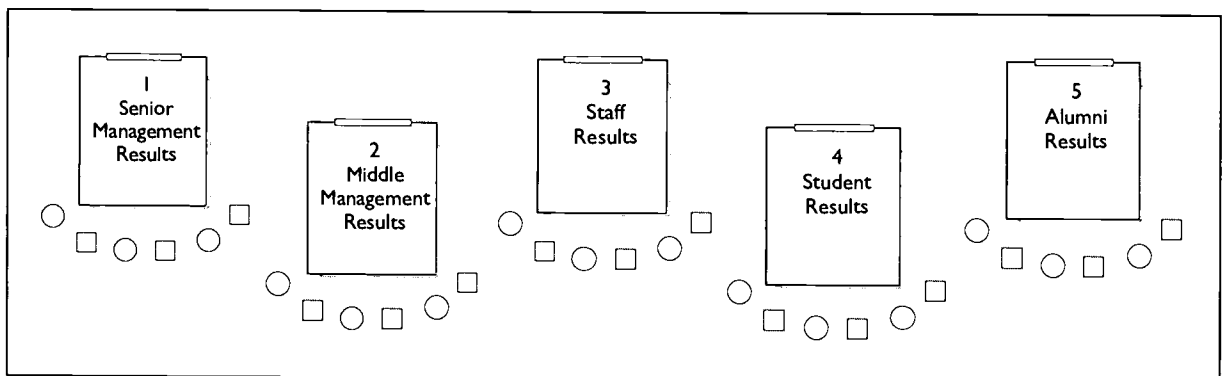

Have participants go to the information station that has their assigned number. Have each group read the excellently prepared information, and capture on the flipchart what they believe is the most important idea(s) or theme(s) from the information.

Participants should put down their *individual* comments. This is not group consensus. After reading the information, everybody should write what they believe is important. If other participants agree with another person’s ideas, they should note this by checking off the idea. This is why everyone has a marker. A flipchart might look like the following.

## V. Student Feedback

1. Students enjoy the community feeling on campus ✓✓
2. Students highly value the teacher/student relationship ✓✓✓✓✓✓
3. Students wish there were more activities on weekends for their participation ✓✓✓✓✓✓✓✓
4. Students are proud of the college's regional reputation ✓✓✓
5. Freshman students have a difficulty with the transition into college life ✓✓✓

Each group should be give 12-15 minutes at each information station. It is important to ensure that the distributed information can be read and digested in 5-6 minutes and that participants can then start to create ideas.

At the end of each 15-minute round, have each group move clockwise, read the survey information, check off the ideas they agree with, and add their own ideas individually.

The process continues until all participants have visited all five information stations, read the information, and created or agreed to the ideas on the flipcharts.

After everyone has had a chance to read, digest, and create ideas for all five questions, have the participants go back to their original question—the one where they started the activity.

You will follow the same process as the original design, whereby participants review their original questions, and check off the ideas they agree with. There will be a lot of new information they haven't seen. Participants should circle the top four or five most important themes. Once again, this will be easy to do because the individual check marks will indicate the most important ideas. Have each group make a short (1-2 minute) presentation of the most important ideas for their station.

Finally, there will be a lot of quality information in the room at this time. Participants will see the range and depth of the information. The leader/facilitator can facilitate a discussion for 20 minutes or so by asking participants any of the following questions:

- What were some discoveries you had about the survey information?
- What are the strongest themes that we need to pay attention to?
- Are there any cross-cutting themes from other groups that you can see?
- What concerns might you have about this information?

You can also seek their advice on how to distribute or engage other institutional stakeholders about this information.

Let participants know that all the information they generated will be typed up and distributed to everyone who attended this meeting. It is also important to communicate how this information will be used (e.g., results go to a campus task force on organizational climate, be reviewed by the board, etc.).

### **Helpful Hint**

It is important that the groups finish on time. Have a two-minute warning bell to alert participants about how much time is left.

### **Helpful Hint**

As the rounds progress, participants will have more information to read and digest. You might allow an extra 2-3 minutes in the final two rounds, but no more than this or it will drag.

BEST COPY AVAILABLE

## Schedule

- |  |                    |
|--|--------------------|
| 1. Facilitator welcomes participants, shares purposes and directions for the activity  | 10 minutes         |
| 2. Facilitator utilizes a counting off method  | 5 minutes          |
| 3. The five groups read the pertinent information, distill themes, and rotate to all five stations                                   | 1 hour, 15 minutes |
| 4. Small groups return to their original question and read the information and individually check off the ideas that they agree with | 10 minutes         |
| 5. Small groups select the top four or five ideas for their survey/information area and prepare a brief presentation                 | 5 minutes          |
| 6. Each small group makes a short presentation about their top five themes   | 10 minutes         |
| <i>Option:</i> Have a discussion about important themes  | 20 minutes         |
| 7. Facilitator thanks participants and explains how their information will be utilized   | 2-3 minutes        |

*Total time: 2 hours*



The president of the institution would take responsibility for convening the senior management on campus—those who would be impacted by the change process. In our example, these leaders might include: the provost, chief academic officer, chief financial officer, chief technology officer, vice president of student life, vice president/director of human resources, vice president of development, some well-respected faculty members, and the president of the alumni association.

This design has three major phases and is conducted over several weeks. In the first meeting, you create strategic questions for senior leadership to ask stakeholders. Then, senior leaders go throughout the campus to engage a diverse group of stakeholders and seek their answers and ideas about the questions. Finally, senior management reconvenes and distills the lessons learned from the information that has been generated.

### III. Logistics

Materials: Not applicable

Space needed: Not applicable

Time frame: This design is conducted over several weeks

Number of participants: Up to 10 senior leaders

### IV. Implementation

1. In the first meeting, the president clarifies the purpose of the two meetings: *“Our goal is to create a set of questions that would engage people’s thinking throughout the campus and provide us with strategic information regarding their concerns and advice about the upcoming change process.”*

*“In our second meeting, two weeks from now, we will come together and share what we have learned and apply those learnings to our change process.”*

The facilitator then has the senior management groups create strategic and interesting question they would ask stakeholders over the next two weeks.

Some examples of “engaging” questions:

1. When you think about this upcoming change process, what are your hopes?  
What concerns you?
2. If you were in charge of organizing a team that would help manage this upcoming change process, who would be on it? Why would they be on it?
3. What cultural norms will help us with this change process? Which ones might get in the way?
4. In your experience, when people take risks on this campus, what happens? Please be specific if you can.
5. In your experience, what change efforts have gone well on this campus? What helped them be successful?
6. If you were to act as a consultant to this upcoming project, what are three things you would do to ensure success?

7. What would an effective communication process look like during the upcoming change process? What would be the essential elements?

You get the idea. The goal is to ask questions that will seek quality information, show people you are interested in their ideas, and help make senior management as smart as possible. Your goal is to come up with a handful of questions (five to eight maximum) that will provide strategic information and convey to stakeholders that senior leadership is trying to create a different process and is willing to listen.

After the senior management group has created their list of strategic questions, they need to come to agreement on who should be interviewed. Have each leader come up with the names of 10 people on the campus or in the community that they believe would be a good source of information and provide an interesting perspective.

The facilitator should strongly suggest that each leader should include some names that aren't usually included in regular circles (e.g., security people, adjunct teachers, small business community members, small time donors, non-tenured faculty; new staff members). You want to avoid "talking to the choir" and include some difference voices.

Each senior leader should review their list with others in the group and give a brief rationale for their list. This is where the facilitator has to be excellent because it is his or her role to ask the difficult questions if the leaders come up with the regular list of people who are always involved in campus activities and political life. One of the things the facilitator must ensure is that there is a blend of different stakeholders for each senior leader. You want to avoid having the chief financial officer talk to only budget people or the provost talk only to faculty. Strongly suggest that they need to interview some people outside their realm of interaction and influence. This way you will have a more integrated view and more people will get to know senior leadership.

After the group has agreed on the questions, and who will be interviewed, there are several things to discuss:

It is helpful to craft a "purpose statement" explaining to stakeholders why senior leaders are interviewing people so everyone knows what to expect. This purpose statement should be written by the president (the facilitator can help) and distributed widely throughout the campus. A sample purpose statement:

*"Dear Campus Members,  
Over the next few weeks, senior leader are going to be interviewing various stakeholders throughout the campus. Our goal is to listen carefully to our people about the upcoming change process. We will seek your advice and ideas. This will only work if you are open and honest with us. Your care for this institution is very important. We are excited about this interview process because you will help make us wiser as we make important decisions for this institution's future.  
We will report back our findings to all those we interview.  
Thank you for your help.*

The facilitator should have an open discussion about the real possibility of people being intimidated by being interviewed by senior leaders. The leaders need to talk about ways to allay people's nervousness.

**Helpful Hint**

We have found that a personal note or phone call to interviewees by the senior leaders expressing their interest and appreciation for the upcoming interview is very helpful. You might include the interview questions ahead of time so the interviewees can prepare themselves. Remember, a note or phone call works best, not an e-mail.

**Helpful Hint**

Senior leaders should meet the interviewees in the interviewee's offices or place of work. This conveys respect, minimizes power, and others will see senior leaders circulating throughout the campus.

After this discussion, the facilitator or president should let everyone know when people should have all their interviews completed. The ideal time frame is two weeks, much longer than this and you will lose momentum and interest.

**Schedule, Part One**

- |  |               |
|--|---------------|
| 1. Senior leader/president clarifies purpose of the meeting.   | 5-10 minutes  |
| 2. Senior group members create strategic questions using the Collapsing Consensus design.                                      | 25-30 minutes |
| 3. Senior group members create a list of stakeholders to be interviewed and validate lists with each other.                    | 30 minutes    |
| 4. (Optional) Group crafts a purpose statement for the interview process.  | 30 minutes    |
| 5. Facilitator creates opportunity for open discussion about stakeholder's concerns about being interviewed by senior leaders. | 15-20 minutes |

*Total time for Part 1: Approximately 2 hours*

BEST COPY AVAILABLE



## Part Two of the Design

The following meeting takes place with the senior leaders two weeks after the initial meetings and after they have interviewed their stakeholders. We will use eight participants as a model for this design.

1. The facilitator asks the leaders to do a little “homework” before they come to the debriefing meeting. Ask them to review their interview data and answer the following questions before they come to the meeting.
  - A. What are three discoveries or surprises you experienced conducting the interviews?
  - B. What are the three strongest pieces of advice you found in your interviews?
  - C. Concerning our institutional culture, what is going to help us with this upcoming change process? What will get in our way?
  - D. If you were a consultant to this upcoming change process, what are two or three strong recommendations you would make?
  - E. What was the tenor of the meetings/interviews with stakeholders? Were they open? Positive? Skeptical?
2. When the senior leadership comes together, have them “pair up” and share the findings of their “homework.” Give them 30 minutes to discuss their findings and put their key findings on flipchart paper.
3. Have each team of two make their presentations to the other leaders. Allow for questions and clarifications. Your goal is to deeply understand what people have found in their interviews.
4. After all four presentations, have an open discussion for about 20–30 minutes about people’s reactions to this interview data. The facilitator should encourage full participation from all the leaders. There will be a powerful story from the interview data. Leaders must understand its complexities and implications.
5. After the discussion period, put the participants into two groups of four. Their goal is to create the key learnings and messages from all the interview data. This information will be communicated back to the interviewees, so it must be honest, clear and digestible. Give each group 30 minutes to put their key learnings/messages on flipchart paper.
6. Have each group do brief presentations of their key messages. Note the common ground themes and reach agreement on what the message will be to stakeholders. If there are any differences, you can note this and the group will have to decide what will be communicated in the final presentations.
7. At this stage, you have distilled the learnings from a tremendous amount of strategic information, gained insight into how stakeholders think and feel about the change process and have key learnings and messages that can be communicated throughout the campus.

A sample of key messages from this process:

- A. There is a great deal of skepticism about this upcoming change process. People are not sure why we are doing it, how it will be implemented, and if it is of real value to the institution.
- B. People have great confidence about the talent of key people on campus. They believe that if we can enroll their support and seek their guidance, we can be very successful.
- C. People want to be helpful and supportive. They are unsure how they can do this.
- D. Communicating to everyone throughout the change effort is very important. People want to understand what is going on and how we are progressing. This has not happened in the past.

- E. Our culture is risk and conflict averse. We don't reward risk takers and we don't manage conflict well. This needs to change if we are to be successful.
- F. Faculty feel strongly that this change process will be helpful for the institution in the long run and want to know what their role is. (How can they contribute?)
- G. Senior leadership must be engaged visibly throughout the change process. People need to see us, hear from us, and we need to seek their feedback!
- H. We need to create a workable plan for this change process, involve stakeholders in creating it, and communicate the plan to everyone on campus.
- I. We have a lot of talent here on campus. We need to utilize this and not be dependent on outside consultants only.

### Helpful Hint

You might consider bringing together some of the people who were interviewed periodically to assess the progress of the change process. You could utilize several designs: See Adapted Fishbowl (page 2.111); and Senior Leadership Meeting (page 2.55) to accomplish this.

8. At this time, senior leadership need to discuss how they will communicate these key messages to the interviewees. The Change Update design (see page 2.47 of this book) will be a helpful format for this communication process.

## Schedule, Part Two

|  |               |
|--|---------------|
| 6. Facilitator welcomes senior leaders and shares purposes for the meeting.                  | 5 minutes     |
| 7. Senior leaders work in pairs to discuss their interview data.                             | 30 minutes    |
| 8. Each pair makes a presentation to the other members of the group.                         | 20-30 minutes |
| 9. Facilitator leads an open discussion about participants' reactions to the interview data. | 20-30 minutes |
| 10. Two working groups create key learnings and messages from interview data.                | 30 minutes    |
| 11. Participants agree on key messages to be communicated to stakeholders.                   | 20-30 minutes |

*Total time for Part 2: Approximately 2-1/2 hours*

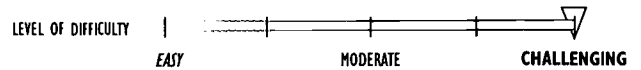

# CUSTOMER/STAKEHOLDER FEEDBACK

---

## I. Goals/Outcomes

1. To build a positive relationship between employees and stakeholders or customers
2. To clearly understand customer/stakeholder expectations
3. To respond to customer/stakeholder concerns

## II. Background/Context

Any institution needs to be responsive to customers if it is to thrive in a competitive environment. The higher education marketplace is becoming increasingly competitive and administrators and faculty need to be aware of the diverse expectations customers have. We realize that “customers” might be a foreign term on many campuses. The reality is that there are customers or stakeholders everywhere. Parents are customers who invest in their children’s education. Students are the customers of the educational experiences they seek. Faculty are the customers of the administrators who provide the infrastructure (space, technology, schedules, etc.) for them to teach. Legislatures are customers or important stakeholders in terms of funding. Alumni are stakeholders who often have a real interest in the success of the institution. Community members are stakeholders in the institution’s organizational life.

This design can be used interchangeably with customers or stakeholders because the main purpose is to solicit and respond to the needs of people.

Too often, we try to obtain the expectations or needs of customers with questionnaires (that historically bring a poor return) or with a focus group. Unfortunately, most focus groups tend to be an exclusive way in which a consultant or facilitator listens to the customer’s concerns and needs. Often, these discussions are tape recorded and even videotaped for review later. This design adds an interesting element by being more interactive and responding to customer/stakeholder feedback in the moment.

People feel more listened to with this design and it creates the opportunity to build a positive relationship in the future. Participants report that they feel engaged and valued for their input.

The facilitator for this design has to be very good. He or she needs to be able to think quickly, listen carefully, keep things moving, and be good with people. If you need an “outsider” to do this, it is worth the investment.

This design is an adaptation of a Fishbowl activity that has been around for decades. Once again, this could be a meeting between administrators and parents, community members, alumni, or even between administrators and faculty, or faculty and students!

At the end of the design we will share some focus questions you can utilize with different groups.

### III. Logistics

Materials: Easels, easel paper, magic markers, moveable chairs

Space needs: Large, comfortable room

Time frame: 3 hours

Number of participants: 10 to 20

### IV. Implementation

We will use 16 participants as a model for this design. The example that follows is a meeting between administrators and alumni.

#### Helpful Hint

In a discussion like this, there is often one or two participants who get “carried away” and talk over the allotted time frame. Before the discussion begins, get agreement from people that two minutes is the limit, and that the facilitator will signal when 30 seconds are left.

#### Stage 1

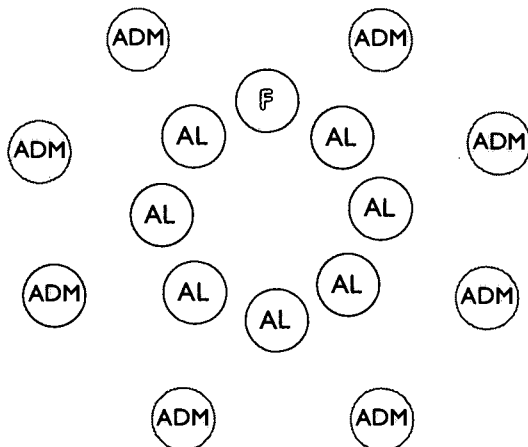

1. The facilitator welcomes participants and explain how the meeting will be conducted. Having a handout with pertinent information is helpful. The facilitator needs to ensure that all participants understand the process and are comfortable with the proceedings. Have everyone introduce themselves and provide any pertinent information (i.e., their role in the college or university; when they attended; and what their major was).

2. In the first Fishbowl, alumni sit in the inside circle with the facilitator (F = facilitator; Adm = administrators; Al = alumni).

The focus of this (example) meeting between administrators and alumni is to deeply understand how alumni perceive the college or university; to solicit advice on how to improve services; and to establish a real connection with alumni.

3. The facilitator starts the discussion with alumni by asking the following question: “If you were to describe to a good friend why you attended this college or university, what would you say?”

The facilitator must make sure that each person in the inner circle has a chance to respond to the

question. Allow 1–2 minutes for each participant and let them know what the time limit is before starting the discussion. The facilitator should keep the first round discussion to no more than 20 minutes.

While the facilitator conducts the discussion, the “outsiders” (administrators) are listening to the alumni’s responses. They should be encouraged to jot down some notes and capture key points that they are learning from the discussion.

4. The second round question focuses on seeking advice from the alumni. The facilitator asks: “Given your experience here at this college/university what is some advice you can give us to further enhance the education we provide for students?”

Once again, adhere to 1–2 minutes per person, keeping the entire discussion to no more than 20 minutes. The administrators (outside circle) are continuing to listen and jot down their learnings.

5. At this time, it might be helpful to take a short (10 minute) break in order for people to stretch.

6. After the short break, the administrators then come into the inner circle while the alumni sit on the outside.

The purpose of this round is to glean what the listeners (administrators) heard the alumni say. The facilitator needs to be able to create a sense of openness with the administrators so they can respond without becoming defensive.

7. This feedback round should last approximately 20 minutes. Some possible questions to focus discussion are:

- A. What have you heard?
- B. What stands out?
- C. What were some discoveries or surprises?
- D. What did you like about what you heard?
- E. What concerns do you have?

8. As the administrators are discussing what they heard, the facilitator should record the most important points on a flipchart, in full view of everyone. Capturing this information helps to structure the conversation, makes the discussion very real, and is a useful record for later.

9. After the administrators have communicated what they heard alumni say (20 minutes), have the alumni and administrators join in a large circle so everyone can see each other.

**Helpful Hint**  
The facilitator needs to probe for understanding to make sure what is being discussed is understood by everyone.

**Helpful Hint**  
Picking the right administrators as “listeners” is important in this design. You may hear things you don’t like and, if the administrators appear defensive, it could damage, not enhance relationships.

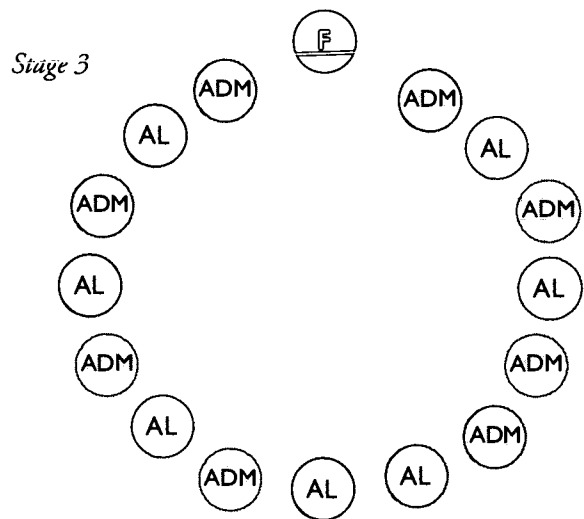

The facilitator then checks with the alumni to see if the administrators captured the essence of their information. Some focus questions could be: “Did we miss anything important?” “Do you feel we heard you?” “Are we on target?” The facilitator keeps this discussion to about 15 minutes. The primary purpose of this round is to make sure alumni felt understood and heard (this almost always happens). This is a reality check more than anything, but a very important step in the process.

10. The next step is to have an open discussion that deals with alumni’s “advice” to enhance the educational process. The facilitator should allow administrators to probe for understanding and clarification non-defensively. (e.g., “Bill, you mentioned that the freshman experience really needs to be more personalized. Could you explain what that means to you?” or, “Carla, you mentioned that we should have more outside experts come on campus to stimulate the thinking of our students on important issues. Can you make some suggestions about possible candidates for a program like this?”) The key is to ensure understanding and clarify any misconceptions (e.g., “Tom, you mentioned that more access to the library needed to be extended to all students, especially during exam week. I wanted to let you know that we have 24 hour access for everyone, one week before and during exam week.”) The goal is to inform, not get caught in debate or defending what has been happening (e.g., “Tom, it’s easy to suggest more extended hours during exam week but that is a very expensive proposal. Do you have any idea what that would cost us?”). You get the idea. Your primary goal is to seek understanding and rightsize any misconceptions.

### Helpful Hint

It is effective if the administrators take responsibility for sending the follow-up report with a personal thank you note to the alumni. You can also communicate that individual administrators will “own” an alumni. If they have any questions or advice in the future, they can directly communicate with their assigned administrator. This works very effectively with community members.

This discussion round should take between 20 and 30 minutes. The facilitator needs to make sure that things keep moving and people don’t get caught defending their ideas.

In the wrap-up, the facilitator needs to be able to capture any loose ends that may have been created. If the administrators have made a commitment that is a response to advice, that needs to be clarified, and a next step agreed upon.

*“Mary, you requested a copy of the capital campaign case study. I believe John said he would get you that as soon as possible. John, how long will that take?”*

*“Charles, you mentioned that your organization has an excellent mentoring program, that might be a helpful model for us. Can we set up a meeting in the next week with key players to learn from your progress?”*

10. The facilitator thanks everyone for attending and communicates that copies of what was discussed will be sent within a week of the meeting.

## Schedule

- |   |               |
|---|---------------|
| 1. Facilitator welcomes participants, explains what will take place, and has everyone introduce themselves. | 15 minutes    |
| 2. First Fishbowl with alumni   |               |
| First question  | 20 minutes    |
| Second question   | 20 minutes    |
| 3. Break  | 10 minutes    |
| 4. Administrators come into the inner circle to share what they heard                                       | 20 minutes    |
| 5. Both groups come together to validate what was discussed   | 15 minutes    |
| 6. Open discussion where administrators clarify and seek understanding                                      | 20-30 minutes |
| 7. Facilitator has a "wrap-up" discussion to clarify commitments and next steps                             | 10-15 minutes |
| 8. Facilitator thanks everyone for participation  | 2-5 minutes   |

*Total time: 2 hours, 30 minutes*

## SECTION 2 | **Communication**

Effective communication is an issue in any institution and leaders must be able to design a responsive and effective communication system for their campuses. Too often we rely on the same way of communicating with stakeholders, without assessing its effectiveness. During a change process, it is essential that people are well informed and are heard. When this doesn't happen, people don't feel valued or respected. You want to avoid this at all costs.

### Developing a Communication Plan

This design is challenging but it will enable the change leader to create an efficient and effective communication system that can be institutionalized throughout the campus. The key to its effectiveness is its ability to identify the best ways to communicate with different stakeholder groups, and design communication vehicles tailored to their needs and interests.

### Change Updates

This design enables the change leader to keep stakeholders informed throughout the change process and, more importantly, seek advice and feedback from participants about the effectiveness of the change process. It is highly interactive and time efficient, and can be used with small or large groups.

### Rumor Mill

This design is just plain fun. It enables the change leader to reverse the negative impact of most rumor mills and grapevines. It puts you in charge of the rumor mill and provides an opportunity for stakeholders to hear accurate, timely, and honest information throughout a change process.

### Senior Management Meeting

This design enables senior management to model openness and collaboration. It helps obtain a balanced perspective from stakeholders by sourcing participant's ideas about:

- What's working well in a change process.
- What needs improvement in the process, and
- Anticipating future challenges.

BEST COPY AVAILABLE



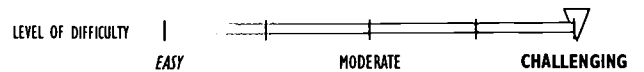

# DEVELOPING A COMMUNICATION PLAN

Step one: IDENTIFICATION PHASE

## I. Goals/Outcomes

1. To identify the key stakeholder groups that need to be communicated with during a change process
2. To identify the best ways to communicate with key stakeholders
3. To develop an effective communication system that can be implemented during a change process

## II. Background/Context

Communication is the essential element in any change process. Most change strategies are well thought out and look great on paper. What many change leaders forget to do is to create a communication process tailored to meet the challenges of the change effort. They rely on traditional and “tried and true” ways of communicating with others on campus. This is not a good idea.

Poor communication can cripple a change effort and cause breakdowns in organizational climate and community. Paying attention to the communication process is key to the success of the change process. People want information throughout a change process. When they don't receive quality and timely communication, they often feel devalued, marginalized, and seek out the “grapevine” or rumor mill.

Institutional leadership can be proactive in creating and managing a responsive and agile communication system. The key challenge is for change leaders to determine the best ways to communicate with stakeholders, not just the most convenient. Too often, organizations will do what's familiar, not what's truly needed. This design will enable you to create the most effective communication process for your institution. Each college and university has unique needs and cultures. It is important to design a communication process that is tailored to respond to this uniqueness.

With this design, diversity really helps. If you only have participants who think alike or have the same institutional experience, you will not be able to create a robust communication system. It is most effective to use stakeholders throughout the institution with this design.

This design uses the Mindmapping technique (see page 2.141 of this book). Before you begin

this design, it is important to ensure that all participants are familiar with Mindmapping. It is also helpful to tape several blank sheets of flipchart paper on a wall (5–6 feet tall and 7–8 feet wide) to use for the mindmap before participants enter the room.

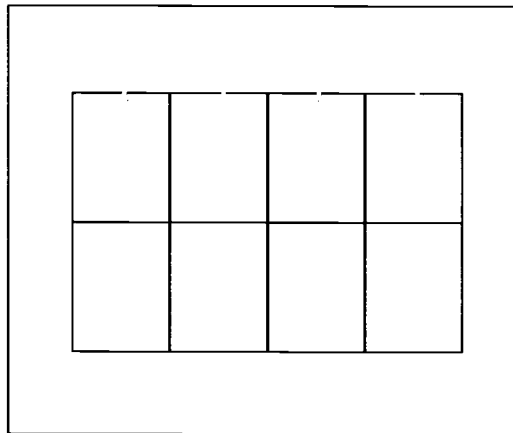

Lastly, this communication design assumes that someone is in charge of communication during the change process. We call this person the “communication czar” (choose whatever title you like). He or she is responsible for coordinating and facilitating communication throughout the change process. We strongly suggest that one person be in charge of ensuring effective communication throughout the campus. This is not meant to create a bottleneck, but one person, with power, needs to accept full responsibility for quality control, coordination of communication, and measuring communication effectiveness.

This design has several steps to it and is best done over several days. We have done it in one day but the work is intense and it will take a lot of coordinating. The key thing to remember for the change leader is to have the right people in the room for each stage. The stages are: 1) identification; 2) validation; and 3) implementation.

### III. Logistics

Materials: Flipchart paper, easels, magic markers, Mindmapping instructions

Space needs: large, comfortable room, moveable chairs, plenty of wall space

Time frame: several hours over several days

Number of participants: 10–40

### IV. Implementation

1. The facilitator discusses the purpose of the meeting, “We are here to create the most effective communication process possible for our upcoming change effort.”
2. The facilitator then passes out copies of the Mindmapping technique (see page 2.141 of this book) and briefly reviews what Mindmapping is for everyone present.
3. After participants agree on the purpose of the meeting and are comfortable with

Mindmapping, the facilitator asks the focus question the group is “Mindmapping.” In our example it would be: “Who do we need to communicate with during our change management process?”

4. Using Mindmapping, the facilitator captures, in full view of everyone, the different stakeholder groups that need to be communicated. Your beginning Mindmap might look like this:

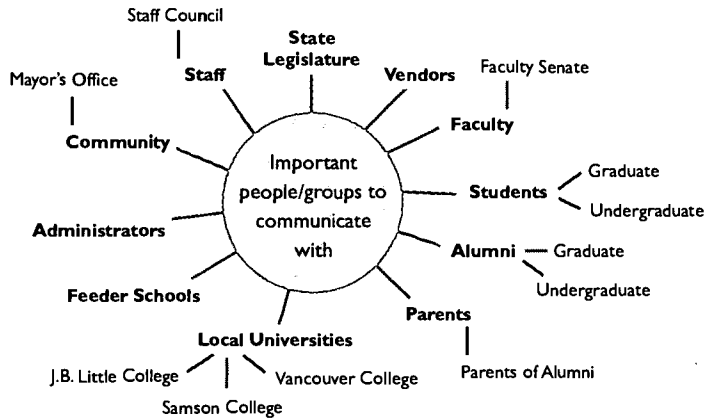

5. After the participants have completed the communication mindmap, have them conduct a Las Vegas vote (see page 2.137 of this book) to determine the most important stakeholders. This doesn't mean you won't communicate with the other groups, but you will need to focus your efforts on the “vital few.”

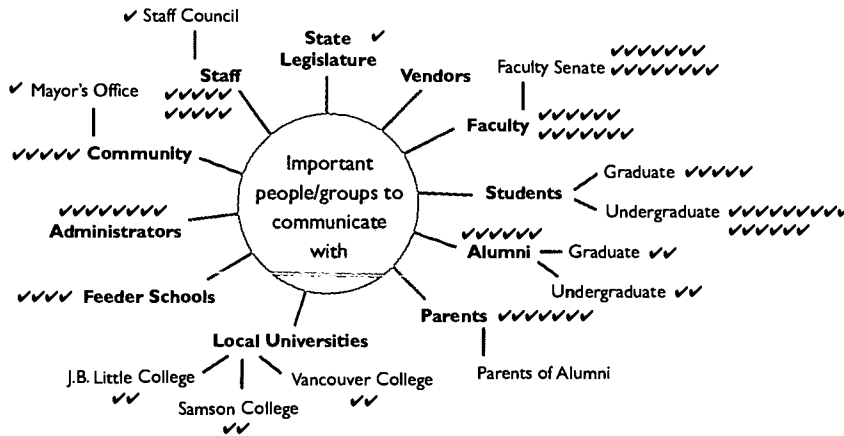

**Helpful Hint**

You can also have participants vote for their top three or four choices (anonymously) by handing out index cards and letting them identify the number one priority, the number two priority, etc., and then create a master list in full view.

BEST COPY AVAILABLE

**Helpful Hint**

Have the seven different work groups use self-managed roles (see page 2.149 of this book) with this part of the design.

You will note with this sample mindmap, the most important stakeholder groups are:

Faculty  
 Faculty senate  
 Undergraduate students  
 Parents  
 Alumni  
 Staff  
 Administrators

6. The next step is to determine the best ways to communicate with each stakeholder group. At this time, the facilitator counts off from one to seven, corresponding to the seven (7) priority stakeholder groups. This gives you five participants in each group.

Have the room set up into seven different work areas:

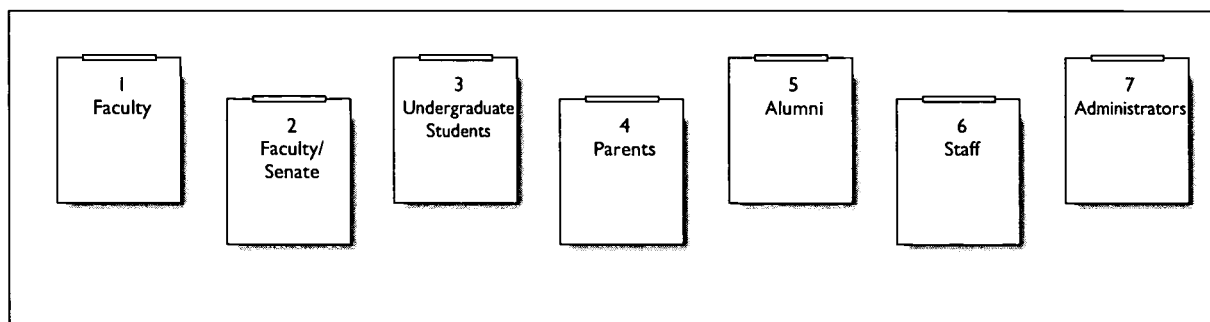

Give each group about 20 minutes to come up with the different ways to communicate with the priority stakeholder groups and capture their ideas on flipcharts. Have them utilize the Las Vegas vote technique (see page 2.137 of this book) to determine the most effective ways to communicate with the different stakeholder groups.

At this stage your work group output might look like this:

A. Faculty

- President's weekly e-mail message
- Breakfast meetings with key faculty
- Weekly updates in campus newsletter
- Voice mail updates
- President's monthly lunch meeting

B. Faculty Senate

- Make monthly presentations to faculty senate
- Write a white paper about the change process and distribute
- Send a special bulletin to faculty senate

C. Undergraduate Students

- Meet with student government
- Meet with student's presidential council
- Meet with campus ministry

- Hold “chews and chats” at lunch time
  - Meet with student athletes’ association
  - Have informal meetings in the student center
- D. Parents
- Communicate progress in quarterly parent’s magazine
  - Meet with parent’s association
  - Send out a special letter informing parents
  - Have a large meeting with parents on parent’s weekend
- E. Alumni
- Meet with alumni council
  - Hold several special evening meetings
  - Have a Saturday update at the football game (before the game)
  - Article in alumni magazine
- F. Staff
- Meet with staff council
  - Meet with union officials
  - Send out a special newsletter
  - Include information in university newsletter
  - Have lunch meeting monthly to update staff
- G. Administrators
- Update weekly with president’s message
  - Have vice presidents hold a special meeting
  - Have special lunches with administrators
  - Include information in campus newsletter

Create the opportunity for each work group to present their ideas to the larger group for feedback and reactions. Use the Constructive Feedback technique (see page 2.133 of this book) to do this. This should take 5–10 minutes per group.

7. After each group has presented its ideas and received feedback, have each work group incorporate the feedback they have received into final recommendations.

## Schedule for Identification Phase

- |   |               |
|---|---------------|
| 1. The facilitator welcomes participants and reviews the purposes of the meeting                            | 10 minutes    |
| 2. The facilitator reviews Mindmapping technique  | 5–7 minutes   |
| 3. The facilitator conducts the Mindmapping exercise  | 10–15 minutes |
| 4. Participants utilize the Las Vegas voting technique to determine key stakeholders                        | 5–7 minutes   |
| 5. Participants determine the best ways to communicate with key stakeholders                                | 20 minutes    |
| 6. Groups present their ideas about the best ways to communicate  | 20–30 minutes |
| 7. Groups use the Constructive Feedback technique (see page 2.133) to provide feedback to the presentations | 10–15 minutes |

*Total time: approximately 2 hours*

---

The key next step is: **VALIDATION**

1. In the next meeting (or next part of the meeting if you are doing a full-day design), it is important to bring in diverse stakeholders to validate your ideas about the most effective ways to communicate to key stakeholders.

2. The change leader would invite several groups (about 30 at a time), to come into a feedback meeting to hear brief presentations about the best ways to communicate. After all the presentations have been conducted, the change leader would facilitate the next steps.

3. Have people count off and create small, mixed groups of 5–6 participants each. You would then give them about 15 minutes to answer the following questions. Use Self-Managed Groups (see page 2.149 of this book) for this part of the design.

A. What are your general reactions to our ideas?

B. Are we missing anything?

C. What are some suggestions or advice you can give us to further enhance our ideas regarding communication?

4. The facilitator or change leader would then create a master list, in full view, on a flipchart. Take one question at a time and take one idea from each group. Make as many rounds as necessary until all suggestions are captured. Your three-question master list might look like this:

#### **General Reactions**

Great beginning, should be effective

Well thought out - comprehensive

This will be difficult to manage

There is a lot of human interaction – we need it

This could really change things around here – good ideas

#### **What Questions Do You Have? Are We Missing Anything?**

You seem to have all the key stakeholders

Has IT been involved in creating this?

What will IT's role be in this process?

Who will be responsible for ensuring quality control?

#### **Ways to Enhance**

You need to establish a small office for communication with appropriate support for this massive effort.

Once you get this set up, have regular (monthly) check-ups to measure how people see the quality and efficiency of the communication process.

Ongoing assessment is necessary to determine what works best.

Make sure you have a feedback loop built in.

After the master lists have been created in full view, the facilitator could have a brief discussion (10 minutes) about people's reactions to the validation ideas. Thank people for their participation and ideas.

## Schedule for the Validation Phase

- |  |               |
|--|---------------|
| 1. The change leader welcomes participants and explains the purposes of the meeting  | 10 minutes    |
| 2. Participants listen to brief presentations about the best ways to communicate with stakeholders                               | 10–15 minutes |
| 3. Participants countoff and create small, mixed groups, and utilize self-managed roles  | 5–10 minutes  |
| 4. Mixed groups answer focus questions   | 15 minutes    |
| 5. The facilitator creates a master list (utilizing a round robin approach) of responses to the focus questions                  | 15–20 minutes |
| 6. The facilitator conducts a brief discussion about reactions to the validation ideas and thanks people for their participation | 10–15 minutes |

*Total time: approximately 1-1/2 hours*



---

The final key step is: IMPLEMENTATION

1. With implementation, the change leader asks key people to meet and discuss the implications of what has been learned so far regarding a communication system/process for the upcoming change project.

You should have very strategic information at this time, so it is important for the change leader to create openness in a discussion about the next steps.

Some of the key issues to reach agreement on are:

Who will be in charge of communication?

What will the quality control look like? There needs to be clear agreement about this.

How will you assess the effectiveness of your communication process? We suggest checking in periodically with stakeholders to see if they feel well-informed and gather ideas to further enhance the ongoing communication system.

Discuss scenarios that will test your thinking about the communication process. (Some examples: What will happen if a newspaper reporter calls? Who will respond? What do we do with rumors? What is the president's role in communication? What do we do when problems occur?)

The key thing to remember with implementation is to pay attention to the communication process throughout the change process. Be open to the ideas of others and remember face-to-face interaction is still the most effective way to communicate with stakeholders and keep them connected to the change process.

There are several designs in this book that will help you with your communication process [e.g., The Rumor Mill design (page 2.51) and the Senior Management Meeting (page 2.55)].

## Schedule for Final Implementation Phase

1. Change leader invites key personnel to discuss the information gathered about the communication process and reaches agreement on key issues.

1-2 hours

*Total time: approximately 1-2 hours*



## CHANGE UPDATES

### I. Goals/Outcomes

1. To fully inform organizational stakeholders about progress being made in a change or planning process
2. To obtain feedback from participants on ways to improve or enhance the change/planning process
3. To create an effective communication system

### II. Background/Context

One of the greatest challenges leaders face during a change process is keeping stakeholders informed throughout the institution. It is important to use a variety of communication vehicles because people have different needs and learning styles. This design is one of the most effective ways for leadership to be proactive about communication and meet the diverse needs of stakeholders.

Change Updates are an adaptation of the Axelrod Conference Model (1999) Walk Thrus. The purpose of these meetings is to relay accurate, up-to-date information about the change process and obtain feedback from participants regarding the change process.

#### **Helpful Hint**

Have good presenters! It is important to have leaders present at Change Updates meetings but make sure the right people are making the presentation. You want clear communicators who know about the change process and can answer most of the questions that will be asked. This may be the chairperson of a planning group, a task force member, a consultant, or a planning facilitator. You don't want people making an update presentation who don't deeply understand the change process. If you have a presenter who is constantly saying, "I don't know the answer to your question, but I will get back in touch with you," you will quickly lose credibility.

### III. Logistics

Materials: Flipchart, easels, informational handouts, feedback form, overhead projector

Space needs: Large, comfortable room

Time frame: 1 to 1-1/4 hours

Number of participants: 10–50

### IV. Implementation

#### **Helpful Hint**

Have good handouts! Make sure your handouts are informative and easy to understand. You don't need complex diagrams. Watch for information overload. Determine what you want to communicate and do it clearly and simply.

1. The Change Update meeting begins with the presenter welcoming participants and informing everyone about the purposes of the meeting. At this time, the presenter passes out clear handouts with the important information provided. This information is also replicated on overheads so that it can be shown to everyone.

The following is a working example to give you a sense of what needs to be communicated and how:

“In our strategic planning process this is what we have discovered from the questionnaires we have collected. The responses are from 725 undergraduates, 112 faculty members, 63 administrators, 442 alumni, and 243 parents.”

The core values of the college are ranked in priority order.

1. Our students (67 percent) believe that the student-teacher relationship is critical to student learning and our mission.
2. Having a close community feeling is important to a majority of our employees and students.
3. Academic excellence and integrity are core to what makes us distinctive. People are very proud of our academic reputation.
4. Our dedication to “service for others” is highly valued and must be preserved as a core element of our institutional mission.
5. Lifelong learning is a goal for many of our current students (61 percent) and valued highly by other stakeholders (44 percent).

The following are the challenges our stakeholders believe must be managed strategically over the next five years. They are in priority order.

1. Maintaining and improving our academic excellence
2. Building positive relationships with the surrounding community
3. Our physical plant must be improved
4. Improving communication throughout the college is essential for community building
5. More parking for students, staff, and faculty must be available
6. Security and safety on our campus needs to be improved

The critical current issues we need to manage are listed as follows.

1. The growth of our undergraduate population is at an all time high. We need to make important and wise decisions regarding growth.
2. Security and safety on our campus must be dealt with immediately.
3. Responding to the recent Middle States Evaluation is important, especially in the areas of faculty-administration relationships and diversity on campus.

The presenter should walk through the information, soliciting questions for clarification. The purpose is to make sure everyone understands the information being presented.

After the information is presented (no more than 15–20 minutes), the facilitator should ask participants to do a “pair and a share” with the person next to them. Give these pairs about five minutes to discuss their reactions to the information that has been presented. The facilitator might suggest that participants talk about: 1) What they liked about the information, 2) What concerns they might have, 3) What discoveries or learnings they have experienced, 4) What questions they have about the presented material. The goal is to get people talking with each other and sourcing their ideas.

After participants have had a few minutes to talk with their partner, the facilitator should conduct a 20–30 minute open discussion regarding people’s reactions. The purpose is to engage people, listen to what they have to say, and answer any questions they might have.

Often, it is helpful to have a recorder capturing people’s reactions and questions on flipchart paper in full view of everyone. This creates a record of the conversations, provides structure, and communicates that people’s questions and ideas are important. The facilitator should let participants know that unanswered questions will be noted and that a communication system will be established to keep people informed about the correct information regarding the unanswered questions (via president’s e-mail, campus voice mail, Web page, newsletter, other update meetings, etc.).

The final step in the Change Update meeting is to obtain feedback from the participants about their reactions to the shared information. The facilitator should provide a short questionnaire at the end of the meeting for participants to answer anonymously. This will ensure honest feedback and give you an accurate snapshot of what people are thinking and feeling. The questionnaire information should be organized and communicated back to participants as soon as possible. It will take courage to report back the findings, especially if they aren’t all positive, but it will build the credibility of the change process. You will find the information from the questionnaire invaluable.

The following questions are examples that have been used effectively in many change update meetings. Limit the number of questions to a maximum of five or six.

#### Questionnaire

1. Overall, how did you find this presentation? From 1 [Not useful]; 2 [Somewhat useful]; 3 [Good, solid information]; 4 [Very useful]; to 5 [Outstanding]
2. What are some reactions you have from today’s presentation?
3. What advice can you give us to further improve our communication with you?
4. What questions do you still have about the change/planning process?
5. What advice can you give us about improving our change/planning process?
6. What are people saying about the change/planning process? (What’s the word on the street?)

You should have Change Update meetings every two weeks throughout a change process. This will keep people informed, gather meaningful feedback, and improve communication and credibility.

## Schedule

|   |               |
|---|---------------|
| 1. Welcome and introduction to the activity                                     | 10 minutes    |
| 2. Presenter walks through the important information                            | 15–20 minutes |
| 3. Participants engage in a “pair and share” to discuss their reactions         | 5 minutes     |
| 4. Presenter facilitates open discussion for all participants                   | 20–30 minutes |
| 5. Presenter hands out short questionnaire and asks participants to fill it out | 5 minutes     |

*Total time: approximately 1 hour 25 minutes*

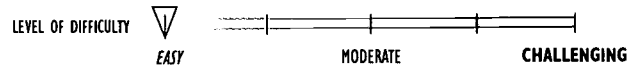

# RUMOR MILL

---

## I. Goals/Outcomes

1. To communicate honestly and effectively with stakeholders during a change process
2. To use the “negativity” associated with rumors in a constructive and positive manner
3. To build trust throughout the organization

## II. Background/Context

In any system-wide change effort, rumors are constantly circulating throughout an institution. This is a normal and natural occurrence that is kept alive for many reasons: 1) People want information, any kind of information during times of change; 2) Rumor mills have been around for a long time, people enjoy “being in the know” and develop elaborate systems to know what’s going on; 3) When honest, open information is not available, people will fill in the gaps, usually with negative information; 4) When there is low trust in the organization, the rumor mill thrives; 5) Information is a source of power in any organization, many people want to be sources and be seen as influential, etc.

For a change leader the greatest concern is the often destructive nature of the rumor mill. It is rare to hear about positive things in the rumor mill. Too often, it is worst case scenario stuff or outright lies. During a change process, leaders want to create the kind of communication process that is effective, transparent, and trusted.

This design changes the game and the destructive nature of rumors by directly addressing the rumors head on! People begin to trust the official sources of information because this type of meeting is courageous and honest.

You will never stop the rumor mill, but you can lessen its negative impact. This design can easily work with groups of 10 to 100 and you provide the best and most honest information regarding the biggest and juiciest rumors!

### III. Logistics

Materials: Overhead projector

Space needed: Large, comfortable room for the number of participants.

Auditoriums are good for this.

Time frame: 30–60 minutes

Number of participants: 10–100 or more

### IV. Implementation

The first step in this design is to collect the top rumors that are circulating throughout the organization regarding the change process. These can be easily collected by asking people throughout

#### Helpful Hint

Secretaries are a wonderful source for rumors. Secretaries know everything! If they trust you, they will tell you amazing things. Their network could teach the Internet a thing or two about speed, access, and leverage!

the organization—in the cafeteria, hallway conversations, social gatherings, informal places where the rumors are born and set free. You get the idea.

You can also conduct a short, anonymous questionnaire that asks 30–40 diverse stakeholders in the organization what's going on out there. Make sure you ensure people's anonymity so that you get the "juicy" rumors.

After you have the rumors, you need to organize them into the "top 10" rumors and create the most honest, straightforward answers for each one. This is the key factor to the success of this design. The

information has to be completely trustworthy, no fudging or vagueness. There may be times when you don't have answers to a rumor, but this should be the exception, not the rule.

Next, you set up a Rumor Mill meeting that is open to all interested parties. Use whatever communication mechanisms necessary to inform as many people as possible about the meeting. Tap the informal network and rally support for people attending the rumor mill meeting.

When participants have convened and are settled in, the leader should "walk thru" each of the 10 rumors using an overhead projector in order for everyone to see easily. The following are some examples:

#### Helpful Hint

Have the Rumor Mill meeting early in the morning or at lunch time. It is helpful to provide some light refreshments for participants. People like to "chew and chat" and more people will attend if they know food is involved.

#### Rumor #1

*"This technology project is going over budget by a million dollars!"*

The facts:

"Presently we are over budget by 12 percent. When we project this out over the next six months, we expect to be over budget by \$225,000."

BEST COPY AVAILABLE

**Rumor #2**

*“The president is not really behind this change effort.”*

The facts:

“The president is very committed to this process. The board is holding him accountable for the success of this project. It is one of the five major goals he has negotiated with the board. He has attended 80 percent of the institutional council meetings for this change effort.”

**Rumor #3**

*“We hear that they are paying the planning consultants \$3,000 per day.”*

The facts:

“The consultant’s daily rate on this project is \$2,000. This is a very competitive rate for the quality of these consultants.”

**Rumor #4**

*“We aren’t kept informed about the decisions that are being made about this project.”*

The facts:

“The minutes from the change management sponsor group are published on e-mail within 24 hours of the meetings. We are open to improving ways of communicating what decisions are being made. Please let us know your suggestions.”

**Rumor #5**

*“They will never make the January 1 cutover date for the new software program.”*

The facts:

“That is correct. We made our best estimate eight months ago but we now realize that the cutover will be delayed at least one month, possibly two. We want to do things right and not put people under stress. We will keep you informed about the progress we make towards our new deadlines.”

You get the idea. Present the rumor and tell the truth. This part of the meeting should move pretty quickly. Obviously, when an organization does this, leaders are taking a risk. You have to weigh the benefits carefully. We have found that people appreciate the honest approach, even when the news is bad. Honesty does build credibility, and employees will usually use the “official” mechanisms for communication in the future, if they believe you will be forthright.

A final step in this meeting is for the leader to solicit people’s reactions from the Rumor Mill information. Suggest that participants do a “pair and share” with the person next to them. Have them talk about their reactions to this new information. Give them 3–4 minutes for this partner chat. The leader should then encourage participants to share their thoughts about their reactions to the Rumor Mill information. Keep this discussion to 15–20 minutes. The primary goal of this step is to have participants hear from each other what their reactions are. It also provides a sense of closure for the meeting. The following are some typical responses.



*"I appreciated the openness but I'm still concerned about the cost of this project."*

*"I learned a lot and had many of my questions answered."*

*"You should provide this forum more often."*

*"You need to provide a variety of ways to keep us informed about what's going on."*

*This was a plus."*

*"It's amazing how fast rumors spread and how negative they usually are."*

It is always a good idea to provide a short, anonymous questionnaire for participants to fill out *before* they leave the Rumor Mill meeting. Not everyone will feel comfortable speaking in front of others, therefore, providing a different vehicle for communication is always helpful. Some suggested questions:

- A. General reactions to the Rumor Mill meeting.
- B. What questions do you still have about the change process?
- C. Are there any rumors out there that we should know about and respond to?

It is most effective when you hold regularly scheduled Rumor Mill meetings. Every two weeks seems to work well after the initial meeting. We were engaged in a year long, institution-wide change process where we utilized the Rumor Mill process. Every Tuesday morning at 8:00 we held the meeting. In the first month, average attendance was close to 100 employees. Over time, this number dwindled down to a handful. We did not discontinue the process due to low attendance. Even with 6–10 participants, our goal was to communicate our commitment to honest information and accountability. In a case study report conducted after the change process was implemented, stakeholders reported that the Rumor Mill meetings were critical to building trust and streamlining information.

## Schedule

- |  |              |
|--|--------------|
| 1. Welcome and introduction of the activity                            | 5–10 minutes |
| 2. Leader presents the top rumors throughout the organization          | 20 minutes   |
| 3. Participants engage in a "pair and share" to discuss their reaction | 5 minutes    |
| 4. Open discussion about Rumor Mill information                        | 5–20 minutes |
| 5. Participants fill out short, anonymous questionnaire                | 5 minutes    |

*Total time: approximately 1 hour*

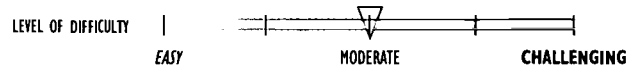

# SENIOR MANAGEMENT MEETING

---

## I. Goals/Outcome

1. To obtain a balanced perspective from employees regarding their successes, concerns, and anticipated challenges about a change effort
2. To create an opportunity for senior management to listen to and communicate with their employees

## II. Background/Context

During a comprehensive change process, change leaders must create opportunities to listen to the “pulse” of the organization. People will have many concerns, questions, hopes, and frustrations. The problem is they rarely get the opportunity to express their ideas in constructive ways. Too often, people go underground and the source of communication and sharing of frustrations becomes the rumor mill or grapevine. We have seen many sophisticated and resilient rumor mills on campuses! This is often a sign that people don’t have access to appropriate communication vehicles and they don’t trust the “official” mechanisms. This design creates an appropriate mechanism for communication and can build trust in the institution.

Senior leadership needs to take responsibility for getting people together who are affected by a change process and let them share their ideas. This type of meeting should be conducted regularly (every 4–5 weeks in a year-long change process) to establish healthy communication with stakeholders and report on progress.

Senior management is often reluctant to get people together because they are fearful of the possible consequences. In the past, they have seen these types of meetings deteriorate into a “complaint” session that focuses only on what is *not* working. Or they find that when you get people together, they are reluctant to express their ideas and the meeting meanders along with little meaning.

This design creates the opportunity for participants to share their ideas in a balanced and

structured way. The three themes that are explored are:

1. What compliments (successes) are people having?
2. What concerns (frustrations) do people have?
3. What challenges (opportunities) should we be thinking about in the future?

### III. Logistics

**Materials:** Flipcharts, newsprint paper, magic markers, moveable chairs, overhead projector, Self-Managed groups handout

**Space needs:** Large, comfortable room

**Time frame:** 1-1/2 to 2 hours

**Number of participants:** 20–100

### IV. Implementation

We will use 70 participants as a model for this design.

The facilitator would have the room set up so that participants could sit at one of the seven tables. There should be no more than 10 people at each table and a flipchart should be at each table.

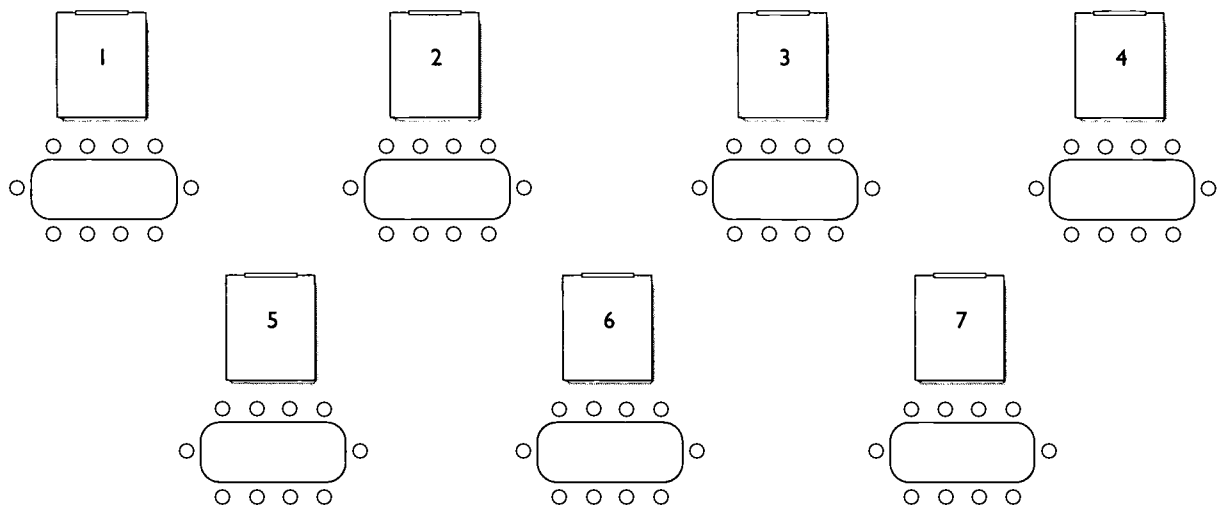

The facilitator reviews the purposes of the meeting so that everyone understands what needs to be accomplished.

At each table, you should have handouts with the three questions for each participant and a description of the Self-Managed roles. (See page 2.149.)

What compliments do you have?

What concerns/frustrations do you have?

What challenges (opportunities) should we be thinking about in the future?

The facilitator reviews the Self-Managed roles handout with all the participants and have them identify persons in each group to fulfill the roles before they begin their task.

- A. Facilitator: keeps everyone involved and things moving
- B. Presenter: presents their group's ideas to the larger group
- C. Recorder: captures participant's ideas on newsprint
- D. Timekeeper: keeps the group aware of how much time is left

Give the participants about 5 minutes to jot down some notes regarding the three questions. Then have them conduct a group discussion for 20–30 minutes about their answers to the questions. The recorder should capture these answers on newsprint in full view of group members. This newsprint should be saved at the end of the meeting and typed up as a record of the discussion.

After each group has answered the three questions and recorded their responses, the facilitator or leader follows the next steps:

In the first “round,” take one idea from each group regarding the compliments or successes. Have someone other than the leader record these comments on overhead, or on newsprint, in full view of all participants. The goal is to listen to the successes and create a positive framework for the meeting. Make as many rounds as necessary to get all the ideas in the room.

In the “second round” you are listening to the concerns of participants. Once again, take one idea from each group and have a recorder capture these on a flipchart or an overhead projector. After you have captured one idea from each group, the leader should respond to the concerns.

Don't be reactive! Participants will be watching closely to the leader's reactions. Keep your answers short, informative, and to the point. Brevity is important, not long, drawn out, complicated explanations. If you can't answer a particular concern, let people know this and promise to find the answer as soon as possible. (This is important in building credibility.) Inform people how you will let them know the correct answers so they can utilize the appropriate vehicle (eg., e-mail, voice mail, newsletter, face-to-face meeting) in the near future. (You can use the Parking Lot tool; see page 2.153.)

You should let participants know that you will have a *second* round, following the same process, taking one idea from each group and then responding. Also, let them know that if there are any concerns left after the second round, they will be collected and addressed at a later time. In having two rounds, you will get the most important concerns on the table. You don't want this part of the meeting to drag on too long or it will turn negative. Remember to announce how participants will be kept informed about their concerns (e-mail, newsletter, periodic meetings, etc.).

The third and final round is about challenges in the future. This is a quick round to raise awareness of what people need to have on their radar screen. Have the presenters report their one or two challenges. You don't need to respond to the challenges because your goal is only to generate awareness. After you have completed all three rounds (compliment, concerns, challenges), you thank participants for their feedback. Let them know that everyone who has attended the meeting will receive a copy of the notes that have been generated by e-mail or hard copy. If there are to be any regular follow-up meetings, let participants know what the schedule will be, and review how you will keep people informed of the change process.

### **Helpful Hint**

It may be helpful to have two people doing the recording to move things along.

### **Helpful Hint**

The reason you capture all the ideas before responding is to give the leader an opportunity to think about his or her answers before responding.

## Schedule

- |   |               |
|---|---------------|
| 1. Facilitator welcomes participants and reviews the purposes of the meeting                                      | 10 minutes    |
| 2. Facilitator reviews handouts for the focus questions and self-managed roles                                    | 5 minutes     |
| 3. Participants individually answer the focus questions and then have a group discussion, recording their answers | 30 minutes    |
| 4. The facilitator solicits ideas from each group regarding the compliments and successes                         | 10–15 minutes |
| 5. In the second round, the facilitator takes one idea from each group regarding their concerns                   | 10–15 minutes |
| 6. Leader responds to list of concerns  | 15–20 minutes |
| 7. Facilitator solicits a second round of concerns  | 10–15 minutes |
| 8. Leader responds to second round of concerns  | 15–20 minutes |
| 9. Facilitator solicits challenges from each group  | 10–12 minutes |
| 10. Facilitator or leader thanks people for their participation and explains next step                            | 10 minutes    |

*Total time: approximately 2-1/2 hours*

## SECTION 3 | **Team/Group Effectiveness**

During most change efforts, many groups and teams are created to perform important tasks. Too often, people are put together with little thought about how they will work as a team. It is often assumed that given a purpose and smart people, everything will work out fine. This rarely happens. Often, groups never realize their promise, get bogged down with conflict, and never tap the talent in the group.

Groups are complex and need to be organized in a way that maximizes people's skills and talents. The designs in this section can help the change leader create very effective groups.

### **Establishing Criteria for Chairpersons and Groups Leaders**

This design addresses the critical issue of group leadership. A group cannot rise above the quality of its leadership, so choosing the best leader is essential. In this activity, group participants agree on criteria for their leader, before selection of their leader. This enables them to choose the best leader to match the unique talents of their particular group and the one best suited to accomplish their goals.

### **Creating Effective Team Ground Rules**

This design creates the opportunity for group members to share the expectations they have for each other. By making these expectations explicit, they can then create working agreements or ground rules that will enable them to perform well together. These ground rules, when adhered to, produce amazing results.

### **Bringing Two Working Groups Together**

When two different groups are put together to work on a project, it is important to create an opportunity for them to understand each other. This design enables members from two different groups to learn about each other in a structured, safe, and open format. Everyone comes away with a deeper understanding of the other group's history, culture, values, and aspirations.

### **Transition Design**

During a long-term change process, group membership constantly changes. New members are brought in, veteran members leave for different assignments, etc. These transition times need to be carefully planned or the group's effectiveness can be impacted. This design creates the opportunity to bring new people on board quickly, to honor the contribution of members who are leaving, and to obtain their wise council.



## ESTABLISHING CRITERIA FOR CHAIRPERSONS AND GROUP LEADERS

---

### I. Goals/Outcomes

1. To create an agreed upon criteria for selecting the best person to chair a committee or work group
2. To fully involve all group members in selecting a chairperson for their work group

### II. Background/Context

In any college or university setting, numerous task forces, committees, and work groups are created each year to carry on the important work of the institution. Many of these work groups are highly effective in accomplishing their goals. Many are not.

Over the years, we have worked with scores of work groups and we have found that one of the most important keys to a group's success is the effectiveness of the chairperson. If you have an effective chair, the chances of the group working together successfully are enhanced. When the chairperson is ineffective, you are in trouble. Things will get bogged down, group morale will plunge, and in the end, the institution suffers.

Unfortunately, too often, the wrong person is selected to be the chair. We have found this to be prevalent in higher education for several reasons: The president or top leaders appoint a chair who they feel comfortable with; the chairperson is selected because he or she has been around for a long time; a tenured faculty member "volunteers" his or her services, regardless of his or her capacity to effectively manage a group; tradition dictates who is chosen, regardless of ability. The list could go on and on.

During a change process, having effective chairs for key work groups (e.g., curriculum review committees, strategic planning task force, technology implementation team) is critical to the success of the change effort. If the wrong person is chosen to be the chair, it signals to committee members and the institution that very little will be accomplished. It is demoralizing to see a group struggle with an ineffective chair.

This design "ups" the chances of selecting the right chairperson for a work group. The key to its effectiveness is having group members create the criteria for the selection of their own chairperson

*before* they decide who it is. The design has several important steps that build a shared database, and help move the group toward a final decision.

### III. Logistics

Materials required: Easels, flipchart paper, markers

Space: Comfortable room with moveable chairs

Time frame: 1 to 1-1/2 hours

Number of participants: 6–20

### IV. Implementation

We will use 16 participants as a model for this design. An outside facilitator would be most helpful with this design.

The facilitator explains to participants that the primary purpose of this design is to create the best criteria possible for choosing a chairperson or leader for the group. It is important to communicate that the criteria will create a framework for choosing the chair but that the selection will happen later.

The facilitator then has group members count off from one to four. This will give you four groups of four participants, randomly mixed.

Ask each small group to spend 15 minutes creating four or five criteria for the “ideal” chairperson for this group. Remind them that the criteria should connect with the purposes and goals of the group (e.g., if this is a strategic planning group, having someone with planning experience would be helpful). Provide some specific examples to stimulate and frame their thinking.

- A. Someone who understands college or university politics
- B. Someone who has strong interpersonal skills
- C. Someone who has the time to do this important job

Suggest that each group have a recorder to capture their ideas.

After each group has created their criteria, have two groups work together. Their goal in the next 15 minutes is to come to general agreement on the top five criteria. Let them know that they should look for common ground ideas (there usually are some) and discuss the best criteria for leading this particular group. Remember, the goal is to come up with the five best, specific criteria.

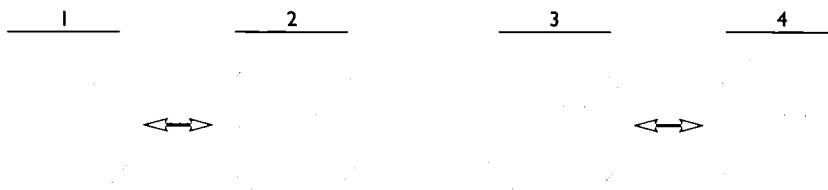



After the two large groups have agreed upon their criteria, the facilitator then creates a master list, on a flipchart, in full view of the participants. The facilitator should take one idea from one group, then one idea from the other group, going back and forth until all the ideas are recorded. The facilitator should prioritize the list as it is being created, by checking off similar ideas. At this junction, your list might look like this:

### Master List

1. Positive reputation throughout the institution
2. Good people skills ✓
3. Organized with planning skills
4. Knows institution well
5. Hardworking
6. Open to new ideas ✓
7. Previous chairperson experience

### Helpful Hint

When two groups work together to create an agreed upon list, there is a tendency to “lump” things together under one major theme (e.g., “The chair should be open to new ideas, be creative, and have strong interpersonal skills.” These are three different criterion!) Watch out for this and communicate to participants that each criterion should be specific and stand by itself.

After the master list is created, the facilitator should have a brief discussion (15 minutes) with group members about their reactions to the list. Some discussion questions might be: What resonates with people? Any discoveries or surprises? What reactions do people have? The goal is to have participants share how they think or feel about the list. This deepens understanding and commitment to the criteria.

Break: 10 minutes.

After the break, the facilitator leads an open discussion about how the group will decide who the chairperson should be. There are no quick and easy answers for this discussion. It is important to remind participants that, however they choose the chairperson, it is important to use the criteria they have created as the critical framework for choosing anyone.

Some suggestions: Have the group select their candidate anonymously, this ensures honesty and safety. Sometimes participants will want some time to think about the criteria before selecting. Don't rush the decision or people will naturally resist the process. You can have the selection process at a different time, such as some time in the next several days. If people get a chance to “sleep on the decision” over a day or two, we have found that it enhances the process. People really think about the criteria carefully and it influences their choice. At other times, we have found that group members will talk to each other, solicit opinions and advice, and come to a general agreement informally before the official decision.

It is important to check in with people to see what they are thinking and feeling. They might be ready for a secret ballot right away, lot of discussion, or a delay in the decision. The facilitator will have to “read” the group carefully on this. . . . }

After the chairperson has been selected, we suggest a final step. Once again, put people into small, mixed groups utilizing a counting off method. When they get into their groups, have them create two or three pieces of advice for the new chairperson. This advice should help the chairperson be successful in his or her new role. (This should take about 10 minutes.) Have a recorder in each group.

Have each group report on one of their pieces of advice and record it in full view. Make as many rounds as possible until all the advice is shared. This quality information gives the new chairperson the data he or she needs to successfully lead this group. It has proven to be an invaluable final step.

Some examples we have seen:

- *Make sure you fully inform all group members of any changes in agendas, meeting times, etc.*
- *Ask for our help and assistance. We want you to be successful.*
- *Establish an ongoing, anonymous, evaluation process for our group's effectiveness.*
- *Clarify the decision-making process or procedure so that everyone in the group understands how decisions will be made.*
- *Design and plan the meetings for full participation of all team members. Don't let a few people dominate discussions.*
- *Over time, it might be helpful to have a co-chair, to share the workload and build the capacity of the group.*
- *Hold people accountable for their areas of responsibility.*

You get the idea. This advice is really a diagnostic of what people want from the chairperson and provides strategic advice for anyone open to the ideas of others.

## Schedule

|   |            |
|---|------------|
| 1. Introduction of activity and counting off  | 10 minutes |
| 2. Groups create ideal criteria   | 15 minutes |
| 3. Groups merge and come to agreement on top five criteria  | 15 minutes |
| 4. Facilitator creates master list of criteria  | 10 minutes |
| 5. Open discussion about list   | 15 minutes |
| 6. Break  | 10 minutes |
| 7. Discussion about how the group will decide ( <i>This depends on who the chairperson will be and the selection process that will be utilized</i> )* |            |
| 8. Groups create advice for new chairperson   | 10 minutes |
| 9. Facilitator creates master list of advice  | 10 minutes |

*Total time: approximately 2 hours*

*\*(Note: This time frame does not include step #7 due to its variability)*

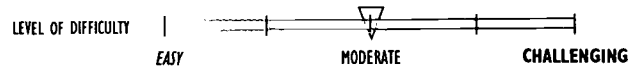

# CREATING EFFECTIVE TEAM GROUND RULES

---

## I. Goals/Outcomes

1. To create “working agreements” that will enhance a group’s productivity
2. To fully involve all team members
3. To create real ownership of the ground rules
4. To tap the experience and resources of team members

## II. Background/Context

As a change leader, you can never assume that if you get a bright, motivated group together, somehow they will all understand how to work together effectively. Groups are complex and complicated because participants come to the table with diverse expectations, experiences, and perspectives. Having clear purposes, the appropriate amount of structure, and agreed upon ground rules or working agreements can leverage a group’s efforts in dramatic ways.

When a group comes together to work on a committee or task force, there are many implicit assumptions about how a group member should behave. These assumptions are rarely made public, yet they have a powerful effect on group cohesiveness and productivity. This design makes participant’s implicit expectations, explicit. Once the ground rules are fully understood and agreed upon by team members, the group can hold each other accountable for the behaviors of team members.

There is no magic set of ground rules that will work for any team because each team is unique. The leader must be able to facilitate the process of the team creating its own ground rules. This ensures real ownership by all participants and helps create group cohesiveness.

This design has several small steps that build on each other. It enable participants to share their ideas, learn from each other, and agree on a common set of rules. It is a great beginning activity for an initial team meeting, but it can also be used if a team is floundering.

### III. Logistics

Materials required: Flipchart paper, easels, magic markers for recording, masking tape

Space: Large, comfortable room with moveable chairs

Time Frame: 1-1/2 hours

Number of Participants: 6–24

### IV. Implementation

We will use 12 people as a working model for this design. An outside facilitator would be a very helpful addition to implement this design.

Have the team members count off from one to four. This will give you four groups of three members, randomly mixed.

Ask the participants in each group to talk about a team they were a part of that they believed was an effective team. (You can define effective as: the group accomplished its goal(s) and people felt good about being part of the team.) Give each group 10 minutes to describe their successful team experiences (approximately 3 minutes per person).

After all the group members have had a chance to tell their stories, ask each group to come up with four or five lessons learned from their successful team experience. Success leaves clues and we want them to help define what made their teams work so well. Their goal is to have general agreement about these four or five lessons and put these lessons on flip chart paper. (You should give them 15 minutes for this task.)

At the end of 15 minutes, you should have four flip charts with the successful team elements on them. It might look like this:

|   |
|---|
| <p><b>1.</b></p> <ol style="list-style-type: none"> <li>1. Diversity of the group</li> <li>2. Well organized</li> <li>3. Conflicts were handled well</li> <li>4. Lots of participation</li> </ol> |
|---|

|  |
|--|
| <p><b>2.</b></p> <ol style="list-style-type: none"> <li>1. Full participation of all team members</li> <li>2. Purposes were clear</li> <li>3. Well-run meetings</li> <li>4. Everyone was kept informed throughout the process</li> <li>5. Feedback was seen as normal and helpful</li> </ol> |
|--|

|  |
|--|
| <p><b>3.</b></p> <ol style="list-style-type: none"> <li>1. People were supportive</li> <li>2. Action-oriented—we got things done</li> <li>3. We kept score on progress being made</li> <li>4. Well organized</li> <li>5. Lots of follow-up and monitoring</li> </ol> |
|--|

|  |
|--|
| <p><b>4.</b></p> <ol style="list-style-type: none"> <li>1. Everyone was involved</li> <li>2. No “bullies”</li> <li>3. Open communication</li> <li>4. People wanted to be part of the team</li> <li>5. People were kept informed</li> </ol> |
|--|

At this time you have a variety of success factors derived from the actual experiences of team members. Have each group report out their lessons learned and make sure everyone can see their flipcharts allowing 1 or 2 minutes per group. It is important to keep this brief to sustain energy, but the facilitator can ask if anyone has questions for clarification, but not for people to justify their lessons.

The next task is to focus on creating the best working agreements for this particular group, using the successful lessons as a common database. The facilitator then asks each small group to come up with three quality ground rules that would enable the team to accomplish its purposes and enhance team cohesiveness. (This should take 10 minutes.)

The facilitator then asks each group to provide one of their suggested ground rules and captures these on flipchart paper. The facilitator should make several rounds, asking for one idea per group until all the ideas are out and recorded in full view.

If some of the groups have similar ground rules, the facilitator should encourage participants to let him or her know this and indicate agreement with a check mark. The new master list might look like this:

#### **Group Master List**

1. Provide an agenda before meetings
2. Have clear next steps with accountability
3. One person talks during a time during meetings
4. Have a record of each meeting distributed to all members ✓
5. Periodically evaluate our team's effectiveness with an anonymous questionnaire to all team members ✓✓
6. Design our meeting for full participants (i.e., small groups, round robin, etc.) ✓
7. Strive to listen to all team members
8. Be tough on the problems but careful with people.

#### **Helpful Hint**

Throughout this design it is helpful to give a 2-minute warning before the end of the allotted time frames. This keeps participants on track and avoids uneven finish times.

#### **Helpful Hint**

Using a round robin approach, where you solicit one idea from each group and make as many rounds as possible, is an important design element. You want to ensure full participation and avoid getting all the ideas from only one or two groups. If you record all the ideas from Group #1 and then go to Group #2 for all the ideas, there is a good chance that all the ideas will be out on the table and Groups #3 and #4 will feel that their time has been wasted. You want to avoid this!

The facilitator now has a master list of eight suggested ground rules with some agreement on specific ideas. Unfortunately, eight ground rules are too many to effectively manage. It has been our experience that three or four ground rules are optimal. You can always add more ground rules later on, after the team has successfully "lived" through the original ground rules and team members believe that adding more ground rules would enhance group effectiveness.

**BEST COPY AVAILABLE**

At this time, the facilitator should suggest using the Las Vegas voting procedure (see full description on page 2.137) to narrow down the list to the best three or four ground rules. With the Las Vegas vote, each team members is given a total of five votes, to use in any way they want. They can use all five of their votes for one ground rule or split their votes by using two votes for one ground rule and three for another ground rule or use one vote for five different ground rules. They can “weigh” their votes as they see fit. You can use colored sticky dots or just have people use their fingers to vote.

### Helpful Hint

When you have groups create a master list, using this approach, the result will be similar. Out of a potential 12 ideas, (in our model three ideas per group times four groups) there will usually be common ground ideas, resulting in a shorter list. Even with a large group of 30 participants, utilizing small groups will give you a manageable list.

The facilitator should mention that the purpose of the Las Vegas vote is to produce the very best ground rules possible. Participants need to vote for those ground rules they believe would really help the group accomplish its task(s) and maintain group cohesiveness.

At the end of the Las Vegas vote, your master list might look like this:

### Group Master List

1. Provide an agenda before meetings
2. Have clear next steps with accountability ✓✓✓✓✓✓✓✓
3. One person talks during a time during meetings
4. Have a record of each meeting distributed to all members  
✓✓✓✓✓✓✓✓
5. Periodically evaluate our team's effectiveness with an anonymous questionnaire to all team members ✓✓✓✓✓✓✓✓✓✓✓✓
6. Design our meeting for full participants  
(i.e., small groups, “round robin,” etc.) ✓✓✓✓✓✓✓✓✓✓✓✓
7. Strive to listen to all team members
8. Be tough on the problems but careful with people.

As you can see, the top four ground rules are:

*Design meetings for full participation (12)*

*Periodically evaluate the effectiveness of our team with an anonymous questionnaire (12)*

*Have clear next steps with accountability (8)*

*Have a record of each meeting distributed to all team members (7)*

The facilitator thanks team members for their work and closes the meeting.

### **Helpful Hint**

Periodically, especially in the early stages, evaluate the effectiveness of your ground rules. Group members need to indicate (anonymously) how the group is doing with “living” their ground rules. This builds in mutual accountability and adds meaning to the use of ground rules.

## **Schedule**

|   |              |
|---|--------------|
| 1. Introduction of activity and counting off  | 10 minutes   |
| 2. Small groups talk about successful team experiences                              | 10 minutes   |
| 3. Small groups create lessons learned and put on newsprint                         | 15 minutes   |
| 4. Brief reports on lessons learned   | 5-10 minutes |
| 5. Small groups agree on three ground rules   | 10 minutes   |
| 6. Facilitator records master list in front of everyone                             | 15 minutes   |
| 7. Facilitator uses the Las Vegas vote to determine best three or four ground rules | 10 minutes   |

*Total time: approximately 1 hour and 30 minutes*

BEST COPY AVAILABLE

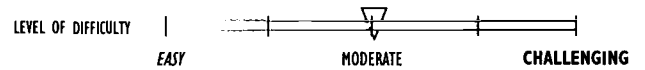

# BRINGING TWO WORKING GROUPS TOGETHER

---

## I. Goals/Outcomes

1. To collect and synthesize information about two groups that will be working together
2. To deeply understand the important values, attitudes, beliefs, and challenges of groups that need to collaborate
3. To begin to develop relationships between two different groups
4. To begin to develop some possibilities for future collaboration between two groups

## II. Background/Context

In a large, complex change process, there are many groups on campus that don't know each other very well. When the change process begins, they are often thrown together to work on a common project. The hope is that if you get smart, dedicated people together and tell them what the goals are, they will be able to work together as a cohesive team. Unfortunately, it doesn't work that way.

We have been in many institutions where different groups (e.g., academic departments, a combined technology/library task force, administrative and faculty working on salary considerations) never get beyond their differences. They don't get to know each other and fail to utilize the diverse skills each possess—even if they are really smart.

In higher education, as in many organizations, there is a strong tendency to focus on the task part of a project and pay little attention to the process part of a change initiative. Unfortunately, it is in the process that things usually break down. Change leaders need to have both discipline and courage if they are to change the natural focus and attention to task only.

This design creates the opportunity to have a good “beginning” when two different groups get together. It engages all participants, values their contributions, and creates a database for understanding each other.

A facilitator works best with this design, ideally someone neutral who has some working knowledge of both groups and the institution. Don't have one person from one of the groups facilitate this meeting, because it will feel like “their” meeting instead of “our” meeting. An outside facilitator can keep everyone on task and it enables everyone to fully participate.



**Helpful Hint**

Make sure you choose a good facilitator. It should be someone who has real experience facilitating and has credibility with both groups.

**III. Logistics**

Materials: Flipchart paper, easels, magic markers, paper, and pens

Space needs: Large, comfortable room with moveable chairs

Time frame: 2-1/2-3 hours

Number of participants: 10-40 participants

**IV. Implementation**

We will use 20 people, 10 in each group, as a model for this design.

The facilitator welcomes participants and explains the purposes of the meeting. Everyone should briefly introduce themselves by name, role, and length of time in the institution, e.g., "My name is Peter Wilson. I am an associate professor of English and I have been at this campus for 11 years." It is important that participants get a feel for who is at the meeting.

The facilitator should then ask each group to get together and create five questions to ask the members of the other group. These questions should enable group members to get to know each other better, and be thought provoking, engaging, and penetrating. Give them 15 minutes for this task. Suggest that each group have a recorder for their questions.

The facilitator can suggest some questions before the groups begin their task to stimulate their thinking and give them some examples of the quality of the questions that are being sought.

- What are three core values that your group/division truly "lives"?
- What is it about your group that makes you feel proud about being a member of it?
- What are some important things you have learned by working with other members of your group?
- What are some regrets you might have about working with your group? What things could you be doing differently?
- How would you describe the culture of your group?
- Describe what communication looks like in your group.

**Helpful Hint**

Limit the number of questions to five. If you have more than five, the design will lose momentum and you will have more information than you can possibly absorb.

The idea is to craft questions that will enable participants to understand the complexities and nuances of the other group.

After each group has generated their best five questions, have each group member choose a partner from the other group to interview. (Group A (○) member interviews Group B (□) member.)

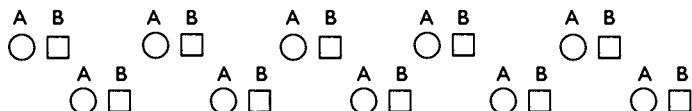

Ask the pairs to take 30 minutes (15 minutes per person) to interview their partner from the other group. Their goal is to have their partner answer the focus questions and for everyone to really listen carefully while interviewing. You want to get quality information from the interview and begin to establish some rapport between members.

After the interviews, give participants a brief break of 10 minutes.

After the interviews are completed, have the groups reconvene into their original group and give them 30 minutes to capture the major ideas and themes they heard from their partner interviews. They need to put this information on a flipchart because they are going to share what they learned about the other group in the next step.

The following might be a small example of a group's interview summary and learnings:

**What are they proud of?**

They have an excellent reputation across campus.  
 They are on the cutting edge of their field.  
 Group members are hard working, smart, and honest in their dealings with each other.  
 They are willing to help anyone on campus.  
 They've received a number of awards for excellence.  
 Projects are completed on time.

**How do they describe their culture:**

Open  
 Friendly  
 Conflict adverse  
 People open to learning  
 No big egos

**How they describe communication in the group:**

Everyone is kept informed  
 Overwhelming at times  
 No secrets  
 People take ownership for communicating with others  
 People are honest in their communication

After each group has captured the essence of the personal interviews on flipcharts, each group then presents their information to the other group.

Their goal is to share what they have learned about the other group. Each group should check for understanding and not rush through the presentations. This is not a data dump. Providing personal examples is helpful, e.g., “Your group talked about your team member’s honesty with each other, even when sharing difficult information.” The goal is to convey both the substance of what was said in the interviews and the quality of the information.

After the presentations, the facilitator should check for understanding and clarification. He or she can ask, “Do you feel that this information reflects your group appropriately? Is there anything that was missed or miscommunicated?” You want to make sure that group members feel understood and heard.

Once the presentations have been made, the facilitator has several options:

*Open up the floor to participant’s general reactions to the shared information. (What resonated? What discoveries were made?)*

*Facilitate a discussion about possibilities, “Given what we have heard, what do we need to keep in mind as we continue to get to know each other? Work together?”*

*Have participants talk about the connections they see between the different groups/organizations. (What are some possible roadblocks or challenges people see as they continue to work together?)*

Keep the facilitated discussion to no more than 20–30 minutes. Remember, this is about creating a positive beginning. Don’t rush for closure at this time. It would be helpful to schedule another meeting with this group as soon as possible to review purposes, create ground rules, and start working on the larger tasks.

## Schedule

|   |               |
|---|---------------|
| 1. Faciliator welcomes participants and explains purposes of the meeting                      | 10 minutes    |
| 2. Participants give brief (30 second) introductions of themselves                            | 15–20 minutes |
| 3. Groups create five questions for interviews  | 15 minutes    |
| 4. Group members pair off and conduct interviews  | 30 minutes    |
| 5. Break  | 10 minutes    |
| 6. Groups reconvene and distill information from the personal interviews                      | 30 minutes    |
| 7. Each group presents what they have learned about the other group                           | 20–30 minutes |
| 8. Faciliator conducts open discussion about participant’s reactions, and possible next steps | 20 minutes    |

*Total time: 2-1/2 to 3 hours*

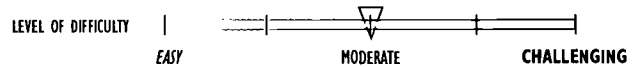

## TRANSITION DESIGN

### I. Goals/Outcome

1. To orient new team members to an ongoing group
2. To facilitate the transition of new group members
3. To leverage the experience of group members who are leaving (Adaptation #2)

### II. Background/Context

In any long-term change process of say six months or more, such as organizational redesign, technology implementation, or strategic planning process, many work groups and teams are created to carry out important work. Due to unforeseen circumstances, some members have to leave the intact team. In other situations, new members are added because the size and complexity of the change process dictates more support.

The challenge for the change leader is to leverage the opportunity of learning from departing members and making new members feel at home with an ongoing group. In fact, you not only want new members to feel welcome, you also need them to make value-added contributions as soon as possible.

You want to avoid the “new kid on the block” syndrome that exists when new members join an intact group. Too often, the new members spend an inordinate amount of time trying to figure out what the norms of the group are. New members often try to be collegial and listen much more than is necessary. They are reluctant to make suggestions. The change leader needs to be able to create the opportunity for new members to contribute fully and not wait until it is appropriate to do so. Furthermore, there is much to learn from the veterans who are leaving. This design enables you to get people on board quickly and distill wisdom from those who are leaving.

Norms are powerful influences in any group. The problem with norms is that they are rarely explicit or acknowledged publicly. These unspoken agreements about “how business is done here” need to be made public so new members can learn as quickly as possible what’s expected and appropriate. This design allows you to surface these implicit norms and creates an atmosphere of openness and understanding. What makes it work is its ability to create the opportunity for everyone to teach and learn from each other.

This design has an adaptation and we will start with the simplest one first.

### III. Logistics

Materials: Pens and paper

Space: Comfortable room with moveable chairs

Time frame: 1 to 1-1/2 hours

Number of participants: 5–15

### IV. Implementation

We will use 10 participants as a model for this design.

1. The leader of the team asks the group of 10 to form two groups. One with veteran members only, the other with the new members. The leader should let participants know that the main purpose of this activity is to have people get to know each other.

#### Helpful Hint

It is important that the leader sit with the new members. This will balance the power in the group, create a sense of safety and give the new members permission to be open.

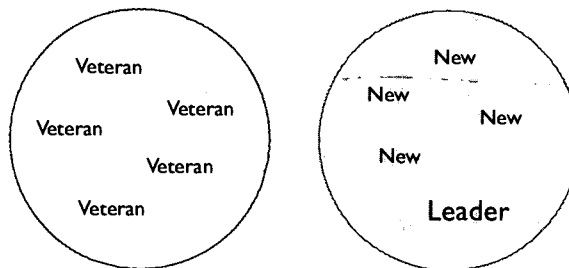

Have each group come up with five or six questions they would like to ask the members of the other group. The leader should strongly suggest that these questions be crafted so that they allow each group to *learn* as much as possible from the other group. Some examples new group members might ask:

- What are two or three successes your team has experienced that you are most proud of?
- What are three norms in your group that we should be aware of?
- Discuss some difficulties in being a part of this group and what have you learned from these difficulties?
- What do you like most about being a part of this team?

Veterans might ask:

- Please describe a time when things didn't go well for you and what you learned from this.
- What are two skills or talents you bring to the table?
- How would you describe your effectiveness as a team player?
- How would a good friend describe you?
- How would someone you have had some difficulties with describe you?

BEST COPY AVAILABLE

You get the idea. The goal is to ask those questions that rarely get asked. People will often manage the appropriate level of risk regarding what kinds of questions that are asked. The leader should double check the questions before participants begin asking them to ensure quality and help manage the risk level.

After the two groups have created their five or six questions, the leader should suggest that the new members ask their first question. This creates a more level playing field and gives them permission to ask their question. After the veterans have answered the new member's first question, they get to ask their first question and listen to the response. This process continues with each group taking a turn asking and answering a question until all questions have been asked.

After all the questions have been answered, the leader should conduct a short discussion about participant's reactions to the meeting. It is helpful to hear how participants experienced this activity. Don't get too deep in the woods with this, keep the discussion to 15–20 minutes. It helps create a sense of closure for the group. Some focus questions you might ask to stimulate discussion are:

- What were some discoveries for people? Surprises?
- What should we keep in mind as we work together in the future?
- How can we take what we have learned about each other and help us achieve our mission?

**Helpful Hint**

The leader in this design needs to manage the conversation carefully. Your goals are to keep participants on task; make sure things don't drag on too long, and check for understanding as the process evolves. If you think one of the participants or groups might not have given a complete answer, or that there is some confusion, you can check to see if the other group is getting the information it needs.

**Schedule for Original Design**

- |   |               |
|---|---------------|
| 1. Leader welcomes participants, explains purposes of the meeting and creates two groups      | 10 minutes    |
| 2. Each group creates questions from the other group  | 15 minutes    |
| 3. Each group takes a turn asking and answering questions                                     | 20-30 minutes |
| 4. Leader facilitates a discussion about participant's reactions to question and answer round | 15-20 minutes |

*Total time: approximately 1-1/2 hours*

BEST COPY AVAILABLE

## ADAPTATION OF THE DESIGN

*(Within an intact group where some members are leaving, the following process could be utilized.)*

Have the group members divide into two groups: those that are leaving and those that are staying.

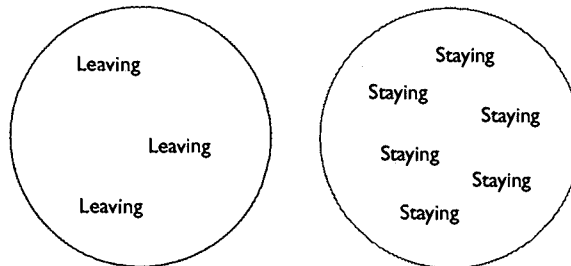

The leader should provide questions for the departing members and give them 15 minutes to organize their thinking and answers. Some examples are:

- As you look back over this team's work together, what are two or three successes this team had?
- What are some things this team could have done differently?
- What personal regrets do you have about this team's work together?
- What advice or wise council can you give the remaining team members?
- What is the most important lesson you are leaving with, from working with this group?
- What hopes or wishes do you have for the remaining team members?

The goal is to tap the wisdom and experience of the leaving members. We have found that when people are leaving, it creates the opportunity for real openness. Most importantly, this design asks for their wise council and provides the remaining members with quality information they can use to leverage the team's effectiveness in the future. It also honors the contribution of the parting members, which should be valued in every organization.

While the departing members are creating the answers to the focus questions, the leader should ask the remaining members to do the following task (giving them 15 minutes to do this): "Please list three to five positive contributions of each member who is leaving." The goal is to create the opportunity for each departing member to hear what contributions they made to the team. It is important to be as specific and clear as possible with these contributions. You want to avoid things like: "You are really a nice person." Some examples:

- A. "Joy, your organizational skills were very helpful. The agendas you provided for our meetings were great."
- B. "Lisa, your ability to listen will be missed. There were many times when we had difficulties where your listening to both sides allowed us to move forward."
- C. "Chris, your positive energy and can-do attitude was refreshing. You took on the technology project with enthusiasm and professionalism."
- D. "Rasheed, your follow through on assignments was outstanding. You completed every assignment on time."

**Helpful Hint**

This design adaptation is a judgment call on the part of the leader. If a group is impersonal or poorly functioning, this design obviously will not work. You also have to take into account the organizational culture, so choose wisely. Our experience has been that this is a very positive experience for participants. It is rare for people to hear what their contributions have been. Creating the opportunity for team members to hear the wisdom of the leaving members leverages their learning in constructive ways. Everyone is a winner.

Follow the basic formula described in the original design. Have the leaving members give the response to one of their questions. Then have the remaining members give one departing member feedback on their positive contribution. Follow this process until all the questions have been asked and the leaving members have heard about their positive contributions.

**Schedule for Adaptation**

- |   |               |
|---|---------------|
| 1. Leader welcomes participants, explains purposes of the meeting, and creates two groups: departing and remaining members. | 10 minutes    |
| 2. Both groups work on their assigned tasks (advice and contributions).   | 15 minutes    |
| 3. Groups share contribution and answers to focus questions.  | 30-40 minutes |
| 4. Leader thanks participants for their time and attention.   | 5 minutes     |

*Total time: approximately 1 hours and 15 minutes*

BEST COPY AVAILABLE



## SECTION 4 | Learning and Leverage

Learning is at the heart of every change process. Most change models look great on paper. It's implementing them that's the difficult thing to do. The activities in this section enable the change leader to learn from the past, look to the future, and leverage people's time in the present. All the designs provide unique ways to engage participant's thinking, solicit their ideas, and use their time well.

### Future Timeline/Horizon Thinking

This activity enables both small (10 people) and large (100 people) groups to anticipate the future trends, issues, and events that will impact the institution. It is a highly interactive, interesting, and informative design. Best of all, it educates all the participants about the things that will need their thinking and attention in the future.

### Lessons Learned

Success leaves clues and this activity enables a group or organization to identify its accomplishments. Most importantly, it helps participants define the specific elements that made for success and apply these to future efforts.

### Rotating Experts

This activity takes a traditional panel discussion and infuses it with energy, interaction, and learning. Instead of experts talking at participants, they work in small groups interacting with them. It utilizes panel members well and leverages the learning of participants.

### Jigsaw Design

This activity is a classic collaborative teaching design that enables participants to share information widely and distill their learning into "chewable chunks." It manages information overload well and is highly engaging and efficient.

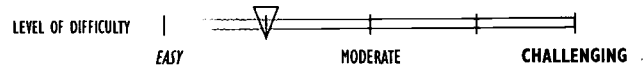

## FUTURE TIMELINE: HORIZON THINKING

---

### I. Goals/Outcomes

1. To anticipate and map out future trends, issues, and events that will impact the future of a division or an institution
2. To engage participants in creating strategic information and defining the implications of the information for the institution
3. To benchmark the institution's readiness regarding possible events, trends, and issues

### II. Background/Context

Thinking strategically and intelligently about the future is a key responsibility for any leader. We often hear leaders tell us that they aren't the creative type and leave the "future stuff" to others. This design enables any leader to engage in "horizon thinking" and anticipate some of the events, issues, and trends that could impact or influence their institution.

The primary goal of this design is to engage stakeholders within the institution in creating a snapshot of the future. It can give leaders information on possible future scenarios that could eventually occur. It is rare for trends, issues, and events to suddenly occur out of nowhere. There are usually small signs on the radar screen that go undetected until they become problems or opportunities. This design can create the structure and discipline necessary for people to think about possible futures, on a regular basis.

One of the key elements of strategic thinking is to consistently look outward. Change leaders must be aware of the external realities that will impact their institution. Looking outward creates a larger context for planning and change management and enables an institution to be proactive about its future.

This design has several steps that build a shared database for all participants. It is one of the most interesting designs we know and one of the easiest to facilitate.

### III. Logistics

Materials: Post-its™, flipchart paper, magic markers, and masking tape

Space needs: Large, comfortable room with usable wall space (30 ft.)

Time frame: 1-1/2 hours

Number of participants: 10–75

### IV. Implementation

We will use 48 participants as a model for this design.

The facilitator welcomes participants and explains the purposes of the meeting (i.e., thinking about the future, spanning 10 years). The room would look like this:

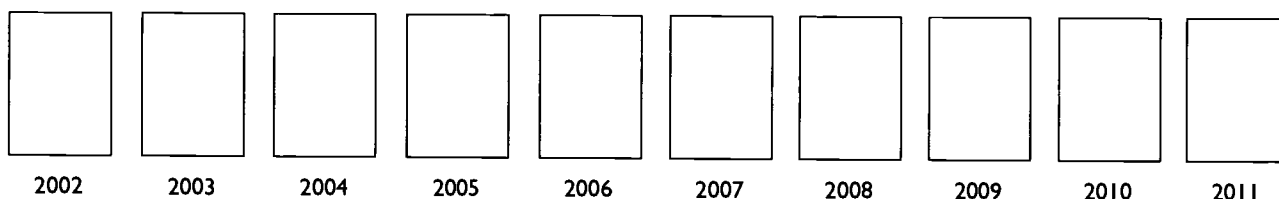

Make sure that each participant is given five Post-its™. The facilitator should explain to everyone that “they are to think about the future events, trends, and issues that could impact or influence the way the institution provides its services, how it conducts its business, or how it operates over the next 10 years.” It is helpful to provide some definitions on a handout. Example:

**An event** is a single occurrence (e.g., election of a new mayor or governor, passage of a piece of legislation).

**An issue** is an important theme that has substantial power and influence to impact an institution (e.g., faculty compensation, and percentage of student scholarships, equity issues about adjunct faculty).

**A trend** is an ongoing set of circumstances that has consistency and momentum (e.g., student population increasing, aging of faculty, increased competition from nonprofits, slowing down of the economy.)

The facilitator briefly walks through the definitions and checks for understanding. The facilitator then instructs participants to put down one event, trend, or issue per Post-its™ and go to the future timeline and “populate” it. They should put their Post-its™ in the year they believe the event, trend, or issue will occur.

Instruct participants that when they come up to the timeline and see a Post-it™ that is similar to one of theirs, they should check off the Post-it™ to indicate agreement and tear up their Post-it™. This way you avoid redundant Post-its™ clogging up the map. (This should take approximately 10–15 minutes.)

At this time, you will have a tremendous amount of information that needs to be distilled and understood by everyone.

There are two possible options at this stage of the design.

One, the facilitator can “walk through” each Post-it™, read it aloud for everyone to hear and check for meaning (e.g., “Why is this an important trend?” “What does this issue mean?” “What does this acronym stand for?”). The goal is to make sure all the participants understand the events, trends, and issues that are on the timeline.

After the facilitator has verbally reviewed the timeline (for 15-20 minutes) with everyone, they should create small working groups of six people. Do this by using a counting off method, in this case, one to eight. Ask the small groups to take 10–12 minutes and come up with three recommendations that would incorporate the information they have just heard and would be beneficial to the institution. After the groups have created their recommendations, the facilitator creates a master list, in full view of everyone on newsprint. The facilitator takes one idea from each group, round robin style, and make as many rounds as possible until all the ideas are captured.

Or implement option two, whereby the facilitator creates small groups by utilizing a counting off method. In this situation, count off one to eight, which will give you eight randomly, mixed groups of six. Ask these newly formed groups to visit the timeline and read about the events, trends, and issues they helped create. Their objective is to become “data detectives” about the future. They need to investigate the timeline and then discuss what they have learned about the future. Their goal then is to come up with three recommendations that would incorporate the future timeline data and strongly relate to their particular institution (give them about 20–25 minutes for these two tasks).

Once again, the facilitator creates a master list in full view, by taking one idea from each group. Make as many rounds as possible until all the ideas are captured. Some possible examples from this design are:

1. Technology will continue to have a powerful influence on student services and classroom instruction. We need to create a technology task force that will continually audit our current readiness and make recommendations to the president’s cabinet.
2. We can see that there will be a natural increase of potential students over the next decade. We need to be prepared for this market as soon as possible. The admissions office needs to be resourced so they can be proactive in establishing a new marketing plan and develop relationships with parents, students, and high school counselors.
3. We are very dependent on the state legislative funding. These demands and expectations will continue to increase. We need to create a benchmarking committee that will continually assess how we are doing in key areas and communicate this to the legislature on a yearly basis.
4. Student housing will continue to be in large demand. Students want to live on campus, so we need to have a plan for this over the next five years. A small task force should be created to come up with solutions in the next three months. Students need to be included in this task force.
5. Competition from for profit companies (e.g., Motorola, IBM, UNEXT) will increase dramatically over the next decade. We need to create a task force that will look at the possibility of creating strategic alliances with our competitors that will enable us to leverage our resources and

### **Helpful Hint**

Most people will find it relatively easy to think 1–3 years out. It is helpful to encourage them to stretch their thinking as far as they can. This activity is about possibility thinking, so don’t worry about making mistakes.

not compete with them head-on.

At this time, the facilitator can thank participants for their work and indicate how the information will be utilized (e.g., go to the steering group of a strategic planning process, go to the president's cabinet for consideration, go to the task force in the future, etc.). It is important to communicate what will happen to the information the group has created.

## Schedule

- |  |               |
|--|---------------|
| 1. Facilitator welcomes participants and explains the purpose of the meeting                         | 10 minutes    |
| 2. Facilitator explains how participants will populate the future timeline                           | 5-7 minutes   |
| 3. Participants use Post-its™ to populate the timeline   | 20 minutes    |
| 4. Option #1 – facilitator walks through the timeline and explains the events, trends, and issues    | 15-20 minutes |
| 5. Small groups create three recommendations from what they have heard from the timeline             | 15 minutes    |
| 6. Option #2 – small groups investigate timeline and create three recommendations                    | 20-25 minutes |
| 7. Facilitator creates a master list from each group making as many rounds as possible               | 20 minutes    |
| 8. Facilitator thanks participants and indicates how the information or recommendations will be used | 5 minutes     |

*Total time: approximately 1-1/2 to 1-3/4 hours*

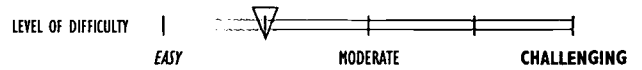

## LESSONS LEARNED

---

### I. Goals/Outcomes

1. To acknowledge organizational and people's accomplishments during a change process
2. To distill lessons learned about accomplishments and apply them to future work

### II. Background/Context

During a long-term, complex change process (such as implementing a new technology, strategic planning, or a curriculum review) it is important to benchmark progress toward institutional goals. It is most strategic to schedule these opportunities on a regular basis before the project begins. Having the discipline of a regular check-in enables you to learn throughout the change process. You can also do this at the end of any project. Furthermore, it is a wonderful way to acknowledge what people have accomplished and learned from the change effort.

We have used this design in a variety of institutions and it has never failed to be valuable for improving employee morale and making the institution smarter.

We will use a one year time frame for this design and suggest that this type of meeting is conducted on a quarterly basis.

### III. Logistics

Materials: Flipchart paper, easels, markers

Space needs: Large, comfortable room with lots of wall space

Time frame: 1 to 1-1/2 hours

Number of participants: 10–50

## IV. Implementation

We will use 30 participants as a model for this design.

The facilitator explains the purpose of the meeting so that all participants understand that this meeting is about benchmarking progress and leveraging learning.

The facilitator asks the participants to work in small groups of three or four. (You can use a counting off method 1–10 giving you 10 groups of three or just have people work with who they want.) Let participants know that their goal in the next 20 minutes is to reflect on the accomplishments realized over the last quarter and to capture these on the formatted flipchart sheets arranged around the room.

The sheets should look like this:

|  |
|--|
| <p>Accomplishments</p> <p>What made it work?</p> <p>What could we have done better?</p> <p>What do we need to continue?</p> <p>What do we need to change/stop?</p> |
|--|

The room should look like this:

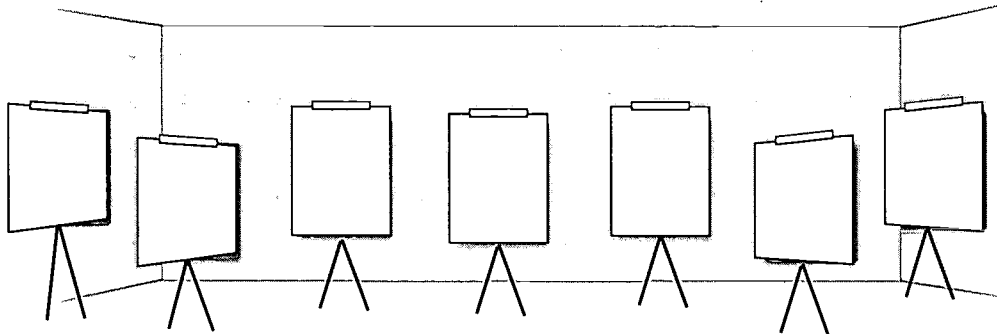

Have each group of three or four work together and note the accomplishments and answer the focus questions. Once the meeting begins, every group is creating data on the newsprint. You should let them know that they need to pay attention to what other groups are creating on their flipcharts.

### Helpful Hint

Make sure you have enough formatted flipcharts for everyone. For a group of 30, about 30 formatted sheets is appropriate. It is a good idea to have some extras in case participants need them. You can tape the flipchart sheets to the wall instead of using easels.

This way you avoid a lot of redundancy. If a group finds it has noted an accomplishment that another group is also working on, they can join that group briefly, share their ideas, and then create a different accomplishment.

It is important to let people know that accomplishments don't have to be big things only. We can learn a lot from the many small accomplishments in a change process. It is also helpful to encourage participants to be as specific as possible when filling out the sheets. The more specific they can be, the more valuable the information will be. Stay away from global

themes like: good teamwork helped, we had a good plan, we kept people informed, etc. Rather, strive for specificity. Some examples:

- A. *The communication team, led by Smith, was excellent. They used a variety of communication vehicles.*
- B. *The planning process created by the operations department, in the physical plant division enabled us to track everything*
- C. *The face-to-face meetings worked best throughout this process for keeping stakeholders informed.*

This might be difficult for participants to do at first because higher education cultures rarely acknowledge specific accomplishments. There seems to be a “collegial humility” where people find it awkward to share in front of their colleagues. Let people know you understand this but the specific quality of information created is what makes this such a powerful learning experience.

Here are two examples of possible accomplishment sheets:

**1. Accomplishment**

*We created an effective communication plan for this project that kept everyone informed.*

**2. What made it work?**

*We did a survey on communication vehicle preferences*

*We had a communication “czar” who was fully responsible for project communication*

*We had ongoing assessment of the quality of the communication process*

*We told the truth*

**3. What could we have done better?**

*We could have learned from how other colleges set up their communication system.*

*Been more open to the ideas of others*

**4. What do we need to continue?**

*Maintain consistent, high quality communications to all stakeholders until the end of the process*

*Keep communication teams together. They are working well.*

**5. What do we need to change/stop?**

*The “rumor mill” meetings served a purpose. They are no longer needed.*

Another example:

**1. Accomplishment**

*We got the library staff involved in doing research for this project.*

**2. What made it work?**

*The library staff, especially William, were very cooperative*

*We met weekly to disseminate information*

*We thanked them for their help*

*The president called the head librarian to thank her for her group’s help*

**3. What could we have done better?**

*Asked sooner!*

*We should have had one member of the library staff on the organizational planning group for this change effort*



**4. What do we need to continue?**

*We need help throughout this project so we can be as smart as possible*

*Keep people in the loop – pay attention to them*

**5. What do we need to change/stop?**

*Have the assistant head librarian (William) be part of the change management steering group*

After 20 minutes or so, (you need to pay attention to the group on this) have a warning bell signal that there are two minutes left. After people have had a chance to fill in the “Accomplishments Sheets,” give them another 10–15 minutes to visit all the sheets in the room. You want to make sure they understand all the accomplishments that have been realized and, most importantly, to distill the learnings from the information being created.

After everyone has had a chance to digest the information, have them get into small, mixed groups of six. (Do this by counting off one to five.) Ask each group of six to take 10–15 minutes and reflect on the most powerful or important lessons learned from all this information. Ask them to come up with the top three lessons that, “If we paid attention to them, we would continue to be successful.” Have a recorder in each group.

At the end of 15 minutes, the facilitator should ask each group to provide a “lesson” and capture these lessons on newsprint in full view of everyone. Make as many rounds as necessary, continuing to take one idea from each group until all lessons have been shared. Check off similar ideas.

Your master list might look like this:

1. Communications are vital to this project. Make sure we resource the communications team well. Have Rasheed work with another member of the communications team and act as co-chairs. We don't want to burn him out.
2. The face-to-face, interactive meetings seem to be the best way to keep people informed and build our sense of community. Make sure these meetings are well designed and facilitated. ✓
3. The faculty needs to be more involved in the change process. We are not accessing their feedback and ideas. Have the vice president meet with the faculty senate as soon as possible to solicit their ideas and concerns. ✓✓
4. We need to continually assess how others are approaching this problem. We can't reinvent the wheel. We have to be open to the ideas of others!
5. The change management team needs to meet more often in the next three months, especially as we approach major milestones.

The information gleaned from this discussion will be invaluable. You will have engaged participants by realizing how much has been accomplished, and what lessons need attention. Often, this data becomes part of a planning report that benchmarks accomplishments.

## Schedule

*Note: This schedule is to be used for each of the quarterly meetings.*

- |   |               |
|---|---------------|
| 1. Facilitator explains purpose of meeting and gives instructions   | 10 minutes    |
| 2. Facilitator counts off the groups  | 5 minutes     |
| 3. Small groups of three or four work together to fill in the flipchart sheets and create the database                | 20 minutes    |
| 4. Small groups look at all the "Accomplishment" sheets in the room to understand all the accomplishments and lessons | 10-15 minutes |
| 5. Facilitator counts off small, mixed groups   | 5 minutes     |
| 6. Small groups create the most important lessons   | 10-15 minutes |
| 7. Facilitator creates the master list  | 15 minutes    |

*Total time: approximately 1-1/2 hours*

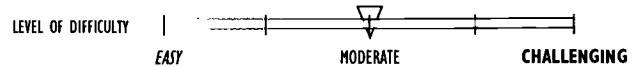

## ROTATING EXPERTS

### I. Goals/Outcomes

1. To personally engage experts on panel discussion and discover their expertise and experience
2. To engage participants more fully in the learning process and help them to take ownership of their learning
3. To leverage the learning of the participants

### II. Background/Context

During a complex and long-term change process, institutions often invite experts on campus to share their specific knowledge about the change process. This could be, for example, about redesigning the governance process, curriculum renewal, technology implementation, or creating a new law school. Leaders often organize a panel of experts to share their knowledge and wisdom with people in their institution. The idea of hearing from experts before engaging in a change process is strategic.

Unfortunately, most panel discussions are dismal failures. What looks good theoretically, usually has very mixed results. There are several reasons for this:

1. Panelists generally sit at a dais in front of the room, taking turns talking to each other, or at the participants. There is little real interaction or exchange of ideas between panel members and the audience.
2. Usually, if you have a panel of 4–5 experts, one or two will tend to dominate the discussion. This seems to be a natural process due to charisma, verbosity, expertise, reputation, or just plain ego. It is rare to see four or five experts fully utilized.
3. When we talk with panel members, they often report they feel frustrated by the structure of the meeting. They would like to be more engaged, be able to answer more questions and be better utilized.
4. People can pay attention to a speaker for about 30 minutes. Unfortunately, panel discussions tend to be 1-1/2 to 2 hours in length. This design changes the structure of a traditional panel discussion and focuses on active learning and engagement. Whenever we have facilitated this design, participants like the more personal interaction, believe they are more engaged in the process, and get better information. Panel members report they feel better utilized.

### III. Logistics

**Materials:** Panel discussion preparation sheets for participants, flipchart paper, easels, markers, moveable chairs

**Space needs:** A very large room or breakout rooms

**Time frame:** 1/2 day

**Number of participants:** 20–80

### IV. Implementation

We will use four panelists and 40 participants as a model for this design.

Before the panel discussion begins, have participants fill out questions #1 and #2 on the preparation sheet. (Please see sheet at the end of this design.) This preparation sheet helps create a framework for learning throughout this design. This should take about 5 minutes.

The facilitator could start the panel discussion meeting in the traditional way, by having the panel members in front of the room and participants in chairs facing them.

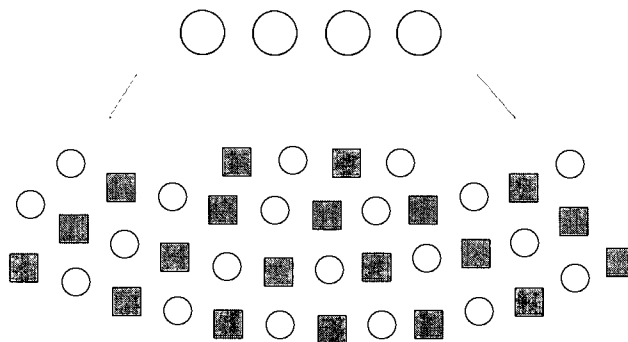

The facilitator lets each panel member introduce himself or herself and gives the audience some background on their experience with this type of change process. It is important that the participants understand the experience and expertise of the panel members. (Keep this brief, about 5 minutes per panel member.)

The facilitator should then have the participants break into four groups of 10. This can be done in several ways:

1. Have pre-assigned groups for the participants
2. Count-off one to four. This will give you four groups of 10, randomly mixed.
3. Just have people self-select and go to any area they want. The rule is that there should be no more than 10 people in each group.

The room might look like this:

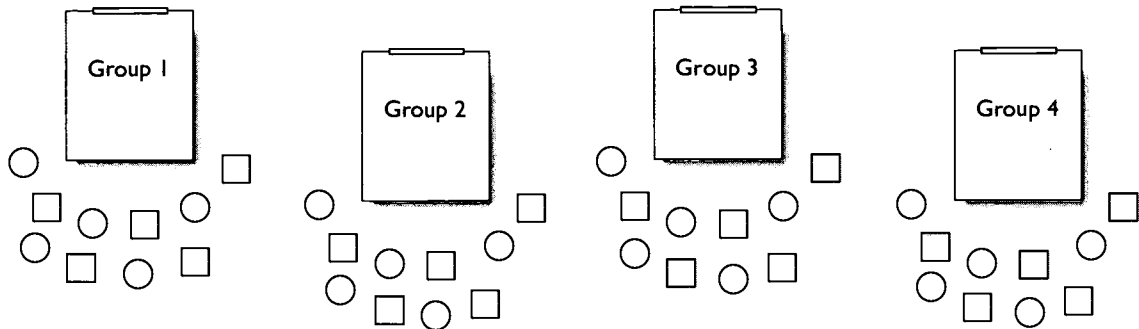

Remember that the room should be large enough for 40 people to work in without voices being overheard. Breakout rooms are preferred, but then you will need extra time for transitions.

Now, this is where the “game” gets changed. Have each panelist join a different group. The goal in the next 20 minutes is for each group to ask as many questions as possible of their panel expert. They need to tap the panel member’s expertise and experience, seek out his or her opinions, and probe for understanding.

4. After 20 minutes, the facilitator signals to all participants the end of the first “round” and the panel members rotate to the next group.

5. Now each group has a new panel member for the next 20 minutes. Once again, their goal is to ask questions of the panel member and tap their expertise.

6. The facilitator signals the end of another round in 20 minutes and the panel members rotate to the next group. This process continues until the panel members have visited all four groups.

7. After all the rounds are finished, it would be appropriate to give participants a 10–15 minute break.

8. When participants return, have them get back into their original panel groups and ask them to do the following activity: Please take 20 minutes to discuss what you have learned and put the most important learning on newsprint to share with the larger group. They should limit their lessons to the top four or five. You don’t want a long laundry list of ideas. (Use Self-Managed roles, see page 2.149 of this book for this activity.)

### **Helpful Hint**

Four panel members seems to be the ideal number, any more and the process bogs down, the panel members get very tired and participants experience information overload.

While participants are discussing and creating their lessons, the facilitator should have a short discussion with the panel members. The panel members will be an excellent source of information about what is on people’s minds. The facilitator should try to capture on newsprint, what the panel members have learned about the institution. Some examples might be:

- A. *Many of the questions that were asked were about the role of top leadership in this change process.*
- B. *People seem concerned that the timeline for this process is too short and will cause undue stress.*
- C. *People kept asking us how we distributed learning throughout our change process. How did we keep people informed?*
- D. *There seems to be a lot of nervousness about making mistakes at this institution. You need to resolve this because you are going to be in the mistake-making business in this upcoming change effort.*

The information gleaned from the panel members can be a rich source of strategic information.

9. After each group has discussed and written down their most important learning, have each group give a short (2–4 minutes) presentation on what they have learned. You want to keep these presentations “short and sweet” so that you don’t lose energy or focus.

After each group has presented, the facilitator should present the learning of the panel members. At this time, the facilitator has several options:

- A. You can have a general discussion for 15 minutes or so to distill the common threads that run through the different group presentations and capture them on newsprint.
- B. Have each group come up with two implications of their learning to the upcoming project (e.g., *this is what we must do . . . we need to avoid.*).
- C. Have the four different groups spend 10 minutes and come up with two strong recommendations they would like to share that would enable the change process to be successful. Some examples might be:

*“There has to be a champion for this project. A person with the ability, authority, and credibility to own this process and make it happen.”*

*“We will have to use outside consultants if we are to be successful. We need to establish protocols on how we use them, and create a database of the best ones available.”*

*“Presidential involvement and support is critical to this process. We need to meet with the president to discuss her role in this process.”*

*“Communication seems to be a critical factor in this process. Ours isn’t very good. We need to create a university-wide process that really works.”*

10. After participants have shared the information from the different discussion/ recommendation options, the facilitator should thank all participants and the panel members for their time and attention. It is most effective to have all of the written newsprint ideas replicated and distributed to all participants as soon as possible. This design engages participants and creates the expectation that the information generated will be utilized. You need to show how this information will be used in your change process.

## Schedule

- |   |               |
|---|---------------|
| 1. Welcome and introduction of panel members  | 20–25 minutes |
| 2. Participants organize into smaller groups  | 5 minutes     |
| 3. Panel members join a group and engage in a question and answer period with participants. Total time for four panel members to rotate to four groups: | 80 minutes    |
| 4. Panel members rotate to a new group – transition time  | 5 minutes     |
| 5. Break  | 10–15 minutes |
| 6. Participants create lessons learned from panel discussion<br>Panel members create strategic advice   | 20 minutes    |
| 7. Participants give short presentations about what they have learned   | 15 minutes    |
| 8. Facilitator presents reactions and advice from panel members   | 10 minutes    |
| 9. Discussion/recommendation options  | 15 minutes    |
| 10. Thanks and good-bye   | 5 minutes     |

*Total Time: approximately 3 hours*

## Panel Discussion Preparation Sheet

1. What do I currently know about this subject?
2. What do I want to learn about this subject?
3. What questions do I have for the panel members?
4. What have I learned from this meeting?
5. What questions do I still have?

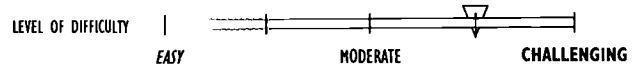

## JIGSAW DESIGN

### I. Goals/Outcomes

1. To leverage participant's learning about the strategic or important elements of a change process
2. To use participant's time effectively and efficiently
3. To provide quality information to participants
4. To engage participants in a creative and meaningful way

### II. Background/Context

This design is one of the most collaborative, engaging, and effective designs we know. It is called the “Jigsaw” because different elements (information) are put together like pieces of a puzzle. In the end, all the strategic information comes together and provides participants with a holistic picture or a system's point of view.

One of the challenges of a change process is to be careful about information overload. People can only handle so much information. This design manages this challenge by creating the opportunity for participants to become content experts in one area and be taught by others about other important areas. It leverages people's time, manages information overload, engages participant's thinking, and produces strategic results. It is a wonderful example of collaboration at its best and is a classic design that is timeless.

There is a substantial amount of up-front planning for this design. The change leader needs to organize information into specific categories. For example:

For a technology implementation effort, you might have five specific themes on which you want to educate the participants, such as:

1. Faculty role in technology implementation
2. Lessons learned from past implementation efforts on the campus
3. External lessons from other campuses that have been engaged in a similar technology change process



4. EDUCAUSE report on technology trends in higher education
5. Financial data on the costs of a technology implementation, promises and pitfalls

For a strategic planning effort, the subject areas might be:

1. Regional data on demographic trends
2. *The Chronicle of Higher Education* special report on future events, trends, and issues impacting higher education
3. Internal report - self-study on campus issues
4. Middle States review process summary
5. Past strategic plan results

The change leader needs to arrange the subject areas into a four-to six-page summary with the most important information. These summaries need to be readable, understandable, and easily digested. The goal is to create a summary that condenses the essential information participants need to know if they are to be well-informed about a topic. Don't short change this. Up-front preparation of these summaries is critical to the successful implementation of this unique design. (You could also use certain articles in this design as a substitute for summaries.)

### III. Logistics

Material: handouts of articles or summaries of pertinent information, flipcharts, easels, magic markers

Space needs: large, comfortable room with moveable chairs

Time frame: approximately 2-1/2 hours

Number of participants: 10–50

### IV. Implementation

We will use 30 participants as a model for this design. We will focus on the beginning steps of a strategic planning process.

1. The facilitator reviews the purpose of the meeting with all participants: *"Our goal today is to understand the critical element of our upcoming strategic planning process. We want to make strong recommendations that will go to the planning council and the president."*

2. The facilitator then creates mixed groups that will function as initial content expert groups. You can do this by having participants count off from one to five. This will give you five randomly mixed groups of six participants each.

The room should look like this:

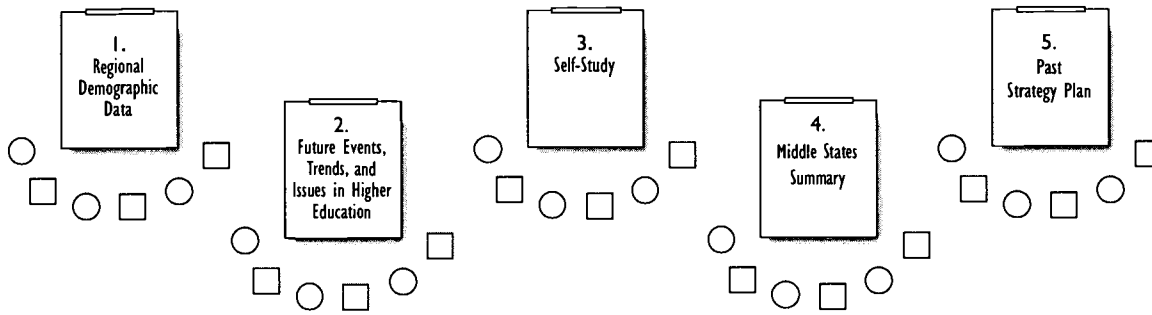

3. The content groups are then given 30 minutes to read their topic papers and agree upon the four or five most important ideas or themes for their subject. The reason they need to capture the most important ideas is that they will then be teaching this information to the other participants in the next round/step. Some examples of teaching points for the regional demographic data might be:

- The short term (1–3 years) economic trends for our state are optimistic.
- We can anticipate a 20 percent bump in student population over the next decade.
- Older adults will be a customer base that we can tap into. It is growing rapidly.

4. After the learning round has taken place, each content/subject group will have six content experts. These groups will then be redistributed into new mixed groups, containing one group member from each of the subject areas. Once again, you have participants count off, but this time it is from one to six. This will give you *six* mixed groups of five participants each. Each new “reconstituted” group should look like this:

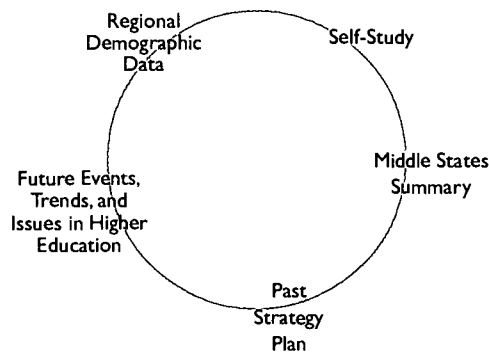

5. In the second round, have each participant take approximately 5 to 7 minutes each and share their four or five most important points or themes from their content area. (In the second round all the pieces of the information puzzle come together to create a shared body of knowledge.) You can leave some limited time for questions and answers, but the primary goal is for each content expert to share what they learned from the original discussion in the first round. Give participants no more than 40 minutes for the second round.

After each participant has shared their most important information, give each group 10 minutes to come up with a list of the most critical information from all the content areas. Suggest that they limit this list to the top five to seven ideas.

6. A 10–15 minute break would be helpful at this time.

7. After the mixed groups have created their most important points, you have two options:

Option 1: Have each mixed group make a brief (2–3 minute) presentation to the larger group. Remind participants that they should note common themes, discoveries, and innovative ideas because they will be making some strong recommendations in the final round.

Option 2: On a flipchart, create a master list of the most important information by taking *one* idea from each group until all the ideas have been shared. If groups have similar lists, note this with a checkmark.

8. After the master list has been created in full view of the participants, or after the brief presentations, you are ready for the final round. Have people remain in their mixed groups and give them 10 minutes to make three strong recommendations, sourced from the information that was shared in steps one, two, and three. They should put these strong recommendations on a flipchart and be ready to give a one-minute presentation of their recommendations. Some examples of strong recommendations about a strategic planning process are:

A. *We need to show tangible results from this process as soon as possible. We cannot get bogged down with process.*

B. *We are going to experience massive changes over the next five years (faculty retiring, competition from for-profit companies, ongoing technology costs). Our leadership must have a plan for each of these important challenges and they need to be inclusive in developing these plans.*

C. *The data show that there is a huge opportunity for adult education. Our graduate schools need to be ready to provide innovative and quality learning experiences for this or our competition will serve their needs.*

D. *Customer service is an emerging issue in which we need to improve. Our students have higher expectations and want easier access to learning opportunities. We need to be prepared for this or they will go elsewhere.*

E. *The quality of our faculty remains an issue. We need to be dedicated and disciplined in finding the best faculty we can afford. This needs to be championed by both the president and provost.*

F. *Our self-study and the Middle States review indicate several issues that we need action on. These issues have been around for a long time. They are: faculty diversity; poor relationships between administration and faculty; a planning to plan mentality; and the need for a more entrepreneurial attitude in our courses, marketing, and service. We need movement on these issues.*

9. After the short presentations, the facilitator conducts a brief, open discussion about participant's reactions to the recommendations. Keep this to about 15 minutes and then thank people for their hard work and participation.

It is important to review where these strong recommendations will go (i.e., to the planning council and president). People need to know how their hard work and ideas will be utilized.

## Schedule

- |   |               |
|---|---------------|
| 1. The facilitator welcomes participants and reviews the purposes of the meeting        | 10 minutes    |
| 2. The facilitator uses a counting off method and creates five mixed groups             | 5–7 minutes   |
| 3. Content groups are given 30 minutes to read papers and agree on most important ideas | 30 minutes    |
| 4. Groups are re-distributed and participants share their key learning                  | 45 minutes    |
| 5. Groups create most important learning from all the shared information                | 10 minutes    |
| 6. Break  | 10–15 minutes |
| 7. Option A: Brief presentation from each group   | 10–15 minutes |
| 8. Option B: Facilitator creates a master list  | 10–15 minutes |
| 9. Participants meet in re-distributed groups and create three strong recommendations   | 10–15 minutes |
| 10. Participants report out the three strong recommendations                            | 10–15 minutes |
| 11. (Optional) Facilitator conducts brief discussion about recommendations              | 15 minutes    |
| 12. Facilitator thanks participants for their time, hard work, and attention            | 1–2 minutes   |

*Total time: approximately 2-1/2–3 hours*

## SECTION 5 | **Problem Solving**

In any change process, problems are inevitable. Solving them effectively can define the quality of life on campus. The designs in this section provide different ways of creating solutions for complex problems. Most importantly, they tap the resources and talent on campus and build the capacity of participants. Using structured, yet creative activities, participants share ideas, develop their creative thinking skills, and craft solutions that can be implemented.

### **Distributed Problem Solving**

This activity identifies real campus issues and challenges that have an impact on the effectiveness of the institution. Participants develop a diagnostic mentality about problem solving, share creative ideas, and receive constructive feedback on their proposals.

### **Adapted Fishbowl**

This is a classic design that is utilized in a creative way. It enables senior leaders (presidents, provosts, and chief financial officers) to solicit honest feedback about change efforts from stakeholders throughout the institution. It provides leaders with quality and strategic information to which they rarely have access.

### **Organized Brainstorming**

Some might think that this title is an oxymoron, but it isn't. Brainstorming can create wonderful and "out of the box" ideas. Unfortunately, you can end up with a long list of ideas that go nowhere. This design provides the appropriate structure to enhance creativity and translate ideas into actionable steps.

### **Group Problem Solving**

This activity utilizes several other designs in the book and culminates in a solution-generating activity. What makes this design unique is that it neutralizes the negative impact of criticism early in the solution process by providing an appropriate time and place for constructive feedback.

BEST COPY AVAILABLE

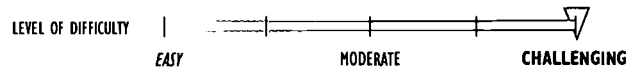

# DISTRIBUTED PROBLEM SOLVING

## I. Goals/Outcomes

1. To engage employees in solving real institutional problems
2. To tap the resources, experiences, and perspectives of all participants
3. To build the problem-solving capacity of internal stakeholders on campus
4. To begin to develop a diagnostic mentality in all the participants

## II. Background/Context

On any campus there are complex problems to solve every day. During a change process, problems tend to increase in pace, complexity, and quantity. How an institution solves its problems defines the quality of life stakeholders experience. In the past, problem solving was seen as the arena for senior management. That has changed.

Organizational problems are distributed throughout an institution and senior management can never know enough to deal with all the important issues and challenges. The key is to tap the experience and ideas that are distributed throughout the institution. The most effective leaders we have known welcome the participation of others in solving problems on campus. They realize that good ideas are everywhere and their responsibility is to organize the opportunity, (or “design” it) for employees to come together and work hard on improving campus life.

In this design, selected stakeholders are brought together to share and solve real organizational problems. This design could work with deans, chairs, administrators, and managers. What makes the design work is that it enables new, and different ideas and perspectives to be created. It fully engages participants (they work very hard), builds the problem-solving capacity of the group, and usually leaves participants with the feeling they have made a real contribution.

One caution, this design will only work if participants feel safe sharing real-life organizational problems. In an institution where mistakes are not tolerated or talked about, the trust level will be very low. Without some level of healthy trust, the risks are too great for this design to be effective. The change leader must be sensitive to the institutional culture and make an intelligent judgment call with this design.

### III. Logistics

Materials: Flipcharts, magic markers, paper

Space needs: Large, comfortable room with moveable chairs

Time frame: Approximately 3 hours

Number of participants: 12–24

### IV. Implementation

We will use 24 people in a model for this design. An outside facilitator would be very helpful with this design.

The facilitator welcomes participants and has everyone briefly introduce themselves (e.g., name, role, years at institution).

The facilitator reviews the purposes of the meeting (i.e., to solve real institutional problems and issues).

The facilitator has the participants count off from one to four. This will give you four groups of six members each, randomly mixed.

The facilitator invites each group member to discuss a tough organizational problem he or she is currently facing. (Alternative: Some group members may want to discuss a problem they have faced in the past that wasn't resolved to their satisfaction, but on which they would like some advice or insight.) Please give them approximately 30 minutes for this part of the design, or about five minutes per person.

After all participants have shared an organizational problem, give each group five minutes to come up with one to share with the larger group. This problem should be the toughest one from all that were presented in the small groups. You can suggest that it be the one problem others will profit learning from the most.

At this time, each group has selected a tough problem to share with others in the meeting. Each group should then share their one tough problem with the larger group in order for everyone to hear all four problems.

Before the reporting, the facilitator should inform participants that, "we are going to act as consultants to each other." The group next to your group will inherit the problem and act as consultants to your group. Therefore:

1. Group B acts as a consultant to Group A
2. Group C acts as a consultant to Group B
3. Group D acts as a consultant to Group C

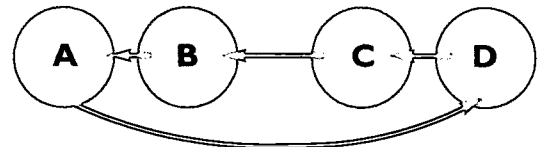

4. Group A acts as a consultant to Group D

#### Helpful Hint

One of the key lessons we have learned about problem solving is the need for a different perspective. Often, when we are stuck with solving a problem, it is because we are too close to it and can't envision alternatives or possibilities. Having someone else inherit your problem creates the opportunity for new ideas and information.

After everyone hears all four tough organizational problems (one from each group) and inherits another group's problem, each consulting group should be given 10 minutes to come up with five or six diagnostic questions that will

enable them to understand their inherited problem. These questions should be crafted in a way that enables the consulting group to diagnose its inherited problem and to more fully understand the complexity of the other's situation. Have the groups assign a recorder to capture their diagnostic questions.

After each consulting group has had 10 minutes to create their diagnostic questions, each group should then be given the opportunity to ask their questions. Take one problem at a time and have each consulting group ask their questions. It is helpful for all participants to hear the quality of the questions that are being asked.

At this time, take a 10–15 minute break. At this stage of the design, participants have accomplished several things:

- A. Discussed tough, real-life organizational problems
- B. Selected one tough problem to solve
- C. Inherited another group's problem
- D. Created diagnostic questions to more be fully informed
- E. Had an opportunity to ask their questions and received new and valuable information

When participants return from their break, the facilitator should give them 15 minutes to come up with ideas on how to solve their consulting problem. Their goal is to act as consultants and provide quality, creative, and doable ideas for their client. Once again, suggest that the groups appoint a recorder (a different one this time) to capture the group's consulting ideas.

At this time, each consulting group takes a turn sharing their advice and ideas about their client's tough problem. After the consulting group provides its ideas, the facilitator can open up the floor and ask the larger group if they have any additional advice or insights into the focus problem. Limit this to several minutes and then go on to the next problem.

After the final round, the facilitator can open the floor and have participants discuss their reactions to the design. Keep this to 10 minutes or so. It is usually helpful to hear what people have to say about all the ideas that have been shared. Thank participants and say good-bye.

If there have been commitments made (e.g., a participant agrees to meet with someone to discuss strategy about a particular problem or someone agrees to follow-up on something), the facilitator should clarify this and get participant's agreement before people leave.

### **Helpful Hint**

Caution participants to stay away from yes or no type questions. Open-ended questions tend to be most helpful with this design (e.g., "What are some things you have already tried to do in solving this problem?" is more effective than "Did you try X?").

### **Helpful Hint**

Limit the number of questions to a maximum of five or six because you are trying to develop good diagnostic skills. If you use more questions, this will not happen and the design will take too long.

### **Helpful Hint**

As participants ask their questions, and receive new information, there will be a tendency to ask follow-up questions. The facilitator needs to be fairly strict about this. The purpose of five or six questions is to create quality information. If you give more than the allotted time, this design will begin to drag. Avoid this!

### **Helpful Hint**

The key element in this design is to keep things moving. The facilitator needs to carefully explain each step, monitor time, make sure participants stick to the rules, and watch out for any wandering off course.



## Schedule

- |  |               |
|--|---------------|
| 1. Facilitator welcomes participants and people introduce themselves                       | 5-10 minutes  |
| 2. Facilitator reviews purposes of the meeting   | 5 minutes     |
| 3. Participants count off and reconvene into four mixed group                              | 5-7 minutes   |
| 4. Participants discuss real-life organizational problems                                  | 25-30 minutes |
| 5. Small groups come up with toughest problem to solve and shares with large group         | 10 minutes    |
| 6. Consulting groups create 5-6 diagnostic questions                                       | 10-12 minutes |
| 7. Consulting groups ask their questions   | 20-30 minutes |
| 8. Break   | 10-15 minutes |
| 9. Consulting groups come up with ideas to help solve real problems                        | 15 minutes    |
| 10. Consulting groups share their ideas with their clients                                 | 20-30 minutes |
| 11. Facilitator has open discussion about participants' reactions and clarifies commitment | 10-12 minutes |

*Total time: approximately 3 hours*



## ADAPTED FISHBOWL

---

### I. Goals/Outcomes

1. To create the opportunity for relevant stakeholders to share their ideas, concerns, and advice about an ongoing change process.
2. To provide the change leader or top leadership with honest feedback and information about a change process.

### II. Background/Context

During any complex change process, the change leader needs to create opportunities for feedback from relevant stakeholders. You don't want to get toward the end of a change process and discover difficult problems that were known about but were never surfaced and discussed. The change leader needs to be proactive and create identified and predictable times to gather people affected by the change together and hear their ideas and concerns. This will take courage. The good news is that by creating these learning opportunities you will be smarter because you will have access to information few change leaders have.

In low trust institutions, obtaining honest information and feedback is almost impossible. It is also difficult to do when the leader is powerful, charismatic, or intimidating. Sometimes, even when a leader is cared for and respected, people will be reluctant to bring up sensitive issues. The challenge for the change leader is: How do I create the opportunity for honest information and feedback from people on my campus?

This design enables the change leader to receive strategic and important information from people as long as the leader is willing to listen to what is being said. The most crucial element of this design is the leader's maturity. We have had clients who told us they were ready to hear the truth but didn't have the emotional maturity to listen to difficult information. You want to avoid this situation.

The "fishbowl" design has been around for a long time. We have adapted it to create an interesting and engaging way to share stakeholder concerns and advice. This design could be used for a single issue (such as: campus morale, institutional communication, faculty concerns) or a systemic issue.

This design works well with an outside or neutral facilitator who has very good skills and is trusted by the leader. Lastly, it is important to have the right people in the room. When you create a

meeting to obtain feedback about the ongoing change process, make sure you have those affected by the change in the room, and not the same old gang that is always brought together.

### III. Logistics

Materials: Moveable chairs, paper, and pens

Space needs: Large, comfortable room

Time frame: Approximately two hours

Number of participants: 20–50

### IV. Implementation

We will use a group of 30 stakeholders as a model for this design.

The facilitator reviews the purpose of the meeting with everyone (e.g., “We are here to create the opportunity for honest feedback about how the change process is going.”).

The facilitator then creates mixed groups by having participants count-off from one to five. This gives you five randomly mixed groups of six participants.

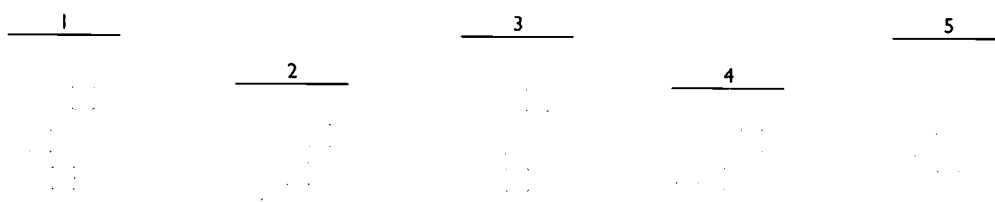

Have participants organize into five groups around the room.

After people have settled into their groups, the facilitator then asks participants the focus question for the meeting: “What are the things the leadership of this campus (or change process) needs to know about the current change process?” Here’s some examples:

- A. Positive things are happening.
- B. Some things that are creating problems for people.
- C. Anticipated problems that will be coming down the road.

Any information that helps the leader make better decisions about the change process is helpful.

Give each small group about 20–25 minutes to discuss the focus questions. Their main goals are to have an open and honest dialogue and create some key messages that would be helpful to the leadership. They should try to keep this to four or five key messages. Before the small groups start their discussion, let them know that they need to choose a spokesperson for the group. This person will represent each group’s ideas and share the key messages with the leaders.

After 20–25 minutes of small group discussion, the facilitator should let participants know it

is time to hear from the spokespersons. Have the spokespersons come into the middle of the room with the facilitator (F) and leader (L). Then, the room should look like this:

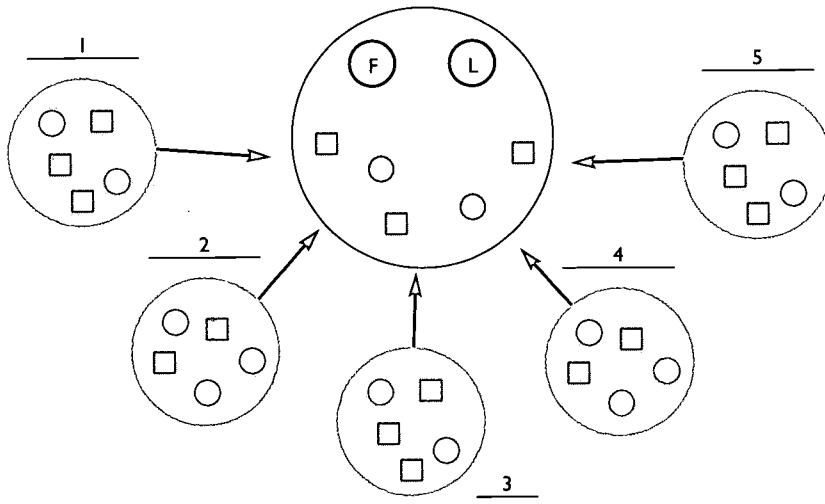

### **Helpful Hint**

The facilitator needs to coach the leader beforehand so that he or she understands the importance of listening to what is being said and not reacting to it.

The group discussion then begins. The facilitator lets each person convey the key messages from their group. This could be done in a structured way (e.g., What is going well? What's not going well? What advice do you have? What problems do you see down the road?). Or, it could be done in a more flexible fashion, depending upon the skill level of the facilitator. This discussion should take no longer than 30 minutes.

The leader's job is to listen to what is being said. He or she can ask some questions for clarification, but should not get engaged in the content. Remember the goal is to listen.

The spokespersons in the middle of the room should speak loud enough for everyone to be able to hear clearly. You want all the participants to hear what the other groups discussed and believe that their ideas are being communicated effectively and honestly.

After the spokespersons have shared their key messages with the leader (for 30 minutes), they should return to their original groups. Give the small groups about 15 minutes to check in with each other and make sure their key messages were communicated.

During this time they can also create new messages. Often, we have found that participants who are listening to the first round discussion have better insights, discoveries, or more

### **Helpful Hint**

The key thing to remember is for the conversation to keep moving. Don't just listen to everything one spokesperson says and then go to the second spokesperson, then the third. By the time you get to the last two spokespersons, most of the information will be shared and they will not feel that their time and effort was valued. The facilitator should make several rounds, listening to each spokesperson briefly convey what their small groups discussed. A skilled facilitator is very important.

### **Helpful Hint**

During the check-in discussion, it is helpful for the facilitator and leader to review together what the most important messages have been so far. At the end of the meeting, the leader should briefly explain what they have learned, with all participants. This creates a very effective conclusion to a powerful and engaging meeting.

quality ideas that need to be shared. This second discussion round creates the opportunity to source these new ideas.

After the 15 minute check-in discussion, the spokespersons come back to the middle of the room, again, to have the final round of discussions with the facilitator and leader.

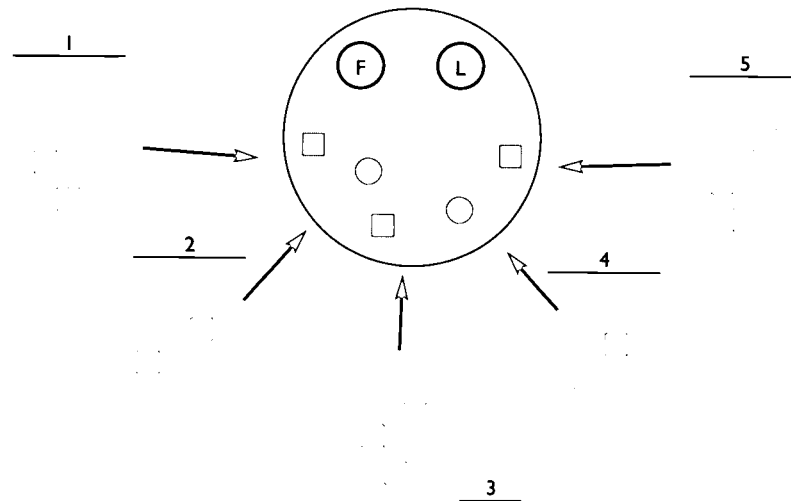

You follow the same process where the facilitator makes sure that all the spokespersons have a chance to share their new ideas and key messages. Keep this second round to about 20 minutes or it will drag on and people will suffer from information overload.

The final step to this design is for the leader to reflect back to all the participants what they heard people say. Keep it short and simple, but provide enough information to convey honestly to all participants that the leader has heard their thinking.

Some examples of a leader's concluding remarks:

*"I have heard that we are relying too much on outside consultants for this project and that I should use more of our own people. I may need your help in identifying these people on our campus."*

*"One of the strongest messages I heard is that I need to be more inclusive when making the most important decisions regarding this change process. I am committed to doing this. I will be meeting with several groups (e.g., faculty senate, administrative council) over the next few weeks to hear their ideas about our change process."*

*"I am much more aware now about the high level of frustration people have with our campus master plan. Many people feel we are building too many new things and could be spending our money more wisely. I will have to think about this more carefully and discuss this matter with you at a later time." (If you say you will get back in touch with people, make sure you do it!)*

*"I must say I was disappointed to hear that my presence isn't felt as much as it needs to be on campus. I travel a great deal building alliances, developing donor relationships, and doing a fair amount of public speaking. I want to be seen and felt more on campus and I will work on this over the next year."*

Finally, the leader thanks all the participants for their time and ideas. If the leader has made any commitments (e.g., a follow-up meeting), make sure he or she reviews this with the group and lets people know who will be contacting them about commitments.

## Schedule

|   |               |
|---|---------------|
| 1. Facilitator welcomes participants and explains the purposes of the meeting                   | 10 minutes    |
| 2. Facilitator creates mixed groups by using a counting-off method                              | 5 minutes     |
| 3. Small groups discuss issues and create strategic questions for the leader                    | 20-25 minutes |
| 4. Spokespersons meet with the leader and facilitator for first discussion                      | 20-30 minutes |
| 5. Small groups check in with each other to ensure key questions and themes are being discussed | 15 minutes    |
| 6. Spokespersons have a second round discussion with the leader and facilitator                 | 20 minutes    |
| 7. Leader reflects back to all participants what they have heard from the previous discussions  | 10 minutes    |
| 8. Leader or facilitator thanks participants for their help                                     | 5 minutes     |

*Total time: Approximately 2 hours*

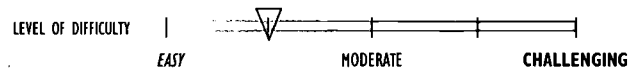

# ORGANIZED BRAINSTORMING

---

## I. Goals/Outcomes

1. To tap the creative potential of a group
2. To prioritize the very best ideas participants produce
3. To fully engage all participants in creating ideas
4. To solve real institutional problems

## II. Background/Context

Brainstorming is a creative and engaging way to develop ideas in a group setting. It was created by Alex Osburn in 1938, and has stood the test of time. It is used in thousands of meetings every day, but unfortunately it is often abused. It usually produces a lot of ideas but, too often, you are left with sheets and sheets of ideas with nowhere to go. Just having a bunch of creative ideas isn't enough, you have to be able to do something with them.

In higher education, intellectual inquiry and criticism are highly valued. If you use a creative technique, you often take a great risk. You need to produce real results as quickly as possible. This adaptation of the classic brainstorming technique is effective, efficient, and can produce results, even with a relatively large group.

The most important element of this tool is the generation of ideas without criticism. Synergy often occurs because participants build on each other's ideas, see different connections and perspectives, and are allowed to be creative and different.

There are four rules or guidelines for brainstorming: 1) evaluation and judgment are not allowed; 2) the quantity of ideas is important, in fact, the more the better; 3) wild, far-fetched ideas are encouraged; 4) ideas can be combined, modified, or built upon.

### III. Logistics

Materials: Flipcharts, newsprint, a variety of colored magic markers, moveable chairs, color peel & stick dots, and timer

Space needs: Large, comfortable room

Time Frame: Approximately 1 hour

Number of Participants: 6–20

### IV. Implementation

We will use 20 participants as a model for this design.

The facilitator announces to the group the topic that the group will be working on during this meeting (e.g., improving campus safety, institutional morale, customer service, freshman involvement in a specific program, inter-departmental communication, etc.). You want to ensure that everyone is on the same page before you begin.

The facilitator should review the four rules or guidelines for brainstorming with everyone. Provide these guidelines on a handout or on a flipchart.

Have the participants count off from one to four. This will give you four, mixed groups of five participants each.

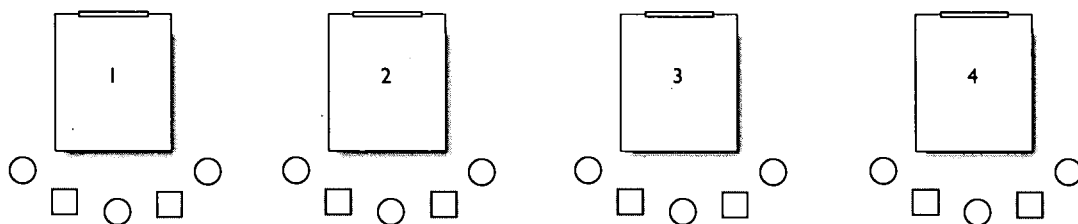

Have each group appoint a recorder who is responsible for capturing the ideas of the group on a flipchart.

Have the small group brainstorm ideas about the topic for 7 minutes. The recorder in each group should capture all the ideas on the flipchart, unedited. Make sure you let the recorders know that they should also be adding their own ideas.

#### Helpful Hint

We have found that using different colored markers when creating the brainstorming list helps stimulate creativity and thinking.

After 7 minutes, let the participants know that the allotted time is up. Request that all participants remain silent for 1 minute. Explain to them that you want them to percolate for awhile and that they will have another opportunity to generate ideas.



After participants have been silent for 1 minute, give them an additional 5 minutes to generate more ideas. At this time, each group should have several sheets of flipchart paper with scores of interesting ideas. An example of one group's thinking might look like this:

### How Do We Improve the Freshman Campus Experience?

1. Hire professional activity planners to make things more interesting
2. Have more parties
3. Pay them to come to the parties
4. Ask them (focus groups) what would improve the freshman experience
5. Have campus-sanctioned dorm parties on the weekend
6. Have bands at the parties
7. Use seniors as mentors or pals that adopt a freshman
8. Pay seniors to be mentors
9. Have weekend lecture series
10. Set up athletic competitions between dorms on the weekend
11. Create small group activities for freshmen
12. Talk to a group of freshmen advisors to find out what the freshmen are thinking
13. Don't let them go home every weekend
14. Create a freshman choir
15. Give them free movie passes
16. Have faculty hold classes in the freshman dorms

### Helpful Hint

The research on creativity indicates that the best ideas are usually generated in the last 25 percent of the time allotted. During a regular brainstorming session, we generate a lot of ideas but they tend to be the usual stuff—mostly ideas that are on the tips of our tongues and the tops of our minds. By providing a second round, participants are often able to stretch their thinking and produce more creative, richer, and out-of-the-box type thinking.

After each group has had their second round, have them use the Las Vegas Voting Technique (see page 2.137 of this book) to come up with the best three to five ideas from their group. Before groups vote, let participants know that they should be voting for those ideas that have the best possibility of being implemented. For example: paying freshmen to come to campus activities might be very creative but how feasible is it? You might adapt a suggestion that has a good chance of being realized (example: instead of

paying freshmen, you might waive the fee for certain activities).

Give participants approximately 5 minutes to complete the Las Vegas vote for their group's list.

At this time, using a round-robin approach, have each group report out their best ideas to the larger group. Take one idea from each group, and create a master list, in full view of participants on a flipchart. Make as many rounds as necessary until you have all the ideas from all four groups. If the groups have similar ideas, note this with a checkmark as you create the master list.

## MASTER LIST

**Ways to Improve Freshman Experience**

1. *Ask them*
2. *Have more activities in the dorms*
3. *Have an appointed "pal" that checks up with them*
4. *Waive freshman fees to campus activities*
5. *Find out what other colleges or universities do with this problem*
6. *Have more non-alcohol parties*
7. *Hire local bands for weekend parties*
8. *Have the president meet regularly with student leaders*
9. *Have freshman pizza parties*
10. *Include freshman in the honors lecture series*

After the master list has been created, and similar ideas are noted, give all participants three "dots" to use in a Las Vegas vote. Instruct participants to put their three votes or dots on the ideas they believe are the best ones. Have participants come up to the master list and vote. (This should take several minutes.)

At this time, you will have a prioritized list of the very best ideas. Your final list may look like this:

## FINAL "LAS VEGAS" VOTE

**Ways to Improve Freshman Experience**

1. *Ask them* ✓✓✓✓
2. *Have more activities in the dorms* ✓✓✓✓✓✓✓✓
3. *Have an appointed "pal" that checks up with them*  
✓✓✓✓✓✓✓✓✓✓✓✓✓✓✓✓✓✓
4. *Waive freshman fees to campus activities*  
✓✓✓✓✓✓✓✓✓✓
5. *Find out what other colleges or universities do with this problem* ✓✓✓✓✓✓✓✓✓✓✓✓
6. *Have more non-alcohol parties* ✓✓✓✓✓✓
7. *Hire local bands for weekend parties* ✓✓
8. *Have the president meet regularly with student leaders* ✓
9. *Have freshman pizza parties*
10. *Include freshman in the honors lecture series* ✓

As you can see, ideas 3, 4, 5, 2 and 1 are the top vote-getters.

At this time, the facilitator has several options:

- A. Thank everyone and let them know how their ideas will be utilized (e.g., go to the campus task force on climate, go to president's council for consideration, go to Human Resources Department or Student Life, etc.)
- B. Create the opportunity to craft beginning action plans for the top five ideas. Have participants work on only the one idea they are interested in and spend 30 minutes creating an implementation plan for their favorite idea.
- C. If you do create some beginning action plans, have the work groups report their ideas and use the "Constructive Feedback" tool (see page 2.133 of this book) to solicit reactions and feedback.

**Helpful Hint**

**With Option B, having participants work on selected ideas, make sure you have allotted time for this activity. Participants should be informed ahead of time that they will generate ideas and work on beginning implementation plan. Don't surprise them.**

BEST COPY AVAILABLE

## Schedule

### Option A:

- |   |               |
|---|---------------|
| 1. Facilitator welcomes participants and explains the purpose of the brainstorming meeting and reviews brainstorming rules. | 10 minutes    |
| 2. Facilitator uses a counting-off method and creates four groups of five participants. (Be sure to appoint a recorder.)    | 5–7 minutes   |
| 3. Small groups brainstorm for 7 minutes.   | 7 minutes     |
| 4. All participants are silent for 1 minute.  | 1 minute      |
| 5. Small groups continue Brainstorming for a second round.  | 5 minutes     |
| 6. Each group uses the Las Vegas voting technique to determine the best ideas.  | 5 minutes     |
| 7. Facilitator creates a master list, soliciting ideas from all the small groups.   | 10–15 minutes |
| 8. All participants vote on the very best utilizing the Las Vegas voting technique.   | 10 minutes    |

*Total time for Option A: approximately 1 hour*

### Option B:

- |  |               |
|--|---------------|
| 1. Organized small groups create beginning action plans for their favorite idea. | 30 minutes    |
| 2. Small groups report their implementation plans.                               | 15 minutes    |
| 3. Utilize Constructive Feedback technique to solicit reactions.                 | 10–15 minutes |

*Total time for Option B: approximately 1 hour*

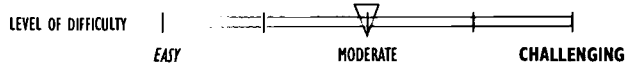

# GROUP PROBLEM SOLVING

---

## I. Goals/Outcomes

1. To move a group through a structured, step-by-step problem solving approach
2. To tap the creative ideas of a group and reduce the power of debilitating criticism
3. To consider a variety of options and their potential consequences in generating solutions
4. To develop specific action plans for agreed-upon solutions

## II. Background/Context

Solving institutional problems can be a very difficult task under the best of circumstances. In higher education, there is an additional complexity. We have often found that campuses can be dominated by critical judgment and argument. We have been in meetings where winning the argument and eviscerating the opponent takes on greater importance than solving the problem. An adversarial climate is not conducive to creative problem solving. When people don't feel safe in exploring different, creative, or even out-of-the-box ideas, good ideas will never see the light of day.

It is important to create intellectual safety in a group that is dealing with a complex or important issue. The change leader can do this by: 1) creating a specific structure to the problem-solving process; 2) allowing creative ideas to blossom before they are attacked; 3) building in time for criticism at the appropriate time/place; and 4) ensuring that a diversity of ideas and perspectives are shared.

Who you invite to this type of meeting is often the key ingredient to its success. It is important to have diversity in the group (i.e., people with different perspectives and experiences) and have some individuals who know something about the problem to be solved.

In our example for this design, we deal with the problem of retaining out-of-state freshmen. We strongly suggest that you have some students in this problem-solving session. When dealing with a curriculum issue, obviously you would want faculty to be heavily involved. We would like you to consider having some diversity—even with a curriculum issue. This could be administrators, former students, and even faculty members from another institution.

We have found that having different and diverse perspectives always enhances the quality of the ideas. It might take a little longer at times, but diversity is worth it.

This design has several steps to it, one building upon another, until you have specific solutions with well thought out action plans. The design can be conducted in two parts if time is a problem. We utilize other designs within this design, specifically Organized Brainstorming (see page 2.117) and The Las Vegas Vote (see page 2.137).

### III. Logistics

Materials: Flipcharts, magic markers

Space needs: Large, comfortable room with moveable chairs

Time frames: Part 1: 1 hour and 15 minutes; Part 2: 2-1/2 hours

Number of participants: 12 to 24

### IV. Implementation

We will use 12 participants as a model for this design. We will use the issue of too many freshmen leaving a college after their first year.

1. In this design, the change leader has to do some upfront homework. It is important to provide relevant and usable information for all the participants and be very clear about the problem you are trying to solve.

2. As you begin this meeting, it is helpful to provide a clear problem statement and relevant information. In our example, your problem statement might look like this: “There is an increasing number of out-of-state students leaving our college after their freshman year. In 1990, we had approximately 3 percent of our freshmen who left, currently, in 2001, we have 7 percent leaving.”

3. It would be helpful to then provide any relevant information that would educate the participants. For example:

Student Life conducted exit surveys for 57 out-of-state freshmen that left the college over the last two years. The following six reasons were given, in priority order:

- Lack of things to do on campus, especially on weekends
- Poor teaching
- Academic expectations were too rigorous
- School wasn't what they expected it to be
- Personal (psychological) problems
- Unable to make friends

4. At this time, the change leader facilitates a brief discussion about people's reactions to the survey data. Do not get into problem-solving ideas. Your goal is to make sure the data makes sense to participants before continuing.

5. The facilitator has the group count off from one to three, and the participants arrange themselves into three mixed groups with four participants each.

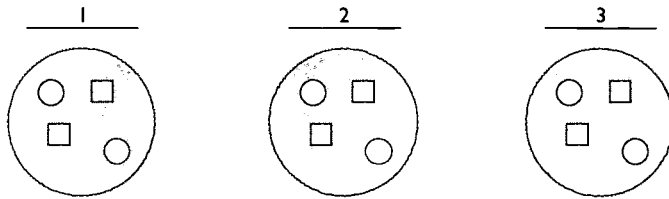

6. The facilitator instructs the groups in using the Organized Brainstorming design (see page 2.117) to generate some solutions to the problem of freshmen leaving. The goals as a group are to generate ideas and then agree on the top three solutions to the problem. This should take approximately 20 minutes.

7. After the groups have engaged in brainstorming, the facilitator then creates a master list in front of the whole group. This is done by taking one idea from each group (by round robin) and using as many rounds as necessary to capture all the suggestions.

At the end of this section you might have a list that looks like this:

- Have paid, senior students act as mentors for incoming freshmen
- Have “freshmen only” weekend concerts
- Have well-known professors give Saturday lectures and presentations throughout the semester
- Set up a tutoring program for students who are having academic difficulties
- Extend the hours of the Student Life Counseling Center until 9:00 p.m. during the week and all day Saturday
- Have more religious services available on campus during the weekend
- Create an “Orientation Week” for incoming freshmen so that they understand the academic expectations of faculty; know what activities are available for them on the weekends
- Have freshmen “mixers” during the semester
- Give freshmen free passes to all the athletic events
- Have a faculty member “adopt” a small group of students during freshmen year. They would meet throughout the semester for lunch to check in on how they are all doing. (Faculty would have to be compensated.)
- Note: One group had more than three solutions.

8. As you can see, there are a lot of good ideas. The challenge is to choose the best ones and begin to create specific action plans that would help put them into operation.

To determine what the best solutions are from the group’s perspective, you can utilize the Las Vegas Vote (see page 2.137). Another way to determine the best ideas is to have each participant choose their top three ideas (anonymously) in priority order. Pass out index cards and have each participant put down their top three choices. The facilitator explains that each of the priority choices has a “value.” A number one priority vote gets five points; a number two gets three votes; and a number three choices gets one vote.

### **Helpful Hint**

Have the work groups utilize Self-Managed Roles (see page 2.149) to facilitate their work.

**Helpful Hint**

Anonymous voting neutralizes the impact of internal politics where a person might feel obligated to vote for a solution because a particular or powerful person or group proposed it.

9. The facilitator then collects these cards and record the votes in full view on the flip chart. For example:

- Have paid, senior students act as mentors for incoming freshmen. Total score: **29**
- Have “freshmen only” weekend concerts. Total score: **1**
- Have well known professors give Saturday lectures and presentations throughout the semester. Total score: **7**
- Set up a tutoring program for students who are having academic difficulties. Total score: **6**
- Extend the hours of the Student Life Counseling Center until 9:00 p.m. during the week and all day Saturday. Total score: **20**
- Have more religious services available on campus during the weekend . Total score: **1**
- Create an “Orientation Week” for incoming freshmen so that they understand the academic expectations of faculty; know what activities are available for them on the weekends. Total score: **5**
- Have freshmen “mixers” during the semester. Total score: **5**
- Give freshmen free passes to all the athletic events. Total score: **1**
- Have a faculty member “adopt” a small group of students during freshmen year. They would meet throughout the semester for lunch to check in on how they are all doing. (Faculty would have to be compensated for this.) Total score: **27**

As you can see, the following ideas received the most votes:

#1: Have paid senior mentors for freshmen. Total score: **29**

#2: Have faculty members “adopt” a group of freshmen. Total score: **27**

#3: Extend the hours of the Student Life Counseling Center. Total score: **20**

This is the end of the first part of this design. You can choose to continue to the second half or conduct it at another time. If you are continuing the design, let the participants take a 10 minute break.

**Schedule, Part I**

|  |                 |
|--|-----------------|
| 1. Facilitator clarifies purpose of the meeting  | 10 minutes      |
| 2. Facilitator shares important information with meeting participants and solicits brief reactions | 10 – 15 minutes |
| 3. The facilitator uses a counting off method to create mixed groups                               | 5 minutes       |
| 4. Small groups utilize the Organized Brainstorming design (page 2.117) to generate solutions      | 20 minutes      |
| 5. Facilitator creates master list of solutions  | 10 – 15 minutes |
| 6. Facilitator uses the Las Vegas vote (page 2.137) or index cards to determine the best solutions | 10 minutes      |

*Total Time: 1 hour 15 minutes*



## Part Two of the Design

At this stage of the design, you have these three solutions identified as the best ideas:

- Have paid senior mentors for incoming freshmen;
- Have faculty members “adopt” a group of freshmen; and
- Extend the hours of the Student Life Counseling Center.

1. The facilitator informs participants that they can select one of the solutions to work on. (By letting participants select their choice, you ensure that people will be working on solutions they believe in and have some interest in making successful.)

2. Your selected groups might look like this:



3. The facilitator should encourage creative ideas for the action planning process. We suggest that you share the following example with all the participants before they begin their action plans:

*We were involved in a creative problem solving session on a campus with a freshmen-housing shortage. Due to unanticipated construction delays, there were going to be nearly 50 incoming freshmen without housing.*

*We created a diverse group of participants (four students, three mid-level administrators, a dean, four faculty members, and the director of facilities). Then, we walked them through a problem-solving session.*

*We encouraged creative thinking because we needed an unusual solution to a difficult problem. Someone in the group suggested that they create a metaphor for the problem they were trying to solve (freshmen housing). They came up with the symbol or picture of a large jar of olives that was stuffed and full to the brim. With the freshmen housing shortage, we were trying to fit more students (or olives) into a place where there was no more room. They realized that somehow they had to create an opening at the bottom of the jar and let some of the olives (students) out.*

*Using the metaphor of letting olives out of the jar, they came up with the following solution:*

*They proposed that a lottery for senior students who might be interested in living off campus be conducted. There were two incentives for living off campus: 1) the seniors would be given a \$750.00 stipend to leave the campus; 2) arrangements with a local hotel would be made to house approximately 50 seniors for one academic year. The local hotel was having difficulty filling its rooms.*

*The seniors who opted for this choice would have the same amenities as regular hotel guests (e.g., room service, rooms cleaned daily, etc.). The hotel was close enough to the campus for students to walk to classes. It also had security and plenty of technology.*

### Helpful Hint

Please see the Self-Selection Tool on page 2.151.

*Student life administrators made the final selection for the “hotel seniors” because they knew the students best. Regular campus regulations were enforced at the hotel. Over 150 seniors applied for the lottery. Hotel and campus administrators met weekly to discuss issues and problems. By all counts, it was a creative and elegant solution to a temporary problem.*

As you can see, this was an unusual solution that could easily have been shot down by a critical audience. Comments like, “What about the insurance costs? What are we, a hotel university?” could have submarined the inventive solution before it blossomed. It takes real discipline to be creative and this particular group was committed to allowing a creative approach before it criticized every element. They followed the steps in this design and answered all the criticisms at the appropriate time.

4. The facilitator gives each group 30 minutes to create an action plan for their proposed solution. Each group writes their ideas clearly on flipchart paper and utilizes the following format:

### **Helpful Hint**

You can use any example you want. The goal is to convey to participants that allowing creative ideas is important. You want to give permission to think differently, rather than critically.

- Proposed solution
- Step(s) to operationalize the solution
- Identify resources needed (money, technology, personnel)
- Identify a possible “champion” or person responsible for implementation
- Who needs to be involved in the implementation
- Estimate the time necessary for implementation
- Indicate measures of success

5. After 30 minutes, have each group present its action plan to the other participants. The groups should explain their rationale and all the elements of their proposed solution. There can be questions for clarification but no feedback at this time.

6. After all three presentations have been made, the facilitator then asks each participant to vote for their favorite solution. Once again, have everyone put his or her top choice anonymously on an index card and pass it to the facilitator. Tally the votes in full view. In our example we will assume that “paying senior mentors” won the vote. If you have a tie between two outstanding solutions, you can utilize the same process that follows.

7. At this time have the participants count off from one to three and form three, mixed groups.

8. Give each mixed group 15 minutes to come up with strengths and negative aspects of the favorite proposal.

9. The facilitator records the strengths of the proposal in full view, on flipchart paper. Then, record the weaknesses of the proposal in full view. Do this by taking one idea from each group and make as many rounds as necessary to solicit all the strengths and weaknesses.

10. At this time, we might have four negative elements to the “pay senior mentors to work with freshmen” solution.

- How do you ensure a positive match between a senior and a freshman?
- Where will we get the money to pay seniors?
- What will be the quality control for managing the effectiveness of this process? (How do we check up and make sure that the seniors are doing their jobs?)
- The legal liability of the senior mentors has not been articulated.

11. The facilitator then assigns small groups of three participants to examine one of the four negative elements. Give each small group 15 minutes to generate solutions to their assigned weaknesses, and post them on a flipchart. (If you have more than four negative elements or weaknesses, utilize the Las Vegas Vote, see page 2.137, to prioritize the most important weaknesses, and assign participants to generate solutions for the top three or four.

12. Now, you have some solutions to the weaknesses that have been identified. Have each small group present its solutions.

The following are solutions for two of the weaknesses of the senior mentor proposal:

**#1. How do you ensure a positive match between a senior and a freshman?**

A. Have freshmen and seniors take the Myers-Briggs assessment and match them according to their personality style.

B. Have freshmen and seniors meet for two days before the semester begins. Design a highly interactive, leadership development program where people will get to know each other through fun activities. At the end of the two days, have the freshmen choose three seniors they would like to have as mentors. Use these preferences to match the mentors.

C. Make freshmen information (within the legal limits) available to the seniors. Have each senior choose three freshmen to mentor after they have read about the incoming freshmen. Use their choices to match people.

**#2. Where will we get the money to pay the senior mentors?**

A. Student Life has allocated \$50,000 for the retention of freshmen because they are so concerned about this issue.

B. We could hold a freshmen only concert early in the fall semester and whatever profits we realize will go to this program. We have a good track record with making money from concerts.

C. Find a trustee that would be interested in this project and name it after him or her. There are several board members who are very interested in campus life and culture, such as Mr. Seitz and Mr. Nicoletto.

Now, you have solutions to the identified weaknesses of the best proposal. You have the ingredients to implement the best solution because you have a clear action plan and a way to deal with any blocks to success.

Thank participants for their time and work and explain how the solutions will be used (e.g., go to the Administrative Council for approval, go to the president's task force on student retention, etc.).

## Schedule, Part 2

|  |               |
|--|---------------|
| 1. The facilitator lets the participants self-select their solutions                                 | 5 minutes     |
| 2. The facilitator discusses the importance of supporting creative ideas and shares example provided | 10 minutes    |
| 3. The facilitator gives each solution group 30 minutes to create action plans                       | 30 minutes    |
| 4. Solution groups make presentations  | 15-20 minutes |
| 5. Participants vote for their favorite solution   | 5 minutes     |
| 6. The facilitator creates mixed groups  | 5 minutes     |
| 7. Small groups create the strengths and weaknesses of the favorite proposed solution                | 15 minutes    |
| 8. The facilitator records the strengths and weaknesses in full view                                 | 15 minutes    |
| 9. The facilitator assigns small groups to one of the negative elements of the favorite proposal     | 15 minutes    |
| 10. Small groups share solutions to the identified weaknesses  | 15 minutes    |
| 11. The facilitator thanks participants for their time and hard work, and explains the next steps    | 10 minutes    |

*Total time: Approximately 2-1/2 hours*

## SECTION 6 | **The Change Leader's Toolkit**

This section provides a valuable source of change management tools and techniques. These are techniques that can be used to enhance the effectiveness of the designs in this book. They help support collaboration and participation. They also can be used in everyday meetings on campus. They are essential tools that should be in every change leader's "bag."

### **Constructive Feedback**

This technique creates the opportunity for all participants in a design to provide helpful feedback on proposed ideas. The quantity and quality of the feedback is increased and enhanced by utilizing this tool.

### **Las Vegas Voting**

This is one of our favorite techniques; besides, it has a great name. This is a multi-voting technique that enables almost any size group (10-50, or even 100 participants) to create a sense of priority ideas from an extensive list of ideas.

### **Mindmapping**

This is a classic creative problem-solving tool that maps out the complexity of a problem or issue. It enables participants to generate creative ideas, see their interconnectedness, and get a picture of the whole problem before jumping to solutions.

### **Nominal Group Technique**

This traditional tool can be used when you have to prioritize a list of ideas. What makes it most effective is that it neutralizes the impact of powerful or dominating people in a group. Everyone votes for their choices anonymously; thus power or politics does not sway the group.

### **Self-Managed Groups**

This technique is very helpful when working with large groups. It enables group members to take full responsibility for their own work by assigning specific roles (recorder, timekeeper, presenter, and facilitator) for each participant. The groups then manage themselves, and take ownership for their process and product.

*(continued)*

## Self-Selection

This technique is really more of an approach to managing a group than a tool to be utilized. In short, it allows participants to choose to discuss only those topics in which they have real interest or experience. No one is assigned to work on a task they have not chosen. It is democratic and treats people like adults.

## Parking Lot

This tool is sometimes called the “Grass Catcher” because it captures or “catches” good ideas. In a meeting, interesting and important ideas might be discussed that have little or nothing to do with the purpose of the meeting. The group can choose to “park” these ideas for consideration later rather than allowing them to wander off.

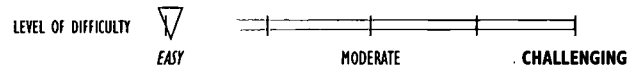

# CONSTRUCTIVE FEEDBACK

---

## I. Goals/Outcomes

1. To be used when you need to create feedback about the presentation of ideas to a large group (10–50 people)
2. Use when trust within the group is low

## II. Background/Context

Whenever you have groups working together to solve difficult institutional problems (such as low campus morale, poor institutional communication, or breakdown in trust between groups), there will be many opportunities to present ideas and receive feedback. Many of the activities presented in this book rely on actively soliciting feedback from other stakeholders.

Feedback creates the opportunity to enhance ideas and provide a reality check on the practicality of suggestions and ideas. Unfortunately, there is a downside to feedback that must be carefully managed by the change leader. We have witnessed work groups making a presentation to others within the institution and seeing the feedback process become a critical and demoralizing process. What should have been an opportunity to build and strengthen ideas becomes a “turkey shoot” where the critics prevail and ideas are destroyed. Once you have experienced a meeting like this, enthusiasm for future presentations quickly fades.

The challenge for the change leader is to create a constructive and timely feedback process. You want to obtain effective and *honest* feedback and create both emotional and intellectual safety in the process.

This tool enables all participants to present their ideas and receive appropriate feedback. It also creates the opportunity for less verbal people to participate and encourages shy group members to provide constructive feedback. It neutralizes the power of the critics while getting their ideas in the room.

### III. Logistics

**Materials:** Large (5" x 7") Post-its™ (allow about 10-12 per participant), flipcharts, and easels

**Space needs:** Large, comfortable room where participants can move around easily

**Time frame:** This depends on the number of people or groups that are presenting. This process should only take 2–4 minutes per presentation.

**Number of participants:** 10 to 50

### IV. Implementation

In this activity we are going to assume that participants have been working in small groups on solving an institutional problem and are ready to present their ideas to others in the larger group.

When participants are ready to make their presentations, the facilitator informs everyone before the presentations are made that the feedback process is going to be a little different.

Make sure that all participants have some large (5" x 7") Post-its™, about 10–12 per participant. Inform everyone that they should use the Post-its™ to write down their feedback regarding the presentations. Their written feedback can address any of the following three elements:

- A. What participants like about the ideas presented by others.** It is always nice to hear what people appreciate about ideas, so encourage this. (e.g., “Your idea of having a weekly breakfast meeting between faculty and administrators is just what we need.”)
- B. Resources to share.** This could include people’s names, suggested contacts, books, research that would help leverage or enhance the effectiveness of the suggested ideas or plans presented. (e.g., “In your plan to assess faculty governance, you should contact Byrne College which just completed a governance audit on their campus” or “You might want to read the article by Dr. Jim Seitz on “Curriculum Renewal and Faculty Engagement” in the October 2000 issue of *Campus Matters*.”)
- C. Suggestions to improve the ideas presented.** (e.g., “You suggest that different groups meet with the president on a regular basis. I believe she should *visit* different places on campus rather than have everyone come to her office” or “Your communication plan seems very one way. You need to build in more interaction where campus stakeholders have the opportunity to provide feedback and ideas.”)

It is always helpful to provide examples so that the participants clearly understand what kind of feedback you seek.

Let participants know that after each presentation, several minutes will be provided so that they can write down their feedback on Post-its™. After they have written their feedback, have them place the Post-its™ on the appropriate flipchart. Then have the next presentation (this should take no more than 2–4 minutes per presentation). Option: You can wait until all the presentations are done before you place the Post-its™ on the flipcharts.

Continue the process of: presentation, time for written feedback, and placing Post-its™ until all the presentations are completed and feedback provided.



The final step is to have each presenting group meet for 10–15 minutes to read the feedback on the Post-its™, react to the feedback, and reach beginning agreement on how to include the suggestions for improvement and resource ideas, where appropriate.

It is helpful to use the same three elements in the same sequence. 1) things you like about the idea, 2) resources to share, 3) suggestions for improvement. The structured sequence ensures that individuals do not go to what is wrong with the ideas right away!

### **Helpful Hint**

**In a group with low trust or one that is very new at collaborative practices, this is an excellent way to solicit feedback in a non-threatening way. As stakeholders get use to being more open, you can try a more direct approach where you solicit verbal feedback from participants.**

**BEST COPY AVAILABLE**

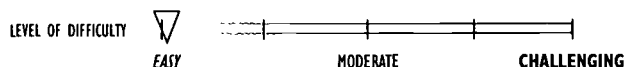

## LAS VEGAS VOTING

---

### I. Goal/Outcome

- I. A simple method to winnow down lengthy lists into a manageable list.

### II. Background/Context

During participative and engaging meetings, a great many ideas can be produced. Many groups utilize brainstorming for the generation of ideas. This, in turn, can create lengthy lists for the group to somehow manage. Even during average meetings, a group can create a long list of recommendations, suggestions, and ideas. The questions still remain: “What do we do with the list? How do we prioritize? Where do we begin?”

The Las Vegas vote is one of our favorite tools to utilize in collaborative efforts. It is open, democratic, and fair to all participants. Most importantly, it allows the change leader to see what people believe are the most important ideas on a list of good suggestions.

### III. Logistics

Materials: Newsprint, magic markers, sticky dots (found at any stationary or office supply store)

Number of participants: Almost any size group (10 to 100)

## IV. Implementation

The group develops a list of activities to be prioritized.

After all the ideas have been generated in a group, the facilitator might have a list like the following example:

### Improving Campus Morale

1. Acknowledge and reward employees throughout campus
2. Have a campus picnic
3. Appoint a “climate coordinator”
4. Have monthly breakfast meetings with leaders
5. Have the president institute a campus update e-mail message
6. Bring together different stakeholder groups to solve campus issues
7. President needs to be more visible
8. Provost needs to be more visible
9. Have a suggestion box in the cafeteria
10. Distribute a questionnaire on campus morale

The facilitator states that, “Each one of these ideas is interesting, but where do we start? How do we choose among all these ideas?”

The facilitator explains to the participants that each person will have five “votes” to distribute among the ideas generated on the list. Participants use their colored dots to identify those ideas they believe will be the best ones to consider and implement. They can weigh their votes any way they want. (e.g., they can put all five of their votes on one idea, or put two votes on one idea, and three on another, or one vote for five different ideas, etc.)

Note: If you don't have sticky dots, you can use fingers to vote. If a participant wants to give a particular idea two votes, they would hold up two fingers. Count the votes as each idea is read aloud and mark the total next to the idea.

If you are using sticky dots, let the participants come up to the flipchart and vote for their

idea(s). In a few minutes you will have a sense of priority among the ideas. Your list may look like this:

**Improving Campus Morale**

1. Acknowledge and reward employees throughout campus ✓✓✓✓✓✓✓✓✓✓
2. Have a campus picnic ✓✓✓✓✓✓✓✓✓✓✓✓
3. Appoint a "climate coordinator"
4. Have monthly breakfast meetings with leaders ✓✓✓
5. Have the president institute a campus update e-mail message ✓✓✓✓✓✓✓✓✓✓
6. Bring together different stakeholder groups to solve campus issues ✓✓✓✓
7. President needs to be more visible ✓✓✓✓
8. Provost needs to be more visible ✓✓✓✓
9. Have a suggestion box in the cafeteria
10. Distribute a questionnaire on campus morale ✓

**Helpful Hint**

When using the Las Vegas Vote, never give more than 10 votes per person. The votes should have some real weight to them so that people "spend" them wisely. In small groups, five votes are plenty. In larger groups, you can use up to 10 votes.

**Helpful Hint**

It may be helpful for the group to agree up front on a simple criterion for voting for an idea (e.g., it will really make a difference, it's something we could do easily, it aligns with our culture and tradition, etc.). Creating a framework, before voting, often helps produce the best ideas.

As you can see, ideas 5, 2, and 1 got the most votes.

**Helpful Hint**

Most of the time (90 percent), with a list of 10 ideas or more, utilizing the Las Vegas Vote will prioritize the top three or four ideas easily. There are times when a list will receive an even number of votes. When this happens, have people conduct a second round with three votes. This second vote will produce some priority ideas because participants can't spread them around as much.

BEST COPY AVAILABLE



# MINDMAPPING

## I. Goals/Outcomes

1. To gather information from relevant stateholders about a key issue
2. To stimulate some creative thinking within a group
3. To arrive at a methodology to solve a problem or to deal with a key issue
4. To capture and then organize the group's thinking

## II. Background/Context

Mindmapping was created and popularized by Tony Buzan in his 1983 book, *Use Both Sides of Your Brain*. It is one of the most creative problem-solving tools ever designed. Mindmapping is the visual depiction of an idea, concept, or issue. It taps both the left and right side of the brain and enables the user to “map” out the complexity of a problem or issue in a practical and powerful way. It helps organize information and thought processes without stifling new and different ideas.

It can be used for project planning, defining goals, action planning, note taking, identifying values, or creative problem solving. It is one of our favorite tools and, when used appropriately, can be a stimulating and interesting tool to use in many different settings. It enables a facilitator to integrate individual thinking into a group setting.

One of the key elements that makes mindmapping work is that there is no judgment about the ideas that are created. All ideas are valid, so they are captured on the mindmap.

Mindmapping never fails to generate more ideas than the traditional linear listing we have all experienced. It also tends to produce ideas of higher quality because people build on the contributions of others and see connections between ideas they wouldn't see on a long list of brainstormed ideas.

We are going to present an adaptation of a traditional mindmap, which usually limits the ideas created to one word. We have found that capturing the essence of what people suggest, and not limiting it to one word, is most productive.

## When to Use

1. Anytime you need to understand the complexity of an issue
2. When you want to stimulate some creative thinking in a group
3. When you want to show participants an innovative way to problem solve

## III. Logistics

Materials: Flipchart paper, colored magic markers, masking tape

Space needs: Room large enough for participants to move about freely

Time frame: Approximately 30 minutes

Number of participants: Mindmapping can be done with several people (up to 50 participants)

## IV. Implementation

We will use a group of 10 participants as a model for this tool.

1. Tape several sheets of flipchart paper to a wall—the larger the better!
2. Have a central theme or problem statement in the center of the mindmap  
*e.g., How can we further improve campus morale?*

Let participants know what the focus question is and that the goal is to generate as many ideas as possible that address the issue.

Before you solicit suggestions from people, have them do a “pair and share” with the person next to them. (This is when two people talk about the focus issue among themselves.) This will generate ideas and energy.

3. After 2–3 minutes of pair and share, have the participants call out their ideas in a brainstorming fashion. Remember that all ideas are valid so write down what people say. Print the words on a line and make sure the lines are connected to the major theme in the center. As the ideas are generated, ask participants if the ideas stand by themselves or are part of another idea.

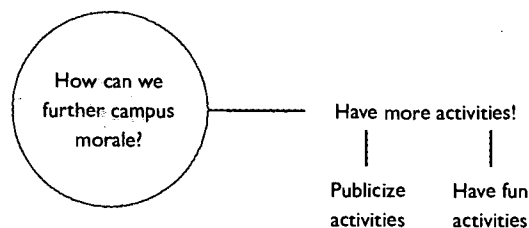

Use different colors when drawing the mindmap. Colors stimulate thinking and creativity. You can also use pictures and images to capture an idea. The images don't have to be artistic or beautiful as long as people understand what they represent.

Examples

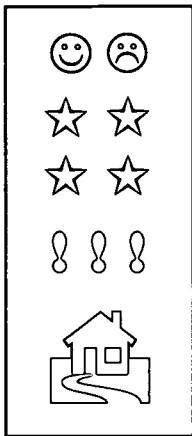

4. Continue to capture all the ideas until everyone is finished. Suggest that when all the ideas have been generated that participants observe a minute of silence. After a quiet minute, ask the group again if they have any new ideas. The minute of silence usually produces several more ideas and can actually “jumpstart” a whole new series of ideas and connections.

5. Your final mindmap might look like this:

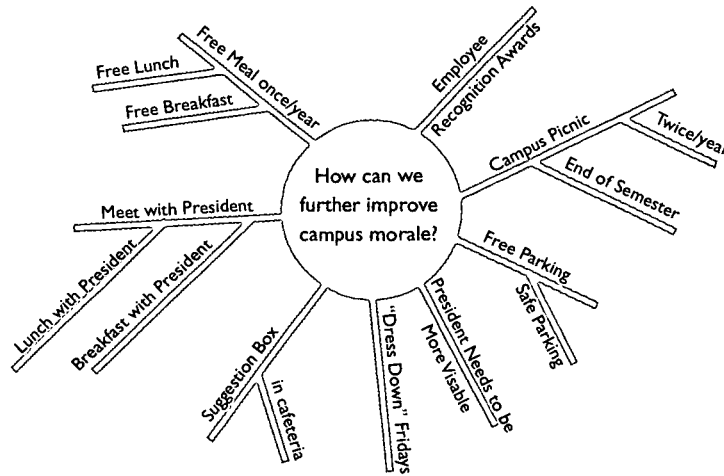

6. After the mindmap is complete, you have an option. There will be many ideas, but which ones do you choose to implement? One of the ways you can determine this is by utilizing the Las Vegas Vote (shown on page 2.137 ). Give people five votes (dots) and have them come up to the mindmap and indicate their preferences.

With our sample list, you will see three or four ideas get the most votes. After the top vote-getters have been selected, you can either put people into small work groups to begin action planning or let another group take responsibility for the implementation of your suggested activities.

BEST COPY AVAILABLE

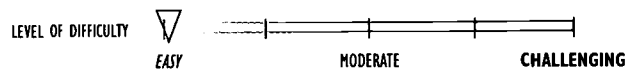

# NOMINAL GROUP TECHNIQUE

## I. Goals/Outcomes

1. To tap the thinking and resources of all attending group members
2. To level the playing field
3. To discover alternative solutions to a problem or issue

## II. Background/Context

The Nominal Group Technique (NGT) has been around for a long time and is best used with small groups (4–10 participants). It enables a facilitator to tap the resources of all group members in a meeting. Too often, meetings are dominated by a couple of people. This technique neutralizes the impact and influence of these individuals while incorporating the ideas of all participants.

In any meeting, a facilitator has to be conscious of several things: some individuals can be easily intimidated by others; often the same people dominate a discussion; the pace and complexity of the discussion can be fast or overwhelming for some people; quiet and shy individuals can find it challenging to fully participate; and often there is disparity of power in a group. When you put top leaders in a work group with people who are several levels below them, there needs to be a way to level the playing field.

What is great about NGT is that it manages all of the stated challenges facing a facilitator and produces a prioritized set of ideas, solutions, or recommendations. There are usually seven steps with the NGT. We have changed the traditional scoring method (i.e., low numbers = high priority idea) by reversing the value of numbers. A higher number in our version means the idea or suggestion is of higher value. We have found that it is easier to score, and makes more sense to people.

## III. When to Use

1. When you want equal participation from all group members
2. When the topic being discussed is a sensitive or controversial issue
3. When there are many good alternatives to a problem or issue
4. When there are different levels of power in the group



## IV. Logistics

Materials: Index cards, flipchart paper, easels, magic markers, pens, and pencils

Space needs: Room large enough for participants to move about freely

Time frame: Approximately one hour

Number of participants: 4-10 participants

## V. Implementation

We will use the same example throughout all seven steps.

Step #1: Define the problem to be solved or the decision to be made. This is obviously very important and central to the success of this technique.

Example: *“What are some ways we can improve the level of trust between our administrators and faculty?”*

Step #2: Have participants silently generate some ideas and suggestions that will effectively deal with the focus question. Each group member should take about 5–10 minutes and write down their suggestions on an index card. (Limit one suggestion per card.)

Step #3: Record the ideas.

The facilitator should use a round robin approach, where one person at a time provides one of their ideas. The facilitator should record the ideas on a flipchart, in full view of everyone. Make as many rounds as necessary until each person has shared all of their ideas. The facilitator should not duplicate ideas on the list, but note with a checkmark (✓) when more than one person has the same idea. At this time your list may look like this:

- A. Have the former president facilitate a meeting between administrators and faculty ✓
- B. Do a climate survey
- C. Have the president meet with the faculty senate
- D. Have top leaders on both sides participate in a team building retreat
- E. Create a more open decision-making process
- F. Share the budget with faculty members ✓✓
- G. Do a study on the equity of faculty salaries
- H. Create and implement a questionnaire that will get at the core issues involved. Use good data.
- I. Have the Smith Consulting Group come in and diagnose our trust level and issues
- J. Find out how other campuses have dealt with this problem

Step #4: Clarify each idea on the generated list.

The purpose of this step is to ensure that everyone understands the suggestions, not whether there are good or bad ideas on the list. There is no judgment or feedback involved with this step.

Step #5: Rank items and list the rankings.

Assign a letter to each suggestion or idea on the flipchart. (We have already done this in our example.) Have each group member write down the letters corresponding to those listed on the flipchart.

### Helpful Hint

In step #3, where you solicit the ideas of group members, you can adapt this step if the trust level is very low in the group. Instead of participants calling out their ideas, collect the index cards that have the ideas on them. Give the group a short break (5 minutes or so) while you record the ideas from the index cards on a flipchart. This way you ensure anonymity and get the ideas on the table.

Ask each member to vote silently for the ideas. They should assign a high number to the very best idea and a low number to the least effective idea. (Remember, this is a reverse of the traditional scoring system.)

When you have a long list of ideas or recommendations, it is helpful if you suggest that the group only evaluate half of the ideas. (In our example of 10 ideas, you would only evaluate five.) This helps make the process more manageable but group members have to agree to this. If one or two members want to evaluate all the ideas, then don't push and have the group evaluate all of them. (We are going to assume that participants were o.k. with our suggestion and will only rank the top five ideas. An individual voting list might look like this:

- A = 2
- B = X
- C = X
- D = X
- E = 1
- F = 5
- G = 3
- H = 4
- I = X
- J = X

Step #6: Tally the rankings.

In this step, each member calls out their rankings and the facilitator lists them on the flipchart in full view. Add up each idea line (A, B, C, etc.) horizontally. The items with the highest totals indicate the group's preferences. Your list might look like this:

|     |   |   |   |   |   |      |
|-----|---|---|---|---|---|------|
| A = | 1 | 4 | 4 | 3 | 5 | = 17 |
| B = | X | 5 | 2 | X | X | = 7  |
| C = | X | 2 | X | X | 1 | = 3  |
| D = | X | X | X | X | 3 | = 3  |
| E = | 2 | 1 | 5 | 1 | 2 | = 11 |
| F = | 5 | X | X | X | X | = 5  |
| G = | X | 3 | X | 5 | X | = 8  |
| H = | 4 | X | 1 | 1 | X | = 6  |
| I = | X | X | X | 2 | X | = 2  |
| J = | 3 | X | 3 | 4 | 4 | = 14 |

**Helpful Hint**  
 In step #6, where the facilitator tallies the rankings, if the trust level is low, the facilitator should collect the voting sheets and tally the results in full view. (This way no one knows who voted for what.)

**Helpful Hint**  
 Do not allow for any discussion time when the ideas are being generated, recorded, or prioritized. Remember, the main purpose of this meeting is to solicit ideas and determine priorities. It is not about debating the pros and cons of the suggested ideas.

BEST COPY AVAILABLE

Step #7: Wrap things up.

In our example, ideas A, J, and E got the highest votes. The priority suggestions should be seriously considered for implementation. It would be helpful to have an open discussion about practical next steps for operationalizing these suggestions and assigning responsibility for them. Keep this discussion to 15–30 minutes.

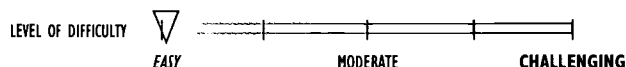

## SELF-MANAGED GROUPS

---

### I. Goals/Outcomes

1. Whenever a facilitator has two or more groups working simultaneously on a task or assignment and you need to provide structure to each small group's effort or activity, Self-Managed Groups can responsibly report back their outcomes without the facilitator's involvement.

### II. Background/Context

When you are engaged in a collaborative change management process, there are many times when you will break a large group of 20–50 participants into smaller, more manageable groups of five to seven people. You may give them a specific task: e.g., “*Please take the next 20 minutes to brainstorm 10 ways to improve communication throughout the campus.*” Or you might ask them to discuss an issue: e.g., “*In the next 45 minutes, please discuss the four recommendations from our self-study regarding diversity. Be prepared to report back key points from your discussion.*”

If a facilitator visits all the groups, checks up on their progress, makes sure they are utilizing their time well, and encourages them to capture their ideas on flipcharts, he or she will quickly become a pest. Utilizing Self-Managed Groups provides structure for all the working groups and allows them to be responsible for the outcome of the group's work.

This tool is very effective in leveraging the time and productivity of larger groups.

### III. Logistics

Materials: Handout explaining the roles (see attachment)

Space needs: Comfortable room where participants can move about freely

Number of participants: 10–50 participants

## IV. Implementation

If you are giving a large group an assignment they will be working on in smaller, mixed groups, you should give them the Self-Managed handout before they go into their small groups to work.

Let all participants know that they should identify persons in their small work group to take responsibility for one role, before they start working. Let the participants know that each group will be responsible for their own work product and process and that you won't be checking in on them. (You can say you are available for any clarification of the task or other help.) They are responsible for "self-managing" their own groups.

You may want to walk all the participants through clarification of the roles. The following notes may prove helpful to aid your thinking about what to say. Tailor this to meet your needs and style. The following roles are clear and self-evident:

**Recorder.** This person captures the group's work on the flipchart. You may want to suggest that people be conscious of who gets assigned this role so that you don't get trapped into traditional roles (e.g., if there is a secretary in the work group, or an adjunct faculty member, they don't automatically get assigned the recorder role).

**Presenter.** This person shares the small group's work with all participants. This role is a juicy one and many people will want it. Top leaders should avoid this role—we see enough of them! Suggest that other people should volunteer to be the presenter.

**Timekeeper.** This person keeps the group gently aware of time. Your goal is to keep the group aware of time throughout the activity—every 10 minutes or so. (This is a great role for top leaders.) Their main goal is to remind the group, every so often, about the time remaining for the task. If you have allowed 30 minutes for the task, then reminding people every 10 minutes is appropriate. If you have given an hour for the task, then every 15 minutes is appropriate. The key is to not aggravate people.

**Facilitator.** The main purpose of this role is to make sure that all the participants are engaged and involved. The facilitator ensures that the dominant participant is not taking over the group, keeps things on track, and ensures the group accomplishes the end task. It is not an easy role. Often verbal people will volunteer for this role, watch out for this. We would suggest the following message, "The role of facilitator is challenging. The main purpose is to ensure that everyone in the group is participating. If you are doing a lot of talking, you are not facilitating!"

Once you have reviewed the roles, let participants move into their smaller work groups. Remind them that they should assign their roles right after the group members have congregated and before they start their task.



## SELF-SELECTION

### I. Goals/Selection

Self-selection is designed to determine:

1. The subject interests of your group participants
2. An instant diagnostic of where people's interest lie
3. The relative (or ranking) importance of the different themes

### II. Background/Context

This tool is more of an approach to collaboration than a specific technique. There will be many times during a change process where people will be working on solving different institutional issues. You might find that you have a group of 30 or 40 stakeholders who are trying to address several issues. An example:

1. Faculty governance
2. Campus climate
3. Residential life
4. Campus safety
5. Parking
6. Resource allocation
7. Undergraduate growth

Each of these issues are important and complex. As a change leader, you might want to have participants make some suggestions about each of these areas or actually come up with some specific actions that must be taken to further improve these areas. The challenge is: how do you assign people to particular themes or problem areas? The last thing you want to happen is to assign people to a theme where they have little experience or interest. This will result in flat recommendations with little passion or innovation.

We have found that when you let people decide for themselves what theme or problem they want to work on, enthusiasm is created and quality ideas are generated. Letting people choose is

democratic, treats them like adults, and is a key element in collaborative processes.

In our example, you have seven major themes that need to be addressed. You would let participants in this type meeting know what you expect them to do (e.g., spend 30 minutes discussing the theme and generate some recommendations, or create action plans to implement some recommendations). Then, let them select the theme they want to work on in depth.

You might find that a dozen or more people select one theme area because they are truly interested in it and three people go to another theme area. This is fine. That's how it's supposed to work. We have even had times when no one chose a particular area where they would like to explore or work.

The self-selection process is an instant diagnostic of what people are interested in. It will let the change leader know the relative importance of the different themes. If no one out of 30–40 participants goes to a particular theme, is it really that important? You might have to find ways to get input in the non-interesting themes at a later time.

### III. Logistics

Materials: Flipcharts

Space needs: Comfortable room where participants can move about freely

Number of participants: 30 to 40 stakeholders in the listed themes



## PARKING LOT

### I. Goals/Outcomes

1. To bring a group back on track
2. To work through strong personalities monopolizing the meeting
3. To capture interesting ideas

### II. Background/Context

Many times during a meeting there tends to be a wandering off from the original purpose and agreed upon agenda for a meeting. This is almost inevitable when you utilize diverse groups. All of a sudden, participants are discussing an idea that has nothing to do with the meeting. Then, they wonder how they got there, and some mumbling can occur, “Where are we going?” “What’s going on here?” “Why are we talking about course scheduling when we are here to talk about limited parking on campus?” You get the idea.

Once a group wanders off it can be difficult to get them back on track. This is especially true when you have strong egos, a revered participant, or a respected leader in the room. What do you say when the provost or the chief financial officer is taking things off track?

The Parking Lot tool is also known as a “grass catcher.” It has been around for a long time and is an effective technique to help any group get back on track. It is a particularly useful tool for groups that have regular meetings together such as administrative councils, technology groups, or faculty senate. In short the Parking Lot captures those interesting ideas that pop up and gives them a home. It is a very simple idea. The facilitator uses a sheet of flipchart paper to record those items, ideas, and issues that detract from the purpose of the meeting, but need to be dealt with at a later date.

### III. When to Use

Almost any important meeting can use the Parking Lot tool. It is inevitable that people will generate many ideas and this is a means to capture those ideas without losing the focus of the meeting.



## IV. Logistics

Materials: Flipcharts and magic markers

Space needs: Room large enough for participants to move about freely

Time frame: Not applicable

Number of participants: 6-20

## V. Implementation

1. Before you start a meeting, the facilitator should share with the participants the general purpose of the meeting. “Today, we are working on improving campus morale” or “The primary purpose of this meeting is to prepare for the large planning conference we are having next week,” etc. It is also important to get agreement on the purpose by checking with all the participants.

2. After the general purpose has been shared, let participants know that you will be utilizing a Parking Lot design to capture important ideas that may come up in the meeting, but have little to do with the purpose of the meeting. Example: “Our purpose is to find ways to improve campus morale. An idea may come up about a particular problem in a dorm. We don’t want to ignore this problem, but it doesn’t meet the purpose of the meeting. We will capture the dorm problem on a flipchart and before we leave, we will agree upon a next step for that particular problem.”

3. It is important to let people know that the Parking Lot issues will be addressed and not forgotten. The facilitator or leader needs to make time toward the end of the meeting to address the Parking Lot issues. We suggest at least 15 minutes before the end of a meeting. During the meeting mentioned previously about campus morale, two issues came up in the discussion and were captured by the facilitator.

A Parking Lot might look like this:

**1. The physical plant people have reported a leak in St. Patrick’s Hall.**

**Action:** John will talk with the physical plant director and come up with a plan by tomorrow.

**2. The campus newsletter isn’t being distributed to all the divisions.**

**Action:** Mary will contact our communication director this afternoon to validate this claim and problem solve it by the end of the week.

# THE ROLE OF THE LEADER FACILITATOR WHEN PLANNING AND IMPLEMENTING A STRATEGIC DESIGN

---

## Introduction

This book is dedicated to leaders who are committed to a disciplined and creative approach to change management. The notion of being intentional in every aspect of this process suggests that “designing” interventions to move the process forward is critical at every stage of any change initiative. While we have provided a theoretical rationale (Part 1) for change in institutions of higher education as well as wide ranging design strategies (Part 2), we have not addressed, specifically, necessary considerations for leaders at the point of implementing these design strategies. This section provides the questions an effective leader/facilitator should be asking prior to implementing such design strategies as well as some specific suggestions that should increase the leader’s chance of success. As we have mentioned throughout, the devil is often in the details.

Most opportunities to move an organization forward are accomplished in some sort of meeting. A design is simply a way of organizing the meeting to accomplish the task and process goals felt to be important. Thus, agenda items are viewed as mini-designs with their own goals, strategies, and desired outcomes. Whether a meeting is attended by two individuals, or as many as a hundred, the questions remain primarily the same and the discipline necessary to ensure success remains important.

## Step I. What Past Experiences and History Does the Group or Team Bring to the Session?

All too often leaders use methods and specific design strategies that have worked other places and at other times, instead of considering the rich history of the group and the “unfinished business” that could block the success of the group itself. For example:

Has the group experienced success or failures during its recent history together? For example, consider a situation in which a blue ribbon steering committee, composed mostly of faculty and administrators, is convened. Over the years the historic relationship between the two groups has been fractious, at best. The beginning of the initiative must include some time and opportunity to create an early success along with a mounting belief that this effort may result in something other than

contentiousness. Such a belief cannot be demanded, expected, or mandated by the hope or goodwill of the leadership. Something in how people conduct themselves during an initial design must provide hope that this time things will be different. The group should not be engaged in potentially polarizing issues before the group's members are confident that the group is ready to handle them.

Is there specific "unfinished business" within the organization or the group that must be dealt with before it is possible to move forward? An example of this might be some misunderstood communications that had increased a sense of mistrust within the group or the organization. Another might be a destructive rumor over the firing of a favorite administrator and the failure to provide any information to the community. Or, still another example could be the failure to disclose how or why a particular course of action was taken by the administration without apparent input from those affected. The point is that, when dealing with change, everything about the process should appear as open and above board as possible. If there are points of contention outside of the change process itself, they need to be removed lest they provide an anchor that can drag down the credibility of the entire process.

Are there unrealistic expectations regarding the outcomes of the change initiative? Leaders sometimes create expectations that cannot be fulfilled. These expectations may simply reflect an overoptimistic, hopeful point of view. Or they could be a manipulative means of getting buy in—calculated half-truths that create support that can be rationalized later. Whatever the reason, they will inevitably come back to haunt the effort and, in turn, the leadership. Honest, clearly defined, and realistic goals are always the best policy.

Are those participating in the change effort "ready" for what it will take to succeed? It's not nearly as difficult to generate enthusiasm for necessary change at the front end of an initiative as it is to maintain the enthusiasm after the sacrifices of time and resources are beginning to take their toll, and the reality hits that there is no "free" ride. The focus here is on the kinds of personal sacrifices that will have to be made by individual group members. These occur both in terms of what will be demanded of them to complete the change, as well as the costs and benefits to be considered prior to setting off on the change process itself. Even if one does not know all of the details, all change has implied costs and these along with the expected benefits need to be pushed into the open from the beginning.

Does the group or organization have the necessary "process" skills to insure success? For the most part, this book has been about how leaders ready their constituents for change, involve them to ensure their "buy in," and engage their ideas so the organization can benefit from the best thinking of those who, ultimately, must live with the final outcome. Process has to do with listening, designing, collaborating, involving, and problem solving in ways that build trust. The outcomes of the change effort must be the result of methods fairly and openly utilized that optimize only as much participation as is necessary to ensure the desired outcomes. We are not suggesting unnecessary process or paralyzing an organization with time wasting maneuvers that have little payoff. Rather, our attempt is to optimize resources and to maximize the use of limited time availability that is endemic in higher education institutions. Participants in the change effort must be able to experience the benefits of their time together. Thus, once again, we come full circle and face the need for design skills and "how" these interventions can influence the course of the change effort. This, in turn, will determine "what" change outcomes can occur.

What are the levels of cohesion, trust and membership present in any group or organization where change is the focus? The level of openness and candor, so essential in meaningful change

efforts, will be directly influenced by the strength of these factors. If trust is low, for example, and leaders attempt to move too fast, they will face resistance as coalitions form and politics predictably subvert the well-intentioned efforts at system change. Building understanding and trust among key constituencies at the beginning of the change effort will pay huge dividends later, when implementation is attempted.

## **Step 2. What Are the Cultural Norms that Tend to Facilitate or Detract from the Ability of the Group to Accomplish Work Successfully?**

One of the critical diagnostic issues that needs to be understood by the leader is what kinds of cultural norms exist that might hinder or facilitate any change initiative? Many a well conceived design has proved to be ineffective, or worse, has resulted in increased resistance because of a leader's insensitivity to organizational norms. Once again, norm represents the unspoken "rules" that govern the behaviors in an organization.

If, for example, large group faculty discussions are inevitably dominated by a few long tenured professors, who easily control the contributions of less vocal or confident members, then the results of such discussions are likely to be predetermined by the few with little input from others. The consequence is that the majority of the individuals fail to "buy in" to the eventual decisions made. The implications for the design are clear. Small group discussions must be utilized, spreading the "air time" among the larger group of participants. However, just as predictable as the control by a few powerful members is the reality that these same few individuals will openly resist any effort of the facilitator to use small groups as a vehicle to spread the participation in the group and allow greater input in the discussion. Thus, the facilitator will have to be steadfast in the commitment to such activity and resist the temptation to give into the old ways of doing business as some of these individuals loudly protest that small groups are a waste of time or imply that 'We don't trust each other.'

Another norm may be that administrators are comfortable with a history of maintaining control over the decision making process by keeping it ill defined. Such long-standing patterns or organizational behaviors can undermine trust. Leaders who understand the nature of cooperative leadership and how decision making can reflect a willingness to empower those influenced by a decision, can provide instant credibility in a change initiative as members of the organization begin to believe that they have the ability to influence the outcome directly.

Diagnostically, the ability to understand dysfunctional norms can provide a leg up for the leader with the courage to take action and design interventions that negate or neutralize patterns of ineffective organizational behaviors. The result will inevitably create a more positive experience.

## **Step 3. What Kind of Meeting Is It?**

There are a wide variety of meetings; each dictates a different kind of design(s). A facilitator needs to be aware of what the particular session is to accomplish and be just as certain that the participants equally understand. Confusion can undermine the motivation and confidence of the participants

and, ultimately influence the trust they have in the overall change process. By categorizing a meeting or, for that matter, an individual agenda item within a meeting, a facilitator can provide considerable direction in relation to the type of “design” that should be used. We believe that a handful of meeting types help to clarify the situation.

**Diagnostic Meetings.** In Part 2, we identified a variety of diagnostic designs that support such a meeting—whether it is for six or 60 individuals. We have a fundamental assumption concerning the use of data in most change efforts. People want the opportunity to discuss their ideas. This is even more important than simply having the opportunity to place their ideas on a piece of paper. Feeling heard and sensing the ability to influence a change process is, to a large degree, dependent on witnessing one’s ideas being heard, understood, and, as a result, feeling empowered. Thus, it is imperative, especially in collegial environments, that dialogue and the opportunity to influence others is part of the diagnostic process.

**Discussion / Dialogue Meetings.** Sometimes it is more important to dig the soil of new ideas or to discuss differences than anything else. Lack of pressure to make decisions or to “win” in an environment where the dialectic still predominates can be refreshing and stimulating for individuals with the intellectual capacity to think creatively and to build on the good ideas of others. The success of such a session hinges on helping participants believe that it is a good use of their time. Providing structure and a climate that supports ideas and common ground rather than exploiting differences can add significantly to the substance of any change process.

**Information Sharing.** Clearly, these categories are not purely independent. Here, for example, it may be possible that a session is designed to bring together best practices in an area relating directly to the change process. Such a session is primarily informational without interest in decision making. The goal is to explore the best alternatives. The degree that wide ranging discussion is part of the need will determine whether the design allows for such discussion to occur (see above). It could be that an objective exploration of the alternatives, with discussion held until a later date, is the primary goal.

**Decision Making.** There are two keys to any decision-making meeting. First is the necessity that sufficient information has been provided so that the discussion and problem solving process which brings the group to the point of decision has been adequate. People resist decisions because the evolution of the decision making process has been flawed.

Second is to be sure that the group is absolutely clear at the front end of the process of how its eventual decision will be made and who is to make it. Thus, is it a leader decision, a committee decision, a majority vote of a particular body, a two-thirds majority, or a consensus of the group? Or, is it a more complex process, such as a double vote two-thirds majority in which there is time between the first and second votes so members can reconsider prior to the final two-thirds vote and legitimate lobbying can occur? Knowing the kind of vote that will take place psychologically prepares the individuals in the group for how they will participate and what level of risk will be incurred. A blind two-thirds vote has a very different level of risk than the open use of consensus. In a highly politicized organization, voice votes can obviously be dangerous to one’s health. Again, the hard work of discussion and problem solving leading to the decision is essential if there is to be a real “buy-in” of the eventual decision regardless of the method used. The challenge is for the leader to select the best possible design to make sure this happens.

**Unfinished Business in the Process Domain.** Sometimes the content or product dimensions that are the focal point of most meetings need to be replaced by an agenda which focuses on issues of

“process”—factors that are blocking the effective work of the group or organization. Such meetings are not usually in search of the kinds of concrete solutions or outcomes that characterize most meetings. Instead, the focus is often on the more ephemeral issues of feelings, attitudes, and morale that can sabotage the outcome of any group effort. Clearly, a different kind of design is essential in such a meeting in order to lower the risk of participants and to allow the maximum candor and response with minimal defensiveness.

## Step 4. What Are the Desired Outcomes? What Would Success Look and Feel Like to the Participants?

The dilemma for any leader is how to establish a balance between content or outcome-based goals that drive most organizations and process goals that are focused on “how” such content goals are to be accomplished.

### Task /Product /Outcome Goals

The following questions need to be asked if maximum success is to be achieved.

1. Are the right people in the room?
2. Are these product goals absolutely clear to everyone?
3. Has there been “buy in” of these goals?
4. If there are multiple goals, have specific design elements been created to address them in ways that will ensure success?
5. Are the various designs “developmentally” organized so that each is placed in a manner that ensures that the group is ready to deal with the issue and other participants in a manner that ensures success?
6. Has the role of a facilitator been legitimized and is that role clear and acceptable to all of those participating?
7. If decisions are to be made, is the decision making process clear and acceptable to those present? Do different decisions demand different decision making standards or procedures? Are these standards and methods determined at the beginning of the session so that the process is not manipulated as events unfold?
8. Have other roles, important to the group’s success, been accepted and defined such as: timekeeper, scribe, process observer, etc.?
9. Is the space suitable to accomplish the necessary tasks? Is the space adaptable to a variety of design configurations so that pairs, small group, and large group activity are possible? (Having the structure of the meeting defined by a table immediately reduces the flexibility and creative opportunities that could be available to the facilitator and the group itself.)
10. Is there sufficient time to complete the tasks outlined on the agenda? Is the time used as a means of stimulating action and providing the focus essential to ensure success?
11. How will commitments made at the end of the meeting be supported and monitored so promises are kept and the apparent success of the meeting is not undermined by lack of follow-through? This level of accountability is absolutely essential and an area of much neglect.

### Process or Maintenance Goals

These goals pay close attention to “how” the product or content is to be addressed so that issues that influence productivity and morale are dealt with in a positive manner. Most organizations run their small group meetings (3 to 20 people) in a rather predictable and even ritualized manner that, over time, becomes less and less productive. The pattern looks something like this: the itemized agenda is too long – impossible to complete, each item is treated in much the same manner – people go around the table and add contributions, often decisions are not reached and many of those present do not participate. Following are a number of questions that focus on the “process” dimension of any meeting that the facilitator/leader should be asking.

1. Has the question been asked, how does the leader or planning group wish to have the participants feel at the end of each design activity? Are they to be pensive, excited, stimulated, frustrated, angry, pleased, satisfied or any other feeling? Much of the work in the process domain has to do with predicting the consequence of the designs being utilized in the task domain of the planning process. To not consider such possible outcomes can result in the possibility of losing control of both the meeting and its outcomes.
2. For each agenda item or individual design component, what is the essential level of participation? Is the discussion such that many will have the ability to address the problem or issue at hand? How can the process be designed so that contributions can be maximized and participants feel heard? What needs to be done so a few individuals does not dominate or control the discussion? Finally, what needs to be designed into the process so that efficiency is maintained while, at the same time, allowing important contributions to be registered?
3. What needs to be done to ensure that the meeting does not become routine, boring, or enervating? Are there a variety of activities that stimulate and challenge and energize the participants over the course of the meeting? Whatever type of meeting, there is no excuse for participants to leave feeling underutilized, bored, or frustrated by lack of productivity.
4. If there are contentious issues, how does the design allow feelings to be addressed without leading to a further polarization of the group?
5. Are specific steps taken in each design to deal with dominating, disruptive, or unruly participants who are capable of hijacking a meeting? It is easier to do this before the predictable behavior occurs as a result of a creative design than it is to have to intervene at the time of the disruption.
6. If a process observer<sup>1</sup> is used to keep the group on course, is that person legitimized for the group and skillful enough to undertake such a difficult role.
7. Are there sufficient opportunities for fun, humor, and breaks – especially when the meeting occurs over a period of hours, let alone days?
8. Is the room structured in a manner that provides the opportunity to utilize a variety of design strategies without being encumbered by such factors as immovable tables, small size, etc.?
9. Is the meeting or event evaluated so that future meetings can benefit from what went well or what factors inhibited the work of the group either in relation to the design(s) or the facilitation or participant behavior?

## Step 5. Additional Design Strategies and Critical Questions

Following are a few additional considerations that may prove helpful as you design interventions to move your change initiative forward.

**What are the specific steps taken to ensure that the “beginning” of the meeting or workshop is successful?** It is not unusual for a significant number of participants in a change initiative to enter with skepticism, resistance or simply old, unproductive patterns. How the meeting is framed, and how the initial activity is conducted can either reinforce or diffuse such attitudes. Most people will take a step back from their old, less than productive behaviors, if they have an experience at the front of a program that is successful and provides the hope that, perhaps, this experience will be different. Looking at a set of design strategies at this level of specificity and sophistication can be the difference between a great start and having to deal with resistances throughout the meeting or program.

**How is the ending created to maximize the positive benefits of the meeting or overall change effort?** Assuming that considerable success has been garnered throughout the meeting or across the entire change initiative, endings become critically important. All too often, endings are anti-climatic and not given the attention they deserve. Previously we stressed the importance of building follow-up into the program and a process for monitoring and ensuring accountability. But, in addition, endings provide people the opportunity to relive some of the significant experiences or outcomes of the program that should be memorialized among the participants. By formalizing designs around endings, leaders can assure themselves that their meeting won't deteriorate into the less than stimulating act of attempting to find dates for a future meeting.

## Conclusion

Intentional leadership is primarily about raising the consciousness of each leader to a level that pays attention to the essential details if any single meeting or long-term initiative is to be successful. It combines the discipline to focus on both the process and task aspects of any meeting and, as part of this, to pay strict attention to the impact of their own facilitator /leader behavior on the group. This section has attempted to create a series of questions meant to focus on the details that might be missed as you begin to expand your leadership sensibilities, especially around the concept of design.



## ABOUT THE AUTHORS

**PATRICK SANAGHAN** Ed.D., is the president of The Sanaghan Group, an organizational consulting firm in Doyleston, Pennsylvania. His organization specializes in collaborative strategic planning, change management, and leadership development. He has over 20 years of consulting experience and has worked with scores of corporations, associations, and universities.

He has facilitated the national boards of dozens of associations, including NACUBO, EDUCAUSE, and ACUTA. His recent clients in higher education have included The College of New Rochelle, The College of St. Elizabeth, Cornell University, DePaul University, St. Joseph's University, and The Catholic University. Other clients include: Shell Oil Company, the U.S. Navy, the William Penn Foundation, the United States Can Company, the Philadelphia City Government, and the Parallax Fund. He is the author of numerous articles and books and is currently writing a book on leadership effectiveness in higher education. He is most interested in developing the capacity for collaboration in complex systems.

**ROD NAPIER** Ed.D., is the president of The Napier Group, in Pottstown, Pennsylvania. Over the past 10 years, recognizing the extraordinary challenges facing higher education, Rod and his colleagues in The Napier Group have focused their change management skills within a wide range of colleges and universities including Bowdoin College, Cornell University, the University of Vermont, Thomas Jefferson University, Wellesley College, St. Joseph's University, the University of San Diego, Southern Methodist University, Swarthmore College, the University of Virginia, and the University of Pennsylvania. The Group's work has ranged from performance management to strategic planning, and from leadership development to executive team building. Formerly a tenured professor at Temple University, he is currently a teaching fellow at the Wharton School's Arresty Institute for Executive Education. He has published a dozen books and his current writing interest is focused on how to imbue courage in high performance teams and will soon be published in *The Courage to Act*.

## INTENTIONAL DESIGN AND THE PROCESS OF CHANGE: Strategies for Successful Change

*By Patrick Sanaghan and Rod Napier*

Single copies NACUBO members: \$59.95  
(single per copy price)

Single copies Nonmembers: \$79.95

### TO ORDER

Go to [www.nacubo.org/shop](http://www.nacubo.org/shop)

Call toll free:

866-348-6300 or 301-362-8198

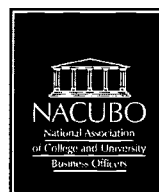

Published by NACUBO, 2002

National Association of College and  
University Business Officers  
2501 M Street, NW  
Washington, DC 20037-1308

**BEST COPY AVAILABLE**



*U.S. Department of Education  
Office of Educational Research and Improvement (OERI)  
National Library of Education (NLE)  
Educational Resources Information Center (ERIC)*



## **NOTICE**

### **Reproduction Basis**

**X**

This document is covered by a signed "Reproduction Release (Blanket)" form (on file within the ERIC system), encompassing all or classes of documents from its source organization and, therefore, does not require a "Specific Document" Release form.

This document is Federally-funded, or carries its own permission to reproduce, or is otherwise in the public domain and, therefore, may be reproduced by ERIC without a signed Reproduction Release form (either "Specific Document" or "Blanket").