

DOCUMENT RESUME

ED 469 205

FL 027 461

TITLE Foreign Languages: PreK-12 Sunshine State Standards and Instructional Practices. Florida Curriculum Framework.

INSTITUTION Florida State Dept. of Education, Tallahassee.

PUB DATE 1996-00-00

NOTE 229p.

AVAILABLE FROM Florida State Department of Education, 325 West Gaines Street, Tallahassee, FL 32399-0400. Web site: <http://www.firn.edu/doe/doehome.htm>.

PUB TYPE Guides - Non-Classroom (055)

EDRS PRICE EDRS Price MF01/PC10 Plus Postage.

DESCRIPTORS *Academic Standards; Accountability; Communication Skills; Cultural Awareness; *Curriculum Development; Educational Environment; Elementary Secondary Education; Evaluation Methods; Faculty Development; Program Improvement; Relevance (Education); *Second Language Instruction; Second Language Learning; State Standards; Student Evaluation; Teaching Methods

IDENTIFIERS *Florida

ABSTRACT

This curriculum framework is a guide for local education communities as they restructure their schools and improve foreign language planning. Grounded in national and state reform efforts, this guide for teachers to help students achieve the Sunshine State Standards, presents broad, overarching ideas for the development of curriculum and instruction. It delineates what knowledge and skills Florida will hold schools accountable for in Grades preK-2 3-5, 6-8, and 9-12. It also highlights strands and standards for foreign languages in five areas: communication (e.g., students engage in conversation, express feelings and emotions, and exchange opinions); culture (students understand the relationship between the perspectives and products of the culture studied and use this knowledge to recognize cultural practices); connections (e.g., students reinforce and further knowledge of other disciplines through foreign language); comparisons (e.g., students recognize that languages have different patterns of communication and apply this knowledge to their own culture); and experiences (students use the language within and beyond the school setting). After an introduction, nine chapters include the following: (1) "Visioning"; (2) "Goal 3 Standards" (from "Florida's System of School Improvement and Accountability"); (3) "Foreign Languages Sunshine State Standards"; (4) "Teaching and Learning"; (5) "Curricular Connections through Instruction"; (6) "Assessment"; (7) "The Learning Environment"; (8) "Professional Development"; and (9) "Foreign Language Program Improvement." The ACTFL proficiency guidelines are attached. (SM)

ED 469 205

PERMISSION TO REPRODUCE AND DISSEMINATE THIS MATERIAL HAS BEEN GRANTED BY

A. M. Duncan

TO THE EDUCATIONAL RESOURCES INFORMATION CENTER (ERIC)

1

U.S. DEPARTMENT OF EDUCATION
Office of Educational Research and Improvement
EDUCATIONAL RESOURCES INFORMATION CENTER (ERIC)

This document has been reproduced as received from the person or organization originating it.

Minor changes have been made to improve reproduction quality.

• Points of view or opinions stated in this document do not necessarily represent official OERI position or policy.

Foreign Languages

PreK-12
Sunshine State
Standards
and Instructional
Practices

*communication
culture
connections
comparisons
experiences*

1027461

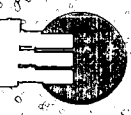

Copyright © 1996 State of Florida, Department of State

Authorization for reproduction is hereby granted to the state system of public education as defined in section 228.041(1), Florida Statutes. No authorization is granted for distribution outside the state system of public education without prior approval in writing.

Foreign Languages

PreK-12
Sunshine State
Standards
and Instructional
Practices

*communication
culture
connections
comparisons
experiences*



Table of Contents: Foreign Languages

ACKNOWLEDGEMENTS iv

INTRODUCTION 1

The Need for Reform

The Value of a Framework

The Standards Movement

Standards Initiatives in Foreign Languages

How Was This Framework Developed?

CHAPTER 1: VISIONING 11

The Importance of a Local Vision

Creating a Vision: The Local Process

Underlying Assumptions of a Vision for Foreign Language Learning

Foreign Language Vision Statement

CHAPTER 2: GOAL 3 STANDARDS 17

The Impact of Goal 3 Standards

Using the Goal 3 Standards

Suggestions for Foreign Language Educators

CHAPTER 3: FOREIGN LANGUAGES
SUNSHINE STATE STANDARDS 29

Why Study Languages?

The Importance of Foreign Languages to Florida

The Role of the Classical Languages

What Should Students Know About a Language
and Be Able to Do With That Language?

Definition of Proficiency

A Note on Competency-Based Placement of Students

The Hierarchic Structure of Strands, Standards, and Benchmarks

Introduction to the Foreign Language Strands

Foreign Languages Sunshine State Standards

CHAPTER 4: TEACHING AND LEARNING 97

The Unique Perspective of Foreign Languages

New Approaches to Teaching and Learning

Instructional Strategies for the 21st Century

Infusing a Multicultural Perspective

Snapshot of an Effective Foreign Language Classroom

Teaching Diverse Students

Diverse Needs

Developmental Differences

Learning Preferences

Students With Disabilities

Integrating Students Who Have a Heritage Language Other Than English

At-Risk Students

Putting These Ideas to Work

CHAPTER 5: CURRICULAR CONNECTIONS THROUGH INSTRUCTION 131

Curricular Connections and the Transfer of Learning

Models for Curricular Connections

Infusion

Parallel Instruction

Multidisciplinary Instruction

Transdisciplinary Instruction

Planning an Interdisciplinary Unit

CHAPTER 6: ASSESSMENT 141

The Assessment Process

Different Types of Classroom Assessment

Traditional Assessment

Assessment Alternatives

The Use of Assessment Rubrics

The Florida Writes Rubrics

CHAPTER 7: THE LEARNING ENVIRONMENT 165

- Design of Facilities
- Safety
- Scheduling
- Learning Resources
- Selection of Materials
- Using Technology
- Snapshot of an Effective Foreign Language Classroom

CHAPTER 8: PROFESSIONAL DEVELOPMENT 175

- The Importance of Professional Development
- Rethinking Professional Development
- Preservice Education
- Effective Professional Development
- The Commitment to Lifelong Learning
- Attributes of the Professional Educator

CHAPTER 9: FOREIGN LANGUAGE PROGRAM IMPROVEMENT 189

- The Nature of School Improvement
- The Evaluation Process
- Planning Changes for Improvement
- The Implementation Process
- Taking the Next Step

ACTFL PROFICIENCY GUIDELINES 199

RESOURCES 213

Acknowledgements

The Florida Department of Education would like to express its most sincere thanks and appreciation to those whose commitment, dedication, and encouragement made this document possible. We would like to especially acknowledge the members of the Florida Foreign Languages Curriculum Framework Writing Team. They reviewed and discussed current research and application in foreign language instruction in order to anticipate the needs of effective citizens in the 21st century:

Team Leader

Bernardo A. García, Florida Department of Education

Chairpersons

Dr. Arnhilda Badía, Florida International University

Gabriel Valdés, Palm Beach County Public Schools

Review Editor

Mario A. Núñez, Florida Department of Education

Assistant Editor

Donald J. Peet, Pinellas County Public Schools

Chapter Editors and Draft Reviewers

Jan Bongren, Brevard County Public Schools

Dorothy Carregal, Hillsborough County Public Schools

Vilma T. Díaz, Broward County Public Schools

Eunice Hopkins, Seminole County Public Schools

Beatrice Palls, Pasco County Public Schools

Doris E. Rodríguez, Orange County Public Schools

Lissi Spencer, Leon County Public Schools

Carmine Zinn, Pinellas County Public Schools

Additional Team Members and Contributors

- Donna L. Boles, Okaloosa County Public Schools
- Rebecca T. Christenberry, Santa Rosa County Public Schools
- Edna Clas-Del Valle, Duval County Public Schools
- Carol Hart, Palm Beach County Public Schools
- Mary Johnson, Lee County Public Schools
- Frank Kress, Sarasota County Public Schools
- Louis P. Lillard, Hendry County Public Schools
- Denise B. Mesa, Dade County Public Schools
- Melanie Piedras, Seminole County Public Schools
- Mattie Rodríguez-Walling, Dade County Public Schools
- Ronald W. Schildbach, Hernando County Public Schools
- Ileana Sotolongo, Dade County Public Schools
- Maria Thomas, Broward County Public Schools
- Mary Voigt, Gulfstream School, Palm Beach County Schools

Introduction

CHAPTER HIGHLIGHTS

- The Need for Reform
- The Value of a Framework
- The Standards Movement
- Standards Initiatives in Foreign Languages
- How Was This Framework Developed?

The Need for Reform

All over this country, educators, citizens, and political and business leaders are working toward education reform. An increasingly service-oriented, information-based society that is virtually exploding with expanding knowledge demands that everyone have the opportunity to acquire the necessary skills to succeed in the information age. Reform is needed to keep pace with opportunities presented by technological advances, new knowledge about how students learn, and new ideas about how people can improve the productivity and quality of their organizations. The need for schools to change is reinforced by the recognition that teaching and learning are most effective when the diverse needs of students are met. Worldwide economic changes and an array of political and social issues also call for new ways of operating schools.

These new conditions require citizens who are prepared to make well-reasoned, thoughtful, and healthy lifelong decisions in an ever-changing world. Students must learn how to locate, comprehend, interpret, evaluate, manage, and apply information from a variety of sources and media. They must learn how to communicate effectively in a variety of settings and for a variety of purposes through many different media. They must develop mathematical skills to analyze information, solve problems, and create products to meet new needs. They must become creative and critical thinkers,

skilled in systematic problem solving. They must learn to wisely allocate resources used to solve problems. They must learn to understand systems and to use technology. They must develop the integrity to work cooperatively and effectively with people from many diverse backgrounds.

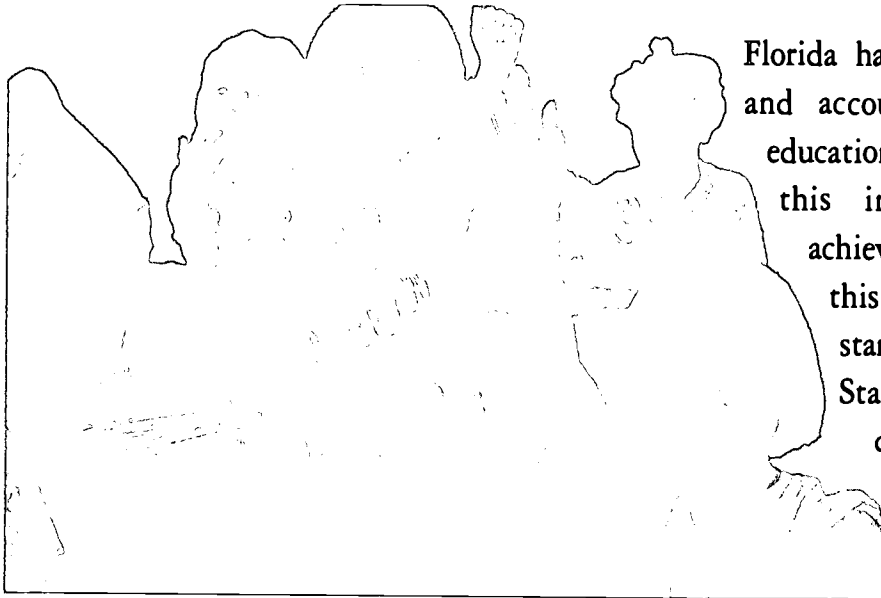

Florida has created a school improvement and accountability initiative to reform education in its public schools. The goal of this initiative is to raise student achievement to world-class levels. To this end, new, high-level academic standards, called the Sunshine State Standards, have been created delineating expected achievement by *all* students. The foreign language standards are presented in this document in chapter 3.

Florida's reform effort is based on a commitment to continuous quality improvement in every school across the state. As such, it calls for improvement teams in schools to articulate a fundamentally new direction for instruction and to reexamine the ways in which the day-to-day business of schools is conducted.

A number of assumptions provide a foundation for Florida's school improvement and accountability initiative. These include the following:

- All children can learn at high levels, given proper instruction in a supportive environment.
- All schools can be successful.
- The state focuses on accountability for student achievement; schools focus on schooling and instructional processes necessary to raise student achievement.
- Children's health, safety, social, and educational needs must be met collaboratively by schools, parents, agencies, and the community.
- The education stakeholders closest to the learners are best able to determine the appropriate strategies to identify and solve school problems and to improve instruction.

- The individual school is the unit of educational accountability for improving student performance, and school-level public reporting of effectiveness is a critical component of accountability.
- Continuous quality improvement is “the way of work”: It results in a focus on education stakeholders, collegiality, teamwork, collaboration, responsiveness, flexibility, innovations, risk taking, and effectiveness.
- The focus of Florida’s reform initiative is on what students need to know and be able to do for the 21st century.

The ultimate goal of education reform is to move from schooling that was designed in, and quite appropriate for, an industrial age to one that reflects and meets the needs of the new information age. Florida’s initiative invites schools to develop learning activities for students that deal with substantial, meaningful knowledge as it relates to performance in real life. Instead of teaching only content knowledge and skills, teachers must practice the difficult art of finding ways for each student to learn and to demonstrate that learning.

This current Florida education initiative differs from earlier approaches to school reform, which were often characterized by detailed legislative mandates and minimum standards. This initiative represents a decentralized approach to reform. The state will hold schools accountable for high levels of student achievement. Local districts and schools are free to design learning environments and experiences that best help their unique students meet the Sunshine State Standards.

Education reform, then, is about developing the capacity at the local level to identify and solve problems related to raising student achievement. Raising student achievement requires both (1) raising expectations through high academic standards grounded in a foundation of reading, writing, and mathematics, applied in real-world contexts, and (2) improving the environment for effective teaching and learning based on current research about how people learn.

The Value of a Framework

This curriculum framework is a resource and a guide for local education communities as they restructure their schools and improve their foreign language programs. Local planners who recognize the diversity of their students’ unique

learning styles, backgrounds, attitudes, interests, aptitudes, and needs know best what specific programs will help their students reach the Sunshine State Standards.

Grounded in national and state reform initiatives, this framework does not prescribe the specifics of classroom instruction. It presents broad, overarching concepts and ideas for the development of curriculum and instruction. Curriculum guides will need to be developed at the local level to provide specific content and specific teaching, learning, and classroom assessment activities. They will need to be far more detailed than this framework and reflect the qualities and flavor of the community as well as the unique needs of the students in the community. This framework also provides overviews of instructional strategies and assessment that can help local educators create supportive, effective educational environments in which all students can achieve Florida's high academic standards and benchmarks.

A statewide external assessment program will monitor student learning in reading, writing, mathematics, and thinking skills. This system will be based on the language arts and mathematics standards articulated in those curriculum frameworks. However, in all subject areas, instruction must support the development of these essential skills.

To help local foreign language educators meet these challenges, this framework

- delineates for stakeholders what knowledge and skills the state will hold schools accountable for students learning at four developmental levels (grades preK-2, 3-5, 6-8, and 9-12);
- gives sample performance descriptions of how students might demonstrate these skills and knowledge, often in authentic, real-world contexts;
- correlates the sample performance descriptions to Florida's Education Goal 3 Standards;
- encourages districts and schools to develop curricula guided by a locally developed vision designed to improve instruction through sound strategies and community support;
- promotes the selection and use of sound, well-developed, flexible, and innovative instructional strategies;
- provides overviews of models of good teaching, learning, and assessment that local education planners are encouraged to investigate and consider;

- presents ideas for developing connections within foreign language instruction and with other disciplines;
- recognizes the knowledge and proficiency of language-enriched-pupils and involves those students as uniquely important contributors to the learning process;
- promotes authentic language learning by framing it in the context of culture;
- encourages the use of instructional materials and activities that acknowledge and respect student diversity;
- discusses the practical aspects of designing a quality learning environment;
- provides suggestions for the professional development of teachers; and
- includes suggestions and criteria for continuous district and school foreign language program improvement.

Florida's school improvement and accountability initiative envisions more effective education for students in Florida's public schools. This system describes a vision of learning and schooling that is innovative, yet sound; ambitious, yet feasible; rigorous for students and demanding of teachers, yet achievable. The ultimate goal is success for every student.

The Standards Movement

The current effort to develop national standards in various subject areas can be traced back to September 1989, when the nation's governors recommended that America establish national education goals. Leading education reformers established goals through America 2000, later renamed Goals 2000, along with a plan to meet these goals. The National Council on Education Standards and Testing recommended the development of voluntary national standards. The National Council of Teachers of Mathematics led the way in the development of national standards; subsequently, standards have been developed in many other academic areas.

The Secretary's Commission on Achieving Necessary Skills (SCANS) Report, developed by the U.S. Department of Labor, verified the need for a plan for education reform. The Commission was charged with examining the demands of the workplace and determining whether the young people of the United States are prepared to meet those demands. Specifically, the Commission was directed to define

the skills and competencies needed for employment, propose acceptable levels of proficiency, suggest effective ways to assess proficiency, and develop a strategy for assuring that the identified skills and competencies become a part of the learning opportunity for every American student.

The SCANS Report, *What Work Requires of Schools*, published in June 1991, defined the workplace competencies and foundational skills required for effective job performance in today's marketplace as well as for the future. This report has had a continuing impact on schools as they work to equip students with marketable skills. Florida's Schoolyear 2000 Initiative conducted research that verified the importance of these skills for Florida's job market. The SCANS competencies provide the basis for Florida's Education Goal 3 Standards.

Standards Initiatives in Foreign Languages

In recent years, an impressive number of published reports originating both outside and within the education community have underscored the need for a proficiency-based curriculum in language instruction. State and federal commissions emphatically concur that proficiency in English and other languages is a necessity for the realization of our nation's social, economic, and political agendas.

In October, 1979, the President's Commission on Foreign Languages and International Studies published an influential report entitled *Strength Through Wisdom*. The report explained why linguistic competence and international understanding are important to all Americans. It also identified points of weakness in our national attitudes toward language study and presented recommendations for remedial action.

These recommendations included support for a K-12 language program, comprehensive teacher preparation and professional development, reinstatement of university language requirements, incentive funding for research and training, international exchanges, and the establishment of advisory committees to establish proficiency guidelines.

In 1984, the Florida Legislature passed Section 240.233 (1) (b), *Florida Statutes*, requiring that after August 1, 1987, all secondary students complete two years of a foreign language or its equivalent in order to be admitted to any one of Florida's

public universities. The Foreign Language Instruction in Florida Project was funded to examine the state's needs with respect to language education and in accordance with the above mentioned statute. The examination of the need for program articulation, an inventory of available human and capital resources, and a cost study for implementing the statute led to the following project objectives.

These objectives were

- to recommend language proficiency standards for each level of education;
- to develop proposals for policy changes in the rules of the State Board of Education, Board of Regents and State Board of Community Colleges related to the implementation of the new language requirement at all levels of education; and
- to design a model for language instruction resource requirements that would identify and generate the basis for additional staff, program development, and instructional equipment.

The National Assessment of Educational Progress (NAEP) was created in conjunction with the National Goals Panel as a reporting mechanism for the reform movement described above. Working closely with NAEP in its identification of significant measurement points and valid assessment techniques, the American Council on the Teaching of Foreign Languages (ACTFL) contributed to the dialogue with its publication of *Standards for Foreign Language Learning: Preparing for the 21st Century*, a consensus document that delineates expected outcomes for language learners.

How Was This Framework Developed?

In response to the education reform initiative reflected in *Florida's System of School Improvement and Accountability*, the Florida Department of Education began the development of a new design for curriculum frameworks in the fall of 1993. This new design is based on approaches being used in other states and was specifically based on a prototype document for science developed through the support of a National Eisenhower Curriculum Framework grant from the United States Department of Education.

In January 1994, a statewide advisory committee was formed, in cooperation with the Florida Organization of Instructional Leaders, to guide the framework activities. *The Principles Guiding the Development of Florida's New Curriculum Frameworks* was produced by this committee. The writing of draft frameworks in the areas of language arts, mathematics, social studies, the arts, foreign languages, and health education/physical education, along with the revision of the science framework, was coordinated by the Department of Education through representative statewide writing teams for each subject area, under the leadership of curriculum specialists from the Department of Education. The writing teams conducted extensive research on content standards and instructional practices, received input from their professional organizations, deliberated issues, reached consensus, and crafted strong initial drafts.

The *Florida Curriculum Framework for Foreign Languages* was developed by a team of Florida educators from fifteen different school districts, including teachers of Latin, French, German, and Spanish. The writing team also included district supervisors and university professors. Valuable orientation and ongoing assistance were provided by program specialists from the Florida Department of Education. Input was solicited through a variety of public focus groups, district reviews, and discussions.

In 1995, systematic analysis of the drafts of the curriculum frameworks in foreign languages and other subject areas was conducted to determine the extent to which each draft addressed the *Principles, Florida's System of School Improvement and Accountability*, other major state initiatives, and national curriculum standards. The analysis also examined consistency in content, style, and format across the documents. The Center for Educational Technology (CET) Florida State University and the Mid-continent Regional Educational Laboratory (McREL) Institute in Aurora, Colorado, conducted this analysis and developed a plan for revising and preparing the final versions of the documents. The McREL Institute was selected for this work because of its expertise in the analysis of standards for curriculum and because of its knowledge of national standards. With continued input from the original curriculum framework writing teams and experts, and the assistance of CET and the McREL Institute, the revisions for each framework were prepared and reviewed.

Statewide reviews of the drafts were conducted through meetings of the original writing teams, focus groups of education stakeholders including business leaders and members of the Florida PTA, conference presentations, and mailings to each school district. The revisions were completed early in 1996. The new curriculum frameworks will provide assistance to all education stakeholders in their collaborative efforts to raise student achievement of Florida academic and work-related standards to world-class levels.

KEY CHAPTER POINTS

- Education reform is needed to keep pace with a changing world.
- Florida has created an education reform initiative to raise student achievement to high levels.
- This initiative empowers schools to identify and solve problems at the local level.
- The *Florida Curriculum Framework for Foreign Languages* articulates state-mandated academic standards that raise expectations for student achievement. It also includes overviews of best practices in instruction for local educators to further investigate.
- This framework has drawn on standards initiatives at national and state levels.

Chapter 1: Visioning

CHAPTER HIGHLIGHTS

- The Importance of a Local Vision
- Creating a Vision: The Local Process
- Underlying Assumptions of a Vision for Foreign Language Learning
- Foreign Languages Vision Statement

The Importance of a Local Vision

A vision is a vivid picture of the desired future: a detailed description of what should be, could be, and might become. Effective leaders and organizations need a clear vision of their goals if they wish to make real improvement. Similarly, Florida's education improvement initiative can best be realized if local community members come together to articulate a shared vision for educational excellence in their community.

Visioning is not about simply talking or writing about missions or goals; visioning uses words to create a dynamic picture of a new condition that will be intellectually and emotionally satisfying when achieved. Unless the stakeholders—educators, support staff, students, parents, and community members—understand the reasons for change and envision the desired changes in place, education reform cannot happen. Once the picture of a new way of doing things in schools and classrooms is clearly in the minds of education stakeholders, they are often not content with the old ways.

Education leaders need to work with the community to create and communicate visions of improved schools, foreign language classrooms, and student achievement that education stakeholders can accept and work toward. In fact, if the vision is

powerful, education stakeholders will think up new strategies along the way, find unexpected resources, work beyond expectations, and make extraordinary things happen in order to fulfill their vision.

Creating a Vision: The Local Process

Real reform of education cannot take place unless local stakeholders share a vision of the future. Schools often develop a vision for their improvement efforts, but the visioning process does not have to stop there. Foreign language educators in every Florida school and district are also encouraged to develop and embrace a vision that defines their discipline, provides purpose and direction for improvement efforts, unifies the school community, and articulates the goals and value of a foreign language education.

All those interested in school improvement should contribute to the development of a school's vision. Parents and guardians, business and community leaders, and other interested stakeholders are invited to join with students, educators, and other professionals in formulating a vision for substantial change. The intellectual and cultural diversity of the vision crafters will help ensure a strong, unique community vision for foreign language education. Involvement of all stakeholders in education builds ownership of both the process and the outcomes.

Vision crafters should focus their primary attention on how best to help their students reach Florida's high academic standards. National, state, and local trends as well as best practices in curriculum, instruction, and assessment need to be considered. The vision described in this framework may also be helpful in the development of a vision for foreign language education in each local Florida school.

Underlying Assumptions of a Vision for Foreign Language Learning

Rapid growth and changing demographic patterns demand that Florida's students approach the 21st century with the ability to communicate across cultures in more than one language. Students who acquire linguistic proficiency as envisioned by this framework will be citizens who are actively, successfully, and joyfully engaged in the world around them.

This framework's vision for language education is grounded in the belief that all students can

- develop and/or maintain proficiency in more than one language, modern or classical;
- learn to use and communicate with a variety of media;
- benefit from interaction with language-enriched peers;
- come to more fully understand both their own culture and the cultures of others;
- understand the concerns and perspectives of those who belong to other ethnic groups;
- reject the stereotyping of themselves and others as they seek out and understand the perspectives of persons from diverse ethnic, social, and educational backgrounds; and
- become equipped to interact successfully as citizens of a global community.

Certain underlying assumptions support the vision for foreign language education articulated in this framework. These include the following:

- Every person is a learner; education professionals, students, and family form a community of learners.
- Effective teaching and learning connect concepts and processes to everyday events.
- A learning environment conducive to quality teaching and learning is the responsibility of the school community.
- Learning takes place both in schools and in communities.
- Cultural diversity enriches the learning environment.
- Instructional programs and teaching strategies should accommodate diverse learning styles and needs.
- Excellence in foreign language teaching and learning grows from a commitment shared by teachers, students, parents, administrators, and the community at large.
- Learning is a lifelong process. Successful learners are lifelong learners.

Foreign Languages Vision Statement

This vision for foreign language education was developed by the statewide curriculum framework writing team. It is presented as a starting point to encourage local communities to develop foreign language visions for their students, their classrooms, their schools, and their district.

This document envisions students who are fully prepared for the demands of an interdependent world. It furthermore anticipates how language instruction in Florida will necessarily evolve as it supplies that vital preparation. The Florida Curriculum Framework for Foreign Languages celebrates a new role for language study within the core curriculum and identifies a new pace for language study, spanning the entire spectrum of schooling. It emphasizes the importance of proficiency as a new goal for language study and knowledge about language acquisition as a new basis for program development.

This curriculum framework envisions

1. *a new status for language education in the state of Florida*
 - *as an integral part of the core curriculum*
 - *as an important communicator of cultural diversity*
 - *as an indispensable preparation for socioeconomic success and civic responsibility*
2. *a new scope and sequence for language instruction in every Florida school district*
 - *spanning the spectrum from Pre-K to Grade 12/Adult Education*
 - *focusing on proficiency*
3. *new emphases and outcomes in the language programs of each Florida school*
 - *learner-centered and performance-based activities*
 - *contextually meaningful and interactive experiences*
 - *the use of authentic materials and assessment*
 - *the use of new methods and technologies*

How Will Language Education Meet the Challenges of the 21st Century?

Language instruction will be

- *student-centered (rather than teacher-dominated) and*
- *firmly grounded in research on second language acquisition.*

The instructional materials used in the language classroom will be

- *drawn from an ever-widening range of available options and selected for their validity and interdisciplinary integrity.*

The instructional sequence for language learners will be

- *proficiency oriented;*
- *enriched by culturally authentic content;*
- *individually paced; and*
- *transacted as a continuous, cumulative, and spiraled process.*

The classroom experiences of language students will be increasingly

- *collaborative;*
- *experiential;*
- *practical; and*
- *meaningful.*

The professional development of language teachers will

- *ensure linguistic proficiency through a certification process that is academically rigorous;*
- *provide culturally authentic experiences which enhance knowledge and motivation;*
- *include extensive and ongoing training in the use of new technology;*
- *continue to raise standards for pedagogical practice and professional commitments; and*
- *nurture and praise traits such as open-mindedness, self-reflection, and educational risk taking.*

When members of a community work together to form a vision, they assess their programs and goals, discuss their options, and chart a course for action. A local vision of teaching and learning in foreign languages reflects the highest ideals of a school community, serving to unify the community and to clarify its commitment to

program improvement. Developing a local vision for improving foreign language education is an ongoing process, one that reflects the best of foreign language teaching, learning, and community values.

KEY CHAPTER POINTS

- A vision is a picture created to describe the desired future.
- Visions unify a group by sensitizing everyone to the nature of commitment.
- Because they are products of communication, visions are neither static nor restrictive.
- The vision statement serves to inspire participants to believe that learning in foreign languages can be different and better.
- Local educators are challenged to become actively involved in assuring the quality of foreign language education for all students.
- A vision statement helps generate a sense of deliberate and conscious effort in all that is done, serving to focus a community's imagination and energy.
- The vision for foreign languages developed by the statewide curriculum framework writing team can serve as a starting point for local communities to develop their own vision.

Chapter 2: Goal 3 Standards

CHAPTER HIGHLIGHTS

- The Impact of Goal 3 Standards
- Using the Goal 3 Standards
- Suggestions for Foreign Language Educators

There are a number of general processes and abilities that are used in all subject areas. For example, locating information, organizing that information, and then using it to solve some problem or produce a product are useful abilities in virtually any area of study. Similarly, identifying the resources necessary for accomplishing a goal, setting milestones, and then managing those resources are abilities that are common to many subject areas. They are also important to success in everyday life at home, in the community, and in the workplace.

These practical but highly important cross-disciplinary processes and abilities have been identified as standards under Goal 3 in the document *Florida's System of School Improvement and Accountability*. One of the seven goals that are the foundation for school reform in Florida, Goal 3 deals with student performance. It states,

Students successfully compete at the highest levels nationally and internationally and are prepared to make well-reasoned, thoughtful, and healthy lifelong decisions.

In all, eleven standards are identified within Goal 3, ten dealing specifically with student achievement. This chapter describes ways in which these ten general standards can be addressed in foreign language education.

It is important to realize that the term *standard* is used somewhat differently in this chapter than it is in chapter 3. A Goal 3 standard describes a general category of processes and abilities that are important to all subject areas and the world of work.

The Sunshine State Standards described in chapter 3 of this framework refer to the knowledge and skills specific to foreign languages.

Both the first ten standards of Goal 3 and the foreign languages standards have been adopted by the State Board of Education and represent what the state will hold schools accountable for reaching. The Goal 3 standards can be summarized as follows:

GOAL 3 STANDARDS

- Standard 1 *Information Managers*
- Standard 2 *Effective Communicators*
- Standard 3 *Numeric Problem Solvers*
- Standard 4 *Creative and Critical Thinkers*
- Standard 5 *Responsible Workers*
- Standard 6 *Resource Managers*
- Standard 7 *Systems Managers*
- Standard 8 *Cooperative Workers*
- Standard 9 *Effective Leaders*
- Standard 10 *Multiculturally Sensitive Citizens*
- Standard 11 *Involvement of Families*

In each subject area in the state of Florida, students will be expected to develop their skills and abilities as information managers, effective communicators, and so on. Indeed, Florida's public schools are accountable to their stakeholders for students learning to apply the first ten standards of Goal 3 to all subject areas. Schools are expected to conduct assessments that will, along with external assessments conducted by the state on the first four standards, show that students are making progress toward Goal 3.

Impact of Goal 3 Standards

Many stakeholders will be affected by the teaching and assessment of Goal 3 standards. Students have a vested interest in understanding and attaining the Goal 3 standards, because these standards will affect their ability to function effectively in their personal and professional lives. Parents or other caregivers must participate in their children's learning process and in the assessment of their children's performance

on Goal 3 standards. Standard 11 of Goal 3 calls on families to “share the responsibility of accomplishing the standards set in Goal 3 throughout a student’s education from preschool through 12th grade.” School administrators and staff should welcome parents as full partners in helping students improve their academic performance by making time and opportunities for mutual communication available. Parents need to communicate with school personnel regarding curriculum, assessment, and goals for individual students, provide a home environment that is supportive of improving student performance, and provide encouragement and discipline as appropriate to support school success.

Teachers must assume new and different roles in assessment. New approaches to understanding student learning and performance will place teachers in the position of assessing student progress in more authentic ways. These expanded assessments should reflect how students will need to use content knowledge, as well as the Goal 3 general processes and abilities, in real life—now and in their future.

Florida’s school administrators have primary responsibility for encouraging, facilitating, and initiating changes within their schools. School administrators will be primarily responsible for identifying strategies for accessing teacher training offered by their district, the state, and other sources such as universities and colleges. Administrators’ primary responsibilities within the framework of Goal 3 assessment will be to support the integration of assessment and instruction in the classroom and establish school reporting systems for the multiple data sources that will be derived from Goal 3 assessment activities.

The business community stands to benefit greatly from the emphasis on Goal 3 standards. Indeed, the Goal 3 standards directly address skills effective workers need to be successful in the 21st century. The skills identified in the U.S. Department of Labor’s SCANS Report on necessary skills for the workplace are the basis of the Goal 3 standards. Consequently, Florida’s emphasis on the Goal 3 standards is an investment in the success of the business community.

Using the Goal 3 Standards

The Goal 3 standards do not exist in isolation; they should be an integral part of daily classroom instruction and assessment. To a great extent, the Goal 3 standards can be thought of as generic processes and abilities that help students apply specific

foreign language content knowledge to real-world situations. As students learn foreign language content, they are using the processes and abilities involved in being an information manager, effective communicator, creative and critical thinker, multiculturally sensitive citizen, and so on.

Teachers should directly address the processes and abilities involved in the Goal 3 standards. In fact, the Goal 3 processes and abilities can and should become a common “language” that is used in every classroom at every grade level. In this section, examples are provided to illustrate how each of the first ten standards can be used in foreign languages. All of the examples depict activities that the teacher designs to help students learn new knowledge and apply that knowledge to classroom and real-world activities. The designing of classroom tasks is one of the most important parts of the art of teaching. In the past, classroom activities often provided little flexibility in terms of the knowledge involved, what students do with that knowledge, and how students demonstrate their competence. The tasks designed around the Goal 3 standards should not be limiting. Each of the Goal 3 standards can play a significant role in tasks designed to integrate real-world problems and situations into classroom activities.

Standard 1: Florida students locate, comprehend, interpret, evaluate, maintain, and apply information, concepts, and ideas found in literature, the arts, symbols, recordings, video and other graphic displays, and computer files in order to perform tasks and/or for enjoyment.

Proficient information managers acquire, use, and manage information purposefully. Developing information managers involves creating tasks that require skills in information acquisition, use, and management. These tasks range from daily functions in school and work settings to everyday activities at home and in the community.

The infusion of technology and multimedia in various spheres of life has placed increased demands on information management skills. People frequently face challenges in locating, interpreting, applying, evaluating, and storing information. Numerous daily tasks require competence in the skills and abilities of Standard 1. Students are expected to develop information manager skills in their native language. In addition, students of a foreign language are expected to develop information manager skills in the language they are studying. Students who are proficient in two or more languages have access not only to information within their own culture but also to sources of knowledge available only through other cultures.

Common examples of information manager skills include

- interpreting weather reports on foreign language TV or information published in foreign language newspapers;
- reading or giving directions in a foreign language on how to get to places;
- understanding and following an authentic recipe representative of another culture published in a foreign language;
- accessing information published in a foreign language from data storage systems, such as electronic encyclopedias or atlases;
- understanding instructions given in a foreign language, such as setting up and operating a new appliance, for example, a VCR;
- following instructions to complete forms or documents written in a foreign language;
- keeping important documents and records organized; and
- interacting on foreign language electronic networks through the Internet.

Standard 2: *Florida students communicate in English and other languages using information, concepts, prose, symbols, reports, audio and video recordings, speeches, graphic displays, and computer-based programs.*

Effective communicators convey thoughts, ideas, and information purposefully. Developing effective communicators involves creating tasks that require skills for transmitting and receiving communications. Communications are transmitted when a student speaks, writes, performs, or creates products. Communications are received by students through observing, reading, and listening—the skills of Standard 1. Media technology can significantly enhance communications.

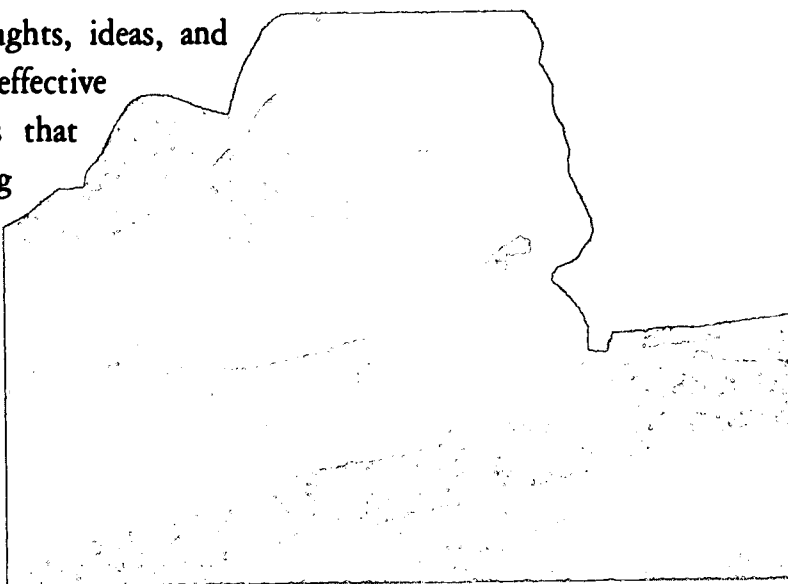

To be competitive in the 21st-century global economy, students should be able to communicate effectively, not only in English, but also in one or more foreign

languages. It is also important for students to be able to use languages pertinent to specialized areas, for example, mathematical notation and vocabulary, scientific language, Latin terminology, music notation, and computer languages.

Communication is an essential form of human engagement. Success in the skills and abilities that are part of Standard 2 is vital to success in school, at home, and the workplace. All students are expected to develop communication skills in their native language. In addition, students of a foreign language are also expected to develop communication skills in the language they are studying. Some examples of activities that involve communication skills include

- initiating and making conversation in a foreign language;
- using a foreign language while making a multimedia presentation to sell a new marketing strategy in other cultural settings;
- writing letters of application (for jobs or educational programs) in a foreign language;
- making formal or informal announcements using a foreign language;
- writing a book review in a foreign language;
- writing or reciting a poem in a foreign language; and
- viewing and listening to an opera or play in a foreign language.

Standard 3: Florida students use numeric operations and concepts to describe, analyze, disaggregate, communicate, and synthesize numeric data, and to identify and solve problems.

Numeric problem solvers analyze and solve mathematical or quantitative problems in applied situations in school, life, and the workplace. Developing numeric problem solvers involves creating tasks that require students to gather, read, manipulate, interpret, organize, and analyze quantitative data. Numeric problem solvers also verify, explain, and justify solutions to quantitative or mathematical problems. Students must be able to take advantage of technology such as calculators and computers that support mathematical problem solving. Common examples of activities that require competence in the skills and abilities of Standard 3 include

- determining the best value of things to buy when visiting abroad;
- keeping accounts and budgets for different purposes; and
- gathering, summarizing, and analyzing data available only in a foreign language to determine needs in particular areas.

Standard 4: *Florida students use creative thinking skills to generate new ideas, make the best decision, recognize and solve problems through reasoning, interpret symbolic data, and develop efficient techniques for lifelong learning.*

Creative and critical thinkers gather new information to answer questions and make conclusions, connections, and inferences from existing information. Creative thinking involves divergent thinking, originality, and the ability to find novel or unique relationships and solutions. Creative thinkers have a high tolerance for ambiguity; they seek out opposing viewpoints.

Developing creative and critical thinkers involves creating tasks that require students to become proficient in using critical and creative thinking processes to solve problems. As they progress through their school years, students are expected to apply various problem-solving processes to the scientific method, logical analysis, trial-and-error techniques, and the creation of functional objects, works of arts, and performances. Students also must be able to creatively deal with limitations imposed upon the creative process, such as space limitations or lack of availability of materials. Teachers should nurture attitudes of persistence and perseverance during problem-solving activities.

Standard 5: *Florida students display responsibility, self-esteem, sociability, self-management, integrity, and honesty.*

In order to develop responsible workers, educators should emphasize the personal and social attributes that form positive social skills, such as self-management behaviors, self-esteem, and honesty. These attributes are used in day-to-day interactions with people in school, at home, in the community, and in the workplace.

Unlike Standards 1 to 4, which focus on cognitive and academic development, Standard 5 emphasizes affective and social growth as well as self-discipline. Instruction in the skills and abilities identified in Standard 5 occurs in formal and informal interactive settings. The foreign language classroom gives students an opportunity to develop empathy, global awareness, and sensitivity to multicultural and ethnic issues that occur both abroad and within their own communities. Teachers, parents, the school community, and the community at large should work as partners to develop students as responsible workers. The learning environment must be conducive to nurturing the personal and social attributes that define

Standard 5. Positive behaviors can be reinforced through consistent role modeling by peers and adults. Mentoring, counseling, individual education plans, and contracts between teachers and students are effective ways to help students become responsible workers.

Standard 6: *Florida students will appropriately allocate time, money, materials, and other resources.*

Developing effective resource managers involves helping students learn to allocate and manage resources to complete projects and tasks. Instruction in and assessment of the skills and abilities delineated in Standard 6 occurs as students prepare action plans to accomplish tasks, allocate time and necessary resources, implement the plans, and evaluate whether or not the resources allocated were adequate. Students can demonstrate their effectiveness as resource managers at home, in school and school-related activities, in the community, and in the workplace.

The intent of Standard 6 is to help students become proficient in allocating time, preparing and following time lines, preparing budgets, and acquiring and distributing materials and other resources, such as facilities, technology, or environmental resources. These skills can be used when conducting research, developing products, or preparing presentations.

Standard 7: *Florida students integrate their knowledge and understanding of how social, organizational, informational, and technological systems work with their abilities to analyze trends, design and improve systems, and use and maintain appropriate technology.*

Developing proficient systems managers involves helping students understand what systems are, how they work, and how to use the systems approach to solve problems or design solutions. Instruction in and assessment of the skills and abilities of Standard 7 occur as students analyze information and solve problems that help them see the big picture and its parts.

The intent of Standard 7 is to help students use the systems approach as a way of getting a better grasp of events and phenomena in their world. Thus, helping students learn about the natural systems of science, the systems of language, and systematic mathematical thinking is a good way to introduce the concept of systems.

Efficient systems managers use systems concepts to process information, solve problems, develop new models, or change existing systems to produce better results.

Various concepts can be studied using the systems approach. Foreign language students should be able to identify and understand natural, social, organizational, informational, and technological systems. Systems in their world include grading systems, the education system, lunchroom system, computer systems, local and international government systems, global systems, or the judicial system.

Standard 8: *Florida students work cooperatively to successfully complete a project or activity.*

In order to develop cooperative workers, educators should emphasize the attributes and interpersonal skills necessary to work effectively in teams, a process that is used extensively in the work world. The goal is to develop students and workers who can interact cooperatively and productively in groups.

Unlike Standard 5 (responsible workers), which deals with affective and social growth on a personal level, Standard 8 deals with goal- or task-oriented social behaviors that involve group work. To help develop cooperative workers, opportunities must be provided for students to perform tasks in cooperative groups. Such opportunities should help students understand group processes, assume various roles in the group, keep the group on task, motivate the group toward task completion, and evaluate the effectiveness of the group in accomplishing goals. Instruction in the skills and abilities identified in Standard 8 might occur in classroom, community, or workplace-like settings. Foreign language students can make connections and cooperate with other students within and outside their communities through pen pal programs or electronic media.

Standard 9: *Florida students establish credibility with their colleagues through competence and integrity, and help their peers achieve their goals by communicating their feelings and ideas to justify or successfully negotiate a position that advances goal attainment.*

In order to develop effective leaders, educators should emphasize the attributes and interpersonal skills necessary for students to advance group and individual goals. Students must learn to develop skills in listening, communicating, decision making, conflict resolution, and negotiation. This standard aims to develop students who can lead groups productively.

Standard 9 is closely related to Standard 5 (responsible workers), which deals with affective and social growth on a personal level, and Standard 8 (cooperative workers), which deals with goal- or task-oriented group behaviors. In order to help develop effective leaders, opportunities must be provided for students to take on leadership responsibilities in safe, nonthreatening environments. Such opportunities should help students learn to communicate directly, treat individuals fairly, and separate work- and group-related issues from personal ones.

Standard 10: Florida students appreciate their own culture and the cultures of others, understand the concerns and perspectives of members of other ethnic and gender groups, reject the stereotyping of themselves and others, and seek out and utilize the views of persons from diverse ethnic, social, and educational backgrounds while completing individual and group projects.

In order to develop multiculturally sensitive citizens and workers, educators should help students become knowledgeable about their own cultural backgrounds and the cultures of others. Instruction in and assessment of the skills and abilities identified in Standard 10 should help students understand the importance of treating others with dignity and respect. This standard involves broadening students' knowledge and understanding of the languages, customs, beliefs, traditions, and values of different cultures. The study of foreign languages accomplishes this by exposing students to experiences that involve other people and cultures, by comparing and contrasting the student's own culture with others, and by expanding the student's own neighborhoods to include the world.

Standard 11: Families will share the responsibility of accomplishing the standards set in Goal 3 throughout a student's education from preschool through 12th grade.

Educators are encouraged to invite and facilitate the involvement of families in their children's education. Parents should be encouraged to volunteer in the classroom, help at home with homework and projects, monitor progress through parent-teacher conferences, generate community support for education, and model lifelong learning.

Suggestions for Foreign Language Educators

Schools will be held accountable for incorporating the Goal 3 student-achievement standards into instruction and classroom assessment. The following are examples of foreign language classroom activities that integrate the Goal 3 standards:

Students are learning about the culture(s) of the country(ies) in which the target language is spoken. For a class "Cultural Fair," each student chooses and researches a different cultural aspect of the target country(ies) and makes a class presentation in the target language. Depending on their choices, students may provide samples of a traditional food, teach the class a song or dance, or display samples of traditional clothing. This activity reinforces students' knowledge of the relationship between language and the culture(s) being studied.

This example uses Standard 1, information managers; Standard 2, effective communicators; Standard 9, effective leaders; and Standard 10, multiculturally sensitive citizens.

Working in pairs, students create skits in the target language involving real-life situations, such as ordering a meal in a restaurant, asking for directions, or making a purchase in a store. The pairs write their skits, practice them, and perform them for the class.

This example uses Standard 2, effective communicators; and Standard 8, cooperative workers.

Students research a holiday celebration in a target-language culture and plan to hold the celebration in class. Students break into groups that will take charge of different tasks in organizing the celebration. Each group plans and obtains the necessary supplies, accounting for the necessary expenditures. The groups use the Internet to correspond with students in the target culture to get information on the celebration. After the party takes place, students reflect on the celebration in their target-language journals and use the target language to share their observations with the class.

This example uses Standard 3, numeric problem solvers; Standard 5, responsible workers; Standard 6, resource managers; Standard 8, cooperative workers; and Standard 10, multiculturally sensitive citizens.

Students read newspaper articles in the target language about the influences of technology in the target culture. In cooperative groups, students discuss the newspaper articles and their use of technology vocabulary. Students then choose a newspaper article to study in detail. Students write responses in the target language to their chosen articles in the form of editorials.

This example uses Standard 2, effective communicators; Standard 4, critical and creative thinkers; Standard 7, systems managers; and Standard 8, cooperative workers.

KEY CHAPTER POINTS

- The first ten standards of Florida's Goal 3 Standards are general processes and abilities that cut across all subject areas.
- These processes and abilities are important to success in school and in everyday life at home, in the community, and in the work world.
- These Goal 3 Standards should be an integral part of daily classroom instruction and assessment in every subject area at every grade level; they will help students apply specific content knowledge in real-world situations.

Chapter 3: Foreign Languages Sunshine State Standards

CHAPTER HIGHLIGHTS

- Why Study Languages?
- The Importance of Foreign Languages to Florida
- The Role of the Classical Languages
- What Should Students Know About a Language and Be Able to Do With That Language?
- Definition of Proficiency
- A Note on Competency-Based Placement of Students
- The Hierarchic Structure of Strands, Standards, and Benchmarks
- Introduction to the Foreign Languages Strands
- Foreign Languages Sunshine State Standards

The standards and benchmarks for foreign languages represent the heart of this curriculum framework because high standards are the center of the efforts to reform and enhance education in Florida. Before addressing the foreign languages standards, it is useful to consider why we need academic standards. In her book *National Standards in American Education: A Citizen's Guide*, Diane Ravitch, former Assistant Secretary of Education at the U.S. Department of Education, explains that standards are a necessary and accepted part of American life in almost every field but education:

Americans clamor for standards in nearly every part of their lives. They expect strict standards to govern construction of buildings, bridges, highways, and tunnels; shoddy work would put lives at risk. They expect explicit standards in the field of telecommunications; imagine how difficult life would be if every city, state, and nation had incompatible telephone systems. They expect stringent standards to protect their drinking water, the food they eat, and the air they breathe.... Even the most ordinary transactions of daily life reflect the omnipresence of standards. (pp. 8-9)

Standards have the potential of affecting many aspects of schooling in Florida. The foreign languages curriculum—what teachers teach and how they teach it—should be organized around the foreign languages standards. Assessment is one of the most obvious areas that will be affected. The state will be assessing reading, writing, and mathematics based on the language arts and mathematics curriculum frameworks. However, on the local level, the state standards in foreign languages should form the basis of classroom assessments for foreign languages. Finally, the systems used to report student progress—report cards and transcripts—should have a clear relationship with these academic standards. In short, the foreign languages standards presented in this framework should be the starting point for foreign language education in Florida's education system. This chapter presents those standards in detail.

Why Study Languages?

The student who acquires proficiency in more than one language

- thinks more analytically and creatively than monolingual peers;
- expresses enthusiasm and aptitude for problem solving;
- functions more confidently and cooperatively in culturally diverse settings; and
- acts with greater awareness of self and others.

The student who completes an extended course of language studies

- fulfills the entrance requirements of most colleges and universities, including those in Florida;
- achieves higher scores on standardized tests such as the SAT, ACT, and HSCT, especially in verbal areas; and
- may earn college credit while still in high school through either advanced placement course work or dual enrollment.

The Importance of Foreign Languages to Florida

Florida is a major port of entry for peoples of all nations. Major businesses from all over the world, having headquarters in Florida, deal daily with a multitude of countries through a variety of languages. In addition, American firms trade abroad

from a Florida base using the state’s multilingual and multicultural resources. Similarly, the media, transnational political and social organizations, governments, professions, entertainment, and the arts from around the world have significant ties to Florida. Indeed, Florida has become a primary hub of America’s international trade.

In order to meet the challenges of the 21st century, the citizens of Florida must learn to live and work in a multilingual, multicultural society. Therefore, it is imperative that the school system educate citizens to be proficient in languages other than English and assure a level of language proficiency that will positively impact Florida’s multilingual, multicultural, social, and economic environment.

An increasingly important goal of the programs in languages other than English is to provide language enrichment opportunities for students whose heritage language is not English. Such opportunities will allow these students to maintain and enhance their proficiency in their heritage language.

Students whose heritage language is not English come to school with language skills in their heritage language. Such skills are the result of natural home language experiences, often supported by years of formal education in the heritage language. The continued development of these students’ heritage language skills may be achieved in two fashions. One is by integrating these students into the foreign language sequence based on their current levels of proficiency in listening, speaking, reading, and writing. Another method is to place them in classes that are specifically designed for the students’ heritage language background. These classes are tailored to meet the students’ native-language levels of proficiency in listening, speaking, reading, and writing skills. Some examples of such courses are Spanish for Spanish Speakers, French for French Speakers, and Haitian Creole for Haitian Creole Speakers.

One of the major changes in the design of language instruction has been the explicit realization that learning a language other than English serves multiple purposes. The central goal of second language learning must continue to be the ability to communicate with native speakers of the other language. Language learning provides an entry into many aspects of other cultures. It fosters and enhances strategies for acquiring knowledge and problem solving not offered by other disciplines. It also provides knowledge of general language learning skills that prepares students for acquiring new language competencies and increases their own native language development and performance.

The Role of the Classical Languages

To introduce students to the language, culture, history, and literary treasures of the Ancient Greeks and Romans leads to a keener understanding of the modern Western civilization, its heritage and canons, and how these influences have had an enduring effect in most world civilizations. Additionally, the study of Latin and Greek assists students in understanding the fundamentals of language structure, heightens their critical thinking, and provides a base for improving and strengthening English vocabulary and verbal skills.

The Classics belong in the curriculum of every school and should be taught as early as possible. However, teachers of Latin and Greek understand the need to make adaptations to the foreign languages benchmarks, instructional strategies, and learner outcomes at all grade levels in order to reflect a lesser emphasis on the attainment of oral communicative competencies than that placed when acquiring modern foreign languages. These instructional modifications are necessary, because the learning of Ancient Greek and Latin is presented in a different context than that of the modern world languages.

What Should Students Know About a Language and Be Able to Do With That Language?

The *Florida Curriculum Framework for Foreign Languages* outlines sequential learner expectations. This framework defines proficiency activities through performance tasks that ideally would begin at PreK and continue through the 12th grade. Initial study of the target language, regardless of grade placement, would begin at a primary level. When using this framework, program planners should keep in mind that these concepts are not to be viewed as rigidly sequential, but rather as developmentally continuous and progressive.

In order for students to reach a confident level of second language proficiency, they will most likely need to follow a sequentially articulated program that extends over the K-12 continuum. Thus, the fully articulated program envisioned by this framework is based on its being implemented from elementary to secondary grades. If implemented in a modified fashion, then the expectancies and performance tasks described here will have to be limited accordingly.

A student’s level of language proficiency depends on the quality and length of exposure to language experiences. Although those experiences may occur through both formal and informal environments, experiences with language outside the school setting should be integrated with formal instruction if the student is to have meaningful learning experiences.

The correlation between years of study and level of second language proficiency for nonnative speakers of the target language is illustrated in table 3.1. Throughout this framework, the levels of language proficiency are referred to as Primary, Intermediate, Middle and High. These correspond to levels identified by the American Council on the Teaching of Foreign Languages (ACTFL). (See the ACTFL Proficiency Guidelines reprinted in this framework for further information.) In table 3.1, language proficiency levels identified by ACTFL appear on the vertical, or left, axis of the table; the corresponding Florida framework proficiency levels are listed along the horizontal, or bottom, axis.

Table 3.1

ACTFL Proficiency Levels	Number of years of study				
Intermediate to Advanced	13				
Novice High to Intermediate Mid	6				
Novice Mid to Novice High	4				
Novice Low to Novice Mid	2				
		Primary	Intermediate	Middle	High
		Florida Framework Language Proficiency Levels			

Table 3.1 presents the correlation between levels of language proficiency and the number of years of language experience provided to a student through formal instruction. A student whose language experience is limited to two years, regardless of when those experiences occur, may not be expected to reach above primary level.

Definition of Proficiency Levels

All students need to be prepared for the demands of the 21st century with increased understanding of the values, customs, traditions, and languages of others. This is one of the most important components in preparing students to be able to link with the rest of the world. It is vital that our students be prepared through global understanding and language skills to be able to enjoy a quality of life in a world that is socially, politically, and economically competitive and complex.

Proficiency focuses on meaningful and functional interaction in the context of the target language and culture. Teaching for proficiency requires a direction that includes sociolinguistic, metalinguistic, and communicative strategies. It restricts formal and extensive grammar explanations to only those that are appropriately embedded within the context of a lesson, because the purpose of instruction is not to teach the language but to allow the student to acquire the language, much the same as one acquires as a child his or her heritage language.

No longer can we afford the learning of foreign languages to be rooted in traditional methodologies. One of the goals of proficiency-based language instruction is to enable the student to function in reality-based learning experiences organized around themes or topics that become progressively and sequentially more difficult. This content-based thematic approach is a radical departure from the grammar-driven instructional model of the past.

Throughout this framework, the levels of language proficiency are referred to as Primary, Intermediate, Middle, and High. In order for students to reach a confident level of second-language proficiency, they will most likely need to follow a sequentially articulated program over thirteen years. The fewer the years of foreign language instruction, the lesser the degree of language proficiency and understanding.

Primary Level

This is the entry level of students as they begin initial study of a second language, regardless of age or grade in school. Students within this level will be able to operate in the language with a very limited capacity, but should be able to satisfy immediate needs with simple learned utterances.

Intermediate Level

Students are able to communicate in meaningful but limited ways. Students can use basic structures with some accuracy. They have minimal sociolinguistic knowledge and use basic vocabulary. They are likely to be able to ask questions, express likes and dislikes, and interact with native speakers of the language in issues of everyday life in the present tense for limited sustained levels. Students are able to satisfy basic survival needs and minimum courtesies relative to the target culture(s).

Middle Level

Students are able to create with the language. They are able to make themselves understood by native speakers who are used to dealing with early language learners. They can maintain face-to-face communications using simple conversational techniques such as short sentences, phrases, and strings of sentences. Students are able to satisfy limited communication and social interaction demands.

High Proficiency Level

Students can be understood by native speakers with relative ease. They can communicate in paragraphs and extended conversations. Students are able to narrate, discuss, and support fairly complex ideas and concepts using concrete facts and topics. They can discuss topics of interest to themselves and to others, such as peers and community members. They are able to satisfy routine social demands and meet most social requirements.

A Note on Competency-Based Placement of Students

Listening, speaking, reading, and writing competencies are integrated along with culture as the mediums through which language acquisition unfolds for students. Credit should be awarded for each year that a high school student is enrolled in the language class and reaches mastery of competencies that have been identified as acceptable performance through a school district.

Although educators must test what they teach, and competency-based assessments should look different from assessments based on traditional methodologies, the use of Carnegie units is a reality that foreign language instructors have to face. Mastery could include the grades of A, B, and C. Non-mastery could be reflected through the use of the letter I (still in progress) or the letters D or F. The focus of appropriate

student placement, however, must be centered around what the student is able to do with the language, rather than how many years he or she spent in the classroom.

The Hierarchic Structure of Strands, Standards, and Benchmarks

The standards presented in this chapter have a specific hierarchic structure. There are several levels of information, each more specific than the next.

Subject area = domain, content area, such as foreign languages, language arts, mathematics, science

Strand = label (word or short phrase) for a category of knowledge, such as culture, reading, algebraic thinking, nature of matter

Standard = general statement of expected learner achievement

Benchmark = learner expectations (what a student should know and be able to do) at the end of the developmental levels of grades PreK-2, 3-5, 6-8, 9-12

with

Sample Performance Descriptions = examples of things a student could do to demonstrate achievement of the benchmark

and

Correlations to Goal 3 Standards = identification of the specific Goal 3 standards that are incorporated into the sample performance descriptions.

The strands, standards, and benchmarks make up the Sunshine State Standards. These have been adopted by the State Board of Education as a rule, 6A-1.09401, FAC. This rule requires public schools to provide appropriate instruction to assist students in the achievement of these standards. Each district school board must incorporate the Sunshine State Standards into the district Pupil Progression Plan.

A strand is the most general type of information. A strand is a label for a category of knowledge under which standards are subsumed. For example, there are five strands in foreign languages:

Strand A: Communication

Strand B: Culture

Strand C: Connections

Strand D: Comparisons

Strand E: Experiences

Each of these strands contains at least one standard. A **standard** is a description of general expectations regarding knowledge and skill development within a strand. For example, within foreign language Strand A: Communication, there are three foreign language standards:

Standard 1: The student engages in conversation, expresses feelings and emotions, and exchanges opinions.

Standard 2: The student understands and interprets spoken and written language on a variety of topics.

Standard 3: The student presents information, concepts, and ideas to an audience of listeners or readers on a variety of topics.

These foreign language standards provide more specific guidance concerning what students should know and be able to do in relationship to the Communication strand.

The most specific level of information is the **benchmark**. A benchmark is a statement of expectations about student knowledge and skill at the end of one of four developmental levels: grades PreK-2, 3-5, 6-8, and 9-12. Benchmarks translate foreign language standards into expectations at different levels of student development. Within a standard, one would expect high school students to be performing differently from primary students. The benchmarks describe these differing levels of expectations. Although the identified developmental levels span several grades in order to accommodate continuous progress approaches, the benchmarks describe expected achievement as students exit the developmental level, that is, at the end of second grade, at the end of fifth grade, at the end of eighth grade, and at the end of twelfth grade. It is expected that several benchmarks might often be combined in a single teaching or assessment activity. The listing of separate benchmarks should not be construed to mean that students must demonstrate achievement of them one at a time, to be checked off by the teacher.

Expectations of student knowledge and skills are described in the benchmarks, but the benchmarks are also written with some assumptions regarding student learning. Although knowledge and skills stated at an earlier level of schooling might not be reiterated within benchmarks at later levels, they remain important and should be reinforced and even retaught, if necessary. For example, during the early years, if students are expected to master the fundamentals of greeting and exchanging essential personal information with others in the target language, learning and assessments in later grades should also incorporate this skill, even though the expectation is not explicitly restated within benchmarks for the later years. It is also assumed that in meeting the expectations described in these benchmarks, students are working with material that is developmentally appropriate with regard to their age, developmental level, and grade level.

Accompanying the benchmarks are sample performance descriptions. These sample performance descriptions suggest how teachers might ask students to apply the knowledge and skill described in the benchmark. For example, consider the following benchmark at the 6-8 level within Foreign Language Strand A, Standard 2:

The student comprehends and interprets the main ideas and details from television, movies, videos, radio, or live presentations produced in the target language.

The sample performance description that accompanies this benchmark is

[Achievement of the benchmarks may be demonstrated when the student] views authentic TV programs produced in the target language and provides a description of the main ideas and the most important details.

To perform this activity, students must apply the knowledge and skill described in the benchmark.

Each sample performance description is keyed to specific Goal 3 standards; for example, in the above sample performance description, students are using the processes and abilities associated with Goal 3 Standards 1, 2, 4, 7, and 10. In addition, these sample performance descriptions incorporate Goal 3 performance at the appropriate developmental levels. In chapter 2, Goal 3 standards were described as an integral part of Florida education. The first ten standards within Goal 3 are to be integrated into each content area.

The sample performance descriptions and their Goal 3 correlations are meant to suggest to local curriculum and assessment developers and teachers the kinds of classroom assessment activities that can be used with the benchmarks. They are not one-to-one assessment items for the benchmarks; neither are they state-mandated assessment activities. They serve only to suggest to local curriculum and assessment designers and teachers how they might begin to think about ways to determine if students are achieving or are making adequate progress toward achieving the benchmarks. They also provide examples of ways in which to integrate knowledge and skills from other content areas. As districts implement these frameworks, it is anticipated that more sample performance descriptions will be developed that are grade specific and will cover the scope of the benchmarks. Designers and teachers should choose the content, topic, or processes for the activities appropriate to the local curriculum and develop completely new performance descriptions.

For ease of reference, the table of standards and benchmarks uses an identification system that mirrors the hierarchic structure just described. Each strand, standard, benchmark, and sample performance description has been assigned a unique identification code. The codes associated with the benchmarks and sample performance descriptions reflect the structure of this coding system. For example, note the following benchmark:

FL.D.2.4.1

The student uses the target language to discuss how aspects of the target culture are reflected in his or her own culture.

This code indicates that the benchmark is in the content area of foreign language (FL) under strand D, Comparisons. The next two numbers identify the standard (2) under which the benchmark is categorized, and the developmental level (4) designated for this benchmark, that is, grades 9-12. The last number, 1, signifies that this is the first benchmark found under the standard at this developmental level. Sample performance descriptions share a similar identification code but differ in having a lowercase letter appended. This can be seen in the code for a sample performance description associated with the benchmark above:

FL.D.2.4.1.b

[Achievement of the benchmarks may be demonstrated when the student] investigates and creates a historical time line that parallels the development of his or her own

culture's architectural styles and the architectural styles of the target culture and discusses how these styles have influenced or not influenced each other.

The letter “b” indicates that this is the second sample performance description provided for this benchmark.

In addition to the coding system, the layout of the table that follows reflects the hierarchic structure: Each new strand, standard, and benchmark level begins a new page. This offers an easy way for teachers to re-sort and organize the material by developmental level.

The standards and benchmarks in the curriculum frameworks identify the essential knowledge and skills that students should learn, for which the state will hold schools accountable. Nevertheless, how the standards and benchmarks are organized, what specific curriculum, instructional strategies, materials, and activities are designed to teach them, how much time is spent teaching them, and when they are taught within the developmental levels are local decisions.

Introduction to Strand A: Communication

People use language to communicate. The language system is not only composed of vocabulary and structures. Although lexicon and grammar are very important concepts to be learned in foreign language study, they do not constitute the complete range of concepts that students should master at all levels. The students should also internalize that

- language is a flexible, adaptable tool that serves as a primary way for people from various cultures and times to communicate what they know, think, and feel about life and nature;
- people who speak different languages use them to conceptualize their knowledge, thoughts, and feelings from different sociolinguistic perspectives;
- language is personal, crucial to self-esteem, and reflective of family, ethnic, cultural, social, and national background;
- language skills are basic to acquiring and communicating knowledge in all subject areas;

- language is social and essential to responsible participation in large and small groups, and responsible citizenship in a participatory democracy requires understanding and effective use of spoken and written language through a variety of media and technology; and
- thinking skills are inherent in the instruction, the acquisition, and the use of all languages; communication among people requires the use of higher order thinking skills to be meaningful and effective.

Introduction to Strand B: Culture

Cultural values and sensitivity are acquired through the study of foreign languages and cultures as well as through individually inherited language and culture. They are also learned through personal experiences of immersion in diverse cultural settings, and through the sharing of multicultural literature of the past and present.

Knowledge about customs, traditions, holidays, artifacts, art, and music has always been basic in the study of a language. However, culture involves other important concepts that should be mastered. These concepts include the following:

- Individuals must perceive themselves as members of a larger society, as the inheritors of a past, both personal and global, and as sharers of and contributors to a variety of communities.
- The study of foreign languages and cultures helps students to develop cultural sensibilities, values, and perspectives that relate to themselves and others.
- Literature and the humanities are expressions of the human intellect and constitute some of the primary means by which a culture transmits itself. They provide enrichment by opening doors to the understanding of people, places, and events otherwise unavailable and add delight to life.
- Although literature can be enjoyed in translation, reading it in the original language adds more to students' lives by broadening insights and opening doors to the understanding of peoples, places, and events.

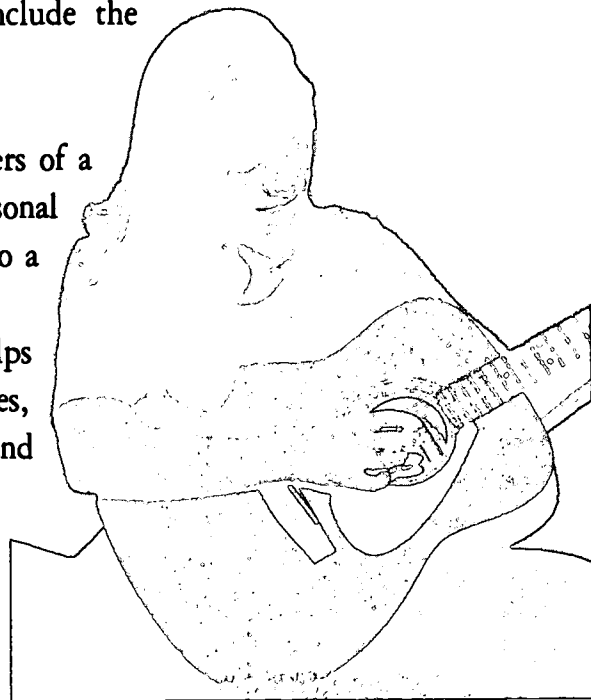

Introduction to Strand C: Connections

Each nation in the world produces practical and valuable information embedded across disciplines and subjects. The sharing and exchange of this information can be more content-rich and exact if the individuals or entities involved can communicate with minimal language or cultural barriers.

A language is to be acquired by the students following the teacher's efforts as a facilitator of that language learning. Language learning best occurs within meaningful contexts, such as instruction that uses subject-area connections. Students can develop strategies to learn a foreign language if the instructional approach is centered on an integrated, content-area enriched, thematic perspective.

This approach must consider the following:

- The development of language communication skills is a lifelong process.
- Learning through language is a constant in an ever-changing world that expects individuals to integrate knowledge across disciplines.
- The exchange of information across disciplines and content areas is more meaningful if students communicate without language or cultural barriers.
- Content-area connections (art, music, social science, mathematics, science) can make instruction more meaningful and serve as a reviewer and reinforcer of acquired knowledge.
- The extent to which language communication and content-area skills are developed influences an individual's ability to become self-sufficient and productive.
- Writing across the curriculum is a way to learn and develop personally as well as a way to communicate with others.

Introduction to Strand D: Comparisons

People all over the world use different languages to communicate. Communication involves processes that are composed of abilities in observing, listening, thinking, speaking, reading, and writing within a cultural context. Therefore, language systems determine thinking and communication.

The use of foreign languages for communication has been emphasized during the last two decades. However, the interdependence of language and culture is a fairly new concept which has been extensively studied by sociolinguists. This research has shown that language and culture coexist interdependently, and that they cannot be separated as discrete units of instruction. Language and culture should be integrated as a single, holistic instructional goal. Students should understand the following concepts during their engagement in foreign language education:

- Communication involves linguistic and paralinguistic processes that are interrelated and mutually supportive.
- These processes include observing, listening, thinking, speaking, reading, and writing within a cultural context.
- Each of these component areas (listening, speaking, reading, writing, and culture) enhances the development of the other within an integrated, holistic cultural setting.
- Culture can be experienced and understood in a variety of settings: cultural expressions, art, music, literature, and history.
- People use reading for personal pleasure and to obtain general information in a variety of disciplines and subjects. Because each nation in the world produces information across disciplines and subjects, people can obtain more information from reading if they can read authentic materials printed in different languages and coming from different cultures.

Introduction to Strand E: Experiences

The world is a network of physical, biological, economic, political, and cultural systems, and the manner in which humans use language to express themselves dramatically affects interactions with other communities and nations.

A world that has been shrinking continuously through a series of very rapid changes in transportation and communication media requires people who can communicate in more than one language. Economic and political concerns also demand proficiency in foreign languages.

Students should internalize the following concepts:

- To survive economically and politically under the competitiveness of the global community, a nation needs individuals proficient in more than one language.
- Communication in languages other than English provides advancement opportunities in most careers and professions due to the needs of global interaction.

Summary of Strands and Standards for Foreign Languages

A. Communication

1. The student engages in conversation, expresses feelings and emotions, and exchanges opinions.
2. The student understands and interprets spoken and written language on a variety of topics.
3. The student presents information, concepts, and ideas to an audience of listeners or readers on a variety of topics.

B. Culture

1. The student understands the relationship between the perspectives and products of the culture studied and uses this knowledge to recognize cultural practices.

C. Connections

1. The student reinforces and furthers knowledge of other disciplines through foreign language.
2. The student acquires information and perspectives that are available only through the foreign language and within the target culture.

D. Comparisons

1. The student recognizes that languages have different patterns of communication and applies this knowledge to his or her own culture.
2. The student recognizes that cultures have different patterns of interaction and applies this knowledge to his or her own culture.

E. Experiences

1. The student uses the language within and beyond the school setting.

Communication

1. The student engages in conversation, expresses feelings and emotions, and exchanges opinions.

Level	Benchmark	Sample Performance Descriptions Achievement of the benchmarks may be demonstrated when the student	Goal 3 Standards
Grades PreK-2	FL.A.1.1.1 expresses likes and dislikes when asked simple questions (e.g., about toys or other objects).	FL.A.1.1.1.a asks and responds to questions of low difficulty level that relate to preferences: (e.g., <ul style="list-style-type: none"> • Do you like to...? • I like to...{play, study, eat, etc.}) 	1, 2
	FL.A.1.1.2 greets others and exchanges essential personal information (e.g., home address, telephone number, place of origin, and general health).	FL.A.1.1.2.a asks and answers simple questions when meeting others (students, adults): (e.g., <ul style="list-style-type: none"> • How are you? • I am fine. • What is your name? • My name is...). 	1, 2
	FL.A.1.1.3 uses appropriate gestures and expressions (i.e., body language) to complete or enhance verbal messages.	FL.A.1.1.3.a appropriately greets and takes leave when addressed by others (students, adults), using a combination of verbal and nonverbal cues (e.g., "My name is... Pleased to meet you," with a handshake or bow. "Goodbye!" with accompanying gestures).	1, 2

A. Communication

1. The student engages in conversation, expresses feelings and emotions, and exchanges opinions.			
Level	Benchmark	Sample Performance Descriptions Achievement of the benchmarks may be demonstrated when the student	Goal 3 Standards
Grades 3-5	FL.A.1.2.1 The student expresses likes or dislikes regarding various objects, categories, people, and events present in the everyday environment.	FL.A.1.2.1.a role plays ordering from a menu, asking for prices, selecting specific items, and paying for the meal (e.g., <ul style="list-style-type: none"> • I want...{chicken, fish} • Do you have...{chicken, fish}? • We have...{rice, soup}today. • I do not want...{rice}, I want...{soup}. How much is the...{soup?}). 	1, 2, 3, 6
	FL.A.1.2.2 The student exchanges information necessary to plan events or activities (e.g., picnics, birthday parties, science projects, and crafts).	FL.A.1.2.2.a designs, in a cooperative group, a calendar that compares and contrasts holiday events in the target culture and in his or her own culture.	1, 2, 3, 4, 5, 6, 8, 10
	FL.A.1.2.3 The student recognizes and appropriately uses oral syntax (grouping of words into sentences and phrases) and inflection in spoken target language.	FL.A.1.2.3.a listens to and appropriately identifies simple sentences, phrases, and short selections, both formally and informally, spoken and/or recorded by a selection of native speakers. The student then produces similar simple sentences and/or phrases, emulating the native speakers' inflection and speech patterns.	1, 2, 10

1. The student engages in conversation, expresses feelings and emotions, and exchanges opinions.

Level	Benchmark	Sample Performance Descriptions Achievement of the benchmarks may be demonstrated when the student	Goal 3 Standards
<p>Grades 6-8</p>	<p>The student</p> <p>FL.A.1.3.1 exchanges information with peers and familiar adults orally and in writing about topics of common interest and about the target culture (e.g., personal relationships, events in the past, or academic and cultural interests).</p>	<p>FL.A.1.3.1.a in cooperative groups, discusses and develops a set of questions, which are grouped by categories, about the target culture(s) (e.g., questions about the weather, questions about applications of mathematical concepts, questions about art, questions about music, or questions about family life and relationships). Then each group present its set of questions to the class, and a master list is developed. The teacher and students then cooperate in researching the answers; the answers are then discussed by the class.</p>	<p>1, 2, 3, 4, 8, 10</p>
	<p>FL.A.1.3.2 interacts with fluent native or neo-native users of the target language, with sufficient skill to gather information necessary for a simple project.</p>	<p>FL.A.1.3.2.a interviews a native speaker in person or by telephone. The student then prepares a biography of the native and orally presents it to the class.</p>	<p>1, 2, 10</p>

A. Communication

1. The student engages in conversation, expresses feelings and emotions, and exchanges opinions.			
Level	Benchmark	Sample Performance Descriptions Achievement of the benchmarks may be demonstrated when the student	Goal 3 Standards
Grades 6-8	FL.A.1.3.3 The student uses appropriate vocabulary and cultural expressions to express the failure to understand a message and to request additional information (i.e., understands how to bridge gaps in communication in the target language).	FL.A.1.3.3.a asks for clarification, repetition, or restatement of a response, while role playing shopping in a department store or supermarket with other students (e.g., <ul style="list-style-type: none"> • How much is that blouse? • Thirty-nine. • Dollars or cents? • Thirty-nine dollars. • Does it include tax? • No, it does not. 	1, 2, 3, 4, 8
	FL.A.1.3.4 The student uses repetition, rephrasing, and gestures effectively to assist in communicating spoken messages.	FL.A.1.3.4.a paraphrases, repeats, and restates questions or answers for clarification, while giving specific directions to a place. The student uses nonverbal communication (e.g., facial expressions and hand and body gestures) to add meaning (e.g., communicates "The supermarket is three blocks away," while mimicking walking, counting with fingers, and looking for an imaginary sign).	1, 2, 4

1. The student engages in conversation, expresses feelings and emotions, and exchanges opinions.			
Level	Benchmark	Sample Performance Descriptions Achievement of the benchmarks may be demonstrated when the student	Goal 3 Standards
Grades 9-12	FL.A.1.4.1 interacts in the target language in a number of true-life situations chosen from a variety of contexts (e.g., asking for information).	FL.A.1.4.1.a participates in a skit in which he or she obtains or conveys specific information or specific services (e.g., makes a long-distance telephone call or makes calls to obtain available rates for transportation services in a target-culture country).	1, 2, 5, 8, 10
	FL.A.1.4.2 rephrases and uses indirect expressions to communicate a message in the target language.	FL.A.1.4.2.a engages in a discussion (e.g., on current events, historical issues, or cultural items) with a peer or target-culture member in which the student restates and clarifies a message in order to convey a new or unfamiliar concept in the target language or culture (e.g., "simpático" in Spanish, "angst" in German, or "menis" in Ancient Greek).	1, 2, 4, 10

A. Communication

2. The student understands and interprets spoken and written language on a variety of topics.			
Level	Benchmark	Sample Performance Descriptions Achievement of the benchmarks may be demonstrated when the student	Goal 3 Standards
Grades PreK-2	The student FL.A.2.1.1 follows and gives simple instructions (e.g., instructions to participate in games or instructions provided by the teacher for classroom tasks).	FL.A.2.1.1.a gives simple commands in the target language to another student, for example, in a "Simon Says" activity: <ul style="list-style-type: none"> • "John, touch your nose" {John touches his nose.} • "John, tell Bob to touch his nose." {John responds: "Bob, touch your nose"; and Bob touches his nose}. 	1, 2
	FL.A.2.1.2 restates and rephrases simple information from materials presented orally, visually, and graphically in class.	FL.A.2.1.2.a verbally paraphrases written instructions or visual signs (e.g., the teacher writes on the blackboard "Today is {date}." Then the student explains what the teacher wrote to another student who does not understand or who cannot see the board).	1, 2

2. The student understands and interprets spoken and written language on a variety of topics.			
Level	Benchmark	Sample Performance Descriptions Achievement of the benchmarks may be demonstrated when the student	Goal 3 Standards
Grades PreK-2	<p>The student</p> <p>FL.A.2.1.3 understands oral messages that are based on familiar themes and vocabulary (e.g., short conversations between familiar persons on familiar topics such as everyday school and home activities).</p>	<p>FL.A.2.1.3.a with other students in a small group, reinterprets short descriptions or narratives about known topics (e.g., leisure time or school activities), acting out the intended meaning through skits, plays, or songs.</p> <p>FL.A.2.1.3.b Participates in a skit in the target language. For example,</p> <ul style="list-style-type: none"> • What do we do at night? • We sleep (Student acts as if sleeping). • What do we do in the morning? • We have breakfast and go to school (Student acts out waking up, eating breakfast, and attending school). 	<p>1, 2, 4, 8</p> <p>1, 2, 4, 8</p>
	<p>FL.A.2.1.4 listens and reads in the target language and responds through role playing, drawing, or singing.</p>	<p>FL.A.2.1.4.a draws, arranges, and counts in logical sequence a series of pictures to tell a known target-language story or song.</p>	<p>1, 2, 3, 4, 10</p>

A. Communication

2. The student understands and interprets spoken and written language on a variety of topics.			
Level	Benchmark	Sample Performance Descriptions Achievement of the benchmarks may be demonstrated when the student	Goal 3 Standards
Grades 3-5	<p>The student</p> <p>FL.A.2.2.1 gives and understands written and verbal instructions, using known, verbal patterns in the target language.</p>	<p>FL.A.2.2.1.a reads a series of simple, known commands and performs the appropriate action (e.g., "Walk to Mary and show me her shoes" or "Carry the apple to John and put the apple on John's head"). Then the student produces a similar, original string of commands directed toward another student.</p>	1, 2
	<p>FL.A.2.2.2 answers or formulates questions about a variety of media experiences produced in the target language (e.g., video, radio, television, songs, or computer programs).</p>	<p>FL.A.2.2.2.a responds to a series of simple oral or written questions, after watching a video about an aspect of the target culture. For example, the student answers in complete sentences questions such as: "Who is...{a character in the video}?", "What happens in...{a particular scene}?", "Do you like...?", and "What is a....?".</p>	1, 2, 10
	<p>FL.A.2.2.3 organizes information in spoken or written form about a variety of topics of academic and cultural interest (e.g., by making lists, categorizing objects, or organizing concepts).</p>	<p>FL.A.2.2.3.a creates and illustrates a target-language catalog of household items, classified by each of the rooms of the student's house, and makes a multimedia presentation (i.e., visual and oral) of the catalog to the class.</p>	1, 2, 7

Communication

2. The student understands and interprets spoken and written language on a variety of topics.

Level	Benchmark	Sample Performance Descriptions Achievement of the benchmarks may be demonstrated when the student	Goal 3 Standards
Grades 3-5	The student FL.A.2.2.4 listens and reads in the target language for leisure and personal enrichment (e.g., listens to, reads, or views age-appropriate stories, plays, poems, films, or visual works of art).	FL.A.2.2.4.a reads comics in the target language and/or views cartoons dubbed in the target language. The student then retells the story orally in the target language or draws a series of cartoons that visually retell the story the student has read, heard, or seen.	1, 2, 4, 10
	FL.A.2.2.5 comprehends and responds to oral messages (e.g., personal anecdotes or narratives) based on familiar themes and vocabulary.	FL.A.2.2.5.a tells or retells personal anecdotes, journal entries, or personal stories to a group (e.g., "What do you do on weekends?" "I...") and then answers short questions from peers about the activities.	1, 2, 8
	FL.A.2.2.6 compares and contrasts age-appropriate target-language records, films, and TV programs.	FL.A.2.2.6.a views a television program from the target culture and compares and contrasts that program with a similar program from his or her own culture. The student then presents his or her results in a Venn Diagram.	1, 2, 3, 4, 7, 10

A. Communication

2. The student understands and interprets spoken and written language on a variety of topics.			
Level	Benchmark	Sample Performance Descriptions Achievement of the benchmarks may be demonstrated when the student	Goal 3 Standards
Grades 3-5	FL.A.2.2.7 The student recognizes the multiple ways in which an idea may be expressed in the target language and uses them appropriately.	FL.A.2.2.7.a role plays having a meal in a restaurant, using appropriate dialogue for different scenarios: 1) dining out with his or her parents, 2) having lunch at school with a friend, and 3) having a special lunch with the school principal.	1, 2, 4

Communication

2. The student understands and interprets spoken and written language on a variety of topics.

Level	Benchmark	Sample Performance Descriptions Achievement of the benchmarks may be demonstrated when the student	Goal 3 Standards
Grades 6-8	The student FL.A.2.3.1 comprehends and interprets the content of authentic, written materials selected according to the familiarity of the topic and the scope of vocabulary and structure (e.g., personal letters and notes, pamphlets, newspapers and magazine articles, and advertisements).	FL.A.2.3.1.a reads and views a variety of product or service advertisements produced by the target culture (e.g., TV commercials and newspaper advertisements). Working in a cooperative group, the student designs and produces a similar advertising campaign (consisting of, e.g., posters, pamphlets, and video) and presents the campaign to the class in the target language.	1, 2, 4, 5, 6, 7, 8, 9, 10
	FL.A.2.3.2 comprehends and interprets the main ideas and details from television, movies, videos, radio, or live presentations produced in the target language.	FL.A.2.3.2.a views authentic TV programs produced in the target language and provides a description of the main ideas and the most important details.	1, 2, 4, 7, 10

II. Communication

2. The student understands and interprets spoken and written language on a variety of topics.			
Level	Benchmark	Sample Performance Descriptions Achievement of the benchmarks may be demonstrated when the student	Goal 3 Standards
Grades 6-8	<p>FL.A.2.3.3 formulates and answers questions about the literary elements (e.g., plot, characters, main ideas, and supporting details) of authentic target-language literary selections.</p>	<p>FL.A.2.3.3.a reads age-appropriate target language materials and describes characters, major events, details, etc.</p>	1, 2, 4, 10
	<p>FL.A.2.3.4 recognizes the relationship between verbal and nonverbal signals in communication, while listening to a live speaker of the target language or while viewing and listening to a mass-media product (i.e., film, video, or concert).</p>	<p>FL.A.2.3.4.a views and listens to authentic target-culture videos or scenes from live plays, then demonstrates recognition and understanding of verbal and nonverbal communication specific to the target culture by retelling or explaining the situation in his or her own words.</p>	1, 2, 7, 10

2. The student understands and interprets spoken and written language on a variety of topics.

Level	Benchmark	Sample Performance Descriptions Achievement of the benchmarks may be demonstrated when the student	Goal 3 Standards
<p>Grades 9-12</p>	<p>The student</p> <p>FL.A.2.4.1 obtains and processes information in spoken or written form on topics of academic, cultural, and historical interest, near the level of an educated native speaker of the language.</p>	<p>FL.A.2.4.1.a writes a formal letter in the target language to a university abroad, inquiring about the availability of programs and scholarship opportunities in his or her academic field of interest.</p> <p>FL.A.2.4.1.b applies for participation in a summer program at a foreign school, making arrangements for room and board, using a class schedule, and using information about transportation and local tourist attractions and activities.</p>	<p>1, 2, 10</p> <p>1, 2, 3, 6, 10</p>
	<p>FL.A.2.4.2 understands the main ideas and significant details of extended discussions, presentations, and feature programs on radio and television, in movies, and in other forms of media designed for use by native speakers.</p>	<p>FL.A.2.4.2.a views two or more complete films, plays, or TV programs produced by the target culture, then compares, contrasts, and critically discusses them. The student uses desktop publishing with other students in a group to produce a "critic's handbook" or catalog of the viewed features that includes information on plot and subplots, character analysis, personal opinions, and relationship of the feature(s) with other works by the same author(s) or director(s).</p>	<p>1, 2, 4, 6, 7, 8, 10</p>

A. Communication

2. The student understands and interprets spoken and written language on a variety of topics.			
Level	Benchmark	Sample Performance Descriptions Achievement of the benchmarks may be demonstrated when the student	Goal 3 Standards
Grades 9-12	<p>The student</p> <p>FL.A.2.4.3 reads authentic written materials and analyzes them orally or in writing (e.g., describes characters, plot, personal reactions, and feelings).</p>	<p>FL.A.2.4.3.a reads a complete, unabridged, authentic literary selection written in the target language (e.g., book, magazine article, short story, or poem), then makes an oral presentation with visual aids about the selection to a peer audience. The student's presentation may include, but need not be limited to, the following: character description(s) and motivation(s), plot and subplots, setting, personal reactions and opinions about the piece, and comparison of the text with similar texts within or outside of the target culture(s).</p>	1, 2, 4, 10
	<p>FL.A.2.4.4 understands various aspects of and relationships between the arts, music, literature, history, politics, or economics as presented through a film or book produced by the target culture.</p>	<p>FL.A.2.4.4.a investigates, in a cooperative group, how a specific culture or historical environment has fostered or inhibited the artistic and literary production of a particular time period of the target culture(s). The student then presents the findings as part of a group research report, group panel presentation, or conference.</p>	1, 2, 4, 8, 9, 10

3. The student presents information, concepts, and ideas to an audience of listeners or readers on a variety of topics.

Level	Benchmark	Sample Performance Descriptions Achievement of the benchmarks may be demonstrated when the student	Goal 3 Standards
<p>Grades PreK-2</p>	<p>The student</p> <p>FL.A.3.1.1 provides simple information in spoken form (e.g., descriptions of family members, friends, objects present in his or her everyday environment, or common school and home activities).</p>	<p>FL.A.3.1.1.a explains the behaviors and actions that take place during and after lunch, after being exposed to a similar response pattern (Gouin Series*), For example:</p> <ul style="list-style-type: none"> • The bell rings. • I keep quiet. • The teacher dismisses the class. • I leave the room. • I walk to the cafeteria. • I see my friends in the cafeteria. • The cafeteria is clean. • I get a tray. • I get in line. • The food is ready. • Grilled cheese is being served today. • I do not like grilled cheese. <p>* A foreign language teaching strategy first outlined in 1984 by Donna Gouin, a French language teacher in Montgomery county (MD) and further refined by Constance K. Knop (1985) and Helena Anderson Curtain (1988). The teacher prepares a series of statements that describe a logical sequential set of actions that take place in a specific context for the student to emulate. Later the student uses the sequence to create an original sequence.</p>	<p>1, 2, 3, 4, 7, 10</p>

A. Communication

3. The student presents information, concepts, and ideas to an audience of listeners or readers on a variety of topics.			
Level	Benchmark	Sample Performance Descriptions Achievement of the benchmarks may be demonstrated when the student	Goal 3 Standards
Grades 3-5	<p>The student</p> <p>FL.A.3.2.1 describes important people (e.g., family members and friends) and objects present in his or her everyday environment and in school.</p>	<p>FL.A.3.2.1.a creates a family tree that includes at least three generations, using pictures and short sentences. The student then presents the tree to the class and answers questions about the depicted family relationships.</p>	1, 2, 3, 4, 10
	<p>FL.A.3.2.2 provides information in spoken or written form on a variety of topics of popular and cultural interest (provides, e.g., descriptions, expressions of opinion, appreciation, and analysis).</p>	<p>FL.A.3.2.2.a working in a cooperative group, develops simple rules and regulations for classroom behavior. Each group reads its rules to the class. The class votes for the adoption of the rules, following parliamentary principles.</p>	1, 2, 4, 8
	<p>FL.A.3.2.3 gives responses in spoken or written form (e.g., answering simple questions, formulating questions, and making simple statements) to age-appropriate stories, poems or other literature, songs, films, or visual works.</p>	<p>FL.A.3.2.3.a selects a favorite popular or famous figure from the target culture (e.g., a singer, artist, historical figure, or politician) and presents his or her brief biography to the class (e.g., when the person lived, why he or she is famous, descriptions of the individual's physical characteristics, and personal opinions about the person's work or performance).</p>	1, 2, 10

3. The student presents information, concepts, and ideas to an audience of listeners or readers on a variety of topics.			
Level	Benchmark	Sample Performance Descriptions Achievement of the benchmarks may be demonstrated when the student	Goal 3 Standards
Grades 6-8	The student FL.A.3.3.1 writes various types of texts (e.g., simple letters and essays) for a defined audience (e.g., teacher, peers, or pen pal) about topics of personal interest or experience (in terms of, e.g., ideas, opinions, attitudes, and feelings).	FL.A.3.3.1.a writes a "want ad" (e.g., to advertise a school dance, sell books, or look for a new editor for the school paper) to be published in a target-language newspaper. The student then determines the cost of the ad. The class publishes an "advertisement list," which is circulated among peers. FL.A.3.3.1.b corresponds in the target language via the Internet to peers who are also studying the target language in other parts of the United States or peers of the target culture(s) within or outside his or her community.	1, 2, 3, 4, 10 1, 2, 4, 7, 10
	FL.A.3.3.2 provides information in spoken and written form on a variety of topics of personal, academic, and cultural interest (e.g., descriptions of popular or historical characters, expressions of opinion, personal conclusions about general-interest topics, and comparisons and contrasts between the target culture and his or her own culture).	FL.A.3.3.2.a compares and contrasts a particular aspect of the target culture and his or her own culture that affects or is of special interest to him or her (e.g., popular music). The student then compiles the findings in a comparison chart and makes an oral presentation to the class.	1, 2, 4, 9, 10

A. Communication

3. The student presents information, concepts, and ideas to an audience of listeners or readers on a variety of topics.			
Level	Benchmark	Sample Performance Descriptions Achievement of the benchmarks may be demonstrated when the student	Goal 3 Standards
Grades 9-12	FL.A.3.4.1 effectively communicates orally in the target language regarding a past, present, or future event.	FL.A.3.4.1.a develops a persuasive speech in the target language about his or her point of view concerning a topic of interest and delivers the speech to the class.	1, 2, 4, 9
	FL.A.3.4.2 communicates in writing using a variety of vocabulary for past, present, and future events and feelings about those events (e.g., by writing a letter to a native speaker of the target language).	FL.A.3.4.2.a writes a letter in the target language to an influential political figure from the perspective of a person living in the target culture. For example, the student might write a letter to a politician from the target culture from the perspective of a teenager living in that culture who is presenting his or her views, along with supporting statistics, regarding a social or economical issue that is affecting that culture (e.g., poverty, deforestation, or pollution).	1, 2, 3, 4, 10

1. The student understands the relationship between the perspectives and products of the culture studied and uses this knowledge to recognize cultural practices.			
Level	Benchmark	Sample Performance Descriptions Achievement of the benchmarks may be demonstrated when the student	Goal 3 Standards
Grades PreK-2	The student FL.B.1.1.1 participates in age-appropriate cultural activities (e.g., games, songs, birthday celebrations, storytelling, dramatizations, and role playing).	FL.B.1.1.1.a compares and contrasts holidays or special occasions of the target culture(s) with those in his or her own culture. The student then plans and participates in selected celebrations of the target culture(s).	1, 2, 4, 6, 10
	FL.B.1.1.2 recognizes patterns of social behavior or social interaction in various settings (e.g., school, family, or immediate community).	FL.B.1.1.2.a role plays greetings and presentations for both formal and informal situations with different audiences (e.g., parents, teachers, friends, other age-group peers, and community members).	1, 2, 8, 10

B. Culture

1. The student understands the relationship between the perspectives and products of the culture studied and uses this knowledge to recognize cultural practices.			
Level	The student	Benchmark	Goal 3 Standards
Grades PreK-2	FL.B.1.1.3 recognizes various familiar objects and norms of the target culture (e.g., toys, dresses, and typical foods).	FL.B.1.1.3.a copies models or creates a variety of objects from the target culture(s) (e.g., realia*, arts, crafts, or religious or mythological objects). * Realia is a term borrowed from anthropology, used to label objects and materials produced by the culture(s) being studied (e.g., Mexican pyramids, Swiss cowbells, French Brie cheese, Japanese "manga" cartoons, and Chinese fans).	1, 4, 6, 10

1. The student understands the relationship between the perspectives and products of the culture studied and uses this knowledge to recognize cultural practices.			
Level	Benchmark	Sample Performance Descriptions Achievement of the benchmarks may be demonstrated when the student	Goal 3 Standards
Grades 3-5	<p>The student</p> <p>FL.B.1.2.1 recognizes various activities and celebrations in which children participate in the target culture (e.g., games, songs, birthday celebrations, storytelling, dramatizations, and role playing).</p>	<p>FL.B.1.2.1.a listens to songs, plays games, or views or performs plays from the target culture(s). Working with other students in a small group, the student develops a similar song, game, or play that reflects an aspect of the target culture (e.g., a song about a mythological legend or a game based on a historical event).</p>	1, 4, 5, 8, 10
	<p>FL.B.1.2.2 identifies patterns of behavior and the values, beliefs, or viewpoints typical of children in the target culture.</p>	<p>FL.B.1.2.2.a working with other students, identifies a game played in the target culture that is similar to a game played in his or her own culture. The group then presents the two versions to the class, which then identifies the similarities and differences between the versions.</p>	1, 2, 4, 6, 8

D. Culture

1. The student understands the relationship between the perspectives and products of the culture studied and uses this knowledge to recognize cultural practices.			
Level	Benchmark	Sample Performance Descriptions Achievement of the benchmarks may be demonstrated when the student	Goal 3 Standards
Grades 3-5	<p>The student</p> <p>FL.B.1.2.3 experiences and reacts to expressive and day-to-day aspects of the target culture enjoyed or produced by groups or individuals who belong to the target culture (e.g., children's songs, simple selections from authentic children's literature, artwork, typical foods, and types of dwellings).</p>	<p>FL.B.1.2.3.a after examining a variety of authentic target-culture food recipes, develops or copies an illustrated recipe book of authentic food items from the target culture. The student then selects a favorite recipe from the book and participates in a "recipe party" in which he or she explains and/or demonstrates the recipe to the class. The student's demonstration may include a list of ingredients, preparation and cooking instructions, presentation of the final product, and eating instructions.</p>	<p>1, 2, 3, 4, 5, 6, 8, 10</p>

1. The student understands the relationship between the perspectives and products of the culture studied and uses this knowledge to recognize cultural practices.			
Level	Benchmark	Sample Performance Descriptions Achievement of the benchmarks may be demonstrated when the student	Goal 3 Standards
Grades 6-8	FL.B.1.3.1 uses appropriate verbal and nonverbal communication for daily activities with peers and adults.	FL.B.1.3.1.a working in a cooperative group, develops a skit about eating in a restaurant in a target culture. The skit deals with the restaurant environment, place setting, menu offerings, customer and host attire and interaction, appropriate eating and drinking behavior, check paying, and tipping.	1, 2, 3, 4, 8, 10
	FL.B.1.3.2 participates in age-appropriate cultural activities (e.g., sports-related activities, music, television, and games).	FL.B.1.3.2.a identifies, plans, and participates in authentic games, sports activities, and/or musical numbers of the target culture, as an individual player or as a part of a cooperative team.	1, 8, 10
	FL.B.1.3.3 recognizes simple themes, ideas, or viewpoints on social behavior or social interaction in various settings (e.g., school, family, and immediate community).	FL.B.1.3.3.a compares, contrasts, and discusses aspects of his or her own school setting with those of schools in the target culture(s) (in terms of, e.g., attendance, grading policies, course offerings and scheduling, and homework policies).	1, 2, 4, 10

D. Culture

1. The student understands the relationship between the perspectives and products of the culture studied and uses this knowledge to recognize cultural practices.			
Level	Benchmark	Sample Performance Descriptions Achievement of the benchmarks may be demonstrated when the student	Goal 3 Standards
Grades 6-8	<p>FL.B.1.3.4</p> <p>identifies and discusses various aspects of the target culture (e.g., educational systems or institutions, means of transportation, and various rules).</p>	<p>FL.B.1.3.4.a</p> <p>compares, contrasts, and discusses social services and product-delivery systems of his or her own culture with those of the target culture(s) (e.g., K-12 school systems, colleges and universities, and health-care-delivery services).</p>	<p>1, 2, 4, 7, 10</p>
	<p>FL.B.1.3.5</p> <p>knows various expressive forms of the target culture such as popular music, dance, children's magazines, comic books, children's literature, and common or everyday artwork (e.g., designs typical of the culture and used in clothing, pottery, ceramics, paintings, and architectural structures) and the influence of these forms on the larger community.</p>	<p>FL.B.1.3.5.a</p> <p>identifies, compares, contrasts, and discusses, using some supportive quantitative data, specific elements of popular culture in both the target culture(s) and his or her own culture. The student then presents findings to the class as an expository speech or essay. For example, the student might compare and contrast the increase or decrease in popularity of a pop star in his or her culture with the target culture.</p>	<p>1, 2, 3, 4, 6, 7, 10</p>

1. The student understands the relationship between the perspectives and products of the culture studied and uses this knowledge to recognize cultural practices.			
Level	Benchmark	Sample Performance Descriptions Achievement of the benchmarks may be demonstrated when the student	Goal 3 Standards
Grades 9-12	<p>The student</p> <p>FL.B.1.4.1 interacts in a variety of situations that reflect the activities of teenagers in the target culture, using appropriate verbal and nonverbal communication.</p>	<p>FL.B.1.4.1.a in a cooperative group, develops, writes, and performs a skit or play whose theme, characters, and plot depict specific social, cultural, artistic, or historical aspects of the target culture (e.g., a "soap opera" such as "The Lives of Our Peers in {target culture}").</p>	1, 2, 4, 5, 8, 9, 10
	<p>FL.B.1.4.2 identifies and discusses various patterns of behavior or interaction and the values and mindsets typical of youth in the target culture.</p>	<p>FL.B.1.4.2.a debates, compares, contrasts, and offers opinions about special issues or topics of interest to both the target culture(s) and his or her own culture in a formal panel setting (e.g., the influence on youth of the arts, television programming, fashion, and consumerism). The student uses quantitative data to support his or her position.</p>	1, 2, 3, 4, 8, 10

B. Culture

1. The student understands the relationship between the perspectives and products of the culture studied and uses this knowledge to recognize cultural practices.			
Level	Benchmark	Sample Performance Descriptions Achievement of the benchmarks may be demonstrated when the student	Goal 3 Standards
Grades 9-12	The student FL.B.1.4.3 identifies and discusses various aspects of the target culture (e.g., social and political institutions and laws).	FL.B.1.4.3.a researches and makes a presentation about the symbols of the target culture (e.g., famous people, monuments, historical dates, and cuisine) and how these symbols represent "high" and "popular" culture around the world. *"High" culture can be defined as the canons of classical Eastern and Western cultural expressions, such as ballet, opera, representational painting and sculpture, universities and other institutions. **"Popular" culture is usually defined as the alternative Eastern and Western cultural expressions as they appear in the media (e.g., popular music, nonrepresentational painting and sculpture, comics, television, and advertising).	1, 2, 4, 6, 10

1. The student understands the relationship between the perspectives and products of the culture studied and uses this knowledge to recognize cultural practices.			
Level	Benchmark	Sample Performance Descriptions Achievement of the benchmarks may be demonstrated when the student	Goal 3 Standards
Grades 9-12	<p>The student</p> <p>FL.B.1.4.4 identifies and discusses artistic expressions and forms of the target culture (e.g., books, periodicals, videos, commercials, music, dance, design, and art).</p>	<p>FL.B.1.4.4.a investigates and reports on the mutual interaction and influence between the arts in the target culture (e.g., how the target culture's dance, art, or music has been presented in films produced by the target culture).</p>	1, 2, 4, 10
	<p>FL.B.1.4.5 identifies and discusses target-language writers and their works and assesses their influence not only on the products of his or her own culture, but also on other world cultures.</p>	<p>FL.B.1.4.5.a identifies, analyzes, compares, and contrasts the lives and work of two or more artists or writers of the target culture through a written report. For example, the student might compare the lives of two famous painters from the target culture and discuss how their work influenced the styles of painters in other cultures.</p>	1, 2, 4, 6, 10

C. Connections

1. The student reinforces and furthers knowledge of other disciplines through foreign language.			
Level	Benchmark	Sample Performance Descriptions Achievement of the benchmarks may be demonstrated when the student	Goal 3 Standards
Grades PreK-2	FL.C.1.1.1.1 The student uses simple vocabulary and phrases to identify familiar objects and concepts from other disciplines.	FL.C.1.1.1.a plays a color-and-number game with fruits and vegetables. For example: <ul style="list-style-type: none"> • How many bananas? • Five. • Are bananas blue or yellow? • Yellow. • How many yellow bananas are here? • Five. • How many blue bananas? • None. 	2, 3, 4, 10
	FL.C.1.1.2 participates in an activity in the target-language class that is based on a concept taught in a content class (e.g., shapes or relationships).	FL.C.1.1.2.a identifies, labels, and draws cities and geographical points on a map of the target country. The student then describes their relative locations using cardinal directions (North, South, East, West).	1, 3, 4, 7, 10

1. The student reinforces and furthers knowledge of other disciplines through foreign language.

Level	Benchmark	Sample Performance Descriptions Achievement of the benchmarks may be demonstrated when the student	Goal 3 Standards
<p>Grades 3-5</p>	<p>FL.C.1.2.1 participates in activities in the language class designed to integrate content-area concepts (e.g., mathematical calculations or cause-and-effect relationships) into target-language instruction (e.g., about countries or cultures).</p>	<p>FL.C.1.2.1.a writes and prepares a specific food recipe of the target culture, using measurements, explaining simple processes, and discussing food sources.</p>	<p>1, 2, 3, 6, 10</p>
	<p>FL.C.1.2.2 uses target-language vocabulary or concepts to reinforce knowledge of a related topic studied in another class (e.g., geographical place names, parts of the body, or basic mathematical operations).</p>	<p>FL.C.1.2.2.a draws a variety of maps that visually describe natural resources, populations, and the geography of countries in which the target language is spoken. The student then adds keys or legends to the maps to clarify meaning.</p>	<p>1, 2, 3, 4, 6, 10</p>

C. Connections

1. The student reinforces and furthers knowledge of other disciplines through foreign language.			
Level	Benchmark	Sample Performance Descriptions Achievement of the benchmarks may be demonstrated when the student	Goal 3 Standards
Grades 6-8	<p>The student</p> <p>FL.C.1.3.1 uses new information from a target-language class (e.g., knowledge gained through a film or discussion in language class) to enhance study of a topic in another class.</p>	<p>FL.C.1.3.1.a views films and/or other information sources and discusses them in the target language. The student compares, contrasts, and discusses a content-area topic studied in the target-language class (e.g., deforestation or pollution) with a similar topic studied in his or her science or social studies class and uses quantitative data for support.</p>	1, 2, 3, 4, 10
	<p>FL.C.1.3.2 uses sources in the target language to assemble specific information about topics of personal interest in connection with ideas being studied in another class.</p>	<p>FL.C.1.3.2.a develops a written plan to increase the awareness of the general public about an issue of general concern for both the target culture and his or her own culture. For example, a plan about "the rise of violence in most societies" would include a statement of facts and supporting data (statistics about violence in the target culture and in his or her own culture), an acceptable generalization based on these facts ("violence is on the rise in these cultures"), a proposed plan of action (how to stop the rise in violence), and an implementation model for the plan (how a community can act to stop the rise in violence).</p>	1, 2, 3, 4, 10

1. The student reinforces and furthers knowledge of other disciplines through foreign language.

<p>Level</p>	<p>Benchmark</p>	<p>Sample Performance Descriptions Achievement of the benchmarks may be demonstrated when the student</p>	<p>Goal 3 Standards</p>
<p>Grades 9-12</p>	<p>FL.C.1.4.1 conducts research on a topic of interest from an academic discipline (e.g., an event, a historical figure, or a scientific concept) using a variety of target-language sources (e.g., print, audio, and CD-ROM).</p>	<p>FL.C.1.4.1.a researches the biography and accomplishments of a major historical or popular figure from the target culture, using a variety of information sources (e.g., biographies or autobiographies, movies, and on-line information). The student writes and orally presents a "living biography," in which he or she assumes the role of the character. Then the student delivers a speech that reflects the biography of the subject, followed by a question-and-answer session from peers, during which the student responds "in character."</p>	<p>1, 2, 4, 5, 6, 7, 10</p>

C. Connections

2. The student acquires information and perspectives that are available only through the foreign language and within the target culture.			
Level	Benchmark	Sample Performance Descriptions Achievement of the benchmarks may be demonstrated when the student	Goal 3 Standards
Grades PreK-2	FL.C.2.1.1 uses the target language to gain access to information that is only available through the target language or within the target culture (listens to a story told in the target language).	FL.C.2.1.1.a listens to and/or reads a fairy tale or mythological story from the target culture and dramatizes the action through play, drawings, or skits.	1, 2, 10

2. The student acquires information and perspectives that are available only through the foreign language and within the target culture.			
Level	Benchmark	Sample Performance Descriptions Achievement of the benchmarks may be demonstrated when the student	Goal 3 Standards
Grades 3-5	<p>FL.C.2.2.1 uses information from a story being studied in the target language and connects elements from the story (e.g., color symbolism, geographical setting, and genre* characteristics) to similar life situations.</p> <p>*genre: a category of artistic composition, marked by a distinctive style, form, or content (<i>American Heritage Dictionary</i>, 2nd ed., Boston: Houghton Mifflin, 1991, p. 553).</p>	<p>FL.C.2.2.1.a reads a short story or poem in the target language, then draws a map of the story's setting. The student then identifies and labels the most important locations, cities, and character dwellings and draws a similar map of his or her own neighborhood.</p>	1, 3, 4, 10
	<p>FL.C.2.2.2 accesses information from a skit or play in the target language that is only available in the target culture.</p>	<p>FL.C.2.2.2.a participates in the staging of a short, authentic play or skit in the target language. Later, in a cooperative group, the student discusses which elements of the play or skit are specific to the target culture or represent unique aspects of the target culture.</p>	1, 2, 4, 5, 6, 8, 10

C. Connections

2. The student acquires information and perspectives that are available only through the foreign language and within the target culture.			
Level	Benchmark	Sample Performance Descriptions Achievement of the benchmarks may be demonstrated when the student	Goal 3 Standards
Grades 3-5	The student FL.C.2.2.3 expresses knowledge of real objects and media intended for same-age native speakers in the target language and identifies the major elements of the source material (e.g., what it is, why peers use it, and where it might be found).	FL.C.2.2.3.a discovers the function and purpose of unfamiliar authentic objects from the target culture(s) [realia] through a question-and-answer "game." For example: <ul style="list-style-type: none"> • Is it a musical instrument? • Yes. • Is it for one person or two persons? • One person. • Is it played alone or in concerts? • It is played alone. • Does it have strings? • Yes, it does. • Is it a guitar? • Yes. 	1, 2, 4, 8, 10
	FL.C.2.2.4 restates and shares information acquired from written texts in the context of a group discussion.	FL.C.2.2.4.a reads descriptions of commercial products from the target culture (in the form of, e.g., commercials, advertisements, and food labels). In a cooperative group, the student identifies written ingredients or characteristics and then matches the descriptions with the products.	1, 2, 4, 8, 10

2. The student acquires information and perspectives that are available only through the foreign language and within the target culture.			
Level	Benchmark	Sample Performance Descriptions Achievement of the benchmarks may be demonstrated when the student	Goal 3 Standards
Grades 6-8	The student FL.C.2.3.1 uses the target language to establish contact with members of the target culture (e.g., to obtain information about a hobby, sport, or topic of general interest).	FL.C.2.3.1.a communicates with a peer from the target culture (e.g., a pen pal, via Internet) and obtains information about a favorite topic of mutual interest (e.g., sports, fashion, or popular culture). The student then compares and contrasts their views in a written journal.	1, 2, 4, 7, 8, 10
	FL.C.2.3.2 uses the target language to gain access to information and perspectives that are only available through the target language or within the target culture (e.g., target-language tourism publications or target-language sources about the target-language community).	FL.C.2.3.2.a contacts a local or foreign school system that is representative of the target culture (e.g., educational attaché or foreign board of education) and obtains basic information about the target culture's educational system.	1, 2, 8, 10
	FL.C.2.3.3 uses films or texts produced in the target language to gain knowledge and understanding of various aspects of the arts, music, literature, history, or economics of the target culture.	FL.C.2.3.3.a views a film biography of a famous historical figure of the target culture and participates in a panel discussion with peers on the historical figure's contributions to the target culture's society.	1, 2, 8, 10

C. Connections

2. The student acquires information and perspectives that are available only through the foreign language and within the target culture.			
Level	Benchmark	Sample Performance Descriptions Achievement of the benchmarks may be demonstrated when the student	Goal 3 Standards
Grades 9-12	FL.C.2.4.1 uses research information as a basis for expressing opinions that reflect knowledge of the target culture.	FL.C.2.4.1.a conducts research for a paper on a recent event of global consequence that occurred within the target culture. The paper includes an analysis of and comments on the event within the appropriate social, economic, and cultural context. The student uses supportive quantitative data in the paper.	1, 2, 3, 4, 5, 6, 7, 10
	FL.C.2.4.2 uses a concept or skill learned in the foreign-language class to communicate information to students in other content-area classes.	FL.C.2.4.2.a makes an oral presentation to students who are not in the target-language class about an issue related to the target culture that was learned in language class (e.g., the student makes an "expert" presentation to a science class on the effects of deforestation on the economy of the target culture). The student also uses supportive quantitative data and visual aids as part of the presentation.	1, 2, 3, 4, 5, 6, 9, 10
	FL.C.2.4.3 uses target-language skills to obtain information and perspectives from speakers of the target language.	FL.C.2.4.3.a telephones or communicates on the Internet and interviews target-culture representatives (e.g., consulates, foreign business offices, or tourism offices) and asks questions regarding a recent political or social event in the target culture.	1, 2, 4, 7, 9, 10

2. The student acquires information and perspectives that are available only through the foreign language and within the target culture.			
Level	Benchmark	Sample Performance Descriptions Achievement of the benchmarks may be demonstrated when the student	Goal 3 Standards
Grades 9-12	The student FL.C.2.4.4 uses target-language sources (e.g., members of the target culture) to obtain information (in person or via the Internet) about a hobby, sport, or topic of personal, community, or world interest.	FL.C.2.4.4.a researches and produces a report on a specific topic of the target culture (e.g., popular sports) using an electronic information provider (e.g., CD-ROM or the Internet) to gather information and quantitative data published in the target language. The student then prepares a report on the subject and presents it to his or her peers.	1, 2, 3, 4, 5, 6, 7, 9, 10
	FL.C.2.4.5 uses the target language to access, process, and discuss information that is only available through the target language or within the target culture (e.g., by using technology such as databases and CD-ROM produced in the target language or consulting target-language sources to gain information on a topic of personal, community, or global concern).	FL.C.2.4.5.a prepares a detailed written report on the uses of media and technology in the target culture, using information published in the target language (e.g., telecommunications magazines or data from international communications companies).	1, 2, 5, 6, 7, 10

D. Comparisons

1. The student recognizes that languages have different patterns of communication and applies this knowledge to his or her own culture.			
Level	Benchmark	Sample Performance Descriptions Achievement of the benchmarks may be demonstrated when the student	Goal 3 Standards
Grades PreK-2	FL.D.1.1.1 The student knows examples of word borrowing from one language to another.	FL.D.1.1.1.a identifies known objects, food items, and cities in his or her native language whose names are derived from the target language, after practicing with similar vocabulary in the target language (e.g., The English word "mosquito" derives from the Spanish noun "mosquito"; the English word "spaghetti" derives from the plural form of the Italian "spaghetti" meaning "string"). The student does one or more of the following activities: <ul style="list-style-type: none"> • sing a song that uses both language word versions • match pictures with words (e.g., match a picture of a mosquito or of spaghetti with the appropriate word) • identify cities or places on a map of the U.S. whose names are derived from the target language. 	1, 2, 4, 7, 10
	FL.D.1.1.2 uses simple vocabulary and short phrases in the target language.	FL.D.1.1.2.a listens to a recording or a live performance of a song in both the target language and in his or her own language, then sings both songs and role plays the story line and/or characters with his or her peers.	1, 2, 4, 8, 10

Comparisons

1. The student recognizes that languages have different patterns of communication and applies this knowledge to his or her own culture.			
Level	Benchmark	Sample Performance Descriptions Achievement of the benchmarks may be demonstrated when the student	Goal 3 Standards
Grades 3-5	FL.D.1.2.1 The student identifies examples and understands the significance of true and false cognates (i.e., words derived from a common original form).	FL.D.1.2.1.a listens to or reads authentic target-language texts (e.g., short stories and poems), then compares and contrasts unknown words and phrases with similar words and phrases in his or her native language to identify any true or false cognates.	1, 2, 4, 7, 10
	FL.D.1.2.2 The student recognizes the similarities and differences between his or her native language and the target language in terms of the pronunciation, alphabet, and forms of written expression.	FL.D.1.2.2.a identifies and lists similarities and differences between the punctuation, left-right, and up-down orientation of written language expression, alpha-numeric codes (e.g., letters and numbers in Western style vs. Cyrillic or Greek, Kanji vs. Chinese ideograms), and oral and written syntax (word order) of both the target language and his or her own language.	1, 2, 3, 7, 10

D. Comparisons

1. The student recognizes that languages have different patterns of communication and applies this knowledge to his or her own culture.			
Level	Benchmark	Sample Performance Descriptions Achievement of the benchmarks may be demonstrated when the student	Goal 3 Standards
Grades 6-8	FL.D.1.3.1 The student understands how idiomatic expressions have an impact on communication and reflect culture, by using them correctly in both oral and written form.	FL.D.1.3.1.a reads and listens to oral communications and authentic literary selections in the target language that contain simple idiomatic expressions (i.e., expressions that completely lose their meaning when translated word by word; e.g., "that's cool," "catch you later," "different strokes for different folks," "yipes!," and "you're a card!"). The student then gives evidence of understanding their usage by correctly incorporating them into oral and written presentations and/or communication.	1, 2, 10
	FL.D.1.3.2 The student identifies and uses typical patterns of communication in the target language (e.g., cognates and syntax variations) both orally and in written form.	FL.D.1.3.2.a reads a variety of short literary selections in the target language written by the same author and then writes a similar, short, written selection emulating styles, subject, content, and word choice of those that were read.	1, 2, 4, 10

Comparisons

1. The student recognizes that languages have different patterns of communication and applies this knowledge to his or her own culture.		Benchmark	Sample Performance Descriptions Achievement of the benchmarks may be demonstrated when the student	Goal 3 Standards
Level	The student			
Grades 9-12	FL.D.1.4.1 knows elements of the target language that signify time, and the similarities and differences between comparable linguistic markers in the target language and in his or her own language.	FL.D.1.4.1.a writes a persuasive essay about a topic of general interest from a perspective other than the present tense, using appropriate grammatical constructions (e.g., verb tense, agreement throughout the writing, and adverbs).	1, 2, 4, 10	
	FL.D.1.4.2 understands and applies the target-language pronunciation, intonation, stress patterns, and writing conventions in a variety of contexts.	FL.D.1.4.2.a reads and orally presents authentic target-language poems or dramatic prose of varying degrees of complexity, using the appropriate intonation, stress, and emotional content needed to have a particular effect on a target audience.	1, 2, 10	
	FL.D.1.4.3 recognizes how languages differ in the way they can be used to communicate similar ideas (e.g., through oral, written, or artistic expression).	FL.D.1.4.3.a reads, compares, contrasts, and discusses two literary selections that deal with the same subject matter: one in the target language, the other in his or her native language.	1, 2, 4, 10	

D. Comparisons

2. The student recognizes that cultures have different patterns of interaction and applies this knowledge to his or her own culture.			
Level	Benchmark	Sample Performance Descriptions Achievement of the benchmarks may be demonstrated when the student	Goal 3 Standards
Grades PreK-2	FL.D.2.1.1 The student knows the similarities and differences between the patterns of behavior of the target culture related to recreation, celebration, holidays, customs, and the patterns of behavior of the local culture.	FL.D.2.1.1.a assumes the roles of different family and society members before, during, and after a major target-culture holiday or celebration.	1, 2, 4, 10
	FL.D.2.1.2 recognizes that there are similarities and differences between objects from the target culture and objects from the local culture (e.g., inside dwellings).	FL.D.2.1.2.a compares, contrasts, counts, and discusses the objects found in different rooms of the target-culture home and those found in his or her own home.	1, 2, 3, 4, 10

Comparisons

2. The student recognizes that cultures have different patterns of interaction and applies this knowledge to his or her own culture.			
Level	Benchmark	Sample Performance Descriptions Achievement of the benchmarks may be demonstrated when the student	Goal 3 Standards
Grades 3-5	<p>The student</p> <p>FL.D.2.2.1 distinguishes the similarities and differences between the patterns of behavior of the target culture related to recreation, holidays, celebrations and the patterns of behavior of the local culture.</p>	<p>FL.D.2.2.1.a compares, contrasts, and discusses the behaviors of individuals and organizations before, during, and after major holidays and celebrations of the target culture and the behaviors of his or her own culture (e.g., before, during, and after Christmas celebrations).</p>	1, 2, 4, 10
	<p>FL.D.2.2.2 recognizes forms of the target language evident in the local culture (e.g. signs, symbols, advertisements, packages, displays, murals, songs, and rhymes).</p>	<p>FL.D.2.2.2.a observes a variety of commercial advertisements (e.g., TV commercials and magazine advertisements) and identifies those elements that reflect the target culture.</p>	1, 2, 4, 10
	<p>FL.D.2.2.3 recognizes some cultural aspects, viewpoints, and attitudes of people in both his or her own culture and the target culture relating to family, school, work, and play.</p>	<p>FL.D.2.2.3.a studies the different aspects of living in a target culture and then compares, contrasts, and discusses a day in the life of a person who lives in the target culture with a day in the life of a person who lives in his or her own culture (e.g., school life, family life, sports, games, and entertainment).</p>	1, 2, 4, 7, 10

D. Comparisons

2. The student recognizes that cultures have different patterns of interaction and applies this knowledge to his or her own culture.			
Level	Benchmark	Sample Performance Descriptions Achievement of the benchmarks may be demonstrated when the student	Goal 3 Standards
Grades 6-8	FL.D.2.3.1 understands cultural traditions and celebrations that exist in the target culture and in the native culture (e.g., holidays, birthdays, "coming of age" celebrations, and recreational gatherings).	FL.D.2.3.1.a participates in an authentic or original (student made), target-language role play that accurately depicts aspects of the life of a teenager in the target culture. The student then compares the relevancy of the issues presented in the role play with those experienced by teenagers in his or her own culture.	1, 2, 8, 10
	FL.D.2.3.2 recognizes the similarities and differences between music and songs from the target culture and those in the native culture.	FL.D.2.3.2.a performs the role of a "disc jockey" in the target culture who plays both classical and popular music and songs from his or her culture and the student's culture. After the performance, the student entertains a question-and-answer session in which he or she persuades the peer audience that the music selections are representative of both his or her culture and the target culture.	1, 2, 9, 10

Comparisons

2. The student recognizes that cultures have different patterns of interaction and applies this knowledge to his or her own culture.			
Level	Benchmark	Sample Performance Descriptions Achievement of the benchmarks may be demonstrated when the student	Goal 3 Standards
Grades 6-8	FL.D.2.3.3 The student recognizes the similarities and differences between attitudes about various topics found among teenagers in American culture and attitudes among teenagers in the target culture (e.g., surveys conducted through face-to-face contact or written exchanges).	FL.D.2.3.3.a views films, commercials, or TV programs targeted to an audience of similar age or interest but produced for the target culture, then discusses in a panel presentation how the persuasion devices used compare with those used in films, TV programs, and commercials in his or her own culture (e.g., celebrity endorsements, "in" vs. "out," or uniqueness or scarcity of product).	1, 2, 4, 10
	FL.D.2.3.4 understands selected economic, political, and social events that have shaped the target culture and its relationship with the United States across time.	FL.D.2.3.4.a reads or views appropriate, authentic, target-culture materials (e.g., films about historical or popular figures that have impacted his or her culture in a significant manner) and then researches and prepares a written report that explores the contributions of historical or popular figures of his or her culture to the target culture.	1, 2, 5, 6, 10

D. Comparisons

2. The student recognizes that cultures have different patterns of interaction and applies this knowledge to his or her own culture.			
Level	Benchmark	Sample Performance Descriptions Achievement of the benchmarks may be demonstrated when the student	Goal 3 Standards
Grades 9-12	FL.D.2.4.1 The student uses the target language to discuss how aspects of the target culture are reflected in his or her own culture.	FL.D.2.4.1.a writes an essay exploring the relationship between both the artistic (e.g., painting, dance, or music) and utilitarian (e.g., architecture, industrial design, or advertisements) forms of expression of the target culture and their influence on the arts and cultural products of his or her own culture.	1, 2, 4, 10
		FL.D.2.4.1.b investigates and creates a historical time line that parallels the development of his or her own culture's architectural styles and the architectural styles of the target culture and discusses how these styles have influenced or not influenced each other.	1, 2, 4, 7, 10
	FL.D.2.4.2 recognizes different world views as presented in the media (e.g., TV, newspapers, and radio).	FL.D.2.4.2.a reads two or more newspaper or magazine articles written in both the target language and his or her own language (and perhaps produced in two or more countries of the same target language). The student then selects a newsworthy item and analyzes and discusses how the same events can be perceived differently, depending on the point of view.	1, 2, 4, 10

2. The student recognizes that cultures have different patterns of interaction and applies this knowledge to his or her own culture.			
Level	Benchmark	Sample Performance Descriptions Achievement of the benchmarks may be demonstrated when the student	Goal 3 Standards
Grades 9-12	<p>The student</p> <p>FL.D.2.4.3 demonstrates knowledge and understanding of the similarities and differences between his or her own culture and the target culture as represented in the media and/or literature.</p>	<p>FL.D.2.4.3.a compares, contrasts, and discusses views about global issues held by people in the target culture and in his or her own culture (e.g., about pollution, violence and war, or technology). The student presents findings, comparing and contrasting his or her own personal opinion on the selected issues (e.g., People in my country believe that..., "People in {country} believe that...", and "I believe that...").</p>	1, 2, 4, 10
	<p>FL.D.2.4.4 recognizes the contributions of other parallel cultures (e.g., Native American, African, and European) to the target culture.</p>	<p>FL.D.2.4.4.a researches and presents a historical, political, or economic contribution of another culture to the target culture and how it universally relates to all cultures. The student then presents the data and his or her conclusions as a formal target-language discourse.</p>	1, 2, 4, 5, 6, 10

E. Experiences

1. The student uses the language within and beyond the school setting.			
Level	Benchmark	Sample Performance Descriptions Achievement of the benchmarks may be demonstrated when the student	Goal 3 Standards
Grades 3-5	FL.E.1.2.1 knows that many people in the United States use languages other than English on a daily basis.	FL.E.1.2.1.a works in a small group to create a list of languages that are commonly spoken in the United States.	1, 2, 4, 5, 8, 9, 10
	FL.E.1.2.2 demonstrates an awareness of employment possibilities (and other applications) for those who are able to master the target language.	FL.E.1.2.2.a works in a small group to create a list of employment and/or travel-abroad opportunities for individuals who can communicate in the target language.	1, 2, 4, 5, 8, 9, 10

1. The student uses the language within and beyond the school setting.			
Level	Benchmark	Sample Performance Descriptions Achievement of the benchmarks may be demonstrated when the student	Goal 3 Standards
Grades 6-8	The student FL.E.1.3.1 knows the major languages other than English that are used in the United States and the geographic regions in which they are most commonly used.	FL.E.1.3.1.a works in a small group to create a map that illustrates which languages are commonly used in different regions of the United States (e.g., Spanish in the Southeast and Southwest, Asian languages on the West Coast).	1, 2, 4, 5, 6, 8, 9, 10
	FL.E.1.3.2 know professional organizations or individuals who use the target language (e.g., foreign consulates, corporations, and educational institutions) that he or she could contact to request information about possible employment opportunities.	FL.E.1.3.2.a writes letters in the target language to target-culture professionals in his or her community and in other communities and requests information about employment and career possibilities available to those who are able to master the target language.	1, 2, 4, 10

E. Experiences

1. The student uses the language within and beyond the school setting.			
Level	Benchmark	Sample Performance Descriptions Achievement of the benchmarks may be demonstrated when the student	Goal 3 Standards
Grades 9-12	<p>The student</p> <p>FL.E.1.4.1 understands that knowing more than one language allows people to function effectively in multilingual communities.</p>	<p>FL.E.1.4.1.a selects a thriving multilingual community in the United States and writes a research paper explaining which languages the residents of this community use in different circumstances (e.g., which languages people use at work, at home, or when conducting business with the government).</p>	1, 2, 4, 10
	<p>FL.E.1.4.2 knows the benefits that being able to communicate in more than one language can have on one's career.</p>	<p>FL.E.1.4.2.a locates and interviews staff at local institutions of higher learning who are speakers of the target language and investigates how the ability to understand more than one language and culture impacts professional development and career growth.</p>	1, 2, 4, 8, 10

Chapter 4: Teaching and Learning

CHAPTER HIGHLIGHTS

- The Unique Perspective of Foreign Languages
- New Approaches to Teaching and Learning
- Instructional Strategies for the 21st Century
- Infusing a Multicultural Perspective
- Snapshot of an Effective Foreign Language Classroom
- Teaching Diverse Students
 - Diverse Needs
 - Developmental Differences
 - Learning Preferences
 - Students With Disabilities
 - Integrating Students Who Have Heritage Languages Other Than English
 - At-Risk Students
- Putting These Ideas to Work

The Unique Perspective of Foreign Languages

Today, the foreign language curriculum is seldom designed around linguistic structures; instead, the curriculum is being designed around what people want to communicate. Thus, the goal of language learning is performance with the language—the development of students' communicative competencies—rather than just knowledge about the language. Students actively engage in meaningful, authentic, and purposeful language learning tasks, which give them the opportunity to emulate authentic language use. Because language is inextricably bound to culture, students are also discovering and exploring other ways of thinking, expressing, and living as they learn to communicate in a foreign language.

New Approaches to Teaching and Learning

Florida's education reform initiative calls on educators to redesign their instructional programs so that every student achieves high academic standards. This redesign may include the structure and context of the learning environment and the use of materials, equipment, and resources. School and district leaders must encourage change and look for creative approaches to teaching and learning. Sequencing of courses may be altered; foreign language instruction may be integrated with other areas of the curriculum; schools and communities may form partnerships; classrooms may be modified to include community settings, museums, nature centers, and other cultural institutions; and electronic networks may link students and teachers across America and to other countries.

Learning theories and instructional practices can inform these new approaches. A tremendous amount of research is available to educators on how children learn and on how to design effective learning environments. This chapter highlights key elements that can help educators, through further investigation, collaborative consideration, implementation, and evaluation, to develop the best learning environments for their unique students.

Developing a Learning-Centered, Authentic Environment

Attempts to improve foreign language teaching must be based on an understanding of how students learn. Learning is a natural process of discovering and constructing meaning from information and experience, filtered through the learner's unique perceptions, thoughts, feelings, and beliefs. The learner grapples with new knowledge until it makes sense and fits into his or her world of understanding.

Based on this knowledge of the learning process, educators are encouraged to design foreign language curricula that allow students to encounter ideas, events, and materials in real-world contexts. Children learn most effectively when actively involved in a subject rather than just hearing or reading about it. Classrooms that are limited to the exclusive use of textbooks, lectures, and paper-and-pencil tasks do not tend to be as successful as those that actively engage students in the learning process. Curiosity, creativity, and higher order thinking are stimulated when experiences are based on real, complex, and relevant ideas and materials. This immersion in direct

experience should be balanced with opportunities for learners to reflect, discuss, and connect concepts with what they have felt, thought, and learned.

Identifying students' interests and questions also helps engage students in the learning process by stimulating the natural curiosity that students bring to school. Children learn best when called upon to make choices and assume more responsibility for their own learning, while the teacher provides support and guidance.

Some of the most efficient learning occurs when students are collaborating with each other in pairs or small groups. Providing students with the opportunity to interact with others in a variety of settings can enhance knowledge and understanding. Feedback from fellow students can help students clarify areas of understanding as well as misconceptions and questions. Collaborative work can also encourage students to take intellectual risks. Students might pose their own problems, devise their own approaches to problem solving, clarify and defend their conclusions, explore possibilities, and use the results to make informed decisions. Students learn the valuable skill of working effectively with others to solve problems and perform investigations, a skill that will be useful in the workplace and in many other areas of their lives.

Providing a Supportive Environment

The teacher is key to creating a supportive, effective learning environment. Teachers provide this kind of environment when they maintain fair, consistent, and caring policies that respect the individuality of students and focus on individual achievement and cooperative teamwork. Students' learning is enhanced when others see their potential, genuinely appreciate their unique talents, and accept them as individuals. In such an environment, students can learn the skills of being responsible for themselves, making decisions, working cooperatively, negotiating conflicts, and taking risks; students also have more freedom to do quality work on their own initiative. In addition, a teacher who creates a



supportive environment for students can reduce the negative effect of factors that can interfere with learning, such as low self-esteem; lack of self-control; lack of personal goals; expectations of failure or limited success; and feelings of anxiety, insecurity, or pressure. A supportive learning environment and a variety of teaching strategies that promote exploration, discussion, and collaborative learning will help ensure that all children have the opportunity to see themselves as capable students, successful in learning foreign language.

Instructional Strategies for the 21st Century

In each foreign language classroom, there is a diverse pool of talent and potential. The challenge is to structure the learning environment so that each student has the freedom to use his or her unique strengths to learn or perform, yet be urged, inspired, and motivated to reach high academic standards. Because all children do not learn in the same way and have varying backgrounds and experiences, flexible and innovative approaches are needed.

To support innovative foreign language classrooms, the instructional strategies on the following pages are provided as examples of the many kinds of strategies that educators might use as they work toward providing the most useful and engaging educational experiences possible. After further investigation, teachers may use these and other instructional strategies for independent or group work. They can creatively adapt and refine them to best fit the needs of the students and the instructional plan, perhaps incorporating several of these strategies into a single lesson or using them in collaboration with a colleague.

COOPERATIVE LEARNING: A strategy in which students work together in small groups to achieve a common goal, while communicating in the target language. Cooperative learning involves more than simply putting students into work or study groups. Teachers promote individual responsibility and positive group interdependence by making sure that each group member is responsible for a given task. Cooperative learning can be enhanced when group members have diverse abilities and backgrounds.

HOW DO YOU USE IT?

After organizing students into groups, the teacher thoroughly explains a task to be accomplished within a time frame. The teacher facilitates the selection of individual roles within the group and monitors the groups, intervening only when necessary, to support students working together successfully and accomplishing the task.

WHAT ARE THE BENEFITS?

- fosters interdependence and pursuit of mutual goals and rewards
- develops leadership skills
- increases the opportunities to use the target language in authentic, communicative situations
- increases the participation of shy students
- produces higher levels of student achievement, thus increasing self-esteem
- fosters respect for diverse abilities and perspectives

There are numerous cooperative learning strategies that educators can use to enhance student learning. Two of these strategies are offered on the next two pages: Jigsawing and Debate.

Cooperative Learning Strategies

JIGSAWING

WHAT IS IT? A cooperative learning strategy in which everyone becomes an “expert” and shares his or her learning so that eventually all group members know the content.

HOW DO YOU USE IT?

The teacher divides students into groups; each group member is assigned a numbered section or a part of the material being studied. Each student meets with the students from other groups who have the same number. This new group learns together, develops expertise in their material, and then plans how to teach the material in the target language to members of their original groups. Students return to their original groups and teach their area of expertise to the other group members.

WHAT ARE THE BENEFITS?

- builds depth of knowledge
- discloses a student’s own understanding and resolves misunderstanding
- builds on conceptual understanding
- develops teamwork and cooperative working skills
- increases the opportunities to use the target language in authentic situations

Cooperative Learning Strategies (*continued*)

DEBATE	
<p>WHAT IS IT? A cooperative learning strategy in which students participate in organized oral and written presentations of various viewpoints using the target language.</p>	
<p>HOW DO YOU USE IT?</p> <p>Students form teams to research and develop their viewpoints on a particular topic or issue. The teacher provides the structure in which students will articulate their viewpoints.</p>	<p>WHAT ARE THE BENEFITS?</p> <ul style="list-style-type: none"> • develops the ability to organize information • develops the ability to filter ideas and draw conclusions • provides opportunities for students to practice articulating their own ideas in the target language and building persuasive arguments

BRAINSTORMING: A strategy for eliciting ideas from a group and communicating them in the target language in oral or written form.

<p>HOW DO YOU USE IT?</p> <p>Students contribute ideas related to a topic. All contributions are accepted without initial comment. After the list of ideas is finalized, students categorize, prioritize, and defend selections.</p>	<p>WHAT ARE THE BENEFITS?</p> <ul style="list-style-type: none"> • reveals background information and knowledge of a topic • discloses misconceptions • helps students relate existing knowledge to content • strengthens target language communication skills • stimulates creative thinking
---	---

FIELD EXPERIENCE: A planned learning experience for students to observe, study, and participate in expressions of the target culture(s) in a setting off the school grounds, using the community as a laboratory.

HOW DO YOU USE IT?

Before the field trip, teachers and students plan and structure communicative activities to engage in during the visit and engage in follow-up activities after the trip.

WHAT ARE THE BENEFITS?

- develops organizational and planning skills
- develops observational skills
- gives students an authentic experience of communicating in a foreign language

FREE WRITING: A strategy for encouraging students to express ideas by writing in the target language.

HOW DO YOU USE IT?

After reflecting on a topic, students respond in writing for a brief time to a target language prompt, a quote, or a question.

WHAT ARE THE BENEFITS?

- develops the ability to link previous knowledge and experience to a topic
- develops creative and critical thinking skills
- provides opportunities to express and share ideas in written form
- encourages students to value writing in the target language

K-W-L (KNOW-WANT TO KNOW-LEARNED): An introductory strategy that provides a structure for recalling what students know regarding a target language or cultural topic, noting what students want to know, and finally listing what has been learned and is yet to be learned.

HOW DO YOU USE IT?

Before engaging in an activity, reading a chapter, listening to a lecture, or watching a film or presentation, the teacher lists on the board under the heading “What We Know” all the information students know or think they know about a topic. Then, the teacher lists all the information the students want to know about a topic under “What We Want to Know.”

While engaging in the planned activity, the students research and read about the topic, keeping in mind the information they had listed under “What We Want to Know.”

After completing the activity, the students confirm the accuracy of what was listed and identify what they learned, contrasting it with what they wanted to know. The teacher lists what the students learned under “What We Learned.”

WHAT ARE THE BENEFITS?

- builds on prior knowledge
- develops predicting skills
- provides a structure for learning
- develops research skills
- develops communication skills in cooperative groups
- strengthens teamwork skills
- provides opportunities to use target-language reading, writing, listening, speaking, and viewing

LEARNING LOG: A strategy to develop structured writing in the target language. An excellent follow-up to K-W-L.

HOW DO YOU USE IT?

During different stages of the language learning process, students respond in written form under three columns:

- “What I Think”
- “What I Learned”
- “How My Thinking Has Changed”

WHAT ARE THE BENEFITS?

- bridges the gap between prior knowledge and new content
- provides a structure for translating target language concepts into written form

GRAPHIC ORGANIZERS: A strategy in which teachers and students transfer abstract concepts and processes into visual representations.

HOW DO YOU USE IT?

The teacher provides a specific format for learning, recalling, and organizing linguistic or cultural concepts learned through the target language.

WHAT ARE THE BENEFITS?

- helps students visualize abstract concepts
- helps learners organize ideas
- provides a visual format for study

Graphic Organizer Strategies

CONSEQUENCE DIAGRAM/DECISION TREES

WHAT IS IT? A graphic organizer strategy in which students use diagrams or decision trees to illustrate real or possible outcomes of different target cultural actions or situations.

HOW DO YOU USE IT?

Students visually depict outcomes for a given problem, by charting various decisions and their possible consequences.

WHAT ARE THE BENEFITS?

- helps in transferring target-language learning to application
- aids in predicting with accuracy
- develops the ability to identify the causes and effects of decisions
- aids in clarifying positive and negative statements

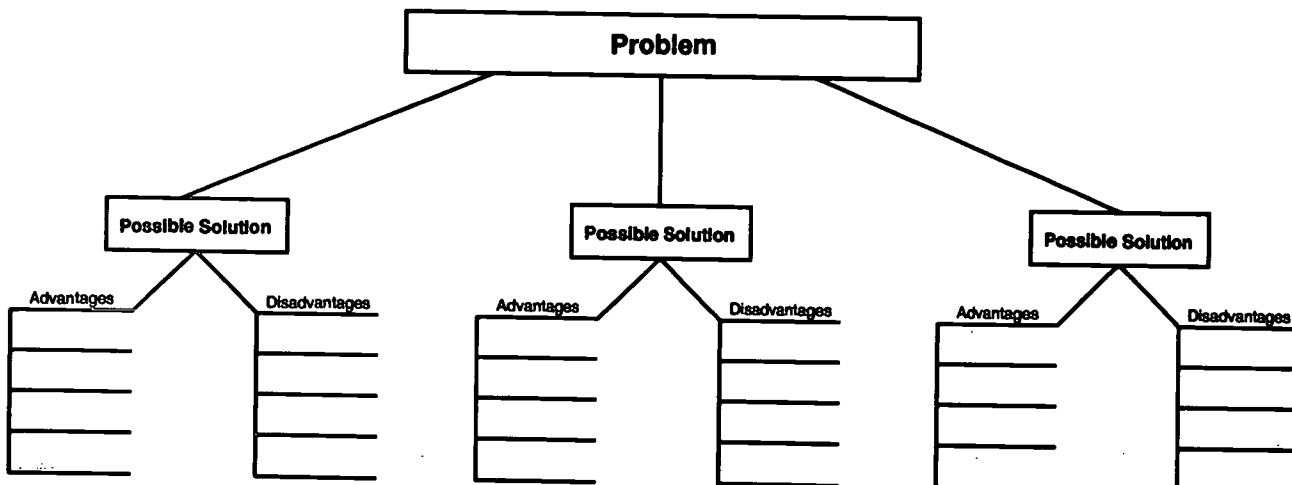

Graphic Organizer Strategies (*continued*)

FLOWCHART	
<p>WHAT IS IT? A graphic organizer strategy used to depict a sequence of events, actions, roles, or decisions.</p>	
<p>HOW DO YOU USE IT?</p> <p>Students structure a sequential flow of events, actions, roles, or decisions graphically on paper.</p>	<p>WHAT ARE THE BENEFITS?</p> <ul style="list-style-type: none"> • fosters logical and sequential thinking • focuses on cultural connections • develops the ability to identify details and specific points • develops organizational skills • aids in planning • provides an outline for writing in the target language

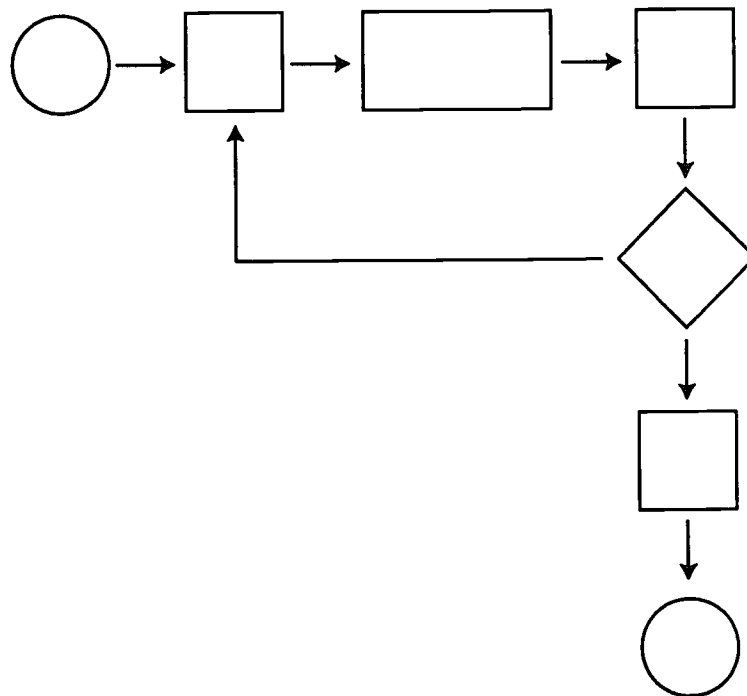

Graphic Organizer Strategies (*continued*)

VENN DIAGRAM

WHAT IS IT? A graphic organizer strategy, derived from mathematics, for creating a visual analysis of information representing the similarities and differences among, for example, target language concepts or target culture objects, events, animals, and people.

HOW DO YOU USE IT?

Using two overlapping circles, students list unique characteristics of two items or concepts (one in the left part of circle and one in the right); in the middle they list shared characteristics. More than two circles can be used for a more complex process.

WHAT ARE THE BENEFITS?

- helps students organize ideas, target language and culture concepts
- helps students develop a plan for writing
- allows students to focus on the similarities and differences within and among languages and cultures
- develops the ability to draw conclusions and synthesize
- stimulates higher cognitive thinking skills

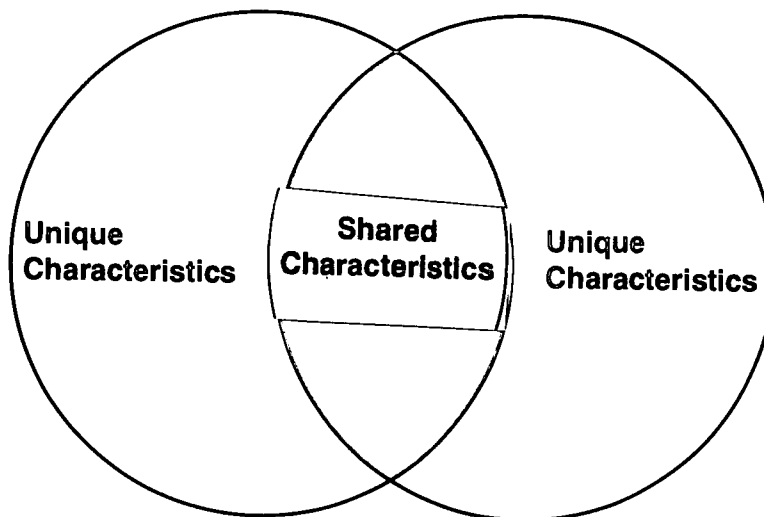

Graphic Organizer Strategies (*continued*)

WEBBING	
<p>WHAT IS IT? A graphic organizer strategy that provides a visual picture of how target language words or phrases connect to a content-based or cultural topic.</p>	
<p>HOW DO YOU USE IT?</p> <p>The teacher lists a topic and builds a web-like structure of target language words or phrases that students call out as being connected to a topic. Students can also use this strategy individually in planning writing or in studying for a test.</p>	<p>WHAT ARE THE BENEFITS?</p> <ul style="list-style-type: none"> ◦ provides opportunities for the visual learner to “recall” the connections for later use ◦ helps students use and share their prior linguistic knowledge ◦ helps students identify patterns of information

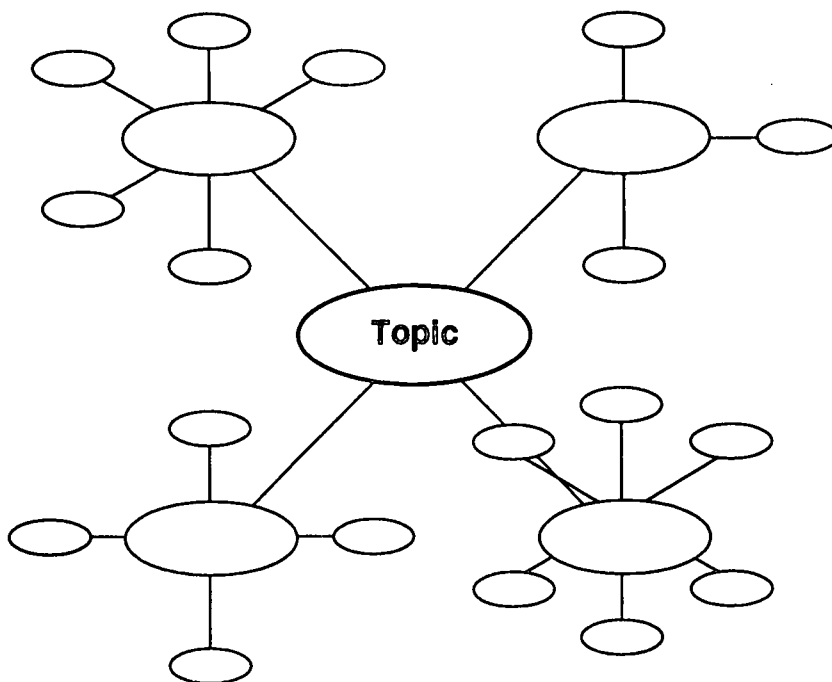

Graphic Organizer Strategies (*continued*)

CONCEPT MAPPING

WHAT IS IT? A graphic organizer strategy that shows the relationships among concepts. Usually the concepts are circled and the relationships are shown by connecting lines with short explanations in the target language, or graphical depictions of the objects or concepts.

HOW DO YOU USE IT?

The teacher selects a main idea. Using the target language, the teacher and students then identify a set of concepts associated with a main idea. Concepts are ranked in related groups from most general to most specific. Related concepts are connected and the links labeled with words, pictures, or short phrases.

WHAT ARE THE BENEFITS?

- helps students visualize how ideas are connected, understand linguistic relationships, and how knowledge is organized
- improves oral communication, comprehension, and problem-solving skills

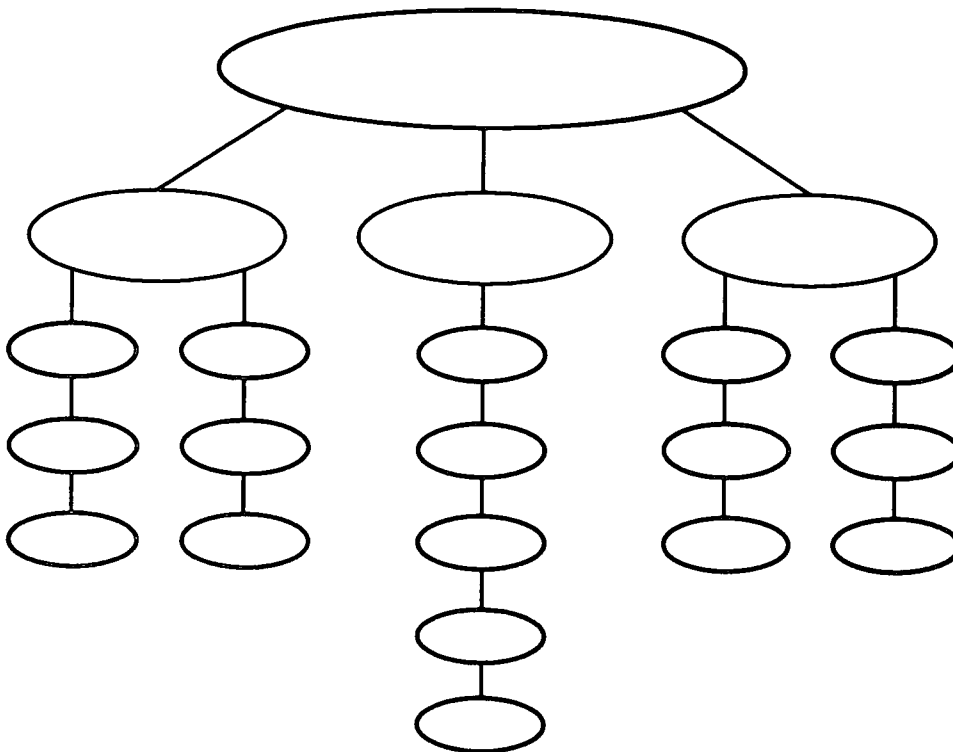

INTERVIEWS: A strategy for gathering information and reporting.

HOW DO YOU USE IT?	WHAT ARE THE BENEFITS?
<p>Students prepare a set of questions and a format for the interview. After conducting the interview, students present their findings to the class.</p>	<ul style="list-style-type: none"> • fosters connections between ideas • develops the ability to interpret answers • develops organizational and planning skills • develops problem-solving skills • provides opportunities to use the target language

CLOZE: An open-ended strategy in which a selected word or phrase is eliminated from a written or oral sentence or paragraph.

HOW DO YOU USE IT?	WHAT ARE THE BENEFITS?
<p>The teacher eliminates a word or phrase from the sentence. Students complete the sentence with a word that “makes sense.” The teacher may select random words or a specific part of speech. This can be expanded to the more difficult task of finding a word that makes sense when only the initial letter of the word is provided.</p>	<ul style="list-style-type: none"> • provides opportunities for creativity • develops the use of precise vocabulary • focuses on the use of precise and correct communication • increases comprehension skills • provides opportunities to use the target language

LANGUAGE EXPERIENCE APPROACH: An approach in which students orally describe an experience in their own words, using the target language, as the teacher records their story. The story serves as the basis for follow-up activities.

HOW DO YOU USE IT?

The teacher plans a shared experience for the class. Afterwards, the teacher or a designated student elicits language from the students that describes their experience and writes down what they say. Together they read or retell the story aloud. Using the story as a basis, the students can then engage in various activities, both oral and written.

WHAT ARE THE BENEFITS?

- engages students' interest and active participation
- gives an authentic experience of using the target language
- develops the ability to share ideas, thoughts, and feelings

TOTAL PHYSICAL RESPONSE (TPR): A strategy in which students respond with physical activity to increasingly complex sets of commands. The students' response of physical activity signals their comprehension of the command. This is ideally suited for beginning foreign language students, but can be adapted and made more complex for higher level students.

HOW DO YOU USE IT?

The teacher asks the student to perform a physical activity, and the student demonstrates comprehension by responding with the appropriate physical activity. The teacher encourages active listening by using an unpredictable sequence of commands.

WHAT ARE THE BENEFITS?

- engages students' interest and active participation
- gives an authentic experience of using the target language
- develops listening comprehension
- facilitates the natural emergence and development of oral communication in the target language

NATURAL APPROACH: A strategy that promotes communicative proficiency by providing real-world, authentic experiences and language experiences within meaningful contexts.

HOW DO YOU USE IT?

The teacher discusses pictures and objects using a sequence of meaningful questions. The teacher starts with questions that require simple “yes” or “no” answers, continues with questions that require either/or responses, follows with “what,” “where,” and “who” questions, and eventually culminates the activity with questions that require responses of full sentences or phrases.

WHAT ARE THE BENEFITS?

- engages students’ interest and active participation
- gives an authentic experience of using the target language
- develops listening and oral comprehension as a continuum within authentic situations
- facilitates the natural emergence and development of oral communication in the target language

PASSWORD/LANGUAGE LADDERS: A strategy in which students learn to speak sentences or phrases (“passwords”) that are associated with desired activities.

HOW DO YOU USE IT?

The teacher introduces a series of phrases in the target language that the students must speak in order to do a desired activity, such as “Can I go to the bathroom?” “May I sharpen my pencil?” “Can you help me?” The students learn new passwords of increasing complexity in subsequent classes.

WHAT ARE THE BENEFITS?

- engages students’ active participation
- gives an authentic experience of using the target language
- develops oral comprehension as a continuum within authentic situations

GOUIN SERIES: A strategy in which students learn to use short sentences or phrases to describe a logical sequence of actions that take place in a specific context that is familiar to the student.

<u>HOW DO YOU USE IT?</u>	<u>WHAT ARE THE BENEFITS?</u>
<p>The teacher orally describes a particular set of logical steps or a daily routine using action verbs in the same tense. Pantomime accompanies the oral description of the action sequence. The students then pantomime the action as they repeat the teacher's description of the action. Eventually, the teacher can request original sequences from the students, based on their own daily experiences.</p>	<ul style="list-style-type: none"> • engages students' interest and active participation • gives an authentic experience of using the target language • develops listening and oral comprehension as a continuum within authentic situations • facilitates the natural emergence and development of oral communication in the target language

DIALOGUE JOURNALS: A strategy in which students use journals as a way to hold private conversations in the target language with the teacher. Dialogue journals are a vehicle for sharing ideas and receiving feedback in the target language. This dialogue can be conducted by e-mail where it is available.

<u>HOW DO YOU USE IT?</u>	<u>WHAT ARE THE BENEFITS?</u>
<p>Students write on topics on a regular basis, and the teacher responds with oral or written advice, comments, and observations in a conversation. In the early stages of learning a language, students can begin by adding a few words and combining them with pictures.</p>	<ul style="list-style-type: none"> • develops communication and writing skills • creates a positive relationship between the teacher and the student • increases student interest and participation • allows the student to direct his or her own learning • provides opportunities to use the target language

CONTINUUMS: A strategy used to indicate the relationships among words or phrases

<u>HOW DO YOU USE IT?</u>	<u>WHAT ARE THE BENEFITS?</u>
<p>Using a selected topic, students place words or phrases on the continuum to indicate a relationship of degree, for example, <i>wee, tiny, little, small, large, huge, enormous, gigantic</i>. This can be accomplished in oral or written form.</p>	<ul style="list-style-type: none"> • acknowledges that others have different perspectives depending on their knowledge and experience regarding the topic • develops the ability to use precise vocabulary • develops critical thinking skills • increases the opportunities to use the target language in authentic situations

INTERACTIVE LANGUAGE TASKS: A strategy in which at least two students work together to accomplish a meaningful target language activity.

<u>HOW DO YOU USE IT?</u>	<u>WHAT ARE THE BENEFITS?</u>
<p>The teacher organizes the class into small groups or pairs that then perform a specific task using language. Examples of tasks include finding differences and similarities, identifying objects or persons, arranging things, giving and following directions, interviewing, surveying, choosing, explaining, and solving problems.</p>	<ul style="list-style-type: none"> • fosters interdependence and pursuit of mutual goals • develops communication skills • strengthens listening skills • provides opportunities to use the target language

CULTURAL PRESENTATIONS: A strategy for creating an exhibit that is focused on aspects of the target culture.

HOW DO YOU USE IT?	WHAT ARE THE BENEFITS?
<p>Students work in groups to create exhibits that represent a particular aspect of the target culture.</p>	<ul style="list-style-type: none"> • develops critical thinking skills • develops the ability to select important high points • encourages creativity and individuality • deepens specific knowledge of of the target culture

THE LEARNING CYCLE: A sequence of lessons designed to have students engage in exploratory investigations, construct meaning out of their findings, propose tentative explanations and solutions, and relate target language and culture concepts to their own lives.

HOW DO YOU USE IT?	WHAT ARE THE BENEFITS?
<p>The teacher engages the learners with an event or question to draw their interest, evoke what they know, and connect that with new ideas. The students explore the concept, behavior, or skill with hands-on experience. They explain the concept, behavior, or skill and define the terms, then use the terms to explain their exploration. Through discussion, the students expand the concept or behavior by applying it to other situations.</p>	<ul style="list-style-type: none"> • encourages students to construct their own understanding of target language and culture concepts • promotes empathy and understanding for people of other cultures • provides hands-on experiences to explore concepts, behaviors, and skills • develops the ability to share ideas, thoughts, and feelings • provides opportunities to use the target language

PROBLEM SOLVING: A learning strategy in which students apply knowledge to solve problems.

HOW DO YOU USE IT?

The students discover a problem; problems can be constructed by the teacher or can be real-world problems suggested by the students. The students define the problem, ask a question about the problem, then define the characteristics of possible solutions, which they research. They choose a promising solution that best fits the criteria stated in the definition of solutions, then test the solution. Finally, they determine if the problem has been solved.

WHAT ARE THE BENEFITS?

- allows students to discover relationships that may be completely new to them
- adapts easily for all grade levels and special-needs students
- develops the ability to construct new ideas and concepts from previously learned information, skills, and strategies
- promotes communicative competence in the target language

REFLECTIVE THINKING: A strategy in which students reflect on what was learned after a lesson is finished, either orally or in written form.

HOW DO YOU USE IT?

Two possible approaches to reflective thinking are (1) students can write in a journal the concept learned, comments on the learning process, questions or unclear areas, and interest in further exploration, all in the students' own words; (2) students can answer an oral questionnaire addressing such questions as Why did you study this? Can you relate it to real life?

WHAT ARE THE BENEFITS?

- helps students assimilate what they have learned
- helps students connect concepts to make ideas more meaningful
- fosters additional opportunities to use the target language in a meaningful setting

READ AND RETELL: An all-purpose strategy that involves students retelling a passage in the target language as they remember it.

HOW DO YOU USE IT?

The teacher asks the students to read a passage. Students can be working together as a class, in small groups, or in pairs, or working alone with the teacher. Then, the teacher asks the students to retell the passage as they remember it, either orally or in writing using the target language.

WHAT ARE THE BENEFITS?

- provides practice in a range of literacy skills in the target language including listening, speaking, reading, writing, interacting, comparing, matching, selecting, remembering, comprehending, and organizing the information
- provides an index of growth and development in a wide range of literacy learning
- provides opportunities to use the target language

LITERATURE, HISTORY, AND STORYTELLING: A strategy in which the culture and history of another country is brought to life through literature, folktales, and folksongs.

HOW DO YOU USE IT?

The teacher locates books, brochures, and tapes relevant to the language being studied and shares them with the class. Another strategy is to ask students to write about their own observations and insights after the writing lesson is over.

WHAT ARE THE BENEFITS?

- personalizes language learning
- allows students to connect language and literature to its social and historical context

Infusing a Multicultural Perspective

Florida students appreciate their own culture and the culture of others, understand the concerns and perspectives of members of other ethnic groups, reject the stereotyping of themselves and others, and seek out and utilize the views of persons from diverse ethnic, social, and educational backgrounds.

Florida's System of School Improvement and Accountability, Goal 3, Standard 10

Ethnic and cultural diversity enrich American society and provide a basis for societal cohesiveness and survival. An effective program of multicultural education integrates a sensitive and thorough study of ethnic and cultural content into the curriculum. A carefully designed and continuous curriculum (preschool through 12th grade) can create the multicultural literacy so necessary for a healthy nation. Each cultural group has its own set of values and perspectives. Many of these values are shared with other cultures and form the basis of American national unity. Each cultural group has also made its own unique contribution to the American society and to the world. Because it is essential that all members of our society develop an understanding of the values and perspectives of racial, ethnic, and cultural groups, schools are restructuring their curricula to infuse multicultural perspectives into everyday instruction.



The presence of students with different cultural and family backgrounds, interests, and values in the same class encourages all students to develop a multicultural perspective. Learning settings that respect diversity encourage social competence and moral development. Students learn what they live. They learn to respect individual differences by understanding how others think and feel. Activities that promote empathy, understanding, and respect for differing points of view promote a multicultural perspective without negating one's own point of view. Students learn to view concepts, issues, events, and themes from the perspective of diverse ethnic and cultural groups. Because the classroom is a model community, students gain the experience of living as responsible citizens in a diverse, democratic society.

Each student brings a wealth of culture that can be recognized, appreciated, and included as part of the instructional content. Teachers can focus on fostering understanding, appreciation, and respect for people of other cultural, language, socioeconomic, religious, or ethnic backgrounds, using the strengths and backgrounds of their own students to enhance the school experience for all. Teachers can design learning activities that prepare students to communicate and work with others, achieving common goals in a culturally diverse environment. Schools can restructure their curricula to ensure that all students, regardless of background or ethnicity, will achieve high academic standards and be able to function successfully in the workplace. The final goal will be for students to have the cultural knowledge, positive attitudes, and motivation that will allow them to participate in a global community in which every person is respected, appreciated, and honored.

Snapshot of an Effective Foreign Language Classroom

The following vignette is offered as an example of integrated, real-world educational experiences that teachers might create for students, using a variety of instructional strategies.

Students in Miss Flores' eighth-grade Spanish class are listening carefully as Miss Flores explains in Spanish what the class activities for the day will be. She tells them that they will be working in groups of four to accomplish specific tasks and that they will be communicating only in Spanish. Miss Flores has set up work stations around the room and the groups are to rotate until they have accomplished all the tasks. The students divide into small groups and head for one of the work stations.

The students are soon using Spanish to communicate with each other as they engage in the various activities designed by Miss Flores. Sean's group is acting out the process of planning a fun evening together. They must agree on a day, time, place, and type of activity they all enjoy doing.

In another group, Tyler is playing the role of the waiter in a restaurant as each group member "orders dinner." His task is to talk the group into ordering exactly the same meal. Mary's group is taking turns reading a Spanish newspaper article about a man who saved a little girl from drowning. After they finish reading, they ask each other questions to make sure everyone understood what happened in the story. Alisa's group is interviewing Miss Flores about her

travels to other countries, finding out where, when, and with whom she travelled. The group also asks her to relate an experience she had during her travels; later, the group must retell the story to the whole class.

In this example, the teacher has incorporated cooperative learning, interactive language tasks, read and retell, interviewing, and problem solving to give her students multiple opportunities to perform in the target language. Thus, she has provided her students with integrated, real-world educational experiences, using a variety of instructional strategies.

Teaching Diverse Students

Schools must accommodate a diversity of student abilities, disabilities, interests, cultural backgrounds, and other factors that affect student performance in school. It is important for all educators to be aware of the characteristics of their students and vary their teaching strategies to meet students' individual needs. Many instructional strategies that have been developed and used by teachers for interacting with students with special needs have proven effective for other students as well.

Increasing ethnic and cultural diversity promises to continue enriching life in the United States. This has important implications for education. As diversity in the school population grows, it becomes more and more evident that all students, regardless of their race, ethnicity, culture, or class, must acquire the knowledge and competencies necessary for functioning effectively with one another. All students must develop the knowledge and competencies necessary to participate successfully in their communities, in the workplace, and in society.

Adapting Instruction for the Diverse Needs of Learners

Given the focus on creating learning-centered classrooms, the unique characteristics of individual learners must guide curriculum planning and affect both the learning environment and the teacher's role in facilitating the learning process. As curricula and learning environments are redesigned, and as teachers plan and teach, it is important to keep in mind that learners

- come to the educational setting with unique knowledge, experiences, and explanations about the world;

- come from many cultures and backgrounds;
- have diverse needs and values;
- actively participate in learning
- have a variety of interests; and
- have a variety of opinions and ideas about school, foreign languages, and the world.

Creating an effective learning environment that can address these diverse needs, backgrounds, and learning styles starts with understanding those needs.

Adapting Instruction for Developmental Differences

Children learn best when material is appropriate to their developmental level and challenges their intellectual, emotional, physical, and social development. Children grow through a series of definable, though not rigid, stages. Schools should demonstrate awareness and understanding of the developmental differences among all, including those children with special emotional, physical, or intellectual challenges as well as those with special abilities. Exploring the developmental differences of children in-depth is beyond the scope of this framework. Much research is available in this broad area.

Adapting Instruction for the Individual Learning Process

Children naturally develop unique capabilities and talents. They acquire preferences for how they learn and the pace at which they learn. There are many forms of intelligence and many ways by which people know, understand, and learn about the world. Seven types of intelligences have been identified by Howard Gardner (1985):

- verbal/linguistic,
- logical/mathematical,
- visual/spatial,
- body/kinesthetic,
- musical/rhythmic,
- interpersonal (dealing with other people), and
- intrapersonal (knowing oneself).

Each student has a dominant learning style that consists of a unique combination of these intelligences. It is important for teachers to understand the learning styles of their students so that they can structure their teaching in a way that incorporates these seven ways of knowing. The foreign language program that matches teaching to learning styles allows students to process material more efficiently, thereby reaching all students and providing the opportunity for deeper and more thorough learning.

There are many other strategies for adapting instruction and the learning environment for students with different needs. One strategy might be to challenge students with open-ended problems to which they can respond on a variety of levels. By encouraging students to explore on their own and by frequently reinforcing their discoveries, teachers can enhance learning. Some students may need additional opportunities to practice previously mastered information. Instruction might take place in the form of individual activities, group activities, games, class discussions, or projects involving multiple skills. It may also be advantageous to vary class grouping to accommodate different tasks or learning styles.

Adapting instruction for the individual needs of students does not mean lowering expectations or having different academic criteria. The teacher's high expectations for academic success play an influential role in the way other students accept a student who has unique needs. This, in turn, can have an impact on a child's self-image, affecting his or her eagerness and ability to learn.

Accommodating Students With Disabilities

Teachers who believe that all students can learn create a supportive learning environment for students with disabilities. In addition, modifications in assignments, courses, instructional methods, instructional materials and resources, and assessment methods can help enhance the learning experience for these students. Course modifications may be made to basic or vocational education courses in the regular classroom or in the exceptional student education classroom; these modifications are described in the State Board of Education Rule 6A-6.0312, FAC. Educators may modify a course by increasing or decreasing instructional time, that is, adjusting the time allotted for completing an assignment or a course or adjusting the length of class assignments. The format of the instruction can also be adapted or

changed. This might include the use of hands-on materials, audio-visual media, instructional technology (including computers), and the use of specially designed materials such as the *Parallel Alternative Strategies for Students* (1992-1995), developed for Florida schools.

Quite often modifications that are effective for students with disabilities work well for other students in the class. Specially designed teaching strategies can be easily integrated into the classroom to enhance the content being presented, to assist with assignments, and to organize the content being learned. Testing modifications, such as flexible scheduling, recorded answers, use of mechanical aids, or revised formatting, are helpful for all students.

Accommodating the needs of students with disabilities may include many other modifications. For example, there are students who need special communication systems in order to participate in classes. Students with hearing impairments may need the assistance of an interpreter or note-taker, or both. Computerized devices can help students with disabilities perform written and oral communication. Students with visual disabilities may require access to Braille and other adaptive technology.

When the needs of learners with disabilities are accommodated by modifying instructional methods, assessment methods, and the physical environment and by providing a supportive environment such students are able to excel. They can develop a greater capacity to take an active role in the learning process and focus on their strengths, which helps them achieve a higher level of knowledge, skills, and competencies in the target language.

Integrating Students Who Have a Heritage Language Other Than English

Students whose heritage language is not English come to the Foreign Language class with language skills that are determined by their previous academic and home experiences. Many such students have had formal educational experiences in their heritage language; these students should be integrated in the foreign language studies continuum at the level of their own language proficiency. Alternatively, they can be placed in heritage language content area and language arts classes that will continue the development of their heritage-language skills and content-area knowledge.

Accommodating At-Risk Students

Students at risk of leaving school before graduation are a special challenge to the classroom teacher. Poor academic performance, as measured by being overage for a particular grade, in conjunction with grade retention and traditional and alternative assessments, has been cited as an accurate indicator of which students may drop out of school. Students who have difficulty meeting the required academic performance levels and who fall behind their peers often see little possibility of catching up; they may be at a high risk of not graduating.

Teachers can raise the level of student motivation by consistently modeling interest in the subject, tasks, and class assignments. They can also create classroom activities in which at-risk students are more likely to be successful and are able to tap into their own intrinsic level of motivation.

Teaching Strategies

Some strategies that have been effective in targeting at-risk students are the following:

- offering limited choices when it comes to alternatives for homework or long assignments;
- using active learning situations such as games, projects, group work, discussions, experiments, board work, creative seat work, and simulations (for example, mock elections, role playing, trials, and plays);
- providing concrete rather than abstract instruction, for example, physical objects, pictures, maps, diagrams, and colors as well as stories and anecdotes, because loading instruction with many examples makes the lesson come to life;
- using puzzles, brain teasers, and games to help students learn facts and figures;
- using short tasks and assignments, which provide more opportunity for completion, giving at-risk students a sense of accomplishment;
- having students compare their current efforts to their previous work rather than to the work of other students;
- avoiding class announcements of poor performance; avoiding posting or calling out grades;

- avoiding situations in which individuals compete openly in class; using, instead, group competitions in which teams are carefully designed so that the at-risk student is likely to meet success;
- helping students to concentrate on the task and its completion rather than on the consequences of failure;
- helping students evaluate situations in which they have been successful; helping students analyze unsuccessful situations and determine why they were unsuccessful; helping students focus on the path to success;
- teaching test-taking skills and avoiding timed tests;
- giving pretests so that students can make positive posttest comparisons, thus treating tests as opportunities for assessing learning rather than measuring ability;
- creating pretesting structures, for example, by providing study guides and outlines and teaching note-taking and outlining skills; and
- providing immediate feedback on student work by circulating around the classroom and monitoring students' efforts on the spot, and promptly returning homework, assignments, and exams.

At-risk students, faced with a problem they have difficulty solving, often give up and simply go on to the next problem, or worse yet, do not even try to solve the problem and end up selecting answers randomly. The ability to persist can be taught. *To encourage at-risk students to persist*, teachers might

- carefully monitor students at work, coaxing them to continue working and to keep at it;
- help students set objectives and goals that bring immediate results;
- help students see that each new, small success brings them closer to their goals and makes them stronger;
- use contract learning, in which students have limited choices that move them step by step toward completion of course objectives;
- offer make-up exams, credit for effort, extra credit options, and extra practice opportunities;
- offer opportunities to rewrite or correct until revisions are completed; and
- help students retrace their work to find errors, analyze problems, and reread portions they have skipped in order to answer the questions.

The Dropout Prevention Act of 1986, Section 230.2316, *Florida Statutes*, was enacted to authorize and encourage school boards to establish Dropout Prevention Programs. These programs are designed to meet the needs of students who are not effectively served by traditional programs in the public school system. This includes students who are unmotivated, unsuccessful, truant, pregnant and/or parenting, substance abusers, and disruptive, as well as those who are in shelters.

Strategies used in these programs that have been found to be effective could prove successful in a more traditional setting. These include

- instructional strategies and tools such as cooperative learning, computer-assisted instruction, authentic/alternative assessment, critical thinking, and graphic organizers;

- competency-based curriculum which allows students to work at their own pace;

- flexible scheduling or use of time;

Students “declare” a schedule and attend, even though it may be beyond the traditional school day. Competency-based curriculum delivered through computer-assisted instruction is well suited to this strategy.

- career awareness and on-the-job training for employability skills;

- experiential learning and hands-on activities;

- mentoring and nurturing;

- course modifications;

Course modifications allow at-risk students to compress or extend the period of time it takes to master material in a given course, to respond to a variety of assessments to demonstrate mastery, and/or to be offered interdisciplinary or intradisciplinary units of instruction through the integration of more than one course description. This gives the overage- for-grade students an opportunity to catch up with their own grade peers.

- summer bridge programs;

Summer bridge programs allow overage-for-grade students to catch up with their own grade peers by attending a rigorous summer session and then being promoted to the next grade level.

- collaborative teaching that combines two classes;

In one model of collaborative teaching, the dropout prevention teacher furnishes expertise in course content, while the specific learning disability teacher offers expertise in course modification.

- thematic units in which teachers identify common themes and realign student performance standards to reflect the theme;

In some models, teachers work together to identify aspects of their discipline that have commonalities; in other models, teachers work separately without any attempt to connect with other subject areas.

- peer counseling and student conflict mediation;

One model pairs at-risk ninth graders with twelfth graders who are selected according to leadership skills and their potential to serve as role models, and who are trained in peer counseling strategies including listening, questioning, paraphrasing, and feedback. These older students also provide academic tutoring and use a variety of peer counseling strategies designed to help the ninth grader become successful in an academic curriculum that addresses social, individual, school, and family concerns; topics could include drug and alcohol abuse, family relations, academic motivation, and coping with stress.

- student support and assistance components, which serve students who are eligible for dropout prevention programs and who are in need of academic or behavioral support;

Students are served in traditional classes through a flexible schedule of auxiliary services, including supplemental materials or alternative strategies to assist with course modification, behavior management, or alternative assessment. Instructional aides or case managers can also be used to support teachers, students, and parents.

- GED/HSCT Exit Option; and

This program allows currently enrolled, dropout-prevention students to earn a standard high school diploma by enrolling in courses for credit that lead to a standard high school diploma and work to master the individual course student performance standards. To enter the program, these students must be behind the class with whom they entered kindergarten and demonstrate probability for success on the GED through documentation of a high score on a standardized test; to complete the program, students must complete required courses and pass the HSCT and the GED tests.

- coordination with other agencies, such as social service, law enforcement, prosecutorial, and juvenile justice agencies as well as community-based organizations.

Putting These Ideas to Work

Current educational philosophy recommends that educators focus on developing a learning-centered curriculum, which includes a number of key ideas:

- The teacher is a facilitator (a “guide on the side” versus “the sage on the stage”).
- The student is a discoverer of knowledge within his or her learning community. This involves students listening to others and learning to filter information and draw conclusions, versus simply taking in a body of knowledge imparted by the teacher.
- The community is a rich resource.
- Real-world learning experiences help students apply knowledge and skills; this helps prepare them for daily living and future employment.

Using the curriculum frameworks as a guideline, local educators will make the final choices regarding how to teach the essentials. These choices will include the themes and topics by which to teach academic standards, the day-to-day content of instruction, the types of materials and resources used, and the teaching strategies that are appropriate for the individual needs of the students and for the teacher’s own strengths. The result of a thoughtfully designed curriculum is students who have the ability to achieve high academic standards and who can be better prepared to live as responsible, effective, and productive citizens within a global society.

KEY CHAPTER POINTS

Instruction that prepares students for the 21st century should focus on

- high academic standards with expectations of high achievement for every student;
- a learning-centered curriculum with the teacher as a facilitator of learning;
- learning based on constructing meaningful concepts from facts;
- learning the target language in its real-world contexts;
- making connections within the foreign language and with other content areas;
- relating the target language to the students' world;
- active, hands-on learning in the classroom;
- more student responsibility and choice;
- students inquiring, problem solving, conjecturing, inventing, producing, and finding answers;
- students working and learning cooperatively;
- accommodating individual student needs, whether cultural, developmental, or cognitive;
- infusing a multicultural perspective;
- expanding resources to include local and global communities;
- using technology to support instruction; and
- relating classroom learning to the skills students will need to function successfully in their communities, in the workplace, and in society.

Chapter 5: Curricular Connections Through Instruction

CHAPTER HIGHLIGHTS

- Curricular Connections and the Transfer of Learning
- Models for Curricular Connections in Instruction
 - Infusion
 - Parallel Instruction
 - Multidisciplinary Instruction
 - Transdisciplinary Instruction
- Planning an Interdisciplinary Unit

*Tomorrow's successful employees will have to be problem solvers, decision makers, adept negotiators, thinkers who are at home with open-endedness, flexibility and resourcefulness. They must be able to deal with uncertainty, complexity, the global village, the information explosion, other technologies and many different cultures—and still maintain a set of values that foster an adequate degree of individual stability, integrity, and social harmony (Caine and Caine, *Making Connections*, 1991).*

Why should teachers try to connect foreign languages to other subject areas? There are at least three compelling reasons for doing so. First, life does not occur in neat, subject-matter packets. A single incident, such as a hurricane, affects a region in many ways. It destroys homes, cultural resources, and businesses; damages the environment; upsets the economy; interrupts school and school programs; tests government emergency response policies; and demands immediate solutions to problems that will have a long-term aesthetic and economic impact upon the quality of life in a community. To address these complex issues, citizens must integrate and use knowledge and skills from a variety of subject areas. Second, making connections among subject areas creates a greater sense of meaning for students; for example, a process they learn in foreign language education helps them better understand social studies. Finally, today's teachers face the challenge of an ever-expanding curriculum.

Although the expansion of the curriculum results in part from important mandates from the state level, most of it results from the simple fact that information in the modern world is expanding at a phenomenal rate. This expansion of information underscores the importance of stressing connections among subject areas.

Curricular Connections and the Transfer of Learning

Connecting important concepts from different disciplines has a number of beneficial effects. One of the most important effects is that it facilitates the transfer of learning. A disappointing fact about education in America is that students frequently demonstrate that they understand something in one setting, but fail to understand that same concept in another setting. Educators refer to this occurrence as a lack of transfer of learning. For example, a student might show that he or she understands how to construct a well-organized paragraph when asked to describe it in a language arts class, but fails to see how that very concept applies to writing an essay in a foreign language. By forging connections among subject areas in the classroom, students have a better chance of recognizing that what they learn in school has applications beyond the classroom. This transfer of learning is illustrated in the following example:

Rachel and Juanita became good friends shortly after Juanita moved to Miami from Venezuela. Rachel had only known Juanita a short time when Juanita invited her to visit her home one weekend. When Rachel arrived, Juanita explained that her grandmother spoke only Spanish.

Rachel was very glad that she had learned in her sixth-grade Spanish class how to respond to introductions. She also remembered just in time to use the formal means of addressing an older person. When Juanita introduced her to "Nana," Rachel respectfully acknowledged Nana's greeting, and replied that she was honored to know her. Juanita later told Rachel that her grandmother was delighted that Juanita had found such a nice friend and that she was touched by Rachel's use of the Spanish language.

Curricular connections also encourage teachers to work in a collaborative mode. Most teachers have heard the expression, "Teaching is one of the most isolated professions in the world." Fortunately, it doesn't have to be. A foreign language teacher who decides to use content from science creates a reason to interact with the science teacher. The interaction among teachers from different content areas can take many forms, depending on the model that is being used for making curricular connections.

Models for Curricular Connections in Instruction

Several strategies will be overviewed in this chapter; curriculum developers and teachers may want to explore these strategies in greater depth. Four effective models of curricular connections are infusion, parallel instruction, multidisciplinary instruction, and transdisciplinary instruction. After further exploration of these models, individual school staff must determine whether any or all of these models will work in their setting.

Infusion

In infusion, a teacher in a given subject area integrates another subject area into his or her instruction.

Students in Ms. Barton's first-year Spanish class are writing reports about how various holidays are celebrated in Mexico. She reminds students of the need to edit their reports and distributes an editing checklist she has obtained from Ms. McColl, the freshman English teacher. Part of each student's grade will be based on how well the reports have been edited using this checklist.

Parallel Instruction

In parallel instruction, teachers from different subject areas focus on the same theme, concept, or problem. Each discipline is taught separately, but teachers must plan together to identify the common element and determine how the concept, theme, or problem will be addressed in each subject area. Homework and assignments commonly vary from subject area to subject area, but all reflect the common theme, project, problem, or concept being addressed.

Sixth-grade teachers in language arts, social studies, and foreign languages decide to use the concept of "cultural identity" as their parallel focus for a four-week block of time. In language arts, students read a variety of short stories from different cultures. Each student also selected a contemporary novel representative of a particular culture, for example Uchida's A Jar of Dreams; Bunting's The Happy Funeral; Greenfield's Sister; Yep's A Child of the Owl; Ishigo's Lone Heart Mountain; Craven's I Heard the Owl Call My Name; Krumgold's And Now, Miguel. While reading the short stories and novels, students keep a journal, noting

representative traditions, lifestyle patterns, and values. Students also interview older family members to learn about their own cultural heritage; again,

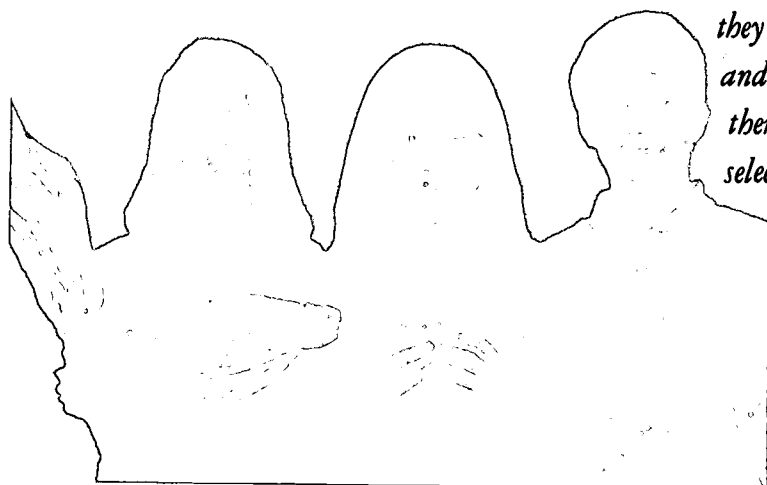

they use their journals to record what they learned and to reflect on how their heritage is important to them. As a final project, students work in groups to select a particular culture and create a unique expression of their cultural identity. Some groups bring in representative recipes they have made; others work on multimedia presentations featuring their chosen culture's art and music; still others bring in cultural artifacts collected from their families and explain how these reflected their cultural identity.

In social studies, students are asked to investigate the culture or subculture evident in their school and to compare it with the adolescent "culture" of another era (for example, the Twenties). During the unit, students record aspects of their middle-school culture that contribute to a cultural identity. They include evidence observed in the hallways, cafeteria, school grounds and classrooms. The class creates a dictionary of idiomatic expressions evident among their peers and participate in discussions on how students who do not follow the cultural norms are treated. At the same time, students work in groups to research the identifying characteristics or cultural identity of an adolescent culture of the Twenties, noting similarities and differences. At the end of the unit, groups present their conclusions to the class.

In French class, students examine the cultural identity of contemporary French society. They look through issues of Paris Match, view videotaped French television commercials and read French newspapers. One class member's parents, who had been raised in the outskirts of Paris, visit the class to answer questions about what they believe contributes to the French cultural identity. As a result of this visit and the connections the family still maintains in France, students are able to develop pen-pal relationships with students in France. As a final project, students write letters in French to the parents who had visited, thanking them for their visit and for helping them to learn about contemporary French culture.

Multidisciplinary Instruction

As with parallel instruction, within multidisciplinary instruction two or more subject areas address a common concept, theme, or problem. The subject areas are

taught separately for the most part, but a common assignment or project links the various disciplines. Teachers must plan together to identify how the concept, theme, or problem will be addressed in each subject area, construct the common project, determine how the project will be divided among the subject areas, and determine how students will work together on the project.

Middle school foreign languages, social studies, and language arts teachers who share the same students and have the same planning period design a common project for their classes. Students will demonstrate an understanding of what they learn in each of their classes by producing a special newspaper section on Guatemala and submitting it to the local paper for publication.

While studying Spanish, students use Spanish-language sources to conduct research about the Guatemalan culture, gathering information on food, sports, games, music, art, festivals, and other elements of the Guatemalan lifestyle. They also use Spanish-language tourism publications to discover how and why Guatemala is important to Latin America. Using Spanish, the students discuss, compare, and contrast Guatemala with previously studied Latin American countries.

While studying social studies, students research Guatemalan history, government, economy, and the country's role in Latin American and world affairs.

While in language arts, students study different journalism techniques, including straight news writing and feature writing. Working in groups, students then use the research they had completed in Spanish and social studies to write articles which are compiled and submitted as a complete section to the local paper's travel section.

Transdisciplinary Instruction

Within transdisciplinary instruction, two or more subject areas address a common concept, theme, or problem; however, the subject areas are presented in an integrated fashion. Classes in the subject areas meet at a common time; teachers integrate planning and team-teach all lessons. Commonly, a major project is the focus of the unit.

Mrs. Browning's third-grade class represents a number of different nationalities. To help students develop an appreciation for the universality of human experience amidst diversity, she constructs a transdisciplinary literature unit. First, she reads several versions of the same folk tale to her students. Each tale has originally been written in a different culture. She then has

students read an adaptation of Little Red Riding Hood and Lon Po Po: A Red Riding Hood Story from China by Ed Young. She asks the students to identify the common elements in these stories, which she then writes on the board. She also explains that certain themes and plots appear in folk tales from a number of cultures around the world.

To make this point even more tangible, she asks three students whose heritage language is Haitian Creole and who are in Madame Francine's Haitian Creole for Haitian Creole Speakers class to select similar folk tales from their heritage language culture to share with the class. These students bring transcripts of oral Haitian folktales, and Mrs. Browning makes a display of the transcripts. With Mrs. Browning's help, these students also present short summaries of their favorite folk tales to the class. She then asks the rest of the class to visit the display and notice how the transcripts are illustrated. The class discusses which universal elements appear in these tales and also how the illustrations add to the tales.

As a final project, the class works together to write and illustrate an original folk tale containing elements the class had identified as universal.

Planning an Interdisciplinary Unit

One of the most effective ways to plan a unit that fosters connections is to focus on creating projects that involve content from different subject areas. As we have discussed, projects are a central part of both multidisciplinary and transdisciplinary instruction. Below is a simple three-step process that can be used to develop projects that forge curricular connections.

Step #1: *Select benchmarks from two or more subject areas that will be integrated into the project.*

For example, assume that a foreign language teacher sets out to construct a project for his high school French students that incorporates a benchmark from foreign language with a benchmark from language arts. He would first consult chapter 3 of this framework and select a benchmark. For example, he might select the following benchmark which can be found within Strand A, Communication under the standard "The student understands and interprets written and spoken language on a variety of topics":

Foreign Language benchmark: *The student reads authentic written materials and analyzes them orally or in writing (e.g., describes characters, plot, personal reactions, and feelings).*

The teacher would then consult the framework for a second content area—language arts, for example. The teacher might pick the following benchmark which can be found under the language arts standard entitled “The student responds critically to fiction, nonfiction, poetry, and drama”:

Language Arts benchmark: *The student analyzes the effectiveness of complex elements of plot (such as setting, major events, problems, conflicts, and resolutions).*

These two benchmarks—one from foreign language, one from language arts—would form the basis for the project. It is important to realize that all benchmarks must be selected with a great deal of attention to their relatedness. In other words, not all pairs of benchmarks make a good match. The two benchmarks depicted are a good match because they both deal with literary criticism. If a teacher tries to force a connection between benchmarks from different content areas, the resulting project will be artificial and will run the risk of confusing students.

Step #2: *Identify an interesting question or questions that can be asked about the benchmarks that have been selected.*

One way to help students explore the relationship between benchmarks is to ask a question that will naturally integrate the benchmarks. The following is a list of useful questions to consider:

- What is the underlying pattern?
- How are these things similar and different?
- What groups can these things be put into? What rules or characteristics have been used to form groups?
- What conclusions can be formed about this information?
- What is the evidence for this position and how good is it?
- What specific rules are operating here? Based upon those rules, what must happen or what will probably happen?
- Are there errors in reasoning that have been made? Are there errors being performed in a process?

- Is there a hidden relationship here? What is the abstract pattern or theme that is at the heart of the relationship?
- Are there different perspectives on an issue that should be explored?
- Is there some new idea or new theory that should be described in detail?
- Is there something that happened in the past that should be studied?
- Is there a possible or hypothetical event that should be studied?
- Is there an obstacle that must be overcome?
- Is there a prediction that can be generated and then tested?
- Can this skill or process be used to accomplish something or better understand something?

Note: Adapted from Marzano, Pickering, McTighe. (1993). *Assessing Student Outcomes*.

To illustrate how a question from this list can be used, consider the two benchmarks that have been selected:

Foreign Language benchmark: *The student reads authentic written materials and analyzes them orally or in writing (e.g., describes character, plot, personal reactions, and feelings).*

Language Arts benchmark: *The student analyzes the effectiveness of complex elements of plot (such as setting, major events, problems, conflicts, and resolutions).*

A question that seems to naturally address these benchmarks is “Can this skill or process be used to accomplish something or better understand something?” It would be logical for the foreign language teacher to ask students to use their language arts skills to help them analyze and better understand literature written in the target language.

Step #3: *Identify a product or products that incorporate the benchmarks that have been selected.*

With the content benchmarks selected and an interesting question identified, the next step is to identify the product or products that best suit the project. It is useful to consider four types of products: (1) conclusions, (2) processes, (3) artifacts, and (4) affective responses. It is important to remember that some products may not be applicable to all subject areas.

Conclusions are generalizations that have been constructed as a natural consequence of studying some issue or topic. For example, in foreign languages, students might produce conclusions about how selected political events have shaped the target culture and its relationship with the United States. When students report their conclusions, they commonly are expected to provide evidence and support. This may be in the form of oral or written reports, videotapes, audiotapes, charts, and graphs.

Processes are sets of actions that are the natural consequences of solving a problem or accomplishing a goal. For example, in foreign languages, students might be asked to develop a detailed process for selecting and using the correct verb form. Processes are commonly demonstrated along with an explanation of how the process works and why it is effective. If the process cannot actually be demonstrated, it is sometimes simulated.

Artifacts are physical products that are natural outcomes of solving a problem or accomplishing a goal. For example, in foreign languages, students might be asked to produce a dish using a recipe written in the target language.

Affective representations are illustrations of emotional responses that result from studying some issue. They take many forms including paintings, murals, dances, songs, sculptures, collages, sketches, poems, personal essays, and dramatizations. For example, after reading *Le Petit Prince* by Antoine de St. Exupery, students might be asked to respond to the relationship that develops between the narrator and the prince by creating a collage or by writing a personal essay reflecting on the nature of friendship.

Of these four types of products, a conclusion seems to be the one best suited for the project regarding literary criticism of a French work. That is, the project requires students to draw some conclusions about the effectiveness of complex elements of plot as they are used in a French novel. With the benchmarks selected, an interesting question identified, and a type of product selected, the teacher would then write the project as a set of directions to the students. For example, those directions might read as follows for a French Advanced Placement (AP) literature high school course:

You have just finished reading L'Etranger by Camus. Although we have discussed how Camus's existential philosophy is evident in the novel, we have not yet identified and analyzed how Camus uses the elements of plot to enhance the philosophical ideas that he raises in the

novel. I'd like you to spend some time in small groups talking about the elements of plot that you have learned about in your language arts class, because the same literary criticism techniques that you have studied there can be used to analyze and better appreciate L'Etranger. For example, how do the setting, characterization, conflicts, and resolution contribute to Camus's existentialist themes? In addition, each of you must read at least two magazine or newspaper book reviews of your choice, either in English or in French. Note those passages in which the critic discusses the characters, setting, and major events that take place in the reviewed book. Then, I'd like each of you to write a book review of L'Etranger similar to one you might read in a newspaper or magazine. Make sure that you do not simply write a plot summary of the book but that you draw some conclusions about the effectiveness of Camus's use of the elements of plot in the novel.

KEY CHAPTER POINTS

- There are four basic ways in which curricular connections can be forged: infusion, parallel instruction, multidisciplinary instruction, and transdisciplinary instruction.
- A three-step process can be used for constructing projects that forge curricular connections.
- Curricular connections make learning more meaningful for students.

Chapter 6: Assessment

CHAPTER HIGHLIGHTS

- The Assessment Process
- Different Types of Classroom Assessment
- The Use of Assessment Rubrics
- The Florida Writes Rubrics

Assessment of student academic achievement is a fundamental component of Florida's school improvement and accountability initiative. Assessment provides essential information on the effectiveness of our reform efforts and on the level of student achievement of Florida's academic standards. Assessment processes are varied and include the use of standardized tests as well as other formal and informal methods to build a web of useful information about student achievement.

Florida schools will be held accountable for student achievement through the collection and analysis of academic assessment information from the state, district, school, and classroom levels and the public reporting of results. One highly visible part of the education accountability program will be a statewide, externally mandated assessment system measuring student progress in reading, writing, and mathematics in a context of high-level thinking and problem solving. This state test will provide an external "spot check" on the first four standards of Goal 3. This system will be criterion-referenced and will include performance-oriented items. It will be administered at three levels: elementary, middle, and high school.

A statewide assessment program, however, is not adequate by itself to provide all of the information on student knowledge and skills needed at the local level. This can only be provided through the proper use of classroom assessment procedures. The focus of this chapter is classroom assessment, one of the teacher's most complex and most important responsibilities. This chapter presents overviews of various strategies

for classroom assessment, all of which curriculum and assessment developers and teachers should explore in greater depth through other more-detailed sources.

Classroom assessment refers to the tasks, activities, or procedures designed to obtain accurate information about student academic achievement. Assessment helps answer these questions: What do students know and what are they able to do? Are the teaching methods and strategies effective? What else can be done to help students learn?

Classroom assessment activities should be systematic, ongoing, and integrated into the process of instruction and learning. This dynamic relationship results in a continuous process of refining goals as the teacher works with the entire class and with individual students. In fact, the term *assessment* comes from the Latin *assidere*, which means “to sit beside.” This meaning creates a picture of the teacher and the student working together to continually improve the processes of teaching and learning. To assess also means to analyze critically and judge definitively. This meaning emphasizes the teacher’s responsibility to make judgments about students’ achievement based on careful consideration of obtained information.

Authenticity in classroom assessment activities is desired whenever possible. That is, assessment activities should not only examine simple recognition or recall of information. They must also focus on the goals of listening, speaking, reading, writing, and culture. Language and cultural knowledge should be organized to connect and create meaning. This organization is influenced by the concepts, content, and context in which the knowledge is acquired. The language teacher’s role in assessment is to use strategies that will provide information about what students can do, how well they have internalized strategies for learning, and how well they use these strategies. Using authentic (i.e., realistic) assessment activities will help reveal whether or not students have learned to do these things. The strategies presented in this chapter will encourage the linkage of curriculum, instruction, and assessment.

The Assessment Process

In recent years, our knowledge of how students learn has increased; for example, we have learned that students acquire knowledge and skills in widely diverse ways. Knowing this, however, only serves to increase the complexity of student assessment.

Because all students do not learn in the same way and because increasing numbers of our students come to school from situations that seriously affect their prospects for success, innovative approaches to instruction and assessment are needed to meet their needs.

The process of assessment is not complete without the communication of results. Timely feedback from assessment is important to positively influence student performance and instruction. Comments about student progress may be formal or informal and should emphasize what students have done successfully and what they have achieved. The process should include opportunities for the student to comment on his or her own progress and for the student's family to be involved in and informed about the assessments. Summary results of classroom assessments should be shared with other educators, citizens, and decision makers, where appropriate, and used by educators to improve instruction.

Different Types of Classroom Assessment

The unique nature of foreign languages, especially the proficiency-oriented language experiences, calls for using multiple forms of assessment to clearly evaluate each student's progress as well as the impact of instructional strategies. Foreign language instruction and content should encourage students to view the language as exciting, relevant, and applicable. The task of teachers and assessment specialists is to use the most effective and valid forms of assessment for the particular educational setting, for the type of knowledge, skill, or ability being assessed, and for the individual student. Developing a variety of assessment options allows the teacher to match the assessment to the student's ability to demonstrate knowledge to verify that learning has taken place.

Even when a variety of options is available, modifications for specific students may also be necessary. Modifications that are made in the classroom for the instruction of special needs students often can be applied to assessment procedures. For example, it may be more effective to allow a student the opportunity to give an oral presentation rather than a written report.

When written tests are used to assess student performance, test administration can be modified in a variety of ways, including flexible scheduling and flexible settings. Students may perform better if not hampered by artificial time limits or disrupted

by other students in the class. Using a revised format that may allow the student to listen to test questions rather than read them can also improve performance for students with reading disabilities. Recording answers or performances via audiotape or computer programs may help a student demonstrate competency under less stressful circumstances.

Assessment techniques overlap and blend together. Using several forms of assessment provides a broader and more comprehensive picture of the learning and teaching of foreign languages. In the past, many foreign language tests consisted primarily of multiple choice, true/false, translation, grammar exercises, and short answer, with less emphasis placed on assessment of speaking and listening skills. Because learning a foreign language may take years, it is important to use a combination of assessment strategies so that the student and the family may witness the learning process. When educators are in a position to observe and collect information continuously, they send a message to the learner, the parents, and the administrators that the learning process is always growing and evolving. Educators are encouraged to select from among the many innovative assessment strategies available, a number of which are described below.

Traditional Assessment

Traditional assessment is a term often used to describe the means of gathering information on student learning through techniques such as multiple-choice, fill-in-the-blank, matching, or true/false questions, and essays. These approaches are particularly useful in assessing students' knowledge of information, concepts, and rules.

Because factual knowledge of information is one important aspect of a foreign language, carefully designed multiple-choice, true/false, and matching questions can enable the teacher to quickly assess the building blocks of the foreign language curriculum. Examples of such skills include the following: Can the student recognize important terms, relationships, and symbols? Does the student recognize how knowledge is organized into patterns, how generalizations are formed from evidence, how events are understood in chronological order, how frames of reference inform decision making, and how predictions can be made from data?

Effective assessment evaluates knowledge of facts as well as their connection to a broader body of knowledge. Proficiency in a foreign language depends on the ability to know and integrate facts into larger constructs.

Assessment Alternatives

There are many “alternatives” to traditional assessment that can be used to broaden the scope of the teacher’s classroom assessment activities. In some of these alternative assessment forms, students perform self-evaluations of their work. In others, teachers make informal observations about a student’s knowledge, skills, and performance that relate to subject-area topics.

The following list of alternative assessment techniques is by no means exhaustive. New assessment techniques are continually being developed to measure students’ progress toward achieving new academic performance standards and benchmarks.

Performance assessments require the student to create a product or construct a response that demonstrates a skill or an understanding of a process or concept. Performance assessments are commonly presented to students as projects that are done over an extended period of time and require that students locate, gather, organize, interpret, and present information. Typically, the project or product of the assessment is rated by the teacher or team of teachers using clearly delineated criteria. Practical linguistic applications in which students have to make appropriate choices from a menu, obtain the necessary information to get from point A to point B, explain the differences between one native language and another, or explain cultural aspects of a language are examples of performance assessment techniques.

During the latter part of the school year, students in Mr. Polk’s second-year French class spend a portion of a session listening to brief reports given by each of the students. Each report includes one description of end-of-the-year activities and one description of his or her plans for the upcoming summer vacation. As the students listen to the reports, they sort the activities into two columns according to whether each activity refers to something the student is going to do or something he or she has done already. Mr. Polk records each of the student’s responses and uses his records to assess each student’s listening comprehension, his or her understanding of a simple narration of events, and his or her ability to correctly identify the grammatical differences between immediate past and future tenses.

Authentic assessments are a form of performance assessment structured around a real-life problem or situation. Although traditional multiple-choice questions can describe real-life situations, the term “authentic assessment” usually is applied to performance assessments.

Diane will be travelling to Germany next semester as a foreign exchange student. For her final project in Mr. Garland's German class, she decides to create an Exchange Student Guide for her upcoming experience. Diane collects all the materials she will need as a foreign exchange student, including information about the travel agency, the airport, the flight

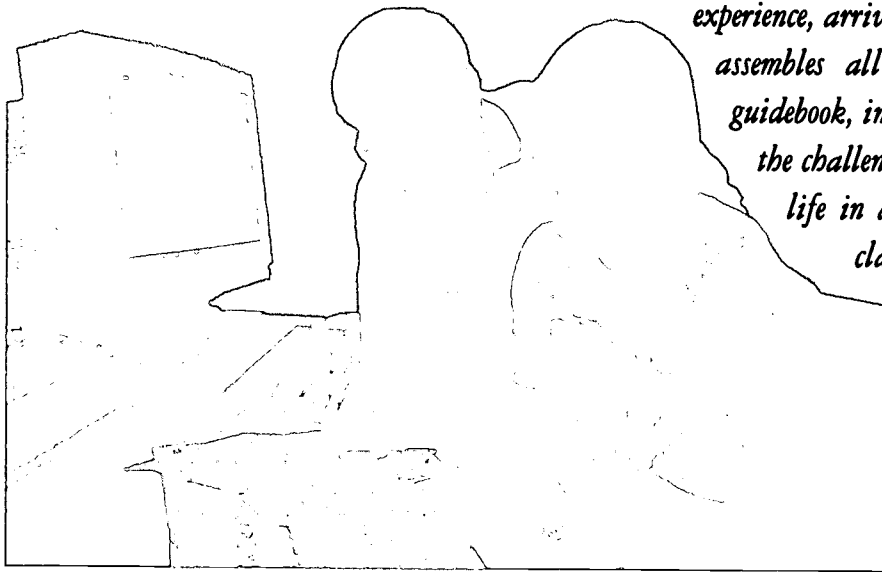

experience, arrival, the host family, and the school. She assembles all of this information into a mini-guidebook, including an essay in which she discusses the challenges she expects to face as she experiences life in another culture. Diane presents to the class in German the information she has

been able to collect. Mr. Garland reviews her project based on the quality of the information Diane has included and her ability to apply her German language skills to an upcoming real-life experience. After a discussion in German with Diane

about her project, Mr. Garland suggests that she speak to some former exchange students to get some tips about living in Germany and add this information to her guidebook.

Teacher observation is a form of data collection in which the instructor observes students performing various activities without interrupting the students' work or thoughts. Teachers use checklists, rating scales, or notebooks to record their judgment about students' competence in specific standards or benchmarks.

Ms. Smith observes her Spanish class as they converse in pairs. As Ms. Smith listens to Stan and Brooke discussing in Spanish their weekend activities, she notices that they both have good oral communication skills. In her notebook, she records that Stan and Brooke can both speak comfortably in Spanish, but that they often use incorrect lexical and grammatical constructions in their speech. Ms. Smith notes that both students are able to make themselves understood even when they do not use correct grammatical conventions.

Interviews require students to respond verbally to specific oral questions. The instructor asks questions, interprets answers, and records results. This form of assessment also allows a teacher to discuss student answers, to probe for more complete responses, and to identify misconceptions so they can be corrected. Correction should be postponed until the interview is completed to encourage the free flow of ideas and to reduce student apprehension.

In his Italian class, Mr. Duncan taught vocabulary related to family life in Italy. For the oral examination, Mr. Duncan interviews Cassie in Italian. He asks her questions about her family members, her home, and her responsibilities in her family. During the interview, Mr. Duncan assesses Cassie's ability to apply grammar and vocabulary concepts to oral responses, her oral communication skills, and the level of proficiency of her responses. After the interview, Mr. Duncan compliments Cassie's accent, pronunciation, and her knowledge of vocabulary. He then discusses her oral constructions and suggests some practice activities to help her study for the next examination.

Conferencing involves a two-way dialogue between a teacher and students or among students for the purpose of evaluating progress on a specific standard or benchmark or on a project.

Mr. DeVry assigns a project to his French class about describing the weather. Emmanuelle and Johnny decide to create a dialogue that the two of them will perform in front of the class. Emmanuelle, a native speaker of French, helps Johnny with vocabulary pertaining to storms, sunshine, rain, and snow. The following day, Johnny and Emmanuelle each brings to class a section of the dialogue written at home. As they compare their sections, Johnny asks Emmanuelle questions about his use of vocabulary and sentence construction. During their conference, Emmanuelle notices that Johnny is confusing some vocabulary terms. Johnny and Emmanuelle include Mr. DeVry in their conference to determine how to assist Johnny in his understanding of the vocabulary before they rewrite and perform their dialogue in front of the class.

Self-assessment enables students to examine their own work and reflect upon their accomplishments, progress, and development. The teacher may supply the student with assessment criteria or assist students in developing their own. This form of assessment assists students in developing the critical thinking and evaluative skills that lead to effective problem solving and independent learning.

Mrs. Endo reads a story aloud to her Japanese-language students. After her students listen to the story, they write short summaries of what Mrs. Endo read aloud, using the appropriate format and writing conventions in Japanese. Mrs. Endo wants her students to assess their own levels of proficiency in aural comprehension through their summarizations of the Japanese story they had heard. After her students write their summaries, Mrs. Endo provides a rubric for self-assessment. The students check their summaries to see if they covered all of the points in the rubric.

Peer assessment involves students evaluating each other's work using objective criteria. It requires students to reflect on the accomplishments of their classmates. By assessing others' work, students often see alternative reasoning patterns and develop an appreciation for diverse ways of approaching and solving problems.

In Mr. Luther's Spanish class, cooperative learning strategies require each student to collaborate in a group to achieve a common goal. Mr. Luther has assigned a role-playing activity of visiting a restaurant and ordering from the menu in Spanish. Each group must develop a situation that they will act out and which will be assessed by their classmates. The classmates must consider each groups' ability to communicate effectively and to make appropriate use of vocabulary and Spanish-language conventions.

Portfolio assessment is a purposeful collection of a student's work that provides a long-term record of the student's best efforts, progress, and achievement in a given area. Materials included may be decided on by the student, the teacher, or both. Depending on the intent, portfolios can serve as the basis for assessing individual student growth over time on given standards and benchmarks, or for assessing learning specific to the objectives addressed in a theme or unit. It is important to note that, although a portfolio can be used as an effective instructional tool, its use as an assessment tool demands a clear understanding of purpose, specification of the desired portfolio contents, and a definition of the methods of rating the individual components of the portfolio.

Mrs. Romano's French class is studying the cultures of various French-speaking countries. Ahmad has chosen to research the culture of Haiti. For his portfolio, Ahmad includes a short paper he wrote about a Haitian holiday, a recording of himself singing a Haitian song, an illustration he made for a Haitian story he has read, and a dialogue he wrote of a simple conversation between a Haitian student and an American student. Mrs. Romano evaluates Ahmad's portfolio according to the progress Ahmad has demonstrated in applying his knowledge of the French language while comparing and contrasting it with the Haitian Creole language and culture.

What could go into a foreign language portfolio?

A portfolio should capture the richness, depth, and breadth of a student's learning within the context of the instruction and the learning that takes place in the classroom. Elements of a portfolio can be stored in a variety of ways; for example, they can be photographed, scanned into a computer, or videotaped. The possible elements of a portfolio include the following selected student products:

Written Presentations

- expressive (diaries, journals, writing logs)
- transactional (letters, surveys, reports, essays)
- poetic (poems, myths, legends, stories, plays)

Performances

- role playing, drama
- dance/movement
- reader's theater
- mime
- choral readings
- music (choral and instrumental)

Representations

- maps
- graphs
- dioramas
- models
- mock-ups
- displays
- bulletin boards
- charts
- replicas

Visual and Graphic Arts

- murals
- paintings
- storyboards
- drawings
- posters
- sculpture
- cartoons
- mobiles

Media Presentations

- videotapes
- films
- audiotapes
- slides
- photo essays
- print media
- computer programs

Oral Presentations

- debates
- addresses
- discussions
- mock trials
- monologues
- interviews
- speeches
- storytelling
- oral histories
- poetry readings
- broadcasts

Journals are a form of record keeping in which students respond in writing to specific probes or questions from the teacher. The probes focus student responses on knowledge or skill specific to a standard or benchmark. Journals of accomplishments can also be used informally to assess the development of writing skills. As with portfolios, whether a journal becomes an assessment tool depends upon how it is organized and evaluated.

Mr. Graham asks students in his introductory Greek class to begin journals in which they will answer, in Greek, teacher-directed questions over the course of the term. The questions can start as simple questions using vocabulary or concepts learned in the class and advance to questions involving more complex responses and lexical structures. Mr. Graham also gives the students informal exercises to complete in their journals. He looks over the journals periodically to assess the ongoing progress of his students' understanding.

The Use of Assessment Rubrics

An assessment rubric is a set of rules used to rate a student's proficiency on performance tasks (for example, essays, short-answer exercises, projects, and portfolios). Rubrics can be thought of as scoring guides that permit consistency in assessment activities. A rubric often consists of a fixed scale describing levels of performance and a list of characteristics describing performance for each of the points on the scale. Rubrics provide important information to teachers, parents, and others interested in what students know and can do. Most often, scoring rubrics are developed by a teacher or team of teachers, but it may be desirable in some instances to involve students in the creation of the rubrics. Different scoring rubrics are usually developed for each assessment activity, although if the activities are similar enough, a single rubric can be applied.

For an example of a carefully developed six-point scoring rubric for use in a writing performance assessment, see the Florida Writes rubrics at the end of this chapter and see publications describing the Florida Writes statewide assessment program. Less formal rubrics that might be used with a high school assignment are shown in the following example:

High-school students in Ms. Tovesky's French class are studying French history and culture in the twentieth century. The instructional unit will emphasize the effects of the World Wars on the lives of the French people. During the unit, students read primary-source materials written

in French. Ms. Tovesky will use traditional tests to measure students' factual knowledge and language vocabulary. However, she also wants the students to demonstrate their ability to use their language skills to analyze historical events. With the students' involvement, agreement is reached that the class assignment will be for students to break into small groups to research an event in French history and culture. Each group will then make a presentation in French to the class in which the students will explain the effects of the historical event on French culture and make connections between the event and other aspects of past and present French society. After each presentation, each student will write a short response in French in which he or she will summarize the main points of each presentation.

Ms. Tovesky creates a four-category checklist to be used to monitor whether each student performs all required dimensions of the assignment. She also creates two five-point scoring rubrics to evaluate the proficiency of each student's class presentation. She creates a third rubric to evaluate the students' listening comprehension, as demonstrated from their written summaries of their classmates' oral presentations.

The simple checklist might look like this:

Student Name & Date:	
Research completed on schedule?	<input type="checkbox"/> Yes <input type="checkbox"/> No
Presentation organized and practiced?	<input type="checkbox"/> Yes <input type="checkbox"/> No
Presentation delivered to class?	<input type="checkbox"/> Yes <input type="checkbox"/> No
Summaries of other groups' presentations completed on time?	<input type="checkbox"/> Yes <input type="checkbox"/> No

Teacher Rubrics

Three simple five-point scoring rubrics are presented here as examples of how teachers might evaluate two important elements of the classroom presentation and one element of the written summaries completed after the class presentations. These rubrics have specific descriptions only at the extremes and mid-point. A “4” and a “2” can be used to indicate performances that fall between these extremes.

Element 1, Material Content of Presentation

<i>Characteristic</i>	<i>Scale</i>
Demonstrates a thorough understanding of the concepts and facts related to the historical event; provides insights into how the event affected French culture; connects the event to other aspects of French society.	5
	4
Displays a complete understanding of the concepts and facts related to the historical event; provides insights into how the event affected French culture.	3
	2
Demonstrates severe misconceptions about the concepts and facts related to the historical event.	1

Element 2, Use of Language Skills in Presentation

<i>Characteristic</i>	<i>Scale</i>
Expresses and interprets events and ideas in French with little or no error in level-appropriate vocabulary and grammar; pronounces most words correctly; communicates to audience through eye contact, appropriate speaking volume, and articulation.	5
	4
Expresses and interprets events and ideas in French with some errors in vocabulary and grammar; pronounces some words incorrectly; usually maintains eye contact and adequate speaking volume while communicating to the audience.	3
	2
Cannot adequately express or interpret events and ideas in French; makes gross errors in vocabulary and grammar; pronounces many words incorrectly; does not communicate to the audience.	1

Element 3, Aural Comprehension (demonstrated through written summaries of classmates' oral presentations)

<i>Characteristic</i>	<i>Scale</i>
Successfully uses the French language to summarize the main points of classmates' oral presentations; makes few or no errors in vocabulary usage or grammar in the written summaries.	5
	4
Demonstrates ability to use the French language to summarize the main points of classmates' oral presentations, with some omission of content; makes some errors in vocabulary usage and grammar in the written summaries.	3
	2
Unable to use the French language to summarize the main points of classmates' oral presentations; summaries have little relevant content; makes gross errors in vocabulary usage and grammar in the written summaries.	1

Student Rubrics

Students may also be asked to evaluate their own presentations. The rubrics created by the teacher can be rewritten as self-assessment rubrics for students so that students have the opportunity, when appropriate, to evaluate their own performances on a scale similar to their teacher's. The two student self-assessment rubrics presented below and on the next pages have been modified from the first two teacher rubrics.

Element 1, Material Content of Presentation

<i>Characteristic</i>	<i>Scale</i>
I understand the concepts and facts related to the historical event I chose to study; I discussed in my presentation how the event affected French culture; I connected the event to other aspects of French society.	5
	4
I understand the concepts and facts related to the historical event I chose to study; I discussed in my presentation how the event affected French culture.	3
	2
I don't really understand the concepts and facts related to the historical event I chose to study.	1

Element 2, Use of Language Skills in Presentation

<i>Characteristic</i>	<i>Scale</i>
I expressed and interpreted events and ideas in French; I made few or no errors in vocabulary, grammar and pronunciation; I was successful in communicating to the audience by maintaining eye contact and speaking at the appropriate volume.	5
	4
I expressed interpreted events and ideas in French; I made some errors in vocabulary, grammar, and pronunciation; I usually kept eye contact with the audience; most of the time the audience could hear and understand me.	3
	2
I couldn't adequately express or interpret events and ideas in French; I made a lot of mistakes in vocabulary, grammar, and pronunciation; I didn't really communicate to the audience.	1

The Florida Writes Rubrics

Another kind of rubric is used by the Florida Writes writing assessment program to assess the quality of student writing. Teachers can use this rubric to assess writing in the foreign language classroom and to prepare students for success on the state writing assessment. These rubrics are presented on the following pages.

Florida Writes Rubric: Grade 4

<p>6 Points</p>	<p>The writing is focused on the topic, has a logical organizational pattern (including a beginning, middle, conclusion, and transitional devices), and has ample supporting ideas or examples. The paper demonstrates a sense of completeness or wholeness. The writing demonstrates a mature command of language, including precision in word choice. Subject/verb agreement and verb and noun forms are generally correct. With few exceptions, the sentences are complete, except when fragments are used purposefully. Various kinds of sentence structures are used.</p>
<p>5 Points</p>	<p>The writing is focused on the topic with adequate development of supporting ideas. There is an organizational pattern, although a few lapses may occur. The paper demonstrates a sense of completeness or wholeness. Word choice is adequate but may lack precision. Most sentences are complete, although a few fragments may occur. There may be occasional errors in subject/verb agreement and in standard forms of verbs and nouns, but not enough to impede communication. The conventions of punctuation, capitalization, and spelling are generally followed. Various kinds of sentence structures are used.</p>
<p>4 Points</p>	<p>The writing is generally focused on the topic, although it may contain some extraneous or loosely related information. An organizational pattern is evident, although lapses may occur. The paper demonstrates a sense of completeness or wholeness. In some areas of the response, the supporting ideas may contain specifics and details, while in other areas, the supporting ideas may not be developed. Word choice is generally adequate. Knowledge of the conventions of punctuation and capitalization is demonstrated, and commonly used words are usually spelled correctly. There has been an attempt to use a variety of sentence structures, although most are simple constructions.</p>
<p>3 Points</p>	<p>The writing is generally focused on the topic, although it may contain some extraneous or loosely related information. Although an organizational pattern has been attempted and some transitional devices have been used, lapses may occur. The paper may lack a sense of completeness or wholeness. Some supporting ideas or examples may not be developed with specifics and details. Word choice is adequate but limited, predictable, and occasionally vague. Knowledge of the conventions of punctuation and capitalization is demonstrated, and commonly used words are usually spelled correctly. There has been an attempt to use a variety of sentence structures, although most are simple constructions.</p>

Florida Writes Rubric: Grade 4 (*continued*)

<p>2 Points</p>	<p>The writing may be slightly related to the topic or may offer little relevant information and few supporting ideas or examples. The writing that is relevant to the topic exhibits little evidence of an organizational pattern or use of transitional devices. Development of supporting ideas may be inadequate or illogical. Word choice may be limited or immature. Frequent errors may occur in basic punctuation and capitalization, and commonly used words may be frequently misspelled. The sentence structure may be limited to simple constructions.</p>
<p>1 Point</p>	<p>The writing may only minimally address the topic because there is little, if any, development of supporting ideas, and unrelated information may be included. The writing that is relevant to the topic does not exhibit an organizational pattern; few, if any, transitional devices are used to signal movement in the text. Supporting ideas may be sparse, and they are usually provided through lists, clichés, and limited or immature word choice. Frequent errors in spelling, capitalization, punctuation, and sentence structure may impede communication. The sentence structure may be limited to simple constructions.</p>
<p>Unscorable</p>	<p>The paper is UNSCORABLE because</p> <ul style="list-style-type: none"> • the response is not related to what the prompt requested the student to do. • the response is simply a rewording of the prompt. • the response is a copy of a published work. • the student refused to write. • the response is illegible. • the response is incomprehensible (words arranged in such a way that no meaning is conveyed). • the response contains an insufficient amount of writing to determine if the student was attempting to address the prompt. • the writing folder is blank.

Florida Writes Rubric: Grade 8

<p>6 Points</p>	<p>The writing is focused, purposeful, and reflects insight into the writing situation. The paper conveys a sense of completeness and wholeness with adherence to the main ideas, and its organizational pattern provides for a logical progression of ideas. The support is substantial, specific, relevant, concrete, and/or illustrative. The paper demonstrates a commitment to and an involvement with the subject, clarity in presentation of ideas, and may use creative writing strategies appropriate to the purpose of the paper. The writing demonstrates a mature command of language (word choice) with freshness of expression. Sentence structure is varied, and sentences are complete except when fragments are used purposefully. Few, if any, convention errors occur in mechanics, usage, and punctuation.</p>
<p>5 Points</p>	<p>The writing focuses on the topic, and its organizational pattern provides for a progression of ideas, although some lapses may occur. The paper conveys a sense of completeness or wholeness. The development of the support is ample. The writing demonstrates a mature command of language, including precision in word choice. There is variation in sentence structure, and, with rare exceptions, sentences are complete except when fragments are used purposefully. The paper generally follows the conventions of mechanics, usage, and spelling.</p>
<p>4 Points</p>	<p>The writing is generally focused on the topic but may include extraneous or loosely related material. An organizational pattern is apparent, although some lapses may occur. The paper exhibits some sense of completeness or wholeness. The support, including word choice, is adequate, although development may be uneven. There is little variation in sentence structure, and most sentences are complete. The paper generally follows the conventions of mechanics, usage, and spelling.</p>
<p>3 Points</p>	<p>The writing is generally focused on the topic but may include extraneous or loosely related material. An organizational pattern has been attempted, but the paper may lack a sense of completeness or wholeness. Some support is included, but development is erratic. Word choice is adequate but may be limited, predictable, or occasionally vague. There is little, if any, variation in sentence structure. Knowledge of the conventions of mechanics and usage is usually demonstrated, and commonly used words are usually spelled correctly.</p>

Florida Writes Rubric: Grade 8 *(continued)*

<p>2 Points</p>	<p>The writing is related to the topic but includes extraneous or loosely related material. Little evidence of an organizational pattern may be demonstrated, and the paper may lack a sense of completeness or wholeness. Development of support is inadequate or illogical. Word choice is limited, inappropriate, or vague. There is little, if any, variation in sentence structure, and gross errors in sentence structure may occur. Errors in basic conventions of mechanics and usage may occur, and commonly used words may be misspelled.</p>
<p>1 Point</p>	<p>The writing may only minimally address the topic. The paper is a fragmentary or incoherent listing of related ideas or sentences or both. Little, if any, development of support or an organizational pattern or both is apparent. Limited or inappropriate word choice may obscure meaning. Gross errors in sentence structure and usage may impede communication. Frequent and blatant errors may occur in the basic conventions of mechanics and usage, and commonly used words may be misspelled.</p>
<p>Unscorable</p>	<p>The paper is UNSCORABLE because</p> <ul style="list-style-type: none"> • the response is not related to what the prompt requested the student to do. • the response is simply a rewording of the prompt. • the response is a copy of a published work. • the student refused to write. • the response is illegible. • the response is incomprehensible (words are arranged in such a way that no meaning is conveyed). • the response contains an insufficient amount of writing to determine if the student was attempting to address the prompt. • the writing folder is blank.

Florida Writes Rubric: Grade 10

<p>6 Points</p>	<p>The writing is focused and purposeful, and it reflects insight into the writing situation. The organizational pattern provides for a logical progression of ideas. Effective use of transitional devices contributes to a sense of completeness. The support is substantial, specific, relevant, and concrete. The writer shows commitment to and involvement with the subject and may use creative writing strategies. The writing demonstrates a mature command of language with freshness of expression. Sentence structure is varied, and few, if any, convention errors occur in mechanics, usage, punctuation, and spelling.</p>
<p>5 Points</p>	<p>The writing is focused on the topic, and its organizational pattern provides for a logical progression of ideas. Effective use of transitional devices contributes to a sense of completeness. The support is developed through ample use of specific details and examples. The writing demonstrates a mature command of language, and there is variation in sentence structure. The response generally follows the conventions of mechanics, usage, punctuation, and spelling.</p>
<p>4 Points</p>	<p>The writing is focused on the topic and includes few, if any, loosely related ideas. An organizational pattern is apparent, and it is strengthened by the use of transitional devices. The support is consistently developed, but it may lack specificity. Word choice is adequate, and variation in sentence structure is demonstrated. The response generally follows the conventions of mechanics, usage, punctuation, and spelling.</p>
<p>3 Points</p>	<p>The writing is focused but may contain ideas that are loosely connected to the topic. An organizational pattern is demonstrated, but the response may lack a logical progression of ideas. Development of support may be uneven. Word choice is adequate, and some variation in sentence structure is demonstrated. The response generally follows the conventions of mechanics, usage, punctuation, and spelling.</p>
<p>2 Points</p>	<p>The writing addresses the topic but may lose focus by including extraneous or loosely related ideas. The organizational pattern usually includes a beginning, middle, and ending, but these elements may be brief. The development of the support may be erratic and nonspecific, and ideas may be repeated. Word choice may be limited, predictable, or vague. Errors may occur in the basic conventions of sentence structure, mechanics, usage, and punctuation, but commonly used words are usually spelled correctly.</p>

Florida Writes Rubric: Grade 10 (*continued*)

<p>1 Point</p>	<p>The writing addresses the topic but may lose focus by including extraneous or loosely related ideas. The response may have an organizational pattern, but it may lack a sense of completeness or closure. There is little, if any, development of the support, and the support may consist of generalizations or fragmentary lists. Limited or inappropriate word choice may obscure meaning. Frequent and blatant errors may occur in the basic conventions of sentence structure, mechanics, usage, and punctuation, and commonly used words may be misspelled.</p>
<p>Unscorable</p>	<p>The paper is UNSCORABLE because</p> <ul style="list-style-type: none"> • the response is not related to what the prompt requested the student to do. • the response is simply a rewording of the prompt. • the response is a copy of a published work. • the student refused to write. • the response is illegible. • the response is incomprehensible (words are arranged in such a way that no meaning is conveyed). • the response contains an insufficient amount of writing to determine if the student was attempting to address the prompt. • the writing folder is blank.

KEY CHAPTER POINTS

- **Assessment processes seek to measure students' acquisition and application of skills and all aspects of knowledge and its connections.**
- **Assessment activities in the classroom should be integral, ongoing parts of the instruction and learning process.**
- **Teachers should use a variety of assessment methods and modifications to address different learning styles and student needs.**
- **Teachers have a wide variety of options for collecting information on the degree to which students have acquired and can apply knowledge and skills specific to foreign languages.**
- **Assessment activities will produce useful information to the degree that they are carefully planned, well organized, and consistently applied.**
- **Accurate assessment of student achievement provides a sound basis for classroom instructional decisions.**

Chapter 7: The Learning Environment

CHAPTER HIGHLIGHTS

- Design of Facilities
- Safety
- Scheduling
- Learning Resources
- Selection of Materials
- Using Technology
- Snapshot of an Effective Foreign Language Classroom

Goal 4: School boards provide a learning environment conducive to teaching and learning.

Florida's System of School Improvement and Accountability

Twenty-first-century classrooms envisioned by Florida's education reform initiative allow students to experience learning in its real-world context. These active learning environments extend beyond the four walls of the classroom into the home, the local community, and even the larger global community. Teachers are encouraged to incorporate more community projects and more interaction with their local communities. For example, teachers may provide opportunities for students to participate in job-shadowing programs with community leaders and members of the business community. Local citizens may be invited into classrooms to share knowledge, skills, or ideas, or to participate in classroom projects. Students may also have direct access to the global community via computers, satellite transmissions, teleconferencing, and other technology, enabling them to work with other students and experts across the state, in other states, or in other countries.

Design of Facilities

There are many factors to consider in designing a physical environment that facilitates the most effective learning. The ideal foreign language classroom is inviting. It has enough space for the free and flexible movement needed for a wide variety of learning approaches, such as cooperative learning, project work, and learning centers. Classroom furnishings may consist simply of tables and chairs, or desks and work areas that can be arranged and rearranged. The acoustics need to facilitate both classroom interaction and quiet time for reflection. Classrooms should have adequate storage and security for equipment and supplies; special consideration should be given to the proper storage of computers and other special equipment. In addition, classrooms should have appropriate technology support facilities, such as network access ports and electrical power outlets with ground fault circuit interruption protection. Teachers also need a carefully designed space for research, planning, collaboration with other teachers, and reflection. The elements considered in the physical design of classrooms can apply in designing the teacher's space as well.

The elementary language classroom should be rich with opportunities to encourage the active and authentic learning of a language. There might be areas for role playing, dancing, and dramatic performances and a music center with tape recorders, CD players, tapes, and musical instruments. Kitchen facilities might also be available for preparing and experiencing foods from other cultures.

The ideal foreign language department in the middle school and high school is housed in an area of the school with access to common rooms or areas for special activities, such as dancing, role playing, dramatic performances, preparing foods, and an audio, video, and computer center.

Educators should become familiar with the legal requirements concerning students with disabilities (I.D.E.A. and Rehabilitation Act, Section 504), which state that classrooms must accommodate disabled students. The Americans with Disabilities Act describes people as disabled if they have a physical or mental impairment that substantially limits one or more activities. There are many possible adaptations to the classroom, hallway, cafeteria, vocational workshop, or other areas of the school that can meet the needs of students with disabilities. These might include ramps, elevators, and raised work spaces for students who use wheelchairs; sound-absorbing

materials to reduce reverberation for hearing-impaired students; and sufficient lighting for students with visual impairment.

Local school districts have many factors to consider when evaluating what is needed for the design or redesign of facilities. These factors might include local needs and goals, budgets, instructional methods, adaptations to meet the needs of individual students, potential changes in student enrollment, and flexibility to allow for changes to meet new conditions in the future.

Safety

Goal 5: Communities provide an environment that is drug-free and protects students' health, safety, and civil rights.

Florida's System of School Improvement and Accountability

Schools should incorporate safety and health practices into the school environment. A safe, secure, learning environment for all students is an essential responsibility of the whole school community. A manual specifying safety policies and regulations and incorporating state and federal policies is available in all local schools. One aspect of school safety involves the physical environment, which should provide safe, clean facilities that meet all legal requirements. The environment should be free of odors, allergens, and harmful chemicals such as asbestos. To provide safety in the physical environment for students with disabilities, adaptations may be necessary, such as flashing fire alarms and special procedures for evacuation. A second aspect of school safety involves the supervision of students. Teachers must be aware of and understand safety procedures inside the school building, on school grounds, on field trips, and at special school events. Class activities conducted away from the classroom need to be carefully planned and examined for possible hazards. A third aspect of safety involves providing an environment in which everyone is safe from verbal, physical, and psychological harm. Teachers should also be prepared to use strategies for crisis intervention and conflict resolution.

Scheduling

Adequate time is essential for quality instruction and learning in order for students to achieve high academic standards. Students need sufficient time for concentrated

involvement in learning experiences or projects. They may need time for extended discussions, experimentation, comprehension, and reflection.

Florida's education reform initiative envisions that a strong element of the school improvement process will be provided by the local school community. This will have a significant effect on teachers' work schedules and on the time teachers spend in preplanning, instruction, assessment, and evaluation of classroom activities. For example, professional educators will need time to research new instructional approaches and to further develop integrated, meaningful lesson plans. Teachers may need additional time for selecting teaching materials, designing student assessment strategies, and structuring specific learning experiences. Time must also be available for conferencing with other teachers, counselors, psychologists, and administrators, and for communicating with parents.

Another aspect of scheduling involves the range of teacher responsibilities and class size, both of which can have a significant impact on the classroom environment. No single formula is adequate to determine the appropriate work load for teachers or the appropriate class size for all schools and districts. Generally, an acceptable range is established at the district level, taking into consideration the characteristics of the unique student population, the composition of individual classes, funding levels, current and planned education reforms, extra duties and activities teachers undertake, and the organization and administration of the school.

To increase the effectiveness of the way time is used for teaching and learning, local school districts and schools are investigating ways to amend their present time structures. For example, educators are using block scheduling, year-round calendars, combined courses, and other strategies.

Learning Resources

Classrooms today are alive with activity and use a broad range of resources: from simple construction paper and crayons, baby food jars, buttons and other manipulatives, newspapers, films, and textbooks to electronic encyclopedias, equipment and software for teleconferencing and satellite transmissions, and sophisticated laboratory devices. There may be colorful displays on the walls, maps to pull down, globes to touch, artifacts and literature reflecting the target language

and the culture of its people, and a variety of primary and secondary source materials, including art prints and music. Computer stations with multimedia capabilities, software, and up-to-date instructional materials are used to encourage active and authentic learning of the target language.

Instructional materials, assistive technology, and equipment are available for students with a variety of special needs. For example, for students with visual impairment, Braille and large-print books can be obtained through the Florida Instructional Materials Center. Adaptive computers, low-vision optical aids, and print-enlarging equipment are also available for vision-impaired students. Close-captioned videos for students with hearing impairments are developed at the Florida School for the Deaf and the Blind. As with instructional modifications, these specialized materials can often benefit students with learning difficulties who do not qualify for exceptional-student education programs.

Selection of Materials

The careful selection of instructional materials that support the development of conceptual understanding and encourage active learning is critical to a successful foreign language program. Teachers play a central role in the selection of instructional materials both for the overall school and for their classrooms. Whenever possible, teachers should collaborate to consider books, resources, and other major purchases for the school or district.

In developing their instructional plans, teachers consider a wide range of materials for use in their classrooms. In addition to textbooks, useful materials include supplementary trade books, reference materials, posters, supplies, audiovisual materials, computer software, and multimedia materials and supplies. Teachers should base their selection of classroom materials on the instructional plan and the specific needs of the students. They might examine the content and presentation of the materials from many different perspectives, including the vision and goals of the local school, the goals of their specific instructional plan, and the school budget. Educators should refer to state guidelines and district policies as possible resources for evaluating and selecting specific materials.

Using Technology

The use of technology is already changing the world of business and industry and is transforming our schools as well. Because technology is such a powerful tool for teachers and students, opportunities for training in its use and application should be a part of all education programs. Achieving high levels of skill in the use of technology will help students reach Florida's high academic standards and contribute to their success in the workplace.

The application of technology in a foreign language classroom can benefit students in a multitude of ways. For example, it can

- give students more control and involvement in their own learning process;
- allow for individualized instruction;
- promote investigative skills;
- serve as an access to almost unlimited sources of information;
- provide students with skills to measure, monitor, and improve their own performance and develop competencies for the workplace;
- make learning more interesting for students;
- enable students to communicate with people from many parts of the world, bringing the sights, sounds, and thoughts of other languages and cultures into the classroom;
- expand authentic language experiences;
- give students access to authentic publications in the target language;
- give students access to television from other countries which allows students to hear how native speakers use their language to communicate with each other and reveals nonverbal and cultural dimensions of the language;
- provide opportunities to apply knowledge to simulated or real-life projects; and
- prepare students for a high-tech world of work.

Technology can transform the classroom/language skills laboratory into a multimedia learning center, giving teachers and students access to word processing, presentation tools, graphics, media integration, desktop publishing, and telecommunications

resources. Students merely need to press a button or tap a few keys and the world unfolds before them. Technology can recreate the multi-dimensional nature of language as it exists within the visual, social, and cultural world, allowing for immersion in the truest sense of the word.

Distance learning uses communications technology to bring teaching and learning together through the transmission of information or expertise from one location to another. The use of this technology allows students to interact directly with teachers, experts, and students outside of their community.

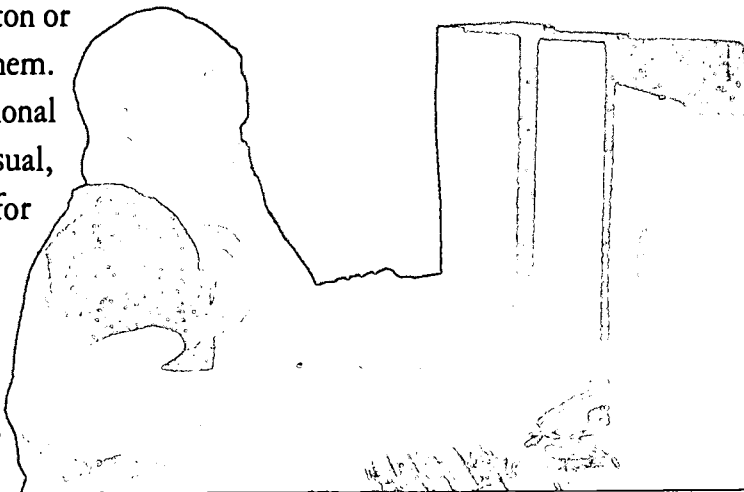

Distance learning technologies are a valuable resource for foreign language education; they can enrich and enhance the learning experience for all students. Using the same technology that distributes most broadcast and cable TV signals, satellite-based distance learning services can reach hundreds or thousands of receiving sites located all over the United States. Some cable companies have developed services targeted specifically to educators and students. Through microwave systems and fiberoptic cables, distance learning programming can be more readily distributed to remote areas. Educators with computers and modems have access to an increasingly large selection of on-line data resources and dial-up bulletin boards. These services typically offer electronic mail, research databases, forums, and discussion groups for a variety of special interests.

Using telecommunications, students in Clearwater can exchange ideas with students in Ocala, Miami, and Pensacola, in other communities across Florida, in other states, and in other countries. Students can write letters to students in other countries on-line or contribute news items to a jointly published on-line newspaper. Students can discuss topics of international concern with students in England, Russia, and Sweden. These examples are not futuristic visions. They are typical experiences happening right now in schools across the country.

One technological tool that promises to have innovative applications in future classrooms is the use of live interactive video over an electronic on-line network. This

technology can provide opportunities for students to take electronic “field trips” to the bottom of the ocean, to the rain forests, to the Arctic, or to outer space.

As technology evolves, it will be essential to evaluate which new tools will be most useful in the educational setting, given program goals, ever-expanding student needs, and existing equipment. Educators will need to keep up with the variety of technologies and their applications. New equipment and software programs become available at a rapid rate; the best choice for today may be quickly outmoded. Therefore, any recommendations for specific hardware or software programs should be flexible, forward thinking, and based on extensive research so that money will be well spent. In addition, teachers must make a commitment to become personally adept in using educational technology. They will need to add to and refine their skills on a regular basis by keeping up with new technological developments and exploring additional capabilities of current technology. Appropriate training and support opportunities should be established by administrators for that purpose.

The age of technology affords educators a wealth of choices. As the use of technology expands into education, educators will have more opportunities to discover new ways to explore ideas and meet the diverse individual needs of students. The availability and appropriate use of technology is indispensable in developing programs that will prepare the students of today to face continuing advancements in the workplace and to meet the technological changes that will occur in the 21st century.

Snapshot of an Effective Foreign Language Classroom

High school students from Canada, Mexico, and the United States are working together to explore ways of preserving environmental balance globally. The classrooms at each site are equipped with video teleconferencing displays. Students discuss specific environmental problems and with the aid of computers, retrieve data necessary to investigate the sources of environmental change.

A student from Mexico provides input on the environmental hazards caused by polluting rivers with chemical waste: “En áreas cerca de la frontera con Estados Unidos, debido a la falta de regulaciones, las industrias echan los desperdicios al agua. La contaminación del agua está causando enfermedades a los residentes del pueblo.” A student from Canada responds, “Les eaux de pluies acides ont pollué les cours d'eau dans beaucoup de régions hors des villes.”

The language students from the United States, who are proficient in both Spanish and French, discuss solutions to the problem: “El Tratado de Libre Comercio provee medios para ayudar a Canadá, a los Estados Unidos y a México a aliviar el problema a través de nuevas técnicas que ayudarán a eliminar la contaminación ambiental. Seulement quand l’industrie arrive à réduire les causes de pluies acides pouvons-nous commencer à renouveler nos ressources naturelles.”

The students brainstorm other solutions. Recommendations are provided in different languages by students from different countries. A final proposal is developed and presented by the students to an international summit that is studying environmental concerns.

These students are learning behaviors and skills needed for success in the 21st century. They are using research skills coupled with technology to solve an authentic problem, working cooperatively with others from different cultures, and using a variety of knowledge sources. Technology enables the students to apply their language skills to diverse situations involving knowledge from various subject areas. Through this process, students are learning to become active global citizens and lifelong learners.

KEY CHAPTER POINTS

- Community resources and the latest technology should be tapped to bring the world into the classroom, allowing students to encounter learning in real-world contexts.
- Effective facilities are carefully planned, taking into account changes in student enrollments, student abilities, budgets, instructional needs, and the goals of the foreign language program.
- A safe, secure, learning environment is a priority for all students.
- Time can be used creatively, as a flexible resource.
- Classrooms should be rich with learning resources that afford opportunities for observation, manipulation of objects, exploration, experimentation, and discussion.
- The careful selection of instructional materials that effectively support the development of conceptual understanding and encourage active learning is critical to a successful foreign language program.
- As technology expands into education, foreign language educators can discover new ways to explore diverse ideas and meet the individual needs of students.

Chapter 8: Professional Development

CHAPTER HIGHLIGHTS

- The Importance of Professional Development
- Rethinking Professional Development
- Preservice Education
- Effective Professional Development
- The Commitment to Lifelong Learning
- Attributes of the Professional Educator

The Importance of Professional Development

Professional development is a continuous improvement process lasting from the time an individual decides to enter the education profession until retirement. It encompasses the processes that educators engage in to initially prepare themselves, continuously update themselves, and review and reflect on their own performance. If educators are to successfully prepare students for the future, they must be prepared for the future themselves. Schools and districts must be committed to offering the highest quality professional development opportunities for their teachers.

Rethinking Professional Development

Just as knowledge and skill requirements are changing for Florida students, so, too, are those for Florida educators. The globalization of commerce and industry, the explosive growth of technology, and the expansion of foreign language knowledge demand that teachers continually acquire new knowledge and skills. The challenge for every avenue of professional development is to provide learning opportunities in which preservice teachers, as well as more experienced teachers, can develop or acquire the necessary knowledge and skills to deal with change and pursue lifelong learning.

Preservice Education

Preservice education encompasses the training, preparation, and courses that future teachers undertake before certification. Research in schools across the nation shows that a crucial component of restructuring education is the teacher preparation program. Preservice education must develop prospective teachers' capacity to facilitate student learning and to be responsive to student and community needs, interests, and concerns (Darling-Hammond, 1993). To that end, teacher education programs at the college or university level are encouraged to incorporate the following:

- courses that develop a broad base of competencies, content area knowledge, and experiences for graduates to bring to the teaching profession;
- courses that include both theory and practice in teaching a diversity of students, including students with special needs;
- courses that present practical, proven, up-to-date approaches to foreign language curriculum, instruction, and assessment;
- training in the ability to understand and nurture the academic, emotional, and physical development of students;
- experiences that develop effective communication, team-building, and conferencing skills;
- extensive and ongoing student-teaching experiences that are supervised by qualified teachers and college or university personnel; and
- recognition that effective teachers must continue to grow professionally throughout their careers and must be proactive in seeking resources, assistance, and opportunities for growth.

By reexamining beliefs about teaching and learning, education faculties can design and implement improved teacher education programs. The goals of any such program are to produce creative, motivated, knowledgeable, confident, and technologically literate beginning teachers committed to lifelong growth.

Effective Professional Development

The term "professional development" is defined in this framework as those processes that improve and enhance the job-related knowledge and skills of practicing classroom teachers. Professional development provides the continuous, on-the-job

training and education needed to improve teaching and, ultimately, student learning. Florida's school improvement initiative encourages local districts and schools to assume greater responsibility for professional development programs tailored to serve local school improvement efforts. Those educators charged with the design of these programs are urged to reflect upon the following characteristics of useful professional development:

An effective professional development program actively engages educators in the improvement process.

One facet of Florida's school improvement and accountability initiative is to encourage local teams of educators to identify needs and clarify goals, solve problems, plan programs, monitor them reflectively, and make necessary adjustments. Professional development programs are an ideal way for districts to empower teachers to share in the decision-making processes within their schools and districts. Planners of professional development programs should encourage teachers to actively analyze their work, identify any needs and gaps in knowledge and skill, and provide suggestions about which resources might best close these gaps. Once educators have identified strategies to make school and classroom improvements, administrators and planners should use teacher expertise, wherever possible, in the preparation and delivery of professional development programs to support these strategies.

An effective professional development program continually updates the teacher's knowledge base and awareness.

Systemic reform requires that teachers incorporate new teaching methods and content to help students achieve Florida's new rigorous academic standards. Consequently, professional development programs must provide teachers with opportunities to acquire a broad base of new subject-area knowledge and instructional strategies so that Florida educators are better equipped to implement strategies to improve schools and raise achievement.

Educators will also need ongoing training in the use of educational technology. Equally important, professional development program planners are encouraged to work with teachers in identifying changes in student diversity, needs, and problems. If teachers are to successfully engage students in the learning process,

they must understand students' cultural and linguistic backgrounds and life circumstances. In addition, professional development programs will need to address the issue of change: how to incorporate and embrace change in the classroom and how systemic reform impacts teaching methods and curriculum planning.

An effective professional development program establishes a collaborative environment based on professional inquiry.

Effective professional development encourages knowledge sharing and other opportunities for teachers to share ideas and experiences. Professional development strategies are most likely to be successful when teachers are encouraged to reflect on their own practices, identify problems and possible solutions, share ideas about instruction, engage in scholarly reading and research, and try out new strategies in their classrooms. Thus, staff networking, clinical education partnerships with universities in peer coaching, and mentoring are important tools to incorporate into long-range professional development planning. Peer coaching offers a nonthreatening environment in which teachers can implement new techniques and ideas and receive feedback from colleagues. Mentoring can be especially beneficial to new teachers; this mutually rewarding relationship with an experienced educator might include an exchange of teaching materials and information, observation and assistance with classroom skills, or field-testing of new teaching methods.

An effective professional development program is continuously improved by follow-up.

Professional development is an ongoing process; it does not simply consist of isolated presentations given by an expert or consultant. Effective inservice includes introductory training as well as a plan for ongoing monitoring, enhancement, and follow-up of learning. Research corroborates the need for follow-up that continues long enough for new behaviors learned during introductory training to be incorporated into teachers' ongoing practice (Sparks and Loucks-Horsley, 1989). Planners can build this kind of reinforcement into professional development programs in a number of ways, including providing opportunities to practice new methods in coaching situations, arranging for ongoing assistance and support, and systematically collecting feedback from teachers.

An effective professional development program is actively and continuously supported by administrators.

Numerous studies (McLaughlin & Marsh, 1978; Stallings and Mohlman, 1981; Loucks and Zacchie, 1983; Fielding and Schalock, 1985; Loucks-Horsley et al, 1987) reveal that active support by principals and district administrators is crucial to the success of any improvement effort. This supportive role begins with leadership that places a high priority on professional development, promotes communication, and fosters a spirit of collegiality. It extends to the thoughtful allocation of resources, including time. Up-to-date materials, classroom equipment, and time for educators to pursue opportunities for professional development and to practice and implement new teaching strategies are essential to ongoing staff improvement efforts. As Judy-Arin Krupp (1991) suggests, schools should

develop a norm for growth...that says staff development is not here to correct defects but to offer opportunities for everyone in the system to grow. Next, we need to recognize that everyone grows differently. We ask, "How can I help you grow as an educator so that we can provide the best possible education for students in this school?" (p. 3)

The Commitment to Lifelong Learning

Effective foreign language educators do not rely solely on inservice programs provided by their schools or districts. They take personal responsibility for planning and pursuing other professional and personal development activities, including growth in proficiency in the language(s) they teach.

As self-directed learners, quality foreign language educators strive to gain new insights, improve their skills, and broaden their perspectives. They work at the school and district levels to create professional development experiences for themselves and their colleagues. They form alliances with supervisors,

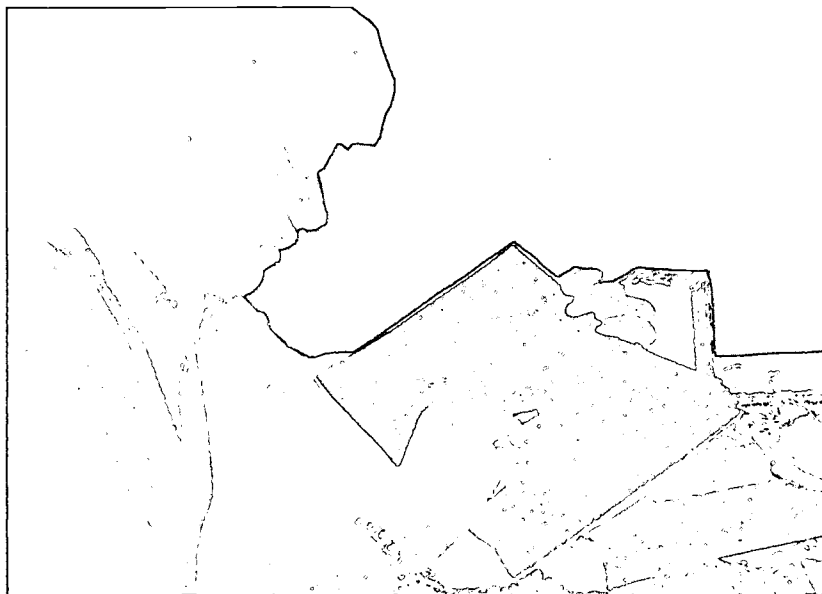

professional development specialists, principals, and other educators across all grade levels. They seek out quality workshops and courses. They take advantage of courses offered through technologies, such as on-line learning, interactive videoconferences, satellite teleconferences, summer inservices abroad, and other innovative approaches to their own education. They also engage in experiential learning opportunities, such as “job shadowing” in their discipline or other practical, real-world experiences in the community.

A particularly useful tool for professional development in foreign languages can be membership in professional organizations. In addition to providing invaluable opportunities for idea sharing and networking with other teachers, many professional organizations also publish journals that feature the latest developments in the field, assess new strategies and methodologies, and highlight new career and training opportunities. Professional organizations specific to foreign languages include the following:

American Association of Teachers of French (AATF)

Fred Jenkins, Executive Director
 57 East Armory Drive
 Champaign, IL 61820
 (217) 333-2842

American Association of Teachers of German (AATG)

Helenè Zimmer-Loew, Executive Director
 112 Haddontowne Court, #104
 Cherry Hill, NJ 08034
 (609) 795-5553

American Association of Teachers of Italian (AATI)

Anthony Mollica, President
 P.O. Box 890
 Lewiston, NY 14092-0890
 (904) 788-2674

American Association of Teachers of Slavic and East European Languages (AATSEEL)

George Gutsche, Secretary-Treasurer
 University of Arizona, Modern Languages 340
 Tucson, AZ 85721
 (602) 321-9765

American Association of Teachers of Spanish and Portuguese (AATSP)

Lynn Sandstedt, Executive Director
 Frasier Hall Room 8, University of Northern Colorado
 Greeley, CO 80639
 (303) 351-1090

American Association of Teachers of Spanish and Portuguese, Florida Chapter (AATSP)

Gregg Kynast, President
 Gainesville High School
 1900 N W 13th Street
 Gainesville, FL 32609
 (904) 955-6707

American Classical League (ACL)

Glenn Dutra, Administrative Secretary
 Miami University
 Oxford, OH 45056
 (513) 529-7741

American Council on the Teaching of Foreign Languages (ACTFL)

6 Executive Plaza
 Yonkers, NY 10701-6801
 (914) 963-8830

Association of Departments of Foreign Languages (ADFL)

Elizabeth Welles, Director
 10 Astor Place
 Modern Language Association
 New York, NY 10003
 (212) 614-6320

Association of Foreign Language Teachers of Dade County (AFLTD)

Karen Kropp-Velazquez, Executive Director

South Dade Senior High

28401 SW 167th Avenue

Homestead, FL 33030

(305) 247-4244

Chinese Language Teachers Association (CLTA)

Madeline Chu, Executive Director

1200 Academy Street

Kalamazoo College

Kalamazoo, MI 49006

(616) 383-5671

Florida American Association of Teachers of Slavic and East European Languages (FAATSEEL)

Paul Stevens, President

Stetson University - History Department

Deland, FL 32720

(904) 882-7535

Florida Association of Teachers of French (FATF)

Teresita Bertot, President

20022 Winona Place #1

West Palm Beach, FL 33405

(407) 655-7358

Florida Association of Teachers of German (FATG)

Lillian Unger, President

Manatee Community College

P.O. Box 1879

Bradenton, FL 34206

(813) 755-1511

Florida Consortium of Multilingual and Multicultural Education (FCOMME)

Gabriel Valdes, Chairperson
 Palm Beach County Public Schools
 3372 Forest Hill Boulevard
 West Palm Beach, FL 33406-5870

Florida Foreign Language Association (FFLA)

Linda Gaskin, Executive Secretary
 Ed White High School
 1700 Old Middleburg Road
 Jacksonville, FL 32210
 (904) 693-7620

Florida Language Association of Managers in Education (FLAME)

Doris Rodriguez, President
 Orange County Public Schools
 445 West Amelia Street
 Orlando, FL 32801
 (407) 849-3337

International Association of Learning Laboratories (IALL)

Trisha Dvorak, President
 812 Washington
 2018 MLB, University of Michigan
 Ann Arbor, MI 48109
 (313) 764-0424

Linguistic Society of America (LSA)

Margaret Reynolds, Executive Director
 1325 18th St. NW, Suite 211
 Washington, DC 20036
 (202) 835-1714

Modern Language Association (MLA)
Phyllis Franklin, Executive Director
 10 Astor Place
 New York, NY 10003
 (212) 475-9500

National Association for Bilingual Education (NABE)
James Lyons, Executive Director
 National Headquarters
 1220 L Street NW, Suite 605
 Washington, DC 20005
 (202) 898-1829

National Association of District Supervisors of Foreign Languages (NADSFL)
Jean Teel, President
 7235 Antioch
 Shawnee Mission Public Schools
 Shawnee Mission, KS 66204
 (913) 677-6415

National Association of Self-Instructional Language Programs (NASILP)
John Means, Executive Director
 Critical Languages 022-38
 Temple University
 Philadelphia, PA 19122
 (215) 787-8268

National Council of Secondary Teachers of Japanese (NCSTJ)
Hitomi Tamura, President
 3339 Tempest Drive
 Lake Oswego, OR 97035
 (503) 697-8560

National Council of State Supervisors of Foreign Languages (NCSSFL)

Paul Sandrock, President
 P.O. Box 7841
 Wisconsin Department of Education
 Madison, WI 53707-7841
 (608) 266-3079

National Network for Early Language Learning (NNELL)

Nancy Rhodes, Executive Secretary
 1118 22nd St. NW
 Center for Applied Linguistics
 Washington, DC 20037
 (202) 429-9292

Southern Conference on Language Teaching (SCOLT)

Lee Bradley, Executive Director
 Valdosta State University
 Modern Language Department
 Valdosta, GA 31698
 (912) 333-7358

Teachers of English to Speakers of Other Languages (TESOL)

Susan Bayley, Executive Director
 1600 Cameron Street, Suite 300
 Alexandria, VA 22314
 (703) 836-0774

Attributes of the Professional Educator

The goal underlying any Florida professional development program is to prepare educators in the competencies needed to successfully implement Florida's long-term education improvement initiative. Shortly after the creation of Florida's school improvement and accountability initiative, the Education Standards Commission began a project to identify and validate those teacher competencies necessary to successfully implement this initiative. The Commission's efforts focused on the preparation and proficiency of teachers in helping students achieve higher and more rigorous standards. The Commission identified twelve broad principles and key

indicators that reflect the high performance standards required of Florida's teachers. These "accomplished practices" are summarized below.

Diversity

The professional educator uses teaching and learning strategies that reflect each student's culture, learning styles, special needs, and socioeconomic background.

Assessment

The professional educator uses assessment strategies (traditional and alternative) to assist the continuous development of the learner.

Planning

The professional educator plans, implements, and evaluates effective instruction in a variety of learning environments.

Human Development and Learning

The professional educator uses an understanding of learning and human development to provide a positive learning environment that supports the intellectual, personal, and social development of all students.

Learning Environments

The professional educator creates and maintains positive learning environments in which students are actively engaged in learning, social interaction, cooperative learning, and self-motivation.

Communication

The professional educator uses effective communication techniques with students and all other stakeholders.

Critical Thinking

The professional educator uses appropriate techniques and strategies that promote and enhance the critical, creative, and evaluative thinking capabilities of students.

Technology

The professional educator uses appropriate technology in teaching and learning processes.

Role of the Teacher

The professional educator works with various education professionals, parents, and other stakeholders in the continuous improvement of the educational experiences of students.

Continuous Improvement

The professional educator engages in continuous professional quality improvement for self and school.

Knowledge and Understanding

The professional educator demonstrates knowledge and understanding of the subject matter.

Ethics and Principles

The professional educator adheres to the Code of Ethics and Principles of Professional Conduct of the Education Profession in Florida.

KEY CHAPTER POINTS

- Florida's school improvement initiative calls on schools to assume greater responsibility for professional development programs.
- If educators are to successfully prepare students for the future, they must be prepared for the future themselves.
- Preservice education should provide education graduates with a broad base of knowledge and skills to facilitate student learning and to be responsive to student and community needs, interests, and concerns.
- Inservice education should continue these efforts in an environment that supports and sustains teachers as individuals and collaborators in the process of systemic reform.
- Professional development programs should be designed to encourage every member of the learning community—teachers, support staff, and administrators—in the pursuit of lifelong learning.
- The role of professional development is to assist educators in developing the accomplished practices necessary to successfully implement Florida's education reform initiative.

Chapter 9: Foreign Language Program Improvement

CHAPTER HIGHLIGHTS

- The Nature of School Improvement
- Attributes of a Successful Foreign Language Program
- The Evaluation Process
- Planning Changes for Improvement
- The Implementation Process
- Taking the Next Step

The fictitious community of Off Cay has large populations of recent immigrants from the Caribbean, Southeast Asia, and Eastern Europe. The School Advisory Council for the Off Cay High School wants to take advantage of the unique opportunity for cross-cultural awareness in the community. The Advisory Council forms a Foreign Language Improvement Team to study how the foreign language programs can enrich their cultural studies by incorporating the community's diversity into its curricula. The Foreign Language Improvement Team includes representatives from local cultural organizations, foreign language teachers, teachers from a variety of disciplines, the principal, district program supervisors, university faculty, students, parents, and other community citizens.

The Nature of School Improvement

The primary goal of Florida's school improvement and accountability initiative is to raise student achievement by returning the problem-solving processes in education to the people closest to the students. This vision of local control can become a reality when individual schools and districts embrace the responsibility of becoming well-informed about the school improvement process, which may be both schoolwide and specifically targeted toward a single program.

In Florida, School Advisory Councils are charged with leading the overall school improvement process by drafting annual plans for raising student achievement and meeting the state education goals and standards in all subject areas. These councils are composed of educators, parents, and community members who are representative of the diverse population served by the school.

The components of the improvement process make up a continuous cycle that entails a thoughtful study of the school program. The improvement process includes the following components: evaluating the results of the existing program in terms of student achievement and identifying areas of concern or areas that need improvement; determining the desired reforms to be undertaken; and implementing and evaluating these reforms. These components of the school improvement process can be applied to subject-area programs as well, both at the district and school levels. This chapter highlights the steps of the improvement process and offers guidelines to local educators as they improve their foreign language programs.

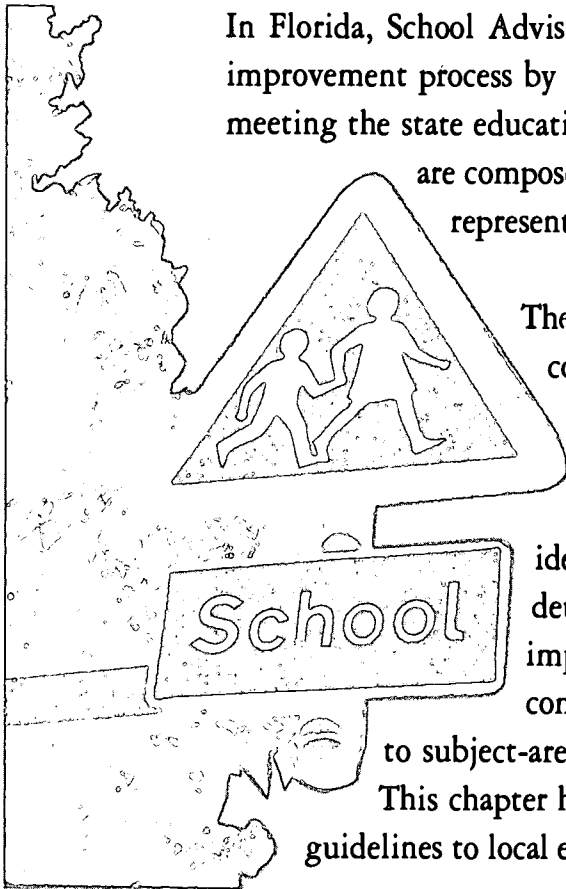

Attributes of a Successful Foreign Language Program

Successful foreign language programs are the product of thorough planning and ongoing review and evaluation. Researchers such as Helena A. Curtain and Carol A. Pesola (1994) suggest that program planners consider the following issues when planning new programs or revising existing programs.

Extended Sequence: Elementary, middle/junior, and high school foreign language programs are grounded in a long, well-articulated sequence of carefully developed curriculum that may extend through grade 12. Students in such programs can develop increased language proficiency and cultural competence as they move up the grade sequence.

Materials: Materials that are appropriate for the student's developmental level, rich in authentic culture and language, and related to the curriculum are key components in language programs. All materials, both print and nonprint, must have the teaching of communication as the main focus.

Staffing: Programs are staffed by appropriately certified teachers who have completed academic and experiential preparation in methods and materials for foreign language instruction and the nature of the school curriculum. Modern foreign language teachers must have a high level of language and cultural competence. The teacher's oral proficiency in the foreign language, based on the ACTFL/ETS proficiency scale, should be on an "advanced" level or higher.

Culture: The connection between language and culture must be made explicit, and foreign language instruction must be implemented within a cultural context. Cultural awareness and understanding should be explicit goals of the program. The language program should collaborate with other cultures/countries (for example, exchange programs and pen pals) to assure language learning within a context of cultural experiences.

Evaluation: In addition to the assessment tools discussed in chapter 6 of this framework, evaluation of foreign language students' performance and achievement should include communicative proficiency-based evaluation. Written product evaluations alone do not provide a complete picture of the academic success of the student. Criterion-referenced testing in both oral and written dimensions should show how the students have achieved program goals and expectancies. Moreover, national norm-referenced evaluation instruments should be identified to help educators assess how students' performance in foreign languages compares with that of other students across the nation, since these are good indicators of student and program success (e.g., the ACTFL/ETS Proficiency Language Interview; the Pimsleur Oral Proficiency Battery; and the Basic Inventory of Natural Language available through Checkpoint Systems, Inc.).

Program Assessment: Program assessment embraces program and curriculum design. It measures the program's impact on student performance not only in language class but in other content areas as well. Types of program assessment include

- pupil language-skills performance;
- pupil attitudes toward other languages and cultures;
- pupil performances in other content areas;
- teacher performance checklists;

- teacher evaluation of program;
- parent attitudes;
- outside consultant observation;
- teacher-peer observation and review; and
- administrator observation and review.

Administrators and program planners should determine the goals of the program at the outset, so that specific instruments can be developed and a time line for assessment can be built into the school schedule. For example, if impact on skills, attitudes, or performance in other content areas is to be measured, pretests will have to be designed and administered before the beginning of the program.

The Evaluation Process

The Foreign Language Improvement Team studies curricula and course descriptions from foreign language programs throughout the Off Cay school district. For guidance in this process, team members review the locally developed vision statement for Off Cay foreign language programs, which states that all Off Cay students will have the ability to participate in a global community. The Improvement Team finds that course offerings are limited to French and Spanish instruction, with several high school students studying German through dual enrollment courses at the local community college. The Improvement Team polls students, teachers, and parents about the foreign language program and learns that there is a great desire expressed for not only more variety in foreign language instruction, but also more opportunities for students to apply their language skills outside of the classroom. The Foreign Language Improvement Team considers various ways in which to incorporate the rich diversity of its community into its foreign language programs.

Regular program evaluation ensures that the school implements foreign language programs that raise the achievement of all students, identify and meet the needs of the local community, and focus on content that aligns with state standards. Program evaluation should include, not just inform, all people involved in and affected by the program. To help facilitate this process, districts and schools are encouraged to create Foreign Language Improvement Teams.

With the overriding goal of student achievement as a backdrop, one of the Foreign Language Improvement Team's first tasks should be to develop a list of questions or concerns about the foreign language program. These might be organized around the

components of this framework, for example, the program's vision, its reflection of Florida's Goal 3 standards, its use of innovative instructional strategies, or its connection to other disciplines. The questions might address program purposes, goals, content, context, instructional strategies, assessment methods and results, resources, attitudes of staff and students toward foreign language, and connections to other disciplines. Questions or concerns might also focus on the unique needs of the school or the local community.

During the evaluation process, it is useful to gather data about a variety of dimensions of the foreign language program from as many sources as appropriate and as possible. Some evaluation methods may be informal, part of the day-to-day activity of teaching and learning; others may be more formal, yielding information gathered from a variety of sources, such as

- surveys, questionnaires, and interviews;
- school statistics (for example, enrollment in specific subjects and electives);
- student assessments;
- reports from external evaluators; and
- self-evaluations.

Once information has been collected, the Foreign Language Improvement Team should interpret it within the context of the identified questions or concerns and make recommendations for changing the program in order to bring about improvement in identified areas. Team members can also use the data to identify additional questions and concerns.

The process of generating questions and concerns to guide the review of the foreign language program, analyzing existing data, reaching conclusions on which parts need changing, and thinking up and testing solutions encourages ownership and shared responsibility for ongoing program improvement. Districts and schools are encouraged to promote and integrate, where appropriate, innovative ideas suggested by those people specifically affected by and involved in the improvements.

Planning Changes for Improvement

The Foreign Language Improvement Team schedules a meeting with leaders from cultural organizations associated with the Eastern European, Caribbean, and Southeast Asian communities in Off Cay to discuss how the local community can participate in the schools' foreign language programs. Several organization members suggest the establishment of a community-wide Cultural Fair, in which foreign language students could participate in planning. A high school French teacher suggests that French classes in the middle and high schools could work with Caribbean cultural organizations to plan exhibits for the fair, which would allow students to use both their language skills and other skills deemed essential in Florida's new academic standards and benchmarks. Many teachers on the team voice their approval. The high school principal, however, feels that the team is misdirecting its attention. Although the proposal of a cultural fair is certainly a good idea for an activity, he asks how it addresses the issue of program improvement. A Laotian businessman on the committee suggests the incorporation of an annual cultural fair into the languages programs so that students of all proficiency levels and all languages will participate. Each language class would represent a region, country, or culture. The students would have the opportunity to write reports in their target language, contact foreign embassies in the target country and learn about the lives of immigrants in target countries, debate political positions between countries, learn about history and economics, and engage in countless authentic language and cultural experiences related to the Cultural Fair. The Foreign Language Improvement Team drafts an improvement proposal that incorporates the establishment of an annual World Cultural Fair, the establishment of two new language programs over the next two years, and the acquisition of computers for language study.

Once areas in need of improvement have been identified, the Foreign Language Improvement Team can investigate various solutions and then develop a plan to make and implement the changes that will bring about improvement. A clear vision of the desired results is vital to success. In general, the plan should include a time line and a division of responsibilities to help assure its completion. It should be flexible and include continuous internal monitoring to determine the effectiveness of the changes to be implemented. The plan should also identify the general elements that will be needed to implement improvements, when each might occur, who will be responsible for what, and what resources are needed. Finally, the plan should align with schoolwide improvement.

It is important to keep in mind that all the additional resources needed may not be readily available. It may take some reallocation, some creative acquisition, some

modification of existing resources to “get the job done.” An important part of the plan is monitoring the results of any changes. If changes are not producing intended improvements or if obstacles develop, other approaches can be tried.

Developers of school and district foreign language improvement plans may wish to consider the following questions as they create the plan for improvement:

- Are all the stakeholders involved in the process?
- Is there a consensus about what needs improvement as well as potential strategies to be undertaken?
- Have periodic checks been established to monitor implementation?
- Has a reasonable time line been set?
- Have measures of adequate progress been clearly defined?
- Are the necessary human and financial resources available to implement the plan?

An important component of the improvement process is gaining the support and endorsement of those administrators who have overall responsibility for providing the resources and services to promote and facilitate the necessary changes. Staff development, different forms of evaluation, and/or different ways of operating in school buildings and classrooms may be required. Thus, administrative support for any improvement plan is critically important.

Once finalized, the improvement plan may be shared with those essential support systems that operate outside of the professional education community. Parents and guardians, elected officials, business and industry leaders, and members of media organizations all have a stake in the school improvement process. By communicating planned program improvements to the public, schools and districts encourage the involvement of all educational stakeholders in the processes and operations of education, which in turn fosters the development of a greater sense of community.

The Implementation Process

The Foreign Language programs at Off Cay obtain the funding to begin one more language program for the next year. The Foreign Language Improvement Team uses polls of students and parents, proposals from foreign language teachers, and the suggestions of district program coordinators to select Russian as the new language. Moreover, the Improvement Team facilitates

the continuation of dual enrollment courses in German and in Japanese at the local community college for interested students. The schools and the community come together to host the first annual World Cultural Fair, in which all language classes participated. The fair is a rousing success; the classes successfully use the resources in the community to participate in a representation of a global community.

Implementation is the stage when the vision for improvement becomes a reality. After the Foreign Language Improvement Team has gained approval for its plan, it should begin to orchestrate and coordinate activities, strategies, and tactics at the school level. Implementation gives teachers and administrators opportunities to put into practice what they have learned during the improvement process and to work toward achieving the goals set forth in the foreign language program vision statement.

Program improvement necessitates change, which progresses through several stages. People may initially oppose a change until they get enough information to become comfortable. With time, the innovation may even be improved by the very people who were opposed to its implementation.

Taking the Next Step

The Off Cay community is proud of the continuing evolution of the foreign language program. New programs in German and Latin are being considered by the school board and student participation in foreign languages has increased dramatically. Foreign Language students use the Internet to communicate with students in other cultures, which creates opportunities to increase cultural knowledge along with improving language skills.

As schools improve, so does the community. As the community changes, so does the district's Pre K-12 foreign language programs. The process is cyclical, continuous, and mutually beneficial.

The cyclical process of evaluation, planning for improvement, implementing changes for improvement, and monitoring the results of those changes has a number of benefits. It involves a broad representation of the local community. It allows for continual improvements that incorporate advances in technology and gains in knowledge associated with the instruction of the foreign language. It provides the

opportunity to create programs that meet the unique needs of students, address specific local issues and concerns, and align with state standards. Ultimately, an ongoing improvement process helps ensure success for each and every Florida student in meeting high academic standards.

KEY CHAPTER POINTS

- In both business and industry and in public sector organizations, a collaborative process of sound and systematic program evaluation, planning for improvement, implementation of innovative strategies, and monitoring of results leads to success.
- The overall improvement process being implemented through each School Advisory Council can also be applied to the foreign language program at either the district or school level.
- Change happens slowly and only in an environment that encourages innovative and proactive thinking.
- To be systemic and successful, school and district programs should be designed with care, include all those concerned about success in education, and provide time for creativity, implementation, practice, reflection, revision, and renewal.

ACTFL Proficiency Guidelines

Note: The ACTFL Proficiency Guidelines have been reprinted here by permission of ACTFL, Yonkers, New York.

The 1986 proficiency guidelines represent a hierarchy of global characterizations of integrated performance in speaking, listening, reading and writing. Each description is a representative, not an exhaustive, sample of a particular range of ability, and each level subsumes all previous levels, moving from simple to complex in an “all-before-and-more” fashion.

Because these guidelines identify stages of proficiency, as opposed to achievement, they are not intended to measure what an individual has achieved through specific classroom instruction but rather to allow assessment of what an individual can and cannot do, regardless of where, when, or how the language has been learned or acquired; thus, the words “learned” and “acquired” are used in the broadest sense. These guidelines are not based on a particular linguistic theory or pedagogical method, since the guidelines are proficiency-based, as opposed to achievement-based, and are intended to be used for global assessment.

The 1986 guidelines should not be considered the definitive version, since the construction and utilization of language proficiency guidelines is a dynamic, interactive process. The academic sector, like the government sector, will continue to refine and update the criteria periodically to reflect the needs of the users and the advances of the profession. In this vein, ACTFL owes a continuing debt to the creators of the 1982 provisional proficiency guidelines and, of course, to the members of the Interagency Language Roundtable Testing Committee, the creators of the government’s Language Skill Level Descriptions.

ACTFL would like to thank the following individuals for their contributions on this current guidelines project:

Heidi Byrnes	Seiichi Makino	James Child	Irene Thompson
Nina Levinson	A. Ronald Walton	Pardee Lowe, Jr.	

These proficiency guidelines are the product of grants from the U.S. Department of Education.

Generic Descriptions—Speaking

Novice

The Novice level is characterized by the ability to communicate minimally with learned material.

Novice-Low

Oral production consists of isolated words and perhaps a few high-frequency phrases. Essentially no functional communicative ability.

Novice-Mid

Oral production continues to consist of isolated words and learned phrases within very predictable areas of need, although quality is increased. Vocabulary is sufficient only for handling simple, elementary needs and expressing basic courtesies. Utterances rarely consist of more than two or three words and show frequent long pauses and repetition of interlocutor's words. Speaker may have some difficulty producing even the simplest utterances. Some Novice-Mid speakers will be understood only with great difficulty.

Novice-High

Able to satisfy partially the requirements of basic communicative exchanges by relying heavily on learned utterances but occasionally expanding these through simple recombinations of their elements. Can ask questions or make statements involving learned material. Shows signs of spontaneity although this falls short of real autonomy of expression. Speech continues to consist of learned utterances rather than of personalized, situationally adapted ones. Vocabulary centers on

areas such as basic objects, places, and most common kinship terms. Pronunciation may still be strongly influenced by first language. Errors are frequent and, in spite of repetition, some Novice-High speakers will have difficulty being understood even by sympathetic interlocutors.

Intermediate

The Intermediate level is characterized by the speaker's ability to

- create with the language by combining and recombining learned elements, though primarily in a reactive mode;
- initiate, minimally sustain, and close in a simple way basic communicative tasks; and
- ask and answer questions.

Intermediate-Low

Able to handle successfully a limited number of interactive, task-oriented and social situations. Can ask and answer questions, initiate and respond to simple statements and maintain face-to-face conversation, although in a highly restricted manner and with much linguistic inaccuracy. Within these limitations, can perform such tasks as introducing self, ordering a meal, asking directions, and making purchases. Vocabulary is adequate to express only the most elementary needs. Strong interference from native language may occur. Misunderstandings frequently arise, but with repetition, the Intermediate-Low speaker can generally be understood by sympathetic interlocutors.

Intermediate-Mid

Able to handle successfully a variety of uncomplicated, basic and communicative tasks and social situations. Can talk simply about self and family members. Can ask and answer questions and participate in simple conversations on topics beyond the most immediate needs; e.g., personal history and leisure time activities. Utterance length increases slightly, but speech may continue to be characterized by frequent long pauses, since the smooth incorporation of even basic conversational strategies is often hindered as the speaker struggles to create appropriate language forms. Pronunciation may continue to be strongly influenced by first language and fluency may still be strained. Although

misunderstandings still arise, the Intermediate-Mid speaker can generally be understood by sympathetic interlocutors.

Intermediate-High

Able to handle successfully most uncomplicated communicative tasks and social situations. Can initiate, sustain, and close a general conversation with a number of strategies appropriate to a range of circumstances and topics, but errors are evident. Limited vocabulary still necessitates hesitation and may bring about slightly unexpected circumlocution. There is emerging evidence of connected discourse, particularly for simple narration and/or description. The Intermediate-High speaker can generally be understood even by interlocutors not accustomed to dealing with speakers at this level, but repetition may still be required.

Advanced

The Advanced level is characterized by the speaker's ability to

- converse in a clearly participatory fashion;
- initiate, sustain, and bring to closure a wide variety of communicative tasks, including those that require an increased ability to convey meaning with diverse language strategies due to a complication or an unforeseen turn of events;
- satisfy the requirements of school and work situations; and
- narrate and describe with paragraph-length connected discourse.

Advanced

Able to satisfy the requirements of everyday situations and routine school and work requirements. Can handle with confidence but not with facility complicated tasks and social situations, such as elaborating, complaining, and apologizing. Can narrate and describe with some details, linking sentences together smoothly. Can communicate facts and talk casually about topics of current public and personal interest, using general vocabulary. Shortcomings can often be smoothed over by communicative strategies, such as pause fillers, stalling devices, and different rates of speech. Circumlocution which arises from vocabulary or syntactic limitations very often is quite successful, though some groping for words may still be evident. The Advanced-level speaker can be understood without difficulty by native interlocutors.

Advanced-Plus

Able to satisfy the requirements of a broad variety of everyday, school, and work situations. Can discuss concrete topics relating to particular interests and special fields of competence. There is emerging evidence of ability to support opinions, explain in detail, and hypothesize. The Advanced-Plus speaker often shows a well developed ability to compensate for an imperfect grasp of some forms with confident use of communicative strategies, such as paraphrasing and circumlocution. Differentiated vocabulary and intonation are effectively used to communicate fine shades of meaning. The Advanced-Plus speaker often shows remarkable fluency and ease of speech but under the demands of Superior-level, complex tasks, language may break down or prove inadequate.

Superior

The Superior level is characterized by the speaker's ability to

- participate effectively in most formal and informal conversations on practical, social, professional, and abstract topics; and
- support opinions and hypothesize using native-like discourse strategies.

Superior

Able to speak the language with sufficient accuracy to participate effectively in most formal and informal conversations on practical, social, professional, and abstract topics. Can discuss special fields of competence and interest with ease. Can support opinions and hypothesize, but may not be able to tailor language to audience or discuss in depth highly abstract or unfamiliar topics. Usually the Superior-level speaker is only partially familiar with regional or other dialectical variants. The Superior level speaker commands a wide variety of interactive strategies and shows good awareness of discourse strategies. The latter involves the ability to distinguish main ideas from supporting information through syntactic, lexical and suprasegmental features (pitch, stress, intonation). Sporadic errors may occur, particularly in low-frequency structures and some complex high-frequency structures more common to formal writing, but no patterns of error are evident. Errors do not disturb the native speaker or interfere with communication.

General Descriptions—Listening

These guidelines assume that all listening tasks take place in an authentic environment at a normal rate of speech using standard or near-standard norms.

Novice-Low

Understanding is limited to occasional words, such as cognates, borrowed words, and high-frequency social conventions. Essentially no ability to comprehend even short utterances.

Novice-Mid

Able to understand some short, learned utterances, particularly where context strongly supports understanding and speech is clearly audible. Comprehends some words and phrases for simple questions, statements, high-frequency commands and courtesy formulae about topics that refer to basic personal information or the immediate physical setting.. The listener requires long pauses for assimilation and periodically requests repetition and/or a slower rate of speech.

Novice-High

Able to understand short, learned utterances and some sentence-length utterances, particularly where context strongly supports understanding and speech is clearly audible. Comprehends words and phrases from simple questions, statements, high-frequency commands and courtesy formulae. May require repetition, rephrasing and/or a slowed rate of speech for comprehension.

Intermediate-Low

Able to understand sentence-length utterances which consist of recombinations of learned elements in a limited number of content areas, particularly if strongly supported by the situational context. Content refers to basic personal background and needs, social conventions and routine tasks, such as getting meals and receiving simple instructions and directions. Listening tasks pertain primarily to spontaneous face-to-face conversations. Understanding is often uneven; repetition and rewording may be necessary. Misunderstandings in both main ideas and details arise frequently.

Intermediate-Mid

Able to understand sentence-length utterances which consist of recombinations of learned utterances on a variety of topics. Content continues to refer primarily to basic personal background and needs, social conventions and somewhat more complex tasks, such as lodging, transportation, and shopping. Additional content areas include some personal interests and activities, and a greater diversity of instructions and directions. Listening tasks not only pertain to spontaneous face-to-face conversations but also to short routine telephone conversations and some deliberate speech, such as simple announcements and reports over the media. Understanding continues to be uneven.

Intermediate-High

Able to sustain understanding over longer stretches of connected discourse on a number of topics pertaining to different times and places; however, understanding is inconsistent due to failure to grasp main ideas and/or details. Thus, while topics do not differ significantly from those of an Advanced-level listener, comprehension is less in quantity and poorer in quality.

Advanced

Able to understand main ideas and most details of connected discourse on a variety of topics beyond the immediacy of the situation. Comprehension may be uneven due to a variety of linguistic and extralinguistic factors, among which topic familiarity is very prominent. These texts frequently involve description and narration in different time frames or aspects, such as present, nonpast, habitual, or imperfective. Texts may include interviews, short lectures on familiar topics, and news items and reports primarily dealing with factual information. Listener is aware of cohesive devices but may not be able to use them to follow the sequence of thought in an oral text.

Advanced-Plus

Able to understand the main ideas of most speech in a standard dialect; however, the listener may not be able to sustain comprehension in extended discourse which is propositionally and linguistically complex. Listener shows an emerging awareness of culturally implied meanings beyond the surface meanings of the text but may fail to grasp socio-cultural nuances of the message.

Superior

Able to understand the main ideas of all speech in a standard dialect, including technical discussion in a field of specialization. Can follow the essentials of extended discourse which is propositionally and linguistically complex, as in academic/professional settings, in lectures, speeches, and reports. Listener shows some appreciation of aesthetic norms of target language, of idioms, colloquialisms, and register shifting. Able to make inferences within the cultural framework of the target language. Understanding is aided by an awareness of the underlying organizational structure of the oral text and includes sensitivity for its social and cultural references and its affective overtones. Rarely misunderstands but may not understand excessively rapid, highly colloquial speech or speech that has strong cultural references.

Distinguished

Able to understand all forms and styles of speech pertinent to personal, social and professional needs tailored to different audiences. Shows strong sensitivity to social and cultural references and aesthetic norms by processing language from within the cultural framework. Texts include theater plays, screen productions, editorials, symposia, academic debates, public policy statements, literary readings, and most jokes and puns. May have difficulty with some dialects and slang.

Generic Descriptions—Reading

These guidelines assume all reading texts to be authentic and legible.

Novice-Low

Able occasionally to identify isolated words and/or major phrases when strongly supported by context.

Novice-Mid

Able to recognize the symbols of an alphabetic and/or syllabic writing system and/or a limited number of characters in a system that uses characters. The reader can identify an increasing number of highly contextualized words and/or phrases including cognates and borrowed words, where appropriate. Material understood rarely exceeds a single phrase at a time, and rereading may be required.

Novice-High

Has sufficient control of the writing system to interpret written language in areas of practical need. Where vocabulary has been learned, can read for instructional and directional purposes standardized messages, phrases or expressions, such as some items on menus, schedules, timetables, maps, and signs. At times, but not on a consistent basis, the Novice-High level reader may be able to derive meaning from material at a slightly higher level where context and/or extralinguistic background knowledge are supportive.

Intermediate-Low

Able to understand main ideas and/or some facts from the simplest connected texts dealing with basic personal and social needs. Such texts are linguistically noncomplex and have a clear underlying internal structure, for example, chronological sequencing. They impart basic information about which the reader has to make only minimal suppositions or to which the reader brings personal interest and/or knowledge. Examples include messages with social purposes or information for the widest possible audience, such as public announcements and short, straightforward instructions dealing with public life. Some misunderstandings will occur.

Intermediate-Mid

Able to read consistently with increased understanding simple connected texts dealing with a variety of basic and social needs. Such texts are still linguistically noncomplex and have a clear underlying internal structure. They impart basic information about which the reader has to make minimal suppositions and to which the reader brings personal interest and/or knowledge. Examples may include short, straightforward descriptions of persons, places, and things written for a wide audience.

Intermediate-High

Able to read consistently with full understanding simple connected texts dealing with basic personal and social needs about which the reader has personal interest and/or knowledge. Can get some main ideas and information from texts at the next higher level featuring description and narration. Structural complexity may interfere with comprehension; for example, basic grammatical relations may be misinterpreted and temporal references may rely primarily on lexical items. Has

some difficulty with the cohesive factors in discourse, such as matching pronouns with referents. While texts do not differ significantly from those at the Advanced level, comprehension is less consistent. May have to read material several times for understanding.

Advanced

Able to read somewhat longer prose of several paragraphs in length, particularly if presented with a clear underlying structure. The prose is predominantly in familiar sentence patterns. Reader gets the main ideas and facts and misses some details. Comprehension derives not only from situational and subject matter knowledge but from increasing control of the language. Texts at this level include descriptions and narrations such as simple short stories, news items, bibliographical information, social notices, personal correspondence, routinized business letters and simple technical material written for the general reader.

Advanced-Plus

Able to follow essential points of written discourse at the Superior level in areas of special interest or knowledge. Able to understand parts of texts which are conceptually abstract and linguistically complex, and/or texts which treat unfamiliar topics and situations, as well as some texts which involve aspects of target-language culture. Able to comprehend the facts to make appropriate inferences. An emerging awareness of the aesthetic properties of language and of its literary styles permits comprehension of a wider variety of texts, including literary. Misunderstandings may occur.

Superior

Able to read with almost complete comprehension and at normal speed expository prose on unfamiliar subjects and a variety of literary texts. Reading ability is not dependent on subject matter knowledge, although the reader is not expected to comprehend thoroughly texts which are highly dependent on knowledge of the target culture. Reads easily for pleasure. Superior-level texts feature hypotheses, argumentation and supported opinions and include grammatical patterns and vocabulary ordinarily encountered in academic/professional reading. At this level, due to the control of general vocabulary and structure, the reader is almost always able to match the meanings derived from extralinguistic knowledge with meanings derived from knowledge

of the language, allowing for smooth and efficient reading of diverse texts. Occasional misunderstandings may still occur; for example, the reader may experience some difficulty with unusually complex structures and low-frequency idioms. At the Superior level the reader can match strategies, top-down or bottom-up, which are most appropriate to the text. (Top-down strategies rely on real-world knowledge and prediction based on genre and organizational scheme of the text. Bottom-up strategies rely on actual linguistic knowledge.) Material at this level will include a variety of literary texts, editorials, correspondence, general reports and technical material in professional fields. Rereading is rarely necessary, and misreading is rare.

Distinguished

Able to read fluently and accurately most styles and forms of the language pertinent to academic and professional needs. Able to relate inferences in the text to real-world knowledge and understand almost all sociolinguistic and cultural references by processing language from within the cultural framework. Able to understand a writer's use of nuance and subtlety. Can readily follow unpredictable turns of thought and author intent in such materials as sophisticated editorials, specialized journal articles, and literary texts such as novels, plays, poems, as well as in any subject matter area directed to the general reader.

Generic Descriptions Writing

Novice-Low

Able to form some letters in an alphabetic system. In languages whose writing systems use syllabaries or characters, writer is able to both copy and produce the basic strokes. Can produce romanization of isolated characters, where applicable.

Novice-Mid

Able to copy or transcribe familiar words or phrases and reproduce some from memory. No practical communicative writing skills.

Novice-High

Able to write simple fixed expressions and limited memorized material and some recombinations thereof. Can supply information on simple forms and documents. Can write names, numbers, dates, own nationality, and other simple

autobiographical information as well as some short phrases and simple lists. Can write all the symbols in an alphabetic or syllabic system or 50-100 characters or compounds in a character writing system. Spelling and representation of symbols (letters, syllables, characters) may be partially correct.

Intermediate-Low

Able to meet limited practical writing needs. Can write short messages, postcards, and take down simple notes, such as telephone messages. Can create statements or questions within the scope of limited language experience. Material produced consists of recombinations of learned vocabulary and structures into simple sentences on very familiar topics. Language is inadequate to express in writing anything but elementary needs. Frequent errors in grammar, vocabulary, punctuation, spelling and in formation of nonalphabetic symbols, but writing can be understood by natives used to the writing of nonnatives.

Intermediate-Mid

Able to meet a number of practical writing needs. Can write short, simple letters. Content involves personal preferences, daily routine, everyday events, and other topics grounded in personal experience. Can express present time or at least one other time frame or aspect consistently, e.g., nonpast, habitual, imperfective. Evidence of control of the syntax of noncomplex sentences and basic inflectional morphology, such as declensions and conjugation. Writing tends to be a loose collection of sentences or sentence fragments on a given topic and provides little evidence of conscious organization. Can be understood by natives used to the writing of nonnatives.

Intermediate-High

Able to meet most practical writing needs and limited social demands. Can take notes in some detail on familiar topics and respond in writing to personal questions. Can write simple letters, brief synopses and paraphrases, summaries of biographical data, work and school experience. In those languages relying primarily on content words and time expressions to express time, tense, or aspect, some precision is displayed; where tense and/or aspect is expressed through verbal inflection, forms are produced rather consistently, but not always accurately. An ability to describe and narrate in paragraphs is emerging. Rarely uses basic

cohesive elements, such as pronominal substitutions or synonyms in written discourse. Writing, though faulty, is generally comprehensible to natives used to the writing of nonnatives.

Advanced

Able to write routine social correspondence and join sentences in simple discourse of at least several paragraphs in length on familiar topics. Can write simple social correspondence, take notes, write cohesive summaries and resumes, as well as narratives and descriptions of a factual nature. Has sufficient writing vocabulary to express self simply with some circumlocution. May still make errors in punctuation, spelling, or the formation of nonalphabetic symbols. Good control of the morphology and the most frequently used syntactic structures, e.g., common word order patterns, coordination, subordination, but makes frequent errors in producing complex sentences. Uses a limited number of cohesive devices, such as pronouns, accurately. Writing may resemble literal translations from the native language, but a sense of organization (rhetorical structure) is emerging. Writing is understandable to natives not used to the writing of nonnatives.

Advanced-Plus

Able to write about a variety of topics with significant precision and in detail. Can write most social and informal business correspondence. Can describe and narrate personal experiences fully but has difficulty supporting points of view in written discourse. Can write about the concrete aspects of topics relating to particular interests and special fields of competence. Often shows remarkable fluency and ease of expression, but under time constraints and pressure writing may be inaccurate. Generally strong in either grammar or vocabulary, but not in both. Weakness and unevenness is one of the foregoing or in spelling or character writing formation may result in occasional miscommunication. Some misuse of vocabulary may still be evident. Style may still be obviously foreign.

Superior

Able to express self effectively in most formal and informal writing on practical, social and professional topics. Can write most types of correspondence, such as memos as well as social and business letters, and short research papers and statements of position in areas of special interest or in special fields. Good control

of a full range of structures, spelling or nonalphabetic symbol production, and a wide general vocabulary allow the writer to hypothesize and present arguments or points of view accurately and effectively. An underlying organization, such as chronological ordering, logical ordering, cause and effect, comparison, and thematic development is strongly evident, although not thoroughly executed and/or not totally reflecting target language patterns. Although sensitive to differences in formal and informal style, still may not tailor writing precisely to a variety of purposes and/or readers. Errors in writing rarely disturb natives or cause miscommunication.

Note: (From Omaggio, 1986, p. 443)

The *ACTFL Proficiency Guidelines*, developed by the American Council on the Teaching of Foreign Languages, are an academic analog to the government language proficiency level descriptions, originally developed by the Foreign Service Institute and currently revised and used by the various language schools participating in the Interagency Language Roundtable (ILR). The government level descriptions differ from the *ACTFL Guidelines* in that a number system is used to designate eleven levels of proficiency, ranging from 0 to 5 (0, 0+, 1, 1+, 2, 2+, 3, 3+, 4, 4+, and 5), whereas the *ACTFL Guidelines* uses the terms Novice, Intermediate, Advanced, and Superior to designate proficiency levels. In addition, the categories of Novice and Intermediate are further subdivided into three categories: Low, Mid, and High; the Advanced level is subdivided into Advanced and Advanced Plus (corresponding to 2 and 2+ on the government scale); the Superior level comprises the government levels 3, 3+, 4, 4+ and 5.

For more detailed information on the correspondence between the ACTFL Proficiency Guidelines, the scale of the Foreign Service Institute (the FSI scale), and the ILR scale, see *Teaching Language in Content* (Omaggio, 1986), pages 10-19.

Resources

- Abrahamson, B., & Smith F. (1991). *Seeking information*. Brookfield, IL: Teachers' Press.
- Abrahamson, B., & Smith F. (1991). *Thinking logically*. Brookfield, IL: Teachers' Press.
- Abrahamson, R. G., & Liou, H. C. (1991). Interaction Generated by Three Computer Programs. In P. Dunkel (Ed.), *Computer assisted learning and testing*. New York: Newbury House.
- Ackerman, D., & Perkins, D. N. (1989). Integrating thinking skills and learning skills across the curriculum. In H.H. Jacobs (Ed.), *Interdisciplinary curriculum: Design and implementation*. Alexandria, VA: Association for Supervision and Curriculum Development.
- Altman, R. (1989). *The video connection*. Boston: Houghton Mifflin.
- American Council on the Teaching of Foreign Languages (ACTFL). (1988). *ACTFL teacher education guidelines*. Yonkers, NY: ACTFL.
- American Council on the Teaching of Foreign Languages (ACTFL). (1989). *ACTFL proficiency guidelines*. Yonkers, NY: ACTFL.
- American Council on the Teaching of Foreign Languages (ACTFL). (1996). *Standards for foreign language learning: Preparing for the 21st century*. Yonkers, NY: ACTFL.
- American Council on the Teaching of Foreign Languages (ACTFL) (Producer), & Galloway, V. (Writer). (1992). *Changing perspectives: Observing teaching and learning*. [Instructional Video Modules]. (Available from ACTFL, 6 Executive Plaza, Yonkers, New York, 10701-6801.)

- American Psychological Association and Mid-continent Regional Educational Laboratory. (1993, January). *Learner-centered psychological principles: Guidelines for school redesign and reform*. Washington, DC: American Psychological Association.
- Asher, J. J. (1986). *Learning another language through actions: The complete teacher's guidebook*. Los Gatos, CA: Sky Oaks.
- Association for Supervision and Curriculum Development (ASCD). (1992). *ASCD curriculum handbook: A resource for curriculum administrators from the Association for Supervision and Curriculum Development*. Alexandria, VA: Author.
- Association for Supervision and Curriculum Development. (1992). *Foreign languages principles*. Alexandria, VA: Association for Supervisors and Curriculum Developers.
- Banks, J. A. (1991). *Teaching strategies for ethnic studies*. Needham Heights, MA: Allyn and Bacon.
- Barron, A. E., & Orwig, G. W. (1993). *New technologies for education: A beginner's guide*. Englewood, CO: Libraries Unlimited, Inc.
- Beane, J. (1991). The middle school: The natural home of integrated curriculum. *Educational Leadership*, 49(2), 9-13.
- Beauvois, M. H. (1992). Computer assisted classroom discussion in the foreign language classroom: Conversation in slow motion. *Foreign Language Annals*, 25, 455-464.
- Becker, H. J. (1987). *The impact of computer use in children's learning: What research has shown and what it has not*. (Report No. 18). Baltimore, MD: The John Hopkins University, Center for Research on Elementary and Middle Schools.
- Blair, R. W. (1982). *Innovative approaches to language teaching*. Boston: Heinle and Heinle.
- Bush, M., Slaton, A., Verano, M., & Slayden, M. (Eds.). (1991). *Interactive videodisc: The why and the how*. Provo, UT: Brigham Young University Press.

- Byrnes, H. (1985). Teaching toward proficiency: The receptive skills. In Alice C. Omaggio (Ed.) *Proficiency curriculum, articulation: The ties that bind*. Middlebury, VT: Northeast Conference on the Teaching of Foreign Languages.
- Caine, R. N., & Caine, G. (1991). *Making connections: Teaching and the human brain*. Alexandria, VA: Association for Supervision and Curriculum Development.
- Commission on Foreign Language and International Studies. (1979). *Strength through wisdom: A critique of U. S. capability*. (Monthly Publication No. 800046 95). Washington, DC: Government Printing Office.
- Cooper, T. (1987). Foreign language study and SAT verbal scores. *Foreign Language Journal*. 71(4), 381-387.
- Curran, L. (1991). *Strengthening cooperative learning in K-2 classes*. Bellevue, WA: Bureau of Education and Research.
- Curtain, H. A. (1993). *Strengthening foreign language instruction through maximizing meaningful communication*. Bellevue, WA: Bureau of Education and Research.
- Curtain, H. A., & Pesola, C. A. (1988). *Languages and children: Making the match*. Menlo Park, CA: Addison-Wesley.
- Crookall, D., & Oxford, R. L. (1990). *Simulation, gaming, and language learning*. New York: Newborn House.
- Darling-Hammond, L. (1993). Reframing the school reform agenda: Developing capacity for school transformation. *Phi Delta Kappan*, 74(10), 752-761.
- Duteu, B. (1995). *Les approches non conventionnelles*. Vanves, France: Hachette Livre.
- Dunkel, P. (1991). *Computer-assisted language learning and testing: Research issues and practice*. New York: Newbury House.
- Fielding, G., & Schalock, H. (1985). *Promoting the professional development of teachers and administrators*. Eugene, OR: ERIC Clearinghouse on Educational Management. (ERIC Document Reproduction Service No. EA 017 747)

- Flor Ada, A. (1990). *A magical encounter: Spanish language children's literature in the classroom*. Compton, CA: Santillana Publishing Company.
- Florida Department of Education. (1993). *Science for all educators: A guide for Florida's teacher educators*. Tallahassee, FL: Author.
- Florida Department of Education. (1993). *Science for all students: The Florida pre K-12 science curriculum framework, a guide for curriculum planners*. Tallahassee, FL: Author.
- Florida Department of Education. (1994, May). *The principles guiding the development of Florida's new curriculum frameworks*. Tallahassee, FL: Author.
- Florida Department of Education. (1995). *Florida writes*. Tallahassee, FL: Author.
- Florida Department of Education. (1995, September). *Florida's system of school improvement and accountability: Blueprint 2000*. Tallahassee, FL: Author.
- Florida Education Standards Commission. (1994, September). *Educator accomplished practices: Knowledge, skills, and dispositions needed by teachers and staff to effectively implement Blueprint 2000*. Tallahassee, FL: Author.
- Galloway, V. (1983). Foreign language in the schools: Through the looking glass. *Modern Language Journal* 67(4), 342-354.
- Galloway, V. (1987). From defining to developing proficiency: A look at the decisions. In H. Byrnes & M. Canale (Eds.), *Defining and developing proficiency: Guidelines, implementations, and concepts*. Lincolnwood, IL: National Textbook Company.
- Galloway, V., & Herron, C. (Eds.) (1995). *Research within reach II: Research-guided responses to the concerns of foreign language teachers*. Valdosta, GA: Southern Conference of Language Teaching (SCOLT).
- Gardner, H. (1985). *The mind's new science—a history of the cognitive revolution*. NY: Basic Books.

- Garrett, N. (1991). Technology in the service of language learning: Trends and issues. *Modern Language Journal*, 75, 74-101.
- Garza, T. J. (1991). Evaluating the use of captioned video material in advanced foreign language learning. *Foreign Language Annals*, 24, 239-258.
- Gibbons, S. Y. (1987). Learning and instruction in the information age. In M. A. White (Ed.), *What curriculum for the information age?* Hillsdale, NJ.: Lawrence Erlbaum Associates.
- Glover, J. A., & Bruning, R. H. (1987). *Educational psychology: Principles and applications* (2nd ed.) Boston: Little, Brown.
- Hansen-Krening, N. (1982). *Language experiences for all students*. Menlo Park, CA: Addison-Wesley.
- Hatfield, W. (1993). *Visions and realities in foreign language teaching: Where we are, where we are going, selected papers from the 1993 Central States Conference*. Lincolnwood, IL: National Textbook Company.
- Hendrickson, J. (1991). On communicative language teaching. *Hispania* 74,1.
- Hudspeth, D., & Brey, R. (1986). *Instructional telecommunications: Practice and principles*. New York: Praeger.
- Jacobs, H. H. (1991). Planning for curriculum integration. *Educational Leadership*, 49(2), 27-8.
- Jarvis, G., & Taylor, S. V. (1990). Reforming foreign and second language teacher education. In D. W. Birckbichler (Ed.), *New perspectives and new directions in foreign language education*. Lincolnwood, IL: National Textbook Company.
- Jenkins, J. M. (1992). Some common threads of interdisciplinary curriculum. In J. Jenkins & D. Tannre (Eds.), *Restructuring for an interdisciplinary curriculum*. Reston, VA: National Association of Secondary School Principals.

- Johnson, D. M. (1991). Second language and content learning with computers: Research in the role of social factors. In P. Dunkel (Ed.), *Computer-assisted language learning and testing*. New York: Newbury House.
- Jones, K. (1982). *Simulations in language teaching*. Cambridge, England: Cambridge University Press.
- Kessler, C. (Ed.). (1992). *Cooperative language learning: A teacher's resource book*. Englewood Cliffs, NJ: Regents-Prentice Hall.
- Krashen, S. (1982). *Principles and practice in second language acquisition*. Oxford, England: Pergamon Press.
- Krashen, S. (1991). *Writing: Research theory and applications*. Torrance, CA: Laredo Publishing Co.
- Krashen, S. (1993). *The power of reading: Insights from the research*. Englewood, CO: Libraries Unlimited, Inc.
- Krashen, S. D., & Terrell, T. (1983). *The natural approach: Language acquisition in the classroom*. San Francisco, CA: Allemany.
- Krupp, Judy-Arin. (1991, Fall). Honoring the individual within staff development: An interview with Judy-Arin Krupp. *Journal of Staff Development*, 12(4), 2-5.
- Leon County Schools. (1992-1995). *Parallel alternative strategies for students*. Tallahassee, FL: Florida Department of Education.
- Lipton, G. (1989). *Practical handbook to elementary foreign language programs*. Lincolnwood, IL: National Textbook Company.
- Lipton, G. (1992). *Elementary foreign language programs: FLES*: An administrator's handbook*. Lincolnwood, IL: National Textbook Company.
- Lipton, G., Rhodes, N. C., & Curtain, H. A. (Eds.). (1986). *The many faces of foreign language in the elementary school: FLES, FLEX and immersion*. Champaign IL: American Association of Teachers of French.

Lonergan, J. (1984). *Using video in language teaching*. Cambridge, England: Cambridge University Press.

Loucks, S., & Zacchei, D. (1983). Applying our findings to today's innovations. *Educational Leadership*, 41(3), 28-31.

Loucks-Horsley, S., Harding, C., Arbuckle, M., Murray, L., Dubea, C., & Williams, M. (1987). *Continuing to learn: A guidebook for teacher development*. Andover, MA: Regional Laboratory for Educational Improvement of the Northeast and Islands, and the National Staff Development Council.

Lussier, D. (1995). *Evaluer les apprentissages dans une approche communicative*. Vanvres, France: Hachette Livre.

Marzano, R. J., Pickering, D., & McTighe, J. (1993). *Assessing student outcomes*. Alexandria, VA: Association for Supervision and Curriculum Development.

McLaughlin, M., & Marsh, D. (1978). Staff development and school change. *Teachers College Record*, 80(1), 69-94.

Met, M. (1988). Tomorrow's emphasis in foreign language: Proficiency. In R. Brandt (Ed.), *Content of the curriculum*. Alexandria, VA: Association for Supervision and Curriculum Development.

Met, M., & Galloway, V. (1992). Research in foreign language curriculum. In Philip Jackson (Ed.), *Handbook of research on curriculum*. New York: Macmillan.

Muñoz de Torres, M. (1986). *Fundamentos basicos para la enseñanza de las artes del lenguaje*. Madrid, Spain: Editorial Playor.

National Advisory Board on International Education Programs. (1983). *Critical needs in international education: Recommendations for action*. Washington, DC: Center for International Education.

National Commission on Excellence in Education. (1983). *A nation at risk: The imperative for educational reform* (Report No. 065000-00177). Washington, DC: Government Printing Office.

- National Governors Association. (1989). *America in transition: The international frontier. Report of the Task Force on International Education*. Washington, DC: Author.
- Oller, J. W., & Richard-Amato, P. A. (1983). *Methods that work: A smorgasbord of ideas for foreign language teachers*. Boston: Heinle and Heinle.
- Omaggio, A. C. (Ed.). (1986). *Teaching language in context: Proficiency-oriented instruction*. Boston: Heinle and Heinle.
- Oxford, R. (1990). *Language learning strategies: What every teacher should know*. New York: Newbury House.
- Pederson, K. M. (1987). Research on CALL. In W. F. Smith (Ed.), *Modern media in foreign language education: Theory and implementation*. (The ACTFL Foreign Language Education Series, volume 18), Lincolnwood, IL: National Textbook Company.
- Perkins, D. N. (1989) Selecting fertile themes for integrated learning. In H.H. Jacobs, (Ed.), *Interdisciplinary curriculum: Design and implementation*. Alexandria, VA: Association for Supervision and Curriculum Development.
- Peterson, N. G., & Sager, C. E. (1993, November). *Schoolyear 2000's assessment of Florida's necessary skills: Final report*. Washington, DC: American Institutes for Research, for the Center for Educational Technology at Florida State University.
- Phillips, J. K. (1989). Teacher education: Target of reform. In H. S. Lepke (Ed.), *Shaping the future: Challenges and opportunities*. Middlebury, VT: Northeast Conference on the Teaching of Foreign Languages.
- Porcher, L. (1994). *Le français langue étrangère*. Vanves, France: Hachette Livre.
- Pusack, J. P., & Otto, S. K. (1991). Dear Wilga, Dear Alice, Dear Tracy, Dear Earl: Four letters on methodology and technology. In Ellen S. Silber (Ed.), *Critical issues in foreign language instruction*. New York: Garland.

- Ravitch, D. (1995). *National standards in American education: A citizen's guide*. Washington, DC: The Brookings Institution.
- Roettger, D., & Szymczuk, M. (Eds.). (1990). *Guide for developing student portfolios*. Johnston, IA: Educational Services, Heartland Area Education Agency.
- Rude, R., & Hauptmann, R. (1992). Multicultural innovations: Curricular reform in the academy. *Multicultural Review*, 3, 68-93.
- Sarason, S. (1993). *The case for change: Rethinking the preparation of educators*. San Francisco: Jossey-Bass.
- Savignon, S. J. (1983). *Communicative competence: Theory and classroom practice*. Reading, MA: Addison-Wesley.
- Scarcella, R., & Oxford, R. (1992). *The tapestry of language learning: The individual in the communicative classroom*. Boston: Heinle and Heinle.
- Secretary's Commission on Achieving Necessary Skills. (1991). *What work requires of schools: A SCANS report for America 2000*. Washington, DC: U.S. Department of Labor.
- Smith, W. F. (Ed.). (1989). *Modern technology in foreign language education*. New York: National Textbook Company.
- Smith, W. F. (Ed.). (1991). *Modern media in foreign language education: Theory and implementation* (The ACTFL Foreign Language Education Series, volume 18.) Lincolnwood, IL: National Textbook Company.
- Smith, W. F. (Ed.). (1991). *Modern technology in foreign language education: Applications and projects* (The ACTFL Foreign Language Education Series.) Lincolnwood, IL: National Textbook Company.
- Southern Governors' Association's Advisory Council on International Education. (1986). *Cornerstone of competition*. Washington, DC: Author.

- Tanner, D. (1992). Synthesis versus fragmentation: The way out of curriculum confusion. In J. M. Jenkins and D. Tanner (Eds.), *Restructuring for an interdisciplinary curriculum*. Reston, VA: National Association of Secondary School Principals.
- Underwood, J. (1984). *Linguistics, computers and the language teacher: A communicative approach*. Rowley, MA: Newbury House.
- United States Department of Education. (1994). The Goals 2000 Act: Educate America Act. (S/N 869-024-00017-1). Washington, DC: Government Printing Office.
- Valencia, S., Hiebert, E. H., & Afflerbach, P. (Eds.). (1994). *Authentic reading assessment: Practices and possibilities*. Newark, DE: International Reading Association.
- Vars, G. F. (1987). *Interdisciplinary teaching in the middle grade*. Columbus, OH: National Middle School Association.
- Young, D. J. (1990). An investigation of students' perspectives on anxiety and speaking. *Foreign Language Annals*, 23, 539-553.
- Zemelman, S., Daniels, H., & Hyde, A. (1993). *Best practice: New standards for teaching and learning in America's schools*. Portsmouth, NH: Heinemann.

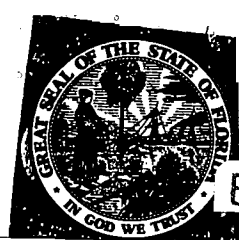

BEST COPY AVAILABLE

Florida Department of Education
Frank T. Brogan, Commissioner of Education
325 West Gaines Street Tallahassee, Florida 32399-0400
<http://www.firn.edu/doe/dcehome.htm>





*U.S. Department of Education
Office of Educational Research and Improvement (OERI)
National Library of Education (NLE)
Educational Resources Information Center (ERIC)*



NOTICE

Reproduction Basis

- This document is covered by a signed "Reproduction Release (Blanket)" form (on file within the ERIC system), encompassing all or classes of documents from its source organization and, therefore, does not require a "Specific Document" Release form.
- This document is Federally-funded, or carries its own permission to reproduce, or is otherwise in the public domain and, therefore, may be reproduced by ERIC without a signed Reproduction Release form (either "Specific Document" or "Blanket").