

## DOCUMENT RESUME

ED 467 392

EF 006 181

TITLE Energy Design Guidelines for High Performance Schools: Cold and Humid Climates.

INSTITUTION National Renewable Energy Lab. (DOE), Golden, CO.; Department of Energy, Washington, DC. Office of Energy Efficiency and Renewable Energy.; Innovative Design, Inc., Raleigh, NC.

REPORT NO DOE/GO-102002-1542

PUB DATE 2002-06-00

NOTE 89p.; Produced by the Office of Building Technology, State, and Community Programs. Technical assistance provided by Padia Consulting, BuildingGreen, and the Sustainable Buildings Industry Council. For related energy design guidelines for other climates, see EF 006 040, EF 006 177-180, and EF 006 182.

AVAILABLE FROM For full text: <http://www.eren.doe.gov/energysmartschools>.

PUB TYPE Guides - Non-Classroom (055)

EDRS PRICE EDRS Price MF01/PC04 Plus Postage.

DESCRIPTORS Architecture; Building Design; Climate; \*Design Requirements; Educational Facilities; \*Educational Facilities Design; Educational Facilities Planning; Elementary Secondary Education; \*Energy Conservation; Energy Management; Humidity; Structural Elements (Construction); Temperature; Thermal Environment

## ABSTRACT

The U.S. Department of Energy's EnergySmart Schools provides school boards, administrators, and design staff with guidance to help them make informed decisions about energy and environmental issues important to school systems and communities. The design guidelines presented in this document outline high performance principles for the new or retrofit design of K-12 schools. The document presents recommended design elements in 10 sections, each representing a key interrelated component of high performance school design: (1) site design; (2) daylighting and windows; (3) energy-efficient building shell; (4) lighting and electrical systems; (5) mechanical and ventilation systems; (6) renewable energy systems; (7) water conservation; (8) recycling systems and waste management; (9) transportation; and (10) resource efficient building products. To effectively integrate energy-saving strategies, these options must be evaluated together from a whole-building perspective early in the design process. A "high performance checklist" for designers is located at the end of the document. The checklist is a quick reference for key architectural and engineering considerations. Case studies can also be found at the end of the document. These guidelines contain recommendations generally appropriate for cold and humid climates, for which Minneapolis-St. Paul, Minnesota, served as a model city. Other guidelines have been developed for the other climate zones. (Contains a list of numerous Web resources.) (EV)

# Cold and Humid Climates

ED 467 392

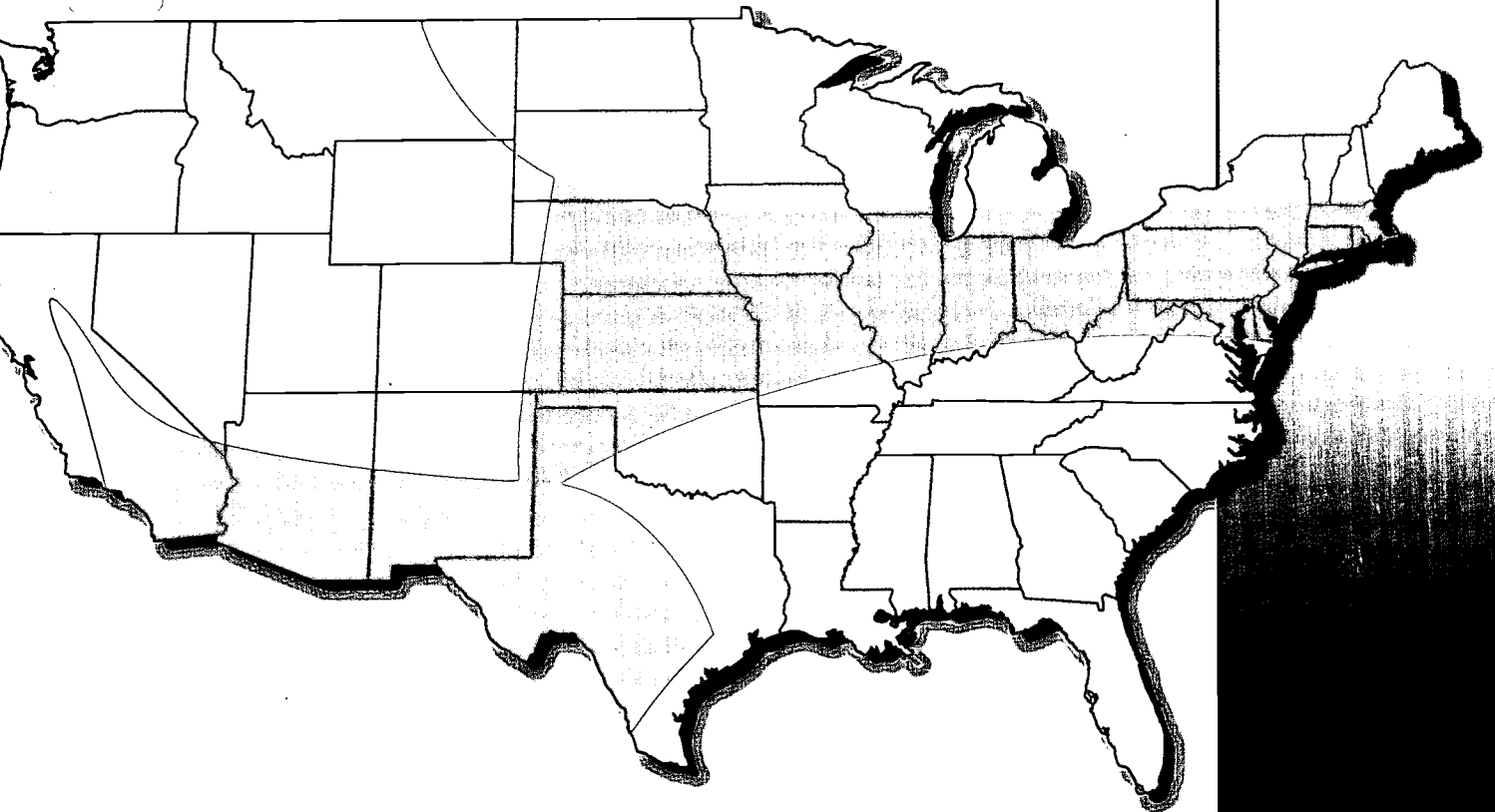

Full text available at:

<http://www.eren.doe.gov/energysmartschools/>

## Energy Design Guidelines for High Performance Schools

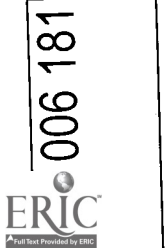

U.S. DEPARTMENT OF EDUCATION  
Office of Educational Research and Improvement  
EDUCATIONAL RESOURCES INFORMATION  
CENTER (ERIC)

This document has been reproduced as received from the person or organization originating it.

Minor changes have been made to improve reproduction quality.

• Points of view or opinions stated in this document do not necessarily represent official OERI position or policy.

BEST COPY AVAILABLE

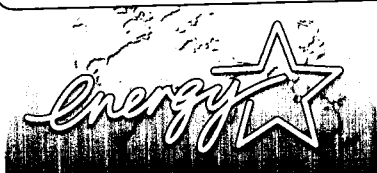

This document was developed by the National Renewable Energy Laboratory with subcontractor Innovative Design. Technical assistance came from Padia Consulting, BuildingGreen, and the Sustainable Buildings Industry Council.

This report was prepared as an account of work sponsored by an agency of the United States government. Neither the United States government nor any agency thereof, nor any of their employees or subcontractors makes any warranty, express or implied, or assumes any legal liability or responsibility for the accuracy, completeness, or usefulness of any information, apparatus, product, or process disclosed, or represents that its use would not infringe privately owned rights. Reference herein to any specific commercial product, process, or service by trade name, trademark, manufacturer, or otherwise does not necessarily constitute or imply its endorsement, recommendation, or favoring by the United States government or any agency thereof. The views and opinions of authors expressed herein do not necessarily state or reflect those of the United States government or any agency thereof.

## Acknowledgements

The US Department of Energy would like to acknowledge the help and assistance of the EnergySmart Schools team and the many reviewers who provided input and feedback during the process of developing this report. Those include:

### National Laboratories

**Lawrence Berkeley National Laboratory:** Dariush Arasteh, Doug Avery; **National Renewable Energy Laboratory:** Ren Anderson, Zahra Chaudhry, Kate Darby, Kyra Epstein, Patty Kappaz, Bryan King, Patricia Plympton, Amy Vaughn; **Dak Ridge National Laboratory:** Sherry Livengood, Ron Shelton; **Pacific Northwest National Laboratory:** Michael Baechler, Kim Fowler, Eric Richman, David Winiarski

### US Department of Energy

David Hansen, George James, Arun Vohra; **Chicago Regional Office:** John Devine, Peter Dreyfuss; **Seattle Regional Office:** Richard Putnam; **Office of Policy and Management:** John Ruckes; **EnergySmart Schools Team:** Larry Schoff, Blanche Sheinkopf; **Rebuild America Products and Services:** Greg Andrews, Ken Baker, Chip Larson, Bill Mixon, Sue Seifert

**Advance Transformer Co.:** Gary Sanders; **AndersonMasonDale Architects:** Peggy Kinsey; **Ashley McGraw Architects, PC:** David Ashley; **Atelier/Jilk:** Bruce Jilk, AIA; **Austin Independent School District:** Dan Robertson; **Building America:** Mark Halverson; **Building Science Corporation:** Joseph Lstiburek, Betsy Pettit; **Cutler-Hammer:** David DePerro; **D & R International:** Bill Zwack; **Donald Aitken Assoc.:** Donald Aitken; **Eley Assoc.:** Charles Eley; **Energy Design & Consulting:** Ed Mangan; **Environmental Support Solutions:** Dana Johnson; **Facility Improvement Corp.:** John Phillips, PE; **Hickory Consortium:** Mark Kelley; **Horst, Terrill & Karst Architects, P.A.:** Mark E. Franzen, AIA; **IBACOS Inc.:** Brad Oberg; **Innovative Design:** Mike Nicklas, Pascale Rosemain; **John Portman & Associates:** Jeff Floyd, AIA; **Kansas State University:** Bruce Snead; **Kinsey Shane and Assoc.:** William T. Traylor, AIA; **Lithonia Lighting Co.:** Richard Heinisch; **Margo Jones Architects:** Margo Jones; **Maryland Energy Administration:** Fred Hoover; **National Institute of Building Sciences:** Bill Brenner; **Noack Little Architects:** Chris Noack **NORESCD:** John Rizzo, PE; **Northeast Energy Efficiency Partnerships Inc.:** Jim Rutherford; **Oregon Office of Energy:** George Churchill; **Poudre School District:** Mike Spearnak; **Power Correction Systems:** Brahm Segal; **SAFE-BIDCD:** Mary Jo Dutra; **Sarnafill Inc.:** Peter D'Antonio; **Sherber Assoc. Inc.:** Michael S. Sherber; **SHW Group:** Gary Keep; **Stanley Architects:** Lars Stanley; **TechBrite:** Michael Boyd; **Texas State Energy Office:** Robin Bailey; **TRACO:** Tony Bartorillo, Scott Roy; **University of Wisconsin-Madison:** Jeffrey Lackney; **US Department of Education:** Jack Lyons, Sylvia Wright; **US EPA:** Melissa Payne; **WaterLess Co. LLC:** Klaus Reichardt; **WattStopper:** Dorene Maniccia; **Weller and Michal Architects Inc.:** Charles J. Michal, AIA

In addition to the reviewers, many participated in the roundtable discussions leading to the publication of this document:

**Association of School Business Officials, International:** Don Tharpe; **Burr Lawrence Rising + Bates Architects:** Tom Bates; **California Energy Commission:** Darryl Mills; **Charles Michal AIA PE LC:** Charles Michal; **CMD Group:** Michelle Hesler; **Council on Educational Facility Planners International:** Elisa Warner; **Dry Creek Elementary Schools:** Kelvin Lee; **Energy Center of Wisconsin:** Abby Vogen; **Estes McClure & Assoc. Inc.:** James McClure; **Florida Solar Energy Center:** Danny Parker; **Hanson Design Group LTD:** Henry Hanson; **Heschong Mahone Group:** Lisa Heschong; **HL Turner Group Inc.:** Harold Turner; **Loudon County Public Schools:** Evan Mohler; **Lawrence Berkeley National Laboratory:** Rick Diamond; **Manheim Township School District:** David Amstrad; **National Association of State Energy Officials:** David Terry; **New York State Energy Research and Development Authority:** Don LaVada; **Padia Consulting Inc:** Harshad Padia; **Portland Public Schools Environmental Services:** Patrick Wolfe; **Public School Construction Program:** Yale Stenzler; **Simon and Assoc.:** Lynn Simon; **Southern California Edison:** Gregg Ander; **Sustainable Buildings Industry Council:** Deane Evans and Ellen Larson; **US DOE:** Mark Bailey; **US Department of Education:** Tom Corwin; **US EPA:** Bob Thompson; **Washington State University Energy Program:** Michael McSorley

This document was produced by the US Department of Energy's Office of Building Technology, State and Community Programs, led by Deputy Assistant Secretary Mark Ginsberg, National Program Manager Daniel Sze, and Outreach and Communications Manager Lani MacRae.

Available electronically at <http://www.doe.gov/bridge>

## Creating High Performance Schools

School districts around the country are finding that smart energy choices can help them save money and provide healthier, more effective learning environments. By incorporating energy improvements into their construction or renovation plans, schools can significantly reduce energy consumption and costs. These savings can then be redirected to educational needs such as additional teachers, instructional materials, or new computers.

The US Department of Energy's (US DOE's) EnergySmart Schools provides school boards, administrators, and design staff with guidance to help them make informed decisions about energy and environmental issues important to school systems and communities. These design guidelines outline high performance principles for the new or retrofit design of your K-12 school. By incorporating these principles, you can create an exemplary building that is both energy- and resource-efficient — a school that is a teaching tool in and of itself.

## The Importance of Connecting Energy and Environmental Issues

Across our country we are again seeing signs that the supply of energy is not keeping up with rising demand. Brownouts are becoming more commonplace. The price of natural gas is twice what it was in the 1990s. We are moving from a period of less expensive energy and seemingly plentiful resources to a time in which building-related decisions will be more strongly influenced by energy and water availability. There is a growing concern about the environmental and societal implications of energy. Today, energy costs over the life of a school will far exceed the initial cost of the building. As prices rise, it will become even more critical to comprehensively address this issue.

This guide was developed to promote long-term thinking and to build our schools in ways that reflect values supportive of our planet. Our schools can make a strong statement that saving energy and resources, while protecting our environment, is important. The message that we give to future generations should be embodied in the buildings we use to teach them.



*"Good teachers never teach anything. What they do is create conditions under which learning takes place."*

— S.I. Hayakawa

*By implementing the high performance practices included within these guidelines, you will be taking a significant step forward in creating the physical conditions in which the learning process can thrive.*

For more information, visit the EnergySmart Schools Web site:

[www.energysmartschools.gov](http://www.energysmartschools.gov)



## Help Your School Earn the ENERGY STAR Label

The ENERGY STAR label on a school building wall tells an important story. The label not only identifies a school building whose energy performance is among the nation's top 25% — but it also lets taxpayers know you're using money wisely, spending the resources on education instead of high energy bills. The label tells students that their school cares about the environment, that you're doing your part to reduce energy-related pollution. And it indicates that your school has the great lighting, comfortable temperatures, and high-quality air that go hand in hand with smart energy use.

ENERGY STAR, a registered trademark of the US Environmental Protection Agency (US EPA) and the US DOE, is the mark of excellence in energy performance. It is a trusted national brand symbolizing superior energy performance in more than 30 categories of consumer electronics and appliances, as well as office buildings, schools, supermarkets, hospitals, and homes. The ENERGY STAR benchmarking tool is a powerful way to manage building energy performance and to earn recognition for excellence in building energy performance. The rating system measures the energy performance of each building on a scale of 1 to 100 and shows how a building compares with other buildings in your portfolio or nationwide. The rating system provides useful baseline information to help organizations set energy performance targets and plan energy-efficiency improvements. Buildings whose energy performance places them in the top 25% among similar buildings nationwide, and that meet industry standards for indoor environment, are eligible to apply for the ENERGY STAR label, a large bronze plaque that can be displayed on the building.

Determining if your buildings qualify for this label is easy. All you need is data about your school's energy use over the past 12 months, the square footage of your buildings, and the number of students enrolled. You can then establish an account for your school district and enter your energy data into the ENERGY STAR computer analysis tool available on the Internet. Each school building that scores 75 or higher, while maintaining indoor air quality that meets industry standards, can apply for the ENERGY STAR label.

By incorporating the energy design guidelines detailed in this document into your school's construction or renovation plans, you can take the first essential steps toward earning the ENERGY STAR label for your school.

# An Introduction to the Energy Design Guidelines

This document presents recommended design elements in 10 sections, each representing a key interrelated component of high performance school design. To effectively integrate energy-saving strategies, these options must be evaluated together from a whole-building perspective early in the design process. A “high performance checklist” for designers is located at the end of the document. The checklist is a quick reference for key architectural and engineering considerations. Case studies can also be found at the end of the document.

Site Design .....	5
Daylighting and Windows .....	11
Energy-Efficient Building Shell .....	19
Lighting and Electrical Systems .....	25
Mechanical and Ventilation Systems .....	31
Renewable Energy Systems .....	39
Water Conservation .....	47
Recycling Systems and Waste Management .....	51
Transportation .....	55
Resource-Efficient Building Products .....	59
Checklist of Key Design Issues .....	63
Case Studies .....	77

## Climate Zones for Energy Design Guidelines

These guidelines contain recommendations generally appropriate for cold and humid climates, for which Minneapolis-St. Paul, Minnesota, served as a model city. Other guidelines have been developed for the other climate zones, shown on the map below.

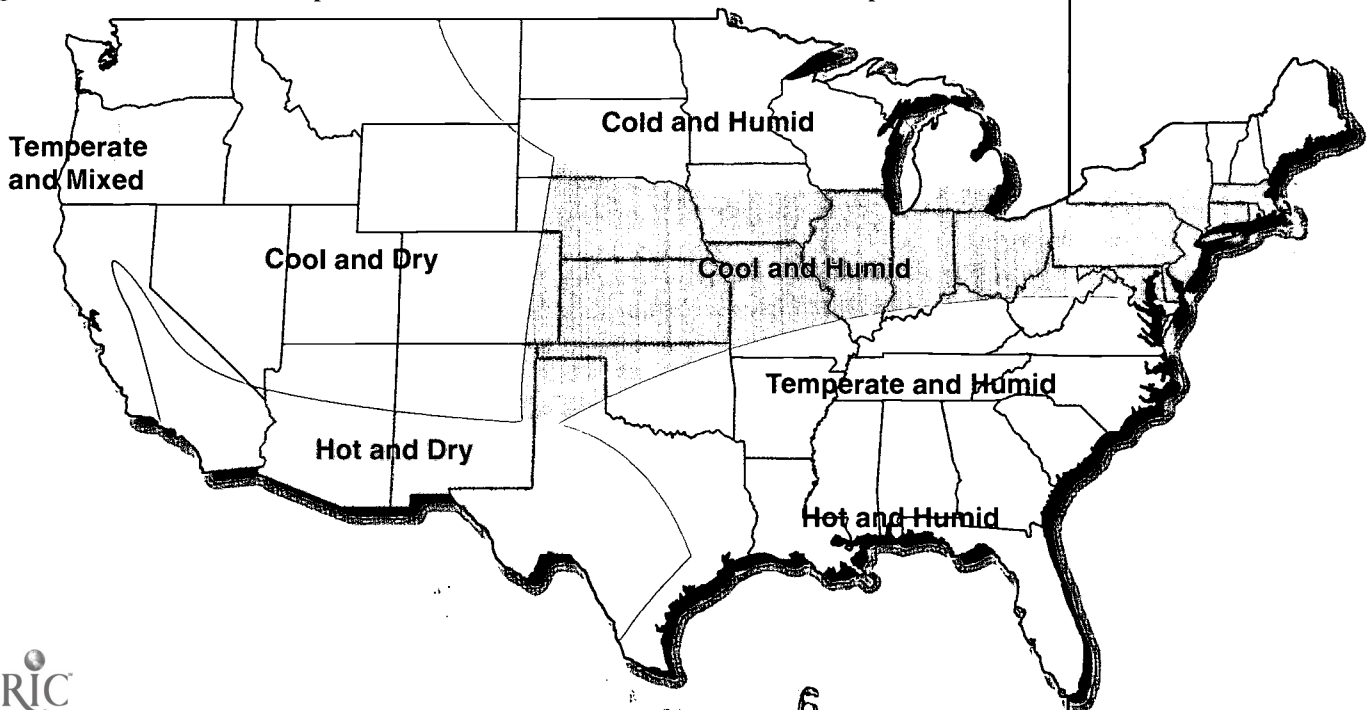

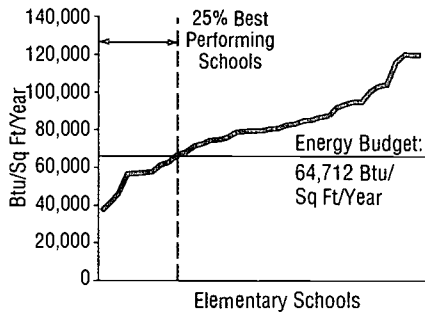

St. Paul Elementary Schools Annual Energy Consumption

### Energy Budgets

The horizontal red line indicates a level of energy consumption achieved by the best 25% of the existing schools.



A 1999 study conducted by the Heschong Mahone Group shows that students with the best daylighting in their classrooms progressed 20% faster on math tests and 26% faster on reading tests in one year than those with the worst daylighting.

## Establishing High Performance Goals

Cost-effective energy- and resource-efficient schools start with good planning. Working closely with the school's design and planning staff, the architects and engineers should develop objectives that reflect local conditions and priorities, balance short-term needs and long-term savings, and address environmental issues. Goals can include reducing operating costs; designing buildings that teach; improving academic performance; protecting the environment; increasing health, safety, and comfort; supporting community values; and considering emerging solutions.

### Reducing Operating Costs

To ensure that your school is water- and energy-efficient, you must first work with the school system to establish clear consumption goals. Given your climatic region and building type, this "energy budget" must be realistic, and it must be based on the potential of current, proven energy-saving technologies.

The graphic profile to the left depicts one simple procedure for establishing a realistic energy budget. The graph plots the range, from best to worst, of the current annual energy consumption (British thermal units per square foot) for all the existing elementary schools within the St. Paul School District, located in Minnesota. An energy budget can be established by simply setting the goal at a level equal to that achieved by the best 25% of the schools in the district. Many energy- and resource-saving options have very good financial value. Some of these solutions do not add anything to installation costs.

### Designing Buildings that Teach

When designing the school, consider the importance of incorporating high performance features that can be used for educational purposes. Some high performance features may be harder to rationalize financially but from an educational standpoint are still important to consider. Solar electric systems (photovoltaics), for example, may have a longer return on investment but, if installed properly, can be a very powerful educational tool.

### Improving Academic Performance

During the past decade, remarkable studies have indicated a correlation between the way schools are designed and student performance. You can maximize student performance by setting air quality objectives that:

- Define a level of indoor air quality desired during occupied times
- Place limitations on the use of materials, products, or systems that create indoor air quality problems
- Require monitoring equipment.

Establishing daylighting objectives will also improve classroom conditions and can help improve performance if you:

- Include controlled daylighting in all classrooms, administrative areas, the gymnasium, and other significantly occupied spaces
- Develop intentional visual connections between the indoor and outdoor environments.

## Protecting Our Environment

High performance school design takes into consideration not only the economic and academic impacts of design but also environmental impacts. Environmentally sound design elements are those that:

- Use renewable energy systems and energy-efficient technologies
- Incorporate resource-efficient building products and systems
- Promote water-conserving strategies
- Use less polluting transportation alternatives
- Establish recycling systems
- Incorporate environmentally sound site design.

## Designing for Health, Safety, and Comfort

You cannot design a high performance school without including design strategies that address health, safety, and comfort issues. Goals should include objectives that:

- Implement daylighting and indoor air quality solutions to make the school a healthier place to teach and learn
- Address acoustical and thermal comfort.

## Supporting Community Values

Incorporating high performance strategies in your school's design results in a win-win situation for the community and the school. Through the implementation of energy-savings strategies, the school saves money and taxpayers benefit. Additionally, the energy dollars saved don't leave the immediate region but stay within the community and help to build a stronger local economy.

Building to high performance standards implies the purchase of locally manufactured products and the use of local services. This approach is effective because much of the environmental impact associated with materials, products, and equipment purchased for construction involves transportation. The more transportation, the more pollution. Specifying local products benefits the community in the same way that retaining energy dollars helps: it strengthens the local economy. Implementing energy-efficient, environmentally sound practices also has a direct impact on the local air and water quality. By establishing goals to positively address these issues, you are taking the first step toward creating a better community in which to live.





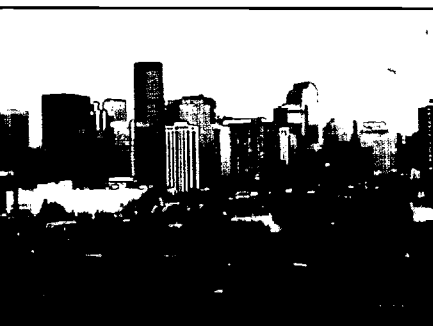

*"We will insist on protecting and enhancing the environment, showing consideration for air and natural lands and watersheds of our country."*

*National Energy Policy, 2001*

## "Whole Building" Energy Analysis

Determining the relative merits of one energy strategy versus another can only be accurately determined by analyzing the specific measure in the context of the "whole building." Each component or system is continually impacted by changing climatic conditions and occupancy demands. Each component has an effect on another.

When evaluating energy options, it is essential that the design team use computer energy analysis programs that can simulate the impact the specific measure has on the overall energy consumption and peak load. The program must be able to provide hourly, daily, monthly, and yearly energy profiles and be able to accurately account for the benefits associated with daylighting. The US DOE has two programs to assist with this analysis: DOE-2 and Energy Plus. More information can be found on these programs in the resources section at the end of this document.

## Considering Emerging Solutions

The recommendations listed within this document reflect proven technologies that have been successfully incorporated into school applications in this climate zone and across the country. However, every year, new solutions are developed that will be able to make your facilities more energy-efficient and environmentally sound. As these new systems, materials, and products become commercially available, designers should exercise care in selecting those that are viable but should not be discouraged from implementing technologies just because they are not commonplace.

Because of their dynamic nature, these emerging solutions will be addressed on the Web site, which provides cost information and examples of current projects where the solution is already in use.

# Site Design

By orienting your school building effectively, you can maximize solar access and boost the effectiveness of daylighting strategies, reducing the need for electrical lighting as well as heating and cooling loads. Designing the site to reduce or eliminate vehicular travel to the school helps to reduce fuel usage and emissions, improving the air quality in and around the school. And water requirements can be reduced by incorporating vegetation native to the local ecosystem in the site design.

Decisions made early in the design can often have a significant impact on many other aspects of the design. Orienting the building linearly on an east-west axis is one important example. By maximizing well-controlled, south-facing glass and minimizing east- and west-facing glass, energy performance is greatly enhanced, comfort conditions are improved, and initial costs associated with cooling are reduced.

The educational potential of high performance design can also be greatly emphasized by integrating effective indoor-outdoor relationships between the building, the site, and the design of outdoor spaces as educational resources and venues.

When considering the location for a school site, it is critical not only to consider your initial cost but also to evaluate environmental implications, how health and safety are influenced, and how well the school design is integrated into the fabric of the community.



Photo: Roy Beaty

*Retaining ecosystems and wildlife habitat surrounding schools and incorporating them into outdoor learning activities enhances student interest in the environment.*

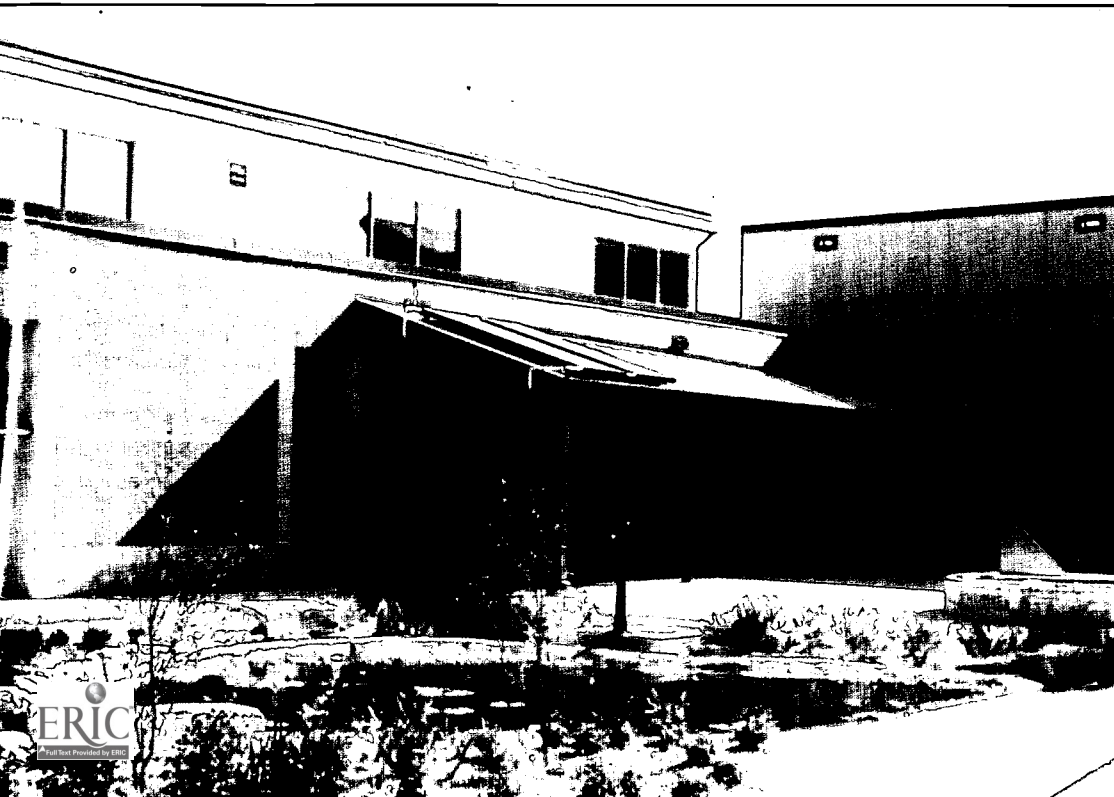

*Students enjoy the outdoor teaching courtyards and "eco-gardens" that allow them to plant native vegetation, view natural habitat and wildlife, and better understand eco-cycles.*



Before — Photo: Davis, Carter, Scott

*The rehabilitation of a vacant commercial building into the new \$1.8-million, 24,000-square-foot Arlington Mill School and Community Center in Virginia was the solution adopted by Arlington Public Schools to meet its urgent need for a new high school facility.*



After — Photo: Estate of Doug Brown

## Guidelines for Site Design

### Selecting a Site

When selecting a school site, the highest priority should be given to appropriately located sites that enable the school to be built cost effectively and in a resource-efficient manner.

#### • Cost

- Consider the rehabilitation of an existing site or an urban in-fill area before choosing an undeveloped site.
- Select a site that can maximize solar access for daylighting and other solar systems and minimize east and west glass.
- Consider the wind resources at the site and the potential for implementing wind energy systems.
- Consider the availability and cost of utilities at the site.
- Analyze mass transit and pedestrian accessibility as well as potential bus routes.

#### • Environment

- Avoid selecting sensitive ecosystems, such as wildlife habitats.
- Consider geological, micro-ecological, and micro-climatic conditions.
- Evaluate the potential implications of erosion control and rainwater management.
- Determine the presence of historic landmarks or archeological features on the site.
- Conduct an assessment of the impact the school will have on the local environment.
- Consider the ability to protect and retain existing landscaping.

#### • Health/Safety

- Determine the existing and projected air, soil, and water quality.
- Evaluate the physical relationships to industries or utilities that may pollute the air.
- Evaluate noise levels typically experienced at the site.

#### • Community

- Determine the ease with which the school could be linked into local communities through safe pedestrian walkways.
- Evaluate the potential for recycling with the city or county.
- Consider sites where local developers are interested in working together to integrate the school into the overall community design.

## Protecting Local Ecosystems

The protection of local ecosystems is critical to an environmentally sensitive site design.

- Protect or restore ecosystems and wildlife habitats on the site.
- Develop a landscaping design that is compatible with existing plants and that uses native plants.
- Protect areas for viewing natural habitat.
- Develop interpretive nature trails through preserved wildlife habitats and ecosystems.
- Use explanatory signage for different plants and trees.
- Consult with local universities, cooperative extension offices, and master gardeners about local ecosystems, how to protect them, and ways to maximize their educational value.

## Water-Conserving Strategies

The implementation of these commonsense ideas will help to drastically reduce school water use and conserve water in the community.

- Use native planting materials and xeriscape principles to minimize the need for site irrigation.
- Employ a rainwater catchment system for irrigation and toilet flushing.
- Use graywater from sinks and water fountains for site irrigation.
- Use soaker hoses and drip irrigation techniques that minimize evaporative losses and concentrate water on the plants' roots.
- Use timers on irrigation systems to water at night.

## Erosion Control and Off-Site Impacts

Developing on-site erosion control and stormwater management strategies will better ensure that off-site impacts can be minimized.

- Employ site contours and natural drainage strategies.
- Minimize surfaces impervious to water.
- Determine the key pollutants that are impacting your watershed, and develop strategies to reduce the likelihood that the pollutants will reach the watershed.



*Employing native xeriscape principles minimizes the need for irrigation.*



*In cold and humid climates, water needs for irrigation can be minimized by protecting the existing natural vegetation and using native planting.*

*The cost effectiveness of the daylighting strategies implemented at East Clayton Elementary School in Clayton, NC, is greatly enhanced by the elongation of the school on an east-west axis. This layout increases the potential for capturing winter gain while reducing unwanted summer sun that more often strikes on east-west surfaces.*



### Building Orientation

To minimize energy use, maximize your potential by siting the school correctly.

- Establish the building on an east-west axis.
- Develop a floor plan that minimizes east- and west-facing glass.
- Emphasizing one-story designs to maximize daylighting increases the foundation perimeter and roof area. Both of these are significant contributors to heat losses and therefore detrimental to low energy use in heating-dominated climates. Larger building footprints increase site impacts and consume more scarce buildable land, especially in urban areas.
- In multiple-story schools, minimize the depth of the rooms to maximize the daylighting contribution.
- Consider seasonal variations in wind speed and direction.

### Renewable Energy

When evaluating site design issues, it is essential to investigate renewable systems early in the process. Solar systems need to have solar access, and wind systems require proper placement to be maximized.

- Consider climatic conditions at the site.
- To improve safety and save energy, consider non-grid-connected photovoltaic systems for:
  - crossing and caution lights
  - lighting at walkways and parking areas
  - telephone call boxes for emergencies.
- Consider installing building-integrated solar thermal systems for domestic hot water, space heating, and absorption cooling.
- Consider building-integrated photovoltaic systems for electricity production.
- Ensure that solar systems are not shaded and that they are positioned to be visible to the students, teachers, and parents.

- Consider wind energy systems for electricity or well water.
- Consider geothermal heat pumps.

## Maximize the Potential of the Site

Understanding and using the ground conditions at the site will determine, to a great degree, both the economic and environmental success of the design.

- Establish floor grades that least impact site grading.
- Use existing site contours to minimize grading and, where appropriate, to create berming opportunities to earth-temper walls.
- Consider existing and new landscaping as a means of providing shading in the warmer months.
- Stockpile appropriate rock from site development for later use as ground cover.

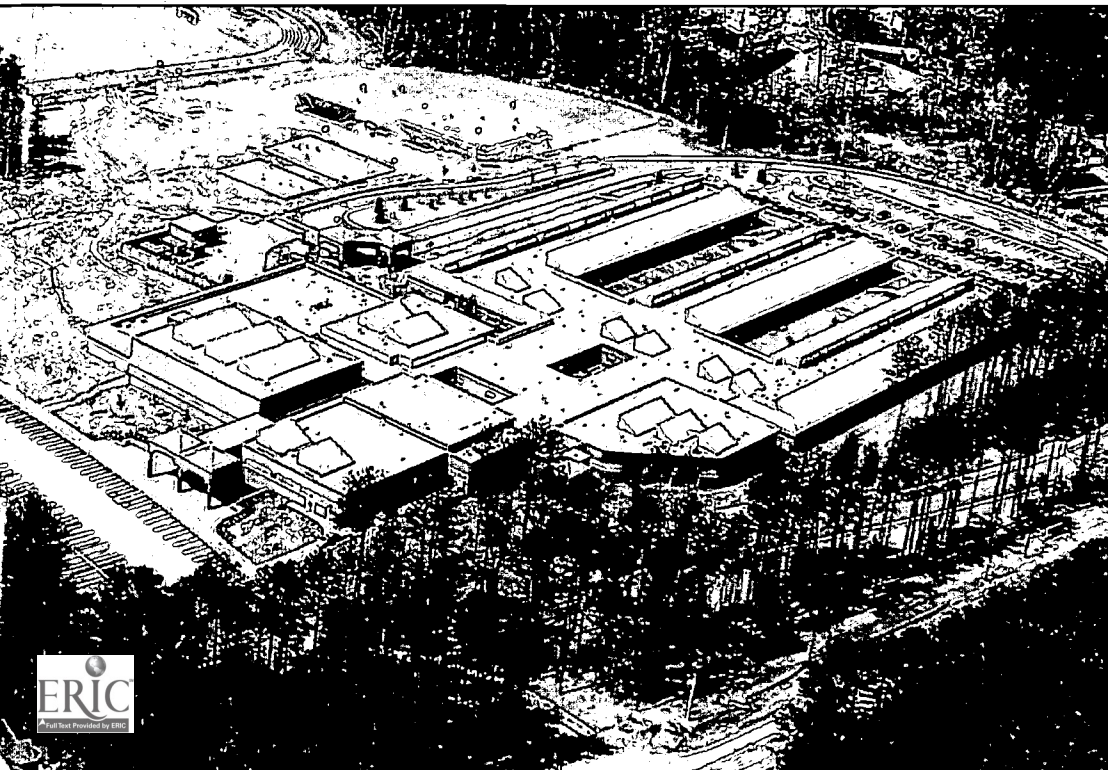

*Durant Road Middle School in Raleigh, NC, is oriented on an east-west axis to maximize solar access.*



*Safe walkways connecting the school to the surrounding neighborhoods help reduce air pollution from cars and buses, avoid air pollution and traffic congestion, and decrease the cost of operating buses, creating a cleaner local environment.*

## Connecting the School to the Community

One of the measures of success of a school is the degree to which the school is a vital part of the community. If addressed early in the site selection and design phase, a school can be planned to serve not just the students but also the entire community.

- Consider designing the school so that the athletic fields, gymnasium, media center, cafeteria, and classrooms can be shared at appropriate times with the community.
- Provide for optimum access to public transit.
- Through good site design, link the school to the surrounding communities through safe bicycle routes and pedestrian pathways.
- Incorporate convenient bicycle parking at the school to encourage bicycle traffic.

*Objectives regarding the protection and retention of existing landscaping as well as the site's natural contours and features have to be established early during the programming phase.*



# Daylighting and Windows

Of all the high performance design features typically considered, none will have a greater impact on your school than daylighting. Not only can optimum daylighting design drastically reduce energy consumption, but it also creates healthier learning environments that may result in increased attendance and improved grades. When properly designed, windows, clerestories, and roof monitors can provide a large portion of lighting needs without undesirable heat gain or glare.

Electric lights actually produce more waste heat energy than daylighting for the equivalent lighting effect. This heat must be removed in warmer months through ventilation or air conditioning. Sunlight, on the other hand, is a cooler light. Reductions in cooling loads due to daylighting strategies often enable designers to downsize air conditioning systems, reducing the initial cost of equipment. High performance windows also help to minimize heat gain in warmer months and heat loss in colder months. Although windows can create glare and skylights may cause overheating, properly designed daylighting strategies can reduce both lighting and cooling energy and control glare.

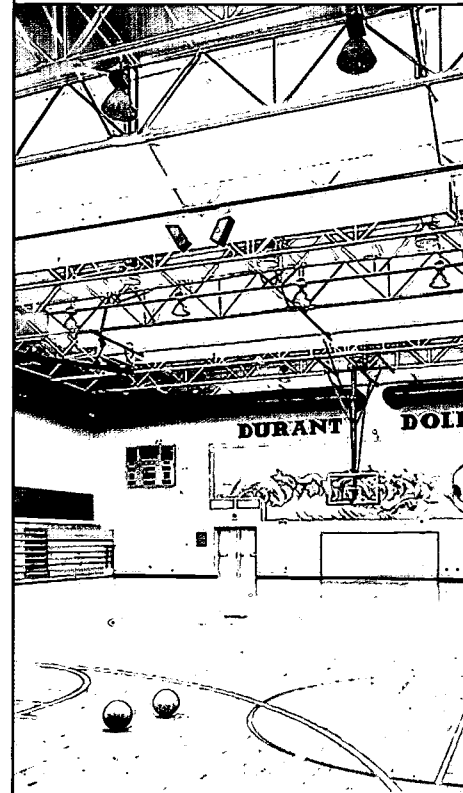
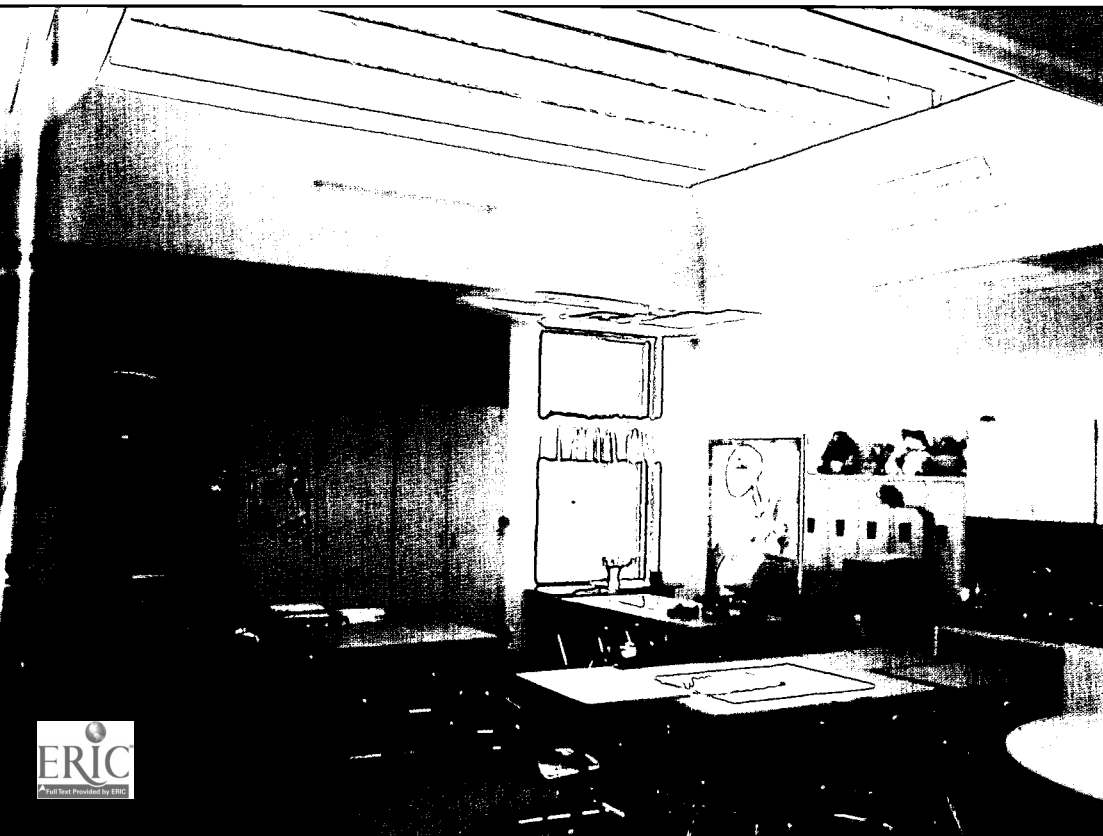

Photo: Robert Flynn

*Effective daylighting strategies reduce both lighting and cooling loads.*



*This classroom, at Roy Lee Walker Elementary School in McKinney, TX, is daylit two-thirds of the time the school is occupied. The daylighting strategy selected consists of roof monitors, lightshelves, and light-colored interior finishes.*



# Design Guidelines for Daylighting and Windows

## Building Orientation and Solar Access

By elongating the school design on an east-west axis, the potential for cost-effective daylighting is maximized.

- Consider daylighting strategies that primarily use south-facing glass and secondarily incorporate north-facing glass. An elongated building that has its major axis running east-west will increase the potential for capturing winter solar gain through south glass as well as reducing unwanted summer sun that more often strikes on the east and west surfaces. Exposed, eastern- and western-facing glass should be avoided wherever possible because it will cause excessive summer cooling loads. South glass should incorporate properly sized overhangs that limit radiation in warmer months.

- Verify that other exterior design elements or existing site features do not negatively affect the daylighting design.

- Make sure other building elements do not unintentionally shade glazing areas that are designed as daylighting elements.
- Consider the reflectance of the materials in front of the glazing areas. The use of lighter roofing colors can reduce the glass area needed for roof monitors, while a light-colored walkway in front of a lower window may cause unwanted reflections and glare inside the classroom.

## Daylighting Strategies

Because lighting is a significant component of a school's energy consumption, efforts to use daylighting should be given a high priority. Properly designed daylighting reduces the need for electric lighting and helps to create a more pleasant environment.

- Good daylighting design can reduce the electricity needed for both lighting and cooling a school. The reason is simple: daylight provides a higher ratio of light to heat than electrical sources. This ratio, known as lighting efficacy, means that daylight provides more light and less heat, which can greatly reduce cooling loads. The chart to the left compares the efficacy (measured in lumens per watt) of various light sources.

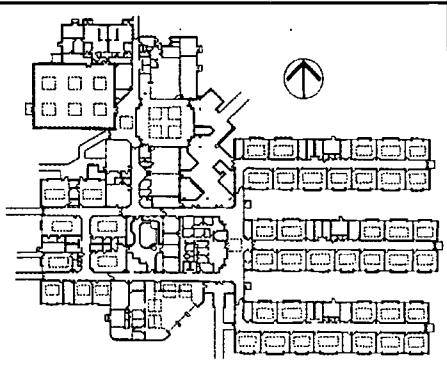

To optimize solar access, develop a floor plan along an east-west axis.

### Lighting Efficacy

Lighting Source	Efficacy (lumens/watt)
Beam Sunlight/ Diffuse Skylight	110-130
High-Intensity Discharge (high pressure sodium, metal halide)	32-124
Fluorescent	55-90
Compact Fluorescent	50-60
Incandescent	10-20

Source: Lawrence Berkeley National Laboratory Lighting Market Source Book for the United States

*Sunlight provides more lumens per watt than electrical lamps.*

- In cold and humid climates, it is important to consider how passive heating can provide benefits without negatively impacting summer cooling. Properly designed south-facing monitors or windows with lightshelves can accomplish both. By facing the glass south and providing overhangs that maximize winter gain and block the majority of direct solar gain during summer peak cooling times, an optimum solution is possible. Because cooling loads are a great concern, it is very important to size the glass area so that during times of peak cooling no more solar gain is allowed to enter into the space than is necessary to provide the required lighting levels. If designed correctly, this sunlight will generate less heat for the same amount of light. This means that, in addition to the lights being off, the peak cooling mechanical load will be reduced.
- Consider daylighting apertures to limit the amount of beam radiation entering during the hottest part of the day in the cooling season. East- and west-facing glass should be minimized. In cold and humid climates, south-facing vertical glazing is typically better because roof overhangs can be designed to effectively admit low-angle winter radiation for daylighting and exclude excessive higher-angle sunlight in the warmer months. North glazing is second best because it doesn't create overheating problems during the cooling seasons, but it also doesn't provide any passive heating benefits. For example, the charts below indicate seasonal sun angles for Minneapolis.

For more information on sun angles, see the resource section in this report.

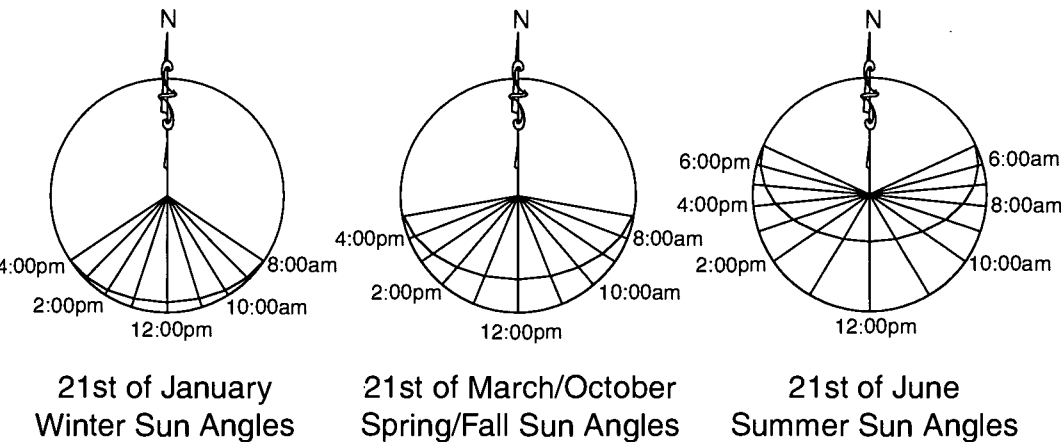

**Sun Angles for Minneapolis, MN**

*Sun angle charts indicate the location (azimuth) of the sun at various times of the year.*

- Use a well-designed overhang to mitigate the potential drawbacks of summertime solar gains through south-facing glazing. An oversized overhang on the south is not recommended on daylighting apertures since it can block significant amounts of diffuse radiation in addition to the direct beam.
- Develop a daylighting design with primary emphasis on south- (typically best) or north-facing roof monitors and a secondary emphasis on lightshelves. Lightshelves can significantly enhance the natural lighting uniformity within a space and also provide good lighting in narrow rooms (less than 16 feet to 20 feet). Lightshelves may also be the only option on multiple-story schools.

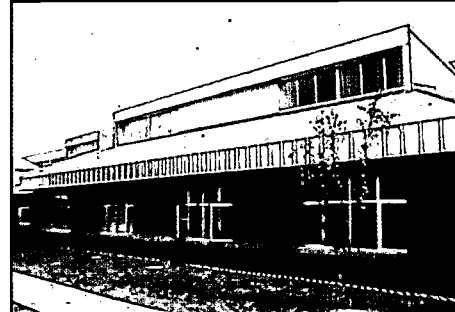

*South-facing roof monitors and windows provide natural light in the classrooms.*



*Properly designed daylighting strategies can provide superior light in classrooms more than two-thirds of the time.*

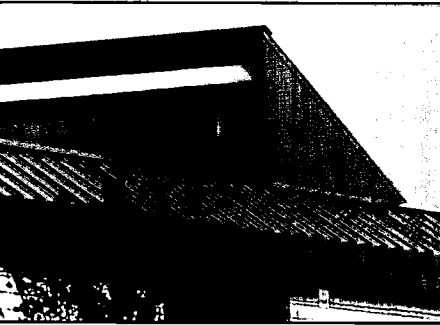

*Clear double glazing has to be used to optimize solar access. Overhangs block excessive radiation in the warmer months.*

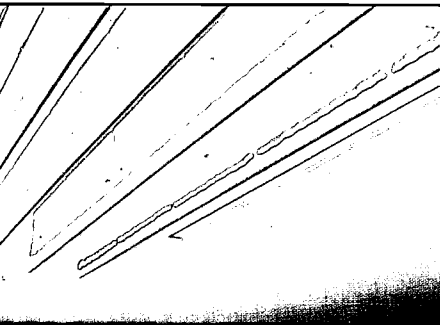

*Translucent baffles block direct beam radiation and diffuse the sunlight throughout the space.*

### Roof Monitors and Clerestories

Roof monitors and clerestories perform two critical functions: they provide uniform light within the room, and they eliminate glare.

- Design daylighting strategies to meet the different lighting needs of each major space, accounting for:
  - differing lighting level requirements by time of day
  - the ability to darken particular spaces for limited periods of time.
- If south-facing roof monitors are employed, they should:
  - employ baffles within the light wells to totally block direct beam radiation from striking people, reflective surfaces, or computers
  - block high summer sun with exterior overhangs
  - reduce contrast between very bright surfaces and less bright areas.
- Optimize the design of roof monitors to enhance their benefits.
  - Minimize the size and maximize the transmission of glass to reduce conductive losses and gains.
  - Develop an overall building structural design that integrates the daylighting strategies and minimizes redundant structural elements.
  - For south-facing monitor glass, select clear double glazing or clear double glazing with argon. Do not use low-e or tinted glass in these windows because it has lower visible light transmission qualities. This adversely affects the daylighting and requires more glass area to achieve the same results.
  - Choose light-colored roofing materials in front of roof monitors to reflect additional light into the glazing.
  - In roof monitor/lightwell assemblies, incorporate white (or very light-colored) baffles that run parallel to the glass and are spaced to ensure that no direct beams can enter into the space. These baffles should be fire-retardant and UV-resistant. Use light-colored translucent baffles because, in addition to reflecting the sunlight into the space, they eliminate contrast from one side of the baffle to the other.
  - At the bottom of the lightwell, provide a transition between the vertical plane surface and the horizontal by either introducing a 45° transition or, if possible, a curved section. This will decrease the contrast between the higher light level inside the lightwell and the horizontal ceiling.
  - Ensure that the walls and ceiling of the roof monitor are well insulated and incorporate appropriate infiltration and moisture barriers.

## Lightshelves

A south-facing window can be easily transformed into a well-controlled lighting source by adding a lightshelf a couple of feet below the top of the window. The lightshelf, made of a highly reflective material, will bounce the sunlight that strikes the top of the surface deep into the building. The reflected sunlight will hit the ceiling and, in turn, provide light for the room. This is an effective strategy for rooms up to 20 feet deep and can be employed in multi-story schools or where roof monitors are not possible. The lightshelf also serves the vital role of shading the window below.

- Select durable materials for both interior and exterior lightshelves, and design them to be capable of carrying the weight of a person.
- Specify aluminum exterior lightshelves as a good compromise among good reflectance, little or no maintenance, and cost.
- Incorporate white painted gypsum board on top of interior lightshelves. However, aluminized, acrylic sheets applied to the top of a shelf allows light to bounce farther back into spaces and can improve performance in deeper rooms without top lighting.
- Use blinds as a strategy to enhance performance. Even with a combination of interior and exterior lightshelves, direct beam light can, at times, enter into the space, creating unwanted glare. If the lightshelves are located close to perpendicular interior walls and are not deep enough to eliminate this problem (which is the typical case), vertical blinds can provide an excellent option. By using vertical blinds for the window section above the lightshelf, the light can be directed toward the walls, thus eliminating glare and enhancing the bouncing of light deep into the space. White blinds are preferred to increase reflectance. If the lightshelf windows are located near the middle of the space and farther away from perpendicular walls, horizontal blinds (flat or curved but turned upside-down) would allow the light to be reflected up toward the ceiling and deep into the space.
- Control the windows located above and below the lightshelves independently. On the south facade, daylighting can be enhanced by:
  - Incorporating vertical blinds that can focus radiation to the perimeter walls within a space and away from people within the space
  - Using horizontal blinds that can be installed to reflect the light up toward the ceiling, thus reflecting it back farther into the space.
- Don't use lightshelves on northern exposures. They are not cost-effective or necessary. However, it is still advisable to use clear double glass or clear double glass with argon (if possible) on high non-view windows on the north.
- When calculating daylighting contribution, don't consider the low north and south windows (view glass) in your calculation, as these windows are often closed or covered.

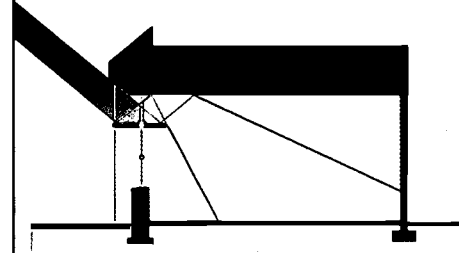

*Using lightshelves on south-facing windows allows natural light to bounce deep into the room.*



*Lightshelves can also shade the lower window glass.*



*Light-colored interior finishes help the uniform distribution of natural light in the classroom.*

### Lighting Controls

Lighting controls can ensure that students and teachers always have adequate light and that energy efficiency is maintained.

- Enhance the economic benefits and provide for smoother transition between varying light conditions by using multi-staged or dimmable lighting controls. The success of these controls relies on:
  - having the sensors mounted in a location that closely simulates the light level (or can be set by being proportional to the light level) at the work plane
  - implementing a fixture layout and control wiring plan that complements the daylighting strategy
  - providing means to override daylighting controls in spaces that are intentionally darkened to use overhead projectors or slides.

### Interior Finishes

The color of interior finishes will have a dramatic impact on the lighting requirements within each space.

- Use white (or very light-colored) paint inside the lightwell area. Colors inside the room can be slightly darker, but the lighter colors will help the light to reflect deeper into the space. Accent colors (with the majority still white) and beige colors are acceptable inside typical rooms. The tables included within the “Energy-Efficient Building Shell” section of this document provide additional information on the recommended reflectance ranges for different interior finishes.
- Apply carpet or other floor coverings that are as light as is practical for maintenance. This will greatly enhance reflectance and require less glazing to produce the same light levels. If the floor finish is dark, more glass is required to effectively daylight the space.
- If there are television monitors, computers, or whiteboards in the classrooms, locate them so as to minimize glare.
- Enhance the daylighting by placing south-facing windows with lightshelves close to perpendicular interior north-south walls. The color of the walls immediately inside the window should be light to enhance this reflectance. See page 22 for reflectance values of interior paint and wood.

### Skylights

Consider skylights if they can be specifically designed to avoid overheating during the warmer months and perform well with minimum maintenance.

- If skylights are used, specify those that incorporate:
  - motorized, louvered systems that seasonally and hourly adjust to allow the optimum amount of radiation to enter the glazing
  - a means to reduce glare and diffuse the radiation once inside the space.

## Windows

Windows will have a significant impact on energy consumption. The characteristics of the windows and their location, design, and purpose will determine, to a great degree, the level of energy efficiency the school achieves.

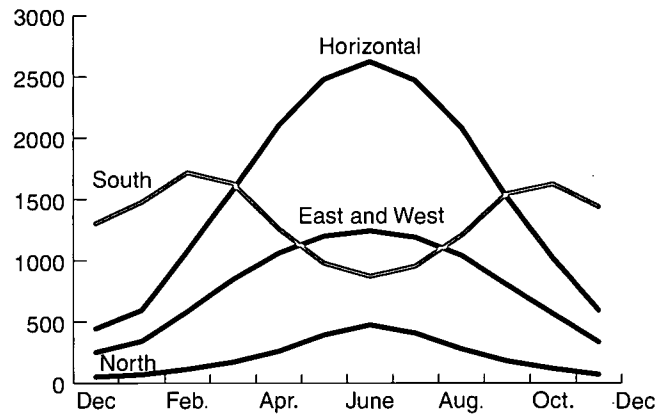

Comparison of Window Orientations — 48° Latitude

The amount of solar radiation striking windows varies with the surface orientation.

## Appropriate Choice

In all cases, windows should be made of high-quality construction, incorporate thermal breaks, and include the appropriate glazing for the particular application. Windows should be designed to meet the overall objective and not be oversized. To determine the optimum glazing for each application, the designer should conduct computer simulations that compare options. The US Department of Energy's DOE-2 program is one of the better analytical tools available for this purpose. More information on the DOE-2 program can be found in the resource section at the end of this document.

- Analyze and select the right glazing for each orientation, location, and purpose. For example, if windows are:
  - oriented east and west and not externally shaded, the best choice is to use a tinted glazing with low-e or low-e with argon
  - well-shaded by building elements (e.g., overhangs) or north-facing, tinting would not be advised since it restricts the transmission of diffuse radiation
  - located close to the floor, comfort becomes a more critical issue, and low-e or low-e windows with argon glazing is appropriate
  - designed as daylighting components above lightshelves or in roof monitors, the best option is typically clear double glazing or clear double glazing with argon.

### Window Selection Considerations

Application	Exposure	Type
View Glass (Non-Daylighting Apertures)	South	Clear Double, Low-e with Argon
	North	Clear Double, Low-e with Argon
	East/West, Unshaded	Tinted Double, Low-e with Argon
	East/West, Shaded	Clear Double, Low-e with Argon
Windows Above Lightshelves	South	Clear Double or Clear Double with Argon
High Windows Above View Glass	North	Clear Double or Clear Double with Argon
Roof Monitors	South	Clear Double or Clear Double with Argon

### Solar Transmission Values for Typical Glass Types

Glazing Type	Solar Transmission	Equivalent U-Value
Clear, Single	75%–89%	1.11
Clear, Double	68%–75%	0.49
Low-e, Double, Clear	45%–55%	0.38
Low-e, Tinted, Gray	30%–45%	0.38
Low-e, Argon	45%–55%	0.3

Considering the transmission values of glass by orientation can greatly reduce cooling loads.

Typically, low-e glass is not recommended because the glass, as well as the complementary components of the daylighting system (e.g., lightshelves, baffles, roof monitors, etc.), all have to increase to account for the reduced transmissions.

### Light Transmission Values

0.9	Standard Double Glazing
0.5-0.9	Internal Venetian Blinds — Drawn
0.4-0.8	Internal Curtains — Drawn
0.4-0.8	Internal Roller Blinds — Drawn
0.7	Heat-Absorbing Glass
0.6	Tree Providing Light Shade
0.5	Internal Blind — Reflective Backing
0.4	Solar Control Glass
0.2	External Blinds — Drawn
0.2	External Shutters — Closed

*Transmission of light is greatly impacted by the type of window treatments used.*

- Select spectrally selective, low solar gain, low-e glazing for non-daylighting apertures.
- Consider the possibilities of implementing natural ventilation strategies that use operable windows.

### Exterior Window Treatments

The most efficient means of appropriately restricting unwanted solar gain from entering glass areas is to block the radiation before it gets to the glazing.

- Properly size fixed overhangs on south-facing roof monitors and lightshelf glazing to block a large portion of the midday summer sun while still allowing the lower winter sun to reach the glass.
- Incorporate overhangs or other design elements above east- and west-facing glazing so that they effectively block the morning and afternoon sun.
- Consider the advantages of using seasonally adjustable or stationary awnings, solar screens, shutters, or vertical louvers when fixed overhangs are not possible or are impractical.



*Clear glass for south-facing roof monitors and low-e glass for view windows are two daylighting and energy-efficient features.*

### Interior Window Treatments

If exterior window treatments cannot effectively control the seasonal and daily variations in radiation (and resulting glare), or if it is desirable to be able to darken the particular space, blinds or shades provide better control.

If blinds or rolling type dark-out shades are employed, install types that are either motorized or easily accessible and made of durable construction materials and components.

# Energy-Efficient Building Shell

Because the building shell is typically responsible for 10%–20% of the total energy consumed in a school, focusing on this area of design can help you reduce energy consumption in your school buildings. Increased insulation in the walls and ceiling helps to reduce heat loss and improve comfort. Light-colored exterior walls and white roofs help to reduce cooling loads. These factors also contribute to reducing the size and cost of the HVAC system you will need. The useful life of building materials, systems, and equipment incorporated in schools can vary considerably, so the building shell decisions you make as a designer will impact the first cost of the school as well as the long-term costs associated with operation, maintenance, and replacement.

Wall insulation should be selected based on the likelihood that it will never be replaced. When selecting your wall and roof systems, it is critical that you choose what is best for the life of the facility. Specify interior and exterior finishes that are durable and as maintenance free as possible, and integrate insulation levels that are appropriate for the life of the facility. Also, incorporate durable strategies that address air infiltration.

If specified correctly, energy-efficient building shell elements can be effective in reducing our impact on the environment, and they will never need to be replaced.

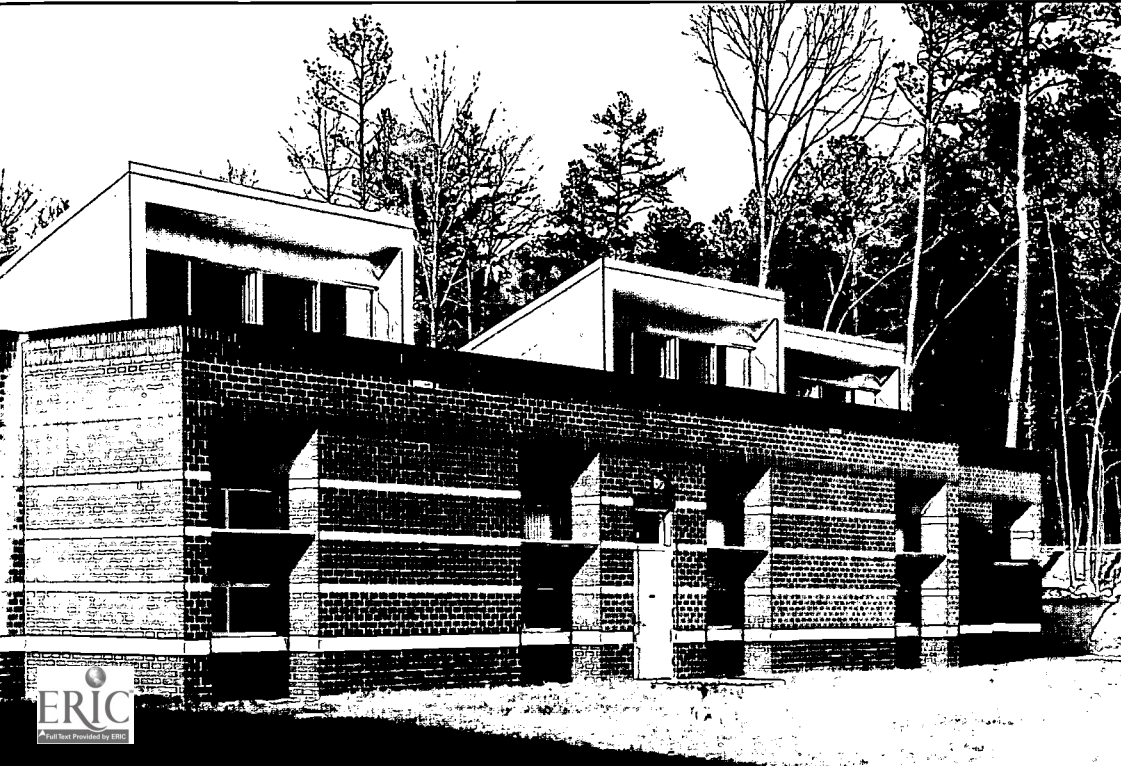

Photo: Robert Flynn

*High-mass exterior walls, light-colored roof finishes, and window treatments including lightshelves and low-e glazing for view windows are among the energy-efficient building shell elements.*



# Design Guidelines for an Energy-Efficient Building Shell

## Massive Wall Construction

In cold and humid climates, high-mass construction techniques are primarily used to store thermal energy in passive solar systems. But they can also be used to moderate the heat gain experienced during the hot days, delaying the impact until the nighttime when ventilation strategies could cool the interior spaces. If adequate mass is incorporated, these cooling strategies are particularly effective since schools are typically not occupied during evening hours.

- By incorporating well-insulated masonry wall systems that are designed so that the mass is inside the insulation and exposed, the mass can be utilized to save thermal energy from passive heating strategies incorporated in the school.
- Employing high-mass wall construction techniques to lag the heat gains. Although not as abundant as in warmer climates, these techniques still provide a moderating effect in the warmer months.

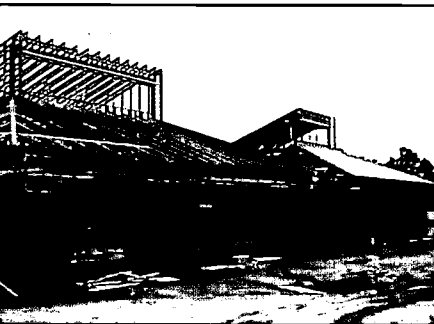

High-mass construction techniques, incorporating a brick-block cavity wall, lag the heat gain experienced during the daytime well into the evening.

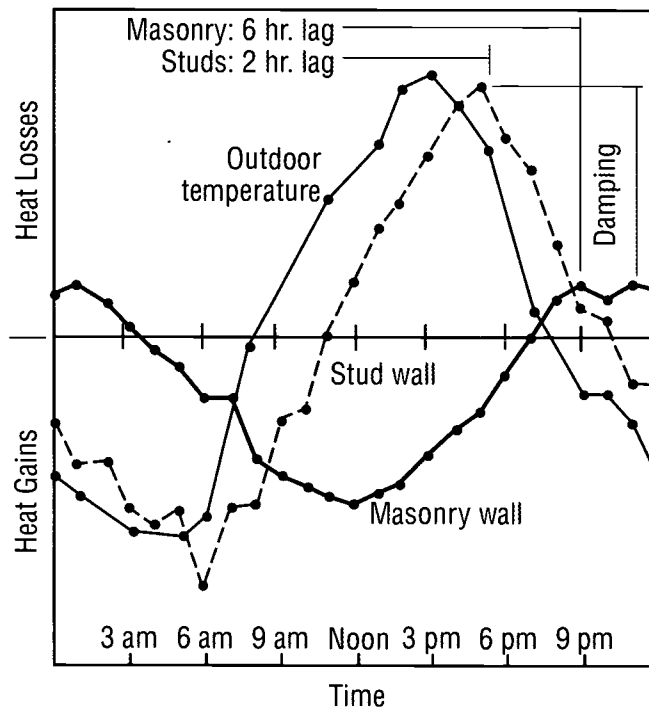

Heat Gain Lags in High-Mass Walls

Using high-mass wall construction techniques can delay thermal gains by up to 12 hours.

- Newer wall systems using insulated concrete forms or tilt-up insulated concrete panels have also proved effective.

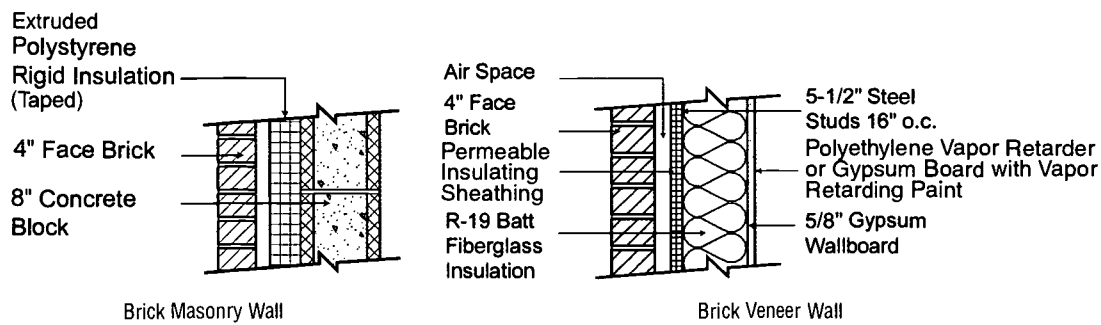

### High-Mass Wall Sections

*Passive solar energy can be stored if mass is exposed inside.*

## Moisture and Infiltration Strategies

Controlling air flow and moisture penetration are critical elements in reducing energy consumption, maintaining structural integrity, and ensuring a healthy indoor environment.

- Because designers in cold and humid climates need to primarily address a heating load, vapor barriers should be placed on the inside of the wall assembly's insulation to prevent moisture from entering the wall cavity.
- Permeable exterior sheathing materials will keep moisture from being trapped in the wall.
- Since air leakage can carry significant amounts of moisture into the building envelope, caulk and seal any building shell penetrations. Consider the use of a continuous air infiltration barrier.

## Insulation Strategies

Energy-efficient building design starts with implementing optimum insulation levels. Evaluating the cost-effectiveness of varying insulation R-values allows you to maximize long-term benefits. High levels of wall and ceiling insulation are particularly important in cold and humid climates.

- When selecting insulation levels, refer to ASHRAE Standard 90.1. R-values required by local building codes should be considered a minimum.
- When determining the choice of insulation, you should consider not only energy efficiency and initial cost but also long-term performance. Carefully research insulation products for stability of R-value over time, and make comparisons based on the average performance over the service life.

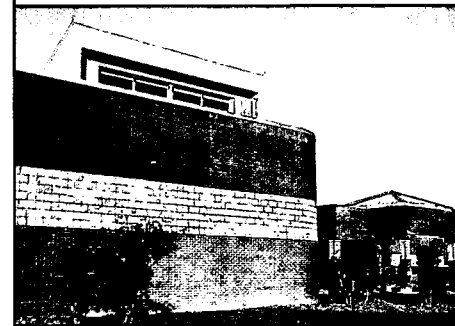

*An energy-efficient building shell requires that the designer view the wall assembly as a system within the "whole building."*

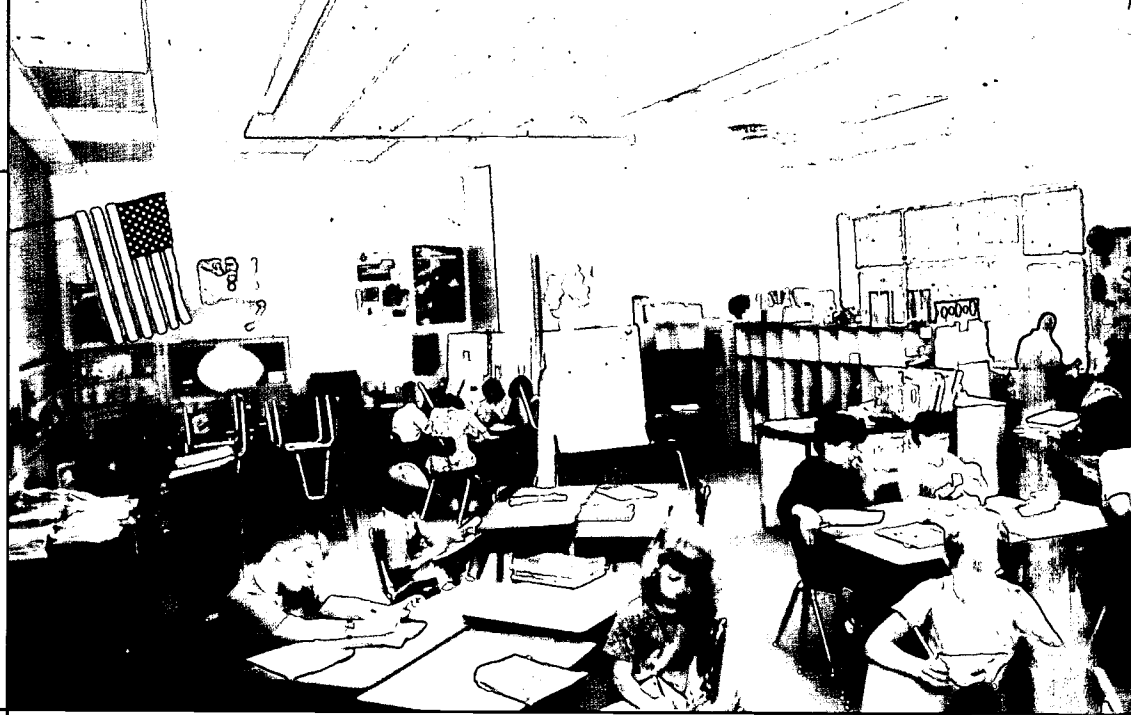

*Light-colored finishes will significantly reduce lighting demands within interior spaces.*

### **Interior Finishes**

By properly selecting interior finishes, lighting energy demands can be reduced and visual comfort can be improved for no additional cost.

- Select light colors for interior walls and ceilings to increase light reflectance and reduce lighting and daylighting requirements.
- Consider the color and finish of interior walls and ceilings. When placed incorrectly, light-colored, glossy finishes can create glare problems that negatively impact visual comfort.

**Reflectance Table: Paints**

<b>Color</b>	<b>Reflectance</b>
Semi-Gloss White	70%
Light Green*	53%
Kelly Green*	49%
Medium Blue*	49%
Medium Yellow*	47%
Medium Orange*	42%
Medium Green*	41%
Medium Red*	20%
Medium Brown*	16%
Dark Blue-Gray*	16%
Dark Brown*	12%

**Reflectance Table: Woods**

<b>Type</b>	<b>Reflectance</b>
Maple	54%
Poplar	52%
White Pine	51%
Red Pine	49%
Oregon Pine	38%
Birch	35%
Beech	26%
Oak	23%
Cherry	20%

\* These values are estimated for flat paints. For gloss paints, add 5%–10%. Source: SBIC, Passive Solar Design Strategies  
*Careful consideration of interior finishes based on reflectance values can reduce lighting demands.*

## Stopping Radiant Heat Gains

In cold and humid climates, creating a building shell that is massive and well-insulated can effectively address conduction gains and losses, but it is also beneficial to take into account radiant solar gains. In the warmer months, up to 90% of the cooling load coming from the roof area can be attributed to radiant heat gain. By addressing this problem, you can decrease your cooling load significantly.

- Incorporate radiant barriers in the roof assemblies to reduce up to 95% of radiant heat gain. When solar radiation strikes a roof, a certain percentage of radiation is reflected away, and the balance is absorbed. When this occurs, it heats up that material, and the material reradiates downward. The low-emissivity properties of the aluminum in the radiant barrier stop this radiant process, allowing only 5% of the radiation to pass through. Radiant barriers that have coatings to protect against oxidation help ensure long-term performance. These types of radiant barriers are superior to reflective roofing strategies that tend to lose their reflective qualities over time. Dust accumulation on radiant barriers reduces their performance. When possible, they should be suspended from the joists or rafters to reduce dust accumulation.
- To reflect solar gain away before it can create negative radiant impacts within the spaces below, incorporate highly reflective roofing systems. This strategy is important, particularly in areas where radiant barriers cannot practically be installed.
- Select a light color for the exterior finish to reflect solar radiation.
- Shade exterior walls with architectural elements (or landscaping) to enhance performance.



*Radiant heat gain can be responsible for 90% of the heat entering through the roof. The use of a radiant barrier can block up to 95% of this gain.*

**Reflectance Values for Exterior Surfaces**

		% Reflected	% Absorbed
<b>Roofing Material (1)</b>			
Single-Ply Roof Membrane	Black EPDM	6%	94%
	Gray EPDM	23%	77%
	White EPDM	69%	31%
Asphalt Shingles	Black	5%	95%
	Medium Brown	12%	88%
	Green	19%	81%
	Gray	22%	78%
	White	25%	75%
Metal Roof	Aluminum	61%	39%
	Metal White	67%	33%
<b>Exterior Wall Material (2)</b>			
Brick	Light Buff	45%	55%
	Dark Buff	40%	60%
	Dark Red	30%	70%
Concrete	Light	55%	45%
	Medium	20%	80%
	Dark	15%	85%

*This chart indicates the reflectance of various typical roofing materials when first installed. Materials that maintain their reflective characteristics should be preferred.*

(1) Source: Berdahl 2000. "Cool Roofing Material Database," LBNL 1981 IES Lighting Handbook

## Embodied Energy

When selecting the building materials, consider that, in many cases, the amount of energy embodied in constructing the school is equal to more than two decades of a school's energy consumption. To seriously address the overall impacts of energy consumption, consider the energy involved in making each product, transporting the product to the site, and implementing the component into the school.

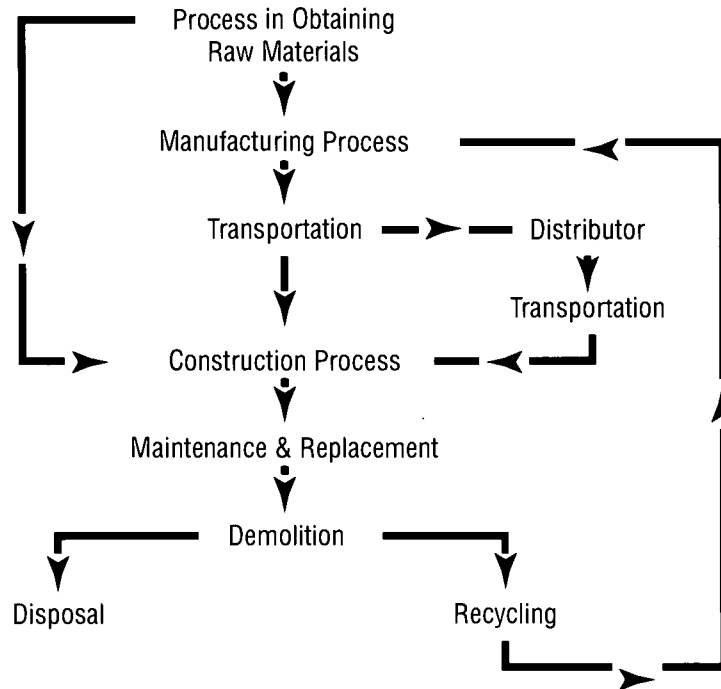

**Total Embodied Energy Diagram**

*Products, materials, equipment, and processes incorporated into construction*

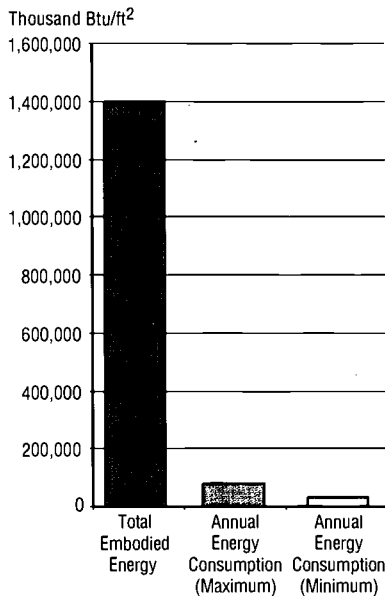

### Total Embodied Energy per Square Foot for Educational Buildings

*The embodied energy of a school building exceeds the annual energy consumption of the school.*

- Because often half or more of the embodied energy involved in constructing a school is related to transportation, select locally made products and construction materials.
- Consider the energy intensity of the manufacturing process involved in making materials and products incorporated in the school.
- Encourage the use of recycled products.
- Evaluate the recyclability of products once the building has passed its useful life.
- If existing structures on the school site are to be demolished, consider how the typically wasted materials could be used in the new construction.

# Lighting and Electrical Systems

The design of your school's lighting system has direct bearing on the performance of your students and teachers. The ability to read comfortably and perform visual tasks is strongly impacted by the type and quality of the lighting systems implemented. Lighting strategies that reduce glare while still producing the required lumen levels are essential components of a high performance school.

Lighting represents 25%–40% of a typical school's energy costs. An energy-efficient lighting system can save thousands of dollars annually in just one school because improving the efficiency of the overall lighting system reduces the energy requirements for both lighting and air conditioning. Controls in daylit spaces can automatically reduce or increase light levels as needed, and occupancy sensors can automatically turn off lights in unoccupied spaces.

Your design team can create an energy-efficient, high-quality lighting system by following three strategies. First, select efficient lamps, ballasts, lenses, and fixtures that address the needs of each space and achieve the highest output of lumens per input of energy. Second, provide occupancy sensors, time clocks, and other controls that limit the time the lights are on to only hours when the space is occupied and the light is needed. And third, provide automated daylighting controls that dim the electrical lighting when sufficient natural light is present.

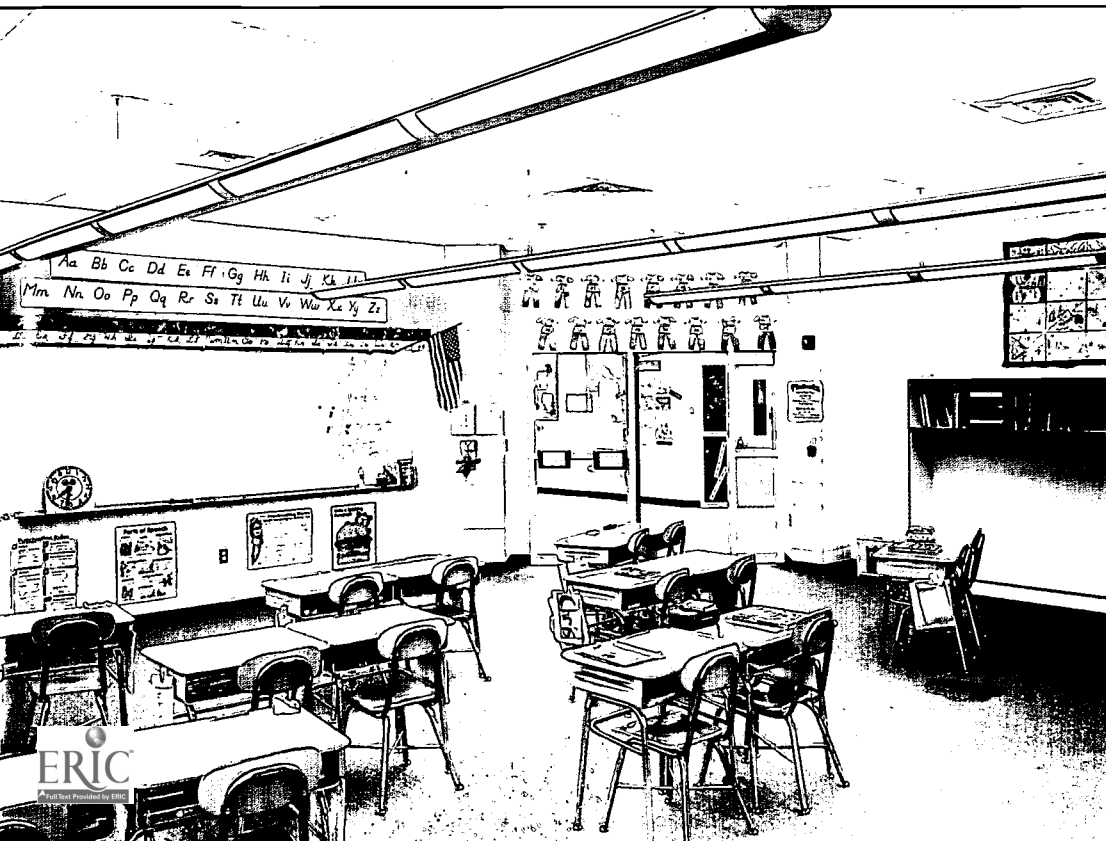

Photo: NREL/PIX03045

*Indirect lighting can provide excellent uniform artificial lighting in a classroom, eliminating glare and contrast between bright and dark areas.*

# Design Guidelines for Lighting and Electrical Systems

## Lighting Strategies

In naturally lit spaces, the artificial lighting design should be compatible with the objectives of the daylighting. In non-daylit spaces, the objective should be to implement the most energy-efficient system possible that minimizes glare while providing the proper level and quality of light.

- Maximize the illumination by considering the geometry and reflectance of finishes in each space.
- Implement indirect lighting strategies as a means to complement daylighting.
- Select fixtures that are designed to minimize glare, particularly in rooms with computers.
- Verify the lighting requirements for each space function.
- Consider the option of providing low-level ambient lighting supplemented by task lighting.
- Prefer photovoltaic lighting systems for remote exterior applications such as parking areas or walkways. It is often more cost effective to use a localized photovoltaic system with its own battery storage than to provide underground electrical service.
- In non-daylit spaces, incorporate lamps with high color rendering.
- Design switching circuits to allow spaces that are not commonly used to be switched off.

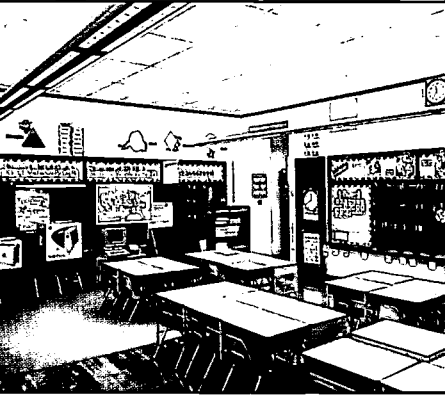

Photo: NREL/PIX03047

*Indirect lighting systems provide high-quality artificial lighting in classrooms.*

## High-Efficacy Lamps

Efficacy is an important measure for energy efficiency in light output per unit of energy used. High-efficacy lamps can provide the same illumination and color rendition as standard lamps but at two to six times the efficiency.

*High-efficacy lamps produce a high light output per unit of electric input.*

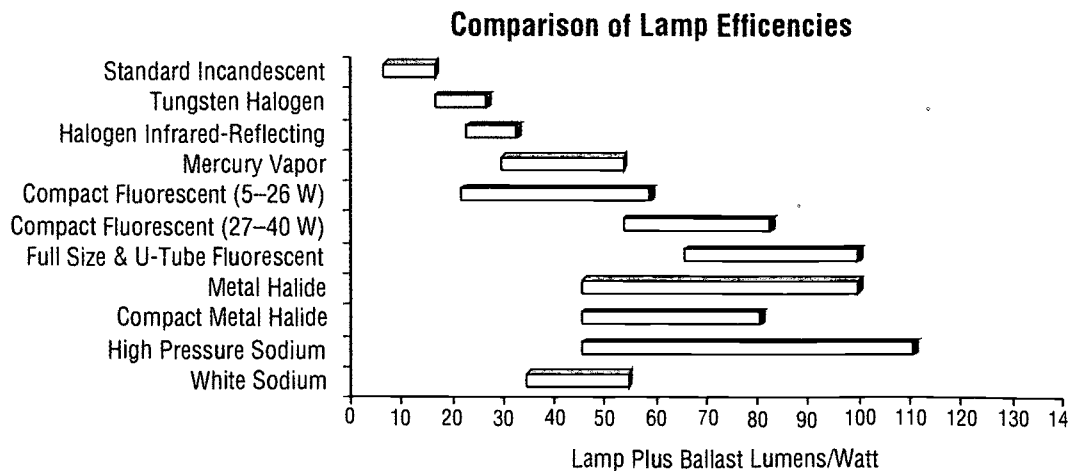

- Minimize the use of incandescent fixtures.
- When selecting lamps, consider the maintenance and lamp replacement costs.
- Select the lamps with the highest lumens of output per watt of input that address the specific need.

**Fluorescent Lamp Technologies — Efficacy Comparisons**

Lamp Type	Lamp Life (hours)	Lumen/Watt	C.R.I.*	Lumen Maint.**	Ballast Factor	Description and Comments
T-5 Fluorescent (28 W/4 Ft)	20,000	104	85	0.95	1	5/8" dia. tube; high lamp and ballast efficiency, high CRI, similar output to T-8 with a 12% reduction in power usage
T-5 HO Fluorescent (54 W/4 Ft)	20,000	93	85	0.95	1	5/8" dia. tube; high lumen output, high CRI; 88% higher lumens than standard 4 ft T-8
T-8 Fluorescent (32 W/4 Ft)	20,000	92	82	0.92	0.9	1" dia; standard for efficient fluorescent lamps; 23% efficiency improvement over T-12
T-12 Fluorescent (34 W/4 Ft)	20,000	69	72	0.89	0.88	1 1/2" dia. tube, still being used where efficiency is not being considered

Developed by Padia Consulting from manufacturers' literature (Philips, Osram Sylvania, General Electric)

\* Color Rendering Index

\*\* The lumen maintenance percentage of a lamp is based on measured light output at 40% of that lamp's rated average life. For T-5, after 8,000 hours of lifetime, the lumens/watt will be 98.8 lumen/watt (104x0.95).

*Fluorescent lamp selection should be based on the illumination needs of the area and lamp replacement frequency and cost.*

## Compact Fluorescent Lamps

- Consider compact fluorescent lamps that are energy-efficient and long-lasting. A 13-watt compact fluorescent lamp (about 15 watts with an electric ballast) provides the same illumination as a 60-watt incandescent lamp and lasts up to 10 times longer. Additionally, they have excellent color rendering.
- In larger daylight spaces like gymnasiums, provide ganged compact fluorescents as a practical means of addressing the need to implement dimmable lamps.
- Select fixtures with effective reflector design.

## Fluorescent Lamps

- Choose the smaller diameter T-8 and T-5 fluorescent tubes over the traditional T-12s because they have a higher efficacy. The T-8 system produces 92 lumens per watt as compared with 69 lumens per watt for the T-12 system. The T-5 system produces 33% more lumens per watt than the T-12 system.
- Specify fixtures that are designed to enhance the efficacy of the T-8 and T-5 lamps by incorporating better optics in the luminaire design.



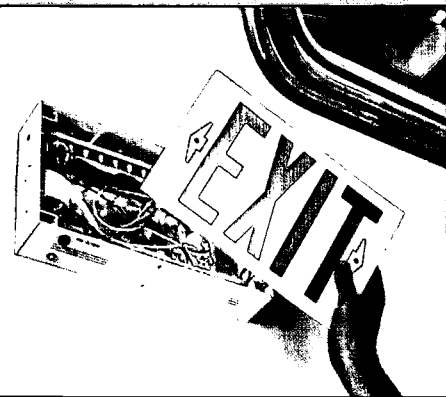

Photo: NREL/PIX07071

*LED exit signs last 10–50 times longer than fluorescent and use less energy.*

## Metal Halide and High-Pressure Sodium Lamps

- Consider metal halide and high-pressure sodium lamps for exterior lighting applications.
- Use metal halide and high-pressure sodium lamps only in areas where the long warm up and restrike time after a power outage will not affect the safety of students, visitors, and staff.

## LED Exit Lights

- Select light-emitting diode (LED) exit lights. Exit signs operate 24 hours a day, 365 days a year. LED exit signs offer energy savings between 80 kilowatt-hours/year and 330 kilowatt-hours/year per fixture with little maintenance. LED exit lights have a projected life ranging from 700,000 hours to more than 5 million hours, and the standby battery requires replacement about every 80,000 hours. Typical fluorescent lamps will last only 15,000 hours.

## High-Efficiency Reflectors

High-efficiency fixtures employ two main strategies to minimize the blockage or trapping of light within the fixture housing: high-efficiency lensed troffers and fixtures with parabolic reflectors.

- Incorporate well-designed troffers that use the shape and finish of the inner housing to minimize inter-reflections and maximize the lumens per watt. A high-efficiency troffer with two or three lamps can produce the same illumination as a standard four-lamp fixture.
- Select fixtures with parabolic reflectors as an alternative means to improve the optics and increase the performance of the light fixtures.

## Ballasts

Solid state electronic ballasts are available in both rapid-start and instant-start models. The instant-start ballasts have a very high efficiency but should be avoided in applications where sensors are used.

While selecting a dimmable ballast, take into consideration the fact that magnetic ballasts will only dim to about 40% of full power before the flicker becomes problematic, whereas electronic ballasts may be dimmed to near zero output with no perceptible flicker. Electronic ballasts also have a higher lumen output at reduced power levels than magnetic ballasts.

- Select high-efficiency electronic ballasts because they save energy, have a low propensity to attract dust, incorporate a minimum of hazardous materials, and operate at a cooler temperature.
- Select electronic ballasts because they minimize the characteristic humming from fluorescent lamps.

- Consider that conventional ballasts cycle at 60 hertz and create a perceptible flicker, whereas electronic ballasts cycle faster, reducing eye strain.
- In areas where daylighting strategies are being implemented, employ electronic ballasts designed specifically for dimming and controlled by photosensors.

## Lumen Maintenance

The output of a fluorescent lamp decreases over its rated life. The strategy used for maintained light level calculations is the initial light output of the luminaires multiplied by factors for lamp depreciation, luminaire depreciation, and room surface dirt depreciation. This will drop the calculated output by 25%–30% or even more.

The better strategy is to measure the light output at the work surface using a light sensor in an “open loop” control. This will save power initially, extend the life of the lamps, and compensate for dirt on luminaires and room surfaces. It is important to establish a program of group lamp replacement. This will ensure that overall lighting levels are even, and maintenance labor costs are reduced by 88% over “spot” replacement.

## Lighting Controls

Because of changing use patterns in schools, occupancy sensors and photosensors can save considerable energy by simply turning off the lights when not needed. There are two commonly used occupancy sensors: infrared and ultrasonic. Infrared sensors detect occupants by sensing changes in heat as occupants move, while ultrasonic sensors detect movement of solid objects. Sensors that combine both technologies are available. It is also important to implement photosensor controls for outdoor lights to ensure that the lights are only on at night.

- Incorporate infrared, ultrasonic, or a combination of infrared and ultrasonic motion detectors in all major spaces to turn off the lights when the space is not occupied.
- In daylit spaces, incorporate staged or dimmable (preferred) lighting controls tied to photocells located within each space and capable of reading light levels at the work surface.
- Incorporate override switches for automatic daylight dimming controls only where the need to manually control lighting levels is necessary to the function of the space.
- Provide photocells on outdoor lights to ensure that they are off during daytime hours.

## Electrical Systems

An inefficient electrical distribution system in a school can result in degraded power quality, the introduction of wasteful harmonics, and line losses up to 3% or 4%.

- Evaluate the merits of a high-voltage distribution system, taking into consideration the initial cost and operational savings due to reduced line losses. Analyze the costs of delivering power at 208/120 volts versus 480/277 volts.

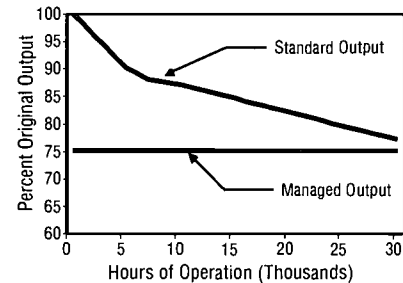
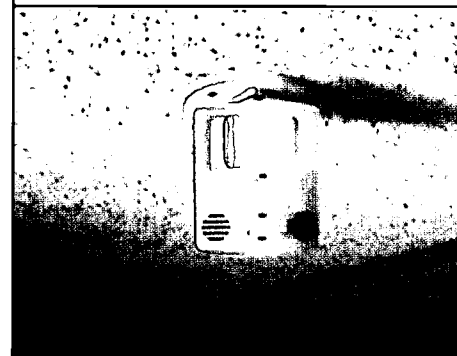

Chart: Padia Consulting

### Typical Degradation of Fluorescent Lamp Output Over Time

*Lamp output degradation should be managed to maintain constant lighting levels.*



*Daylight sensors combined with occupancy sensors are used as an energy-saving measure to turn the lights off if the natural light level is sufficient or if the space is unoccupied.*



Money Isn't All You're Saving

**ESTABLISH ENERGY PERFORMANCE GOALS**

*For new school design (K-12), the US EPA recommends setting a design target and monitoring progress throughout the design process.*

*The ENERGY STAR label can also be used to identify energy-efficient office equipment, exit signs, water coolers, and other products. By choosing these products, your school can save energy and money.*

- Correctly size transformers to fit the load, keep losses to a minimum, and optimize transformer efficiency. The correct sizing of a transformer depends on the economic value and size of load losses versus no-load losses, and consideration of expected transformer life.
- Consider more efficient transformers that operate at lower temperatures. Most transformers range in efficiency between 93% and 98%. Transformer efficiency is improved by reducing the losses in the transformer. Transformer efficiency standards exist in some states, and efficient transformers are required by code in others. Check with your state energy office.
- Consider using K-rated transformers to serve non-linear equipment. K factor is a constant developed to take into account the effect of harmonics on transformer loading and losses. A K-rated transformer may initially cost more, and may be less efficient, but it should result in a longer transformer life.
- Evaluate the distribution system to determine if power factor correction is justified. Utilities usually charge users for operating at power factors below a specified level. In addition to causing unnecessary line losses, low power factors create the need for a larger energy source. If power factor correction is necessary, a common method is to place power-factor-corrective capacitors or three-phase synchronous capacitors (motors) in the system, close to the load.
- In some situations, disconnecting the primary side of transformers not serving active loads can save energy. Disconnecting the primary side of transformers is safe provided that critical equipment such as fire alarms and heating control circuits are not affected.
- Where possible, minimize long runs of wire from power distribution panels to electrical equipment. Where equipment would be likely to operate at a low voltage due to distance from the distribution panel, install larger wire to reduce voltage drop.

Because appliances, motors, fans, and other electrical equipment are responsible for a high percentage of building electrical consumption, it is important to select equipment that is properly sized, energy-efficient, and environmentally sound.

- Don't oversize the equipment. It will add to the peak electrical loads, and oversized equipment often does not operate as well at part-load conditions.
- Use high-efficiency motors and, where appropriate, variable frequency drives. Compare motors using No. 112, Method B, developed by the Institute of Electrical and Electronic Engineers (IEEE).
- Select fans and pumps for the highest operating efficiency at the predominant operating conditions.
- Set temperatures on water heaters based on use requirements.
- Use timers to limit the duty cycle of heaters when they are not in full use.
- Select energy-efficient food-service appliances.
- Specify ENERGY STAR-rated appliances.

# Mechanical and Ventilation Systems

In cold and humid climates, heating, ventilation, and air conditioning (HVAC) systems are typically responsible for 50%–60% of the energy consumed in schools. By using the "whole-building" approach — looking at how all the building's design elements work together — your design team can factor in energy-saving choices that reduce heating and cooling loads and downsize the HVAC system needed. By not over-designing the HVAC system, you can reduce initial equipment costs as well as long-term operating costs.

More importantly, HVAC systems have a significant effect on the health, comfort, productivity, and academic performance of students and teachers. A study by the US General Accounting Office found that half of the more than 90,000 public schools in the country are facing noise control problems, lack of adequate ventilation, physical security issues, poor indoor air quality, comfort issues, and below-standard lighting conditions. A 1999 US Department of Education study found that 26% of the country's schools had unsatisfactory levels of fresh air. Most of these issues are directly or indirectly linked to HVAC system design and operation and can be corrected by improved mechanical and ventilation systems.

The best HVAC design considers all the interrelated building systems while addressing indoor air quality, energy consumption, and environmental benefit. Optimizing the design and benefits requires that your mechanical system designer and your architect address these issues early in the schematic design phase and continually revise subsequent decisions throughout the remaining design process. It is also essential that you implement well-thought-out commissioning processes and routine preventative maintenance programs.

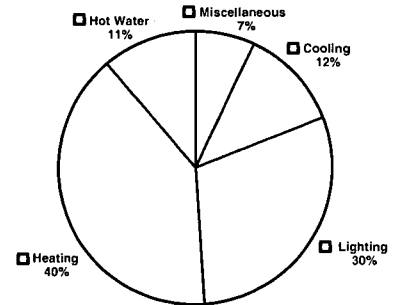

### School Energy Use Distribution

*In typical schools, energy is primarily used for heating and lighting.*



*At Roy Lee Walker Elementary School, McKinney, TX, the energy-efficient mechanical system is exposed to serve as an educational tool for energy conservation.*

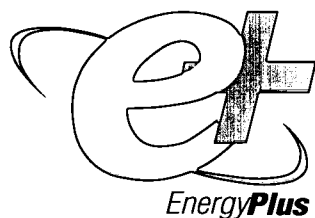

*EnergyPlus is a new-generation building energy simulation program designed for modeling buildings with associated heating, cooling, lighting, and ventilation flows. EnergyPlus builds on the most popular features and capabilities of BLAST and DOE-2 and includes many advanced and innovative simulation capabilities.*

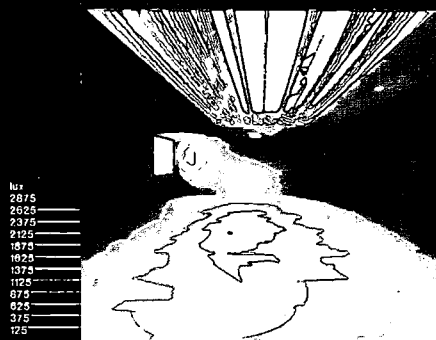

*Computer simulations of daylighting are essential to achieving a clear understanding of how this energy strategy impacts mechanical loads and the “whole building” performance.*

*Communication among members of the school system, architects, and engineers early in the predesign process is critical for establishing the most energy-efficient “whole-building” strategy.*

## Design Guidelines for Mechanical and Ventilation Systems

### Energy Analysis

To optimize the selection of efficient, cost-effective mechanical and ventilation systems, perform an energy analysis early in the process, during the schematic design phase. System optimization also improves indoor air quality, allows better humidity control, and potentially lowers construction costs due to a reduction in size of mechanical and electrical systems. Several available computer programs can provide building simulations on an hourly basis to predict the energy behavior of the school's structure, air conditioning system, and central equipment plant.

An energy analysis considers the school's key components — the building walls and roof, insulation, glazing, the lighting and daylighting systems, as well as the HVAC systems and equipment. The analysis program can simultaneously assess and predict the results of choices associated with each component. For buildings in the design phase, computer models are generally useful for comparing alternatives and predicting trends.

Energy analysis computer programs that simulate hourly performance should include a companion economic simulation to calculate energy costs based on computed energy use. This model can estimate monthly and annual energy usage and costs. Some models allow the user to input estimated capital equipment and operating costs so that the life-cycle economics of the design can be evaluated and compared.

- Prior to starting work on the design, establish an “energy budget” for the project that exceeds the minimum building code standards. One consideration is to set an energy budget that would potentially qualify the school for an ENERGY STAR buildings label. An ENERGY STAR designation places the school in the top 25% of energy performance.
- Develop a clear understanding of how the school system wants to balance initial cost versus life-cycle cost, and point out the long-term advantages of investing in more energy-efficient, and environmentally friendly approaches.
- When evaluating life-cycle costs, take into account:



- the initial cost of equipment
  - anticipated maintenance expenses
  - projected annual energy costs
  - projected energy and labor cost escalation rates
  - replacement costs.
- Optimize the mechanical system as a complete entity to allow for interactions between system components.
  - In the schematic design phase, determine the mechanical system implications of all related site, building shell, daylighting, and lighting elements.

When energy use and operating expenditures are considered at the outset of the design process, energy- and resource-efficient strategies can be integrated at the lowest possible cost.

## Cooling Systems

Consider cooling systems appropriate for cold and humid climates that match the building loads and are not over-designed.

- Evaluate various cooling equipment sizes and models to select the unit that best matches the demand requirements. To accomplish this, use an hourly computer simulation tool to generate energy consumption profiles and the incidence of coincidental peak cooling loads. Select equipment that achieves a high efficiency at the predominant load but also remains efficient over the range of operating conditions.
- For cold and humid climates, consider the use of desiccant dehumidification (enthalpy heat exchangers), which can reduce the need for mechanical cooling to remove moisture. The requirements for proper maintenance of these systems should also be evaluated.
- Consider natural gas and/or solar-driven absorption cooling as a method of reducing peak electricity consumption.
- A form of free cooling is nighttime ventilation. Use nighttime ventilation strategies to cool interior mass and flush out stale air prior to morning occupancy. This purging cycle can be effective during low nighttime temperatures.
- To reduce upper atmospheric ozone depletion, reduce the use of CFC and HCFC refrigerants.
- Consider thermal (ice or water) storage in situations where peak load avoidance is critical. Thermal storage is a cost-saving technique that takes advantage of off-peak utility rate schedules where applicable. Some electric utilities promote thermal storage by offering an incentive for power usage that can be displaced from peak to off-peak time.



*The energy budget and goals should be established prior to the start of the schematic design phase.*

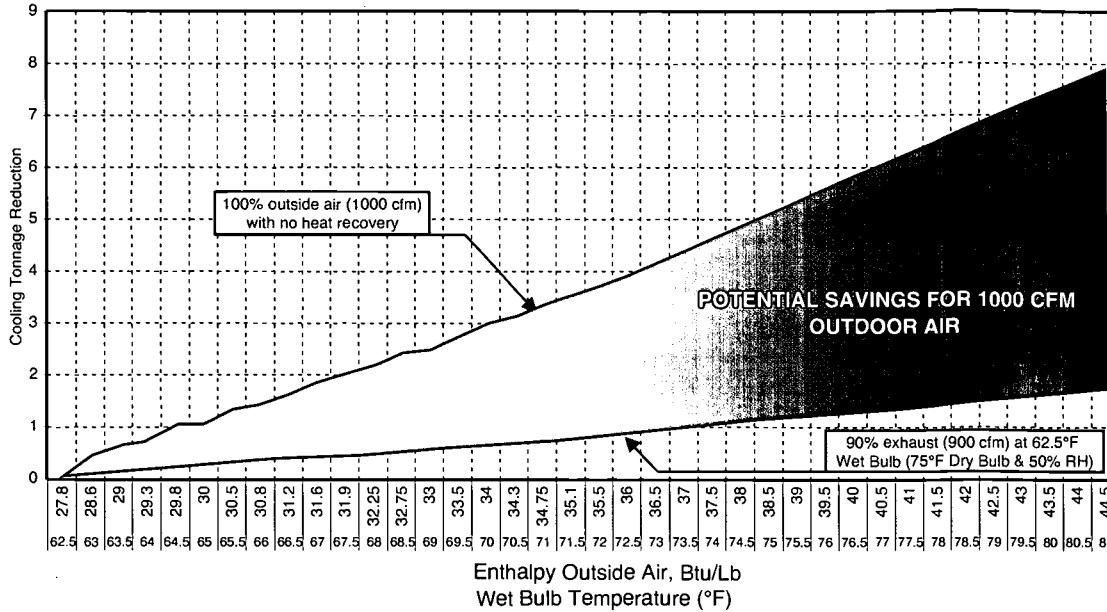

An outside air-handling unit equipped with an enthalpy heat exchanger results in a sizable reduction in cooling load and maintains a humidity level required for space comfort conditions.

Source: PADIA Consulting

### Water-Source Heat Pumps

A water-source heat pump system is well suited to transfer heat from an interior zone, where cooling may be desired, to the perimeter, where heating may be needed. Buildings with simultaneous heating and cooling needs and a use for recovered heat (hot water) are ideal candidates for water-source heat pumps.

- Consider water-source heat pumps when it is necessary to subdivide the school building into many small conditioned zones to provide better comfort control.
- Consider the benefits of the heat pumps equipped with a hot gas reheating (free heating energy) in cold and humid climate regions.
- Evaluate the higher maintenance costs associated with multiple compressions and fans.
- Provide dedicated make-up air units to introduce fresh conditioned outdoor air for ventilation.

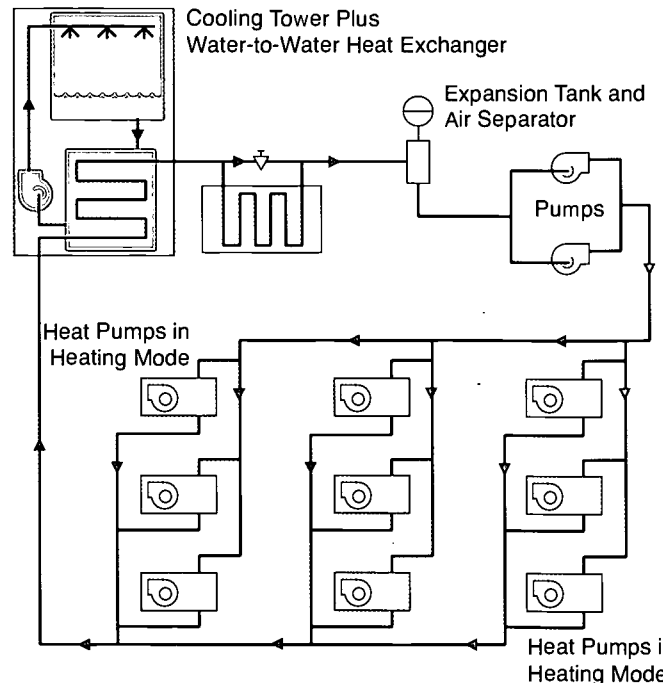

**Water-Source Heat Pumps**

Water-source heat pumps can provide significant savings in cold and humid climates.

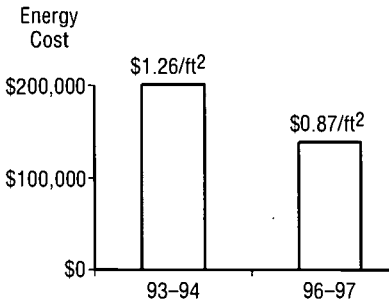

### Energy Savings

Built in 1971, the 160,000-square-foot Daniel Boone High School, in Gray, TN, was heated by electricity and cooled by a two-pipe chilled water system. After analysis of other two-pipe retrofit options, a new geothermal heat pump system was installed in 1995-96. Costing an additional \$197,000 and saving \$33,000 versus the next best two-pipe system considered, the geothermal system saved Washington County Schools \$62,000 the first complete year of operation.

## Boilers

When considering centralized systems, choose the most efficient heating for the particular need.

- Consider condensing boilers. They are typically 10% more efficient than conventional boilers.
- Consider multiple, modular boilers that are more efficient at partial load.
- Employ draft control devices that reduce off-cycle losses.
- Design a water reset control that is keyed to the outside air temperature.
- Incorporate burner flame controls.
- For small renovation projects, install time clocks to control night and weekend set-back.

## Ventilation and Indoor Air Quality Strategies

ASHRAE Standard 62 addresses the criteria necessary to meet ventilation and indoor air quality requirements. The outside air requirements for proper ventilation of an occupied school are considerable and have a substantial impact on HVAC system energy consumption and operating costs. The strategy employed to achieve proper ventilation must be carefully considered.

- Implement ventilation strategies that will ensure outside air by complying with ASHRAE Standard 62-1999.
- Consider a dedicated ventilation system such that the quantity of air can be regulated and measured, providing a greater certainty that proper ventilation is maintained. Such a dedicated system can also improve overall energy efficiency.
- Consider the use of a heat recovery system, like an air-to-air heat exchanger, that will transfer the heat between air supplied to and air exhausted from the building.
- Separate and ventilate highly polluting spaces. Provide separate exhaust from kitchens, toilets, custodial closets, chemical storage rooms, and dedicated copy rooms to the outdoors, with no recirculation through the HVAC system.
- Consider an enthalpy recovery system.

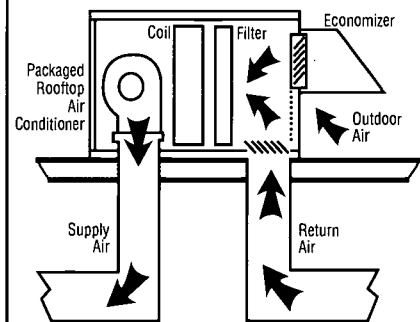

### Economizer Cycle Diagram

An air economizer cycle based on enthalpy control can lower energy consumption by using as much as 100% outside air.

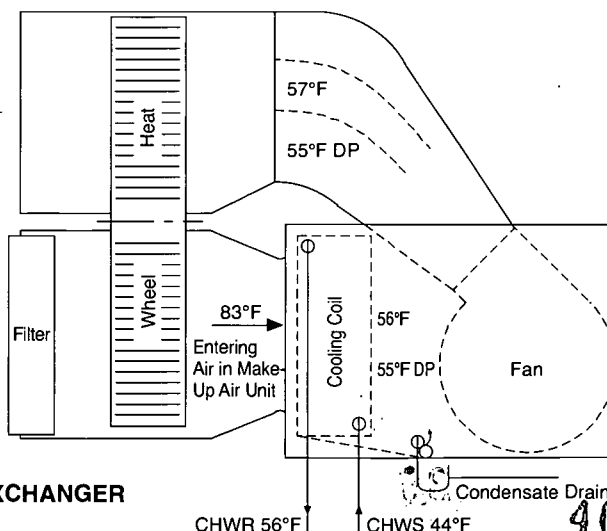

### Enthalpy Recovery System

An enthalpy recovery system is used to reduce energy consumption by capturing the energy that would normally be lost in the exhaust airstream.



## Cool and Humid Climates

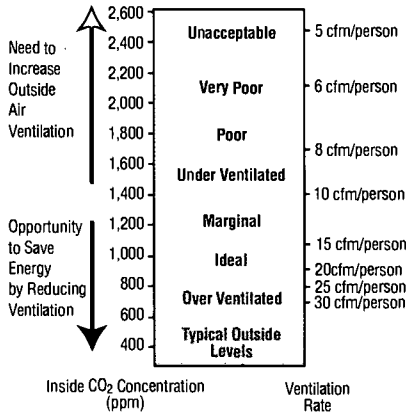
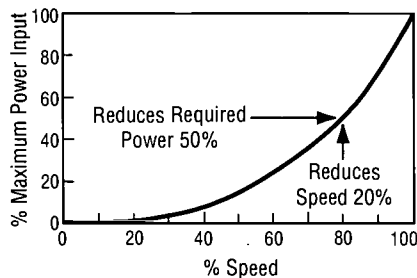

Diagram: TelAir, Goleta, CA

### Conditions of Indoor Air Quality

Carbon dioxide concentration is a factor in determining adequate indoor air quality.



Graphic: Padia Consulting

### VAV Fan Speed vs Input Power

Controlling motor speed to control air flow is the more energy-efficient strategy. Variable frequency drive control offers a distinct advantage over other forms of air volume control in variable air volume systems.

- Evaluate the use of an outdoor air economizer cycle that will allow up to 100% outdoor air to be introduced into the distribution system to provide space cooling.
- Locate outdoor air intakes a minimum of 7 feet vertically and 25 feet horizontally from polluted and/or overheated exhaust (e.g., cooling towers, loading docks, fume hoods, and chemical storage areas). Consider other potential sources of contaminants, such as lawn maintenance. Separate vehicle traffic and parking a minimum of 50 feet from outdoor air inlets or spaces employing natural ventilation strategies. Create landscaping buffers between high traffic areas and building intakes or natural ventilation openings.
- Locate exhaust outlets at a minimum of 10 feet above ground level and away from doors, occupied areas, and operable windows. The preferred location for exhaust outlets is at roof level projecting upward or horizontally away from outdoor intakes.
- Provide filters capable of 60% or greater dust spot efficiency, and install them in a location capable of intercepting all make-up and return air. In dusty areas, use a higher efficiency filtration system (80%–85% by ASHRAE standards with 30% efficient pre-filters).

## Distribution Systems

Design an air distribution system that is energy-efficient and protects against poor indoor air quality.

- Where individual room control is desired or diverse loads are present, employ variable air volume systems (versus constant air systems) to capitalize on reduced fan loads during times of reduced demand.

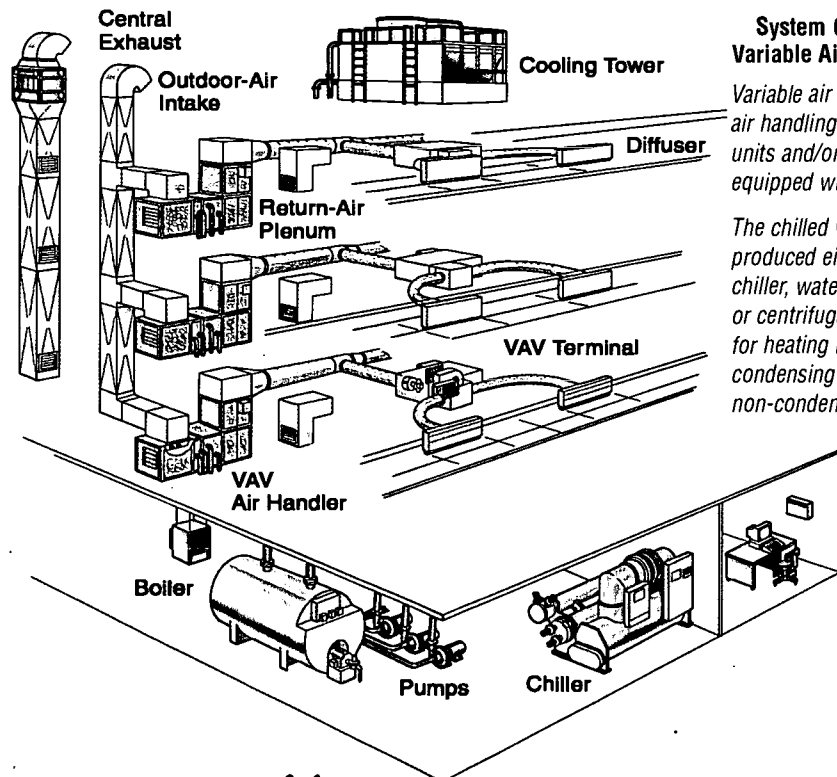

### System Control Schematic — Variable Air Volume (VAV) System

Variable air volume (VAV) central air handling units with VAV terminal units and/or fan powered boxes equipped with hot water reheat coil.

The chilled water for cooling is produced either by an air cooled chiller, water cooled screw chiller, or centrifugal chiller. The hot water for heating is provided either by a condensing boiler or a conventional non-condensing boiler.

- Use constant volume systems when the load is uniform and predictable (e.g., kitchen).
- If a particular mechanical system serves more than one space, ensure that each space served has the same orientation and fulfills a similar function. Consider independent mechanical rooms and systems on separate floors to reduce ductwork and enhance the balance of air delivered.
- Consider a design that supplies air at lower temperatures to reduce airflow requirements and fan energy.
- Specify ductwork that has smooth interior surfaces and transitions to minimize the collection of microbial growth. Design ductwork and plenums to minimize the accumulation of dirt and moisture and to provide access areas in key locations for inspection, maintenance, and cleaning. Use mastic to seal metal ductwork. Where possible, locate ductwork in conditioned or semi-conditioned spaces.
- Specify duct leakage tests.
- Make sure that air handling units and filters are easy to access and maintain.
- Reduce duct pressures to minimize the amount of fan energy used to distribute the air. Use low-velocity coils and filters.
- To minimize energy consumption, select fans for the highest operating efficiency at predominant operating conditions, and use lower fan speeds to reduce noise levels. Consider direct-drive fans for their improved efficiency.
- Use filters that meet a minimum of 60% ASHRAE Dust Spot Method Standards.

## Controls

To ensure proper, energy-efficient operation, implement a control strategy that is tied to key energy systems. Include system optimization, dynamic system control, integrated lighting, and HVAC control.

- Use direct digital control systems for greater accuracy, performance, and energy savings.
- Set up the HVAC control system to operate according to need. Limit electrical demand during peak hours by turning off (or rotating) non-essential equipment.
- Establish temperature and humidity set points based on occupancy patterns, scheduling, and outside climatic conditions.
- Install occupancy sensors to reduce ventilation air requirements for unoccupied spaces.
- Make owners aware that they should periodically verify the accuracy of the sensors and control functions and calibrate if necessary.
- Notify owners of the need to periodically audit all computer-controlled HVAC systems to verify performance and calibration.

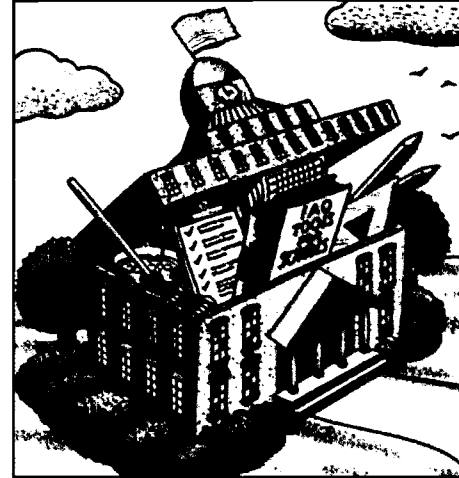

### Indoor Air Quality: Tools for Schools

*This program is designed to give schools the information and skills they need to manage air quality in a low-cost, practical manner. The kit is published by the US EPA and co-sponsored by the American Lung Association.*



*Control strategies like occupancy and pollutant sensors are essential to improve efficiency in the school's energy system management.*

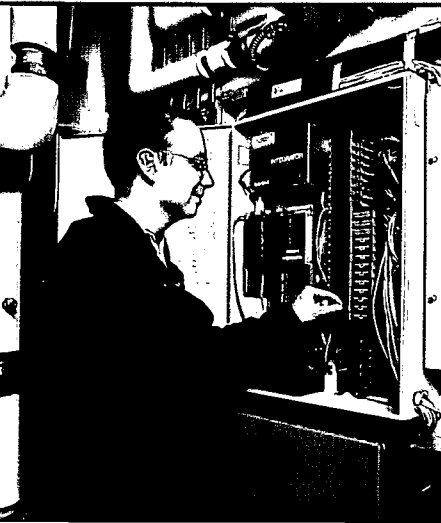

Photo: NREL/PIX09214

*An energy management system optimizes mechanical and lighting system operation.*

- Install sensors for relative humidity and temperature as close to occupants as possible. Carbon dioxide concentration sensors may be a helpful addition to a properly designed and maintained ventilation system.
- If using VAV systems, set supply-air temperature reset controls based on occupancy of space. Specify VAV controls to ensure that the proper amount of outdoor air is maintained, even when the total air supply is decreased.
- Control strategies for chilled water plant operation should address:
  - variable speed drives
  - the selection of modular chillers or chillers with multiple compressors
  - a chilled water reset
  - variable flow through the chillers
  - a condenser water reset
  - chiller sequencing
  - the soft-starting of chiller motors
  - demand control.
- In small schools, consider time clocks with night and weekend setbacks.
- Work with the school system to establish a means to monitor and document the performance of the energy management control system and provide training of future maintenance staff.

### Hot and Chilled Water Distribution

- Carefully select heat exchangers with a low approach temperature and reduced pressure drops.
- In large systems with multiple heat exchangers, designate a separate pump for each heat exchanger to maintain high efficiency at part-load operating conditions.
- Consider primary pumping systems with variable-speed drives because of their effects on a part-load energy use.

### Water Heating

- Consider heat pump water heaters or tankless (instantaneous) water heaters.
- Consider localized versus centralized hot water equipment by evaluating the types of loads served. A remote location may be best served by localized equipment.
- Consider a solar-assisted hot water system.
- Consider heat recovery systems.
- Use tankless water heaters in areas that are remote and require small hot water amounts.
- Minimize the standby heat losses from hot water distribution piping and hot water storage tanks by increasing insulation levels, using anti-convection valves, and using heat traps.

# Renewable Energy Systems

There is no shortage of renewable energy. And renewable energy can contribute to reduced energy costs and reduced air pollution. More importantly, the renewable energy systems that you design into your school will demonstrate to the students the technologies that will fuel the 21st century.

Over the past two decades, the cost of renewable energy systems has dropped dramatically. Wind turbines can now produce electricity at less than 4 cents per kilowatt-hour — a seven-fold reduction in energy cost. Concentrating solar technologies and photovoltaics have dropped more than three-fold during the past 20 years. And, with improvements in analytical tools, passive solar and daylighting technologies can be implemented into schools with less than a two-year return on investment.

Incorporating renewable energy options into your school design helps students learn firsthand about these cost-effective and energy-efficient options. Input from teachers early in the design process helps to ensure that energy features are incorporated in a way that optimizes the learning experience. Buildings that teach offer students an intriguing, interactive way to learn about relevant topics like energy and the environment.

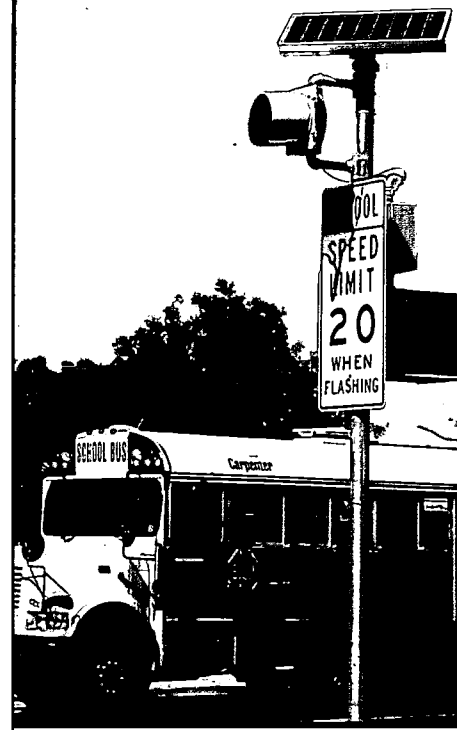

Photo: Glen Bair, by State of Texas  
Energy Conservation Office

*Photovoltaic-powered school zone warning signals can be used as an alternative to traditional electric traffic signals.*



Photo: NREL/PIX06461

*Nantucket Elementary School, in Nantucket Island, MA, features a roof-mounted photovoltaic array that saves energy and serves as a teaching tool.*

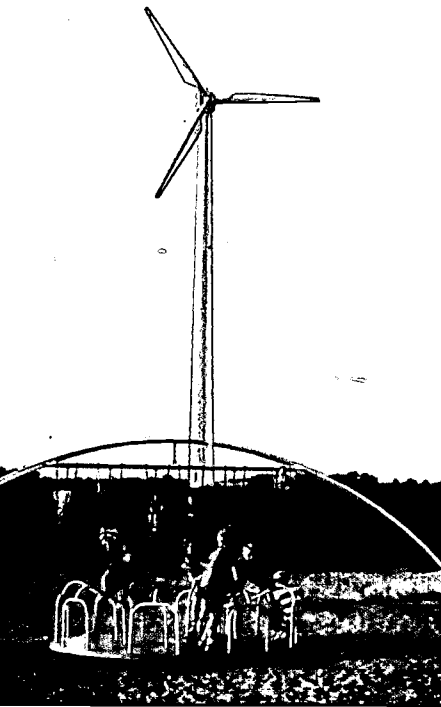

Photo: American Wind Energy Association

*The wind turbine at Spirit Lake Elementary, in Spirit Lake, IA, saves the school \$25,000 annually.*

# Design Guidelines for Renewable Energy Systems

## Available Renewable Energy Resources

When evaluating potential renewable systems, use the best available historic climatic data, closest to the school site.

- Even though the radiation levels in cold and humid climates are lower than in most parts of the country, you should still evaluate the potential for solar systems. The following data show that the region's solar resource is good, but state specific information can be obtained from the State Energy Alternatives Web site.

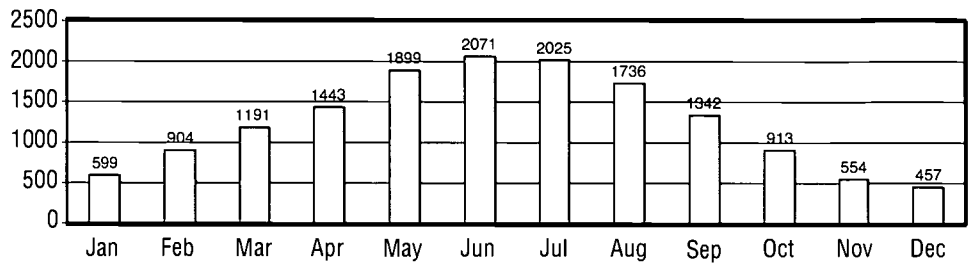

### Average Incident Solar Radiation in Minneapolis (Btus/Square Foot/Day)

NOTE: Watts/Square Meter x .317 = Btus/Square Foot

Color Key kWh/m<sup>2</sup>/day

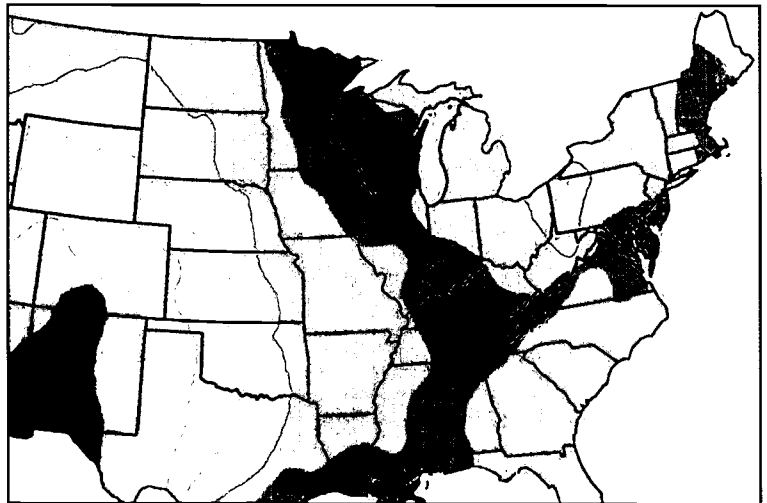
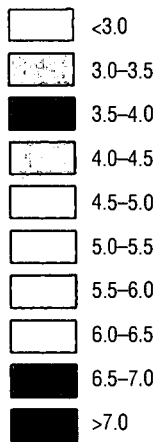

### Average Direct Normal Radiation (kWh/Square Meter/Day)

- Wind generation becomes cost-effective in most areas when the average wind speed exceeds 10 miles per hour. In locations where the wind is marginally below this amount, wind systems should still be considered for their educational values.

Like in Minneapolis, wind in much of this region annually exceeds 10 miles per hour and is very good for wind applications.

Check the US DOE's State Energy Alternatives Web site (see the resources section at the end of this document) to determine the wind resources in your location.

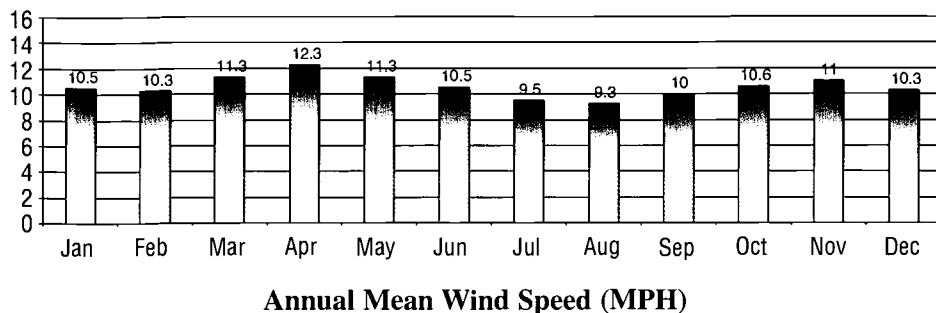

Annual Mean Wind Speed (MPH)

## Building Orientation and Solar Access

Employing renewable energy strategies cost effectively requires the school to be sited to maximize the locally available natural resources.

- Establish the building on an east-west axis that maximizes southern exposure for daylighting and other solar systems. In Minneapolis, true north is 1°42' east of magnetic north (magnetic north is the direction a compass points).
- Ensure that adjacent buildings or trees do not block the intended solar access.

## Building-Integrated Approaches

To maximize cost effectiveness and improve aesthetics, consider integrating solar thermal and photovoltaic systems into the building shell.

- Integrate solar systems into the overall design to allow the system to serve multiple purposes (e.g, a photovoltaic array that can also serve as a covered walkway).
- Eliminate the additional costs associated with a typical solar system's structure by designing the building's roof assembly to also support the solar components.
- Minimize redundant materials by using the glazing of the solar collector as the waterproofing skin of the building.
- Incorporate building-integrated approaches as a strategy to save valuable land.

## Renewable Energy Applications for Schools

A variety of renewable energy applications are effective in cold and humid climates. Daylighting, passive cooling, solar hot water and space heating, photovoltaics, and wind should all be considered as energy-saving strategies that also help to teach students about energy technologies.

### Daylighting

Because of the unique potential of this renewable energy option to provide multiple benefits, daylighting is discussed in a separate section within these guidelines. See the Daylighting and Windows section.



Photo: NREL/PIX08884

*This building-integrated photovoltaic system covers the roof of this school's cafeteria.*



*Massive walls have long been used to minimize the impact of midday sun.*

**Passive Cooling**

- Natural ventilation should be viewed as a practical strategy for many of the warmer months of the year. Consider operable windows to provide the opportunity for natural ventilation when interior building loads dominate and the humidity is in acceptable ranges.

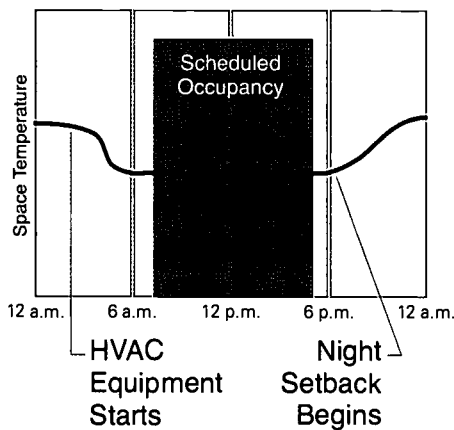

**Without Unoccupied Ventilation**

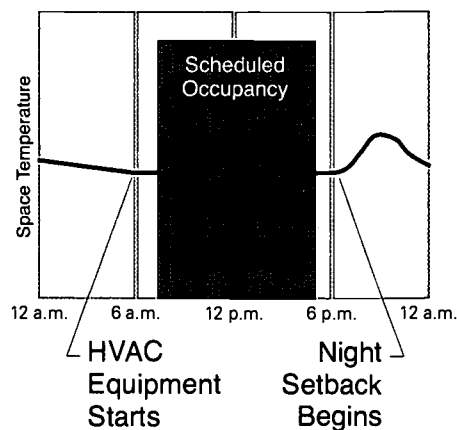

**With Unoccupied Ventilation**

**The Effect of Night Purging**

*Using night purging brings cool, outside nighttime air into the building to reduce HVAC startup loads.*

- Incorporate night purging as a technique to improve performance. Using either natural, mechanical, or hybrid approaches to purge the air within a school can provide energy and indoor air quality benefits. When the ambient temperature during the nighttime drops several degrees or more below the set temperature, bringing outside air into the building and purging the warmer air can greatly reduce the cooling load on the building the next morning.
- Install massive wall construction to both reduce and stabilize cooling loads by including:
  - high-mass walls to increase the lag time of temperature flows
  - mass located inside the wall insulation to stabilize internal temperature fluctuation
  - light-colored exterior finishes to reflect solar radiation striking walls.

**Solar Hot Water**

Because of the high hot water demands associated with cafeterias, solar heating systems are often viewed as important strategies in reducing energy bills. In middle schools and high schools, with showers for gym classes and sports programs, it is even more beneficial to address this significant load.

### Closed-Loop Systems

- Select a closed-loop, freeze-resistant solar system.

In closed-loop systems, a small pump circulates antifreeze-protected fluids through the collection loop when there is adequate solar radiation and the differential between the collector fluid temperature and the tank temperature justifies the collection mode continuing.

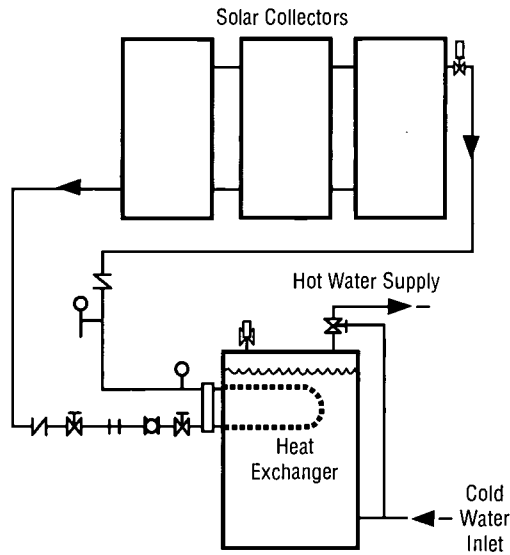

**Closed-Loop Solar Hot Water System Diagram**

*Closed-loop systems use a controller to shut the system down when the temperature differential becomes too small or when the tank reaches a set peak temperature.*

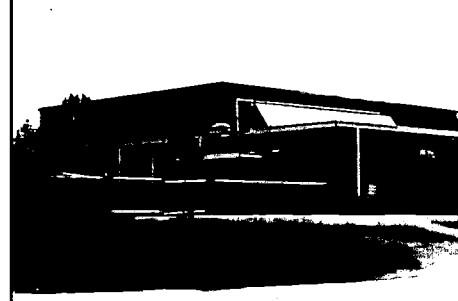

*This solar domestic water system was added to the school's kitchen roof area and provides the majority of hot water required by the cafeteria.*





Photo: Advanced Energy

*Geothermal systems have the added advantage of no outdoor condensing unit or cooling tower.*

### Wind

Wind turbines convert the kinetic energy in the wind into mechanical power. This mechanical power can be used directly (e.g., water pumping), or it can be converted into electricity.

- Consider wind electric generators as a cost-effective application in areas where the sustained wind speed exceeds 10 miles per hour.
- Consider wind systems for well water pumping.
- Address potential noise problems by properly siting wind installations.
- Consider the educational benefits of installing a windmill or a wind generator on the school site.

### Geothermal Heat Pumps

Geothermal heat pumps work differently than conventional air source heat pumps in that geothermal systems use the more moderately tempered ground as a heat source and heat sink. The result is that geothermal systems are more efficient and more comfortable.

- Use closed-loop systems in areas where well water is not present or adequate.
- Use open-loop systems in regions where sub-surface water can be extracted and reinjected into the ground, through wells, in an environmentally sound manner.
- Conduct a detailed site survey, and thoroughly analyze the heat gain and loss to avoid oversizing.
- Specify high-efficiency heat pumps.
- Avoid using excessive amounts of antifreeze.
- Specify thermally-fused, high-density polyethylene (HDPE) for all in-ground piping.

### Photovoltaics

Photovoltaic modules, which convert sunlight into electricity, have numerous school applications and can be designed as "stand-alone" applications or for utility "grid-connected" applications.

**Stand-Alone Systems**

- Select stand-alone photovoltaic systems to address small, remotely-located loads. They tend to be more cost-effective than the conventional approach requiring extensive underground wiring. Some of the more appropriate applications include parking and walkway lighting, caution lights at street crossings, security lights, emergency telephone call boxes, and remote signage.

Because these systems are not connected into the utility grid, battery storage is typically required. Depending upon the device being powered, a DC to AC inverter may or may not be installed.

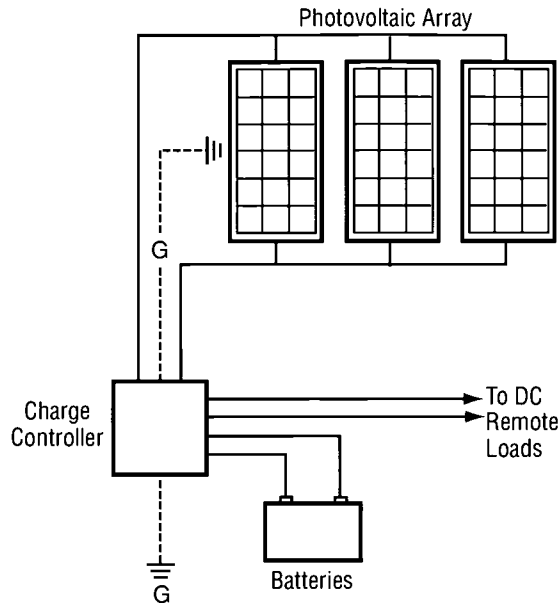

**Stand-Alone Photovoltaic System**

*Stand-alone systems are ideal for remote loads located away from electrical lines.*

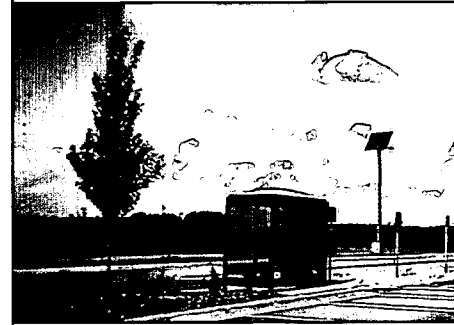

*These stand-alone photovoltaic systems power parking lights.*

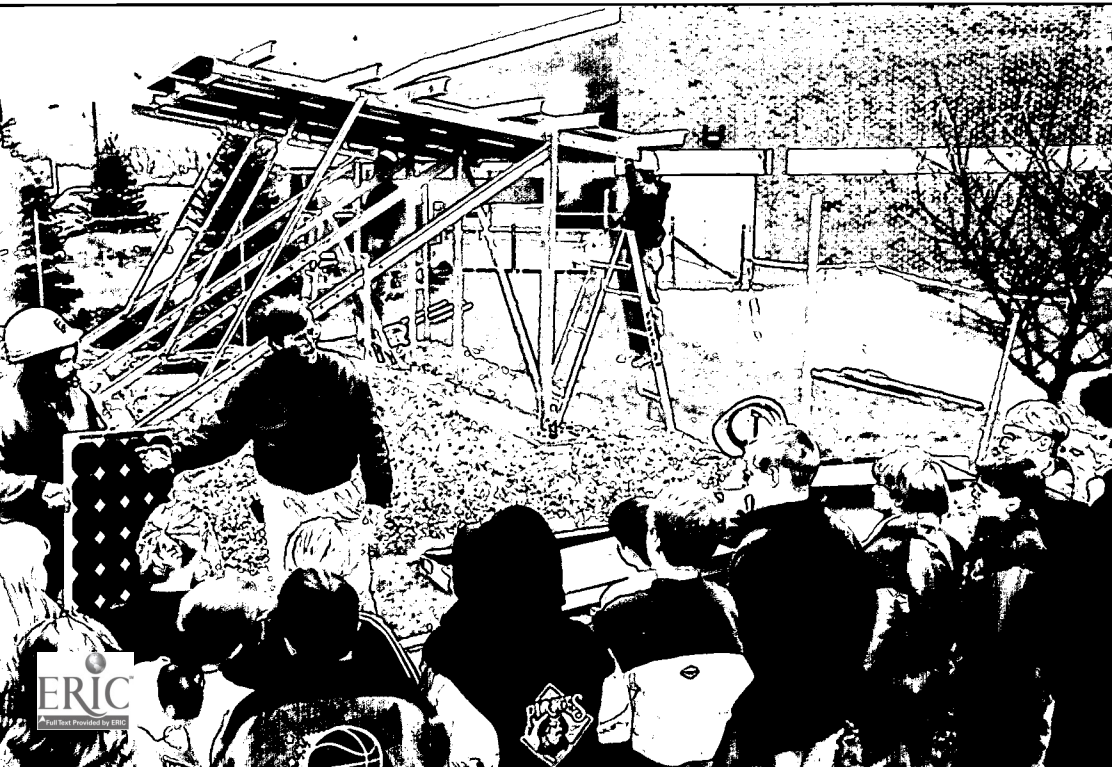

Photo: Bluffsview Middle School  
*Photovoltaic systems can be great teaching tools as well as energy savers.*



Photovoltaic systems in schools provide substantial energy savings and are educational tools for sustainability.

### Grid-Connected Systems

- Choose grid-connected systems in large applications where peak load pricing is high or where first cost is an issue. Because these systems typically rely on the utility to provide power when the sun isn't shining, battery cost is eliminated and long-term maintenance is reduced greatly. This strategy is typically advantageous to both the utility and the school because peak demand will be occurring when the sun is shining.

In these applications, a DC to AC inverter is required. Additionally, in the event of a utility power failure, protection must be provided to ensure that the system does not feed back into the utility grid.

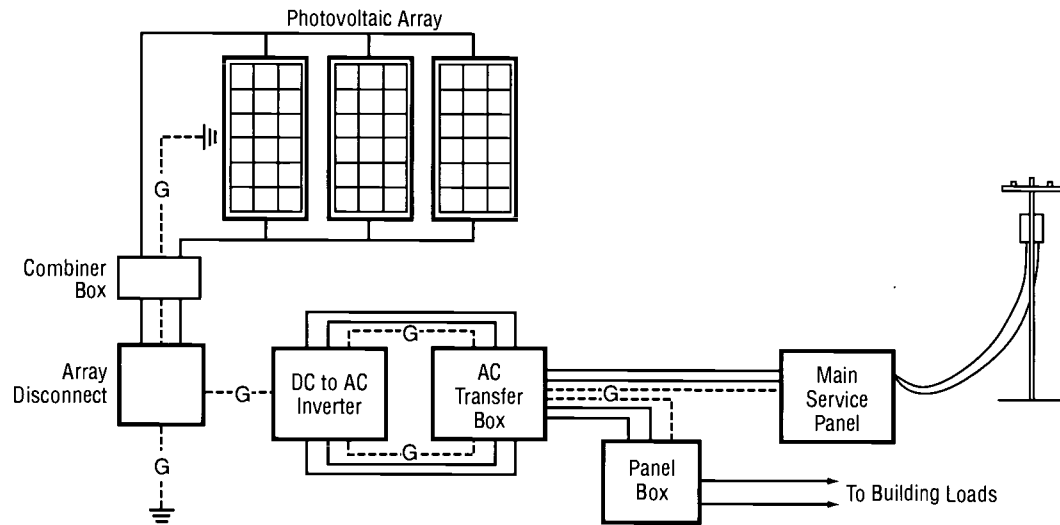

**Grid-Connected Photovoltaic System Diagram**

Grid-connected systems work well for large loads located near existing electrical service.

# Water Conservation

Every day the United States withdraws 340 billion gallons of fresh water from streams, reservoirs, and wells — an amount equal to 1,000 gallons per person per day. And as the population grows, so does that demand for water. Combine the impacts of rising population with the demographic shift in people to more arid regions, and the pressure of providing clean water becomes more critical every year.

Water rationing is becoming commonplace in thousands of communities across the country, and the price of water is escalating at unprecedented rates. You can make a considerable difference at your school in reducing community water use. By using water-conserving fixtures, implementing graywater or rainwater catchment systems, and using xeriscape practices, schools can easily reduce their municipal water consumption 25%–75%. By saving half of the 1 million to 3 million gallons that each of the 90,000 public schools consume every year, more than 200 million gallons of treated water could be saved each day.

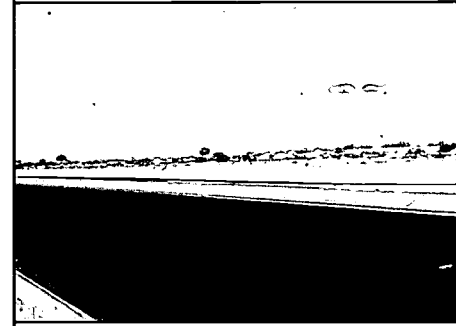

*Many areas of the United States have resorted to piping or developing canals to move water from one region to another.*



Photo: NREL/PIX00653

*This water-conserving sink uses infrared sensors.*

*The Roy Lee Walker School, in McKinney, TX, collects 700,000 gallons of rainwater each year for toilet flushing and site irrigation.*





*A water gauge that measures the rainwater collection tank level helps demonstrate the value of water to students.*

*Water needs for irrigation can be minimized by using native planting.*



## **Design Guidelines for Conserving Water**

### **Water-Conserving Landscaping Strategies**

The demand for water will be greatly impacted by the amount of site irrigation required. By limiting new landscaped areas and considering the type of plants and vegetation installed, water needs will be reduced.

- Minimize disruption to the existing site conditions, and retain as much existing vegetation as is practical.
- Incorporate native and drought-resistant plants and xeriscape principles to minimize irrigation requirements.
- Use soaker hoses and drip irrigation technologies to minimize evaporative losses and concentrate water on plants.
- Provide timers on watering systems to ensure that irrigation occurs during the night.

### **Conservation of Water During Construction**

By including specifications addressing water during construction, you can save a considerable amount of water during your construction projects.

- Include disincentives in specifications to the general contractor for excessive water use and incentives for reducing consumption during construction.
- Specify that the general contractor is responsible for water cost during construction.
- Minimize watering requirements by specifying appropriate times of year when new landscaping efforts should occur.
- At pre-bid meetings, stress to the general contractor and sub-contractors the importance of water conservation.

## Water-Conserving Fixtures

One of the most effective means to limit demand for water is to reduce the requirements associated with necessary plumbing fixtures.

- Consider the standards of the 1992 Energy Policy Act as a minimum. Specify low-flow toilets that use less than 1.6 gallons per flush.
- Consider showerheads that require less than 2.5 gallons per minute and incorporate levers for reducing flow between 2.1 and 1.5 gallons per minute.
- Use aerators to reduce flow in lavatory faucets to as low as 1 gallon per minute.
- Specify self-closing, slow-closing, or electronic faucets where it is likely that faucets may be left running in student bathrooms.
- Consider waterless urinals or 1-gallon-per-flush urinals.

Projected Water Savings by Installing Waterless Urinals in Schools

	School with Regular Urinals	School with Waterless Urinals
Number of Males	300	300
Number of Urinals	10	10
Use/Day/Male	2	2
Gallon/Flush	3	0
School Days/Year	185	185
Water Saved/Year		222,000 Gallons

*Waterless urinals are one way to reduce water usage in your school.*

Cross-Section of EcoTrap

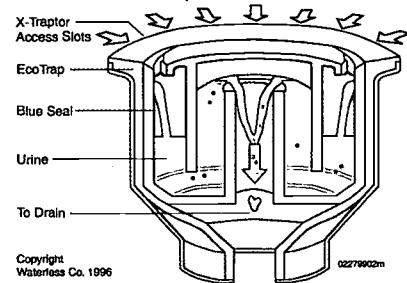

### Waterless Urinals

*With waterless urinals, the traditional water-filled trap drain is eliminated, and the unit does not need to be flushed.*



Photo: Darrow School

*At the Samson Environmental Center of Darrow School, New Lebanon, NY, the Living Machine is used to teach students about on-site biological wastewater treatment systems. This garden uses large tropical plants to create a refuge for the microorganisms that break down nutrients and chemicals in the water and releases water that is treated to tertiary or, if desired, drinking water quality.*

*Biological wastewater treatment systems, like this living machine, can transform "waste" into a resource that can be used to improve soil conditions on the site, save water, reduce the need for municipal treatment infrastructure, and address problems directly associated with septic system technologies.*



Roy Lee Walker Elementary School, in McKinney, TX, collects 700,000 gallons of rainwater each year.

## Rainwater Management

Rainwater captured off the roof of your school can be harvested and stored in cisterns for non-potable use. In most rainwater catchment systems, the water runs off the roof into gutters and downspouts, which carry the water to a storage device for future use.

- Consider the savings made possible by a reduced need for retention ponds.
- When cost-effective, implement a rainwater collection system to provide water for toilet flushing and irrigation through separate plumbing lines.
- Use a durable storage container, and locate it away from direct sunlight and septic tanks.
- Design systems so that potable water can be safely added to storage tanks, and guarantee an uninterrupted supply to toilets and irrigation systems.
- Determine the necessary water treatment and filters for your area.
- Install a storage tank underground to minimize freeze problems.

### Rainwater Catchment Diagram

The initial water collected off the roof is intentionally "dumped" in order to reduce filtration of large particles. A low flow pump and chlorinator are used to stop algae growth. Make-up water, from your typical potable supply, is added to the tank when rainfall is insufficient.

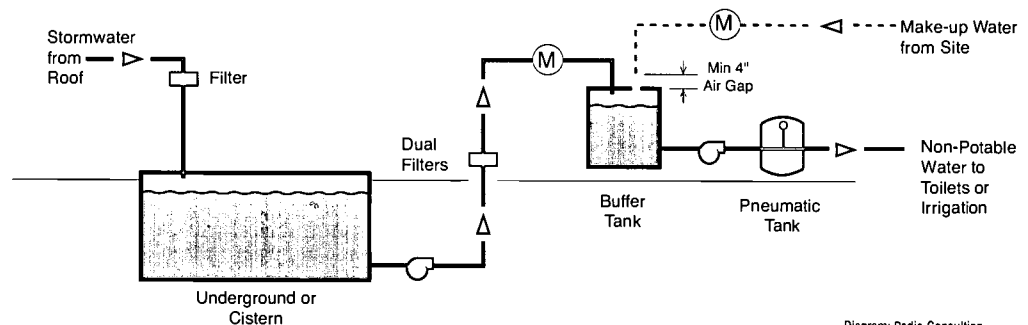

Diagram: Padia Consulting

## Graywater Systems

Relatively uncontaminated waste can be easily captured, stored, and used to fulfill non-potable needs.

- Use graywater from lavatories and water fountains for underground site irrigation. Design the system, meeting local regulations, to:
  - get the graywater into the soil as soon as possible instead of storing it
  - irrigate below the surface of the ground only
  - deliver the graywater to biologically activate the soil where organic matter will quickly be broken down.

### Graywater System Diagram

Graywater collects through a separate plumbing system and is treated and stored in an underground tank. The graywater is then pumped into a second hydropneumatic tank that maintains the proper system pressure. When necessary, additional fresh water is brought into the graywater storage tank to maintain the minimum level for the circulation pumps.

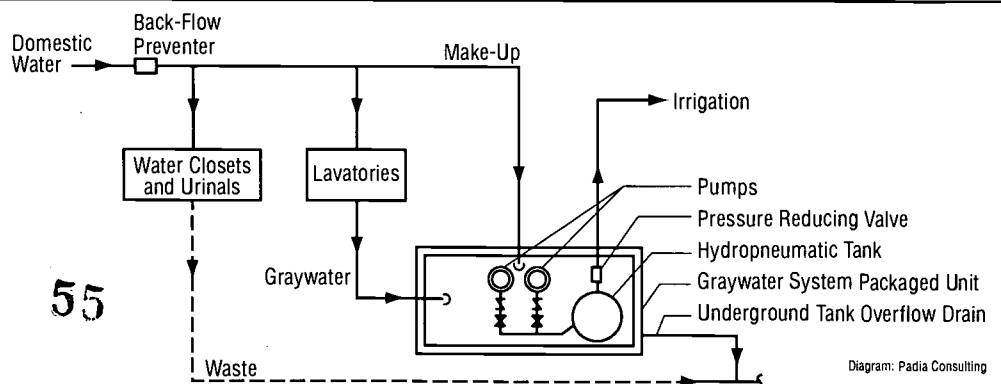

Diagram: Padia Consulting

# Recycling Systems and Waste Management

Public schools across the country are producing billions of pounds of municipal solid waste each year. You can help reduce much of this waste by recycling or composting at your schools. In a compilation of studies of waste generation in Washington State and New York City schools reported by the US EPA, paper was found to account for up to half of waste in schools, organic (compostable) materials up to a third, plastic about 10%, and glass and metals about 7%. To the extent that school buildings can be made more recycling and composting friendly, very high percentages of this waste material can be kept out of the waste stream. In fact, if every school system implemented aggressive recycling efforts, landfills would have 1.5 billion pounds less solid waste each year.

By creating schools in which comprehensive waste recycling can be carried out, your design team has an opportunity to instill the practice of recycling in your school's children. Hundreds of schools throughout the country have embarked on exciting and highly successful hands-on programs to encourage recycling. Often, the students themselves design and manage these programs — and see the fruits of their labors as waste reduction or recycling is quantified. The most successful recycling and waste management programs are integrated into classes, with students making use of mathematical, investigative, and communication skills in implementing these programs.

*For efficient recycling collection, the recycling bins must be labeled and located in areas easily accessible by students and staff.*



Photo: Chittenden Solid Waste District  
*Michael Kellogg, waste reduction specialist for the Chittenden Solid Waste District, VT, educates students from the Calliope House of Allen Brook School in Williston about the system used to code types of plastics.*





Photo: Huntsville High School East

*Signage can encourage students and staff to actively recycle major waste materials in the school.*



Photo: Mount Baker School District

*In Deming, WA, the Mount Baker School District's recycling effort is in its eighth year and is now saving \$25,000 annually. Successful because of its outstanding student participation, the award-winning program has a long list of recyclable or reusable materials. The program is totally self-supporting, and last year the students saved \$18,000 through recycling and reuse and an additional \$7,000 from avoided disposal fees. In 1999, through the school's efforts, 89,700 pounds of materials were recycled or reused and not put into a landfill.*



## Design Guidelines for Implementing Recycling Systems and Waste Management

### Paper, Plastics, Glass, and Aluminum Recycling

Students are able and eager to participate in recycling programs. Successful recycling programs teach students recycling skills and save money through reuse of materials and avoided disposal fees.

Paper represents one of the largest components of a school's waste stream. In addition to glass, aluminum, plastic bottles, and cans, even styrofoam can now be recycled.

- Allocate space within each classroom, the main administrative areas, and the cafeteria for white and mixed paper waste.
- Provide central collection points for paper and cardboard that are convenient to custodial staff as well as collection agencies or companies.
- Place the receptacles for all recyclables where the waste is generated. The best places are in the cafeteria and administrative areas. Receptacles should be made available in public spaces, gymnasiums, and hallways for plastic and aluminum in schools with soda machines.
- Locate convenient bins for other materials being recycled.

In implementing a comprehensive approach to recycling, consider all the aspects needed to make recycling easier and more educational.

- Integrate containers into cabinetry, or have free-standing stations that do not disrupt other functions in the spaces.
- Design bins to be easily dumped into a cart that will be taken by custodial staff to a central collection point.
- Incorporate chutes to accommodate recycling in multi-story facilities.
- Establish a color coding system, and use clearly labeled dispersed containers and centralized bins to distinguish the recycled material.
- Use dispersed receptacles and centralized bins that are easy to clean and maintain.
- Coordinate with a local recycling agency or waste hauler to obtain important information regarding its trucks and how it prefers to access the recycling bins.

## Safe Disposal of Hazardous Waste

- Provide a secure space within the school to temporarily store hazardous materials (e.g., batteries, fluorescent lights, medical waste) until they can be taken to a recycling center or safe disposal site.

## Composting

About a third of the average school's waste stream is food and other organic materials. Composting is one environmentally friendly way of handling this waste.

- Design a conveniently located composting bin.
- Use vermicompost bins in classrooms as educational tools. The bins use worms to dramatically speed up the decomposition of food.

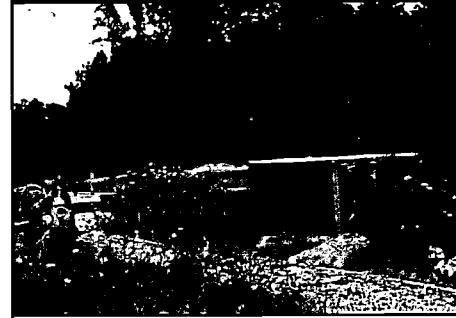

*Composted kitchen scraps can be used to fertilize gardens at the school.*



Photo: Chittenden Solid Waste District  
*Michael Kellogg, waste reduction specialist for the Chittenden Solid Waste District, VT, teaches students from Calliope House of Allen Brook School in Williston how worms can compost their food scraps.*



Photo: NREL/PIX05289

*Recycling by the contractor during construction should be encouraged to decrease the amount of waste sent to landfills.*

## Construction Waste Recycling and Waste Management

Recycling efforts should begin during the construction of the school and engage the general contractor and all sub-contractors.

- Specify the specific job-site wastes that will be recycled during construction (corrugated cardboard, all metals, clean wood waste, gypsum board, beverage containers, and clean fill material).
- Require that the contractor have a waste management plan that involves everyone at the site.
- Stockpile appropriate existing topsoil and rock for future ground cover.
- Monitor the contractor and sub-contractor's recycling efforts during construction.

To minimize the impacts from any hazardous materials or waste used in construction require that the contractor use safe handling, storage, and control procedures, and specify that the procedures minimize waste.

Photo: Craig Miller Productions and DOE/PIX03494

*Construction waste materials, including corrugated cardboard, metals, clean wood waste, gypsum board, and clean fill material like concrete or brick can be recycled or reused.*



# Transportation

In many school districts across the country, more energy dollars are spent by the school system in transporting students to and from school than in meeting the energy needs of their school buildings. Up to 40% of morning traffic congestion at schools is a result of parents driving children to school.

Incorporating a network of safe walkways and bike paths that connect into the community's sidewalks and greenways can reduce local traffic congestion, minimize busing costs, and reduce air pollution. And, by incorporating natural gas, biodiesel, methanol, or solar electric buses into a district's existing vehicle fleet, you can help to reduce fuel costs and harmful emissions — lowering fuel costs and contributing to reduced operating and maintenance costs.

Today, nearly 60% of all school buses run on diesel, a highly polluting transportation fuel that poses considerable health risks. Due to particulate emissions, the use of diesel fuel is increasingly becoming associated with asthma and other lung-related diseases. Alternative fuel buses and school fleet vehicles can be used to provide environmentally friendly alternatives to high-polluting vehicles. Options for alternative fuel buses include electric, hybrid electric, compressed natural gas, ethanol, and biodiesel — all of which are available today. In addition to long-term energy savings, these vehicles serve as great educational tools for the students and the community. The US DOE's Clean Cities Program can help you determine the best alternative fuel vehicles for your fleet.



*Driving students one at a time to school each day is responsible for 0.5–3.3 tons of carbon dioxide per student being emitted into the air each year. Providing safe pedestrian walkways throughout the surrounding neighborhood allows students who attend a school in their community to walk, reducing busing and single car traffic.*



*The design team, developers, and local planning departments must work in close collaboration to maximize the pedestrian access to the school site from the community.*

# Design Guidelines for Integrating Transportation Considerations into School Design

## Connecting the School to the Community

One of the measures of success of a school is the degree to which the school is a vital part of the community. If addressed early in the site selection and design phase, a school can be planned to serve not just the students but also the entire community.

- Design the school so that the athletic fields, gymnasium, media center, and classrooms are accessible and can be shared at appropriate times with the community.
- Provide good access to public transit.
- Through good site design, link the school to the surrounding communities through safe bicycle routes, pedestrian pathways, and greenways.
- Incorporate convenient bicycle parking at the school to discourage single car traffic.

In areas of the country experiencing growth, more schools are being built in conjunction with the construction of large subdivisions by local developers. This situation offers the school system and the community an excellent opportunity to coordinate with developers in making the school a more integral part of the community.

- Work with the developer to implement new, safe walkways and bike paths that link the neighborhood to the school.
- Develop a master plan with the community so that the main pedestrian ways to the site do not cross over busy roads. Or, if that cannot be avoided, provide safe and handicap-accessible pedestrian overpasses or underpasses.
- Develop recreational facilities that can be shared with the school.

Photo: Northwest Landing

*With the tremendous amount of fuel currently consumed in transporting students, and the resulting pollution, it is critical to locate schools in a manner that minimizes vehicular transportation and maximizes the potential for pedestrian access. This master plan encourages walking instead of driving. Homes are, on average, a 10–15 minute walk from schools. Connecting school sites into the community's walkway system greatly decreases busing and car drop-offs and, in turn, reduces localized air pollution.*



## Walkways and Bike Paths

Safe walkways and bike paths that link the school to the sidewalks and greenways of the surrounding communities offer an easy solution to many of the school's budgetary problems and the community's air pollution and traffic problems. During the early planning of the school, the design team should work with the adjacent developers and local planning officials in implementing strategies to enhance safe pedestrian paths connecting the school and the community.

- If sidewalks provide the main pedestrian access to the school, encourage the developer and/or local planning department to separate them a safe distance from the road.
- Use walkway surfacing materials that are appropriate for handicap access.
- Provide separate bike paths.
- Incorporate caution lights throughout the community to warn drivers of the likelihood of student pedestrian travel.
- Provide controllable crossing lights at the intersections of student pedestrian paths and roadways.
- Provide underpasses or overpasses at the intersection of high-traffic roads and main pedestrian paths.
- On school property, minimize potential conflicts by separating students and vehicular pathways.

## High-Efficiency and Low-Emission Vehicles

In addition to incorporating safe and traffic-reducing elements into your site design, consider the use of high-efficiency and low-emission vehicles in your fleet. Electric vehicles, hybrid electric vehicles, and vehicles using alternative fuels like ethanol and compressed natural gas are cost-effective and proven options.

### Electric Vehicles

Although a school bus can be powered by pure electricity, only a few electric school bus options are available today. However, small maintenance carts and other vehicles that are used by school officials and staff can easily use electricity as a fuel. Electric vehicles typically have limited ranges, so they are great for short trips and stop-and-go driving. Electric vehicles reduce local pollution, but unless they are charged with renewable energy, they are still a source of regional pollution.

These charging areas can be viewable by students to assist with teaching about renewable energy and can include displays to indicate to students the contribution that the station is providing.

- To ensure availability, the school or school system should provide a charging station for electric vehicles.



### CLEAN CITIES PROGRAM

*The Clean Cities Program, sponsored by the US DOE, supports public-private partnerships that help get alternative fuel vehicles into the market and build supporting infrastructure.*

*Unlike traditional command and control programs, the Clean Cities Program takes a unique, voluntary approach to alternative fuel vehicle development, working with coalitions of local stakeholders to help develop the industry and integrate this development into larger planning processes.*

*Currently there are 80 Clean Cities coalitions dedicated to getting alternative fuel vehicles on the road. The Clean Cities Program helps educate fleets across the country on which AFVs and fuel types are right for each fleet. Coalitions also assist fleets with understanding incentives and legislation related to AFVs. More information on the Clean Cities Program can be found in the resources section at the end of this document.*

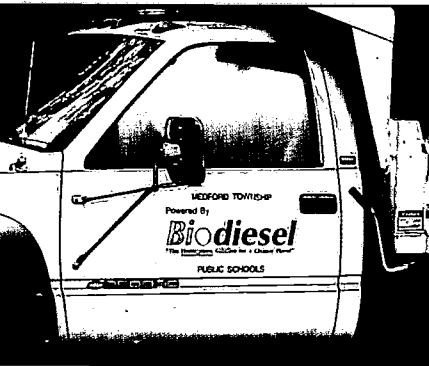

Photo: Medford Township Board of Education

*Medford Township Schools, in Medford, NJ, converted 22 of their school buses to run on a fuel consisting of 20% soy bean-derived biodiesel. According to Joe Biluck, director of operations for the school system, their goal of reducing pollution has been achieved. Particulate emissions have been reduced by 35%–40%.*

## Hybrid Electric Vehicles

Hybrid electric vehicles (HEVs) have the same power as conventional vehicles and do not have the reduced driving range that electric vehicles have. There are several options for HEV buses available today, and there are two HEV automobiles that can be used as school fleet vehicles. HEVs can be produced in a variety of ways, but typically the battery pack helps supplement the vehicle's power when accelerating and hill climbing. During stop-and-go driving, both the traditional gasoline engine and batteries work together. For extended highway driving, the engine does most of the work because that is when it is operating most efficiently.

## Ethanol

Ethanol is typically produced from domestic-grown, plant-based materials such as corn or other grains. Ethanol buses and vehicles are good options for school districts because several vehicle choices are available. Ethanol fuel can be found at fueling stations across the country; however, some areas have more stations than others. Vehicles using ethanol as a fuel perform as well as typical conventional vehicles. Under current conditions, the use of ethanol-blended fuels such as E85 (85% ethanol and 15% gasoline) can reduce the net emissions of greenhouse gases by as much as 37%.

- To ensure availability, the school or school system should provide a storage tank for ethanol fuel.

## Compressed Natural Gas Vehicles

Compressed natural gas (CNG) vehicles operate like any conventional vehicles. Drivers can't tell the difference in performance. CNG buses are being used by many schools districts across the nation. CNG is a great option for schools because the vehicles are readily available and the fuel is considerably less expensive than gasoline. There are also several CNG sedans and trucks that are produced by auto manufacturers and that would be good options for use in school fleets. Exhaust emissions from NGVs are much lower than those from gasoline powered vehicles.

- To ensure availability, the school system should provide a CNG fueling station.

Photo: NREL/PIX04152

*This school bus looks and operates like a standard diesel bus but runs on compressed natural gas.*



# Resource-Efficient Building Products

A school, like any building, is only as good as the sum of the materials and products which it is made. To create a high performance school, your design team must select the most appropriate materials and components and combine these elements effectively through good design and construction practices.

Typically, architects and engineers primarily consider the performance of materials and components in terms of how they serve their intended function in the building. When it is appropriate that material function be a top consideration, your design team should also consider the materials from a broader environmental perspective. For example, indoor air quality can be improved by eliminating or minimizing volatile organic compounds in paints, carpet, and adhesives and by minimizing formaldehyde in plywood, particleboard, composite doors, and cabinets.

Using resource-efficient products and systems not only contribute to improving indoor air quality, energy efficiency, and durability of a school, but they also help reduce harm to the natural environment by minimizing use of limited resources and promoting reuse and recycling.



Photo: NREL/PIX03049



Photo: NREL/PIX03050

*True linoleum, unlike vinyl flooring, is made from wood flour, cork, and linseed oil. It gets harder over time, and makes for an attractive, durable surface.*





Photo: NREL/PIX02213

These ceiling beams are made from recycled wood products.

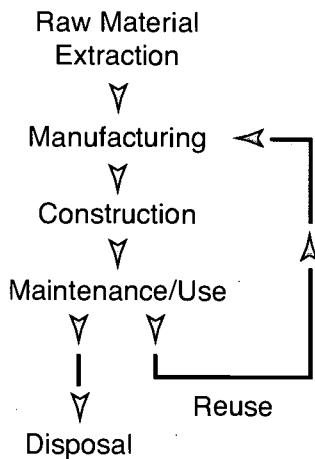

**Life-Cycle Analysis**

The life cycle of a building product can have significant environmental implications.

# Design Guidelines for Resource-Efficient Building Products

## The Life-Cycle Approach

To select environmentally preferable products, it is necessary to consider environmental impacts from all phases in the product's life cycle. This approach is called life-cycle analysis. A product's life cycle can be divided into the following phases:

- raw material extraction
- manufacturing
- construction
- maintenance/use
- reuse or disposal.

Environmentally important impacts associated with the transportation of raw materials and finished products are included with each of these phases.

Unlike many consumer products, in which the "use" phase is very short (a soft-drink bottle, for example), building materials are typically in place for a relatively long time. As a result, if there are ongoing environmental impacts associated with the use phase, these often outweigh those from other phases.

The following is a list of key issues to consider at each phase of the life cycle and some examples of products that have environmental advantages.

### Phase 1: Raw Material Extraction

Building materials are all made from resources that are either mined from the earth or harvested from its surface. The most common materials are sand and stone to make concrete, clay for bricks, trees for wood products, and petroleum for plastics and other petrochemical-based products.

- Eliminate component materials from rare or endangered resources.
- Determine if there are significant ecological impacts from the process of mining or harvesting the raw materials.
- Specify that wood products must be harvested from well-managed forests. Require that suppliers show proof of credible third-party verification of environmentally sound harvesting methods.
- Determine the origin of the primary raw materials, and select options closer to the site, requiring less shipping.



Photo: NREL/PIX03048

*Cork is harvested from the cork oak. The bark can be removed from the tree about every 9 years without adversely affecting the tree. Cork is used to make cork and linoleum flooring.*

## Phase 2: Manufacturing

Manufacturing operations can vary considerably in their impact on the environment. The manufacturer of one product may rely on numerous out-sourcing operations at separate locations or obtain raw materials from another country. Another, less energy-intensive product may be produced in a single, well-integrated operation at one site with raw materials and components coming from nearby locations. Likewise, a particular manufacturer may use a process that relies on toxic chemicals while a competing manufacturer may incorporate environmentally friendly technologies to accomplish the same end.

- Determine if the manufacturing process results in significant toxic or hazardous intermediaries or byproducts. Most petrochemical-based processes involve some hazardous ingredients, so plastics should be used only when they offer significant performance advantages.
- Specify products that are made from recycled materials.
- Select products that are made from low-intensity energy processes. The manufacture of some materials, such as aluminum and plastics, requires a lot of energy while the "embodied energy" to make other materials is considerably less.
- Select products manufactured at facilities that use renewable energy.
- Consider the quantity of waste generated in the manufacturing process and the amount that is not readily usable for other purposes.

## Phase 3: Construction

To a great degree, the energy and environmental impacts of products and materials are determined by the way they are implemented.

- Avoid products containing pollutants by:
  - excluding high volatile organic compound paints (VOC), carpets, and adhesives
  - not incorporating products with excessive formaldehyde
  - using the least toxic termite and insect control.
- When pesticide treatments are required, bait-type systems should always be preferred over widespread chemical spraying and soil treatments.
- Separate materials that out-gas toxins (e.g., plywood with formaldehyde) or emit particulates (e.g., fiberglass insulation) with careful placement, encapsulation, or coating barriers.



Photo: NREL/PIX03041

*This environmentally sound, no-VOC carpet line is leased and maintained by the manufacturer, which reduces waste by recycling and reusing the carpet tiles. The up-front and maintenance costs are lower, and the environmental and health benefits are substantial.*

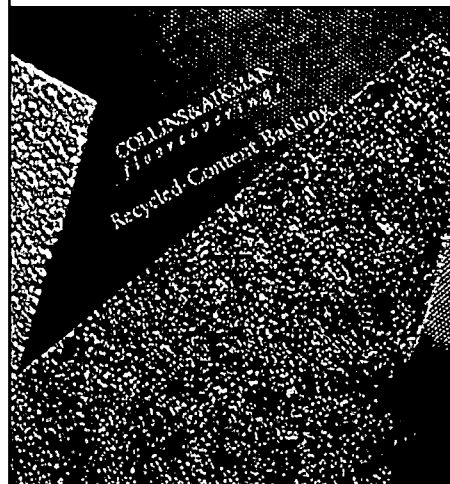

Photo: NREL/PIX03043

*Choose carpet backings with low or no formaldehyde to avoid indoor air contamination.*

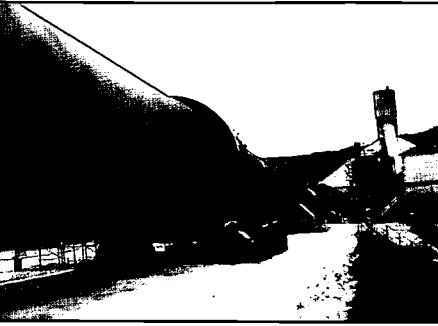

Photo: BuildingGreen Inc.

*Cement manufacturing is very energy intensive. The cement kiln is the largest piece of moving industrial machinery in common use, and temperatures inside it reach 2,700°F.*

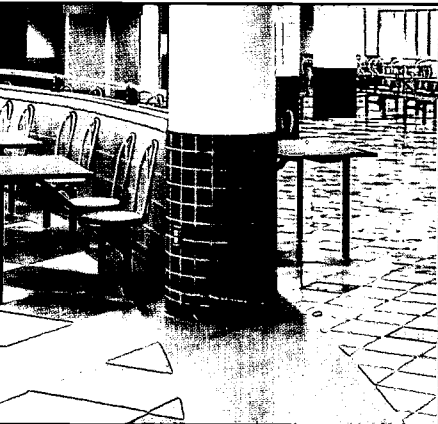

Photo: Barry Halkin Photography

*Recycled tiles installed in school hallways and cafeterias require very low maintenance.*

- Require the contractor to recycle construction materials.
- Ensure that unconventional products are installed properly.
- Require proper handling and storage of toxic materials at the job site.
- Require that the packaging of products, materials, and equipment delivered to the site be made of recyclable or reusable materials, and discourage unnecessary packaging.
- Ensure that product and material substitutions occurring during construction contain the same energy and environmental benefits.
- Avoid materials that are likely to adversely affect occupant health. Interior furnishings and finishes and mechanical systems all have the potential to affect the indoor air quality for better or worse. Material Safety Data Sheets (MSDS) can be a good source of information on the contents of various products.

### Phase 4: Maintenance/Use

How easily building components can be maintained — as well as their impact on long-term energy, environmental, and health issues — is directly linked to the quality of the materials, products, and installation.

- Select materials, products, and equipment for their durability and maintenance characteristics. Particular attention should be paid to selecting roofing systems, wall surfaces, flooring, and sealants — components that will be subject to high wear-and-tear or exposure to the elements.
- Avoid products with short expected life spans (unless they are made from low-impact, renewable materials and are easily recycled) or products that require frequent maintenance procedures.
- Provide detailed guidance on any special maintenance or inspection requirements for unconventional materials or products.

### Phase 5: Disposal or Reuse

Some surfaces in the school, such as carpets, may need to be replaced on a regular basis. The building as a whole will eventually be replaced or require a total renovation. To minimize the environmental impacts of these future activities, designers have to choose the right materials and use them wisely.

- Select materials that can be easily separated out for reuse or recycling after their useful life in the structure. Products that should be avoided include those that combine different materials (e.g., composites) or undergo fundamental chemical change during the manufacturing process.
- Avoid materials that become a toxic or hazardous waste problem at the end of their useful life. Preservative-treated wood, for example, contains highly toxic heavy metals that are contained within the wood for a time but will eventually be released when the wood decays or burns.

# Checklist of Key Design Issues

The following checklist can be used by school designers, planners, and administrators when considering comprehensive high performance strategies for new and renovated schools.

The format follows each of the 10 design components and cross-references issues of critical importance for the school decisionmakers.

## Legend

- Critical Design Element
- Suggested Design Element

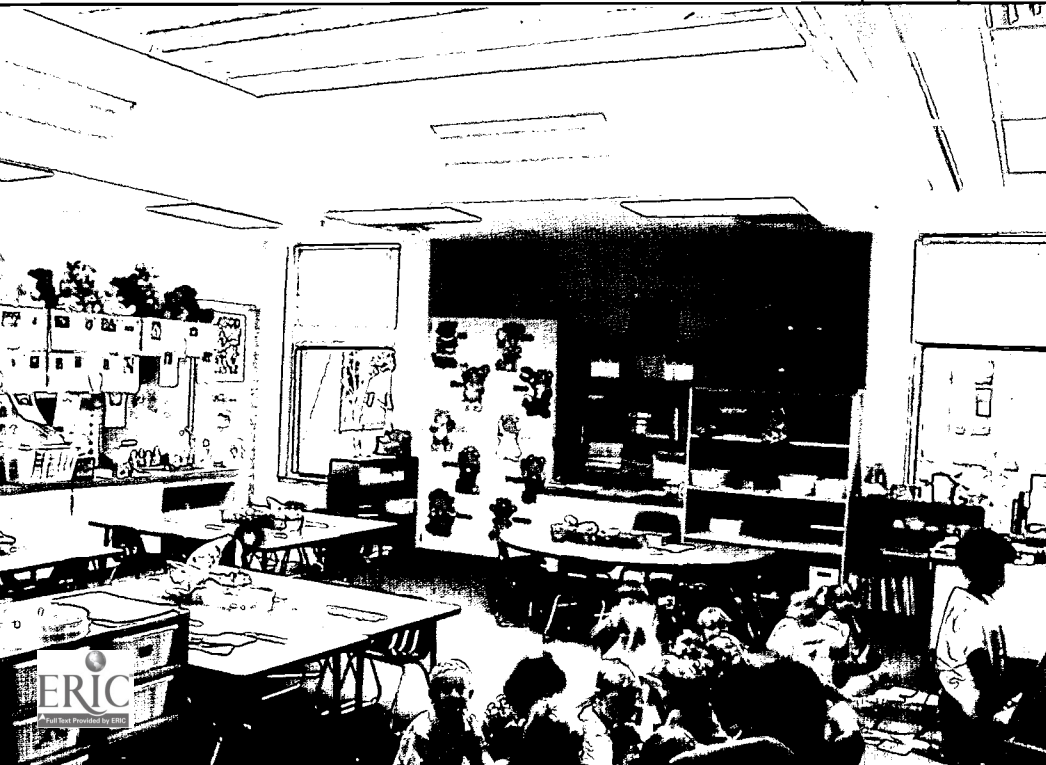
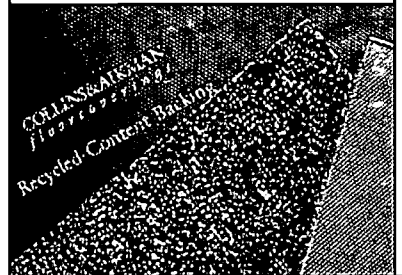
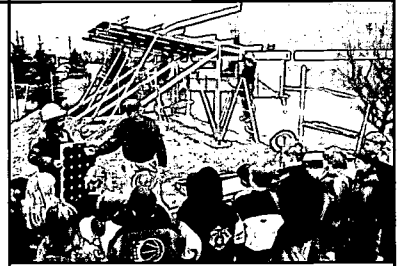

# Checklist of Key Issues for Site Design

## Site Design

- Take advantage of your site's natural resources by:
  - orienting the building to optimize solar access and daylighting
  - using vegetation and earth formations to your advantage.
- Incorporate strategies to save water, such as the use of rainwater catchment systems and xeriscape landscaping principles.
- Retain and add site features that could become educational resources for teachers to incorporate into their instructional programs.
- Include outdoor teaching and interpretive areas.
- Provide diverse, natural environments for exploration.
- Showcase local natural features.
- Maximize the educational opportunities of the pedestrian pathways from residential areas to the school.
- Provide the school with information on environmental design features.
- Develop the site in a manner that protects the existing landscaping, ecosystems, and wildlife habitat.
- Employ energy-saving strategies, and use renewable energy to reduce air pollution.
- Create earth berms to provide sound barriers.
- Develop on-site erosion control and stormwater management strategies.
- Connect the school's walkways and bike paths directly into greenways and sidewalks surrounding residential areas.
- Design the school as a part of the community by:
  - providing easy, safe pedestrian access to surrounding communities and mass transit
  - allowing for shared recreational facilities.

	Reducing Operating Costs	Designing Buildings that Teach	Improving Academic Performances	Protecting Our Environment	Designing for Health, Safety, & Comfort	Supporting Community Values
• Take advantage of your site's natural resources by:	<input checked="" type="checkbox"/>		<input type="checkbox"/>	<input checked="" type="checkbox"/>	<input type="checkbox"/>	
– orienting the building to optimize solar access and daylighting	<input checked="" type="checkbox"/>			<input checked="" type="checkbox"/>	<input type="checkbox"/>	
– using vegetation and earth formations to your advantage.	<input checked="" type="checkbox"/>			<input checked="" type="checkbox"/>	<input type="checkbox"/>	
• Incorporate strategies to save water, such as the use of rainwater catchment systems and xeriscape landscaping principles.	<input checked="" type="checkbox"/>			<input checked="" type="checkbox"/>		<input checked="" type="checkbox"/>
• Retain and add site features that could become educational resources for teachers to incorporate into their instructional programs.		<input checked="" type="checkbox"/>	<input checked="" type="checkbox"/>	<input checked="" type="checkbox"/>		
• Include outdoor teaching and interpretive areas.		<input checked="" type="checkbox"/>	<input checked="" type="checkbox"/>	<input type="checkbox"/>		
• Provide diverse, natural environments for exploration.		<input checked="" type="checkbox"/>	<input checked="" type="checkbox"/>	<input type="checkbox"/>		
• Showcase local natural features.		<input checked="" type="checkbox"/>				
• Maximize the educational opportunities of the pedestrian pathways from residential areas to the school.		<input checked="" type="checkbox"/>	<input checked="" type="checkbox"/>			
• Provide the school with information on environmental design features.		<input checked="" type="checkbox"/>	<input checked="" type="checkbox"/>	<input type="checkbox"/>		
• Develop the site in a manner that protects the existing landscaping, ecosystems, and wildlife habitat.		<input type="checkbox"/>		<input type="checkbox"/>		<input type="checkbox"/>
• Employ energy-saving strategies, and use renewable energy to reduce air pollution.	<input checked="" type="checkbox"/>			<input checked="" type="checkbox"/>		<input checked="" type="checkbox"/>
• Create earth berms to provide sound barriers.			<input type="checkbox"/>		<input checked="" type="checkbox"/>	
• Develop on-site erosion control and stormwater management strategies.				<input checked="" type="checkbox"/>		<input checked="" type="checkbox"/>
• Connect the school's walkways and bike paths directly into greenways and sidewalks surrounding residential areas.	<input checked="" type="checkbox"/>			<input checked="" type="checkbox"/>	<input checked="" type="checkbox"/>	<input checked="" type="checkbox"/>
• Design the school as a part of the community by:	<input checked="" type="checkbox"/>			<input checked="" type="checkbox"/>		<input checked="" type="checkbox"/>
– providing easy, safe pedestrian access to surrounding communities and mass transit				<input checked="" type="checkbox"/>		<input checked="" type="checkbox"/>
– allowing for shared recreational facilities.				<input checked="" type="checkbox"/>		<input checked="" type="checkbox"/>



# Checklist of Key Issues for Energy-Efficient Building Shell

## Energy-Efficient Building Shell

- Carefully evaluate building shell issues. Many of these components are likely to go unchanged during the life of the facility.
- Consider the wide range of building systems that can improve energy consumption, reduce maintenance requirements, and improve comfort. These include:
  - light-colored exterior walls and high-reflectance roofing systems
  - radiant barriers (in addition to insulation) in the roof/ceiling assemblies
  - massive wall construction
  - optimum wall and roofing insulation
  - infiltration and weather-resistive barriers
  - light-colored interior walls and ceilings.
- Incorporate artwork and graphics in the building that will help to educate students about energy and environmental issues.
- Design energy-efficient building components to make their purpose and function obvious to the students.
- Highlight different wall and glass treatments on each facade to emphasize the appropriateness of different design responses.
- Consider building shell issues that directly impact comfort and health and indirectly affect the performance of students within the classroom.
- Consider the embodied energy of optional building components and implementation strategies.
- Consider the color and finish of interior surfaces in controlling glare and improving visual comfort.
- Employ energy-saving strategies that will result in more energy dollars staying within the community.

Reducing Operating Costs	Designing Buildings that Teach	Improving Academic Performances	Protecting Our Environment	Designing for Health, Safety, & Comfort	Supporting Community Values
--------------------------	--------------------------------	---------------------------------	----------------------------	---	-----------------------------

<input checked="" type="checkbox"/>					
<input checked="" type="checkbox"/>			<input checked="" type="checkbox"/>	<input type="checkbox"/>	<input checked="" type="checkbox"/>
<input checked="" type="checkbox"/>			<input checked="" type="checkbox"/>	<input type="checkbox"/>	<input checked="" type="checkbox"/>
<input checked="" type="checkbox"/>			<input checked="" type="checkbox"/>	<input type="checkbox"/>	<input checked="" type="checkbox"/>
<input checked="" type="checkbox"/>			<input type="checkbox"/>	<input checked="" type="checkbox"/>	<input checked="" type="checkbox"/>
<input checked="" type="checkbox"/>			<input checked="" type="checkbox"/>	<input checked="" type="checkbox"/>	<input type="checkbox"/>
	<input checked="" type="checkbox"/>				
	<input checked="" type="checkbox"/>				
	<input checked="" type="checkbox"/>				
		<input checked="" type="checkbox"/>		<input checked="" type="checkbox"/>	
			<input checked="" type="checkbox"/>		
<input checked="" type="checkbox"/>					<input checked="" type="checkbox"/>

# Checklist of Key Issues for Lighting and Electrical Systems

## Lighting and Electrical Systems

- Select high-efficiency lamps, ballasts, lenses, and lighting fixtures that address the specific task requirements.
- Specify high-efficiency appliances and equipment.
- Use long-life lamps to reduce maintenance.
- Develop the primary lighting strategy around a daylighting approach.
- Incorporate controls, occupancy sensors, and dimmable or staged lights to automatically reduce electric lighting during times of adequate daylighting.
- Provide photocell controls on exterior lights to ensure lights are not operating during the day.
- Consider light-emitting diode (LED) exit lights.
- Minimize electrical line losses by installing a high-voltage distribution system.
- Conduct a commissioning process that verifies the proper operation of equipment and systems.
- Implement a regular maintenance schedule to ensure proper operation.
- Use ASHRAE Standard 9.01-1999 to establish lighting power densities (LPDs) for each space within the school.
- Incorporate photovoltaic and solar thermal-electric systems where appropriate.
- Monitor total building energy use and renewable energy system contribution.
- Design lighting to uniformly light each space, minimize glare, and reduce overheating from light fixtures.
- Select lamps with minimal or no hazardous materials.
- Design site lighting in a manner that will minimize "light pollution" by:
  - using fixtures with cut-off angles that prevent light from going beyond the specific area to be lighted
  - optimizing the height of luminaries for pathways to improve illumination and prevent light from straying onto adjacent properties
  - limiting exterior lighting to critical areas only.

Reducing Operating Costs	Designing Buildings that Teach	Improving Academic Performances	Protecting Our Environment	Designing for Health, Safety, & Comfort	Supporting Community Values
--------------------------	--------------------------------	---------------------------------	----------------------------	---	-----------------------------

<input type="checkbox"/>		<input type="checkbox"/>	<input type="checkbox"/>	<input type="checkbox"/>	<input type="checkbox"/>
<input type="checkbox"/>			<input type="checkbox"/>		<input type="checkbox"/>
<input type="checkbox"/>	<input type="checkbox"/>		<input type="checkbox"/>		<input type="checkbox"/>
<input type="checkbox"/>		<input type="checkbox"/>	<input type="checkbox"/>	<input type="checkbox"/>	<input type="checkbox"/>
<input type="checkbox"/>			<input type="checkbox"/>		<input type="checkbox"/>
<input type="checkbox"/>			<input type="checkbox"/>		<input type="checkbox"/>
<input type="checkbox"/>			<input type="checkbox"/>		<input type="checkbox"/>
<input type="checkbox"/>	<input type="checkbox"/>		<input type="checkbox"/>	<input type="checkbox"/>	<input type="checkbox"/>
<input type="checkbox"/>	<input type="checkbox"/>	<input type="checkbox"/>	<input type="checkbox"/>	<input type="checkbox"/>	<input type="checkbox"/>
<input type="checkbox"/>		<input type="checkbox"/>		<input type="checkbox"/>	<input type="checkbox"/>
<input type="checkbox"/>			<input type="checkbox"/>	<input type="checkbox"/>	<input type="checkbox"/>
<input type="checkbox"/>		<input type="checkbox"/>		<input type="checkbox"/>	<input type="checkbox"/>
<input type="checkbox"/>			<input type="checkbox"/>	<input type="checkbox"/>	<input type="checkbox"/>
<input type="checkbox"/>			<input type="checkbox"/>	<input type="checkbox"/>	<input type="checkbox"/>



# Checklist of Key Issues for Lighting and Electrical Systems

Reducing Operating Costs

Designing Buildings that Teach

Improving Academic Performances

Protecting Our Environment

Designing for Health, Safety, & Comfort

Supporting Community Values

- Select ballasts that do not contain PCBs.
- Minimize glare and eye strain by:
  - incorporating indirect lighting, particularly in computer areas
  - using lenses that shield the lamp from direct view and help disperse light more evenly
  - evaluating the location of the lighting sources in relationship to the occupants and what the occupants will be viewing
  - avoiding reflected glare commonly experienced when viewing a computer screen and seeing the light fixtures
  - minimizing situations of "transient adaptation" in which the eye cannot properly adjust when going from one space to another with drastically different light levels.
- Employ energy-efficient lighting and electrical systems that will result in more energy dollars staying within the community.
- Consider life-cycle costs to ensure that the best long-term solutions are implemented.

# Checklist of Key Issues for Mechanical and Ventilation Systems

## Mechanical and Ventilation Systems

- Implement the most energy-efficient mechanical and ventilation strategies to save energy.
- Consider the initial cost of equipment, anticipated maintenance expenses, and projected operating costs when evaluating the life-cycle benefits of system options.
- Use a computer energy analysis program that simulates hourly, daily, monthly, and yearly energy consumption and effectively accounts for daylighting benefits (i.e., reduced cooling).
- Optimize the mechanical system as a complete entity to allow for the interaction of various building system components.
- Employ the most energy-efficient mechanical systems by:
  - not oversizing equipment
  - eliminating systems that first cool air and then reheat it or mix cool and hot air
  - matching the air supply to the load, without adding a reheat penalty
  - considering thermal storage systems
  - zoning air handling units so that each unit serves spaces with similar orientation and use patterns.
- Implement a strategy that energy efficiently ensures adequate outside air by incorporating economizer cycles and heat recovery systems.
- Provide safe visual access to mechanical systems to explain how they work.
- Use energy monitoring stations as teaching aids.
- Improve student and teacher performance by ensuring adequate fresh air is provided by:
  - complying with ASHRAE ventilation standards
  - incorporating pollutant sensors
  - using nighttime ventilation strategies in the cooling season to flush out air prior to morning occupancy
  - installing ductwork that has smooth internal surfaces and transitions to minimize the collection of microbial growth
  - designing ductwork and plenums to minimize the accumulation of dirt and moisture and providing access areas in key locations for inspection, maintenance, and cleaning

Reducing Operating Costs

Designing Buildings that Teach

Improving Academic Performances

Protecting Our Environment

Designing for Health, Safety, & Comfort

Supporting Community Values



# Checklist of Key Issues for Mechanical and Ventilation Systems

- locating outdoor-air intakes a safe distance from polluted and/or overheated exhaust grilles and away from parking or traffic.
- Implement mechanical and ventilation strategies that control humidity and address all physical, biological, and chemical pollutants.
- Incorporate renewable energy systems to provide for absorption cooling, space heating, hot water, and electricity.
- Address the impacts of CFCs and HCFCs when selecting refrigerants for cooling systems.
- Implement indoor air quality strategies that can provide for healthier learning environments.
- Design the mechanical and ventilation systems to maximize the comfort of the students and teachers.
- Employ energy-efficient mechanical and ventilation systems that will result in more energy dollars staying within the community.

Reducing Operating Costs	Designing Buildings that Teach	Improving Academic Performances	Protecting Our Environment	Designing for Health, Safety, & Comfort	Supporting Community Values
--------------------------	--------------------------------	---------------------------------	----------------------------	---	-----------------------------

■	□	■	■	■	■
■		■	■	■	■
■		■	■	■	■
■		■	■	■	■
■		■	■	■	■



# Checklist of Key Issues for Water Conservation

## Water Conservation

- Encourage the general contractor to conserve water during construction.
- Incorporate indigenous vegetation to minimize irrigation requirements.
- Install water-conserving fixtures.
- Incorporate graywater systems.
- Consider rainwater collection systems.
- Provide more localized hot water heaters, closer to the loads in the school, to avoid wasting water and energy.
- Use educational signage and graphics to help inform students and staff about the need to conserve water, and instruct them on what they can personally do to save water.
- Install monitoring devices, sight glasses in storage tanks, and energy management systems that can be used by students to monitor school usage and see the benefits of using graywater.
- Adequately insulate hot water supply piping.
- Ensure that the water is clean and lead-free.
- Implement water-conserving strategies that will reduce the need to provide water from non-sustainable aquifers and water sources not within the immediate region.
- Consider installing an on-site biological wastewater treatment system.
- Check the condition of all existing plumbing lines and fixtures for sources of potential contamination, particularly lead.
- Use only lead-free materials in the potable plumbing system to avoid lead-related impacts such as lower IQ levels, impaired hearing, reduced attention span, and poor student performance.
- Verify the condition of the potable water supply.
- Install separate plumbing lines that will allow the school to irrigate by using reclaimed water, avoiding the costs, chemicals, and energy associated with treating water to potable levels but still achieving health standards for discharging into streams.

Reducing Operating Costs	Designing Buildings that Teach	Improving Academic Performances	Protecting Our Environment	Designing for Health, Safety, & Comfort	Supporting Community Values
--------------------------	--------------------------------	---------------------------------	----------------------------	---	-----------------------------

<input type="checkbox"/>			<input type="checkbox"/>		<input type="checkbox"/>
<input type="checkbox"/>			<input type="checkbox"/>		<input type="checkbox"/>
<input type="checkbox"/>			<input type="checkbox"/>		<input type="checkbox"/>
<input type="checkbox"/>			<input type="checkbox"/>		<input type="checkbox"/>
<input type="checkbox"/>			<input type="checkbox"/>		<input type="checkbox"/>
<input type="checkbox"/>	<input type="checkbox"/>	<input type="checkbox"/>	<input type="checkbox"/>		<input type="checkbox"/>
<input type="checkbox"/>	<input type="checkbox"/>	<input type="checkbox"/>	<input type="checkbox"/>		<input type="checkbox"/>
<input type="checkbox"/>			<input type="checkbox"/>	<input type="checkbox"/>	<input type="checkbox"/>
<input type="checkbox"/>			<input type="checkbox"/>		<input type="checkbox"/>
<input type="checkbox"/>	<input type="checkbox"/>	<input type="checkbox"/>	<input type="checkbox"/>		<input type="checkbox"/>
<input type="checkbox"/>			<input type="checkbox"/>	<input type="checkbox"/>	<input type="checkbox"/>
<input type="checkbox"/>			<input type="checkbox"/>	<input type="checkbox"/>	<input type="checkbox"/>
<input type="checkbox"/>			<input type="checkbox"/>		<input type="checkbox"/>
<input type="checkbox"/>			<input type="checkbox"/>		<input type="checkbox"/>



# Checklist of Key Issues for Transportation

## Transportation

- Work with developers and local planning departments to design easy, safe pedestrian access throughout the community to the school site.
- Use high-efficiency buses and service vehicles.
- Use graphics and signage to help educate students and the community about the environmental benefits of the energy-efficient and low-emission approaches to transportation implemented by the school.
- Give high priority to the placement of bicycle racks, and use personalized nameplates for regular bikers.
- Incorporate a highly visible solar electric and/or wind-powered charging station for electric buses and service vehicles.
- Design sidewalks and bike paths throughout the community and school site to help reduce air pollution associated with busing and single car drop-offs.
- Use low-emission methanol, biodiesel, natural gas, and solar electric buses and service vehicles to reduce air pollution.
- Stress safety when designing walkways and bike paths.
- Use photovoltaic systems to reliably power:
  - parking and walkway lights
  - caution lights and street crossings
  - electric charging stations.
- Allow for handicap access.
- Encourage recreational activities by providing access to athletic facilities that can be shared with residents of the local community.
- Provide pedestrian ways to and a mass transit stop at the school site so that the school is more easily accessible to the community.
- Implement energy-efficient transportation options that keep energy dollars in the community, strengthening the local economy.
- Choose high-efficiency and low-emission vehicles as the best long-term solution to protect against future energy cost escalation.

Reducing Operating Costs

Designing Buildings that Teach

Improving Academic Performances

Protecting Our Environment

Designing for Health, Safety, & Comfort

Supporting Community Values

<input checked="" type="checkbox"/>			<input checked="" type="checkbox"/>	<input checked="" type="checkbox"/>	<input checked="" type="checkbox"/>
<input checked="" type="checkbox"/>			<input checked="" type="checkbox"/>	<input checked="" type="checkbox"/>	<input checked="" type="checkbox"/>
	<input checked="" type="checkbox"/>	<input checked="" type="checkbox"/>			
	<input checked="" type="checkbox"/>				
<input checked="" type="checkbox"/>	<input checked="" type="checkbox"/>		<input checked="" type="checkbox"/>	<input checked="" type="checkbox"/>	<input checked="" type="checkbox"/>
<input checked="" type="checkbox"/>			<input checked="" type="checkbox"/>	<input checked="" type="checkbox"/>	<input checked="" type="checkbox"/>
<input checked="" type="checkbox"/>			<input checked="" type="checkbox"/>	<input checked="" type="checkbox"/>	<input checked="" type="checkbox"/>
<input checked="" type="checkbox"/>			<input checked="" type="checkbox"/>	<input checked="" type="checkbox"/>	<input checked="" type="checkbox"/>
<input checked="" type="checkbox"/>			<input checked="" type="checkbox"/>	<input checked="" type="checkbox"/>	<input checked="" type="checkbox"/>
<input checked="" type="checkbox"/>			<input checked="" type="checkbox"/>	<input checked="" type="checkbox"/>	<input checked="" type="checkbox"/>
<input checked="" type="checkbox"/>			<input type="checkbox"/>	<input checked="" type="checkbox"/>	<input checked="" type="checkbox"/>
<input checked="" type="checkbox"/>			<input type="checkbox"/>	<input checked="" type="checkbox"/>	<input checked="" type="checkbox"/>
<input checked="" type="checkbox"/>			<input checked="" type="checkbox"/>	<input checked="" type="checkbox"/>	<input checked="" type="checkbox"/>
<input checked="" type="checkbox"/>			<input checked="" type="checkbox"/>	<input checked="" type="checkbox"/>	<input checked="" type="checkbox"/>
<input checked="" type="checkbox"/>			<input checked="" type="checkbox"/>	<input checked="" type="checkbox"/>	<input checked="" type="checkbox"/>
<input checked="" type="checkbox"/>			<input checked="" type="checkbox"/>	<input checked="" type="checkbox"/>	<input checked="" type="checkbox"/>
<input checked="" type="checkbox"/>			<input checked="" type="checkbox"/>	<input checked="" type="checkbox"/>	<input checked="" type="checkbox"/>
<input checked="" type="checkbox"/>			<input checked="" type="checkbox"/>	<input checked="" type="checkbox"/>	<input checked="" type="checkbox"/>
<input checked="" type="checkbox"/>			<input checked="" type="checkbox"/>	<input checked="" type="checkbox"/>	<input checked="" type="checkbox"/>





# Checklist of Key Issues for Resource-Efficient Building Products

- Separate polluting materials from exposed surfaces.
- Incorporate indoor planting strategies.
- Avoid equipment that requires toxic or irritating maintenance procedures.
- Provide detailed guidance on preferable maintenance procedures to minimize exposure of staff and students to toxic and irritating chemicals.
- Work with the school system to develop an indoor pollutant source assessment and control plan.
- Choose products and materials that are locally produced or made from readily available materials.
- Choose products and building procedures that maximize local labor.
- Select indigenous materials, and implement designs that enhance the connection to "place."
- Select materials that can be reused or recycled, minimizing impacts on landfills.

Reducing Operating Costs

Designing Buildings that Teach

Improving Academic Performances

Protecting Our Environment

Designing for Health, Safety, & Comfort

Supporting Community Values

# Case Studies

The following case studies demonstrate successful applications of high performance solutions appropriate for cold and humid climates. Contact information is provided to allow you to gain firsthand knowledge from schools that have successfully implemented many of the high performance design strategies included in this guideline.

To find additional case studies around the country, log on to the EnergySmart Schools Web site:

**[www.energysmartschools.gov](http://www.energysmartschools.gov)**

or call the US DOE's energy clearinghouse:

**1 (800) DOE-3732**

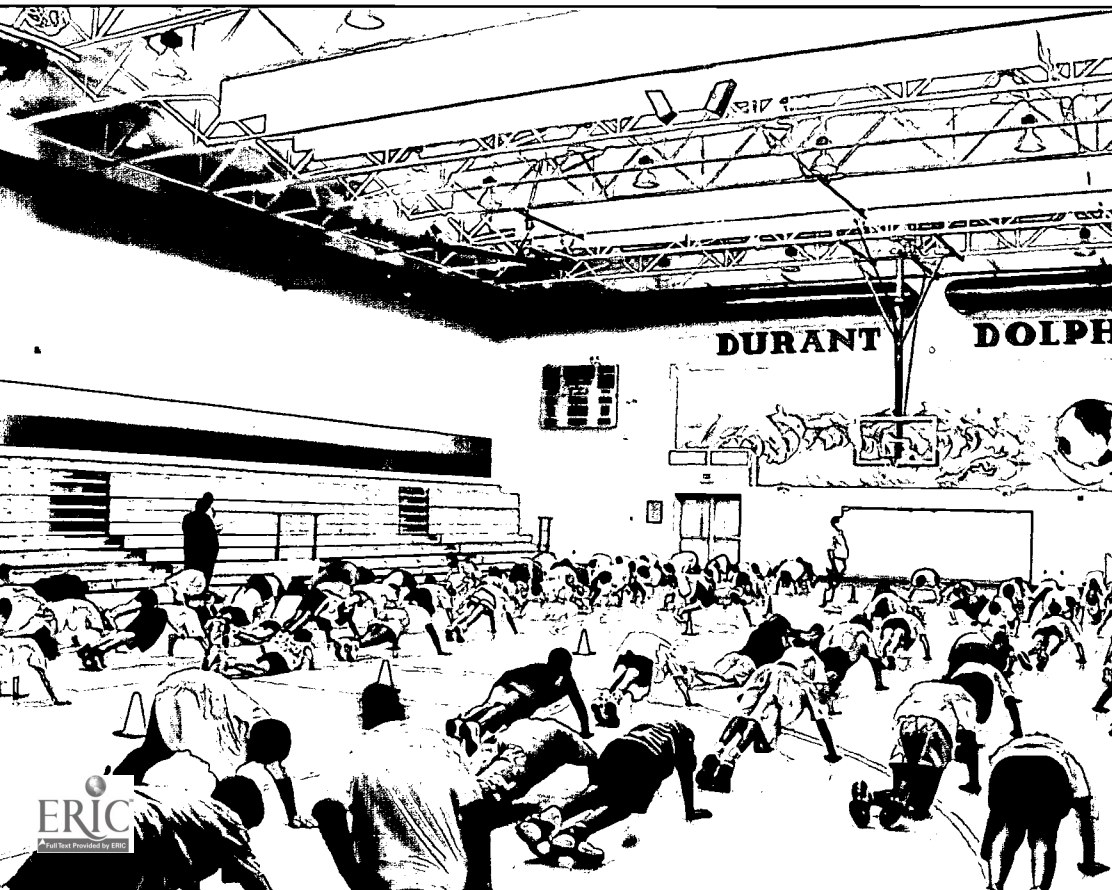

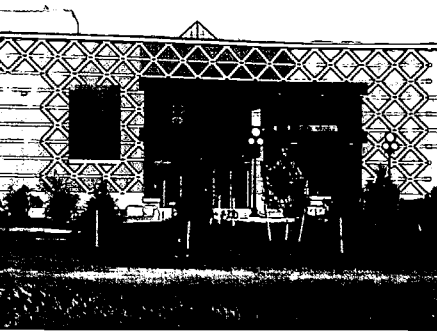

Photo: Chris Barnes

**Contact:**

*Bruce Cook, Principal  
Brunswick High School  
116 Maquoit Rd.  
Brunswick, ME 04011  
Phone: (207) 798-5500  
Jack Despres, Head of Science  
Department  
Phone: (207) 798-5500*

**Benefits:**

- ✓ *Protection of local environment*
- ✓ *Water management strategies*
- ✓ *Environmental stewardship*

## Brunswick High School, Brunswick, Maine

*"We have found no dangerous readings indications of stress to the environment near the school. The retention ponds and water flow patterns around the school grounds appear to have functioned exactly as envisioned in both normal and abnormal weather events. Runoff from the parking lots and roofs is processed in the ponds, which are healthy and full of wildlife."*

— Jack Despres, head of science department, Brunswick High School

Maquoit Bay near Brunswick, Maine, supports a productive shellfish industry. When a 50-acre site a mile from the bay was selected for the town's new high school, strong concerns were voiced by the community that pollutants from stormwater runoff would migrate to the bay, destroying fish. As a result, the town enacted one of the strictest environmental ordinances in the nation to protect the bay.

The design of the new high school and grounds, completed in July 1995, employs a system of man-made ponds, wetlands, and grassed swales that collect, divert, and slow the rate of stormwater runoff. Native sandy topsoil has been replaced with silty loam to promote quality turf for the playing fields and minimize leaching of nutrients into the ground water. Fifteen of the school's 50 acres have been preserved in their natural state. More than 75 species or varieties of native trees and shrubs are marked with identification tags, giving students a distinctive place for nature studies, which have been integrated into the curriculum.

The design of the school building itself minimizes energy consumption and its impact on the environment by incorporating local building materials, natural daylight, energy-efficient light fixtures, energy recovery equipment, and an energy usage monitoring system that is also used as a teaching tool.



Photo: Peter Kerze

**Contact:**

*Barbara Shin, Principal  
Interdistrict Downtown School  
10 South 10th St.  
Minneapolis, MN 55403  
Phone: (612) 752-7100*

**Benefits:**

- ✓ *\$5,600 savings per year*
- ✓ *Environmental impact*
- ✓ *Improved indoor environment quality*

✓ *Energy education*

## Interdistrict Downtown School, Minneapolis, Minnesota

The Interdistrict Downtown School in Minneapolis, Minnesota is a multi-cultural magnet school for 520 students, kindergarten through twelfth grade. The school was completed in 1998 and incorporates a 2,115-square-foot solar wall heating system. The \$50,000 active solar collector brings in outside air through perforations in the collector and is heated by the sun. The warm air is sent into the building's HVAC system. The collector, which was installed on the south penthouse wall, not only saves \$5,600 per year in energy but also serves as an educational tool, introducing students to renewable energy principles. On a typical winter day, the solar collector is capable of preheating the air entering a building by 30°F.

## Union 32 Community Building, Montpelier, Vermont

*"The sunshine is always an added bonus. The building is an important part of the spirit of cooperation and collaboration at our school. I expect that we will continue to value it for years to come"*

**Dot Blake, principal, Union 32 High School**

Faced with the prospect of severe overcrowding, the Union 32 High School in Montpelier, Vermont was preparing for the usual short-term fix — rent portable classrooms. When this news reached Andrew and Carolyn Shapiro, local residents with children in the school, they were not pleased. As an expert in energy efficiency and healthy buildings, Andrew knew that the portable classrooms would likely create poor air quality, bad lighting, and high heating bills. The Shapiros proposed an alternative: — why not have the community work together to build the needed classrooms and do it right?

Led by Andrew and Carolyn, more than 300 volunteers donated time and skills to have the building ready for occupancy by the next September. Many materials were supplied by local businesses at reduced cost. All the exterior siding and trim and interior trim came from stressed pine trees in a 100-acre woodland owned by the school, and framing lumber also came from a nearby source. The building was completed for a remarkable \$30 per square foot — less than the cost of set-up and two years rent for two portable classrooms!

The building was designed for energy efficiency and is projected to consume half the energy of the portable classroom alternative. Contributing to the energy savings is the row of high windows on the southeast façade that bounce daylight off a wide interior lightshelf deep into the space. The walls are packed with 7 inches of cellulose insulation, the windows are low-e with argon gas, and an energy recovery ventilator provides fresh air and saves energy on heating and cooling.

Perhaps as an indication of how strongly the community feels about this building, they have chosen to move it to make room for the new addition rather than simply tear it down. In addition to a great building (now called the Community Building), the school gained a higher level of commitment and support from the community.

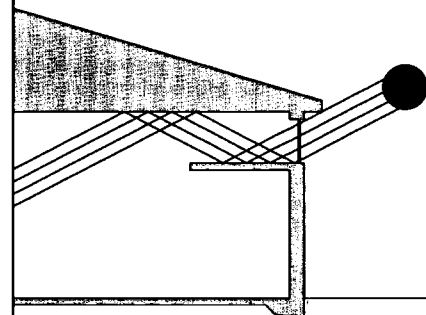

### Owner:

*Union 32 Community Schools  
930 Gallison Hill Rd.  
Montpelier, VT 05602*

### Contact:

*Andrew M. Shapiro  
Phone: (802) 229-5676*

### Benefits

- ✓ *Community values*
- ✓ *Better learning environment*
- ✓ *Energy savings*

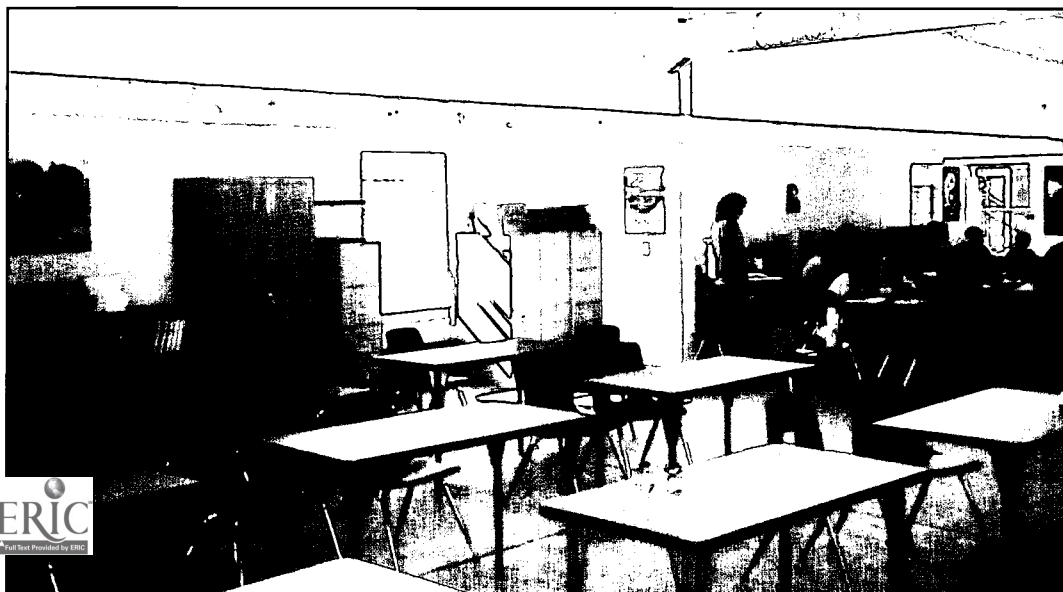



Photo: Forest City Community Schools

**Contacts:**

Ron Kvale, Science Teacher  
Forest City Community Schools  
810 West K St.  
Forest City, Iowa 50436  
Phone: (515) 585-2323

**Benefits:**

- ✓ Provide for 80%–90% of the school electrical needs
- ✓ Community values
- ✓ Eco-education
- ✓ Environmental impact

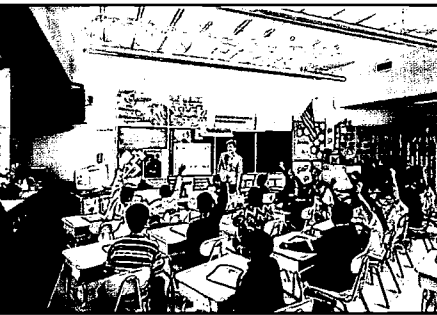

Photo: Jim Wilkes

**Contacts:**

Norma Bushorr, Principal  
Mary McLeod Bethune  
Elementary School  
Phone: (716) 325-6945

**Benefits:**

- ✓ Energy savings
- ✓ Increased visual comfort

## Forest City Community Schools, Forest City, Iowa

*"We will give our students firsthand experience in a technology that may be a big part of their energy future. We also want to share this data with other school districts and wind energy enthusiasts."*

**Dwight Pierson, superintendent, Forest City Community Schools**

*"We knew we were in a prime area of the state for using wind energy. When we found it would be to the school's advantage, we made a presentation to the school board."*

**Ron Kvale, teacher and member of the Wind Turbine Task Force**

The wind turbine project began when Paul Smith, then a student at Forest City High School, presented a research paper on wind energy to the town's school board. Smith began researching the benefits of wind turbines for his science project.

The presentation generated a great deal of interest and resulted in the installation of the 600-kWh wind turbine. The turbine began producing electricity for the school system in January 1999. In addition to incorporating wind energy into the classroom curriculum, the school district maintains a Web site with a microprocessor-based connection to the turbine that displays electrical production and wind energy data. The turbine provides 80%–90% of the electrical needs of the community's entire school system.

Forest City Community Schools views renewable energy and energy efficiency as cost-effective ways to reduce electrical costs while being environmentally conscious and creating opportunities for students to study the benefits of renewable energy production in a hands-on manner. The city and its municipal utility have contracted with the school system to buy all excess power generated.

## Mary McLeod Bethune Elementary School, Rochester, New York

Indirect lighting in schools can solve the problem of glare and visual discomfort for students and teachers. Lighting that is too bright or glaring on work surfaces or computers, creating high contrast between those surfaces and dark backgrounds, can give teachers and students headaches and eyestrain and can lead to absenteeism and poor performance.

The energy-efficient indirect lighting system at Mary McLeod Bethune Elementary School directs the light to the ceiling, where it is bounced into the classrooms and workspaces uniformly and without glare. This system is controlled by occupancy sensors and can be adjusted manually. In areas that need more direct task lighting, compact fluorescent lights are used to downlight specific workstations.

Mary McLeod Bethune Elementary also capitalizes on natural daylighting. Indirect lighting works well with daylighting, matching the light quality and complementing its energy saving attributes. The use of dimmable lights ensures that a constant and high quality light level is maintained in classrooms, work areas, the auditorium/cafeteria, and the media center.

## Spirit Lake Community Schools, Spirit Lake, Iowa

*"The final payment for the loan on the first turbine was made during the 1998 fiscal year. Today, \$25,000 per year in savings goes to the school's instructional programs. The development of wind energy is one of the most popular projects in the community. Everyone loves that we are helping to reduce our dependence on fossil fuels while educating our children about the importance of resource conservation."*

**Jim Tirevold, facilities manager, Spirit Lake Community Schools**

*"Education was the first priority. We need to teach preservation of the environment and, to do that, we have to model it. I've never been involved in something so accepted by so many."*

**Harold Overmann, superintendent, Spirit Lake Community Schools**

On July 22, 1993, the wind turbine on the lawn of Spirit Lake Elementary School began producing electricity. By August 2000, seven years and two months later, the school's turbine had produced a total output of 2,068,803 kilowatt hours of electricity, which saved the district \$176,445 in electricity costs. This corresponds to an average electrical output of 288,670 kilowatt hours per year and an average savings of \$24,620 per year. Looking at the entire seven year, two-month period of operation, nearly all of the electrical needs of the elementary school have been met by the wind turbine.

The wind turbine system has made a significant contribution to the environment. The 2,068,803 kilowatt hours of electricity produced by the turbine in the first 86 months of operation is the energy equivalent of 3,641 barrels of oil or 1,034 tons of coal. It has eliminated 3,103,205 pounds of CO<sub>2</sub> emissions and 442,724 pounds of SO<sub>2</sub> emissions that would have been released to the atmosphere by conventional energy production.

In addition to its excellent financial success and its significant contribution to the environment, the school's wind turbine has been used in the curriculum as an educational tool for the students. The Spirit Lake Environmental Impact Calculator at the school district's wind energy Web site allows all the students in the district to monitor and study the environmental benefits of wind power generated at the school. They can choose interactive lessons from all areas of the curriculum. Wind production is entered into the environmental impact calculator to see the natural resources saved and emissions avoided by the wind-produced energy.

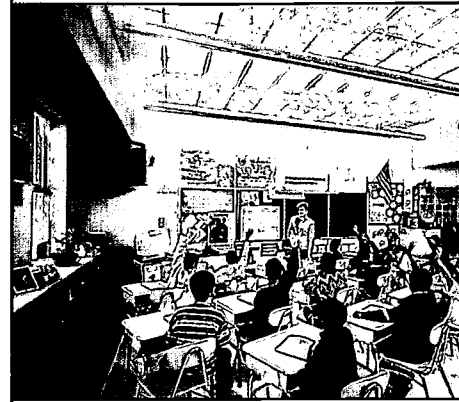

Photo: Jim Wilkes

### Contact:

*Jim Tirevold, Facility Manager  
Spirit Lake Community  
Schools  
900 20th St.  
Spirit Lake, Iowa 51360  
Phone: (712) 336-2820*

### Benefits:

- ✓ Resource savings
- ✓ Environmental impact
- ✓ Eco-education

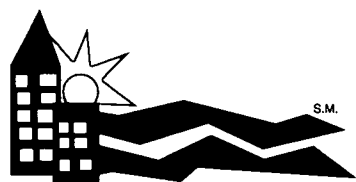

## Rebuild America U.S. Dept. of Energy

*EnergySmart Schools is part of the Rebuild America program, a national US DOE initiative to improve energy use in buildings. This means that if your school is part of a Rebuild America community partnership, you're ready to benefit from EnergySmart Schools.*

*Be sure to ask about energy improvements and educational materials for your bus fleet as well as your buildings. Rebuild America focuses on buildings, but its representatives can also direct you to resources for buses. After all, the goal of EnergySmart Schools is a comprehensive one: a nation of schools that are smart about energy in every way.*

## Web Resources for More Information

*EnergySmart Schools Web Site:* [www.energysmartschools.gov](http://www.energysmartschools.gov)

### Comprehensive Sources

[www.ase.org/greenschools/newconstruction.htm](http://www.ase.org/greenschools/newconstruction.htm) — Alliance to Save Energy's Green Schools Program

[www.eren.doe.gov/EE/buildings.html](http://www.eren.doe.gov/EE/buildings.html) — US DOE's Energy Efficiency and Renewable Energy Network buildings site

[www.advancedbuildings.org/](http://www.advancedbuildings.org/) — Advanced Buildings, Technologies, and Practices

[www.edfacilities.org/rl/](http://www.edfacilities.org/rl/) — National Clearinghouse for Educational Facilities

[www.epa.gov/building/schools](http://www.epa.gov/building/schools) — US EPA's ENERGY STAR for Schools

### Introductory Section

[www.rebuild.org](http://www.rebuild.org) — US DOE's Rebuild America program, with energy-efficient solutions for communities

[www.eren.doe.gov/buildings/energy\\_tools/doe\\_tools.html](http://www.eren.doe.gov/buildings/energy_tools/doe_tools.html) — DOE energy simulation software

[www.usgbc.org](http://www.usgbc.org) — US Green Building Council

### Site Design

[www.epa.gov/glnpo/greenacres/natvland.html](http://www.epa.gov/glnpo/greenacres/natvland.html) — EPA's site on native landscaping

[www.water.az.gov](http://www.water.az.gov) — Arizona Department of Water Resources

### Daylighting and Windows

[windows.lbl.gov/daylighting/designguide/designguide.html](http://windows.lbl.gov/daylighting/designguide/designguide.html) — Lawrence Berkeley National Laboratory's "Tips for Daylighting with Windows"

[www.eren.doe.gov/erec/factsheets/windows.html](http://www.eren.doe.gov/erec/factsheets/windows.html) — US DOE's "Advances in Glazing Materials for Windows"

[www.nfrc.org](http://www.nfrc.org) — National Fenestration Rating Council

[www.daylighting.org](http://www.daylighting.org) — Daylighting Collaborative

[aa.usno.navy.mil/data/docs/AltAz.html](http://aa.usno.navy.mil/data/docs/AltAz.html) — US Naval Observatory's sun or moon altitude/azimuth table

### Energy Efficient Building Shell

[www.nrel.gov/buildings\\_thermal/](http://www.nrel.gov/buildings_thermal/) — National Renewable Energy Laboratory's Center for Buildings and Thermal Systems

[www.ornl.gov/roofs+walls/index.html](http://www.ornl.gov/roofs+walls/index.html) — Oak Ridge National Laboratory's Building Thermal Envelope Systems and Materials Program

[gundog.lbl.gov/dirsoft/d2whatis.html](http://gundog.lbl.gov/dirsoft/d2whatis.html) — Lawrence Berkeley National Laboratory's DOE-2 energy simulation software

### Renewable Energy Systems

[www.eren.doe.gov/state\\_energy/](http://www.eren.doe.gov/state_energy/) — US DOE's State Energy Alternatives

[www.eren.doe.gov/greenpower/](http://www.eren.doe.gov/greenpower/) — US DOE's Green Power Network

[www.nrel.gov](http://www.nrel.gov) — National Renewable Energy Laboratory

[www.schoolsgoingsolar.org](http://www.schoolsgoingsolar.org) — The Interstate Renewable Energy Council Schools Going Solar program

## Lighting and Electrical Systems

[www.iaeel.org](http://www.iaeel.org) — International Association for Energy-Efficient Lighting

[eetd.lbl.gov/btp/lsr/](http://eetd.lbl.gov/btp/lsr/) — Lawrence Berkely National Laboratory's Lighting Systems Research Group

## Mechanical and Ventilation Systems

[www.epa.gov/iaq/schools/](http://www.epa.gov/iaq/schools/) — US EPA's Tools for Schools Indoor Air Quality program

[www.eren.doe.gov/buildings/energy\\_tools/energyplus/](http://www.eren.doe.gov/buildings/energy_tools/energyplus/) — US DOE's EnergyPlus energy simulation program

[epbl.lbl.gov/EPB/thermal/](http://epbl.lbl.gov/EPB/thermal/) — Lawrence Berkeley National Laboratory's information on Resource Efficient Building Conditioning

## Resource-Efficient Building Products

[www.sustainable.doe.gov/buildings/rescon.shtml](http://www.sustainable.doe.gov/buildings/rescon.shtml) — US DOE's resource list of resource-efficient building products

[www.ciwm.ca.gov/GreenBuilding/Materials](http://www.ciwm.ca.gov/GreenBuilding/Materials) — California Integrated Waste Management Board's site on green building materials

[www.ciwm.ca.gov/ConDemo/Products/default.asp](http://www.ciwm.ca.gov/ConDemo/Products/default.asp) — California Integrated Waste Management Board's site of Recycled-Content Building Products Database

## Water Conservation

[www.epa.gov/ow/](http://www.epa.gov/ow/) — US EPA's Office of Water

[www.water.az.gov](http://www.water.az.gov) — Arizona Department of Water Resources

[www.amwua.org/conservation-school.htm](http://www.amwua.org/conservation-school.htm) — Arizona Municipal Water User Association's "Water in Our Desert Community," an instructional resource for middle school students

## Recycling and Waste Management

[www.epa.gov/globalwarming/actions/waste/warm.htm](http://www.epa.gov/globalwarming/actions/waste/warm.htm) — US EPA's Waste Reduction Model to calculate greenhouse gas emissions

[www.p2pays.org/ref/01/00626.htm](http://www.p2pays.org/ref/01/00626.htm) — North Carolina Division of Pollution Prevention and Environmental Assistance's "Beyond Recycling: A Waste Reduction Manual for Schools"

## Transportation

[www.cities.doe.gov](http://www.cities.doe.gov) — US DOE's Clean Cities Program

[www.ott.doe.gov/](http://www.ott.doe.gov/) — US DOE's Office of Transportation Technologies

[www.ctts.nrel.gov](http://www.ctts.nrel.gov) — National Renewable Energy Laboratory's Alternative Fuels Web site

This publication, and additional information, is available online at:

[www.energysmartschools.gov](http://www.energysmartschools.gov)

### Photos Credits:

All photographs not specifically credited were taken by Innovative Design.

## For helpful resources or more information:

Call DOE's energy clearing house:  
1 (800) DOE-3732

Ask a question about saving energy in your school or request information about the EnergySmart Schools campaign. You may want to inquire about the availability of the following EnergySmart Schools resources:

### Publications and Videotapes

- Design Guidelines for New Schools and Major Renovations
- Portable Classroom Guidelines
- Decisionmaker Brochures
- Designing Smarter Schools, a 30-minute videotape that originally aired on the CNBC television network
- Educational CD-ROM featuring teaching and learning materials
- The High Performance Schools 30-minute video is also available by calling one of these three numbers: (303) 443-3130 Ext. 106, (202) 628-7400, or (202) 857-0666

### Services

- Technical assistance
- Regional peer exchange forums
- State-based forums for school decisionmakers
- Financing workshops
- Technology workshops



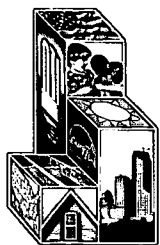

Office of Building Technology, State and Community Programs  
Energy Efficiency and Renewable Energy  
US Department of Energy



Rebuild America Schools  
U.S. Department of Energy



*U.S. Department of Education  
Office of Educational Research and Improvement (OERI)  
National Library of Education (NLE)  
Educational Resources Information Center (ERIC)*



## **NOTICE**

### **Reproduction Basis**

- This document is covered by a signed "Reproduction Release (Blanket)" form (on file within the ERIC system), encompassing all or classes of documents from its source organization and, therefore, does not require a "Specific Document" Release form.
- This document is Federally-funded, or carries its own permission to reproduce, or is otherwise in the public domain and, therefore, may be reproduced by ERIC without a signed Reproduction Release form (either "Specific Document" or "Blanket").