

DOCUMENT RESUME

ED 466 377

SE 066 107

AUTHOR McGowen, Mercedes A.
TITLE Cognitive Units, Concept Images, and Cognitive Collages: An Examination of the Processes of Knowledge Construction.
PUB DATE 1998-04-00
NOTE 260p.; Ph.D. Thesis, University of Warwick.
PUB TYPE Dissertations/Theses - Doctoral Dissertations (041)
EDRS PRICE MF01/PC11 Plus Postage.
DESCRIPTORS Academic Achievement; Algebra; *Cognitive Processes; Higher Education; Mathematics Instruction; *Remedial Mathematics; Sociocultural Patterns; Thinking Skills; Undergraduate Study

ABSTRACT

The fragmentation of strategies that distinguishes the more successful elementary grade students from those least successful has been documented previously. This study investigated whether this phenomenon of divergence and fragmentation of strategies would occur among undergraduate students enrolled in a remedial algebra course. Twenty-six undergraduate students enrolled in a remedial algebra course used a reform curriculum, with the concept of function as an organizing lens and graphing calculators during the 1997 fall semester. These students could be characterized as "victims of the proceptual divide," constrained by inflexible strategies and by prior procedural learning and/or teaching. In addition to investigating whether divergence and fragmentation of strategies would occur among a population assumed to be relatively homogeneous, the other major focus of this study was to investigate whether students who are more successful construct, organize, and restructure knowledge in ways that are qualitatively different from the processes utilized by those who are least successful. It was assumed that, though these cognitive structures are not directly knowable, it would be possible to document the ways in which students construct knowledge and reorganize their existing cognitive structures. Data reported in this study were interpreted within a multi-dimensional framework based on cognitive, sociocultural, and biological theories of conceptual development, using selected insights representative of the overall results of the broad data collection. In an effort to minimize the extent of researcher inferences concerning cognitive processes and to support the validity of the findings, several types of triangulation were used, including data, method, and theoretical triangulation. Profiles of the students characterized as most successful and least successful were developed. Analyses of the triangulated data revealed a divergence in performance and qualitatively different strategies used by students who were most successful compared with students who were least successful. The most successful students demonstrated significant improvement and growth in their ability to think flexibly to interpret ambiguous notation, switch their train of thought from a direct process to the reverse process, and to translate among various representations. They also curtailed their reasoning in a relatively short period of time. Students who were least successful showed little, if any, improvement during the semester. They demonstrated less flexible strategies, few changes in attitudes, and almost no difference in their choice of tools. Despite many opportunities for additional practice, the least successful were unable to reconstruct previously learned inappropriate schemas. Students' concept maps and schematic diagrams of those maps revealed that most successful students organized the bits and pieces of new knowledge into a

Reproductions supplied by EDRS are the best that can be made
from the original document.

basic cognitive structure that remained relatively stable over time. New knowledge was assimilated into or added onto this basic structure, which gradually increased in complexity and richness. Students who are least successful constructed cognitive structures which were subsequently replaced by new, differently organized structures which lacked complexity and essential linkages to other related concepts and procedures. The bits and pieces of knowledge previously assembled were generally discarded and replaced with new bits and pieces in a new, differently organized structure. (Contains 17 pages of references.) (Author/MM)

Reproductions supplied by EDRS are the best that can be made
from the original document.

Cognitive Units, Concept Images, and Cognitive Collages:

An Examination of The Processes of Knowledge Construction

PERMISSION TO REPRODUCE AND
DISSEMINATE THIS MATERIAL HAS
BEEN GRANTED BY

M. McGowen

TO THE EDUCATIONAL RESOURCES
INFORMATION CENTER (ERIC)

1

U.S. DEPARTMENT OF EDUCATION
Office of Educational Research and Improvement
EDUCATIONAL RESOURCES INFORMATION
CENTER (ERIC)

This document has been reproduced as
received from the person or organization
originating it.

Minor changes have been made to
improve reproduction quality.

Points of view or opinions stated in this
document do not necessarily represent
official OERI position or policy.

Mercedes A. McGowen

Ph.D. Thesis in Mathematics Education

**University of Warwick
Mathematics Education Research Centre
Institute of Education**

April, 1998

BEST COPY AVAILABLE

2

SE 066107

Table of Contents

List of Tables v

List of Figures vi

Acknowledgments viii

Dedication: Robert B. Davis ix

Declaration x

Summary xi

CHAPTER 1 *Thesis Overview* 1

Introduction 1

Background and Statement of the Problem 1

What skills, when, and for whom? 3

A “Splintered Vision” 4

Flexible Thinking: Interpreting Mathematical Notation 7

Theoretical framework 7

Thesis 7

Research questions 8

Design and Methodology 9

General Conclusions 10

Thesis Organization 12

CHAPTER 2 *General Literature Review* 15

Introduction 15

The Nature of Knowledge Construction and Representation 16

Conceptual Structures 17

Schemas and Frames 20

Concept Images 22

Conceptual Reorganization 24

Process-Object Theories of Cognitive Development 25

What does it mean “to understand?” 28

Ambiguous Notation: A Need for Flexible Thinking 30

The notions of procept and the “proceptual divide” 32

The Notion of Representation 35

External Models of Conceptual Systems 37

	<i>Concept Maps: External Representations of Conceptual Structures</i>	37
	Current Issues on the Nature of Knowledge Acquisition	42
	<i>Social and Individual Dimensions of Mathematical Development</i>	42
	<i>Technological Challenges to Current Beliefs and Practices</i>	44
	The Roles of Perception & Categorization	48
	<i>Classification Systems: Biological Considerations</i>	50
	Summary	55
CHAPTER 3	<i>Cognitive Units, Concept Images and Cognitive Collages</i>	58
	Introduction: On the Shoulders of Giants...	58
	Conceptual Structures	59
	Cognitive Collages, Concept Images, and Cognitive Units	61
	Path-Dependent Logic	62
	Concept Maps: Representations of Cognitive Collages	65
	Concept Maps: Tools for Instruction and Analysis	66
	Thesis and Research Questions	68
	Summary	69
CHAPTER 4	<i>Methodology</i>	70
	A Piagetian Paradigm Extended	70
	<i>Research Design: Method and Data Collection Instruments</i>	71
	Triangulation	73
	Variables to be taken into Consideration	74
	<i>Prior variables</i>	75
	<i>Independent variables</i>	76
	<i>Intervening variables</i>	76
	<i>Dependent variables</i>	77
	<i>Consequent variables</i>	78
	Data Collection	78
	<i>Field Test Study</i>	78
	<i>Field, Preliminary and Main Study Pre- and Post-Course Self Evaluations</i>	78
	<i>Pre-Course Self-Evaluation Survey</i>	80
	<i>Post-Course Self-Evaluation Survey</i>	81
	<i>Pre- and Post-course Tests</i>	82
	Relevance to Main Study Research Questions	83
	<i>Questions that test students' ability to take into account the role of context when evaluating an arithmetic or functional expression.</i>	84
	<i>Questions that test students' ability to evaluate functions using various representational forms.</i>	84
	<i>Questions that test students' ability to write an algebraic representation given the graph of a linear function.</i>	86
	<i>Questions that test students' ability to recognize and take into account the role of context when evaluating a functional expression.</i>	86
	<i>Questions that test students' ability to write an algebraic representation given the graph of a quadratic function.</i>	86
	<i>Main Study Pre- and Post-Test Question Classification</i>	87

Main Study Interview Question 87
Concept Maps 88
 Evaluation of concept maps 88
 Revisions in use and evaluation of Concept Maps in Main Study 88
Instructional Treatment 89
Summary 91

CHAPTER 5 *Preliminary Studies* 93

Introduction 93
Field Study 94
 Results of the Field Study: A Demographic Profile 94
 Results of Field Study Pre- and Post-Course Attitude Responses 97
 Results of Field Study Students' Self Evaluation of Abilities 98
Preliminary Study 99
 Preliminary Study Self-evaluation Survey Results 99
 Field & Preliminary Studies: Triangulation of Data About Prior Variables 100
Classroom-based Qualitative Studies 104
 Background and Problem Statement 104
 Results of the Teaching Intervention 107
 Analysis of the Results 108
Use of Concept Maps 112
Summary of Findings 114
Conclusions 116

CHAPTER 6 *Divergence and Fragmentation* 118

Overview of Main Study Quantitative Investigations 118
Modifications to the Preliminary Studies Instruments 118
A Student Profile 118
Prior Variables: Results of Student Self-Evaluation Surveys 119
Students' Ability to Interpret Ambiguous Notation 125
 Main Study Pre- and Post-Test Results 125
Divergent Paths-Results of the Quantitative Studies 129
Qualitative Divergence 131
 Stability of Students' Responses 132
 Flexibility of Thought: Ability to Reverse a Direct Process 136
Reconstruction of a Cognitive Collage: One Student's Efforts 139
 Flexibility of Thought: Translating Between Various Representations 142
 Flexibility of Thought: Procedural vs. Conceptual Thinking 145
Summary and Conclusions 147

CHAPTER 7 *A Tale of Two students* 150

Introduction 150

Perceptions and Strategies 151

MC and SK: Ability to Interpret Ambiguous Notation 153

MC and SK: Ability to Think Flexibly to Reverse a Direct Process 154

Shaping and Refining the Cognitive Collages of MC and SK 159

Perceptions, Cognitive Units, Concept Images, Retrieval of Schemas 160

Two paths diverge... the path taken by MC 162

Two paths diverged...the path taken by SK 165

And they will differ...as syllable from sound 170

CHAPTER 8 *Visual Representations of Cognitive Collages:* 172

A look back and an overview of what is yet to come 172

The Cognitive Collages of MC and SK 174

Goals of Learning: MC and SK 179

Underlying Structure: Schematic Diagrams 181

Schematic Diagrams of Concept Maps 185

Basic Categorization Schemes 187

The Nature of Students' Classification Schemes: Most & Least Successful 190

MC and SK: A Comparison of Classification Schemes: 191

Conclusions 195

CHAPTER 9 *Reflections and Future Directions* 197

An Emerging Cognitive Collage of the Most/ Least Successful 197

Divergence and Fragmentation of Strategies 197

The Cognitive Collages of Two Students: MC(S2) and SK (S23) 198

Divergence and Fragmentation of Strategies: MC (S2) and SK (S23) 200

The processes of constructing cognitive collages: MC (S2) and SK (S23) 202

Reflections and Observations 203

Strengths and Weaknesses of the Study 206

Future Directions and Possibilities 207

Bibliography 210

Appendix A *Terms and Definitions* 227

Appendix B *Data Collection Instruments* 229

Appendix C *Student Concept Maps and Schematic Diagrams* 235

List of Tables

Table 4.1:	Pre- and Post-Test Question Classification	87
Table 5.1:	Field Study: Student Profile (n = 237)	95
Table 5.2:	Field Study: Demographic Profile (n = 237)	96
Table 5.3:	Field & Preliminary Studies: Initial States Comparison of Pre-Course Self Evaluation of Abilities	100
Table 5.4:	Field & Preliminary Studies: Changed States Comparison of Post-Course Self Evaluation of Abilities	101
Table 5.5:	Field & Preliminary Studies: Self-evaluation Comparison of Means	102
Table 6.1:	Field, Preliminary & Main Studies: Initial States: Comparison of Pre-Course Self Evaluation of Abilities	120
Table 6.2:	Field, Preliminary & Main Studies: Improved States: Comparison of Post-Course Self Evaluation of Abilities	120
Table 6.3:	Main, Preliminary & Field Studies: Self-evaluation of Mathematical Abilities – Comparison of Means	121
Table 6.4:	Main Study: Most and Least Successful Mean Responses: Pre- Course, Post Course Self Evaluation of Abilities	123
Table 7.1:	MC and SK: Flexible Thinking–Interpreting Ambiguous Notation	158
Table 8.1:	Basic Classification Schemas of Concept Maps (Most Success)	188
Table 8.2:	Least Successful: Basic Classification Schemas used on Concept Maps	189
Table 8.3:	MC’s Cognitive Collage of the Category Representations	192
Table 8.4:	SK’s Cognitive Collage of the Category Quadratic Function	193
Table 8.5:	MC’s Cognitive Collage of the Category Parameters	194
Table 8.6:	SK’s Cognitive Collage of the Category Parameters	194

List of Figures

- FIGURE 5.1. Field & Preliminary Studies: Initial States
Comparison of Pre-Course Self Evaluation of Abilities 101
- FIGURE 5.2. Field & Preliminary Studies: Changed States
Comparison of Post-Course Self Evaluation of Abilities 102
- FIGURE 5.3. Field (F) & Preliminary (P) Studies: Initial & Changed States
Comparison of Pre-Course/Post-Course Evaluation of Abilities 103
- FIGURE 5.4. Function Machine Representations: Binary & Unary Processes 105
- FIGURE 5.5. TI-83 View Screen of Binary and Unary Operations 106
- FIGURE 5.6. WC: Concept Map Week 4: Inappropriate Connections 112
- FIGURE 5.7. WC: Concept Map Week 15: Reconstructed Concept Image 113
- FIGURE 6.1. Field, Preliminary, and Main Study Comparison:
Pre-course Self-evaluation Survey Mean Responses 122
- FIGURE 6.2. Field, Preliminary, and Main Study Comparison:
Post-course Self-evaluation Survey Mean Responses 122
- FIGURE 6.3. Main Study: Most & Least Successful Mean Responses:
Pre-Course Self Evaluation of Abilities—Initial State 123
- FIGURE 6.4. Main Study: Most & Least Successful Mean Responses:
Post-Course Self Evaluation of Abilities—Improved State 124
- FIGURE 6.5. Main Study: Most & Least Successful Initial State and Improved State
Paired Mean Responses of Self-evaluation Surveys 124
- FIGURE 6.6. Main Study: Pre-test Students' Ability to Interpret Notation 126
- FIGURE 6.7. Main Study: Pre- test Responses 128
- FIGURE 6.8. Main Study: Post-test Responses 128
- FIGURE 6.9. Main Study: Analysis of Pre- and Post-Test Responses 129
- FIGURE 6.10. Comparison of Most/Least Successful Pre- & Post-test Responses 130
- FIGURE 6.11. Analysis of Pre- & Post-test Responses: Most/Least Successful 130
- FIGURE 6.12. Comparison: Pre & Post-test Responses by Each Extreme Group 131
- FIGURE 6.13. Reconstruction of Schemas and Curtailment of Reasoning 133
- FIGURE 6.14. Pre- and Post-test Results: Arithmetic & Algebraic Squaring
Processes — Evaluating a Quadratic Function 135
- FIGURE 6.15. Reconstruction and Curtailment: Most/Least Successful 135

List of Figures

FIGURE 6.16.	Pre- and Post-test Results: Reversal of a Direct Process	137
FIGURE 6.17.	Post-test & Final Exam: Reversal of a Direct Process	137
FIGURE 6.18.	Flexibility: Use of Various Representations and Contexts	142
FIGURE 6.19.	Ability to Translate between Representational Forms	144
FIGURE 6.20.	Interpreting Ambiguous Notation: Procedural vs. Conceptual	145
FIGURE 7.1.	MC(S2) and SK(S23): Pre- and Post-test Responses	153
FIGURE 7.2.	MC Post-Test P10 & P11: Ability to Think Flexibly	157
FIGURE 7.3.	SK Post-test P10 & P11: Ability to Think Flexibly	157
FIGURE 7.4.	MC and SK: Competency Summary Profiles	160
FIGURE 7.5.	Student MC: Final Exam Open Response	163
FIGURE 7.6.	Student SK: Final Exam Open Response	165
FIGURE 8.1.	MC: Concept Map of Function Week 4	175
FIGURE 8.2.	MC: Concept Map of Function Week 9	175
FIGURE 8.3.	SK: Concept Map of Function Week 4	176
FIGURE 8.4.	SK: Concept Map of Function Week 9	176
FIGURE 8.5.	SK: Concept Map of Function Week 15	177
FIGURE 8.6.	Schematic Diagrams of Student Concept Maps: MC	183
FIGURE 8.7.	Schematic Diagrams of Student Concept Maps: SK	184
FIGURE 8.8.	MC: Schematic Diagram of Week 9 Concept Map	185
FIGURE 8.9.	SK: Schematic Diagrams of Week 4 and Week 9 Concept Maps	186
FIGURE C.1.	MC(S2): Concept Maps Week 4 and Week 9	237
FIGURE C.2.	MC(S2): Preliminary Notes: Concept Map Week 15	238
FIGURE C.3.	MC(S2): Schematic Diagrams of Weeks 4, 9 & 15 Concept Maps	239
FIGURE C.4.	SK(S23): Concept Maps Week 4 and Week 9	240
FIGURE C.5.	SK(S23): Schematic Diagrams of Weeks 4, 9 & 15 Concept Maps	241
FIGURE C.6.	TP(S1): Concept Maps Week 4 and Week 9	242
FIGURE C.7.	TP(S1): Schematic Diagrams of Weeks 4, 9 & 15 Concept Maps	243
FIGURE C.8.	BC(S26): Concept Maps Week 4 and Week 9	244
FIGURE C.9.	BC(S26): Schematic Diagrams of Weeks 4, 9 & 15 Concept Maps	245

Acknowledgments

*The moral is it hardly need by shown,
All those who try to go it sole alone,
Too proud to be beholden for relief,
Are absolutely sure to come to grief.*
– Frost, *Moral*

The writing of this dissertation has been a challenging adventure—across seas, venturing forth to explore new vistas, making new discoveries, mathematical, visual, and musical, fulfilling long-held dreams, and at home—facing the herculean task of assembling the bits and pieces of new knowledge into the cognitive collage that is this thesis—assembled with the threads of intuition and analysis, shaped by the ambered heat of debates, and refreshed by quiet reflections down peaceful roads, alone and with colleagues and friends.

It has required a delicate juggling act—trying to balance my roles of student, observer, listener, and researcher, with those of wife, mother, teacher, friend and author. The debt of gratitude I owe to numerous friends, colleagues, and my family for their patience, support, humour and generosity is one I acknowledge but cannot hope to repay.

To my thesis advisor, Dr. David Tall—my sincere thanks and appreciation for a most remarkable four years of adventure and challenge and joy. His writings opened up the world of mathematics education research for me. His knowledge, expertise, humour, patience, and encouragement set standards of excellence and scholarship set me on journeys, intellectual and historical, which I shall long remember and which I shall try to live up to. His love of music and drama introduced me to the music of the night. May the challenges and adventures long continue!

I wish to thank Dr. Eddie Gray for his advice, insights, and critiques which proved invaluable—and inspired me to think about ways to present the data of this dissertation with greater clarity, which, it turned out, was the key to making sense of it after all.

To my colleagues and, in particular, my colleagues-in-arms, my textbook co-authors, Phil DeMarois and Darlene Whitkanack, my heart-felt gratitude for their friendship and shared knowledge. They have nourished me intellectually, encouraged me professionally, and sustained me in moments of doubt.

To Keith Schwingendorf—my thanks for introducing me to the writings of David Tall, in the rain at Allerton, and during the remaining days of the conference.

I owe much gratitude to the students who have participated in this research study. They gave generously of their time and of themselves. They were wonderful teachers and supportive partners in this research.

Finally, I thank my husband, Bill, my sons, Bill, Mike, Tom, and John, and my extended family, including Jennifer, Laura, Debbie, and Molly, for their love, patience, and support. This thesis would never have been completed without their generosity and friendship. They are my compass—as I went forth on my adventures, constructing new cognitive collages of thoughts, caught up in the plethora of details, deadlines, and tasks yet-to-be-done—they were always there, patient witnesses to what *really* matters most in life—love, friendship, and shared visions.

Dedication:

Robert B. Davis

Robert Davis' work and writings have focused for more than twenty years on two objectives: trying to improve instructional programs in mathematics and attempting to build an abstract model of human mathematical thought. His writings, particularly *Learning Mathematics: The Cognitive Science Approach to Mathematics Education*, have been a major influence, shaping my theoretical perspective and goals as a classroom teacher, curriculum developer, and researcher. His writings have contributed to my intellectual growth and understanding of fundamental issues in the learning and teaching of mathematics. Bob lived his beliefs—and spent his lifetime working to solve the novel, difficult problems of meeting the social and human needs of students. As a teacher, he shared his vision and wisdom, offering us problems and challenges that aroused our interest. Each of us who was privileged to know him has our own cognitive collages of uniquely wonderful memories of Bob. I am grateful for his friendship, encouragement, and generosity of spirit over the years and consider myself privileged to have known him—to have been able to exchange ideas, share a meal or two, and plan future projects with him. In the past few years, Bob's writings reflected his concern about the growing polarization reflected in the paradigm differences that presently divide those concerned with the learning and teaching of mathematics. Characteristically, his concern was tempered by his optimism and hope for the future. It seems only fitting that a man who spent his life finding ways to gently challenge his students and colleagues has left us yet another problem to focus our energies on:

Speaking personally, I hope we will pay far more attention in this new era to the paradigm differences that divide those of us who are concerned with the learning and teaching of mathematics. These differences exist, they are extreme, and if we ignore them we shall balkanize an area of intellectual activity that deserves better.

It is to the memory of Robert B. Davis that I dedicate this thesis—a cognitive collage shaped by his ideas and vision—an attempt to take up his challenge.

Declaration

I declare that the material in this thesis has not been previously presented for any degree at any university. I further declare that the research presented in this thesis is my unaided work. The summarized results of the field study quantitative data summarized in Chapter 5 are an expanded version of a paper published in the *British Society for Research into Learning Mathematics 1995 Conference Proceedings*, written with Phil DeMarois and Carole Bernett.

Summary

The fragmentation of strategies that distinguishes the more successful elementary grade students from those least successful has been documented previously. This study investigated whether this phenomenon of divergence and fragmentation of strategies would occur among undergraduate students enrolled in a remedial algebra course. Twenty-six undergraduate students enrolled in a remedial algebra course used a reform curriculum, with the concept of function as an organizing lens and graphing calculators during the 1997 fall semester. These students could be characterized as “victims of the proceptual divide,” constrained by inflexible strategies and by prior procedural learning and/or teaching. In addition to investigating whether divergence and fragmentation of strategies would occur among a population assumed to be relatively homogeneous, the other major focus of this study was to investigate whether students who are more successful construct, organize, and restructure knowledge in ways that are qualitatively different from the processes utilized by those who are least successful. It was assumed that, though these cognitive structures are not directly knowable, it would be possible to document the ways in which students construct knowledge and reorganize their existing cognitive structures.

Data reported in this study were interpreted within a multi-dimensional framework based on cognitive, sociocultural, and biological theories of conceptual development, using selected insights representative of the overall results of the broad data collection. In an effort to minimize the extent of researcher inferences concerning cognitive processes and to support the validity of the findings, several types of triangulation were used, including data, method, and theoretical triangulation. Profiles of the students characterized as most successful and least successful were developed. Analyses of the triangulated data revealed a divergence in performance and qualitatively different strategies used by students who were most successful compared with students who were least successful.

The most successful students demonstrated significant improvement and growth in their ability to think flexibly to interpret ambiguous notation, switch their train of thought from a direct process to the reverse process, and to translate among various representations. They also curtailed their reasoning in a relatively short period of time. Students who were least successful showed little, if any, improvement during the semester. They demonstrated less flexible strategies, few changes in attitudes, and almost no difference in their choice of tools. Despite many opportunities for additional practice, the least successful were unable to reconstruct previously learned inappropriate schemas. Students’ concept maps and schematic diagrams of those maps revealed that most successful students organized the bits and pieces of new knowledge into a basic cognitive structure that remained relatively stable over time. New knowledge was assimilated into or added onto this basic structure, which gradually increased in complexity and richness. Students who are least successful constructed cognitive structures which were subsequently replaced by new, differently organized structures which lacked complexity and essential linkages to other related concepts and procedures. The bits and pieces of knowledge previously assembled were generally discarded and replaced with new bits and pieces in a new, differently organized structure.

*Say something to us we can learn
By heart and when alone repeat.
Say something!...
Use language we can comprehend.
Tell us what elements you blend...*

– Robert Frost, *Choose Something Like a Star*

1.1 Introduction

There is a group of students who have not been the subject of much research to date, those who enroll in undergraduate institutions under-prepared for college level mathematics course work. Remedial (also referred to as “developmental”) courses at U.S. colleges and universities are a filter which blocks many students from attaining their educational goals. These students pay college tuition for courses they have taken previously in high school and which do not count for credit towards graduation at most colleges and universities. These courses move along at a pace which many students find impossible to maintain. During each term and in each course, some students succeed, others fail. Dropout rates as high as 50% in the traditional developmental courses have been cited [Hillel, et. al., 1992]. Already over-taxed algebraic skills, combined with time constraints due to unrealistic commitments of full-time enrollment (12 semester hours) and 15 or more hours of outside employment per week on the part of many of these students doom them to yet another unsuccessful mathematical experience. Historically, at the community college of this study, less than 15% of students who initially enroll in a traditional introductory algebra course complete a mathematics course that satisfies general education graduation and/or transfer requirements within four semesters of their enrollment in the developmental program [McGowen, DeMarois, and Bernett, 1995].

1.2 Background and Statement of the Problem

For the most part, students who enroll in the developmental courses could be characterized as victims of “*the proceptual divide*” described by Gray and Tall [1994]. These students have experienced mathematics which “places too great a cognitive

strain, either through failure to compress (knowledge) or failure to make appropriate links.” They have resorted to the “more primitive method of routinizing sequences of activities—rote learning of procedural knowledge” [Tall, 1994, p 6].

It is not uncommon for the students enrolled in undergraduate remedial mathematics courses to be left with feelings of failure and a belief that mathematics is irrelevant. For these students, mathematics inspires fear, not awe, discouragement, not jubilation, and a sense of hopelessness, not amazement. Why is it that mathematics proves to be so difficult for so many students who attempt rigorous mathematics courses and that they do not succeed? Even many of those who complete three or four years of “rigorous” high school mathematics are unsuccessful in subsequent college-level mathematics courses—only 27 percent of students who enroll in college complete four years, despite the fact that 68 percent of incoming freshman at four-year colleges and universities had taken four years of mathematics in high school [National Center for Education Statistics, 1997].

Many parents, students, and instructors of mathematics believe that there are students “who cannot do mathematics.” At a time when our classes increasingly are filled with students that many dismiss as incapable of learning mathematics, we are reminded of Krutetskii’s perspective. Thirty-six years ago, in a book for parents, Krutetskii wrote in support of the case of mathematics for all:

...generally speaking, the discussion cannot be about the absence of any ability in mathematics, but must be about the lack of development of this ability...Absolute incapability in mathematics (a sort of “mathematical blindness”) does not exist... [Krutetskii, 1969a, Vol. II, p. 122].

His description of children’s difficulties in learning mathematics also describes the undergraduate students enrolled in developmental algebra courses and the reasons why they are in our remedial courses. He reminds us:

Don’t make a hasty conclusion about the incapacity of children in mathematics on the basis of the fact that they are not successful in this subject. First,...clarify the reason for their lack of success. In the majority of cases, it turns out to be not lack of talent, but a deficiency of knowledge, laziness, a negative attitude toward mathematics, the absence of interest in mathematics, conflict with the teacher, or some other reason, having little to do with ability. Success in removing these causes may bring about great success on the part of the student in mathematics. A common reason for apparent “incapability” in the study of mathematics is that the student does not believe in his abilities as

a result of a series of failures [Ibid., p. 122].

The failure to develop various components of the structure of mathematical abilities identified by Krutetskii are also causes of students' lack of success in addition to the reasons cited. These include the failure to:

- think flexibly;
- develop conceptual links between and among related concepts;
- curtail reasoning;
- generalize;
- modify improper stereotyped learning strategies.

I would add the following which the results of this study suggest underlie and contribute to students' lack of success, in addition to those already cited:

- the qualitatively different ways of constructing and organizing new knowledge and the restructuring of existing cognitive structures;
- inadequate categorization and information-processing skills.

1.3 What skills, when, and for whom?

For many instructors whose teaching responsibilities include large numbers of these students, the question of "What mathematics, when, and for whom?" is the subject of much concern in recent years and is increasingly in need of a response from the mathematics community. Many students do not have as their objective the development of advanced mathematical thinking [e.g in the sense of Tall, 1991a], particularly those who are enrolled in undergraduate developmental mathematics programs. Certainly, for those students who intend to enroll in courses in which they are expected to make the transition to advanced mathematical thinking, a necessary prerequisite is the development of an object-oriented perspective and a high level of manipulative competency [Beth and Piaget, 1966; Dubinsky, 1991; Breidenbach et al., 1992; Cottrill et al., 1996; Sfard, 1995, 1992; Sfard & Linchevski, 1994; Cuoco, 1994; Tall, 1995a].

Undergraduate calculus enrollment in the U.S. has declined 20% in the past five years and increased enrollments in relatively the same percentages in statistics and teacher preparation courses have been reported [Loftsgaarden, et al., 1997]. Given

these facts, how appropriately is the present curriculum aligned with the needs of our students? To what degree is the development of an object-oriented perspective necessary for those students who do not have as their goal advanced mathematical thinking; who do not intend to enroll in the calculus course sequence appropriate for future engineers, for those intending to major in mathematics, and for others who need math-intensive programs?

1.3.1 A “Splintered Vision”

Competing visions of what mathematics students should learn have polarized mathematics practitioners and educators, students, their parents, and the community at large. Robert Davis described the position in which we trap students: “There is at present a tug of war going on in education between a ‘drill and practice and back to basics’ orientation that focuses primarily on memorizing mathematics as meaningless rote algorithms vs. an approach based upon understanding and making creative use of mathematics” [Davis, 1996, personal communication].

These conflicting beliefs and practices were recently cited and the current U.S. mathematics curriculum described as unfocused, “a splintered vision” [Beaton, et. al., 1997]. They are reflected in our mathematics curricular intentions, textbooks, and teacher practices. In comparison to other countries, the U.S. “adds many topics to its mathematics and science curriculum at early grades and tends to keep them in the curriculum longer than other countries do. The result is a curriculum that superficially covers the same topics year after year—a breadth rather than a depth approach.” Does this current splintered vision of mathematics really serve the best interests of mathematicians, teachers, students, and the public?

A need for a different vision was argued by Whitehead, who offered the following scathing indictment of algebra as traditionally taught in many classrooms:

Elementary mathematics... must be purged of every element which can only be justified by reference to a more prolonged course of study. There can be nothing more destructive of true education than to spend long hours in the acquirement of ideas and methods that lead nowhere....[The] elements of mathematics should be treated as the study of fundamental ideas, the importance of which the student can immediately appreciate;...every proposition and method which cannot pass this test, however important for a more advance study, should be ruthlessly cut out. The solution I am urging is to eradicate the fatal disconnection of topics which kills the vitality of our mod-

ern curriculum. There is only one subject matter, and that is Life in all its manifestations. Instead of this single unity, we offer children Algebra, from which nothing follows...

– Alfred North Whitehead, 1957

The different vision of Algebra called for by Whitehead is still a subject of contention and debate more than sixty years later. Algebra, as envisioned by the U.S. Department of Education, is an essential component of the school curriculum, not a subject which should be eliminated from the curriculum. Recent papers presented at the Algebra Initiative Colloquium set forth principles to guide algebra reform:

- Algebra must be part of a larger curriculum that involves creating, representing, understanding, and applying quantitative relationships.
- The algebra curriculum should be organized around the concept of function (expressed as patterns and regularity).
- New modes of representation need to complement the traditional numerical and symbolic forms.
- Algebraic thinking, which embodies the construction and representation of patterns and regularities, deliberate generalization, and most important, active exploration and conjecture, must be reflected throughout the curriculum across many grade levels.

– The Algebra Initiative Colloquium, 1995

Though the National Council of Teachers of Mathematics proposes the standard “Algebra for All,” the *NCTM Curriculum and Evaluation Standards* [1989] fail to clarify what algebra concepts and skills all students should be expected to learn. What do we really mean by “Algebra for All?” In our efforts to make mathematics accessible and attractive to a large number of students, are we, as Al Cuoco worries, “changing the very definition of mathematics?” [Cuoco, 1995].

Terms whose meanings were once commonly understood by those engaged in the practices of mathematics now have different meanings and serve as flashpoints for increasingly vehement discourse. Dialogue based on a common language and definitions has become extremely difficult. As Humpty Dumpty pointed out to Alice in *Through the Looking Glass*: “You see, it’s like a portmanteau—there are two meanings packed up into one word.” In the absence of mutually agreed-to definitions and

accepted meanings, the debate continues among those who favor a “return to basics” and those who are attempting to implement reforms into the teaching and learning of school mathematics, with increasingly high costs for all. Our vision has not only become fragmented, but clouded by emotion. Witness the on-going saga in California where efforts to establish a set of statewide mathematics standards have generated contentious debate and vehemence on both sides. In, 1997, the California State Board of Education revised the K–7 mathematics standards their own appointed commission had worked more than a year to develop. At the heart of the debate is how much emphasis to put on fundamentals such as memorizing multiplication tables and formulas. Appointed Standards commissioners, along with those who support reform initiatives argue that the State Board revisions shifts the focus to a back-to-basics computational approach.

The U.S. government strongly supports the idea of “Algebra for All.” Several recent papers written by staff of the U.S. Department of Education and by U.S. Secretary of Education Richard Riley advocate taking more mathematics courses in high school [National Center for Education Statistics (NCES), 1997]. These documents offer evidence to support the claim that U.S. students wait too long to take Algebra. The assumption that algebra is the key to well-paying jobs and a competitive work force however is challenged by many who claim they succeeded without needing to take Algebra. It requires greater efforts on the part of mathematically-knowledgeable observers to support this assertion with more data and to disseminate the results to the public, as well as to those who teach mathematics in classrooms.

The extent to which problem-solving skills and the use of symbols to mathematize situations are recognized in the workplace frequently go unnoticed by employers as well as by employees [National Center for Education Statistics, 1997]. School mathematics, and algebra in particular, are seen by many as irrelevant, except as a barrier to be gotten past and then forgotten. We urgently need to address the question: What mathematics do we want students to learn? A clearer understanding of the differences and needs of the individual students in our classes must be taken into account in our curricular design and instructional practices. Current practices result in our “building Alban houses with windows shut down so close” some students’ spirits cannot see [Dickinson, 1950].

1.3.2 Flexible Thinking: Interpreting Mathematical Notation

The difficulty facing instructors of remedial undergraduate courses is that of clarifying the reasons for the student's previous lack of success and identifying what precisely is lacking in an individual student's development. Preliminary studies confirmed that one of the difficulties students experience in developmental algebra courses is that of interpreting mathematical notation. They have not learned to distinguish the subtle differences symbols play in the context of various mathematical expressions. What do students think about when they encounter function notation, the minus symbol, or other ambiguous mathematical notation? What are they prepared to notice?

1.4 Theoretical framework

This research is situated within the theoretical framework of current research that suggests that the development of new knowledge begins with perception of objects in our physical environment and/or actions upon those objects [Piaget, 1972; Skemp, 1971, 1987; Davis, 1984; Dubinsky & Harel, 1992; Sfard, 1991, Sfard & Linchevski, 1994; Tall, 1995a]. Perceptions of objects leads to classification, first into collections, then into networks of local hierarchies. Actions on objects lead to the use of symbols both as processes *to do* things and as concepts *to think about*. The notion of *procept*, i.e., "symbolism that inherently represents the amalgam of process/concept ambiguity" was hypothesized by Gray and Tall to explain the divergence and qualitatively different kind of mathematical thought evidenced by more able thinkers compared to the less able [Gray and Tall, 1991a, p. 116].

1.5 Thesis

It is hypothesized that (i) divergence and fragmentation of strategies occur between students of a undergraduate population of students who have demonstrated a lack of competence and/or failure in their previous mathematics courses. In order to explain *why* this phenomenon occurs, it is also hypothesized that (ii) successful students construct, organize, and reconstruct their knowledge in ways that are qualitatively different from those of students least successful and that *how* knowledge is structured and organized determines the extent to which a student is able to think flexibly and make appropriate connections. The inability to think flexibly leads to a frag-

mentation in students' strategies with resulting divergence between those who succeed and those who do not. These processes of construction, organization, and reconstruction are constrained by a student's initial perception(s) and the categorization of those perceptions which cue selection and retrieval of a schema that directs subsequent actions and thoughts.

1.6 Research questions

A divergence of performance and fragmentation of strategies in elementary grade classrooms have been reported in Russian studies [Krutetskii, 1976, 1969a, 1969b, 1969c, 1969d; Dubrovina, 1992a, 1992b; and Shapiro, 1992] and in the studies of Gray and Tall [1994, 1993, 1992, 1991b, 1991c], and Gray, Tall, and Pitta [1997]. This study investigated the nature of the processes of knowledge construction, organization, and reconstruction and the consequences of these processes for undergraduate students enrolled in a remedial algebra course. Strategies students employed in their efforts to interpret and use ambiguous mathematical notation and their ability to translate among various representational forms of functions were also subjects of study. Given a population of undergraduate students who have already demonstrated a lack of competence or failure previously, the main research questions addressed are:

- does divergence and fragmentation of strategies occur among undergraduate students enrolled in a remedial algebra course who have previously been unsuccessful in mathematics?
- do students who are more successful construct, organize, and restructure knowledge in ways that are qualitatively different from the processes utilized by those who are least successful?

Related questions addressed students' ability to think flexibly, recognize the role of context when interpreting ambiguous notation, and develop greater confidence and a more positive attitude towards mathematics. The study examined whether students classified as 'less able' and/or 'remedial,' could, with suitable curriculum:

- demonstrate improved capabilities in dealing flexibly and consistently with ambiguous notation and various representations of functions?
- develop greater confidence and a more positive attitude towards mathematics?

1.7 Design and Methodology

One aim of this research was to extend the classroom teaching experiment [Steffe & Cobb, 1988; Steffe, von Glaserfeld, Richards and Cobb, 1983; Confrey, 1995, 1993, 1992; Thompson, 1996; 1995] to students at undergraduate institutions enrolled in a non-credit remedial algebra course. This course is prerequisite for the vast majority of U.S. college mathematics courses. The subjects of study were twenty-six students enrolled at a suburban community college in the Intermediate Algebra course. A reform curriculum was used, with a process-oriented functional approach which integrated the use of graphing calculator technology.

Research for this dissertation included two preliminary studies: a broad-based field study ($n = 237$) and a classroom-based study ($n = 18$) at the Chicago northwest suburban community college which was also the site of the main study. The quantitative field study was undertaken in order to develop a profile of undergraduate remedial students and to characterize some of the *prior variables* they bring to the course, such as their attitudes and beliefs. Classroom-based preliminary studies were conducted so that a local student profile could be developed and prior variables identified, which could be compared with those of the broader-based field study. A preliminary classroom-based qualitative study also investigated students' ability to deal with ambiguous mathematical notation.

The main study ($n=23$) included both quantitative and qualitative components. Data was collected which focused on two groups of extremes: the most successful and least successful students of those who participated in the study. Students' *concept maps*, i.e., external visual representations of a student's internal conceptual structures at a given moment in time, were used to document the processes by which the most successful and least successful students construct, organize, and reconstruct their knowledge and to provide evidence of how students integrate new concepts and skills into their existing conceptual frameworks. They also reveal the presence of inappropriate *concept images* (in the sense of Tall and Vinner, 1981) and connections.

The accumulated data reported in this study was interpreted within a multi-dimensional framework based on cognitive, sociocultural, and biological theories of conceptual development, using selected insights representative of the overall results of the broad data collection of this research. In an effort to minimize the extent of

researcher inferences concerning cognitive processes and to support the validity of the findings several types of triangulation were used, including data, method, and theoretical triangulation [Bannister et. al., 1996, p. 147]. Profiles of the students characterized as most successful and least successful were developed based on analysis and interpretation of the triangulated data.

1.8 General Conclusions

The most successful students construct and organize new knowledge and restructure their existing conceptual structures in ways that are qualitatively different from those of the least successful students. The divergence and fragmentation of strategies over time of undergraduate remedial students were documented, both quantitatively and qualitatively. Qualitative differences were found that suggest that the most successful students:

- experienced growth in understanding and in competence to a far greater extent than did the least successful, who experienced almost no growth in understanding or improvement in their mathematical abilities.
- constructed and organized new knowledge into a basic cognitive structure that remained relatively stable over time.
- assimilated new bits and pieces of knowledge into this basic structure, generally enriching the existing structure(s) and by accommodation which resulted in a restructuring of existing cognitive structures over time.
- focused on qualitatively different features of perceived representations than did the least successful students.
- used classification schemes which were qualitatively different from those used by the least successful students.
- improved in their ability to deal flexibly with the ambiguity of notation.
- improved in their ability to translate among various representations of functions during the semester.
- improved in their ability to reverse their train of thought from a direct process to its reverse process.
- demonstrated an ability to curtail reasoning in a relatively short period of time.

- exhibited a consistency of performance in handling a variety of conceptual and procedural tasks stated in several different formats and contexts, using various representational forms.
- were able to demonstrate they had developed *relational* understanding, i.e., they were able to make connections with an existing schema which resulted in a changed mental state which gave them a degree of control over the situation not previously demonstrated, accompanied by a change in feeling from insecurity to confidence.

Least successful students, on the other hand

- replaced their existing cognitive structures with new structures. They retained few, if any of the bits and pieces of knowledge previously assembled in the new, differently organized structure.
- were constrained by their inefficient ways of structuring their knowledge and inflexible thinking. Caught in a procedural system in which they were faced with increasingly more complex procedures, they increasingly experienced frustration and cognitive overload.
- demonstrated a lack of appropriate connections which contributed to their inability to flexibly recall and select appropriate procedures, even when they had these procedures available to them.
- were unable to curtail their reasoning within the time span of the semester in many instances.
- were inconsistent in handling a variety of conceptual and procedural tasks stated in several different formats and contexts, using various representational forms.

Other findings indicate that:

- the initial focus of attention cues the selection of different cognitive units and retrieval of different schemas by the two groups of students of the extremes.
- there were generally positive changes in nearly all students' beliefs about their ability to interpret mathematical notation, interpret and analyze data, and to solve a problem not seen previously. There was also a positive change in attitude about the use of the graphing calculator to better understand the mathematics and in the willingness to attempt a problem not seen previously.

1.9 Thesis Organization

This thesis consists of nine chapters, a bibliography, and appendices.

Chapter 1 contains an overview of the thesis and includes: a brief introduction and background description; a statement of the problem; a brief description of the theoretical framework on which the study is based; the thesis and the main research questions; an overview of the methodology and design of the study; and a summary of the conclusions. This synopsis of the dissertation concludes the chapter.

Chapter 2 is a general literature review. The main research topics reviewed include: the nature of cognitive structures and their organization; the processes of knowledge construction; relevant theories of cognitive development, issues of representation, and current issues of knowledge acquisition.

Chapter 3 describes the researcher's theoretical perspective and how this perspective is situated among past and current research. A theoretical model of the processes of knowledge construction is presented, situated among other major models previously developed, together with the main theses and research questions. A rationale for the use of concept maps and corresponding schematic diagrams as tools of analysis to document the nature of students' processes of construction, assimilation, and accommodation is presented.

Chapter 4 describes the methodology and key components of the methods used to collect and analyze the data reported in this study. The methodology and methods employed in this study are situated within the theoretical framework of constructivist extended teaching experiments adapted to the study of undergraduate students enrolled in a remedial Intermediate Algebra course.

Chapter 5 describes the preliminary studies. A description of the subjects of the study, the instruments used, a summary of the data, and observations resulting from the analysis of the data are presented. The preliminary studies include a broad-based field study, a local, classroom-based quantitative study and a qualitative classroom study which examined students' difficulties interpreting ambiguous notation and in reconstructing their existing concept images. The chapter concludes with a summary of and conclusion about the findings of the preliminary studies. Modifications made in the data collection instruments and methods of analysis prior to undertaking the main study are described.

Chapter 6 begins with an overview of the main study and statement of the first thesis to be addressed. Quantitative and qualitative studies are described which examined the thesis:

Thesis I: Fragmentation of strategies and divergence of performance occur among undergraduate students enrolled in a remedial algebra course who have previously been unsuccessful in mathematics.

The research question related to this thesis is addressed:

Question I: Does a fragmentation of strategies and resulting divergence of performance occur among students of an already stratified population of undergraduate students who have previously been unsuccessful in mathematics?

Two other questions related to this thesis are also addressed in *Chapter 6*. Do students classified as ‘less able’ and/or ‘remedial,’ with suitable curriculum:

- demonstrate improved capabilities in dealing flexibly and consistently with ambiguous notation and various representations of functions?
- develop greater confidence and a more positive attitude towards mathematics?

Results of the main study quantitative surveys are reported and analyzed. They are used to establish a student profile which includes identification of prior variables, situating the findings of this study within the context of the field and preliminary studies. The results of the qualitative component which document the divergence and fragmentation of strategies that occurred during the semester between the two groups of extremes (the most successful and the least successful) are presented. The findings are interpreted, using the theoretical framework described in *Chapter 3*. Modifications of the preliminary instruments prior to the main study which were described previously in *Chapter 5* are reviewed briefly, where appropriate.

Chapter 7 describes the qualitative component of the main study which investigated the nature of students’ processes of construction. Two students who are representative of the extremes of the class of students who participated in the study are profiled. For each of the two typical students, a brief description of the student’s background is given, followed by an analysis of each student’s mathematical growth during

the semester. The divergence in performance and use of strategies are reported. The second main thesis question is examined:

Thesis II: Successful students construct, organize, and reconstruct their knowledge in ways that are qualitatively different from those of students least successful. How students structure and organize knowledge determines the extent to which a student is able to think flexibly and make appropriate connections. These processes of construction, organization, and reconstruction are constrained by a student's initial perception(s) and the categorization of those perceptions which cue selection and retrieval of a schema that directs subsequent actions and thoughts.

Chapter 8 continues the examination of this thesis. The processes of knowledge construction, organization and reconstruction of the two representative students are analyzed. Data which suggests the extent to which these processes are constrained by a student's initial perception(s) and the categorization of those perceptions are reported and the second main research question is addressed:

Question II: Do successful students construct, organize, and reconstruct their knowledge in ways that are qualitatively different from the processes utilized by those least successful?

Concept maps constructed by students and the corresponding schematic diagrams prepared by the researcher are presented, together with analyses of the data and are offered as evidence in support of the thesis.

Chapter 9 summarizes the findings of the study and describes the researcher's conclusions and reflections. An overview of other theoretical perspectives that hold promise for informing on-going efforts in mathematics education research and suggest possible new directions and frameworks for future studies is presented. Strengths and weaknesses of the research design used in this study are also discussed.

A Bibliography of References and Appendices follow Chapter 9.

*Everything has been thought of before;
the task is to think of it again in ways
that are appropriate to one's current circumstances.*

—Attributed to Goethe

2.1 Introduction

Students who enroll in our undergraduate institutions under-prepared for college level mathematics course work have not been the subject of much research to date. Most of the research on cognitive development has had as its focus students in grades K–6 [Piaget, 1972; Steffe et. al., 1983; Davis, 1984; Gray, 1991; Gray & Tall, 1994] or students in grades 6–12 [Confrey, 1991, 1993; Davis, 1984; Sfard, 1991; Kieran, 1993, 1992; Heid, 1989; Tall & Thomas, 1991; Thompson, 1994a]; or undergraduate students enrolled in Calculus or other advanced mathematics courses [Dubinsky, 1991; Frid, 1994; Ferrini-Mundy & Graham, 1994; Tall, 1995, 1991c]. Students enrolled in remedial programs constitute a substantial part of undergraduate enrollment at many U.S. colleges and universities. Unfortunately, this population continues to grow. The 1995 Conference Board of Mathematical Sciences [CBMS] Survey of Undergraduate Programs [Loftsgaarden et al., 1997] reports that 800,000 students studying mathematics in two-year college mathematics programs were enrolled in developmental courses, (i.e., remedial courses: Arithmetic, Beginning Algebra, Intermediate Algebra, Geometry). These students constitute 53% of total mathematics enrollment, a 10% increase since the 1990 CBMS survey. At four-year colleges and universities, 222,000 students were enrolled in undergraduate remedial mathematics courses in 1995 (15% of the total undergraduate mathematics course enrollment). Together, these populations constitute nearly one-third of the combined total of 3.2 million undergraduate mathematics course enrollments, a not insignificant portion of the teaching load of many college mathematics departments.

This study focused on the conceptual development of undergraduates enrolled in remedial algebra courses. Skemp's theory of intelligence [1971, 1987], Davis' [1984] general theory of mathematical thinking, and Gray & Tall's [1994, 1991d]

notions of *procent* and *proceptual divide* were major influences in the development

of the theoretical framework described in Chapter 3. These theories have a common characteristic: they are all based on the belief that an individual's knowledge representations in the mind are characterized as structured and connected in some manner, not merely a collection of isolated facts. These theories are reviewed, along with a number of other theories which offer insights into how knowledge is represented in the mind. Theorists who operate within this framework attempt to account for the experiential aspect of cognition, focusing on cognition from the point of view of the cognizing subject.

Theories of cognitive development which influenced this study include those which postulate a process-object construction of knowledge and the conceptual structures that result from these construction processes [Piaget, 1950; Dienes, 1960; Davis, 1975, 1984; Skemp, 1979; Greeno, 1983; Rumelhart & Norman, 1978, 1981; Dubinsky, 1991; Sfard, 1991, 1994; Gray and Tall, 1994; Tall, 1995]. Other literature relevant to this thesis is also reviewed, including theories which do not reflect the perspectives of those already cited, but rather reflect an evolutionary perspective of the brain [Dehaene, 1997; Edelman, 1992]; theories of distributed intelligence [Pea, 1993; Salomon, 1993]; epistemological pluralism [Papert & Turkle, 1992]; and socio-cultural theories developed in the Vygotskian tradition, including those of Cobb, Bauersfeld, & Yaekel [1995] and Lave [1988].

2.2 The Nature of Knowledge Construction and Representation

Current research suggests that the development of new knowledge begins with perception of objects in our physical environment and/or actions upon those objects. In the process of developing understanding, various knowledge representation structures are created [Piaget, 1970]. The literature is replete with the use of terms such as concept, concept image, and schemas to describe these conceptual structures. A *concept* has been defined by Skemp as the end product of abstracting which requires for its formation a number of experiences which have something in common [Skemp, 1987, p. 11]. Tall and Vinner introduced the term *concept image* to describe "the total cognitive structure that is associated with the concept, which includes all the mental pictures and associated properties and processes" [Tall & Vinner, 1981, p. 152]. Barnard & Tall [1997] postulated the existence of *cognitive units*, pieces of cognitive structure that can

be held in the focus of attention all at one time, in which inessential details are suppressed to manageable levels by the multi-processing system of the brain. They argue that these cognitive units can be expanded or compressed and refined into concept images. The term *schema* generally is understood to mean concept images that are refined and restructured into a more complex, stable structure [Skemp, 1971, 1987; Tall & Vinner, 1981; Dubinsky, 1991; Tall, 1994, 1995; Thompson, 1994] or *frames* that are retrievable when needed [Davis, 1984]. Skemp defined a *schema* as a conceptual structure with its own name that has, beyond the separate properties of its individual concepts, three functions: it integrates existing knowledge, it acts as a tool for future learning and it makes possible understanding [Skemp, 1987, p. 24].

In a constructivist approach, students are assumed to construct their own conceptual understandings as they participate in cultural practices, frequently while interacting with others. A constructivist perspective holds that understandings are not built up of received pieces of knowledge but are the products of previous acts of construction. The restructuring of previously built structures is synonymous with the Piagetian notion of accommodation or conceptual change, a process which becomes the content in subsequent constructions as knowledge is actively built up by the cognizing subject [von Glaserfeld, 1989]. Ernest summarized this perspective when he wrote: "Knowing is active, it is individual, and personal, and it is based on previously-constructed knowledge" [Ernest, 1996, p. 338].

2.3 Conceptual Structures

What are the ways in which new knowledge is assembled, organized and restructured? What might these processes of knowledge construction look like and how do we recognize them? Are the bits and pieces of knowledge assembled into different cognitive structures for students who are successful compared with the cognitive structures assembled by less able students? Since these questions have a direct bearing on the present research, a review of the theories of Skemp, Davis, Gray and Tall, which postulate conceptual structures together with the relationships hypothesized to exist between these structures, provide a framework within which to interpret the data collected in this study.

Davis [1984, 1996] has argued for a postulated general theory of mathematical thinking of how the human mind can deal with the wholeness of knowledge, and not see everything as a large collection of very small pieces (in the way too many curricula do). He postulated that “there has to be some sort of knowledge representation structure. One cannot think about a problem without some mental representation of the problem, and one cannot make use of a piece of knowledge without some representation for that knowledge. One needs, then, a representation of the problem situation, and a (separate) representation of relevant knowledge. The representation of the problem situation will often need to be built up gradually by successive approximations” [Davis, 1984, p. 294]. He uses the term “assembly” as a technical term to describe how a new piece of knowledge representation structure is built up using bits and pieces of previously synthesized knowledge representation structures.

Davis believed that “when we know something we know it metaphorically.... We use a metaphor in order to represent some piece of knowledge within our own minds. Quite apart from sharing any ideas with anyone else, we use metaphors within our own minds in order to be able to think” [Davis, 1984, p. 178]. He thought of a complex network of schemas, concept images, and cognitive units metaphorically as a *cognitive collage*, uniquely and dynamically constructed over time as new knowledge is added to and synthesized into one’s existing network of knowledge representation structures. In describing how a piece of knowledge is represented in the mind, he wrote: “a single ‘piece of knowledge’ in the mind is, in fact, the cognitive equivalent of a collage, a ‘chunk’ made up of bits and pieces that were lying around and available as building material---with a little bit of added construction or adjustment where necessary” [Davis, 1984, p 154].

Dörfler uses the terms “mind” and “cognition” interchangeably, which he views metaphorically:

...as a kind of space that can contain something and that can be structured. As the product of so-called cognitive or mental constructions in that mental space, mental objects originate or are produced. These mental objects then can be manipulated, transformed, combined, and so on with a kind of mental operation. And, even more importantly, the mental objects are representatives or replicas of so-called mathematical objects. This means they have properties and behave as the mathematical objects do. [Dörfler, 1996, p. 467].

Knowledge conceived of as a connected web of local hierarchies has been described metaphorically by other researchers. Hiebert & Carpenter are in agreement with Davis's claim that, in order to think about mathematical ideas, they must be represented in some way internally [Hiebert & Carpenter, 1992; p. 66]. They hypothesized that internal representations can be connected; these connections can only be inferred; internal representations are influenced by external activity; and connections between internal representations can be stimulated by connections that are constructed between corresponding external representations. Once constructed, the relationships between internal representations would produce networks of knowledge:

The notion of connected representations of knowledge...provides a useful way to think about understanding mathematics...it provides a level of analysis that makes contact with both theoretical cognitive issues and practical educational issues; it generates a coherent framework for connecting a variety of issues in mathematics teaching and learning, and it suggests interpretations of students' learning that help to explain their successes and failures [Hiebert & Carpenter, 1992, p 67].

Like Davis, Hiebert and Carpenter use metaphors to think about and communicate their ideas about networks of knowledge. Metaphorically, networks of connected internal representations are structured in local hierarchies, with some representations subsumed by other representations, with special cases examples of details and generalizations the overarching representations. A network of internal representations of knowledge is thought of as a spider web:

The junctures, or nodes, can be thought of as the pieces of represented information, and the threads between them as the connections or relationships. All nodes in the web are ultimately connected, making it possible to travel between them by following established connections. Some nodes, however, are connected more directly than others. The webs may be very simple, resembling linear chains, or they may be extremely complex, with many connections emanating from each node. [Hiebert & Carpenter, 1992, p. 67].

This description suggests a familiarity with the notion of semantic nets, i.e., visual re-presentations of a student's internal representations and connections between those representations. In some of the literature, semantic nets are also referred to as cognitive maps, concept maps, or just simply, webs. In fact, Hiebert and Carpenter acknowledge this familiarity, citing the extensive work on knowledge structures and

semantic nets of Chi [1978]; Geeslin & Shavelson [1975]; Greeno [1978]; Leinhardt & Smith [1985], and Quillian [1968]. The notion of semantic nets, or concept maps, is reviewed in greater depth in Section 2.7.1.

Other researchers agree that internal representations of knowledge are structured, though they do not use metaphors to describe the organization of internal knowledge representations. Rumelhart & Norman [1978, 1981] maintain that knowledge is reorganized as more and more pieces of knowledge are acquired. Hatano argues that “most, if not all, mathematics educators would agree that students’ mathematical cognition constitutes a theory-like knowledge system, that is, an organized body of knowledge” [Hatano, 1996, p. 197]. He also argues that one’s knowledge becomes richer and better organized as one gains expertise, with the reorganization of the knowledge system occurring at a number of different levels, individual to societal [Hatano, 1996, p. 202]. Tall [1992a], in describing the exponential growth of knowledge in recent years, questions how this growth is encompassed in the minds of ordinary human beings today. His response provides yet another example of the notion that knowledge is structured and that the manner in which knowledge is structured assists or constrains the development of concepts:

First it is through the use of language, that enables the communication of thought, and through written symbolism that enables the essence of this thought to be passed on from generation to generation. But what is more important still is the manner in which the underlying concepts develop and the way in which the symbolism is used to assist the development of these concepts [Tall, 1992a, p. 58].

2.3.1 *Schemas and Frames*

Skemp considers a *schema* to be “a conceptual structure stored in memory” [Skemp, 1981, p. 163]. He argues that a schema integrates existing knowledge and, even more than a concept, greatly reduces cognitive strain. He considers it as a major instrument of adaptability, “being the most effective organization of existing knowledge both for solving new problems and for acquiring new knowledge...The schema is a tool of learning” [Skemp, 1987, p. 24]. Skemp argues that inappropriate early schemas will make the assimilation of later ideas much more difficult, perhaps impossible. Tall [1992a] extends Skemp’s definition of schema to explicitly acknowledge the

dynamical functionality of schemas, defining a schema to be a coherent mental activity in the mind of an individual *that exists in time and changes over time*.

Davis [1984] postulated a very special kind of knowledge representation structure or schema, known as a “*frame*,” a fairly large knowledge representation structure that includes a considerable body of information. Davis credits Minsky [1975] with introducing the term “*frame*.” A frame can be retrieved or modified, synthesizing new information with existing general information [Davis, 1984, p.45-48]. This frame-oriented view provides an explanation as to why individual students reading (or viewing) the same information display differences in their processing of information and hence, in their learning—they have non-identical frames in memory through which the information is processed.

Davis’ notion of “*frames*” corresponds closely to that of Skemp’s notion of *schema*, although Davis claims that frames “can be explicitly identified and described as a result of observable behavior which they produce” [Davis, 1984, p. 126]. The inflexible nature of well-practiced schemas is mentioned by both Davis and Skemp, who argue that a schema can become an obstacle to adaptability. Consider the observed behavior of students who are able to demonstrate a change in performance shortly after instruction, but subsequently revert to their earlier behavior. Piaget explains this phenomenon as the lack of readiness for transition to another stage. Davis argues that it is not a lack of readiness so much as it is the existence and continued presence of earlier frames. Skemp explains the phenomenon claiming that if what is learned does not fit into an existing schema, it is rejected. It has a highly selective effect on our experience and that what does not fit into the schema is largely not learned at all.

Skemp uses the terms *schema* and *conceptual structure* interchangeably, though he claimed that the term *conceptual structure* emphasizes two qualities: its components are concepts and these are integrated, not isolated. He rejected Davis’ use of the term *frame*, claiming it was less suggestive of many of the qualities of a *schema*, particularly its organic quality and the *interiority* of its concepts; i.e., the richness of the various concepts in a network of cognitive structures and the complexity of appropriate linkages among them. Skemp points out that the term *schema* has been in use much longer, having been introduced by Bartlett [1932]. He also argued that Davis’

use of the terms “slots” or “variables” does not make the important distinction between primary and secondary concepts, nor do these terms explain the process of abstraction by which we form progressively higher order concepts. Skemp was wary of accepting information technology metaphors as explanations of human thinking, arguing that “Computers process symbols, not information. They work at the level of syntax only, not semantics” [Skemp, 1987, p. 123–125].

Davis was recently asked if “frames” could be thought of as very refined, stable cognitive collages and if this interpretation was consistent with what he intended the relationship between ‘frames’ and cognitive collages to be. In a personal communication, Davis replied:

That is EXACTLY what I meant! You are pointing out to me that I never clearly discussed the relation between what I called “collages” (a phrase I really picked up from Bob Lawler), and what I called “frames” (the name Marvin Minsky introduced)—but the relation between the two is essentially what you suggest. I presume that every frame WAS originally constructed by increments, as a collage....So, in what way is a “frame” different from any other collage? I think it is precisely what you have suggested: when a collage has been carefully shaped and trimmed into something that works really well—and perhaps when we have used it enough to recognize how well it works—then I would call it a frame. It isn't different, but it is very refined and very stable and most of the time it is very adequate. [Davis, 1997, personal communication].

Despite the different terminology, Skemp and Davis are describing the same ideas, something each acknowledged in their references to the other's work. Both developed theories of cognitive development which built on the ideas of Piaget [1970], reflecting cognitive positions that hold that knowledge is constructed by an active, knowing subject. Instruments of construction include cognitive structures such as concepts, concept images, and schemas [Skemp], or frames and cognitive collages [Davis], which are themselves products of the processes of knowledge construction.

2.3.2 Concept Images

Another cognitive structure that is an instrument of knowledge construction is that of *concept image*, an expression widely referenced in the current literature. Tall and Vinner formulated the notion of *concept image*, *i.e.* “the total cognitive structure that is associated with the concept, which includes all the mental pictures and associated properties and processes” to explain the phenomenon that many concepts met in

mathematics have been encountered in some form or other before they are formally defined [Tall & Vinner, 1981]. As a consequence of these previous encounters, complex cognitive structures are created which yield a variety of images unique to an individual when the concept is invoked. The distinction arose as a way to understand the reasoning expressed by students which was inconsistent with mathematical definitions they were taught.

Thompson reaffirms Tall & Vinner's notion of concept image, focusing on the dynamics of mental operations; reminding us that "a person's actual images can be drawn from many sources and that an individual's concept images will be highly idiosyncratic:

By "image" I mean much more than a mental picture. Rather I have in mind an image as being constituted by experiential fragments from kinaesthesia, proprioception, smell, touch, taste, vision, or hearing. It seems essential also to include the possibility that images entail fragments of past affective experiences, such as fearing, enjoying, or puzzling, and fragments of past cognitive experiences, such as judging, deciding, inferring, or imagining [Thompson, 1996, pp. 267-268].

Writing about the role of imagery in his analysis of students' concepts of speed and acceleration, Thompson describes how he made sense of what he observed while interacting with the students. His concepts of students' mental operation and mental images were given meaning in the context of working with the students. He imputed his concepts of their mental operations and images to the students to explain their reasoning.

Thompson [1996] argues that the role imagery plays in mathematical activity evolves as particular concepts become increasingly abstract. He portrays the construct of image as dynamic, originating in bodily actions and movements of attention, and as the source and carrier of mental operations. "Mathematical reasoning at all levels is firmly grounded in imagery;" it is drawn from many sources and is highly idiosyncratic [Thompson, 1996, pp. 267-68]. Piaget's distinctions between three types of images are interpreted by Thompson to mean (a) images associated with the creation of objects; (b) images which contribute to the building of understanding and comprehension, with 'understandings-in-the-making' as contributing to ever more stable images, and (c) images that support thought experiments and reasoning by way of quantitative relationships—shaped by operations which, in turn, are constrained by the

image; nothing more than a symbol of an operation [Ibid]. Thompson argues that the predominant image evoked in students by the word function, i.e., “two written expressions separated by an equal sign” [Thompson, 1994, p. 24].

One might ask: Is a concept different from a concept image and if so, in what way(s)? In this study, using the definition of *concept* as an idea, an abstraction which requires for its formation a number of experiences which have something in common, a *named concept* is considered a notion that is widely accepted by the community, i.e., quadratic function is a concept with characteristics and properties accepted by a wide community. A *concept image* of quadratic function, used in the sense of Tall and Vinner [1981], is unique for each individual who has some understanding of the general notion of quadratic function, which may or may not include all of the characteristics and properties associated with the notion of quadratic function by the wider mathematics community.

2.3.3 Conceptual Reorganization

Piaget postulated two basic learning mechanisms for major conceptual reorganizations that occur in the course of intellectual development; *assimilation* and *accommodation*. Various researchers have interpreted these constructs to fit within their own theoretical frameworks. Steffe [1996] cites Piaget’s definition of assimilation in support of his observation that, without assimilation, there would be no learning.

Assimilation is the integration of any sort of reality into a structure. It is this assimilation which seems to me fundamental in learning, and which seems to me the fundamental relation from the point of view of pedagogical or didactic applications [Piaget, 1964, p. 18; cited in Steffe, 1996, p. 490].

Accommodation is described by Steffe as “a modification of a conceptual structure in response to a perturbation which is necessary for cognitive development to occur.” He regards a perturbation as “any disturbance in the components of an interacting system created through the functions of the system... which can activate or disequilibrate a system at rest or a system in a dynamic equilibrium” [Steffe, 1996, p. 490–491]. Steffe explains the need for the second learning mechanism, *accommodation*, based on the observation that “items produced by assimilation are constructed items” which are not fully accounted for by assimilation alone. He considers accommodation

to be a modification of an existing conceptual structure in response to a perturbation which “accounts for qualitative changes in mental or physical actions, operations, images, and schemes” [Steffe, 1996, p. 490].

Davis [1984] interprets *accommodation* not only as a modification of an existing system, but extends this Piagetian notion to include a synthesis of new knowledge representation structures. He argues that frame retrieval and frame instantiation are examples of what Piaget called “assimilation” and that an unacceptable match between perceived input(s) and a retrieved frame is a precondition for Piaget’s notion of *accommodation*:

It is easy to relate these decisions to Piaget’s concepts of *assimilation* and *accommodation*. When the judgement is made that the instantiated frame is an acceptable match to the input data, we can say that ‘assimilation’ occurs. If this judgement is that the match is unacceptable, we have a pre-conditions for ‘accommodation’ to take place, although more steps are needed before accommodation can be considered complete [Davis, 1984, p. 178].

2.4 Process-Object Theories of Cognitive Development

The development of mathematical growth is described as starting from perceptions of and actions on objects in the environment, thinking about them, and resulting in the performance of new actions upon the mental and/or physical objects [Piaget, 1970]. Tall [1995] hypothesized that there are two sequences of development of mathematical thinking beginning with object and action, and argues that these two sequences are quite distinct. He identified three components of human activity: perceptions as inputs; thought as internal processing; and actions as the outputs. Perceptions of objects leads to classification, first into collections, then into hierarchies and the beginnings of verbal deduction relating to the properties and the development of systematic verbal proof. Actions on objects lead to the use of symbols both as processes to do things and as concepts to think about.

Tall’s theory of cognitive development is situated within the literature of theories of learning and reasoning which hold that (a) intelligence is largely a property of the minds of individuals; (b) mathematical knowledge is hierarchically structured; and (c) which highlight the duality of process and concept. Piaget [1970] described the process–object duality as a development in which the process by which mathematical

entities move from one level to another and is achieved by operations on these entities, which in turn results in objects. The process repeats itself until “structures that are alternately structuring or being structured by ‘stronger’ structures “are reached.

Davis [1984] describes the cognitive shift from process to object as “achieving noun status,” saying “As a procedure is practiced, the procedure itself becomes an entity—it becomes a *thing*. It, itself, is an input or object of scrutiny” [Davis, 1984, p. 36]. Greeno [1983] discussed the notion of “conceptual entities” which could be used as inputs to other procedures. Dubinsky [1991] speaks of *encapsulation* of process as object. Sfard [1994] argues that “the operational (process-oriented) conception emerges first and that the mathematical objects (structural conceptions) develop afterward through reification of the processes.” She theorizes that the majority of mathematical notions draw their meaning from two kinds of processes: the primary processes (those from which the given notion originated), and secondary processes, (those in which the given notion serves as input). Abstract objects act as a link between these two kinds of processes and appear crucial for our understanding of the corresponding notions.

This process-object construction is accompanied by a cognitive shift from concrete to abstract thought. Process-object theories of cognitive development hypothesized by Dubinsky and Sfard identified several stages in the transition from process to object. Sfard hypothesized in addition to the two approaches to concept development (operational and structural), three stages of development: *interiorization* (processes performed on already familiar objects), *condensation* (the process is compressed into a more compact, self-contained whole which can be dealt with without necessarily considering the intermediate steps); and *reification* (the cognitive shift that converts the already condensed process into an object-like entity [Sfard, 1992, pp. 64-65].

Dubinsky [1991] and his colleagues also proposed a theory (APOS) characterized by three stages of development from action to encapsulated object: *action* (any physical or mental transformation of objects to obtain other objects), *processes* (steps can be described or reflected upon, without necessity to perform them), *object* (individual sees totality of the process, recognizes that transformations can act on it, and is able to construct the transformations. A *schema*, for Dubinsky and his colleagues, is an object, “a coherent collection of actions, processes, objects and other schemas, which

are linked in some way and brought to bear upon a problem situation.” Skemp considers existing schema as indispensable tools for the acquisition of further knowledge and argues for the organization of processes and objects into schemas, though, he does not characterize the process as one of encapsulation in the sense of Dubinsky or Sfard.

What model of cognitive development describes the students of this study? Sfard’s process-object theory, with three stages of development: interiorization, condensation, and reification, and Dubinsky’s APOS theory are hierarchical models which do not consider the roles of perception and categorization in the retrieval of schemas, nor the connectedness of ideas which are not always hierarchically organized. Kieran questions whether students must first develop process conceptions which precede object construction when technology and various representations are used [Kieran, 1993, pp. 189–237]. Kieran also raised the question of whether the learning of graphical representations of functions follow the same process-to-object sequence that has been documented in studies involving algebraic representations and set-theoretic definitions. She notes that a process conception is generally the first step in acquiring new mathematical notions and that this process approach to graphical representations might not be appropriate. “The technology-supported projects...have clearly shown that this route is not the one that has to be followed if we want to encourage students to learn to read the global features of graphs. We have choices now” [Kieran, 1993, p. 232]. In addressing Kieran’s question, Thompson wrote:

I see every reason to believe that in an individual student’s construction of function, process conceptions of function will precede object conceptions of function. What has changed because of technological advances are the kinds of experiences we can engender in the hope that students eventually create functions as objects [Thompson, 1994, p. 28].

The notion of *procept* enables us to think about different kinds of encapsulation in different contexts and to see how learners face cognitive difficulties related to symbolism [Tall, 1995]. Tall hypothesizes two sequences of development beginning with the object and action that are quite distinct. By viewing growth in elementary mathematics as a single development in the manner of a neo-Piagetian stage theory, Tall proposed an alternative theory in which two different developments occur at the same time, which can occur independently of each other.

One is visuo-spatial becoming verbal and leading to proof, the other uses symbols both as processes to do things (such as counting, addition, multiplication) and also concepts to think about (such as number, sum, product) [Tall, 1995, p. 162].

His theory explicitly takes into consideration the perception and categorization of objects in the external world, something the theories of Sfard and Dubinsky fail to do.

I find it useful to separate out three components of human activity as input (perception), internal activity (thought) and output (action)...Elementary mathematics begins with perceptions of and actions on objects in the external world. The perceived objects are at first seen as visuo-spatial gestalts, but then, as they are analyzed and their properties teased out, they are described verbally, leading in turn to classification (first into collections, then into hierarchies) [Tall, 1995, pp. 161–162].

Davis, Tall, and Thomas (in press) point out the need to focus on *both* operational processes and the properties of objects. They conclude that “focusing on both operational processes and the properties of objects...gives a *versatile* approach” [Davis, Tall, & Thomas, in press]. Dugdale considers shifts in concepts as students reorganize their ideas “to accommodate new information, apply previous ideas in different contexts, and establish interconnections to be a normal part of learning: a process of changing perceptions and evolving ideas” [Dugdale, 1993, p. 126].

2.5 What does it mean “to understand?”

Understanding is frequently characterized as connected knowledge, i.e., knowledge that includes meaningful connections [Davis, 1992a, 1986; Eisenberg & Dreyfus, 1994; Hiebert & Carpenter, 1992; Hiebert & Lefevre, 1986; Kaput, 1992a; Kaput, 1992b; Krutetskii, 1976; Skemp, 1971; Tall, 1995]. Understanding is subjective, a process by which one assimilates “something into an appropriate schema” [Piaget, 1972; Skemp, 1987, p. 29-33]. Hiebert and Carpenter define understanding in terms of whether the ideas are connected:

A mathematical idea or procedure is understood if it is part of an internal network. More specifically, the mathematics is understood if its mental representation is part of a network of representations. The degree of understanding is determined by the number and the strength of the connections. A mathematical idea, procedure, or fact is understood thoroughly if it is linked to existing networks with stronger or more numerous connections [Hiebert & Carpenter, 1992, p. 67].

They suggest that the structure of the internal representation assists or constrains the development of understanding and that an external representation is necessary in order to communicate mathematical ideas. Sierpiska [1992, 1994] makes the point that, in order to understand a concept, it is necessary to see instances and non-instances of the defined object to become aware of its relations with other concepts, noting the similarities and differences, and have grasped the applications possible. She characterizes understanding using four categories: *identification* (the ability to recognize the object within a group of objects); *discrimination* (ability to recognize similarities and differences between two distinct objects); *generalization* (which permits the extension of the object's use); and *synthesis* (implies the existence of appropriate links among objects).

The notion of understanding as the assimilation of new knowledge into an existing, appropriate schema is generally accepted among cognitive scientists, though there are those who would disagree with Hiebert & Carpenter's claim that a more thorough understanding is always reflected by more numerous connections. Tall [1995] would counter that it is not the number of connections that is significant but the nature of the connections and linkages formed. The nature of external mathematical representations influence the nature of internal representations, which, in turn influence how external mathematical representations are perceived, categorized and assimilated [Greeno, 1988; Kaput, 1989].

Skemp [1976] distinguishes two types of understanding, crediting Stieg Mellin-Olsen for bringing to his (Skemp's) attention the fact that there were two meanings of the word understanding currently in use at the time. Mellin-Olsen named the two types of understanding "relational understanding" and "instrumental understanding." Skemp initially did not regard this latter type of understanding as a form of understanding, describing it as "rules without reason." Skemp characterizes relational understanding as knowing both what to do and why [Skemp, 1976, p. 20]. He describes instrumental learning as learning an increasing number of fixed plans in which the learner is dependent upon outside guidance for learning each new plan. Relational understanding, on the other hand, consists of "building up a conceptual structure (schema) from which its possessor can (in principle) produce an unlimited number of plans for getting from any starting point within his schema to any finishing point"

[Skemp, 1976, p. 25]. Skemp distinguishes between cognitively-based skills (*automatic skill* with understanding characterized by adaptability and a well-connected schema) and well-drilled habits (*mechanical skill* or rote-learned habit with little or no adaptability and few linkages in the existing schema) [Skemp, 1987, p. 126–127].

A growing recognition of the roles of curriculum and instructional practices that promote the development of understanding as described by Skemp and encourage the formation of meaningful connections is evident in recent reform projects [Harvard Consortium Calculus Project; DeMarois, McGowen, & Whitkanack Developmental Algebra Project; the Connected Math Project; the ARISE Project, etc.] and national standards documents [National Council of Teachers of Mathematics Curriculum and Evaluation Standards, 1989; The American Mathematical Association of Two Year Colleges Crossroads Standards, 1995; The Algebra Initiative Colloquium, 1995, etc.]. Though the need to form meaningful connections among the bits and pieces of knowledge that are acquired is widely recognized, how to achieve this goal remains an open question, as much of the current literature attests [Cuoco, et. a., 1996; Cuoco, 1994; Demana, 1993; Dugdale, 1993; Gray & Tall, 1993; Kieran, 1993; Kaput, 1993; Mason, et. al., 1982; Moschkovich et al., 1993; Sfard & Linchevski, 1994; Romberg et. al., 1993; and Thompson, 1994; 1996].

2.6 Ambiguous Notation: A Need for Flexible Thinking

Davis [1984] argues that fundamental processes such as the need to recognize and resolve ambiguities need to be analyzed across a broad spectrum of mathematical topics in order to improve the odds of obtaining a reasonably representative picture of students' mental information processing. The ability to flexibly interpret and use the ambiguity of mathematical notation is necessary for successful mathematical thinking. This dual use of symbolism for both procedure and concept is found throughout mathematics. Most ambiguity in mathematics is a natural consequence of the identity or equivalence of structure that makes mathematics so powerful and utilizes this isomorphism of structure to make mathematical language and notation as brief, concise and multi-interpretable as possible.

The mathematician is untroubled by the ambiguity of mathematical notation, understanding that interpretation may vary in the course of a calculation, argument or

deduction, according to context. The student who is unaware of the existence of the duality and ambiguity cannot even attempt to develop more flexible strategies which improve his/her chances for success. Skemp claims that “symbols are magnificent servants, but bad masters, because by themselves they don’t understand what they are doing” [Skemp, 1971]. Skemp cautions that new material needs to be presented in such a way that it can always be assimilated conceptually. He defines symbolic understanding to be “the ability to connect mathematical symbolism and notation with relevant mathematical ideas” [Skemp, 1987, p. 184]. Skemp’s definition is similar to that put forth by Backhouse [1978] and by Byers and Herscovics [1977]. A symbol system is “a set of symbols corresponding to a set of concepts, together with relations between the symbols corresponding to relations between the concepts” [Skemp, 1987, p. 185].

The duality and ambiguity of mathematical notation is encountered in fields other than the mathematics classroom and research. Computer programmers and software engineers must deal unambiguously with the fact that the minus symbol can be interpreted in various ways—it is used to indicate subtraction, to indicate the process of taking the additive inverse or as the sign of a negative number. Mathematically, the first two instances can be interpreted as functional processes, the first binary and the second unary. However, in the third instance, a negative number is not a process but an object. Mathematicians and those teaching mathematics are themselves comfortable with the duality of notation. Accustomed to thinking flexibly, mathematicians and mathematics education researchers, on occasion however, fail to deal unambiguously with notation themselves. A recently published research article described an activity used in a task-based interview as follows:

The fact that $-2^{\frac{1}{2}}$ would give an imaginary number leads to a discussion of the alternative suggestions of (a) accepting complex numbers as legitimate results of exponentiation or (b) limiting the extension of exponentiation to positive bases [Borasi, 1994 p. 207].

The ambiguity of notation is cited by Skemp, who identifies position, as well as size, as components of a symbol system which contribute to students’ difficulties. The expression $-2^{\frac{1}{2}}$ requires the mutual assimilation of separate schemas, each of which has a structure of its own. Skemp points out that, if the relationship between ambiguous symbols and the conceptual structure is such that they are in equilibrium,

or in which the conceptual structure is dominant, symbols help us use the power of mathematics. If, however, the symbols dominate the conceptual system, students will become “progressively more insecure in their ability to cope with the increasing number, complexity, and abstractness of the mathematical relations they are expected to learn” [Skemp, 1987, p. 186].

It has been suggested that because of the mathematician’s desire for precision and rejection of ambiguity, we have failed to fully understand this duality and ambiguity of symbolism which gives it such flexibility, particularly in the teaching of mathematics. The cognitive obstacles faced by students who attempt to reconcile the ambiguities of notation frequently go unrecognized by their professors, particularly when these struggles occur at the college level. Thompson [1994] reminds us of the need to align our perspectives about mathematics and the learning of mathematics in order to more effectively communicate with our students:

...an instructor who fails to understand how his/her students are thinking about a situation will probably speak past their difficulties. Any symbolic talk that assumes students have an image like that of the instructor will not communicate. Students need a different kind of remediation, a remediation that orients them to construct the situation in a mathematically more appropriate way... Whatever students have in mind as they employ symbolic mathematics it often is not the situation their professors intend to capture with their symbolic mathematics [Ibid., p. 32].

2.6.1 The notions of *procept* and the “*proceptual divide*”

This phenomenon of the duality and ambiguity of mathematical notation perceived as procedure and concept has been proposed by Gray and Tall [1991a] as an explanation of an underlying cause of elementary-grade students’ success or lack of success in mathematics. Subsequently, Gray and Tall [1994] hypothesized that the ability to think flexibly in mathematics depends on the dual use of symbolism for both procedure and concept, a duality found throughout mathematics. They defined the amalgam of procedure and concept which is represented by the same notation to be a *procept*, i.e., “symbolism that inherently represents the amalgam of process/concept ambiguity” to explain the divergence and qualitatively different kind of mathematical thought evidenced by more able thinkers compared to the less able [Gray and Tall, 1991a, p.1]. The symbol -3 is an example of a *procept* which can be interpreted in

several ways, depending upon the context. If arithmetic operations are analyzed using the notion of function, -3 could be interpreted as either the unary process of taking the additive inverse (a process requiring one input) or as a mathematical object, the concept negative three, and subtraction is a binary process which requires two inputs, 7 and 3, in the subtraction, $7-3$.

The ability to think flexibly is considered to be an essential component of the ability to be successful in mathematics. The theories of 'encapsulation' focus on the manner in which processes are encapsulated as objects, which generally lead to quantifiable differences in procedures. Qualitative differences in more able student's abilities to think successfully compared with the abilities of less able students have been documented in the studies of Krutetskii [1969] and other Russian researchers including Dubrovina [1992] and Shapiro [1992]. A qualitative difference in the numerical processing of elementary grade children was noted and reported by Gray [1991].

The divergence between procedure and procept was characterized by Gray and Tall as the "*proceptual divide*" (i.e., a bifurcation of strategy between flexible thinking and procedural thinking which distinguishes more successful students from those less successful) [Gray & Tall, 1994, p. 132]. This divergence is evidenced by observable qualitative differences in the strategies employed by the less successful and the more successful students. Various levels of the encapsulation of the procedure can be seen to be successively sophisticated growth of the procept. Skemp alludes to the notions of *procept* and *proceptual divide* when he discusses the difficulties students have in learning to understand mathematical symbolism. He asks:

So how can we help children to build up an increasing variety of meanings for the same symbols? How can we prevent them from becoming progressively more insecure in their ability to cope with the increasing number, complexity, and abstractness of the mathematical relations they are expected to learn? [Skemp, 1987, p. 186].

Although rote-learning of procedures may increase the foundation on which to build, the meaningful learning of procedures is essential for flexible thinking. Some students experience a cognitive shift from concrete actions and processes to abstract cognitive objects able to be manipulated in the mind while others remain locked into procedures. The more successful develop a flexible proceptual system of deriving new knowledge from old and have a built-in feed-back loop that creates new mathematical

objects. The less successful are caught in a procedural system in which they are faced with harder and harder procedures that eventually result in cognitive overload. Even when the less successful have the procedures available to them, they may lack the flexibility to use them in the most economical and productive way [Gray and Tall, 1994; 1991a].

It should be noted, however, that performing sequential steps of a process is not necessarily an indicator of inflexibility. Davis cautions us to distinguish between inflexible, rote procedures and steps in a procedure that are decision steps. He points out that “the phrase ‘definite sequential order’ does *not* imply inflexibility” [Davis, 1984, p. 30]. Skemp makes a similar distinction between routine manipulations and problem-solving activity; and between “automatic” skills which are performed automatically according to well formed habits, whereas rote skills are characterized by “mechanical manipulation of meaningless symbols” [Skemp, 1987, p. 61].

The findings of Krutetskii [1969] and of his Russian colleagues, Dubrovina [1992a, 1992b] and Shapiro [1992], offer strong evidence in support of the notion that schemas can be both instruments of adaptability and of inflexibility. Krutetskii and his colleagues studied the characteristics of thought of students (grades 5–8) of varying levels of ability over several years, using the genetic method of observing individual students in teaching-learning situations. Krutetskii found that mathematically able students’ thinking is characterized by (1) broad generalizations which occur immediately; (2) the tendency to think in terms of curtailed structures; (3) great flexibility of mental processes; and (4) a striving for clarity, simplicity, and economy. His colleagues examined the extremes of children in various grades (2–4; 9–10) to further test the structure of mathematical abilities hypothesized by Krutetskii. A full report of this body of research is included in the volumes translated and published by the National Council of Teachers of Mathematics (Volumes 1–6) and the subsequent volumes by the University of Chicago Press.

The findings of Gray [1991], Gray and Tall [1994], and, more recently, Gray, Pitta and Tall [1997], support and add to the body of research that shows qualitative differences in the strategies and initial foci of attention of the extremes of classes of elementary grade children (grades 3–6). They report low achievers appear to focus on detail and exhibit a tendency to mentally imitate procedures. High ability students

demonstrate flexible interpretations of symbolism, an ability to compress knowledge, and to focus on generative properties that leads to the formation of qualities of abstraction. Image formation appears to be a crucial factor in the divergence of thinking that is termed the proceptual divide.

2.7 The Notion of *Representation*

An issue on which researchers hold differing perspectives concerns the notion of “representation.” Steffe argues that “Many accounts of knowledge representation are misleading because they are based on the assumption that concepts are things—mental objects— “out there” to be represented. He, like Dörfler, regards “mathematical concepts as mental acts or operations, and it is these operations that are represented. We believe that representation elements are constructed as part of the construction of the concept...Image and externalization are two basic aspects in the construction and elaboration of representational elements” [Steffe, 1995, p.487].

Thompson characterizes Piaget’s notion of image as the products of *acting*. He contrasts Piaget’s notion, which includes its theoretical context, with that of Kosslyn, who characterizes images as the *products* of acting. Piaget’s idea of image is that images are “residues of coordinated actions, performed within a context with an intention, and only early images are concerned with physical objects.” Kosslyn conceives of images as data structures that result from the processes of perception [Thompson, 1996, p. 270]. Kosslyn [1980] argues forcefully that it is erroneous to equate image representations with mental photographs, while describing organizational processes of knowledge construction:

These organizational processes result in our perceptions being structured into units corresponding to objects and properties of objects. It is these larger units that may be stored and later assembled into images that are experienced as quasi-pictorial, spatial entities resembling those evoked during perception itself....It is erroneous to equate image representations with mental photographs, since this would overlook the fact that images are composed from highly processed perceptual encodings [Kosslyn, 1980, p. 19, cited in Thompson, 1996, p. 269].

Tall [1995] theorizes that when we visualize, we use not “picture-making” facilities, but “picture-recognizing” facilities.”

I do not believe in my own case that I have things in my mind that correspond to visualizations either. Despite working for many years on visualizations in mathematics, in which I can produce good external pictures on the computer screen to represent mathematical concepts, the pictures I conjure up in my mind are very different from the external representations [Tall, 1995, p 165].

The debate among mathematics education researchers concerning the issue of whether one does or does not associate image representations with mental photographs appears to have shifted in recent years to focus on the dynamics of mental representations and theories of understanding. von Glaserfeld identifies two meanings of the word *representation*: (1) the Piagetian interpretation in which the term representation “refers to a re-presentation (from memory) of an experience one has had at some earlier moment” and (2) the sense in which Kaput uses the term representation to refer to “graphic or symbolic structures that provide the cognizing subject with the opportunity to carry out certain mental operations.” A reference to the symbolic unit $f(x)$ as the “representation of a function” evokes certain perceptual and/or conceptual operations, as well as possibly evoking memories of earlier experiences [von Glaserfeld, 1996, p. 308].

Thompson [1994] questions whether the mental objects students construct are functions and/or representations of functions. He also cites Kaput: “What is being represented, for a knowledgeable third party observer, is NOT what is being represented for the person living in the representational process” [a quote by Kaput, cited by Thompson, 1994, p. 27]. Thompson argues that the notion of “multiple representations” as currently construed is not appropriate to focus on. “The core concept of function is not represented by any of what are commonly called the multiple representations of function, but instead our making connections among representational activities produces a subjective sense of invariance.” [Thompson, 1994, p. 39]. Given the constraints of impoverished conceptual foundations, Thompson identifies the need to give explicit attention to students’ imagery and to provide instruction that focuses explicitly on the development of flexible thinking:

...we need to pay much closer curricular and pedagogical attention to students’ per-symbolic actions, such as imagining dynamic situations so that their images adhere consistently to systems of constraints....The importance of attending to students’ conceptualizations of situations applies to

more than physical phenomena and physical quantities. It applies whenever we use mathematical notation referentially [Thompson, 1994, p. 30–31].

2.7.1 External Models of Conceptual Systems

Goldin and Kaput [1996] provide a theoretical model of representation and counter the objections of radical constructionists who would argue that it is fundamentally wrong to term internal systems “representational” because there is nothing directly knowable that is being represented. Those who would argue that (1) because we have direct access only to our worlds of experience, not to any “external” world thus what is out there is not directly knowable, and that (2) internal representations should be considered as “presentations” not representations, Goldin and Kaput reply that theirs is a hypothetical model, a constructed model developed by an observer:

...to help explain an individual’s observed behavior, or the behavior of a population of individuals...the description of external systems of representation...is constructed by the theorist or community of theorists, as is any scientific model or theory. It is not assumed to exist independently of such acts of constructions...This is the standard method of science: (a) to create structured models that embody relations among selected observables, (b) to use these relations to help generate hypotheses that can be tested, and (c) to explain the outcomes of observations...To us, internal representation, like external representation, is intended to be part of a theoretical model explanatory of phenomena that can be observed. It is not a requirement of a scientific theory that its every component be directly observable, only that it have consequences that are observable...models involving internal constructs do better in explaining our observations of behavior than models without them” [Goldin & Kaput, 1996, pp. 406–408].

2.7.2 Concept Maps: External Representations of Conceptual Structures

It has been argued that *concept maps* are external visual representations of a student’s internal conceptual structures and their organization at a given moment in time. These maps are used to document the processes of constructing new knowledge structures and reorganizing existing knowledge structures. The use of *concept maps* as an instructional tool and as a research tool has been cited in recent years in science education research literature [Novak, 1985, 1984; Moreira, 1979; Cliburn, 1990; Lambiotte and Dansereau, 1991; Wolfe and Lopez, 1993] and in mathematics education research literature [Skemp, 1987; Laturno, 1993; Park and Travers, 1996; Lanier,

1997; Wilcox and Lanier, 1997]. A concept map is a device for representing the conceptual structure of a subject discipline in a two-dimensional form which is analogous to a road map. In much of the literature, Novak, of Cornell University, is credited with the development of this tool in the early 1980's, though some literature cites the earlier work of Buzan in the late 1970's.

The use of concept maps as an instructional tool is based on Ausubel's learning theory, which places central emphasis on the notions of advanced organizers and subsumption to explain the influence of students' prior knowledge on subsequent meaningful learning. According to Ausubel, the linking together of new knowledge with existing knowledge and relevant concepts results in meaningful learning. When meaningful learning occurs, it produces a series of changes in the cognitive structure, modifying the existing structure and forming new linkages and connections as new knowledge is integrated into and added onto the existing cognitive framework [Ausubel, Novak, et al., 1978]. Concept maps serve to clarify links between new and old knowledge and force the learner to externalize those links.

Concept mapping was originally developed as a way of "determining how changes in conceptual understanding were occurring in students" [Novak, 1990, p. 937]. The instructional purposes for which concept maps are intended vary within two main schools of concept mapping practice. One school of thought claims that concept maps are useful to test students' understanding of a specific topic; with the instructor creating an "expert" map, and grading a student's map by determining how closely the student map matches that of the expert. Another school argues that concept maps are useful primarily for the creator of the map as a means by which s/he can make explicit her/his understanding of a topic. In the process of constructing a concept map, students reflect on their recent learning, clarify their understanding of terms and definitions and focus their attention on the linkages between concepts. Student misconceptions are also revealed.

Mathematics, according to Skemp, is a knowledge structure with a hierarchic nature in that certain concepts are prerequisite for the formation of other concepts. He used the term *concept map* in the sense of a concept-dependency network to refer to the process of schema construction in which order is important, with the necessary direction being from lower to higher order concepts. Skemp envisioned concept maps

as advanced organizers and as a means of analysis when planning lessons and used them to plan a teaching sequence and for diagnosis. “If a learner has difficulty with a particular concept, reference to an appropriate concept map [prepared by the instructor] may suggest that the roots of the problem lie further back, and indicates which areas we should check” [Skemp, 1987, p. 122]. Skemp credited Tollman with the notion of a cognitive map, which he (Skemp) used as a transitional metaphor of conceptual structures. He found a cognitive map diagram a useful way of representing knowledge structures because it could be interpreted at three levels of abstraction:

- as a road map where each point represents a physical location.
- as a cognitive map where each dot represents a concept, and each line represents a connection between concepts.
- as a generalized schema, representing an unspecified knowledge structure.

Claiming that “concepts represent, not isolated experiences, but regularities abstracted from these,” Skemp argued that “we can think of them [cognitive maps] as mental models derived from certain features of the outside world” [Skemp, 1987, p. 116]. Like Davis, Skemp speaks of conceptual structures metaphorically, using a metaphor from photography, a lens of varifocal length, when he refers to them as *cognitive maps*:

A major feature of intelligent learning is the discovery of these regularities, and the organizing of them into conceptual structures that are themselves orderly. These conceptual structures, or schemas, are like cognitive maps only more so. We could think of them as cognitive atlases, of a rather special kind....The way in which I successively access these mental maps is...like looking at increasingly small areas of the same map under increasing magnification....I have used a metaphor from photography, in which we can buy a single lens of variable focal length. Looking at the same landscape, we can use this to give a wide angle view that we see in less detail, or by increasing the focal length we can get a larger, more detailed image of a smaller area....knowledge is organized in schemas, now thought of as conceptual structures in which many of the concepts have *interiority*. In our schemas... we store all the detail we need for a wide variety of purposes, and use vari-focal access to scan them in the right amount of detail for the job in hand [Skemp, 1987; pp. 116–118].

Research on the efficacy of concept maps as teacher-directed guides showed that the use of teacher-constructed maps increased either learning and/or retention of

science information [Cliburn, 1990; Lambiotte and Dansereau, 1991; Moreira, 1979; Wolfe and Lopez, 1993]. Lambiotti and Dansereau also tested the efficacy of different presentation types (text outlines, lists, concept maps) on learning between students with differing prior amounts of prior knowledge. They found that students with low prior knowledge learned better with teacher and/or student-constructed concept mappings than with the other two more linear presentations and that the richness of knowledge, evidenced by the inter-connections of the concepts was increased by their use as well in introductory science classes.

Park and Travers [1996] used concept maps to assess conceptual understanding of two groups of students enrolled in the second semester freshman calculus course at a major midwestern university; an experimental group taking an intensive computer laboratory course and another group taking a standard, traditionally taught course. Students were given lists of concepts and constructed their own concept maps. They were encouraged to include additional terms not provided on the list and were told that cross links carried additional credit. The student-constructed concept maps were analyzed using two quantitative methods: the maps were first scored, using point totals on propositions, hierarchy and cross links; concepts and misconceptions. Each map was then analyzed quantitatively, using a congruence coefficient between the instructor's map and that of the students, to determine the extent of similarity between the student-constructed map and that of the instructor. The findings, all favorable to the computer-based course, suggest an alternative way to document the effects of projects designed to promote reform in undergraduate mathematics courses.

The use of concept maps as a research tool with community college mathematics students within a narrow range of competence was studied by Laturno [1994]. Correspondence between concept maps and clinical interviews in determining concept connectivity, and the ability of concept maps to predict academic achievement were examined. Students from three remedial arithmetic classes and two remedial elementary algebra classes, all taught by the same instructor, constructed two concept maps during the fifth and sixth week of the semester course. Subsequent maps were constructed during the fifteenth and sixteenth weeks of the semester but were not included in the reported results. The concept maps were analyzed quantitatively, with varying numbers of points assigned according to five categories: number of concepts repre-

sented, quantity of valid relationships between nodes, the levels of hierarchy in the structure, examples, and cross-links.

This method of analysis parallels that used by Novak & Gowin [1984] and by Wallace & Mintzes [1990]. Scores for each of five categories were recorded, as well as total points for each map. The scores for the two concept maps (week 5 and week 6) were correlated, as well as the total concept map score with the number of units mastered in the course. Students were provided with a list of ten mathematical concepts which were assumed to be familiar to them based on prior course work which were to be used in the construction of a concept map. Scores on the mathematical concept map allowed placement of students into three groups: high, medium, and low. Twenty-four students, six each from the two courses within the high and low scoring groups were randomly selected and requested to participate in interviews during weeks 15 and 16. There was significant agreement between the researcher's placement of students based on the week 5 and 6 concept maps, and the course instructor's placement of students based on task-based interviews at the end of the semester. The classroom instructors based their placement solely on work done during the task-based interviews according to how well the student connected ideas in mathematics during the interview. Student generated concept map representations produced conclusions about the student's complexity of knowledge connections similar to the data obtained from interviews. It was claimed that concept maps would provide a reliable alternative to the time-consuming clinical interview for classroom practitioners and researchers.

Wilcox and Lanier [1997] used concept maps as an instructional tool to document changes in the nature of middle school teachers' thinking about their assessment practices as a result of using decision-making case studies during an intensive three-week summer session. Both the initial and final concept maps were returned to the students so that the students/teachers could compare and contrast the two maps, analyzing the changes in their own thinking which had occurred over time. Lanier [1997] also reported on one middle grade teacher's use of concept maps during the year to inform her instructional decisions and to better understand what students knew, didn't know, and how they applied their knowledge.

Pre- and post-unit concept maps were used to as means of assessment that allowed students to demonstrate their understanding of a topic in a non-traditional way

which gave them control over the situation. The post-concept map was augmented with a set of questions which students completed and submitted with their concept map. No in-depth qualitative analysis of concept maps was done in any of the cited studies, nor was any evidence of qualitative analyses of concept maps found in several searches of dissertation abstracts. Several studies did report students' comparisons of their early and later maps to document growth over time of mathematical knowledge.

2.8 Current Issues on the Nature of Knowledge Acquisition

Identification of current issues which involve the nature of mathematical learning and characterizations of knowledge acquisition, together with historical overviews of various theoretical positions are provided in recent volumes edited by Steffe and Gale [1995]; Steffe, Nesher, Cobb, Goldin and Greer [1996]; Cobb and Bauersfeld [1995] and Gavriel Salomon [1993a, 1993b]. Generally, cognitive psychologists have continued to focus on procedural knowledge, a focus which mathematics education researchers contend provides no clarification of issues such as what it means to have a conceptual understanding as opposed to a procedural understanding. Differing perspectives between the traditional information processing (or computational view) in cognitive psychology and those who consider knowledge distributed among various systems still generate considerable debate. Greer [1996] points out that there has been a noticeable effort to address the lack of social and cultural contexts, resulting in a richer and more complex view of intellectual functioning. However, he also points out that "there is no unifying theoretical framework visible on the horizon....current research is characterized by methodological diversity, and a certain lack of agreed conventions and systematicity in the communication of experimental findings" [Greer, 1996, p. 182].

2.8.1 Social and Individual Dimensions of Mathematical Development

Students' mathematical activity cannot be adequately accounted for solely in terms of individualistic theories such as constructivism or information processing psychology. Recognition that there is a social dimension of mathematical development is becoming more widely-accepted among many researchers. Questions and theories regarding the nature of individual mathematical construction are being integrated with

questions concerning the initiation of that individual into the mathematical community, with a growing consensus that students construct their own mathematics in a social context. There is an emerging acceptance that knowing and doing mathematics is an inherently social and cultural activity. Social and cultural influences are not limited to the process of learning but also extend to its products—increasingly sophisticated ways of knowing.

Theories developed in both the Vygotskian tradition and in the sociolinguistic tradition exemplify the collectivist position and can be contrasted with individualistic theories (neo-Piagetian) which treat mathematical learning almost exclusively as a process of active individual construction. One of Vygotsky's main tenets was that socio-cultural factors were essential in intellectual development. The integration and awareness of the social perspective (Vygotskian) with the individual (Piagetian) perspective acknowledges the impossibility of constructing a theory of knowledge that ignores either of these two perspective. Confrey [1993] offers a theory of intellectual development that integrates Piaget's view of biologically developmental human beings with the Vygotskian perspective in which human beings are viewed as productive members of a collective enterprise. In order to avoid placing the individual in tension with the social, she argues that the roles of nurture and reproduction need to be included when considering human development, thus making biological evolution the bridging construct, recognizing the importance of environmental concerns and of diversity.

Cobb & Bauserfeld [1995] characterize the two general theoretical positions on the relationship between social processes and psychological development as collectivism and individualism and seek to transcend the apparent opposition between these two theoretical positions. According to their interactionist perspective, individual students' mathematical activity and the classroom microculture are reflexively related. Collaborative activities which support conceptual and procedural developments simultaneously are both constrained by the group's establishment of a consensual domain and adaptability to each other's activities. Bauserfeld and his colleagues chose as their primary point of reference, the classroom microculture, instead of society's wider institutionalized mathematical practices. The notion of reflexivity implies that "neither an individual student's mathematical activity nor the classroom micro-culture can be

adequately accounted for without considering the other” [Cobb & Bauersfeld, 1995, pp. 9–10].

2.8.2 Technological Challenges to Current Beliefs and Practices

Recent technological developments also challenge current beliefs about the nature of mathematics and the hierarchical cognitive models of learning mathematics. The use of technology and collaborative group activities provide opportunities to re-examine those beliefs and to discuss the trade-offs and risks on empirical grounds, in a forum that does not put students in the middle of our on-going debates. The theory of epistemological pluralism, which allows for multiple ways of thinking and knowing [Papert and Turkle, 1992] and the theory of distributed cognitions, in which knowledge is part of communities and in the interactions of persons with their tools as well as their environment [Pea, 1993; Salomon et al, 1991; Salomon, 1993a, 1993b] offer us a broader framework in which to work.

Papert & Turkle [1992] argue that there are different ways of knowing and that not all persons think hierarchically. They contend that the prevailing models of cognitive theory which commit us to the superiority of algorithmic and formal thinking needs to be broadened to include a recognition that concrete thinking is as important as abstract thinking and an object of science in its own right. Their research documents the discrimination that has occurred in classrooms against students who wish to use technology in a non-canonical way. In these classrooms students are expected to change their approach to knowledge acquisition by those who teach and are committed to a formal, rule-driven hierarchical approach to learning. Recent technological developments “have created an opening for epistemological pluralism” and recent intellectual movements provide an opportunity to “break with ways of thinking that take the abstract as the quintessential activity of intelligence.” Armed with the idea of *closeness to objects* (i.e., a contextual and associational style of working which does not exclude a hierarchical style in combination with the contextual and associational), Papert and Turkle offer a different theory: those who do so well do not have better rules, but a tendency to see things in terms of relationships, rather than properties. The degree of closeness to objects has developmental primacy—it comes first—before the tendency to use a concrete and negotiational style or an abstract style of thinking. This tendency

to see things in terms of relationships is also argued by those who argue that everyday categories are not mentally represented in terms of classical defining features, but in prototypes, typical features, and exemplary models [Rosch, 1973, 1975; Mervis et al., 1976; Labov, 1973; Smith and Medin, 1981; Hintzman, 1988; and Barsalou, 1992].

The belief that one's physical interactions with materials and tools are influenced by social interactions is another theoretical perspective that has recently gained wider acceptance. Based on the premise that changing the unit of analysis or changing the context in which a phenomenon is studied may reveal a qualitatively different phenomenon, Pea [1993] takes issue with the widespread popular view of intelligence as the property solely of the mind. In his analysis of studies done by Papert, Pea believes that Papert missed the key point—an explicit recognition of the intelligence represented and representable in design, specifically in designed artifacts that play important roles in human activities. Pea argues that the student is not engaged in solitary discovery in the Piagetian sense, but that s/he could be scaffolded in the achievement of activity either explicitly by the intelligence of the teacher, or implicitly by that of the designers, now embedded in the constraints of the artifacts with which the student was working” [Pea, 1993, pp. 64-65].

Anyone who has closely observed the practices of cognition is struck by the fact that the ‘mind’ rarely works alone. Pea rejects the fixed-quantity concept of intelligence contributing to task achievement by a human-computer system. He argues that the notion of distributed intelligence is not a theory of mind or culture, but a heuristic framework within which theoretical and empirical questions about human thought and symbol systems can be raised and addressed [Pea, 1993, p. 47–48]. People-in-action, activity systems are defined to be the units of analysis for deepening our understanding of thinking. *Distributed intelligence* is defined to mean that “resources in the world are used, or come together in use, to shape and direct possible active emerging from desire,” with intelligence being accomplished rather than possessed.

Activity is enabled by intelligence, but not only intelligence contributed to by the individual agent...While it is people who are in activity, artifacts bring the affordances of a new artifact into the configuration of another agent's activity, can advance that activity by shaping what are possible and what are necessary elements of that activity [Pea, 1993, p. 50].

Activity is perceived as something to be accomplished; achieved in means—ends adaptations which may be more or less successful.

The focus in thinking about distributed intelligence is not on intelligence as an abstract property or quantity residing in minds, organizations, or objects, In its primary sense here, intelligence is manifest in activity that connects means and ends through achievements [Ibid.].

Pea suggests that “smart tools” such as jogger pulse meters, world-time clocks, and automatic street locators literally carry intelligence in them. In other words, these tools and practices are carriers of patterns of previous reasoning, used in ways that renders the tools invisible by a new generation with little or no awareness of what purposes they were created for or of the struggles that went into their invention.

The inventions of Leibniz’ calculus and Descartes’s coordinate graphs were startling achievements; today they are routine content for high school mathematics....This encapsulation of distributed intelligence, manifest in such human activities as measuring or computing, may arise because we are extraordinarily efficient agents, always trying to make what we have learned works usable again and again” [Pea, 1993, p.53].

Salomon [1993] raises the issue of including the individual’s cognitions, representations, and mental operations in a theoretical formulation of distributed cognition. He argues that, since not all cognitions can be distributed, individual and distributed cognitions must be examined in interactions. He disagrees with Pea and argues that “not all cognitions are constantly distributed, not all of them can be distributed, and no cognitive theory, particularly one that attempts to account for developments and changes over time, can do without reference to individuals’ mental representations” [Salomon, 1993]. Salomon concludes that distributed cognitions and individuals’ cognitions need to be seen as affecting each other and that in order to account for changes and developments in the performance of joint distributed systems, one has to consider the role played by the individual partners [Salomon, 1993, p. 134].

Salomon and his colleagues argue that the effects of technology should be emphasized so that autonomous intellectual performance can be achieved. They base their choice on the fact that such tools are not sufficiently prevalent yet and thus how a person functions away from the technology must be considered” [Salomon, et al., 1991, p. 5]. They characterize two ways of evaluating intelligence for partnership

between peoples and technologies: *systemic* (attends to the aggregate performance of the partnership) and *analytic* (articulates the specific contributions made by the person and the technology to the performance); claiming that the analytic approach is “more oriented toward the study of human potential and toward educational concerns” [Salomon et al., Ibid.]. Salomon and his colleagues characterize the two kinds of cognitive effects of technologies on intelligence: *effects with technology* obtained during intellectual partnership with the tools and *effects of technology* in terms of the transferable cognitive residue left behind in the form of improved skills and strategies. They characterize an *intelligent technology* as one which undertakes “significant cognitive processing on behalf of the user and thus is a partner in distributed intelligence” [Salomon, Perkins, and Globerson, 1991, p. 2]. Jones elaborated on this notion, characterizing the use of graphing calculators in terms of an *intelligent partnership*, in which there is a complementary division of labor:

The user plans and implements the solution, but passes the responsibility over to the calculator at the appropriate time....A crucial aspect of the partnership is the constant monitoring and checking of the information generated by the calculator to make sure that the solution is consistent with the user's knowledge and understanding of the problem at hand [Jones, 1994, p. 213].

Despite differences, Pea, Salomon, Jones, and others believe that new technologies can support human activities by serving as experimental platforms in the evolution of intelligence—by opening up new possibilities for distributed intelligence. The intelligences revealed through the practices of human activities reoriented from an educational emphasis on individual, tool-free cognition to facilitating individuals' responsive and novel uses of resources for creative and intelligent activity alone and in collaboration are distributed—across minds, persons, and the symbolic and physical environments, both natural and artificial.

The notion of situated-distributed cognition is gaining acceptance among other theorists. Cobb qualifies his support of the position espoused by Salomon and insists that “One ought to include in a theory of distributed cognitions the possibility that joint systems require and cultivate specific individual competencies; i.e., cognitive residues, which affect performance in subsequent distributed activities,” a position similar to that maintained by Salomon [Cobb, 1997, p. 135] Bruner also supports the

notion that a person's knowledge is not just in one's head, but is both situated and distributed. He wrote:

To overlook this situated -distributed nature of knowledge and knowing is to lose sight not only of the cultural nature of knowledge but of the correspondingly cultural nature of knowledge acquisition [Bruner, 1990, p. 106].

2.9 The Roles of Perception & Categorization

The roles of perception and categorization in the formation and organization of conceptual systems are a recurrent theme in the literature. It is argued that every time we perceive an object we classify it [Davis, 1984; Dehaene, 1997; Edelman, 1992; Krutetskii, 1969b; Lakoff, 1987; Roth, 1996; Skemp, 1987; Tall, 1992a]. von Glasersfeld [1995] describes the process by means of which concepts and categories are formed in Piagetian terms, claiming this process is always an *empirical abstraction*—the means by which categories are formed and generalized; an inductive process of abstraction from sensory or motor experience. *Reflective abstraction* is the process of deriving generalizations in which patterns are derived from actions or operations.

Processes by which perceptions are transformed into mental representations (concepts) which result in categorization, recognition, and identification as distinct from the representations themselves are a matter of convenience for discussion, rather than a matter of precise definition. Perceived items are assumed to be assigned to categories by comparison and matched with stored representations. Krutetskii distinguishes between mental perception and visual perception. In capable children, Krutetskii observed that they “seemed to have an analytic-synthetic perception of mathematical material....in capable children, this [analytic-synthetic] comprehension is extraordinary. It is highly original and tends to be so “curtailed” that perception and comprehension seem simultaneous” [Krutetskii, 1969c, p. 74].

Roth [1996] claims that the ability to categorize (i.e, to form concepts) is a fundamental property of perception and that we also categorize remembered events and/or objects. Skemp expressed a similar view: We classify every time we recognize an object as one which we have seen before. Naming an object classifies it....But once it is classified in a particular way, we are less open to other classifications” [Skemp, 1987, pp. 100–11]. In contrasting the way in which mature mathematicians structure their

knowledge contrasted with students, Tall points out that mature mathematicians are not immune from cognitive conflict. They are “able to link together large portions of knowledge into sequences of deductive argument...it seems so much easier to categorize this knowledge in a logically structured way” [Tall, 1991, p. 7].

Inagaki & Sugiyama [1988] found that young children attribute unknown properties to animate objects based on similarity-based inferences, whereas older children and adults use category-based inferences. Graham and Ferrini-Mundy [1989] reported that students were unable to classify graphical representation as functions, when the graph was not associated with the formula which generated the graph. Gray, Pitta, and Tall [1997] reported that low achievers categorize images on the basis of recollections of personal happenings and relationships; high achievers classified images by filtering out the superficial aspects of the perceived object, concentrating on the more abstract qualities of the items.

The notion of an initial focus of attention, together with the notion of *path-dependent logic*, i.e., that the response is determined by how the object and/or action is perceived, how context is interpreted and categorized, is regularly described in the literature to account for students’ differing interpretations and responses. Gray, Pitta, and Tall [1997] contend that “different perceptions of [the original] objects, whether mental or physical, are at the heart of different cognitive styles that lead to success and failure in elementary arithmetic.” Dörfler contends that the construction of mental objects involve more general psychological processes and states, including “attitudes, beliefs, willingness to accept something, ascribing properties, hypothetical thinking, preparedness to assume that something is the case, imagination, conviction, and focus of attention” [Dörfler, 1996, p. 475]. Mason argues that “the basic powers of sense-making have to do with focusing attention on outer, material objects, and on inner, mental images” [Mason, 1996, p.2].

The notion of “path-dependent logic” is discussed explicitly by Tall [1977] and implicitly by Davis [1984], Dubinsky & Harel [1992], Hiebert and Carpenter [1992]; Greeno [1988], Kaput [1992b; 1989], Gonzales & Kohlers [1982]; and Skemp [1971]. The path of approach can be determined not only by cognitive conflict; but can also be determined in whole, or in part, by the form of the external representation or by the context in which it is presented. Either can trigger selection and retrieval of a specific

cognitive unit. Students' misinterpretations of the expression $y(t)$ to mean y times t are indicative of the difficulties of interpreting ambiguous notation related to algebraic structure, illustrating the path-dependent logic activated by erroneous interpretations.

2.9.1 Classification Systems: Biological Considerations

Recently reported findings of neurological research on the brain and in the fields of categorization and perception suggest that we need to enlarge our analytic and interpretive perspectives in order to progress in our efforts to understand students' processes of conceptual construction and the organization of the resulting cognitive structures. Categorization plays an important role in how students' initial perceptions activate conceptual schemas and particular concept images. Human categorization is complex. Conceptual categories, which represent the shared characteristics by which individually different things are mentally grouped together, serve to organize our knowledge of the world into manageable chunks [Dehaene, 1997; Edelman, 1992; Lakoff, 1987; Roth, 1996]. Lakoff has argued that "An understanding of how we categorize is central to any understanding of how we think and how we function" [Lakoff, 1987, p. 6].

The research of Rosch and her colleagues linked reason to the biological brain and culture. Rosch [1973, 1975] challenged the traditional notion that category representation was based on defining features (classical categorization), a notion which dates back to the time of the ancient Greeks. She and her colleagues provided convincing evidence that people do not mentally represent everyday categories in terms of defining features, i.e., that concepts are not always represented mentally as well-defined sets according to characteristic properties. Initially, Rosch [1973] proposed that the conceptual representation of a given category is lodged in a prototype; a composite that includes characteristics of the most typical members of the category. This idea was subsequently refined and reformulated to include both the typical features model and the exemplary model [Rosch, 1973; 1975; Mervis et al., 1976; Labov, 1973; Smith and Medin, 1981; Hintzman, 1988; Barsalou, 1992].

One level, the basic level of categorization, has special properties. The notion of a basic level emphasizes the importance of hierarchical relationships in the relationship of conceptual information, with categories organized from the most general to the

most specific. Those that are cognitively basic are in the middle of the hierarchy, moving upwards towards greater generalization and downwards towards greater specialization [Lakoff, 1987, p. 13]. Subsequent studies provided additional evidence against the defining feature method of categorization. Labov [1973] found that context affects how persons categorize everyday objects. Mervis and his colleagues [1976] showed that typical category members are categorized more quickly than atypical category members. Murphy and Wright [1984] confirmed the importance of expert knowledge on categorization and concluded that the greater knowledge of experts may have led them to focus on shared features, rather than on distinctive features of various psychiatric disorders when compared with the concepts of novices, who tended to focus on distinctive features.

References to proto-typical categorizations and similarity-based inferences are found in mathematics education research literature, as well as in neuro-scientific research literature [Davis, 1984; Dorfler, 1989; Dugdale, 1993; Goldenberg, 1987; Keller & Hirsch, 1994; Markovitz et. al., 1988, Tall & Bakar, 1990; Vinner, 1992]. Martinez-Cruz [1995] investigated the question: "What are the concept images and the concept definition of function that students have?" The commonly reported result that students identify graphs as functions only if they were within the students' previous experience was supported by his findings. His report concludes with a statement characterizing one student's prototypical view of functions: "for some students one single model was more anchored in their mind than others, and they acted accordingly" [Martinez-Cruz, 1995, p. 279].

Hatano hypothesizes that, for a coherent conception of a knowledge acquisition system, the process of knowledge acquisition requires restructuring and describes the reorganization of conceptual structures in terms of prototypes:

Knowledge systems before and after restructuring are different in organization; for example, one piece of knowledge may become differentiated, while other separate pieces of knowledge may become amalgamated...Relationships between pieces of knowledge may also change as restructuring takes place; for example, the same phenomenon may be explained differently, some instances may become prototypical whereas others may become marginal [Hatano, 1996, p. 199].

There is evidence to support the claim that the ability to carry out categorization is embodied in the nervous system. Reported results of recent neurological studies utilizing magnetic resonance imaging (MIR) techniques, as well as other neurological methods of examination, revealed that the process of comparison and matching with stored representations is accomplished by parallel processing by an essentially sequential transformation in which information is continuously fed forward at the same time it is being processed in the various stages [Dehaene, 1997; Edelman, 1992; Kosslyn, 1994; Roth & Bruce, 1996]. Dehaene claims that “the structure of our brain defines the categories according to which we apprehend the world through mathematics” [Dehaene, 1997, p. 245]. As an explanation of how, on the basis of innate categories of their intuitions, mathematicians elaborate ever more abstract symbolic constructions, Dehaene [1997], along with Changeux [1995], hypothesized that an evolutionary process of construction followed by selection is at work in mathematics. They argue convincingly that our brain architecture imposes strong constraints on the mental manipulation of mathematical objects.

Edelman [1992] maintains that concepts are the products of the brain re-categorizing its own activities. He postulated the theory of neuronal group selection which proposes that categorization always occurs in reference to internal criteria of value and that this reference defines its appropriateness. Value criteria do not determine specific categorizations, but do constrain the domains in which they occur [Edelman, 1992, p.90]. Perceptual categorization is defined to be “the selective discrimination of an object or event from other objects or events for adaptive purposes....that does not occur by classical categorization, but rather by disjunctive sampling of properties” [Edelman, 1992, p. 87].

Mathematics education researchers have begun to take into account the neuropsychological bases of mathematics in their analyses of students’ work and behavior. The complementary roles of perception (input) and action (output) means that the cognitive growth which occurs in mathematics is implicitly designed to make maximum use of two highly contrasting features of the brain: the small focus of attention which requires one to compress knowledge appropriately; and a large capacity for stored experiences and concepts, according to Tall [1995]. In his early work on cognitive conflict, he argued that “understanding in mathematics often occurs in significant jumps”

and that “lack of understanding...may leave the individual in a general state of confusion, unable to pinpoint the difficulty.” He examined these phenomena from a theoretical perspective that considered them to be a result of brain activity [Tall, 1977]. Davis [1984] and Tall [1995] postulated the need for compression of knowledge due to the large capacity of the brain to store information (passive memory) and the small capacity of workbench memory (active memory).

Based on his observations, Krutetskii raised questions which he foresaw as the task of future investigations, both for mathematics learning and for learning in general:

- Is it possible that some people’s brains, because of certain conditions, become “oriented” toward perception of particular stimuli (“relationships” and “symbols”) and tend toward optimal response to these stimuli?”
- Is it possible to indicate a kind of “partiality” of the properties of a person’s nervous processes (in particular, capacity) in conformity with the nature of one or another of his activities; that the nervous system might exhibit its properties differently according to this? [Krutetskii, 1969c, p. 103–104].

Krutetskii concedes that “perhaps some people’s nervous systems are more sensitive to stimuli with mathematical characteristics (relations, symbols, numbers) than to other stimuli, and associations are formed more easily, with less effort and greater retention” [Krutetskii, 1969c, p. 104]. Like many of those cited in this review who hold that initial perceptions and focus of attention determine the schema and/or concept image retrieved from memory, he suggests that “basic difficulties of mastering skills or particular intellectual activities lie in the sphere of how the initial data are perceived and not in the sphere of what operations follow this perception” [Krutetskii, 1969b, p. 106].

Krutetskii raised questions nearly thirty years ago that the research of present-day neurobiology and neuropsychology are beginning to address. Using new brain imaging tools, the findings of this research are currently revolutionizing our knowledge of cerebral functioning and offer the possibility of a closer examination of the neural bases of mathematics [Crick, 1994; Dehaene, 1997; Edelman, 1992, Roth & Bruce, 1995]. It is interesting to note that Krutetskii questioned whether the strength of neural processes takes on one characteristic in connection with mathematical activity and another during other types of activity [Krutetskii, 1969b, p. 111]. Recent discover-

ies by the Austrian neuropsychologist, Hittmair–Delazer, suggests that neuronal networks dedicated to more advanced mathematical abilities such as algebra exist separate and distinct from those neuronal networks involved in mental calculation, against all intuition [Dehaene, 1997, p. 198].

It is conjectured by Dehaene that “learning probably never creates radically novel cerebral circuits. But, it can select, refine, and specialize preexisting circuits until their meaning and function depart considerably from those Mother Nature assigned them” [Dehaene, 1997, p. 203]. Many categories of words—animals, tools, verbs, color words, body parts, numerals, and so on—have been found to rely on distinct sets of regions spread throughout the cortex. In each case, to determine the category to which a word belongs, the brain seems to activate in a top-down manner the cerebral areas that hold non-verbal information about the meaning of the word [Dehaene, 1997, 228].

Determination of individuals’ classification schemas is often extremely difficult. Lakoff [1987] describes an Australian aboriginal language, Dyirbal, which has four classifiers, one of which precedes every noun; *bayi*, *balan*, *balam*, *bala*. The category, *balan*, includes women, fire, and dangerous things, as well as birds that are not dangerous, exceptional animals such as the platypus, bandicoot, and echidna, rivers and swamps. This category, *balan*, also includes harmful fish, such as the gar fish and the stone fish; two stinging trees, and a stinging nettle vine. Speakers of Dyirbal do not learn category members one by one, but operate in terms of some general principles. What appears to be an illogical classification system to a Western culture eye, is actually a principled and consistent system of classification to those who use the system [Lakoff, 1987, p. 92–104].

If one assumes that students categorize their perceptions according to a classification system based on their own internal value system, then, it could be argued, the system could possibly be structured according to the general principles hypothesized by Lakoff. He offers a theory of cognitive models based on general principles which he argues are found in systems of human categorization:

- centrality (the basic members of the category)
- chaining (the process of linking central members to other members)
- experiential domains (basic domains of experience which may be cul-

ture specific)

- idealized models (idealized models of the world, including myths and beliefs that can characterize the links in category chains)
- specific knowledge (specific knowledge overrides general knowledge)
- The Other (the “everything else” category, with no central members, chaining, etc.—a catch-all category)
- No common properties (categories not defined by common properties)
- Motivation (the general principles that make sense of a system of classification but do not predict what the categories will be) [Lakoff, 1987, p. 95–96].

Lakoff argues that general principles are characteristic of all natural language systems of human categorization and that, in order to understand how human beings categorize in general, one must at least understand human categorization in the special case of natural language. A question of interest is whether students categorize according to systems of classification that are structured, but which appear to their mathematics instructors to be a *Dyirbalian* system, i.e., a relatively regular and principled way of classifying which appears unstructured and lacking to one who is unaware of the general principles and system used to classify objects. If Lakoff and others who hold similar positions are correct, then it seems reasonable to conjecture that, what appears to us to be unconnected lists of concepts and/or procedures produced by some students are in fact, based on general principles and structured in some manner which makes sense to the student. They are, as it were, unrecognized systems of classification—*Dyirbalian* systems of classification.

2.10 Summary

This chapter surveyed the literature on the nature of knowledge construction, knowledge representation structures, and conceptual structures as instruments of cognition. Notions seminal to this dissertation, such as concept image, procept, proceptual divide, and representation were discussed. Issues of knowledge representation were examined from a constructivist perspective. The extent to which concept maps can be considered external representations of internal conceptual structures was also examined. Process-object theories of cognitive development which hold that intelligence is

largely a property of the minds of individuals were reviewed and aspects of alternative theories which take into account the social dimension of mathematical development were summarized. The chapter continued with a discussion of technological challenges to current beliefs and practices. Various theories, including those of epistemological pluralism and distributed cognitions were reviewed. A brief discussion of the roles of perception and categorization and biological considerations concluded the chapter. The theoretical framework which guided the research of this study is situated within the body of literature surveyed in this chapter and is described in the following chapter.

Despite differences in alternative research perspectives, efforts to find points of agreement on underlying principles of knowledge construction are being made. Evidence of the desire on the part of those who hold differing epistemological positions to consider the views of others with whom they disagree occurs in the recent literature. In an effort to bridge the apparent impasse that the diversity of alternative epistemologies for models of education and research has produced, Steffe proposed that those who hold differing perspectives seek “ways of thinking that might lessen, if not neutralize, some of the essential differences that have been identified and elaborated on” [Steffe, 1995, p. 489]. Mason argued for consideration of the views of the opposition in a polarizing debate:

a reasonable alternative to polarized debates is to grasp both poles, to argue that where you stand determines to some extent what you can see; that there can never be a universal platform, a single all-embracing, all-explaining perspective. Rather than deciding on one or another, it is usually most fruitful to grasp them both, to see both poles of a tension as releasing energy for deepening appreciation of the situation [Mason, 1994, pp. 192–193].

This review of the literature of alternative perspectives concludes with a comment by Bob Davis. Over the past several years, Davis [1996a, 1996b, 1992b] frequently advocated the need to find ways to bring various theoretical perspectives together. He argued eloquently that those who see the world (a) from a perspective of human cognition; (b) those who view the world from the perspective of specialists in mathematics (meaning the mathematics educators rather than those who create mathematics), and (c) the various interest groups whose aims are sometimes in conflict,

should be listening to one another more. He claimed that much is to be gained from trying to overlap these perspectives:

When one tries to examine school or university mathematics programs from more than one perspective, these programs begin to look very different, and important new possibilities come to mind. Indeed I would argue that the kinds of changes that are desperately needed in mathematics instruction can only be made if we are able to bring these various viewpoints together—the combination would be far more potent than the various parts can be, acting alone [Davis, 1996a, p. 285].

Cognitive Units, Concept Images and Cognitive Collages

*Much as I own I owe
The travelers of the past
Because their to and fro
Has cut this road to last,
I owe them more today
Because they've gone away*

*And come not back with steed
And chariot to chide
My slowness with their speed
And scare me to one side.
They have found other means
For haste and other scenes.
They leave the road to me....*

– Frost, Closed for Good

3.1 Introduction: On the Shoulders of Giants...

There are many whose work and writings have influenced my thinking and theoretical perspective over the past several years. I am indeed a product of all I have surveyed as a result of having stood, as Lynn Steen wrote, “on the shoulders of giants.” The primary sources and major influences on my thinking, my research, and my teaching have been the works and writings of Davis, Skemp, Tall, Gray, and Krutetskii. My own theoretical framework has been evolving as I continue to assemble bits and pieces of knowledge gleaned from each of them to formulate my own theories, enlarge and test my understandings. Relevant bits and pieces from other researchers’ work have contributed to the foundation of my theoretical framework, including the work of Piaget, von Glaserfeld, Steffe, Vygotsky, Sfard, Thompson, Confrey, Salomon, and Pea.

My own theoretical framework has been enriched by the work of many others too numerous to mention, as well as to those already cited. It could be characterized as an interactionist perspective which attempts to combine elements of the various epistemological positions, including those of constructivism and cognitive science, as well as sociocultural perspectives such as those espoused by Vygotsky, epistemological pluralism, and distributed cognition. Knowledge is viewed, not only as an organization

of interiorized actions in the Piagetian sense, but also as an organization of possible interiorized social interactions. Knowledge is both an acquisition and a process of acquiring by the individual, shaped and modified by reflective abstraction and by social interactions in which shared meanings and insights are generated. Knowledge is believed to be organized, composed of various conceptual structures whose nature and construction reflect the influences of Skemp and Davis, as well as those of Tall and Vinner. Perceptions are categorized by selective sampling of properties based on an individual's value criteria. The processes of construction, organization, and reconstruction of knowledge are thought to be impacted by the brain's architecture, as well as by the experiences and environment in which learning occurs. In the following sections of this chapter, I present this theoretical framework in greater detail.

3.2 Conceptual Structures

Robert Davis once used the term *cognitive collage* to describe a knowledge representation structure: "...a frame or any other knowledge representation structure actually is: A single piece of knowledge in the mind is, in fact the cognitive equivalent of a collage" [Davis, 1984; p. 154]. A *collage* is defined as "an artistic composition of materials and objects pasted over a surface, often with unifying lines and colours" [American Heritage Dictionary, 1982, p. 291]. The notion of *cognitive collage* as a metaphor to describe the processes of knowledge construction and the results of those processes resonated within me. I regularly use metaphors to think with. I use metaphors to communicate my thoughts to others. I use metaphors in my teaching, a practice that was documented by a colleague whose dissertation focused on the use of metaphor in the mathematics classroom [Currie, 1993]. The use of *metaphor* (i.e., the mapping of one thing to another in a different domain), to think with as well as communicate with, is accepted by researchers in different domains [Skemp, 1987; Davis, 1984; Lakoff, 1987; Edelman, 1992; Roth, 1996].

Davis [1984] claimed that one of the most powerful tools for knowing something is the metaphor:

In order 'to think' about abstract matters we make use of our cognitive collages. But this means that, since we use these collages, built up from primitive origins, in order to do our thinking, these collages themselves must play a major role in shaping our thinking.... Quite apart from shar-

ing any ideas with anyone else, *we use metaphors within our own minds in order to be able to think* [Ibid., p. 178].

He credits Lakoff and others with clarifying the true role of metaphor as an essentially conceptual tool for knowing something. Edelman justifies the use of metaphor and argues that the symbols of cognition must match the conceptual apparatus contained in real brains, and that when symbols fail to match the world directly, human beings use metaphor and metonymy to make connections, in addition to imagery and the perception of body schemes [Edelman, 1992, p. 139].

Davis' description of a *cognitive collage* evoked memories of an earlier time, when I was a juried artist and taught courses in drawing and painting. The expression, *cognitive collage*, recalled to mind images of the paintings of Margo Hoff, a contemporary and friend of Louise Nevelson, the New York sculptor. Many of Margo's later works were large collages constructed of painted pieces of canvas assembled into images that conveyed a sense of place and of experiences recalled to memory and immediately recognized—arrangements of fantastic colours and shapes—that are as vivid in my mind today as when I first saw those works nearly twenty years ago. As I moved from collage to collage, my reactions were—"Oh course!" and "Yes! That's what it feels like!" Her paintings gave shape and substance to episodic memories of places and experiences long-forgotten and now recalled.

I also recalled the paintings of Martyl, a Chicago area artist whose work has been shown at the Royal British Artists Gallery, London, as well as in galleries and museums throughout the United States. An extraordinary woman, she was the art editor for the *Bulletin of Atomic Scientists*, founded at the time of the first atomic bomb to confront the social and political consequences of the work of a group of nuclear physicists, one of whom was her husband, Alexander Langsdorf. When I first met her, she was semi-retired, teaching only the Masters' Course in Painting at the Art Institute. Despite her last minute preparations for a trip, she took time to critique my work and to give me a tour of the marvellous house she and Alex lived in, designed by Mies Van de Rohe, the day before she left for Greece. Her collage paintings, particularly her series entitled "Islands," consisted of assembled painted bits and pieces of paper which transported this viewer to places of mystery, of serenity, and of wonderment. A collage, in the hands of an artist, is much more than a haphazard arrangement of photo-

graphs commonly thought of as a “collection of pictures on the refrigerator door.” It is truly an artistic composition of bits and pieces assembled into a cohesive whole, with unifying lines and colours that resonate with the viewer, modifying his/her experiences consciously and in ways that one is not aware of until later—sometimes much later.

The process of assembling bits and pieces into a coherent organized whole is a wondrous thing—as is the process of learning and developing understanding. The term, *cognitive collage* to describe the process of constructing cognitive structures is so apt—knowledge is indeed assembled from bits and pieces, usually incrementally, though sometimes by chunks, organized into a coherent whole that makes sense—at least to the person who constructed it. Extending the metaphor to our classrooms, each student is a more or less capable artist—each creates his/her own cognitive collages. It is our task as teachers and researchers to interpret and understand the external, observed lines and colours of our students’ internal assemblages of bits and pieces of knowledge—their cognitive collages.

3.3 Cognitive Collages, Concept Images, and Cognitive Units

The theoretical framework which guided the research reported in this dissertation is itself a *cognitive collage*: i.e., a metaphorical characterization of a conceptual framework of cognitive structures which includes complex networks of schemas, concept images, and cognitive units, flexibly linked together by highly individual paths, with varying hierarchical levels, degrees of compression, and flexibility. The term *concept image* is used here to mean everything associated with the concept name, including mental images, properties, processes, contexts of applications, etc., as defined by Tall and Vinner [1981]. A *cognitive unit* consists of those bits and pieces of knowledge chunked together that can be held in the focus of attention, (i.e., held in working memory), which acts as the cue for retrieval and selection of the schema which determine subsequent actions or those facets of a concept image needed for the task at hand. It is used in the present study in a modified sense of Barnard and Tall, who define it to be “a piece of cognitive structure that can be held in the focus of attention all at one time” [Barnard & Tall, 1997, p. 41].

The notion of conceptual categories structured in some manner is not a new idea in mathematics education research. A *schema* is a very stable, refined cognitive collage. It can be a cognitive unit or a concept image which has been carefully shaped and refined with use into an effective tool for organizing and retrieving stored knowledge. A schema can also be used to organize and assimilate new knowledge into an existing cognitive structure. According to Skemp, schemas are sources of the plans that form the basis of skills, along with genetically-programmed plans of actions and plans of actions learned as habits. He defines skill as the combination of having a plan and being able to put it into action [Skemp, 1987, p. 126].

Different aspects or parts of these more complex cognitive structures are evoked, depending upon the cue(s) that trigger retrieval and selection of that part of the concept image or schema deemed relevant for the task at hand. This complex network of schemas, concept images, and cognitive units is perceived as an increasingly complex cognitive collage, uniquely and dynamically constructed over time, as new knowledge is added onto and assimilated into an existing cognitive collage.

3.4 Path-Dependent Logic

This metaphorical characterization of a conceptual framework is consistent with a cognitive approach that takes account of the development of knowledge structures and thinking processes of the individual student in dynamic equilibrium with his/her environment. The notion of a conceptual framework, characterized metaphorically as a *cognitive collage*, provides a means of describing and characterizing the way in which students construct new knowledge and grow in their understanding of mathematics. Cognitive units, concept images, and schemas are all cognitive collages (i.e., cognitive structures). *Cognitive units* can be compressed chunks of more complex collages or a particular feature/property of the perceived object or action that is the initial focus of attention. Concept images and schemas, which, as they grow in interiority and become more complex, are not able to be held as a unit in working memory.

How do you interpret $-x$? Do you say “the additive inverse of x ,” or “the opposite of x ” or “negative x ”? If you read $-x$ as “the additive inverse of x ” or “the opposite of x ” what comes to mind—a process (taking the additive inverse) or an object (negative number)? How do you think students interpret the symbol $-x$? Is their interpreta-

tion dependent upon the words used with the symbol(s)? What concept image do various students have? Do they see two symbols, $-$ and x , or one symbol, $-x$?

What students' perceive initially and the processes by which they construct their knowledge were subjects of this study. One's initial *focus of attention*, i.e., the perceived object which activates a particular cognitive unit, directs the path of categorization which results in the selection and retrieval of a specific schema or concept image. Tall argued that "As the learner restructures his mathematical schema to understand these [mathematical] ideas, cognitive conflict is bound to occur. It can give rise to path-dependent logic, in which the learner can give different answers to the same questions depending on the path of approach to that question" [Tall,1977, p.1]. However, this researcher believes that path-dependent logic is also dependent upon the nature of the individual's processes of constructing and organizing knowledge which constrain the ability to flexibly alter one's existing cognitive structures. It is argued that one's initial focus of attention activates path-dependent logic by retrieval of conflicting schemas without necessarily giving rise to cognitive conflict and the restructuring of those existing schemas.

Consider students' difficulties interpreting the ambiguity of the minus symbol when their arithmetic understanding of this symbol remains unchallenged. Where a number is concerned, such as -3 , the value is negative. Later, when numbers are replaced by variables, e.g., $-x$, the student's arithmetic schema needs to be restructured. Students are generally taught that "we don't like to start an algebraic expression with a minus sign," thus when we write $y = mx + c$, for $m = -1$, we tend to write $y = c - x$, and avoid confronting the ambiguity directly. However, the problem really begins to surface when students encounter quadratic functions. What is the difference between $y(x) = -x^2 + 1$ and $y(x) = 1 - x^2$? There is a real ambiguity here, which is decided more by intuition than by logic. Is $-x^2$ equal to $-(x^2)$ or $(-x)^2$? When evaluating a quadratic function such as $y(x) = -x^2 + 1$ for $y(-3)$, is -3^2 equal to $-(3)^2$ or $(-3)^2$? Mathematicians, using the traditional power notation, interpret the algebraic expression $y = -x^2$ as $y = -(x^2)$, when given a negative number input. The graphical representation of $y = -x^2$ is generally described as "the opposite of the graph of $y = x^2$."

Computer scientists interpreted $y = -x^2$ as $y = (-x)^2$. However, in recent years, the Texas Instruments graphing calculators (TI-81, TI-82, and TI-83) have been pro-

grammed to implement the mathematician's intuitive, traditional power notation interpretation in their software. These calculators include separate keys for the binary operation of subtraction and the additive inverse. Entry of -3^2 yields an answer of -9 , but entry of $(-3)^2$ results in a positive-valued answer, 9 . Inclusion of both keys, with their different functionality, places the burden of interpretation on the user, as well as focusing attention of the need to understand the role of context and grouping symbols.

This is an example of a situation in which the use of technology requires mathematicians to clarify their own understandings and reexamine their assumptions, as they integrate the use of these technological tools into their courses. Use of these graphing calculators necessitates explicit acknowledgment of the ambiguity of the notation, as well as a rethinking of what activities might be appropriate to create cognitive dissonance which has the potential to effect reconstructions of students' inadequate arithmetic schemas and in their understanding of the minus symbol. The reform curriculum includes investigations designed to create cognitive dissonance, with explicit discussion of the ambiguity of the minus symbol, particularly when the graphing calculator is introduced. The materials use the traditional mathematical interpretation in which $-x^2$ is understood to mean $-(x^2)$.

The fact that students experience no cognitive conflict when executing procedures suggests that they routinize the procedures, developing mechanical skills, not cognitively-based skills, which contributes to the lack of flexibility. This inflexibility impacts the path of approach to the categorization, selection and retrieval of concept images and/or schemas. Individuals build up their mental images of a concept in a way that may not always be coherent and consistent. Consider the example of students who have learned a process incorrectly and do not experience cognitive conflict when the context is changed. Students frequently write t^2-4 , when asked to square the binomial $(t-2)^2$. They generally fail to recognize that the same process of squaring a binomial is invoked when they are given a quadratic function such as $f(x) = x^2-3x+5$, and asked to evaluate $f(t-2)$. They fail to execute the procedure correctly in the second context as well as in the first instance, sometimes writing $t^2+4-3t+12+5$ in the second instance, while writing t^2-4 in the first instance. Two different, incorrect answers to the same task, the second embedded in a context different from the first, is indicative of path-dependent logic and a compartmentalization of knowledge.

The students experience no cognitive conflict. When interviewed, the students expressed surprise that they were being asked to square a binomial as part of the process of evaluating a function. They readily admitted that they had not recognized the process of squaring a binomial embedded in the evaluation of a function. In fact, they were unaware that they had given two different answers, both incorrect, for squaring a binomial, until, during the interview, they examined their work and reflected on what they had previously written. It is conceivable that students' inconsistent responses are based on the path of approach based on their initial perception and categorization, resulting in retrieval of different frames [Davis, 1984], or because of the schema utilized [Skemp, 1987].

3.5 **Concept Maps: Representations of Cognitive Collages**

There are those who would argue that it is not possible to characterize a student's internal representations by any external means and that the current discussion of internal vs. external representations is a source of on-going debate. I tend to agree with Rumelhart and Norman's definition of representation: "a *representation* is a something that stands for something else, a kind of model of the thing represented [Rumelhart and Norman, 1985; p.16]. *Internal representation* is used in the sense defined by Goldin and Kaput [1996] to refer to "possible mental configurations of individuals, such as learners" [Goldin, 1996, p. 399]. Such configurations are not directly observable. The experience of metacognitive awareness is inevitably imperfect and incomplete, directly accessible only to the person who experiences it when describing his/her own mental processes.

Goldin and Kaput [1996] argue that it is not a requirement of a scientific theory that its every component be directly observable, only that it have consequences that are observable. The *external representation* of a concept map is an observable representation of the student's internal cognitive collage at a given moment in time. In the process of creating the concept map, the student is engaged in a metacognitive activity that shapes and modifies the individual's understanding of what s/he knows as the map is being constructed. The following student's response, written as part of her portfolio evaluation at the end of the semester is typical:

Concept maps have helped me see how things are connected and what they have in common. For example, while I was doing my concept map for FUNCTION, I remembered that from an arithmetic sequence you can get either linear or quadratic. I never really saw it that way, because for linear you need the 1st finite difference and for Quadratic you need the 2nd finite difference.

Student ZH

The process of constructing concept maps by students is a means of engaging students in metacognitive activity that does indeed shape and modify the individual student's understanding of what s/he knows. Those maps, triangulated with other data, enhance our understanding of students' processes of knowledge construction and provide a representation of the process of construction and the structure of the resulting cognitive structures. Hatano [1996] argues the case for the ongoing usefulness of general accounts of aspects of cognition, notably expertise and knowledge representation. He suggests that "some restructuring is needed in order to proceed to a more advanced version of mathematics, and that many dropouts in mathematics are due to failure to restructure...Students' initial understanding of a mathematical concept could be considerably different from its mature, if not final form" [Hatano, 1996. p. 208]. His comments lend credence to the use of student's concept maps as a means for reflection and connection-making on the part of students. The growing body of evidence on the efficacy of using concept map data suggests that the use of concept maps is a viable, alternative means of documenting students' growth in mathematical understanding and their processes of knowledge construction, organization, and reconstruction.

3.6 Concept Maps: Tools for Instruction and Analysis

Though students' conceptual frameworks and their knowledge representation structures are not directly observable, a focus of this research was to document mathematical growth and understanding during a sixteen-week semester course and to provide evidence of the nature of the knowledge construction process, albeit imperfectly. Much human activity is goal directed. This implies that if we want to understand what people are doing "we need to go beyond the outward and easily observable aspect of their actions and ask ourselves what is their goal....To limit a description of what was happening to the observable behaviors, superficially very different, would be to miss what they had in common, namely the goal state" [Skemp, 1987, p. 104]. Students'

concept maps are considered an external means of documenting the process of assembly, i.e. the construction of cognitive collages (knowledge representation structures), particularly as this construction occurs over time. They provide visual evidence of the processes by which students organize and integrate new concepts and procedures into their existing conceptual frameworks and can reveal the presence of inappropriate concept images and connections.

The use of concept maps as an instructional tool and as a research tool has been cited in the literature [Skemp, 1987; Laturno, 1994; Park & Travers, 1996]. Skemp credits Tollman with the notion of a cognitive map, which is used by Skemp as a transitional metaphor generalized into the concept of a schema, i.e., a particular knowledge structure. For Skemp, *schemas* are “mental models which embody selected features of the outside world” which can be represented as “cognitive maps” used as a transitional metaphor of conceptual structures [Skemp, 1987, pp. 108–109].

Skemp used cognitive maps to clarify the process of concept formation and for the purpose of planning instruction—identifying various skills and the sequencing of those skills necessary for the development of a particular mathematical concept [Skemp, 1987]. The use of concept maps in this study differs from that of Skemp, in that it is the students who are constructing the maps, not the instructor. The purpose is also different. In this study, concept maps were used to reveal characteristics about the nature of students’ knowledge construction processes, not for purposes of planning instruction. Laturno used concept maps as a mean of instructional assessment. Park & Travers used them as a comparative research tool, contrasting the maps of students with those of an ‘expert,’ a use of concept maps typically described in the research literature of the sciences. The studies cited, including those of Laturno [1994] and Park & Travers [1996], used quantitative methods of analysis and assign point values to various map components.

Qualitative methods for analyzing students’ concept maps were developed for this study, in contrast to the quantitative methods of analysis used by Laturno, Park & Travers, and those reported by researchers in the science literature. In an attempt to more clearly identify the underlying structure of students’ concept maps, schematic diagrams of each of the three concept maps were constructed by the researcher for each of the eight students in the two groups of extremes. Analyses of the concept maps

and their corresponding schematic diagrams, which have the labels and the highly idiosyncratic quality of the lines and handwriting of each student eliminated, permit the viewer to more easily compare the maps created by an individual student in week 4 with his/her later maps of week 9 and week 15. This method of presentation clearly reveals the underlying structure of each map for a given student, as well as documenting the changes in structure that have occurred over time. It also allows for a more focused comparison of the maps of one student with those of another student.

3.7 Thesis and Research Questions

This study investigated the nature of the processes of knowledge construction, organization, and reconstruction and the consequences of these processes for a population of undergraduate students enrolled in a remedial algebra course, a population generally assumed to be relatively homogeneous. The strategies students employed in their efforts to interpret and use ambiguous mathematical notation and their ability to translate among various representational forms of functions were also subjects of study. It is hypothesized that divergence and fragmentation of strategies occur between students of a undergraduate population of students who have demonstrated a lack of competence and/or failure in their previous mathematics courses. It was expected that the divergence between those who were more successful and those who were least successful would be observable, though the divergence would probably be less pronounced than that reported by Gray & Tall [1994], given that the population of the study generally consists of students in the 45–75% range of a typical high school graduating class.

Given a population of undergraduate students who were previously unsuccessful in their mathematics course(s) or who are underprepared to enroll in the subsequent course, the main research question related to this thesis is addressed:

- does divergence and fragmentation of strategies occur among undergraduate students enrolled in a remedial algebra course who have previously been unsuccessful in mathematics?

The study investigated students' ability to think flexibly, to recognize the role of context when interpreting ambiguous notation and symbols, the development of greater confidence and a more positive attitude towards mathematics. Two other questions

were addressed which asked whether students classified as 'less able' and/or 'remedial,' could, with suitable curriculum:

- demonstrate improved capabilities in dealing flexibly and consistently with ambiguous notation and various representations of functions?
- develop greater confidence and a more positive attitude towards mathematics?

In order to explain *why* the phenomenon of divergence occurs, it is also hypothesized that successful students construct, organize, and reconstruct their knowledge in ways that are qualitatively different from those of students least successful and that *how* knowledge is structured and organized determines the extent to which a student is able to think flexibly and make appropriate connections. The inability to think flexibly leads to the fragmentation in students' strategies and a resulting divergence that is both quantitative and qualitative, between those who succeed and those who do not. These processes of construction, organization, and reconstruction are constrained by a student's initial perception(s) and the categorization of those perceptions which cue selection and retrieval of a schema that directs subsequent actions and thoughts. The research question related to this thesis is:

- do students who are more successful construct, organize, and restructure knowledge in ways that are qualitatively different from the processes utilized by those who are least successful?

3.8 Summary

The theoretical framework, along with a statement of the two major theses and related research questions were presented in this chapter. Both the theoretical framework and theses are situated within the existing body of related research which considered the divergence that occurs in mathematics classrooms between students who succeed and those who fail. The present study extends the existing body of research to investigate whether students who are successful construct conceptual structures that are qualitatively different from those constructed by students who are unsuccessful.

*Grant me intention, purpose, and design—
That's near enough for me to the Divine.
And yet for all this help of head and brain
How happily instinctive we remain,
Our best guide upward further to the light,
Passionate preference such as love at sight.*

– Robert Frost, *Accidentally on Purpose*

4.1 A Piagetian Paradigm Extended

Skemp defines a methodology as “a collection of methods for constructing (building and testing) theories, together with a rationale that decides whether or not a method is sound. This includes both constructing a new theory *ab initio*, and improving an existing theory by extending its domain or increasing its accuracy and completeness” [Skemp, 1987, p. 130]. The collection of methods used in this study include (a) quantitative methods of data collection used to indicate global patterns that could be generalizable across populations to document changes in students’ beliefs and to measure improvements in their mathematical competencies; and (b) qualitative methods that add depth and detail to the quantitative studies and allows the researcher to focus on the individual student within the broad-based context of the quantitative studies.

The research described in this thesis is an extension of the teaching experiment based on the constructivist methodology of Steffe (as cited in Skemp, 1987, p. 136). Extended teaching experiments have typically involved students in elementary grades [Steffe & Cobb, 1988; Steffe, von Glaserfeld, Richards and Cobb, 1983; Skemp, 1987]; or students in grades 6–12 [Confrey, 1991, 1993; Heid, 1988a; Thompson, 1996; 1994]. One aim of this research is to extend the teaching experiment approach to undergraduate classrooms in which students are enrolled in non-credit remedial algebra courses that are prerequisite for the vast majority of college level mathematics courses. The methodology of this study acknowledges the relations between instruction and learning. However, working from a cognitive perspective, the purpose of this study is to make and test hypotheses about the nature of students’ processes of constructing, organizing, and assimilating new knowledge into their existing cognitive

collages of conceptual structures, seeking evidence that changes in outward behavior index changes in internal representations. The effect the learning environment had on the performance of individual students is considered, but was not a primary focus of this research.

Skemp [1987] suggests that distinguishing between what has been learned with understanding and what has just been memorised requires a combination of a teaching situation and diagnostic interviews. It is the combination which offers opportunities for inferences both about the states of students' schemas at various stages in their learning and about the process by which they progress from one stage to another. To what extent is this possible and practical for classroom instructors? As both researcher and instructor of the course during the preliminary and main classroom-based studies, one of my goals was to develop a plan of research, together with data collection instruments which could be utilized by classroom instructors who are interested in the mental processes of their students. For many teachers, the situation in which clinical interviews are conducted with selected students is neither practical nor possible. Opportunities to construct theory and develop curriculum provide instructors with opportunities to develop their own theoretical understanding in close relation to their own experience and classroom needs, using the basic tenets of constructivism as guiding principles to build models of the realities of our students with whom we interact, constructing our own understanding of our students' understanding of the mathematics they are learning.

4.1.1 Research Design: Method and Data Collection Instruments

Sfard [1991] has pointed out, "It is easier to show what students cannot do rather than what they think and imagine." In order to distinguish between students who construct cognitive collages that include meaningful connections between new and existing knowledge conceptual structures and demonstrate the ability to think flexibly and those who do not, a modified grounded theory approach to evaluation of data and generalization of theory arising out of the analysis of data taken from a variety of contexts is used. The quantitative preliminary studies included a broad-based field study involving 237 students at 22 sites in several states and a classroom-based study at the site where the main study was to be conducted. A preliminary qualitative study was

also conducted at the site of the main study. Methods of data collection included (a) pre- and post-course surveys; (b) pre- and post-course tests; (c) student work collected throughout the semester which included, in addition to the problems assigned, students' descriptions, explanations, and reflections on their work, (d) task-based interviews; and (e) student-created concept maps. Questions included in the pre- and post-course tests used a variety of representational forms designed to test students' ability to think flexibly and to go beyond execution of procedural rules to document characteristics of higher-order student understanding, using a Krutetskian model [Krutetskii, 1969].

Quantitative data (the pre- and post-course self-evaluation surveys and tests, together with student work collected during the semester) were analysed to identify areas of focus. Qualitative methods and data (task-based interviews with individual students twice during the semester—midterm and at the end of the semester—and student-created concept maps) are expected to add depth and detail to the quantitative studies where the results indicate global patterns that could be generalizable across populations. A goal of this research is to identify some of the quantitative and qualitative characteristics of students' growth in their understanding of mathematics and in their ability to interpret and use ambiguous mathematical notation. It is predicted that there exist both quantitative and qualitative differences in the strategies and construction processes used by undergraduate students of an undergraduate remedial population. It is the nature of these differences that is the main focus of investigation.

Skemp's criteria of adaptability and Krutetskii's structure of mathematical abilities were used as the models of the research design to analyze the strategies and processes of knowledge construction used by students at the extremes of an already stratified population. Krutetskii [1969] studied the extremes of various elementary-age groups in their studies of students' ability to generalize, to think flexibly, and to curtail reasoning. Students in the mid top third and mid bottom third of a population of children ages 7–12 were studied by Gray and Tall [1994] and Gray and Pitta [1997]. They documented qualitative differences in the strategies employed by the more able and those less able students. This research extends this approach to examine whether undergraduate remedial students experience a divergence as a result of using qualitatively different strategies.

4.2 Triangulation

Drop-out and withdrawal rates in the developmental courses typically range between twenty-five and fifty percent. Since it is not possible to predict with any certainty which students will still be in class and part of the study at the end of the semester, and since this study has as its focus investigating the nature of students' developing understanding and processes of knowledge construction over time, the selection of students to be profiled was not done until after the semester ended. In an attempt to clearly distinguish characteristics differences between those students who succeed and those who do not, the decision was made to analyse in depth the data of those students categorized as *more able* and those categorized as *less able*.

Results of the pre-and post-test questionnaires, together with results of the open-response final exam and departmental final exam were used to rank the students. Those categorized as more able were the top fifteen percent of the ranked students and those categorized as less able were those ranked in the bottom fifteen percent of the class at the end of the semester. Follow-up interviews and analysis of their strategies and concept maps are used to develop profiles of each of these two subgroups of the class. The accumulated data is analyzed and interpreted within the theoretical framework described in the preceding chapter. Profiles of two students are developed.

Gray and Tall (1994) reported on the qualitative differences in strategies used by students aged 9–12, as did Krutetskii [1969]. A difference between these earlier studies and the present one is that the populations of their research were assumed to be a fairly normally-distributed population of elementary-grade students. The population participating in this research consists of undergraduate students enrolled in undergraduate remedial algebra courses who have (1) failed the course previously, either at college or in high school; (2) have taken the course previously and passed—but were unable to pass a placement exam that qualified them to enroll in a college-level mathematics course; or (3) took the course several years ago and need to review their skills, having forgotten much of what they once knew.

Various types of triangulation were used: data triangulation, method triangulation and theoretical triangulation [Bannister et al., 1996, pp. 146-148]. The need to collect data from different participants at different stages in the activity and from different sites of the setting (*data triangulation*) is addressed by collecting data of all stu-

dents in the classroom setting and in the interview setting at different times during the semester. The pre- and post-course attitude surveys and curriculum materials were used in a broad-based field study. Pre- and post-course self evaluation surveys were used in all three studies: the field study, the preliminary classroom study, and in the main study. Responses of the main study participants are situated within the framework and analysis of the broader-based field study and compared with the preliminary study data as well. Different methods are used to collect information (*method triangulation*). Written surveys, pre- and post-test questionnaires, task-based interviews, student work and concept maps are the instruments used in the collection of data. Several questions asked on the pre- and post-test questionnaire are also included on unit exams, and on the final exam to allow comparisons among instruments, question formats and contexts, and consistency of performance and strategy by individual students over time.

Theoretical triangulation is used in an effort to avoid the limitations that result when explanations rely on a single theory. The theoretical framework used in the analysis of data presented in this dissertation is situated within the theories and research of Skemp [1987]; Davis [1984; 1992, 1996]; Krutetskii [1969]; and Gray and Tall [1994]. The theoretical framework in this dissertation also draws from the work of Salomon and Pea [1993]; Confrey [1993], and Jones [1992] as well as many others (theoretical triangulation). The recent research on the brain, categorization, and perception by Crick, [1994]; Dehaene [1997]; Edelman [1992]; Lakoff [1987]; Kosslyn [1994]. and Roth [1995] offers a broader framework in which data can be analyzed and interpreted. Efforts to integrate the quantitative and qualitative techniques used in this research and to validate the results of each type of data collection lends confirmation to and strengthens the thesis.

4.3 Variables to be taken into Consideration

In any research project, there are factors which should be taken into consideration when examining the results. The subjects of this research have prior histories consisting of a variety of experiences, not all of which can be known or discovered by the researcher. We start with bits and pieces of a complex jigsaw puzzle, and hope to add a few more pieces here and there. Utilizing an appropriate research design based on an

articulated theoretical framework, maintaining persistence in the search for answers and analysing the data to distinguish the significant from the insignificant, the researcher hopes to contribute to the existing body of research on how students think and the processes by which they construct knowledge to develop understanding.

4.3.1 Prior variables

Prior variables consist of factors that already exist such as students' backgrounds, their attitudes, cognitive preferences, competencies, and concept images constructed appropriately and inappropriately. In this study, the prior variables are the students enrolled in a reform developmental algebra course at a community college that is the site of this research. These students have been described as victims of the "proceptual divide," classified as "less able" by virtue of the fact that they are enrolled in a remedial algebra course. Many of these students have taken the course previously and have failed, either to complete the course or to develop sufficient competency and understanding to successfully complete a subsequent college-level mathematics course. Their prior experiences with mathematics have led them to believe that mathematics is a collection of meaningless rules and procedures to be memorized [Davis, 1989; Keller & Hirsch, 1994; Krutetskii, 1976; Gray & Tall, 1993; McGowen et al., 1995; Tall & Razali, 1993, Vinner, 1997]. The focus has been on instruction that contributes to instrumental understanding [Skemp, 1987], through the teaching of endless skills and procedures, reinforced by the vast majority of text materials used in high school and college classrooms today. Instructors who teach this course express amazement and frustration that so many students have completed their high school mathematics courses and have entered college with so little mathematical understanding. The prior variables of students' already formed cognitive units, concept images, and schemas assembled into highly individual cognitive collages are a focus of investigation and examination in the main study. The broad-based preliminary studies investigate some of the prior variables such as students' backgrounds, attitudes, and existing concept images before undertaking the main study.

4.3.2 Independent variables

The independent variables of this study include the “reform” curriculum as described below, with the extensive use of technology. The curriculum that serves as an independent variable is the intended curriculum. Students are required to purchase a graphing calculator (the TI-82 or TI-83 graphing calculator) since the text integrates use of the calculator as a tool to explore mathematics extensively. Instructor decisions to supplement or revise the curriculum based on classroom interactions and diagnosed needs of students relevant to this study are also described.

4.3.3 Intervening variables

Numerous intervening variables must be acknowledged. The first is the role of the student and the role of the instructor in the classroom community. The curriculum used in this study is based on the philosophy that students should be actively engaged in doing mathematics rather than watching someone else (the teacher) do mathematics. Student effort and dedication to the course is a second intervening variable. The subjects participating in this study are young adults (aged 17-20) for the most part, who, typically have varying levels of commitment to academic excellence with respect to the study of mathematics. A majority of them are enrolled as full-time students and work fifteen or more hours a week at an outside job. They enter college unprepared to learn independently or to put forth the sustained effort necessary for reflective learning. The level of commitment to this course varies widely. For those who exert little effort, the outcomes are going to be marginal at best.

A third intervening variable is the implemented curriculum. The number of sections in the text that students actually study, the sequence in which topics are studied, and the time spent investigating various topics significantly impact the formation of the students’ concept images. Students’ concept maps created throughout the semester reveal that students tend to organize their knowledge based on the sequence in which topics are introduced and the emphasis placed on particular topics.

What is assessed, the methods and artifacts of assessment are other intervening variables. The instructor involved in this project believes that assessment should be a learning experience for students as well as herself, and that the purpose of assessment is to provide opportunities for students to demonstrate what they know and understand,

as well as the competencies they have acquired. Efforts to reduce “test anxiety” include giving students opportunities to demonstrate their skills and understanding in a variety of ways. Weekly journals, take-home small group exams and oral exams are used, in addition to individual in-class assessments. The semester grade is determined based on the student’s self-evaluation and defence of a portfolio of work personally selected, which s/he believes demonstrates the competence and level of understanding of the content of the course to support the grade indicated by the student in conference with the instructor.

Students’ use of the technology is another factor that impacts student learning and understanding of concepts. The use of technology not only changes the sequence of instruction but changes the types of skills students need to learn, as well as the nature of the learning process. Students who are already having difficulties coping with learning new mathematical concepts and procedures tend to view the graphing calculator as a tool they reject since it necessitates the learning of more procedures, together with connections to the mathematics they are already struggling to learn. Instead, they may elect not to add to their cognitive burden and continue to depend on rote-learned algorithms, using pencil and paper as their primary tool. As the results of the preliminary and main studies are reported in the following chapters, it is appropriate to keep these variations in mind.

4.3.4 Dependent variables

The key dependent variables are students’ ability to think flexibly, recognizing the role of context and the impact their processes of knowledge construction have on this development. Using a non-traditional text with ready access to powerful graphing technology, does an already stratified population of undergraduate students develop the ability to think flexibly when confronted with ambiguous notation and symbols such as functional notation and the minus symbol used in various contexts? These variables are measured using the instruments previously cited and described in greater detail later in this chapter.

4.3.5 Consequent variables

Students' future success in mathematics courses, long-term changes in attitudes and beliefs about mathematics and in the ability to think flexibly and to reason quantitatively in daily life are consequent variables in this study whose investigation is beyond the scope of this study.

4.4 Data Collection

The data collection instruments used in the main study include pre- and post-course self-evaluation surveys; pre- and post-course tests focused on students' ability to interpret ambiguous notation and translate among various representational forms; student work collected throughout the semester; task-based interviews conducted twice during the semester at mid-term and during the final week of the semester; and student-created concept maps assigned at weeks 4, 9, and 14, with completed maps collected the following week and retained by the researcher. Each of these instruments and the nature of revisions to the various instruments for use in the main study are described in the following sections.

4.4.1 Field Test Study

The field study consisted of three quantitative components: a demographic questionnaire designed to provide some general characteristics of undergraduate students enrolled in a remedial algebra course; pre- and post-course attitude surveys designed to document changes in attitude that occurred during the course; and pre- and post-course student self-evaluation surveys completed during the first and last week of the term, designed to document changes in students' beliefs about their ability to do mathematics. The forms were used during the 1995/96 academic year. Data collected also included task-based interviews with field-site students and instructors, which were video-taped and transcribed.

4.4.2 Field, Preliminary and Main Study Pre- and Post-Course Self Evaluations

Pre- and post course self-evaluation surveys designed to document changes in students' perceptions of their abilities to do mathematics were given to all participating students during the first and last week of a sixteen-week semester course. The pre-

and post-course instruments had been previously tested (1994–1996) and revised during a curriculum implementation field study of the text materials used in the present study. Student responses documented perceived changes in their self-evaluations of their (1) ability to interpret notation and symbols; (2) ability to analyse and interpret data; (3) ability to solve problems not seen before; (4) willingness to attempt new problems; and (5) belief about the usefulness of the graphic calculator to impact their understanding of mathematical concepts and ideas.

The original field study surveys contained nineteen pre- and post-course questions. The surveys were shortened to the twelve question form used in both the preliminary and main studies. Five questions dealing with students' perceptions of their abilities listed above were analysed for this study, as they relate directly to the focus of this research. Data collected from the other questions related to students' perceptions of their ability to work in groups and the extent to which they perceived the course to be more or less interesting than anticipated provide background information about students' beliefs about the classroom environment and their interactions with peers and the instructor in that environment. Both forms of the survey also included two questions relating to attendance and hours spent outside of class on homework.

The pre-course survey was given to students during the first week of class and the post-course survey was administered during the last week of the sixteen-week semester, a few days prior to the final exams. The post-course self-evaluation survey questions are not identical to those used on the pre-course survey. The pre-course survey asked students where they were at the beginning of the semester. The post-course survey asked students if they felt they had improved, rather than asking the question in traditional before and after format. This format allowed students to indicate improvement in their perceived abilities, even if they had high positive attitudes initially. These survey instruments are included in the following section and in Appendix B, Data Instruments, as distributed to the students.

4.4.3 Pre- Course Self-Evaluation Survey

1. About how often did you attend your previous mathematics class?

less than 1	1–3	3–5	5–7	more than 7
1	2	3	4	5

2. IN ADDITION TO the time spent in class, about how many hours PER WEEK did you spend on homework outside of class for previous math classes?

less than 1	1–3	3–5	5–7	more than 7
1	2	3	4	5

3. How would you rate your ability to interpret mathematical notation and symbols at the BEGINNING OF THE SEMESTER?

very poor	somewhat poor	fair	somewhat good	very good
1	2	3	4	5

4. How would you rate your ability to interpret and analyze data at the BEGINNING OF THE SEMESTER?

very poor	somewhat poor	fair	somewhat good	very good
1	2	3	4	5

5. How would you rate your willingness to attempt to solve a problem you have never seen before at the BEGINNING OF THE SEMESTER?

very poor	somewhat poor	fair	somewhat good	very good
1	2	3	4	5

6. How would you rate your ability to solve a problem you have never seen before at the BEGINNING OF THE SEMESTER?

very poor	somewhat poor	fair	somewhat good	very good
1	2	3	4	5

7. Do you feel that the use of the graphing calculator helps, hurts, or does not affect your understanding of mathematical concepts and ideas?

hurt considerably	hurt somewhat	did not affect	helped somewhat	helped considerably
1	2	3	4	5

4.4.4 Post-Course Self-Evaluation Survey

8. About how often did you attend this mathematics class?

less than 1	1-3	3-5	5-7	more than 7
1	2	3	4	5

9. IN ADDITION TO the time spent in class, about how many hours PER WEEK did you spend on homework outside of class for this mathematics classes?

less than 1	1-3	3-5	5-7	more than 7
1	2	3	4	5

10. To what degree do you think this course has improved your ability to interpret mathematical notation and symbols?

not at all	a little	somewhat	a good bit	very much
1	2	3	4	5

11. To what degree do you think this course has improved your ability to interpret and analyze data?

not at all	a little	somewhat	a good bit	very much
1	2	3	4	5

12. To what degree do you think this course has improved your willingness to attempt to solve a problem you have never seen before?

not at	all a little	somewhat	a good bit	very much
1	2	3	4	5

13. To what degree do you think this course has improved your ability to solve a problem you have never seen before?

not at all	a little	somewhat	a good bit	very	much
1	2	3	4	5	5

14. Do you feel that the use of the graphing calculator helped, hurt, or did not affect your understanding of mathematical concepts and ideas?

hurt	hurt	did not	helped	helped
considerably	somewhat	affect	somewhat	considerably
1	2	3	4	5

4.4.5 Pre- and Post-course Tests

In order to document changes that occurred during the semester in students' ability to interpret ambiguous arithmetic (the minus symbol) and functional notation as well as their ability to think flexibly and to translate among various representational forms, a pre-test consisting of twelve questions was given to all students who were enrolled in the Intermediate Algebra course and participated in either the preliminary or main studies during the first week of the sixteen week semester. The post-test, was given to students during the last week of class, a few days prior to the final exam.

The pre- and post tests used in the preliminary study included several questions designed to test student's understanding of the order of operations. Using the results of the preliminary study, the pre- and post-tests used in the main study were shortened. Only one question on order of operations was retained. Questions designed to test student's ability to think flexibly when required to reverse a direct process replaced more unfocused questions of the preliminary study. The pre-test used in the main study consisted of twelve questions. The same twelve questions were used on the post-test, with four additional questions. Individual student's post-test results were shared with each student during an end-of semester task-based interview. Responses of both the pre- and post-test were categorized as (a) correct; (b) no attempt and (c) incorrect and analysed using a Pearson chi-square test with two degrees of freedom and $\alpha = 0.05$.

To provide a quantified ranking of class members for analysis purposes consistent with their overall course grade, post-test responses were combined with the responses to similar questions included on various assessment instruments throughout the semester (journals, unit exams, the final open-response and departmental final exams). The questions presented on various evaluation instruments throughout the year were similar in structure and content, but were presented in different formats (multiple choice, open response, contextual problem situations) and in various representational forms (symbolic—either algebraic notation or functional notation; graphic, and numeric—tables). The total number of correct responses from the various data collection instruments served as the basis, once the course was completed, for classifying those students who were most successful (the top fifteen percent of the participants) and those who were least successful (the bottom fifteen percent of the participants). These rankings were also correlated with students' final course grades.

4.5 Relevance to Main Study Research Questions

The related research question of whether students classified as ‘less able’ and/or ‘remedial,’ could, with suitable curriculum develop greater confidence and a more positive attitude towards mathematics was addressed by the pre- and post-course self evaluation surveys which were designed to document changes in students perceptions of their mathematical abilities. The main thesis research question, which asked whether divergence and fragmentation of strategies occur among undergraduate students enrolled in a remedial algebra course who have previously been unsuccessful in mathematics, was addressed by the pre- and post-course test questions, which were designed to document whether students demonstrated improved capabilities in dealing flexibly and consistently with ambiguous notation and various representations of functions. A goal of the research was to investigate how data based on student responses to questions of this nature could be used to provide information that might help the classroom instructor better understand how students are thinking. The pre- and post-course test questions, were designed to address the main and related research questions, but were also typical of questions students typically encounter in the subsequent course and are generally found on departmental exams.

The twelve questions included on the pre- and post-test given participants in this study were designed to document changes in competence to interpret ambiguous functional notation and symbols (the minus symbol). They also provide data on students’ ability to interpret and use ambiguous notation to:

- evaluate functions using various representational forms (symbolic, graphic, and numeric) and questions stated in different contexts (open response, multiple choice, contextual problem situations).
- write an algebraic representation (a) given the graph of a linear function or (b) the graph of a quadratic function.
- recognize and take into account the role of context when evaluating an arithmetic or function expression.

The twelve categorized pre- and post-course test questions are listed, along with the four additional questions included on the post-test main study questionnaire. Students were instructed to (1) answer the question, (2) write down their first thoughts when they first looked at the question, and (3) to rate their confidence that the response

given was correct. They had the option of using graphing calculators as they deemed appropriate. The main study pre- and post-test forms are included in Appendix B: Data Collection Instruments.

4.5.1 Questions that test students' ability to take into account the role of context when evaluating an arithmetic or functional expression.

1. Evaluate -5^2
What first comes to mind: Confidence
1 2 3 4 5
15. Evaluate: $37 - 5 \div 2 + 4 \times 3$
What first comes to mind: Confidence
1 2 3 4 5
16. Evaluate $(-5)^2$
What first comes to mind: Confidence
1 2 3 4 5
17. Given a function f , what does $f(x)$ represent?
What first comes to mind: Confidence
1 2 3 4 5
18. In the expression $(x - c)$, is the value of c positive, negative or neither?
What comes to mind: Confidence
1 2 3 4 5

4.1.1 Questions that test students' ability to evaluate functions using various representational forms.

19. Given $f(x) = x^2 - 5x + 3$, find $f(-3)$.
What comes to mind: Confidence
1 2 3 4 5
20. Given $f(x) = x^2 - 5x + 3$, find $f(t-2)$.
What comes to mind: Confidence
1 2 3 4 5

Use the given the graph to answer questions 8 and 9.

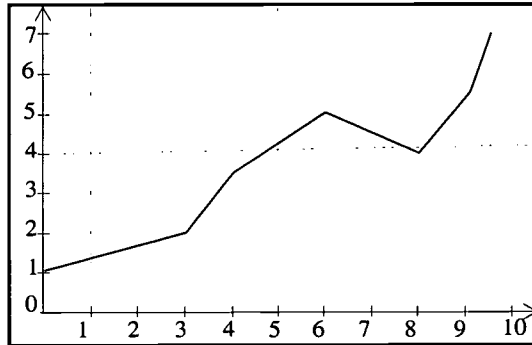

21. Indicate what $y(8) =$ _____

What comes to mind:

Confidence

1 2 3 4 5

22. If $y(x) = 2$, what is $x?$ _____

What comes to mind:

Confidence

1 2 3 4 5

Consider the following tables for functions f and g then answer questions 10 and 11.

x	$f(x)$
1	3
2	-1
3	1
4	0
5	-2

x	$g(x)$
-2	3
-1	1
0	5
1	2
2	4

23. What is the value of $f(g(1))$? Why?

What comes to mind:

Confidence

1 2 3 4 5

24. What is the value of $g(f(5))$? Why?

What comes to mind:

Confidence

1 2 3 4 5

4.1.2 Questions that test students' ability to write an algebraic representation given the graph of a linear function.

25. Write the equation of the linear function given either its table or graph.

What comes to mind:

Confidence

1 2 3 4 5

X	Y ₁
15	15
3	9
0	3
-3	-3
-6	-9
-9	-15
-12	-21
X = -6	

```

WINDOW
Xmin=-3
Xmax=6
Xscl=1
Ymin=-4
Ymax=10
Yscl=2
Xres=1
    
```

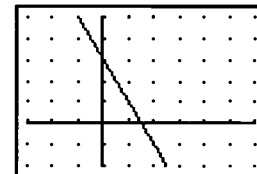

4.1.3 Questions that test students' ability to recognize and take into account the role of context when evaluating a functional expression.

26. Given a function f , what is the meaning of $-f(x) f(-x)$?

What first comes to mind:

Confidence

1 2 3 4 5

27. Given a function f , what is the meaning of $-f(x) f(-x)$?

What first comes to mind:

Confidence

1 2 3 4 5

4.1.4 Questions that test students' ability to write an algebraic representation given the graph of a quadratic function.

The graph of a quadratic function appears below.

```

WINDOW
Xmin=-9.4
Xmax=9.4
Xscl=1
Ymin=-25
Ymax=20
Yscl=5
Xres=1
    
```

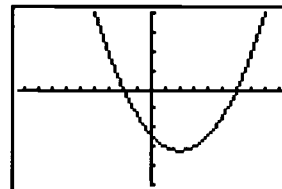

28. (a) What are the zeros of this function?

What comes to mind:

Confidence

1 2 3 4 5

(b) What are the factors of this function?

What comes to mind:

Confidence

1 2 3 4 5

(c) Write the algebraic representation of this function.

What comes to mind:

Confidence

1 2 3 4 5

4.1.5 Main Study Pre- and Post-Test Question Classification

The pre- and post-test questions were classified and analysed using a variety of classification schemas. The table 4.1 below describes the various classification schemes used to categorize the pre- and post-test questions:

Table 4.1: Pre- and Post-Test Question Classification

QUESTION CATEGORY	QUESTION #
Conceptual questions requiring no process	4, 5, 13, 14
Procedural questions requiring process	1–3, 6–12, 15, 16
Flexibility of thinking: reversibility of process	1,3; 8, 9; 10,11; 13,14
Interpretation of the Minus symbol: arithmetic context, process	1, 2, 3
Interpretation of the Minus symbol: functional context, process	6, 7, 13, 14
Interpretation of functional notation: table, process/conceptual	10, 11
Interpretation of functional notation: graphic, process, conceptual	8, 9, 12

4.2 Main Study Interview Question

The purpose of the following question was to establish some triangulation between students' written responses and their verbal responses in an interview setting. Question 16 was included on both the pre- and post test given students participating in both the preliminary and main study. No student answered the question correctly and only three students of the preliminary study attempted to answer the question on the post-test. It was decided to investigate students' perceptions of this question in the main study during end of the course task-based interviews conducted just prior to final exams.

29. Consider the following graphs for functions f and g . The graph of f is the line. The graph of g is the parabola. Approximate the value of $g(f(1))$. Describe how you determined your answer.

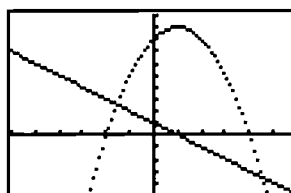
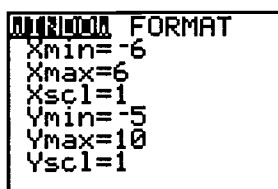

What first comes to mind:

Confidence

4.3 Concept Maps

The second main research question which asked whether students who are more successful construct, organize, and restructure knowledge in ways that are qualitatively different from the processes utilized by those who are least successful is addressed by analyses of students' concept maps and the corresponding schematic diagrams, which provide visual evidence of the processes by which students organize and assimilate new concepts and procedures into their existing conceptual frameworks. The use of concept maps provided a means by which mathematical growth was documented and provided evidence of the nature of the knowledge construction process. Students were asked to construct concept maps on the topic of *Function* in weeks 4, 9 and 15. These maps were collected by the researcher, reviewed with each student and retained by the researcher. Students did not have further access to their maps. It was believed that a later concept map would more accurately reflect the student's conceptual structure at the time the map was constructed, if the student did not have the earlier map to refer to. The concept map instructions used in the main study are included in Appendix C: Student Concept Maps & Schematic Diagrams.

4.3.1 Evaluation of concept maps

In the preliminary study, a quantitative method of evaluation was used to analyse student concept maps using a modified schema based on the evaluation method report by Laturno [1994] in which points for various elements were assigned as follows:

- a) Number of Concepts (1 pt. each),
- b) Levels: 4 maximum (5 pts. each),
- c) Relationships (1 pt. each),
- d) Cross-links (5 pts. each).

4.3.2 Revisions in use and evaluation of Concept Maps in Main Study

As a result of the interview data obtained in the preliminary study, the concept map instructions were revised prior to the main study. Students were directed to record

the elements they planned to use on small post-it notes prior to constructing the map. Once the elements were recorded on sticky-backed post-its, students were encouraged to move them around on paper until the arrangement appropriately reflected groupings and connections the student felt were appropriate. Only after this experimental, planning stage was completed, were students to draw the concept map they planned to submit. The activities of planning and constructing concept maps engaged students in reflective practices and required them to think about appropriate linkages between and among various elements and/or clusters of elements.

The quantitative method of evaluating concept maps used in the preliminary study was rejected after the preliminary study was completed. A goal of this research was to investigate whether qualitatively different strategies were used by the most successful and the least successful students. It was decided that the quantitative method of analysis should be abandoned and a new method of analysis designed. In the main study, schematic diagrams of each map were drawn by the researcher. These schematic diagrams revealed the structural properties of each concept map which was hidden in the complexity and detail of the original maps. This qualitative method of analysis, developed by the researcher, is discussed in greater detail in Chapter 8.

4.4 Instructional Treatment

It is not the purpose of this study to evaluate whether or not the curriculum is a viable alternative to the present traditional curriculum—rather it is described so that student’s behaviors can be examined in the context of the classroom environment. In order to better understand students’ behaviors and interpret students’ concept maps it is necessary to know the sequence of instruction and the topics on which emphasis was placed.

The instructional treatment in the Intermediate Algebra course of this study is based on a pedagogical approach that uses a constructivist theoretical perspective of how mathematics is learned [Davis et al., 1990]. The concept of function is used as an organizing lens throughout the course. Function is initially defined as “a process that receives input and returns a unique value for output” [DeMarois, McGowen, & Whitkanack, 1996, p. 92]. Each function is based in a problem situation. Functions are investigated numerically, graphically, and with function machines before the symbolic

form is created. Tables, equations, graphs, function machines, verbal and written descriptions are all used to analyse functional relationships and to explore the duality and ambiguity of mathematical notation. Function machines are a visual tool used to help students focus attention on the processes involved as they interpret and analyse functions; identifying input, process and the resulting output. Small group work is an integral component of the learning environment, both in and outside the classroom.

Students are introduced to functions and relations in the context of investigations of measures of central tendency and variability. Arithmetic and geometric sequences, with ordered lists as inputs lead to the study of linear, exponential and quadratic functions. Linear and exponential functions are introduced as sequences, characterized by constant first finite differences (linear functions) and constant finite ratios (exponential functions). Quadratic functions are subsequently introduced as sequences characterized by constant second finite differences. Finite differences and finite ratios were used to analyse numerical tables of data in order to determine parameter values of the algebraic representation that described the relationship. Given a table of values, or given a problem situation in which they need to construct a table of values, students analyse the data to determine whether it models a linear, an exponential or a quadratic function. After identifying the general form of the appropriate model, they are expected to determine the parameter values and a specific algebraic model suitable for the problem situation which they use to answer questions about the problem situation. Rational, radical, and logarithmic functions are subsequently studied.

Skills are taught and practiced as needed in the context of the problem situation. Students are encouraged to become more independent learners, with a resulting shift away from negative attitudes about themselves and mathematics and from expecting teachers and the text to provide all of the answers. Typically, class starts with students in small groups discussing the investigations done prior to class, followed by whole class discussion, with clarification of the difficulties encountered as necessary. Lectures by the instructor generally consist of introducing new topic investigations or are directed towards focusing students on identifying the main concepts and skills, providing them with focused opportunities to make connections. Students are expected

to take responsibility for their own learning, to reflect upon their understandings of mathematical concepts, and to justify their responses both verbally and in writing.

The curriculum was designed to utilize the graphing calculator (TI-82 or TI-83) in pedagogically sound ways. It is viewed as a tool to foster mathematical thinking using activities which generate cognitive dissonance, causing students to re-examine existing beliefs and practices. The graphing calculator is used to investigate problem situations using graphical and numerical representations of a given function linked to its algebraic representation, frequently along with function machine representations. The integration of graphing calculator technology into the curriculum resulted in a different sequence and choice of topics, with skills taught as needed in the investigation of problem situations.

4.5 Summary

The research methodology and the rationale for the various data collection instruments were described in this chapter. The data collection consisted of three major components: a broad-based field study designed to provide data used to develop a profile of undergraduate students enrolled in a remedial algebra course; a classroom-based study, with both a quantitative and qualitative component; and the main classroom-based study, which also included a quantitative and a qualitative component.

Prior variables of students' beliefs and attitudes were established by means of demographic surveys in both the preliminary and main studies. Changes in those prior variables were documented using pre- and post-course self-evaluation surveys. The quantitative and qualitative components of the main study was designed to address the two main theses. The first thesis, whether divergence and fragmentation of strategies occur between students of a undergraduate population of students who have demonstrated a lack of competence and/or failure in their previous mathematics courses, is examined both quantitatively and qualitatively. Pre- and post-test questions were designed to examine this thesis and to provide data to address the related research questions of whether students classified as 'less able' and/or 'remedial,' could, with suitable curriculum: (a) demonstrate improved capabilities in dealing flexibly and consistently with ambiguous notation and various representations of functions and (b) develop greater confidence and a more positive attitude towards mathematics.

The data collected by means of these instruments were triangulated, with students' classwork and with interview data, using data, method, and theoretical triangulation. Profiles of two students, representative of the two groups of extremes, the most successful and the least successful were developed, using the theoretical framework described in the previous chapter. More detailed descriptions of the data collection methods and results of the preliminary studies and main study are provided in the following chapters.

The second thesis, that successful students construct, organize, and reconstruct their knowledge in ways that are qualitatively different from those of students least successful was examined using the profiles of two students representative of the two groups of extremes, those most successful and those least successful. Their processes of knowledge construction and restructuring were investigated by means of student-constructed concept maps, which documented these processes. The schematic diagrams of each concept map of the individual students in each group of extremes, provided a means by which the underlying structure of students' concept maps could be revealed and the maps done over time could be compared. Efforts to develop a qualitative method of concept map analysis resulted in an updated review of literature which helped clarify the research questions used in the main study. This qualitative method is discussed in greater detail in Chapter 8.

*Precipitately they retired back cage and instituted an investigation
On their part, though without the needed insight. They bit the glass and
listened for the flavor. They broke the handle and the binding off it.
...Who said it mattered what
monkeys did or didn't understand? They might not understand a
burning glass. They might not understand the sun itself. It's knowing
what to do with things that counts.*

– Robert Frost, *At Woodward's Gardens*,

5.1 Introduction

Based on the methodology and methods described in the previous chapter, the components of the quantitative and qualitative preliminary studies are described. Data from these studies are presented, along with an analysis of the results. The qualitative study examines students' efforts to make sense of ambiguous notation and the role of context in interpreting notation. Results of both studies are analyzed using the theoretical framework and the findings are summarized. Quantitative results indicate a statistically significant positive shift in students' beliefs about their mathematical abilities.

Data from the preliminary studies provide a profile of the students that are the subjects of this research and were used to identify areas of focus in the main study. It was considered appropriate and reasonable to investigate some of the prior variables such as students' backgrounds, attitudes, and existing concept images before undertaking the main study. Two different preliminary studies were undertaken: a broad-based quantitative study and a qualitative classroom-based study. The broad-based study consisted of three components: (1) a demographic study; (2) an attitudinal study and (3) a study of students' self-evaluation of their abilities. The purpose of these studies was to

- collect demographic data on a broad population of undergraduate students enrolled in developmental algebra courses;
- investigate whether changes occurred in students' perceptions of their ability to (a) interpret notation, (b) interpret and analyze data, (c) to solve a problem not seen previously; (d) their willingness to attempt a problem not seen previously, and (e) their belief about the usefulness of the graphing calculator in understanding mathematics.

Within this global framework, a classroom-based study was also conducted. Using the results of the broad-based demographic and quantitative studies, a classroom-based study was conducted to investigate whether instances of meaningful learning occurred and to examine the processes of knowledge assimilation and reconstruction. The use of concept maps as a means of collecting data and as an instrument of analysis was also investigated. The preliminary studies and the results of each study are described and discussed in this chapter.

5.2 Field Study

The field study consisted of three quantitative components: a demographic questionnaire designed to provide some general characteristics of undergraduate developmental students; pre- and post-course attitude surveys designed to document changes in attitudes that occurred during the course; and pre- and post-course student self-evaluation surveys completed during the first and last week of the term, designed to document changes in students' beliefs about their ability to do mathematics. Data was collected using task-based interviews with field-site students and instructors, which were video-taped and transcribed. Students participating in this study completed a Intermediate Algebra course using a reform curriculum during the 1995-1996 academic year.

Students enrolled in the Intermediate Algebra course at twelve colleges and universities who participated in the study numbered more than two hundred and fifty. Because of withdrawals and students failing to complete all forms, the number of participants in each of the categories of this study will vary. Rather than deal with many missing cases, only those pre- and post-course surveys and questionnaires with complete files were used for the study. Differences on the attitude surveys were assessed using the two large independent sample z-test for comparing means. Only those tests that had significant findings at the $\alpha = 0.05$ level of significance ($p < 0.05$) are reported.

5.2.1 Results of the Field Study: A Demographic Profile

A total of 237 students completed the field study demographic questionnaire. A student profile was developed, based on this self-reported data. The statistics reveal

some of the intervening variables of student effort and motivation: sixty percent of the students considered themselves fair or disastrous mathematics students; four out of five were taking twelve or more hours of courses per week; more than half the students worked fifteen or more hours on an outside job; and only one of every four students spent five or more hours per week outside of class on homework.

Statistics on attendance, time spent on academic work, and reflections on their expectations of the course reported by students at the end of the term are summarized in Table 5.1. When interpreting these statistics, note the interesting statistics on time spent on the course and hours spent outside of class on homework. Nearly fifty percent of the students reported spending more or much more time on homework for the reform Intermediate Algebra course compared with previous mathematics courses, yet only 1 in 4 students reported spending five or more hours per week outside of class on homework. It should be noted that the developmental Intermediate Algebra course at most colleges and universities is a 4- semester credit hour course. Percentages are subject to a margin of error of 1%, with ninety-five percent confidence.

Table 5.1: Field Study: Student Profile (n = 237)

Students who completed the course indicate they	Interm n = 237
attended <i>almost always</i> or <i>always</i>	82%
spent <i>more</i> or <i>much more</i> time on this course	46%
spent 5 hours/week or more on homework	25%
found the graphing calculator difficult to use	16%
found the course more interesting than expected	34%
found the course somewhat harder or much harder	55%

The demographic profile was used to compare general characteristics of the students who participated in the local preliminary and main studies with students who participated in the broad-based field study. All students who participated in the main study (n = 26) were twenty-years old or younger, as were all but three of the eighteen students in the preliminary study. Several students exhibited the characteristic attitudes about resistance to change and mathematics reported in the field study data. They

lacked study and organizational skills which were occasionally the source of tension among the older members of the preliminary study and the younger students. On more than one occasion, older students were observed telling younger members of their groups to either come to class prepared to work, with their homework done or to leave the group. Data from the field study attitude surveys established some of the prior variables such as attitudes and beliefs that students bring to the remedial class. These prior variables were included in the student profile and are summarized in Table 5.2.

Table 5.2: Field Study: Demographic Profile (n = 237)

Students who	Inter m n=237
considered themselves fair/disastrous	60%
were full-time students	81%
were enrolled for 12 or more hours	81%
worked more than 12 hours outside	68%
took math the previous term	65%
took math one or more than one year ago	35%
were between 17 and 20 years old	76%
were twenty-six years old or older	9%
used a graphing calculator in school	47%
used a scientific calculator inside of school	68%
used a graphing calculator outside of school	26%
used a four-function calculator outside of school	70%
had never used any calculator	5%
were female	57%

Observations reported by field study instructors support these statistics. In general, the younger students (age 17-20) lack study and organizational skills; appear ill-equipped to handle the demands of a full-time academic program and the competing demands of jobs and social obligations; and are very resistant to changes in the didactic contract (i.e., what the teacher's role is; what the student's role is, and what it means to learn mathematics) that occur as a result of using a reform algebra curriculum [McGowen and Bernett, 1996].

5.2.2 Results of Field Study Pre- and Post-Course Attitude Responses

Pre- and post-course attitude surveys were completed and returned by 237 Intermediate Algebra students who participated in the field study. Analysis of the data indicates that after using the reform materials, significant shifts in attitude occurred during the term. Pre- and post differences on the attitude surveys were assessed using the two large independent sample z-test for comparing means. Students had more disagreement with the statements: (a) mathematics is mostly facts and procedures that have to be memorized; (b) learning to do mathematics means just learning the procedures; and (c) the time spent using a graphing calculator could be better spent practising skills. There was also a shift indicating more students felt less confusion when trying to read x - and y -values from a graph. Though the shift in responses of these questions is significant, it must be noted that the shifts were from agreement with the statement initially to a neutral “no opinion” response by the end of the semester.

Intermediate Algebra students generally agreed with the statement, “I have trouble keeping up in mathematics class.” There was no significant attitude change in their belief that a math class in which the teacher lectures most of the time is the way mathematics is supposed to be taught. This result is supported by the findings of the pre- and post-course self evaluation, as well as field-testers’ observations that students enrolled in the Intermediate Algebra course were resistant to changing the didactic contract. The statistics suggest that the NCTM Curriculum and Evaluation Standards [1989] have not yet impacted many students to the extent one could hope, nearly a decade after publication. Many students continue to experience mathematics taught instrumentally. They remain convinced that mathematics is a collection of procedures to be memorized; that getting “the right answer” is what learning mathematics is all about, even though the pre- and post-course responses of the participants of this study indicated a significant shift towards more disagreement with the statement: The best way to do mathematics is to memorize all formulas. [Note: The NCTM *Curriculum and Evaluation Standards* set forth a vision of what the K–12 mathematics curriculum should include in terms of content priority and emphasis in a document designed to establish a broad framework to guide reform in school mathematics.]

5.2.3 Results of Field Study Students' Self Evaluation of Abilities

Prior variables related to students' beliefs about their ability to do mathematics were also investigated before undertaking the main study. To establish the prior variables of students' beliefs about their mathematical abilities, students were asked to rate their (1) ability to interpret notation and symbols; (2) ability to analyze and interpret data; (3) ability to solve problems not seen before; (4) their willingness to attempt a new problem not seen previously during the first week of the term; and (5) the extent to which use of the graphing calculator helps understanding of mathematical concepts. During the last week of the term, students were asked to evaluate the extent to which the course had improved their ability in each of the five categories. Pre-course differences in the responses of students who participated in the field study were compared with those of the preliminary study, as well as post-course differences for both groups.

Since the pre- and post-course self-evaluation surveys did not use identical questions, statistical tests were not used to compare pre- and post-course survey results. The pre-course survey documents the initial state of students' beliefs at the beginning of the course and are used to establish the prior variables of the various studies. The post-course survey questions asked students to rate their *improvement in abilities*, thus documenting a *changed state*. Results of both surveys were used to provide some triangulation of the data collected from the field, preliminary, and main studies about prior variables and the changed state of those variables at the end of the course.

Pre- and post-course self evaluation surveys were completed and returned by 237 students who participate in the field study. Results indicate that at the beginning of the course, three-fifths of the 237 students rated their ability to interpret mathematical notation and symbols as very poor (1), or somewhat poor (2), as well as their ability to analyze and interpret data [McGowen and Bernett, 1966]. This finding validates the student profile statistic in which the participants characterized themselves as fair or disastrous mathematics students. Despite beliefs that their ability to solve a problem not seen previously had improved, their willingness to attempt to solve a problem was not impacted to the same degree. This is not as inconsistent as it might appear when considered in the context of intermediate algebra students' belief that mathematics is a collection of procedures to be memorized and their preference that someone give them

the solution to a problem rather than work out the answer for themselves when faced with a problem they could not solve quickly. It provides additional documentation of the observation that the younger students (aged 17–20) resist changing the unwritten social contract.

5.3 Preliminary Study

Prior variables related to students' beliefs about their ability to do mathematics before undertaking the main study were investigated and analyzed within the context of the broader-based study. The pre-course survey documents the initial state of students' beliefs at the beginning of the course. The data are used to establish the prior variables of the local preliminary study. The post-course survey documents the changed state of those beliefs. The same questionnaire used in the field survey was used in the classroom-based preliminary study. Twenty-three students were initially enrolled in the Intermediate Algebra course participating in the preliminary study. Eighteen of those students completed the course (78%), somewhat better than the figure reported nationally for students in the traditional course [Hillel, et al., 1992]. Sixteen students completed the pre- and post-course surveys and only those responses are reported and analyzed. As the pre-course survey documented students' initial perceptions and the post-survey documented the changed stated of students' beliefs, students' pre- and post-course responses were not analyzed using statistical tests.

5.3.1 Preliminary Study Self-evaluation Survey Results

A majority of the students who participated in the local preliminary study reported they lacked self-confidence and had a negative attitude towards mathematics, with high math and test anxiety. Six of the sixteen students who completed the pre-course survey rated themselves as somewhat good (4) or very good (5) in their ability to interpret mathematical notation and in their ability to analyze and interpret data and three of the sixteen students rated themselves somewhat good or very good in their ability to solve a problem never seen before. These responses are consistent with the student profile data in which the participants characterized themselves as fair or disastrous mathematics students. Seven of the sixteen students in the classroom-based study considered themselves willing to attempt a problem not seen previously. Less than

one-third of the participants believed that use of the graphing calculator helps them understand mathematical concepts, a percentage that is slightly lower than that reported in the initial field survey.

The post-course mean responses of the preliminary classroom study suggest that changes in the state of students' beliefs about their mathematical abilities occurred during the semester. No improved state of willingness to attempt a problem not seen previously was documented in the local study, paralleling a similar finding in the larger field study. Given field-testers' reports of students' resistance to change, as well as the observed resistance on the part of some students at the local site, together with the fact that nearly half (44%) of the students in the local study initially believed themselves willing to attempt a new problem on the pre-course survey, it is not surprising there was no documented change in state.

5.3.2 Field & Preliminary Studies: Triangulation of Data About Prior Variables

Results of the preliminary study survey of students' beliefs about their mathematical abilities were compared with the corresponding results of the field study survey in order to provide some triangulation of the data collected from the field and preliminary studies about prior variables and the changed state of those variables at the end of the course. The pre-course responses of the field and preliminary study students are summarized in Table 5.3.

**Table 5.3: Field & Preliminary Studies: Initial States
Comparison of Pre-Course Self Evaluation of Abilities**

Students who rated themselves as somewhat good (4) or very good (5) at the beginning of the semester in:	Field n=237 Pre	Prelim m n=16 Pre
1. Ability to interpret notation & symbols	30%	38%
2. Ability to analyze and interpret data	25%	38%
3. Ability to solve problem not seen before	29%	19%
4. Willing to attempt a problem not seen before	36%	44%
5. Use of graphing calculator helps understand mathematics	39%	31%

Pre-course mean responses of the students participating in the classroom study were also compared with the pre-course mean responses of the field study to examine similarities and differences in the responses of the two groups. The initial mean responses of the students in the field study are somewhat more negative than the initial mean responses of the preliminary study survey, with one exception: students in the local preliminary study believed they were less able to solve a problem not seen previously that were the students in the field study. The bar charts in Figure 5.1 provide a visual comparison of the initial states of students' beliefs. The vertical scale indicates the Likert scale mean response for each question indicated on the horizontal axis by its corresponding table number. The mean response of the pre-course question of the field study is to the left of the mean response of the preliminary study.

**FIGURE 5.1. Field & Preliminary Studies: Initial States
Comparison of Pre-Course Self Evaluation of Abilities**

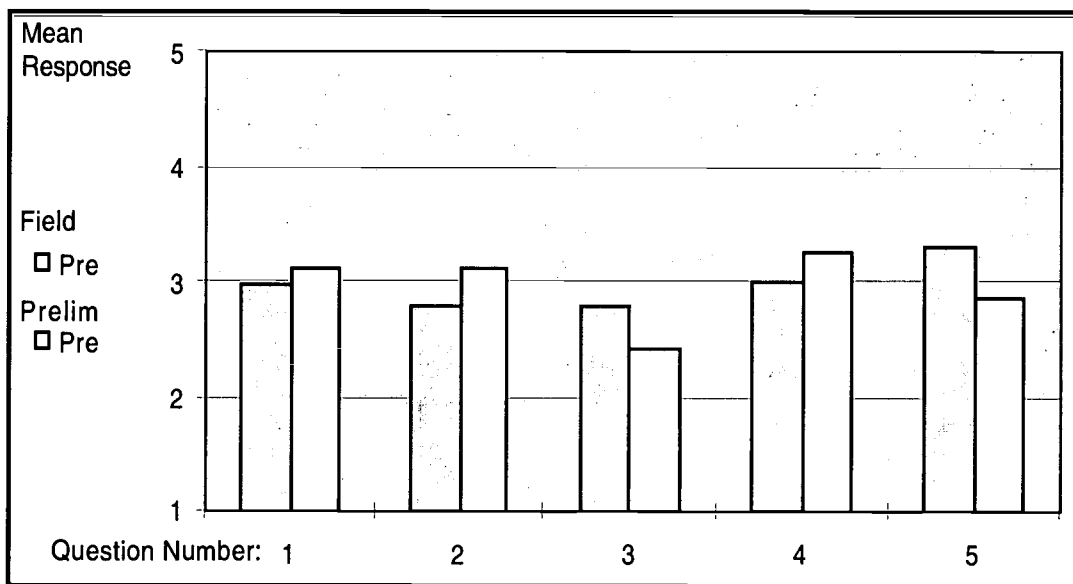

Post-course mean responses of the two studies were also compared. A summary of the mean responses of both groups are reported in Table 5.4.

**Table 5.4: Field & Preliminary Studies: Changed States
Comparison of Post-Course Self Evaluation of
Abilities**

Students who rated themselves as somewhat good (4) or very good (5) at the end of the semester in:	Field n=237 Post	Prelim n=16 Post
1. Ability to interpret notation & symbols	39%	56%
2. Ability to analyze and interpret data	51%	56%
3. Ability to solve problem not seen before	40%	50%
4. Willing to attempt a problem not seen before	42%	44%
5. Use of graphing calculator helps understand mathematics	81%	94%

The bar charts in Figure 5.2 provide a visual comparison of the changed states of students' beliefs. The mean response for each post-course question of the field study is to the left of the mean response of the preliminary study.

**FIGURE 5.2. Field & Preliminary Studies: Changed States
Comparison of Post-Course Self Evaluation of Abilities**

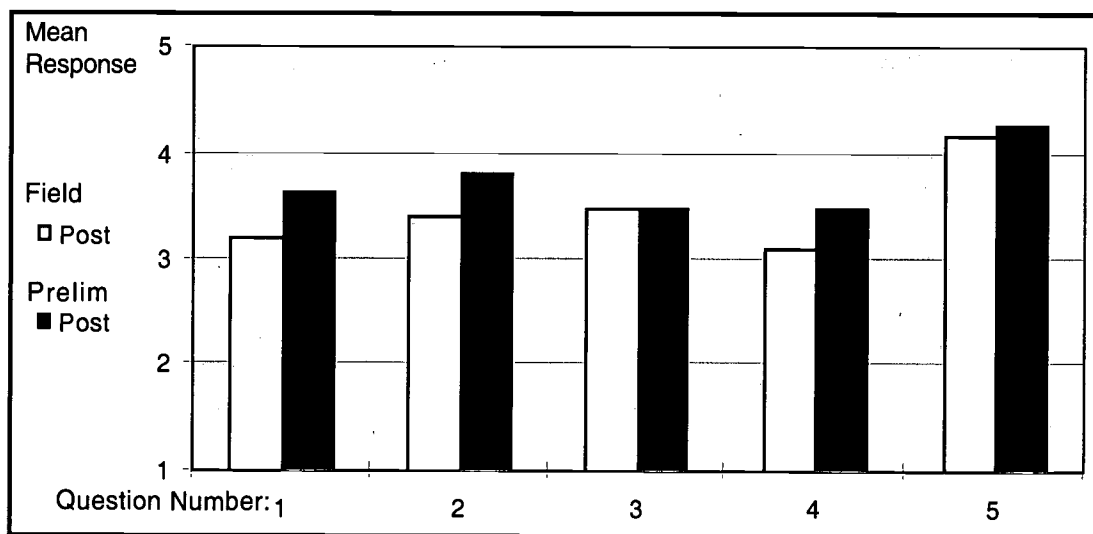

Analyses of the mean responses of the pre- and post-course surveys of the field and preliminary studies for each of the five questions indicate that the prior variables for both groups are similar, as are the changed states of both groups at the end of the course. Students of both groups initially had a more negative attitude in response to the pre-course question on ability to solve a problem not seen before compared with their

responses to any of the other questions. Neither group had a noticeable change in their willingness to attempt a problem not seen previously. The field and preliminary studies pre-course mean responses together with their respective post-course mean responses are summarized in Table 5.5.

Table 5.5: Field & Preliminary Studies: Self-evaluation Comparison of Means

Group	Survey	Q1	Q2	Q3	Q4	Q5.
FIELD (n=237)	Pre:	2.97	2.80	2.80	3.00	3.30
PRELIM (n=16)	Pre:	3.13	3.13	2.44	3.25	2.88
FIELD (n=237)	Post:	3.20	3.40	3.50	3.10	4.15
PRELIM (n=16)	Post:	3.63	3.81	3.50	3.50	4.25

The bar charts in Figure 5.3 provide a visual comparison of field and preliminary studies pre-course mean responses together with their respective post-course mean responses for each question. The mean response of the field study is displayed to the left of the mean response of the preliminary study, followed by the post-course mean responses displayed in the same order, for each of the five questions.

FIGURE 5.3. Field (F) & Preliminary (P) Studies: Initial & Changed States
Comparison of Pre-Course/Post-Course Evaluation of Abilities

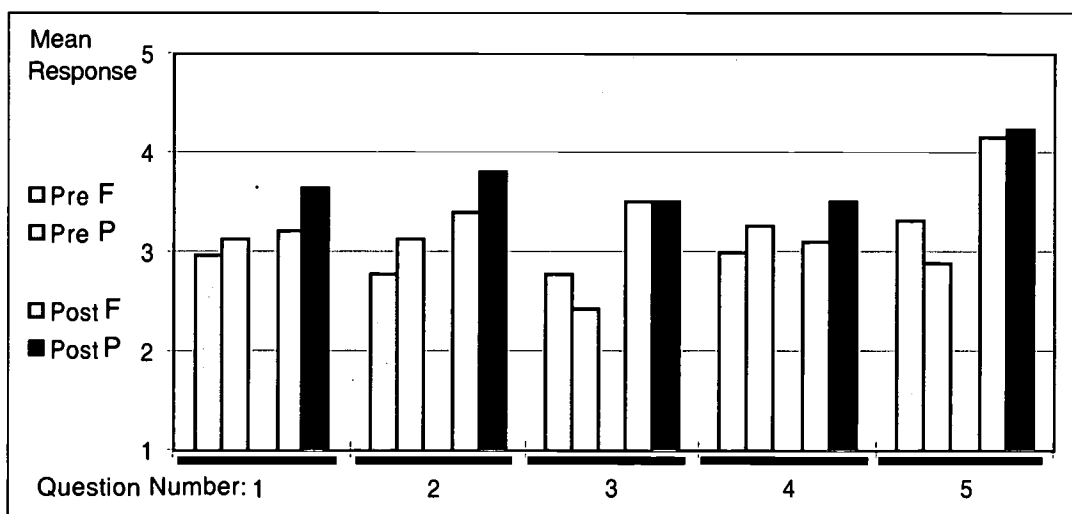

5.4 Classroom-based Qualitative Studies

Students in the field study, as well as students in courses using the reform curriculum at the community college in classes taught by the researcher previously, experienced great difficulty interpreting mathematical notation and forming connections between concepts and processes. In addition to testing the null hypotheses that there would be no differences in means of student responses on the attitude surveys or on the self-evaluation of abilities in the quantitative studies, research questions were formulated that were expected to provide opportunities for students to reveal their thinking as well as the products of their thinking. It was conjectured that students' lack of understanding of order of operations, as well as inflexibility in interpreting notation, underlay many of the difficulties students were experiencing with notation. Pre- and post-test questionnaires were utilized to elicit information about the nature of the difficulties students were experiencing. In order to document growth in the understanding of mathematical concepts and students' evolving ability to deal flexibly with mathematical notation, concept maps were used to (a) promote reflective activity and review by students, (b) to provide diagnostic information to the instructor, and (c) as a data collection instrument which would provide additional insights about students' growth in understanding of mathematical concepts and the making of meaningful connections.

5.4.1 Background and Problem Statement

Students in developmental algebra courses experience great difficulty interpreting mathematical notation. They have not learned to distinguish the subtle differences symbols play in the context of various mathematical expressions [Gray & Tall, 1991; Kuchemann, 1981]. The ability of undergraduates enrolled in a remedial algebra course to interpret function notation and the minus symbol was a focus of the preliminary study. What do students think about when they encounter function notation, the minus symbol, or other ambiguous mathematical notation? What are they prepared to notice? The study examined the extent to which students were successful in their efforts to make sense of mathematical notation, together with the processes by which they reconstructed their existing inappropriate concept images.

Since the concept of function was used as an organizing lens throughout the course, a pre-test and post-test was designed to provide information about students'

ability to interpret function notation and the minus symbol in various contexts, evaluate functions, and translate among representations. Students' difficulties in interpreting and using the “-” symbol were indicated on the pre-test given to twenty-three students, during the first week of class. They were asked to evaluate -3^2 and $(-3)^2$. Only five of twenty-three students correctly evaluated both, indicating an ability to distinguish between the process of finding the additive inverse of a number squared, i.e., $-x^2$, commonly interpreted in the U.S. as “finding the opposite of x squared,” and squaring a negative number, $(-x)^2$. Students were also asked to evaluate a quadratic function for a negative-valued numerical input and an algebraic input. They were assigned the following problem and asked to show the process by which they arrived at their answer:

Math Problem: If $f(x) = x^2 - 3x + 5$

Find $f(-3)$. Show all work and explain what you did.

Initially, ten of the twenty-three students wrote:

$$\begin{aligned} f(-3) &= -3^2 - 3(-3) + 5 \\ &= 9 + 9 + 5 = 23. \end{aligned}$$

Though these ten students did not use grouping symbols to indicate they were squaring a negative number, they interpreted -3^2 as $(-3)^2$, though they used parentheses when substituting -3 for x in the linear term. Nine other students showed the same work initially, but evaluated -3^2 as -9 , with $f(-3) = 5$. Three students used correct notation, writing $f(-3) = (-3)(-3) - 3(-3) + 5$, then completed the evaluation correctly. One student interpreted $f(-3)$ as a multiplication and proceeded to divide both sides by -3 . Based on their written work, the majority of errors were initially attributed to (a) a failure on the part of students to use grouping symbols consistently or (b) a lack of understanding about the algebraic order of operations.

Students were asked to investigate problem situations designed to produce cognitive dissonance and result in more appropriate understanding of the order of operations and about arithmetic operations such as unary or binary operations. The graphing calculator and iconic function machine representations were used to investigate the role order of operations and grouping symbols play in the two processes: squaring a negative number $(-3)^2$ and with finding the additive inverse of a number squared -3^2 . The notion of function was used as an organizing lens together with the graphing cal-

calculator to analyze both processes. Figure 5.4 illustrates the use of the function machine for these investigations.

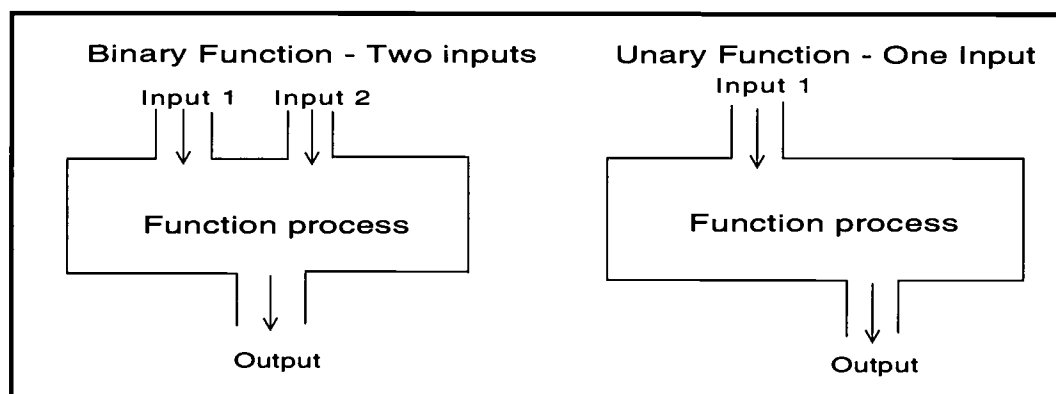

FIGURE 5.4. Function Machine Representations: Binary & Unary Processes





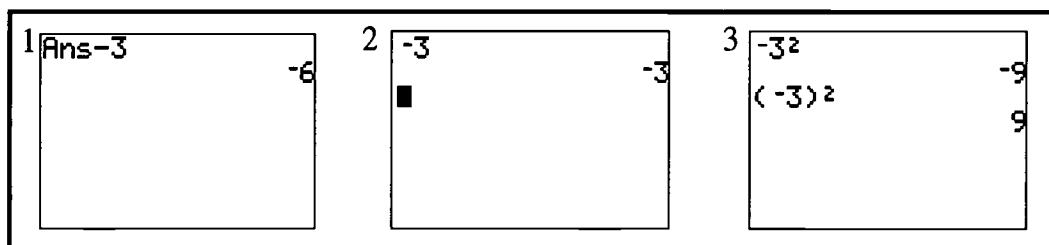





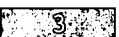

The visual representation of a function machine and the graphing calculator offer students tools for visualization and analysis of the processes of finding the opposite of a number squared and squaring a negative number. Each operation has its own key on the TI-82 and TI-83 graphing calculators. Since these calculators are themselves function machines, they automatically supply the missing input when the binary operation of subtraction is selected and only one input is entered. The graphing calculator displays what the student enters (input) as well as the result of the computation (output). The calculator displays of three investigations using the minus symbols are shown in Figure 5.5.

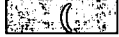
FIGURE 5.5. TI-83 View Screen of Binary and Unary Operations

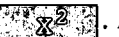

Students were asked to (1) subtract three, (2) find the additive inverse of three; and to enter -3^2 . The sequence of keystrokes corresponding to the entry as display for each investigation was: (1)  . In (2), the additive inverse key, com-

monly referred to in the U.S. as the “opposite” key, was used instead of the subtract operator:  followed by  and in (3), the first sequence of keystrokes was:   ; the second sequence was:     . After each sequence, the  key was pressed to display the result.

Explicit discussion focused on the input-output process conception of function. The need for consistency in the use of notation and the role of context were also topics of class discussion. Students analyzed other arithmetic and algebraic operations using an input-output representation (a function machine), characterizing various operations as either binary or unary functions. Reconceptualizing arithmetic operations as unary or binary functions provided students with a framework within which they could clarify their understanding of the difference between the operations of subtraction and finding the additive inverse of a number. The arithmetic investigations were followed by investigations evaluating symbolic representations such as $f(x) = x^2$ for $f(-3)$. Students were asked to submit a written reflection about their investigations as a homework assignment. In the reflection they were to complete three sentences: (1) “I used to think...(2) Now I realize... and 3) I’ve changed my mind about...”

5.4.2 Results of the Teaching Intervention

Six of the eighteen students were able to evaluate both arithmetic expressions correctly a week later on the first unit exam. By the end of the sixteen-week term, in the context of evaluating a quadratic function for a negative-valued numerical input, ten of the eighteen students consistently evaluated the function correctly. Four students who evaluated -3^2 incorrectly during the classroom investigation, wrote on their reflections that they had made a careless sign error and understood the problem. One student wrote that she knew her answer was correct (it was actually incorrect) because the other members of her group agreed with her. None of these students consistently evaluated either the numerical expression or a quadratic function with a negative-valued input correctly throughout the remaining twelve weeks of the semester.

A comment about ‘correct’ vs. ‘incorrect’ evaluations seems appropriate, as the interpretation of this symbol pattern often depends upon conventional precedence. For example, a software developer has the sometimes difficult task of transforming

ambiguous mathematical notation into unambiguous programming code when designing routines which are supposed to reflect accepted mathematical practice. The general computer programming convention for the notation -3^2 is that the number includes its sign, thus -3^2 is thought of as meaning $(-3)^2$, i.e., negative three squared. On the TI-82 and TI-83 graphing calculators, -3^2 is interpreted to mean find the additive inverse of three squared. This interpretation of the notation parallels the familiar mathematical interpretation of $y = -x^2$, whose graph is a parabola opening downwards.

5.4.3 Analysis of the Results

Based on students' written reflections, together with students' interviews, use of the graphing calculator and a function machine representation to reconceptualize arithmetic operations as functions resulted in modifications of students' existing concept images. For several students, meaningful learning occurred. Using criteria proposed by David Clark et al. [1996], learning in which "students are actively involved in integrating, or linking, new concepts and skills into an already existing conceptual framework, not simply accumulating isolated facts and procedures," is characterized by evidence that indicates the student:

- claims to have learned something new;
- can articulate what it is they think they have learned, with some degree of clarity and accuracy;
- can demonstrate formation of links with an existing framework that the student already possesses.

The reconstruction of their existing concept images documented in the written comments and student interviews provide insights into the nature of the reconstruction process. Students who successfully reconstructed their existing cognitive structures focused on qualitatively different features of the processes than did those students, who reconstructed their existing concept images inappropriately. The following statements illustrate some of these differences. A comment typical of the student who was successful in reconstructing existing concept images is that of Student BF:

I realized that the problem was looking for the opposite of 3^2 ...but I didn't understand the rationale. When I see the sign $(-)$ it is a change for me to know that it means "the opposite of." I always thought it meant a negative

number or, $-(-x)$ a positive x . The reflection assignment enhanced my understanding of the opposite of a square by looking at it as two functions, and then order of operations would have exponents first, then the opposite of the value. I didn't know what the order of operations was in relation to exponents and opposing...I do know this now. Exponentiation takes precedence over opposing in the absence of grouping symbols.

Student BF

Her comment suggests that BF has achieved understanding, as defined by Skemp [1987, p. 112]. She has made connections with an existing schema which resulted in a changed mental state that gives her a degree of control over the situation not previously had. The articulate response of this student suggests that she has assimilated her newly-acquired knowledge, reconceptualizing the two processes of squaring a negative number and taking the opposite of a number squared as functional processes. Her response also indicates a change from insecurity to confidence.

Other students' responses reveal the complexity of interpreting ambiguous notation and the difficulties inherent in trying to re-construct one's understanding of a concept or process as a result of cognitive conflict. Tall and Vinner [1981, p. 152] have pointed out that: "Only when conflicting aspects are evoked simultaneously need there be any actual sense of conflict or confusion." One can almost hear the confusion and effort as these students describe their experiences:

I learned that without parentheses you cannot make $-3^2 = 9$. The change of thinking I've had since this assignment is drastic! I began to realize how crucial parentheses are. The parentheses show that there is only one operation being done. Without parentheses, two operations are being taken. Ex: $-3^2 = -9$ means *take the opposite and square*; $(-3)^2$, just square -3 . I find this a bit hard getting used to!

Student MH

Any two negative numbers that are multiplied by each other must result in a positive answer. After discussing the assignment I felt that even though I may not have been able to find the correct answer, I still learned that I have to go about a few different ways to try to find an answer and by discussing with someone else I am able to check my answers...sometimes my old ways of thinking like to butt in and I have a hard time saying no and to keep on trying the problem.

Student JA

If one accepts Skemp's claim that "assimilation to an existing schema gives a feeling of mastery and is usually enjoyed" (Skemp, 1987, p. 281), then neither of these

students has yet assimilated the new knowledge into their existing schemas. How students build new cognitive collages depends upon their prior experiences and previously-constructed cognitive collages, how the problem is represented, how they represent relevant knowledge, what their attention focuses on based on the visual cues they pick up from scanning the written symbols. Their implicit beliefs, true in a given context, can subsequently lead to cognitive conflict in another context. Contrast the responses of student (BF) who reconstructed more appropriate concept images which remained stable throughout the semester with the responses of students who reconstructed their concept images inappropriately.

Now I know that when you square a -3 it stays negative. -3^2 is always negative.

Student CB

I didn't understand that when you multiply -3^2 that it is $(-3)(3)$ which will give you the answer -9 . I always thought it was $(-3)(-3)$ regardless of parentheses. Now I realize that was wrong.

Student KP

One student cited her use of the mnemonic, *My Dear Aunt Sally*, for the order of operations; i.e., multiplication, division, addition and subtraction [MDAS], which is taught in some traditional U.S. classrooms. In Britain, the mnemonic for order of operations taught in traditional classrooms is Brackets, Of, Division, Multiplication, Addition and Subtraction [BODMAS]. It should be noted that there had been *no* reference in class to "my dear Aunt Sally." Student CP's comment is evidence of the retrieval of a prior schema which was cued by discussion of order of operations.

I think I have a better understanding of negative vs. opposite especially after mention of my dear Aunt Sally.

Student CP

All three of these students, given -3^2 , focused on the fact that the answer *must be negative* and ignored what it means to square a number. They attempted to resolve the cognitive conflict they had experienced by focusing on getting the correct answer despite knowing the other procedure. Apparently, these students were only able to focus on one aspect of the problem at a time—either the process of squaring or the fact that the answer must be negative. This is an example of the difficulty of size and position described by Skemp [1987]. He attributes students' difficulty to having to deal

with two schemas: the symbol system, and the structure of mathematical concepts. In these instances, the students' responses suggest that it is the symbol system that dominates the conceptual structure and mathematics is nothing more than the manipulation of symbols. Cognitive conflict is not resolved appropriately.

Davis [1984] provides some additional insight. He explains this phenomenon claiming that a frame (schema), once judged acceptable, is used for all subsequent processing and that the original data is thereafter ignored. "People do not typically distinguish between the information contained in the primitive data source, and the information contained in the instantiated frame. This information has been obtained by combining information from the actual input and from the frame, and so subsequent processing makes no distinction" [Davis, 1984, pp. 65-66]. The comments of these three students suggest that this phenomenon has occurred: the need to consider context when interpreting the minus symbol does not fit into the students' retrieved schemas, thus making the assimilation of new ideas investigated in class much more difficult.

Students' efforts to interpret ambiguous notation demonstrate how very differently individual students assemble bits and pieces of knowledge into their existing cognitive collages and demonstrate the bifurcation that occurs as a consequence of the qualitatively different ways of thinking and constructing knowledge. As Sfard reminds us: "Algebraic symbols do not speak for themselves. What one actually sees in them depends on the requirements of the problem to which they are applied. Not less important, it depends on what one is *able* to perceive and *prepared* to notice" [Sfard, 1991, p. 17]. According to Skemp, "We classify every time we recognize an object as one which we have seen before...once it is classified in a particular way, we are less open to other classifications" [Skemp, 1987, pp. 10-11]. Edelman argues that the ability to carry out categorization is embodied in the nervous system and that perceptual categorization is "the selective discrimination of an object or event from other objects or events for adaptive purposes....that does not occur by classical categorization, but rather by disjunctive sampling of properties" [Edelman, 1992, p. 87].

An analysis of students' comments supports these claims. The focus of attention for one student, CB, is the exponent and the squaring process, which causes conflict as she reconstructs her knowledge, now that she is aware that the minus symbol denotes a negative answer in this context. Two students focused their attention on the

presence/absence of parentheses; one appropriately, MH, and one inappropriately. KP, like CB, disjunctively samples multiple cues (squaring indicated by the exponent, the minus symbol indicating a negative number, and the minus symbol indicating the answer should be negative), combining them inappropriately. Student BF focuses on the two processes, comparing and contrasting them, combining the visual cues of parentheses, exponents, and minus symbols into a coherent, appropriate reconstruction of her knowledge and growing awareness of the role of context.

Interview data typical of students who reconstructed their knowledge not only reveal something of their prior understandings, but also provide clues about the initial focus of attention. Student KK appears to have focused initially on “doing something”—squaring a number. The role of context has become a focus of attention, as indicated by her observation that she had never thought about the order of operations. Student LZ appears to focus on the arrangement of symbols, comparing his previous interpretation with his reconstructed interpretation.

I never thought about the order of operations when I was supposed to square three first then put in the opposite.

Student KK

I was confused because before whenever a variable was to be substituted for a particular number it was expressed like this: $x = -1$, not $f(-1)$. I used to think that $-3^2 = 9$. Now I realize that the answer is -9 . I used to think f times (-1) . Now I realize what the problem asks for. I used to think the substitution was correct. Now I realize that the parentheses are missing and my notation is incorrect.

Student LZ

5.5 Use of Concept Maps

Misconceptions were not only revealed in students' reflection writings but were also documented in the *concept maps* they did throughout the semester. The first concept map of the student WC, shown in Figure 5.6, was drawn in the fourth week of the semester. It indicates she has incorrectly associated $y(x) = -x^2$ with a graphical representation of a parabola opening upwards and $y(x) = x^2$ with the graphical image of a parabola opening downward. WC's misconceptions are indicated in Figure 5.6 by arrows in the lower left corner of the concept map.

FIGURE 5.6. WC: Concept Map Week 4: Inappropriate Connections

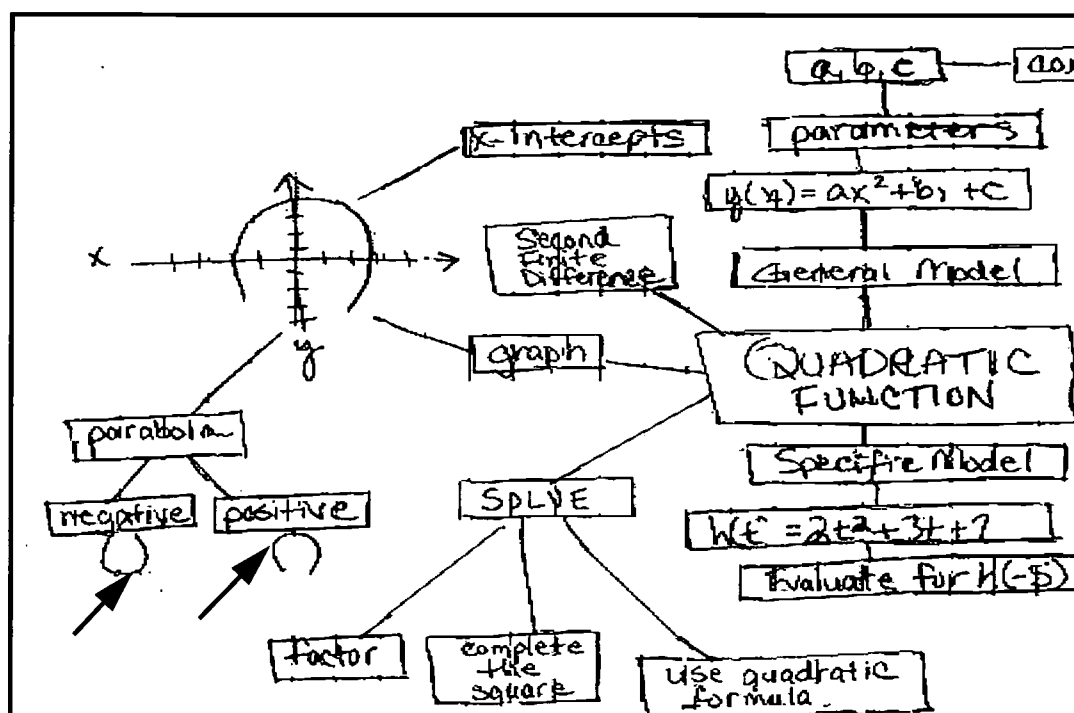

She maintained that the graph of $y(x) = x^2$ opened downward and that the graph of $y(x) = -x^2$ opened upward. Challenged by the members of her group during a small group discussion in class subsequent to turning in her concept map, WC and the members of her group decided to test her assumptions. They entered both functions on the graphing calculator and examined the graphs, as well as the input/output table values of the two functions. Even though these investigations demonstrated that her initial assumptions were incorrect, WC needed to explore additional quadratic functions in which the quadratic term was preceded by a minus sign before she was able to abandon her incorrect beliefs. Once reconstructed, WC's concept image remained stable throughout the semester. The reconstructed portion of her concept image is outlined and marked by an arrow in the portion of the final concept map completed in week 15 displayed in Figure 5.7.

FIGURE 5.7. WC: Concept Map Week 15: Reconstructed Concept Image

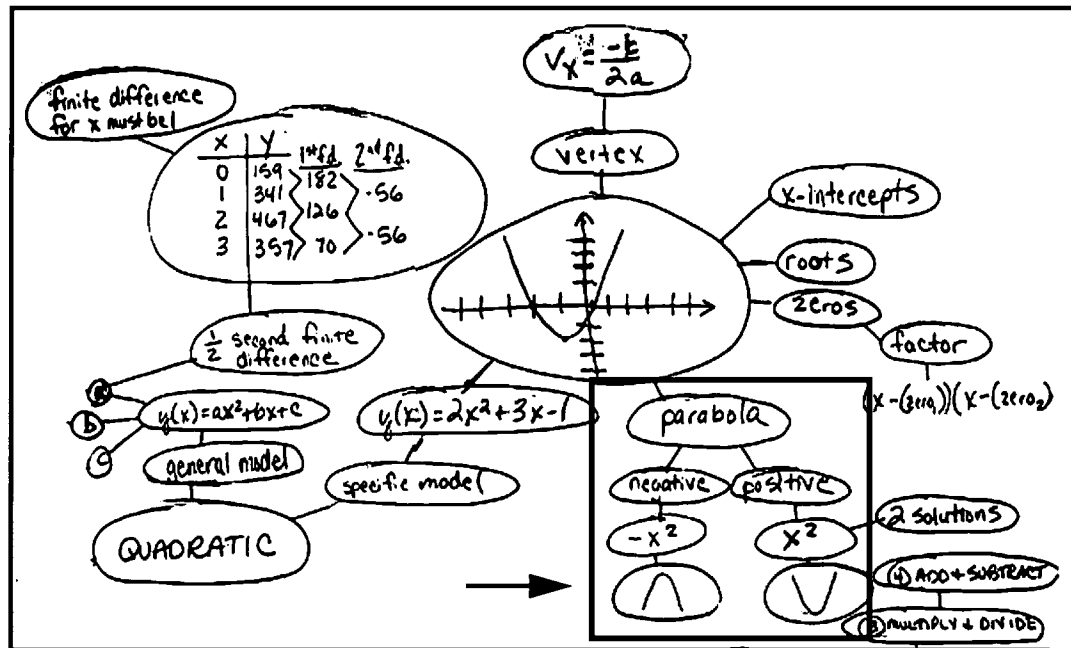

It is conjectured that the ability to reconstruct inappropriate concept images is less difficult if inappropriate concept images are identified before they have been assimilated into more complex existing concept images which have been tightly integrated into cognitive collages or schemes that are very refined and stable. Despite the teaching intervention, and the investigations on calculator and with function machine, this student continued to interpret $-x$ as a negative number and $-(-x)$ as a positive value. Her concept image of the minus symbol was much more deeply embedded into an existing conceptual schema, and was not impacted during the semester.

5.6 Summary of Findings

In this chapter, based on the methodology described in Chapter 4, data from the quantitative and qualitative preliminary classroom studies were presented and analyzed. Results from the field and preliminary studies indicate that the research questions designed to provide data about students' ability to think flexibly and to recognize the role of context when interpreting ambiguous notation and symbols were reasonable. The preliminary study investigated the questions of whether students classified as 'less able' and/or 'remedial'

- demonstrate improved capabilities in dealing flexibly and consistently

with ambiguous notation and various representations of functions?

- develop greater confidence and a more positive attitude towards mathematics?

It was felt that the design of the instruments was fundamentally sound. The pre- and post-course attitude surveys of the field study identified prior variables which were used to develop a profile of the students of this already stratified population. The students of the preliminary classroom-based survey, though they constituted a small sample ($n = 16$), are shown to be representative of the students based on the field study profile. Students who enroll in the undergraduate remedial Intermediate Algebra course are generally recent high school graduates who are unused to sustained academic efforts; resistant to renegotiating the unwritten didactic contract; want to get on with their lives; and view mathematics as something that blocks their way. Convinced they are not good in mathematics, many believe that mathematics consists of “getting the right answer” and that the teacher should “show me how to do it.”

Results of the data collection for the quantitative field and preliminary studies were analyzed using the theoretical framework. The quantitative results indicate positive changed states of students’ beliefs about their mathematical abilities for students of the broad-based field study and for the students of the local preliminary study. The only exception was that the students of neither study changed their beliefs about their willingness to attempt a problem not seen previously. As the initial responses were nearly neutral, this result is not unexpected, given they have as their goal “just get through this class so I can go on with my life.” Whatever it is that they feel passionately about, it generally isn’t mathematics.

The use of concept maps appeared to be a viable means for documenting students’ processes of knowledge construction. However, when students were interviewed after turning in their maps, the need to triangulate the concept map data with other data became apparent. These interviews led to the realization that interpretations of student concept maps as visual re-presentations of their conceptual structures are constrained by (a) the amount of time a student is able to spend on the task of constructing the map; (b) the amount of information and the number of connections between and among elements a student is able to record on a two-dimensional, finite-sized sheet of paper; and, most importantly, (c) by the student’s ability to categorize,

organize, and reflect upon his/her perceptions, actions, and schemas employed. Any or all of these constraints can distort the visual representation of one's cognitive collage. Even though the interviews are conducted one or two weeks after the actual map construction, these follow-up discussions were yet another reflective activity in which students were able to interpret, explain, clarify, and reflect upon their processes and thinking as they constructed their maps. The interviews frequently resulted in revised interpretations of the student's knowledge construction processes and provided additional information about the nature of the student's thinking and understanding.

Instructions for creating a concept map were revised. In order to minimize concepts and processes being omitted from a map because of lack of space on the map, instructions for creating a concept map were revised. In the main study, an intermediate step was introduced between the initial brainstorming and the actual map construction. New directions included the recommendation to write all terms on small post-its which could then be arranged and rearranged as additional elements were included in the map. The final concept map drawing done was to be done only after the arrangement reflected an organization and connections the student felt was appropriate. It was assumed that subsequent maps would more closely reflect students' thinking and cognitive structures at the time a new map was created, if the earlier maps were retained by the investigator/instructor and unavailable for reference. Each individual student would receive timely feedback during interviews scheduled the week after the assigned concept map was turned in. The same topic, *Function*, would be assigned as the subject of each map, rather than different subjects assigned for each new map in order to collect data on students' developing concept images and schemas of a given concept.

5.7 Conclusions

Errors initially attributed to misunderstandings about order of operations masked other underlying causes of student difficulties, particularly the lack of flexibility in interpreting ambiguous notation. As the result of a teaching intervention designed to address students' lack of understanding about order of operations, misconceptions associated with the minus symbol were revealed. As a result of this experience, students voiced their confusion—identifying and describing their struggles to

determine which interpretation of the minus symbol was appropriate in a given context. One student voiced the difficulty many in the class expressed: “How do I know what the negative sign means in a given problem? Which way do I think about it?”

The conceptual requirements for understanding ambiguous expressions, both arithmetic and functional, appear to be far more formidable in their complexity than has generally been recognized. Reflective investigations, along with use of function machine representations and the graphing calculator, generated cognitive dissonance that challenged most students to reconceptualize previous understandings after reflecting on what they had done and thought. The qualitative and quantitative preliminary studies document the complexity of the task and the cognitive demands on students as they attempt to make sense of ambiguous mathematical notation.

Preliminary findings focused the investigator’s attention on the need for further research in order to better understand what it is that students’ understand when they see ambiguous notation and to more closely examine why it was that students reconstructed their prior knowledge in so very many different ways. Questions about the stability of students’ reconstructed concept images and schemas were raised and the need to modify the data collection methods of the main study to include documentation of stability or the lack thereof over time was identified. The quantitative method of analyzing the concept maps did not prove to be satisfactory and the need to develop a qualitative method of analysis was recognized.

*Two roads diverged in a wood, and I—
I took the one less traveled by,
And that has made all the difference.*

– Robert Frost, *The Road Not Taken*

6.1 Overview of Main Study Quantitative Investigations

The main study consists of quantitative and qualitative components, similar to those used in the preliminary studies. In this chapter, results of the quantitative studies will be reported, analyzed, and the findings interpreted using the theoretical framework described in Chapter 3. The pre-course demographic survey used in previous studies was used in the main study to establish a student profile of the students who were subjects of the main study. Prior variables which impacted these students previously were identified using the pre-course student self-evaluation surveys, which were given students during the first week of class. Both the main study student profile and prior variables data are triangulated with the results of the field and preliminary studies. Post-course self-evaluation surveys given students during the final week of class, were used to document improved states of students' beliefs about their mathematical abilities.

Pre- and post-course self-evaluation survey questions used in the main study were those used in preliminary studies and described in Chapter 5. Responses from the five questions relevant to this study are reported and analyzed. Post-course self-evaluation survey questions were not identical to those used on the pre-course survey. Pre-course questions asked students to rate their abilities initially. The post-course questions asked them to evaluate their improvement at the end of the semester. This format allowed students to indicate improvement in their perceived abilities, even if they had high positive attitudes initially. No pre- and post-survey statistical comparisons were made, since the pre- and post-course self-evaluation questions were not identical.

It was hypothesized that divergence and fragmentation of strategies occur between students of a undergraduate population of students who have demonstrated a lack of competence and/or failure in their previous mathematics courses. In this chap-

ter we report the results of the studies designed to address the main research question:

Does divergence and fragmentation of strategies occur among undergraduate students enrolled in a remedial algebra course who have previously been unsuccessful in mathematics?

and the related questions: Do students classified as “less able” and/or “remedial,” with suitable curriculum:

- demonstrate improved capabilities in dealing flexibly and consistently with ambiguous notation and various representations of functions?
- develop greater confidence and a more positive attitude towards mathematics?

The divergence that occurred between two groups of extremes of the students who participated in the main study; i.e., the most successful and the least successful, was examined using pre- and post-test results, student work, and interviews. In particular, this study sought to determine the nature and extent of changes in students’ mathematical abilities to think flexibly to interpret ambiguous notation and translate among various functional representations. Questions were designed to test students’ ability to (1) curtail reasoning, (2) reverse a direct process, and (3) to translate between various representations. The stability of their responses over time was also examined. The responses are interpreted using the theoretical framework described in Chapter 3.

6.2 Modifications to the Preliminary Studies Instruments

Data collection instruments and/or their instructions were described in Chapter 4 and modifications to the various instruments prior to the preliminary studies were reported in Chapter 5. Changes to these instruments are reviewed when the study which utilized the instrument is described.

6.3 A Student Profile

The subjects of this study were undergraduate students who completed a developmental Intermediate Algebra course at a large suburban community college located northwest of Chicago, IL. Twenty-six students of the thirty-three [78%] who initially enrolled completed the course. The dropout rate of 22 percent of the initial enrollment

was lower than the 50 percent reported nationally in the traditional developmental courses [Hillel, et al., 1992]. Twenty-three of the twenty-six students who completed the course are included in the study, having completed the pre- and post-course responses and participated in the interviews conducted throughout the semester. Only paired responses are reported and analyzed.

Demographic survey responses of the main study are consistent with those used to develop the student profiles of the earlier studies. All but two of the main study students were enrolled full-time (12 or more semester hours). Except for one student, they all worked at jobs outside of school, averaging more than 20 hours per week of outside employment. Students were twenty years of age or younger, either recent high school graduates, or students who had attended the community college the previous year. Six students were taking the course for the second time. One of the six students was attempting the course for the third time, having attempted the course twice previously and having dropped the course both times.

6.4 Prior Variables: Results of Student Self-Evaluation Surveys

A comparison of pre-course survey responses indicates that the prior variables of attitudes about their mathematical abilities is roughly the same for students of the field, preliminary, and main studies. Not surprisingly, students' responses indicated they lacked self-confidence and had a negative attitude towards mathematics at the beginning of the semester. Interviews with each student during the first two weeks of the semester confirmed these findings. Feelings of high math and test anxiety were also noted during these interviews. Students in the field, preliminary and main studies indicated that they have difficulty interpreting notation and symbols; analyzing and interpreting data; and solving a problem never seen before. Less than half of the students were willing to attempt a problem not seen previously.

Based on the post-course surveys, comparisons of the responses of students who believed their abilities had improved by the end of the term indicate that students of all three studies showed positive improvement from their initial negative attitudes. The pre-course initial state comparisons are presented in Table. 6.1.

**Table 6.1: Field, Preliminary & Main Studies: Initial States:
Comparison of Pre-Course Self Evaluation of Abilities**

Students who rated themselves as somewhat good (4) or very good (5) at the beginning of the semester	Field n=237 Pre	Prelim n=16 Pre	Main n=23 Pre
1. Ability to interpret notation & symbols	30%	38%	22%
2. Ability to analyze and interpret data	25%	38%	35%
3. Ability to solve problem not seen before	29%	19%	22%
4. Willing to attempt a problem not seen before	36%	44%	35%
5. Use of graphing calculator to understand mathematics	39%	31%	57%

The post-course improved state comparisons for all three studies are shown in Table 6.2.

**Table 6.2: Field, Preliminary & Main Studies: Improved States:
Comparison of Post-Course Self Evaluation of Abilities**

Students who rated themselves as somewhat good (4) or very good (5) at the end of the semester	Field n=237 Post	Prelim n=16 Post	Main n=23 Post
6. Ability to interpret notation & symbols	39%	56%*	74%*
7. Ability to analyze and interpret data	51%	56%	61%
8. Ability to solve problem not seen before	40%	50%	61%
9. Willing to attempt a problem not seen before	42%	44%	61%
10. Use of graphing calculator to understand math	81%	94%	83%

* indicates significant improvement in state compared with field study post-course responses

The improvements in state were not as uniform across all three studies as the percentages reflecting students' initial state of beliefs. Post-test improvements in state of students' beliefs in the main and preliminary studies in their ability to interpret notation and symbols at the end of the term compared with students of the field study suggests that explicit investigation and discussion of ambiguous notation impacted students' beliefs about their ability to interpret notation and symbols. This was particularly evident in the main study, in which interpretation of ambiguous notation was investigated and discussed explicitly throughout the semester.

The triangulation of main study data with that of the field and preliminary studies establishes the validity of the main study demographic student profile and prior variables within the framework and analysis of the earlier studies. The triangulated data indicate a consistency in the data reported in all three studies across classes and semesters of some of the prior variables undergraduate students bring with their entry into the remedial Intermediate Algebra course. Comparisons of the pre-course mean responses of the main, preliminary and field study surveys, along with a comparison of the post-course mean response data for all three studies, are given in Table 6.3.

**Table 6.3: Main, Preliminary & Field Studies:
Self-evaluation of Mathematical Abilities – Comparison of Means**

Group	1 Notation	2 Data	3 Solve	4 Willing	5 Graphing Calculator
PRE-COURSE					
Field (n=237)	2.97	2.80	2.80	3.00	3.30
Preliminary (n=16)	3.13	3.13	2.44	3.25	2.88
Main (n = 23)	2.96	3.13	2.78	3.04	3.61
POST-COURSE					
Field (n=237)	3.20	3.40	3.50	3.10	4.15
Preliminary(n=16)	3.63	3.81	3.50	3.50	4.25
Main (n = 23)	3.91	3.65	3.57	3.70	4.21

The bar charts in Figure 6.1 provide a visual comparison of the pre-course mean responses of all three studies. Field, preliminary, and main study survey mean responses are displayed, from left to right: field responses [left], preliminary study responses [middle], and main study responses [right] for each question. The post-course mean responses for all three studies are displayed in Figure 6.2, using the same order. Question numbers which correspond to the listing of questions in Tables 6.1 and 6.2 are displayed below the horizontal axis. The vertical scale indicates the mean response for each question. A gray-scale key, designating the field, preliminary, and main study responses is also included.

**FIGURE 6.1. Field, Preliminary, and Main Study Comparison:
Pre-course Self-evaluation Survey Mean Responses**

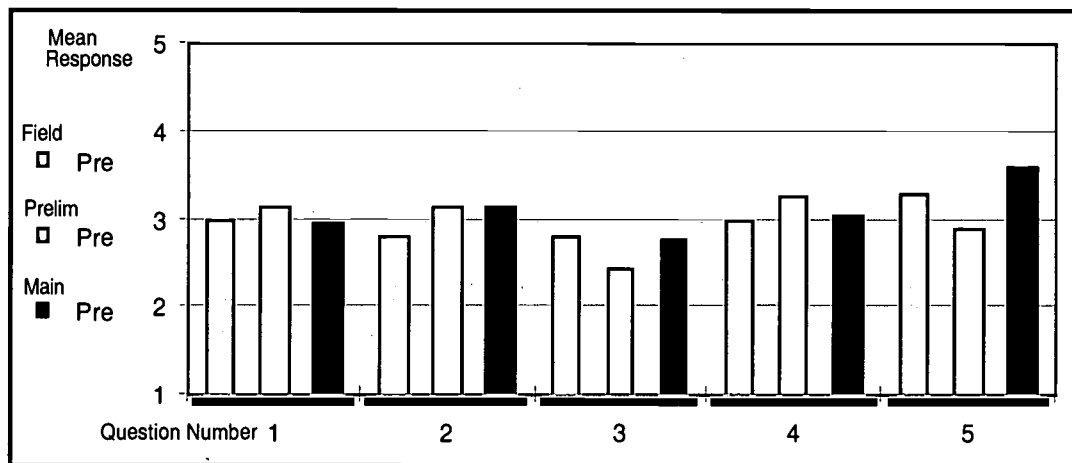

**FIGURE 6.2. Field, Preliminary, and Main Study Comparison:
Post-course Self-evaluation Survey Mean Responses**

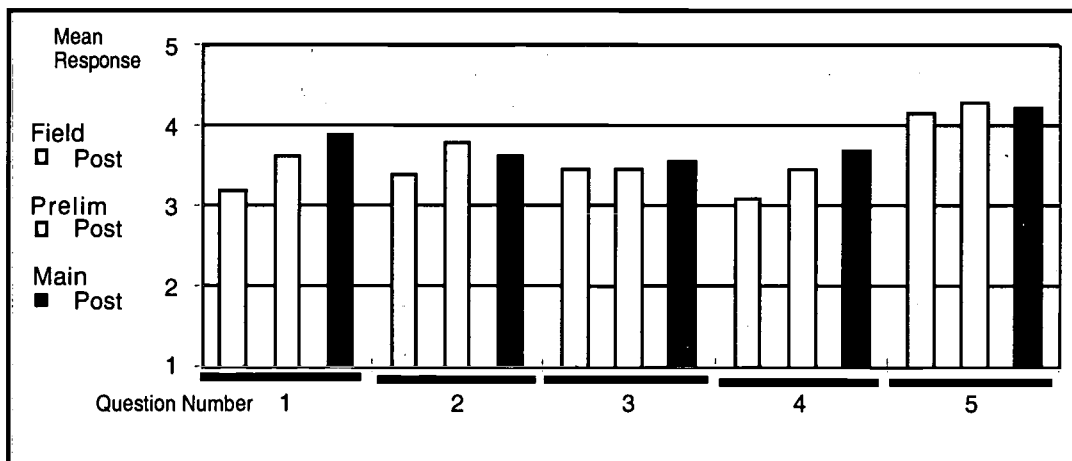

Though nearly eighty percent of the main study students rated themselves very poor mathematically at the beginning of the semester, the mean responses of the self-evaluation pre-course surveys [Figure 6.1] suggest a somewhat different picture—that overall, the students' beliefs about their mathematical ability was more neutral than negative. However, an examination of the mean responses of the extremes of the class, i.e., the most successful and the least successful students, displayed in Table 6.4, suggests yet another possibility: students who were most successful in the course actually had more negative attitudes at the beginning of the term than did the students who were the least successful during the semester. The most successful students also experienced greater improvement in state during the semester.

**Table 6.4: Main Study: Most and Least Successful Mean Responses:
Pre- Course, Post Course Self Evaluation of Abilities**

Students who rated themselves as somewhat good (4) or very good (5) at the beginning, improved at the end of the semester	Most	Least	Most	Least
	Pre	Pre	Post	Post
1. Ability to interpret notation & symbols	2.75	3.25	4.25	3.25
2. Ability to analyze and interpret data	3.25	3.50	4.00	3.75
3. Ability to solve problem not seen before	2.50	3.75	3.75	4.00
4. Willing to attempt a problem not seen before	2.25	3.50	4.25	3.50
5. Use of graphing calculator to understand math	3.25	3.75	4.50	4.25

A visual comparison of the pre-course mean responses of the most and least successful students is displayed in Figure 6.3. The pre-course mean response of the most successful students for each question is displayed to the left of the mean response of the least successful students.

**FIGURE 6.3. Main Study: Most and Least Successful Mean Responses:
Pre- Course Self Evaluation of Abilities–Initial State**

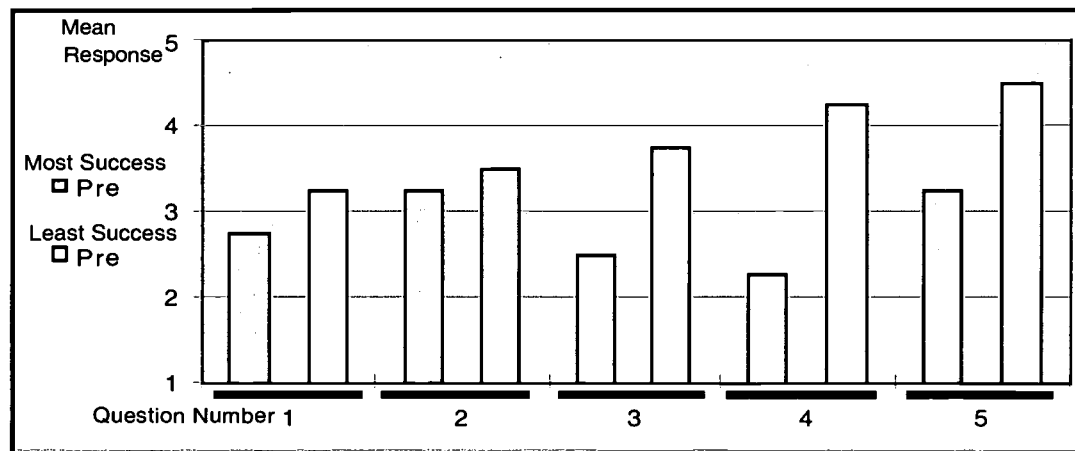

Initially, the most successful students underestimated their mathematical abilities compared with the estimates of the least successful, who tended to rate their abilities and confidence in their responses higher than their performance on the pre-test warranted. Initially, *more negative beliefs about their mathematical abilities were held by those students who were most successful during the semester.*

The post-course mean response of the most successful students for each ques-

tion is displayed to the left of the mean response of the least successful students in Figure 6.4.

FIGURE 6.4. Main Study: Most and Least Successful Mean Responses: Post- Course Self Evaluation of Abilities–Improved State

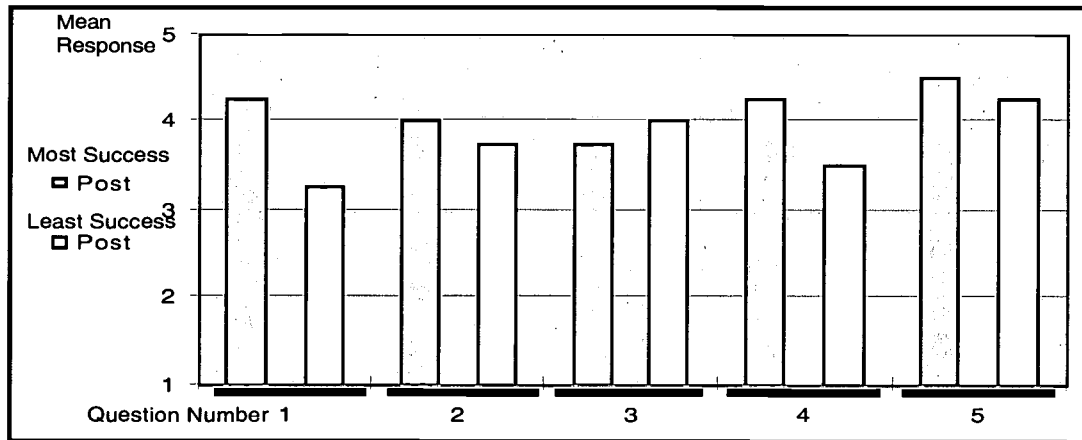

The initial states of the beliefs about their mathematical abilities of both groups of extremes and the changed states of those beliefs are shown in Figure 6.5. Initial state paired responses for Question 1 are displayed to the left of the final state paired responses for the same Question. In all paired responses, the mean response of the most successful students (M) is displayed to the left of the mean response of those least successful (L).

FIGURE 6.5. Most (M) & Least (L) Successful Initial State and Improved State Paired Mean Responses of Self-evaluation Surveys

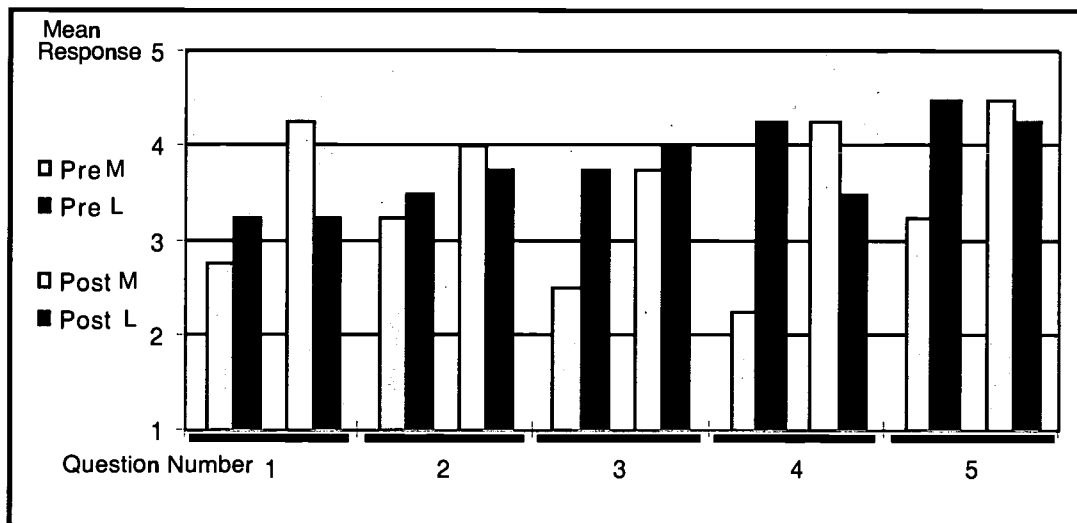

6.5 Students' Ability to Interpret Ambiguous Notation

The preliminary studies established a student profile and identified prior variables which provide background and context for interpreting results of the main study. Results of the preliminary studies indicated that students' have great difficulty interpreting ambiguous notation and that the process of reconstruction of an inappropriate concept image which includes interpretation and use of the minus symbol appears very difficult for some students, seemingly impossible for others. Pre- and post-tests provided information about students' ability to interpret function notation and the minus symbol in various contexts; to evaluate functions; and to translate between representations. The preliminary version consisted of twenty questions. For the main study, the number of pre-test questions was reduced to twelve questions, focused on students' ability to think flexibly to interpret notation and to translate among various representations. The main study post-test consisted of sixteen questions; the twelve pre-test questions and four additional questions. Both instruments, in their final form, are included in appendix B: Data Collection Instruments. They are discussed in more detail in a previous chapter [Chapter 4]. The pre- and post-tests tested the null hypothesis that there would be no demonstrated differences in competence in interpreting ambiguous notation and translating among various functional representations.

6.5.1 Main Study Pre- and Post-Test Results

The pre-test was given to students during the first week of class. Responses of the pre-test were similar to those reported in the preliminary study [Chapter 5]. They indicated that less than fifty percent of the students were able, except for the arithmetic computation of squaring a negative number, to correctly answer even one of the remaining eleven questions at the beginning of the semester. Five of the twenty-six students of the main study correctly evaluated the function $f(x)$ for a negative-valued input, $f(-2)$, given $f(x) = x^2 - 5x + 3$. Three of the twenty-three students of the preliminary study answered this question correctly. Only one student in the main study was able to evaluate the function correctly when asked to find an algebraic input, $f(h-1)$. It should be noted that all students had satisfied the prerequisite for this course (i.e., a grade of C or better in Introductory Algebra or entry based on a placement test score). Recall that six of these students were repeating the course; two for the second time.

One of the six students was attempting the course for the third time, having dropped the course on each of his two previous attempts.

The results of the pre-test are summarized in the chart in Figure 6.6. The twelve pre-test questions are indicated in the left-most column. Each column, numbered from 1–26 (indicated at the top of the display), contains the responses of an individual student. The column numbers reflect the students' end-of course ranking, determined by the combined total numbers of correct responses on the post-test, the departmental final open response, and multiple choice exams. Correct responses are indicated by the black cells and incorrect responses by the striped cells. Cells left blank (white) indicate the student made no attempt to answer the question. Questions referenced in the preceding discussion are indicated by the arrows on the left. The row numbers on the right edge of the summary indicate the total number of correct responses for that question and the total number of correct responses for each of the questions discussed is highlighted by a small dark square. The numbers along the bottom of the chart indicate the number of correct pre-test responses for a given student.

FIGURE 6.6. Main Study: Pre-test: Students' Ability to Interpret Notation

	Student Rank																											
Pre-test(12 Questions)	1	2	3	4	5	6	7	8	9	10	11	12	13	14	15	16	17	18	19	20	21	22	23	24	25	26	Total	
11. Tables: find $g(f(2))$																												1
10. Tables: find $f(g(2))$																												1
12. Graph: (linear) find eq																												1
9. Graph: find x if $y(x) = 8$																												3
5. Sign of c in $(x - c)$																												5
4. Meaning of $f(x)$																												1
7. Given f , find $f(h - 1)$ →																												1
6. Given f , find $f(-2)$ →																												5
2. Order of operations																												9
1. $-(n \text{ squared})$ →																												6
8. Graph: find $y(3)$																												8
3. Square of a negative number																												23
Number of correct responses	2	3	2	4	2	4	1	6	1	1	4	3	5	1	2	2	3	2	2	2	2	1	2	1	4	2	2	

Based on the results of the preliminary study and the main study pre-test, students' ability to interpret and use ambiguous notation was a focus of investigation and explicit discussion throughout the semester. The need to recognize the role of context and to use notation and substitution consistently was also emphasized. During the first

two weeks, students were introduced to a process notion of function, in which an informal process definition of function is introduced: A function represents a process that receives input and returns exactly one output for a given input [DeMarois, McGowen & Whitkanack, 1998]. Investigations and explicit discussion of function notation were a regular part of classroom discourse. Explorations, with questions similar to those tested in the preliminary study teaching experiment were assigned. Function evaluation with numerical and algebraic inputs was also a subject of investigation, as students attempted to make sense of the notation. Students' answers which included inconsistent and/or inappropriate use of notation were considered incorrect.

A journal problem assigned at the beginning of the third week of the course provided additional data about students' ability to interpret ambiguous in the context of evaluating a quadratic function.

$$\text{If } f(x) = x^2 - 3x + 5$$

- a. find $f(t - 2)$. Show all work and explain what you did.
- b. find $f(-3)$.

Eleven of the 26 students used consistent, correct notation. They wrote

$$f(-3) = (-3)(-3) - 3(-3) + 5$$

and completed the evaluation correctly. Fifteen students wrote:

$$f(-3) = -3^2 - 3(-3) + 5$$

Eight of those students interpreted -3^2 as $(-3)(-3) = 9$ and proceeded to complete evaluation of the function: $f(-3) = 23$. Though none of these students used grouping symbols to indicate they were squaring a negative number, they all used parentheses when substituting -3 for x in the linear term, illustrating their inconsistent use of notation. Subsequent interviews with the fifteen students revealed their lack of awareness of using notation inconsistently or that what they wrote indicated the use of two different values for x : 3 in the quadratic term and -3 in the linear term. Six of the fifteen students showed the same work initially, but evaluated -3^2 as -9 , which resulted in an incorrect answer. Seven students wrote $-9 + 9 + 5 = 5$; two students wrote $(-3)(3) - (3)(-3) + 5 = 5$.

A post-test was administered during the 15th week of the semester. The pre-test responses and post-test responses are summarized in Figures 6.7 and 6.8 respectively and are interpreted in the same manner as the results displayed in Figure 6.6.

FIGURE 6.7. Main Study: Pre- test Responses

Pre-test(12 Questions)	Student Rank																										Total
	1	2	3	4	5	6	7	8	9	10	11	12	13	14	15	16	17	18	19	20	21	22	23	24	25	26	
11. Tables: find $g(f(2))$	[Pattern]																										1
10. Tables: find $f(g(2))$	[Pattern]																										1
12. Graph: (linear) find eq	[Pattern]																										1
9. Graph: find x if $y(x) = 8$	[Pattern]																										3
5. Sign of c in $(x - c)$	[Pattern]																										5
4. Meaning of $f(x)$	[Pattern]																										1
7. Given f , find $f(h - 1)$	[Pattern]																										1
6. Given f , find $f(-2)$	[Pattern]																										5
2. Order of operations	[Pattern]																										9
1. $-(n \text{ squared})$	[Pattern]																										6
8. Graph: find $y(3)$	[Pattern]																										8
3. Square of a negative number	[Pattern]																										23
Number of correct responses	2	3	2	4	2	4	4	1	6	1	1	4	3	5	1	2	2	3	2	2	2	1	2	1	4	2	2

FIGURE 6.8. Main Study: Post-test Responses

Post-test(14 Questions)	Student Rank																										Total
	1	2	3	4	5	6	7	8	9	10	11	12	13	14	15	16	17	18	19	20	21	22	23	24	25	26	
14. Meaning of $f(-x)$	[Pattern]																										3
13. meaning of $-f(x)$	[Pattern]																										5
11. Tables: find $g(f(2))$	[Pattern]																										5
10. Tables: find $f(g(2))$	[Pattern]																										9
12. Graph: (linear) find eq	[Pattern]																										7
9. Graph: find x if $y(x) = 8$	[Pattern]																										9
5. Sign of c in $(x - c)$	[Pattern]																										10
4. Meaning of $f(x)$	[Pattern]																										14
7. Given f , find $f(h - 1)$	[Pattern]																										17
6. Given f , find $f(-2)$	[Pattern]																										17
2. Order of operations	[Pattern]																										17
1. $-(n \text{ squared})$	[Pattern]																										18
8. Graph: find $y(3)$	[Pattern]																										18
3. Square of a negative number	[Pattern]																										25
Number of correct responses	14	12	11	11	9	8	8	8	8	8	7	7	7	6	5	5	5	5	5	5	4	4	3	4	3	2	5

Analysis of the results indicates that there was a significant difference in the number of correct post-test responses compared with the pre-test responses, indicating growth in students' ability to interpret ambiguous notation and translate among repre-

sentations. A Pearson Chi-square test confirms that the number of correct responses on the post-test Questions 1–12 differs significantly from the number of correct responses of the pre-test Questions 1–12, with more correct responses on the post-test than predicted ($\chi^2 = 86.176$, and two degrees of freedom, $p < 0.0001$).

Not only did the total number of correct responses increase significantly on the post-test compared with the pre-test, but the number of problems not attempted was reduced significantly as well. The overall change in the number of incorrect responses, though decreased, was not significant. These differences are shown in Figure 6.9.

FIGURE 6.9. Main Study: Analysis of Pre- and Post-Test Responses

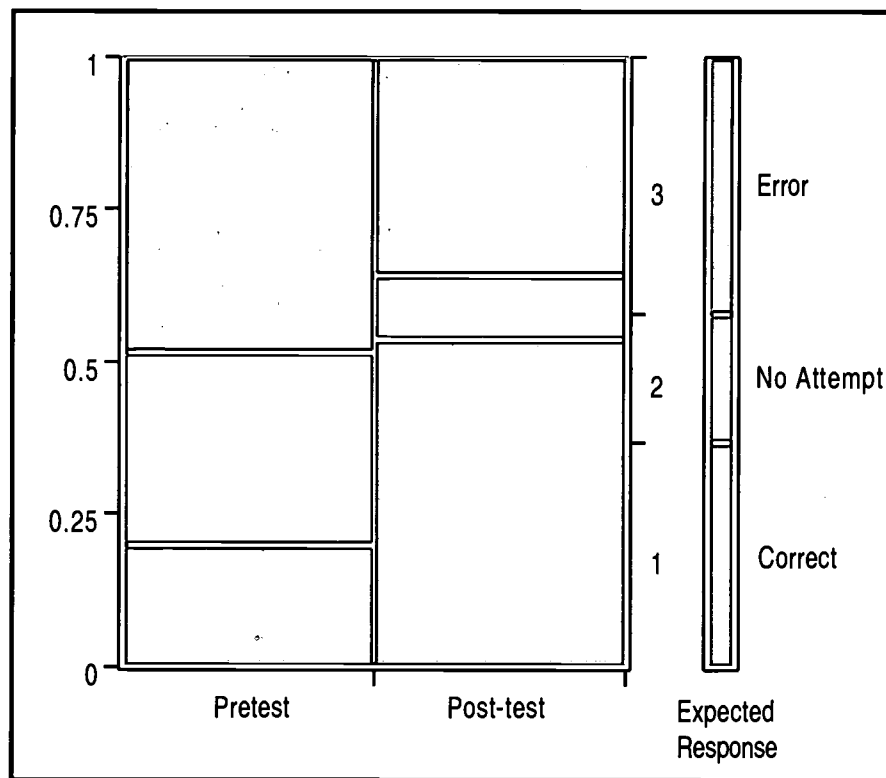

6.6 Divergent Paths-Results of the Quantitative Studies

When the pre- and post-test responses of the extremes of the class are analyzed, the results indicate the divergence of performance that has occurred during the semester between the most and least successful students. On the pre-test, the number of correct responses of each group was approximately the same, suggesting a similar initial level of competence. The divergence that occurred is shown in Figure 6.10.

FIGURE 6.10. Comparison of Most/Least Successful Pre- & Post-test Responses

	Pretest (12 Questions)				Post Test (12 Questions)			
	Most Success		Least Success		Most Success		Least Success	
11. Tables: find $g(f(2))$	[Hatched]		[Hatched]		[Solid Black]		[Hatched]	
10. Tables: find $f(g(2))$	[Hatched]		[Hatched]		[Solid Black]		[Hatched]	
12. Graph: (linear) find eq	[Hatched]		[Hatched]		[Solid Black]		[Hatched]	
9. Graph: find x if $y(x) = 8$	[Hatched]		[Hatched]		[Solid Black]		[Hatched]	
5. Sign of c in $(x - c)$	[Hatched]		[Hatched]		[Solid Black]		[Hatched]	
4. Meaning of $f(x)$	[Hatched]		[Hatched]		[Solid Black]		[Hatched]	
7. Given f , find $f(h - 1)$	[Hatched]		[Hatched]		[Solid Black]		[Hatched]	
6. Given f , find $f(-2)$	[Hatched]		[Hatched]		[Solid Black]		[Hatched]	
2. Order of operations	[Hatched]		[Hatched]		[Solid Black]		[Hatched]	
1. $-(n \text{ squared})$	[Hatched]		[Hatched]		[Solid Black]		[Hatched]	
8. Graph: find $y(3)$	[Hatched]		[Hatched]		[Solid Black]		[Hatched]	
3. Square of a negative number	[Hatched]		[Hatched]		[Solid Black]		[Hatched]	
Number of correct responses	2	3	2	4	14	12	11	11

Both groups demonstrate approximately the same level of competence at the beginning of the semester. A noticeably improved level of performance on the post test at the end of the semester is indicated for the most successful students. Almost no improvement occurred for those students who were least successful. The significant improvement of the most successful students compared with the minimal improvement of the least successful and the divergence of performance that occurred during the sixteen week course is clearly indicated in the bar charts of Figure 6.11.

FIGURE 6.11. Analysis of Pre- & Post-test Responses: Most/Least Successful

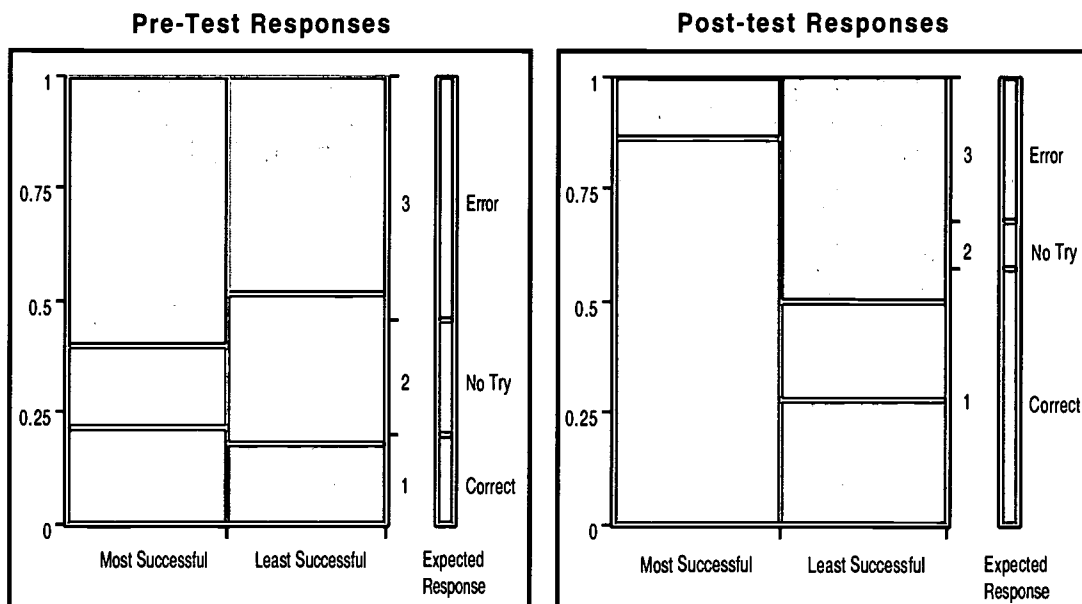

A closer examination of the pre- and post-test responses of each group of extremes suggests that the significant change in the overall class responses is due primarily to differences in the pre- and post-test responses of the most successful students. Pre- and post-test responses for each group of extremes are displayed in the bar charts in Figure 6.12. The number of correct post-test responses of the most successful students in the bar chart on the left indicates a significant difference compared with the pre-test responses ($\chi^2 = 86.176$, with two degrees of freedom, $p < 0.0001$). By contrast, the bar chart on the right in Figure 6.12 reveals how slight the improvement in performance is for the least successful students. The difference in the number of correct post-test responses compared with the number of correct pre-test responses was not significant.

FIGURE 6.12. Comparison: Pre & Post-test Responses by Each Extreme Group

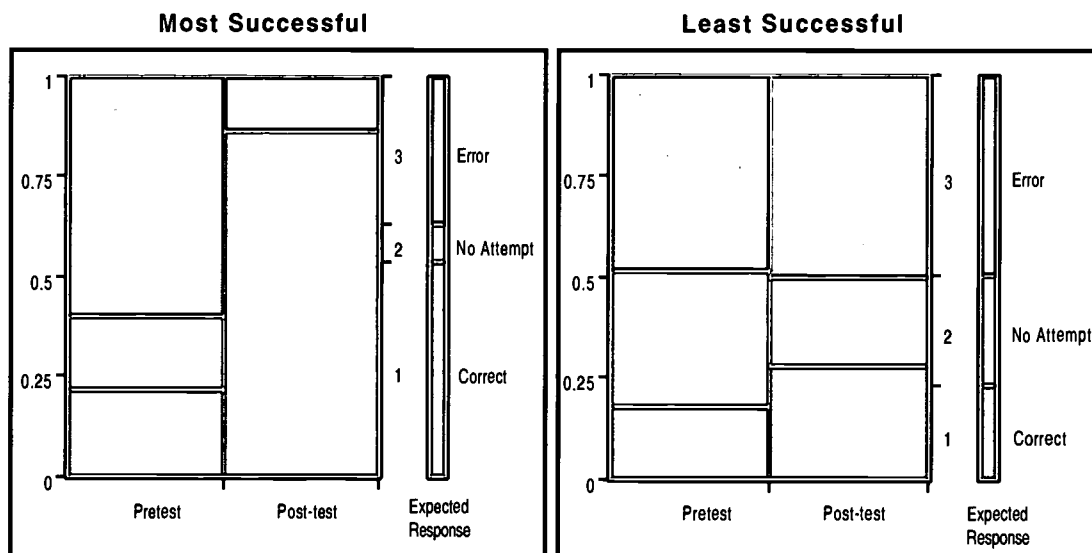

6.7 Qualitative Divergence

Among the aptitudes essential for mastery of mathematics, Krutetskii [1969] identified the ability to *curtail* reasoning [the ability to drop the intermediate (connecting) system of substantiation from the reasoning process and to connect the first link directly with the last as it applies to a series of mathematical operations] and the ability to switch over from a direct to a reverse train of thought; i.e., *reversibility*. His research with elementary school children (grades 5–8) challenges the prevailing assumption that repeated exercises on problems of a single type is a necessary condition for the transition from ‘detailed’ to ‘curtailed’ reasoning.

His data suggests that curtailment begins immediately after the method of solution has been generalized for the most capable students. For capable pupils, the curtailment process develops swiftly after solving the first problem of a type that is new to them. This characteristic is not typical of all students. The extent to which this condition is typical varies for capable, average, and less capable pupils. Average pupils usually cannot proceed with solutions if even one step is left out of the reasoning process. They apparently do not develop the ability for 'curtailment' until later stages of mastery, after they have had the benefit of repeated exercises. Less capable pupils have even greater difficulty and do not begin to curtail reasoning until after they have had lengthy exercises, if they are able to curtail reasoning at all [Krutetskii, 1969d, pp. 41–50]. Additional studies on divergent performance of more able and less able students and the characteristic components of mathematical abilities of students in grades 2–4 were conducted by Dubrovina [1992]. Studies of the process of curtailment of students in grades 9 and 10 were conducted by Shapiro [1992]. Their findings support Krutetskii's results, documenting the qualitative divergence that occurs as a consequence of the presence or lack thereof of the various components of mathematical abilities identified by Krutetskii.

6.7.1 Stability of Students' Responses

Investigations, assignments, small-group work, and class discussions during the semester provided students with opportunities for reflective practice. Problems structured similarly to those students had difficulty with at the beginning of the semester were included on assignments, as well as on various forms of evaluation. Student work over time was analyzed to determine whether the phenomena of curtailment and reversibility of thought occurred in a population of remedial undergraduate students. The stability of students' responses in the main study on similarly structured problems assigned throughout the semester supports the findings of Krutetskii [1969] and Shapiro [1992] on curtailment. A comparison of responses for the tasks of evaluating a quadratic function using a negative-valued input and using an algebraic input document the process of curtailment which occurred at various times throughout the semester experienced by the most and least successful students. Baseline information was established with the Pre-test Questions 6 and 7 responses. None of the students who

were characterized as those most successful upon completion of the course, nor those who were eventually characterized as least successful, answered Pre-test Questions 6 or 7 correctly, though all students in both groups of extremes attempted these problems on the post test. Similarly structured problems were included on a weekly journal assignment [week 3]; the first unit exam [week 6]; the post-test Questions 6 and 7 [week 15] and on the open-response final exam [week 16]. Student responses for the two tasks, given similarly structured problems at different points during the semester, are summarized in Figure 6.13. As in the charts presented previously, dark cells indicate correct responses, striped cells represent incorrect responses and cells left blank indicate no attempt was made to answer the question.

FIGURE 6.13. Reconstruction of Schemas and Curtailment of Reasoning

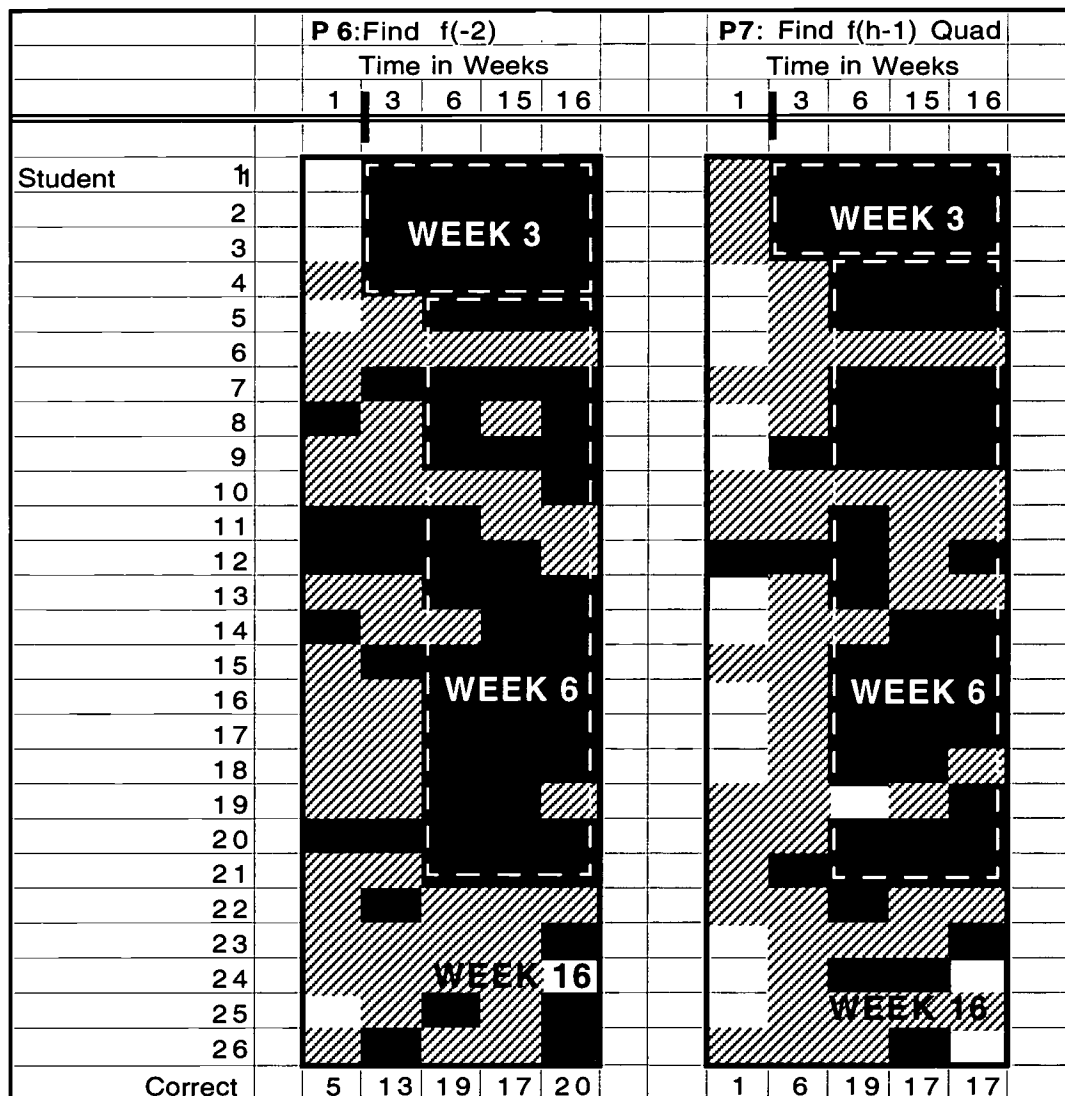

Responses for each of the two questions indicate there were three distinct time periods during which curtailment and/or reconstruction of inappropriate schemas occurred for most, if not all the students within the groups: most successful, average, and least successful. These time periods, together with the responses of students who were able to demonstrate a consistency of performance [indicated by the dotted rectangles] are shown in Figure 6.13. The dotted rectangles enclose the responses of students who were able to curtail their reasoning by the time indicated in the column headings, given in weeks. Reading the chart by rows, left to right, the left edge of the dotted rectangle indicates the earliest time by which most students in a group demonstrated consistency. This is an indication that successful and relatively stable reconstructions of inappropriate schemas and curtailed reasoning have occurred with respect to the evaluation of quadratic functions using a negative-valued input and the process of squaring a binomial. Each row represents the responses of one student, ranked from the most successful [1] to the least successful [26], top to bottom.

The chart on the left in Figure 6.13 summarizes the responses of students for the evaluation of a quadratic function with a negative-valued numerical input. These responses of the most successful are contrasted with those of students who were able to curtail their reasoning by week 6, [students 5–21] and with the responses of those who were still struggling in week 16 [students 22–26]. The most successful students [1–4] required almost no practice and very little time [week 3] in which to construct a more appropriate schema which remained stable throughout the semester. The data suggests that average students [5–21] usually needed additional practice and experience. Most were successful by week 6. The least successful students [22–26], despite an entire semester of experience and practice, still struggled and were inconsistent at the end of the semester.

The right-hand chart in Figure 6.13, summarizes students' responses for the problem which asked them to square a binomial as part of the overall process of evaluating a quadratic function. The most successful students [1–3] again managed to construct an appropriate schema which remained stable throughout the semester by week 3. Several students, with additional experience, reflection, and practice, developed consistent performances by week 6. The least successful [students 22–26] were, for the most part, unable to develop proficiency by week 16.

The pre- and post-test responses for the two squaring process in the context of evaluating a quadratic function are compared in Figure 6.14.

FIGURE 6.14. Pre- and Post-test Results: Arithmetic & Algebraic Squaring Processes — Evaluating a Quadratic Function

	Pretest (12 Questions)								Post Test (12 Questions)							
	Most Success				Least Success				Most Success				Least Success			
	1	2	3	4	22	23	24	26	1	2	3	4	22	23	24	26
7. Given f , find $f(h-1)$	[Hatched]				[Hatched]				[Solid Black]				[Hatched]			
6. Given f , find $f(-2)$	[Hatched]				[Hatched]				[Solid Black]				[Hatched]			

Students who were eventually categorized as those most successful, at the beginning of the semester demonstrated the same level of competence as did those who were eventually classified as least successful. The post-test results for students characterized as most successful when compared with the results of the least successful illustrates the divergence that occurred during the semester. Note that Students 24 and 26 answered P7 correctly, though their responses to P6 were incorrect on both pre- and post-tests. Neither student was able to answer the arithmetic questions, P1 and P3, correctly, suggesting that difficulties interpreting the minus symbol are an underlying cause of the difficulties they experienced in answering P6.

A comparison of the stability of responses of the most successful with those of the least successful in Figure 6.15 illustrates the differences in ability to reconstruct schemas and curtail reasoning even more starkly.

FIGURE 6.15. Reconstruction and Curtailment: Most/Least Successful

	P6: Find $f(-2)$ quad					P7: Find $f(h-1)$ Quad				
	Week					Week				
	1	3	6	15	16	1	3	6	15	16
Most Successful										
Student 1	[Hatched]	[Solid Black]	[Solid Black]	[Solid Black]	[Solid Black]	[Hatched]	[Solid Black]	[Solid Black]	[Solid Black]	[Solid Black]
Student 2	[Hatched]	[Solid Black]	[Solid Black]	[Solid Black]	[Solid Black]	[Hatched]	[Solid Black]	[Solid Black]	[Solid Black]	[Solid Black]
Student 3	[Hatched]	[Solid Black]	[Solid Black]	[Solid Black]	[Solid Black]	[Hatched]	[Solid Black]	[Solid Black]	[Solid Black]	[Solid Black]
Student 4	[Hatched]	[Solid Black]	[Solid Black]	[Solid Black]	[Solid Black]	[Hatched]	[Solid Black]	[Solid Black]	[Solid Black]	[Solid Black]
Least Successful										
Student 22	[Hatched]	[Hatched]	[Hatched]	[Hatched]	[Hatched]	[Hatched]	[Hatched]	[Hatched]	[Hatched]	[Hatched]
Student 23	[Hatched]	[Hatched]	[Hatched]	[Hatched]	[Hatched]	[Hatched]	[Hatched]	[Hatched]	[Hatched]	[Hatched]
Student 24	[Hatched]	[Hatched]	[Hatched]	[Hatched]	[Hatched]	[Hatched]	[Hatched]	[Hatched]	[Hatched]	[Hatched]
Student 26	[Hatched]	[Hatched]	[Hatched]	[Hatched]	[Hatched]	[Hatched]	[Hatched]	[Hatched]	[Hatched]	[Hatched]

Reading the chart row by row, from left to right, it is noted that all of the most successful students were able to correctly evaluate a quadratic function given a negative-valued input by the third week. Note that both students 24 and 26 correctly answer P6 and P7 on the final exam, the post-test question they answered incorrectly the week previously. Two facts should be taken into account in trying to interpret these changed results. First, both students, in interviews following the post-test and prior to the final exam, investigated similarly structured problems and reflected on their incorrect post-test responses. Second, the final exam was a multiple choice exam—the post-test was an open response format. It remains an open question as to whether these students have restructured their schemas into a more appropriate, stable cognitive collage, or whether their responses are the result of being retained in memory for a brief period of time.

6.7.2 Flexibility of Thought: Ability to Reverse a Direct Process

Students' ability to switch their train of thought and reverse a direct process was also a subject of investigation—another indicator of flexible thinking. The ability to evaluate a function for a given input, together with the ability to find the input given a specific output is considered a two-way association. A student who is able to make the transition from being able to evaluate a function for a given input and is also able to find the input, given a specific output, regardless of starting point, who recognizes that these are two different processes, would be considered to have demonstrated flexible thinking.

Pre- and post-test responses provide some indication of the ability of students in each group of extremes to think flexibly and to switch one's train of thought from a direct process to its reverse process. Four direct processes were examined, together with their reverse processes. Baseline data indicative of students' abilities to reverse a process, using various representations, were provided by the pre- and post-test question pairs, P3 and P1 [arithmetic]; P8 and P9 [graphical]; P10 and P11 [numerical-table]; and P13 and P14 [functional symbolic]. P13 and P14 were used on the post-test only. The pre-test responses of each group of extremes for the paired reverse process questions are shown in Figure 6.16 on the left. The post-test responses are shown on the right.

FIGURE 6.16. Pre- and Post-test Results: Reversal of a Direct Process

	Pretest (12 Questions)								Post Test (12 Questions)							
	Most Success				Least Success				Most Success				Least Success			
	1	2	3	4	22	23	24	26	1	2	3	4	22	23	24	26
14. Meaning of $f(-x)$									█	█	█	█				█
13. Meaning of $-f(x)$									█	█	█	█				█
11. Tables: find $g(f(2))$	█	█	█	█	█	█	█	█	█	█	█	█	█	█	█	█
10. Tables: find $f(g(2))$	█	█	█	█	█	█	█	█	█	█	█	█	█	█	█	█
9. Graph: find x if $y(x) = 8$	█	█	█	█	█	█	█	█	█	█	█	█	█	█	█	█
8. Graph: find $y(3)$	█	█	█	█	█	█	█	█	█	█	█	█	█	█	█	█
1. $-n$ squared	█	█	█	█	█	█	█	█	█	█	█	█	█	█	█	█
3. Square of a negative n	█	█	█	█	█	█	█	█	█	█	█	█	█	█	█	█

A comparison of the pre-test responses in Figure 6.16 indicate that both groups of extremes demonstrated a similar lack of competence to reverse a process at the beginning of the semester, even at the computational level [P3 and P1]. Responses to post-test and final exam questions related to reversing a direct process, similarly structured but using different formats (post-open response; final exam, multiple choice) and various representations, are shown in Figure 6.17.

FIGURE 6.17. Post-test & Final Exam: Reversal of a Direct Process

			Most Success				Least Success			
			1	2	3	4	22	23	24	26
Reverse	Post 9	Graph: Linear f : find x if $y(x) = 8$	█	█	█	█	█	█	█	█
Direct	Post 8	Graph: Linear f : find $y(3)$	█	█	█	█	█	█	█	█
Reverse	Final 33	Graph: Linear f : Find x if $y(x) = -3$	█	█	█	█	█	█	█	█
Direct	Final 32	Graph: Linear f : find $y(2)$	█	█	█	█	█	█	█	█
Reverse	Post 11	Tables: find $g(f(2))$	█	█	█	█	█	█	█	█
Direct	Post 10	Tables: find $f(g(2))$	█	█	█	█	█	█	█	█
Reverse	Final 30	Tables: find $g(f(2))$ (mc)	█	█	█	█	█	█	█	█
Direct	Final 29	Tables: find $f(g(2))$ (mc)	█	█	█	█	█	█	█	█
Reverse	Post 14	Symbolic: Meaning of $f(-x)$	█	█	█	█	█	█	█	█
Direct	Post 13	Symbolic: Meaning of $-f(x)$	█	█	█	█	█	█	█	█
Reverse	Post 1	Symbolic: $-n$ squared	█	█	█	█	█	█	█	█
Direct	Post 3	Symbolic: square of a negative n	█	█	█	█	█	█	█	█

The post-test responses [Figure 6.17] reveal that the divergence occurred between the two groups, based on their responses to questions in arithmetic, as well as in symbolic contexts, using various representations (graphs, tables, arithmetic computations). By the end of the semester, the most successful students demonstrated that given the graph of a function, they were able to evaluate a function and to reverse thinking to solve for a specified value. They were able to extend their knowledge about function evaluation. They could evaluate a composition of a function using tables and were able to reverse their train of thought, first using the output of a function, g , as input in another function, f , then using the output of f as input into the function, g . Having successfully reconstructed their inappropriate cognitive collages of quadratic processes, they were able to square a negative number as well as find the additive inverse of a number squared. The most successful students were also able to describe the direct process and its reversal, distinguishing them as distinct processes.

The post-test responses in Figure 6.17 of least successful students, on the other hand, when compared with their pre-test responses, indicate that no improvement in their abilities to reverse a process occurred during the semester. The inflexibility of their thinking extends even to arithmetic computational processes. The ability to reverse their train of thought appeared frozen, regardless of which representation was used. When one recalls that these are undergraduate students in a class where graphing calculators were an integral component of the course which they were encouraged to use, not only in class but on all assessments, these results are even more discouraging.

Reversal questions that were conceptual, i.e., they involved no procedure in order to determine the answer, such as Post-test Questions 10 and 11; 13 and 14, proved more difficult, even for the most successful students. Perhaps it is because conceptual reversal questions frequently require two types of flexible thinking: the ability to reverse one's train of thought and the ability to think procedurally; recognizing when the symbol or expression indicates a *to do* procedure and when the notation requires no procedure, but is an object to think about and with. All four of the most successful students were able to correctly reverse the direction of their thinking, when confronted with procedural questions. They were able to recognize the reverse processes of finding output given an input and finding an input given an output, when asked what the expressions $-f(x)$ and $f(-x)$ meant to them. Each student saw $f(x)$ as the output

and x as the input. The difficulty lay, not in their ability to switch their train of thought, but in their ability to interpret notation flexibly—to interpret the minus symbol and what it means in the given context, taking into consideration what values are included in the domain and range. Despite their overall improvement, two of the four most successful students continued to interpret a minus sign in front of a variable to mean that the “value of the output is negative” in the first instance, and that the “value of the input is negative” in the second instance, even at the end of the semester. Each of the least successful students interpreted the minus sign in front of a variable to mean that the value was a negative number.

6.8 Reconstruction of a Cognitive Collage: One Student's Efforts

Skemp defines a symbol as “a sound, or something visible, mentally connected to an idea” [Skemp, 1971, p. 69]. What is the idea, or ideas, to which the minus symbol is attached for students? What meaning does it have? The quantitative data contribute bits and pieces of knowledge to our understanding of students' difficulty interpreting ambiguous notation, but do not address the cognitive aspects of the student's behaviour. What does the student perceive? What meaning does the symbol(s) have? What makes reconstruction of the limiting cognitive collage and/or cognitive units which include notions about the minus symbol so difficult for so many students? Mathematician colleagues dismiss the difficulties students experience in interpreting this symbol. It is so obvious and trivial to them, that it does not appear to be a difficulty even worthy of examination. The introduction and growing use of technological tools which seek to implement the mathematician's intuitive understanding of the minus symbol with the computer scientists' traditional programming practices challenge us to rethink our own understandings, as well as our instructional practices. Before examining other aspects of flexible thinking, let us consider the processes of reconstruction of one student's existing cognitive collage in which her schemas for dealing with the minus symbol were well-established and refined.

The following excerpt is a portion of a transcript of an interview with MD, a student in the most successful group who, on the post-test, when asked the meaning of $-f(x)$ [P13], responded “negative output” and when asked “What first comes to mind when you see $f(-x)$,” [P14], answered “negative input.” However, in her response to

P5, she stated that the value of c was neither positive nor negative: “ x is some number; c is some number; subtraction is between them.” Her response suggests that this student does, on occasion, take into consideration the context in which the symbol is given and that she recognizes that a variable can take on a range of values; that it is not “just a place-holder for a missing number.”

The interview began with questions about the arithmetic processes of squaring a negative number and finding the additive inverse [“taking the opposite”].

I: What does it mean “to square” a number?

MD: Squaring...multiplying a number times itself, like -5 times -5.

I: What is negative five squared?

MD: Twenty-five. [She responds quickly and confidently.]

I: [showing student post test problem: -5^2] What comes to mind?

MD: Square negative five.

I: How did you get the answer -25 ?

MD: Oh! On the calculator. I just entered the problem exactly as written.

I: You told me a few minutes ago that “to square” means multiplying a number times itself.

MD: Yes.

I: ...and that squaring negative five gives an answer.

MD: of 25. Yes.

I: If you square a negative number, what is the sign of the answer?

MD: (very quickly) Positive! It's always positive.

I: Then what process was used by the calculator to produce an answer of -25 ?

MD: Oh! Square five, then take the opposite of the answer.

I: What does it mean “to take the opposite—

MD: Change the sign of the number or answer.

Both her confidence and the quickness of her responses suggests that MD has a relational understanding of what it meant to square a number and an understanding of the process of finding the additive inverse of a number. The interview continued and MD was asked to interpret symbolic notation preceded by a minus sign.

I: How do you interpret this? [writes down $-f(x)$].

MD: negative output. The answer is negative.

I: and [writes down $f(-x)$]?

MD: The input is negative.

I: How do you know the answer is negative? [Interviewer points at $-f(x)$].

MD: I don't—I just assumed it was negative. The minus sign is in front of f .

I: And in $f(-x)$?

MD: Negative, the input is negative.

I: How do you know—

MD: I just assumed it would be negative because the minus sign is in front of x .

I: [writes down -5 and $-x$.] as she asks MD: Does it make a difference if the minus sign is in front of a number or in front of a variable?

MD: Being in front of a variable, it would be a negative answer. And negative five is just that, negative five.

MD's concept image of the minus symbol appears to be very stable and refined, part of a schema, well used and unquestioned. The interview continued:

I: You wrote that c in the expression $(x - c)$ was neither positive nor negative—that it could be positive, negative, or zero. How is the minus symbol in the expression $(x - c)$ different from $-f(x)$ or $f(-x)$?

MD: Because they [points at $-f(x)$ and $f(-x)$] are by themselves.

It was decided to try an intervention during which, it was hoped, MD would experience cognitive dissonance while investigating instances in which the minus symbol precedes a variable. MD was requested to take out her graphing calculator and was asked:

I: Use the $Y_1 =$ key and enter [writes down: $-3x$, avoiding stating a verbal interpretation].

MD [enters $-3x$, using the opposite ($-$) key, not the subtract operator key on the TI-83 calculator.

I: If you substitute 2 for x , what answer would the calculator display?

MD: (answering quickly) "negative six," as she substitutes the value 2 for x and displays the answer.

I: And if you substitute negative one for x ?

MD: (quickly) three, again verifying her answer by substituting the value for x in the expression.

I: And if you substituted zero?

MD: Zero.

I: How did you get the answer negative six?

MD: I multiplied 2 by negative 3.

I: And the answer 3?

MD: I multiplied negative one by negative 3.

I: MD, would you review your answers displayed on the calculator? MD, reviewing your substitutions and the results, was the answer for $-3x$ always negative?

MD: No, only if x was a positive number—Oh! The minus sign doesn't always mean a negative answer!

The physical arrangement of the minus symbol preceding a variable appears to be perceived initially as a cognitive unit for MD, as well as for many of the other students interviewed. This symbol pattern apparently activates a path of selection and

retrieval based on an arithmetic conceptualization of a negative number—an object, not a process, which cues the retrieval of a schema that includes a concept image of the minus symbol as always indicating a negative number. This concept image is so refined and stable, it's selection and retrieval is automatic. The inability to interpret this symbol pattern flexibly contributes to students' difficulties, particularly when they encounter quadratics. Recall the efforts of the student described in the Preliminary Study who struggled to overcome the association of $y = -f(x)$ with the graph of a parabola opening upwards, and $y = f(x)$ with the graph of a parabola opening downward.

6.8.1 Flexibility of Thought: Translating Between Various Representations

Students' efforts to translate among representational forms were also documented. They were asked to determine the algebraic representations of linear and quadratic functions from graphs, to evaluate linear and quadratic functions using tables, graphs and algebraic representations, and to interpret the minus symbol in both arithmetic and functional contexts. Pre-test, post-test, and final exam responses in Figure 6.18 provide a means of comparing students' abilities to translate among symbolic, graphical and numerical representations in different contexts and formats, for similarly-structured questions. The pre-test was administered during the first week of the semester; the open response post test in Week 15; and the multiple choice format Final Exam in Week 16.

FIGURE 6.18. Flexibility: Use of Various Representations and Contexts

Post & Final:	P12:Gr->eq			P8:Gr y(3)=?			P9:y(x)=8,x=			P10:Tbl f(g)			P11:Tbl g(f)			
	Pre	15	16	Pre	15	16	Pre	15	16	Pre	15	16	Pre	15	16	
Week 15 & Week 16	Week	1	15	16	Week	1	15	16	Week	1	15	16	Week	1	15	16
Most Successful																
Student 1																
Student 2																
Student 3																
Student 4																
Least Successful																
Student 22																
Student 23																
Student 24																
Student 26																

The charts in Figure 6.18 provide additional documentation of the divergent performance of students in the two groups of extremes. It is interesting to note the strengths and weakness of the individual students of a group, as well as the overall strength and weakness of the groups. Usually, the students who were least successful were able to answer procedural questions involving a reversal of process and functional notation using a graph (P8 and P9) to a greater extent than they were able to answer questions using a table or questions that did not require a procedure in order to answer the question (P10 and P11; P13 and P14). Procedural questions which involved looking up a value in a table to evaluate a function without its rule included proved to be the most difficult for these students, a finding that confirms the findings of earlier research which describes students inability to deal with functions if the function rule is not given [Cuoco, 1994; DeMarois & McGowen, 1996; Dreyfus & Vinner, 1989' Dugdale, 1993; Heid, 1988; Keller & Hirsch, 1994; Kieran, 1993].

The most successful students demonstrated flexibility of thinking in their ability to use various representations, alternative procedures, and the graphing calculator effectively in intelligent partnerships. They demonstrated the ability to translate among representations, switching from pencil and paper to the graphing calculator and back to pencil and paper freely and comfortably. The least successful students usually selected and used only one representational form to investigate and solve a problem—even when an alternative procedure would have been more efficient or appropriate. Their choice was invariably the more familiar symbolic procedure—an indication of, and reaction to, cognitive stress. It was as if they were saying “I can't deal with all of this! I'll deal only with this piece!” when they were already struggling to master new material.

This response suggests that the student is able to focus on only small bits at a time, an ability which fits in with the SOLO (Structure of the Observed Learning Outcomes) taxonomy of Biggs and Collis [1982]. They proposed a hierarchy of “pre-structural, unistructural, multistructural, relational, extended abstract “levels to evaluate the quality of learning in many subject areas [Biggs & Collis, 1982, p. 25]. The response, “I can't deal with all of this, I'll only deal with this piece” suggests that this student might be classified at the unistructural or, possibly, the (unconnected) multistructural level, according to the SOLO taxonomy.

The study also examined students' responses to various traditional algebraic tasks, using graphs, tables, and symbolic representations. Post-test and final exam responses of the most and least successful students are summarized in Figure 6.19.

FIGURE 6.19. Ability to Translate between Representational Forms

		Most Success				Least Success			
		1	2	3	4	22	23	24	26
Graphs									
Post 12	Linear: find equation								
Post 9	Piecewise f: find x if $y(x) = 8$								
Final 32	Linear: find $y(-2)$								
Post 8	Piecewise f: find $y(3)$								
Final 33	Linear: Find x if $y(x) = -3$ (mc)								
Final 11	Linear: find equation								
Tables									
Post 11	Given the tables: find $g(f(2))$								
Post 10	Given the tables: find $f(g(2))$								
Final 30	Given the tables: find $g(f(2))$								
Final 29	Given the tables: find $f(g(2))$								
Final 28	Given the tables: find $g(2)$								
Final 27	Given the tables: find $f(2)$								
Algebraic Representations									
Post 15	Find factors from graph								
Final Open	Find factors from equation or graph								
Final Open	Find x-intercepts								
Post 15	Find zeros of the function								
Final Open	Find zeros of the function								
Final 9	Find x-intercepts								

Students who were most successful showed a consistency of performance in interpreting functional notation and in translating among representational forms on procedural tasks involving linear and quadratic functions. Their performance in answering questions which required knowledge of mathematical terms (i.e., x -intercepts, zeros of the function, and factors) was also consistent, even when the questions were presented in different formats (open response, multiple choice) and contexts (traditional algebraic, functional). The least successful students performed best on questions that involved procedural tasks such as the evaluation of linear functions or determining algebraic representations of linear functions from graphs in a multiple choice format. They demonstrated no consistency of performance across different for-

mats, contexts or on procedural activities in which the function rule was not stated, such as evaluating compositions of functions. They were unable to translate among representations. Their weakest performance was on tasks using algebraic representations of quadratic functions and/or graphs to determine x -intercepts, zeros of the function, and factors. These students have formed cognitive collages in which their limited understanding of mathematics terms; the fabric of words and expressions by which we communicate, shape, and modify our understandings in order to construct new collages, is too delicate, like lace or open cutwork, too fragile to hold the various bits and pieces together.

6.8.2 Flexibility of Thought: Procedural vs. Conceptual Thinking

Responses of students in the two groups of extremes to questions that involved the use of a procedure were compared with their responses to questions that involved interpreting ambiguous notation which required conceptual thinking, but no process. These responses are summarized in Figure 6.20.

FIGURE 6.20. Interpreting Ambiguous Notation: Procedural vs. Conceptual

Question		Most Success				Least Success			
		1	2	3	4	22	23	24	26
Procedural									
Post 1	Symbolic: $-(n \text{ squared})$	■	■	■	■	■	■	■	■
Post 7	Symbolic: Given the function f , find $f(h-1)$	■	■	■	■	■	■	■	■
Post 6	Symbolic: Given quad function f , find $f(-2)$	■	■	■	■	■	■	■	■
Final 14	Symbolic: Evaluate $f(0)+g(-2)$; f :linear; g :quad	■	■	■	■	■	■	■	■
Post 3	Symbolic: square of a negative n	■	■	■	■	■	■	■	■
Procedural/Conceptual									
Post 11	Tables: find $g(f(2))$	■	■	■	■	■	■	■	■
Post 10	Tables: find $f(g(2))$	■	■	■	■	■	■	■	■
Post 9	Graph: Linear f : find x if $y(x) = 8$	■	■	■	■	■	■	■	■
Post 8	Graph: Linear f : find $y(3)$	■	■	■	■	■	■	■	■
Final 31	Symbolic: Linear f : find eq given 2 pts (mc)	■	■	■	■	■	■	■	■
Conceptual									
Post 14	Symbolic: Meaning of $f(-x)$	■	■	■	■	■	■	■	■
Post 13	Symbolic: Meaning of $-f(x)$	■	■	■	■	■	■	■	■
Post 5	Symbolic: Sign of c in $(x - c)$	■	■	■	■	■	■	■	■
Final 26	Symbolic: Linear f : Identify Domain/Range	■	■	■	■	■	■	■	■
Post 4	Symbolic: Meaning of $f(x)$	■	■	■	■	■	■	■	■

A lack of consistency in the responses of the both groups of students is observed. Not surprisingly, the most successful students experienced some difficulties with conceptual questions that involved interpretation of the minus symbol. The inconsistency of responses of those least successful is within and between all categories of questions. At their best, the least successful were able to answer slightly more than fifty percent of the traditional procedural questions and only one-third of the procedural questions that involved translating among representations. One student of the four least successful students was able to answer one conceptual question.

The ability to interpret ambiguous notation and use various representational forms of functions are considered indicators of the ability to think flexibly; a characteristic of proceptual thinking identified by Gray and Tall [1994]. Krutetskii [1969], [Dubrovina, 1992], Shapiro [1992], Gray and Tall [1994] and others argue that flexible thinking is necessary for success in mathematics. The ability to think flexibly has been characterized to mean different things. Krutetskii [1969b] and Shapiro [1992] characterize flexible thinking as *reversibility*, i.e., the establishment of two-way relationships indicated by an ability to “make the transition from a ‘direct’ association to its corresponding ‘reverse’ association [Krutetskii, 1969d, p. 50]. Gray and Tall [1994] characterize flexible thinking in terms of *the ability to think proceptually*, i.e., to move flexibly between interpreting notation as a process to do something [procedural] and as an object *to think with* and *to think about* [conceptual], depending upon the context.

In this study, flexibility of thought encompasses both the Krutetskiian and Gray and Tall notions, each of which is a facet of a characterization that encompasses both meanings. The data presented here are considered examples of flexible thinking in the Krutetskiian sense, demonstrating the ability to make the transition from a direct to its reverse association, as well as in the proceptual sense of Gray and Tall. In attempting to classify the questions as procedural or proceptual, the distinction between what is meant by *conceptual* and *proceptual* needed to be clarified. Many of the questions appeared to be both *proceptual*, i.e., requiring an ability to flexibly interpret symbols which represent both a process and an object of thought, and *conceptual*, used to refer to all the connections between representations. Questions in which various representations (tables, graphs, and symbols) are combined were classified as *conceptual*, rather than *proceptual*, as these questions involved a fluency to interpret not only symbols but

features of the other representations as well. In this sense, the inability to use symbols flexibly causes the *proceptual divide*, which is actually part of a bigger *conceptual divide*, in which the inability to use symbols flexibly is compounded by the inability to use and translate among various representational forms flexibly.

6.9 Summary and Conclusions

It was hypothesized that divergence and fragmentation of strategies occur between students of a undergraduate population of students who have demonstrated a lack of competence and/or failure in their previous mathematics courses. In order to explain *why* this phenomenon occurs, it was also hypothesized that (ii) successful students construct, organize, and reconstruct their knowledge in ways that are qualitatively different from those of students least successful and that *how* knowledge is structured and organized determines the extent to which a student is able to think flexibly and make appropriate connections. In this chapter, quantitative and qualitative components of this study documented the divergence that occurred during the semester between students who were ultimately most successful and those who were least successful. Analyses of student's efforts to distinguish between squaring a negative number and finding the additive inverse of a number squared and in interpreting ambiguous notation reveal the complexity and difficulty in reconstructing prior knowledge and schemas. Divergence in students' processes of reconstruction of inappropriate schemas was also noted.

The main thesis question of whether divergence and fragmentation of strategies occur among undergraduate students enrolled in a remedial algebra course who have previously been unsuccessful in mathematics was addressed. The evidence, in the form of data and the analyses of those data, supports the thesis that such divergence does indeed occur, and that, even in a population assumed to be relatively homogeneous, the divergence leads not only to a proceptual divide, but a conceptual divide. The contrast between successful students' curtailment of the procedures in a relatively short time period and the lack of curtailment by those least successful over sixteen weeks is striking. Two groups of students enter a course with approximately the same level of competence and skill, yet, in a relatively short period of time, divergence sets in. Successful students developed mastery of the two procedures involving quadratic

functions by the third week of the semester, and maintained a consistency in their responses throughout the semester. The least successful students not only were unable to develop mastery, but, despite many opportunities for reflective practice, were unable to develop any degree of proficiency on material they had seen in previous mathematics courses by the end of a sixteen week semester.

Though the most successful students demonstrated significant growth in their mathematical abilities over the semester, their improvement in ability to deal flexibly with conceptual questions was not as great as their improvement in the ability to deal flexibly with ambiguous notation in procedural questions. Students at the other extreme, the least successful, were somewhat more able to deal flexibly with procedural questions involving ambiguous functional notation than they were with traditionally formatted questions. Results of the study indicate that the least successful demonstrated almost no growth. What little growth did occur was very inconsistent, for individual students, as well as among members of the group. Students who are unable to flexibly interpret and use ambiguous notation and to translate among representations, are bound up in ever-increasing webs of cognitive overload. These students collect bits and pieces of knowledge, assembling them using the fragile fabric of their language and understandings, until the weight of the assembled pieces causes the structure to tear apart, leaving connected fragments of knowledge lying around. Some pieces will eventually be picked up, dusted off, and used. Other fragments fall into the cracks of memory, where they are forgotten.

The related questions of whether students classified as 'less able' and/or 'remedial,' could, with suitable curriculum (a) demonstrate improved capabilities in dealing flexibly and consistently with ambiguous notation and various representations of functions and (b) develop greater confidence and a more positive attitude towards mathematics were also addressed. The findings of this study would argue for a qualified response: for some students the answer is "Most definitely!" For other students, the search for activities that will break down the barriers of inflexible thinking and negative attitudes, which generate cognitive dissonance yet reduce the cognitive stress to a level that is manageable continues.

This study, recognizing the inadequacy of using only results of the analyses of quantitative data to explain the behaviours observed in students will support the find-

ings presented here with results of additional qualitative data analyses in the next chapter. The difficulties undergraduate students experience in their mathematics classes as a result of inflexible ways of thinking, their difficulties interpreting ambiguous notation and recognizing the role of context, with the resulting fragmentation of strategies will be examined qualitatively to provide further data triangulation and to enrich the final analyses of the data. The fragmentation of strategies that occurs as a result of the initial perceptions, categorization, and retrieval of schemas that leads to the divergence of performance is also documented as are students' processes of knowledge construction, organization, and reconstruction.

*Our knowledge is a torch of smoky pine
That lights the pathway but one step ahead
Across a void of mystery and dread.*

– George Santana,
O World, Thou Chooseth Not the Better Parts

7.1 Introduction

The phenomenon of divergence occurs in classrooms of undergraduate students enrolled in remedial mathematics courses, as well as in the classrooms of elementary age students and students in the middle grades. In order to better understand this repeating pattern which results in success for some and failure for others, it is not enough to document the existence of the phenomenon, but to examine possible causes of the divergence. It was hypothesized that successful students construct, organize, and reconstruct their knowledge in qualitatively different ways than do students who are least successful. These processes are constrained by a student's initial perception(s) and the categorization of those perceptions which cue selection and retrieval of a schema that directs subsequent actions and thoughts. *How* knowledge is structured and organized determines the extent to which a student is able to think flexibly. The inability to think flexibly leads to the fragmentation in students' strategies and the resulting divergence of performance, both quantitatively and qualitatively, between those who succeed and those whose who do not. This divergence of performance has been documented in the preceding chapter.

The focus now shifts to examine more closely the strategies used by students who think flexibly and those who do not. To address the main research question of whether students who are most successful construct, organize, and restructure their knowledge in ways that are qualitatively different from those who are least successful, two students' processes of constructing their cognitive collages of conceptual structures are examined. Two students who are representative of the extremes of the students who participated in the study are profiled. These students represent subjects from the top 15% and the bottom 15% of the class, based on their responses on the post-course test and the final exams (multiple choice and open response). A brief descrip-

tion of each student's background is followed by an analysis of each student's mathematical growth during the semester, based on the data of their pre- and post-tests, their work during the semester, and interviews. The qualitatively different strategies used by each student are described within the theoretical framework. The second main thesis question is addressed: "Do successful students construct, organize, and reconstruct their knowledge in ways that are qualitatively different from the processes utilized by those least successful?" The results of the main study presented in this chapter are interpreted using the theoretical framework set forth in Chapter 3. Data are triangulated with other data collected during the semester and are further analyzed in the next chapter, using students' concept maps and schematic diagrams of those concept maps.

7.2 Perceptions and Strategies

Let me summarize the bits and pieces of knowledge that have been assembled for two students: MC (S2), a student in the most successful group and SK (S23), a student in the group of least successful students. Gradually, as more and more bits and pieces of knowledge are presented, the initial cognitive collages of these students are restructured into more refined, stable cognitive collages which are used as evidence in support of the thesis and to address the main research question: Do students who are more successful construct, organize, and restructure knowledge in ways that are qualitatively different from those least successful?

MC's ambition is to be an illustrator and is planning to major in graphic design. He has a look of curiosity about him as he enters class, warily during the first few weeks, with cautious optimism by mid-term, and with genuine pleasure by the end of the semester. His natural inclination to put himself wholeheartedly into whatever task he has set for himself is contagious and becomes more evident as his confidence in his ability to do mathematics grows. Students who work with MC develop a comradeship and support each other's efforts to succeed. MC had three years of mathematics in high school: Algebra I, Geometry, and Algebra II. He took no mathematics course his senior year. After graduating from high school, he enrolled at the community college which was the site of this research. MC tested into an Arithmetic class. He completed that individualized course, followed by the individualized, self-paced three-part Introductory Algebra course in the Math Lab. He completed all three components

of the Introductory Algebra course successfully and was now enrolled in the regular sixteen-week Intermediate Algebra course. MC maintains that the arithmetic and Introductory Algebra courses were a review of mathematics he had learned previously in high school—most of which he readily admits he was unable to remember. The Intermediate Algebra course was the first course in which he used the graphing calculator. He had never experienced mathematics taught using non-traditional materials and reform instructional practices. On the pre-course attitude survey, he reported that he attended the previous mathematics course regularly, and that he had spent one to three hours per week outside of class on homework. He felt that his ability to interpret notation was somewhat good; his ability to interpret and analyze data fair; his willingness to attempt a problem somewhat poor; and his ability to solve a problem very poor. He believed mathematics was mostly facts and procedures to be memorized.

SK wants to be an elementary grade school teacher (K–3). She is a recent high school graduate and also had three years of mathematics in high school, taking the Algebra II course her senior year. She tested into the Introductory Algebra course and elected to take the individualized three-component, self-paced Introductory Algebra course in the Math Lab, rather than the one-semester classroom-based course. Having successfully completed the three Introductory Algebra components during the previous semester, she was now enrolled in Intermediate Algebra. Like MC, SK reported she had never used the graphing calculator before this class, except for adding, subtracting, etc. On her pre-course student information survey, she indicated that she had attended her previous mathematics class regularly; generally spent three to five hours per week outside of class on homework in her previous class; and rated her ability to interpret mathematical notation and symbols somewhat poor. She considered her ability to interpret and analyze data, her willingness to attempt to solve a problem not seen before, and her ability to solve a problem not seen previously was also somewhat poor. SK was firmly convinced that “there was only one way to learn and teach math” and that “math was about doing a lot of the same problems in order to have an understanding of what you were learning.” She thought that “this work was tedious and boring.”

7.2.1 MC and SK: Ability to Interpret Ambiguous Notation

The performances of both students on the pre-test suggests that MC is more flexible in his thinking initially. He demonstrates an ability to reverse his train of thought [P3 and P1] when given an arithmetic context and is able to find the output for a function using a graph when no rule is stated [P8]. SK is able to square a negative number. By the end of the semester, MC is able to answer all but the two conceptual questions involving the minus symbol. SK correctly answers four of fourteen post-course questions, three of which are questions involving arithmetic computations. Even with the aid of the calculator, SK is not fully confident in her answers when asked to square a negative number [P3] and to find the additive inverse of a number squared [P1]. Figure 7.1 summarizes the pre- and post-test responses for both students.

FIGURE 7.1. MC(S2) and SK(S23): Pre- and Post-test Responses

Pre & Post Test Question	MC	SK		MC	SK
	Pre	Pre		Post	Post
14. Meaning of $f(-x)$					
13. Meaning of $-f(x)$					
11. Tables: find $g(f(2))$					
10. Tables: find $f(g(2))$					
12. Graph: (linear) find eq					
9. Graph: find x if $y(x) = 8$					
5. Sign of c in $(x - c)$					
4. Meaning of $f(x)$					
7. Given f , find $f(h-1)$					
6. Given f , find $f(-2)$					
2. Order of operations					
1. $-(n \text{ squared})$					
8. Graph: find $y(3)$					
3. Square of a negative n					
Correct responses	3	1		12	4

A closer examination of their actual written responses, together with interview data reveals qualitative differences in their thinking and strategies. MC demonstrates some ability to think flexibly at the beginning of the semester as he recognizes the direct and reverse processes in P1 and P3 and acknowledges them as two distinctly different processes. On the pre-test, MC is asked what comes to mind when he is to evaluate -3^2 (P1) and to evaluate $(-3)^2$ (P3). His response for P1:

3. 3 · I recognize that -3^2 means the opposite of 3^2 and equals -9

In response to P3, MC writes:

This problem is different than problem #1 because of the parentheses.
This is solved by squaring -3 ; $-3 \cdot -3 = 9$

He rates his confidence in the correctness of his answers to each question as 5, on a scale of 1 (I can't answer the question) to 5 (very confident in my answer). SK on the same two questions writes:

P1: $-3 \cdot -3 = -9$ and for P3: $(-3)(-3) = 9$

SK indicates her confidence in the answer for P1 is 3 (somewhat confident in my answer) and for P3 she rates the answer 4 (fairly confident in my answer). There is no indication that she sees any distinction in the process used in P1 and that used in P3. Her replies suggest that she retrieves and implements two different schemas to answer P1. She perceives -3 as a unit and squares the unit, but maintains the minus symbol in front of her answer. She does not seem to have recognized another rule that is in conflict with her operational rule "a number times itself," namely that a negative times a negative is a positive and that a value squared, unless it is zero, is always positive. On P3, she appears to use the same operational rule—squaring means a number times itself. Her use of parentheses suggests that she uses them because they are given in the original problem but that they have no other significance for her.

7.2.2 MC and SK: Ability to Think Flexibly to Reverse a Direct Process

The pre- and post-test responses of the two students for the two pairs of questions, designed to test students' ability to reverse a direct process given a table or a graph of one or more functions and no stated rule, were compared. Pre- and post-test questions, P8 and P9, consisted of a graph of a piece-wise linear function with no stated rule. Students were asked to use the graph to answer Questions 8 and 9.

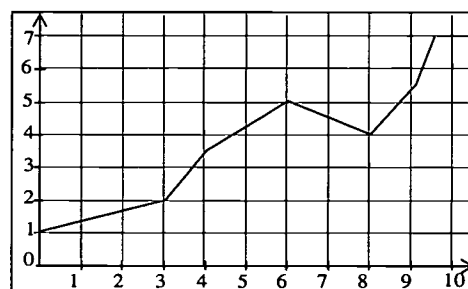

8. Indicate what $y(8) =$ _____ What comes to mind:

9. If $y(x) = 2$, what is x ? _____ What comes to mind:

On the pre-test, MC attempted an answer for P8. He labelled both the x - and y -axis and circled the number 3 on the x -axis and 2 on the y -axis. He wrote for P8: I think of y being 2 since x is 3. For P9, MC described what came to mind:

P9: I think that x can be any number. I would plug it in and *try to solve* for y if x were given.

MC's response indicates he is able to deal with the direct process of evaluating a function using a graph but is unable to see P9 as a reversal of the direct process of evaluating a function, given the input. His description also suggests he has a proto-typical concept image of variable: "When I see the variable, x , I'm going to *solve* for the missing variable." Though he answered pre-test Question 8 correctly, he indicated he was not confident in his answer, selecting a rating of 1 (I don't know how to answer the question). His initial confidence rating for Question 9 was a 2 (not very confident in my answer).

SK labels the x - and y -axis, but makes no attempt to answer either Question 8 or Question 9 on the pre-test. She also gives no response to the question: What comes to mind? and rates her confidence at level 1 (I can't do this problem). Her responses to the same two questions on the post-test demonstrate almost no improvement in her ability to think flexibly or in her competence, even on procedural questions. Confidence ratings for both problems remains at level 1 (I don't know how to answer the question). For P8, her response confirms that the confidence rating is valid and that, when in doubt, she falls back on something she knows how to do: Given a graph, label the axes. SK wrote:

P8: Label x and y [which she has done on the graph].

She answers P9 with two questions of her own.

P9: Is all $y(x)$ equal 2? Does only x equal 2?

By the end of the semester MC demonstrates improvement in his ability to think flexibly to reverse a process (P8 and P9; P10 and 11). His response for post-test P8 was succinct and confident:

P8: I assume that $x = 8$ and found the y value; $y(8) = 4$

He circles the point on the graph corresponding to 8 on the x -axis and rates his confidence in the answer as a 4 (fairly confident in my answer). On P9 on the post-test, his confidence rating is again 4 (fairly confident in my answer) and his answer again succinct:

P9: Scale the y axis to 2 and scale down x to find value; $x = 3$.

MC's improved flexibility in thinking to reverse a process was also documented in his responses to Questions 10 and 11 on the post-test, using a table representation to evaluate a composition of two functions, f and g , without a stated rule for either function on the post-test. Pre- and post-test Questions 10 and 11 were as follows:

Consider the following tables for functions f and g then answer Questions 10 and 11.

x	$f(x)$
1	3
2	-1
3	1
4	0
5	-2

x	$g(x)$
-2	3
-1	1
0	5
1	2
2	4

10. What is the value of $f(g(1))$? Why?

11. What is the value of $g(f(5))$? Why?

Though he is unable to answer either question on the pre-test, he nevertheless wrote what thoughts came to mind for each question:

P10: I'm really not sure how these two tables relate to one another other than they're in the same format. 1 comes to mind because it's opposite of 2.

P11: -1 comes to mind because its opposite of 2 on the table of functions for f .

His answers on the post test to both questions [P10 and P11] indicate he has begun to think proceptually. His confidence in the correctness of his answers has increased from a 1 for both questions on the pre-test (I don't know how to do this problem) to a 5 for both questions on the post-test (Very confident in my answer). MC's

responses to post-test P10 and P11 are shown in Figure 7.2. His explanation suggests that he is able to think of $f(g(1))$ as an object that is equivalent to $f(2)$ in Question 10. He appears confident evaluating a composition of two functions even when no rule is stated. MC refers to “the output $g(-2) = 3$ ”; he is able to think of $f(5)$ as -2 ; and writes that $f(g(1))$ is equal to $f(2)$; Look at table values $f(2) = -1$ so $f(g(1)) = -1$.”

FIGURE 7.2. MC Post-Test P10 & P11: Ability to Think Flexibly

Consider the following tables for functions f and g :

x	$f(x)$
1	3
2	-1
3	1
4	0
5	-2

x	$g(x)$
-2	3
-1	1
0	5
1	2
2	4

10. What is the value of $f(g(1))$? Why?
 What comes to mind: $g(1) = 2$
 $f(g(1))$ is equal to $f(2)$ look at table values
 $f(2) = -1$ so $f(g(1)) = -1$
 Confidence 1 2 3 4 5

11. What is the value of $g(f(5))$? Why?
 What comes to mind: $f(5) = -2$
 Finding the output of $f(5)$ which is -2 , then inputting -2 in function $g(x)$, and using table values to find output
 $g(-2) = 3$
 Confidence 1 2 3 4 5

MC’s work suggests that his initial focus of attention is the notation $f(g(1))$, which acts as a cognitive unit used to retrieve a schema, which he subsequently unparses. He maintains an awareness of his objective to determine the value of $f(g(1))$. An examination of the work of SK reveals a very different initial focus of attention, the cognitive unit $f(2)$, which appears to cue a schema constrained by her procedural, inflexible thinking. Her work is displayed in Figure 7.3.

FIGURE 7.3. SK Post-test P10 & P11: Ability to Think Flexibly

10. What is the value of $f(g(1))$? Why?
 What comes to mind: $f(2)$ think of $g(1)$ meaning when x is at 1 what is g .
 Confidence 1 2 3 4 5

11. What is the value of $g(f(5))$? Why?
 What comes to mind: $f(-2)$ what is x when f is at 5.
 Confidence 1 2 3 4 5

A comparison of the pre- and post-test responses of MC and SK to conceptual questions [P4, P5, P13, P14] that require no process provides still other examples of answers which are typical of the students in each of the two extremes. These responses of MC and SK are summarized in Table 7.1.

Table 7.1: MC and SK: Flexible Thinking–Interpreting Ambiguous Notation

Question #		RESPONSE	
MC pre 4:	$g(x)$	g represents a number that is being multiplied by x	3
SK pre 4:	$g(x)$	multiplication	1
MC post 4:	$f(x)$	function notation; $f(x)$ represents the output of the function; $f(\text{input}) = \text{output}$	5
SK post 4:	$f(x)$	function; function machine; when given this you must plug in the values you are given for x .	3
MC pre 5:	$(x-c)$	The value for c is negative because of the $-$ sign in front of c . c will subtract from any number that comes before the $-$ symbol.	5
SK pre 5:	$(x-c)$	rewrite as $(x+ \bar{c})$	4
MC post 5:	$(x-c)$	The value of c is neither because it may be positive or negative. If c were positive it would become negative and if it were negative it would become positive.	5
SK post 5:	$(x-c)$	subtract, change to $x+ \bar{c}$; c is negative	3
MC post 13:	$-f(x)$	$-f(x)$ means multiply the output by -1 ;	4
SK post 13:	$-f(x)$	f of the function is negative.	2
MC post 14:	$f(-x)$	$f(-x)$ means multiply the input by -1	4
SK post 14:	$f(-x)$	x is negative in that function.	2

Growth in students' ability to think flexibly and recognize the role of context in interpreting the ambiguity of the minus symbol was not as noticeable as the growth in the ability to deal flexibly with function notation, both procedurally and conceptually. Both MC and SK initially interpret $g(x)$ procedurally, interpreting the notation to mean multiplication of g times x . By the end of the semester, MC has developed a more flexible way of thinking about the notation $f(x)$ while SK remains at a procedural level of interpretation: "plug in the values you are given for x ." MC focuses on the notation and the input/output process: function notation—>output of a function; SK initially thinks function—>function machine—>plug in values. MC interprets the minus symbol in

front of $f(x)$ as multiplying the output by -1 . His response suggests he perceives the answer as being *the opposite* of the output value and similarly for the input, given the notation $f(-x)$. SK's concept image of the output is of a negative value, not of something that has its sign changed, saying that "x is negative in that function."

Both students use two different schemas simultaneously. With no cognitive dissonance or conscious awareness that they are doing so, they mentally use the symbol twice—first to indicate that c is negative, followed by use of the minus symbol as the subtraction operator: "c will subtract from any number that comes before the $-$ symbol." MC's response to post-test Question 5 provides some additional evidence that he has developed a more flexible way of thinking about variables and has grown in his ability to interpret ambiguous notation. On the pre-test, he perceived $(x-c)$ as indicating that "the value for c is negative because of the $-$ sign in front of c . However, he adds, "c will subtract from any number that comes before the $-$ symbol," illustrating the confusion that results when two concept images are retrieved, along with two distinct schemas for interpretation and use of the minus symbol. SK retrieved a different concept image and schema—when you see a minus symbol in front of a letter, change signs and add. Note that she does not answer the question, which suggests once again, that when confronted with a question she can't answer, she retrieve a default schema that she knows how to implement.

The post-test response of MC to P5 is consistent with his other post-course interpretations of the minus symbol in conceptual questions and provides triangulated evidence of the development of his ability to think more flexibly: "the value of c is neither because it may be positive or negative. If c were positive it would become negative and if it were negative it would become positive." SK repeats the rule she was taught when subtracting algebraically: subtract—change signs and add; a view that has remained unchanged throughout the semester. She still uses the minus symbol twice; once to subtract and as the sign of c , indicating a negative-valued number.

7.3 Shaping and Refining the Cognitive Collages of MC and SK

Are two different concept images of MC (S2) and SK (23) beginning to emerge from the bits and pieces of knowledge presented thus far? It should be mentioned that both MC and SK are conscientious students who attended class regularly and worked

very hard to keep up with their assignments. Both were quiet students, yet strong-willed and fiercely determined to complete the course successfully so that they could get on with their lives. An examination of the summarized competency profiles of these two representative students of the extremes is shown in Figure 7.4. Each row represents a category of six questions. The rows are arranged from A, easiest (bottom) to H, hardest (top). The questions in each group are numbered (1–6) and arranged from left, easiest (1) to right, hardest (6). Both category and question orderings are based on the total number of correct responses of the most successful group of students for each category. Observe that the strengths SK demonstrates appear to be of skills associated with quadratic functions [Row E] and of solving systems of equations [Row F]. MC appears to have approximately the same competencies. This area of strength for both MC and SK, indicated in Figure 7.4 by the white rectangle, is examined in greater detail in the following section.

FIGURE 7.4. MC and SK: Competency Summary Profiles

Category of Questions		MC (41)						SK (15)					
		1	2	3	4	5	6	1	2	3	4	5	6
H	Interpreting Ambiguous Notation	H	■	■	■	■	■	H	■	■	■	■	■
G	MC Final: Solving Equations	G	■	■	■	■	■	G	■	■	■	■	■
F	Solving Systems	F	■	■	■	■	■	F	■	■	■	■	■
E	MC Final: Quadratics: Skills	E	■	■	■	■	■	E	■	■	■	■	■
D	GR: Given a Quadratic Function	D	■	■	■	■	■	D	■	■	■	■	■
C	Using Graphs	C	■	■	■	■	■	C	■	■	■	■	■
B	Using Tables	B	■	■	■	■	■	B	■	■	■	■	■
A	Quad f : Interpretation & Use	A	■	■	■	■	■	A	■	■	■	■	■

7.3.1 Perceptions, Cognitive Units, Concept Images, Retrieval of Schemas

A closer analysis of work which indicates MC's and SK's understanding of quadratic functions and of linear systems at the time of the final exam provides us with additional bits and pieces of knowledge to assimilate into the growing cognitive collages of both students, which are typical of students in the two groups of extremes they represent. The divergence in performance was hypothesized to be a consequence of qualitative differences in the strategies students use, the way in which they categorize their initial perceptions, and in the way they structure their knowledge. The theoretical framework elaborated in Chapter 3 is used to interpret both two students' work.

On the open-response final exam, students were asked to solve a problem typically given students in traditional sections of the Intermediate Algebra and/or the subsequent College Algebra course. They were asked to determine an algebraic model of the parabolic path of a projectile and to determine at what time the projectile would hit the ground. The version of the problem used on the final open response exam is:

A toy rocket is projected into the air at an angle. After 6 seconds, the rocket is 87 feet high. After 10 seconds, the rocket is 123 feet high. After one-half minute, the rocket is 63 feet high.

- a. The model for the rocket's motion is $h = at^2 + bt + c$ where h is the height in feet of the rocket after t seconds. Using the given information, find the values for a , b , and c so the function models the situation. Briefly explain what you did.
- b. Approximate how long it will take for the rocket to hit the ground. Why? Explain how you arrived at your answer.
- c. What representation did you choose to investigate this problem? Why?
- d. Describe the process you used to find the answers to part a and to part b.

During the semester, problems which required students to determine the parameter values in order to establish an algebraic model for a problem situation, and then to use the model to answer other questions about the situation were a focus of investigation and discussion. The final exam problem was not typical of problems investigated during the semester. During the semester, students were given a set of data and asked to determine the algebraic model. Though they had also studied systems of equations, they had only seen one problem prior to the final exam in which they were asked to solve a system in order to determine parameters. In this instance, students had only the written description of the problem.

Students had several alternative ways in which they could determine the parameter values of a model appropriate for a given situation. They could set up a system of three linear equations in three unknowns and solve the system using matrices on the graphing calculator, or solve the 3×3 system algebraically. (three students selected this method). Still other students, having used regression models with actual real world messy data, had realized that traditional textbook problems could be solved simply by entering the ordered pairs into lists, selecting the appropriate regression

model which calculates parameter values appropriate for the problem, enter and graph the algebraic representation, and either use the ROOT [or ZERO] option to find the solution, if $y = 0$.

Once the parameters and the algebraic representation of the problem situation were determined, students had several options for determining when the projectile would hit the ground. They could graph the equation and examine the graph to find the x-intercept or they could display table values for input and output, or they could use the TRACE command and approximate the answer. They could also solve the equation algebraically, using the quadratic formula. This problem was rich with options and it was believed that the options individual students selected would reveal something about their thinking.

7.3.2 Two paths diverge... the path taken by MC

The work of MC and SK on this problem is compared. Their work was typical of the approach and strategies employed by the other students in their respective groups. MC's initial focus of attention appears to have been the general algebraic model, which he has circled. This focus of attention is consistent with what he claimed to notice on various post-test questions. An examination of his work suggests that MC's initial focus of attention cued retrieval of a concept image of quadratic function that includes a notion of the general quadratic equation form, a recognition that a specific model appropriate for the problem conditions is needed and connections to an appropriate schema, having identified that the task was to determine parameter values. He perceives the time/height relationship and records the time and height values as ordered pairs; which he enters in two lists on the calculator. MC's work is shown in Figure 7.5.

FIGURE 7.5. Student MC: Final Exam Open Response

2. A toy rocket is projected into the air at an angle. After 6 seconds, the rocket is 87 feet high. After 10 seconds, the rocket is 123 feet high. After one-half minute, the rocket is 63 feet high.

a. The model for the rocket's motion is $h = at^2 + bt + c$ where h is the height in feet of the rocket after t seconds. Using the given information, find the values for a , b , and c so the function models the situation. Briefly explain what you did.

→ QUAD Reg: $y = Ax^2 + Bx + C$

Specific model $-0.5000x^2 + 17.000x + 2.999$

$A = -0.5$	t_1	t_2
$B = 17$	6	87
$C = 3$	10	123
	30	63

STAT Plot ON (plot points on graph.)
Follow quad reg. paste in Y_1 . The line falls directly on ordered pairs.

b. Approximate how long it will take for the rocket to hit the ground. Explain how you arrived at your answer. The rock rises for 25 sec. then it begins to descend it will hit the ground at approx. somewhere between 34 and 34.5 seconds. (I used the table values to

c. What representation did you choose to investigate this problem? Why? GRAPHICAL. I felt most comfortable w/ Find out put at zero) I didn't feel confident trying to investigate Algebraically

d. Describe the process you used to find the answers to part a and to part b.

PART A
PART B

His work and explanations indicate that MC has formed an intelligent partnership with his technology (i.e., he passes control to his tool for certain tasks, then takes back control when it is appropriate, always testing his work against that done by the technology) as described by Jones [1994]. MC graphs the discrete points and examines the resulting plot, having established an appropriate view window. Using the information provided by the plot, MC then selects the quadratic regression option to determine parameter values. He enters his algebraic model and tests it graphically against the plot of the discrete points, saying: "The line falls directly on the ordered pairs." It should be noted that the number of decimal places used for the parameter values in the model compared to those he initially recorded, $[-.5, 17, \text{ and } 3]$ was in line with a convention students had used throughout the semester when working on problems which included real world data. The class had agreed to use regression model parameters rounded to three decimal places unless the problem included directions which differed from this convention. MC used the convention consistently, though he occasionally included an additional decimal, as in this problem $[-0.5000]$.

MC demonstrates his ability to interpret the problem, clearly describe his process, and interpret the results of his calculations in a mathematically meaningful way, moving efficiently and appropriately towards his overall objective. He acknowledges his awareness of alternative strategies that might be used in this problem and rejects the algebraic alternative; explaining that he “didn’t feel confident trying to investigate algebraically.” Despite this lack of confidence in his algebraic skills, MC selects an appropriate alternative strategy, using the list, graphing, and table features of the calculator to find an appropriate quadratic regression model and to visualize the time/height relationship. His ability to translate among representations is documented and his work suggests that he has formed mental connections linking the notions of zeros of the function, x -intercepts, general quadratic form and the specific algebraic model appropriate to the problem situation.

An interview with MC at mid-term, together with his written self evaluation submitted in his portfolio provides triangulation of his developing ability to interpret and use ambiguous notation, as well as his growth toward proceptual understanding. MC comments:

I’m learning how these algebraic models are set up and what the variables that they contain represent. I’m no longer just blindly solving for x , but rather understanding where x (input) came from and how it was found from the data given. Through this kind of learning I have developed an understanding for the use of function notation [$f(x) = \text{output}$] and how it replaces the dependent variable, y .

He attempts to relate new knowledge to his previously acquired knowledge, claiming:

I have been able to utilize mathematical knowledge that I have gained from previous courses. An example of this is taking my previous skill such as finding slope and applying it to rates of change and from this have moved on to comprehend arithmetic and geometric sequences and then have moved forward even further to understanding linear, exponential, and quadratic models. It’s a good feeling to see things connecting together as I move further along in the text. As I go from investigation to investigation I really see connections in material that are clear and that help establish a solid body of knowledge.

In his final interview of the semester, MC speaks of his understanding of function notation:

I think the most memorable information from this class would be the use and understanding of function notation. A lot of emphasis was put on input and output which really helped me comprehend some algebraic processes such as solving for x .

The process of connecting new knowledge to prior knowledge is a goal of his learning. He describes his use of the graphing calculator as a tool for understanding and visualizing mathematics and connection-making:

Another process that was very helpful in understanding algebra (specifically factoring) was using a graph to find the x -intercepts to find the zeros of an equation. This is a procedure I had never seen before, but I was able to connect it to my prior knowledge. I found [the graphing calculator] very useful to graph equations to find the number of solutions (finding zeros), and also to find equations when they are unknown (using the graphing calculator as a data process machine).

7.3.3 Two paths diverged...the path taken by SK

The path taken by SK is very different from that taken by MC. An examination of her work on the same final exam problem contributes shape and substance to the cognitive collage of SK. Using the lines and colours of her words, actions, and writings, the picture that emerges presents a stark contrast to the cognitive collage that represents MC. SK's response to the final exam question is displayed in Figure 7.6.

FIGURE 7.6. Student SK: Final Exam Open Response

2. A toy rocket is projected into the air at an angle. After 6 seconds, the rocket is 87 feet high. After 10 seconds, the rocket is 123 feet high. After one-half minute, the rocket is 63 feet high.

a. The model for the rocket's motion is $h = at^2 + bt + c$ where h is the height in feet of the rocket after t seconds. Using the given information, find the values for a , b , and c so the function models the situation. Briefly explain what you did.

$h = 6t^2 + 10t + 30$

$a = 6$
 $b = 10$
 $c = 30$

I choose these numbers because h equals the height in feet at t seconds. The numbers in front of t equal the seconds.

b. Approximate how long it will take for the rocket to hit the ground. Explain how you arrived at your answer. $10^2 - 4(6)(30) = -620$

$y = \frac{-10 + \sqrt{-620}}{2(6)} = -7.93$ $y = \frac{-10 - \sqrt{-620}}{2(6)} = 12.07$

c. What representation did you choose to investigate this problem? Why?

I choose to use the quadratic formula.

d. Describe the process you used to find the answers to part a and to part b.

In part a I choose the amount of seconds it would take for the rocket to reach it's height + in part b I plugged those #s into the quadratic formula.

MTH 080 Final Exam F96

Initially, SK focuses on the three time values which she has circled: 6 seconds; 10 seconds; and 30 seconds [a conversion of one-half minute] and notices that she is dealing with a quadratic equation. She ignores the corresponding height values. It is possible that she has some sense of a time/height relationship, but her notion of a time-height relationship appears unconnected with any notion that there is a functional relationship in which time and height values are perceived as ordered pairs and/or input/output values. SK's cognitive collage possibly includes a concept image of *parameter* at this point in time, though there is no evidence to support this belief, given her work on this problem. She writes, "I choose these numbers because h equals the height in feet at t seconds. The numbers in front of t equal the seconds." It seems that, if she has a concept image of *parameter*, it is a fragmentary collage of bits and pieces of knowledge, organized ineffectively and lacking in interiority. The selection of time values as coefficients of the quadratic equation suggests a compartmentalized cognitive collage in which cognitive dissonances seldom, if ever, arise.

Her initial focus of attention on the three time values, together with the realization that she is dealing with a quadratic equation, $h = at^2 + bt + c$, sets up an inappropriate path-dependent logic characterized by SK's focus on "getting the answer." This results in the selection and retrieval of a very different schema from that of MC. Focused on solving a quadratic equation, SK retrieves a schema characterized by her demonstrated tendency to "plug the numbers"—into the equation; into the discriminant; and into the quadratic formula. Her work suggests SK has a very sparse concept image of quadratic function with few connections from the procedures she links to quadratic equations to other cognitive units or concept images, and which is constrained by her inflexible thinking and strategies.

SK's initial perception of the problem task could be interpreted to indicate that she has an understanding of the problem requirements and a schema by which she can determine the answer. It could be argued that she has recognized the need to create the algebraic model for this problem situation, which requires her to find values for a , b , and c ; and that once she has the equation, she solves it to answer the question in part b. However, upon reflection one wonders to what extent she really understands the problem, or whether, uncertain of what to do, she has reverted to using a schema learned previously. Davis [1984] describes the situation in which a student fails to match his

initial perceptions with a cognitive unit that cues the retrieval of an appropriate schema. This description seems to describe SK:

If no appropriate input can be obtained from the present 'primitive' input source, a frame [schema] will typically make a *default evaluation*...Once an instantiated frame [schema] is judged acceptable, nearly all subsequent information processes used this instantiated frame as a data base. The original primitive data is thereafter ignored. [Davis, 1984, p. 65]

Davis' description offers an explanation of SK's behaviour in this instance. Not knowing what to do to find the values of a , b , and c , it seem likely that SK has retrieved a schema she is comfortable using—her cognitive collage of quadratic equations, which consists primarily of memorized procedures (finding the discriminant; use the discriminant value in the quadratic formula to “solve” the equation). One can surmise that this cognitive collage, very refined and very stable, is a schema which is flawed and incomplete, based on the work which documents her failure to take into account that (a) there are no real solutions if the value under the radical is negative; (b) that the quadratic formula is used to determine the values of the independent variable, not the dependent variable; and that (c) the division bar is a grouping symbol indicating that the numerator sum or difference is divided by the denominator, not just the radical.

SK does indeed ignore the original data which does not fit her retrieved schema. Even after sixteen weeks of class investigations and homework assignments which focused on functional relationships and alternative methods of finding parameters using various representations of functions, SK ignores information which provide the data necessary to determine the parameters: the three input/output (time, height) ordered pairs. Her assignment of the time values as coefficients, a , b , and c suggests she does not yet have a firm understanding of parameters. She demonstrates proficiency in her attention to some details, recognizing the need to have consistent units, changing one-half minute into 30 seconds, and that the model is quadratic. Other details, including the three height values are ignored. Her ability to recall memorized procedures she has associated with quadratic equations is accurate, as is her understanding that the discriminant can be used to simplify quadratic formula computations.

However, the execution of those procedures is flawed. She calculates the discriminant correctly, using incorrect parameter values and fails to interpret the result cor-

rectly. She does not interpret the final result in the context of the problem, choosing instead to state two solutions. Both solution values determined by SK using the quadratic formula are inaccurate, due to her failure to divide correctly. Though aware that the quadratic formula is used to find solutions to a quadratic equation, SK is confused about what variable she is solving for. Once the default quadratic equation schema has been retrieved and actions based on that schema initiated, SK focuses on “getting the answer.” Noticeably lacking is the strategy of checking one’s work against the constraints of the problem, interpreting the results in light of the original problem situation, testing her answers to determine if they make any sense. The connections SK appears to have formed are procedural connections necessary to “get the answer” between the process of finding solutions using the quadratic formula and use of the discriminant to make that process easier. Both procedures are linked to the notion of quadratic equations which includes knowledge that there are, generally, two solutions to a quadratic equation.

Based on her work, one might assume that SK does not know how to solve linear systems using the matrix and/or regression features of the graphing calculator. In fact, of the five problems on the final exam, SK correctly answered four of them. She was able to solve a 2×2 inconsistent linear system and a 3×3 system, using the matrix features of the graphing calculator. It should be noted, however, that none of the problems she solved correctly were contextual problems. All were written in traditional symbolic form of textbook exercises and all but the 2×2 consistent linear system were multiple choice format questions. None of the other final exam linear system problems required more than procedural knowledge. This is another indication of the compartmentalization of SK’s knowledge, in which procedures are linked to a particular concept, in this instance, the use of matrices to solve *linear* systems, used only when her perception cues the cognitive unit which retrieves the linear systems schema. It seems obvious from her work and explanations that SK did not perceive the toy rocket problem as a system problem. Her original perceptions were classified under the category dealing with quadratic equations, thus failing to recognize that the original information required the retrieval of a strategy for determining parameters based on solving a linear system.

Her initial focus of attention, coupled with her flawed and incomplete construction of her cognitive collages of quadratic equations and systems of equations are underlying causes of her lack of success in this instance. It appears that SK has assembled some bits and pieces of knowledge appropriately, but she is missing other basic pieces. How she has assembled those bits and pieces constrains her ability to construct concept images and cognitive collages that have interiority and which permit meaningful connections. Lacking rich concept images and locked into inflexible thinking, when confronted with situations in which she is unclear what to do, SK retreats to the familiar and defaults to using those procedures she knows.

SK views the graphing calculator as a tool for verifying her calculations. It is used only when she is uncertain which of two calculation procedures to use. In that instance, she just enters what she sees and accepts the calculator answer. Midway through the semester, SK described her feelings about the graphing calculator:

I find the graphing calculator to be very confusing. I feel as if everything is thrown at me at once. I have never used the graphing calculator before this class, and now I find it difficult to adopt to using it. The only thing I can do without too much difficulty is put a table into the calculator. After that I don't know what to do. A change that would help to improve my learning in this class would be a slower and more thorough explanation of the graphing calculator.

Her growing frustration with the class and with herself increased as the semester passed. She actively resisted assuming responsibility for figuring things out on her own. Provided with handouts that included step by step directions for each procedure introduced during the first eight weeks of the semester—which included views of the screen displays—she never used them. For a student such as SK, learning the calculator procedures in addition to the mathematics she was already struggling with introduced too much cognitive load to cope with. By the end of the semester her feelings were unchanged. In an interview, she said, “Personally I am still overwhelmed by the calculator.” This student remains firmly convinced that

I need that type of concrete repetitious work. In my past math classes I was given a book where there were definitions and formulas to follow. With any type of problem I need to have a step by step process to follow. I have trouble deciding what kind of function it is, or what should go where. For example, I still cannot tell the difference between a linear, quadratic, and exponential model.

She was adamant that there was only one way she could learn math—her way. Perhaps SK was right, though the fact that if that method really worked, she wouldn't be taking remedial mathematics courses escaped her. Despite the inadequacies of the instructional methods she had experienced previously, and her great efforts and time commitment, she was unwilling to change her beliefs or to try alternatives. Her resistance grew more pronounced during the semester. When the end of the course evaluations were compared with the pre-course responses, SK was one of only two students, both in the low group of extremes, who, not surprisingly, had a more negative attitude that when she enrolled in the course.

7.4 And they will differ...as syllable from sound

The cognitive collages of the two students who are representative of the extremes, the most successful and the least successful, provide detailed evidence of the divergence that occurs over a sixteen week semester. This divergence is much starker than imagined and is portrayed, not in the nuances of soft pastel colours indicative of slight shadings of differences, but in the contrast of brilliant, bold colours of brightness and darkness. In the classroom one sees divergence of performance—an examination of the grades of students at the end of the term usually confirms this, particularly in undergraduate remedial classes. The divergence reported in this dissertation is far greater than that measured by the ability to get the correct answer. It is evidenced in students' ability to think flexibly—to reverse a direct process; to interpret ambiguous notation; in what they perceive initially and how they categorize their initial perceptions; in the strategies they select; in their abilities to make connections; in the cognitive collages of concept images and schemas they construct and retrieve; and in the confidence they develop in the correctness of their answers or the uncertainty that overwhelms them, leaving them unwilling or unable to take risks in a learning environment different from that they are accustomed to or to renegotiate the didactic contract.

Some students, despite previous experiences which encouraged instrumental learning [Skemp, 1971], are able to develop improved capabilities and deal flexibly and consistently with various representational forms of functions. They develop greater confidence in their ability to do mathematics and acquire confidence and a more positive attitude. Other students are victims of the proceptual divide as Gray and

Tall [1994] have so aptly described them—constrained by their inflexible thinking and strategies—doomed to fail yet again and again and again.

What is it that students are willing and disposed to attend to or to expose? Why is it students enrolled in the same class, with the same instructor and instructional treatment, during the same time period, initially at approximately the same level of competency at the beginning of the semester, take such divergent paths which lead to success or to failure? Why are some students able to think flexibly and others remain inflexible and unchanged? In the next chapter we continue to develop our cognitive collages of MC and SK. The nature of the processes by which they construct knowledge is scrutinized more closely, as we seek answers to these questions.

Visual Representations of Cognitive Collages:

*The brain is just the wright of God,
For lift them, pound for pound,
And they will differ, if they do,
As syllable from sound.*

– Emily Dickinson, *The Brain is Wider than the Sky*

8.1 A look back and an overview of what is yet to come

Two theses are the subject of this study. The first thesis— divergence and fragmentation of strategies occur between students of a undergraduate population of students who have demonstrated a lack of competence and/or failure in their previous mathematics courses—was investigated in Chapter 6 and the main research questions related to this thesis were addressed. Using their responses to pre- and post-test questions, the work of two groups of students, those most successful and those least successful, was described and interpreted within the theoretical framework outlined in Chapter 3. Evidence which support the thesis was presented. Chapter 7 continued the examination of this thesis, contrasting the responses and strategies of two students representative of each group of extremes. It was argued that the construction, organization, and reconstruction processes are constrained by a student's initial perception(s) and the categorization of those perceptions, which cue selection and retrieval of a schema that directs subsequent actions and thoughts.

In this chapter the second thesis is examined—successful students construct, organize, and reconstruct their knowledge in ways that are qualitatively different from those of students who are least successful. Evidence drawn from analyses of student-constructed concept maps, triangulated within the framework of the cognitive collages of students in the extremes of a remedial undergraduate population will be presented in defence of this thesis. It is argued that, though students' cognitive collages of knowledge representation structures are not directly knowable, it is possible to document the qualitatively different ways in which students construct and organize new knowledge, and restructure their existing cognitive structures, using student-constructed concept maps done at different points in time during the semester. Each map is a discrete repre-

sentation at a particular moment in time, with maps on the same subject done at differ-

ent points in time during the semester. The longitudinal nature of the data collected by this means provides a means by which the processes of construction, organization, and restructuring that occurred are analyzed. When triangulated with the data already presented, the concept map analyses provide documentation of these processes of construction.

The responses and strategies of two students, one from each group of extremes were reported and analyzed in Chapter 7. The study of these two students continues in this chapter, which begins with an examination of their concept maps, constructed during week 4 and week 9 of the semester. The underlying structure of each map is revealed and analyzed, using schematic diagrams of each map. Careful study of the structure of the maps of MC (S2) and SK (S23), suggests radically different routes to success and failure, routes which are also found in the maps of other students in each group. An analysis of the development of classification schemas for all eight students—the four most successful and the four least successful is presented. The chapter concludes with a review of the evidence that supports the second thesis, based on the data provided by students' concept maps and the researcher's schematic diagrams of those maps. This evidence is triangulated and the classification schemes of the two profiled students are examined within the broader context of the classification schemes of the eight students of the two groups of extremes, those most and least successful.

Students were assigned concept maps on *Function* three times during the semester; during weeks 4, 9 and 15. Each map was collected a week after its assignment and retained as part of the data collection, though it was reviewed with the individual student in order to clarify his/her intent and rationale for the connections indicated on the map. Students did not have access to the completed maps during the semester once these discussions had occurred. The maps of two students, MC (S2) and SK (S23), are presented and analyzed. Their maps, like their work analyzed in the previous chapters, are typical of those created by the other students in their respective groups. Even on first impression, the maps support the thesis that students organize their knowledge in qualitatively different ways. More convincing evidence is provided by the schematic diagrams which correspond to each student's maps, which reveal the underlying structure of the corresponding maps, and are indicative of the student's knowledge construction, organization, and reconstruction processes.

8.2 The Cognitive Collages of MC and SK

The concept maps of MC (Student 2), the student who started his college mathematics career in the self-paced arithmetic course in the Math Lab are examined first. The maps created during week 4 and week 9 respectively are shown in Figure 8.1 and 8.2 on the following page. His final concept map, created during week 15, was drawn on a very large piece of posterboard, which was not able to be scanned. Copies of his week 4 and week 9 concept maps, with the rough draft of his week 15 concept map are included in Appendix C. MC's concept maps of *Function* are representations of his cognitive collages on *Function* at given moments in time. They convey, albeit imperfectly, the nature of knowledge construction that has occurred over time. MC has visualized his notion of *Function*. in a way that reflects his unique way of thinking and organizing his knowledge about Function.

The words along the outer edges of the Week 4 central image of *Function* as a function machine is *changing* [left edge] and *quantities* [right edge] as you view the map. By week 9, MC appears to have enriched his concept images of *representations* and *equations* and added to his cognitive collage a new cognitive unit, *finite differences*. Though the shape of the central figure has been modified, his second map resembles the first, and the basic features of the first map are retained. Concept images of the notions *measures of central tendency* and *measures of variability* remain virtually unchanged from week 4. As these topics were used to introduce the notion of function and not revisited, it is not surprising that no new knowledge of these topics has been included on the week 9 map. The topics included on the maps by MC appear to follow the sequence of instruction, though the organization of those topics and the connections shown are uniquely his own. In his final interview, MC commented on the construction of his week 15 concept map:

While creating my [final] concept map on *function*, I was making strong connections in the area of representations. Specifically between algebraic models and the graphs they produce. I noticed how both can be used to determine the parameters, such as slope and the y-intercept. I also found a clear connection between the points on a graph and how they can be substituted into a general form to find a specific equation. Using the calculator to find an equation which best fits the graph is helpful in visualizing the connection between the two representations. I think it's interesting how we learned to find finite differences and finite ratios early on and

then expanded on that knowledge to understand how to find appropriate algebraic models.

FIGURE 8.1. MC: Concept Map of Function Week 4

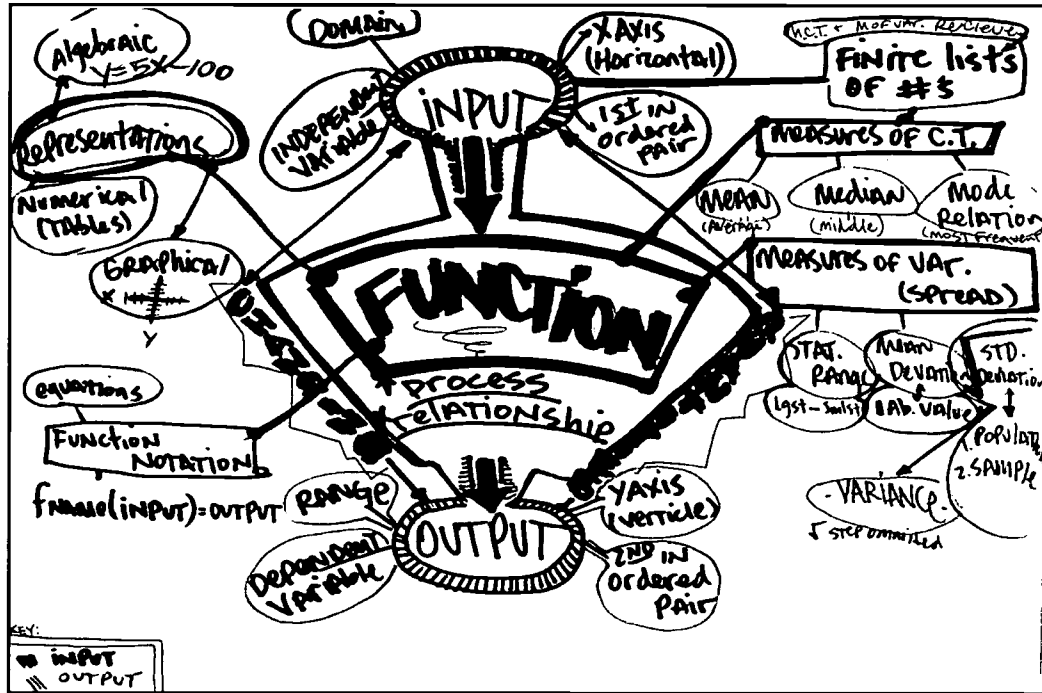
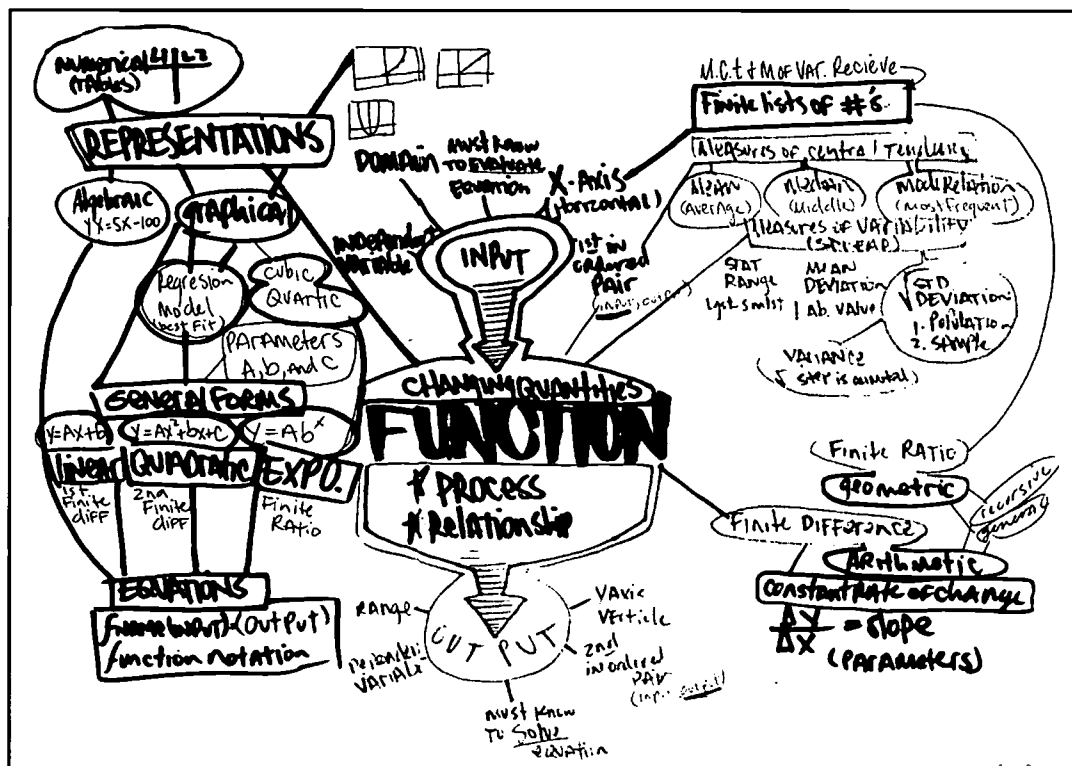

FIGURE 8.2. MC: Concept Map of Function Week 9



The maps in Figure 8.3 and Figure 8.4 were completed and submitted during week 4 and week 9 by SK.

FIGURE 8.3. SK: Concept Map of Function Week 4

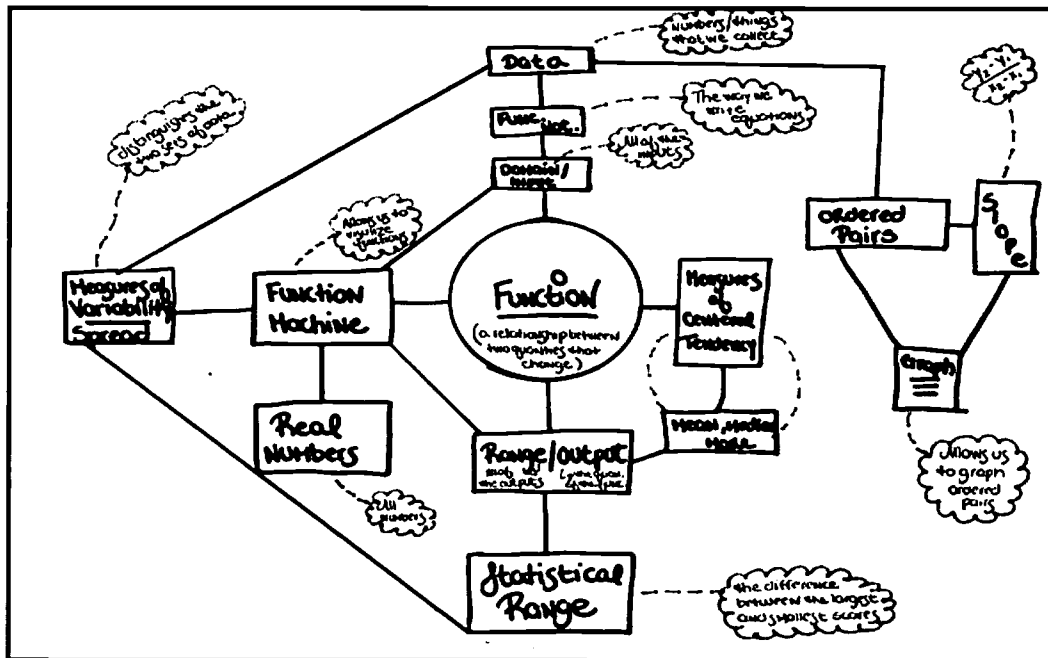
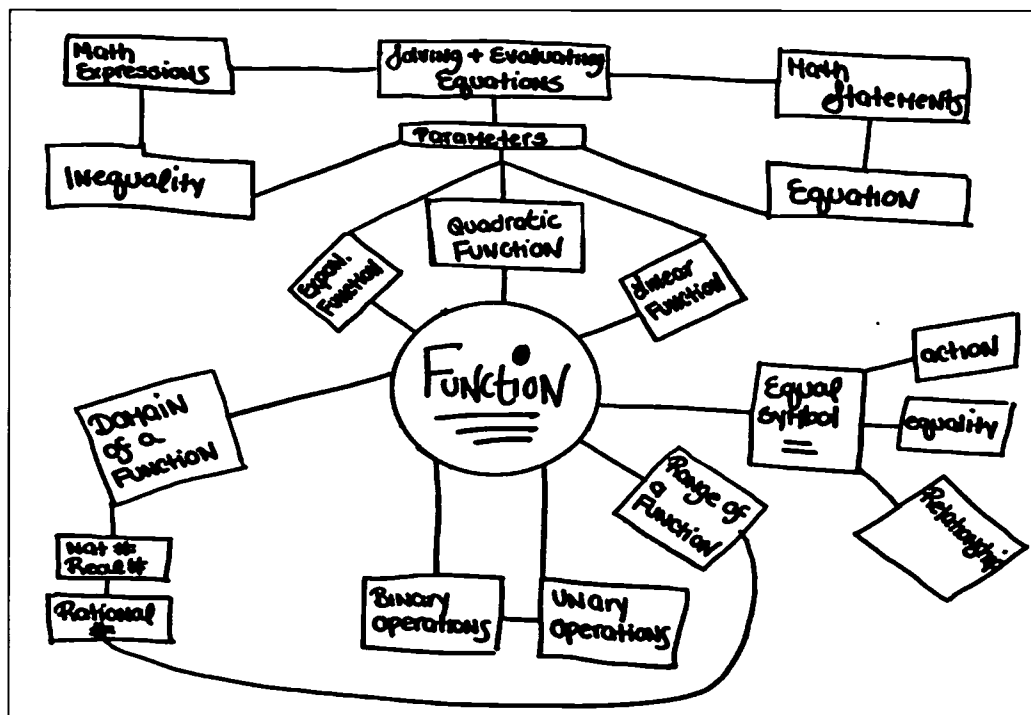
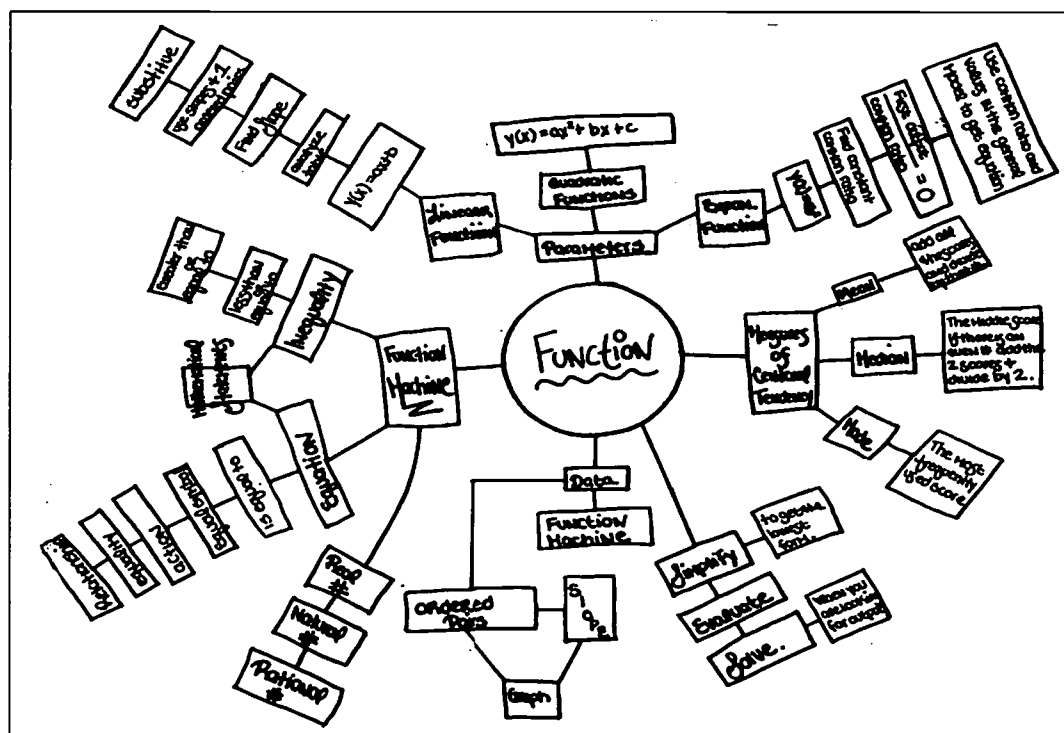

FIGURE 8.4. SK: Concept Map of Function Week 9



The sparse maps of SK provide a sharp contrast to those of MC. There is no interiority to any of the concepts identified on SK's maps of week 4 and of week 9. The week 4 map includes definitions, evidence of her belief discussed in the preceding chapter that she needs to know the definitions before she can learn about a concept. The week 9 map consists only of names of concepts, a bare skeleton of a cognitive collage, with no definitions included. One wonders what SK has associated with the labels she has included on her maps—what the nature of the connections she has indicated might be. Her final map [week 15] in Figure 8.5 contains fewer concepts branching from the main topic of the map, *Function*. The basic functions studied in the course, linear, quadratic, and exponential, together with procedures associated with each of these function types, have been incorporated under the main heading, *parameters* on her map.

FIGURE 8.5. SK: Concept Map of Function Week 15



This final concept map, completed in the week just prior to the final exam, provides additional information about what SK did or did not know about parameters on the day of the final exam. This question arose in the preceding chapter when her work on the rocket problem was analyzed. The concept map completed in week 15 suggests

that SK has constructed a concept image of *parameters* which consists of an association with the general form of each type of function; a recognition that the letters a , b , and c are called *parameters*; and procedures by which the parameters are calculated for linear and exponential functions. The map does not include any procedure for calculating the parameters of a quadratic function. Given the fact that SK has included step-by-step procedures for determining the parameters of a linear function and of an exponential function, the absence of a procedure associated with quadratic functions, supports the conclusion that SK has no schema for determining the parameters of a quadratic function. Her final map once again includes definitions of terms like *simplify* (to get the lowest form); *evaluate* (when you're looking for output); and *solve* (when you are looking for input). The lack of definitions on the week 9 concept map is perhaps, an indication that by week 9 SK had not yet clarified her understanding of these terms. The inclusion of definitions on the week 15 map reinforces the notion that she remains convinced of the importance of having a definition first. SK identified her strengths and weaknesses based on her final map. The procedural nature of her learning is confirmed during the interview:

The one operation I feel the strongest about is solving mathematical statements. When given an equation or an inequality I can solve for X . When solving an equation you have the output and are looking for the input. You must get one of the variables alone on one side of the equal sign. Once you have isolated one of the variables you must simplify to solve the problem. This type of solving is done algebraically. When evaluating a function you must know the input and use it to get the output. When given the input you need to substitute that into the equation to receive your answer.

Note SK's use of the word *concept* when referring to these *processes* of solving an equation and evaluating a function:

These concepts are clearly labeled on my concept map.

It should be noted that her concept images of *solve* and of *evaluate* on the concept map are the reverse of what she said a week later in this interview. It was pointed out to SK during the interview that she had indicated a different interpretation of these two processes on her final map. Her surprise, when she subsequently examined her map, indicated that she was unaware she had formed two separate concept images for

these processes and that, at different times under different circumstances, she retrieved one or the other. Sk's greatest weakness, which she described during her interview was:

My greatest weakness on my concept map is understanding linear, quadratic, and exponential functions. After using my notes and the book I was able to put together some of the pieces of my confusion. I can get the formulas but when I have a specific problem I don't know which formula to choose to complete the problem.

8.2.1 Goals of Learning: MC and SK

One of MC's goals of learning was to connect new knowledge to his prior knowledge and to build connections between and among concepts. Recall his interview comments at the end of the semester cited previously:

I have been able to utilize mathematical knowledge that I have gained from previous courses. It's a good feeling to see things connecting together as I move further along in the text. As I go from investigation to investigation I really see connections in material that are clear and that help establish a solid body of knowledge. Another process that was very helpful in understanding algebra (specifically factoring) was using a graph to find the x -intercepts to find the zeros of an equation. This is a procedure I had never seen before, but I was able to connect it to my prior knowledge.

SK also expressed the desire to relate new knowledge to her prior learning. When describing her weaknesses as she perceived them based on constructing her final map, she said:

Also, when looking at a graph I can't tell if it is linear, quadratic, or exponential. This was the first time I have worked with these functions and I think that may have been part of the problem because I had no prior knowledge to build on.

There are other areas that I feel that I have a strong understanding about as well. I choose mathematical statements because I was able to use my past knowledge and the new knowledge I have obtained this semester to have a better understanding.

Both students indicate they have the same overall goal of learning: the connection of new knowledge to prior knowledge. They are in the same classroom environment, both attend class regularly, and both work at learning mathematics, highly

motivated to succeed. In terms of competency, MC and SK appeared to have similar strengths and weaknesses at the beginning of the semester, based on their pre-test responses. They even had similar prior experiences in learning mathematics and their beliefs were conditioned by these experiences. Yet, even with a similar foundation, their performances diverged during the sixteen weeks, a divergence also reflected in their attitudes and beliefs. MC described his prior experiences and beliefs early in the semester in an interview:

When I started this course I had the misconception that all of the algebraic formulas would be given to us, and we would just have to follow a process to solve for them.

He recognized the need to take responsibility for his own learning. At mid-term, after receiving back an exam on which he was disappointed with his performance compared with a group exam done shortly before the individual exam, he said:

I've never been very good at taking math exams, I find that a lot of what I know slips away when it's time to show and prove. To be honest, I wasn't as prepared as I could have been. After receiving a score of nearly proficient on the test I took it upon myself to go back to Section 1.4 in the book and review everything from that point on in order to fully understand the material. I did that because I realize that math is a very progressive subject, and if I were to continue forward with minimal understanding of the previous sections, I would surely have minimal understanding of the rest of the sections.

SK, on the other hand, though she describes similar prior experiences and the beliefs that were shaped by those experiences, sees the responsibility for learning in a different light. In her first interview, SK described her beliefs about mathematics:

I thought math was about doing a lot of the same problems in order to have an understanding of what you were learning. I have always thought that doing mathematics meant doing operations, with formulas. I believe that learning math with concrete functions, definitions, and examples is the best way for me to learn math.

By the end of the semester, SK indicates very little change in her beliefs. She has shifted some of what she perceives to be the teacher's role to that of her fellow students, who are members of her group:

After being in this class I realize that you can learn mathematics with less teacher-student interaction and more student-student interaction. I have started to take responsibility for my actions.

She shifts some of the responsibility for her failure to do well on (a) the text; (b) the graphing calculator; and (c) the pace of instruction.

- The most challenging thing is the fact that there is not direct formulas and direct “teaching.” I need an example which allows me to see how to do the work and then I could actually do the work for myself.
- A change that would help to improve my learning in this class would be a slower and more thoroughly explanation of the graphing calculator. I think more explanation on how everything ties together would be helpful. For example, a step by step process of why this part of the problem goes into the calculator and so on.
- I have a difficult time because so much depends on what I do. I have to keep up with all the assignments and I can’t let myself fall behind because if I miss one day of work I have no idea what is going on.

MC’s attitudes and beliefs have undergone a change during the semester, those of SK have been impacted to a far lesser extent. MC focuses on understanding *why*, SK focuses on understanding *how to*—clear-cut examples of the relational understanding and the instrumental learning described by Skemp [1987, pp. 166–172]. MC is willing and able to change his beliefs; SK holds fast to her previous beliefs, despite her growing frustration and lack of progress. In her final interview, she says, “Even now, I believe that learning math with concrete functions, definitions and examples is the best way for me to learn math.” Her early and later responses characterize this student and reflect the value she attaches to repetition and procedural rules which shape the construction and organization of her cognitive collages of cognitive units, concept images and schemas. MC, given the opportunity, chooses to travel the path towards proceptual understanding. SK, offered the same opportunities, stays her course on the path of divergence towards the proceptual divide.

8.3 Underlying Structure: Schematic Diagrams

Can the concept maps of these two students contribute more bits and pieces of knowledge that might shape the cognitive collages of MC and SK and inform our understanding of these two students? Schematic diagrams of their concept maps are

analyzed, together with the classification schemes each used when constructing their maps, in an effort to better understand the nature of their processes of constructing, organizing, and reconstructing their knowledge. The underlying structures of each map done by MC and SK during week 4, week 9, and week 15 are revealed in the schematic diagrams of those maps. They illustrate the differences in the nature of the processes of construction and reconstruction used by MC and SK. The concept maps of every student in each of the groups of extremes was analyzed in a similar fashion. The schematic diagrams of the maps of MC and SK are typical of the diagrams of the other students' concept maps in their respective groups and are shown in Figure 8.6 (MC) and Figure 8.7 (SK) on the following two pages.

The schematic diagrams maintain a one-to-one correspondence with the named concepts, processes, and representations included on students' original maps. Each node of the schematic diagram corresponds to one named concept, process or representation from the original map. The schematic diagrams were created using a background grid which imposed a degree of regularity on the relative positions of the various nodes and main branches. Other than this degree of regularity, the approximate location of each main branch [indicated by a slightly larger rectangle] relative to the central rectangle representing *Function* has been maintained; as has the approximate location of each node relative to its category as assigned by the student. Upon completion, the schematic diagrams were scaled so that all three schematic diagrams for a given student could be displayed on the same page to facilitate analysis.

The week 4 map elements are unpatterned. Those elements in the schematic diagrams of week 9 and week 15 that are unpatterned are the elements that were on a previous map [and diagram] which had been retained in the same relative position and within the same category. Beginning with the week 9 map, concepts, processes, and representations that are new [i.e. not included on a previous map/diagram] are indicated by gray-coloured nodes. A boldly-outlined and striped node represents an element that was present on an earlier map and is now in a different category and/or relative position. The maps are arranged from earliest (top) to latest (bottom), beginning at the top of the page with the schematic diagram of the week 4 concept map. Both the maps and their corresponding schematic diagrams illustrate the development over time of a student's cognitive collage of the notion of function.

FIGURE 8.6. Schematic Diagrams of Student Concept Maps: MC

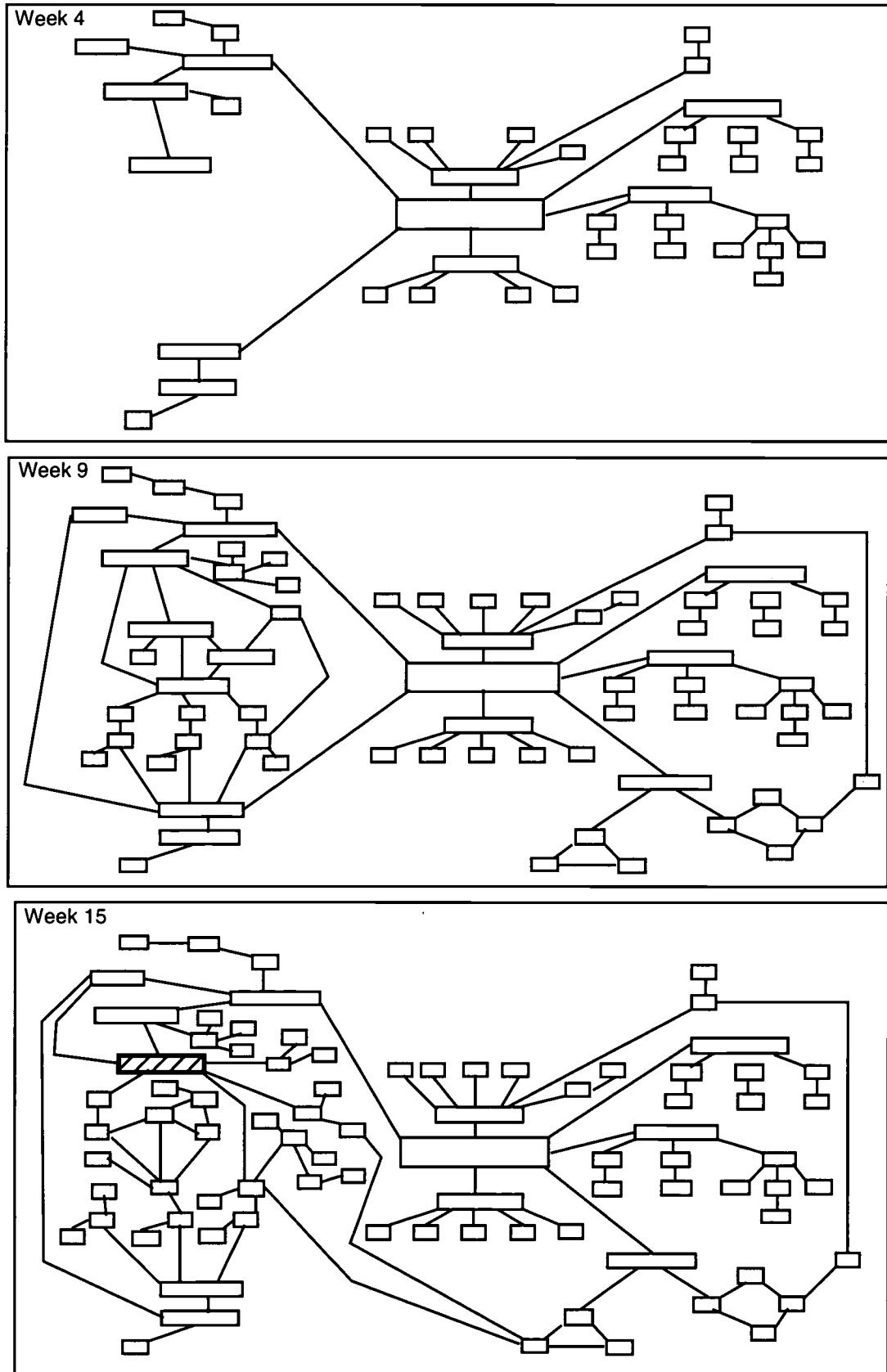
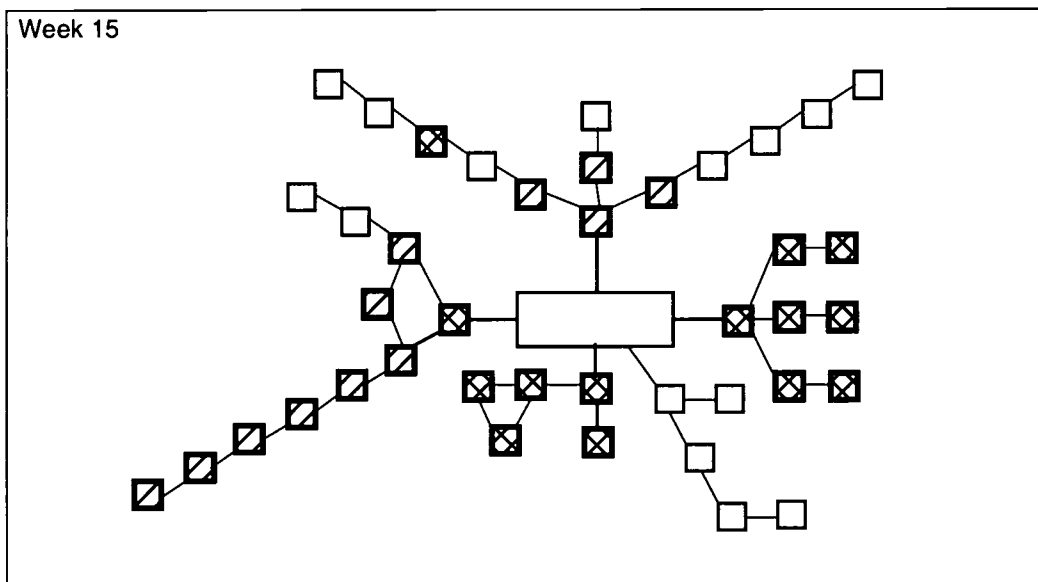
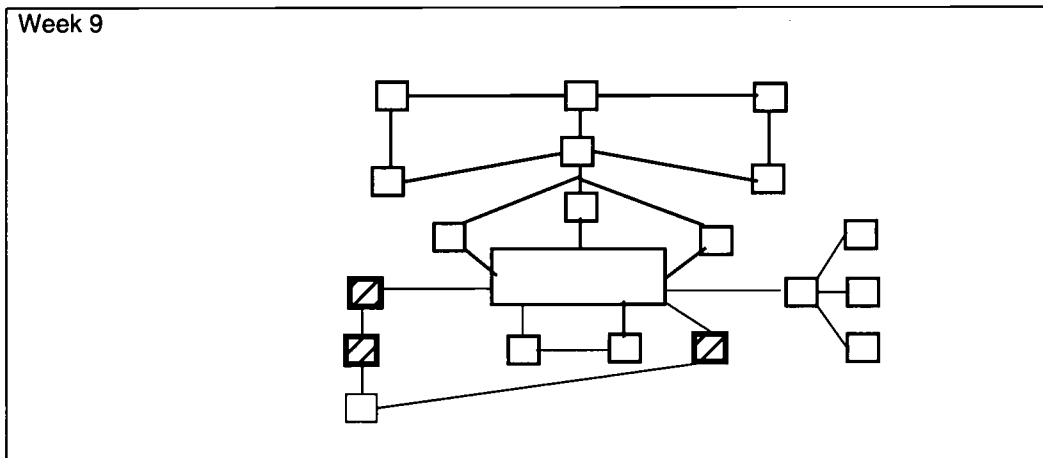
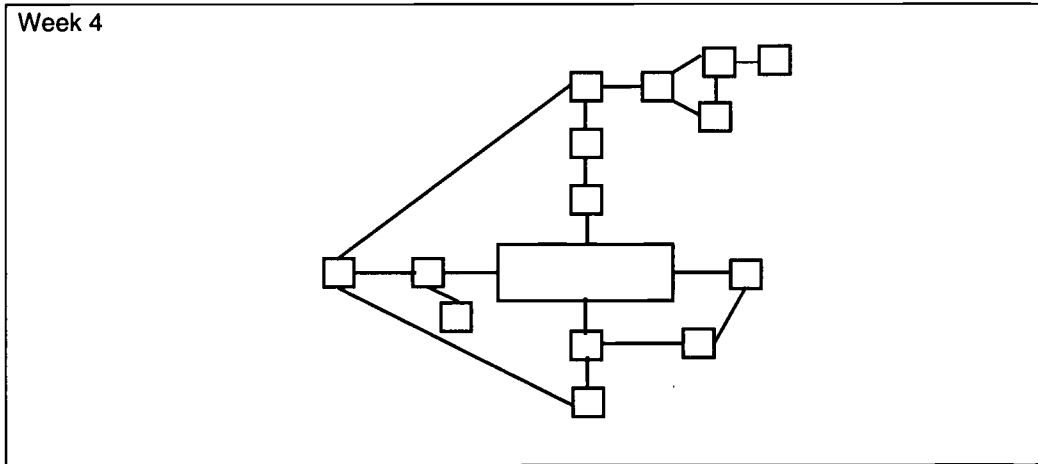

FIGURE 8.7. Schematic Diagrams of Student Concept Maps: SK



8.6 Schematic Diagrams of Concept Maps

The three schematic diagrams of MC are analyzed, followed by a similar analysis of the schematic diagrams of SK. A first glance at the schematic diagrams of MC in Figure 8.6, strikes you with a sense of familiarity, as your eye moves from the diagram of Week 4 to that of Week 9 and to that of Week 15. It's as if a voice is saying "I've seen this before." A closer inspection of the week 4 map compared with that of week 9, and then with that of week 15, reveals the similar structures evident in all three maps.

A more careful inspection reveals that the basic structure assembled by week 4 remains relatively unchanged in week 9 and in week 15. New concept images composed of bits and pieces of knowledge have been assimilated into the week 4 structure in Figure 8.8. [indicated by the dashed rectangle]. A new concept image that includes the cognitive unit, *finite differences*, has been added onto the basic week 4 structure in the lower right corner. The basic structure of the cognitive collage constructed by week 4 is retained over time, with new bits and pieces of knowledge integrated into and added onto that existing framework by week 9. Analysis of the week 15 schematic diagram reveals this same process of construction, and the retention of the basic week 4 structure, which remained relatively intact.

FIGURE 8.8. MC: Schematic Diagram of Week 9 Concept Map

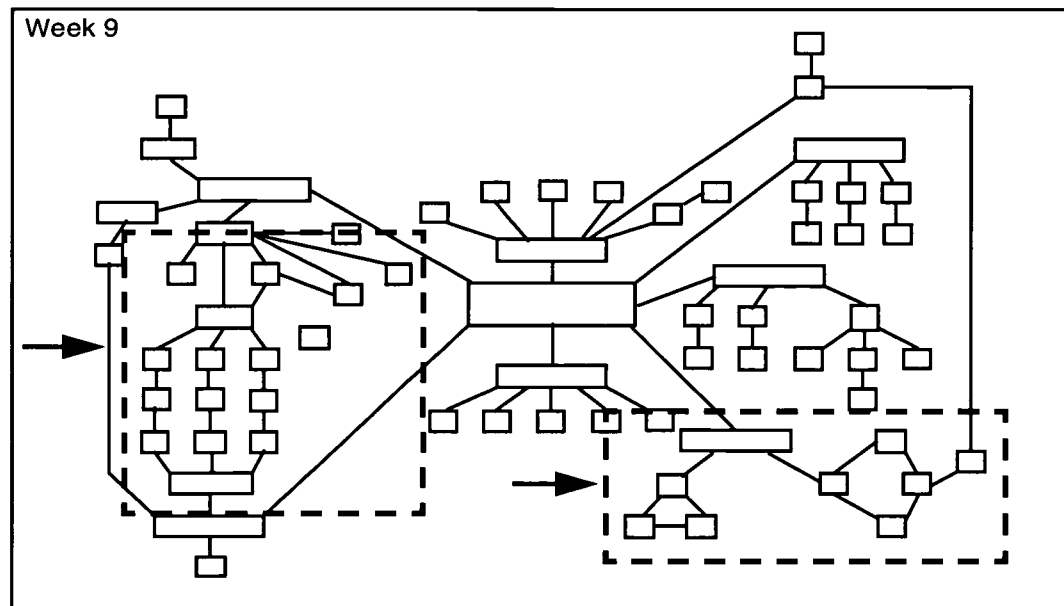

The schematic diagrams of the concept maps constructed by SK during the sixteen-week semester convey no sense of familiarity as one's eye moves from the week 4 diagram to that of week 9 and then to the diagram constructed during week 15. A more careful study of the three maps still reveals no similarities—no basic structure that has remained intact. In fact, this sequence of schematic diagrams suggests that a new cognitive framework has been constructed by week 9, and yet another new framework by week 15. A comparison of the schematic diagram of week 9 with that of week 4 reveals that only three elements [bolded and striped] from the week 4 structure are included in the week 9 map. The retained elements, however, have been restructured into a new framework. They appear in the new week 9 map in a different category and/or position than they did in the earlier week 4 map. All other elements of the week 9 map are new [shaded gray]. These differences are shown in Figure 8.9.

FIGURE 8.9. SK: Schematic Diagrams of Week 4 and Week 9 Concept Maps

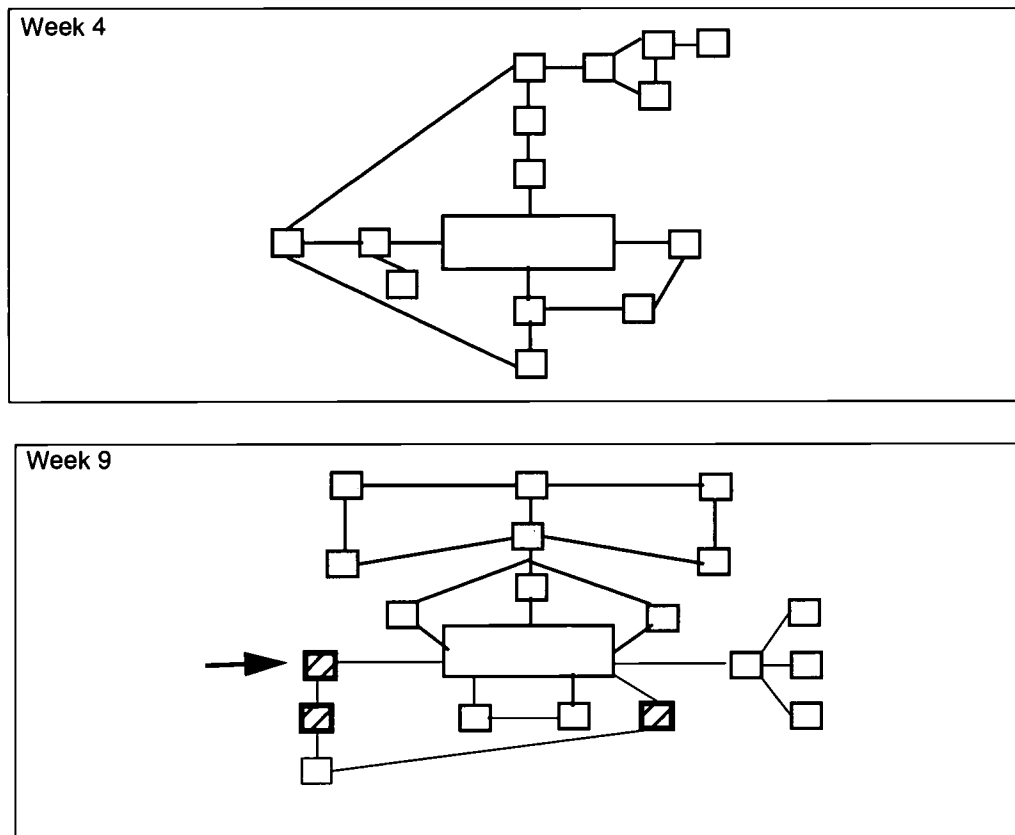

In the week 15 map, only five elements from the original map are retained relatively intact from the week 4 map, despite not being included on the week 9 map. The stu-

dent does not appear to have anything to fall back upon, a counter-example of what Davis [1984] describes as “falling back to the default position,” and to what was concluded about SK’s selection of a schema to deal with the final exam problem.

One might ask, when confronted with these qualitatively different schematic diagrams, whether this difference was unique to these two individual students. The schematic diagrams of the concept maps of the other students in each group revealed similar construction and reorganization processes, thus providing triangulation of the data previously described and analyzed. Each student’s maps reflected his/her style, in a manner similar to that of one’s signature being a unique trait of the individual. However, each set of schematic diagrams for students classified as most successful had a common characteristic: *each set of diagrams of the concept maps constructed over the sixteen-week semester retained the basic structure of the week 4 map in the week 9 and week 15 maps*. Students that are successful appear to construct and organize new knowledge into a basic framework which is retained. New bits and pieces of knowledge are added onto and integrated into the existing framework to form increasingly rich, complex cognitive networks.

Each set of schematic diagrams for students classified as least successful also exhibited a common characteristic: *a new structure replaced the previous structure in each subsequent map, with few, if any elements of the previous map retained in the new structure. No basic structure was retained from map to map*. The set of concept maps, together with their schematic diagrams for two other students, one from each group of extremes are included in Appendix C, so as to provide the reader with additional examples of the characteristic differences in the concept maps and their related schematic diagrams of students in each group of the extremes.

8.7 Basic Categorization Schemes

This chapter began with a detailed presentation and analysis of the concept maps of the two students representative of the most successful and least successful students. In order to provide triangulation of this data, the concept maps and schematic diagrams of two additional students, one from each group of extremes, are included in Appendix C. Further triangulation is provided using the classification schemes of all eight students, the four most successful, and the four least successful. The basic cate-

gories used by each of the eight students in their concept maps were examined, together with the concepts they had included in each category. The main category headings that branched directly off of the main topic of *Function* are summarized in Tables 8.1 and 8.2.

Table 8.1: Basic Classification Schemas of Concept Maps (Most Success)

TP S1 (Most Successful):

Week 4	Week 9	Week 15
Representation	Representation	Representation
Function Machine	Function Machine	Function Machine
M of Central Tendency	M of Central Tendency	M of Central Tendency
M of Variability	M of Variability	M of Variability
	Sequences	Parameters
	Mathematical Models	Systems of Equations
		Rational Functions

MC S2 (Most Successful)

Week 4	Week 9	Week 15
Visualizing Process	Visualizing Process	Visualizing Process
Data	Data	Data
Representations	Representations	Representations
Relationship of Variables: Changing Quantities	Relationship of Variables: Changing Quantities	Relationship of Variables: Changing Quantities
M of Central Tendency	M of Central Tendency	M of Central Tendency
M of Variability	M of Variability	M of Variability
Function Notation	Finite Differences	

MD S3 (Most Successful)

Week 4	Week 9	Week 15
Representations	Graph	Graph
Domain/Range	Equation	Equation
M of Central Tendency	M of Central Tendency	M of Central Tendency
M of Variability	M of Variability	M of Variability
	Quadratic Function	Quadratic Function
	Linear Function	Linear Function
		Exponential Function

LK S4 (Most Successful)

Week 4	Week 9	Week 15
Representations	Representations	Representations
M of Central Tendency	M of Central Tendency	M of Central Tendency
M of Variability	M of Variability	M of Variability
Data	Data	Data
Rates of Change	Quadratic Function	Quadratic Function
	Exponential Function	Exponential Function
	Linear Function	Linear Function
		Systems

Table 8.2: Least Successful: Basic Classification Schemas used on Concept Maps**SK S23 (Least Successful)**

Week 4	Week 9	Week 15
Domain/Input	Quadratic Function	Parameters*
Measures of Central Tendency	Linear Function	Measures of Central Tendency
Range/Output	Exponential Function	Simplify
Function Machine	Equal Symbol	Data
	Range of a Function	Function Machine
	Unary Operations	
	Binary Operations	
	Domain of a Function	

BC S26 (Least Successful)

Week 4	Week 9	Week 15
Relation	Central Tendency	Relation
	Input	Input
	Rate of Change	Notation
	Representation	Binary/Unary
	Standard Deviation	Graphs/Tables
	Formulas	

AT S22 (Least Successful)

Week 4	Week 9	Week 15
Representations	No map submitted	Models
Input/Output		Change
Measures of Central Tendency		Algebraic Functions
Measures of Variability		Things that work with Data
		Terms relating to Data
		Situations with change/algebra

MM S24 (Least Successful)

Week 4	Week 9	Week 15
Change	Change	Rate of Change
Variability	Variability	Models
	Models	Data
	Data	

Analyses of the basic classification scheme used by each student of the most successful group, triangulated with the evidence of the schematic diagrams of their concept maps, support the thesis that successful students construct, organize, and restructure their knowledge in qualitatively different ways than do students who are least successful. The most successful students' classifications indicate that a basic categorization scheme is created and retained over time. The basic categories, once established, remained relatively stable over the course of the semester, growing in interiority as new elements were assimilated. New categories were created as new

knowledge was acquired. Occasionally the elements in a category were re-classified and assimilated into other existing categories, or were combined with other elements into a new category. Students in the least successful group created new classification systems which retained few, if any of the prior categories. Membership in the categories also varied considerably over time, in contrast to the stability of categories of the most successful students.

Comparisons of the basic classification schemes used by students in both groups of extremes confirm the concept map and schematic diagram analyses. This triangulated evidence supports the conclusion that students classified as most successful construct a basic framework which remains relatively stable over time and that new bits and pieces of knowledge are assimilated into this basic, retained cognitive framework. Students classified as least successful do not create and retain a basic framework over time into which they assimilate new knowledge. Instead, they appear to create new, differently organized collages, retaining few, if any of the elements from the previous framework in the newly-constructed cognitive collage. Those few elements that are retained are generally reassembled into new local hierarchies and/or networks of cognitive units, concept images, and schemas.

8.7.1 The Nature of Students' Classification Schemes: Most & Least Successful

The categories used by the students do not permit of easy identification, despite the fact that, in the classification schemes of those students who were successful, most, if not all of the original classification schemes and categories are retained over time. The classification schemes, like the maps of the most successful students, had other common characteristics: all included *Measures of Central Tendency* and *Measures of Variability* on each of their three maps. Three of the four successful students had the category *Representations* on each of their three maps. Their concept maps, together with the corresponding schematic diagrams, and the basic classification schemes employed, indicate that their processes of constructing, organizing, and restructuring knowledge facilitate the building of increasingly complex cognitive structures that have interiority—their basic structures, retained and relatively stable, provide a foundation on which to construct cognitive collages that are enhanced by the lines, colours, and shapes of their networks of cognitive units, concept images and schemas.

The concept maps and schematic diagrams of the least successful reveal the fragmentary and sparse nature of their conceptual structures. No category appears on all three maps of any individual student. There are also *no categories that were common* on any maps of all of the least successful students. As new knowledge was acquired, new cognitive structures and new categories were formed, with few, if any previous elements retained. Prior concepts and/or cognitive units that were retained were reclassified and used in new categories with a different classification scheme. Most concepts and cognitive units that appeared on an earlier map were not retained.

The processes of knowledge construction used by these students are similar to those of the carpenter who builds a framework with weakened lumber and/or nails, or who attempts to build a framework on a weakened foundation which cannot support the weight of the structure. It collapses and the carpenter begins again, constructing a new, differently organized framing system, occasionally salvaging bits and pieces from the collapsed structure. If the processes documented in these students' concept maps and schematic diagrams are typical of the processes of knowledge construction of students who fail, the reasons for their lack of success is better understood—they do not utilize or build onto their previously constructed structures. It is conceivable that these prior structures are retained somewhere in memory, but are organized in a way that makes efficient retrieval of the concept image(s) and/or schema(s) difficult, if not impossible.

8.8 MC and SK: A Comparison of Classification Schemes:

In addition to the schematic diagrams and basic classification system, the terms and groupings of students' concept maps offer a glimpse into the way individual students organize and restructure their knowledge over time. An examination of the classification schemes of quadratic functions by our two profiled students provides triangulation of the conclusions formed earlier in Chapter 7, based on MC's and SK's responses to the final exam question concerning the toy rocket. At week 9, just prior to the main investigations of quadratic functions, MC's map and classification scheme, shown in Table 8.3 suggest his concept image of quadratic functions is very sparse.

Table 8.3: MC's Cognitive Collage of the Category *Representations*

Week 4	Week 9	Week 15
	Quadratic 2nd finite difference $y = ax^2 + bx + c$	Quadratic 2nd finite difference $y = ax^2 + bx + c$ 3 solutions poss-graphs finding zeros (factors) and x-intercepts factoring (sol. graphs) discriminant (to x-inter) $b^2 - 4ac$ max # of solutions: 2 (finding zeros) Use Appropriate Method(s)

By week 15, six weeks later, he has formed several powerful connections and his concept images have grown in interiority. The bits and pieces of knowledge of new knowledge have been organized into a cognitive collage rich in connections and interiority. The terms, their organization and restructuring that has occurred in the category of Quadratics which was included in the more general category, *Algebraic Models* reflects this growing interiority of MC's cognitive collage of quadratic functions which developed over a period of six weeks is well-documented in his work as well as in his concept maps. In Week 4, there is no mention of quadratic functions. By Week 9, shortly after quadratic functions were introduced, two basic concepts are recorded: *2nd finite difference* and the general form of the equation, $y = ax^2 + bx + c$. By Week 15, the concept map of MC, while retaining the two basic concepts from Week 9, includes connections between various representations (symbolic, numerical and graphical), as well as between concepts and processes (terms enclosed in parentheses on the classification table); i.e., *finding zeros* → *factors*; *finding zeros* → *x-intercepts*; *discriminant* → *x-intercepts*.

Under another general category, *Representations*, MC links *graphical* → *find zeros*, which he shows as a shared term under the category *Quadratics*. He perceives *factoring*, a category under *Quadratics*, as connected with *Graphical Representations* and its sub-category *x-intercepts*. *Parameters*, a sub-category on his week 15 concept map under *Algebraic Models* is linked to another sub-category, *regression models*, in *Graphical Representations*, which he identifies are useful in finding *parameters*, and links to 2nd finite differences, which is linked to the general form of the quadratic,

$y = ax^2 + bx + c$. The classification scheme used by SK, given in Table 8.4, provides a stark contrast to the scheme used by MC.

Table 8.4: SK's Cognitive Collage of the Category Quadratic Function

Week 4	Week 9	Week 15
	QUADRATIC FUNCTION	PARAMETERS
	Parameters	Quadratic Functions
	solving & evaluating eq math statements math expressions	$y(x) = ax^2 + bx + c$
	Equation	Linear Function
		$y(x) = ax + b$ analyze table find slope use slopes+1ord.pr substitute
	Inequality	Exponential Function
		$y(x) = ab^x$ find cnst common. ratio see quadratic above 1st out/c.ratio=0 use c.ratio in g.eq

In week 4, SK likewise provides no information to indicate what she knows or how she thinks about Quadratic Functions. Shortly after the topic of Quadratic Functions was introduced, SK's concept map and classification scheme in week 9 indicates she has formed a limiting, constrained concept image, which includes the notions of *parameters*, *equation*, and *inequality*—notions which have much more general applicability than just to quadratics. There are no categories or terms included, which distinguish quadratic functions from other types of functions. In fact, the category *parameters*, lists a distinguishing characteristic property of *equations* and *inequalities*: *math statements*. Unlike her Week 15 final map, no definitions or step-by-step procedures are included. SK lists no information about the kind of equations she is solving and/or evaluating, nor does she include any properties which are typical of either category. Her classification scheme by week 15 reveals no specific knowledge about quadratic functions, except it's general form. Her categorization schemes for Linear and Exponential Functions are included, as they provide a contrast to her categorization scheme for Quadratic Functions. Both Exponential and Linear Functions *list the steps of the computational process* for finding parameters. SK lists no steps for finding the

parameters of a quadratic function. At week 15, SK's concept image of quadratics looks similar to that indicated on MC's concept map six weeks earlier. It is of interest to compare SK's classification of *Parameters* (Table 8.6) with that of MC's classification (Table 8.5).

Table 8.5: MC's Cognitive Collage of the Category *Parameters*

Week 4	Week 9	Week 15
REPRESENTATIONS Graphical	REPRESENTATIONS Graphical Regression (best fit)	REPRESENTATIONS Graphical Regress models (best fit) Use to find parameters
Algebraic (one example)	Algebraic Equations (to Gen. Forms) General Forms(Linear,etc) Parameters: a, b, c Linear 1st finite difference $y = ax + b$	Algebraic Models Parameters: a, b, c Linear 1st finite difference $ax + b$ a =slope(const chg) b =output; in=0or b = y-intercept Systems (to equations) Elimination Substitution Matrices Use coeffs & const

Table 8.6: SK's Cognitive Collage of the Category *Parameters*

Week 4	Week 9	Week 15
	QUADRATIC FUNCTION Parameters solving & evaluating eq math statements math expressions	PARAMETERS Quadratic Functions $y(x) = ax^2 + bx + c$ Linear Function $y(x) = ax + b$ analyze table find slope use slopes+1ord.pr substitute Exponential Function $y(x) = ab^x$ find cnst common. ratio see quadratic above 1st out/c.ratio=0 use c.ratio in g.eq

Though SK lists *Parameters* as a category under *Quadratic Function* in Week 9, she makes no specific reference to it in her Week 15 map. When one recalls SK's

strong procedural tendencies and her beliefs about needing concrete steps and definitions, the absence of a procedure by which to calculate the parameters for a specific quadratic algebraic model is surprising, particularly when the detailed procedures for both the linear and exponential functions are noted.

We are reminded of SK's work on the toy rocket problem described in Chapter 7. The list of concepts included on her maps, together with her work reviewed earlier in Chapter 7 and with information obtained from interviews with her, support the conclusion that SK's concept image of Quadratic Functions is indeed accurately reflected and represented in her concept maps and classification schemes. It seems reasonable to conclude that SK did *not* know how to find the parameters of a quadratic equation, and not knowing, she did indeed retrieve a default schema—given a quadratic function, solve it using the quadratic formula. The fact that the category *Parameters*, a major sub-category in Week 9, is not included in her concept map and classification scheme of Week 15, suggests that the term, *parameters*, is a compartmentalized term, inappropriately connected, and stored in the crevices of memory, isolated and forgotten.

Both students' classification schemes show evidence of the restructuring that occurred between week 9 and week 15. MC's final map suggests that his construction processes consist mainly of assimilating new knowledge into his existing framework, with accommodation, subsequently, when necessary. SK's work reveals a process of construction that consists of replacing the previous structure with a new one, using a new classification system, new categories, and mostly new elements. The triangulation of the data of the students' work with their concept maps and their classification schemes contribute more evidence to that already provided by the schematic diagrams, which reveal the divergent processes of constructions.

8.9 Conclusions

In this chapter, we explored the thesis that successful students construct, organize, and reconstruct their knowledge in qualitatively different ways from students who are not successful. The concept maps and their corresponding schematic diagrams revealed how differently knowledge is structured by students who are most successful and those least successful. The classification schemes contribute additional details about students' different ways of categorizing concepts. They also provide a more

detailed look at how students organized their knowledge. Student-constructed concept maps, completed at different points in time during the semester, together with their corresponding schematic diagrams, provide evidence in support of the main thesis.

The maps and schematic diagrams of students who are most successful indicate that their processes of assembling cognitive collages of knowledge facilitate the building of increasingly complex cognitive structures that have interiority. They include basic structures that are retained and remain relatively stable, providing a foundation on which to construct cognitive collages that are enhanced by the lines, colours, and shapes of their networks of cognitive units, concept images and schemas. The maps of those least successful reveals a process of construction that consist of replacing the previous structure with a new structure organized differently, which includes a new classification system, new categories, and mostly new elements. The triangulated data of the concept maps, classification schemes and strategies of students of the two groups of extremes supports the thesis that students who are most successful construct, organize, and restructure their knowledge in ways that are qualitatively different from those of students least successful.

*A theory if you hold it hard enough
And long enough gets rated as a creed:*

– Frost, *Etherealizing*

And there is always more that should be said.

– Frost, *The Wind and the Rain*

9.1 An Emerging Cognitive Collage of the Most/ Least Successful

The task of assembling the bits and pieces of knowledge which have been collected and organized into the cognitive collage that is this thesis, assimilating new bits and pieces—using the threads of intuition and analysis—occasionally restructuring the collage already assembled to form a coherent picture that illuminates our intuitions and expands our understandings has been daunting. The collage that has emerged reveals a picture of divergence and fragmentation of strategies—a conceptual divide as well as a proceptual divide—greater than was initially predicted. The weight of evidence which has been presented supports the thesis that qualitative, as well as the quantitative divergence occurs between students who are successful and those who are unsuccessful in the mathematics classrooms of a population which consists of students who have demonstrated weaknesses or failure in their previous mathematics courses.

9.1.1 Divergence and Fragmentation of Strategies

Both quantitative and qualitative divergence was clearly documented. It was expected that the most successful students would demonstrate growth in mathematical understanding and competence to a greater extent than do the least successful students. What was unexpected was how little growth occurred among the students least successful. It is in the diversity of ways that students did or did not improve that is of interest. Remedial undergraduate students who were successful improved in their ability to deal flexibly with (a) ambiguous notation, (b) in their choice of strategies and tools; (c) in their ability to translate among representations and (d) in their ability to switch their train of thought from a direct process to its reverse process, as well as (e) demonstrate the ability to curtail reasoning in a relatively short period of time. Though

the most successful students demonstrated significant growth in their mathematical abilities over the semester, their ability to deal flexibly with conceptual questions was more inconsistent than their ability to deal flexibly with ambiguous notation in procedural questions. Restructuring their cognitive collages built on arithmetic understandings of the minus symbol proved difficult even for the students most successful, who demonstrated significant improvement in their ability to think flexibly generally.

Results of the study indicate that the least successful students experienced almost no growth. What little improvement they made was very inconsistent, for individual students, as well as for the group. Surprisingly, these students were able to deal with procedural questions involving ambiguous functional notation better than they were able to deal with traditionally formatted questions. It is believed that, as functional notation was not part of their prior experiences, previously constructed inappropriate schemas caused less interference. However, their failure to assimilate and retain the bits and pieces of new knowledge in a coherent, connected framework, upon which they could continue to build their cognitive collages of mathematical knowledge constrained their ability to think flexibly and effectively.

Lacking a coherent structured collage, these students were unable to flexibly interpret and use ambiguous notation to translate among representations, or to switch their train of thought, bound up in ever-increasing webs of cognitive overload. These students collected bits and pieces of knowledge, assembling them using the fragile fabric of their inadequate language and understandings, until the weight of the assembled pieces caused their structures to tear apart, leaving connected fragments of knowledge lying around. Some pieces may eventually be picked up, dusted off, and used. Other fragments fell into the cracks of memory, where they are forgotten. Even with guided practice, in the sense described by Krutetskii, these students were unable to reconstruct their existing schemas into more appropriate, flexible cognitive structures.

9.2 The Cognitive Collages of Two Students: MC(S2) and SK (S23)

The divergent performance and strategies of two students, MC (S2) and SK(S23), were examined, using the theoretical framework described in Chapter 3. MC, representative of the group, those most successful, demonstrated an improved ability during the semester to think flexibly. His work, supported by interview data,

indicates that he was able to deal with both direct and reverse processes, and recognized them as two distinctly different processes [Post-test questions P1 and P3; P8 and P9; P10 and P11; P13 and P14]. He was able to translate flexibly and consistently among various representational forms [tables, graphs, traditional symbolic forms, and functional forms]. Confidence in the correctness of his answers increased over the course of the sixteen weeks.

A closer examination of his work suggests that he initially focuses on the mathematical expression as an entity, then unparses it as necessary. On the toy rocket problem, MC's initial focus of attention appears to have been the general algebraic model, which cued retrieval of a concept image of quadratic function rich in interiority. His work demonstrates his coherent, rich understanding, his concept maps provide support for this conclusion. On his final map, MC indicates cross links between graphical and algebraic representations. He links factors with (a) the number of possible solutions to a quadratic, (b) with finding the zeros of a function, and with (c) solving a quadratic equation. He cites the need to use appropriate methods, and considers the regression models feature of the graphing calculator to be an efficient means of finding parameters, given data. MC moves flexibly between procedural and conceptual thinking. He is able to describe and justify procedures used, as well as answer questions about functions when no rule is provided. By the end of the semester, he demonstrated improvement in his ability to recognize the role of context when interpreting ambiguous notation [Post-test P5], as well as to parse and unparse the notation, depending upon the context.

SK demonstrated no ability to reverse a direct process, in either numerical or algebraic contexts, at the beginning of the semester or at the end of the semester. On at least two occasions, she retrieves and implements two different schemas, and does not recognize the conflict [her responses to P1 and to P5 on the pre- and post-test]. She shows almost no growth in her ability to interpret and use ambiguous mathematical notation, nor is she able to translate among various representational forms consistently by the end of the semester. She readily admits she is unable to distinguish between a linear, quadratic, and exponential function, even after sixteen weeks of investigation of these three function types. Confidence in the correctness of her answers decreased over the semester, and her attitude became more negative.

SK usually focused initially on the numerical values stated in a problem. When confronted with a problem for which she has no appropriate schema, she retrieves a default schema learned previously. Though this is something we all do on occasion, SK appears to use this strategy on a consistent basis. She demonstrated no ability to move flexibly between procedural and conceptual thinking, instead clinging to the step-by-step procedures she has memorized, using them uncritically. When given a function without its rule, she was able to execute only a one-step procedural task, and then only intermittently. SK remains bound by an arithmetic interpretation of the minus symbol—when a minus sign precedes a variable it is interpreted to mean a negative-valued number. Her work on the toy rocket problem suggests that her concept image of quadratic functions is even more sparse than her concept images of linear and exponential functions. This conclusion is validated by the evidence of her concept maps and interview data. It is noted that both her concept image of linear function and of exponential function, as indicated in her classification scheme and on her concept map (Week 15), is limited to the computational procedures used to determine the parameters. Neither her classification schemes, nor her concept maps, reveal any interiority to these concepts—there are no links to other concepts, to graphical representations or to alternative strategies for finding parameters. She compartmentalizes her knowledge, building new cognitive collages rather than assimilating new knowledge into her existing cognitive structure.

9.2.1 Divergence and Fragmentation of Strategies: MC (S2) and SK (S23)

The fragmentation of strategies that occurred as a result of the initial perceptions, categorization, and retrieval of schemas which leads to the divergence of performance was documented. To examine why this divergence occurred, the study also investigated students' processes of knowledge construction, organization, and reconstruction. It was hypothesized that successful students construct, organize, and reconstruct their knowledge in qualitatively different ways than do students who are least successful and that *how* knowledge is structured and organized determines the extent to which a student is able to think flexibly.

MC (S2) and SK(S23) both used two different schemas simultaneously when interpreting the minus symbol, given variables in an algebraic context. With no cogni-

tive dissonance or conscious awareness that they are doing so, they mentally use the minus symbol twice—to indicate that c is negative, followed by use of the minus symbol as the subtraction operator. MC's responses on the post-test provide evidence that he has developed a more flexible way of thinking about variables and has grown in his ability to interpret ambiguous notation. However, even though he has successfully reconstructed his cognitive collage to interpret notation more flexibly, he is still unable to interpret the minus symbol in a similarly flexible manner at the end of the semester, interpreting the minus symbol in the expression $(x-c)$ to mean that “the value for c is negative because of the $-$ sign in front of c , “adding that “ c will subtract from any number that comes before the $-$ symbol,” illustrating the confusion that results when two concept images are retrieved, along with two distinct schemas for interpretation and use of the minus symbol. SK retrieves a different concept image and schema, based on a well-remembered rule—when you see a minus symbol in front of a letter, change signs and add. She does not attempt to interpret the expression, $(x-c)$, which suggests that, once again when confronted with a question she can't answer, SK retrieves a default schema that she knows how to implement.

The qualitative divergence that occurred was hypothesized to be a consequence of qualitative differences in the strategies students use, the way in which they categorize their initial perceptions, and in the way they structure their knowledge. Despite a lack of confidence in his algebraic skills, MC is able to select an appropriate alternative strategy when necessary, using the list, graphing, and table features of the calculator. His ability to translate among representations is documented. His work suggests that he has formed mental connections linking the notions of zeros of the function, x -intercepts, general quadratic form and the specific algebraic model appropriate to the problem situation. He relates new knowledge to his previously acquired knowledge, building on the cognitive collage he has already constructed.

The path taken by SK is very different from that taken by MC. Using the lines and colours of her words, actions, and writings, the picture that emerges presents a stark contrast to the cognitive collage that represents MC. SK's initial focus of attention is on the numerical values stated in a problem when she is dealing with a quadratic equation, $h = at^2 + bt + c$. This initial focus of attention sets up an inappropriate path-dependent logic and retrieval of a schema that is characterized by SK's focus on

“getting the answer,” resulting in the selection and retrieval of a very different schema from that of MC. SK’s initial perception of the problem task of determining the algebraic model of the path of the toy rocket could be interpreted to indicate that she has an understanding of the problem requirements and a schema by which she can determine the answer. Not knowing what to do to find the parameter values of a , b , and c , SK ignored the original data which does not fit her retrieved schema. Instead, she retrieved a schema she felt comfortable using—her cognitive collage of quadratic equations, which appears to consist primarily of memorized procedures (finding the discriminant; use the discriminant value in the quadratic formula to “solve” the equation). What few connections SK appears to have formed are procedural connections necessary to “get the answer” in the process of finding solutions.

Her knowledge is compartmentalized. Despite knowing how to solve a linear system of equations using the matrix features of the graphing calculator, SK fails to recognize that the toy rocket problem involves solving a system of linear equations to determine the parameter values, and that the matrix features and/or the regression model features of the calculator would be appropriate means of accomplishing this task. Her initial focus of attention, coupled with her flawed and incomplete construction of her cognitive collages of quadratic equations and systems of equations are underlying causes of her lack of success in this instance. It appears that SK has assembled some bits and pieces of knowledge appropriately, but she is missing other basic pieces. How she has assembled those bits and pieces constrains her ability to construct concept images and cognitive collages that have interiority and which permit meaningful connections. Lacking rich concept images and locked into inflexible thinking, when confronted with situations in which she is unclear what to do, SK retreats to the familiar and defaults to using those procedures she knows.

9.2.2 The processes of constructing cognitive collages: MC (S2) and SK (S23)

The two students’ processes of constructing their cognitive collages of conceptual structures were examined in detail, using their concept maps and schematic diagrams of those maps. Evidence drawn from analyses of student-constructed concept maps, triangulated within the framework of the cognitive collages of students in the extremes of an undergraduate population of remedial students was presented in

defence of the thesis that successful students construct, organize, and restructure knowledge in qualitatively different ways than do students who are least successful. It was argued that, though students' cognitive collages of knowledge representation structures are not directly knowable, that it was possible to document the qualitatively different ways in which students construct and organize new knowledge, and restructure their existing cognitive structures.

Student-constructed concept maps done at different points in time during the semester provided the means of documenting these processes. The concept maps of the two profiled students, MC and SK, constructed during week 4 and week 9 of the semester, were examined. The underlying structure of each map was revealed and analyzed, using schematic diagrams of each map created by the researcher. The structures of the maps of MC (S2) and SK (S23), revealed radically different routes to success and failure, a pattern which was found in the maps of other students in each group. Analysis of the classification schemas for all students of the two groups of extremes—the four most successful and the four least successful— was presented.

The data provided by students' concept maps, their work and documented strategies, together with the researcher's schematic diagrams of the concept maps and students' classification schemes, were interpreted within a multi-dimensional theoretical framework. Successful students organized the bits and pieces of new knowledge into a basic cognitive structure that remained relatively stable over time. New knowledge was assimilated into or added onto this basic structure, which gradually increased in complexity and richness. Students who are least successful constructed cognitive structures which were subsequently replaced by new, differently organized structures which lacked complexity and essential linkages to other related concepts and procedures. The bits and pieces of knowledge previously assembled were generally discarded and replaced with new bits and pieces in a new, differently organized structure.

9.3 Reflections and Observations

The combination of a teaching situation, combined with the various methods of collecting the accumulated data described and analyzed in these chapters provides opportunities for inferences, about the states of students' schemas at various stages in their learning and about the processes by which they progress from one stage to another.

As researcher and instructor of the course during the preliminary and main classroom-based studies, one of my goals was to develop a plan of research, together with data collection instruments, which could be utilized by classroom instructors who are interested in the mental processes of their students. As Mason [1997] has pointed out, “absence of evidence of behaviour does not mean evidence of absence of ability—just not *knowing* or *thinking* to behave in a particular way at a particular time [Mason, 1997, p. 379]. The triangulated data, collected over time and presented in this dissertation, is an attempt to minimize the extent of researcher inferences concerning cognitive processes. The subjects of this research have prior histories consisting of a variety of experiences, not all of which can be known or discovered by the researcher. It is acknowledged that interpretations which can be attributed to students’ understanding are limited by the constraints of students’ willingness, their disposition, their cultural environment, and factors identified by Krutetskii [1969] and others. Analyses of the triangulated data revealed a divergence in performance and qualitatively different strategies used by undergraduate remedial students who were most successful compared with students who were least successful.

The most successful students demonstrated significant improvement and growth in their ability to think flexibly to interpret ambiguous notation, switch their train of thought from a direct process to the reverse process, and to translate among various representations. They curtailed their reasoning in a relatively short period of time. Students who were least successful showed little, if any, improvement during the semester. They demonstrated less flexible strategies, few changes in attitudes, and almost no difference in their choice of tools. Despite many opportunities for additional practice, the least successful were unable to reconstruct previously learned inappropriate schemas.

Behaviours similar to those reported in this study have been documented in the Russian studies of grades 1-3 and in grades 7-8, as well as in the present study at the undergraduate level. Krutetskii [1969] identified a structure of mathematical abilities necessary for successful mathematical performance. Subsequent studies by him and by several other Russian researchers documented the divergence of strategies, characterizing and classifying the performances and abilities of students into the categories of gifted, very able, able, average, and less able. Their work suggests the divergence to be

a consequence to the qualitatively different strategies and abilities they identified, though they do not explicitly refer to this phenomenon by name.

The findings suggest that the phenomenon of divergence occurs in classrooms, not only of elementary-grade children, but possibly across the full spectrum of grade and course levels. The research of Gray and Tall [1994] documented the bifurcation of strategies that occurred in elementary grade classrooms and concluded that this divergence was a consequence of students' ability to think flexibly. The documented need to think flexibly, together with evidence that suggests successful students construct, organize, and restructure their conceptual structures in ways that are qualitatively different from students who are least successful, has profound implications for those of us who are attempting to deal with the practical problems of attending to the social and human needs of our students.

Students' concept maps and schematic diagrams of those maps revealed that most successful students organized the bits and pieces of new knowledge into a basic cognitive structure that remained relatively stable over time. New knowledge was assimilated into or added onto this basic structure, which gradually increased in complexity and richness. Students who are least successful constructed cognitive structures which were subsequently replaced by new, differently organized structures which lacked complexity and essential linkages to other related concepts and procedures. The bits and pieces of knowledge previously assembled were generally discarded and replaced with new bits and pieces in a new, differently organized structure. If these findings can be supported by further research, the implications for instruction are significant.

In particular, what mathematics we should be teaching, when, and to whom needs to be re-examined. The undergraduate students of this study were, for the most part, conscientious students, with many competing demands on their time, their energies, and their interests. The algebra courses, even more than calculus courses, are a filter which prevents many students from accomplishing their goals. When one considers the significant improvement of the most successful students, one must ask: "What if?" What if these students had been given the opportunity to learn mathematics in ways that made sense to them *earlier*? Is it too little, too late for some of them? Would

students like SK have developed more flexible thinking and been able to build cognitive collages and a more solid foundation for subsequent learning?

9.4 Strengths and Weaknesses of the Study

Clarke, Helme, and Kessel (1996) report that very few students who claimed to have learned something new actually met their criteria for meaningful learning. However, their research consisted of video-taping a single lesson, followed by interviews of the students. They question whether it is reasonable to expect significant learning to occur in every lesson. The data reported in this paper would seem to indicate that meaningful learning did occur, but usually over time, and only after students have had the opportunity to reflect and synthesize their learning into their cognitive collages. The findings of the study also indicate that meaningful learning did not occur for all students—that, for those least successful, despite hard work and great effort on the part of students like SK, little, if any learning occurred. Was this the result of instruction, the sequence of instruction, the nature of the tasks, or were there other factors, as yet unidentified, that explain the divergence and qualitatively different ways students construct knowledge?

Though the use of concept maps, together with the corresponding schematic diagrams, documented the qualitatively different ways in which students who are successful and those who are not successful constructed knowledge, it must be remembered that these visual representations were constrained by factors which limited the extent to which the concept maps represented the totality of a student's knowledge on a given topic at a particular moment in time. Some students found it difficult to translate their three-dimensional way of thinking about concepts and relations to a two-dimensional surface. Other students were not always able to complete their maps in as much detail as they were capable of because of social and work commitments outside of class which constrained the amount of time spent constructing the map. As the maps were focused on a single topic, *Functions*, how student's thought about related topics was not generally reflected in their maps.

However, concept maps, when triangulated and interpreted with other data, provide evidence of students' processes of knowledge construction and evidence of inappropriate knowledge constructions. Though limited in scope, concept maps and

their related schematic diagrams reveal how students organize newly-acquired knowledge, restructure prior knowledge, and perceive relationships. In addition to providing researchers with data about students' processes of knowledge construction, they contain evidence of students' inappropriate constructions and a means of engaging students in reflective activities.

The role of technology in the process of learning and teaching of mathematics needs to be more deeply understood and researched as well. Clearly, we need to have a better understanding of the differences and needs of the individual students in our classes, which must be taken into account in our curricular design and instructional practices. This study suggests that technology can be a powerful tool for some students—in their acquisition of new knowledge and in the development of new insights and connections, as well as in the reconstruction of existing inappropriate concept images. For other students, technology appears to add to the cognitive overload they are already experiencing, disenfranchising them, rather than empowering them.

9.5 Future Directions and Possibilities

In future studies of mathematical learning in classroom settings, we need to have a clearer picture of the previous mathematical understanding and concepts students bring to the task and detailed analysis about which new pieces of knowledge they develop as a result of different interactional activities. We need to know which mathematical invariants students construct during their activities, which new rules, concepts, or modes of representations they adopt, which new relations or structures they discover. We also have to analyze the role that information and conventions provided by others play. Such analyses are needed not only to provide suggestions for better mathematics education but also to contribute to a better understanding of the psychological issues related to how new knowledge comes to be constructed, discovered, and used by students.

An earlier chapter began with lines from Robert Frost's poem, *The Road Not Taken*, to introduce the notion of divergence among the two groups of extremes of students who participated in this study. The lines of that poem aptly describe my feelings as I reflect back on this study:

*Two roads diverged in a yellow wood,
And sorry I could not travel both
And be one traveler, long I stood...
Oh, I kept the first for another day!*

Additional research on the use of concept maps as a research tool and students' ways of categorizing is needed. A pre-test, triangulated with an initial concept map and task-based interview, to document a students' prior knowledge at the beginning of a course could provide additional meaningful data. At the time this study was designed and implemented, the literature on perception and categorization was not identified as a component of the theoretical perspective within which I intended to interpret the data. It was only as the data was analyzed—when the findings revealed the strikingly different patterns of knowledge construction—and the need to interpret the qualitatively different classification schemes became necessary—that it occurred to me that this body of research from other domains could provide insights which could help me better understand and interpret the data.

The theses developed in this dissertation were based on the premises that (a) students do develop and acquire abilities and that (b) that differences in attainment are sometimes caused by cultural influences, including schooling. More recently, the realization that classification schemes are the results of perceptions, which, to some extent as yet unknown, are determined by biological structure, as well as by adaptive use as a result of evolution and behaviour have become the focus of interest. It seems specious to conclude, as David Geary [1996] has, that differences in attainment are caused by a variety of influences, including culture and schooling, without including biological structure as a possible contributory source of the qualitative differences which have been documented.

Research on the roles of perception and categorization, neuro-psychological theories of how the brain functions, and recent findings that support an evolutionary viewpoint of mathematics in the learning of mathematics, offer a broader framework within which to continue the investigations initiated in the study reported in this dissertation. The work of Rosch (prototype and typicality features of categorization) and Lakoff (Dyirbalian categorization), Edelman (theory of neuronal group selection); and the recent research of Dehaene (evolutionary theory of mathematics), together with the

literature on cognitive psychology, sociocultural theories, and theories of distributed cognition offer a multi-dimensional framework in which perspectives can be developed which synthesize those aspects of each by which progress can be made.

Lakoff's description of the Dyirbal system of classification suggests that perhaps, just perhaps, students like SK categorize and organize their perceptions to form connections in ways that are as mysterious to the mathematician's ways of thinking and structuring knowledge as the Dyirbal classification system is to any Western-cultured person. Recent reports of neurological research on the brain and in the fields of categorization and perception offer fascinating evidence that suggests we need to enlarge our analytic and interpretive perspectives in order to progress in our efforts to understand students' processes of conceptual construction and the organization of the resulting cognitive structures.

The trade-off between access and understanding that comes from focusing on either tool-aided cognition or tool-unaided cognition, described by Pea [1993] needs to be examined objectively and dispassionately, so as opportunities for learner participation in higher level activities and meaningful contributions are not lost. As Pea points out,

We are still faced with the moral question of educational aims—whether they are to foster intelligence that is executed 'solo,' is tool-aided, or is collaborative, or in what combination for what content domains and activities. We are at a point in cultural history where these issues of tool-aided, socially shared cognition must be examined and debated on empirical grounds [Pea, 1993, p. 74].

It is within an expanding theoretical framework which considers these recent developments, that the question is asked: "What if students like SK are organizing their knowledge according to a classification scheme which is not recognized or understood?" There exists the possibility that some students have different ways of knowing—ways of perceiving, categorizing, constructing, organizing, and restructuring knowledge—which those of us engaged in the teaching and learning of mathematics are unfamiliar with and have failed to consider. It is within this framework that my own future research is planned. The conundrum of students like SK, who claim to want to connect new knowledge to old, yet appear unable to integrate new knowledge into existing structures, except in a very limited way, is still an unsolved problem.

Bibliography

- American Mathematical Association of Two-Year Colleges (1995). *Crossroads in Mathematics: Standards for Introductory College Mathematics Before Calculus*. Memphis, TN: AMATYC.
- Ausubel, D. P. (1968). *Educational Psychology: A Cognitive View*. New York: Holt, Rinehart & Winston.
- Ausubel, D., Novak, J., & Hanesian, H. (1978). *Educational Psychology: A Cognitive View, 2nd Edition*. New York, NY: Holt, Rinehart, and Winston.
- Backhouse, J. (1978). Understanding School Mathematics—A Comment. *Mathematical Teaching*. 82.
- Bakar, M. & Tall, D. O. (1991). Students' Mental Prototypes of Functions and Graphs. In Furinghetti, F. (Ed.), *Proceedings of the Fifteenth Conference of the International Group for the Psychology of Mathematics Education* Vol. 1. Genova, Italy. 104–111.
- Banister, P., Burman, E., Parker, I., Taylor, M., & Tindall, C. (1996). *Qualitative Methods in Psychology: A Research Guide*. Buckingham: Open University Press.
- Barnard, T. & Tall, D.O. (1997). Cognitive Units, Connections, and Mathematical Proof. In Pehkonen, E. (Ed.), *Proceedings of the 21st Annual Conference for the Psychology of Mathematics Education*, Vol 2. Lahti, Finland. pp. 41–48.
- Barsalou, L.W. (1983). "Ad hoc" Categories. *Memory and Cognition*, II, 3, 211–227.
- Beaton, A., Mullis, I., Martin, M., Gonzales, E., Kelly., D. and Smith., T. (1996). Mathematics Achievement in the Middle School Years: IEA's Third International Mathematics and Science Study (TIMMS). Chestnut Hill, MA: Boston College.
- Beth, E.W. & Piaget, J. (1966). *Mathematical Epistemology and Psychology*. (W. Mays, trans.) Reidel, Dordrecht (originally published 1965).
- Biggs, J. B. & Collis, K. F. (1982). *Evaluating the Quality of Learning: The SOLO Taxonomy*. New York, NY: Academic Press.
- Boers, M. A. M. & Jones, P. L. (1994). Student's Use of Graphics Calculators Under Exam Conditions. *International Journal of Mathematics Education in Science and Technology*.
- Borasi, R. (1994). Capitalizing of Errors as "Springboards for Inquiry": A Teaching Experiment. *Journal for Research in Mathematics Education*. 25, 2, 166–208.
- Breidenbach, D., Dubinsky, E., Hawks, J., & Nichols, D. (1992). Development of the Process Concept of Function. *Education Studies in Mathematics* 23 (3), 247–285.
- Bruner, J. (1990). *Acts of Meaning*. Cambridge, MA: Harvard University Press.
- Bruner, J. (1966a). *Towards a Theory of Instruction*. New York, NY: Norton.

-
- Bruner, J. (1996b). *The Culture of Education*. Cambridge, MA: Harvard University Press.
- Byers, V. & Herscovics, N. (1977). Understanding School Mathematics. *Mathematical Teaching*. 81.
- Changeux, J. (1985). *Neuronal Man: The Biology of Mind*. Princeton, NJ: Princeton University Press.
- Chi, M. (1978). Knowledge Structures and memory development. In Siegler, R. (Ed.). *Children's Thinking: What develops?* Hillsdale, NJ: Lawrence Erlbaum. 73–96.
- Clarke, D., Helme, S. and Kessel, C. (1996). *Studying Mathematics Learning in Classroom Settings: Moments in the Process of Coming to Know*. A paper presented at the National Council of Teachers of Mathematics Research Pre-session. San Diego, CA. April, 1996.
- Cliburn, J. (1990). Concept Maps to promote meaningful learning. *Journal of College Science Teaching*. Feb., 212–217.
- Cobb, P. (1997). Learning from Distributed Theories of Intelligence. In Pehkonen, E. (Ed.), *Proceedings of the 21st Annual Conference for the Psychology of Mathematics Education*, Lahti, Finland: Vol 2, 169–176.
- Cobb, P. (1994). (Ed.). *Learning Mathematics: Constructivist and Interactionist Theories of Mathematical Development*. Dordrecht, The Netherlands: Kluwer Academic Publishers.
- Cobb, P. and Bauersfeld, H. (1995). *The Emergence of Mathematical Meaning: Interaction in Classroom Cultures*. Hillsdale, NJ: Lawrence Erlbaum Associates, Publisher.
- Cobb, P. and Bauersfeld, H. (1995). The Coordination of Psychological and Sociological Perspectives in Mathematics Education. In Cobb, P. and Bauersfeld, H., *The Emergence of Mathematical Meaning: Interaction in Classroom Cultures*. Hillsdale, NJ: Lawrence Erlbaum Associates, Publisher. 1–16.
- Confrey, J. (1995). Student Voice in Examining Splitting as an Approach to Ratio, Proportions, and Fractions. In Miera, L. & Carraher, D. (Eds.), *Proceedings of the 19th Annual Conference for the Psychology of Mathematics Education*, Vol. 1. Recife, Brazil. 3–29.
- Confrey, J. (1993). The Role of Technology in Reconceptualizing Functions and Algebra. *Proceedings of the Fifteenth Annual Meeting North American Chapter of the International Group for the Psychology of Mathematics Education*. Vol. 1. 47–74.
- Confrey, J. (1992). Using Computers to Promote Students' Inventions on the Function Concept. In S. Malcolm, L. Roberts, and K. Sheingold (Eds.) *This Year in School Science 1991*. Washington, DC: American Association for the Advancement of Science. 141–174.

-
- Cottrill, J., Dubinsky, E., Nichols, D., Schwingendorf, K., Thomas, K., & Vidakovic, D. (1996). Understanding the Limit Concept: Beginning with a Coordinated Process Scheme. In Davis, R. (Ed.), *Journal of Mathematical Behavior* 15. 167–192.
- Crawford, K. (1997). Distributed Cognition, Technology, and Change: Themes for the Plenary Panel. In Pehkonen, E. (Ed.), *Proceedings of the 21st Conference of the International Group for the Psychology of Mathematics Education* Vol. 1. Lahti, Finland. 81–89.
- Crick, F. (1994). *The Astonishing Hypothesis*. London: Simon & Schuster.
- Cuoco, A., Goldenberg, E. O., & Mark, J. (1996). Habits of Mind: An Organizing Principle for Mathematics Curricula. In Davis, R. (Ed.), *The Journal of Mathematical Behavior*. 15(4). 375–402.
- Cuoco, A. (1995). Some Worries about Mathematics Education. *Mathematics Teacher*, Reston, VA: National Council of Teachers of Mathematics, Vol. 88, 3, 186–187.
- Cuoco, A. (1994). Multiple Representations of Functions. In Kaput, J. & Dubinsky, E. (Eds.), *Research Issues in Undergraduate Mathematics Learning*. Washington, DC: Mathematical Association of America. 121–140.
- Currie, C. (1993). *Teacher Use of Figurative Language in Algebra Classrooms: Three Case Studies*. Unpublished doctoral dissertation.
- Davis, R. B. (1997). personal communication.
- Davis, R. B. (1996a). Cognition, Mathematics, and Education. In Steffe, L.P., Nesher, P., Cobb, P., Goldin, G.A., & Greer, B. (1996). *Theories of Mathematical Learning*. NJ: Lawrence Erlbaum Associates, Publishers, 285–302.
- Davis, R. B. (1996b). One Very Complete View (Though only one) of How Children Learn Mathematics. A Review of David Geary's book: *Children's Mathematical Development: Research and Practical Applications*. *Journal of Research in Mathematics Education*. 27, 1, 100–106.
- Davis, R. B. (1996c). personal communication.
- Davis, R. B. (1993). What Algebra Do Students Need to Learn and How Should They Learn It? A paper presented at the NCTM Research Pre-session, Seattle, WA., March 30, 1993.
- Davis, R. B. (1992a). Understanding "Understanding". *Journal of Mathematical Behavior*. 11, 3. 225–241.
- Davis, R. B. (1992b). "Reflections on Where Mathematics Education Now Stands and on Where It May Be Going". D. Grouws (Ed.) *Handbook on Research in Mathematics Teaching and Learning*, New York: Macmillan, 724–732.
- Davis, R. B. (1989). Three Ways of Improving Cognitive Studies in Algebra. In Wagner, S. & Kieran, C. (Eds.), *Research Issues in the Learning and Teaching of Algebra*. National Council of Teachers of Mathematics and Lawrence Erlbaum Associates. 115–119.

-
- Davis, R. B. (1986). Conceptual and Procedural Knowledge in Mathematics: A Summary Analysis. In Hiebert, J. (Ed.) *Conceptual and Procedural Knowledge: The Case of Mathematics*. Hillsdale, NJ: Erlbaum. 265–300.
- Davis, Robert B. (1984). *Learning Mathematics: The Cognitive Science Approach to Mathematics Education*. London: Croom Helm Ltd.
- Davis, R. B. (1975). Cognitive Processes Involved in Solving Simple Algebraic Equations. *Journal of Children's Mathematical Behavior* 1 (3). 7–35.
- Davis, R.B., Maher, C. A. & Noddings, N. (Eds.) (1990). Constructivist Views on the Teaching and Learning of Mathematics. *Journal for Research in Mathematics Education Monograph No. 4*. Hillsdale, NJ: Lawrence Erlbaum Publishers.
- Dehaene, S. (1997). *The Number Sense: How the Mind Creates Mathematics*. New York, NY: Oxford University Press.
- Demana, F., Schoen, H. L., & Waits, B. (1993). Graphing in the K–12 Curriculum: The Impact of the Graphing Calculator. In Romberg, T. A., Fennema, E., & Carpenter, T. P. (Eds.), *Integrating Research on the Graphical Representation of Functions*. Hillsdale, NJ: Lawrence Erlbaum Associates. 41–68.
- DeMarois, P. & McGowen, M. (1996). Understanding of Function Notation by College Students in a Reform Developmental Algebra Curriculum. In Jakubowski, E., Watkins, D., & Biske, H. (Eds.), *Proceedings of the Eighteenth Annual Meeting of the North American Chapter of the International Group for the Psychology of Mathematics Education*. Vol. 1. Panama City, Florida. 183–188.
- DeMarois, McGowen, and Whitkanack. (1996). *Applying Algebraic Thinking to Data: Concepts and Processes for the Intermediate Algebra Student*. Glenview, IL: HarperCollins College Publishers.
- Dickinson, Emily. “Bring Me the Sunset in a Cup” (1950). In Louis Untermeyer (Editor). *Combined Edition of Modern American Poetry and Modern British Poetry*. New York: Harcourt, Brace and Company, Inc. 99.
- Dienes, Z. (1960). *Building Up Mathematics*. London: Hutchinson Educational.
- Dörfler, W. Is the Metaphor of Mental Object Appropriate for a Theory of Learning Mathematics? In Steffe, L., Neshier, P., Cobb, P., Goldin, G.A., & Greer, B. (1996). *Theories of Mathematical Learning*. Mahwah, NJ: Lawrence Erlbaum Associates, Publishers. 467–476.
- Dreyfus, T. & Vinner, S. (1989). Images and Definitions for the Concept of Function. *Journal for Research in Mathematics Education* 20. 356–366.
- Dreyfus, T. and S. Vinner (1982). Some aspects of the function concept in college students and junior high school teachers. *Proceedings of the Sixth International Conference for the Psychology of Mathematics Education*. Antwerp: 12–17.
- Dubinsky, E. & Harel, G. (1992). The Nature of the Process Conception of Function. In Harel, G. & Dubinsky, E., *The Concept of Function Aspects of Epistemology and Pedagogy*. Washington, DC: Mathematical Association of America. 85–106.

-
- Dubinsky, E., Schoenfeld, A., & Kaput, J. (1996). *Research In Collegiate Mathematics Education. II*. Providence, RI: American Mathematical Society.
- Dubinsky, E., Schoenfeld, A., & Kaput, J. (1994). *Research In Collegiate Mathematics Education. I*. Providence, RI: American Mathematical Society.
- Dubinsky, E. (1991). Reflective Abstraction. In Tall, D. O. (Ed). *Advanced Mathematical Thinking*. Dordrecht, The Netherlands: Kluwer Academic Publishers. 95–126.
- Dubrovina, I. V. (1992a). The Nature of Abilities in the Primary School Child. In Kilpatrick, J. & Wirszup, I. (Eds.). *Soviet Studies in the Psychology of Learning and Teaching Mathematics*. Chicago, IL: University of Chicago Press. VIII, 65–96.
- Dubrovina, I. V. (1992b). A Study of Mathematical Abilities in Children in the Primary Grades. In Kilpatrick, J. & Wirszup, I. (Eds.). *Soviet Studies in the Psychology of Learning and Teaching Mathematics*. Chicago, IL: University of Chicago Press. VIII, 3–64.
- Dugdale, S. (1993). Functions and Graphs—Perspectives on Student Thinking. In Romberg, T. A., Fennema, E., & Carpenter, T. P. (Eds.), *Integrating Research on the Graphical Representation of Functions*. Hillsdale, NJ: Lawrence Erlbaum Associates. 101–130.
- Edelman, G. (1992). *Bright Air, Brilliant Fire: On the Matter of the Mind*. New York, NY: Basic Books, A Division of Harper Collins Publishers.
- Eisenberg, T. & Dreyfus, T. (1994). On Understanding How Students Learn to Visualize Function Transformations. In Dubinsky, E., Schoenfeld, A., & Kaput, J. (Eds.), *Research In Collegiate Mathematics Education. I*. Providence, R.I.: American Mathematical Society. 45–68.
- Ernest, P. (1996). Varieties of Constructivism: A Framework for Comparison. In Steffe, L.P., Neshet, P., Cobb, P., Goldin, G.A., & Greer, B. *Theories of Mathematical Learning*. Mahwah, NJ: Lawrence Erlbaum Associates, Publishers, 335–350.
- Fey, J. T., Heid, M. K., Good, R., Sheets, C., Blume, G., & Zbiek, R. M. (1991). *Computer-Intensive Algebra*. College Park, MD: The University of Maryland and The Pennsylvania State University.
- Fey, J. T., Heid, M. K., Good, R., Sheets, C., Blume, G., & Zbiek, R. M. (1995). *Concepts in Algebra: A Technological Approach*. Dedham, MA: Janson.
- Ferrini-Mundy, J. & Graham, K. (1991). *Research in Calculus Learning: Understanding of Limits, Derivatives, and Integrals*. Paper presented at the Joint Mathematics Meeting, Special Session on Research in Undergraduate Mathematics Education, January, 1991. San Francisco. CA.
- Frid, S. (1994). Three Approaches to Undergraduate Calculus Instruction: Their Nature and Potential Impact on Students' Language Use and Sources of Conviction. In Dubinsky, E., Schoenfeld, A., & Kaput, J. (Eds.), *Research In Collegiate Mathematics Education. I*. Providence, RI: American Mathematical Society. 69–100.

-
- Frost, Robert (1995). *The Road Not Taken*. In *Collected Poems, Prose, & Plays*. New York: Literary Classics of the United States, Inc. 103.
- Garcia, R. & Piaget, J. (1989). *Psychogenesis and the History of Science*. New York: Columbia University Press.
- Geeslin, W.E. & Shavelson, R. (1975). Comparison of content structure and cognitive structure in high school students' learning of probability. *Journal for Research in Mathematics Education*, 6, 109–120.
- Geary, D. (1996). Chapter 6 in Sternberg, R.J & Ben-Zeev (Eds.). *The Nature of Mathematical Thinking*. Mahwah, NJ: Lawrence Erlbaum Associates, Publishers.
- Goldenberg, E. P. (1991). The Difference Between Graphing Software and Educational Graphing Software. In Zimmerman, W & Cunningham, S. (Eds.). *Visualization in Teaching and Learning Mathematics* MAA Notes Number 19. Washington, DC: Mathematical Association of America. 77–86.
- Goldenberg, P. (1988). Mathematics, Metaphors, and Human Factors: Mathematical, Technical, and Pedagogical Challenges in the Educational Use of Graphical Representations of Functions. *Journal of Mathematical Behavior*, 7(2). 135–173.
- Goldenberg, P. (1987). Believing is seeing: How Preconceptions Influence the Perception of Graphs. In Bergeron, J, Kieran, C, & Herscovics, N (Eds.), *Proceedings of the 11th Annual Meeting of the PME-NA* (Vol 1). University of Montreal. 197–203.
- Goldenberg, P., Lewis, P., & O'Keefe, J. (1992). Dynamic Representation and the Development of a Process Understanding of Function. In Harel, G & Dubinsky, E. (Eds.), *The Concept of Function Aspects of Epistemology and Pedagogy*. Washington, DC: Mathematical Association of America. 235–260.
- Goldin, G. (1996). Theory of Mathematics Education. In Steffe, L.P., Nesher, P., Cobb, P., Goldin, G.A., & Greer, B. *Theories of Mathematical Learning*. Mahwah, NJ: Lawrence Erlbaum Associates, Publishers, 303–306.
- Goldin, G.A. & Kaput, J. (1996). A Joint Perspective on the Idea of Representation in Learning and Doing Mathematics. In Steffe, L.P., Nesher, P., Cobb, P., Goldin, G.A., & Greer, B. (1996). *Theories of Mathematical Learning*. Mahwah, NJ: Lawrence Erlbaum Associates, Publishers, 397–430.
- Gonzales, E. G. & Kohlers, P.S. (1982). Mental Manipulation of arithmetic symbols. *Journal of Experimental Psychology. Learning, memory and cognition*, 8. 308–319.
- Gray, E. M. (1991). An Analysis of Diverging Approaches to Simple Arithmetic: Preferences and Its Consequences. *Educational Studies in Mathematics* 22, 551–574.
- Gray, E.M. & Tall, D. O. (1994). Duality, Ambiguity, and Flexibility: A “Proceptual” View of Simple Arithmetic. In *Journal for Research in Mathematics Education*, 25, 2, 116–140.

-
- Gray, E. M. & Tall, D. O. (1993). Success and Failure in Mathematics: The Flexible Meaning of Symbols as Process and Concept. *Mathematics Teaching*, 142, 6–10.
- Gray, E.M. & Tall, D. O. (1992). Mathematical Processes and Symbols in the Mind. In Z. A. Karian (Ed.). *Symbolic Computation in Undergraduate Mathematics Education*. MAA Notes 24, 57-68.
- Gray, E. M. & Tall, D. O. (1991a). *Success and Failure in Mathematics: Procept and Procedure: A Primary Perspective*. Mathematics Education Research Centre. University of Warwick.
- Gray, E. M. & Tall, D. O. (1991b). Duality, Ambiguity and Flexibility in Successful Mathematical Thinking. *Proceedings of the XV International Conference for the Psychology of Mathematics Education*, Assisi: Vol. 2, 72–79.
- Gray, E. M. & Tall, D. O. (1991c). *Success and Failure in Mathematics: Procept and Procedure: Secondary Mathematics*. University of Warwick: Mathematics Education Research Centre.
- Gray, E., Pitta, D. and Tall, D. (1997). Objects, actions, and images: A Perspective on early number development. In Pehkonen, E. (Ed.), *Proceedings of the 21st Annual Conference for the Psychology of Mathematics Education*, Vol. 1. Lahti, Finland.
- Greeno, J. G. (1988). *Situations, Mental Models, and Generative Knowledge* (Report No. IRL 88–0005). Palo Alto: Institute for Research in Learning.
- Greeno, J.G. (1983). Conceptual entities. In Genter & Stevens (Eds.), *Mental Models*, 227–252.
- Greeno, J.G. (1978). A study of problem solving. In Glaser, R. (Ed.). *Advances in instructional psychology*. Hillsdale, NJ: Erlbaum. Vol. 1, 13–75.
- Greer, B. (1996). Theories of mathematics education: The role of cognitive analyses. In Steffe, L.P., Neshier, P., Cobb, P., Goldin, G.A., & Greer, B. (1996). *Theories of Mathematical Learning*. Mahwah, NJ: Lawrence Erlbaum Associates, Publishers, 179–198.
- Grouws, Douglas A. (1992). *Handbook of Research on Mathematics Teaching and Learning*. New York: Macmillan Publishing Company.
- Harel, G & Dubinsky, E. (1992). *The Concept of Function Aspects of Epistemology and Pedagogy*. Washington, DC: Mathematical Association of America.
- Hatano, G. (1996). A conception of knowledge acquisition and its implications for mathematics education. In Steffe, L.P., Neshier, P., Cobb, P., Goldin, G.A., & Greer, B. (1996). *Theories of Mathematical Learning*. Mahwah, NJ: Lawrence Erlbaum Associates, Publishers, 197–218.
- Heid M.K. (1988a). *The Impact of Computing on School Algebra: Two Case Studies Using Graphical, Numeric, and Symbolic Tools*. Paper presented to the theme group on Microcomputers and the Teaching of Mathematics at the Sixth International Congress on Mathematics Education, Budapest, Hungary.

-
- Heid M.K. (1988b). Resequencing skills and concepts in applied calculus using the computer as a tool, *Journal for Research in Mathematics Education* 19: 1. 3–25.
- Herscovics, Nicholas. (1989). Cognitive obstacles encountered in the learning of algebra. In C. Kieran, and S. Wagner (Eds.), *Research Agenda for Mathematics Education: Research Issues in the Learning and Teaching of Algebra*. Reston, VA: NCTM. Hillsdale, NJ: Lawrence Erlbaum Publishers. 60–86.
- Hiebert, James and Thomas P. Carpenter (1992). Learning and Teaching with Understanding. D. Grouws (Ed.) *Handbook on Research in Mathematics Teaching and Learning*, New York. Macmillan. 65–97.
- Hiebert, J. & Lefevre, P. (1986). Procedural and Conceptual Knowledge. In Hiebert, J. (Ed.), *Conceptual and Procedural Knowledge: The Case of Mathematics*. Hillsdale, NJ: Erlbaum. 1–27.
- Hillel, Joel; Lee, Lesley; Laborde, Collete and Linchevski, Liora (1992). Basic Functions Through the Lens of Computer Algebra Systems. *Journal of Mathematical Behavior*, 11. 119–158.
- Hintzman, D.L. (1988) Judgements of frequency and recognition memory in a multiple-trace memory model. *Psychological Review*. 95, 528–551.
- Inagaki, K., & Sugiyama, K. (1988). Attributing human characteristics: Developmental changes in over- and underattribution. *Cognitive Development*. 3, 55–70.
- Janvier, C. (1978). *Problems of Representation in the Teaching and Learning of Mathematics*. Hillsdale: NJ: Lawrence Erlbaum Associates.
- Janvier, C. (1987). Representation and Understanding: The Notion of Function as an Example. In Janvier, C. (Ed.), *Problems of Representation in the Teaching and Learning of Mathematics*. Hillsdale: NJ: Lawrence Erlbaum Associates. 67–72.
- Jones, P. L. (1994). Realizing the Educational Potential of the Graphics Calculator. In Lum, L. (Ed.). *Proceedings of the Sixth Annual International Conference on Technology in Collegiate Mathematics*. Massachusetts: Addison Wesley Publishing Company. 212–217.
- Kaput, J. (1995). A Research Base Supporting Long Term Algebra Reform? In Owens, D. T., Reed, M. K., & Millsaps, G. M. (Eds.) *Proceedings of the Seventeenth Annual Meeting of the North American Chapter of the International Group for the Psychology of Mathematics Education* (Volume 1). 71–94.
- Kaput, J. & Dubinsky, E. (1994). *Research Issues in Undergraduate Mathematics Learning*. Washington, DC: Mathematical Association of America.
- Kaput, J. (1993). The Urgent Need for Proleptic Research in the Representation of Quantitative Relationships. In Romberg, T. A., Fennema, E., & Carpenter, T. P. (Eds.), *Integrating Research on the Graphical Representation of Functions*. Hillsdale, NJ: Lawrence Erlbaum Associates. 279–312.

-
- Kaput, J. (1992a). Patterns in Students' Formalizations of Quantitative Patterns. In Harel, G & Dubinsky, E. (Eds.), *The Concept of Function Aspects of Epistemology and Pedagogy*. Washington, DC: Mathematical Association of America. 290–317.
- Kaput, J. (1992b). Technology and mathematics education. In D. Grouws (Ed.). *Handbook on Research in Mathematics Teaching and Learning*, New York: Macmillan. 515–556.
- Kaput, J. (1989). Linking representations in the symbol systems of algebra. In C. Kieran, and S. Wagner (Eds.). *Research Agenda for Mathematics Education: Research Issues in the Learning and Teaching of Algebra*. Hillsdale, NJ: Lawrence Erlbaum Publishers. 167–194.
- Keller, B. A. & Hirsch, C. R. (1994). Student Preferences for Representations of Functions. In Lum, L. (Ed) *Proceedings of the Fifth Annual International Conference on Technology in Collegiate Mathematics*. Reading, Mass: Addison-Wesley Publishing Company. 178–190.
- Kieran, C. (1993). Functions, Graphing, and Technology: Integrating Research on Learning and Instruction. In Romberg, T. A., Fennema, E., & Carpenter, T. P. (Eds.), *Integrating Research on the Graphical Representation of Functions*. Hillsdale, NJ: Lawrence Erlbaum Associates. 189–237.
- Kieran, Carolyn. (1992). The learning and teaching of school algebra. In D. Grouws (Ed.). *Handbook on Research in Mathematics Teaching and Learning*, New York: Macmillan. 390–419.
- Kieran, C. (1983). Relationships Between Novices' Views of Algebraic Letters and their Use of Symmetric and Asymmetric Equation-Solving Procedures. In Bergeron, J. C. & Herscovics, N. (Eds.) *Proceedings of the Fifth Annual Meeting of PME-NA*, Vol 1. Montreal, Canada. University of Montreal. 161–168.
- Kosslyn, S. (1994). *Image and Brain: The Resolution of the Imagery Debate*. Cambridge, MA: MIT Press.
- Kosslyn, S. (1980). *Image and Mind*. Cambridge, MA: Harvard University Press.
- Krutetskii, V. A. (1976). *The Psychology of Mathematical Abilities in Schoolchildren*. Kilpatrick, J. & Wirszup, I. (Eds.). (Teller, J. Jr.). Chicago, IL: University of Chicago Press.
- Krutetskii, V.A. (1969a). Mathematical Aptitudes. In Kilpatrick, J. & Wirszup, I. (Eds.). *Soviet Studies in the Psychology of Learning and Teaching Mathematics*. Chicago, IL: University of Chicago Press. II, 113–128.
- Krutetskii, V.A. (1969b). An Experimental Analysis of Pupils' Mathematical Abilities. In Kilpatrick, J. & Wirszup, I. (Eds.). *Soviet Studies in the Psychology of Learning and Teaching Mathematics*. Chicago, IL: University of Chicago Press. II, 105–112.
- Krutetskii, V.A. (1969c). An Analysis of the Individual Structure of Mathematical Abilities in Schoolchildren. In Kilpatrick, J. & Wirszup, I. (Eds.). *Soviet Studies in the Psychology of Learning and Teaching Mathematics*. Chicago, IL: University of Chicago Press. II, 59–104.

-
- Krutetskii, V.A. (1969d). An Investigation of Mathematical Abilities in Schoolchildren. In Kilpatrick, J. & Wirszup, I. (Eds.). *Soviet Studies in the Psychology of Learning and Teaching Mathematics*. Chicago, IL: University of Chicago Press. II, 5–57.
- Kuchemann, D.E. (1981). Algebra. In Hart, K. (Ed.), *Children's Understanding of Mathematics*. 11, 16, 102–119.
- Labov, W. (1973). The boundaries of words and their meanings. In Bailey, C.J. and Shuy, R. (eds.). *New Ways of Analyzing Variations in English*. Washington, DC: Georgetown University Press.
- Lacampagne, C., Blair, W., & Kaput, J. (Eds.) (1995). *The Algebra Initiative Colloquium*. Washington, DC: U. S. Department of Education.
- Lakoff, G. (1987). *Women, Fire and Dangerous Things: What Categories Reveal About the Mind*. Chicago, IL: The University of Chicago Press.
- Lambiotte, J. & Dansereau, D. (1991). Effects of knowledge maps and prior knowledge on recall of science lecture content. *Journal of Experimental Education*. 60, 3, 189–201.
- Lanier, P. (1997). Assessment in the Service of Instruction. A paper presented at the annual meeting of the National Council of Supervisors of Mathematics. St. Paul, MN.
- Laturno, J. (1994). The Validity of Concept Maps as a Research Tool in Remedial College Mathematics. In Kirshner, D. (Ed.) *Proceedings of the Sixteenth Annual Meeting of the North American Chapter of the International Group for the Psychology of Mathematics Education* Volume 2. 60–66.
- Lave, J. (1988). *Cognition in Practice*. Cambridge, England: Cambridge University Press.
- Leinhardt, G. & Smith, D.A. (1985). Expertise in mathematics instruction: Subject matter knowledge. *Journal of Educational Psychology*. 77, 247–271.
- Loftsgaarden, Don O., Rung, Donald C. and Watkins, Ann E. (1997). *Statistical Abstract of Undergraduate Programs in the Mathematical Sciences in the United States: Fall 1995 CBMS Survey*, Mathematical Association of America, MAA Reports No. 2.
- Martinez-Cruz, Armando (1995). Graph, Equation, and Unique Correspondence: Three Models of Students' Thinking about Functions in a Technology-Enhanced Pre-Calculus Class. In Owens, D. T., Reed, M. K., & Millsaps, G. M. (Eds.), *Proceedings of the Seventeenth Annual Meeting of the North American Chapter of the International Group for the Psychology of Mathematics Education* Vol. 1. 277–283.
- Markovitz, Z., Eylon, B., & Bruckheimer, M. (1988). Difficulties Students have with the Function Concept. In Coxford, A. F. & Shulte, P. (Eds.) *The Ideas of Algebra*, 1988 Yearbook. Reston, VA: NCTM.43–60.
- Markovitz, Z., Eylon, B., & Bruckheimer, M. (1986). Functions Today and Yesterday. *For the Learning of Mathematics* 6(2). 18–24.

-
- Markovitz, Z., Eylon, B., & Bruckheimer, M. (1983). Functions: Linearity Unconstrained. In *Proceedings of the Seventh Conference of the International Group for the Psychology of Mathematics Education*. Rehovot, Israel: Weizmann Institute, Department of Science Teaching. 271–277.
- Mason, J. (1997). Describing the Elephant: Seeking Structure in Mathematical Thinking: A Review of the Nature of Mathematical Thinking. *Journal for Research in Mathematics Education*. 28, 3, 377–382.
- Mason, J. (1996). Invoking Children's Powers of Mathematical Thinking. Draft notes of a paper, Invoking Powers, Early Algebra Working Group communication.
- Mason, J. (1994). Enquiry in Mathematics and in Mathematics Education. In Ernest, P (Ed.). *Constructing Mathematical Knowledge: Epistemology and Mathematics Education*. London: Falmer Press. 190–200.
- McGowen, M. and Bennett, C. (1996). Renegotiating the Unwritten Social Contract: Implementation of a Reform Algebra Curriculum. A paper presented at the International Congress of Mathematics Education, Seville, Spain.
- McGowen, M., DeMarois, P. and Bennett, C. (1994). *Restructuring the Developmental Algebra Curriculum: A Problem-Centered Lab Approach*. A paper presented at the annual meeting of the British Society for Research in the Learning of Mathematics.
- Minsky, M. (1975). A Framework for Representing Knowledge. In Winston, P. (Ed.). *The Psychology of Computer Vision*. New York, NY: McGraw-Hill.
- Monk, G. S. (1992). Students' Understanding of a Function Given by a Physical Model. In Harel, G & Dubinsky, E. (Eds.), *The Concept of Function Aspects of Epistemology and Pedagogy*. Washington, DC: Mathematical Association of America. 175–193.
- Monk, G.S. (1989). *A Framework for Describing Student Understanding of Functions*. A paper presented at the AERA annual meeting, San Francisco, CA.
- Moschkovich, J., Schoenfeld, A. H., & Arcavi, A. (1993). Aspects of Understanding: On Multiple Perspectives and Representations of Linear Relations and Connections Among Them. In Romberg, T. A., Fennema, E., & Carpenter, T. P. (Eds.), *Integrating Research on the Graphical Representation of Functions*. Hillsdale, NJ: Lawrence Erlbaum Associates. 69–100.
- Moreira, M.A. (1979). Concept Maps as tools for teaching. *Journal of College Science Teaching*. May. 283–286.
- Morse, J. M. (1994). *Critical Issues in Qualitative Research Methods*. New York: Sage Publications, 23–65.
- National Council of Teachers of Mathematics. (in press). *A Framework for Constructing a Vision of Algebra*.
- National Council of Teachers of Mathematics (1989). *Curriculum and Evaluation Standards for School Mathematics*. Reston, VA. NCTM.
- National Council of Teachers of Mathematics (1991). *Professional Standards for the Teaching of School Mathematics*. Reston, VA: NCTM.

-
- National Research Council (1996). *Mathematics and Science Education Around the World: What Can We Learn from the Survey of Mathematics and Science Opportunities (SMSO) and the Third International Mathematics and Science Study (TIMSS)?* Washington, DC: National Academy Press.
- National Research Council (1991). *Moving Beyond Myths: Revitalizing Undergraduate Mathematics*. Washington DC: National Academy Press.
- National Research Council (1989). *Everybody Counts: A Report to the Nation on the Future of Mathematics Education* (summary). Washington D.C: National Academy Press.
- National Center for Education Statistics (NCES) (1997). *Findings From Education and the Economy: An Indicators Report*, Washington, DC: U.S. Government Printing Office, <http://nces.ed.gov/pubs97/97939.html>.
- Norman, F. A. & Prichard, M. K. (1994). Cognitive Obstacles to the Learning of Calculus: A Krutetskiian Perspective. In Kaput, J. & Dubinsky, E. (Eds.), *Research Issues in Undergraduate Mathematics Learning*. Washington, DC: Mathematical Association of America. 65–77.
- Novak, J. (1990). “Concept Mapping: A Useful Tool for Science Education.” *Journal of Research in Science Teaching*. 27, 10, 937–949.
- Novak, J. (1985). Metalearning and metaknowledge strategies to help students learn how to learn. *Cognitive Structure and Conceptual Change*. West, L. & Pines, L. (Editors). Orlando, FL: Academic Press. 189–209.
- Novak, J. D. & Gowin, D. B. (1984). *Learning How to Learn*. New York: Cambridge University Press.
- Novak, J. (1981). Applying learning psychology and philosophy of science to biology teaching. *The American Biology Teacher*. 43, 1, 12–20.
- Papert, S. & Turkle, S. (1992). Epistemological Pluralism and the Revaluation of the Concrete. *Journal of Mathematical Behavior*. 11, 2–33.
- Park, K. & Travers, K. (1996). A Comparative Study of a Computer-Based and a Standard College First-Year Calculus Course. In Dubinsky, E., Schoenfeld, A., & Kaput, J. (1994). *Research In Collegiate Mathematics Education. II*. Providence, RI: American Mathematical Society. 155–176.
- Pea, R. (1993). Practices of distributed intelligence and designs for education. In Salomon, G. (Ed.) (1993). *Distributed Cognitions*. New York, NY: Cambridge University Press. 47–87.
- Piaget, J. (1970). *The Principles of Genetic Epistemology*. New York, NY: Columbia University Press.
- Piaget, J. & Inhelder, B. (1969). *The Psychology of the Child*. New York, NY: Basic Books.
- Piaget, J. (1950). *The psychology of intelligence*. New York, NY: Harcourt Bruce.

-
- Pirie, S. & Kieren, T. (1994). Growth in Mathematical Understanding: How Can We Characterize It and How Can We Represent It? In Cobb, P. (Ed.). *Learning Mathematics: Constructivist and Interactionist Theories of Mathematical Development*. Dordrecht, The Netherlands: Kluwer Academic Publishers. 61–86.
- Quillan, M.R. (1968). Semantic Memory: In Minsky, M. (Ed.), *Semantic information processing*. Cambridge, MA: MIT Press. 227–270.
- Romberg, T. & Spence, M. (1995). Some Thoughts on Algebra for the Evolving Work Force. In Lacampagne, C., Blair, W., & Kaput, J. (Eds.), *The Algebraic Initiative Colloquium*. Washington, DC: U. S. Department of Education.
- Romberg, T., Fennema, E., Carpenter, T. (1993a). (Eds.). *Integrating Research on the Graphical Representation of Functions*. Hillsdale, NJ: Lawrence Erlbaum Associates, Publishers.
- Romberg, T., Fennema, E., Carpenter, T. (1993b). Towards a Common Perspective. In Romberg, T., Fennema, E., Carpenter, T. (Eds.). *Integrating Research on the Graphical Representation of Functions*. Hillsdale, NJ: Lawrence Erlbaum Associates, Publishers. 1–9.
- Rosch, E. (1975). Cognitive representations of semantic categories. *Journal of Experimental Psychology: General*. 104, 3, 192–233.
- Rosch, E. (1973). On the internal structure of perceptual and semantic categories. In Moore, T.E. (ed.) *Cognitive Development and the Acquisition of Language*. New York, NY: Academic Press.
- Rosch, E., Mervis, C.B., Gray, W.D., Johnson, D.M., and Boyes-Barem, P. (1976). Basic objects in natural categories. *Cognitive Psychology*. 8, 382–439.
- Roth, I. & Bruce, V. (1995). *Perception and Representation: Current Issues* (2nd Edition). Buckingham, England: Open University Press.
- Rumelhart, D.E. & Norman, D.A. (1985). Representation of knowledge. In Aitkenhead, A.M. and Slack, J.M. (Eds.). *Issues in Cognitive Modeling*. Hillsdale, NJ: Lawrence Erlbaum Associates.
- Rumelhart, D.E. & Norman, D.A. (1981). Analogical Processes in learning. In Anderson, J.R. (Ed.). *Cognitive skills and their acquisition*. Hillsdale, NJ: Lawrence Erlbaum Associates, Publishers. 335–359.
- Rumelhart, D.E. & Norman, D.A. (1978). Accretion, tuning and restructuring: Three modes of Learning. In Cotton, J.W. & Klatzky (Eds.). *Semantic factors in cognition*. Hillsdale, NJ: Lawrence Erlbaum Associates, Publishers. 37–54.
- Salomon, G. (Ed.) (1993). *Distributed Cognitions*. New York, NY: Cambridge University Press.
- Salomon, G. (1993). No distribution without individuals' cognition: a dynamic interactional view. In Salomon, G. (Ed.) (1993). *Distributed Cognitions*. New York, NY: Cambridge University Press. 111–138.
- Salomon, G, Perkins, D.N., & Globerson, T. (1991). Partners in Cognition: Human Intelligence with Intelligent Technologies. *Educational Researcher* 20: 3, 2–9.

-
- Sfard, A. (1995). The Development of Algebra: Confronting Historical and Psychological Perspectives. In Davis, R. (Ed.), *Journal of Mathematical Behavior* 14. 15–39.
- Sfard, A. & Linchevski, L. (1994). The Gains and Pitfalls of Reification—The Case of Algebra. *Educational Studies in Mathematics* 26. 191–228.
- Sfard, A. (1992). Operational Origins of Mathematical Objects and the Quandary of Reification—The Case of Function. In Harel, G & Dubinsky, E. (Eds.), *The Concept of Function Aspects of Epistemology and Pedagogy*. Washington, DC: Mathematical Association of America. 59–84.
- Sfard, A. (1991). On the Dual Nature of Mathematical Conceptions: Reflections on Processes and Objects as Different Sides of the Same Coin. *Educational Studies in Mathematics* 22(1). 1–36.
- Shapiro, S. I. (1992). A Psychological Analysis of the Structure of Mathematical Abilities in Grades 9 and 10. In Kilpatrick, J. & Wirszup, I. (Eds.). *Soviet Studies in the Psychology of Learning and Teaching Mathematics*. Chicago, IL: University of Chicago Press. VIII, 97–142.
- Sierpinska, A. (1994). *Understanding in Mathematics*. London: The Falmer Press.
- Sierpinska, A. (1992). On Understanding the Notion of Function. In Harel, G & Dubinsky, E. (Eds.), *The Concept of Function Aspects of Epistemology and Pedagogy*. Washington, DC: Mathematical Association of America. 25–58.
- Skemp, R. (1987). *The Psychology of Learning Mathematics Expanded American Edition*. Hillsdale, NJ: Lawrence Erlbaum & Associates, Publishers.
- Skemp, R. (1979). *Intelligence, Learning, and Action*. New York: John Wiley & Sons.
- Skemp, R. (1976) “Relational Understanding and Instrumental Understanding.” *Mathematics Teaching*. 77, 20–26.
- Skemp, R. (1971). *The Psychology of Learning Mathematics*. Middlesex, England: Penguin Books, Ltd.
- Smith, E.E. & Medin, D.L. (1981). *Categories and Concepts*. Cambridge, MA: Harvard University Press.
- Steffe, L. (1995). Alternative Epistemologies: An Educator’s Perspective. In Steffe, L. & Gale, J. (Eds.). *Constructivism in Education*. Hillsdale, NJ: Lawrence Erlbaum Associates, Publishers. 489–523.
- Steffe, L. and Cobb, P. (1988). *Construction of Arithmetical Meanings and Strategies*. New York: Springer Verlag.
- Steffe, L. & Gale, J. (1995).(Eds.) *Constructivism in Education*. Hillsdale, NJ: Lawrence Erlbaum Associates, Publishers.
- Steffe, L., Neshet, P., Cobb, P., Goldin, G.A., & Greer, B. (1996).(Eds.) *Theories of Mathematical Learning*. Mahwah, NJ: Lawrence Erlbaum Associates, Publishers.
- Steffe, L., von Glaserfeld, E., Richards, J., & Cobb, P. (1983). *Children’s counting types: Philosophy, theory, and application*. New York, NY: Praeger.

-
- Steffe, L. & Wiegel, H. (1996). On the Nature of a Model of Mathematical Learning. In Steffe, L.P., Nesher, P., Cobb, P., Goldin, G.A., & Greer, B. *Theories of Mathematical Learning*. Mahwah, NJ: Lawrence Erlbaum Associates, Publishers, 477–498.
- Tall, D.O. (1996). Information Technology and Mathematics Education: Enthusiasms, Possibilities and Realities. *Proceedings of International Congress on Mathematics Education 8*. Seville, Spain. (in press).
- Tall, D.O. (in preparation). Biological Brain and Mathematical Mind.
- Tall, D. O. (1995). Cognitive Growth in Elementary and Advanced Mathematical Thinking. *Proceedings of the International Conference for the Psychology of Mathematics Education*. Recife, Brazil: I. 161–175.
- Tall, D.O. (1994). Understanding the Processes of Advanced Mathematical Thinking. An invited ICMI lecture at the International Congress of Mathematicians, Zurich, Switzerland.
- Tall, D.O. (1993). Real Mathematics, Rational Computers, and Complex People. In Lum, L., *Proceedings of the Fifth International Conference on Technology in College Mathematics*. Reading, MA: Addison Wesley. 243–258.
- Tall, D. O. (1992a). Mathematical Processes and Symbols in the Mind. In Z. A. Karian (Ed.), *Symbolic Computation in Undergraduate Mathematics Education*. MAA Notes 24. Mathematical Association of America. 57–68.
- Tall, D.O. (1992b). The Transition to Advanced Mathematical Thinking: Functions, Limits, Infinity, and Proof. In Grouws, D. A. (Ed.) *Handbook of Research on Mathematics Teaching and Learning*. New York: Macmillan Publishing Company. 495–511.
- Tall, D.O. (1991a). The Psychology of Advanced Mathematical Thinking. In Tall, D. O. (Ed.), *Advanced Mathematical Thinking*. Dordrecht, The Netherlands: Kluwer Academic Publishers. 3–21.
- Tall, D.O. (1991b). Reflections. In Tall, D. O. (Ed.), *Advanced Mathematical Thinking*. Dordrecht, The Netherlands: Kluwer Academic Publishers. 251–259.
- Tall, D. O. (1991c). Intuition and Rigor: The Role of Visualization in Calculus. In Zimmermann, W & Cunningham, S. (Eds.). *Visualization in Teaching and Learning Mathematics* MAA Notes Number 19. Washington, DC: Mathematical Association of America. 105–119.
- Tall, D. O. (1989b). Concept Images, Generic Organizers, Computers, and Curriculum Change. *For the Learning of Mathematics* 9(3). 37–42.
- Tall, D.O. (1977) Cognitive Conflict and the Learning of Mathematics. In the *Proceedings of the First Conference of the International Group for the Psychology of Mathematics Education*. Utrecht, Netherlands.
- Tall, D.O. & Bakar, M. (1992). Students' Mental Prototypes for Functions and Graphs. *International Journal of Math, Education, Science, and Technology* 23 (1). 39–50.

-
- Tall, D.O. and Razali, M. R. (1993). Diagnosing Students' Difficulties in Learning Mathematics. *International Journal for Math, Education, Science & Technology* 24 (2). 202–209.
- Tall, D.O. & Thomas, M. (1989). Versatile Learning and the Computer. *Focus* 11(2). 117–125.
- Tall, D. O. & Vinner, S. (1981). Concept image and concept definition in mathematics, with special reference to limits and continuity. *Educational Studies in Mathematics*. 12. 151–169.
- Thompson, P.W. (1996). Imagery and the Development of Mathematical Reasoning. In Steffe, L.P., Neshet, P., Cobb, P., Goldin, G.A., & Greer, B. (1996). *Theories of Mathematical Learning*. Mahwah, NJ: Lawrence Erlbaum Associates, Publishers, 267–284.
- Thompson, P.W. (1995). Constructivism, Cybernetics, and Information Processing: Implications for Technologies of Research on Learning. In *Constructivism in Education*. Hillsdale, NJ: Lawrence Erlbaum Associates, Publishers. 123–134.
- Thompson, P. W. (1994a). Students, Functions, and the Undergraduate Curriculum. In Dubinsky, Schoenfeld and Kaput, (Eds.). *Research in Collegiate Mathematics Education. I*. CBMS Issues in Mathematics Education. Vol. 4. 21–44.
- Thompson, P.W. (1994b). Images of Rate and Operational Understanding of the Fundamental Theorem of Calculus. In Cobb, P. (Ed.). *Learning Mathematics: Constructivist and Interactionist Theories of Mathematical Development*. Dordrecht, The Netherlands: Kluwer Academic Publishers. 61–86.
- Turkle, S. & Papert, S. (1992). Epistemological Pluralism and the Reevaluation of the Concrete. *Journal of Mathematical Behavior* 11. pp. 3–33.
- U.S. Department of Labor, Bureau of Labor Statistics. 1997. *Occupational Outlook Handbook*, Washington, DC: U.S. Government Printing Office, <http://stats.bls.gov:80/oco2003.htm>.
- Vinner, S. (1997). From Intuition to Inhibition—Mathematics, Education and other Endangered Species. In Pehkonen, E. (Ed.), *Proceedings of the 21st Annual Conference for the Psychology of Mathematics Education*, Vol I. Lahti, Finland. 63–78.
- Vinner, S. (1992). The Function Concept as a Prototype for Problems in Mathematics Learning. In Harel, G & Dubinsky, E. (Eds.), *The Concept of Function Aspects of Epistemology and Pedagogy*. Washington, DC: Mathematical Association of America. 195–213.
- Vinner, S. & Dreyfus, T. (1989). Images and Definitions for the Concept of Function. *Journal for Research in Mathematics Education* 20: 4. 356–366.
- von Glaserfeld, E. (1996). Aspects of Radical Constructivism and its Educational Recommendations. In Steffe, L., Neshet, P., Cobb, P., Goldin, G.A., & Greer, B. (Eds.) *Theories of Mathematical Learning*. Mahwah, NJ: Lawrence Erlbaum Associates, Publishers. 307–314.

-
- von Glaserfeld, E. (1995). Sensory Experience, Abstraction, and Teaching. In *Constructivism in Education*. Hillsdale, NJ: Lawrence Erlbaum Associates, Publishers. 369–384.
- von Glaserfeld, E. (1991). Abstraction, Representation, and Reflection: An Interpretation of Experience and Piaget's Approach. In Steffe, L. P. (Ed.), *Epistemological Foundations of Mathematical Experience*. New York: Springer-Verlag. 45–65.
- von Glaserfeld, E. (1989). Constructivism in Education. In Husen, T. & Postlethwaite, N. (Eds.). *International encyclopedia of education* [Suppl.]. Oxford, England: Pergamon. 11–12.
- Vygotsky, L.S. (1978). *Mind in society: The development of higher psychological processes*. Cambridge, Ma: Harvard University Press.
- Wallace, J.D., Mintzes, J.J. & Markham, K.M. (1992). Concept mapping in college science teaching—What research says. *Journal of College Science Teaching*. Nov., 84–86.
- Watkins, A. et al. 1993. A Survey of Two-Year College Mathematics Programs: The Boom Continues. *The AMATYC Review*. Spring, 1993. 14: 2, 57.
- Whitehead, A. N. (1957). *Aims of Education*. (reprint of 1932 Edition). New York: Harcourt Brace. 10.
- Wilcox, S. & Lanier, P. (1997). *Integrating Assessment and Instruction: Using Cases in Professional Development* (in press).
- Williams, S. R. (1993). Some Common Themes and Uncommon Directions. In Romberg, T. A., Fennema, E., & Carpenter, T. P. (Eds.), *Integrating Research on the Graphical Representation of Functions*. Hillsdale, NJ: Lawrence Erlbaum Associates. 313–337.
- Wolfe, R. & Lopez, A. (1993). Structured overviews for teaching science concepts and terms. *Journal of Reading*. 36, 4, 315–317.

A.1 Terms and Definitions

accommodation: a modification of a conceptual structure in response to a perturbation which is necessary for cognitive development to occur.

assimilation: the integration of any sort of reality into a structure.

automatic skill: skill with understanding, characterized by adaptability and a well-connected schema.

collage: an artistic composition of materials and objects pasted over a surface, often with unifying lines and colour.

category: a specifically defined division in a system of classification.

catalyst: one that precipitates a process or event without being involved in or changed by the consequences.

cognitive collage: a metaphorical characterization of a conceptual framework of cognitive structures which includes complex networks of schemas, concept images, and cognitive units, flexibly linked together by highly individual paths, with varying hierarchical levels, degrees of compression, and flexibility.

cognitive unit: those bits and pieces of knowledge chunked together that can be held in the focus of attention (i.e., held in working memory), which act as the cues for retrieval and selection of the schema which determine subsequent actions or those facets of a concept image needed for the task at hand.

concept image: everything associated with the concept name, including mental images, properties, processes, contexts of applications.

concept maps: external visual re-presentations of a student's internal conceptual structures at a given moment in time that is explanatory of the process of constructing new knowledge structures and reorganizing existing knowledge structures.

distributed intelligence: resources in the world are used, or come together in use, to shape and direct possible active emerging from desire.

epistemology: a theory of the nature, genesis, and warranting of subjective knowledge, including a theory of individual learning

external representation: of a concept map is an observable representation of the student's internal cognitive collage at a given moment in time.

intelligence: the ability to learn in a particular way; a kind of learning that results in the ability to achieve goal states in a wide variety of conditions, and by a wide variety of plans.

intelligent technologies: those which undertake significant cognitive processing on behalf of the user and thus is a partner in distributed intelligence.

interiority of a concept: the richness of the various concepts in a network of cognitive structures and the complexity of appropriate linkages among them.

internal representation refers to possible mental configurations of individuals, such as learners.

methodology: a theory of which methods and techniques are appropriate and valid to use to generate and justify knowledge, given the epistemology.

mechanical skill: rote-learned habit with little or no adaptability and few linkages in the existing schema.

ontology: a theory of existence concerning the status of the world and what populates it.

pedagogy: a theory of teaching—the means to facilitate learning according to the epistemology

prior variables: attitudes, beliefs and competencies they bring to the current course.

procept: symbolism that inherently represents the amalgam of process/concept ambiguity.

proceptual divide: a bifurcation of strategy between flexible thinking and procedural thinking which distinguishes more successful students from those less successful—the divergence in performance that is a result of a failure to think proceptually.

procedure: a specific algorithm for carrying out a process.

process: the cognitive representation of a mathematical operation.

representation: a something that stands for something else, a kind of model of the thing represented.

schema: a very stable, refined cognitive collage. It can be a cognitive unit or a concept image which has been carefully shaped and refined with use into an effective tool for organizing and retrieving stored knowledge and can also be used to organize and assimilate new knowledge into an existing cognitive structure

skill: the combination of having a plan, and being able to put it into action. Sources of the plans that form the basis of skills include schemas, genetically-programmed plans of actions and plans of action learned as habits. In the case of the latter two, plan and action are fused and contain a small cognitive element, with useful, effective skills in a particular situation or under certain conditions, but they are inflexible, lacking adaptability.

understanding: connected knowledge, i.e., a process by which one assimilates something into an appropriate schema.

B.1 Pre- Course Self-Evaluation Survey

1. About how often did you attend your previous mathematics class?

less than 1	1-3	3-5	5-7	more than 7
1	2	3	4	5

2. IN ADDITION TO the time spent in class, about how many hours PER WEEK did you spend on homework outside of class for previous math classes?

less than 1	1-3	3-5	5-7	more than 7
1	2	3	4	5

3. How would you rate your ability to interpret mathematical notation and symbols at the BEGINNING OF THE SEMESTER?

very poor	somewhat poor	fair	somewhat good	very good
1	2	3	4	5

4. How would you rate your ability to interpret and analyze data at the BEGINNING OF THE SEMESTER?

very poor	somewhat poor	fair	somewhat good	very good
1	2	3	4	5

5. How would you rate your willingness to attempt to solve a problem you have never seen before at the BEGINNING OF THE SEMESTER?

very poor	somewhat poor	fair	somewhat good	very good
1	2	3	4	5

6. How would you rate your ability to solve a problem you have never seen before at the BEGINNING OF THE SEMESTER?

very poor	somewhat poor	fair	somewhat good	very good
1	2	3	4	5

7. Do you feel that the use of the graphing calculator helps, hurts, or does not affect your understanding of mathematical concepts and ideas?

hurt considerably	hurt somewhat	did not affect	helped somewhat	helped considerably
1	2	3	4	5

B.2 Post-Course Self-Evaluation Survey

1. About how often did you attend this mathematics class?

less than 1	1-3	3-5	5-7	more than 7
1	2	3	4	5

2. IN ADDITION TO the time spent in class, about how many hours PER WEEK did you spend on homework outside of class for this mathematics classes?

less than 1	1-3	3-5	5-7	more than 7
1	2	3	4	5

3. To what degree do you think this course has improved your ability to interpret mathematical notation and symbols?

not at all	a little	somewhat	a good bit	very much
1	2	3	4	5

4. To what degree do you think this course has improved your ability to interpret and analyze data?

not at all	a little	somewhat	a good bit	very much
1	2	3	4	5

5. To what degree do you think this course has improved your willingness to attempt to solve a problem you have never seen before?

not at	all a little	somewhat	a good bit	very much
1	2	3	4	5

6. To what degree do you think this course has improved your ability to solve a problem you have never seen before?

not at all	a little	somewhat	a good bit	very	much
1	2	3	4		5

7. Do you feel that the use of the graphing calculator helped, hurt, or did not affect your understanding of mathematical concepts and ideas?

hurt	hurt	did not	helped	helped
considerably	somewhat	affect	somewhat	considerably
1	2	3	4	5

B.3 Pre- and Post-Course Questionnaire

1. Evaluate -3^2
What first comes to mind:
2. Evaluate: $37 - 5 \div 2 + 4 \times 3$
What first comes to mind:
3. Evaluate $(-3)^2$
What first comes to mind:
4. Given a function f , what does $f(x)$ represent?
What first comes to mind:
5. In the expression $(x - c)$, is the value of c positive, negative or neither?
What comes to mind:
6. Given $f(x) = x^2 - 5x + 3$, find $f(-3)$.
What comes to mind:
7. Given $f(x) = x^2 - 5x + 3$, find $f(t-2)$.
What comes to mind:

Given the graph

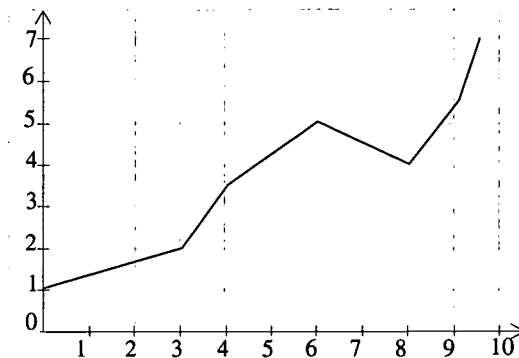

8. Indicate what $y(8) =$ _____
What comes to mind:
9. If $y(x) = 2$, what is x ?
What comes to mind:

Consider the following tables for functions f and g :

x	$f(x)$
1	3
2	-1
3	1
4	0
5	-2

x	$g(x)$
-2	3
-1	1
0	5
1	2
2	4

10. What is the value of $f(g(1))$? Why?
What comes to mind:

11. What is the value of $g(f(5))$? Why?
What comes to mind:

12. Write the equation of the linear function given either its table or graph.
What comes to mind:

X	Y1
-6	15
-3	9
0	3
3	-3
6	-9
12	-21

X=-6

```

WINDOW
Xmin=-3
Xmax=6
Xscl=1
Ymin=-4
Ymax=10
Yscl=2
Xres=1
    
```

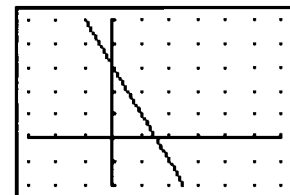

13. Given a function f , what is the meaning of $-f(x)$?
What first comes to mind:

(Post-test only)

14. Given a function f , what is the meaning of $f(-x)$?
What first comes to mind:

(Post-test only)

15. The graph of a quadratic function appears below. (Post-test only)

```

WINDOW
Xmin=-9.4
Xmax=9.4
Xscl=1
Ymin=-25
Ymax=20
Yscl=5
Xres=1
    
```

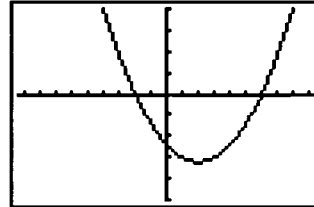

a. What are the zeros of this function?

What comes to mind:

b. What are the factors of this function?

What comes to mind:

c. Write the algebraic representation of this function.

What comes to mind:

16. Consider the following graphs for functions f and g . The graph of f is the line. The graph of g is the parabola. Approximate the value of $g(f(1))$. Describe how you determined your answer. (Post-test only)

```

WINDOW FORMAT
Xmin=-6
Xmax=6
Xscl=1
Ymin=-5
Ymax=10
Yscl=1
    
```

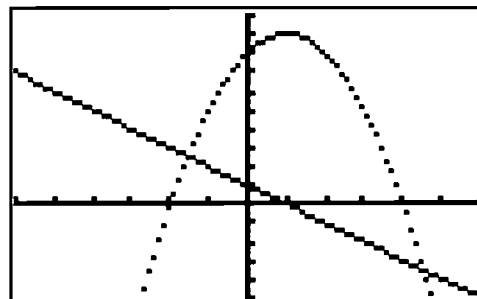

What comes to mind:

B.4 Demographic Survey: Student Information

You are participating in a field study of curriculum materials designed to improve mathematical understanding through the use of group learning and technology. Your complete answers will help us evaluate the effectiveness of these materials. *Your answers will in no way affect your grade for this course.* Results are strictly confidential. Thank you for your cooperation.

Instructor _____ I.D.# _____

Institution _____ I.D.# _____

Institution type _____ Two-year _____ Four-year

Term Semester: _____ Fall, 1995 _____ Spring, 1996

Quarter: _____ Fall, 1995 _____ Winter, 95/96 _____ Spr, 1996

DAREC Course Code _____ 001 (Introductory Algebra) _____ 002 (Intermediate Algebra)

Course Title _____

Student Name _____

Social Security Number _____ - _____ - _____

Sex _____ Male _____ Female

Age _____ 17-20 _____ 21-25 _____ 26-30 _____ 30-35 _____ over 35

Major (if known), otherwise write Unknown _____

Student status: _____ Full-time (12 or more hours) _____ Part-time

Hours enrolled this term:

_____ 1-5 hr _____ 6 - 11 hrs _____ 12-15 hr _____ more than 15

Hours worked on outside job per week (on average):

_____ 0-5 hr _____ 6 - 11 hrs _____ 12-15 hr _____ more than 15

When did you take your last math course?

_____ last term _____ 1-5 years ago _____ more than 5 years ago

As an algebra student I believe that I am:

_____ Excellent _____ Good _____ Fair _____ Disastrous

Indicate the kind of calculator(s) you have used previously **in school** (Check all that apply):

_____ Never used a calculator

_____ Four function (add, subtract, multiply, divide, square root)

_____ Scientific (powers, trig functions, log and statistics functions)

_____ Graphing (indicate: TI-81, TI-82, TI-85, Casio 7700, HP 28 or HP 48G)

Indicate the kind of calculator(s) used previously **outside of school** (Check all that apply):

_____ Never used a calculator

_____ Four function (add, subtract, multiply, divide, square root)

_____ Scientific (powers, trig functions, log and statistics functions)

_____ Graphing (indicate: TI-81, TI-82, TI-85, Casio 7700, HP 28 or HP 48G)

Appendix C *Student Concept Maps and Schematic Diagrams*

C.1 Concept Maps

Purpose

Concepts maps are used to

- organize and reflect on the content learned.
- provide a tool for self-assessment and review.
- visualize and make explicit the connections between various concepts.
- record the development of richer understandings built on previously learned content.

Definition: Concept maps are a visual language for integrating thinking, learning, teaching, and assessment.

A concept map provides a visual picture of a whole topic or concept and shows how different ideas and/or processes are related to the main topic.

Students create concept maps by following a trail of thoughts from an initial idea and mapping these thoughts out on paper.

The concept map requires that students think about specific connections in their knowledge of a concept.

Students use concept maps

- to visualize connections between newly-acquired knowledge and previously-learned content.
- to organize and reflect on the content learned.
- for review.

The process of creating a concept map helps the student

- recall details.
- identify main points of topics discussed.

C.2 Creating a Concept Map

- On a piece of paper, write down the main topic of the concept map, then list all of the words that you associate with that topic. Concepts, procedures, your feelings about the topic, previous knowledge and other representations such as function machines, graphs and/or tables can also be included on your list.
- Think in terms of making an outline, with a Main Idea, supporting ideas, and details. Making your list of concepts and procedures is kind of like making an outline of a book you've been assigned in English class.

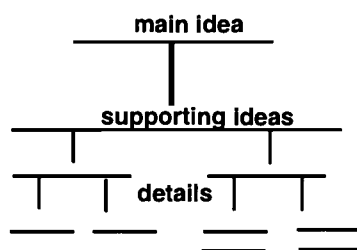

- Working from your list, use a highlighter and identify what you think are the most important supporting ideas for your topic. Under each of your main sub-groups, identify those words, representations, and procedures you associate with each of your main supporting categories.
- After you have finished analyzing your list, write each word on a separate post-it.
- Post the main topic in the middle of a piece of paper. Arrange the post-it for each key word or idea you've listed around the main topic.
- Near each key word, arrange post-it notes with the words, representations, and procedures you associate with that key word. Writing the words on post-it notes allows you to rearrange the words so that you can indicate the connections among words in that group and between words in other groups that you see as related.
- Build from the main topic in a way that makes sense to you.
- When you've posted and arranged all of your words, draw in the linkages and connections between words and between groups of words. Use arrows to indicate the direction of each link. Wherever possible, write in the relationship along the connecting link.
- Sometimes, you have a word that you connect with more than one key word. Arrange your key words so that the shared connecting word is located between them so you can draw connections to both key words.
- Be creative and personalize your map.

Figure C. 1. MC(S2): Concept Map Week 4 and Week 9

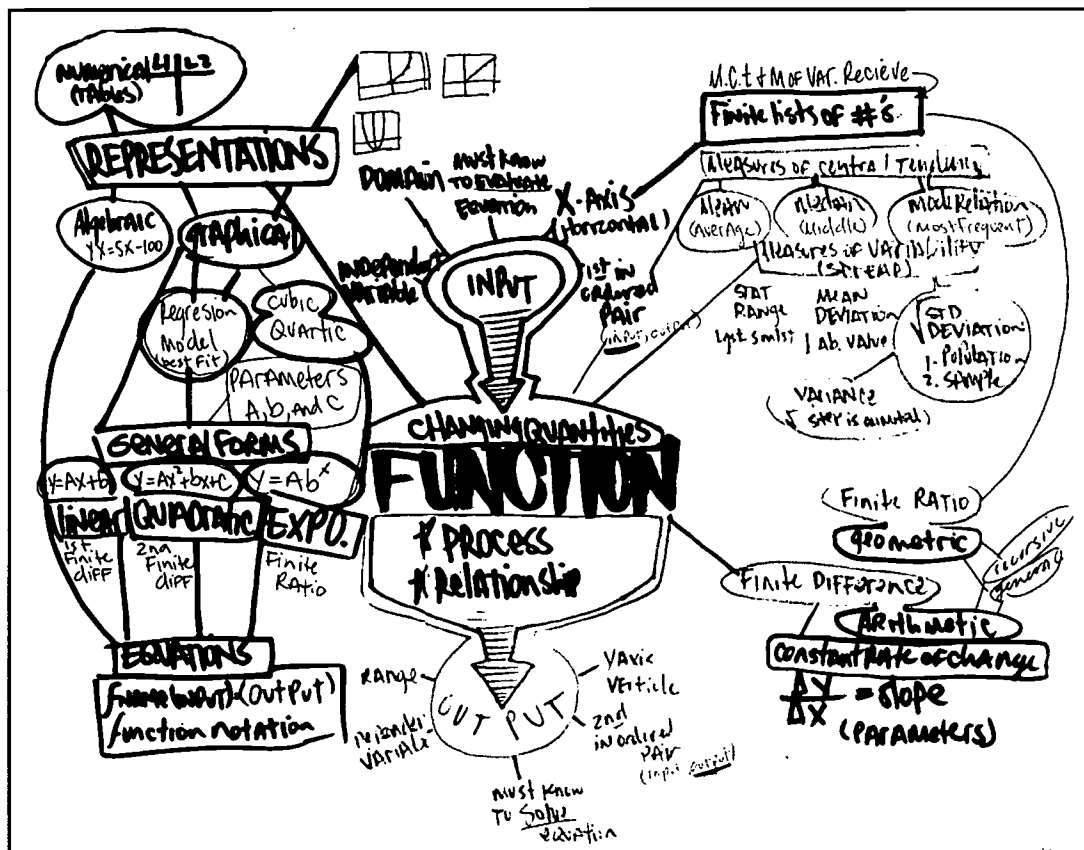
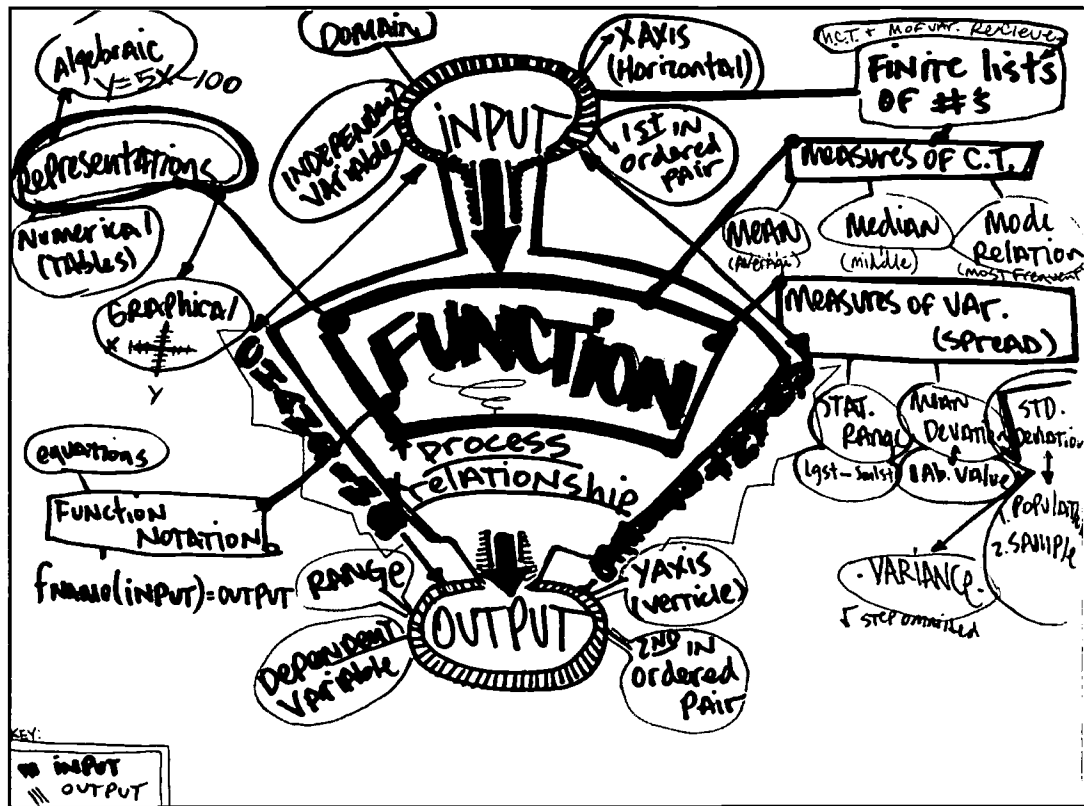

Figure C. 2. MC(S2): Preliminary Notes: Concept Map Week 15

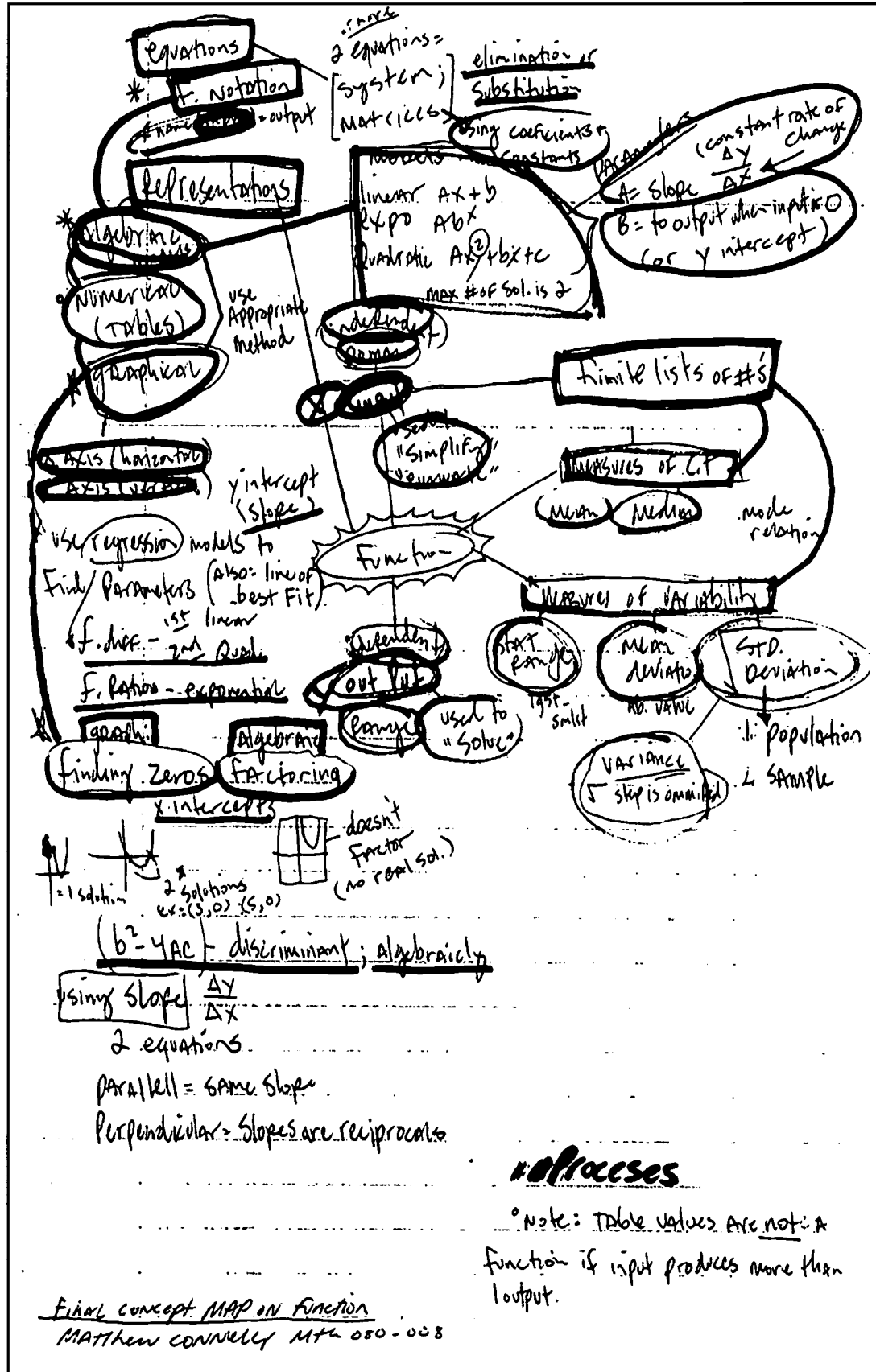

FIGURE C.3. MC (S2): Schematic Diagrams of Weeks 4, 9, & 15 Concept Maps

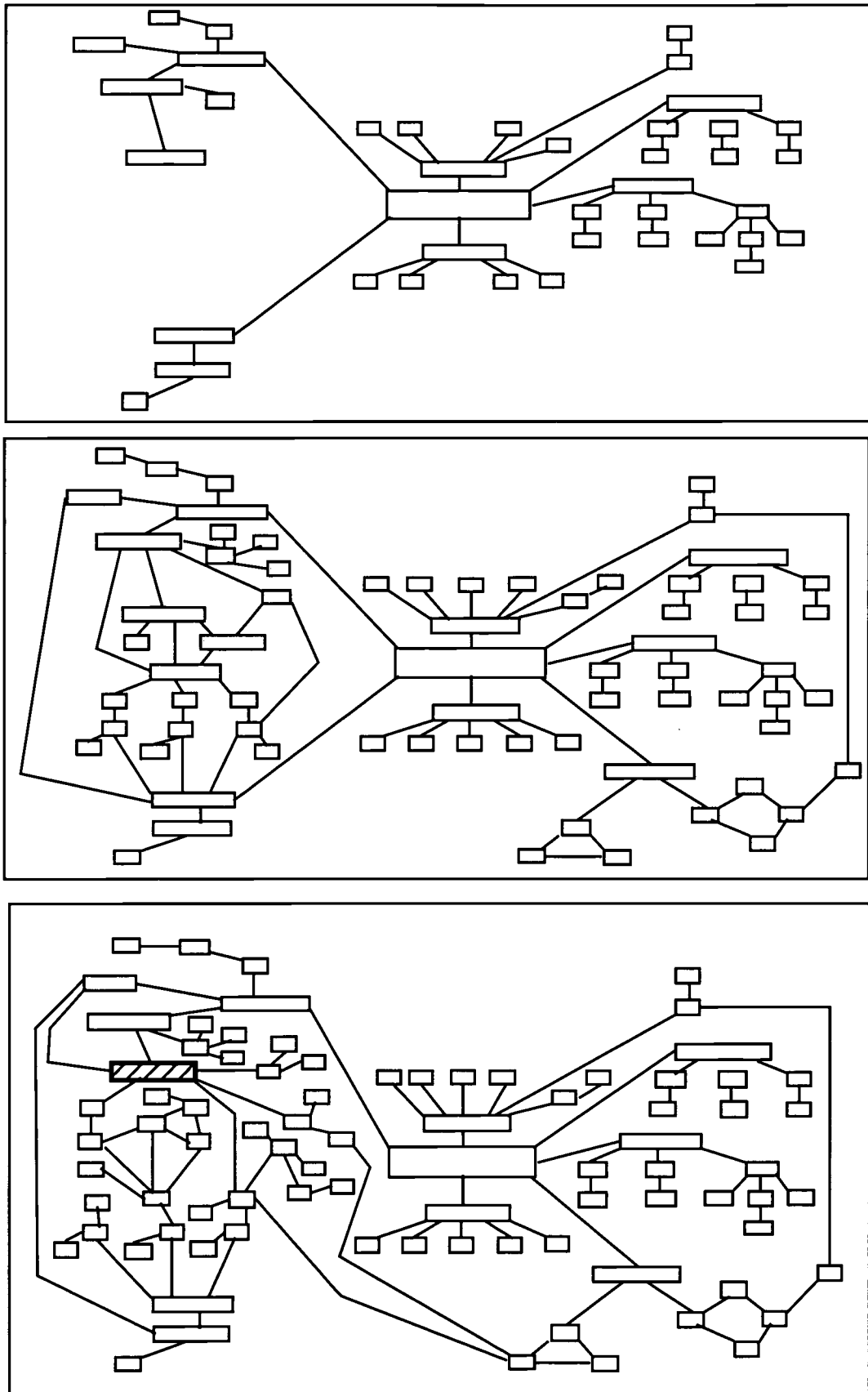

FIGURE C.1. SK (S23) Concept Maps Weeks 4, 9, and 15

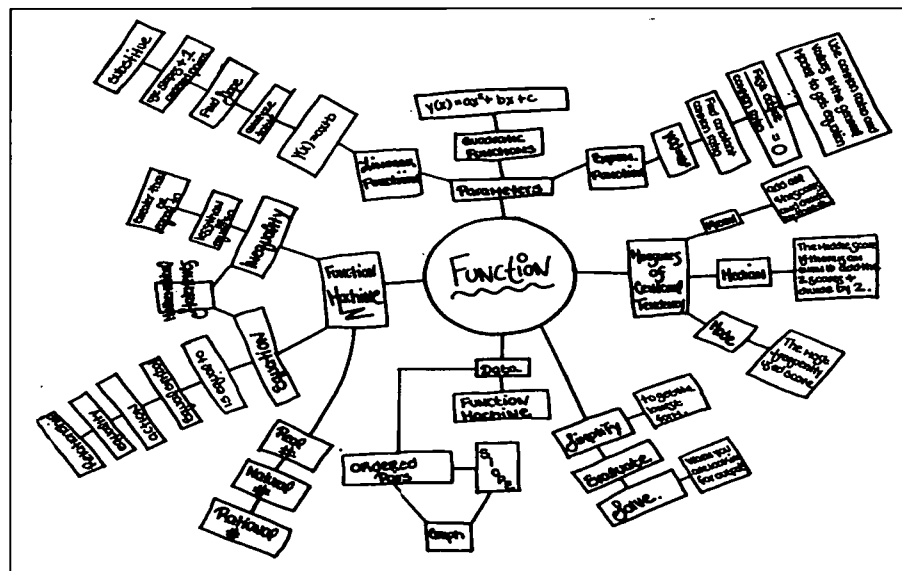
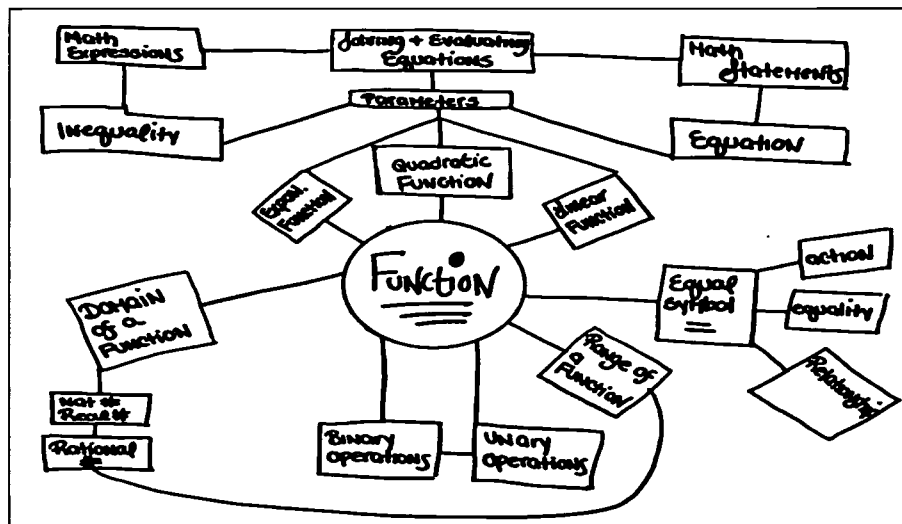
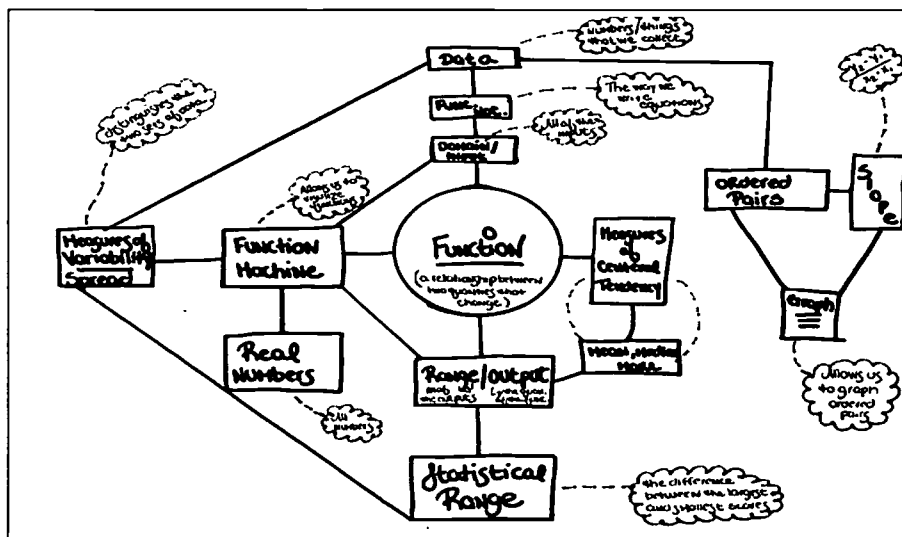

FIGURE C.2. SK (S23): Schematic Diagrams of Weeks 4, 9, & 15 Concept Maps

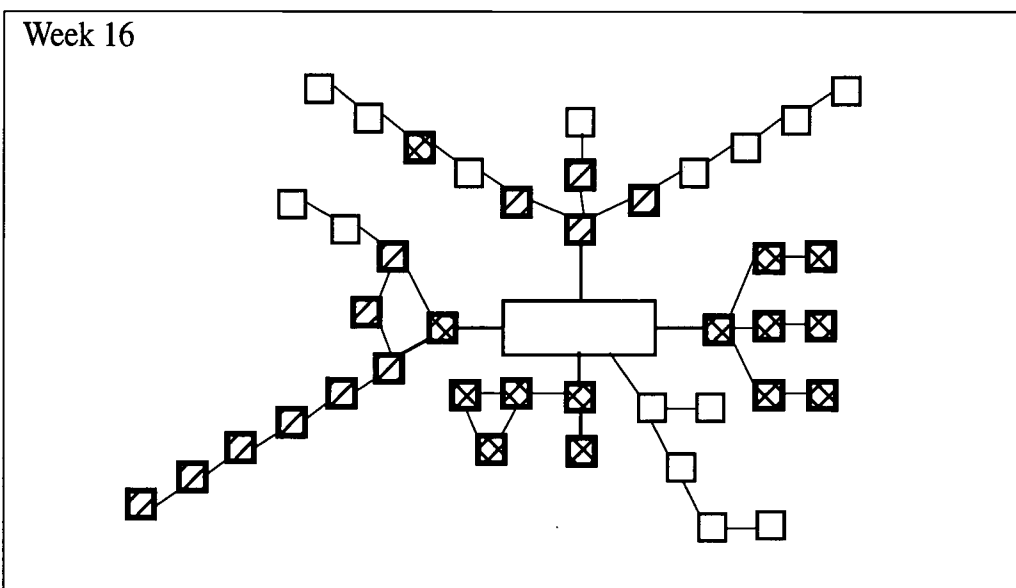
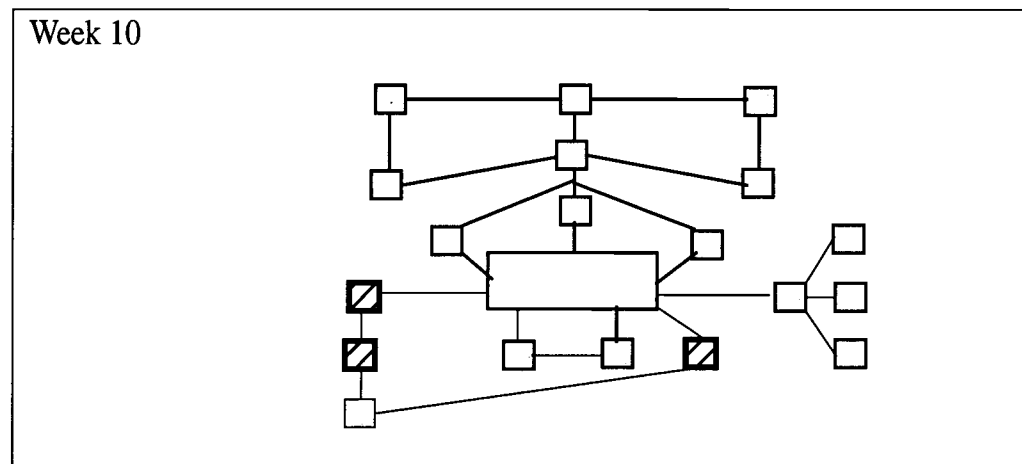
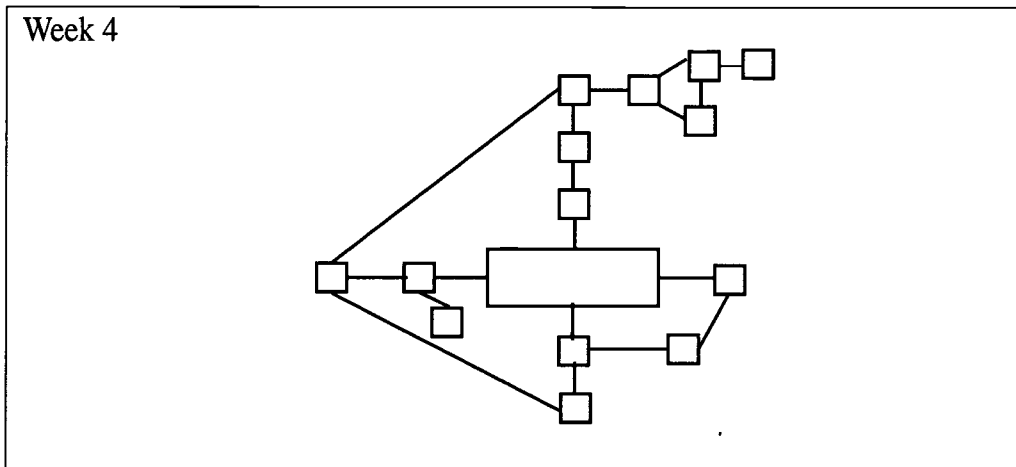

FIGURE C.3. TP (S1) Concept Maps Weeks 4, 9, and 15

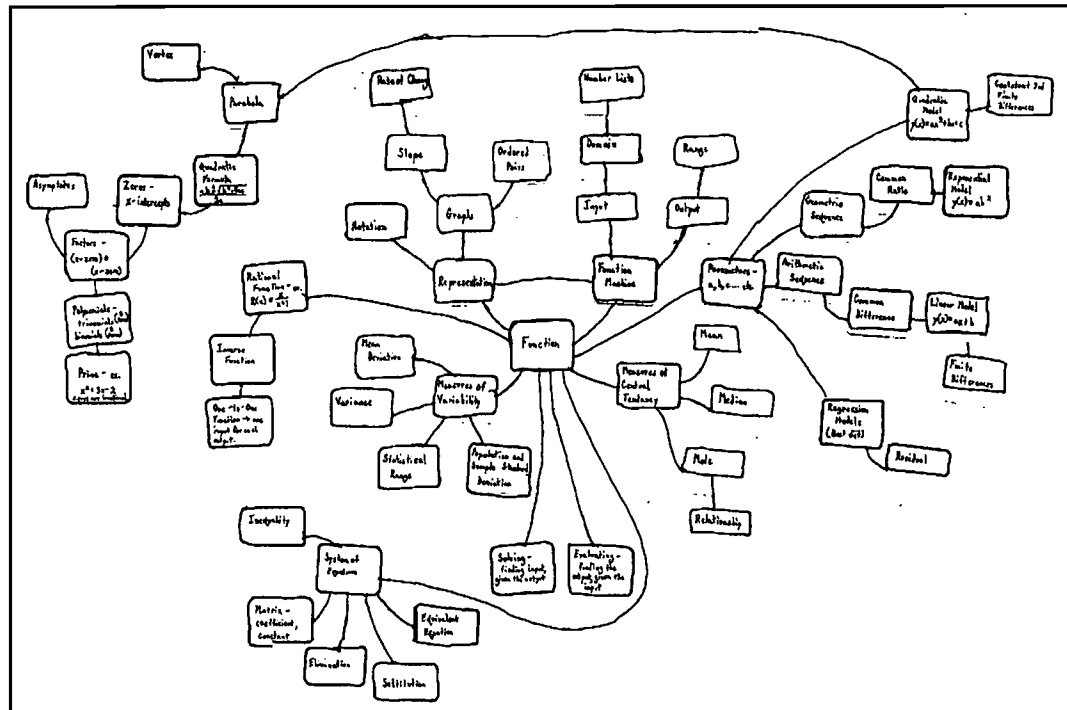
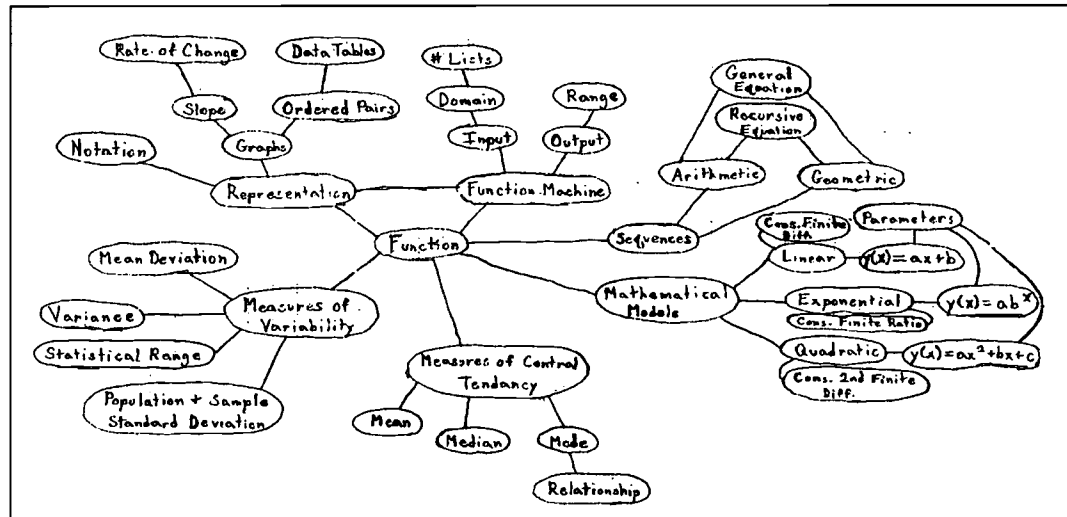
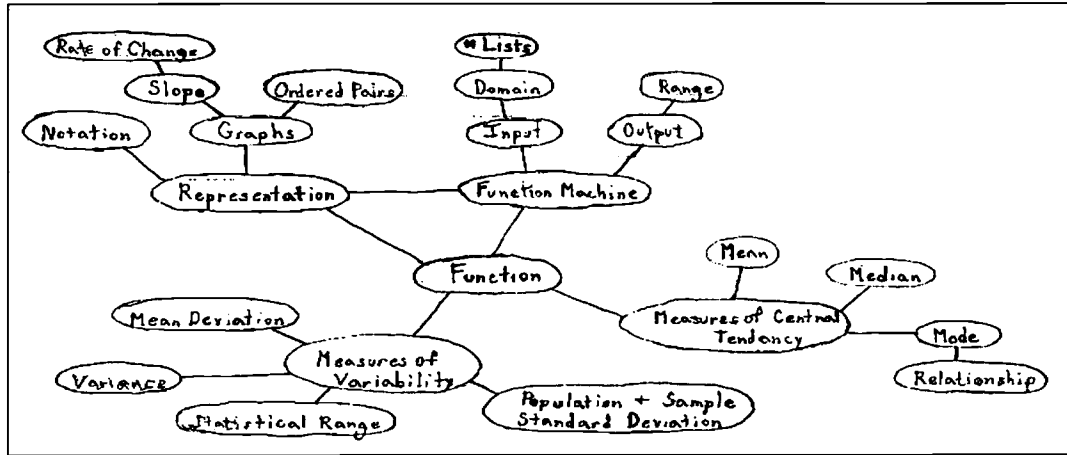

Figure C. 4.TP (S1): Schematic Diagrams of Weeks 4, 9, & 15 Concept Maps

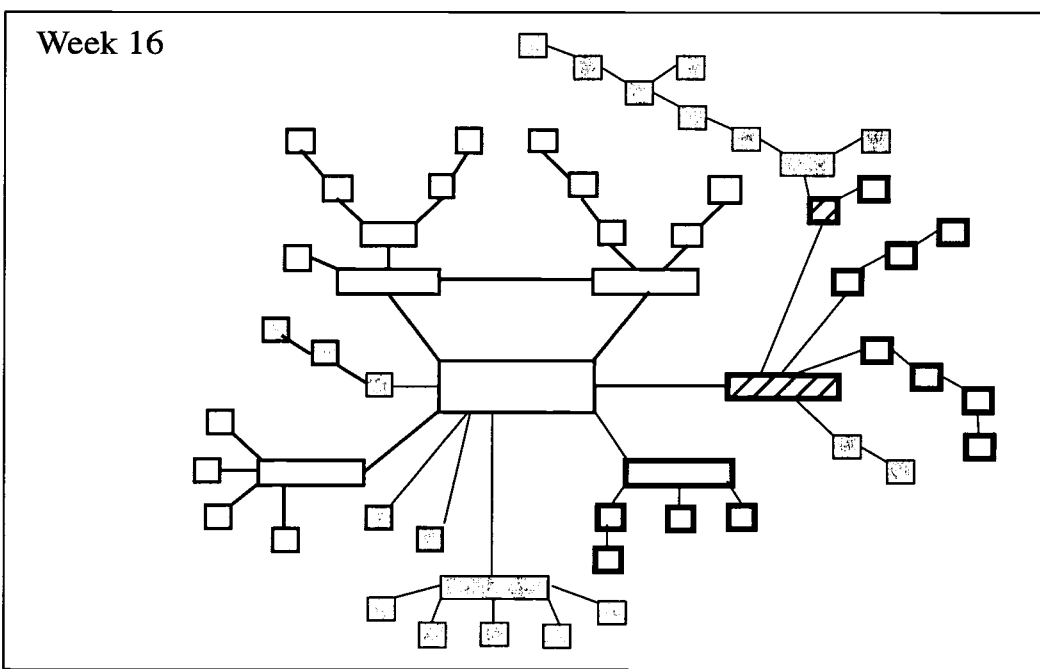
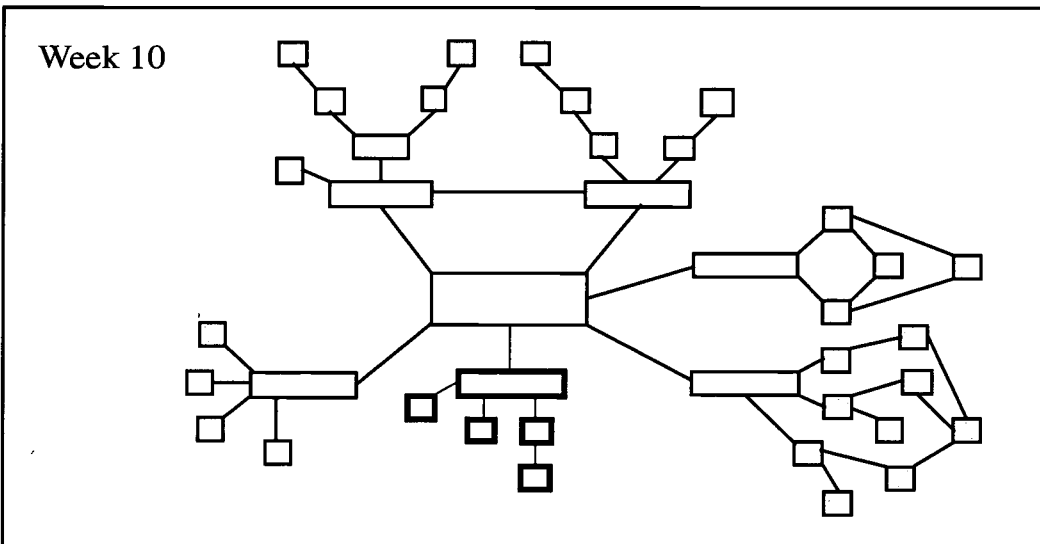
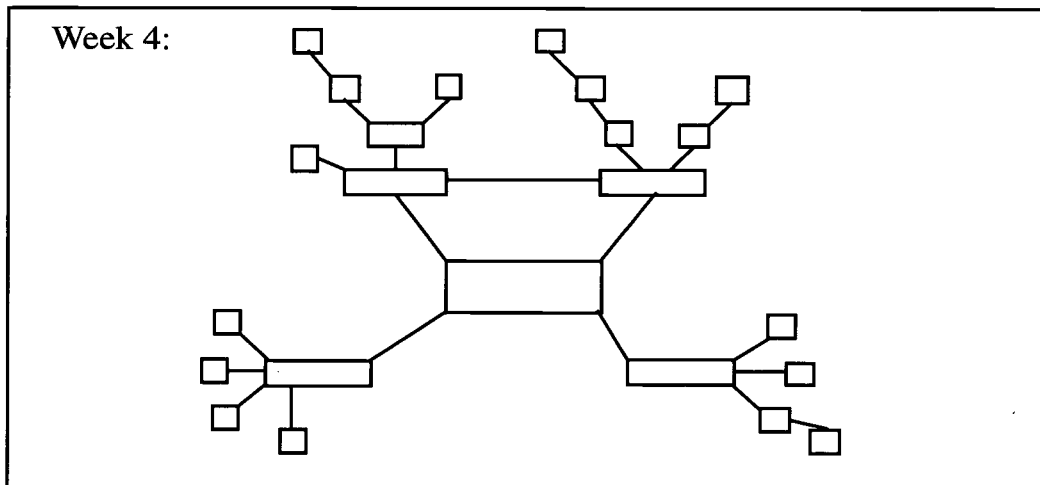
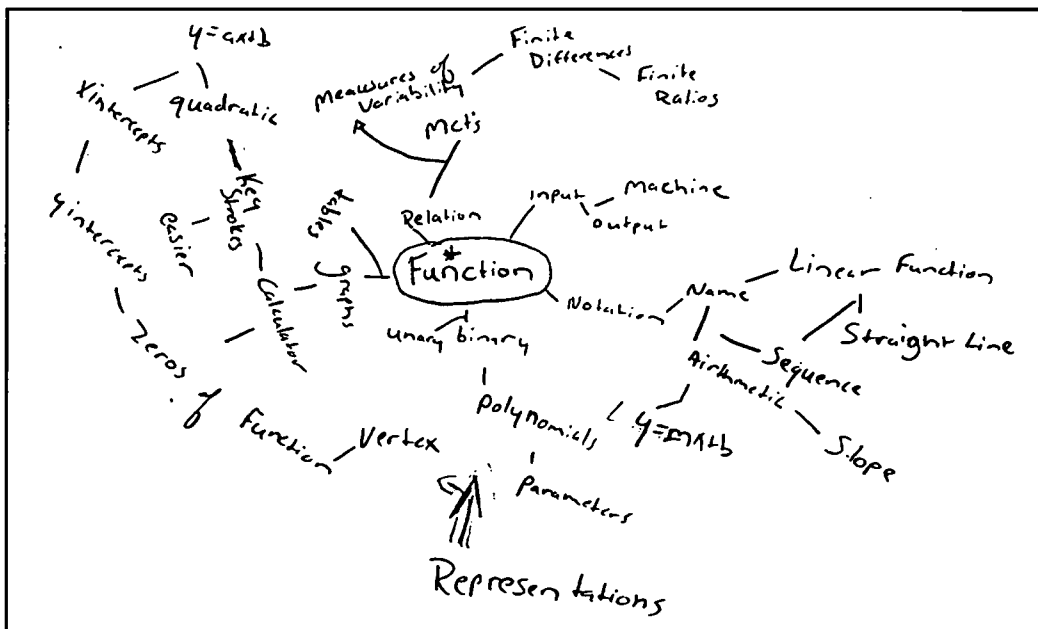
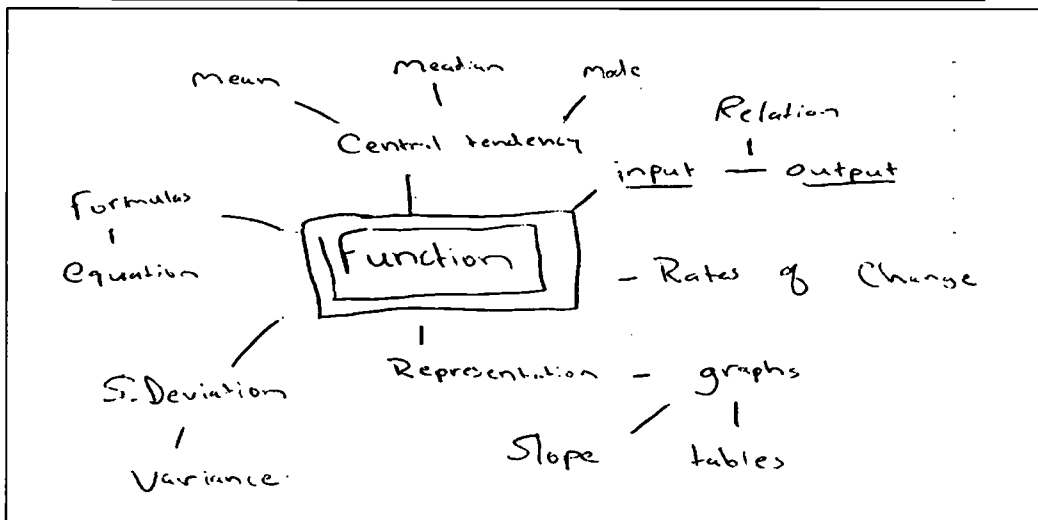
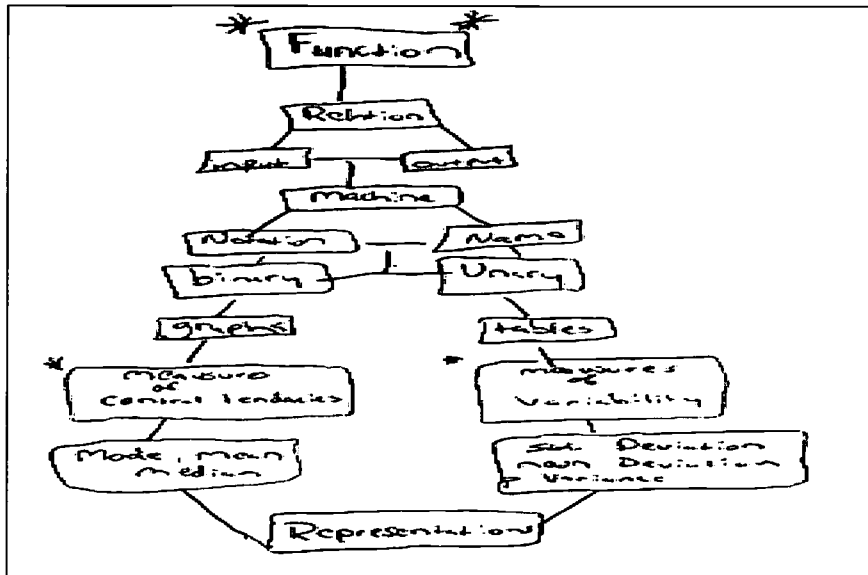

Figure C. 5.BC (S26): Concept Maps Weeks 4, 9, and 15





U.S. Department of Education
Office of Educational Research and Improvement (OERI)
National Library of Education (NLE)
Educational Resources Information Center (ERIC)

ED066107



REPRODUCTION RELEASE

(Specific Document)

I. DOCUMENT IDENTIFICATION:

Title: Cognitive Units, Concept Images, and Cognitive Collages: An Examination of the Process of Knowledge Construction.

Author(s): McGowen, Mercedes A.

Corporate Source:

Publication Date: 1998
(Ph.D. Thesis)

University of Warwick, Coventry, U. K.

II. REPRODUCTION RELEASE:

In order to disseminate as widely as possible timely and significant materials of interest to the educational community, documents announced in the monthly abstract journal of the ERIC system, *Resources in Education* (RIE), are usually made available to users in microfiche, reproduced paper copy, and electronic media, and sold through the ERIC Document Reproduction Service (EDRS). Credit is given to the source of each document, and, if reproduction release is granted, one of the following notices is affixed to the document.

If permission is granted to reproduce and disseminate the identified document, please CHECK ONE of the following three options and sign at the bottom of the page.

The sample sticker shown below will be affixed to all Level 1 documents

<p>PERMISSION TO REPRODUCE AND DISSEMINATE THIS MATERIAL HAS BEEN GRANTED BY</p> <p>_____</p> <p>MERCEDES A. MCGOWEN</p> <p>_____</p> <p>TO THE EDUCATIONAL RESOURCES INFORMATION CENTER (ERIC)</p>

Level 1

X

Check here for Level 1 release, permitting reproduction and dissemination in microfiche or other ERIC archival media (e.g., electronic) and paper copy.

The sample sticker shown below will be affixed to all Level 2A documents

<p>PERMISSION TO REPRODUCE AND DISSEMINATE THIS MATERIAL IN MICROFICHE, AND IN ELECTRONIC MEDIA, FOR ERIC COLLECTION SUBSCRIBERS ONLY, HAS BEEN GRANTED BY</p> <p>_____</p> <p>_____</p> <p>TO THE EDUCATIONAL RESOURCES INFORMATION CENTER (ERIC)</p>
--

2A

Level 2A

Check here for Level 2A release, permitting reproduction and dissemination in microfiche and in electronic media for ERIC archival collection subscribers only

The sample sticker shown below will be affixed to all Level 2B documents

<p>PERMISSION TO REPRODUCE AND DISSEMINATE THIS MATERIAL IN MICROFICHE ONLY HAS BEEN GRANTED BY</p> <p>_____</p> <p>_____</p> <p>TO THE EDUCATIONAL RESOURCES INFORMATION CENTER (ERIC)</p>

2B

Level 2B

Check here for Level 2B release, permitting reproduction and dissemination in microfiche only

Documents will be processed as indicated provided reproduction quality permits. If permission to reproduce is granted, but no box is checked, documents will be processed at Level 1.

I hereby grant to the Educational Resources Information Center (ERIC) nonexclusive permission to reproduce and disseminate this document as indicated above. Reproduction from the ERIC microfiche or electronic media by persons other than ERIC employees and its system contractors requires permission from the copyright holder. Exception is made for non-profit reproduction by libraries and other service agencies to satisfy information needs of educators in response to discrete inquiries.

Sign here, please

 Signature:	Printed Name/Position/Title: Dr. Mercedes A. McGowen, Professor Emerita	
Organization/Address: (home): 601 Pleasant Place, Streamwood, IL 60107	Telephone: (630) 837-2482	FAX: (847) 925-6049
	E-Mail Address: mmcgowen@harper.cc.il.us	Date: 7/23/02

III. DOCUMENT AVAILABILITY INFORMATION (FROM NON-ERIC SOURCE):

If permission to reproduce is not granted to ERIC, or, if you wish ERIC to cite the availability of the document from another source, please provide the following information regarding the availability of the document. (ERIC will not announce a document unless it is publicly available, and a dependable source can be specified. Contributors should also be aware that ERIC selection criteria are significantly more stringent for documents that cannot be made available through EDRS.)

Publisher/Distributor:
Address:
Price:

IV. REFERRAL OF ERIC TO COPYRIGHT/REPRODUCTION RIGHTS HOLDER:

If the right to grant this reproduction release is held by someone other than the addressee, please provide the appropriate name and address:

Name:
Address:

V. WHERE TO SEND THIS FORM:

Send this form to the following ERIC Clearinghouse: ERIC/CSMEE 1929 Kenny Road Columbus, OH 43210-1080 E-mail: beckrum.1@osu.edu FAX: 614-292-0263
--