

DOCUMENT RESUME

ED 463 880

PS 030 299

AUTHOR Erickson, Judith; King, Mindy Hightower
 TITLE Kids Count in Indiana 2001 Data Book: County Profiles of Child Well-Being.
 INSTITUTION Indiana Youth Inst., Indianapolis.
 PUB DATE 2001-00-00
 NOTE 473p.
 AVAILABLE FROM Indiana Youth Institute, 603 E. Washington St., Suite 800, Indianapolis, IN 46204. Tel: 800-343-7060 (Toll Free); Tel: 317-920-2700; Fax: 317-924-1314; Web site: <http://www.iyi.org>.
 PUB TYPE Numerical/Quantitative Data (110) -- Reports - Descriptive (141)
 EDRS PRICE MF01/PC19 Plus Postage.
 DESCRIPTORS Academic Achievement; Accidents; Acquired Immune Deficiency Syndrome; Adolescents; Birth Weight; Births to Single Women; Child Abuse; *Child Health; Child Neglect; Child Safety; Child Welfare; *Children; *Counties; Crime; Day Care; Demography; Drinking; Dropout Rate; Early Parenthood; Economic Status; Elementary Secondary Education; Incidence; Infants; Juvenile Justice; Lunch Programs; Mortality Rate; Poverty; Prenatal Care; Prenatal Drug Exposure; *Social Indicators; State Surveys; Statistical Surveys; Substance Abuse; Suicide; Tables (Data); Tobacco; Trend Analysis; Unemployment; Violence; *Well Being
 IDENTIFIERS Arrests; Child Mortality; *Indiana; *Indicators; Project Head Start; Sexually Transmitted Diseases; Vaccination

ABSTRACT

This Kids Count data book examines statewide trends in the well-being of Indiana's children. The statistical portrait is based on indicators in 10 general areas: (1) child and family demographics; (2) economic well-being; (3) poverty; (4) child safety; (5) child abuse and neglect; (6) education; (7) child health; (8) mortality; (9) high risk behavior; and (10) juvenile justice. The first part of the data book summarizes findings in the areas listed above. The data indicate an increase in single parent households, cases of child abuse, and infant mortality. The data also indicate a decrease in teen birth rates, high school graduation rates, cigarette smoking, alcohol consumption, marijuana use, juvenile arrest rates, and juvenile delinquency cases. The second section of the data book includes indicator definitions and data sources. The remainder and bulk of the data book contains state and county profiles for the indicators, with comparison data for the current year and a baseline year. (SD)

000000 136114

Reproductions supplied by EDRS are the best that can be made
 from the original document.

Kids Count in Indiana

2001 Data Book

County
Profiles
of Child
Well-being

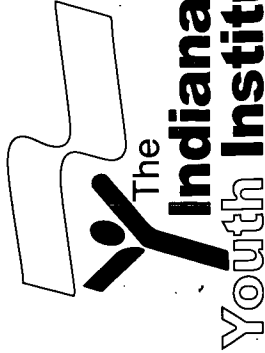

U.S. DEPARTMENT OF EDUCATION
Office of Educational Research and Improvement
EDUCATIONAL RESOURCES INFORMATION
CENTER (ERIC)

- This document has been reproduced as received from the person or organization originating it.
- Minor changes have been made to improve reproduction quality.

- Points of view or opinions stated in this document do not necessarily represent official OERI position or policy.

PERMISSION TO REPRODUCE AND
DISSEMINATE THIS MATERIAL HAS
BEEN GRANTED BY

J.D. Huse

TO THE EDUCATIONAL RESOURCES
INFORMATION CENTER (ERIC)

BEST COPY AVAILABLE

Kids Count in Indiana, a project of the Indiana Youth Institute, is a state and county-by-county effort to track the status of children in Indiana. By providing practitioners, policy makers and citizens with trends in child well-being, Kids Count in Indiana seeks to enrich community, county and state discussions about ways to secure better futures for all children. At the state level, the principal activity of the project is the publication of the annual **Kids Count in Indiana Data Book**, which uses the best available data to measure the healthy development of youth.

Copyright © 2001 by the Indiana Youth Institute. All rights reserved.

Please use the following citation when referencing the Kids Count in Indiana Data Book:

Erickson, J.B., & Hightower King, M.M. (2001). Kids Count in Indiana 2001 Data Book: County Profiles of Child Well-being. Indianapolis, IN: Indiana Youth Institute.

Acknowledgements

The *Kids Count in Indiana 2001 Data Book* could not have been produced without the help of many people who supplied information and reviewed the text.

We wish to thank the

- Annie E. Casey Foundation
- Indiana Family and Social Service Administration
- Indiana State Department of Health
- Indiana Department of Education
- Indiana Prevention Resource Center
- Division of State Court Administration, Supreme Court of Indiana
- Non-Public Education Association
- Indiana Business Research Center.

We also wish to thank:

- Authors: Judith Erickson, Ph.D., Mindy Hightower King, Ph.D.
- Design and Printing: Ad-Link Marketing
- Data Formatting: On-Net Services

Indiana Youth Institute Mission

The Indiana Youth Institute promotes the healthy development of children and youth by serving the institutions and people of Indiana who work on their behalf.

For information about additional copies of the **Kids Count in Indiana 2001 Data Book**, contact:

Indiana Youth Institute
 3901 North Meridian Street, Suite 200
 Indianapolis, IN 46208-4046
 317-920-2700
 800-343-7060
 Fund Development Hotline 877-IYI-TIPS (494-8477)
 Fax on Demand 877-550-FAXX (3299)
 317-924-1314 fax
<http://www.iyi.org>

Kids Count in Indiana

is generously supported by:

Lilly Endowment

Annie E. Casey Foundation

Riley Memorial Association

KeyBank

Inland Foundation

Ontario Corporation
Foundation, Inc.

YMCA of Greater Indianapolis

Clarian Health

AD-LINK Marketing, Inc.

Borshoff Johnson Matthews

Center for Youth Development
& Policy Research

Global Magic

Network Indiana

On-Net Internet Services, Inc.

Kids Count in Indiana 2001 Data Book

*County Profiles
of
Child Well-Being*



Board of Directors 2001-2002

IYI Board of Directors

PRESIDENT

Norris Lineweaver

President & CEO
YMCA of Greater Indianapolis
Indianapolis, Indiana

VICE PRESIDENT

Ann Whitlock Swedeen, Ed.D.

Consulting Services
Indianapolis, Indiana

SECRETARY/TREASURER

Edward L. Williams

Director of Community Relations
Harrah's East Chicago
East Chicago, Indiana

Directors

HONORARY BOARD MEMBER

Judy O'Bannon

First Lady
Indianapolis, Indiana

Emily Alim

Deputy Executive Director of Operations
Ivy Tech State College
Gary, Indiana

Linda Chezem, J.D.

Professor
IU School of Medicine
Department of Public Health
Indianapolis, Indiana

Jerry Finn

President
J.K. Finn Consulting
Floyds Knobs, Indiana

Timothy Harris

President
Harris & Ford, LLC
Indianapolis, Indiana

Anne Hoover

Executive Director
Community Partnerships with Youth, Inc.
Indianapolis, Indiana

Patty Jischke

Community Volunteer
West Lafayette, Indiana

Phyllis Kincaid

Executive Director Emeritus
Youth Resources of Southwestern Indiana
Evansville, Indiana

Mindy Lewis

Associate Director
Cummins Engine Foundation
Columbus, Indiana

Liesel Mindrebo

Hoosier Girls State Governor
Noblesville, Indiana

Beverley Pitts

Associate Provost
Ball State University
Muncie, Indiana

Randy Roberts

President
Lincoln Printing Corporation
Fort Wayne, Indiana

Dennis Savaiano, Ph.D.

Dean, School of Consumer & Family Sciences
Purdue University
West Lafayette, Indiana

Timothy Seiler, Ph.D.

Director, The Fund Raising School & Public
Service
Center on Philanthropy
Indianapolis, Indiana

Dawn Tabler

Senior Vice President & Senior Manager
KeyBank National Association
Indianapolis, Indiana

Barry C. Tyler, Jr.

Hoosier Boys State Governor
Hammond, Indiana

Barbara Wilcox

Executive Associate Dean
IUPUI School of Education
Indianapolis, Indiana

Olgen Williams

Executive Director
Christamore House
Indianapolis, Indiana

Rinzer Williams

Gary, Indiana

Esperenza Zendejas

Education Strategy
Eli Lilly Corporation
Indianapolis, Indiana

*Indiana Youth Institute
Committee Members
2001-2002*

Rebecca Debono Klein

Indianapolis, Indiana

Jama Pryor

Fund Raising & Public Relations Counselor
Greenwood, Indiana

Table of Contents

Executive Director's Message	4	Early Childhood Education	22	Mortality: Dying Too Young	36
A Special Tribute	5	Educare		Infant deaths	
Using the Kids Count Data Book	6	Licensed and registered child care		Child deaths	
Indiana's Children and Their Families	8	Early Head Start and Head Start		Preventable deaths among teens	
Population estimates		First Steps		School Safety	37
Marriage in Indiana		T.E.A.C.H. Indiana		Perceived safety in schools	
Divorce in Indiana		Indiana's Schools, Grades K-12	24	Guns and other weapons at school	
Single parent households		State aims for education		Physical fights and threats with weapons	
Indiana's Workforce	10	Enrollment		ATOD Use	38
Unemployment		Ethnic diversity		Cigarette smoking	
Wages and income		Expenditures		Alcohol consumption	
Families in Need	12	Alternative schools		Smokeless tobacco use	
Poverty		Home schooling		Marijuana use	
Low-income families		Charter schools		Adolescent Sexuality	40
Programs to Assist Poor Families	14	Test Scores in Indiana	26	Sexuality education	
TANF		The National Assessment of Educational Progress		Sexually transmitted idseases	
Food Stamp Program		College entrance examinations		HIV/AIDS	
IMPACT Program		The SAT		Juveniles and the Law	42
National School Lunch and Breakfast Program		The ACT		The F.B.I. Uniform Crime Report	
Supplemental Food Program for Women, Infants		High School Graduation	28	Indiana Judicial Report	
and Children (WIC)		Graduation Qualifying Examination		Commitments to the Department of Correction	
Sources of Support for Indiana's Families	16	Educating Special Populations	29	Afterschool Time	43
Alimony and child support		Postsecondary Education	30	Definitions and Data Sources	44
The Indiana Child Support Program		Community Colleges in Indiana		Indiana Profile	48
The Earned Income Tax Credit		Twenty-first Century Scholars Program		County Profiles	50
Child Abuse and Neglect in Indiana	18	Other supports for postsecondary education			
Institutional maltreatment		Health Care for Young Hoosiers	31		
Fatalities		Children's Health Insurance Program (CHIP)			
Protecting Indiana's Children	20	Immunizations			
Substitute care		Prenatal Care in Indiana	32		
Adoption		Drinking alcohol during pregnancy			
Programs to help prevent maltreatment		Smoking during pregnancy			
		Low birthweight			
		Starting Life	34		
		Non-marital births			

Executive Director's Message

In the face of horrific tragedy on September 11 - a day of death and despair - life started all over again.

Children who woke up that morning and went to school returned home to a different world. Same house. Different world. And life was starting all over again.

To say that "virtue" or "good" can be found in the ashes of the attack on America can dangerously imply that it's a good thing the attack happened. This, of course, is not true. A nation now longs for the relative tranquility that existed when they went to bed on September 10.

But search for good we must. After all, life has started all over again.

Encouraging evidence recently was reported in a national news story quoting therapists, mimisters, employers, and psychologists, all of whom have noticed a distinct re-shuffling of American priorities following September 11. Career, wealth and material gain have been knocked off their perch, replaced by renewed devotion to faith, family, and community.

One corporate executive from Chicago told USA Today, "We're seeing it big time. The event de-emphasized what most people value, the money and the luxuries. People are questioning what's really important." A Florida state senator added, "This has encouraged me to think about the time I devote to my political life, my work life, my kids and my family. You realize life is very fragile."

A Cleveland rabbi summarized these sentiments: "This has people talking about the most basic issues in their lives. It's a deepening of a reflection of what life is all about. People think, 'What do I want to accomplish? What do I want to leave behind?'"

This cathartic moment bodes well for the well-being of children and youth. Focusing on "the most basic issues in (our) lives" and on "what's really important" can only lead to more adults actively and passionately involved in the lives of more kids. The multiplication of these caring relationships has great potential to transform the world

- a transformation even greater than the painful changes forced on us by terrorism.

Yes, indeed. Despite death and destruction, life itself has started all over again.

This reformation of personal priorities sets the context for this year's KIDS COUNT in Indiana Data Book. A renewed emphasis on personal relationships with children, combined with the very public displays of charity, compassion, and heroism we've recently witnessed across our nation, definitively demonstrate that ample human and financial resources exist to promote healthy youth development and resolve the challenges faced by children and youth.

The highlights from this year's data book include:

According to the 2000 Census, 27.6% of Hoosier family households are headed by single parents, up from 22.1% in 1990.

Indiana's teen birth rate is 51.3 per 1,000 females ages 15-19, down from 53.2 the previous year, yet higher than the national rate of 49.6.

Indiana's child poverty rate is lower than the national rate, but Indiana's child poverty rate has remained steady at 14% while the nation's child poverty rate has decreased to 17%.

The number of substantiated cases of child abuse in Indiana increased by 15.2%, while the substantiated cases of child neglect rose by 19.4%.

The Indiana Department of Education reports a high school graduation rate for the Class of 2000 of 89%, down from 89.5% the previous year. However, only 68.3% of the students who started as high school freshmen in 1996 graduated in the Spring of 2000.

Indiana's infant mortality rate (death before the child's first birthday) rose from 75 per 1,000 infants in 1998 to 78 deaths in 1999. This increase has occurred while the national rate has remained at 72 deaths per thousand infants.

While significant percentages of Indiana youth are smoking cigarettes, those percentages are declining. For example, the percentage among high school seniors over the last four years has declined from 41.6% to 35.1%. Similarly, the percentage among 8th graders over the last five years has dropped from 27.1% to 16.1%.

The consumption of alcohol by Indiana youth also has declined at all grade levels. For example, over the last decade the percentage for 8th graders has dropped from 33.6% to 24.7%, and the percentage for 10th graders has declined from 50.7% to 39.1%.

The rate of marijuana use among Indiana teens has declined recently, but remains higher than a decade ago. In 2001, 23.5% of high school seniors report smoking marijuana, down from 25.4% in 1996, but higher than the 14.4% reported in 1992.

In criminal justice, Indiana's estimated juvenile arrest rates declined from the previous year and are lower than national averages. For example, our state's estimated juvenile arrest rate for violent crimes of 304 per 100,000 youth is lower than the national rate of 394 per 100,000. For property crimes, Indiana's estimated rate of 1,696 arrests per 100,000 juveniles trailed the national rate of 2,130 per 100,000.

The number of juvenile delinquency cases in the Hoosier State dropped by 14.4%, the third straight year the number of cases has declined.

The opportunities and challenges presented by these data are clear. A renewed focus on "what's really important" offers renewed hope in an era when life itself is starting all over again.

Bill Stanczykiewicz
President & CEO
Indiana Youth Institute

Special Tribute

The mark of a great person lies not only in their knowledge of a selected field, but also in their quest for exploring new areas and developing new interests.

Whether it's psychology, sociology, archaeology, or the well-being of children, Judith Erickson has certainly devoted herself to her work. A remarkable person has many interests, and Judith is no exception.

Judith's career has taken twists and turns one would expect of someone with a thirst for knowledge. Whether it's participating in archaeological digs in Israel, photographing youth from around the world, or writing the text of the Kids Count in Indiana data book, Judith commits her energies to her work. With over forty years' experience in the youth development field, her wealth of knowledge is enviable. Her career began as a frontline youth worker in Spokane, Washington, as a caseworker for the State Department of Public Assistance.

She has continued to serve young people most of her life, whether as a camp director at the Minneapolis Council of Camp Fire Girls, a sociology professor at Macalester College in St. Paul and the Center for Youth Development and Research in Minneapolis; a program associate for the Science Education Directorate at the National Science Foundation in Washington, DC, or a visiting fellow at Boys Town Center for the Study of Youth Development. Judith has served on national committees such as the Carnegie Council on Adolescent Development, the Kids Count Network Advisory Board, advisory panels such as the Commission on Youth Development for the Boys and Girls Club of America, and as an associate editor for

CYD Journal (formerly known as *New Designs for Youth Development*). She has presented countless papers and research findings on youth development issues to national experts who call **her** to solicit her opinion on youth issues.

With credentials like that, one might expect Judith to "know it all." In fact, the staff at IYI jokes that she really

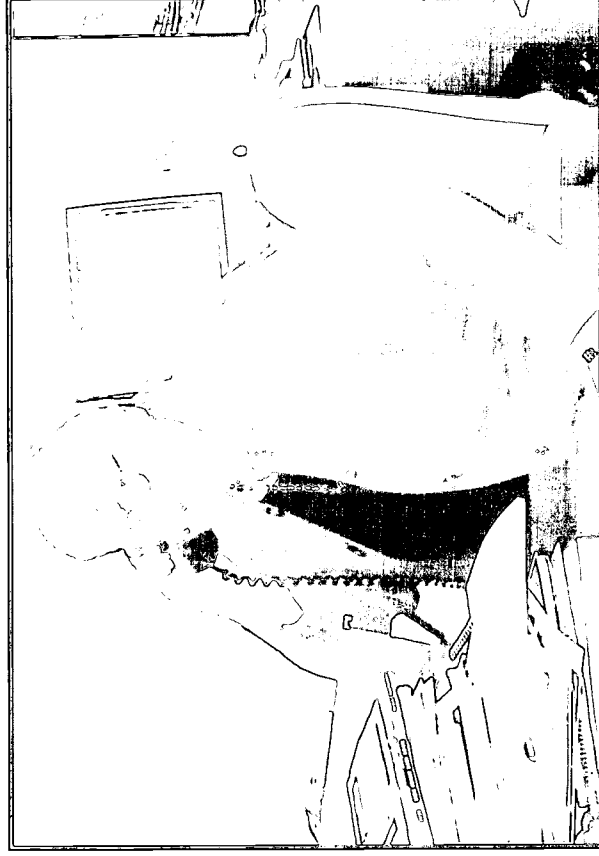

programs in the country), to a series of Indiana Youth Polls asking young people their views on high school life and beyond, and racism and poverty.

True to her educational training, Judith has often remarked that there is a science behind youth development. She wants us to understand there's more to youth programs than the obvious benefits of providing activities for young people. The science behind youth development lies in the benefits young people gain as they grow into adulthood and become healthy, successful, and contributing members to their communities. From the beginning of her career, Judith has helped shape the field of youth development by keeping the science aspect in the forefront of her work.

But it isn't her wealth of knowledge or her contacts within the state and national systems of youth development that make Judith extraordinary. It is her devotion to and genuine love for youth from all cultures, and the hope that every child has a chance to grow up in this world with opportunities to participate in youth development programs.

Twelve years ago, Dr. Judith Erickson joined the Indiana Youth Institute as the Director of Research Services. On

December 31, Judith will retire from IYI, marking the end to one chapter of her life, but the rest of the book is just beginning! She will be greatly missed as a staff member, but will always remain a friend to many of us. We know we are not alone in wishing Judith well in her next adventures. We feel fortunate she shared twelve years of her personal and professional life with us.

Using the Kids Count Data Book

The 2001 Kids Count in Indiana Data Book is the eighth in a series of annual sourcebooks. This report brings together a great deal of information about Indiana's youngest citizens and their families. The data come from many sources and in many forms; altogether, they provide a picture of how well Indiana's young people and their families are faring.

Frequently Asked Questions

Where do the data come from?

The Indiana Youth Institute (IYI) does not generate the statistical information contained in the data book. Most of the numbers are supplied by Indiana state agencies such as the Indiana State Department of Health, the Indiana Family and Social Services Administration, the Indiana Department of Correction, and the Indiana Department of Workforce Development that collect the information for administrative purposes. Some of the numbers come from federal sources such as the U.S. Census Bureau, the FBI, the Centers for Disease Control and Prevention, and the U.S. Department of Education. Also included is information from studies conducted by academic institutions and research organizations such as the Hudson Institute, Indiana Prevention Resource Center, the Indiana Business Research Center, and the Indiana Economic Development Council. For information about a specific indicator, consult the "Definitions and Data Sources" section.

Are the numbers accurate?

Every effort is made to make sure that the numbers in the data book are accurate. Errors do creep in, however. Some errors may be made when the information is collected, others when it is transferred to an electronic database and still others when it is reported. When IYI recognizes that an error has been made in the book, an "errata notification" is published. Where there are known problems with an indicator, we try to point them

out. Further information can be found in the endnotes and in the "Definitions and Data Sources" section.

Many indicators are expressed in the form of rates, calculated either directly on 1990 and 2000 census population data or on annual population estimates created by the U.S. Census Bureau. The new census data will provide the statistical base for the first decade of the 21st century.

Why are some of the numbers so old?

This data book contains the most current information available at press time. State agencies, the sources for most of the data, must collect information from all 92 counties and compile it into a single data set for the state as a whole. This can be a daunting task, particularly in those county-level agencies that still do not have computer systems available. Periodically, IYI will update the on-line Kids Count Database on IYI's Web site when updated information becomes available. It may also be possible to obtain more recent information from state agencies through the Access Indiana Information Network, the state's official Web site (www.state.in.us), or directly from the county offices that collect the information for the state.

State and County Profiles

The profiles for Indiana and each of the 92 counties contain more than 40 indicators related to the well-being of Hoosier young people. Most of the indicators appear year after year. They have been chosen because:

- ▢ The data come from a reliable source;
- ▢ The data are available for the state and each county;
- ▢ The data are gathered in the same way each year and will probably be available in the future, and

- ▢ Data book users have told us this is the information they need.

The information provided in the data book allows you to ask such questions as:

- ▢ How is my county doing overall?
- ▢ How do the most current numbers compare with the 1990 figures?
- ▢ What indicators appear to be moving in a positive direction? In a negative direction?
- ▢ How does my county compare with the state as a whole?
- ▢ How does my county compare with neighboring counties or with counties of similar size?

The answers to such questions can be helpful in discussing what research, planning, and action are necessary to improve the well-being of the young people in your county.

Some Cautions For Interpreting Data

We offer the following precautions for using the information in this data book.

Understand the indicator: Understand what is being measured and how the information is presented. Some figures represent actual numbers while others are given as rates or percentages. **Rates and percentages** permit comparisons from one group or county to another, or for different years in the same group or county. **"Percent change"** indicates how much change has occurred between two points in time. Percent change is calculated using the formula:

$$\frac{\text{Value at Time 2} - \text{Value at Time 1}}{\text{Value at Time 1}} \times 100 = \text{Percent Change}$$

Beware of small numbers: Indiana's counties vary greatly in size and composition. What may be a fairly regular event in one county may be a very rare event in another. There may also be greater variations from year to year in some counties than in others. In general, the smaller the county the smaller the number of some events that can be expected to occur. For example: If two child deaths occur in County X in 1997, but three deaths occur the following year (1998), there will be a 50% rise in child deaths between 1997 and 1998. If only one death occurs in 1999, there will be a 67% decrease in child deaths between 1998 and 1999. Using the above formula, the calculations would be as follows:

% change between 1998 (Time 2) and 1997 (Time 1):

$$\frac{3 - 2}{2} \times 100 = \frac{1}{2} \times 100 = .5 \times 100 = 50\% \text{ increase}$$

% change between 1999 (Time 2) and 1998 (Time 1):

$$\frac{1 - 3}{3} \times 100 = \frac{-2}{3} \times 100 = -.67 \times 100 = -67\% \text{ decrease}$$

In the case of "rare events," longer trends rather than year-to-year differences are more useful as a gauge of whether progress is being made toward improving the well-being of your county's children.

Many indicators are related: Look at the patterns among indicators in your county. Unemployment rates and poverty are obviously related. Perhaps less obvious are the relationships among teen births, maternal smoking, low birthweight, and infant mortality. Talk with people in your community to help uncover more subtle links among the indicators. Share information with people from other counties; find out what they are doing to promote change.

Remember the limits and uses of data: Numerical data provide important information, but they are just one type of information. A number may reflect more or less accurately how many Hoosier children live below the poverty line, but a number cannot describe the day-to-day complexities for a family living in need. A

number can tell us how many Hoosier infants are born too soon or too small, but a number cannot express the anxieties of parents who watch their tiny children struggle for life. A number can tell us how many Hoosier children have completed high school, but a number cannot describe the efforts of families, teachers, and students themselves that brought them to this point, nor can a number express the pride in accomplishment that comes with the diploma. Numbers must be used with care, and their meaning must derive from what is actually happening in the lives of the people represented by the numbers.

About Kids Count 2001

Kids Count in Indiana is part of a network of projects in 50 states, the District of Columbia and the Virgin Islands coordinated and supported by the Annie E. Casey Foundation.

KIDS COUNT on the Internet

Kids Count in Indiana provides the executive summary and county profiles in portable document format (PDF) on the Indiana Youth Institute's Web site: www.iyi.org. The Indiana project has compiled information about Hoosier young people from many sources, beginning with 1990 and continuing through the most current year available. These statistics are in the **Kids Count in Indiana** on-line database on the IYI Web site.

The national KIDS COUNT 2000 Data Book: State Profiles of *Child Well-Being* as well as other KIDS COUNT publications are available on the Annie E. Casey Foundation Web site: www.aecf.org.

Most of the state KIDS COUNT projects also have Web sites. Links on the national Web site will take the user directly to a state's site. States vary in the amount of information they distribute via their Web sites.

Abbreviations used in the Kids Count in Indiana Data Book

- SFY – State Fiscal Year – July 1 through June 30
- SY – School Year – From the start of the school term in the fall through the end of summer
- FFY – Federal Fiscal Year – October 1 through September 30
- CY – Calendar Year – January 1 through December 31.

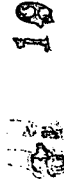

Indiana's Children and Their Families

Indiana's Population

From 1990 to 2000, Indiana's population increased 9.7% to 6,080,485. This increase reflects the combined effects of births, deaths, and migration into and out of the state. During this same period of time, the U.S. population increased 13.2%.¹ Indiana's population growth has not occurred evenly throughout the state. Eighty-one of Indiana's 92 counties experienced growth during the last 10 years, and 11 experienced slight declines in their populations.² Indiana's fastest growing counties include:

- ▢ Hamilton County, which grew 67.8% during the past decade, adding 73,804 residents.
- ▢ Hendricks County, which grew 37.5% during the past decade, adding 28,376 residents.
- ▢ Johnson County, which grew 30.8% during the past decade, adding 27,100 residents.

Indiana's population is expected to continue growing during the next 10 years. The U.S. Census Bureau estimates there will be over 6.3 million Hoosiers in 2010.³

Indiana's Children

The population of Hoosiers under the age of 18 increased by 8.1% during the past decade to a total of 1,574,396. In 1990, children made up 26.3% of Indiana's total population; in 2000, children represent 25.9% of the Hoosier state.⁴

Indiana's child population continues to diversify, although at a slower pace than that of the rest of the nation. Hispanics are the fastest-growing ethnic group of children in the state, with a 108% increase in child population since 1990 (Figure 1). Although Hispanic children currently make up 4.8% of the total child population in Indiana, the growth of the Hispanic child population has been more dramatic in some counties. For example, in 2000, Hispanic children represented 16.4% of the child population in Lake County, 11.4% in Elkhart County, 10% in Clinton County, and 9.9% in Noble County.⁵

Place of Birth

Hoosiers are more likely to stay in their home state than other U.S. residents. In 2000, it was estimated that 72% of all Hoosiers had been born in the state of Indiana. In the United States as a whole, only 59.7% of the population currently live in the same state in which they were born. Just over 3% of Hoosiers were born outside the United States, compared with 11.2% of all Americans.⁶

Educational Attainment in Indiana

Among Hoosiers age 25 and over, 18.3% do not have a high school diploma (Figure 2). Of the remaining 3,104,485 Hoosier adults with high school diplomas or GEDs, 6.8% have an associate's degree, 15.1% have a baccalaureate degree, and 9.2% have a graduate or professional degree. These numbers are slightly lower than those of the nation as a whole. Among all Americans 25 and older with a high school diploma or GED, 7.9% have an associate's degree, 19.7% have a baccalaureate degree, and 11% have a graduate or professional degree.⁷

Figure 1. Percent Growth in Child Population by Race/Ethnicity, Indiana: 1990 to 2000

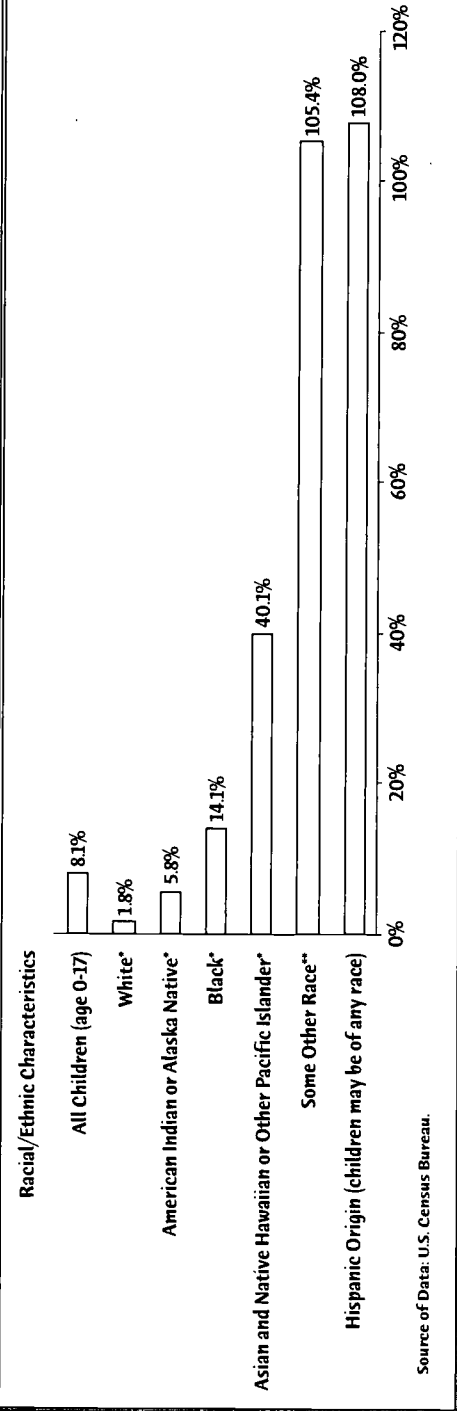

Marriage and Divorce in Indiana

In 2000, 58.3% of men and 54.4% of women age 15 and over were currently married in Indiana.⁸ Data from 1999 indicates that the average age for first marriages has increased since 1995. In 1999, the average age for first-time brides was 24.4, and the average age for first-time grooms was 26.3. In 1995, the average ages were 23.8 for brides and 25.7 for grooms. In Indiana, 48,373 marriages were

Figure 2. Highest Level of Education Attained by Residents 25 Years and Older with a High School Diploma, Indiana: 2000

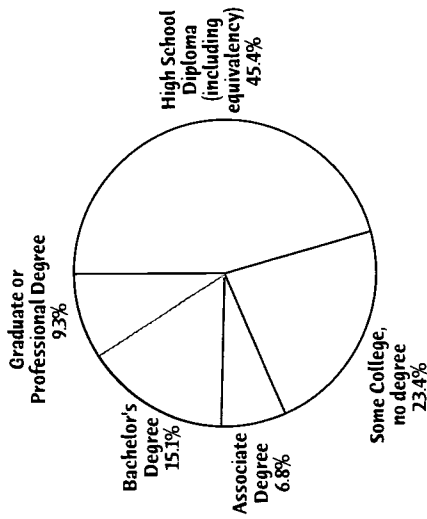

Source of Data: U.S. Census Bureau, 2000 Supplementary Survey

performed in 1999.⁹ This is more marriages than in 1998, but fewer than in 1995.

Data from the 2000 Census Supplementary Survey indicates that 10% of men and 11.3% of women were divorced in 2000.¹⁰ However, because Indiana is one of three states that does not compile statistical information about divorce, it is not known how many divorces are granted to Hoosiers each year or how many involve couples with children.

The only estimate of divorce trends in the state of Indiana is found in the Court Services Administration annual judicial report of domestic relations case filings. *Case filing data are not a substitute for actual divorce data* since they include instances of couples who withdraw from the process after filing, as well as other couples who may file more than once in a single year.

Since 1991, there has been an overall downward trend in divorce case filings in Indiana. In 2000, there were 39,144 cases filed in circuit, probate, and county courts. This number represents a 17% decrease since 1991 when 47,157 filings were recorded.¹¹

Single Parent Households¹²

Since 1990, the number of family households with their own children that are headed by a single parent in Indiana has increased 32.5% to 211,723. *Family households with their own children* are those that include sons or daughters by birth, stepchildren, or adopted children who are unmarried and under the age of 18. In 1990, 22.1% of family households with their own children were headed by single parents. Results from the 2000 Census indicate that 27.6% of Hoosier family households with their own children are now headed by single parents.

While most single parents are mothers, a growing number of fathers are now raising their children alone in Indiana. In 1990, the number of Hoosier families with their own children headed by a single mother was 129,971. By 2000, this figure had increased to 160,311, representing an increase of 23.3%. The number of family households with their own children headed by single fathers was 29,776 in 1990. In 2000, that figure rose 72.7% to a total of 51,412 families with their own children headed by single fathers (Figure 3).

Figure 3. Number of Single Parent Family Households with Own Children < 18, Indiana: 1990, 2000

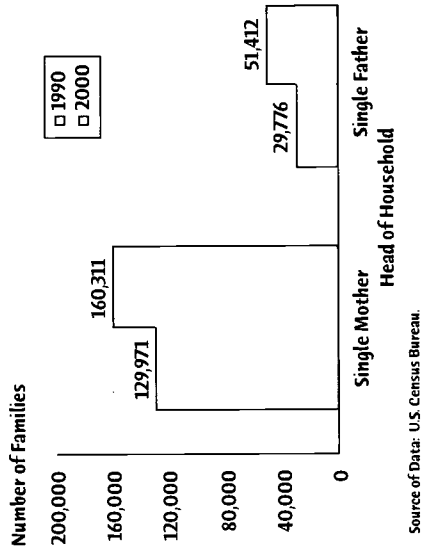

Source of Data: U.S. Census Bureau

¹ 2000 Decennial Census, U.S. Census Bureau.

² Indiana Business Research Center, Kelley School of Business, Indiana University, Bloomington.

³ *Ibid.*

⁴ 2000 Decennial Census, U.S. Census Bureau.

⁵ 2000 Decennial Census, U.S. Census Bureau.

⁶ 2000 Supplementary Census, U.S. Census Bureau.

⁷ *Ibid.*

⁸ *Ibid.*

⁹ Indiana State Department of Health, 1999 Marriage Report.

¹⁰ 2000 Supplementary Census, U.S. Census Bureau.

¹¹ 2000 Indiana Judicial Report, Vol. 1, Executive Summary (Indianapolis, IN: Supreme Court of Indiana, 2001).

¹² 1990 and 2000 Decennial Census, U.S. Census Bureau.

Indiana's Workforce

Indiana's labor force picture still remained strong in mid-2001 but, as is true for the rest of the nation, the state is faced with increasing job loss and rising rates of unemployment. Figures for July 2001 show an estimated 3,156,100 Hoosiers, aged 16 and older able and available for work. The Department of Workforce Development noted that job loss has occurred in both the goods and service producing sectors of Indiana's economy in the past year.¹

For a majority of Hoosier children younger than age 18, all parents in the home are in the labor force:

➤ The Supplementary Survey (C2SS) conducted by the U.S. Census Bureau in 2000, examined the numbers of children who had all parents in their home in the labor force. The survey estimated that in Indiana 62.3% of children younger than age six had working parents, compared with 60.4% nationally. An estimated 67.9% of the state's children ages six through 17 had working parents, compared with 69.2% nationally.

Unemployment

The preliminary unemployment rate in Indiana was 4.1%, continuing an upward trend that began in September 2000. An estimated 128,800 Hoosiers were unemployed in July 2001, an increase of 17.7% from a year earlier. In July 2000, 3.5% of Indiana's labor force was unemployed. The July 2001 rate for Indiana remained below the national rate of 4.7%, sustaining trends of the 1990s. A smaller proportion of Indiana's labor force was unemployed in July 2001 than in the adjoining states of Illinois (5.4%), Ohio (4.4%), Kentucky (5.1%), and Michigan (5.3%). As in past years, there was wide variation in unemployment rates within Indiana.

➤ Orange County had the highest preliminary unemployment rate in July 2001—8.7%—followed by Greene (7.4%) and Fayette (7.0%) Counties.

➤ Hamilton County continued to have the lowest unemployment in the state (1.8%) in July 2001. Boone, Hendricks, and Decatur Counties all had rates of 2% or less.

Wages and Income

In 2000, incomes in the United States remained at the all-time high reached in 1999.² There are several ways of reporting incomes, and Table 1 presents four of the most frequently used: the average wage per job, per capita income, median household income, and median family income.³ However calculated, the figures collected in 2000 for 1999 income show that Indiana continues to lag behind the nation as a whole. While it is true that the cost of living in Indiana is somewhat lower than the U.S. as a whole, it is also true that the incomes for Hoosier households and families are frequently sustained by more than one wage earner and/or by wage earners who hold more than one job.

What it costs to raise a child

Since 1960, the U.S. Department of Agriculture has issued annual estimates of expenditures on children by U.S. families. The estimates are for raising children up through age 17—and do not include postsecondary education. In 1960, low-income families (with an average pre-tax income of \$23,800) spent an estimated \$121,230 per child (in 2000 dollars), while upper-income families (average pre-tax income of \$95,800) spent \$241,770. In 1960, a middle-income family (average pre-tax income of \$50,600) spent about \$146,780 (in year 2000 dollars) per child. In 2000, estimated expenditures per child had risen to \$165,630 for a middle-income family. The greatest increases in spending between 1960 and 2000 among middle-income families were for food (18% vs. 24%), child care and education (1% vs. 10%), and health care (4% vs. 7%). For children born in 2000, it is anticipated that expenditures will rise to \$171,460 for low-income families, and to \$233,530 and \$340,130 for middle- and upper-income families, respectively.⁴

Youth in the Labor Force

Typically, American youngsters begin working for pay outside their own homes during elementary school. For the first years, most of their work is sporadic, informal, and undertaken voluntarily. By middle school, however,

Table 1. Income Comparisons, Indiana and U.S.: 2000

	Indiana	U.S.	Indiana as a Percentage of U.S. Income Measure
Average wage per job*	\$29,876	\$33,467	89.3%
Per capita income**	\$27,011	\$29,676	91.0%
Median household income***	\$40,566	\$41,343	98.1%
Median family income***	\$48,792	\$49,497	98.6%

Sources of Data:

Indiana Economic Development Council. Average wage per job figures are for 1999.
 * U.S. Department of Commerce.
 ** U.S. Census Bureau, 2000 Supplementary Survey of persons living in households, U.S. and Indiana. Figures are for 2000 inflation adjusted dollars.

many students report they spend more time working. A recent study examined the work patterns of young people. Just under half of the participants in the study who had turned 12, but were younger than age 13 in 1995-97, reported a work activity. Of those who reported working, 56% did babysitting and 40% did yard work. By the time they had reached age 14, the legal age for work in nonagricultural industries (under both federal and state limits), their work had diversified and their work-time had increased.⁵

The work patterns of Hoosier students are similar, according to self-reports of work activity given in the Indiana 2001 Prevention Resource Center Survey.⁶ Fewer than half (48.3%) of the 6th-grade respondents reported no work activity for pay outside of the home. That proportion dropped steadily to 18.2% of 12th-graders who reported no work activity. Figure 1 shows that among the students who worked between one and 59 days while school was in session, patterns among boys and girls were similar. More boys than girls reported working 60 to 180 days of the school year in grades 6 through 10. In the upper two grades, more girls reported working between 60 and 180 days than did boys—49.6% vs. 46.8% in grade 11, and 55.8% vs. 51.4% in grade 12.

The overall figures are consistent with estimates of the employment of 16- through 19-year olds published annually by the U.S. Department of Labor. In Indiana, an estimated 50.8% of this age group was employed in 2000 (an estimated total of 146,000 teens), compared with 45.4% nationally. Youth unemployment rates in Indiana, as true for the nation as a whole, are higher than for the population of all ages in the workforce. The

estimated 2000 youth unemployment rate in Indiana was 11.1%, compared with 13.1% nationally. For both Indiana and the nation, youth unemployment declined slightly between 1999 and 2000 (from 12.4% in Indiana and from 13.9% in the U.S. as a whole).⁷

Minors wishing to work in Indiana must obtain a work permit (if they have not graduated from high school or received a General Educational Development (GED) diploma). Young workers are subject to restrictions on the types of jobs they may hold, work conditions, and the daily and weekly hours they may work. Work permits may be revoked for students who miss too many days of school or are not making satisfactory academic progress.⁸ These last aspects of the state's Child Labor Laws are variously enforced by different school corporations.

Youth employment is a bellwether for the economy in general: more youth are able to find jobs in good economic times than in bad. The general trend for

youth employment in Indiana was upward between 1991 and 2000. Between SFYs 2000 and 2001, however, there was a sharp drop, of 16.8%, in the number of work permits issued—from 136,820 to 113,769. Fourteen- and 15-year-olds had the biggest decline, and 17-year-olds the smallest.⁹ The loss of federal support for summer jobs programs also had an impact on the number of youths who were able to find employment.

⁷ Indiana Department of Workforce Development, Press release: "Indiana's preliminary unemployment rate is 4.3% for July, compared to National rate of 4.7%," September 7, 2001. Figures presented are not seasonally adjusted.
⁸ U.S. Census Bureau, Current Population Reports, P60-213, Money Income in the United States: 2000 (Washington, DC: U.S. Government Printing Office, September 2001; Weinberg, Daniel H. "Press Briefing on 2000 Income and Poverty Estimates," U.S. Census Bureau, September 25, 2001.
⁹ Although Indiana's overall annual growth in the number of jobs has outpaced much of the nation, wages have not kept up. Average wage per job data were supplied by the Indiana Economic Development Council. Per capita income, and median household and family

Figure 2: Work Permits Issued to Indiana Teens, SFYs 1991-2001

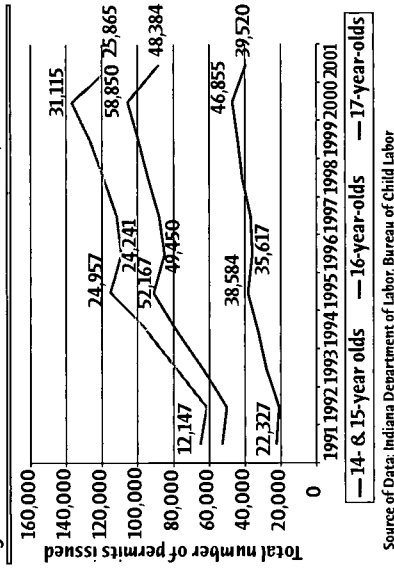

Source of Data: Indiana Department of Labor, Bureau of Child Labor

income data are estimates that come from the Indiana and U.S. profiles of selected economic characteristics produced from the U.S. Census 2000 Supplementary Survey. In September 2000, the U.S. Census Bureau published income data for 2000, based on the Current Population Survey. That source produced two-year average figures for 1999-2000 of \$42,168 as the national median household income, and \$41,010 as the median household income in Indiana. Available on the U.S. Census Bureau Web site: www.census.gov.
⁴ Lino, Mark, *Expenditures on Children by Families: 2000 Annual Report*. Miscellaneous Publication No. 1528-2000 (Washington, DC: U.S. Department of Agriculture, Center for Nutrition Policy and Promotion, 2001). The annual pre-tax income range for low-income families was <\$38,300; for middle-income families, \$38,000 to \$64,000; and for upper income families, more than \$64,000. Report available on the USDA Web site www.cnpp.usda.gov.
⁵ U.S. Department of Labor, *Report on the Youth Labor Force*, Revised November 2000. Available on the U.S. Department of Labor Web site: www.state/bls.gov/olpub/rylf/rylfhome.htm.
⁶ Indiana Prevention Resource Center, *Alcohol, Tobacco and Other Drug Use by Indiana Children and Adolescents: 2001 Prevalence Statistics*, Prevention Monograph Series, Monograph No. 01-03 (Bloomington, IN: Indiana Prevention Resource Center, Indiana University-Bloomington, August 28, 2001).
⁷ U.S. Department of Labor, "Employment status of the civilian noninstitutional population by sex, age, race and Hispanic origin," 2000 annual averages and 1999 annual averages. Available on U.S. Department of Labor, Bureau of Labor Statistics Web site: www.stats.bls.gov.
⁸ Child Labor provisions are defined in IC 20-8.1-4 and IC 22-2-2-4.
⁹ Indiana Department of Labor. On Web site: www.state.in.us/labor/childlabor/twpsatstat.gif. The Indiana Department of Labor has created an excellent Web site for teens that outlines labor laws, resources for finding and holding jobs, etc.: <http://www.teenworker.org>.

Figure 1: Students Working Outside of Home by Gender and Grade, Indiana: 2001

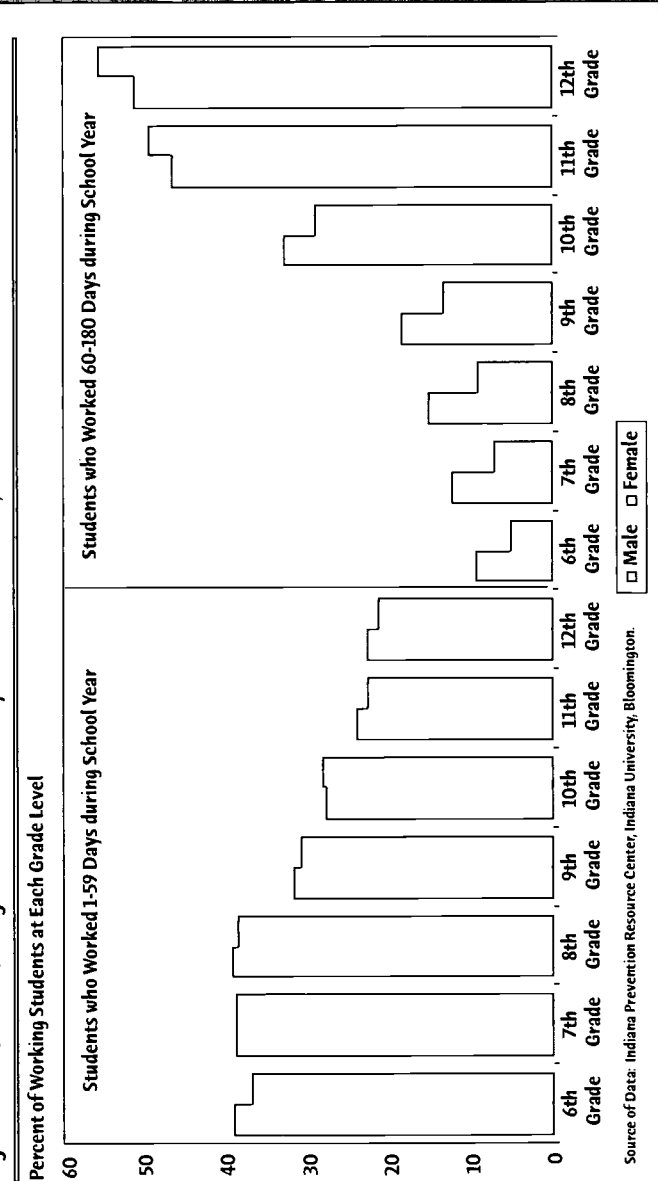

Source of Data: Indiana Prevention Resource Center, Indiana University, Bloomington.

Families in Need

Poverty

Two statistics are used by the federal government to define poverty. Poverty thresholds are updated annually by the U.S. Census Bureau and are used mainly for statistical purposes such as calculating the number of Americans living in poverty each year. *Poverty guidelines*, published by the Department of Health and Human Services, are a simplified version of the poverty thresholds used for administrative purposes, such as determining financial eligibility for certain federal programs (TANF and food stamps, for example).¹

Income data for 1999 collected in the 2000 U.S. Census will not be released until 2002. Although the figures will be more accurate than other estimates, they will already be three years out of date – a problem in a rapidly changing economy. Between censuses, the U.S. Census Bureau uses several different models to estimate the number of Americans living in poverty; the estimates differ depending on the model used.

Between the decennial censuses, the annual Current Population Survey (CPS) conducted by the U.S. Census Bureau is used to estimate U.S. and state populations living below the poverty threshold. Figures for 1999

Table 1. Estimated Population Living Below the Poverty Level, Indiana and U.S.: 1999, 2000

	U.S. Poor % of pop.	Indiana's Poor % of pop.	Est. number
Census Supplementary Survey 2000			
Age < 5	19.7	16.5	67,020
Age 5-17	16.1	13.6	152,339
All Ages < 18	17.1	14.3	219,359
All Ages	12.5	10.4	612,802
SAIPE Estimates, 1998 Income			
Age < 5	20.8	15.4	66,054
Age 5-17	17.5	12.6	137,395
All Ages < 18	18.9	14.1	219,858
All Ages	12.7	10.0	588,765

Source of Data:
 *U.S. Census Bureau 1999, Small Area Income and Poverty Estimates, based on 1998 income, U.S. and Indiana.
 †U.S. Census Bureau, 2000 Supplementary Survey of persons living in households, based on 1999 income, U.S. and Indiana.

represent a three-year average of CPS data (1998-2000). Using this model, an estimated 8.2% of Hoosiers of all ages (compared with a national rate of 11.9%) were living in households with incomes below the poverty level.²

The Census Bureau also creates a series of Small Area Income and Poverty Estimates (SAIPE) to help the U.S. Department of Education distribute Title I funds. Figures based on 1998 income showed an estimated 14.1% of Hoosier children younger than age 18 (compared with 18.9% nationally) to be living in families with incomes below the poverty threshold.³ These figures include an estimated 4% of Indiana's children (compared with 8% of the nation's) living in extreme poverty—i.e., in households with incomes less than half of the poverty level. Table 1 contains SAIPE poverty estimates for income year 1998.

More current poverty estimates come from the U.S. Census Bureau's 2000 Supplementary Survey. These estimates, also presented in Table 1, show 14.3% of young Hoosiers younger than age 18 living in poverty, compared with 10.4% of the population of all ages.

Of the children younger than age five—the period when poverty has the greatest impact on healthy development—an estimated 16.5% of Hoosier children were living in poverty (compared with 19.7% of all U.S. children). The figures drop to 13.6% and 16.1% for children ages five through 17 in Indiana and the U.S., respectively.

Children have become the poorest age group in the nation. The 2000 Supplementary Survey estimated that children younger than age 18 represent about 27% of the population of both the U.S. and Indiana. Children, however, are nearly 36% of the individuals living below the poverty line in Indiana (and just over 35% in the U.S.).⁵ Recently released figures for the U.S. as a whole, based on the 2000 Current Population Survey, estimate that the U.S. child poverty rate was 16.2%, while the rate for the elderly (the poorest group before 1974) was 10.8%.⁶

We have presented several estimates of the numbers and proportions of the state's and nation's poor to demonstrate that poverty estimates are just that: estimates.

Table 2 summarizes the federal poverty thresholds for 2000, the poverty guidelines for 2000 and 2001, and the hourly wage required to reach each poverty income level in 2001.⁷

Low-income families

Although the percentage of Indiana's children living in families with incomes below the poverty level has declined since the early 1990s and remains below the percentage for all U.S. children, many of the once-poor (by federal standards) families have moved into the economic group designated as "low income." These families have household incomes ranging between 100% and 200% of the poverty level (between \$17,650 and \$35,300 for a family of four in 2001).

The federal poverty level does not represent "income that will meet the basic day-to-day needs of family living." Considerably more resources are needed if families are to live without sacrificing basic necessities. Two, more realistic estimates of the earned income needed to meet the bare requirements of living in Indiana are available. Wider Opportunities for Women, in partnership with the Indiana Coalition on Housing and Homeless Issues, created a "Self-Sufficiency Standard" for Indiana counties in 1998, and the Indiana Economic Development Council has developed "Basic Needs Budgets" for Hoosier families in 2000.

The Self-Sufficiency Standard calculated income needed to provide housing, food, health care, child care, as well as cover transportation, miscellaneous expenses and taxes, taking into account the child care tax credit and the Earned Income Tax Credit. Estimates varied by place and family composition, and ranged between an estimated \$22,400 (Orange County) and \$29,400 (Marion County) for families of three (one adult, two children), and between \$28,800 and \$34,600 for

families of four (two adults, two children).⁸ These figures were well above the poverty guidelines for 1998: \$13,650 for a family of three and \$16,450 for a family of four, and in urban counties, even exceeded the upper limit of the "low-income" designation of 200% of the poverty guideline.⁹

The Indiana Economic Development Council's "Basic Needs Budgets" includes food, housing (assumes families are renting), health care, child care, transportation, personal and household items, and taxes. This budget also takes into account the earned income and child care tax credits. Estimates vary by the size of the family and where in Indiana they are living. The Basic Needs Budget was estimated at \$26,532 for a family of three (one adult, two children) living in a rural area. The same family living in an urban area would require \$31,214. A rural family of four (two working adults, two children) would require \$31,380 for a Basic Needs Budget, while the same family living in an urban area would need \$34,613 to meet their basic needs.¹⁰ For the rural families, the Basic Needs Budgets would have been about 185% of the federal poverty guidelines in 2000; for the urban families, the Basic Needs Budgets would have exceeded 200% of the federal poverty guidelines.

¹ Office of the Assistant Secretary for Planning & Evaluation, "The 2001 HHS Poverty Guidelines." (Washington, DC: U.S. Department of Health and Human Services, 2001). Information about poverty guidelines is available on the HHS Web site: aspe.hhs.gov/poverty/; it is also published annually in the *Federal Register*.

² Dalaker, Joseph, U.S. Census Bureau, *Current Population Reports Series P60-214, Poverty in the United States: 2000* (Washington, DC: U.S. Government Printing Office, 2001). On Web site: www.census.gov.

³ U.S. Census Bureau, "Small Area Income and Poverty Estimates: Tables for States and Counties by Income Year and Statistic." (Washington, DC: Author, August 31, 2001). On Web site: www.census.gov.

⁴ Annie E. Casey Foundation, *KIDS COUNT 2001 Data Book* (Baltimore, MD: Author, 2001) p. 70. The extreme poverty estimates for 1997 are based on the Small Area Income and Poverty Estimates (SAIPE) model of the U.S. Census Bureau and represent an average of figures for 1996-98.

⁵ Indiana and U.S. profiles of selected economic characteristics, *Census 2000 Supplementary Survey*.

⁶ U.S. Census Bureau, "Income and Poverty 2000." PowerPoint presentation, September 2001. Available on the Bureau's Web site: www.census.gov.

⁷ *Federal Register*, Vol. 65, No. 31, February 15, 2000, pp. 7555-7557; and Vol. 66, No. 33, February 16, 2001, pp. 10695-10697.

⁸ Pearce, D. and Brooks, J. *The Self-Sufficiency Standard for Indiana: Summary Report* (Indianapolis, IN: Indiana Coalition on Housing and Homeless Issues, Fall 1999); U.S. Department of Health and Human Services, "The 1998 HHS Poverty Guidelines" (Washington, DC: Author, 1998).

⁹ *Federal Register*, Vol. 63, No. 36, February 24, 1998, pp. 9235-9238.

¹⁰ Average rural and urban Basic Needs Budget estimates calculated for this data book by the Indiana Economic Development Council. Estimates take into account the federal EITC, Child and Dependent Care Credit, Child Tax Credit and Additional Tax Credit, and the Indiana EITC.

Table 2. U.S. Poverty Guidelines and Thresholds by Size of Family: 2000, 2001

Size of Family Unit	Poverty Guidelines 2000	Poverty Thresholds 2000	Poverty Guidelines 2001 (100% of Poverty Level)	150% of Poverty Level	185% of Poverty Level	Hourly Wage Needed to Reach Poverty Level in 2001*
1	\$8,350	\$9,959	\$8,590	\$12,885	\$15,892	\$4.30
2	\$11,250	\$11,869	\$11,610	\$17,415	\$21,479	\$5.80
3	\$14,150	\$13,874	\$14,630	\$21,945	\$27,066	\$8.40
4	\$17,050	\$17,574	\$17,650	\$26,475	\$32,653	\$8.80
5	\$19,950	\$20,236	\$20,670	\$31,005	\$38,240	\$10.30
6	\$22,850	\$22,579	\$23,690	\$35,535	\$43,827	\$11.85

*Based on a 2000 hour work year.

Source of Data: Federal Register, February 15, 2000 and February 16, 2001; U.S. Census Bureau.

Programs to Assist Poor Families

Welfare reform efforts in Indiana place an emphasis on "work first" and "personal responsibility," by replacing cash assistance with transitional services that help people gain employment. Eligibility criteria for these programs are tied to income as a percentage of the federal poverty guidelines. Since 1994, the number of Indiana families receiving public assistance has fallen dramatically (Figure 1).

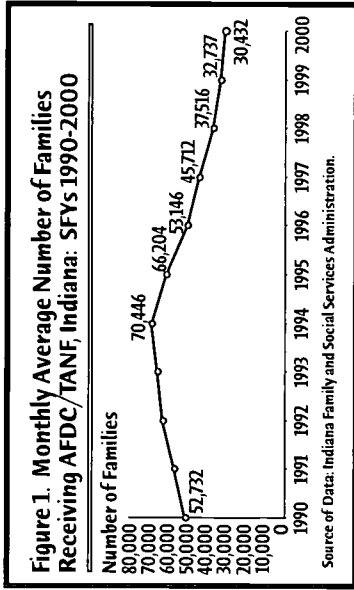

Temporary Assistance for Needy Families (TANF)

Temporary Assistance for Needy Families (TANF) replaced AFDC (Aid to Families with Dependent Children) in 1997. The TANF program provides cash assistance to families with children younger than age 18 who are deprived of financial support by a parent due to death, absence from the home, unemployment, physical

Family Size	Gross Income Limit	Maximum Monthly Benefit
1	\$286.75	\$139.00
2	\$471.75	\$229.00
3	\$592.00	\$288.00
4	\$712.25	\$346.00
5	\$832.50	\$405.00
6	\$952.75	\$463.00

Source of Data: Indiana Family and Social Services Administration.

or mental incapacity. Financial eligibility for TANF is determined by comparing family size and total family income (Table 1). At the point of application, the family's pre-tax (gross) income may not exceed 185% of the standard, and after-tax (net) income may not exceed the standard. Once eligibility is determined, benefits continue until the family's net income reaches 100% of the federal poverty guidelines.

In SFY 2000, the monthly average number of families receiving TANF benefits was 30,432. This number is down from 32,737 in SFY 1999 and represents a 57% decrease since 1994, before the implementation of Indiana's welfare reforms (Figure 1).

The monthly average number of recipients receiving benefits in SFY 2000 was 76,602. 2000 Census figures indicate this number represents 0.37% of Indiana's population.

The total value of TANF benefits paid in SFY 2000 was \$80.6 million, down from \$87.3 million in SFY 1999 and \$216.6 million in 1994.¹

Food Stamp Program

Indiana's Food Stamp program is designed to raise the nutritional level of low-income households by supplementing their available food-purchasing dollars with food stamp coupons. The program is federally funded, but administered through each state. Federal regulations developed by the U.S. Department of Agriculture (USDA), Food and Nutrition Services, govern implementation of the program. In Indiana, the Family and Social Services Administration (FSSA) is responsible for ensuring that federal regulations are implemented and consistently applied in each county.

In order to qualify for food stamp benefits, applicants must meet both financial and non-financial requirements. Financial criteria include income and asset limits. Non-financial requirements include state residency, citizenship/alien status, work registration,

and cooperation with the IMPACT program. Eligible participants receive food coupon benefits based on family size (Table 2).

Household Size	Maximum Gross Monthly Income Limit	Maximum Food Stamp Allotment
1	\$905	\$130
2	\$1,219	\$238
3	\$1,533	\$341
4	\$1,848	\$434
5	\$2,162	\$515
6	\$2,476	\$618

Source of Data: Indiana Family and Social Services Administration.

Food stamp benefits are used like cash to buy eligible items at any store, supermarket or cooperative approved by the USDA. From May 2001 through March 2002, Indiana will be replacing paper food stamps with an Electronic Benefits Transfer (EBT) system in each of the 92 counties. EBT will allow for benefits to be accessed with a plastic Hoosier Works card, similar to commercial debit and ATM cards.

In SFY 2000, a monthly average of 297,341 Hoosiers received nutritional assistance through the food stamp program. This number is down from 299,879 in SFY 1999 and represents a 42% decrease since 1994 (Figure 2).

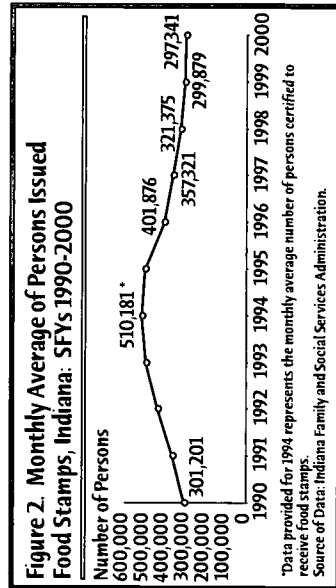

▣ The total value of food stamps issued in SFY was \$261.8 million, down from \$416.7 million in 1994.¹

IMPACT Program

The Indiana Manpower and Comprehensive Training (IMPACT) Program provides services designed to help TANF and food stamp recipients reach economic self-sufficiency. The IMPACT program emphasizes job placement and retention, complemented by education and training services.

IMPACT program participants receive job search assistance, job readiness training, on-the-job training, educational and vocational training, and community work experience. Additional supportive services can provide participants with clothing and shoes, drivers' training, books and training manuals, activity fees, transportation stipends, medical expenses, child care subsidies, and assistance with vehicle repair and maintenance.

▣ In SFY 2000, 23,216 Hoosiers received job placements through the IMPACT program. This number is up from 4,665 in SFY 1994.¹

National School Lunch and Breakfast Program

The National School Lunch Program was initiated after the end of World War II, and the School Breakfast Program was added in 1975. Participating students from families with incomes below 130% of the poverty guidelines are eligible for free meals, while students from families with incomes below 185% of the poverty guidelines are eligible for reduced-price meals. Students who attend both public and private schools are eligible to receive free or reduced-price meals. Under a state program initiated during the 1999-2000 school year, all public school students in Indiana who are eligible for free and reduced-price meals are also eligible for free textbooks.

34
4,665

▣ During the 2000-2001 school year, 223,182 students (21.2% of those enrolled in public and non-public schools) were eligible for free meals and textbooks, and an additional 74,054 (7% of public and non-public school students) were eligible to purchase meals at a reduced price.²

Supplemental Food Program for Women, Infants and Children (WIC)

The federally-funded WIC program provides support for pregnant and postpartum women, infants, and children younger than age six living in households with incomes less than 185% of the federal poverty guidelines. Eligible participants receive vouchers that can be redeemed for foods with high nutritional value through any approved retailer.

▣ In FFY 1999, the WIC program provided nutritional support to 233,611 women, infants, and young children in Indiana.³

¹ Indiana Family and Social Services Administration, Division of Family and Children, *Demographic Trend Report, State Fiscal Year 2000* (Indianapolis, IN: 2000)

² Indiana Department of Education, School and Community Nutrition Programs.

³ Indiana State Department of Health.

Sources of Support for Indiana Families

Alimony and child support

A comparison of data from the 1990 and 2000 U.S. Censuses reveals that the number of households headed by only one parent in Indiana has risen markedly—by 32.5% overall, by 23% for families headed by a single mother, and by 73% for families headed by a single father. Mothers remain the heads of more than three-fourths of the single-parent families, however. Child support has become an ever more important source of income for those children who *actually receive it*. Both federal and state governments have increased efforts to collect child support from absent parents, but results remain mixed. Indiana has done better than the nation as a whole.

The 2000 KIDS COUNT national data book reports that 47% of Indiana mothers, compared with 34% nationally, received child support or alimony from the absent parent. Comparable figures for the number of single fathers receiving child support or alimony are not available.¹

The Indiana Child Support Program

Funds paid for child support by non-custodial parents are collected and disbursed by the Indiana Child Support Bureau of the Division of Family and Children. The Bureau and its agents, the County Prosecutors' Offices, provide services to establish paternity and court orders, enforcement of court orders, and location of absent parents. The Bureau aggressively pursues funds due to Hoosier children, using such tools as income withholding, property liens, interception of tax refunds and unemployment compensation benefits, as well as suspension of driver's, professional and recreational licenses, and interceptions of lottery winnings.²

Two statistics reflect Indiana's intensified efforts to obtain child support: the dollar amount actually collected and disbursed, and the number of paternity

cases filed in Indiana courts.³ Between SFYs 1995 and 2000, the state more than doubled the amount of child support collected, and in CY 2000, more paternity cases were filed in Indiana courts than in any previous year.

In SFY 2000, \$357,002,273 was collected from absent parents to provide support for Hoosier children—more than three and one-half times the \$100.1 million in child support collected in 1990 (Figure 1). The amount of child support collected increased by 36% between 1999 and 2000.

Figure 1. Child Support Collected, Indiana: SFYs 1990-2000

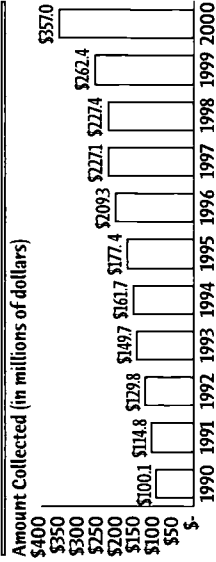

Source of Data: Indiana Family and Social Services Administration.

In FFY 2000, the total number of cases for which paternity had been established in Indiana was 365,076.

The number of paternity cases filed in Indiana courts rose by 8% between CYs 1999 and 2000. There were 15,442 paternity cases filed in CY 2000, up 16% from the 13,290 cases filed in 1999.

Figure 2. Paternity Cases Filed in Indiana Courts: 1989-2000

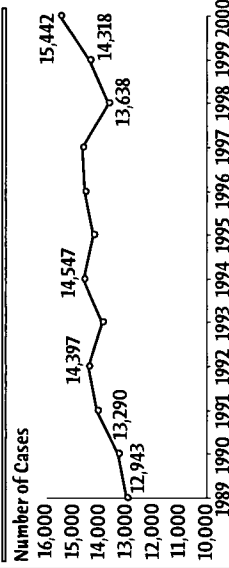

Source of Data: Supreme Court of Indiana, Division of State Court Administration.

The Earned Income Tax Credit (EITC)

Since 1994, the federal government has provided the EITC, a refundable tax credit to ease the tax burden for working Americans with low to moderate incomes. Workers who qualify for the credit may get back some or all of the federal income taxes withheld from their paychecks; workers with incomes too low for withholding may also be eligible for the credit. The maximum credit available differs according to the amount of earned income and the number of children. In tax year (TY) 2000, a household with two children and earnings between \$9,700 and \$12,700 could qualify for a maximum credit of \$3,888. A household with the same earnings, but with one child could receive a maximum credit of \$2,350. Overall, just under 18.8 million working families and individuals received nearly \$31 billion in federal Earned Income Tax credits for TY 1999. Complex changes in the federal tax law for 2001 are expected to provide an increase of \$88 billion in refundable tax relief for low-income families during the next 10 years.⁴ The latest tax year for which comparable state and national data are available is 1999.

In TY 1999, 351,821 Hoosier working families and individuals received \$551,110,000 in federal earned income tax credits; most refunds went directly into Indiana's economy.⁵

The Washington-based Brookings Institution has studied the impact of the EITC in 27 metropolitan areas across the nation, including the Indianapolis region. Their figures are derived from returns filed in 1998 for TY 1997. In the nine-county Central Indiana region alone, 94,342 households (12.9% of all tax returns filed) claimed more than \$146 million in EITCs for 1997. The study concluded the EITC provides significant support for Hoosier families and their communities, but also found many eligible working families failed to claim the benefit, and further, fees paid to tax preparers took a significant proportion of the refund many families received.⁶ The study was conducted before Indiana

replaced the state's "earned income credit" with a refundable earned income tax credit.

Indiana's Earned Income Tax Credit

Beginning with TY 1999, Indiana offered a state earned income tax credit, in addition to the federal credit already available. To be eligible, an individual or couple must have at least one qualifying child in the household and have Indiana income of less than \$12,000 per year (including wages, salaries, tips, net earnings from self-employment, and other employee compensation). At least 80% of the income must be from earnings. The maximum Indiana credit is \$400, and declines as income increases toward \$12,000. In 2001, the Indiana legislature reauthorized this state credit through TY 2003.⁷

 In TY 1999, \$15.9 million in state earned income tax credits were returned to Hoosier taxpayers.⁸

¹ KIDS COUNT 2001 Data Book, p. 70. The estimates for income in 1998 represent averages of data from the Current Population Surveys of 1997, 1998, and 1999, expressed in 1998 dollars. Income was reported for the prior calendar year in these surveys.

² Division of Family and Children, *Demographic Trend Report, State Fiscal Year 2000* (Indianapolis, IN: Indiana Family and Social Services Administration, 2000) pp. 13-17.

³ *Ibid.*, p. 17.

⁴ Greenstein, Robert. *The Changes the New Tax Law Makes in Refundable Tax Credits for Low-Income Working Families* (Washington, DC: Center on Budget and Policy Priorities, June 18, 2001), p. 1.

⁵ Center on Budget and Policy Priorities, *The Earned Income Credit 2001 Outreach Kit* (Washington, DC: Author, 2001).

⁶ Center on Urban & Metropolitan Policy, *Rewarding Work: The Impact of the Earned Income Tax Credit in Greater Indianapolis* (Washington, DC: The Brookings Institution, June 2001), available on Web site at: www.brookings.edu.

⁷ "State Tax Changes Benefit Taxpayers." Press release issued by the Indiana Department of Revenue, February 22, 2000. On IDOR Web site at: www.in.gov/dor/publications/press/pdfs/taxchg.pdf.

⁸ Indiana Department of Revenue, personal communication August 31, 2001.

Child Abuse and Neglect

The rates of child abuse and neglect remain stubbornly and unacceptably high. Nearly three million U.S. children were the subject of nearly two million investigations for maltreatment in 1999, the most recent year for which national data are available. After rising steadily to a rate of substantiated maltreatment of 15.3 per thousand children younger than age 18 in 1993, the national annual rates declined just as steadily, reaching 11.8 per thousand in 1999.¹ (National data for 2000 will not become available until 2002.) Although the number of reports of suspected maltreatment in Indiana fell steadily from a high of 69,458 in SFY 1995 to 42,979 in SFY 2000, the picture of the outcomes of investigations is less clear, and less encouraging (Table 1 and Figure 1).²

Indiana once recorded three outcomes for investigations: substantiated, indicated, and unsubstantiated. Early in 1995, the state eliminated the "indicated" category and outcomes were designated either substantiated or unsubstantiated. Also in SFY 1995, the number of child protection caseworkers was increased and their training strengthened. These changes led to a marked increase in the rate of substantiated cases—up from 12.1 per 1,000 children in SFY 1994 to 17.1 per 1,000 in SFY 1995. The rate declined to 15.9 per 1,000 in SFY 1996, and by 1998 had fallen

markedly to 10.8 per 1,000. The nature of the declining rates was somewhat ambiguous; county offices of the Division of Family and Children (DFC) were using a new computer system and some counties' data were not fully recorded as workers adapted to the new system. Data recording stabilized in SFY 1999. The overall rate of substantiated maltreatment that year rose to 13.9 cases per 1,000 children younger than age 18. The percentages of reported cases of abuse that were substantiated also rose, to 48% in SFY 1999, and of substantiated neglect, to 47% (from 34.0% and 34.4% respectively in SFY 1998). In SFY 2000, both the rate and numbers of children for whom maltreatment was substantiated rose again.³

There were 42,979 reports to offices of the DFC in SFY 2000—a decline of 782 children from the number reported in SFY 1999 (Figure 1).

Of the 15,532 reports of abuse, however, 9,052 were substantiated. Suspected sexual abuse was reported for 6,924 children, of which 4,637 (67%) cases were substantiated. Suspected physical abuse was reported for 8,608 children, of which 4,415 (51%) cases were substantiated. For both types of abuse, 58% of the reports were

substantiated. The number of children for whom abuse was substantiated in 2000 increased by 15.2% over substantiations in SFY 1999.

There were 27,447 reports of suspected neglect in SFY 2000; of these, 15,634—57%—were substantiated. The number of children for whom neglect was substantiated in 2000 also increased—by 19.4%—over substantiations in SFY 1999.

Maltreatment of children varied by age. Nearly 15% of physical abuse victims were younger than age four; 16% were ages 4-6; 37% ages 7-12, and 27% were ages 13-17. Of the sexual abuse victims, just below 5% were younger than age four; nearly 15% ages 4-6; and 30% were ages 7-12, while nearly 40% were ages 13-17. Of the neglect victims, more than 30% were younger than age 4; more than 17% were ages 4-6; more than 31% were ages 7-12 and more than 15%, ages 13-17. (Figures do not total 100% because of rounding and the numbers of victims whose ages were not recorded.)

76% of the victims of maltreatment were white; 19% were African American; one percent were Native American, and fewer than one percent each were Asian/Pacific Islanders or multi-racial. Hispanic children may be of any race, and they are included in the previous percentages. There were 731 Hispanic victims of maltreatment—just under 3% of the total number of victims.

Boys were slightly more likely than girls (53% vs. 46%) to be physically abused, while victims of sexual abuse were overwhelmingly girls (77% vs. 22%). Victims of neglect were nearly evenly divided by gender.

Most physical abuse (64%) and neglect (85%) were perpetrated by the victim's natural parent(s). Children were more likely to be sexually abused by an unrelated individual (52%) or a relative other than a parent or grandparent (12%).

Table 1. Substantiated Cases of Child Abuse and Neglect, Indiana: SFYs 1990-2000

	State Fiscal Year										
	1990	1991	1992	1993	1994	1995 ¹	1996	1997	1998	1999	2000
Noninstitutional Substantiated Cases	6,800	8,606	7,799	7,574	9,357	14,965	14,324	11,127	10,140	13,095	15,634
Neglect	3,845	4,074	3,895	4,061	4,441	4,821	4,136	3,421	2,851	4,088	4,617
Sexual Abuse	2,994	3,735	3,205	3,203	3,845	5,157	4,700	3,556	3,154	3,780	4,415
Rate of substantiated cases per 1,000 children <18	9.1	11.3	10.2	10.0	12.1	17.1	15.9	12.4	10.8	13.9	16.1
Substantiated Cases	32	35	34	23	41	89	125	97	69	106	146
Neglect	110	111	107	136	116	175	147	111	169	215	242
Sexual Abuse	89	88	79	60	55	128	131	197	94	96	142
Total Substantiated cases	13,870	16,649	15,119	15,067	17,855	25,335	23,563	18,419	16,477	21,380	25,196

¹In early 1995, the indicated category of maltreatment was eliminated. This table recalculates abuse and neglect rates for substantiated cases only for all years.

²Source of Data: Indiana Department of Welfare, Annual Reports, SFYs 1990, 1991; Indiana Family and Social Services Administration, Division of Family and Children, Annual Reports SFYs 1992 through 2000.

Figure 1. Reported and Substantiated Cases of Noninstitutional Child Abuse and Neglect, Indiana: SFYs 1990-2000

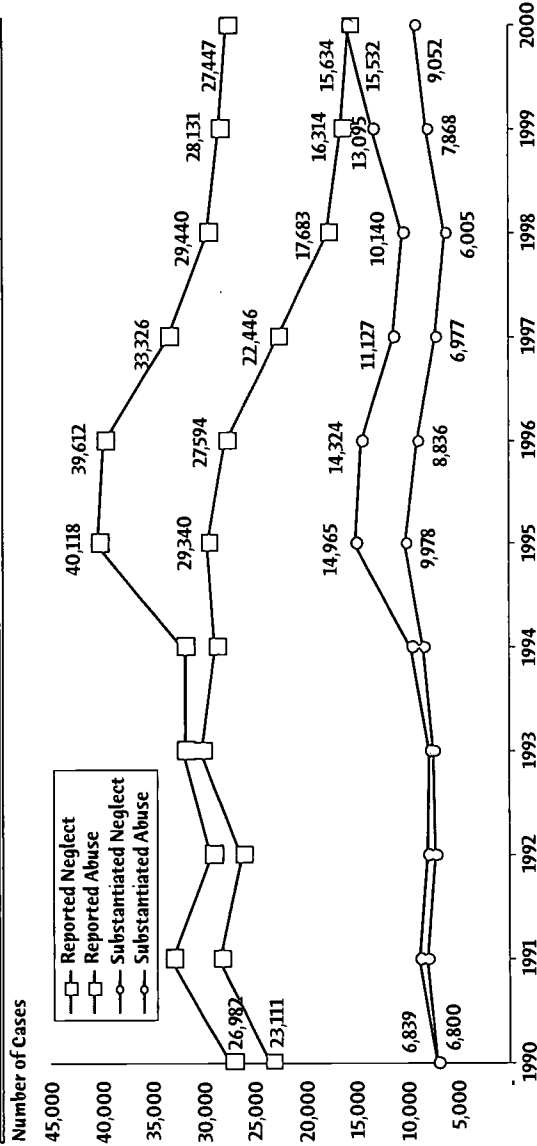

Source of Data: Indiana Family and Social Services Administration, Family Protection and Preservation.

The distribution of victims in SFY 2000 by age, race/ethnicity, gender, and relationship to the perpetrator did not differ substantially from SFY 1999.

Institutional maltreatment

Institutional abuse and neglect is that which takes place when a child is in an out-of-home setting such as a school, child care center, home or ministry, state institution, or foster home responsible for his or her well-being.

There were 384 child victims of substantiated institutional abuse in SFY 2000; of these, 242 (63%) were sexually abused, and 142 (37%) physically abused. Of the 132 substantiated cases of sexual abuse that took place in residential facilities, 81 (61%) were perpetrated by another resident, while a surprising 52 (39%) were perpetrated by a staff member.

Fatalities

There were 45 fatalities from abuse and neglect in SFY 2001—one more than in SFY 2000, but fewer than the all-time high of 65 children who died in SFY 1998. Of the 45 children who died of maltreatment in SFY 2001, 26 (58%) died from abuse and 19 (42%) died from neglect.

Of the 26 abuse victims, 6 (23%) were killed by their natural mothers, and 13 (50%) by their natural fathers. Of the 19 victims of neglect, the child's mother was the perpetrator in 11 (58%) deaths, and the child's father in one (5%) death. There were no deaths in 2001 in which the perpetrator had no relationship to the child victim.⁴

¹ U.S. Department of Health and Human Services, Administration on Children, Youth and Families. *Child Maltreatment 1999* (Washington, DC: U.S. Government Printing Office, 2001).

² Family and Social Services Administration, Division of Family & Children, *Demographic Trend Report: 2000 State Fiscal Year* (Indianapolis, IN: FSSA, 2001).

³ All statistical information about child maltreatment in Indiana is drawn from Section F, the report of the Family Protection/Preservation Bureau, in *Demographic Trend Report: 2000 State Fiscal Year*.

⁴ All statistical information related to child fatalities comes from: Division of Family and Children, "Child Abuse and Neglect Fatality Review: Statistical Overview" (Indianapolis, IN: Family and Social Services Administration, September 14, 2001).

Protecting Indiana's Children

Substitute Care

Substitute care is needed for children who—because of abuse or neglect by their primary caregiver(s) or their own behavior—cannot remain safely in their own homes. At the end of SFY 1999, there were 11,402 children in substitute care; these figures include children declared delinquent. During SFY 2000, 5,220 children entered, while 5,326 left, substitute care. At the end of June 2000, 11,305 young Hoosiers were being cared for outside of their own homes. Nearly half of these children (48%) were living in foster homes.¹

Indiana's Family Preservation Program seeks to prevent the unnecessary separation of families. The most desired outcome for children who have been removed from their own homes is safety, and when deemed prudent, reunification. In SFY 2000, 1,745 children (32.8%) returned to their own homes while an additional 216 (4.1%) were placed permanently with relatives. There are many children who cannot return to their own homes who still experience multiple substitute care placements once they have left their own families.

Adoption

The federal Adoption and Safe Families Act of 1997 (P.L. 105-89) was passed to promote permanency planning. The law clarifies that the child's health and safety are to be paramount in the decisions related to removal or reunification. The federal law also established incentive payments to states in which adoptions of foster children in the current fiscal year exceed those in any previous fiscal year after FY 1996. States are required to file a petition to terminate parental rights when a child has been in substitute care for 15 of the more recent 22 months, the child has been abandoned as determined by the courts, or the parent has assaulted the child or killed or assaulted another child in the home.²

Before a child becomes available for adoption, the rights of the parents must be terminated by court action. The number of termination of parental rights cases filed in

Indiana courts increased steadily between CYs 1995 and 1999—to 1,816—but declined in CY 2000 to 1,637 (Figure 1).³

In SFY 2000, 1,118 adoptions of children in state care were finalized in Indiana.

The Special Needs Adoption Program (SNAP). This public/private partnership program to promote adoption of children with special needs was implemented in 1989. "Special needs" include factors such as racial or ethnic background, age, membership in a minority sibling group, a medical condition or physical, mental, or emotional handicaps. The Children's Bureau of Indianapolis coordinates the publication of the *My Forever Family* book containing photographs and information about children available for adoption. Additional outreach efforts to potential adoptive parents include the internet, the adoption "hotline," and media campaigns. In CY 1999 alone, the Division of Family and Children received 10,365 inquiries about adoption.

In CY 1999, 1,133 children were placed in adoptive homes—an increase of nearly 19% over the 954 placements made in CY 1998—and another all-time high for Indiana. Adoptions were finalized for 1,014 "SNAP" children in CY 1999.

Figure 1. Termination of Parental Rights Cases Filed in Indiana Courts: 1995-2000

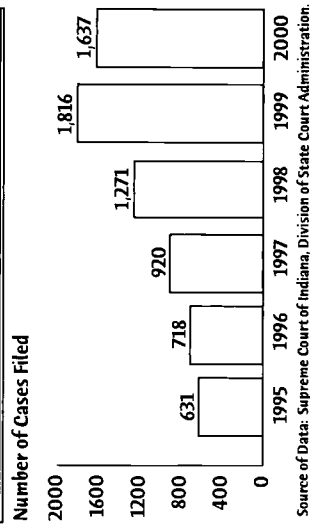

Between CYs 1990 and 1999, a total of 5,168 "special needs" children were placed in adoptive homes. In 1999, an additional 1,193 children were awaiting termination of parental rights.

Programs to help prevent maltreatment

Healthy Families Indiana (HFI)

This voluntary program—a collaborative project of the Indiana State Department of Health, the Criminal Justice Institute, the Division of Mental Health, the Division of Family and Children, the Children's Trust Fund, Prevent Child Abuse-Indiana, and numerous community-based organizations—serves families in all 92 counties whose children may be at risk for abuse and/or neglect. HFI is designed to improve family coping skills and functions, encourage positive parenting skills and parent-child interaction to promote optimal child development, and to prevent child maltreatment.

In FFY 2000, some 9,600 families received services through Healthy Families Indiana, an increase of 7% over the 9,000 families served in 1999.⁴

The Children's Trust Fund (CTF)

Indiana created the CTF in 1994 with revenues from the sale of "Kids First" license plates. The CTF supports community-based programs that promote the well-being of all children as well as programs targeted to families at particular risk for abusing and/or neglecting their children. As the number of special license plates has proliferated, CTF has received a smaller share of revenues from sales.

For SFY 2000, CTF provided 66 projects with \$2.6 million in support; in SFY 2001, 69 projects were awarded \$2.2 million, and in SFY 2002, 83 programs were awarded \$2.4 million.⁵

"Heirloom" birth certificates were introduced in 1997, and revenues from sales were designated to support, develop, and operate programs that address infant mortality. Birth certificate revenues have been disappointingly low; to date, no grants have been made from this fund.

Children at "high-risk"

The Annie E. Casey Foundation has developed a KIDS COUNT "Family Risk Index" to estimate the number of children who are potentially at high risk for negative outcomes—only one of which would be maltreatment. The index represents the percentage of children living in families that have four or more of the following characteristics:

- ☐ child is not living with two parents,
- ☐ household head is a high-school dropout,
- ☐ family income is below the poverty line,
- ☐ child is living with parent(s) who is/are underemployed,
- ☐ family is receiving welfare benefits, and
- ☐ child does not have health insurance.

Indiana made marked improvement in the percentage of children falling into the "high-risk" category based on this index between 1990 and 1999: from 12% to 6%, a reduction of 50% (Figure 2).⁶ Only two states, South Dakota and Wisconsin, had smaller percentages (5%) of children estimated to be at high risk. Still, use of the index estimates that 99,000 children in Indiana may live in circumstances that place them at high risk.

Figure 2. Percentage of Children at High Risk, Indiana: 1990-2000

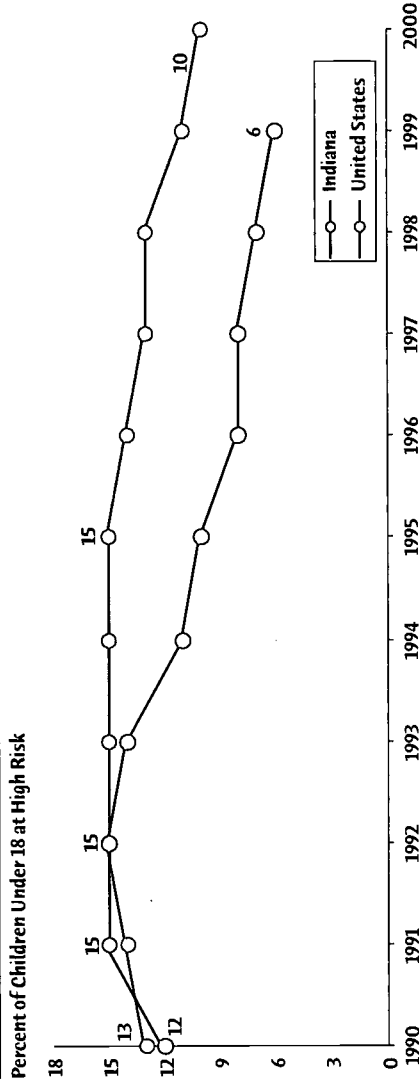

Source of Data: The Annie E. Casey Foundation

¹ All statistical information about substitute care and adoption in Indiana is drawn from Section F of the *Demographic Trend Report, 2000 State Fiscal Year*.
² *Ibid.*, pp. 105-123.
³ Division of State Court Administration, *2000 Indiana Judicial Report*. Vols. I-III (Indianapolis IN: Supreme Court of Indiana, 2001).
⁴ Indiana Family and Social Services Administration, Division of Families and Children, personal communication.
⁵ Indiana Family and Social Services Administration, Press Release: "O'Bannon announces \$2.39 million in child abuse prevention grants from 'Kids First' license plates sales," May 3, 2001.
⁶ Annie E. Casey Foundation, "High-Risk Kids in America During the 1990s," A KIDS COUNT Working Paper (Baltimore, MD: Annie E. Casey Foundation, 2001). The annual percentages represent a 3-year moving average of the index calculated from the U.S. Census Bureau's Current Population Survey reports.

Early Childhood Education

In 2000, 62.3% of Indiana families with children under the age of six had all parents in the workforce.¹ As a result, three out of five young children spend some or all of their day being cared for by someone other than their parents. As the number of mothers entering the workforce continues to increase, the need for high-quality, affordable, and accessible child care will also continue to grow.

Educare

The Educare program is administered by the Bureau of Child Development in the Indiana Family and Social Services Administration (FSSA) and subsidizes child care for children younger than age 13 living in working families with incomes of 85% or less of the state median income. Educare is funded through the Social Services Block Grant (SSBG), Temporary Assistance for Needy Families (TANF), Child Care and Development Funds (CCDF), and School Age Child Care Funds. Educare funds are available for eligible families in all 92 counties and are administered through the voucher and child care contracts system. In Indiana, 78,788 children received services through Educare in SFY 2000.²

New legislation passed in 2001 outlines eight minimum requirements all child care providers must meet in order to receive vouchers from the state for subsidized child care. Beginning July 1, 2001, all child care providers who receive state vouchers must:

- ☞ have a working smoke detector,
- ☞ have an annual TB test and provide the results to the voucher agent,
- ☞ have a written emergency plan available to parents,
- ☞ maintain current certification in infant/child CPR and First Aid,
- ☞ have a working telephone,
- ☞ have monthly documented fire drills,

- ☞ lock up all firearms, ammunition, poisons, chemicals, bleach and cleaning materials, and
- ☞ provide a criminal history check for the provider and all adults who are residents of the provider's home.³

Licensed and Registered Child Care

As the need for out-of-home child care has grown, the number of licensed child care centers, homes, and registered ministries increased. Between SFY 1990 and 2000, the number of licensed child care centers increased 12%, the number of licensed child care homes increased by 107% over the same period of time (Figure 1).⁴

- ☞ Licensed child care centers are nonresidential buildings in which child care services are provided for more than 10 consecutive work days. The maximum number of children cared for in each center is determined by the square footage of the facility and the number of caregivers. In SFY 2000, 62,482 children were cared for in 685 licensed child care centers.

- ☞ Licensed child care homes provide care for up to 12 children in a residential setting (homes that provide care for five or fewer unrelated children are license-exempt). In SFY 2000, 3,515 licensed child care homes cared for 40,247 children.

- ☞ Registered child care ministries are facilities operated by a church or religious organization exempt from federal taxation. These facilities may choose to become licensed centers, but are not required to do so. In SFY 2000, there were 504 registered child care ministries. Information on the number of children cared for in child care ministries is not available.

Recent legislation has addressed the need for licensed providers to maintain certain standards in Indiana. Senate Bill 110, passed by Indiana's General Assembly in 2001, sets higher educational standards for licensed child care providers in Indiana by requiring all new licensed providers in homes and centers to have a high school diploma or GED. In addition, licensed providers are required to complete a Child Development Associate credential (CDA) or the equivalent of an associate's degree in Early Childhood Education.

Figure 1. Number of Licensed Child Care Homes and Centers, Indiana: SFYs 1990-2000

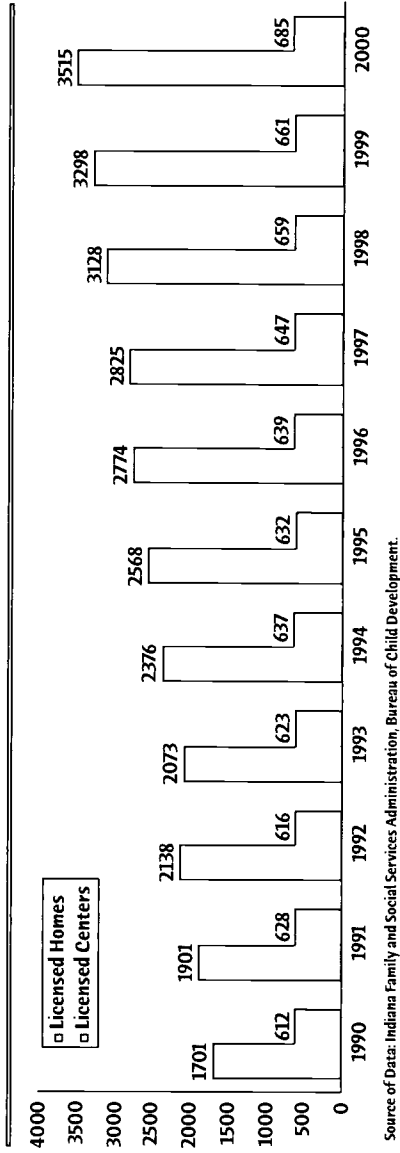

Source of Data: Indiana Family and Social Services Administration, Bureau of Child Development.

Senate Bill 110 also reinstates state licensing of Class II child care homes. If providers meet certain eligibility requirements, Class II licensure allows for them to care for up to 16 children in a residential setting. Class I homes, which have been previously allowed to care for up to 12 unrelated children, are now allowed to care for up to three additional school-age children during breaks from school if they meet certain provisions specified in the bill.⁵

Head Start and Early Head Start

Head Start and Early Head Start are federally funded programs that provide comprehensive developmental services to children ages birth to two (Early Head Start) and three to five (Head Start) and their families. The majority of children in Head Start and Early Head Start are from low-income families. These programs provide extensive health, nutritional, educational, social and other services to help children achieve their full potential. In Indiana, every county is served by a Head Start grantee.

☞ In SFY 2000, the funded capacity of Head Start increased to 12,678, from serving 11,170 children in SFY 1999.

☞ Early Head Start programs, although not available to all Indiana counties, served 608 children in SFY 2000.⁶

First Steps

First Steps is a locally-based coordinated system to provide services to infants and young children age two to three with disabilities or who are developmentally vulnerable. First Steps services include special instruction, physical therapy, transportation, respite care, assistive technology, nursing and health services, and nutritional assistance. In SFY 2000, 11,737 children received services through First Steps.⁷

T.E.A.C.H. Indiana

Introduced in 1998, T.E.A.C.H. provides scholarships for increased educational opportunities for Indiana's child care workers. Teachers, directors, and other providers are given financial assistance in order to work toward a CDA credential or an associate's degree in Early Childhood Education. Scholarship recipients also receive increased compensation in the form of a raise or bonus when they accomplish their educational goal. Since June 1999, T.E.A.C.H. has provided scholarships for more than 778 child care providers in 76 different counties.⁸

¹ 2000 Supplemental Census, U.S. Census Bureau.

² Indiana Family and Social Services Administration, Division of Family and Children, *Demographic Trend Report, State Fiscal Year 2000* (Indianapolis, IN: 2000).

³ *Digest of Senate Bill 110*, April 29, 2001. Available on the internet at www.state.in.us/serv.

⁴ Indiana Family and Social Services Administration, Division of Family and Children, *Demographic Trend Report, State Fiscal Year 2000* (Indianapolis, IN: 2000).

⁵ *Digest of Senate Bill 110*, April 29, 2001. Available on the internet at www.state.in.us/serv.

⁶ Indiana Family and Social Services Administration, Division of Family and Children, *Demographic Trend Report, State Fiscal Year 2000* (Indianapolis, IN: 2000).

⁷ *Ibid.*

⁸ *Ibid.*

Indiana's Schools, Grades K-12

State aims for education

In April 2001, the Department of Education adopted the following aims for education in Indiana:

- ▢ safe and caring schools,
- ▢ high standards, assessments, and accountability,
- ▢ a system preparing high-performing, responsible, and responsive citizens,
- ▢ high student achievement, and
- ▢ effective use of resources.

The Indiana legislature passed a series of laws (P.L.146-1999, P.L.193-1999, and P.L.221-1999) in 1999 that spell out higher standards, school improvements and enhanced accountability policies.¹ A permanent body and working group called the Education Round Table has been appointed by the governor and the superintendent of public instruction to make recommendations on academic standards and on the content and format of the ISTEP examination program. Indiana is now debating the recommendations of the Education Round Table as well as the study of the state's standards. completed by Achieve, Inc. in January 2000.² Indiana's academic standards are among the strongest in the nation.³

In October 2001, the Indiana State Board of Education set requirements for placing Indiana's schools into five performance improvement categories as required by P.L. 221. They are:

- ▢ exemplary progress,
- ▢ commendable progress,
- ▢ academic progress,
- ▢ academic watch/priority, and
- ▢ academic probation/high priority.

The new accountability procedures will be implemented gradually and the plan will be fully operational in 2005.⁴

To assist with monitoring school progress and accountability, P.L. 221 permits Indiana to assign identification numbers to individual students for the first time. In the fall of 2001, some of the state's third-

graders will be the first to receive the nine-digit IDs in a voluntary trial program. By the beginning of SY 2003-04, all students will have unique numbers that will stay with them throughout their careers in Indiana's public and accredited non-public schools.⁵ The new tracking system will facilitate better record-keeping at all levels of administration and make feasible, accurate compilations of heretofore rather fuzzy statistics in important areas such as ISTEP+ test-retest passing rates, and student dropout and graduation rates.

Enrollment

In SY 1999-2000, there were 1,125,834 students enrolled in Indiana's schools. Table 1 compares student population figures for SYs 1994-95, 1998-99, and 1999-00.⁶ Public school enrollment (including children in pre-kindergarten) increased by just over two percent in five years, while enrollment in state-operated schools⁷ declined by nine percent. Non-public school enrollment grew by nearly 9.6%, but the number of home schooled students increased by 308%.⁸ Public school enrollment in grades K-12 only, was 983,090 in SY 1999-2000.

Table 1. Enrollment in Grades K-12 by Type of School, Indiana: SYs 1994-95, 1998-99, 1999-2000

Type of School	School Year			% Change between SYs 1994-95 and 1999-2000
	1994-1995	1998-1999	1999-2000	
Public schools*	968,357	988,064	988,691	2.1
State-operated schools	1,249	1,831	1,136	-9
Non-public schools	105,905	118,621	116,066	9.6
Home schools	4,880	17,699	19,941	308.6

*Enrollment figures include children in pre-kindergarten.

Source of Data: Indiana Department of Education.

Ethnic diversity

The racial/ethnic composition of the student bodies within Indiana's public school corporations varies widely, but overall, Hoosier students are predominantly white. This is even more true of those who teach them and administer their schools. The student enrollment figures for SY 1999-00 reflect the growth of the Hispanic population of the state. Although the proportion of

African-American students has remained essentially the same since SY 1994-95, the number of African-American school personnel declined slightly (Table 2). In general, teachers and administrators continue to be less diverse than their students.⁹

Table 2. Racial/Ethnic Composition of Public School Students and Teachers/Administrators, Indiana: SYs 1994-95 and 1999-2000

Racial/Ethnic Group	1994-95 School Year		1999-2000 School Year	
	Students %	Teachers Admin. %	Students %	Teachers Admin. %
White	85.67	94.01	82.35	94.64
African American	11.2	5.27	11.5	4.57
Asian/Pacific Islands	0.8	0.17	0.97	0.17
American Indian	0.17	0.09	0.21	0.03
Multi-racial	N/A	N/A	1.52	0.02
Hispanic	2.17	0.46	3.46	0.56

Source of Data: Indiana Department of Education.

Expenditures

Spending for Indiana's public schools (including transportation and federal grant expenditures) rose to more than \$6.1 billion in SFY 2000—an increase of 4.6% over expenditures in SFY 1999 and an increase of 30% over spending in SFY 1995. In that five-year period, tuition support for regular instruction rose by 26.6%, while expenditures for special education rose by 63.9%. There was also a five-year increase of 184.3% in tuition support for "at risk" students. Spending for ISTEP+ remediation was increased by 87.5% to nearly \$21.5 million. An additional \$5 million was spent on remediation for high school students who failed the Graduation Qualifying Examination.¹⁰

Statewide, the per pupil expenditure rose as well, to \$6,698 in SFY 2000, up 3.8% from SFY 1999 and up 25.9% from \$5,322 in SFY 1995. Per pupil expenditures vary considerably from one school corporation to another depending on local resources, and from one student to another, depending on identified educational needs.¹¹



Alternative schools

Alternative school programs received a boost when the Indiana General Assembly amended the Indiana Administrative Code in 1997. Alternative education has expanded options for students in grades 6-12. Students are eligible for alternative public education if they have withdrawn from school or intend to do so; do not comply academically and would benefit from a different type of instruction; are parents or expectant parents, are employed and their wages are necessary for their own support or the support of their immediate families; or are "disruptive" students whose own behavior affects their learning in regular classrooms. Most programs offer students more individualized instruction using alternative teaching and learning strategies. In the past year, there has been greater emphasis on alternative schooling for middle school students. Schools are also doing more to keep students in these programs until they can either return to regular classrooms or graduate from high school.²

➤ 253 alternative education programs in 72 counties received operating grants from the Department of Education in SY 2000-01.

➤ 31,454 students received education in alternative programs in SY 2000-01.

Home Schooling in Indiana

Home schooling continues to be an increasingly popular option for Hoosier families. In Indiana, participation of home schooled students in public school classes and extra-curricular activities may take place with the permission of the school superintendent. If a student is enrolled in a public school by the time the official student count is taken in September, the public school will receive state funding for that student based on the number of classes taken. Although Indiana law does not require ISTEP + or other testing for home schooled students, the Department of Education does recommend periodic, standardized achievement testing.

➤ The final estimate of the number of Indiana's home schooled students in SY 1999-2000 was 19,941 – up 13% from the previous year, and representing a ten-fold increase since the 1991-92 school year.

Making an accurate count of home schooled students continues to be a challenge for the Indiana Department of Education. Some home-schooled children never enter public or private schools and remain unidentified, while others transfer or re-enter schools, or are withdrawn completely without reporting the change to the local superintendent as required by law.¹³

Charter Schools

Public Law 100-2001, sec. 21 passed by the legislature in its 2001 session makes possible the establishment of charter schools in Indiana school corporations.¹⁴ A "charter school" is a public school that is nonsectarian and nonreligious, and operates under a charter, that is, a written contract between an organizer and a sponsor. The "organizer" must be a group or an entity that has been determined by the Internal Revenue Service to be operating under not-for-profit status or has applied for such determination; a "sponsor" must be one of the following: (a) a governing body,¹⁵ (b) a state educational institution that offers a four-year baccalaureate degree, or (c) the executive of a consolidated city. An existing school may be converted to a charter school.¹⁶

According to the law, a charter school may be established to provide innovative and autonomous programs that do the following:

- serve the different learning styles and needs of public school students,
- offer public school students appropriate and innovative choices,
- afford varied opportunities for professional educators,
- allow public schools freedom and flexibility in exchange for exceptional levels of accountability, and,
- provide parents, students, community members, and local entities with an expanded opportunity for involvement in the public school system.

Charter schools are subject to all federal and state laws and constitutional provisions that prohibit discrimination on the basis of disability, race, color, gender, national

origin, religion or ancestry.¹⁷ In passing this legislation, Indiana has tried to learn from both the successes and failures of other states' experiences in chartering and monitoring these innovative public schools. It is expected that Hoosier children will have the option of attending the state's first charter schools in 2002.

¹ Standards, Assessment, School Improvement, and Accountability, PL.146-199, PL.193-1999, and PL.221-1999. Provide for additions and revisions of Indiana Code, Section 20.

² Achieve, Inc., *Measuring Up: An Achieve Standards and Benchmarking Report for Indiana* (Washington, DC: Author, January 2000).

³ Achieve, Inc., *Benchmarking to the Best: Raising Achievement in America's Schools, 2000 Annual Report*. On Web site: www.achieve.org.

⁴ Indiana Department of Education, "Indiana State Board of Education Sets Requirements for School Categories." Press release, October 4, 2001.

⁵ Indiana Department of Education, "Implementation of Public Law 221: Use of Student Identification Numbers. Memorandum to school administrators from Dr. Steve Grimes, Assistant Superintendent, June 13, 2001.

⁶ Indiana Department of Education, "Education in Indiana: Facts & Statistics" (Indianapolis, IN: author, 2001).

⁷ State-operated schools include such institutions as the Indiana School for the Deaf and the Indiana School for the Blind; the Indiana Soldiers' and Sailors' Children's Home, schools in juvenile correctional facilities, and others for groups of children with special needs.

⁸ "Education in Indiana," August 2001.

⁹ *Ibid.*

¹⁰ *Ibid.*

¹¹ *Ibid.*

¹² Indiana Department of Education, Division of Alternative Education and Learning Opportunities, 2001. Student eligibility for alternative education defined in IC 20-10, 1-4, 6-63.

¹³ Indiana Department of Education, "Education in Indiana: Facts & Statistics" (Indianapolis, IN: Author, 2001). Additional information about home schooling may be found on the Indiana Department of Education Web site at www.doe.state.in.us/services.

¹⁴ Article 5.5 of the Indiana Code outlines the provisions of PL. 100-2001, sec. 21.

¹⁵ A "governing body" is any township trustee and the township board of a school township, any board of school commissioners, any metropolitan board of education, any board of trustees or any other board or commission charged by law with the responsibility for administering the affairs of a school corporation. IC 20-10-1-1-5.

¹⁶ IC 20-5-5-1, Chapter 1, Definitions.

¹⁷ IC 20-5-5-2, Chapter 2, Descriptions.

Test Scores in Indiana

The National Assessment of Educational Progress (NAEP)

In 1969, the U.S. Department of Education began to make periodic assessments of student performance through administering NAEP examinations in selected subject matter in grades 4, 8, and 12. Since 1990, state-level assessments have also been conducted, using separate representative samples of students from each participating state. Indiana 4th-grade students participated in a state-level assessment of mathematics in 1992, 1996, and 2000; Hoosier 8th-graders participated in these assessments and in 1990 as well. Each time they have participated in NAEP, Indiana students have increased their scores from the previous test administration and have done better than students in the nation as a whole (Figure 1). Student math performance is reported as an average score that ranges from 0 to 500.¹ Indiana's NAEP 2000 math scores are particularly encouraging and reflect the ongoing efforts of students, teachers, and parents to improve academic preparedness.

Grade 4

Fourth-graders in Indiana earned an average NAEP math score of 234—above the national average score of 226. Indiana's scores were the second highest achieved by any state, tying with Connecticut for second place (Massachusetts and Minnesota tied for first place, both with scores of 235). Mathematics performance is reported at three achievement levels: Basic, Proficient and Advanced. Indiana's students were again ahead of national averages: 78% of Hoosier 4th-graders (vs. 67%) scored at the basic level or higher; 31% (vs. 25%) achieved the Proficient level; and, 3% (vs. 2%) achieved scores at the Advanced level. Less than a fourth (22%) of Indiana's 4th-graders (vs. 33% nationally) had scores below Basic level, but this means there is work still to be done.

Figure 1. NAEP Mathematics Scores, Indiana and U.S.: 1990, 1992, 1996, and 2000

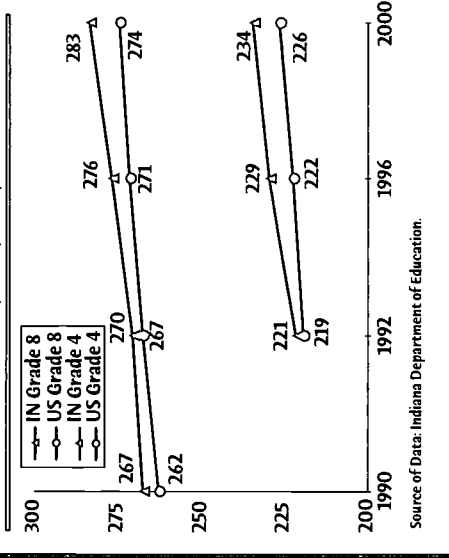

Grade 8

Indiana's 8th-graders also performed very well on the NAEP 2000 mathematics exam, with the fourth highest score of 283, placing them above the national average of 274. Indiana's 8th-grade scores tied with those of Massachusetts, North Dakota, Ohio, Vermont, and Connecticut (Minnesota, Montana, Kansas, and Maine had higher scores than Indiana). More than three-fourths (76%) achieved scores at the basic level or higher (vs. 65% nationally); 31% (vs. 26%) were scored as Proficient; and 5% (also 5% nationally) received scores qualifying for the Advanced level. As was true for 4th-graders, however, just under a fourth (24%) of Hoosier 8th-graders scored below the Basic level (vs. 35% nationally).

College entrance examinations

Most college-bound students take standardized entrance examinations. Although some schools have stopped requiring test scores, a majority of colleges and universities continue to consider the test scores of applicants in making admission and scholarship decisions, academic advising, and course placement.

The two most widely used entrance examinations are the SAT, first given in 1941, and the ACT, first given in 1959. The SAT has two parts, verbal and mathematics, each of which has a perfect score of 800. Scores on the two portions of the test are summed to yield a maximum composite score of 1600. The ACT is scored on a scale of 1 to 36. The composite score is based on subscores in four academic areas: English, reading, mathematics, and science reasoning.

The scores of individual students on both examinations are sensitive to many variables—among them: household income; parental educational attainment; race/ethnicity; type, location, and size of school attended; rigor of high school coursework completed; and grades earned. In addition, a state's aggregated scores are strongly affected by the percentage of its students who take the test. The students who take these examinations are self-selected, and the College Board (SAT) and ACT strongly advise against making state-by-state comparisons. The practice continues, however.

The SAT^{®2}

In 2000-2001, more than 45% of the nation's high school graduates—1,276,320 in all—took the SAT. The 41,424 students from Indiana represented 60% of the state's graduating Class of 2001; they achieved a total score of 1000, compared with the national average of 1020. Compared with scores for the Class of 2000, the 2001 average of Indiana students' verbal test scores increased by one point to 499; math test scores remained the same for both years at 501. National scores averaged 506 for the verbal test (also up one point) while math scores, at 514, remained the same as for the previous class. Indiana's increasing diversity and the high percentage of students taking the SAT have been deemed factors in the state's SAT scores. Although racial/ethnic diversity has increased in recent years, Indiana's schools remain considerably less diverse than those in the nation as a whole. Fourteen states had greater participation than Indiana in the SAT in 2001. The average verbal score for these states was 503.9 and mathematics, 504.4 — higher than Indiana's. The state's five-year gain of five points on the verbal score and seven points on the math test scores outpaced the improvement for the group of states with higher participation in 2001 (1.5 and 6.9, respectively). During the past 10 years, Indiana's average scores increased by 14 points on the verbal test and 16 points on the math test—greater than the national increases of 7 and 14 points on the two parts of the test, respectively.

The ACT³

The national average composite score on the ACT, taken by 1,069,772 students in the graduating class of 2001 (38%), remained unchanged at 21.0 for the fifth year in a row. The composite score for the 20% of Indiana's students who took the test also remained the same as in 2000, at 21.4. Consistently, Indiana students have achieved composite scores above the national average. If the proportion of graduating students were the major factor in determining scores, it would be expected that

states with lower participation would have higher scores. In 17 states, fewer than 20% of the students took the ACT; the average composite score for these states was 21.3—below Indiana's composite score of 21.4.

¹ National Center for Educational Statistics, "What is NAEP," "NAEP Scale Scores," and "NAEP Performance Categories" from the NAEP State Mathematics 2000 Report (Washington, DC: U.S. Department of Education, 2001) on the Web at nces.ed.gov/nationsreportcard/, viewed 8/29/01. Additional information about NAEP performance in Indiana is in "4th graders score second highest, 8th graders fourth in national math tests." Press release from the Office of Governor Frank O'Bannon, August 2, 2001. On the Web at: ideanet.doe.state.in.us/reed/newstr/2001August/NAEP%20News%20Release.htm.

² Information about the SAT comes from the national and Indiana reports: 2001 College-Bound Seniors: A Profile of SAT Program Test (Princeton, NJ: The College Board, 2001). These materials are available on the College Board Web site at www.collegeboard.org, viewed 8/28/01.

³ Information about the ACT was drawn from ACT High School Profile Report, H.S. Graduating Class of 2001. State Composite for Indiana and National Reports (Iowa City, IA: ACT, 2001). Also: ACT, "ACT Average Composite Score Steady for Fifth Straight Year," National Press Release, August 15, 2001; "ACT Average Composite Scores by State." Available on the ACT Web site at www.act.org/news, viewed 8/24/2001.

High-School Graduation

The public school graduating Class of 2000 received 56,999 diplomas. Of these, 45.7% of the students received regular diplomas, 23.5% academic honors diplomas, and the remaining 30.8%, Core 40 only diplomas. These figures include 2,691 students who graduated following a regular appeal waiver and 110 who received a Core 40 waiver. The number of students awarded diplomas declined by three percent from the previous year. An additional 864 students in the Class of 2000 received Certificates of Achievement—a figure 76% higher than in the Class of 1999 and 137% higher than in the Class of 1995. The number of students ages 19 and younger earning GEDs also increased—by four percent between 1999 and 2000, and by 106% between 1995 and 2000.¹

To calculate the graduation rate, the Indiana Department of Education (IDOE) uses methodology employing an “odds ratio” that a 9th-grade student will graduate from high school four years later. In SY 2000, students who graduated during the summer were included in the total numbers.

The IDOE reports a graduation rate for the Class of 2000 of 89.0%, down from 89.5% for the Class of 1999 and from 89.7% for the Class of 1998.

A simpler estimate of student progression through the state’s public high schools is obtained by dividing the number of graduates by the number of students who were enrolled in Grade 9 four years earlier. The state and county data pages provide these figures as the “percent of freshman class graduating in four years.” This measure has been calculated by IYI. It does not calculate student transfers in and out of the state or county, students transferring in and out of private or home schools, incarcerated students, deaths, or those who graduated in less than four years, earned a GED, or entered college without a high-school diploma.

The number of public school graduates in SY 1999-2000 represents 68.3% of the number of students enrolled as freshman in SY 1996-97.

The Graduation Qualifying Examination (GQE)

Indiana was one of 18 states in which high-school graduation is contingent on passing a statewide exit examination in SY 2000-01; six additional states are expected to add an exit examination requirement between 2002 and 2008.² Members of the graduating Class of 2000 were the first required to demonstrate they had acquired the 9th-grade skills assessed by the GQE. They first took the test in the fall of 1997 and at that time, 54% met the standards in both mathematics and English/language arts. By the spring of 2000, an additional 32% of the students hoping to graduate had passed both parts of the examination (94% had passed the English/language arts portion, and 89% had passed the math portion). The estimates are based on the number of Grade 10 students tested in Fall 1997.³ By the time the Spring 2001 GQE results were announced, 93.7% of the class had met the GQE standards, 4.6% had earned a diploma via the appeal process, and 0.2% via the Core 40 waiver. Only 1.5% of the Class of 2000 who have completed all necessary course requirements must still pass the GQE to receive their diplomas.⁴

Although sued by the Indiana Civil Liberties Union (ICLU) on behalf of the students with disabilities who had not passed the GQE, the Department of Education remained firm that all students had to pass the exam or obtain a waiver as outlined in P.L.146. The court agreed, saying that providing remediation would be better than throwing out the test results. The ICLU appealed the decision, and again lost. At the time this report was completed, the ICLU was waiting to hear whether or not the Supreme Court of Indiana would hear the case.

The first-time passing rate for the GQE has increased among each succeeding class of 10th graders taking the exam. While 54% of the Class of 2000 passed both parts of the exam the first time it was administered in 1997, 55 % of 10th-

graders passed in 1998, and 57% passed in 1999. The final figures for the Classes of 2001 and 2002 were not available at the time this report was written.

¹ “Education in Indiana,” August 2001.

² Boser, Ulrich. “Pressure Without Support; States have forged ahead with accountability systems, but not the infrastructure to support them,” *Education Week*, Vol. 20, No. 17, January 11, 2001, pp. 68-84.

³ “Statewide ISTEP + Results Announced.” Press release from the Indiana Department of Education, February 6, 1998; “Spring 2000 Graduation qualifying Exam (GQE) Results,” Press release from the Indiana Department of Education, May 22, 2000. On IDOE Web site at: www.state.in.us/read/newsr/00May/.

⁴ “Spring 2001 Graduation Qualifying Exam (GQE) Results.” Press release from the Indiana Department of Education, June 29, 2001. On IDOE Web site at: www.state.in.us/read/newsr/2001June/.

Educating Special Populations

Federal and state laws establish the right of every child to receive a free and appropriate education, in the least restrictive environment possible. Both nationally and in Indiana, special education services have been made available to increased numbers of students with disabilities; the costs of providing these services have continued to increase as well. Some of the escalating numbers reflect expanded eligibility criteria and the development of better strategies for identifying and serving children with special needs. Beyond this, however, there may simply be more of them to identify and serve. As medical technologies have improved, for example, children are surviving conditions related to low birthweight and injury in greater numbers, enabling them to participate in regular classrooms. Indiana schools have also identified and provided services to more emotionally handicapped students. The Division of Special Education predicts the same factors that have led to recent increases will be sustained over the next three to five years, and that the numbers of students requiring special education services will continue to grow.¹

The unduplicated federal count of students receiving special education services reached 155,206 in 2000-01, a figure that includes students ages three through 21 attending Indiana's public schools. The number of special education students increased by 3.1% from the previous year, and by 47.9% from a decade earlier. Overall public school enrollment increased by .18% and 3.7% in the same periods, respectively.

In 1990-91, just over 11% of public school students received special education services. By 2000-01, 15.7% of the students were receiving services.

Some of the increased need for special education services relates to slow or no progress in meeting those Healthy People 2000 environmental and behavioral goals in areas which research has shown to be related to children's physical disabilities, developmental delays, and learning problems. These factors include: inadequate maternal and child nutrition, inadequate prenatal care and low birthweight, maternal use of alcohol, tobacco and other drugs during pregnancy, inadequate health care (whether by choice or inaccessibility), poor parenting skills and teen parenthood, as well as exposure to environmental hazards such as lead, mercury, and other toxins.²

¹ The rights of disabled students are guaranteed by the federal Americans with Disabilities Act, Section 504 and in Title II (Student Placement in Elementary and Secondary Schools). These rights are further spelled out in the Indiana Administrative Code at 511 IAC 7-17-36 and 511 IAC 7-27-9, effective June 21, 2000. The Division of Special Education of the Indiana Department of Education prepared a report for hearings held during the 2001 legislative session that outlined issues related to increases in the special education child count: "Child Count Review and Analysis," December 1, 2000.

² U.S. Department of Health and Human Services. *Healthy People 2010*. 2nd ed. With Understanding and Improving Health and Objectives for Improving Health. 2 vols. (Washington, DC: U.S. Government Printing Office, November 2000); Institute for Southern Studies, *Gold and Green Report*, 2000. On ISS Web site at: www.southernstudies.org; viewed 8/30/01; Indiana State Department of Health, Data Analysis Team, *Indiana Health Behavior Risk Factors*, 1998; *Indiana Health Behavior Risk Factors*, 1999. On ISDH Web site: www.state.in.us/isdh/dataandstats/brfss. Indiana State Department of Health, Data Analysis Team, 1999 *Indiana Natality, Induced Termination of Pregnancy/Marriage Report*. CD-ROM version, May 2001.

Table 1. Growth of Special Education in Public Schools, Indiana: SYs 1990-91 and 2000-01

Exceptionality Area	1990-1991	2000-2001	Percent Change
Mental handicap	16,157	23,215	43.7
Hearing impairment	819	1,650	101.5
Communication disorder	38,918	47,146	21.1
Visual impairment	335	709	111.6
Emotional handicap	5,086	11,893	133.8
Orthopedic impairment	507	1,689	233.1
Other health impairment	N/A	3,945	—
Learning disability	42,441	59,421	40.0
Dual sensory impairment	29	23	-6.0
Multiple handicap	480	1,368	185.0
Traumatic brain injury	N/A	525	—
Autism	136	3,071	2,158.1
Developmental delay	N/A	551	—
TOTALS	104,908	155,206	47.9
SCHOOL ENROLLMENT	953,203	988,691	3.7
% of All Students	11.01%	15.70%	—

Source of Data: Indiana Department of Education, Division of Special Education.

Postsecondary Education

While a high school diploma now represents a minimum standard for well-paying work, most jobs require postsecondary training or education. Indiana's adults have a relatively low level of postsecondary educational attainment. The most recent estimates from the U.S. Census Bureau showed that only 19.9% of Hoosier adults aged 25 and older have earned baccalaureate degrees or more. Although this figure represents an improvement over adults' educational attainment in 1990 (15.6%), Indiana's rate in 2000 was well below the U.S. rate of 25.1%. It is encouraging that increasing numbers of Indiana's young people are planning to continue their education. Seniors graduating in the Class of 2000 were asked about their plans for additional education after high school. Well over half (56.3%) intend to enter a four-year college program, an increase of 14% from the percentage (49.3%) who intended to pursue a baccalaureate degree in the Class of 1995. A higher percentage (8.4%) of graduating seniors intended to enter vocational or technical training from the Class of 2000 than in the Class of 1999 (7.7%).¹ In most Indiana counties, the percentages of students expecting to attend a two-year college has been relatively low. As statewide access to two-year college programs grows, the numbers of graduating seniors expecting to enter community colleges undoubtedly will increase. According to the National Center for Education Statistics, in 1998, 60.5% of Indiana's students went on to college, compared with 57.2% in the nation as a whole. Indiana moved to 17th place among the 50 states in 1998, up from 40th place in 1986.²

Community Colleges of Indiana

A community college system for Indiana became a much-awaited reality in Fall 2000, when a partnership of Vincennes University and Ivy Tech formed the Community College of Indiana (CCI). Pilot programs opened on campuses in Gary, Lafayette, Indianapolis, and Evansville; six more campuses were added in 2001 in Anderson, East Chicago, Marion, Michigan City, Muncie, and Valparaiso. "CCI combines Ivy Tech's strong technical training programs with Vincennes' broad range of liberal arts to form the state's first comprehensive community college

system," Governor O'Bannon's office noted.³ As anticipated, enrollment has increased rapidly. CCI enrollments reached 26,986 in Fall 2001, up from 22,979 in Fall 2000 and from 19,255 in Fall 1999. Enrollments in CCI grew by 40% between 1999 and 2001. CCI and its Ivy Tech and Vincennes partners saw systemwide enrollment growth of 36% between 1999 and 2001.⁴

Twenty-first Century Scholars Program

The Twenty-first Century Scholars initiative was announced in SY 1990-91 to increase Indiana's high-school graduation rate and provide access to postsecondary education for low- and moderate-income students. The program provides tuition support in addition to the regular state grant program to students who pledge as 8th-graders to prepare themselves for college, including maintaining a C average and graduating from high school, staying out of trouble with the law, and remaining drug-free. The first Scholars to graduate from college in four years would have done so in 1998-99.

In the 11 years of the program, 11,035 students have enrolled. Well over half of the scholars have affirmed the pledge made as 8th-graders. In 2001, 19% of the scholars earned Academic Honors diplomas and 22% met Core 40 criteria.

Scholars are 10% to 12% more likely to enter college than other students; the percentage of scholars graduating from college within four years increased from about 43% in 1998 to nearly 60% in 2000. More than 66% of the scholars who entered college attend public colleges in Indiana.⁵

An evaluation of the impact of the program completed in 2001 by the Indiana Education Policy Center concluded that the Scholars Program provides an incentive for low-income students to prepare themselves academically for college and ensures that they will get ample student aid. The study noted that the Scholars Program represents a model that states can adopt "to provide financial access to students from low-income families."⁶

Other Supports for Postsecondary Education

The *Indiana Career and Postsecondary Advancement Center (ICPAC)* was established in 1986 to inform, encourage and support the education and career development of Hoosiers. ICPAC provides numerous publications and services to Indiana's students and their families as they prepare for life after high school. ICPAC works under the direction of the Indiana Commission for Higher Education in partnership with the Department of Workforce Development, the State Student Assistance Commission of Indiana, and other agencies. It is a sponsor of the state's "College Goal Sunday" held annually in early February to assist students and their families with applications for financial aid.⁷

The *Indiana College Savings Plan*—made possible by legislation passed by the Indiana General Assembly in 1996—encourages families to save and invest in tax-deferred accounts for their children's education. The account owner may live anywhere and the beneficiary may attend any accredited school in the country.⁸

¹ Figures supplied by the Indiana Department of Education.

² Information from the National Center for Education Statistics cited in "Record Number of Indiana High School Graduates Going on to College: State's National Rank Jumps to 17th." Press release issued by the Indiana Commission for Higher Education, October 21, 2000.

³ "Community College of Indiana launches Year 2 with enrollment increase, new campuses." Press release issued by the Office of Governor Frank O'Bannon, August 22, 2001.

⁴ "O'Bannon: CCI enrollment boost shows Hoosiers are seeking higher ed alternatives." Press release issued by the Office of Governor Frank O'Bannon, August 22, 2001.

⁵ Information about the 21st Century Scholars program was provided by the State Student Assistance Commission of Indiana, October 2001.

⁶ St. John, Edward P., Musoba, Glenda D., and Simmons, Ada B. "Keeping the Promise: The Impact of Indiana's 21st Century Scholars Program." (Bloomington, IN: Indiana Education Policy Center, Indiana University, 2001). Available on IEPAC Web site at: www.indiana.edu/~iepac/welcome.html.

⁷ For more information and a publications catalogue, see the Indiana Career and Postsecondary Advancement Center Web site: www.icpac.indiana.edu.

⁸ Indiana Family College Savings Plan Web site: www.incollegesave.com.

Health Care for Young Hoosiers

Children's Health Insurance Program (CHIP)

In 1997, Congress passed the Children's Health Insurance Program (CHIP) as part of the federal Balanced Budget Act to encourage states to provide health insurance to uninsured children. At that time, an estimated 15% of all children in the U.S. and 12.4% of Hoosier children were uninsured. The Indiana General Assembly responded by replacing Medicaid with the Hoosier Healthwise program for low-income pregnant women and children. Hoosier Healthwise provides coverage for children younger than age 19 living in households with incomes below 150% of the federal poverty guideline (currently \$26,475 for a family of four). In January 2000, families with incomes of 150% up to 200% of the federal poverty guideline (currently \$35,300 for a family of four) could also receive coverage by paying a small monthly premium. The Plan covers routine checkups, well-child visits, doctor visits, hospital stays and specialty care, prescription drugs, mental health, vision and dental care, screenings, immunizations, diagnoses and treatments.¹

Since the program went into effect in July 1998, Indiana has been highly successful in enrolling pregnant women and children in Hoosier Healthwise. Outreach has been accomplished in cooperation with a network of 521 enrollment centers throughout Indiana—including schools, township trustees, community action programs, WIC centers, local departments of health and health clinics, community-based agencies and organizations, as well as the 92 local offices of the Division of Family and Children.²

By June 2001, 178,139 children, adolescents, and pregnant women had been enrolled in Hoosier Healthwise, in addition to the 210,423 already enrolled in Medicaid. Total enrollment has increased by 75% since May 1998 (the last time persons could enroll under the "old" program).

The number of Primary Medical Providers working with Hoosier Healthwise has increased by 13.5%, from 1,832 to 2,080 in all 92 counties. Additionally, more than 128 dentists have joined the program.

While health insurance coverage among low-income children increased between 1998 and 1999, the mothers of these children are less likely to have coverage. An analysis of national data from the 2000 Current Population Survey estimated that some 5.9 million (16%) women caring for young children were without health insurance. The same study estimated that 92,000 low-income mothers in Indiana—12%—were uninsured.³

Immunizations

The widespread vaccination of the nation's children since the early 1970s has prevented millions of illnesses and many thousands of deaths. The recommended immunization schedule for children younger than age two becomes increasingly complex as new vaccines become available. The 4:3:1:3 Series of Coverage recommended immunizations for two-year-olds (i.e., 24 through 35 months of age) includes: four doses of DPT (diphtheria and tetanus toxoids, and pertussis vaccine); three doses of poliovirus vaccine (IPV); one dose of MMR (measles, mumps, and rubella) and three doses of Hib (haemophilus influenza, Type B). The 4:3:1:3:3 adds three doses of hepatitis B. In addition, varicella (chickenpox) and heptavalent conjugate pneumococcal vaccines are also recommended by the American Academy of Pediatrics.⁴ Neither Indiana nor the nation as a whole attained the goal of 90% coverage (using the 4:3:1:3 Series) in 2000. The same target has been set for Healthy People 2010.⁵

The Centers for Disease Control and Prevention conduct an annual National Immunization Survey (NIS) to monitor coverage among U.S. two-year-olds.

In 2000, 76.2% of U.S. children ages 19-35 months had received the 4:3:1:3 Series of Coverage; 72.8% had received the 4:3:1:3:3 Series, and 77.6% had received the 4:3:1 Series. Comparable coverage figures for Indiana children were 76.3%, 72.0%, and 77.7%, respectively.⁶

¹ Information about the Hoosier Healthwise program is available on the Indiana Family and Social Services Administration Web site: www.in.gov/fssa/programs/chip/.
² These figures are based on data from the U.S. Census Bureau's Current Population Survey and are available on the Census Bureau Web site at: www.census.gov/hhes/hithins/historic/index.html.
³ Guyer, Jocelyn, Broadbudd, Matthew, and Duide, Annie. "Millions of Mothers Lack Health Insurance Coverage" (Washington, DC: Center on Budget and Policy Priorities, May 10, 2001).
⁴ "Recommended Childhood Immunization Schedule, United States, January-December 2001." Approved by the Advisory Committee on Immunization Practices, the American Academy of Pediatrics and the American Academy of Family Physicians." On the CDC Web site at: www.cdc.gov/nip.
⁵ U.S. Department of Health and Human Services, *Healthy People 2010*. 2nd ed. Vol. 1, Section 14. "Immunization and Infectious Diseases."
⁶ Centers for Disease Control and Prevention, "National, State, and Urban Area Vaccination Coverage Levels Among Children Aged 19-35 Months—United States, 2000." *MMWR Weekly*, Vol. 50, 30 (August 3, 2001), pp. 637-641.

Prenatal Care

A healthy start in life begins with early and adequate prenatal care for both mother and child; such care is associated with lowered risk of premature birth, normal infant birthweight and maternal weight gain, and with early detection and better management of medical and obstetrical conditions. A greater percentage of Hoosier mothers began prenatal care in the first trimester in 1999 (79.5%) than in 1998 (77.0%). The national rate is also improved, to 83.3% in 1999. Indiana continues to lag behind the nation as a whole as the state works toward the Healthy People 2010 target of 90% receiving first trimester prenatal care (the same goal as in 2000). The percentages of women beginning care in the first trimester also vary by age and race/ethnicity (Table 1).

Only 44.2% of all 10- to 14-year olds who gave birth in 1999 began prenatal care in the first trimester. The percentage dropped to 37.8% among the 74 African-American teens in this age group. Among teens ages 15-17, 61.2% began prenatal care in the first trimester and 68.7% of teens ages 18-19 also did so. In these age groups and as a whole, fewer non-white women began care early. The rate for Hispanics, at 62.9%, was the lowest for all groups.¹

Table 1. Prenatal Care in the First Trimester by Age and Race/Ethnicity of Mother, Indiana: 1999

Age of Mother	Percentage of Infants Born to Mothers Who Received 1st Trimester Care			
	Total	White	A/E/A* African-American	Asian/PI Hispanic**
10-14	44.2	50.0	37.8	
15-17	61.2	63.9	52.6	
18-19	68.7	70.2	61.9	
20-45+	81.6	83.1	68.0	
All Ages	79.5	81.3	65.5	80.0
				62.9

*American Indian/Eskimo/Aleut.
**Hispanics may be of any race; Hispanics are included in the total percentages and racial figures.

Source of Data: Indiana State Department of Health, Data Analysis Team.

Drinking alcohol during pregnancy

Recent studies of the impact of alcohol on unborn children have concluded that there is no safe limit for alcohol consumption. The risk of fetal alcohol syndrome and fetal alcohol effects are widely known. There are more subtle behavioral consequences of prenatal alcohol exposure, however, that show up later in childhood (even when statistical controls for all of the other factors that influence child behaviors are applied). Children of mothers who drank—even in amounts as small as one drink per week—during pregnancy were found to be more likely to have attention and other cognitive problems, mental health problems such as anxiety or withdrawal, and behavior problems such as aggression and delinquency. The severity of the problems was related to the magnitude of prenatal alcohol exposure.²

Few Hoosier women reported using alcohol during pregnancy in 1999. The rate fell slightly to 0.8% in 1999 (down from 0.9% in 1999). While such a change is welcome, alcohol consumption figures for Hoosier women may represent an undercount, since women have been found prone to supplying inaccurate information about use of substances known to affect pregnancy outcomes.

Alcohol consumption varies by the race/ethnicity of the mother. Use of alcohol was more frequently reported by American Indian/Eskimo/Aleut (1.8%) and African-American (1.3%) than for other race/ethnic groups of Hoosier women. Alcohol consumption was more often reported by women aged 20 and older, than by teens.

Smoking during pregnancy³

More than one in five (20.9%) Hoosier women who gave birth in 1999 reported smoking during pregnancy. This figure represents a small, but encouraging decline from the rate of 21.3% in 1998. Hoosier female high-school students are more likely to smoke than students nationally⁴. Likewise, pregnant Hoosier women of whatever age, were much more likely to smoke than pregnant women nationally—20.9% vs. 12.6% in 1999.

Although the smoking rate for all pregnant women declined in 1999, there was no change in the direction of a disturbing trend first noted five years earlier: an increase in smoking among teen-aged mothers. Nationally, earlier increases in teen-aged smoking have begun to have an impact on smoking patterns among 20- to 24-year-old mothers. These same trends have appeared in Indiana: there were slightly higher proportions of 10- through 17-year-olds who reported smoking during pregnancy in 1999 than in 1998.

Women of all ages in different race/ethnic groups had great variation in reported smoking rates: 21.8% of white women; 15.8% of African-American women; 4.2% of Asian/Pacific Island and 5.3% of Hispanic women. American Indian/Eskimo/Aleut women reported the highest rate of all: 32.7%.

Low birthweight

Infants who weigh less than 2,500 grams (5 lb. 8 oz.) at birth are defined as having low birthweight (LBW); infants weighing less than 1,500 grams (3 lb. 5 oz.) are considered to be at very low birthweight (VLBW). An infant may have a birthweight that is low for gestational age or low because of premature birth (i.e., less than 37 completed weeks of gestation). The lower the birthweight, the greater the probability an infant will have neurological and health problems, developmental delays, attention and learning disorders, and behavioral problems.

Table 2. Smoking During Pregnancy by Age and Race/Ethnicity of Mother, Indiana: 1999

Age of Mother	All Races		White		African-American		AI/E/A*		Asian/PI		Hispanic**	
	Number	%	Number	%	Number	%	Number	%	Number	%	Number	%
10-14	23	13.9	18	20.5	5	6.8						
15-17	922	26.1	831	31.0	72	9.0						
18-19	2,449	32.0	2,249	36.4	171	12.7						
20+	14,605	19.5	13,168	20.0	1,212	17.3						
All Ages	17,852	20.9	16,269	21.8	1,460	15.8	32.7		4.2		5.3	

*American Indian/Alaskan/Eskimo/Aleut

**Hispanics may be of any race; Hispanics are included in racial totals.

Source of Data: Indiana State Department of Health, Data Analysis Team.

Below normal birthweight is associated with environmental toxins, the age and race/ethnicity of the mother, her general physical health and nutritional status, oral health, adequacy of prenatal care, maternal behaviors such as drug, alcohol, and tobacco use, multiple births and the spacing of births, and maternal infections such as sexually transmitted diseases. Other infections such as bacterial vaginosis (BV), which affects only women and is caused by an imbalance in the bacteria normally found in the vagina, are also related to pregnancy outcomes. BV has been linked with ectopic pregnancy and infertility, preterm labor resulting in low birthweight, and uterine infections after pregnancy. BV also increases susceptibility to sexually transmitted diseases and HIV infection if the woman is exposed to the virus. Studies have found that bacterial vaginosis is common in women of reproductive age and affects as many as 16% of all pregnant women. Diagnosis and treatment have increased in recent years, but many women remain unaware that this relatively common condition can undermine a healthy pregnancy and birth. Rates of infection vary widely among ethnic groups: six percent among Asians, nine percent among whites, 16 percent among Hispanics, and 23 percent among African-Americans. More research is needed to identify the impact of this disease on the differential rates of low birthweight among the infants of women in different ethnic groups.⁵

Nationally, the percentage of babies born at low birthweight has increased steadily since the mid-1980s (from 6.8%) to 7.6% in 1998 and 1999. Preliminary data for 2000 suggest no change. In Indiana, the percentage of LBW babies increased from 7.7% in 1997, to 7.9% in 1998. In 1999, however, the rate of low birthweight declined slightly to 7.8%.

The late 1990s saw essentially no change in the percentage of babies born at very low birthweight in the nation as a whole; the rate remained at 1.4%, but up from 1.2% in the 1970s. In Indiana, the rate increased slightly between 1998 and 1999—from 1.4% to 1.5%.

LBW is also associated with multiple births. The number of multiple births in Indiana increased by 10% between 1998 and 1999—from 2,533 to 2,787—representing 29.8 and 32.6 per thousand live births, respectively (the rate of multiple births increased by 9.4%). Of the multiple live births in 1999, 2,590 were twins, 178 were triplets, and 19 were quadruplets.

In Indiana in 1999, infant birthweight continued to vary by the age and race/ethnicity of the mother. The younger the mother, the greater the likelihood her child would weigh less than 5.5 pounds. While low birthweight rates among African-American infants born to women of all ages were well above those of any other race/ethnic group, this was particularly true for infants born to teen mothers.⁶

¹ Indiana State Department of Health, Data Analysis Team.
² Sood, Beena, et al, "Prenatal Alcohol Exposure and Childhood Behavior at Age 6 to 7 Years: I. Dose-Response Effect," *Pediatrics*, 108, 2 (August 2001). On Pediatrics Web site at: www.pediatrics.org/content/full/108/2/e34.
³ Information about smoking patterns nationally is drawn from a report issued by the Centers for Disease Control and Prevention: Ventura, Stephanie J., et al, "Births: Final Data for 1999," *National Vital Statistics Report*, 49, 1 (April 17 2001). Information for Indiana comes from *Indiana Natality, Induced Termination of Pregnancy, and Marriage Report: State, County and City Data, 1999*. CD-Rom edition (Indianapolis, IN: Indiana State Department of Health, April 2001), and Centers for Disease Control and Prevention, Women and Smoking: A Report of the Surgeon General—2001. On CDC Web site: www.cdc.gov/tobacco/sgr/sgr_for_women/
⁴ Indiana Prevention Resource Center, Alcohol, Tobacco and Other Drug Use by *Indiana Children and Adolescents: Prevalence Statistics; Main Findings* (Bloomington, IN: Indiana Prevention Resource Center, Indiana University, Bloomington, 2001).
⁵ "Bacterial Vaginosis (BV)," Fact Sheet published by the National Center for HIV, STD and TB Prevention, Centers for Disease Control and Prevention, September 2000. Available on the CDC Web site at www.cdc.gov/nchstp/dstd/Fact_Sheets/FactsBV.htm. "Tracking the Hidden Epidemics 2000: Trichomoniasis and Bacterial Vaginosis Chancroid," CDC, Center for HIV, STD and TB Prevention. Brochure released August 23, 2001. On CDC Web site at: www.cdc.gov/nchstp/od/news/RevBrochure1.pdfTrichomoniasis.htm.
⁶ Safe Motherhood: Investing in the Health of Women," *Chronic disease notes & reports*, 13, 2 (Spring/Summer 2000). Published by the National Center for Chronic Disease Prevention and Health Promotion, CDC. Available on the CDC Web site: www.cdc.gov.
⁷ Indiana State Department of Health, Data Analysis Team.



Starting Life

The number of infants born in Indiana has continued to rise since 1995, to 85,489 in 1999, up from the most recent low point of 82,522 in 1994. Births to women younger than age 20, however, have declined again, continuing the trend that began in 1996. There were 11,301 births to women younger than age 20 in 1999—representing 13.7% of all births. In 1999, the birth rate among Hoosier women ages 15-19 declined to an all-time low of 51.3 births per 1,000 females in the age group, down from 64.1 per thousand in 1995. Decline in the teen birth rate (ages 15-19) in the United States also reached an all-time low in 1999, 49.6 per 1,000, and preliminary figures for 2000 show a further decline, to 48.7. Nationally, the decline in teen births began in 1991 when the rate was 62.3 per 1,000. Between 1990 and 1994, Indiana's teen birth rate was below that of the nation; in 1995 the rate jumped and has remained above the national rate since.

- ☞ 165 infants were born to 10- to 14-year-old Hoosier mothers in 1999; 3,528 to mothers' ages 15- to 17; and 7,608 to mothers' ages 18- to 19.
- ☞ The 1999 birth rate for 10- to 14-year olds remained the same as in 1998, at 0.8 per thousand. More encouraging is the one-year drop in the birth rates for 15- to 17-year olds—from 29.0 to 27.4 per 1,000, and for 18 and 19-year-olds—from 89.4 to 86.3 per thousand (Table 1).
- ☞ Decline in the numbers and rates of births to teens has been attributed to many factors, including:
 - ☞ a vigorous economy (including an expansion of the Earned Income Tax Credit),
 - ☞ use of new and more effective methods of contraception,
 - ☞ increased public education about HIV and other sexually transmitted diseases,
 - ☞ a focus on males as targets for policies affecting reproductive behavior,
 - ☞ a rise in conservative attitudes toward premarital sex among religious youth, and

Table 1. Reported Pregnancies, Fetal Deaths, Abortions, and Live Births by Age of Mother, Indiana: 1999

Age of Mother	Pregnancies		Fetal Deaths		Abortions		Live Births	
	Number	Rate (per 1,000 women in age group)	Number	Rate (per 1,000 women in age group)	Number	As a % of pregnancies	Number	Rate (per 1,000 women in age group)
10-14	236	1.2	2	0.8	69	29.4	165	0.8
15-17	4,260	33.1	26	27.4	706	16.6	3,528	27.4
18-19	9,209	104.5	54	86.3	1,547	16.8	7,608	86.3
15-19	13,469	62.1	80	51.3	2,253	16.7	11,136	51.3
All Ages	97,664	74.0	499	56.1	11,676	12.0	85,489	56.1

Source of Data: Indiana State Department of Health, Data Analysis Team.

☞ an emerging social consensus that non-marital childbearing does not relieve a mother from the responsibility of working to help support her child(ren).¹

A recent national survey asked teens themselves about the primary reason for the decline in teen pregnancy. The most frequent responses were "worry about AIDS/STDs" and that "more birth control or protection is available." Other responses included: increased attention to the issue (14.9%), more parental involvement (8.9%), changing morals and values (5.2%), fewer teens having sex (3.7%), the improved economy (1.9%), and welfare reform (1.0%).²

In Indiana, most of the births to women younger than age 20 in Indiana were first births, although the percentage declines with age (Table 2). More than a fourth of the 18- and 19-year-old women who gave birth in 1999 already had one or more children. A comparison of the 1998 and 1999 percentages reveals that repeat births among Indiana's teens increased slightly between 1998 and 1999.

Rates of reported pregnancies are calculated the same way as age-specific birth rates—the number of occurrences per 1,000 women in the age group. Reported adolescent pregnancy rates are higher than birth rates, but are also declining in both number and as rates. The pregnancy rate among Hoosier teens ages 15-19 was 62.1 per 1,000 young women in 1999, compared with a reported rate of 64.6 per 1,000 in 1998.

Fetal deaths and abortions are the source of the difference between numbers of pregnancies and live births (Table 1).

☞ 11,676 abortions were performed for Hoosier women in 1999—2,322 for women younger than age 20.

The younger the mother, the more likely she was to terminate her pregnancy. Teens reported 14% of the pregnancies and nearly 20% of the abortions. Contrary to public perception, however, teen pregnancies do not account for a majority of abortions performed.³

Non-marital births

Trends in the United States

Historically, the rates of births to women younger than age 20 have been much higher than in the 1990s, but most of these women were married by the time their children were born. In 1970, about one in ten U.S. births (11%) to women of all ages was to an unmarried woman.⁴ While earlier, pre-marital pregnancies usually resulted in a "shot gun" marriage by the time of the infant's birth, since the late 1970s fewer women have been choosing

Table 2. Live Birth Order by Age of Mother, Indiana: 1999

Age of Mother	% First Births	Live Birth Order* % Second Births	% Third or Higher
10-14	98.8	1.2	-
15-17	89.6	9.2	0.9
18-19	72.2	22.6	5.1
All Ages	38.6	33.1	28.1

*Rows do not sum to 100% because order was not determined for a small number of births.

Source of Data: Indiana State Department of Health, Data Analysis Team.

marriage as an option. In the 1960s, 60% of pre-maritally pregnant women younger than age 30 married; by the 1990s, that figure had dropped to 23%. By 1999, one in three (33%) U.S. births to women of all ages was non-marital.

Teens no longer represent the large proportion of women giving birth outside of marriage they once did. In 1970, 50% of non-marital births were to women younger than age 20; by 1999, the teen proportion of non-marital births had fallen to 29% nationally. Of concern still, however, is the increased likelihood that a woman who has had one non-marital birth will have another. Only 50% of non-marital births to women of all ages were first births in 1999. A majority of non-marital pregnancies were unintended.

Non-marital births in Indiana

Table 3 presents information about non-marital births to Hoosier women in 1999. More than one in three (34.6%) births in Indiana was non-marital—above the figure for the U.S. as a whole (33.0%). In 1998, 33.6% of births were non-marital, compared with 32.8% for the U.S. as a whole. The percentages differ by the age and race/ethnicity of the mother. The younger the mother, the less likely she was to be married; in Indiana, 99.4% of all births to 10- to 14-year olds were non-marital; among 18-19 year olds, the figure had dropped to just below half (48.9%) of all births. The proportion of Hoosier births to women of all ages that were non-marital was much higher for African-American women—77.0%—than for any other racial/ethnic group.

82.8% of all 1999 births in Indiana to women younger than age twenty occurred outside of marriage; for white births, the figure was 79.0% and for African-American births, 97.5%. Asian/Pacific Island women had the lowest percentage (11.1%) of non-marital births, while about half (50.9%) of births to American Indian/Eskimo/Aleut women were non-marital.

Hispanics/Latinos may be of any race, and are included in the previous statistical breakdowns. When separated by ethnicity, 45.2% of births to Hispanic women were non-marital. Between 1998 and 1999, the percentage of non-marital births fell slightly for all racial/ethnic groups but white and Hispanic.

Table 3. Percent of Births to Unmarried Women by Age Group and Race/Ethnicity, Indiana and U.S.: 1999

Age of Mother	Non-Marital Births as a % of All Births				
	U.S. Total	White	African-American	Asian/Pi	Hispanic**
10-14	96.5	98.9	100.0		
15-17	87.7	93.3	91.4		
18-19	74.0	77.5	73.4		
20-24	48.5	48.9	43.0		
All Ages	33.0	34.6	29.6	11.1	45.2

*American Indian, Eskimo, Aleut.

**Hispanics may be of any race and are included in the U.S. and Indiana race category columns.

Source of Data: Indiana State Department of Health, Data Analysis Team.

¹ Wertheimer, Richard, Jager, Justin, and Moore, Kristin Anderson, "State Policy Initiatives for Reducing Teen and Adult Non-marital Childbearing: Family Planning to Family Caps." *New Federalism: Issues and Options for States*, Series A, No. A-43, November 2000.

² National Campaign to Prevent Teen Pregnancy, *With One Voice: America's Adults and Teens Sound Off About Teen Pregnancy*. Summary from Power Point version on the Campaign's Web site at: www.teenpregnancy.org.

³ Indiana State Department of Health, *Indiana Natality, Induced Termination of Pregnancy, and Marriage Report: State, County, and City Data, 1999*. C-D Rom Version (Indianapolis, IN: Author, April 2001).

⁴ Terry-Humen, Elizabeth, Manlove, Jennifer, and Moore, Kristin A. "Births Outside of Marriage: Perceptions vs. Reality." *Child Trends Research Brief* (April 2001).

Mortality: Dying Too Young

One of the great achievements of the twentieth century was the reduction in infant and child deaths. Yet as we begin this next century, an excessive number of children die too young—some from readily preventable deaths, others from congenital conditions, or from diseases for which preventative measures or cures have not yet been found.

Infant deaths

In 1999, the infant mortality rate in Indiana rose slightly from 75 per 1,000 live-born infants in 1998 to 78 deaths in 1999.¹ For the nation as a whole, the most recent data available from 1998 indicate that the infant mortality rate remains at 72 (the same rate as in 1997).² The general trend in Indiana has continued downward since 1988 when the infant mortality rate reached 11.0. Still, 671 Hoosier infants did not reach their first birthdays in 1999.

Infant mortality in Indiana differs markedly by race. Among white infants, the mortality rate was 6.8 per thousand live births, while among African-American infants, the rate was 17.0—two and one-half times higher than for white infants.

In 1998, when the state infant mortality rate was 76, the most recent national KIDS COUNT rankings placed Indiana 31st among the 50 states (with a rank of one being best).

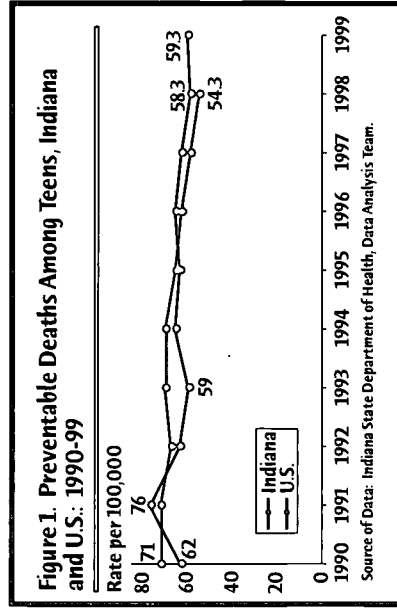

Child deaths

Deaths among children in Indiana rose slightly in 1999 over 1998 to 275 deaths per 100,000 children ages one through 14. Leading causes of death in this age group were non-vehicular accidents, motor vehicle crashes, cancer, congenital anomalies, and homicide.

In 1998, Indiana's child death rate was 26 and the U.S. rate was 24. Indiana placed 27th among the 50 states in the most recent national KIDS COUNT rankings.³

Preventable deaths among teens

In 1999, there were 336 deaths among teens ages 15-19 from four causes: motor vehicle crashes (128), other accidents (49), suicide (36), and homicide (50). The teen preventable death rate from these causes rose slightly in 1999 to 59.3, up from 58.3 per 100,000 teens ages 15-19 (Figure 1).

In 1998, Indiana's teen preventable death rate was 59 and the national rate was 54. Indiana ranked 25th among the 50 states.⁴

Homicide Trends. Although there were variations from year to year, the general trend in homicides among teens ages 15 through 19, and young adults ages 20 through 24, was upward between 1990 and 1999 (Figure 2).⁵

In 1999, the homicide rate for teens dropped for the first time in three years to 11.3 per 100,000 youth, ages 15 through 19. The 50 homicide deaths represent a decrease from a rate of 12.4 (55 deaths) per 100,000 in 1998.

The homicide rate per 100,000 young adults ages 20-24 (69 deaths) declined to 17.4 in 1999—the lowest rate since 1994.

Suicide trends. Deaths from suicide in Indiana have also varied from year to year, but the overall trend

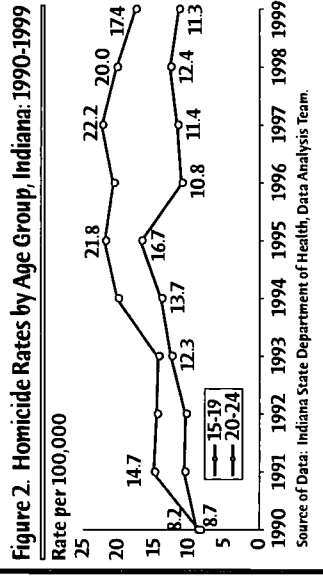

among young adults ages 20 through 24 has been upward, while the trend throughout the decade among teens ages 15 through 19 has been generally downward (Figure 3).⁶

In 1999, the suicide rate for 15- through 19-year-olds was 8.1 per 100,000 youths in that age group, an increase from the lowest rate of the decade, 7.3, in 1997.

Among young adults, the suicide rate dropped to 14.3 per 100,000 persons ages 20-24 (57 deaths). The suicide rate for 1999 was the lowest for this age group since 1993.

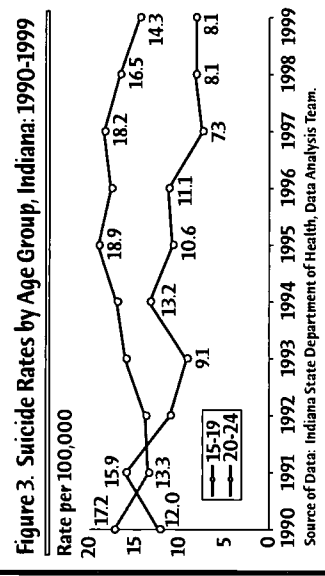

¹ Indiana State Department of Health, 1999 Indiana Mortality Report.

² Annie E. Casey Foundation, 2000 KIDS COUNT Data Book, p. 71.

³ *Ibid.*

⁴ *Ibid.*

⁵ Indiana State Department of Health, 1999 Indiana Mortality Report.

⁶ *Ibid.*

safety, Weapons, and Violence

Through its annual survey of alcohol, tobacco, and other drug (ATOD) use, the Indiana Prevention Resource Center (IPRC) also collects data on Indiana students' perceptions of safety as well as the prevalence of weapon use and violence in their schools. Although the IPRC has been conducting its annual survey since 1991, data on school safety and violence has been collected since 1996. In March and April 2001, the IPRC collected data from 96,079 students in 292 Indiana schools.

Perceived Safety in School

Overall, most students in Indiana report feeling "very safe" in school. In 2001, 84.3% of 6th graders, 80.6% of 8th graders, 79.2% of 10th graders, and 83% of 12th graders reported they felt "very safe" while in class at school (Figure 1). Approximately 2% of the students in each grade level reported they felt "very unsafe" in class. Data collected in 1996, however, show that students felt safer in the classroom six years ago.

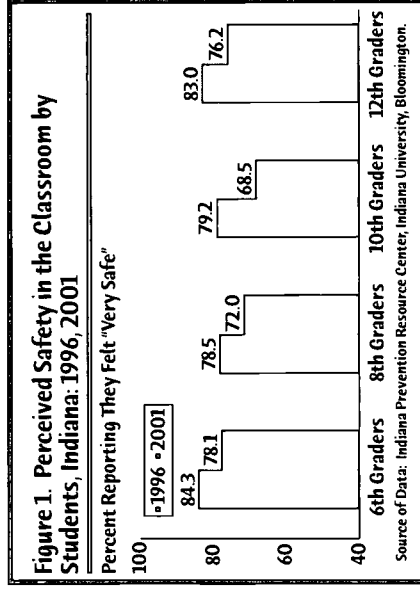

Perceptions of school safety while on campus for afterschool activities are very similar to perceptions of classroom safety. While the majority of Indiana students feel "very safe," fewer students report feeling "very safe" in 2001 compared to 1996 (Figure 2). For example, 74.5% of 10th graders felt "very safe" during afterschool

activities in 1996, but only 69.1% of 10th graders felt "very safe" in 2001.

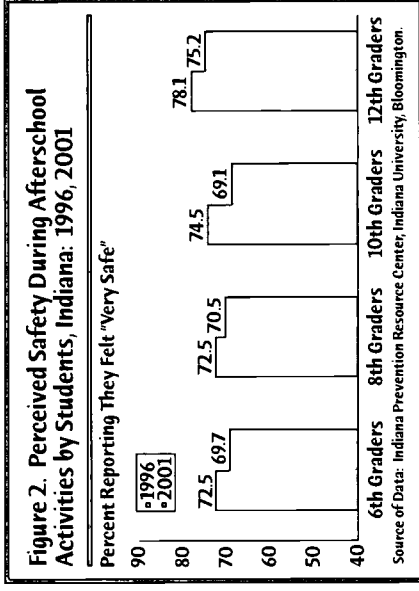

Guns and Other Weapons at School

Data on the prevalence of weapons in Indiana schools show fewer students brought guns and other weapons to school in 2001 compared with 1996. While it could be argued that even one student carrying a gun or other weapon to school is too many, these data suggest that far fewer weapons are being brought into Indiana schools now compared with six years ago.

In 2001, .8% of 6th graders, 1.2% of 8th graders, 1.5% of 10th graders, and 1.5% of 12th graders reported they had carried a gun to school during the past year. Within each grade level, these figures represent nearly a 50% reduction from 1996 when the proportions were 1.1%, 2.9%, 3.3%, and 3.1%, respectively. Similarly, the percentage of students who reported carrying a weapon other than a gun to school during the past year has dropped over 50% since 1991 (Figure 3).

Physical Fights and Threats with Weapons

Fewer Indiana students reported engaging in physical fights during the past year in 2001 compared to 1996. In 1996, 40.3% of 6th graders, 42.7% of 8th graders, 33.8% of 10th graders, and 25.3% of 12th graders reported participating in a "physical fight" during the past year. In 2001, those percentages dropped to 36.5%, 38.1%, 29.5%, and 20.9%, respectively.

Despite the recent reductions in the percentage of students who reported carrying a weapon to school during the past year, a number of Indiana youth reported being threatened by a weapon during the past year. In 2001, 8.5% of 6th graders, 8.5% of 8th graders, 9% of 10th graders, and 3.6% of 12th graders reported being threatened by a weapon while on school property during the past year. While comparable estimates do not exist for 1996, data from 1998 indicates those proportions have remained relatively constant over the past three years.

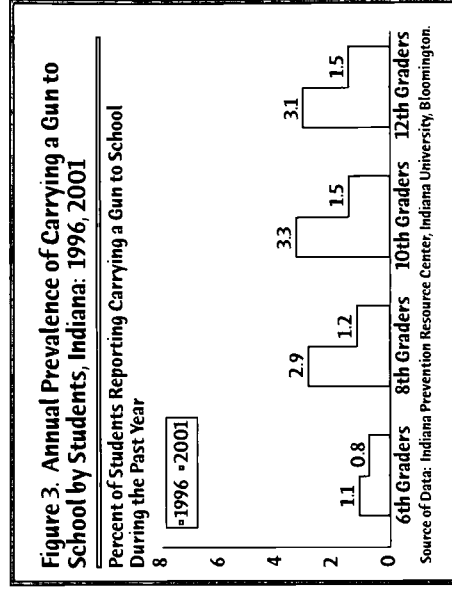

All data in this section come from: Indiana Prevention Resource Center, Alcohol, Tobacco, and Other Drug Use by Indiana Children and Adolescents: Prevalence Statistics; Main Findings (Bloomington, IN: Indiana Prevention Resource Center, Indiana University, Bloomington, August 2001).



Alcohol, Tobacco and Other Drug Use

Since 1991, the Indiana Prevention Resource Center (IPRC), with support from the Division of Mental Health and Addiction, has conducted an annual survey of alcohol, tobacco, and other drug (ATOD) use among Indiana students in grades 6-12. In March and April of 2001, the IPRC collected data from 96,079 students in 292 Indiana schools.

The results of this survey over the past 11 years show that, in general, ATOD use among Indiana's youth has decreased for all grade levels. In particular, rates of cigarette smoking and smokeless tobacco use have decreased markedly. Less dramatic decreases have been observed with alcohol and marijuana use. However, despite reductions over the past decade, Indiana's rates of ATOD use continue to remain somewhat higher than national rates.²

Cigarette Smoking

Between 1991 and 1997, smoking rates among Hoosier youth increased to their highest levels of the decade. For example, 41.6% of 12th graders reported monthly smoking in 1997. In 2001, monthly smoking rates among 12th graders dropped to 35.1%. The decrease in smoking rates among middle school students was even more marked, with rates among 8th graders dropping from 27.1% in 1996 to 16.1% in 2001 (Figure 1). Although

Figure 1. Percent of 8th Graders Using Cigarettes Monthly, Indiana and U.S.: 1991-2001

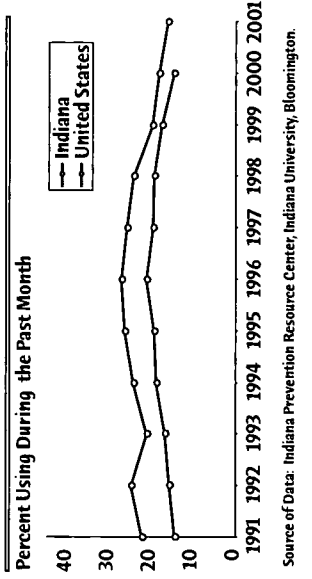

smoking rates among youth in Indiana are decreasing, they still remain somewhat higher than national rates.

Interestingly, decreases in youth rates of cigarette smoking in Indiana have been paralleled by increased perceptions of health risks associated with smoking. In 1997, 36.8% of 8th graders, 40.7% of 10th graders, and 44.7% of 12th graders reported smoking a pack or more of cigarettes a day posed a "great risk" to one's health. In 2001, those percentages rose to 47.1%, 53.7%, and 55.9%, respectively. While these data suggest Hoosier youth are becoming better educated about the health risks of cigarette smoking, national data indicate that Indiana's youth still lag behind national trends in their perceptions of risks associated with smoking.

Specifically, national data from 2000 show that 58.8% of 8th graders, 65.9% of 10th graders, and 73.1% of 12th graders reported smoking a pack or more of cigarettes per day posed a "great risk" to one's health.

Alcohol Consumption

Alcoholic beverages—which include beer, wine, coolers, and hard liquor—are the most commonly used substances among Indiana's youth. In 2001, 20.3% of 6th graders and 70.5% of 12th graders reported consuming alcohol during the past year. In addition, 9.2% of 6th graders and 49.9% of 12th graders reported consuming alcohol during the past month.

Since 1991, the proportion of Hoosier youth who consumed alcohol during the year or month before the survey has declined at all grade levels. For example, in 2001, 24.7% of 8th graders consumed alcohol during the past month, compared to 33.6% in 1991. Among 10th graders, the proportion dropped from 50.7% in 1991 to 39.1% in 2001. Reductions in alcohol use among high-school seniors have been less dramatic. Monthly rates of alcohol use among 12th graders declined from 1991 through 1996 (Figure 2). Since 1996, however, rates have remained somewhat constant, mirroring rates at the national level.

Perhaps just as important as the consumption of alcohol among young Hoosiers, are behaviors related to drinking and driving. In 2001, 25.9% of 12th graders reported they had driven a car while under the influence of alcohol during the year prior to the survey. Included in that figure are the 8.5% of high school seniors who reported they had combined drinking and driving more than five times during the past year. The 2001 survey also showed that 21.7% of 8th graders, 29.5% of 10th graders, and 33.3% of 12th graders had ridden in a car with a drunk driver during the past year.

Figure 2. Percent of 12th Graders Using Alcohol Monthly, Indiana and U.S.: 1991-2001

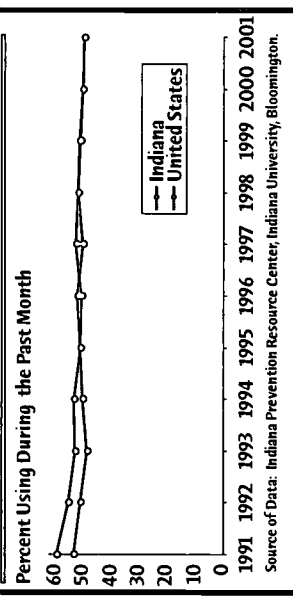

Smokeless Tobacco Use

In 1991, smokeless tobacco ranked behind alcohol and cigarettes as the third most commonly used substance by Indiana youth. Monthly rates of smokeless tobacco use among Indiana's 10th graders in 1991 were substantially higher than national rates. In 2001, only 3.5% of 8th graders, 6.9% of 10th graders, and 9.7% of 12th graders reported using smokeless tobacco during the month prior to the survey, rates that are similar to the 2000 national rates. These figures are down sharply from 1991 when the proportions of young smokeless tobacco users were 13.7%, 18.1%, and 38%, respectively.

Marijuana Use

During the past decade, marijuana has been the most widely used illicit drug among youth in Indiana and in the nation as a whole. From 1992 to 1996, marijuana use rates among Hoosier youth increased substantially for all grade levels. For example, in 1992, 14.4% of high-school seniors had used marijuana during the past month. By 1996, that figure had risen to 25.4% (Figure 3) and the decline since then has been only slight. In 2001, 23.5% of 12th graders reported using marijuana during the past month.

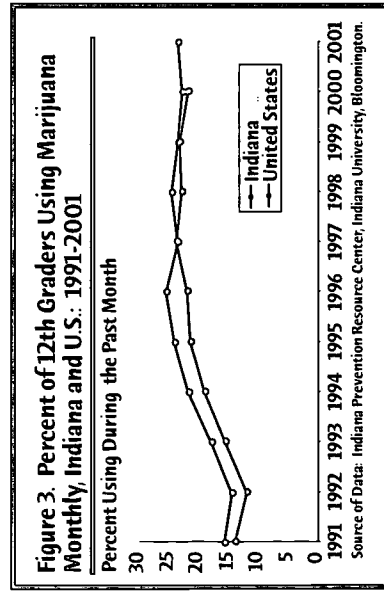

The sluggish rate of decline in marijuana use since 1996 has been paralleled by very little change in the perceived risks of marijuana use as well as perceived peer approval of marijuana use, for example. In 1996, 65.7% of 8th graders, 54.5% of 10th graders, and 52.7% of 12th graders reported that smoking marijuana regularly is associated with "great risk" of harm. These figures are relatively the same in 2001 (Figure 4). Additional data collected by the IPRC suggest that young Hoosiers' perceptions about their peers' attitudes toward smoking marijuana haven't changed much since 1996 either. In 2001, 69.7% of 8th graders, 62.6% of 10th graders, and 62.6% of 12th graders reported their close friends would disapprove if they smoked marijuana on a regular basis. With the exception of 8th graders, these proportions are similar to those reported in 1996, suggesting that Indiana's high-school students' attitudes towards regular marijuana use haven't changed much in the past five years.

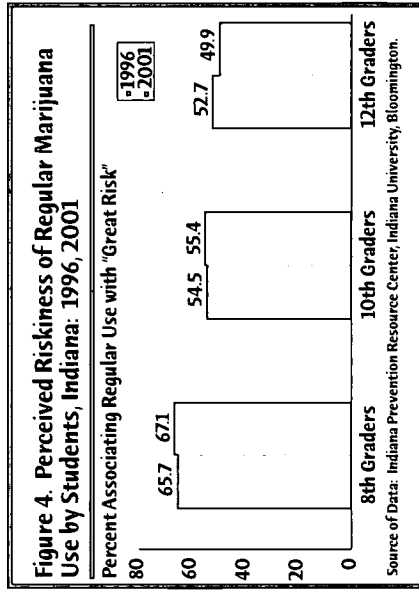

† All Indiana data in this section come from: Indiana Prevention Resource Center, Alcohol, Tobacco, and Other Drug Use by Indiana Children and Adolescents: Prevalence Statistics; Main Findings (Bloomington, IN: Indiana Prevention Resource Center, Indiana University, Bloomington, August 2001).
 ‡ All national data in this section come from: Johnston, L.D., O'Malley, P.M., & Bachman, J.G. (2001). *Monitoring the Future. National Results on Adolescent Drug Use: Overview of Key Findings, 2000*. (NIH Publication No. 01-4923). Bethesda, MD: National Institute on Drug Abuse.

Adolescent Sexuality

Sexuality education

The National Campaign to Prevent Teen Pregnancy recently conducted a survey among a nationally-representative sample of teens (ages 12-19) and adults, asking for their views on various issues related to adolescent sexuality. More than one-third of teens reported "they have not had even a single helpful conversation with their parents about sex." Yet when asked who was the "most influential" when it comes to sexual decision-making, 38.3% of teens named parents and 31.7% named friends (50% of the adults named friends and 31.7% named parents). While 91% of the adults disagreed with the statement that "sex education is primarily the responsibility of schools," 88% agreed that "parents believe they should talk to their kids about sex but often don't know what to say, how to say it, or when to start." Thus, Americans are faced with dilemma regarding what to tell young people, when and how to tell them, and who should do it.

Students in Indiana currently have varied access to sexuality information. Although the state mandates that students receive education about AIDS, it does not mandate a broader sexuality education. Some school corporations provide it, and some do not. Where sexuality education is provided, parents may request their children be excused. Indiana receives funding from federal and state sources for adolescent pregnancy prevention. Federal funds may be used for programs that teach abstinence only (until marriage) as the sole strategy; state funds may be used for programs that, while stressing abstinence, also provide information about family planning, contraception and/or disease risk-reduction methods.

After a thorough review of the research literature, a recent report by the U.S. Surgeon General concluded that there are effective programs available to community-based organizations, schools, religious groups, and clinics that offer a variety of approaches, but that the limited studies of abstinence-only programs make it too early to draw conclusions about their value. The report also notes that:

Table 1. Sexually Transmitted Diseases, Indiana: 1990, 1998-2000

	Age Group	1990		1998		1999		2000	
		Number	%	Number	%	Number	%	Number	%
Gonorrhea	10-14	212	1.9	0	0.0	102	1.7	129	2.0
	15-19	3,961	35.2	3,000	45.2	1,890	30.7	1,886	29.3
	20-24	3,451	30.7	1,983	29.8	1,913	31.1	2,082	32.3
Total Cases	All ages	11,257	100.0	6,643	100.0	6,154	100.0	6,445	100.0
Syphilis—Primary and Secondary	10-14	1	0.8	0	0.0	3	0.7	5	1.4
	15-19	20	15.0	18	4.3	48	10.7	70	19.9
	20-24	32	24.1	40	9.4	85	18.9	78	22.2
Total Cases	All ages	133	100.0	212	100.0	449	100.0	352	100.0
Chlamydia	10-14	227	2.5	310	2.8	274	2.3	272	2.0
	15-19	4,000	44.5	4,845	43.0	5,008	42.1	5,190	37.4
	20-24	2,883	32.1	3,698	32.8	3,988	33.6	4,951	35.6
Total Cases	All ages	8,985	100.0	11,267	100.0	11,884	100.0	13,894	100.0

Source of Data: Indiana State Department of Health, Data Analysis Team.

Youth development programs, although they typically do not specifically address sexuality, have been shown to have a significant impact on sexual health and behavior. Programs that improve education and life options for adolescents have been demonstrated to reduce their pregnancy and birth rates.¹

The report cites the need to "research, develop, disseminate, and evaluate educational materials and guidelines for sexuality education, covering the full continuum of human sexual development, for use by parents, clergy, teachers, and other community leaders."²

Sexually transmitted diseases (STDs)

A recent national report noted that: "Teens are at high behavioral risk for acquiring more STDs. Teenagers and young adults are more likely than other age groups to have multiple sex partners, to engage in unprotected sex and, for young women, to choose sexual partners older than themselves."³ Nationally, sexually transmitted diseases (including sexually transmitted HIV) cost the nation some \$16.6 billion.

Indiana tracks the incidence of three sexually-transmitted diseases: gonorrhea, syphilis, and chlamydia, as well as HIV (Table 1). The good news is that the total number of diagnosed primary and secondary syphilis cases in Indiana declined between 1999 and 2000. The bad news is that the number of gonorrhea and chlamydia cases rose (Table 1) in the same period. In 1999, Indiana had the second highest rate (76 per 100,000) of primary and secondary syphilis in the nation. With a rate of 50.0 cases per 100,000, Indianapolis topped the list of cities with the highest rates. The primary and secondary syphilis rate for Indiana in 1999 was three times higher than the rate for the U.S. as a whole (2.5 cases per 100,000). Indiana and Marion County have waged vigorous public awareness campaigns since recognizing that syphilis had reached epidemic proportions. Cases of syphilis in Indiana dropped 22%, from 449 in 1999, to 352 in 2000. The number of cases among teens ages 10 through 19 however, increased by 47% from 51 in 1999, to 75 in 2000.

Overall, cases of diagnosed gonorrhea increased nearly 5% from 6,154 in 1999 to 6,445 in 2000. The change for teens and young adults varied; among 10- to 14-year-olds, diagnosed gonorrhea infection rose by 26%. The overall number of diagnosed chlamydia cases rose by 17%, from 11,884 in 1999, to 13,894 in 2000. The numbers of cases among young adults, ages 20-24 rose by 24% between 1999 and 2000.⁴

HIV/AIDS

The numbers of persons with HIV and AIDS infections continued to grow between December 1999 and December 2000. HIV diagnoses increased by 5.4% and AIDS diagnoses by 6.7% in one year. (The HIV and AIDS registries are distinct; when a case meets the surveillance case definition of AIDS, it is moved from the HIV to the AIDS registry.) Nearly half of the cumulative AIDS cases in the nation as a whole have been transmitted by men having sex with men (MSM). In Indiana, the proportion was higher: for 62% of AIDS cases and 60% of HIV cases, transmission was via MSM. Nationally, 10% of AIDS has been transmitted heterosexually; in Indiana, 9% of the AIDS cases and 17% of HIV cases have been heterosexually transmitted.⁵

Table 2 shows the age at which the 3,478 HIV cases and 6,089 AIDS cases had been diagnosed among Indiana residents by December 2000.⁶ By June 2001, an additional 117 cases of HIV, and 151 cases of AIDS were diagnosed. There have been relatively few diagnoses established for children younger than 13. Of these, however, most were children born to infected mothers who transmitted the disease perinatally. Better diagnosis of maternal HIV/AIDS has identified these infants, and better treatment and obstetrical techniques have meant that more of these children do not contract the disease. Understanding the scope of HIV/AIDS in the adolescent population remains problematic. Because symptoms may take years to show up and adolescents are somewhat less likely to receive regular medical care, their disease often goes undiagnosed. It is believed that many of the persons who receive diagnoses in their 20s and early 30s actually contracted HIV as adolescents.

¹ Satcher, David, *Call to Action to Promote Sexual Health and Responsible Sexual Behavior*, July 2001.
² *Ibid.*
³ *Ibid.*
⁴ Centers for Disease Control and Prevention, *Tracking the Hidden Epidemics: Trends in the United States, 2000*. On the CDC Web site at: www.cdc.gov.
⁵ Indiana State Department of Health, *HIV/STD Quarterly Report* (June 2001).
⁶ Indiana State Department of Health, *HIV/STD Quarterly Report* (January 2000, July 2000, December 2000). On ISDH Web site: www.state.in.us/isdh/programs/hivstd/quarterly. Divisions of HIV/STD Prevention, National Center for HIV, STD and TB Prevention, "Basic Statistics - Cumulative AIDS Cases." On Centers for Disease Control and Prevention Web site: www.cdc.gov/hiv/stats/cumulative/htm.

Table 2. HIV/AIDS, Indiana and U.S.: Cumulative Cases through December 31, 2000

Age at Diagnosis	Indiana HIV Cases		Indiana AIDS Cases		U.S. AIDS Cases	
	Number	%	Number	%	Number	%
0-12	39	1	41	<1	8,908	1
13-19	136	4	40	<1	4,061	<1
20-29	1,297	37	1,202	20	128,726	17
30-39	1,354	39	2,890	47	345,822	45
40-49	487	14	1,364	22	202,901	26
50 and older	165	5	552	9	84,044	11
Total, All Ages	3,478	100	6,089	100	774,467*	100
% increase since Dec. 31, 1999	5.4		6.7		5.6	

*Total U.S. AIDS figure includes 5 cases for which age or gender data were missing.

Source of Data: Indiana State Department of Health, Data Analysis Team; U.S. Centers for Disease Control and Prevention.

Juveniles and the Law

The F.B.I. Uniform Crime Report (UCR)

The Federal Bureau of Investigation publishes an annual compilation based on their uniform system of voluntary crime reporting from the nation's 16,500 law enforcement jurisdictions. Nationally, UCR arrest data are used to chart trends in crime. These data have several limitations, including that they only record the most serious crime committed and do not differentiate multiple arrests for the same individual, multiple arrests for a single crime, nor the disposition following arrest. Furthermore, Indiana remains one of a few states that do not mandate reporting to the F.B.I., and in any given year, about a third of the state's arrest data are missing—and not the same third in any given year. The published annual UCR report, *Crime in the United States*, contains adjusted figures. The figures for Indiana are consistently inflated by the urban bias that results from better reporting from jurisdictions in the state's largest cities. Indiana is not the only state with incomplete data. The National Archive of Criminal Justice Data (NACJD) at the University of Michigan has refined the methodology for adjusting for missing data. The adjusted estimates for 1998 (the most recent year for which data are available) show a decline in Indiana's juvenile arrest rates from 1997, and that Indiana's rates are again below the rates for the nation as a whole (Figure 1).¹

☞ In 1998, an estimated 304 per 100,000 juveniles (ages 10-17) were arrested for violent crimes (homicide, rape, assault, and robbery) in Indiana. The U.S. violent crime rate was 394 per 100,000. In 1997, the juvenile violent crime arrest rate in Indiana was 381 per 100,000 and for the U.S., was 412 per 100,000.

☞ The rate of estimated juvenile arrests for property crimes (burglary, larceny-theft, motor-vehicle theft, and arson) was 1,696 per 100,000 in Indiana compared with a U.S. rate of 2,130 per 100,000. The respective property crime arrest rates in 1997 were 1,956 and 2,338 per 100,000.

Figure 1. Juvenile Arrests for Violent and Property Crimes, Indiana and U.S.: 1995-98

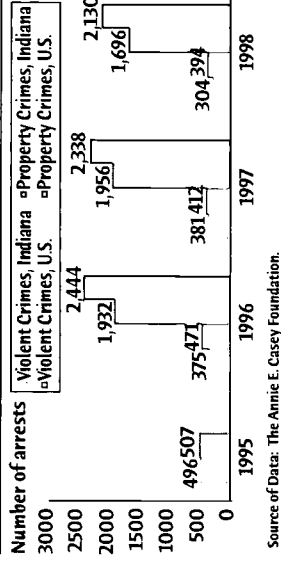

Source of Data: The Annie E. Casey Foundation.

Commitment to the Department of Correction

Young people who have run afoul of the law are detained in many local and county facilities across the state. Only a small proportion of the total number of delinquent and status offenders is committed to the Indiana Department of Correction. Commitment may be the outcome of a single serious offense, but more likely it comes at the end of a long, troubled road which other institutions—family, school, faith communities, and social services agencies—have failed to alter.

☞ There were 2,036 youths committed to the Indiana Department of Correction in 2000—up two percent from the 1,991 committed in 1999, but below the high of 2,182 committed in 1998.⁴

☞ In January 2001, there were 1,382 juveniles incarcerated in the Department of Correction's 10 facilities. The average per diem cost per juvenile was \$122.08, which amounts to more than \$61.58 million annually. Tabulating only the most serious offenses, it was reported that 37% had committed a property offense and nearly 31%, a crime against another person; 8.6% of the juvenile offender population had one or more drug offenses.⁵

¹ National KIDS COUNT 2000 Data Book.

² These data include cases filed in Indiana's Circuit, Superior, Probate, County and Municipal Courts; they are summarized in the 2000 *Indiana Judicial Report*, Vols. I-III.

³ 2000 *Indiana Judicial Report*.

⁴ Indiana Department of Correction.

⁵ Indiana Department of Correction, Juvenile Population, January 1, 2001. On DOC Web site at: www.state.in.us/indocorrection/statistics/statistics.html.

Indiana Judicial Report

The annual judicial report issued by the Division of State Court Administration provides another source of information about Hoosier juveniles and the law.² These data also have limitations. In many instances, it is the judge who decides whether a juvenile is to be charged with a delinquency or status offense or is to be a "Child in Need of Services" (CHINS). Further, the report does not provide information about the outcomes of the cases filed. In the absence of better data, we continue to use this information to chart trends.

☞ The number of juvenile delinquency cases filed declined for the third successive year to 24,643 in 2000, down 14.4% from the high number of 28,775 such cases filed in 1997.

☞ After falling for two years, case filings for status offenses rose by 3.3% between 1999 and 2000—to 6,033. This number was still below the peak of 6,069 status cases filed in 1997.

☞ 8,080 CHINS filings were made in 2000, continuing the consistent upward trend from 1989, the first year for which we have data. Since 1997, CHINS filings have increased 179% (from 6,854).³

Afterschool Time

Through its annual survey of alcohol, tobacco, and other drug (ATOD) use, the Indiana Prevention Resource Center (IPRC) also collects data on Indiana students' participation in afterschool activities. The data are collected by having students report the estimated number of days per school year they spend engaging in various afterschool activities.

In March and April 2001, the IPRC collected data from 96,079 students in 292 schools. The 2001 data from the IPRC illustrates a number of trends in how young Hoosiers spend their afterschool time. A summary of their findings appears in Table 1.

Regular participation in school sports increases during middle school and the first two years of high school. Rates of participation in school sports taper off slightly after 10th grade. Data from the IPRC indicate that at least half of 6th, 8th, and 10th graders spent some time during the past year participating in school sports during their afterschool hours. The slight decline in sports participation for high school seniors may be related to the greater proportion of 12th graders who worked outside the home for pay.

Male and female students report equal levels of regular participation in sports in 6th grade, but slightly more males participate regularly in sports in middle school and high school. Participation in school sports was the most common supervised afterschool activity reported by Hoosier students. Among 6th graders, nearly equal proportions of male and female students reported regular participation (defined as at least 30 days out of the school year). Approximately 4-6% more males than females in 8th, 10th, and 12th grade reported regular participation in sports (Figure 1).

Regular participation in supervised youth activities (such as 4-H, Little League, and Scouts) decreases about 50% between 6th and 12th grade. In 2001, 14.5% of 6th graders reported participation in supervised youth activities for at least 30 days out of the school year. During the same year, 6.4% of high-school seniors reported regular participation in the same type of activities.

Figure 1. School Sports Participation During the Afterschool Hours, by Gender, Indiana: 2001

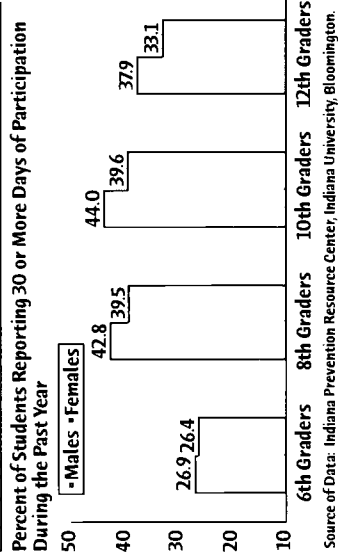

Equal proportions of male and female students regularly volunteer outside the home in 6th and 8th grades. However, more females regularly volunteer while in 10th grade, and do so even more during the 12th grade. In 2001,

approximately 10% of 6th and 8th grade boys and girls regularly volunteered outside the home after school. Among 10th graders, however, slightly more females than males (11.6% versus 10%) spent more than 30 days volunteering during the school year. Among 12th graders the difference between females and males is more marked: 15% of females regularly volunteer compared with 10.7% of males (Figure 2).

The percentage of young Hoosiers who spend regular time working outside the home increases significantly from middle school to high school, with nearly two-thirds of high-school seniors regularly working outside the home in 2001. In 2001, 13.2% of 6th graders, 21.6% of 8th graders, and 42.5% of 10th graders reported working outside the home 30 or more days during the school year. High-school seniors had the highest rates of out-of-home employment, with 64.7% of 12th graders regularly working outside the home.

Figure 2. Volunteering Outside the Home During the Afterschool Hours, by Gender, Indiana: 2001

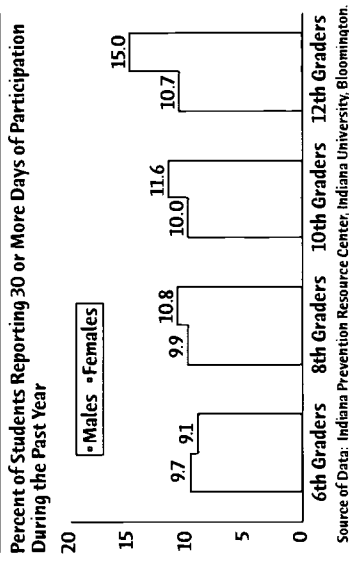

The percentage of Indiana youth who regularly spend time at home alone unsupervised by adults increases as students get older. In 2001, 26.3% of 6th graders regularly spend time at home alone unsupervised by an adult. There is a sharp increase between 6th and 8th grade with 46.7% of 8th graders regularly spending time at home unsupervised by adults. Among 10th and 12th graders, roughly equal proportions regularly spend unsupervised time at home (56.9% and 59.3% respectively).

Table 1. Percent of Students Participating 30 or More Days Per School Year in Various Afterschool Activities, Indiana: 2001

Activity	6th Graders	8th Graders	10th Graders	12th Graders
School sports team	26.8	40.9	41.6	35.5
School club/intramurals	6.9	9.0	11.6	14.5
Supervised youth activities (4-H, scouts)	14.5	12.4	8.7	6.4
At home without adult supervision	26.3	46.7	56.9	59.3
Work for pay outside the home	13.2	21.6	42.5	64.7
Volunteer outside the home	9.4	10.0	10.7	12.8

Source of Data: Indiana Prevention Resource Center, Indiana University, Bloomington.

All data in this section come from: Indiana Prevention Resource Center, Alcohol, Tobacco, and Other Drug Use by Indiana Children and Adolescents: Prevalence Statistics, Main Findings (Bloomington, IN: Indiana Prevention Resource Center, Indiana University, Bloomington, August 2001).

Indicator Definitions and Data Sources

The following indicators are included in the state and county profiles. Data year definitions are as follows:

SFY State Fiscal Year: July 1 – June 30

SY School Year: From the beginning of the school term in the fall through the end of the summer (e.g., SY 2000 corresponds to the school term beginning fall 1999 and ending summer 2000)

FFY Federal Fiscal Year: October 1 – September 30

CY Calendar Year: January 1 – December 31

Economic Well-Being

% Children in Poverty, Age 0-17 (CY) – The percentage of children younger than age 18 living in households with incomes below the federal poverty thresholds in 1990 and in 1997. More recent county-level child poverty rates were not available when this report was completed. The federal poverty level is calculated annually and differs according to the size and composition of the household. In 1990, the poverty guideline for a 3-person household (one adult and two children) was \$10,560; in 1997 the poverty guideline for such a family was \$12,919.

Source of Data: U.S. Census Bureau, *Current Population Survey*.

Per Capita Income (CY) – The per capita income is calculated by dividing the total personal income of the residents of the state (or county) by the total number of residents in the state (or county) in 1990 and in 1999.

Source of Data: Bureau of Economic Analysis, U.S. Department of Commerce.

Unemployment Rate (CY) – The percentage of unemployed persons ages 16 and older in the labor force in 1990 and in 2000; figures include persons looking for work.

Source of Data: Indiana Department of Workforce Development.

Indiana
Youth
Institute

Monthly Average of Families Receiving TANF (SFY) – The average number of families per month who received Aid for Families with Dependent Children (AFDC) in SFY 1990, and the average number of families per month who received Temporary Assistance for Needy Families (TANF) in SFY 2000.

Source of Data: Indiana Family and Social Services Administration, Family Resources Bureau.

Monthly Average of Persons Issued Food Stamps (SFY) – The average number of persons issued Food Stamps in 1990 and in 2000.

Source of Data: Indiana Family and Social Services Administration.

% of Students Receiving Free Lunches / Text Books (SY) – Percent of public and private school students in grades K-12 who receive free lunches and text books. Students from families with incomes below 130% of the poverty guidelines are eligible for free meals. Under a state program initiated during the 1999-2000 school year, all public school students in Indiana who are eligible for free meals are also eligible for free textbooks.

Source of Data: Indiana Department of Education.

Early Childhood

of First Step Children Served (FFY) – The number of children from birth to age 3 with disabilities, developmental delays, or at significant risk for disabilities or delays served by the First Steps Early Intervention program in 1998 and in 2000.

of Licensed Child Care Centers (SFY) – The number of child care centers licensed by the Indiana Family and Social Services Administration, Bureau of Child Development in 1990 and in 2000.

of Licensed Child Care Homes (SFY) – The number of child care homes licensed by the Indiana Family and Social Services Administration, Bureau of Child Development in 1990 and in 2000.

of Registered Child Care Ministries (SFY) – The number of child care ministries registered with the Indiana Family and Social Services Administration, Bureau of Child Development in 1993 and in 2000.

of Licensed Child Care Slots per 100 Children Age 0-4 (SFY) – The capacity of licensed child care centers and homes in the county (or state) per 100 children age 0-4 in 1996 and in 2000. This figure was calculated by dividing the capacity of all licensed centers and homes by the total number of children age 0-4 in the county (or state).

Source of Data: All early childhood data provided by the Indiana Family and Social Services Administration, Division of Family and Children, and the U.S. Census Bureau.

Child Protection

of Reported Cases of Child Abuse Processed by CPS (SFY) – The number of reported cases of suspected child abuse processed by Child Protection Services (CPS) in 1990 and in 2000. Each reported case is investigated and a determination of case status made—i.e., as “substantiated” or “unsubstantiated.”

% of Child Abuse Cases Substantiated by CPS (SFY) – The percentage of cases that following investigation by Child Protection Services were determined to be substantiated child abuse in 1990 and in 2000.

of Reported Cases of Child Neglect Processed by CPS (SFY) – The number of reported cases of suspected child neglect processed by Child Protection Services (CPS) in 1990 and in 2000. Each reported case is investigated and a determination of case status made—i.e., as “substantiated” or “unsubstantiated.”

% of Child Neglect Cases Substantiated by CPS (SFY) – The percentage of cases that following investigation by Child Protection Services were determined to be substantiated child neglect in 1990 and in 2000.

of Child Physical Abuse Case Substantiated by

CPS (SFY) – The number of cases that following investigation by Child Protection Services were determined to be substantiated child physical abuse in 1990 and in 2000. Substantiated child physical abuse numbers are included within the total number of substantiated child abuse cases.

of Child Sexual Abuse Case Substantiated by

CPS (SFY) – The number of cases that following investigation by Child Protection Services were determined to be substantiated child sexual abuse in 1990 and in 2000. Substantiated child sexual abuse numbers are included within the total number of substantiated child abuse cases.

Child Abuse and Neglect Rate (SFY)

– The rate of substantiated cases of child abuse and neglect per 1,000 children younger than age 18 in 1990 and in 2000.

of Child Abuse and Neglect Deaths (SFY) – The number of deaths of children younger than age 18 that occurred as a consequence of abuse or neglect in 1990 and in 2000.

Source of Data: All child abuse and neglect data were supplied by the Indiana Family and Social Services Administration, Family Protection and Preservation Bureau.

of Juvenile CHINS Case Filings (CY) – The number of cases filed in Indiana courts on behalf of children younger than age 18 who were alleged to be children in need of services (CHINS) because of abuse, neglect or endangerment in 1990 and in 2000.

Source of Data: Supreme Court of Indiana, Division of State Court Administration.

Racial/Ethnic Child Characteristics of Indiana's Child Population

All race and ethnicity data come from the 2000 Census. The 2000 Census was the first to allow respondents to identify themselves and other household members with

more than one race. Therefore, racial characteristics of Indiana's children from the 2000 Census are not directly comparable with 1990 Census data. It should also be noted that "White", "Black", "Asian", etc. are racial categories, while "Hispanic" and "Non-Hispanic" are ethnicity categories. Therefore, children can be of any race and of either "Hispanic" or "Non-Hispanic" origin.

White only – The percent of children age 0-17 who were identified in the 2000 Census as "White" and no other race. These children were also identified as "non-hispanic".

Black only – The percent of children age 0-17 who were identified in the 2000 Census as "Black" and no other race. These children were also identified as "non-hispanic".

Asian only – The percent of children age 0-17 who were identified in the 2000 Census as "Asian" and no other race. These children were also identified as "non-hispanic".

NHOPI only – The percent of children age 0-17 who were identified in the 2000 Census as "Native Hawaiian or Other Pacific Islander" and no other race. These children were also identified as "non-hispanic".

American Indian or Alaska Native – The percent of children age 0-17 who were identified in the 2000 Census as "American Indian or Alaska Native" and no other race. These children were also identified as "non-hispanic".

Two or more races – The percent of children age 0-17 who were identified in the 2000 Census as being of more than one race. These children may be of two races (e.g., white and black), or they may be of more than two races (e.g., White, Black, and Native American). These children were also identified as "non-hispanic".

Hispanic – The percent of children age 0-17 who were identified in the 2000 Census as being of Hispanic origin. These children may be of any of the above racial categories.

Source of Data: All racial and ethnic data were supplied by the U.S. Census Bureau.

Child Population

Number of Children, Age 0-4 – Total number of children age 0-4 as enumerated by the 1990 and 2000 Census.

Number of Children, Age 5-9 – Total number of children age 5-9 as enumerated by the 1990 and 2000 Census.

Number of Children, Age 10-14 – Total number of children age 10-14 as enumerated by the 1990 and 2000 Census.

Number of Children, Age 15-19 – Total number of children age 15-19 as enumerated by the 1990 and 2000 Census.

Source of Data: All child population data were supplied by the U.S. Census Bureau.

Health & Well-being

Total # of Live Births (CY) – The total number of live births to women of all ages in 1990 and in 1999.

% of Low Birthweight Babies (CY) – The percentage of infants born at a birth weight of less than 2,500 grams (about 5.5 pounds) in 1990 and in 1999.

% of Mothers who Received 1st Trimester Prenatal Care (CY) – The percentage of pregnant women who began care during the first three months of pregnancy in 1990 and in 1999.

% of Mothers who Smoked During Pregnancy (CY) – The percentage of women who reported that they had smoked during pregnancy in 1990 and in 1999.

Non-Marital Births as a % of All Births (CY) – Births to single mothers of all ages as a percentage of all live births in 1990 and in 1999.

of Babies Born to Single Mothers Under Age 20 without a High School Diploma (CY) – The number of babies born to unmarried women under age 20 who have less than a high school education in 1990 and in 1999. This indicator was included because these risk factors are cumulative in their effect on the development and well-being of infants.

Teen Birth Rate, Age 15-17 (CY) – The number of births to mothers age 15 through 17 per 1,000 females in this age group in 1990 and in 1999.

Total # of Infant Deaths (CY) – The number of deaths among infants under one year of age in 1990 and in 1999.

Total # Child Deaths, Age 1-14 (CY) – The number of deaths from all causes among children ages 1 through 14 in 1990 and in 1999. Deaths are reported by place of residence, not place of death.

Total # Teen Deaths by Accident, Homicide, and Suicide (CY) – The number of deaths among teens age 15-19 due to accident, homicide, and suicide in 1990 and in 1999. Deaths are reported by place of residence, not place of death.

Source of Data: All pregnancy, birth and mortality data supplied by the Indiana State Department of Health.

of Children Enrolled in Hoosier Healthwise (SFY) – The number of children younger than age 19 who were enrolled in the Hoosier Healthwise program in May 1998 and June 2000, not including blind and disabled children. Hoosier Healthwise is a program for children and pregnant women instituted July 1, 1998—funded through Medicaid and the Children's Health Insurance Program (CHIP). These figures include children enrolled in Hoosier Healthwise Package A that expanded eligibility for comprehensive medical and dental service to children younger than age 19 in families with incomes up to 150% of the federal poverty guideline. Hoosier Healthwise coverage is also available to children in families with incomes between 150-200% of the federal poverty guideline through a sliding scale of low premiums and co-payments (Package C).

Source of Data: Indiana Family and Social Services Administration.

% Noncompliance with Youth Tobacco Access Laws (CY) – The percentage of retail sales outlets that were willing to sell tobacco products to minors. The data are based on annual compliance inspections conducted since 1997 and in 2000 by the Indiana State Excise Police on behalf of the Division of Mental Health, Family and Social Services Administration in accordance with federal Synar-Amendment legislation.

Source of Data: Institute for Drug Abuse Prevention, Indiana University-Bloomington.

Education, Grades K-12

Public School Enrollment, K-12 (SY) – The total enrollment in Indiana public schools, kindergarten through grade 12, in SY 1989-90 and in SY 1999-2000.

Source of Data: Indiana Department of Education.

Non-Public School Enrollment (SY) – The total enrollment in non-public schools (independent and parochial) in base SY 1994-95 and SY 2000-2001. Comparable data were not available for earlier school years.

Source of Data: Indiana Non-Public School Association.

of Home Schooled Children (SY) – The number of children being educated at home registered with the Indiana Department of Education (as required by state law) in base SY 1989-90 and SY 1999-2000.

Source of Data: Indiana Department of Education.

of Alternative School Participants (SY) – The number of students in grades 6-12 who participated in public alternative school programs in base SY 1989-1990 and in SY 1999-2000. These figures do not include students who attended private alternative schools or who participated in a small number of public alternative school programs for students below the 6th grade.

Source of Data: Indiana Department of Education.

Total Per Pupil Expenditure (SY) – Total dollar amount spent per student enrolled in public schools in the county (or state) in SY 1989-1990 and in SY 1999-2000.

Source of Data: Indiana Department of Education.

% of 10th Graders Passing the GQE Math Standard (SY) – The percent of 10th graders in public schools who earned a passing score on the Math Standard of the Graduation Qualifying Exam in SY 1999-2000. Earlier data was not available from the Department of Education.

Source of Data: Indiana Department of Education.

% of 10th Graders Passing the GQE Language Standard (SY) – The percent of 10th graders in public schools who earned a passing score on the Language Standard of the Graduation Qualifying Exam in SY 1999-2000. Earlier data was not available from the Department of Education.

Source of Data: Indiana Department of Education.

% of Graduates Passing the GQE (SY) – The percent of public high school graduates who passed the Graduation Qualifying Exam in SY 1999-2000. High school seniors who did not pass the GQE may graduate on a waiver. Earlier data was not available from the Department of Education.

Source of Data: Indiana Department of Education.

of Public High School Graduates (SY) – The number of students who graduated from Indiana public high schools during SY 1989-1990 and during SY 1999-2000.

Source of Data: Indiana Department of Education.

% of High School Graduates (SY) – The percent of students enrolled in 12th grade who graduated from public high schools during SY 1989-1990 and in SY 1999-2000.

Source of Data: Indiana Department of Education.

% of Freshman Class Graduating in 4 Years (SY) – The percent of freshmen class graduating in 4 years for SY 1999-2000 is calculated by dividing the number of public high school graduates in SY 1999-2000 by the number of public high school freshmen in SY 1996-1997. The percent of freshmen class graduating in 4 years for SY 1989-1990 is calculated by dividing the number of public high school graduates in SY 1989-1990 by the number of public high school freshmen in SY 1986-1987. Some figures exceed 100% in counties experiencing rapid rates of growth.

Source of Data: Indiana Department of Education. Calculations by the Indiana Youth Institute.

% of High School Grads Intending 4-Year College (SY) – The percent of public high school graduates indicating their intention to attend a 4-year college following graduation during SY 1989-1990 and in SY 1999-2000.

Source of Data: Indiana Department of Education.

% of High School Grads Intending Vocational/Tech School (SY) – The percent of public high school graduates indicating their intention to attend a vocational or technical school following graduation during SY 1989-1990 and in SY 1999-2000.

Source of Data: Indiana Department of Education.

of Public School Student Dropouts (SY) – The number of public school students who dropped out of grades 7 through 12 in SY 1990-91 and in SY 1998-99. A dropout is a student who leaves school before graduation without transferring to another school or institution. Dropouts include students who fail to return to school following expulsion when eligible; students who transfer to adult programs, technical schools, GED programs, or to programs not leading to a high-school diploma, and students who are incarcerated in adult institutions. Students who suffer from prolonged illness or die, suspended students, and students who transfer to another institution within an education program leading to a high-school diploma are not defined as dropouts.

Source of Data: Indiana Department of Education.

of Expulsions and Suspensions (SY) – The combined number of expulsions and suspensions for all causes in grades K-12 in public schools during SY 1998-1999. Earlier data is not available as the Department of Education began collecting this information in SY 1997-1998.

Source of Data: Indiana Department of Education.

Juveniles and the Law

of Juveniles Committed to the Dept. of Correction (CY) – The number of children younger than age 18 committed to the Indiana Department of Correction in 1994 and in 2000. The Indiana Department of Correction changed its reporting system in 1994. Therefore, 1994 is used as the base year.

Source of Data: Indiana Department of Correction.

of Juvenile Status Case Filings (CY) – The number of cases filed in Indiana courts on behalf of children younger than age 18 who were alleged to have committed status offenses (i.e., acts that would not have been defined as offenses if committed by an adult) in 1990 and in 2000.

Source of Data: Supreme Court of Indiana, Division of State Court Administration.

of Juvenile Delinquency Case Filings (CY) – The number of cases filed in Indiana courts on behalf of children younger than age 18 who were alleged to be delinquent in 1990 and 2000.

Source of Data: Supreme Court of Indiana, Division of State Court Administration.

Indiana Households

Percent of Households with Children Under 18 Headed by Married Couples – The percent of all Indiana households with children age 0-17 who were headed a married couple in 2000. The children in these families were related to the head of the household by blood, marriage, or adoption.

Percent of Households with Children Under 18 Headed by Single Mothers – The percent of all Indiana households with children age 0-17 who were headed by an unmarried female in 2000. The children in these families were related to the head of the household by blood, marriage, or adoption.

Percent of Households with Children Under 18 Headed by Single Father – The percent of all Indiana households with children age 0-17 who were headed by an unmarried male in 2000. The children in these families were related to the head of the household by blood, marriage, or adoption.

Percent of Households with Children Under 18 Headed by Other – The percent of all Indiana households with children age 0-17 who were headed by someone other than married couples or single males or females who were related to the children in 2000. This figure includes households in which children unrelated to the head of the household and households with no adults present.

Source of Data: All household data were supplied by the 2000 Census, U.S. Census Bureau.

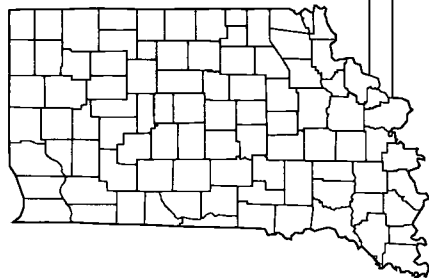

Indiana

Kids Count in Indiana 2001



Economic Well-being

	Current Year	Base Year
% of Children in Poverty, Age 0-17 (CY)	1997 14.8	1990 14.2
Per Capita Income (CY)	1999 \$26,157	1990 \$17,625
Unemployment Rate (CY)	2000 3.2	1990 5.3
Monthly Average of Families Receiving TANF (SFY)	2000 30,432	1990 52,732
Monthly Average of Persons Issued Food Stamps (SFY)	2000 297,341	1990 315,742
% of Students Receiving Free Lunches / Text Books (SY)	2001 21.2	1991 18.3

Early Childhood

# of First Steps Children Served (FFY)	2000 16,548	1998 10,857
# of Licensed Child Care Centers (SFY)	2000 685	1990 612
# of Licensed Child Care Homes (SFY)	2000 3,515	1990 1,701
# of Registered Child Care Ministries (SFY)	2000 504	1993 192
# of Licensed Child Care Slots per 100 Children, Age 0-4 (SFY)	2000 24.3	1996 21.1

Child Protection

# of Reported Cases of Child Abuse Processed by CPS (SFY)	2000 15,532	1990 23,111
% of Child Abuse Cases Substantiated by CPS (SFY)	2000 58.0	1990 55.2
# of Reported Cases of Child Neglect Processed by CPS (SFY)	2000 27,447	1990 26,982
% of Child Neglect Cases Substantiated by CPS (SFY)	2000 57.0	1990 52.3
# of Child Physical Abuse Cases Substantiated by CPS (SFY)	2000 4,415	1990 2,994
# of Child Sexual Abuse Cases Substantiated by CPS (SFY)	2000 4,637	1990 3,845
Child Abuse and Neglect Rate (SFY)	2000 16.1	1990 31.0
# of Child Abuse and Neglect Deaths (SFY)	2000 44	1990 52
# of Juvenile CHINS Case Filings (CY)	2000 8,080	1990 4,409

Racial/Ethnic Characteristics of Children Age 0-17 in Indiana

One Race (Non-Hispanic Origin)	81.6%
White	10.3%
Black	0.2%
American Indian or Alaska Native	0.9%
Asian	0.0%
Native Hawaiian or Other Pacific Islander	0.3%
Some Other Race	1.9%
Two or More Races (Non-Hispanic Origin)	4.8%
Hispanic Origin*	

*Hispanic children may be of any race.

Number of Children Under the Age of 20 1990 & 2000

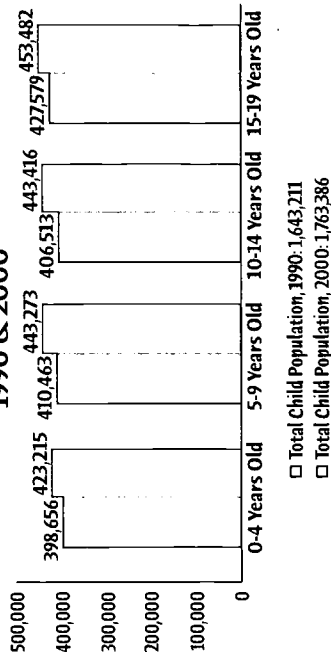

000000 136140

Health & Well-being

	Current Year	Base Year
Total # of Live Births (CY)	1999 85,489	1990 85,986
% of Low Birthweight Babies (CY)	1999 7.8	1990 6.6
% of Mothers who Received 1st Trimester Prenatal Care (CY)	1999 79.5	1990 78.8
% of Mothers who Smoked During Pregnancy (CY)	1999 20.9	1990 26.6
Non-Marital Births as a % of All Births (CY)	1999 34.6	1990 26.2
Teen Birth Rate, Age 15-17 (CY)	1999 27.4	1990 35.6
Total # of Infant Deaths (CY)	1999 671	1990 827
Total # of Child Deaths, Age 1-14 (CY)	1999 325	1990 340
Total # of Teen Deaths by Accident, Homicide and Suicide (CY)	1999 263	1990 265
# of Children Enrolled in Hoosier Healthwise (SFY)	2000 338,809	1998 210,423
% Noncompliance with Youth Tobacco Access Laws (CY)	2000 22.0	1997 24.3

Percent of Households with Children Under 18 Headed by Parents and Others, Census 2000

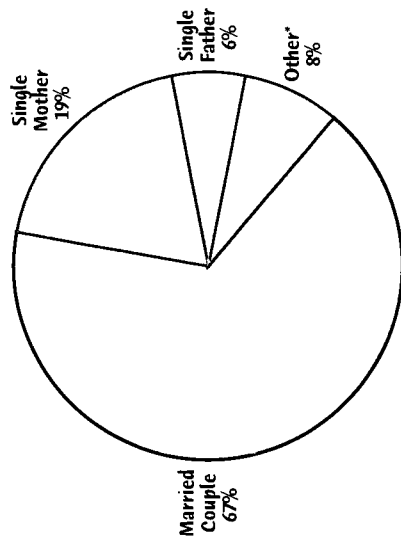

* "Other" includes households with children unrelated to the householder(s) and households with no adults present.

Education, Grades K-12

Public School Enrollment, K-12 (SY)	2000 983,090	1990 826,193
Non-Public School Enrollment (SY)	2001 119,069	1995 107,197
# of Home Schooled Children (SY)	2000 13,974	1990 509
# of Alternative School Participants (SY)	2001 31,454	1990 1,127
Total Per Pupil Expenditure (SY)	2000 \$6,698	1990 \$4,204
% of 10th Graders Passing the GQE Math Standard (SY)	2000 64.0	2000 64.0
% of 10th Graders Passing the GQE Language Standard (SY)	2000 70.0	2000 70.0
% of Graduates Passing the GQE (SY)	2000 95.1	2000 95.1
# of Public High School Graduates (SY)	2000 56,999	1990 64,605
% of High School Graduates (SY)	2000 89.0	1990 80.4
% of Freshman Class Graduating in 4 Years (SY)	2000 68.3	1990 81.3
% of Grads Intending 4-year College (SY)	2000 56.8	1990 46.1
% of Grads Intending Vocational/Tech School (SY)	2000 8.1	1990 7.8
# of Public School Student Dropouts (SY)	2000 8,253	1990 17,827
# of Expulsions and Suspensions (SY)	1999 312,202	1999 312,202

Juveniles and the Law

# of Juveniles Committed to the Dept. of Correction (CY)	2000 2,036	1994 1,528
# of Juvenile Status Case Filings (CY)	2000 6,033	1990 2,797
# of Juvenile Delinquency Case Filings (CY)	2000 24,419	1990 16,791

Number of Babies Born to Single Mothers Under Age 20 without a High School Diploma

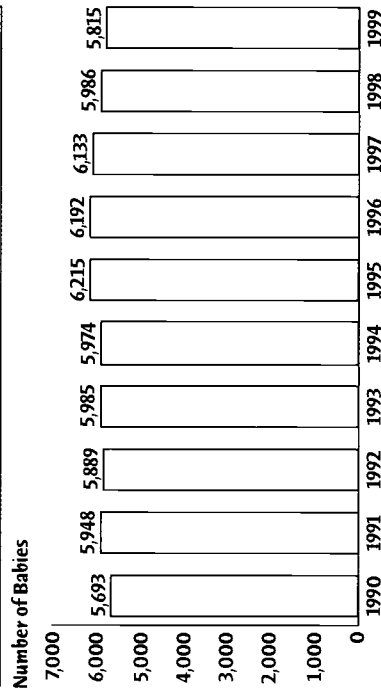

DATA YEAR DEFINITIONS

SFY - State Fiscal Year: July 1-June 30

SY - School Year: From the start of the school term in the fall through the end of the summer

FFY - Federal Fiscal Year: October 1-September 30

CY - Calendar Year: January 1 - December 31



Adams County

Kids Count in Indiana 2001

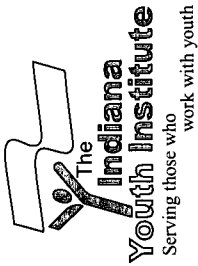

Economic Well-being

	Current Year	Base Year
% of Children in Poverty, Age 0-17 (CY)	1997 14.4	1990 17.2
Per Capita Income (CY)	1999 \$22,812	1990 \$15,629
Unemployment Rate (CY)	2000 3.5	1990 6.6
Monthly Average of Families Receiving TANF (SFY)	2000 57	1990 132
Monthly Average of Persons Issued Food Stamps (SFY)	2000 867	1990 1,000
% of Students Receiving Free Lunches / Text Books (SY)	2001 11.7	1991 10.3

Early Childhood

# of First Steps Children Served (FFY)	2000 82	1998 48
# of Licensed Child Care Centers (SFY)	2000 1	1990 1
# of Licensed Child Care Homes (SFY)	2000 15	1990 8
# of Registered Child Care Ministries (SFY)	2000 4	1993 1
# of Licensed Child Care Slots per 100 Children, Age 0-4 (SFY)	2000 8.7	1996 3.3

Child Protection

# of Reported Cases of Child Abuse Processed by CPS (SFY)	2000 62	1990 114
% of Child Abuse Cases Substantiated by CPS (SFY)	2000 56.0	1990 70.2
# of Reported Cases of Child Neglect Processed by CPS (SFY)	2000 175	1990 55
% of Child Neglect Cases Substantiated by CPS (SFY)	2000 65.0	1990 49.1
# of Child Physical Abuse Cases Substantiated by CPS (SFY)	2000 22	1990 12
# of Child Sexual Abuse Cases Substantiated by CPS (SFY)	2000 13	1990 21
Child Abuse and Neglect Rate (SFY)	2000 14.3	1990 16.8
# of Child Abuse and Neglect Deaths (SFY)	2000 0	1990 0
# of Juvenile CHINS Case Filings (CY)	2000 29	1990 28

Racial/Ethnic Characteristics of Children Age 0-17 in Adams County

One Race (Non-Hispanic Origin)	94.8%
White	0.2%
Black	0.2%
American Indian or Alaska Native	0.2%
Asian	0.0%
Native Hawaiian or Other Pacific Islander	0.0%
Some Other Race	0.0%
Two or More Races (Non-Hispanic Origin)	0.5%
Hispanic Origin*	4.1%

*Hispanic children may be of any race.

Number of Children Under the Age of 20 1990 & 2000

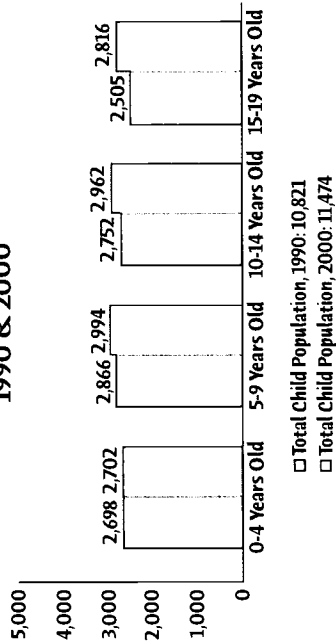

000000 136141

Health & Well-being

	Current Year	Base Year
Total # of Live Births (CY)	1999 537	1990 623
% of Low Birthweight Babies (CY)	1999 6.7	1990 3.5
% of Mothers who Received 1st Trimester Prenatal Care (CY)	1999 60.5	1990 70.7
% of Mothers who Smoked During Pregnancy (CY)	1999 11.7	1990 14.3
Non-Marital Births as a % of All Births (CY)	1999 14.2	1990 11.7
Teen Birth Rate, Age 15-17 (CY)	1999 7.5	1990 25.2
Total # of Infant Deaths (CY)	1999 5	1990 8
Total # of Child Deaths, Age 1-14 (CY)	1999 6	1990 3
Total # of Teen Deaths by Accident, Homicide and Suicide (CY)	1999 1	1990 0
# of Children Enrolled in Hoosier Healthwise (SFY)	2000 995	1998 596
% Noncompliance with Youth Tobacco Access Laws (CY)	2000 N/A	1997 29.4

Percent of Households with Children Under 18 Headed by Parents and Others, Census 2000

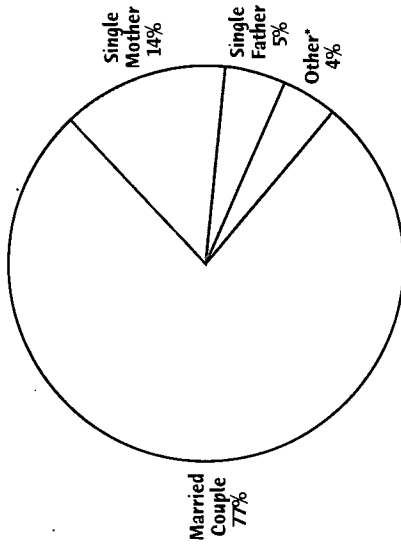

* "Other" includes households with children unrelated to the householder(s) and households with no adults present.

Education, Grades K-12

Public School Enrollment, K-12 (SY)	2000 5,210	1990 4,773
Non-Public School Enrollment (SY)	2001 1,854	1995 1,762
# of Home Schooled Children (SY)	2000 43	1990 1
# of Alternative School Participants (SY)	2001 187	1990 0
Total Per Pupil Expenditure (SY)	2000 \$6,410	1990 \$3,736
% of 10th Graders Passing the GOE Math Standard (SY)	2000 76.0	2000 76.0
% of 10th Graders Passing the GOE Language Standard (SY)	2000 74.0	2000 74.0
% of Graduates Passing the GOE (SY)	2000 97.9	2000 97.9
# of Public High School Graduates (SY)	2000 388	1990 360
% of High School Graduates (SY)	2000 89.8	1990 89.5
% of Freshman Class Graduating in 4 Years (SY)	2000 79.7	1990 89.3
% of Grads Intending 4-year College (SY)	2000 50.3	1990 40.7
% of Grads Intending Vocational/Tech School (SY)	2000 6.4	1990 9.6
# of Public School Student Dropouts (SY)	2000 52	1990 48
# of Expulsions and Suspensions (SY)	1999 1,288	1999 1,288

Juveniles and the Law

# of Juveniles Committed to the Dept. of Correction (CY)	2000 7	1994 8
# of Juvenile Status Case Filings (CY)	2000 9	1990 8
# of Juvenile Delinquency Case Filings (CY)	2000 91	1990 29

Number of Babies Born to Single Mothers Under Age 20 without a High School Diploma

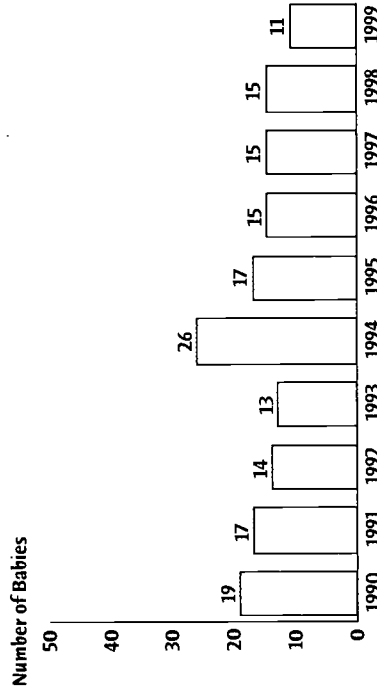

DATA YEAR DEFINITIONS

- SFY - State Fiscal Year: July 1-June 30
- SY - School Year: From the start of the school term in the fall through the end of the summer
- FFY - Federal Fiscal Year: October 1-September 30
- CY - Calendar Year: January 1 - December 31

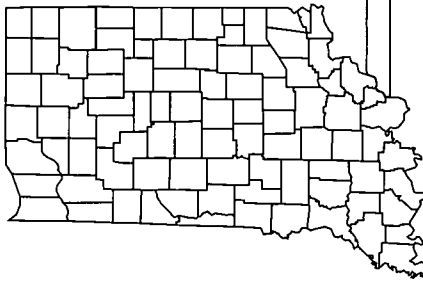

Allen County

Kids Count in Indiana 2001

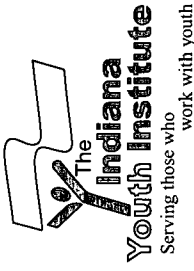

Economic Well-being

	Current Year	Base Year
% of Children in Poverty, Age 0-17 (CY)	1997 14.1	1990 10.5
Per Capita Income (CY)	1999 \$28,985	1990 \$20,028
Unemployment Rate (CY)	2000 3.0	1990 5.2
Monthly Average of Families Receiving TANF (SFY)	2000 1,557	1990 2,547
Monthly Average of Persons Issued Food Stamps (SFY)	2000 15,069	1990 13,634
% of Students Receiving Free Lunches / Text Books (SV)	2001 21.0	1991 16.3

Early Childhood

# of First Steps Children Served (FFY)	2000 1,013	1998 594
# of Licensed Child Care Centers (SFY)	2000 45	1990 41
# of Licensed Child Care Homes (SFY)	2000 140	1990 88
# of Registered Child Care Ministries (SFY)	2000 32	1993 11
# of Licensed Child Care Slots per 100 Children, Age 0-4 (SFY)	2000 22.2	1996 22.6

Child Protection

# of Reported Cases of Child Abuse Processed by CPS (SFY)	2000 607	1990 690
% of Child Abuse Cases Substantiated by CPS (SFY)	2000 54.0	1990 60.1
# of Reported Cases of Child Neglect Processed by CPS (SFY)	2000 1,569	1990 977
% of Child Neglect Cases Substantiated by CPS (SFY)	2000 63.0	1990 59.9
# of Child Physical Abuse Cases Substantiated by CPS (SFY)	2000 206	1990 75
# of Child Sexual Abuse Cases Substantiated by CPS (SFY)	2000 121	1990 92
Child Abuse and Neglect Rate (SFY)	2000 15.3	1990 18.6
# of Child Abuse and Neglect Deaths (SFY)	2000 1	1990 0
# of Juvenile CHINS Case Filings (CY)	2000 744	1990 384

Racial/Ethnic Characteristics of Children Age 0-17 in Allen County

One Race (Non-Hispanic Origin)	74.9%
White	14.5%
Black	0.3%
American Indian or Alaska Native	1.4%
Asian	0.0%
Native Hawaiian or Other Pacific Islander	0.4%
Some Other Race	2.9%
Two or More Races (Non-Hispanic Origin)	5.6%
Hispanic Origin*	

*Hispanic children may be of any race.

Number of Children Under the Age of 20 1990 & 2000

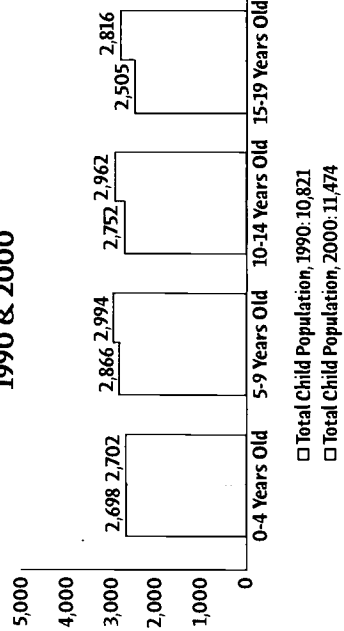

Health & Well-being

	Current Year	Base Year
Total # of Live Births (CY)	1999 5,079	1990 5,330
% of Low Birthweight Babies (CY)	1999 7.9	1990 6.3
% of Mothers who Received 1st Trimester Prenatal Care (CY)	1999 78.2	1990 81.5
% of Mothers who Smoked During Pregnancy (CY)	1999 17.6	1990 23.1
Non-Marital Births as a % of All Births (CY)	1999 35.7	1990 28.4
Teen Birth Rate, Age 15-17 (CY)	1999 32.8	1990 38.0
Total # of Infant Deaths (CY)	1999 37	1990 51
Total # of Child Deaths, Age 1-14 (CY)	1999 21	1990 17
Total # of Teen Deaths by Accident, Homicide and Suicide (CY)	1999 18	1990 9
# of Children Enrolled in Hoosier Healthwise (SFY)	2000 16,960	1998 10,751
% Noncompliance with Youth Tobacco Access Laws (CY)	2000 16.0	1997 20.0

Education, Grades K-12

Public School Enrollment, K-12 (SY)	2000 51,212	1990 43,311
Non-Public School Enrollment (SY)	2001 14,182	1995 13,077
# of Home Schooled Children (SY)	2000 482	1990 15
# of Alternative School Participants (SY)	2001 3,424	1990 0
Total Per Pupil Expenditure (SY)	2000 \$6,950	1990 \$4,182
% of 10th Graders Passing the GQE Math Standard (SY)	2000 60.0	2000 60.0
% of 10th Graders Passing the GQE Language Standard (SY)	2000 69.0	2000 69.0
% of Graduates Passing the GQE (SY)	2000 93.1	2000 93.1
# of Public High School Graduates (SY)	2000 2,966	1990 3,389
% of High School Graduates (SY)	2000 93.2	1990 79.1
% of Freshman Class Graduating in 4 Years (SY)	2000 66.1	1990 82.6
% of Grads Intending 4-year College (SY)	2000 62.1	1990 49.5
% of Grads Intending Vocational/Tech School (SY)	2000 9.7	1990 7.0
# of Public School Student Dropouts (SY)	2000 262	1990 858
# of Expulsions and Suspensions (SY)	1999 26,977	1999 26,977

Juveniles and the Law

# of Juveniles Committed to the Dept. of Correction (CY)	2000 117	1994 108
# of Juvenile Status Case Filings (CY)	2000 1,135	1990 70
# of Juvenile Delinquency Case Filings (CY)	2000 2,647	1990 445

Percent of Households with Children Under 18 Headed by Parents and Others, Census 2000

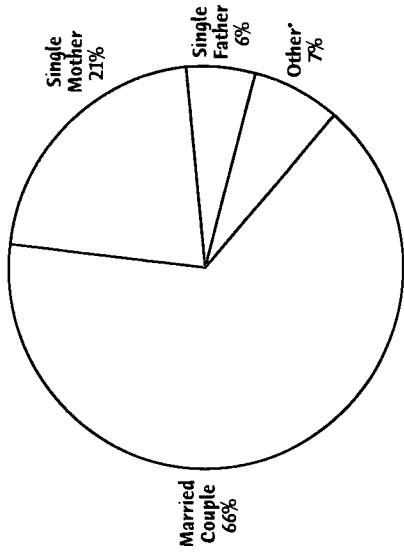

*"Other" includes households with children unrelated to the householder(s) and households with no adults present.

Number of Babies Born to Single Mothers Under Age 20 without a High School Diploma

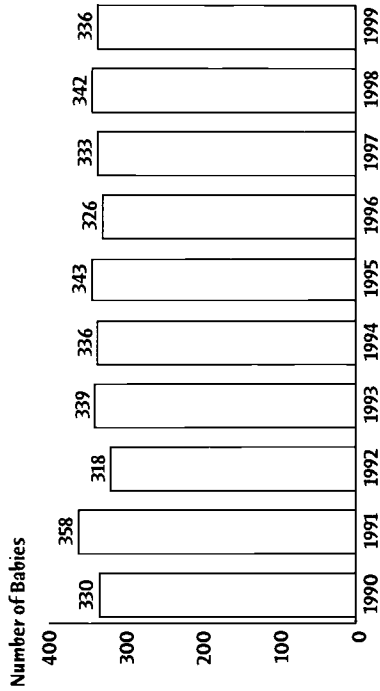

DATA YEAR DEFINITIONS

- SFY - State Fiscal Year: July 1-June 30
- SY - School Year: From the start of the school term in the fall through the end of the summer
- FFY - Federal Fiscal Year: October 1-September 30
- CY - Calendar Year: January 1 - December 31



Bartholomew County

Kids Count in
Indiana 2001



Economic Well-being

	Current Year	Base Year
% of Children in Poverty, Age 0-17 (CY)	1997 11.7	1990 10.7
Per Capita Income (CY)	1999 \$29,271	1990 \$18,849
Unemployment Rate (CY)	2000 2.4	1990 4.9
Monthly Average of Families Receiving TANF (SFY)	2000 160	1990 430
Monthly Average of Persons Issued Food Stamps (SFY)	2000 2,586	1990 2,962
% of Students Receiving Free Lunches / Text Books (SY)	2001 16.6	1991 13.8

Early Childhood

# of First Steps Children Served (FFY)	2000 281	1998 194
# of Licensed Child Care Centers (SFY)	2000 11	1990 13
# of Licensed Child Care Homes (SFY)	2000 47	1990 25
# of Registered Child Care Ministries (SFY)	2000 4	1993 0
# of Licensed Child Care Slots per 100 Children, Age 0-4 (SFY)	2000 25.8	1996 31.1

Child Protection

# of Reported Cases of Child Abuse Processed by CPS (SFY)	2000 140	1990 278
% of Child Abuse Cases Substantiated by CPS (SFY)	2000 54.0	1990 49.6
# of Reported Cases of Child Neglect Processed by CPS (SFY)	2000 347	1990 641
% of Child Neglect Cases Substantiated by CPS (SFY)	2000 41.0	1990 37.3
# of Child Physical Abuse Cases Substantiated by CPS (SFY)	2000 31	1990 35
# of Child Sexual Abuse Cases Substantiated by CPS (SFY)	2000 45	1990 23
Child Abuse and Neglect Rate (SFY)	2000 12.6	1990 45.2
# of Child Abuse and Neglect Deaths (SFY)	2000 0	1990 0
# of Juvenile CHINS Case Filings (CY)	2000 27	1990 66

Racial/Ethnic Characteristics of Children Age 0-17 in Bartholomew County

One Race (Non-Hispanic Origin)	91.1%
White	2.1%
Black	0.1%
American Indian or Alaska Native	1.9%
Asian	0.0%
Native Hawaiian or Other Pacific Islander	0.3%
Some Other Race	1.7%
Two or More Races (Non-Hispanic Origin)	2.9%
Hispanic Origin*	

*Hispanic children may be of any race.

Number of Children Under the Age of 20 1990 & 2000

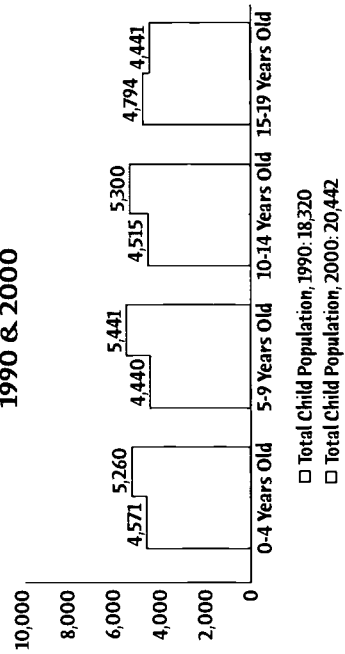

000000 136143

Health & Well-being

	Current Year	Base Year
Total # of Live Births (CY)	1999 1,076	1990 1,009
% of Low Birthweight Babies (CY)	1999 7.6	1990 6.2
% of Mothers who Received 1st Trimester Prenatal Care (CY)	1999 82.6	1990 84.3
% of Mothers who Smoked During Pregnancy (CY)	1999 19.7	1990 29.8
Non-Marital Births as a % of All Births (CY)	1999 28.4	1990 20.9
Teen Birth Rate, Age 15-17 (CY)	1999 21.8	1990 33.9
Total # of Infant Deaths (CY)	1999 10	1990 5
Total # of Child Deaths, Age 1-14 (CY)	1999 3	1990 2
Total # of Teen Deaths by Accident, Homicide and Suicide (CY)	1999 3	1990 1
# of Children Enrolled in Hoosier Healthwise (SFY)	2000 3,575	1998 1,707
% Noncompliance with Youth Tobacco Access Laws (CY)	2000 50.0	1997 25.6

Percent of Households with Children Under 18 Headed by Parents and Others, Census 2000

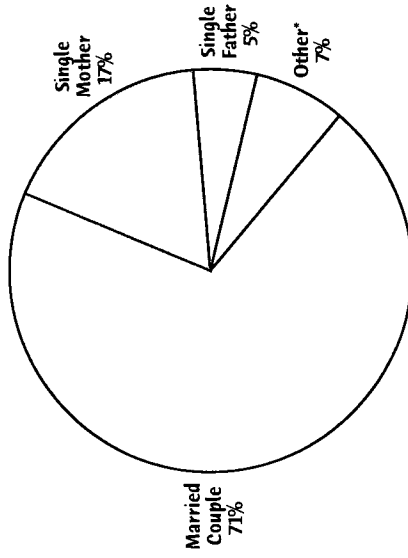

*"Other" includes households with children unrelated to the householder(s) and households with no adults present.

Education, Grades K-12

Public School Enrollment, K-12 (SY)	2000 11,430	1990 9,656
Non-Public School Enrollment (SY)	2001 1,841	1995 1,592
# of Home Schooled Children (SY)	2000 193	1990 1
# of Alternative School Participants (SY)	2001 802	1990 0
Total Per Pupil Expenditure (SY)	2000 \$6,890	1990 \$4,415
% of 10th Graders Passing the GQE Math Standard (SY)	2000 71.0	2000 71.0
% of 10th Graders Passing the GQE Language Standard (SY)	2000 75.0	2000 75.0
% of Graduates Passing the GQE (SY)	2000 97.5	2000 97.5
# of Public High School Graduates (SY)	2000 646	1990 893
% of High School Graduates (SY)	2000 87.9	1990 77.5
% of Freshman Class Graduating in 4 Years (SY)	2000 68.1	1990 83.5
% of Grads Intending 4-year College (SY)	2000 69.8	1990 47.7
% of Grads Intending Vocational/Tech School (SY)	2000 8.7	1990 12.3
# of Public School Student Dropouts (SY)	2000 102	1990 231
# of Expulsions and Suspensions (SY)	1999 1,514	1999 1,514

Juveniles and the Law

# of Juveniles Committed to the Dept. of Correction (CY)	2000 13	1994 14
# of Juvenile Status Case Filings (CY)	2000 53	1990 0
# of Juvenile Delinquency Case Filings (CY)	2000 238	1990 152

Number of Babies Born to Single Mothers Under Age 20 without a High School Diploma

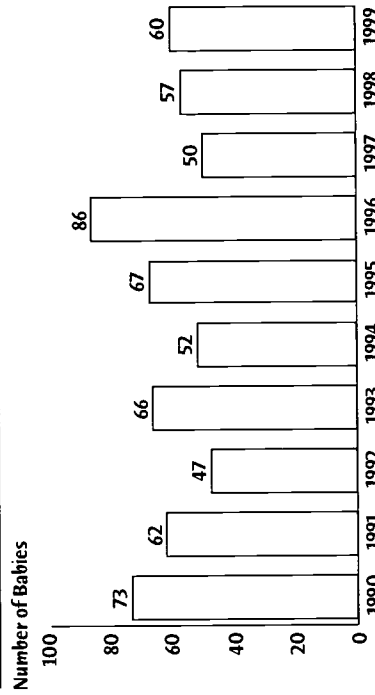

DATA YEAR DEFINITIONS

SFY - State Fiscal Year: July 1-June 30

SY - School Year: From the start of the school term in the fall through the end of the summer

FFY - Federal Fiscal Year: October 1-September 30

CY - Calendar Year: January 1 - December 31



Benton County

Kids Count in Indiana 2001

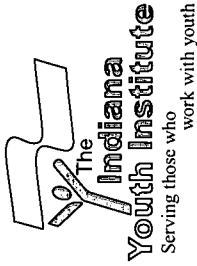

Economic Well-being

	Current Year	Base Year
% of Children in Poverty, Age 0-17 (CY)	1997 12.6	1990 8.3
Per Capita Income (CY)	1999 \$22,518	1990 \$16,151
Unemployment Rate (CY)	2000 3.3	1990 3.4
Monthly Average of Families Receiving TANF (SFY)	2000 11	1990 38
Monthly Average of Persons Issued Food Stamps (SFY)	2000 237	1990 304
% of Students Receiving Free Lunches / Text Books (SY)	2001 15.7	1991 16.1

Early Childhood

# of First Steps Children Served (FFY)	2000 15	1998 9
# of Licensed Child Care Centers (SFY)	2000 2	1990 0
# of Licensed Child Care Homes (SFY)	2000 7	1990 4
# of Registered Child Care Ministries (SFY)	2000 0	1993 0
# of Licensed Child Care Slots per 100 Children, Age 0-4 (SFY)	2000 28	1996 26.6

Child Protection

# of Reported Cases of Child Abuse Processed by CPS (SFY)	2000 22	1990 57
% of Child Abuse Cases Substantiated by CPS (SFY)	2000 59.0	1990 73.7
# of Reported Cases of Child Neglect Processed by CPS (SFY)	2000 49	1990 49
% of Child Neglect Cases Substantiated by CPS (SFY)	2000 45.0	1990 69.4
# of Child Physical Abuse Cases Substantiated by CPS (SFY)	2000 9	1990 11
# of Child Sexual Abuse Cases Substantiated by CPS (SFY)	2000 4	1990 19
Child Abuse and Neglect Rate (SFY)	2000 12.9	1990 34.3
# of Child Abuse and Neglect Deaths (SFY)	2000 0	1990 0
# of Juvenile CHINS Case Filings (CY)	2000 14	1990 10

Racial/Ethnic Characteristics of Children Age 0-17 in Benton County

One Race (Non-Hispanic Origin)	93.9%
White	0.2%
Black	0.0%
American Indian or Alaska Native	0.2%
Asian	0.0%
Native Hawaiian or Other Pacific Islander	0.0%
Some Other Race	1.4%
Two or More Races (Non-Hispanic Origin)	4.3%
Hispanic Origin*	

*Hispanic children may be of any race.

Number of Children Under the Age of 20 1990 & 2000

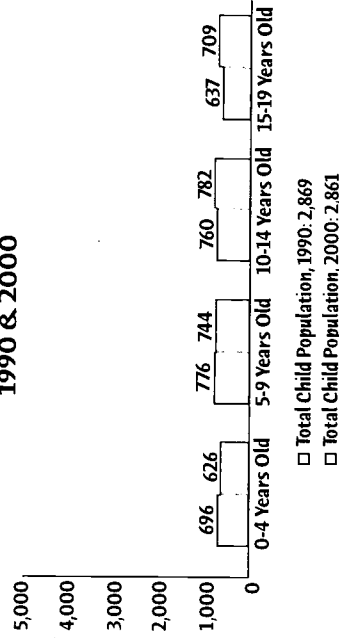

000000 136144

Health & Well-being

	Current Year	Base Year
Total # of Live Births (CY)	1999 125	1990 129
% of Low Birthweight Babies (CY)	1999 5.6	1990 2.3
% of Mothers who Received 1st Trimester Prenatal Care (CY)	1999 80.8	1990 79.8
% of Mothers who Smoked During Pregnancy (CY)	1999 24.0	1990 27.9
Non-Marital Births as a % of All Births (CY)	1999 28.0	1990 20.2
Teen Birth Rate, Age 15-17 (CY)	1999 16.7	1990 9.3
Total # of Infant Deaths (CY)	1999 1	1990 0
Total # of Child Deaths, Age 1-14 (CY)	1999 1	1990 1
Total # of Teen Deaths by Accident, Homicide and Suicide (CY)	1999 1	1990 0
# of Children Enrolled in Hoosier Healthwise (SFY)	2000 420	1998 202
% Noncompliance with Youth Tobacco Access Laws (CY)	2000 11.0	1997 N/A

Percent of Households with Children Under 18 Headed by Parents and Others, Census 2000

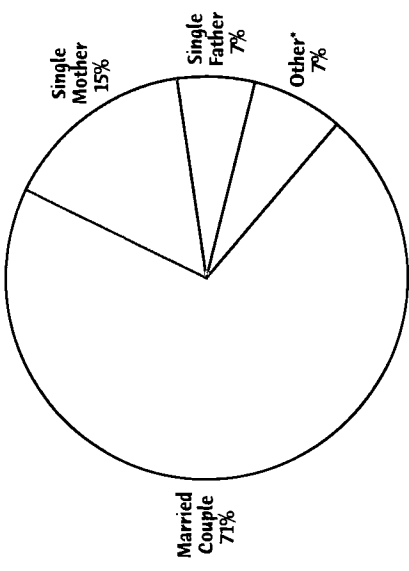

Other includes households with children unrelated to the householder(s) and households with no adults present.

Education, Grades K-12

Public School Enrollment, K-12 (SY)	2000 2,132	1990 1,617
Non-Public School Enrollment (SY)	2001 138	1995 149
# of Home Schooled Children (SY)	2000 25	1990 3
# of Alternative School Participants (SY)	2001 17	1990 13
Total Per Pupil Expenditure (SY)	2000 \$6,971	1990 \$4,720
% of 10th Graders Passing the GQE Math Standard (SY)	2000 70.0	2000 70.0
% of 10th Graders Passing the GQE Language Standard (SY)	2000 69.0	2000 69.0
% of Graduates Passing the GQE (SY)	2000 97.3	2000 97.3
# of Public High School Graduates (SY)	2000 149	1990 167
% of High School Graduates (SY)	2000 93.0	1990 80.3
% of Freshman Class Graduating in 4 Years (SY)	2000 85.6	1990 104.4
% of Grads Intending 4-year College (SY)	2000 46.3	1990 41.5
% of Grads Intending Vocational/Tech School (SY)	2000 1.3	1990 8.5
# of Public School Student Dropouts (SY)	2000 12	1990 18
# of Expulsions and Suspensions (SY)	1999 430	1999 430

Juveniles and the Law

# of Juveniles Committed to the Dept. of Correction (CY)	2000 1	1994 0
# of Juvenile Status Case Filings (CY)	2000 0	1990 0
# of Juvenile Delinquency Case Filings (CY)	2000 67	1990 13

Number of Babies Born to Single Mothers Under Age 20 without a High School Diploma

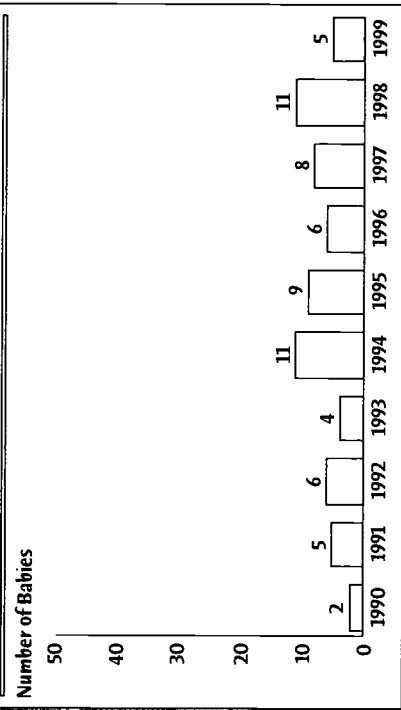

DATA YEAR DEFINITIONS

- SFY - State Fiscal Year: July 1-June 30
- SY - School Year: From the start of the school term in the fall through the end of the summer
- FFY - Federal Fiscal Year: October 1-September 30
- CY - Calendar Year: January 1 - December 31



Blackford County

Kids Count in Indiana 2001

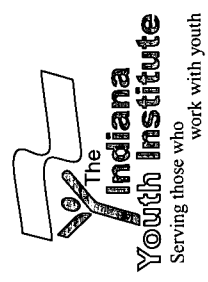

Economic Well-being

	Current Year	Base Year
% of Children in Poverty, Age 0-17 (CY)	1997 16.3	1990 12.3
Per Capita Income (CY)	1999 \$20,456	1990 \$14,497
Unemployment Rate (CY)	2000 5.9	1990 9.3
Monthly Average of Families Receiving TANF (SFY)	2000 47	1990 126
Monthly Average of Persons Issued Food Stamps (SFY)	2000 929	1990 1,184
% of Students Receiving Free Lunches / Text Books (SY)	2001 20.0	1991 18.7

Early Childhood

# of First Steps Children Served (FFY)	2000 40	1998 39
# of Licensed Child Care Centers (SFY)	2000 0	1990 1
# of Licensed Child Care Homes (SFY)	2000 14	1990 1
# of Registered Child Care Ministries (SFY)	2000 0	1993 0
# of Licensed Child Care Slots per 100 Children, Age 0-4 (SFY)	2000 18.4	1996 8.7

Child Protection

# of Reported Cases of Child Abuse Processed by CPS (SFY)	2000 22	1990 54
% of Child Abuse Cases Substantiated by CPS (SFY)	2000 41.0	1990 94.4
# of Reported Cases of Child Neglect Processed by CPS (SFY)	2000 50	1990 46
% of Child Neglect Cases Substantiated by CPS (SFY)	2000 54.0	1990 84.8
# of Child Physical Abuse Cases Substantiated by CPS (SFY)	2000 4	1990 10
# of Child Sexual Abuse Cases Substantiated by CPS (SFY)	2000 5	1990 17
Child Abuse and Neglect Rate (SFY)	2000 10.5	1990 21.5
# of Child Abuse and Neglect Deaths (SFY)	2000 0	1990 0
# of Juvenile CHINS Case Filings (CY)	2000 89	1990 11

Racial/Ethnic Characteristics of Children Age 0-17 in Blackford County

One Race (Non-Hispanic Origin)	97.5%
White	0.0%
Black	0.3%
American Indian or Alaska Native	0.1%
Asian	0.0%
Native Hawaiian or Other Pacific Islander	0.0%
Some Other Race	1.1%
Two or More Races (Non-Hispanic Origin)	1.0%
Hispanic Origin*	

*Hispanic children may be of any race.

Number of Children Under the Age of 20 1990 & 2000

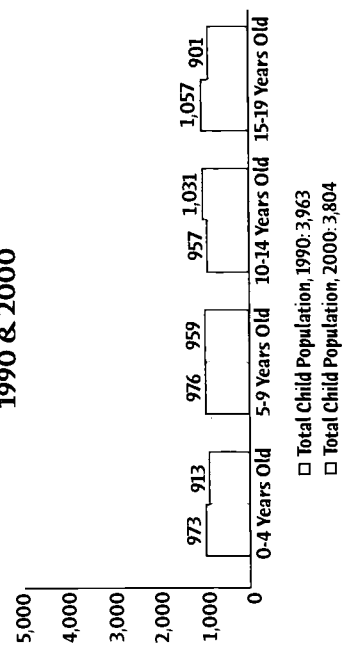

Health & Well-being

	Current Year	Base Year
Total # of Live Births (CY)	1999	1990
% of Low Birthweight Babies (CY)	1999	1990
% of Mothers who Received 1st Trimester Prenatal Care (CY)	1999	1990
% of Mothers who Smoked During Pregnancy (CY)	1999	1990
Non-Marital Births as a % of All Births (CY)	1999	1990
Teen Birth Rate, Age 15-17 (CY)	1999	1990
Total # of Infant Deaths (CY)	1999	1990
Total # of Child Deaths, Age 1-14 (CY)	1999	1990
Total # of Teen Deaths by Accident, Homicide and Suicide (CY)	1999	1990
# of Children Enrolled in Hoosier Healthwise (SFY)	2000	1998
% Noncompliance with Youth Tobacco Access Laws (CY)	2000	1997

Education, Grades K-12

Public School Enrollment, K-12 (SY)	2000	2,323	1990	1,649
Non-Public School Enrollment (SY)	2001	68	1995	64
# of Home Schooled Children (SY)	2000	26	1990	3
# of Alternative School Participants (SY)	2001	29	1990	0
Total Per Pupil Expenditure (SY)	2000	\$6,725	1990	\$3,943
% of 10th Graders Passing the GQE Math Standard (SY)	2000	64.0	2000	64.0
% of 10th Graders Passing the GQE Language Standard (SY)	2000	67.0	2000	67.0
% of Graduates Passing the GQE (SY)	2000	99.3	2000	99.3
# of Public High School Graduates (SY)	2000	144	1990	230
% of High School Graduates (SY)	2000	78.9	1990	80.3
% of Freshman Class Graduating in 4 Years (SY)	2000	72.0	1990	91.6
% of Grads Intending 4-year College (SY)	2000	50.7	1990	34.3
% of Grads Intending Vocational/Tech School (SY)	2000	4.9	1990	11.0
# of Public School Student Dropouts (SY)	2000	40	1990	45
# of Expulsions and Suspensions (SY)	1999	808	1999	808

Juveniles and the Law

# of Juveniles Committed to the Dept. of Correction (CY)	2000	2	1994	5
# of Juvenile Status Case Filings (CY)	2000	0	1990	0
# of Juvenile Delinquency Case Filings (CY)	2000	18	1990	19

Percent of Households with Children Under 18 Headed by Parents and Others, Census 2000

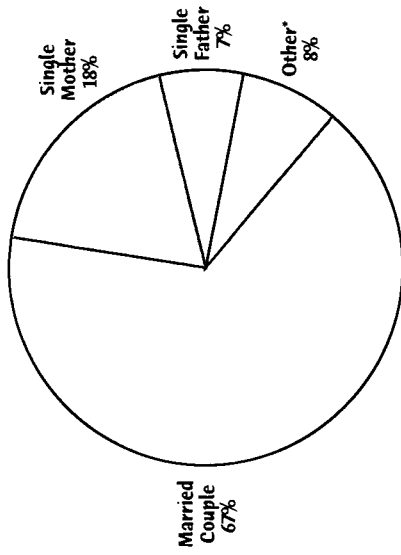

* "Other" includes households with children unrelated to the householder(s) and households with no adults present.

Number of Babies Born to Single Mothers Under Age 20 without a High School Diploma

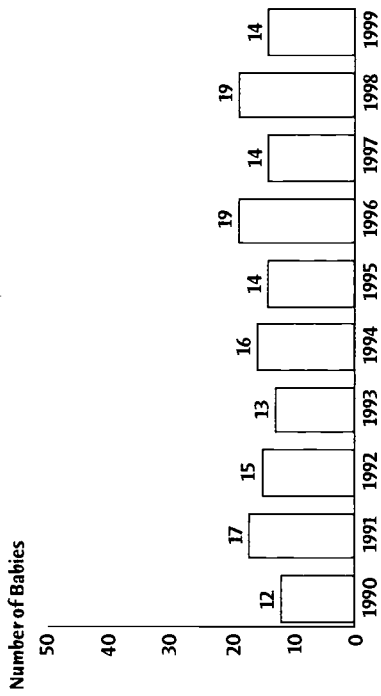

DATA YEAR DEFINITIONS

- SFY - State Fiscal Year: July 1-June 30
- SY - School Year: From the start of the school term in the fall through the end of the summer
- FFY - Federal Fiscal Year: October 1-September 30
- CY - Calendar Year: January 1 - December 31

000000136145

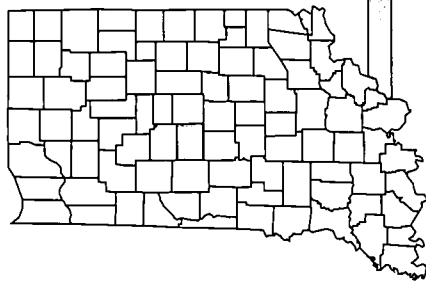

Boone County

Kids Count in Indiana 2001



Economic Well-being

	Current Year	Base Year
% of Children in Poverty, Age 0-17 (CY)	1997 7.0	1990 8.0
Per Capita Income (CY)	1999 \$34,544	1990 \$21,118
Unemployment Rate (CY)	2000 1.7	1990 2.4
Monthly Average of Families Receiving TANF (SFY)	2000 53	1990 72
Monthly Average of Persons Issued Food Stamps (SFY)	2000 883	1990 766
% of Students Receiving Free Lunches / Text Books (SY)	2001 9.4	1991 7.5

Early Childhood

# of First Steps Children Served (FFY)	2000 159	1998 88
# of Licensed Child Care Centers (SFY)	2000 6	1990 5
# of Licensed Child Care Homes (SFY)	2000 21	1990 22
# of Registered Child Care Ministries (SFY)	2000 5	1993 0
# of Licensed Child Care Slots per 100 Children, Age 0-4 (SFY)	2000 24.4	1996 23.9

Child Protection

# of Reported Cases of Child Abuse Processed by CPS (SFY)	2000 91	1990 86
% of Child Abuse Cases Substantiated by CPS (SFY)	2000 38.0	1990 73.3
# of Reported Cases of Child Neglect Processed by CPS (SFY)	2000 117	1990 94
% of Child Neglect Cases Substantiated by CPS (SFY)	2000 37.0	1990 69.1
# of Child Physical Abuse Cases Substantiated by CPS (SFY)	2000 21	1990 21
# of Child Sexual Abuse Cases Substantiated by CPS (SFY)	2000 14	1990 17
Child Abuse and Neglect Rate (SFY)	2000 6.5	1990 16.4
# of Child Abuse and Neglect Deaths (SFY)	2000 0	1990 0
# of Juvenile CHINS Case Filings (CY)	2000 262	1990 20

Racial/Ethnic Characteristics of Children Age 0-17 in Boone County

One Race (Non-Hispanic Origin)	96.2%
White	0.4%
Black	0.2%
American Indian or Alaska Native	0.5%
Asian	0.0%
Native Hawaiian or Other Pacific Islander	0.1%
Some Other Race	0.9%
Two or More Races (Non-Hispanic Origin)	1.8%
Hispanic Origin*	

*Hispanic children may be of any race.

Number of Children Under the Age of 20 1990 & 2000

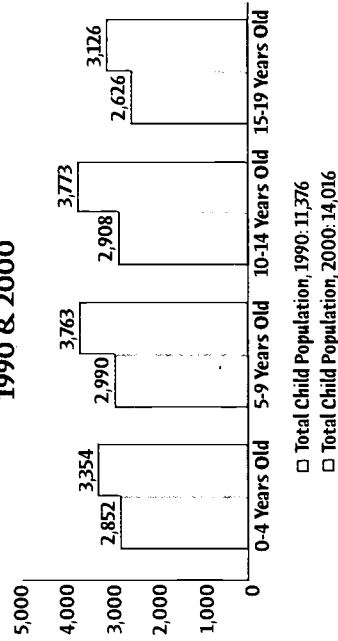



Health & Well-being

	Current Year	Base Year
Total # of Live Births (CY)	1999 614	1990 598
% of Low Birthweight Babies (CY)	1999 6.8	1990 5.7
% of Mothers who Received 1st Trimester Prenatal Care (CY)	1999 85.5	1990 82.6
% of Mothers who Smoked During Pregnancy (CY)	1999 15.6	1990 20.6
Non Marital Births as a % of All Births (CY)	1999 18.6	1990 12.5
Teen Birth Rate, Age 15-17 (CY)	1999 12.9	1990 22.8
Total # of Infant Deaths (CY)	1999 2	1990 5
Total # of Child Deaths, Age 1-14 (CY)	1999 1	1990 0
Total # of Teen Deaths by Accident, Homicide and Suicide (CY)	1999 1	1990 0
# of Children Enrolled in Hoosier Healthwise (SFY)	2000 1,234	1998 619
% Noncompliance with Youth Tobacco Access Laws (CY)	2000 30.0	1997 N/A

Percent of Households with Children Under 18 Headed by Parents and Others, Census 2000

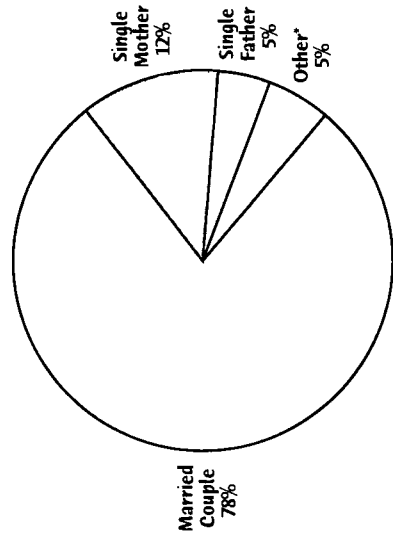

Education, Grades K-12

Public School Enrollment, K-12 (SY)	2000 8,373	1990 6,064
Non-Public School Enrollment (SY)	2001 353	1995 161
# of Home Schooled Children (SY)	2000 104	1990 1
# of Alternative School Participants (SY)	2001 449	1990 0
Total Per Pupil Expenditure (SY)	2000 \$5,721	1990 \$3,621
% of 10th Graders Passing the GQE Math Standard (SY)	2000 75.0	2000 75.0
% of 10th Graders Passing the GQE Language Standard (SY)	2000 78.0	2000 78.0
% of Graduates Passing the GQE (SY)	2000 99.8	2000 99.8
# of Public High School Graduates (SY)	2000 480	1990 535
% of High School Graduates (SY)	2000 95.8	1990 86.2
% of Freshman Class Graduating in 4 Years (SY)	2000 77.0	1990 84.7
% of Grads Intending 4-year College (SY)	2000 73.3	1990 54.3
% of Grads Intending Vocational/Tech School (SY)	2000 7.7	1990 8.4
# of Public School Student Dropouts (SY)	2000 26	1990 79
# of Expulsions and Suspensions (SY)	1999 1,814	1999 1,814

Juveniles and the Law

# of Juveniles Committed to the Dept. of Correction (CY)	2000 3	1994 0
# of Juvenile Status Case Filings (CY)	2000 65	1990 0
# of Juvenile Delinquency Case Filings (CY)	2000 113	1990 61

* "Other" includes households with children unrelated to the householder(s) and households with no adults present.

Number of Babies Born to Single Mothers Under Age 20 without a High School Diploma

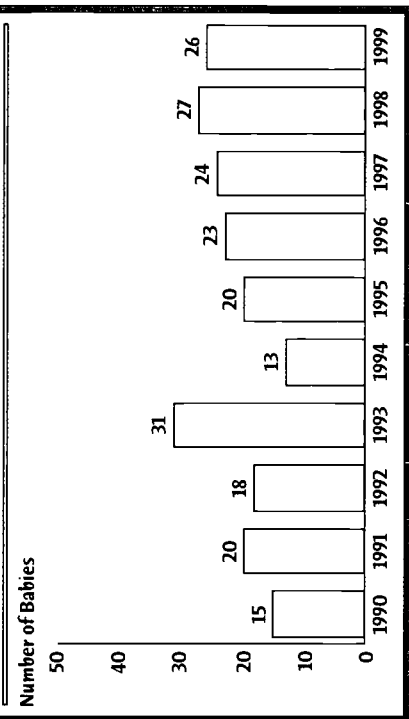

DATA YEAR DEFINITIONS

- SFY - State Fiscal Year: July 1-June 30
- SY - School Year: From the start of the school term in the fall through the end of the summer
- FFY - Federal Fiscal Year: October 1-September 30
- CY - Calendar Year: January 1 - December 31

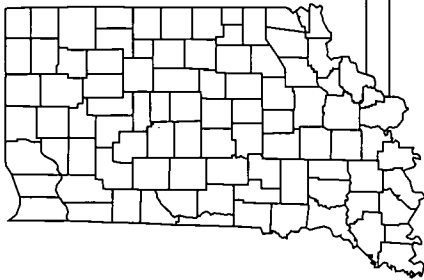

Brown County

Kids Count in Indiana 2001



Economic Well-being

	Current Year	Base Year
% of Children in Poverty, Age 0-17 (CY)	1997 13.1	1990 8.1
Per Capita Income (CY)	1999 \$25,990	1990 \$14,739
Unemployment Rate (CY)	2000 2.4	1990 4.5
Monthly Average of Families Receiving TANF (SFY)	2000 28	1990 66
Monthly Average of Persons Issued Food Stamps (SFY)	2000 438	1990 505
% of Students Receiving Free Lunches / Text Books (SY)	2001 15.2	1991 11.9

Early Childhood

# of First Steps Children Served (FFY)	2000 38	1998 25
# of Licensed Child Care Centers (SFY)	2000 2	1990 1
# of Licensed Child Care Homes (SFY)	2000 6	1990 3
# of Registered Child Care Ministries (SFY)	2000 2	1993 1
# of Licensed Child Care Slots per 100 Children, Age 0-4 (SFY)	2000 13	1996 14.9

Child Protection

# of Reported Cases of Child Abuse Processed by CPS (SFY)	2000 51	1990 66
% of Child Abuse Cases Substantiated by CPS (SFY)	2000 45.0	1990 50.0
# of Reported Cases of Child Neglect Processed by CPS (SFY)	2000 91	1990 107
% of Child Neglect Cases Substantiated by CPS (SFY)	2000 26.0	1990 49.5
# of Child Physical Abuse Cases Substantiated by CPS (SFY)	2000 14	1990 11
# of Child Sexual Abuse Cases Substantiated by CPS (SFY)	2000 9	1990 10
Child Abuse and Neglect Rate (SFY)	2000 12.3	1990 47.9
# of Child Abuse and Neglect Deaths (SFY)	2000 0	1990 0
# of Juvenile CHINS Case Filings (CY)	2000 18	1990 10

Racial/Ethnic Characteristics of Children Age 0-17 in Brown County

One Race (Non-Hispanic Origin)	96.8%
White	0.3%
Black	0.2%
American Indian or Alaska Native	0.1%
Asian	0.0%
Native Hawaiian or Other Pacific Islander	0.1%
Some Other Race	1.3%
Two or More Races (Non-Hispanic Origin)	1.2%
Hispanic Origin*	

*Hispanic children may be of any race.

Number of Children Under the Age of 20 1990 & 2000

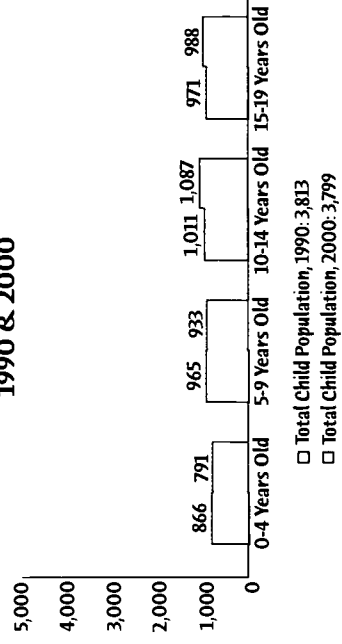

Health & Well-being

	Current Year	Base Year
Total # of Live Births (CY)	1999 170	1990 168
% of Low Birthweight Babies (CY)	1999 4.7	1990 5.4
% of Mothers who Received 1st Trimester Prenatal Care (CY)	1999 81.2	1990 78.8
% of Mothers who Smoked During Pregnancy (CY)	1999 18.2	1990 25.0
Non Marital Births as a % of All Births (CY)	1999 20.0	1990 14.3
Teen Birth Rate, Age 15-17 (CY)	1999 13.9	1990 23.3
Total # of Infant Deaths (CY)	1999 1	1990 2
Total # of Child Deaths, Age 1-14 (CY)	1999 1	1990 0
Total # of Teen Deaths by Accident, Homicide and Suicide (CY)	1999 2	1990 0
# of Children Enrolled in Hoosier Healthwise (SFY)	2000 726	1998 400
% Noncompliance with Youth Tobacco Access Laws (CY)	2000 N/A	1997 25.6

Percent of Households with Children Under 18 Headed by Parents and Others, Census 2000

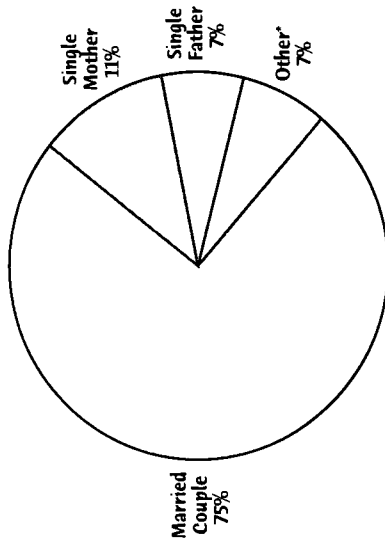

* "Other" includes households with children unrelated to the householder(s) and households with no adults present.

Number of Babies Born to Single Mothers Under Age 20 without a High School Diploma

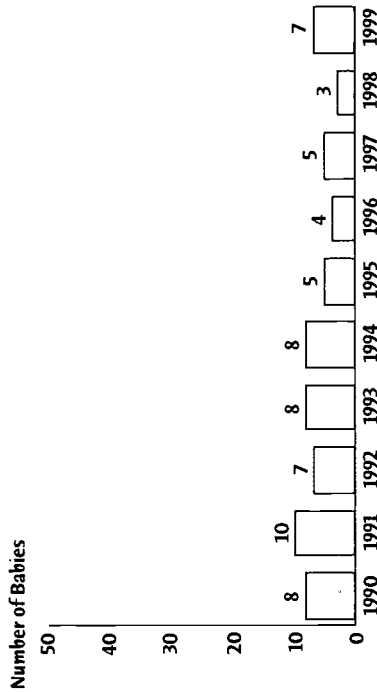

Education, Grades K-12

Public School Enrollment, K-12 (SY)	2000 2,434	1990 2,182
Non-Public School Enrollment (SY)	2001 50	1995 37
# of Home Schooled Children (SY)	2000 138	1990 7
# of Alternative School Participants (SY)	2001 31	1990 0
Total Per Pupil Expenditure (SY)	2000 \$6,449	1990 \$4,004
% of 10th Graders Passing the GQE Math Standard (SY)	2000 65.0	2000 65.0
% of 10th Graders Passing the GQE Language Standard (SY)	2000 73.0	2000 73.0
% of Graduates Passing the GQE (SY)	2000 94.1	2000 94.1
# of Public High School Graduates (SY)	2000 152	1990 183
% of High School Graduates (SY)	2000 100.0	1990 74.6
% of Freshman Class Graduating in 4 Years (SY)	2000 71.4	1990 79.2
% of Grads Intending 4-year College (SY)	2000 45.4	1990 16.0
% of Grads Intending Vocational/Tech School (SY)	2000 .7	1990 3.8
# of Public School Student Dropouts (SY)	2000 0	1990 53
# of Expulsions and Suspensions (SY)	1999 545	1999 545

Juveniles and the Law

# of Juveniles Committed to the Dept. of Correction (CY)	2000 1	1994 1
# of Juvenile Status Case Filings (CY)	2000 29	1990 11
# of Juvenile Delinquency Case Filings (CY)	2000 47	1990 41

DATA YEAR DEFINITIONS

SFY - State Fiscal Year: July 1-June 30

SY - School Year: From the start of the school term in the fall through the end of the summer

FFY - Federal Fiscal Year: October 1-September 30

CY - Calendar Year: January 1 - December 31

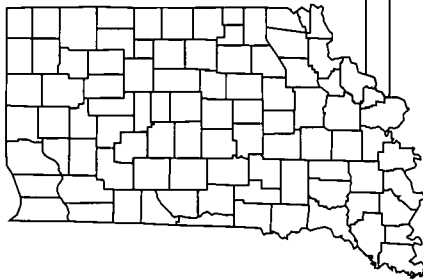

Carroll County

Kids Count in Indiana 2001



Economic Well-being

	Current Year	Base Year
% of Children in Poverty, Age 0-17 (CY)	1997 11.0	1990 9.4
Per Capita Income (CY)	1999 \$23,483	1990 \$16,464
Unemployment Rate (CY)	2000 2.5	1990 4.1
Monthly Average of Families Receiving TANF (SFY)	2000 27	1990 68
Monthly Average of Persons Issued Food Stamps (SFY)	2000 414	1990 551
% of Students Receiving Free Lunches / Text Books (SY)	2001 13.6	1991 11.5

Early Childhood

# of First Steps Children Served (FFY)	2000 30	1998 12
# of Licensed Child Care Centers (SFY)	2000 1	1990 1
# of Licensed Child Care Homes (SFY)	2000 7	1990 13
# of Registered Child Care Ministries (SFY)	2000 2	1993 2
# of Licensed Child Care Slots per 100 Children, Age 0-4 (SFY)	2000 8.1	1996 15.9

Child Protection

# of Reported Cases of Child Abuse Processed by CPS (SFY)	2000 47	1990 58
% of Child Abuse Cases Substantiated by CPS (SFY)	2000 74.0	1990 50.0
# of Reported Cases of Child Neglect Processed by CPS (SFY)	2000 70	1990 75
% of Child Neglect Cases Substantiated by CPS (SFY)	2000 61.0	1990 25.3
# of Child Physical Abuse Cases Substantiated by CPS (SFY)	2000 16	1990 7
# of Child Sexual Abuse Cases Substantiated by CPS (SFY)	2000 19	1990 4
Child Abuse and Neglect Rate (SFY)	2000 15.0	1990 22.8
# of Child Abuse and Neglect Deaths (SFY)	2000 0	1990 0
# of Juvenile CHINS Case Filings (CY)	2000 2	1990 7

Racial/Ethnic Characteristics of Children Age 0-17 in Carroll County

One Race (Non-Hispanic Origin)	94.8%
White	0.3%
Black	0.2%
American Indian or Alaska Native	0.0%
Asian	0.0%
Native Hawaiian or Other Pacific Islander	0.0%
Some Other Race	0.0%
Two or More Races (Non-Hispanic Origin)	0.5%
Hispanic Origin*	4.2%

*Hispanic children may be of any race.

Number of Children Under the Age of 20 1990 & 2000

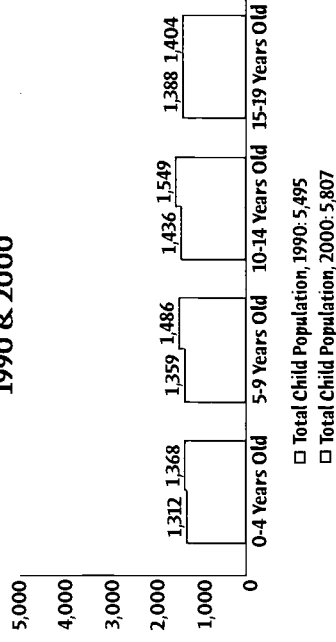

000000 136148

Health & Well-being

	Current Year	Base Year
Total # of Live Births (CY)	1999 261	1990 242
% of Low Birthweight Babies (CY)	1999 6.1	1990 2.1
% of Mothers who Received 1st Trimester Prenatal Care (CY)	1999 90.8	1990 80.7
% of Mothers who Smoked During Pregnancy (CY)	1999 14.2	1990 19.8
Non Marital Births as a % of All Births (CY)	1999 19.2	1990 16.5
Teen Birth Rate, Age 15-17 (CY)	1999 8.7	1990 12.0
Total # of Infant Deaths (CY)	1999 1	1990 2
Total # of Child Deaths, Age 1-14 (CY)	1999 0	1990 1
Total # of Teen Deaths by Accident, Homicide and Suicide (CY)	1999 1	1990 1
# of Children Enrolled in Hoosier Healthwise (SFY)	2000 652	1998 356
% Noncompliance with Youth Tobacco Access Laws (CY)	2000 N/A	1997 N/A

Percent of Households with Children Under 18 Headed by Parents and Others, Census 2000

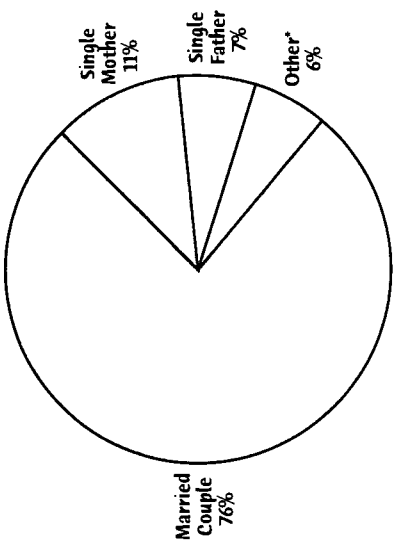

*"Other" includes households with children unrelated to the householder(s) and households with no adults present.

Education, Grades K-12

Public School Enrollment, K-12 (SY)	2000 2,893	1990 2,661
Non-Public School Enrollment (SY)	2001 0	1995 0
# of Home Schooled Children (SY)	2000 60	1990 16
# of Alternative School Participants (SY)	2001 0	1990 0
Total Per Pupil Expenditure (SY)	2000 \$5,482	1990 \$3,846
% of 10th Graders Passing the GQE Math Standard (SY)	2000 71.0	2000 71.0
% of 10th Graders Passing the GQE Language Standard (SY)	2000 72.0	2000 72.0
% of Graduates Passing the GQE (SY)	2000 95.9	2000 95.9
# of Public High School Graduates (SY)	2000 194	1990 193
% of High School Graduates (SY)	2000 84.5	1990 79.2
% of Freshman Class Graduating in 4 Years (SY)	2000 78.5	1990 81.4
% of Grads Intending 4-year College (SY)	2000 50.0	1990 37.1
% of Grads Intending Vocational/Tech School (SY)	2000 12.4	1990 16.5
# of Public School Student Dropouts (SY)	2000 37	1990 48
# of Expulsions and Suspensions (SY)	1999 485	1999 485

Juveniles and the Law

# of Juveniles Committed to the Dept. of Correction (CY)	2000 8	1994 4
# of Juvenile Status Case Filings (CY)	2000 0	1990 3
# of Juvenile Delinquency Case Filings (CY)	2000 67	1990 30

Number of Babies Born to Single Mothers Under Age 20 without a High School Diploma

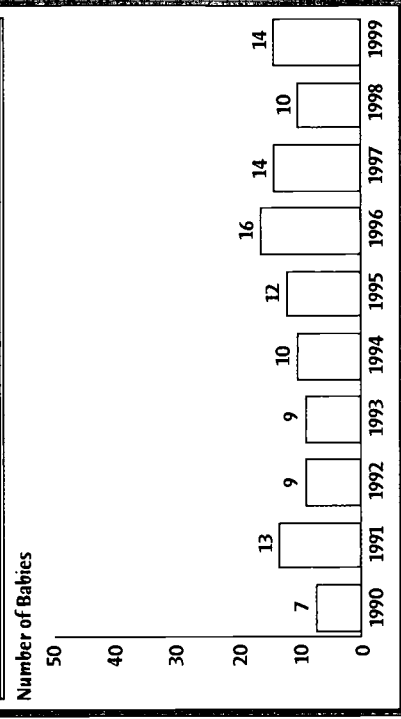

DATA YEAR DEFINITIONS

- SFY - State Fiscal Year: July 1-June 30
- SY - School Year: From the start of the school term in the fall through the end of the summer
- FFY - Federal Fiscal Year: October 1-September 30
- CY - Calendar Year: January 1 - December 31

134

135

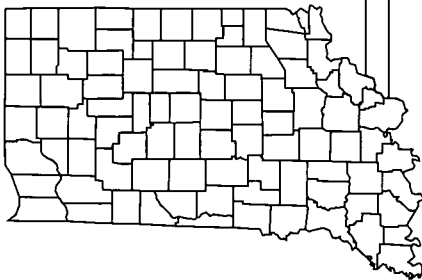

Cass County

Kids Count in Indiana 2001



Economic Well-being

	Current Year	Base Year
% of Children in Poverty, Age 0-17 (CY)	1997 14.7	1990 13.4
Per Capita Income (CY)	1999 \$23,362	1990 \$15,827
Unemployment Rate (CY)	2000 3.3	1990 6.9
Monthly Average of Families Receiving TANF (SFY)	2000 122	1990 340
Monthly Average of Persons Issued Food Stamps (SFY)	2000 1,746	1990 2,776
% of Students Receiving Free Lunches / Text Books (SY)	2001 23.4	1991 15.5

Early Childhood

# of First Steps Children Served (FFY)	2000 68	1998 57
# of Licensed Child Care Centers (SFY)	2000 4	1990 6
# of Licensed Child Care Homes (SFY)	2000 14	1990 2
# of Registered Child Care Ministries (SFY)	2000 5	1993 2
# of Licensed Child Care Slots per 100 Children, Age 0-4 (SFY)	2000 15.4	1996 20.1

Child Protection

# of Reported Cases of Child Abuse Processed by CPS (SFY)	2000 110	1990 163
% of Child Abuse Cases Substantiated by CPS (SFY)	2000 50.0	1990 56.4
# of Reported Cases of Child Neglect Processed by CPS (SFY)	2000 149	1990 273
% of Child Neglect Cases Substantiated by CPS (SFY)	2000 45.0	1990 62.3
# of Child Physical Abuse Cases Substantiated by CPS (SFY)	2000 29	1990 26
# of Child Sexual Abuse Cases Substantiated by CPS (SFY)	2000 26	1990 15
Child Abuse and Neglect Rate (SFY)	2000 12.2	1990 36.4
# of Child Abuse and Neglect Deaths (SFY)	2000 0	1990 0
# of Juvenile CHINS Case Filings (CY)	2000 29	1990 25

Racial/Ethnic Characteristics of Children Age 0-17 in Cass County

One Race (Non-Hispanic Origin)	86.6%
White	1.7%
Black	0.3%
American Indian or Alaska Native	0.4%
Asian	0.0%
Native Hawaiian or Other Pacific Islander	0.1%
Some Other Race	1.3%
Two or More Races (Non-Hispanic Origin)	9.5%
Hispanic Origin*	

*Hispanic children may be of any race.

Number of Children Under the Age of 20 1990 & 2000

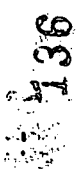
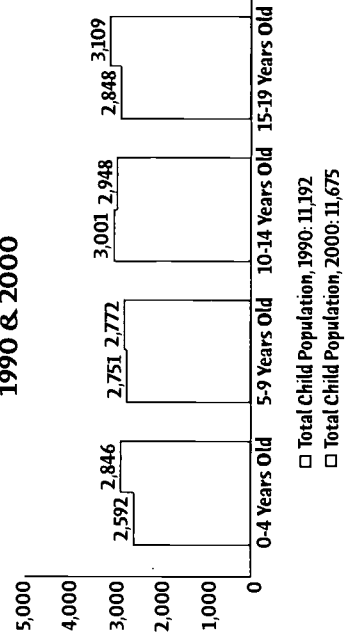

Health & Well-being

Percent of Households with Children Under 18 Headed by Parents and Others, Census 2000

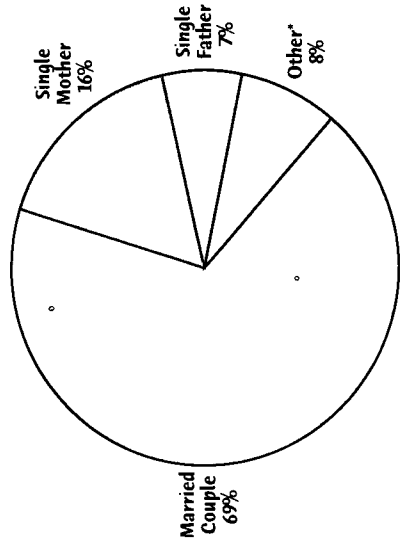

*"Other" includes households with children unrelated to the householder(s) and households with no adults present.

Number of Babies Born to Single Mothers Under Age 20 without a High School Diploma

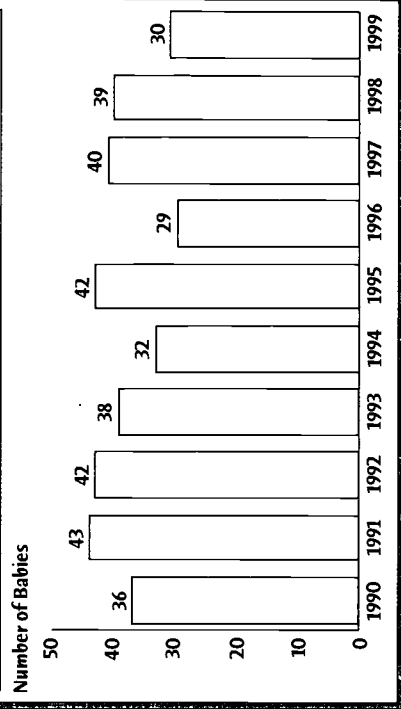

	Current Year	Base Year
Total # of Live Births (CY)	1999 575	1990 555
% of Low Birthweight Babies (CY)	1999 6.4	1990 6.3
% of Mothers who Received 1st Trimester Prenatal Care (CY)	1999 76.7	1990 78.7
% of Mothers who Smoked During Pregnancy (CY)	1999 23.0	1990 31.4
Non Marital Births as a % of All Births (CY)	1999 33.6	1990 23.1
Teen Birth Rate, Age 15-17 (CY)	1999 19.8	1990 26.4
Total # of Infant Deaths (CY)	1999 2	1990 3
Total # of Child Deaths, Age 1-14 (CY)	1999 3	1990 8
Total # of Teen Deaths by Accident, Homicide and Suicide (CY)	1999 1	1990 2
# of Children Enrolled in Hoosier Healthwise (SFY)	2000 2,567	1998 1,342
% Noncompliance with Youth Tobacco Access Laws (CY)	2000 0	1997 N/A

Education, Grades K-12

Public School Enrollment, K-12 (SY)	2000 6,570	1990 5,938
Non-Public School Enrollment (SY)	2001 267	1995 280
# of Home Schooled Children (SY)	2000 97	1990 2
# of Alternative School Participants (SY)	2001 0	1990 0
Total Per Pupil Expenditure (SY)	2000 \$7,572	1990 \$4,068
% of 10th Graders Passing the GQE Math Standard (SY)	2000 66.0	2000 66.0
% of 10th Graders Passing the GQE Language Standard (SY)	2000 68.0	2000 68.0
% of Graduates Passing the GQE (SY)	2000 92.9	2000 92.9
# of Public High School Graduates (SY)	2000 425	1990 577
% of High School Graduates (SY)	2000 90.4	1990 75.8
% of Freshman Class Graduating in 4 Years (SY)	2000 69.0	1990 100.5
% of Grads Intending 4-year College (SY)	2000 50.8	1990 37.0
% of Grads Intending Vocational/Tech School (SY)	2000 14.8	1990 6.4
# of Public School Student Dropouts (SY)	2000 46	1990 169
# of Expulsions and Suspensions (SY)	1999 1,445	1999 1,445

Juveniles and the Law

# of Juveniles Committed to the Dept. of Correction (CY)	2000 13	1994 10
# of Juvenile Status Case Filings (CY)	2000 32	1990 0
# of Juvenile Delinquency Case Filings (CY)	2000 115	1990 118

DATA YEAR DEFINITIONS

SFY - State Fiscal Year: July 1-June 30
 SY - School Year: From the start of the school term in the fall through the end of the summer
 FFY - Federal Fiscal Year: October 1-September 30
 CY - Calendar Year: January 1 - December 31



Clark County

Kids Count in Indiana 2001

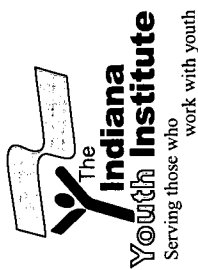

Economic Well-being

	Current Year	Base Year
% of Children in Poverty, Age 0-17 (CY)	1997 15.5	1990 13.8
Per Capita Income (CY)	1999 \$24,955	1990 \$16,581
Unemployment Rate (CY)	2000 3.3	1990 5.9
Monthly Average of Families Receiving TANF (SFY)	2000 450	1990 902
Monthly Average of Persons Issued Food Stamps (SFY)	2000 4,232	1990 4,607
% of Students Receiving Free Lunches / Text Books (SY)	2001 21.2	1991 19.2

Early Childhood

# of First Steps Children Served (FFY)	2000 343	1998 226
# of Licensed Child Care Centers (SFY)	2000 15	1990 9
# of Licensed Child Care Homes (SFY)	2000 29	1990 9
# of Registered Child Care Ministries (SFY)	2000 8	1993 4
# of Licensed Child Care Slots per 100 Children, Age 0-4 (SFY)	2000 27.2	1996 28.5

Child Protection

# of Reported Cases of Child Abuse Processed by CPS (SFY)	2000 432	1990 298
% of Child Abuse Cases Substantiated by CPS (SFY)	2000 57.0	1990 58.1
# of Reported Cases of Child Neglect Processed by CPS (SFY)	2000 1,208	1990 265
% of Child Neglect Cases Substantiated by CPS (SFY)	2000 59.0	1990 47.2
# of Child Physical Abuse Cases Substantiated by CPS (SFY)	2000 119	1990 58
# of Child Sexual Abuse Cases Substantiated by CPS (SFY)	2000 129	1990 49
Child Abuse and Neglect Rate (SFY)	2000 40.5	1990 20.6
# of Child Abuse and Neglect Deaths (SFY)	2000 0	1990 0
# of Juvenile CHINS Case Filings (CY)	2000 136	1990 111

Racial/Ethnic Characteristics of Children Age 0-17 in Clark County

One Race (Non-Hispanic Origin)	85.2%
White	8.3%
Black	0.2%
American Indian or Alaska Native	0.5%
Asian	0.0%
Native Hawaiian or Other Pacific Islander	0.3%
Some Other Race	2.9%
Two or More Races (Non-Hispanic Origin)	2.5%
Hispanic Origin*	

*Hispanic children may be of any race.

Number of Children Under the Age of 20 1990 & 2000

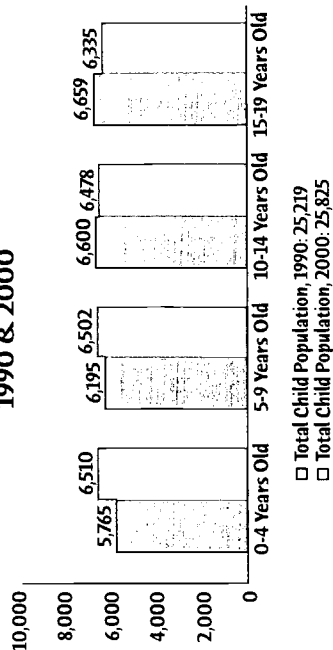

000000 136150

Health & Well-being

	Current Year	Base Year
Total # of Live Births (CY)	1999 1,323	1990 1,207
% of Low Birthweight Babies (CY)	1999 8.7	1990 6.0
% of Mothers who Received 1st Trimester Prenatal Care (CY)	1999 79.7	1990 80.0
% of Mothers who Smoked During Pregnancy (CY)	1999 22.6	1990 28.7
Non Marital Births as a % of All Births (CY)	1999 37.3	1990 27.3
Teen Birth Rate, Age 15-17 (CY)	1999 27.3	1990 32.6
Total # of Infant Deaths (CY)	1999 15	1990 10
Total # of Child Deaths, Age 1-14 (CY)	1999 1	1990 3
Total # of Teen Deaths by Accident, Homicide and Suicide (CY)	1999 1	1990 1
# of Children Enrolled in Hoosier Healthwise (SFY)	2000 4,889	1998 3,209
% Noncompliance with Youth Tobacco Access Laws (CY)	2000 10.0	1997 5.3

Percent of Households with Children Under 18 Headed by Parents and Others, Census 2000

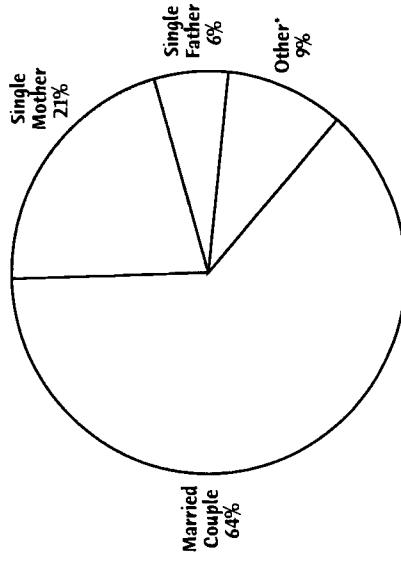

* "Other" includes households with children unrelated to the householder(s) and households with no adults present.

Education, Grades K-12

Public School Enrollment, K-12 (SY)	2000 14,164	1990 12,451
Non-Public School Enrollment (SY)	2001 2,062	1995 1,833
# of Home Schooled Children (SY)	2000 294	1990 12
# of Alternative School Participants (SY)	2001 139	1990 0
Total Per Pupil Expenditure (SY)	2000 \$7,168	1990 \$4,220
% of 10th Graders Passing the GQE Math Standard (SY)	2000 50.0	2000 50.0
% of 10th Graders Passing the GQE Language Standard (SY)	2000 60.0	2000 60.0
% of Graduates Passing the GQE (SY)	2000 90.9	2000 90.9
# of Public High School Graduates (SY)	2000 805	1990 1,075
% of High School Graduates (SY)	2000 89.3	1990 73.0
% of Freshman Class Graduating in 4 Years (SY)	2000 63.7	1990 80.7
% of Grads Intending 4-year College (SY)	2000 49.3	1990 44.3
% of Grads Intending Vocational/Tech School (SY)	2000 4.1	1990 7.1
# of Public School Student Dropouts (SY)	2000 116	1990 335
# of Expulsions and Suspensions (SY)	1999 5,315	1999 5,315

Juveniles and the Law

# of Juveniles Committed to the Dept. of Correction (CY)	2000 22	1994 11
# of Juvenile Status Case Filings (CY)	2000 91	1990 99
# of Juvenile Delinquency Case Filings (CY)	2000 349	1990 192

Number of Babies Born to Single Mothers Under Age 20 without a High School Diploma

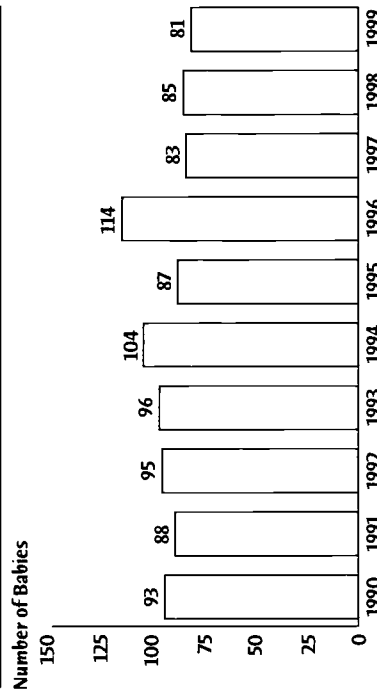

DATA YEAR DEFINITIONS

SFY – State Fiscal Year: July 1-June 30
 SY – School Year: From the start of the school term in the fall through the end of the summer
 FFY – Federal Fiscal Year: October 1-September 30
 CY – Calendar Year: January 1 – December 31

142

143

Kids Count 2001

Indiana Youth Institute

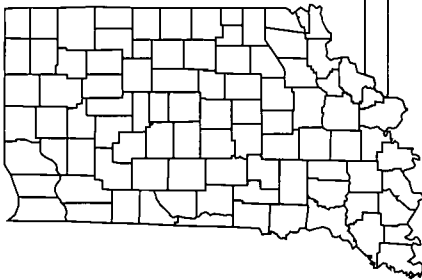

Clay County

Kids Count in Indiana 2001



Economic Well-being

	Current Year	Base Year
% of Children in Poverty, Age 0-17 (CY)	1997 15.9	1990 15.2
Per Capita Income (CY)	1999 \$20,520	1990 \$14,182
Unemployment Rate (CY)	2000 4.8	1990 5.1
Monthly Average of Families Receiving TANF (SFY)	2000 97	1990 198
Monthly Average of Persons Issued Food Stamps (SFY)	2000 1,221	1990 1,526
% of Students Receiving Free Lunches / Text Books (SY)	2001 20.6	1991 18.1

Early Childhood

# of First Steps Children Served (FFY)	2000 64	1998 59
# of Licensed Child Care Centers (SFY)	2000 1	1990 2
# of Licensed Child Care Homes (SFY)	2000 23	1990 3
# of Registered Child Care Ministries (SFY)	2000 3	1993 0
# of Licensed Child Care Slots per 100 Children, Age 0-4 (SFY)	2000 18.1	1996 15

Child Protection

# of Reported Cases of Child Abuse Processed by CPS (SFY)	2000 80	1990 85
% of Child Abuse Cases Substantiated by CPS (SFY)	2000 63.0	1990 50.6
# of Reported Cases of Child Neglect Processed by CPS (SFY)	2000 140	1990 145
% of Child Neglect Cases Substantiated by CPS (SFY)	2000 62.0	1990 57.2
# of Child Physical Abuse Cases Substantiated by CPS (SFY)	2000 30	1990 14
# of Child Sexual Abuse Cases Substantiated by CPS (SFY)	2000 20	1990 10
Child Abuse and Neglect Rate (SFY)	2000 19.6	1990 33.2
# of Child Abuse and Neglect Deaths (SFY)	2000 0	1990 0
# of Juvenile CHINS Case Filings (CY)	2000 15	1990 21

Racial/Ethnic Characteristics of Children Age 0-17 in Clay County

One Race (Non-Hispanic Origin)	97.3%
White	0.3%
Black	0.3%
American Indian or Alaska Native	0.1%
Asian	0.0%
Native Hawaiian or Other Pacific Islander	0.2%
Some Other Race	1.0%
Two or More Races (Non-Hispanic Origin)	0.8%
Hispanic Origin*	

*Hispanic children may be of any race.

Number of Children Under the Age of 20 1990 & 2000

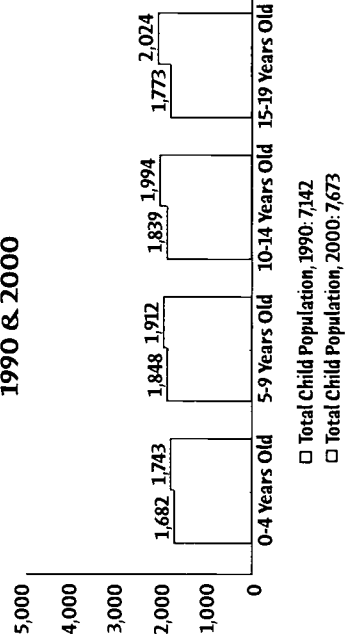

000000 136151

Health & Well-being

	Current Year	Base Year
total # of Live Births (CY)	1999 343	1990 366
% of Low Birthweight Babies (CY)	1999 6.1	1990 4.9
% of Mothers who Received 1st Trimester Prenatal Care (CY)	1999 84.3	1990 85.0
% of Mothers who Smoked During Pregnancy (CY)	1999 29.2	1990 27.0
Non Marital Births as a % of All Births (CY)	1999 29.4	1990 16.7
Teen Birth Rate, Age 15-17 (CY)	1999 25.4	1990 43.4
Total # of Infant Deaths (CY)	1999 6	1990 1
Total # of Child Deaths, Age 1-14 (CY)	1999 1	1990 0
Total # of Teen Deaths by Accident, Homicide and Suicide (CY)	1999 2	1990 0
# of Children Enrolled in Hoosier Healthwise (SFY)	2000 1,698	1998 916
% Noncompliance with Youth Tobacco Access Laws (CY)	2000 N/A	1997 13.6

Percent of Households with Children Under 18 Headed by Parents and Others, Census 2000

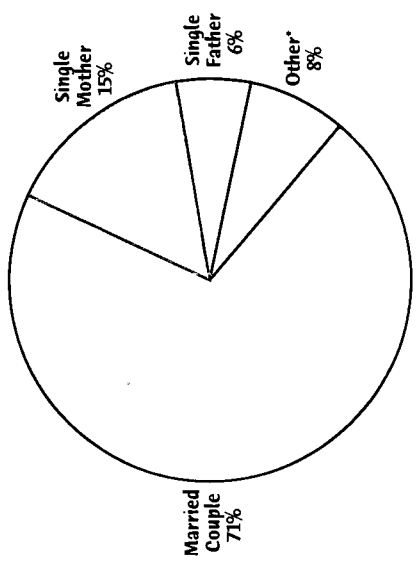

* "Other" includes households with children unrelated to the householder(s) and households with no adults present.

Education, Grades K-12

Public School Enrollment, K-12 (SY)	2000 4,695	1990 4,111
Non-Public School Enrollment (SY)	2001 276	1995 229
# of Home Schooled Children (SY)	2000 133	1990 0
# of Alternative School Participants (SY)	2001 79	1990 0
Total Per Pupil Expenditure (SY)	2000 \$6,137	1990 \$3,884
% of 10th Graders Passing the GQE Math Standard (SY)	2000 70.0	2000 70.0
% of 10th Graders Passing the GQE Language Standard (SY)	2000 72.0	2000 72.0
% of Graduates Passing the GQE (SY)	2000 98.1	2000 98.1
# of Public High School Graduates (SY)	2000 257	1990 310
% of High School Graduates (SY)	2000 91.7	1990 81.0
% of Freshman Class Graduating in 4 Years (SY)	2000 72.6	1990 80.1
% of Grads Intending 4-year College (SY)	2000 56.4	1990 48.3
% of Grads Intending Vocational/Tech School (SY)	2000 4.7	1990 17.2
# of Public School Student Dropouts (SY)	2000 32	1990 69
# of Expulsions and Suspensions (SY)	1999 1,385	1999 1,385

Juveniles and the Law

# of Juveniles Committed to the Dept. of Correction (CY)	2000 2	1994 4
# of Juvenile Status Case Filings (CY)	2000 80	1990 32
# of Juvenile Delinquency Case Filings (CY)	2000 141	1990 49

Number of Babies Born to Single Mothers Under Age 20 without a High School Diploma

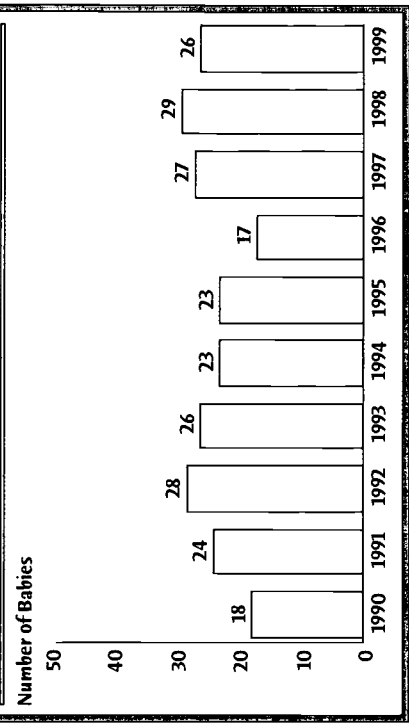

DATA YEAR DEFINITIONS

- SFY - State Fiscal Year: July 1-June 30
- SY - School Year: From the start of the school term in the fall through the end of the summer
- FFY - Federal Fiscal Year: October 1-September 30
- CY - Calendar Year: January 1 - December 31

147

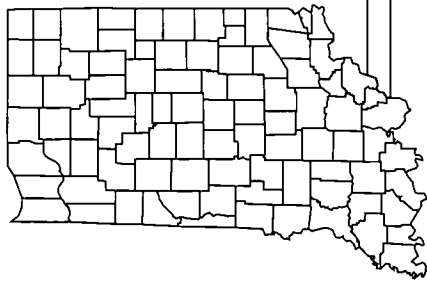

Clinton County

Kids Count in Indiana 2001



Economic Well-being

	Current Year	Base Year
% of Children in Poverty, Age 0-17 (CY)	1997 13.1	1990 11.7
Per Capita Income (CY)	1999 \$22,540	1990 \$15,838
Unemployment Rate (CY)	2000 2.7	1990 4.7
Monthly Average of Families Receiving TANF (SFY)	2000 80	1990 263
Monthly Average of Persons Issued Food Stamps (SFY)	2000 1,144	1990 1,856
% of Students Receiving Free Lunches / Text Books (SY)	2001 22.2	1991 19.3

Early Childhood

# of First Steps Children Served (FFY)	2000 118	1998 74
# of Licensed Child Care Centers (SFY)	2000 2	1990 2
# of Licensed Child Care Homes (SFY)	2000 14	1990 14
# of Registered Child Care Ministries (SFY)	2000 4	1993 0
# of Licensed Child Care Slots per 100 Children, Age 0-4 (SFY)	2000 12	1996 16.5

Child Protection

# of Reported Cases of Child Abuse Processed by CPS (SFY)	2000 91	1990 108
% of Child Abuse Cases Substantiated by CPS (SFY)	2000 64.0	1990 52.8
# of Reported Cases of Child Neglect Processed by CPS (SFY)	2000 144	1990 97
% of Child Neglect Cases Substantiated by CPS (SFY)	2000 63.0	1990 56.7
# of Child Physical Abuse Cases Substantiated by CPS (SFY)	2000 20	1990 18
# of Child Sexual Abuse Cases Substantiated by CPS (SFY)	2000 38	1990 19
Child Abuse and Neglect Rate (SFY)	2000 16.4	1990 22.4
# of Child Abuse and Neglect Deaths (SFY)	2000 0	1990 0
# of Juvenile CHINS Case Filings (CY)	2000 24	1990 24

Racial/Ethnic Characteristics of Children Age 0-17 in Clinton County

One Race (Non-Hispanic Origin)	88.7%
White	0.2%
Black	0.1%
American Indian or Alaska Native	0.2%
Asian	0.0%
Native Hawaiian or Other Pacific Islander	0.0%
Some Other Race	0.7%
Two or More Races (Non-Hispanic Origin)	10.0%
Hispanic Origin*	

*Hispanic children may be of any race.

Number of Children Under the Age of 20 1990 & 2000

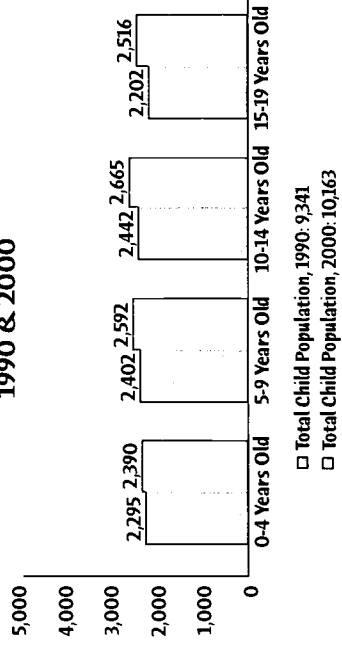

000000 136152

Health & Well-being

	Current Year	Base Year
total # of Live Births (CY)	1999 497	1990 505
% of Low Birthweight Babies (CY)	1999 5.4	1990 6.1
% of Mothers who Received 1st Trimester Prenatal Care (CY)	1999 74.4	1990 67.6
% of Mothers who Smoked During Pregnancy (CY)	1999 21.9	1990 25.9
Non Marital Births as a % of All Births (CY)	1999 31.8	1990 22.6
Teen Birth Rate, Age 15-17 (CY)	1999 24.0	1990 33.1
Total # of Infant Deaths (CY)	1999 5	1990 7
Total # of Child Deaths, Age 1-14 (CY)	1999 2	1990 1
Total # of Teen Deaths by Accident, Homicide and Suicide (CY)	1999 1	1990 3
# of Children Enrolled in Hoosier Healthwise (SFY)	2000 1,839	1998 897
% Noncompliance with Youth Tobacco Access Laws (CY)	2000 0	1997 5.6

Percent of Households with Children Under 18 Headed by Parents and Others, Census 2000

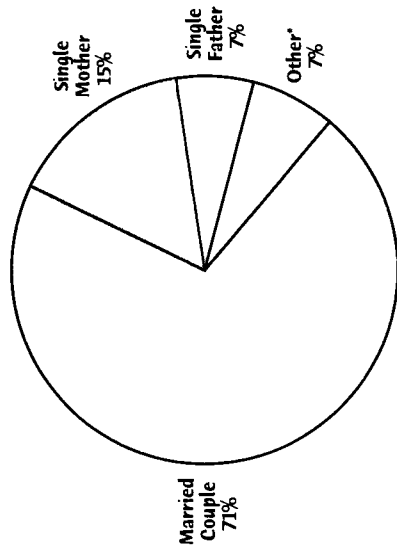

* "Other" includes households with children unrelated to the householder(s) and households with no adults present.

Education, Grades K-12

Public School Enrollment, K-12 (SY)	2000 6,397	1990 5,079
Non-Public School Enrollment (SY)	2001 339	1995 194
# of Home Schooled Children (SY)	2000 90	1990 6
# of Alternative School Participants (SY)	2001 0	1990 0
Total Per Pupil Expenditure (SY)	2000 \$5,765	1990 \$3,632
% of 10th Graders Passing the GQE Math Standard (SY)	2000 71.0	2000 71.0
% of 10th Graders Passing the GQE Language Standard (SY)	2000 74.0	2000 74.0
% of Graduates Passing the GQE (SY)	2000 96.3	2000 96.3
# of Public High School Graduates (SY)	2000 375	1990 381
% of High School Graduates (SY)	2000 90.6	1990 77.7
% of Freshman Class Graduating in 4 Years (SY)	2000 69.2	1990 81.6
% of Grads Intending 4-year College (SY)	2000 44.3	1990 43.8
% of Grads Intending Vocational/Tech School (SY)	2000 14.9	1990 11.5
# of Public School Student Dropouts (SY)	2000 46	1990 133
# of Expulsions and Suspensions (SY)	1999 1,953	1999 1,953

Juveniles and the Law

# of Juveniles Committed to the Dept. of Correction (CY)	2000 16	1994 4
# of Juvenile Status Case Filings (CY)	2000 36	1990 25
# of Juvenile Delinquency Case Filings (CY)	2000 144	1990 26

Number of Babies Born to Single Mothers Under Age 20 without a High School Diploma

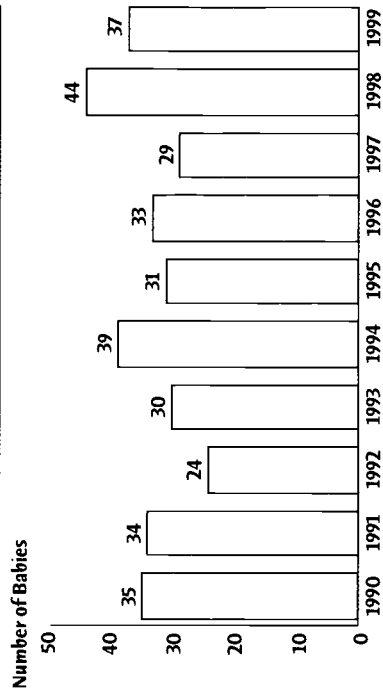

DATA YEAR DEFINITIONS

SFY - State Fiscal Year: July 1-June 30

SY - School Year: From the start of the school term in the fall through the end of the summer

FFY - Federal Fiscal Year: October 1-September 30

CY - Calendar Year: January 1 - December 31

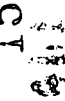



Crawford County

Kids Count in Indiana 2001



Economic Well-being

	Current Year	Base Year
% of Children in Poverty, Age 0-17 (CY)	1997 23.4	1990 22.9
Per Capita Income (CY)	1999 \$18,841	1990 \$11,555
Unemployment Rate (CY)	2000 5.9	1990 9.9
Monthly Average of Families Receiving TANF (SFY)	2000 54	1990 98
Monthly Average of Persons Issued Food Stamps (SFY)	2000 887	1990 1,001
% of Students Receiving Free Lunches / Text Books (SY)	2001 34.4	1991 26.2

Early Childhood

# of First Steps Children Served (FFY)	2000 43	1998 25
# of Licensed Child Care Centers (SFY)	2000 2	1990 2
# of Licensed Child Care Homes (SFY)	2000 12	1990 2
# of Registered Child Care Ministries (SFY)	2000 0	1993 0
# of Licensed Child Care Slots per 100 Children, Age 0-4 (SFY)	2000 32.4	1996 7.7

Child Protection

# of Reported Cases of Child Abuse Processed by CPS (SFY)	2000 24	1990 59
% of Child Abuse Cases Substantiated by CPS (SFY)	2000 46.0	1990 45.8
# of Reported Cases of Child Neglect Processed by CPS (SFY)	2000 80	1990 106
% of Child Neglect Cases Substantiated by CPS (SFY)	2000 61.0	1990 65.1
# of Child Physical Abuse Cases Substantiated by CPS (SFY)	2000 3	1990 15
# of Child Sexual Abuse Cases Substantiated by CPS (SFY)	2000 8	1990 4
Child Abuse and Neglect Rate (SFY)	2000 20.8	1990 54.6
# of Child Abuse and Neglect Deaths (SFY)	2000 0	1990 0
# of Juvenile CHINS Case Filings (CY)	2000 48	1990 4

Racial/Ethnic Characteristics of Children Age 0-17 in Crawford County

One Race (Non-Hispanic Origin)	97.0%
White	0.1%
Black	0.3%
American Indian or Alaska Native	0.2%
Asian	0.1%
Native Hawaiian or Other Pacific Islander	0.1%
Some Other Race	0.5%
Two or More Races (Non-Hispanic Origin)	1.6%
Hispanic Origin*	

*Hispanic children may be of any race.

Number of Children Under the Age of 20 1990 & 2000

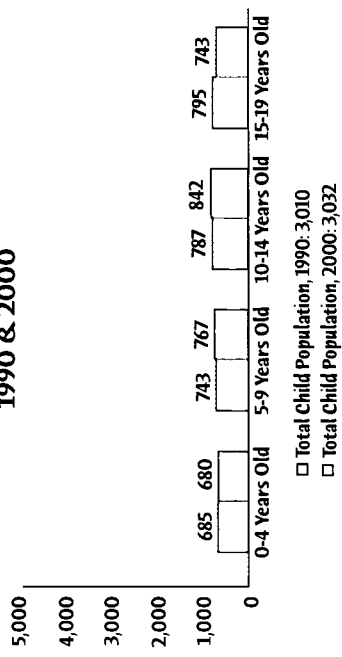

000000 136153

Health & Well-being

	Current Year	Base Year
U.S. # of Live Births (CY)	140	147
% of Low Birthweight Babies (CY)	1999 7.9	1990 6.1
% of Mothers who Received 1st Trimester Prenatal Care (CY)	1999 78.6	1990 74.3
% of Mothers who Smoked During Pregnancy (CY)	1999 32.9	1990 40.1
Non Marital Births as a % of All Births (CY)	1999 30.0	1990 20.4
Teen Birth Rate, Age 15-17 (CY)	1999 10.7	1990 28.9
Total # of Infant Deaths (CY)	1999 0	1990 0
Total # of Child Deaths, Age 1-14 (CY)	1999 1	1990 3
Total # of Teen Deaths by Accident, Homicide and Suicide (CY)	1999 0	1990 1
# of Children Enrolled in Hoosier Healthwise (SFY)	2000 1,036	1998 637
% Noncompliance with Youth Tobacco Access Laws (CY)	2000 N/A	1997 N/A

Percent of Households with Children Under 18 Headed by Parents and Others, Census 2000

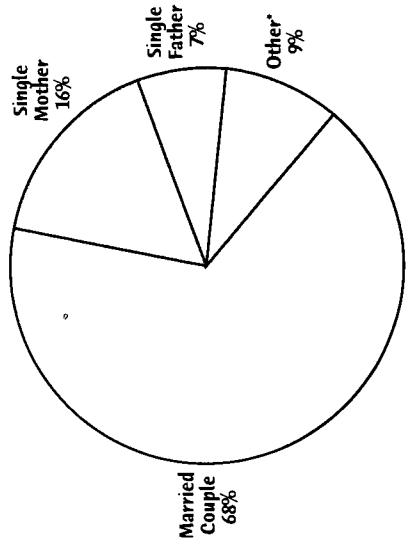

*"Other" includes households with children unrelated to the householder(s) and households with no adults present.

Education, Grades K-12

Public School Enrollment, K-12 (SY)	2000 1,911	1990 1,760
Non-Public School Enrollment (SY)	2001 0	1995 0
# of Home Schooled Children (SY)	2000 74	1990 7
# of Alternative School Participants (SY)	2001 65	1990 0
Total Per Pupil Expenditure (SY)	2000 \$6,541	1990 \$3,404
% of 10th Graders Passing the GQE Math Standard (SY)	2000 51.0	2000 51.0
% of 10th Graders Passing the GQE Language Standard (SY)	2000 64.0	2000 64.0
% of Graduates Passing the GQE (SY)	2000 92.4	2000 92.4
# of Public High School Graduates (SY)	2000 105	1990 124
% of High School Graduates (SY)	2000 86.9	1990 70.4
% of Freshman Class Graduating in 4 Years (SY)	2000 66.9	1990 72.5
% of Grads Intending 4-year College (SY)	2000 32.4	1990 31.7
% of Grads Intending Vocational/Tech School (SY)	2000 3.8	1990 2.0
# of Public School Student Dropouts (SY)	2000 18	1990 55
# of Expulsions and Suspensions (SY)	1999 1,166	1999 1,166

Juveniles and the Law

# of Juveniles Committed to the Dept. of Correction (CY)	2000 0	1994 0
# of Juvenile Status Case Filings (CY)	2000 0	1990 0
# of Juvenile Delinquency Case Filings (CY)	2000 38	1990 23

Number of Babies Born to Single Mothers Under Age 20 without a High School Diploma

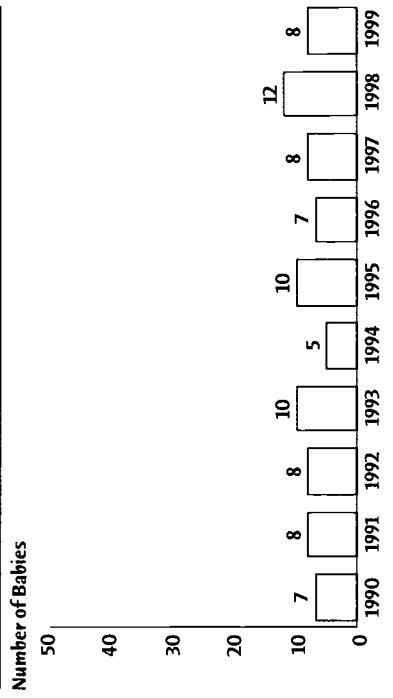

DATA YEAR DEFINITIONS

SFY - State Fiscal Year: July 1-June 30
 SY - School Year: From the start of the school term in the fall through the end of the summer
 FFY - Federal Fiscal Year: October 1-September 30
 CY - Calendar Year: January 1 - December 31

51

155

Kids Count 2001

www.iyi.org

Indiana Youth Institute

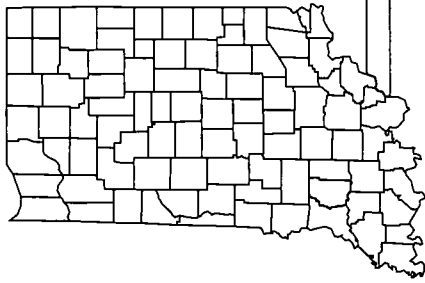

Daviess County

Kids Count in Indiana 2001



Economic Well-being

	Current Year	Base Year
% of Children in Poverty, Age 0-17 (CY)	1997 20.1	1990 20.8
Per Capita Income (CY)	1999 \$20,882	1990 \$14,459
Unemployment Rate (CY)	2000 3.5	1990 4.0
Monthly Average of Families Receiving TANF (SFY)	2000 126	1990 238
Monthly Average of Persons Issued Food Stamps (SFY)	2000 1,554	1990 1,553
% of Students Receiving Free Lunches / Text Books (SY)	2001 21.7	1991 17.7

Early Childhood

# of First Steps Children Served (FFY)	2000 56	1998 64
# of Licensed Child Care Centers (SFY)	2000 2	1990 2
# of Licensed Child Care Homes (SFY)	2000 34	1990 8
# of Registered Child Care Ministries (SFY)	2000 2	1993 1
# of Licensed Child Care Slots per 100 Children, Age 0-4 (SFY)	2000 21.4	1996 17.1

Child Protection

# of Reported Cases of Child Abuse Processed by CPS (SFY)	2000 24	1990 44
% of Child Abuse Cases Substantiated by CPS (SFY)	2000 58.0	1990 77.3
# of Reported Cases of Child Neglect Processed by CPS (SFY)	2000 85	1990 84
% of Child Neglect Cases Substantiated by CPS (SFY)	2000 47.0	1990 64.3
# of Child Physical Abuse Cases Substantiated by CPS (SFY)	2000 5	1990 12
# of Child Sexual Abuse Cases Substantiated by CPS (SFY)	2000 9	1990 6
Child Abuse and Neglect Rate (SFY)	2000 6.5	1990 15.3
# of Child Abuse and Neglect Deaths (SFY)	2000 0	1990 1
# of Juvenile CHINS Case Filings (CY)	2000 15	1990 60

Racial/Ethnic Characteristics of Children Age 0-17 in Daviess County

One Race (Non-Hispanic Origin)	95.5%
White	0.4%
Black	0.2%
American Indian or Alaska Native	0.2%
Asian	0.0%
Native Hawaiian or Other Pacific Islander	0.0%
Some Other Race	0.7%
Two or More Races (Non-Hispanic Origin)	2.9%
Hispanic Origin*	

*Hispanic children may be of any race.

Number of Children Under the Age of 20 1990 & 2000

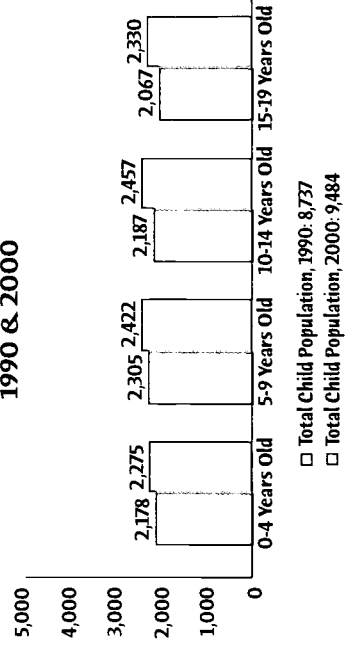

Birth & Well-being

	Current Year	Base Year
Total # of Live Births (CY)	1999 463	1990 458
% of Low Birthweight Babies (CY)	1999 5.6	1990 5.0
% of Mothers who Received 1st Trimester Prenatal Care (CY)	1999 62.6	1990 61.5
% of Mothers who Smoked During Pregnancy (CY)	1999 19.9	1990 17.7
Non Marital Births as a % of All Births (CY)	1999 25.5	1990 16.8
Teen Birth Rate, Age 15-17 (CY)	1999 21.1	1990 30.2
Total # of Infant Deaths (CY)	1999 2	1990 2
Total # of Child Deaths, Age 1-14 (CY)	1999 2	1990 1
Total # of Teen Deaths by Accident, Homicide and Suicide (CY)	1999 1	1990 1
# of Children Enrolled in Hoosier Healthwise (SFY)	2000 1,969	1998 1,045
% Noncompliance with Youth Tobacco Access Laws (CY)	2000 40.0	1997 N/A

Percent of Households with Children Under 18 Headed by Parents and Others, Census 2000

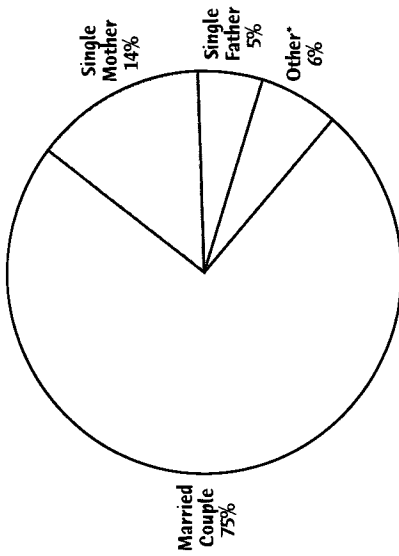

*"Other" includes households with children unrelated to the householder(s) and households with no adults present.

Education, Grades K-12

Public School Enrollment, K-12 (SY)	2000 4,463	1990 3,566
Non-Public School Enrollment (SY)	2001 1,043	1995 985
# of Home Schooled Children (SY)	2000 46	1990 0
# of Alternative School Participants (SY)	2001 42	1990 0
Total Per Pupil Expenditure (SY)	2000 \$5,779	1990 \$4,200
% of 10th Graders Passing the GQE Math Standard (SY)	2000 70.0	2000 70.0
% of 10th Graders Passing the GQE Language Standard (SY)	2000 70.0	2000 70.0
% of Graduates Passing the GQE (SY)	2000 94.3	2000 94.3
# of Public High School Graduates (SY)	2000 247	1990 285
% of High School Graduates (SY)	2000 90.0	1990 76.8
% of Freshman Class Graduating in 4 Years (SY)	2000 75.1	1990 83.1
% of Grads Intending 4-year College (SY)	2000 43.3	1990 38.2
% of Grads Intending Vocational/Tech School (SY)	2000 8.9	1990 11.2
# of Public School Student Dropouts (SY)	2000 53	1990 106
# of Expulsions and Suspensions (SY)	1999 1,010	1999 1,010

Juveniles and the Law

# of Juveniles Committed to the Dept. of Correction (CY)	2000 0	1994 4
# of Juvenile Status Case Filings (CY)	2000 0	1990 0
# of Juvenile Delinquency Case Filings (CY)	2000 103	1990 20

Number of Babies Born to Single Mothers Under Age 20 without a High School Diploma

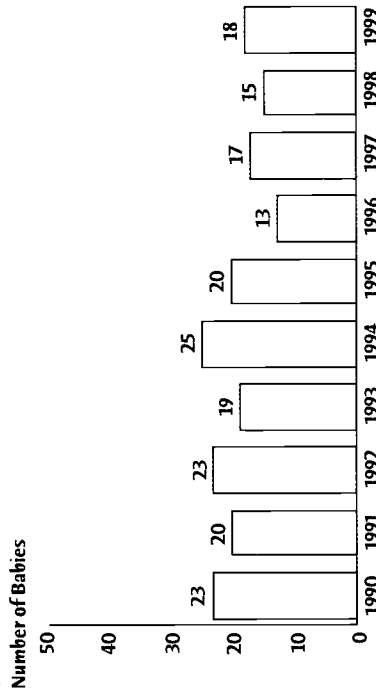

DATA YEAR DEFINITIONS

- SFY - State Fiscal Year: July 1-June 30
- SY - School Year: From the start of the school term in the fall through the end of the summer
- FFY - Federal Fiscal Year: October 1-September 30
- CY - Calendar Year: January 1 - December 31

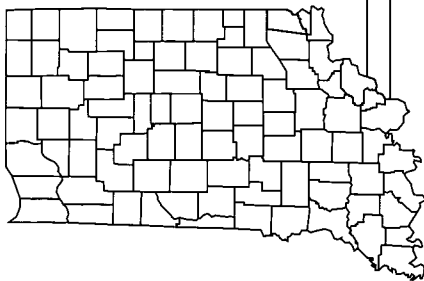

Dearborn County

Kids Count in
Indiana 2001



Economic Well-being

	Current Year	Base Year
% of Children in Poverty, Age 0-17 (CY)	1997 10.0	1990 8.8
Per Capita Income (CY)	1999 \$24,441	1990 \$16,205
Unemployment Rate (CY)	2000 3.1	1990 8.3
Monthly Average of Families Receiving TANF (SFY)	2000 115	1990 276
Monthly Average of Persons Issued Food Stamps (SFY)	2000 1,337	1990 1,790
% of Students Receiving Free Lunches / Text Books (SY)	2001 11.2	1991 14.3

Early Childhood

# of First Steps Children Served (FFY)	2000 71	1998 47
# of Licensed Child Care Centers (SFY)	2000 6	1990 3
# of Licensed Child Care Homes (SFY)	2000 8	1990 3
# of Registered Child Care Ministries (SFY)	2000 1	1993 1
# of Licensed Child Care Slots per 100 Children, Age 0-4 (SFY)	2000 20.7	1996 9.6

Child Protection

# of Reported Cases of Child Abuse Processed by CPS (SFY)	2000 79	1990 129
% of Child Abuse Cases Substantiated by CPS (SFY)	2000 58.0	1990 64.3
# of Reported Cases of Child Neglect Processed by CPS (SFY)	2000 115	1990 174
% of Child Neglect Cases Substantiated by CPS (SFY)	2000 57.0	1990 56.3
# of Child Physical Abuse Cases Substantiated by CPS (SFY)	2000 27	1990 28
# of Child Sexual Abuse Cases Substantiated by CPS (SFY)	2000 19	1990 12
Child Abuse and Neglect Rate (SFY)	2000 33.3	1990 27.6
# of Child Abuse and Neglect Deaths (SFY)	2000 0	1990 0
# of Juvenile CHINS Case Filings (CY)	2000 47	1990 29

Racial/Ethnic Characteristics of Children Age 0-17 in Dearborn County

One Race (Non-Hispanic Origin)	97.1%
White	0.7%
Black	0.2%
American Indian or Alaska Native	0.2%
Asian	0.0%
Native Hawaiian or Other Pacific Islander	0.1%
Some Other Race	0.8%
Two or More Races (Non-Hispanic Origin)	0.8%
Hispanic Origin*	0.8%

*Hispanic children may be of any race.

Number of Children Under the Age of 20 1990 & 2000

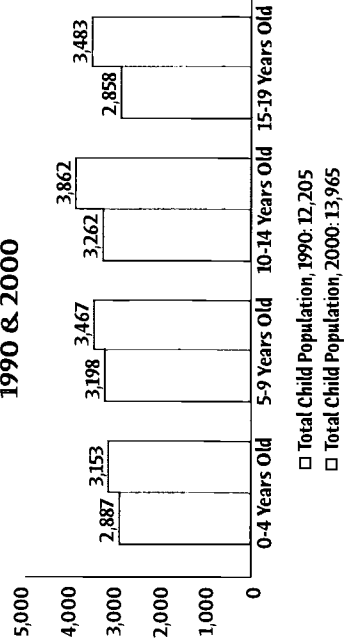

000000 136155

Health & Well-being

	Current Year	Base Year
Total # of Live Births (CY)	1999 436	1990 526
% of Low Birthweight Babies (CY)	1999 8.0	1990 5.7
% of Mothers who Received 1st Trimester Prenatal Care (CY)	1999 88.5	1990 78.9
% of Mothers who Smoked During Pregnancy (CY)	1999 30.5	1990 24.3
Non Marital Births as a % of All Births (CY)	1999 31.7	1990 18.6
Teen Birth Rate, Age 15-17 (CY)	1999 13.9	1990 22.6
Total # of Infant Deaths (CY)	1999 6	1990 5
Total # of Child Deaths, Age 1-14 (CY)	1999 3	1990 3
Total # of Teen Deaths by Accident, Homicide and Suicide (CY)	1999 1	1990 2
# of Children Enrolled in Hooster Healthwise (SFY)	2000 1,656	1998 993
% Noncompliance with Youth Tobacco Access Laws (CY)	2000 N/A	1997 N/A

Percent of Households with Children Under 18 Headed by Parents and Others, Census 2000

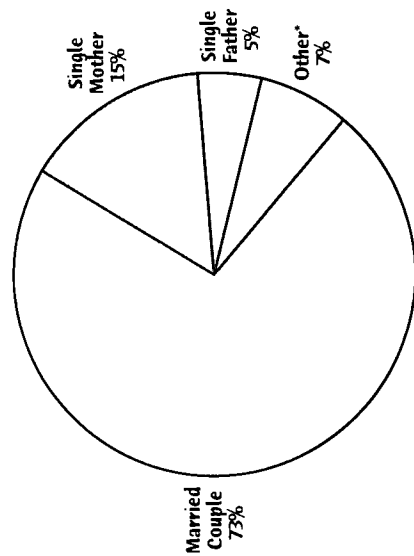

*"Other" includes households with children unrelated to the householder(s) and households with no adults present.

Education, Grades K-12

Public School Enrollment, K-12 (SY)	2000 8,806	1990 6,894
Non-Public School Enrollment (SY)	2001 832	1995 637
# of Home Schooled Children (SY)	2000 132	1990 3
# of Alternative School Participants (SY)	2001 0	1990 0
Total Per Pupil Expenditure (SY)	2000 \$6,341	1990 \$3,930
% of 10th Graders Passing the GQE Math Standard (SY)	2000 64.0	2000 64.0
% of 10th Graders Passing the GQE Language Standard (SY)	2000 71.0	2000 71.0
% of Graduates Passing the GQE (SY)	2000 97.9	2000 97.9
# of Public High School Graduates (SY)	2000 618	1990 545
% of High School Graduates (SY)	2000 90.6	1990 81.8
% of Freshman Class Graduating in 4 Years (SY)	2000 84.3	1990 90.4
% of Grads Intending 4-year College (SY)	2000 53.9	1990 40.4
% of Grads Intending Vocational/Tech School (SY)	2000 8.9	1990 6.6
# of Public School Student Dropouts (SY)	2000 67	1990 122
# of Expulsions and Suspensions (SY)	1999 3,101	1999 3,101

Juveniles and the Law

# of Juveniles Committed to the Dept. of Correction (CY)	2000 14	1994 1
# of Juvenile Status Case Filings (CY)	2000 0	1990 0
# of Juvenile Delinquency Case Filings (CY)	2000 494	1990 210

Number of Babies Born to Single Mothers Under Age 20 without a High School Diploma

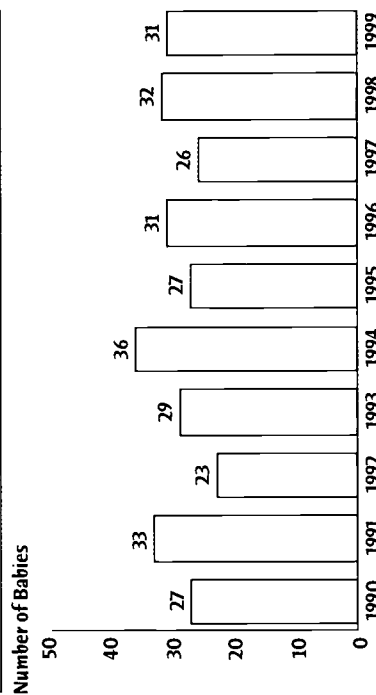

DATA YEAR DEFINITIONS

SFY - State Fiscal Year: July 1-June 30

SY - School Year: From the start of the school term in the fall through the end of the summer

FFY - Federal Fiscal Year: October 1-September 30

CY - Calendar Year: January 1 - December 31



Decatur County

Kids Count in Indiana 2001



Economic Well-being

	Current Year	Base Year
% of Children in Poverty, Age 0-17 (CY)	1997 12.1	1990 10.8
Per Capita Income (CY)	1999 \$24,638	1990 \$15,200
Unemployment Rate (CY)	2000 2.0	1990 4.2
Monthly Average of Families Receiving TANF (SFY)	2000 48	1990 139
Monthly Average of Persons Issued Food Stamps (SFY)	2000 907	1990 1,420
% of Students Receiving Free Lunches / Text Books (SY)	2001 12.8	1991 12.1

Early Childhood

# of First Steps Children Served (FFY)	2000 79	1998 48
# of Licensed Child Care Centers (SFY)	2000 2	1990 3
# of Licensed Child Care Homes (SFY)	2000 9	1990 4
# of Registered Child Care Ministries (SFY)	2000 1	1993 0
# of Licensed Child Care Slots per 100 Children, Age 0-4 (SFY)	2000 12.6	1996 11.6

Child Protection

# of Reported Cases of Child Abuse Processed by CPS (SFY)	2000 64	1990 84
% of Child Abuse Cases Substantiated by CPS (SFY)	2000 53.0	1990 75.0
# of Reported Cases of Child Neglect Processed by CPS (SFY)	2000 102	1990 93
% of Child Neglect Cases Substantiated by CPS (SFY)	2000 62.0	1990 58.1
# of Child Physical Abuse Cases Substantiated by CPS (SFY)	2000 14	1990 21
# of Child Sexual Abuse Cases Substantiated by CPS (SFY)	2000 20	1990 18
Child Abuse and Neglect Rate (SFY)	2000 15.3	1990 23.1
# of Child Abuse and Neglect Deaths (SFY)	2000 0	1990 2
# of Juvenile CHINS Case Filings (CY)	2000 14	1990 12

Racial/Ethnic Characteristics of Children Age 0-17 in Decatur County

One Race (Non-Hispanic Origin)	97.7%
White	0.1%
Black	0.0%
American Indian or Alaska Native	0.7%
Asian	0.0%
Native Hawaiian or Other Pacific Islander	0.0%
Some Other Race	0.5%
Two or More Races (Non-Hispanic Origin)	0.9%
Hispanic Origin*	

*Hispanic children may be of any race.

Number of Children Under the Age of 20 1990 & 2000

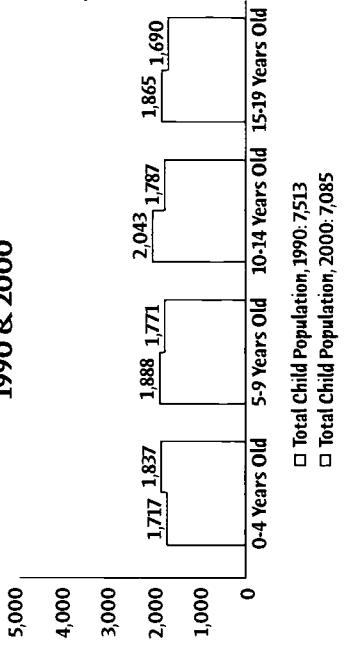

Health & Well-being

	Current Year	Base Year
Total # of Live Births (CY)	1999 400	1990 367
% of Low Birthweight Babies (CY)	1999 9.8	1990 6.8
% of Mothers who Received 1st Trimester Prenatal Care (CY)	1999 82.3	1990 76.6
% of Mothers who Smoked During Pregnancy (CY)	1999 29.0	1990 26.2
Non Marital Births as a % of All Births (CY)	1999 31.8	1990 16.1
Teen Birth Rate, Age 15-17 (CY)	1999 27.9	1990 39.2
Total # of Infant Deaths (CY)	1999 3	1990 3
Total # of Child Deaths, Age 1-14 (CY)	1999 0	1990 1
Total # of Teen Deaths by Accident, Homicide and Suicide (CY)	1999 1	1990 2
# of Children Enrolled in Hoosier Healthwise (SFY)	2000 1,210	1998 660
% Noncompliance with Youth Tobacco Access Laws (CY)	2000 10.0	1997 N/A

Percent of Households with Children Under 18 Headed by Parents and Others, Census 2000

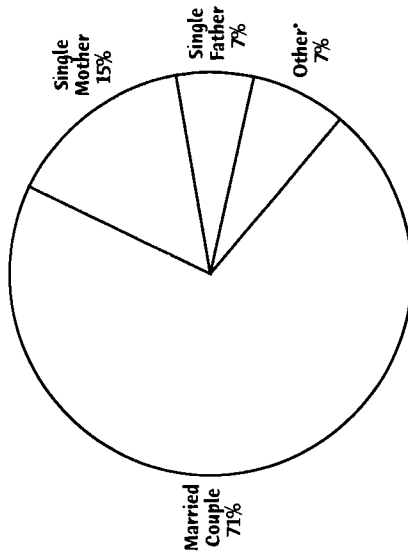

* "Other" includes households with children unrelated to the householder(s) and households with no adults present.

Education, Grades K-12

Public School Enrollment, K-12 (SY)	2000 4,275	1990 4,275
Non-Public School Enrollment (SY)	2001 315	1995 317
# of Home-Schooled Children (SY)	2000 63	1990 0
# of Alternative School Participants (SY)	2001 0	1990 0
Total Per Pupil Expenditure (SY)	2000 \$6,074	1990 \$3,645
% of 10th Graders Passing the GQE Math Standard (SY)	2000 72.0	2000 72.0
% of 10th Graders Passing the GQE Language Standard (SY)	2000 75.0	2000 75.0
% of Graduates Passing the GQE (SY)	2000 93.4	2000 93.4
# of Public High School Graduates (SY)	2000 289	1990 344
% of High School Graduates (SY)	2000 88.1	1990 82.9
% of Freshman Class Graduating in 4 Years (SY)	2000 75.5	1990 86.0
% of Grads Intending 4-year College (SY)	2000 56.4	1990 37.8
% of Grads Intending Vocational/Tech School (SY)	2000 3.5	1990 7.3
# of Public School Student Dropouts (SY)	2000 44	1990 75
# of Expulsions and Suspensions (SY)	1999 860	1999 860

Juveniles and the Law

# of Juveniles Committed to the Dept. of Correction (CY)	2000 7	1994 1
# of Juvenile Status Case Filings (CY)	2000 0	1990 0
# of Juvenile Delinquency Case Filings (CY)	2000 109	1990 40

Number of Babies Born to Single Mothers Under Age 20 without a High School Diploma

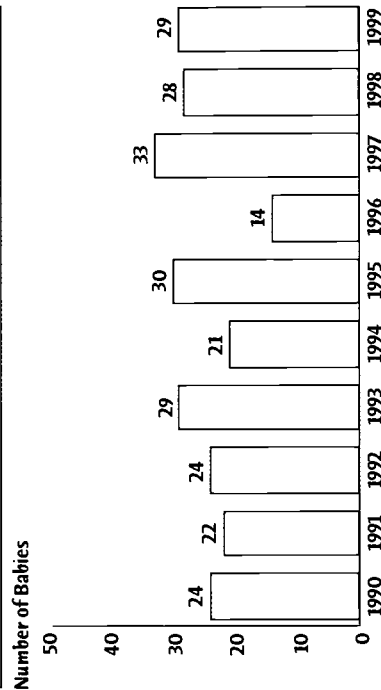

DATA YEAR DEFINITIONS

- SFY - State Fiscal Year: July 1-June 30
- SY - School Year: From the start of the school term in the fall through the end of the summer
- FFY - Federal Fiscal Year: October 1-September 30
- CY - Calendar Year: January 1 - December 31

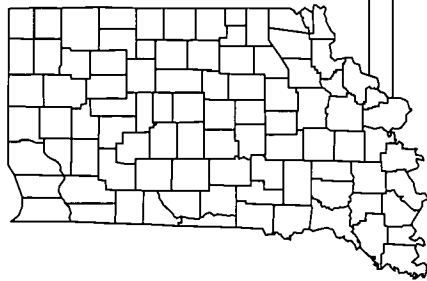

DeKalb County

Kids Count in Indiana 2001



Economic Well-being

	Current Year	Base Year
% of Children in Poverty, Age 0-17 (CY)	1997 7.7	1990 11.1
Per Capita Income (CY)	1999 \$24,808	1990 \$16,259
Unemployment Rate (CY)	2000 3.5	1990 6.0
Monthly Average of Families Receiving TANF (SFY)	2000 49	1990 80
Monthly Average of Persons Issued Food Stamps (SFY)	2000 714	1990 551
% of Students Receiving Free Lunches / Text Books (SY)	2001 10.0	1991 8.9

Early Childhood

# of First Steps Children Served (FFY)	2000 134	1998 105
# of Licensed Child Care Centers (SFY)	2000 8	1990 2
# of Licensed Child Care Homes (SFY)	2000 29	1990 16
# of Registered Child Care Ministries (SFY)	2000 2	1993 0
# of Licensed Child Care Slots per 100 Children, Age 0-4 (SFY)	2000 23.3	1996 16.2

Child Protection

# of Reported Cases of Child Abuse Processed by CPS (SFY)	2000 203	1990 206
% of Child Abuse Cases Substantiated by CPS (SFY)	2000 58.0	1990 69.9
# of Reported Cases of Child Neglect Processed by CPS (SFY)	2000 539	1990 309
% of Child Neglect Cases Substantiated by CPS (SFY)	2000 61.0	1990 71.5
# of Child Physical Abuse Cases Substantiated by CPS (SFY)	2000 62	1990 24
# of Child Sexual Abuse Cases Substantiated by CPS (SFY)	2000 56	1990 9
Child Abuse and Neglect Rate (SFY)	2000 8.6	1990 48.0
# of Child Abuse and Neglect Deaths (SFY)	2000 1	1990 0
# of Juvenile CHINS Case Filings (CY)	2000 190	1990 135

Racial/Ethnic Characteristics of Children Age 0-17 in DeKalb County

One Race (Non-Hispanic Origin)	95.4%
White	0.4%
Black	0.2%
American Indian or Alaska Native	0.4%
Asian	0.1%
Native Hawaiian or Other Pacific Islander	0.1%
Some Other Race	1.0%
Two or More Races (Non-Hispanic Origin)	2.4%
Hispanic Origin*	

*Hispanic children may be of any race.

Number of Children Under the Age of 20 1990 & 2000

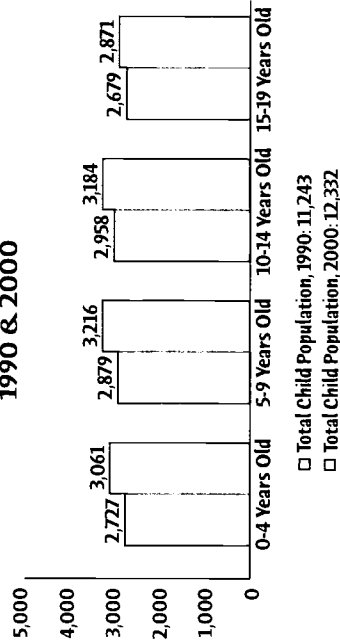

000000 136157

Health & Well-being

	Current Year	Base Year
Total # of Live Births (CY)	1999 556	1990 568
% of Low Birthweight Babies (CY)	1999 7.0	1990 4.8
% of Mothers who Received 1st Trimester Prenatal Care (CY)	1999 80.6	1990 84.5
% of Mothers who Smoked During Pregnancy (CY)	1999 28.1	1990 31.2
Non Marital Births as a % of All Births (CY)	1999 31.5	1990 19.0
Teen Birth Rate, Age 15-17 (CY)	1999 20.9	1990 27.1
Total # of Infant Deaths (CY)	1999 3	1990 3
Total # of Child Deaths, Age 1-14 (CY)	1999 1	1990 4
Total # of Teen Deaths by Accident, Homicide and Suicide (CY)	1999 2	1990 0
# of Children Enrolled in Hoosier Healthwise (SFY)	2000 1,414	1998 592
% Noncompliance with Youth Tobacco Access Laws (CY)	2000 100.0	1997 N/A

Percent of Households with Children Under 18 Headed by Parents and Others, Census 2000

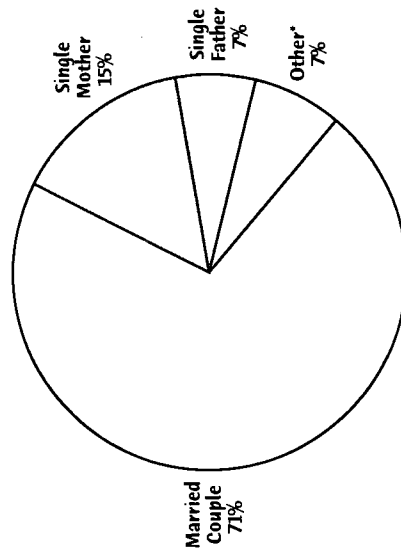

*"Other" includes households with children unrelated to the householder(s) and households with no adults present.

Education, Grades K-12

Public School Enrollment, K-12 (SY)	2000 7,038	1990 6,029
Non-Public School Enrollment (SY)	2001 750	1995 315
# of Home Schooled Children (SY)	2000 98	1990 4
# of Alternative School Participants (SY)	2001 0	1990 0
Total Per Pupil Expenditure (SY)	2000 \$7,222	1990 \$3,902
% of 10th Graders Passing the GQE Math Standard (SY)	2000 65.0	2000 65.0
% of 10th Graders Passing the GQE Language Standard (SY)	2000 68.0	2000 68.0
% of Graduates Passing the GQE (SY)	2000 93.3	2000 93.3
# of Public High School Graduates (SY)	2000 417	1990 515
% of High School Graduates (SY)	2000 88.3	1990 79.4
% of Freshman Class Graduating in 4 Years (SY)	2000 68.5	1990 93.3
% of Grads Intending 4-year College (SY)	2000 53.2	1990 35.5
% of Grads Intending Vocational/Tech School (SY)	2000 13.2	1990 8.1
# of Public School Student Dropouts (SY)	2000 64	1990 130
# of Expulsions and Suspensions (SY)	1999 2,222	1999 2,222

Juveniles and the Law

# of Juveniles Committed to the Dept. of Correction (CY)	2000 8	1994 12
# of Juvenile Status Case Filings (CY)	2000 53	1990 124
# of Juvenile Delinquency Case Filings (CY)	2000 206	1990 120

Number of Babies Born to Single Mothers Under Age 20 without a High School Diploma

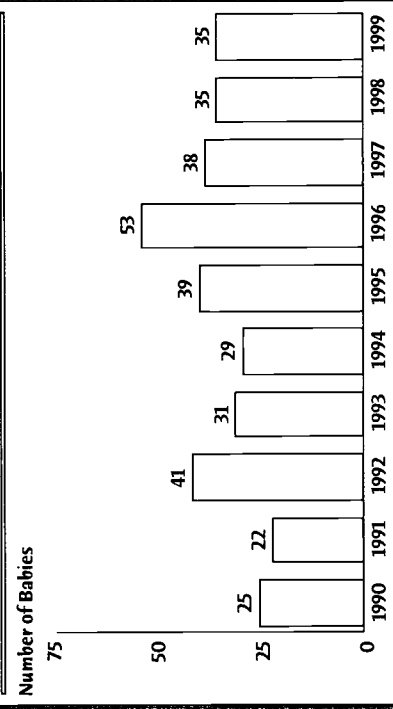

DATA YEAR DEFINITIONS

- SFY - State Fiscal Year: July 1-June 30
- SY - School Year: From the start of the school term in the fall through the end of the summer
- FFY - Federal Fiscal Year: October 1-September 30
- CY - Calendar Year: January 1 - December 31

170

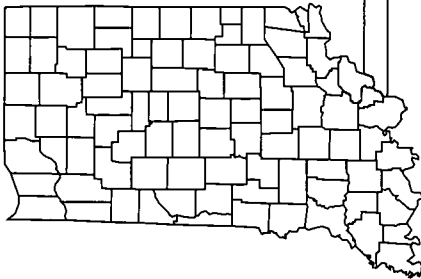

Delaware County

Kids Count in Indiana 2001



Economic Well-being

	Current Year	Base Year
% of Children in Poverty, Age 0-17 (CY)	1997 20.0	1990 17.7
Per Capita Income (CY)	1999 \$24,362	1990 \$16,602
Unemployment Rate (CY)	2000 3.3	1990 5.6
Monthly Average of Families Receiving TANF (SFY)	2000 697	1990 1,658
Monthly Average of Persons Issued Food Stamps (SFY)	2000 7,942	1990 8,865
% of Students Receiving Free Lunches / Text Books (\$Y)	2001 26.0	1991 22.0

Early Childhood

# of First Steps Children Served (FFY)	2000 305	1998 260
# of Licensed Child Care Centers (SFY)	2000 9	1990 13
# of Licensed Child Care Homes (SFY)	2000 47	1990 21
# of Registered Child Care Ministries (SFY)	2000 14	1993 8
# of Licensed Child Care Slots per 100 Children, Age 0-4 (SFY)	2000 22.4	1996 16.8

Child Protection

# of Reported Cases of Child Abuse Processed by CPS (SFY)	2000 289	1990 431
% of Child Abuse Cases Substantiated by CPS (SFY)	2000 48.0	1990 55.7
# of Reported Cases of Child Neglect Processed by CPS (SFY)	2000 829	1990 1,065
% of Child Neglect Cases Substantiated by CPS (SFY)	2000 55.0	1990 53.6
# of Child Physical Abuse Cases Substantiated by CPS (SFY)	2000 53	1990 69
# of Child Sexual Abuse Cases Substantiated by CPS (SFY)	2000 87	1990 64
Child Abuse and Neglect Rate (SFY)	2000 24.0	1990 43.2
# of Child Abuse and Neglect Deaths (SFY)	2000 2	1990 1
# of Juvenile CHINS Case Filings (CY)	2000 195	1990 277

Racial/Ethnic Characteristics of Children Age 0-17 in Delaware County

One Race (Non-Hispanic Origin)	85.4%
White	9.5%
Black	0.3%
American Indian or Alaska Native	0.5%
Asian	0.1%
Native Hawaiian or Other Pacific Islander	0.4%
Some Other Race	2.2%
Two or More Races (Non-Hispanic Origin)	1.7%
Hispanic Origin*	

*Hispanic children may be of any race.

Number of Children Under the Age of 20 1990 & 2000

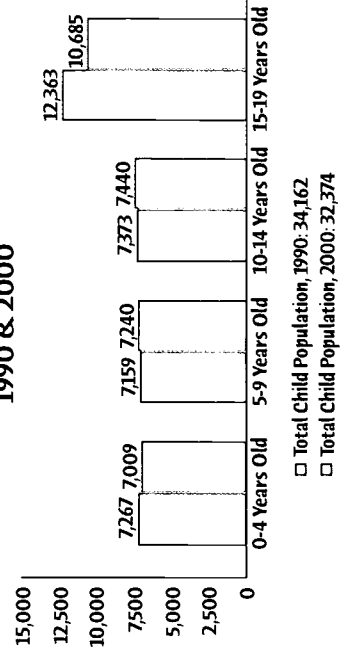

000000 136158

Health & Well-being

	Current Year	Base Year
Total # of Live Births (CY)	1999 1,423	1990 1,557
% of Low Birthweight Babies (CY)	1999 8.7	1990 6.4
% of Mothers who Received 1st Trimester Prenatal Care (CY)	1999 85.8	1990 82.3
% of Mothers who Smoked During Pregnancy (CY)	1999 25.5	1990 30.4
Non Marital Births as a % of All Births (CY)	1999 38.9	1990 30.3
Teen Birth Rate, Age 15-17 (CY)	1999 28.4	1990 35.4
Total # of Infant Deaths (CY)	1999 8	1990 17
Total # of Child Deaths, Age 1-14 (CY)	1999 1	1990 5
Total # of Teen Deaths by Accident, Homicide and Suicide (CY)	1999 3	1990 5
# of Children Enrolled in Hoosier Healthwise (SFY)	2000 7,813	1998 5,023
% Noncompliance with Youth Tobacco Access Laws (CY)	2000 40.0	1997 N/A

Percent of Households with Children Under 18 Headed by Parents and Others, Census 2000

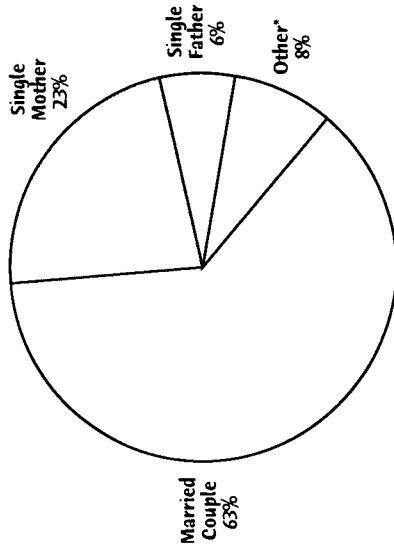

* "Other" includes households with children unrelated to the householder(s) and households with no adults present.

Education, Grades K-12

Public School Enrollment, K-12 (SY)	2000 17,718	1990 16,375
Non-Public School Enrollment (SY)	2001 1,693	1995 1,149
# of Home Schooled Children (SY)	2000 170	1990 18
# of Alternative School Participants (SY)	2001 665	1990 0
Total Per Pupil Expenditure (SY)	2000 \$7,327	1990 \$4,773
% of 10th Graders Passing the GQE Math Standard (SY)	2000 62.0	2000 62.0
% of 10th Graders Passing the GQE Language Standard (SY)	2000 71.0	2000 71.0
% of Graduates Passing the GQE (SY)	2000 96.6	2000 96.6
# of Public High School Graduates (SY)	2000 1,122	1990 1,359
% of High School Graduates (SY)	2000 86.2	1990 77.8
% of Freshman Class Graduating in 4 Years (SY)	2000 76.2	1990 76.6
% of Grads Intending 4-year College (SY)	2000 56.5	1990 37.5
% of Grads Intending Vocational/Tech School (SY)	2000 8.1	1990 6.7
# of Public School Student Dropouts (SY)	2000 198	1990 346
# of Expulsions and Suspensions (SY)	1999 5,172	1999 5,172

Juveniles and the Law

# of Juveniles Committed to the Dept. of Correction (CY)	2000 9	1994 22
# of Juvenile Status Case Filings (CY)	2000 18	1990 234
# of Juvenile Delinquency Case Filings (CY)	2000 486	1990 239

Number of Babies Born to Single Mothers Under Age 20 without a High School Diploma

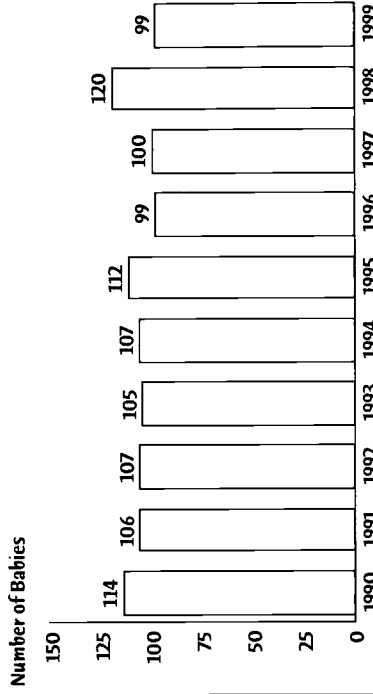

DATA YEAR DEFINITIONS

SFY - State Fiscal Year: July 1-June 30

SY - School Year: From the start of the school term in the fall through the end of the summer

FFY - Federal Fiscal Year: October 1-September 30

CY - Calendar Year: January 1 - December 31

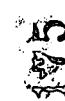
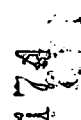



Dubois County

Kids Count in Indiana 2001



Economic Well-being

	Current Year	Base Year
% of Children in Poverty, Age 0-17 (CY)	1997 5.6	1990 5.5
Per Capita Income (CY)	1999 \$29,424	1990 \$18,848
Unemployment Rate (CY)	2000 2.3	1990 3.2
Monthly Average of Families Receiving TANF (SFY)	2000 34	1990 71
Monthly Average of Persons Issued Food Stamps (SFY)	2000 547	1990 591
% of Students Receiving Free Lunches / Text Books (SY)	2001 7.3	1991 5.7

Early Childhood

# of First Steps Children Served (FFY)	2000 99	1998 80
# of Licensed Child Care Centers (SFY)	2000 4	1990 2
# of Licensed Child Care Homes (SFY)	2000 38	1990 13
# of Registered Child Care Ministries (SFY)	2000 1	1993 1
# of Licensed Child Care Slots per 100 Children, Age 0-4 (SFY)	2000 27.7	1996 17.1

Child Protection

# of Reported Cases of Child Abuse Processed by CPS (SFY)	2000 87	1990 84
% of Child Abuse Cases Substantiated by CPS (SFY)	2000 49.0	1990 59.5
# of Reported Cases of Child Neglect Processed by CPS (SFY)	2000 166	1990 105
% of Child Neglect Cases Substantiated by CPS (SFY)	2000 48.0	1990 77.1
# of Child Physical Abuse Cases Substantiated by CPS (SFY)	2000 19	1990 10
# of Child Sexual Abuse Cases Substantiated by CPS (SFY)	2000 24	1990 10
Child Abuse and Neglect Rate (SFY)	2000 11.2	1990 17.6
# of Child Abuse and Neglect Deaths (SFY)	2000 0	1990 0
# of Juvenile CHINS Case Filings (CY)	2000 26	1990 19

Racial/Ethnic Characteristics of Children Age 0-17 in Dubois County

One Race (Non-Hispanic Origin)	95.2%
White	0.2%
Black	0.1%
American Indian or Alaska Native	0.1%
Asian	0.0%
Native Hawaiian or Other Pacific Islander	0.0%
Some Other Race	0.5%
Two or More Races (Non-Hispanic Origin)	3.8%
Hispanic Origin*	

*Hispanic children may be of any race.

Number of Children Under the Age of 20 1990 & 2000

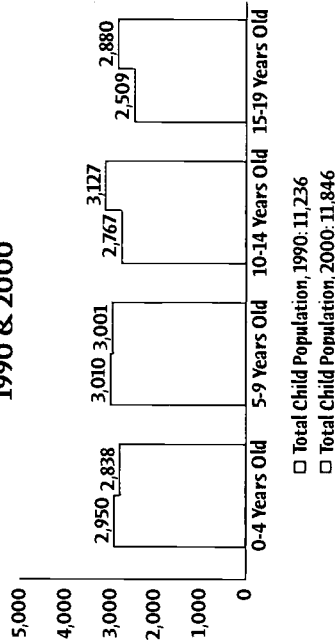

000000 136159

Health & Well-being

	Current Year	Base Year
Total # of Live Births (CY)	1999 558	1990 586
% of Low Birthweight Babies (CY)	1999 6.8	1990 3.8
% of Mothers who Received 1st Trimester Prenatal Care (CY)	1999 89.6	1990 92.6
% of Mothers who Smoked During Pregnancy (CY)	1999 13.3	1990 15.5
Non Marital Births as a % of All Births (CY)	1999 17.6	1990 11.4
Teen Birth Rate, Age 15-17 (CY)	1999 16.3	1990 17.3
Total # of Infant Deaths (CY)	1999 1	1990 3
Total # of Child Deaths, Age 1-14 (CY)	1999 1	1990 1
Total # of Teen Deaths by Accident, Homicide and Suicide (CY)	1999 5	1990 2
# of Children Enrolled in Hoosier Healthwise (SFY)	2000 1,047	1998 499
% Noncompliance with Youth Tobacco Access Laws (CY)	2000 0	1997 30.0

Percent of Households with Children Under 18 Headed by Parents and Others, Census 2000

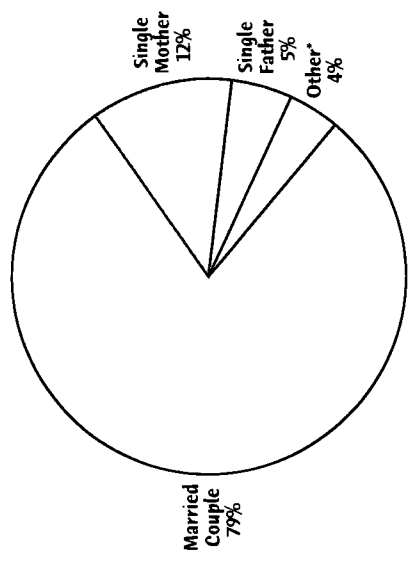

*"Other" includes households with children unrelated to the householder(s) and households with no adults present.

Education, Grades K-12

Public School Enrollment, K-12 (SY)	2000 7,316	1990 5,956
Non-Public School Enrollment (SY)	2001 561	1995 626
# of Home Schooled Children (SY)	2000 53	1990 2
# of Alternative School Participants (SY)	2001 0	1990 0
Total Per Pupil Expenditure (SY)	2000 \$6,642	1990 \$4,543
% of 10th Graders Passing the GQE Math Standard (SY)	2000 82.0	2000 82.0
% of 10th Graders Passing the GQE Language Standard (SY)	2000 81.0	2000 81.0
% of Graduates Passing the GQE (SY)	2000 98.8	2000 98.8
# of Public High School Graduates (SY)	2000 507	1990 469
% of High School Graduates (SY)	2000 94.9	1990 92.2
% of Freshman Class Graduating in 4 Years (SY)	2000 88.8	1990 93.8
% of Grads Intending 4-year College (SY)	2000 58.6	1990 46.7
% of Grads Intending Vocational/Tech School (SY)	2000 10.3	1990 8.1
# of Public School Student Dropouts (SY)	2000 29	1990 37
# of Expulsions and Suspensions (SY)	1999 486	1999 486

Number of Babies Born to Single Mothers Under Age 20 without a High School Diploma

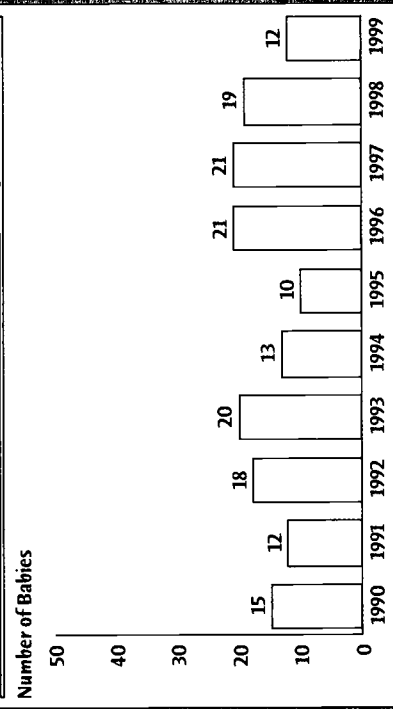

Juveniles and the Law

# of Juveniles Committed to the Dept. of Correction (CY)	2000 10	1994 1
# of Juvenile Status Case Filings (CY)	2000 21	1990 26
# of Juvenile Delinquency Case Filings (CY)	2000 102	1990 36

DATA YEAR DEFINITIONS

SFY - State Fiscal Year: July 1-June 30
 SY - School Year: From the start of the school term in the fall through the end of the summer
 FFY - Federal Fiscal Year: October 1-September 30
 CY - Calendar Year: January 1 - December 31

178

178

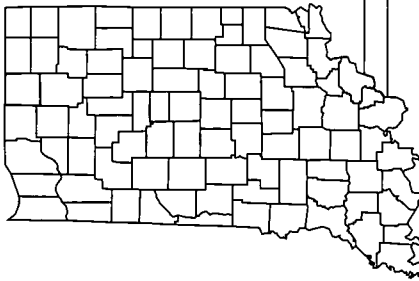

Elkhart County

Kids Count in Indiana 2001



Economic Well-being

	Current Year	Base Year
% of Children in Poverty, Age 0-17 (CY)	1997 14.1	1990 9.9
Per Capita Income (CY)	1999 \$26,360	1990 \$17,922
Unemployment Rate (CY)	2000 2.8	1990 5.6
Monthly Average of Families Receiving TANF (SFY)	2000 675	1990 825
Monthly Average of Persons Issued Food Stamps (SFY)	2000 6,845	1990 5,043
% of Students Receiving Free Lunches / Text Books (SY)	2001 21.0	1991 14.0

Early Childhood

# of First Steps Children Served (FFY)	2000 441	1998 231
# of Licensed Child Care Centers (SFY)	2000 18	1990 24
# of Licensed Child Care Homes (SFY)	2000 86	1990 37
# of Registered Child Care Ministries (SFY)	2000 14	1993 7
# of Licensed Child Care Slots per 100 Children, Age 0-4 (SFY)	2000 15.5	1996 15.7

Child Protection

# of Reported Cases of Child Abuse Processed by CPS (SFY)	2000 563	1990 934
% of Child Abuse Cases Substantiated by CPS (SFY)	2000 44.0	1990 70.4
# of Reported Cases of Child Neglect Processed by CPS (SFY)	2000 838	1990 744
% of Child Neglect Cases Substantiated by CPS (SFY)	2000 39.0	1990 68.5
# of Child Physical Abuse Cases Substantiated by CPS (SFY)	2000 79	1990 168
# of Child Sexual Abuse Cases Substantiated by CPS (SFY)	2000 167	1990 250
Child Abuse and Neglect Rate (SFY)	2000 11.7	1990 39.6
# of Child Abuse and Neglect Deaths (SFY)	2000 2	1990 2
# of Juvenile CHINS Case Filings (CY)	2000 202	1990 186

Racial/Ethnic Characteristics of Children Age 0-17 in Elkhart County

One Race (Non-Hispanic Origin)	78.1%
White	6.6%
Black	0.2%
American Indian or Alaska Native	0.9%
Asian	0.1%
Native Hawaiian or Other Pacific Islander	0.3%
Some Other Race	2.5%
Two or More Races (Non-Hispanic Origin)	11.4%
Hispanic Origin*	

*Hispanic children may be of any race.

Number of Children Under the Age of 20 1990 & 2000

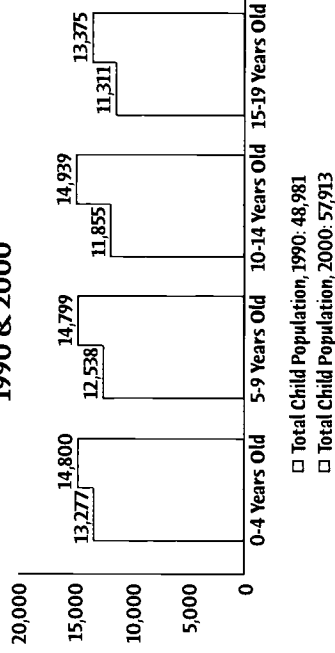

000000 136160

Health & Well-being

	Current Year	Base Year
Total # of Live Births (CY)	1999 3,134	1990 2,712
% of Low Birthweight Babies (CY)	1999 7.1	1990 5.8
% of Mothers who Received 1st Trimester Prenatal Care (CY)	1999 67.6	1990 74.5
% of Mothers who Smoked During Pregnancy (CY)	1999 19.4	1990 25.3
Non Marital Births as a % of All Births (CY)	1999 36.7	1990 24.5
Teen Birth Rate, Age 15-17 (CY)	1999 37.9	1990 39.8
Total # of Infant Deaths (CY)	1999 21	1990 27
Total # of Child Deaths, Age 1-14 (CY)	1999 12	1990 11
Total # of Teen Deaths by Accident, Homicide and Suicide (CY)	1999 6	1990 8
# of Children Enrolled in Hoosier Healthwise (SFY)	2000 9,334	1998 6,375
% Noncompliance with Youth Tobacco Access Laws (CY)	2000 5.0	1997 9.1

Percent of Households with Children Under 18 Headed by Parents and Others, Census 2000

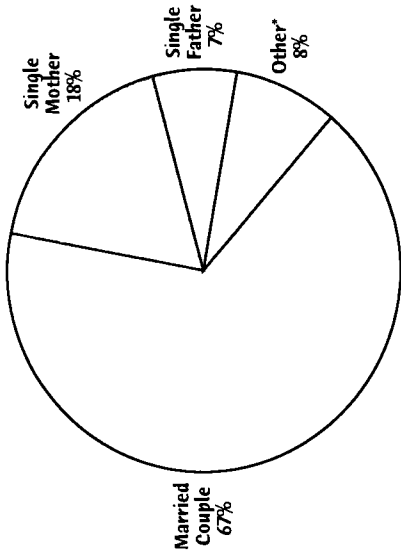

*"Other" includes households with children unrelated to the householder(s) and households with no adults present.

Education, Grades K-12

Public School Enrollment, K-12 (SY)	2000 32,476	1990 23,612
Non-Public School Enrollment (SY)	2001 3,488	1995 3,007
# of Home Schooled Children (SY)	2000 511	1990 15
# of Alternative School Participants (SY)	2001 456	1990 0
Total Per Pupil Expenditure (SY)	2000 \$6,852	1990 \$4,042
% of 10th Graders Passing the GQE Math Standard (SY)	2000 66.0	2000 66.0
% of 10th Graders Passing the GQE Language Standard (SY)	2000 71.0	2000 71.0
% of Graduates Passing the GQE (SY)	2000 97.2	2000 97.2
# of Public High School Graduates (SY)	2000 1,563	1990 1,732
% of High School Graduates (SY)	2000 87.4	1990 74.4
% of Freshman Class Graduating in 4 Years (SY)	2000 66.4	1990 83.5
% of Grads Intending 4-year College (SY)	2000 57.7	1990 44.0
% of Grads Intending Vocational/Tech School (SY)	2000 4.9	1990 6.7
# of Public School Student Dropouts (SY)	2000 498	1990 562
# of Expulsions and Suspensions (SY)	1999 13,684	1999 13,684

Juveniles and the Law

# of Juveniles Committed to the Dept. of Correction (CY)	2000 68	1994 59
# of Juvenile Status Case Filings (CY)	2000 211	1990 88
# of Juvenile Delinquency Case Filings (CY)	2000 587	1990 435

Number of Babies Born to Single Mothers Under Age 20 without a High School Diploma

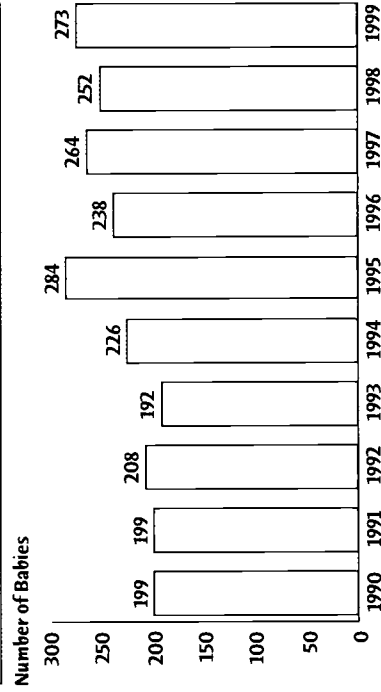

DATA YEAR DEFINITIONS

SFY - State Fiscal Year: July 1-June 30
 SY - School Year: From the start of the school term in the fall through the end of the summer
 FFY - Federal Fiscal Year: October 1-September 30
 CY - Calendar Year: January 1 - December 31

182

183

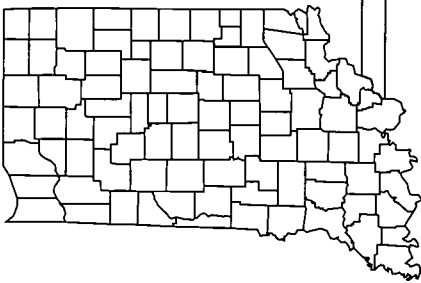

Fayette County

Kids Count in Indiana 2001



Economic Well-being

	Current Year	Base Year
% of Children in Poverty, Age 0-17 (CY)	1997 15.3	1990 14.7
Per Capita Income (CY)	1999 \$22,307	1990 \$15,542
Unemployment Rate (CY)	2000 6.0	1990 13.3
Monthly Average of Families Receiving TANF (SFY)	2000 165	1990 412
Monthly Average of Persons Issued Food Stamps (SFY)	2000 1,665	1990 2,366
% of Students Receiving Free Lunches / Text Books (SY)	2001 28.1	1991 21.4

Early Childhood

# of First Steps Children Served (FFY)	2000 97	1998 138
# of Licensed Child Care Centers (SFY)	2000 1	1990 1
# of Licensed Child Care Homes (SFY)	2000 16	1990 3
# of Registered Child Care Ministries (SFY)	2000 2	1993 0
# of Licensed Child Care Slots per 100 Children, Age 0-4 (SFY)	2000 16.6	1996 14

Child Protection

# of Reported Cases of Child Abuse Processed by CPS (SFY)	2000 93	1990 155
% of Child Abuse Cases Substantiated by CPS (SFY)	2000 52.0	1990 48.4
# of Reported Cases of Child Neglect Processed by CPS (SFY)	2000 222	1990 131
% of Child Neglect Cases Substantiated by CPS (SFY)	2000 43.0	1990 42.0
# of Child Physical Abuse Cases Substantiated by CPS (SFY)	2000 21	1990 21
# of Child Sexual Abuse Cases Substantiated by CPS (SFY)	2000 27	1990 17
Child Abuse and Neglect Rate (SFY)	2000 21.7	1990 32.0
# of Child Abuse and Neglect Deaths (SFY)	2000 0	1990 0
# of Juvenile CHINS Case Filings (CY)	2000 34	1990 43

Racial/Ethnic Characteristics of Children Age 0-17 in Fayette County

One Race (Non-Hispanic Origin)	95.8%
White	1.9%
Black	0.1%
American Indian or Alaska Native	0.3%
Asian	0.0%
Native Hawaiian or Other Pacific Islander	0.1%
Some Other Race	1.1%
Two or More Races (Non-Hispanic Origin)	0.7%
Hispanic Origin*	

*Hispanic children may be of any race.

Number of Children Under the Age of 20 1990 & 2000

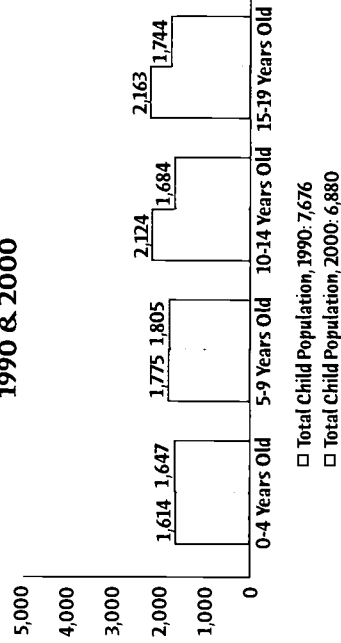

Birth & Well-being

	Current Year	Base Year
% of Live Births (CY)	285	375
% of Low Birthweight Babies (CY)	1999	1990
% of Mothers who Received 1st Trimester Prenatal Care (CY)	9.1	8.0
% of Mothers who Smoked During Pregnancy (CY)	81.8	82.4
Non Marital Births as a % of All Births (CY)	34.4	30.1
Teen Birth Rate, Age 15-17 (CY)	32.6	27.5
Total # of Infant Deaths (CY)	25.4	40.9
Total # of Child Deaths, Age 1-14 (CY)	1	8
Total # of Teen Deaths by Accident, Homicide and Suicide (CY)	1	0
# of Children Enrolled in Hoosier Healthwise (SFY)	2	0
% Noncompliance with Youth Tobacco Access Laws (CY)	1,873	1,155
	2000	1997
	10.0	5.0

Percent of Households with Children Under 18 Headed by Parents and Others, Census 2000

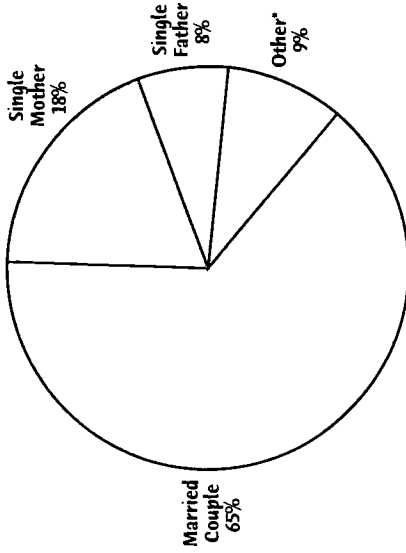

*"Other" includes households with children unrelated to the householder(s) and households with no adults present.

Education, Grades K-12

Public School Enrollment, K-12 (SY)	2000	4,144	1990	4,583
Non-Public School Enrollment (SY)	2001	405	1995	456
# of Home Schooled Children (SY)	2000	106	1990	0
# of Alternative School Participants (SY)	2001	186	1990	0
Total (Per Pupil Expenditure (SY)	2000	\$8,882	1990	\$4,847
% of 10th Graders Passing the GQE Math Standard (SY)	2000	61.0	2000	61.0
% of 10th Graders Passing the GQE Language Standard (SY)	2000	72.0	2000	72.0
% of Graduates Passing the GQE (SY)	2000	94.8	2000	94.8
# of Public High School Graduates (SY)	2000	231	1990	487
% of High School Graduates (SY)	2000	93.2	1990	75.3
% of Freshman Class Graduating in 4 Years (SY)	2000	50.8	1990	107.7
% of Grads Intending 4-year College (SY)	2000	44.6	1990	32.9
% of Grads Intending Vocational/Tech School (SY)	2000	10.8	1990	8.4
# of Public School Student Dropouts (SY)	2000	29	1990	134
# of Expulsions and Suspensions (SY)	1999	951	1999	951

Juveniles and the Law

# of Juveniles Committed to the Dept. of Correction (CY)	2000	2	1994	10
# of Juvenile Status Case Filings (CY)	2000	14	1990	29
# of Juvenile Delinquency Case Filings (CY)	2000	144	1990	122

Number of Babies Born to Single Mothers Under Age 20 without a High School Diploma

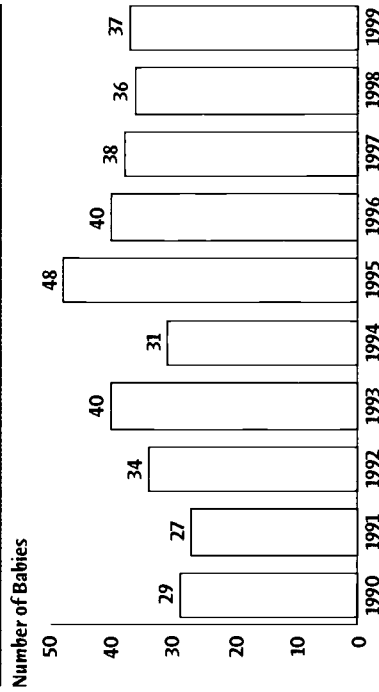

DATA YEAR DEFINITIONS

SFY - State Fiscal Year: July 1-June 30

SY - School Year: From the start of the school term in the fall through the end of the summer

FFY - Federal Fiscal Year: October 1-September 30

CY - Calendar Year: January 1 - December 31



Floyd County

Kids Count in Indiana 2001



Economic Well-being

	Current Year	Base Year
% of Children in Poverty, Age 0-17 (CY)	1997 14.4	1990 16.1
Per Capita Income (CY)	1999 \$27,009	1990 \$17,829
Unemployment Rate (CY)	2000 3.0	1990 5.1
Monthly Average of Families Receiving TANF (SFY)	2000 434	1990 866
Monthly Average of Persons Issued Food Stamps (SFY)	2000 3,696	1990 3,940
% of Students Receiving Free Lunches / Text Books (SY)	2001 22.7	1991 19.5

Early Childhood

# of First Steps Children Served (FFY)	2000 249	1998 180
# of Licensed Child Care Centers (SFY)	2000 12	1990 8
# of Licensed Child Care Homes (SFY)	2000 27	1990 13
# of Registered Child Care Ministries (SFY)	2000 9	1993 4
# of Licensed Child Care Slots per 100 Children, Age 0-4 (SFY)	2000 34.4	1996 28.6

Child Protection

# of Reported Cases of Child Abuse Processed by CPS (SFY)	2000 138	1990 284
% of Child Abuse Cases Substantiated by CPS (SFY)	2000 72.0	1990 52.5
# of Reported Cases of Child Neglect Processed by CPS (SFY)	2000 319	1990 339
% of Child Neglect Cases Substantiated by CPS (SFY)	2000 78.0	1990 57.5
# of Child Physical Abuse Cases Substantiated by CPS (SFY)	2000 62	1990 42
# of Child Sexual Abuse Cases Substantiated by CPS (SFY)	2000 38	1990 33
Child Abuse and Neglect Rate (SFY)	2000 18.7	1990 34.5
# of Child Abuse and Neglect Deaths (SFY)	2000 1	1990 0
# of Juvenile CHINS Case Filings (CY)	2000 24	1990 86

Racial/Ethnic Characteristics of Children Age 0-17 in Floyd County

One Race (Non-Hispanic Origin)	89.2%
White	5.8%
Black	0.1%
American Indian or Alaska Native	0.5%
Asian	0.0%
Native Hawaiian or Other Pacific Islander	0.3%
Some Other Race	2.4%
Two or More Races (Non-Hispanic Origin)	1.7%
Hispanic Origin*	

*Hispanic children may be of any race.

Number of Children Under the Age of 20 1990 & 2000

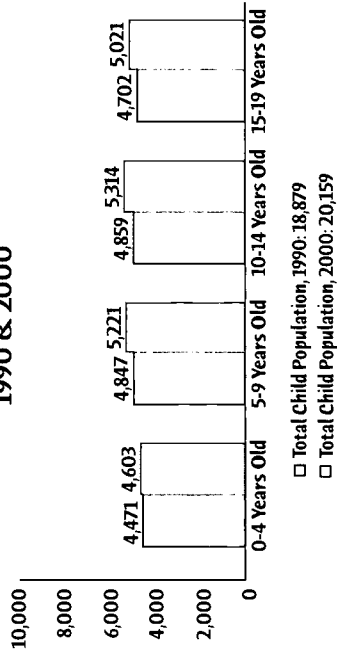

000000 136162

Birth & Well-being

	Current Year	Base Year
Total # of Live Births (CY)	1999 895	1990 937
% of Low Birthweight Babies (CY)	1999 8.2	1990 6.5
% of Mothers who Received 1st Trimester Prenatal Care (CY)	1999 82.2	1990 86.8
% of Mothers who Smoked During Pregnancy (CY)	1999 21.0	1990 30.5
Non Marital Births as a % of All Births (CY)	1999 36.8	1990 28.3
Teen Birth Rate, Age 15-17 (CY)	1999 25.9	1990 53.1
Total # of Infant Deaths (CY)	1999 4	1990 6
Total # of Child Deaths, Age 1-14 (CY)	1999 1	1990 1
Total # of Teen Deaths by Accident, Homicide and Suicide (CY)	1999 3	1990 3
# of Children Enrolled in Hoosier Healthwise (SFY)	2000 3,672	1998 2,675
% Noncompliance with Youth Tobacco Access Laws (CY)	2000 0	1997 N/A

Education, Grades K-12

Public School Enrollment, K-12 (SY)	2000 11,296	1990 9,117
Non-Public School Enrollment (SY)	2001 1,995	1995 1,465
# of Home Schooled Children (SY)	2000 128	1990 7
# of Alternative School Participants (SY)	2001 826	1990 0
Total Per Pupil Expenditure (SY)	2000 \$7,606	1990 \$4,273
% of 10th Graders Passing the GQE Math Standard (SY)	2000 64.0	2000 64.0
% of 10th Graders Passing the GQE Language Standard (SY)	2000 68.0	2000 68.0
% of Graduates Passing the GQE (SY)	2000 95.7	2000 95.7
# of Public High School Graduates (SY)	2000 672	1990 705
% of High School Graduates (SY)	2000 87.3	1990 89.9
% of Freshman Class Graduating in 4 Years (SY)	2000 73.4	1990 80.8
% of Grads Intending 4-year College (SY)	2000 67.3	1990 47.2
% of Grads Intending Vocational/Tech School (SY)	2000 6.4	1990 5.0
# of Public School Student Dropouts (SY)	2000 119	1990 200
# of Expulsions and Suspensions (SY)	1999 5,828	1999 5,828

Juveniles and the Law

# of Juveniles Committed to the Dept. of Correction (CY)	2000 18	1994 7
# of Juvenile Status Case Filings (CY)	2000 99	1990 0
# of Juvenile Delinquency Case Filings (CY)	2000 274	1990 98

Percent of Households with Children Under 18 Headed by Parents and Others, Census 2000

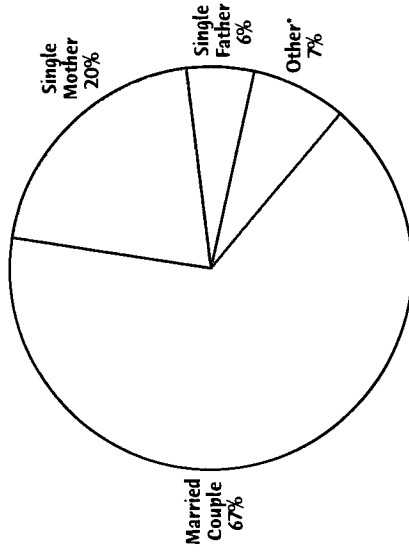

*"Other" includes households with children unrelated to the householder(s) and households with no adults present.

Number of Babies Born to Single Mothers Under Age 20 without a High School Diploma

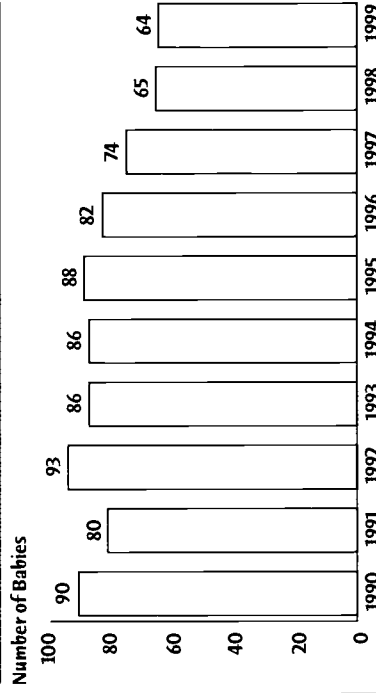

DATA YEAR DEFINITIONS

SFY - State Fiscal Year: July 1-June 30

SY - School Year: From the start of the school term in the fall through the end of the summer

FFY - Federal Fiscal Year: October 1-September 30

CY - Calendar Year: January 1 - December 31

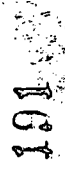

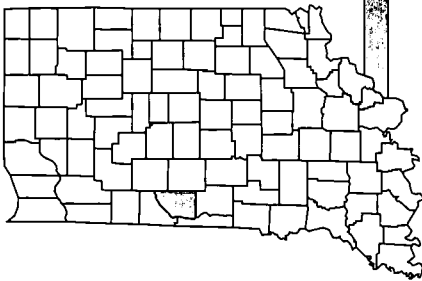

Fountain County

Kids Count in Indiana 2001



Economic Well-being

	Current Year	Base Year
% of Children in Poverty, Age 0-17 (CY)	1997 12.8	1990 13.1
Per Capita Income (CY)	1999 \$20,773	1990 \$14,210
Unemployment Rate (CY)	2000 3.5	1990 6.6
Monthly Average of Families Receiving TANF (SFY)	2000 29	1990 112
Monthly Average of Persons Issued Food Stamps (SFY)	2000 593	1990 890
% of Students Receiving Free Lunches / Text Books (SY)	2001 18.5	1991 15.4

Early Childhood

# of First Steps Children Served (FFY)	2000 35	1998 23
# of Licensed Child Care Centers (SFY)	2000 1	1990 1
# of Licensed Child Care Homes (SFY)	2000 5	1990 2
# of Registered Child Care Ministries (SFY)	2000 0	1993 0
# of Licensed Child Care Slots per 100 Children, Age 0-4 (SFY)	2000 8.7	1996 3.8

Child Protection

# of Reported Cases of Child Abuse Processed by CPS (SFY)	2000 27	1990 65
% of Child Abuse Cases Substantiated by CPS (SFY)	2000 63.0	1990 63.1
# of Reported Cases of Child Neglect Processed by CPS (SFY)	2000 74	1990 68
% of Child Neglect Cases Substantiated by CPS (SFY)	2000 73.0	1990 83.8
# of Child Physical Abuse Cases Substantiated by CPS (SFY)	2000 9	1990 7
# of Child Sexual Abuse Cases Substantiated by CPS (SFY)	2000 8	1990 16
Child Abuse and Neglect Rate (SFY)	2000 15.3	1990 24.0
# of Child Abuse and Neglect Deaths (SFY)	2000 0	1990 0
# of Juvenile CHINS Case Filings (CY)	2000 30	1990 10

Racial/Ethnic Characteristics of Children Age 0-17 in Fountain County

One Race (Non-Hispanic Origin)	97.7%
White	0.1%
Black	0.1%
American Indian or Alaska Native	0.2%
Asian	0.0%
Native Hawaiian or Other Pacific Islander	0.0%
Some Other Race	0.5%
Two or More Races (Non-Hispanic Origin)	1.3%
Hispanic Origin*	

*Hispanic children may be of any race.

Number of Children Under the Age of 20 1990 & 2000

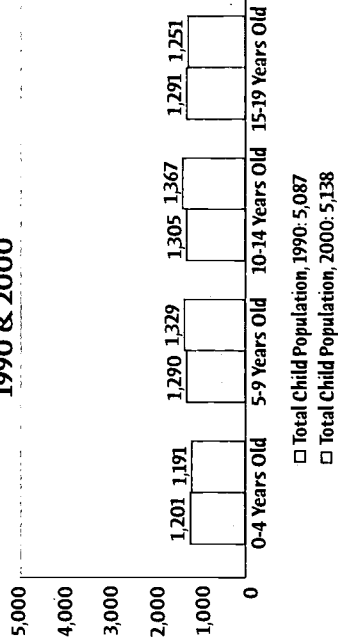

000000736163

Health & Well-being

	Current Year	Base Year
Total # of Live Births (CY)	1999 240	1990 201
% of Low Birthweight Babies (CY)	1999 9.2	1990 9.0
% of Mothers who Received 1st Trimester Prenatal Care (CY)	1999 81.3	1990 75.4
% of Mothers who Smoked During Pregnancy (CY)	1999 25.0	1990 31.8
Non Marital Births as a % of All Births (CY)	1999 26.7	1990 21.4
Teen Birth Rate, Age 15-17 (CY)	1999 27.5	1990 26.5
Total # of Infant Deaths (CY)	1999 0	1990 2
Total # of Child Deaths, Age 1-14 (CY)	1999 1	1990 0
Total # of Teen Deaths by Accident, Homicide and Suicide (CY)	1999 0	1990 0
# of Children Enrolled in Hoosier Healthwise (SFY)	2000 875	1998 529
% Noncompliance with Youth Tobacco Access Laws (CY)	2000 N/A	1997 N/A

Percent of Households with Children Under 18 Headed by Parents and Others, Census 2000

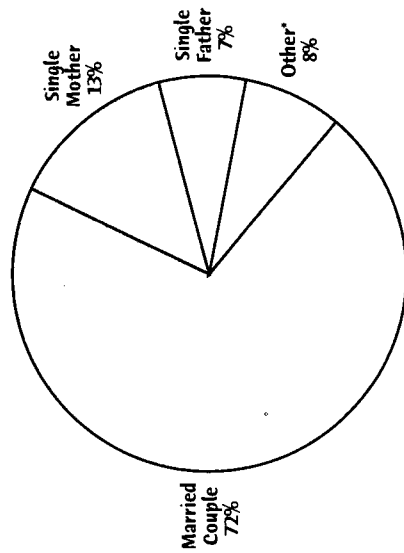

*"Other" includes households with children unrelated to the householder(s) and households with no adults present.

Education, Grades K-12

Public School Enrollment, K-12 (SY)	2000 3,361	1990 3,018
Non-Public School Enrollment (SY)	2001 100	1995 47
# of Home Schooled Children (SY)	2000 60	1990 2
# of Alternative School Participants (SY)	2001 0	1990 0
Total Per Pupil Expenditure (SY)	2000 \$6,240	1990 \$3,932
% of 10th Graders Passing the GQE Math Standard (SY)	2000 67.0	2000 67.0
% of 10th Graders Passing the GQE Language Standard (SY)	2000 70.0	2000 70.0
% of Graduates Passing the GQE (SY)	2000 96.2	2000 96.2
# of Public High School Graduates (SY)	2000 237	1990 235
% of High School Graduates (SY)	2000 87.9	1990 88.8
% of Freshman Class Graduating in 4 Years (SY)	2000 76.2	1990 81.3
% of Grads Intending 4-year College (SY)	2000 48.1	1990 34.6
% of Grads Intending Vocational/Tech School (SY)	2000 21.9	1990 8.0
# of Public School Student Dropouts (SY)	2000 33	1990 33
# of Expulsions and Suspensions (SY)	1999 886	1999 886

Juveniles and the Law

# of Juveniles Committed to the Dept. of Correction (CY)	2000 4	1994 1
# of Juvenile Status Case Filings (CY)	2000 0	1990 1
# of Juvenile Delinquency Case Filings (CY)	2000 52	1990 11

Number of Babies Born to Single Mothers Under Age 20 without a High School Diploma

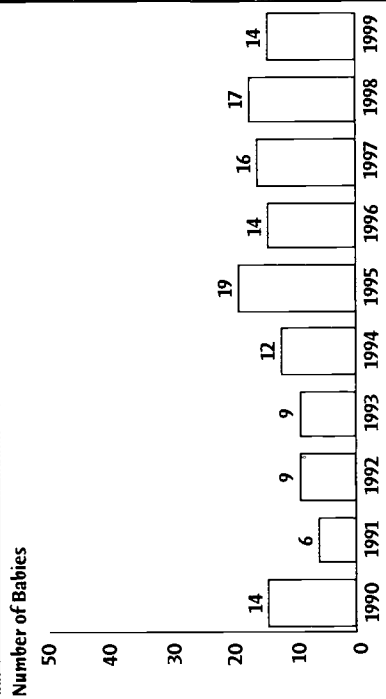

DATA YEAR DEFINITIONS

- SFY - State Fiscal Year: July 1-June 30
- SY - School Year: From the start of the school term in the fall through the end of the summer
- FFY - Federal Fiscal Year: October 1-September 30
- CY - Calendar Year: January 1 - December 31

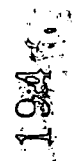

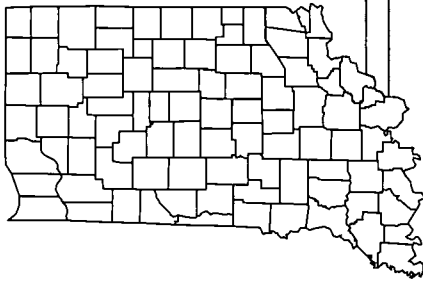

Franklin County

Kids Count in Indiana 2001



Economic Well-being

	Current Year	Base Year
% of Children in Poverty, Age 0-17 (CY)	1997 11.0	1990 12.7
Per Capita Income (CY)	1999 \$21,512	1990 \$14,097
Unemployment Rate (CY)	2000 3.6	1990 8.2
Monthly Average of Families Receiving TANF (SFY)	2000 52	1990 104
Monthly Average of Persons Issued Food Stamps (SFY)	2000 713	1990 913
% of Students Receiving Free Lunches / Text Books (SY)	2001 18.7	1991 13.7

Early Childhood

# of First Steps Children Served (FFY)	2000 45	1998 34
# of Licensed Child Care Centers (SFY)	2000 0	1990 0
# of Licensed Child Care Homes (SFY)	2000 12	1990 3
# of Registered Child Care Ministries (SFY)	2000 0	1993 0
# of Licensed Child Care Slots per 100 Children, Age 0-4 (SFY)	2000 8.7	1996 6.3

Child Protection

# of Reported Cases of Child Abuse Processed by CPS (SFY)	2000 57	1990 47
% of Child Abuse Cases Substantiated by CPS (SFY)	2000 58.0	1990 89.4
# of Reported Cases of Child Neglect Processed by CPS (SFY)	2000 103	1990 64
% of Child Neglect Cases Substantiated by CPS (SFY)	2000 30.0	1990 64.1
# of Child Physical Abuse Cases Substantiated by CPS (SFY)	2000 7	1990 7
# of Child Sexual Abuse Cases Substantiated by CPS (SFY)	2000 26	1990 5
Child Abuse and Neglect Rate (SFY)	2000 10.1	1990 16.6
# of Child Abuse and Neglect Deaths (SFY)	2000 0	1990 0
# of Juvenile CHINS Case Filings (CY)	2000 11	1990 18

Racial/Ethnic Characteristics of Children Age 0-17 in Franklin County

One Race (Non-Hispanic Origin)	98.3%
White	0.0%
Black	0.1%
American Indian or Alaska Native	0.2%
Asian	0.0%
Native Hawaiian or Other Pacific Islander	0.1%
Some Other Race	0.6%
Two or More Races (Non-Hispanic Origin)	0.7%
Hispanic Origin*	

*Hispanic children may be of any race.

Number of Children Under the Age of 20 1990 & 2000

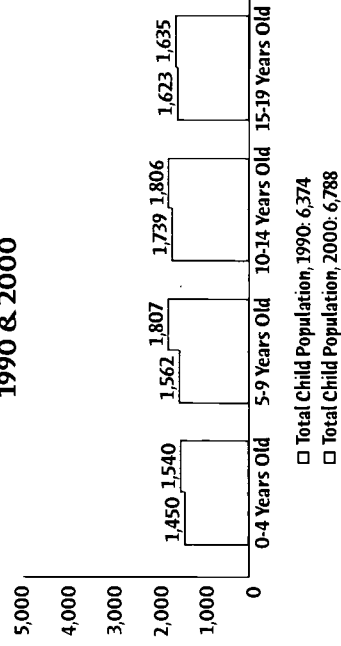

000000 136164

Health & Well-being

	Current Year	Base Year
Total # of Live Births (CY)	1999 183	1990 281
% of Low Birthweight Babies (CY)	1999 4.4	1990 8.5
% of Mothers who Received 1st Trimester Prenatal Care (CY)	1999 82.5	1990 76.5
% of Mothers who Smoked During Pregnancy (CY)	1999 24.6	1990 24.2
Non Marital Births as a % of All Births (CY)	1999 26.2	1990 13.9
Teen Birth Rate, Age 15-17 (CY)	1999 14.0	1990 35.2
Total # of Infant Deaths (CY)	1999 2	1990 2
Total # of Child Deaths, Age 1-14 (CY)	1999 0	1990 2
Total # of Teen Deaths by Accident, Homicide and Suicide (CY)	1999 0	1990 1
# of Children Enrolled in Hoosier Healthwise (SFY)	2000 1,037	1998 521
% Noncompliance with Youth Tobacco Access Laws (CY)	2000 10.0	1997 27.8

Percent of Households with Children Under 18 Headed by Parents and Others, Census 2000

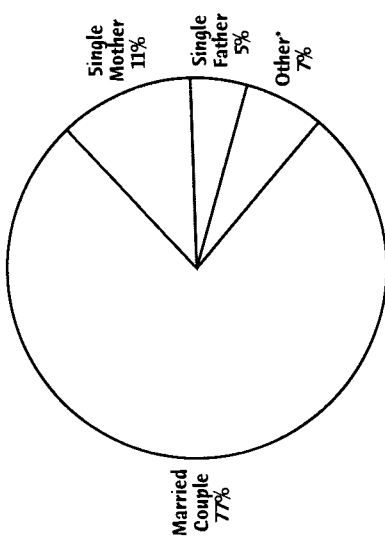

*"Other" includes households with children unrelated to the householder(s) and households with no adults present.

Education, Grades K-12

Public School Enrollment, K-12 (SY)	2000 2,955	1990 2,605
Non-Public School Enrollment (SY)	2001 290	1995 488
# of Home Schooled Children (SY)	2000 108	1990 0
# of Alternative School Participants (SY)	2001 40	1990 0
Total Per Pupil Expenditure (SY)	2000 \$5,896	1990 \$3,889
% of 10th Graders Passing the GQE Math Standard (SY)	2000 62.0	2000 62.0
% of 10th Graders Passing the GQE Language Standard (SY)	2000 69.0	2000 69.0
% of Graduates Passing the GQE (SY)	2000 88.6	2000 88.6
# of Public High School Graduates (SY)	2000 193	1990 178
% of High School Graduates (SY)	2000 81.4	1990 58.5
% of Freshman Class Graduating in 4 Years (SY)	2000 74.2	1990 72.7
% of Grads Intending 4-year College (SY)	2000 41.5	1990 38.7
% of Grads Intending Vocational/Tech School (SY)	2000 7.3	1990 5.5
# of Public School Student Dropouts (SY)	2000 47	1990 121
# of Expulsions and Suspensions (SY)	1999 803	1999 803

Juveniles and the Law

# of Juveniles Committed to the Dept. of Correction (CY)	2000 2	1994 7
# of Juvenile Status Case Filings (CY)	2000 0	1990 0
# of Juvenile Delinquency Case Filings (CY)	2000 106	1990 0

Number of Babies Born to Single Mothers Under Age 20 without a High School Diploma

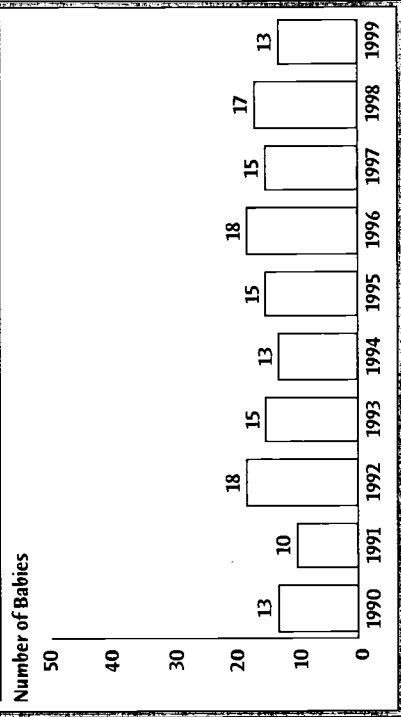

DATA YEAR DEFINITIONS

- SFY - State Fiscal Year: July 1-June 30
- SY - School Year: From the start of the school term in the fall through the end of the summer
- FFY - Federal Fiscal Year: October 1-September 30
- CY - Calendar Year: January 1 - December 31





Fulton County

Kids Count in Indiana 2001



Economic Well-being

	Current Year	Base Year
% of Children in Poverty, Age 0-17 (CY)	1997 14.1	1990 12.9
Per Capita Income (CY)	1999 \$20,776	1990 \$14,864
Unemployment Rate (CY)	2000 5.8	1990 5.0
Monthly Average of Families Receiving TANF (SFY)	2000 55	1990 97
Monthly Average of Persons Issued Food Stamps (SFY)	2000 662	1990 676
% of Students Receiving Free Lunches / Text Books (SY)	2001 18.8	1991 13.3

Early Childhood

# of First Steps Children Served (FFY)	2000 57	1998 39
# of Licensed Child Care Centers (SFY)	2000 1	1990 1
# of Licensed Child Care Homes (SFY)	2000 23	1990 17
# of Registered Child Care Ministries (SFY)	2000 2	1993 0
# of Licensed Child Care Slots per 100 Children, Age 0-4 (SFY)	2000 23.4	1996 18.1

Child Protection

# of Reported Cases of Child Abuse Processed by CPS (SFY)	2000 19	1990 86
% of Child Abuse Cases Substantiated by CPS (SFY)	2000 84.0	1990 65.1
# of Reported Cases of Child Neglect Processed by CPS (SFY)	2000 42	1990 115
% of Child Neglect Cases Substantiated by CPS (SFY)	2000 98.0	1990 61.7
# of Child Physical Abuse Cases Substantiated by CPS (SFY)	2000 10	1990 13
# of Child Sexual Abuse Cases Substantiated by CPS (SFY)	2000 6	1990 27
Child Abuse and Neglect Rate (SFY)	2000 10.4	1990 36.5
# of Child Abuse and Neglect Deaths (SFY)	2000 0	1990 0
# of Juvenile CHINS Case Filings (CY)	2000 11	1990 12

Racial/Ethnic Characteristics of Children Age 0-17 in Fulton County

One Race (Non-Hispanic Origin)	93.1%
White	1.0%
Black	0.3%
American Indian or Alaska Native	0.5%
Asian	0.1%
Native Hawaiian or Other Pacific Islander	0.1%
Some Other Race	1.8%
Two or More Races (Non-Hispanic Origin)	3.2%
Hispanic Origin*	

*Hispanic children may be of any race.

Number of Children Under the Age of 20 1990 & 2000

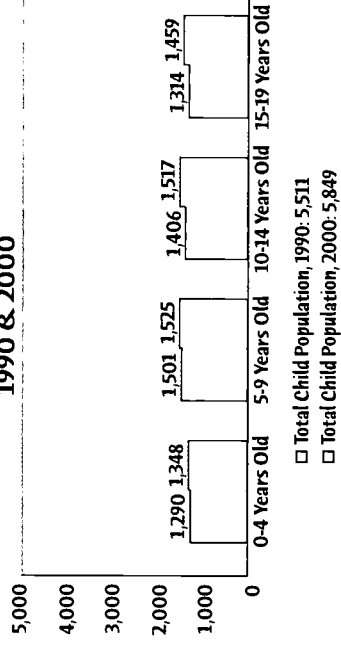

000000 136165

Health & Well-being

	Current Year	Base Year
Total # of Live Births (CY)	1999 281	1990 269
% of Low Birthweight Babies (CY)	1999 6.0	1990 6.7
% of Mothers who Received 1st Trimester Prenatal Care (CY)	1999 78.3	1990 80.1
% of Mothers who Smoked During Pregnancy (CY)	1999 27.8	1990 30.9
Non-Marital Births as a % of All Births (CY)	1999 28.8	1990 20.4
Teen Birth Rate, Age 15-17 (CY)	1999 16.7	1990 16.8
Total # of Infant Deaths (CY)	1999 0	1990 1
Total # of Child Deaths, Age 1-14 (CY)	1999 1	1990 1
Total # of Teen Deaths by Accident, Homicide and Suicide (CY)	1999 0	1990 1
# of Children Enrolled in Hoosier Healthwise (SFY)	2000 1,153	1998 669
% Noncompliance with Youth Tobacco Access Laws (CY)	2000 N/A	1997 N/A

Percent of Households with Children Under 18 Headed by Parents and Others, Census 2000

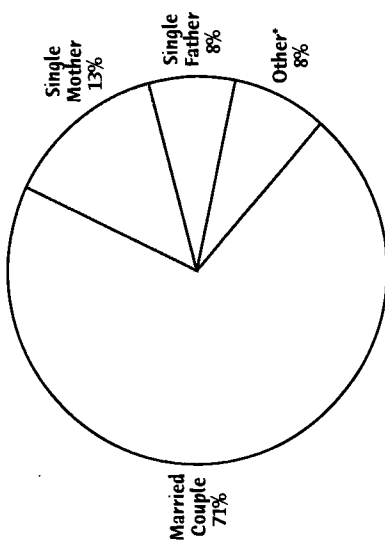

*"Other" includes households with children unrelated to the householder(s) and households with no adults present.

Education, Grades K-12

Public School Enrollment, K-12 (SY)	2000 2,865	1990 2,528
Non-Public School Enrollment (SY)	2001 126	1995 11
# of Home Schooled Children (SY)	2000 41	1990 1
# of Alternative School Participants (SY)	2001 16	1990 0
Total Per Pupil Expenditure (SY)	2000 \$5,671	1990 \$3,644
% of 10th Graders Passing the GQE Math Standard (SY)	2000 71.0	2000 71.0
% of 10th Graders Passing the GQE Language Standard (SY)	2000 79.0	2000 79.0
% of Graduates Passing the GQE (SY)	2000 94.4	2000 94.4
# of Public High School Graduates (SY)	2000 215	1990 187
% of High School Graduates (SY)	2000 87.5	1990 84.4
% of Freshman Class Graduating in 4 Years (SY)	2000 82.7	1990 78.9
% of Grads Intending 4-year College (SY)	2000 57.2	1990 37.6
% of Grads Intending Vocational/Tech School (SY)	2000 8.8	1990 9.1
# of Public School Student Dropouts (SY)	2000 27	1990 36
# of Expulsions and Suspensions (SY)	1999 373	1999 373

Number of Babies Born to Single Mothers Under Age 20 without a High School Diploma

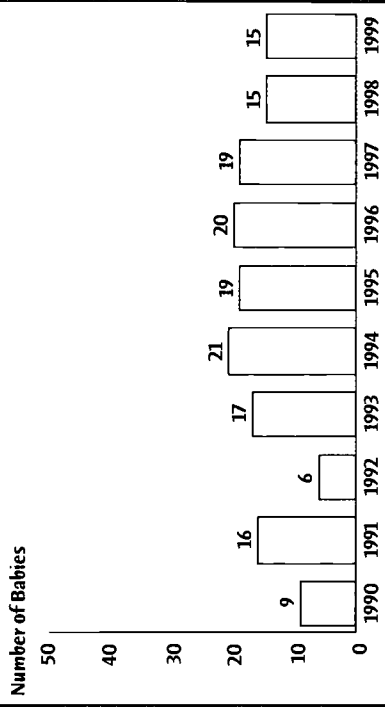

Juveniles and the Law

# of Juveniles Committed to the Dept. of Correction (CY)	2000 3	1994 2
# of Juvenile Status Case Filings (CY)	2000 0	1990 0
# of Juvenile Delinquency Case Filings (CY)	2000 20	1990 29

DATA YEAR DEFINITIONS

SFY - State Fiscal Year: July 1-June 30
 SY - School Year: From the start of the school term in the fall through the end of the summer
 FFY - Federal Fiscal Year: October 1-September 30
 CY - Calendar Year: January 1 - December 31

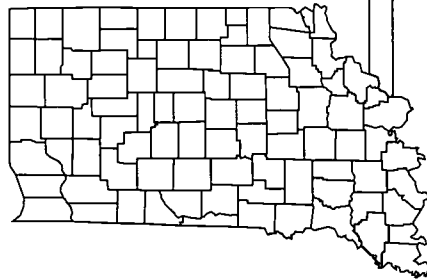

Gibson County

Kids Count in Indiana 2001



Economic Well-being

	Current Year	Base Year
% of Children in Poverty, Age 0-17 (CY)	1997 11.9	1990 11.1
Per Capita Income (CY)	1999 \$23,042	1990 \$15,648
Unemployment Rate (CY)	2000 3.8	1990 6.4
Monthly Average of Families Receiving TANF (SFY)	2000 80	1990 207
Monthly Average of Persons Issued Food Stamps (SFY)	2000 1,115	1990 1,645
% of Students Receiving Free Lunches / Text Books (SY)	2001 13.9	1991 10.8

Early Childhood

# of First Steps Children Served (FFY)	2000 82	1998 56
# of Licensed Child Care Centers (SFY)	2000 3	1990 4
# of Licensed Child Care Homes (SFY)	2000 48	1990 3
# of Registered Child Care Ministries (SFY)	2000 3	1993 1
# of Licensed Child Care Slots per 100 Children, Age 0-4 (SFY)	2000 34.4	1996 23.6

Child Protection

# of Reported Cases of Child Abuse Processed by CPS (SFY)	2000 102	1990 61
% of Child Abuse Cases Substantiated by CPS (SFY)	2000 69.0	1990 54.1
# of Reported Cases of Child Neglect Processed by CPS (SFY)	2000 205	1990 110
% of Child Neglect Cases Substantiated by CPS (SFY)	2000 69.0	1990 75.5
# of Child Physical Abuse Cases Substantiated by CPS (SFY)	2000 29	1990 3
# of Child Sexual Abuse Cases Substantiated by CPS (SFY)	2000 41	1990 18
Child Abuse and Neglect Rate (SFY)	2000 26.3	1990 18.6
# of Child Abuse and Neglect Deaths (SFY)	2000 1	1990 0
# of Juvenile CHINS Case Filings (CY)	2000 41	1990 34

Racial/Ethnic Characteristics of Children Age 0-17 in Gibson County

One Race (Non-Hispanic Origin)	94.5%
White	2.3%
Black	0.2%
American Indian or Alaska Native	0.3%
Asian	0.0%
Native Hawaiian or Other Pacific Islander	0.1%
Some Other Race	1.5%
Two or More Races (Non-Hispanic Origin)	1.1%
Hispanic Origin*	

*Hispanic children may be of any race.

Number of Children Under the Age of 20 1990 & 2000

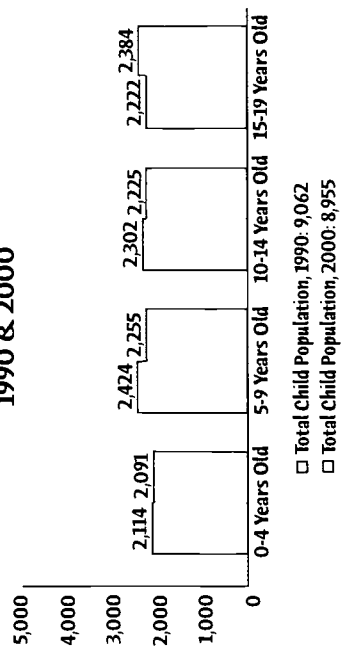

000000 136166

Birth & Well-being

	Current Year	Base Year
Total # of Live Births (CY)	1999 402	1990 424
% of Low Birthweight Babies (CY)	1999 7.7	1990 6.4
% of Mothers who Received 1st Trimester Prenatal Care (CY)	1999 87.3	1990 83.1
% of Mothers who Smoked During Pregnancy (CY)	1999 25.9	1990 26.7
Non Marital Births as a % of All Births (CY)	1999 31.8	1990 17.7
Teen Birth Rate, Age 15-17 (CY)	1999 23.5	1990 23.2
Total # of Infant Deaths (CY)	1999 7	1990 2
Total # of Child Deaths, Age 1-14 (CY)	1999 3	1990 1
Total # of Teen Deaths by Accident, Homicide and Suicide (CY)	1999 1	1990 1
# of Children Enrolled in Hoosier Healthwise (SFY)	2000 1,592	1998 815
% Noncompliance with Youth Tobacco Access Laws (CY)	2000 10.0	1997 N/A

Percent of Households with Children Under 18 Headed by Parents and Others, Census 2000

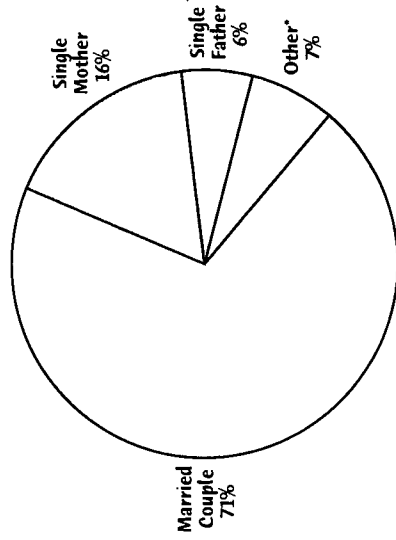

*"Other" includes households with children unrelated to the householder(s) and households with no adults present.

Education, Grades K-12

Public School Enrollment, K-12 (SY)	2000 5,078	1990 4,542
Non-Public School Enrollment (SY)	2001 762	1995 623
# of Home Schooled Children (SY)	2000 74	1990 1
# of Alternative School Participants (SY)	2001 24	1990 0
Total Per Pupil Expenditure (SY)	2000 \$7,362	1990 \$4,657
% of 10th Graders Passing the GQE Math Standard (SY)	2000 69.0	2000 69.0
% of 10th Graders Passing the GQE Language Standard (SY)	2000 74.0	2000 74.0
% of Graduates Passing the GQE (SY)	2000 94.5	2000 94.5
# of Public High School Graduates (SY)	2000 381	1990 392
% of High School Graduates (SY)	2000 94.1	1990 82.3
% of Freshman Class Graduating in 4 Years (SY)	2000 77.6	1990 85.8
% of Grads Intending 4-year College (SY)	2000 45.1	1990 29.0
% of Grads Intending Vocational/Tech School (SY)	2000 6.0	1990 5.1
# of Public School Student Dropouts (SY)	2000 26	1990 75
# of Expulsions and Suspensions (SY)	1999 704	1999 704

Juveniles and the Law

# of Juveniles Committed to the Dept. of Correction (CY)	2000 4	1994 4
# of Juvenile Status Case Filings (CY)	2000 0	1990 15
# of Juvenile Delinquency Case Filings (CY)	2000 37	1990 10

Number of Babies Born to Single Mothers Under Age 20 without a High School Diploma

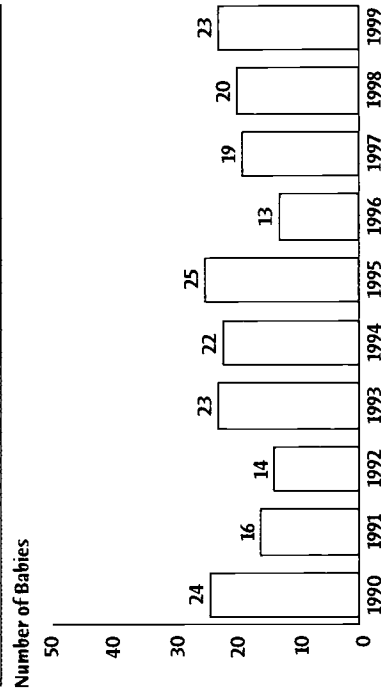

DATA YEAR DEFINITIONS

SFY - State Fiscal Year: July 1-June 30
 SY - School Year: From the start of the school term in the fall through the end of the summer
 FFY - Federal Fiscal Year: October 1-September 30
 CY - Calendar Year: January 1 - December 31



Grant County

Kids Count in Indiana 2001



Economic Well-being

	Current Year	Base Year
% of Children in Poverty, Age 0-17 (CY)	1997 20.6	1990 18.2
Per Capita Income (CY)	1999 \$22,247	1990 \$16,225
Unemployment Rate (CY)	2000 4.6	1990 7.9
Monthly Average of Families Receiving TANF (SFY)	2000 410	1990 891
Monthly Average of Persons Issued Food Stamps (SFY)	2000 5,263	1990 5,721
% of Students Receiving Free Lunches / Text Books (SY)	2001 26.8	1991 21.3

Early Childhood

# of First Steps Children Served (FFY)	2000 247	1998 151
# of Licensed Child Care Centers (SFY)	2000 7	1990 6
# of Licensed Child Care Homes (SFY)	2000 30	1990 7
# of Registered Child Care Ministries (SFY)	2000 5	1993 5
# of Licensed Child Care Slots per 100 Children, Age 0-4 (SFY)	2000 17.6	1996 17.7

Child Protection

# of Reported Cases of Child Abuse Processed by CPS (SFY)	2000 144	1990 359
% of Child Abuse Cases Substantiated by CPS (SFY)	2000 45.0	1990 61.3
# of Reported Cases of Child Neglect Processed by CPS (SFY)	2000 397	1990 559
% of Child Neglect Cases Substantiated by CPS (SFY)	2000 32.0	1990 47.9
# of Child Physical Abuse Cases Substantiated by CPS (SFY)	2000 35	1990 36
# of Child Sexual Abuse Cases Substantiated by CPS (SFY)	2000 30	1990 91
Child Abuse and Neglect Rate (SFY)	2000 11.5	1990 38.5
# of Child Abuse and Neglect Deaths (SFY)	2000 0	1990 0
# of Juvenile CHINS Case Filings (CY)	2000 37	1990 53

Racial/Ethnic Characteristics of Children Age 0-17 in Grant County

One Race (Non-Hispanic Origin)	82.1%
White	9.6%
Black	0.4%
American Indian or Alaska Native	0.5%
Asian	0.0%
Native Hawaiian or Other Pacific Islander	0.5%
Some Other Race	3.0%
Two or More Races (Non-Hispanic Origin)	4.0%
Hispanic Origin*	

*Hispanic children may be of any race.

Number of Children Under the Age of 20 1990 & 2000

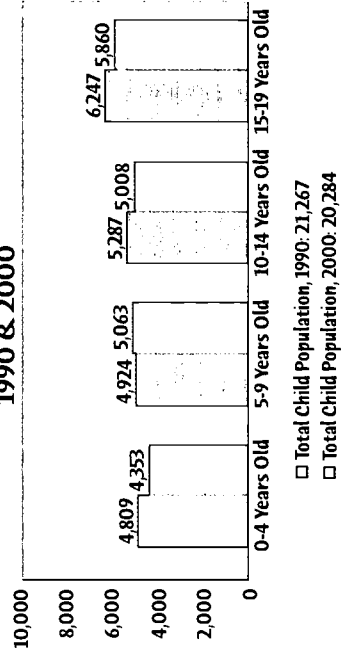

Health & Well-being

	Current Year	Base Year
Total # of Live Births (CY)	1999 866	1990 1,095
% of Low Birthweight Babies (CY)	1999 9.6	1990 9.2
% of Mothers who Received 1st Trimester Prenatal Care (CY)	1999 79.8	1990 76.5
% of Mothers who Smoked During Pregnancy (CY)	1999 26.6	1990 32.7
Non Marital Births as a % of All Births (CY)	1999 40.3	1990 33.0
Teen Birth Rate, Age 15-17 (CY)	1999 33.5	1990 37.0
Total # of Infant Deaths (CY)	1999 8	1990 20
Total # of Child Deaths, Age 1-14 (CY)	1999 3	1990 3
Total # of Teen Deaths by Accident, Homicide and Suicide (CY)	1999 1	1990 7
# of Children Enrolled in Hoosier Healthwise (SFY)	2000 5,289	1998 3,637
% Noncompliance with Youth Tobacco Access Laws (CY)	2000 33.0	1997 15.8

Percent of Households with Children Under 18 Headed by Parents and Others, Census 2000

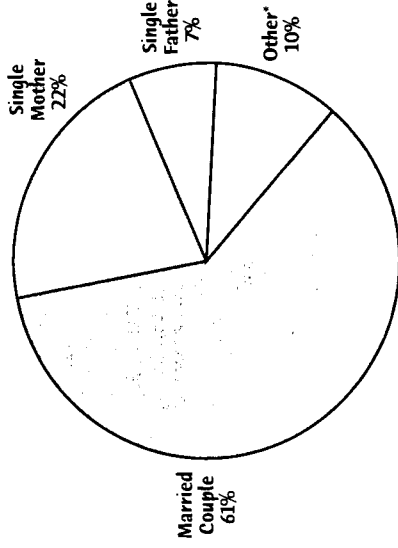

* "Other" includes households with children unrelated to the householder(s) and households with no adults present.

Education, Grades K-12

Public School Enrollment, K-12 (SY)	2000 11,382	1990 11,148
Non-Public School Enrollment (SY)	2001 739	1995 543
# of Home Schooled Children (SY)	2000 145	1990 5
# of Alternative School Participants (SY)	2001 335	1990 0
Total Per Pupil Expenditure (SY)	2000 \$7,424	1990 \$4,574
% of 10th Graders Passing the GQE Math Standard (SY)	2000 59.0	2000 59.0
% of 10th Graders Passing the GQE Language Standard (SY)	2000 66.0	2000 66.0
% of Graduates Passing the GQE (SY)	2000 95.7	2000 95.7
# of Public High School Graduates (SY)	2000 634	1990 1,018
% of High School Graduates (SY)	2000 91.0	1990 77.2
% of Freshman Class Graduating in 4 Years (SY)	2000 67.4	1990 80.1
% of Grads Intending 4-year College (SY)	2000 49.7	1990 30.8
% of Grads Intending Vocational/Tech School (SY)	2000 12.2	1990 6.7
# of Public School Student Dropouts (SY)	2000 72	1990 244
# of Expulsions and Suspensions (SY)	1999 4,660	1999 4,660

Juveniles and the Law

# of Juveniles Committed to the Dept. of Correction (CY)	2000 21	1994 14
# of Juvenile Status Case Filings (CY)	2000 40	1990 20
# of Juvenile Delinquency Case Filings (CY)	2000 242	1990 69

Number of Babies Born to Single Mothers Under Age 20 without a High School Diploma

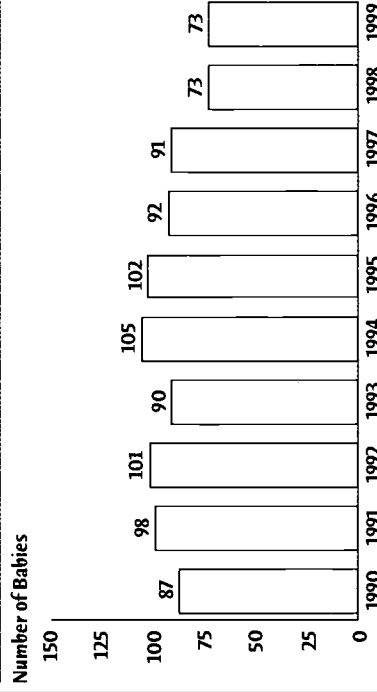

DATA YEAR DEFINITIONS

- SFY - State Fiscal Year: July 1-June 30
- SY - School Year: From the start of the school term in the fall through the end of the summer
- FFY - Federal Fiscal Year: October 1-September 30
- CY - Calendar Year: January 1 - December 31



Greene County

Kids Count in Indiana 2001



Economic Well-being

	Current Year	Base Year
% of Children in Poverty, Age 0-17 (CY)	1997 15.9	1990 18.2
Per Capita Income (CY)	1999 \$19,220	1990 \$14,630
Unemployment Rate (CY)	2000 7.0	1990 8.3
Monthly Average of Families Receiving TANF (SFY)	2000 85	1990 263
Monthly Average of Persons Issued Food Stamps (SFY)	2000 1,360	1990 1,821
% of Students Receiving Free Lunches / Text Books (SY)	2001 21.9	1991 18.5

Early Childhood

# of First Steps Children Served (FFY)	2000 73	1998 65
# of Licensed Child Care Centers (SFY)	2000 3	1990 2
# of Licensed Child Care Homes (SFY)	2000 38	1990 9
# of Registered Child Care Ministries (SFY)	2000 0	1993 0
# of Licensed Child Care Slots per 100 Children, Age 0-4 (SFY)	2000 26.3	1996 18.7

Child Protection

# of Reported Cases of Child Abuse Processed by CPS (SFY)	2000 167	1990 124
% of Child Abuse Cases Substantiated by CPS (SFY)	2000 55.0	1990 60.5
# of Reported Cases of Child Neglect Processed by CPS (SFY)	2000 310	1990 249
% of Child Neglect Cases Substantiated by CPS (SFY)	2000 65.0	1990 55.4
# of Child Physical Abuse Cases Substantiated by CPS (SFY)	2000 30	1990 31
# of Child Sexual Abuse Cases Substantiated by CPS (SFY)	2000 62	1990 13
Child Abuse and Neglect Rate (SFY)	2000 35.2	1990 44.3
# of Child Abuse and Neglect Deaths (SFY)	2000 0	1990 0
# of Juvenile CHINS Case Filings (CY)	2000 77	1990 29

Racial/Ethnic Characteristics of Children Age 0-17 in Greene County

One Race (Non-Hispanic Origin)	Percentage
White	97.4%
Black	0.1%
American Indian or Alaska Native	0.3%
Asian	0.2%
Native Hawaiian or Other Pacific Islander	0.0%
Some Other Race	0.0%
Two or More Races (Non-Hispanic Origin)	Percentage
Hispanic Origin*	0.7%
	1.3%

*Hispanic children may be of any race.

Number of Children Under the Age of 20 1990 & 2000

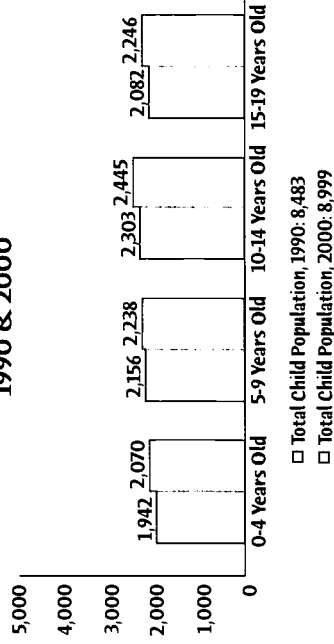

Birth & Well-being

	Current Year	Base Year
Total # of Live Births (CY)	1999 364	1990 416
% of Low Birthweight Babies (CY)	1999 5.5	1990 7.2
% of Mothers who Received 1st Trimester Prenatal Care (CY)	1999 77.7	1990 81.1
% of Mothers who Smoked During Pregnancy (CY)	1999 29.1	1990 23.8
Non Marital Births as a % of All Births (CY)	1999 31.0	1990 13.2
Teen Birth Rate, Age 15-17 (CY)	1999 19.4	1990 29.8
Total # of Infant Deaths (CY)	1999 5	1990 5
Total # of Child Deaths, Age 1-14 (CY)	1999 2	1990 2
Total # of Teen Deaths by Accident, Homicide and Suicide (CY)	1999 1	1990 2
# of Children Enrolled in Hoosier Healthwise (SFY)	2000 2,107	1998 1,078
% Noncompliance with Youth Tobacco Access Laws (CY)	2000 10.0	1997 N/A

Percent of Households with Children Under 18 Headed by Parents and Others, Census 2000

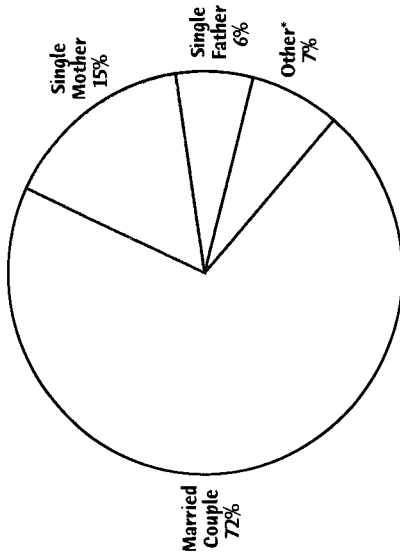

*"Other" includes households with children unrelated to the householder(s) and households with no adults present.

Education, Grades K-12

Public School Enrollment, K-12 (SY)	2000 5,861	1990 4,861
Non-Public School Enrollment (SY)	2001 51	1995 92
# of Home Schooled Children (SY)	2000 115	1990 0
# of Alternative School Participants (SY)	2001 0	1990 0
Total Per Pupil Expenditure (SY)	2000 \$6,741	1990 \$3,921
% of 10th Graders Passing the GQE Math Standard (SY)	2000 65.0	2000 65.0
% of 10th Graders Passing the GQE Language Standard (SY)	2000 71.0	2000 71.0
% of Graduates Passing the GQE (SY)	2000 98.2	2000 98.2
# of Public High School Graduates (SY)	2000 333	1990 409
% of High School Graduates (SY)	2000 87.9	1990 83.6
% of Freshman Class Graduating in 4 Years (SY)	2000 71.0	1990 92.3
% of Grads Intending 4-year College (SY)	2000 40.2	1990 66.4
% of Grads Intending Vocational/Tech School (SY)	2000 8.4	1990 3.6
# of Public School Student Dropouts (SY)	2000 50	1990 76
# of Expulsions and Suspensions (SY)	1999 1,396	1999 1,396

Juveniles and the Law

# of Juveniles Committed to the Dept. of Correction (CY)	2000 3	1994 5
# of Juvenile Status Case Filings (CY)	2000 0	1990 0
# of Juvenile Delinquency Case Filings (CY)	2000 152	1990 29

Number of Babies Born to Single Mothers Under Age 20 without a High School Diploma

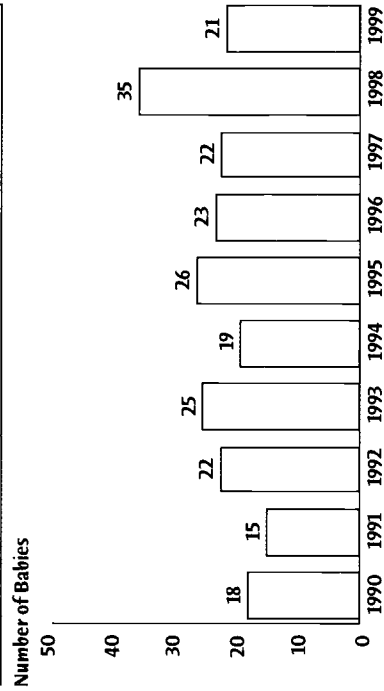

DATA YEAR DEFINITIONS

- SFY - State Fiscal Year: July 1-June 30
- SY - School Year: From the start of the school term in the fall through the end of the summer
- FFY - Federal Fiscal Year: October 1-September 30
- CY - Calendar Year: January 1 - December 31

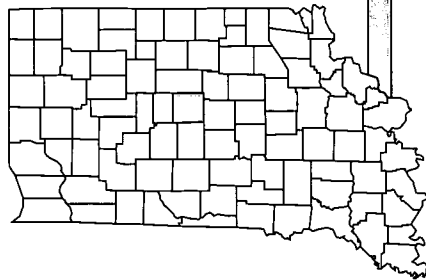

Hamilton County

Kids Count in
Indiana 2001



Economic Well-being

	Current Year	Base Year
% of Children in Poverty, Age 0-17 (CY)	1997 4.3	1990 4.3
Per Capita Income (CY)	1999 \$40,435	1990 \$26,737
Unemployment Rate (CY)	2000 1.4	1990 2.3
Monthly Average of Families Receiving TANF (SFY)	2000 116	1990 238
Monthly Average of Persons Issued Food Stamps (SFY)	2000 1,476	1990 1,637
% of Students Receiving Free Lunches / Text Books (SY)	2001 4.3	1991 4.6

Early Childhood

# of First Steps Children Served (FFY)	2000 794	1998 352
# of Licensed Child Care Centers (SFY)	2000 28	1990 16
# of Licensed Child Care Homes (SFY)	2000 98	1990 71
# of Registered Child Care Ministries (SFY)	2000 7	1993 2
# of Licensed Child Care Slots per 100 Children, Age 0-4 (SFY)	2000 32.6	1996 33.7

Child Protection

# of Reported Cases of Child Abuse Processed by CPS (SFY)	2000 141	1990 171
% of Child Abuse Cases Substantiated by CPS (SFY)	2000 64.0	1990 40.9
# of Reported Cases of Child Neglect Processed by CPS (SFY)	2000 131	1990 103
% of Child Neglect Cases Substantiated by CPS (SFY)	2000 41.0	1990 27.2
# of Child Physical Abuse Cases Substantiated by CPS (SFY)	2000 28	1990 12
# of Child Sexual Abuse Cases Substantiated by CPS (SFY)	2000 62	1990 36
Child Abuse and Neglect Rate (SFY)	2000 3.0	1990 10.3
# of Child Abuse and Neglect Deaths (SFY)	2000 0	1990 1
# of Juvenile CHINS Case Filings (CY)	2000 471	1990 23

Racial/Ethnic Characteristics of Children Age 0-17 in Hamilton County

One Race (Non-Hispanic Origin)

White	92.2%
Black	1.6%
American Indian or Alaska Native	0.1%
Asian	2.6%
Native Hawaiian or Other Pacific Islander	0.0%
Some Other Race	0.2%
Two or More Races (Non-Hispanic Origin)	1.4%
Hispanic Origin*	1.9%

*Hispanic children may be of any race.

Number of Children Under the Age of 20 1990 & 2000

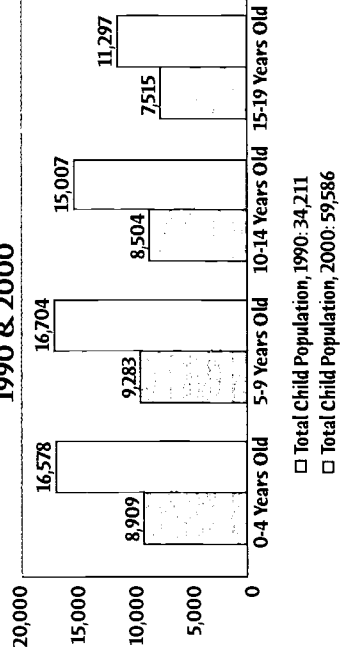

Health & Well-being

	Current Year	Base Year
Total # of Live Births (CY)	1999 2,980	1990 1,846
% of Low Birthweight Babies (CY)	1999 6.5	1990 5.3
% of Mothers who Received 1st Trimester Prenatal Care (CY)	1999 87.6	1990 89.0
% of Mothers who Smoked During Pregnancy (CY)	1999 7.7	1990 14.5
Non Marital Births as a % of All Births (CY)	1999 11.1	1990 9.3
Teen Birth Rate, Age 15-17 (CY)	1999 8.5	1990 15.4
Total # of Infant Deaths (CY)	1999 15	1990 11
Total # of Child Deaths, Age 1-14 (CY)	1999 3	1990 4
Total # of Teen Deaths by Accident, Homicide and Suicide (CY)	1999 4	1990 5
# of Children Enrolled in Hoosier Healthwise (SFY)	2000 2,619	1998 1,354
% Noncompliance with Youth Tobacco Access Laws (CY)	2000 30.0	1997 15.0

Education, Grades K-12

Public School Enrollment, K-12 (SY)	2000 32,660	1990 18,703
Non-Public School Enrollment (SY)	2001 2,312	1995 1,340
# of Home Schooled Children (SY)	2000 298	1990 14
# of Alternative School Participants (SY)	2001 118	1990 0
Total Per Pupil Expenditure (SY)	2000 \$6,391	1990 \$3,933
% of 10th Graders Passing the GQE Math Standard (SY)	2000 83.0	2000 83.0
% of 10th Graders Passing the GQE Language Standard (SY)	2000 86.0	2000 86.0
% of Graduates Passing the GQE (SY)	2000 98.0	2000 98.0
# of Public High School Graduates (SY)	2000 1,860	1990 1,350
% of High School Graduates (SY)	2000 92.8	1990 82.4
% of Freshman Class Graduating in 4 Years (SY)	2000 84.4	1990 92.1
% of Grads Intending 4-year College (SY)	2000 78.0	1990 51.8
% of Grads Intending Vocational/Tech School (SY)	2000 2.5	1990 8.6
# of Public School Student Dropouts (SY)	2000 160	1990 222
# of Expulsions and Suspensions (SY)	1999 2,747	1999 2,747

Juveniles and the Law

# of Juveniles Committed to the Dept. of Correction (CY)	2000 25	1994 2
# of Juvenile Status Case Filings (CY)	2000 119	1990 43
# of Juvenile Delinquency Case Filings (CY)	2000 780	1990 235

Percent of Households with Children Under 18 Headed by Parents and Others, Census 2000

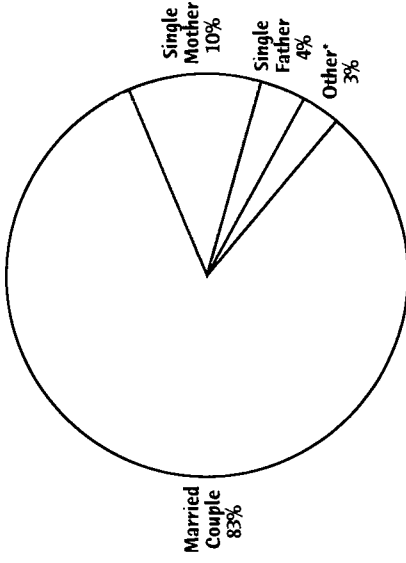

*"Other" includes households with children unrelated to the householder(s) and households with no adults present.

Number of Babies Born to Single Mothers Under Age 20 without a High School Diploma

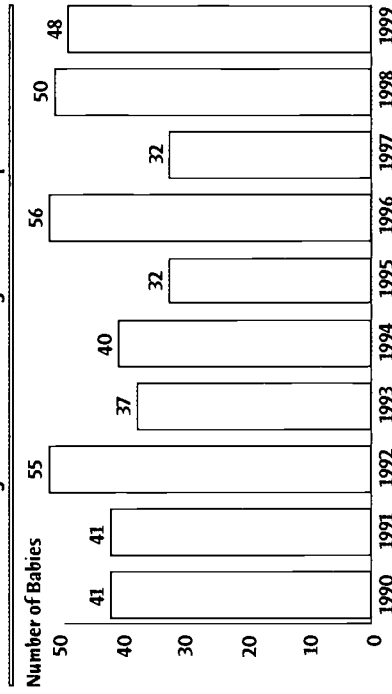

DATA YEAR DEFINITIONS

- SFY - State Fiscal Year: July 1-June 30
- SY - School Year: From the start of the school term in the fall through the end of the summer
- FFY - Federal Fiscal Year: October 1-September 30
- CY - Calendar Year: January 1 - December 31

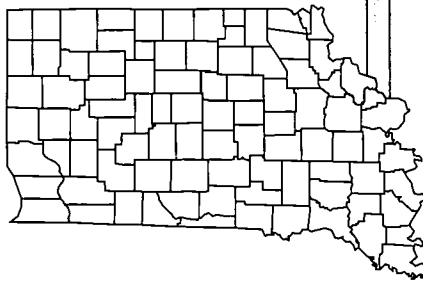

Hancock County

Kids Count in
Indiana 2001



Economic Well-being

	Current Year	Base Year
% of Children in Poverty, Age 0-17 (CY)	1997 6.7	1990 5.6
Per Capita Income (CY)	1999 \$29,269	1990 \$19,057
Unemployment Rate (CY)	2000 2.1	1990 3.2
Monthly Average of Families Receiving TANF (SFY)	2000 60	1990 129
Monthly Average of Persons Issued Food Stamps (SFY)	2000 959	1990 1,069
% of Students Receiving Free Lunches / Text Books (SY)	2001 6.6	1991 5.8

Early Childhood

# of First Steps Children Served (FFY)	2000 204	1998 115
# of Licensed Child Care Centers (SFY)	2000 5	1990 4
# of Licensed Child Care Homes (SFY)	2000 24	1990 12
# of Registered Child Care Ministries (SFY)	2000 2	1993 0
# of Licensed Child Care Slots per 100 Children, Age 0-4 (SFY)	2000 17.2	1996 13.2

Child Protection

# of Reported Cases of Child Abuse Processed by CPS (SFY)	2000 98	1990 217
% of Child Abuse Cases Substantiated by CPS (SFY)	2000 54.0	1990 49.8
# of Reported Cases of Child Neglect Processed by CPS (SFY)	2000 117	1990 236
% of Child Neglect Cases Substantiated by CPS (SFY)	2000 44.0	1990 53.0
# of Child Physical Abuse Cases Substantiated by CPS (SFY)	2000 21	1990 28
# of Child Sexual Abuse Cases Substantiated by CPS (SFY)	2000 32	1990 45
Child Abuse and Neglect Rate (SFY)	2000 7.2	1990 31.4
# of Child Abuse and Neglect Deaths (SFY)	2000 0	1990 0
# of Juvenile CHINS Case Filings (CY)	2000 18	1990 11

Racial/Ethnic Characteristics of Children Age 0-17 in Hancock County

One Race (Non-Hispanic Origin)	Percentage
White	97.0%
Black	0.2%
American Indian or Alaska Native	0.2%
Asian	0.3%
Native Hawaiian or Other Pacific Islander	0.0%
Some Other Race	0.1%
Two or More Races (Non-Hispanic Origin)	0.9%
Hispanic Origin*	1.3%

*Hispanic children may be of any race.

Number of Children Under the Age of 20 1990 & 2000

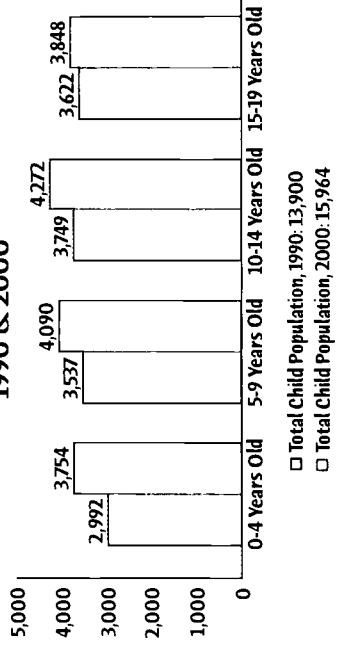

Health & Well-being

	Current Year	Base Year
% of Live Births (CY)	1999 703	1990 602
% of Low Birthweight Babies (CY)	1999 6.1	1990 4.3
% of Mothers who Received 1st Trimester Prenatal Care (CY)	1999 89.2	1990 89.8
% of Mothers who Smoked During Pregnancy (CY)	1999 16.8	1990 23.3
Non Marital Births as a % of All Births (CY)	1999 20.6	1990 13.6
Teen Birth Rate, Age 15-17 (CY)	1999 9.6	1990 18.1
Total # of Infant Deaths (CY)	1999 4	1990 12
Total # of Child Deaths, Age 1-14 (CY)	1999 2	1990 3
Total # of Teen Deaths by Accident, Homicide and Suicide (CY)	1999 2	1990 3
# of Children Enrolled in Hoosier Healthwise (SFY)	2000 1,449	1998 713
% Noncompliance with Youth Tobacco Access Laws (CY)	2000 30.0	1997 26.3

Education, Grades K-12

Public School Enrollment, K-12 (SY)	2000 10,037	1990 8,478
Non-Public School Enrollment (SY)	2001 454	1995 327
# of Home Schooled Children (SY)	2000 125	1990 0
# of Alternative School Participants (SY)	2001 32	1990 0
Total Per Pupil Expenditure (SY)	2000 \$6,247	1990 \$3,691
% of 10th Graders Passing the GQE Math Standard (SY)	2000 69.0	2000 69.0
% of 10th Graders Passing the GQE Language Standard (SY)	2000 78.0	2000 78.0
% of Graduates Passing the GQE (SY)	2000 97.8	2000 97.8
# of Public High School Graduates (SY)	2000 677	1990 754
% of High School Graduates (SY)	2000 93.7	1990 88.7
% of Freshman Class Graduating in 4 Years (SY)	2000 83.4	1990 90.8
% of Grads Intending 4-year College (SY)	2000 65.1	1990 34.4
% of Grads Intending Vocational/Tech School (SY)	2000 2.4	1990 7.5
# of Public School Student Dropouts (SY)	2000 51	1990 92
# of Expulsions and Suspensions (SY)	1999 1,479	1999 1,479

Juveniles and the Law

# of Juveniles Committed to the Dept. of Correction (CY)	2000 13	1994 2
# of Juvenile Status Case Filings (CY)	2000 3	1990 1
# of Juvenile Delinquency Case Filings (CY)	2000 99	1990 8

Percent of Households with Children Under 18 Headed by Parents and Others, Census 2000

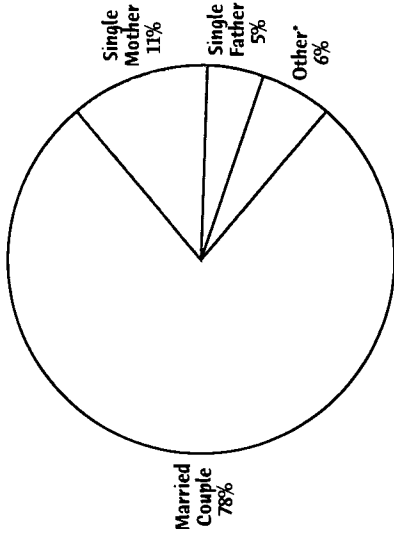

*"Other" includes households with children unrelated to the householder(s) and households with no adults present.

Number of Babies Born to Single Mothers Under Age 20 without a High School Diploma

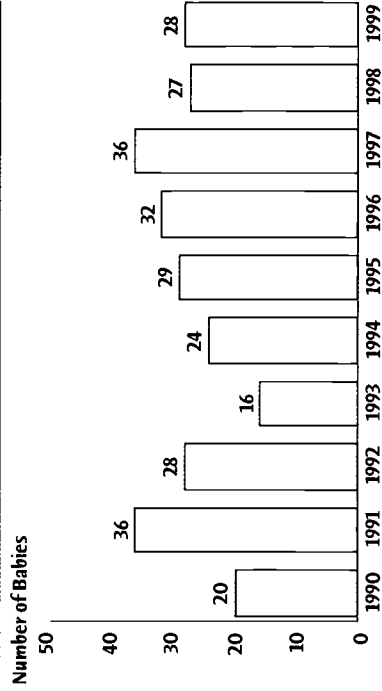

DATA YEAR DEFINITIONS

- SFY - State Fiscal Year: July 1-June 30
- SY - School Year: From the start of the school term in the fall through the end of the summer
- FFY - Federal Fiscal Year: October 1-September 30
- CY - Calendar Year: January 1 - December 31

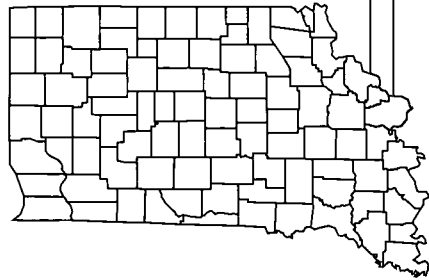

Harrison County

Kids Count in Indiana 2001



Economic Well-being

	Current Year	Base Year
% of Children in Poverty, Age 0-17 (CY)	1997 13.1	1990 12.6
Per Capita Income (CY)	1999 \$23,459	1990 \$14,804
Unemployment Rate (CY)	2000 2.9	1990 5.4
Monthly Average of Families Receiving TANF (SFY)	2000 118	1990 191
Monthly Average of Persons Issued Food Stamps (SFY)	2000 1,275	1990 1,911
% of Students Receiving Free Lunches / Text Books (SY)	2001 14.8	1991 17.6

Early Childhood

# of First Steps Children Served (FFY)	2000 127	1998 80
# of Licensed Child Care Centers (SFY)	2000 1	1990 2
# of Licensed Child Care Homes (SFY)	2000 27	1990 18
# of Registered Child Care Ministries (SFY)	2000 4	1993 1
# of Licensed Child Care Slots per 100 Children, Age 0-4 (SFY)	2000 21	1996 19

Child Protection

# of Reported Cases of Child Abuse Processed by CPS (SFY)	2000 89	1990 100
% of Child Abuse Cases Substantiated by CPS (SFY)	2000 48.0	1990 47.0
# of Reported Cases of Child Neglect Processed by CPS (SFY)	2000 151	1990 108
% of Child Neglect Cases Substantiated by CPS (SFY)	2000 52.0	1990 38.9
# of Child Physical Abuse Cases Substantiated by CPS (SFY)	2000 26	1990 27
# of Child Sexual Abuse Cases Substantiated by CPS (SFY)	2000 17	1990 7
Child Abuse and Neglect Rate (SFY)	2000 12.5	1990 24.0
# of Child Abuse and Neglect Deaths (SFY)	2000 0	1990 0
# of Juvenile CHINS Case Filings (CY)	2000 32	1990 10

Racial/Ethnic Characteristics of Children Age 0-17 in Harrison County

One Race (Non-Hispanic Origin)	97.1%
White	0.3%
Black	0.3%
American Indian or Alaska Native	0.3%
Asian	0.0%
Native Hawaiian or Other Pacific Islander	0.0%
Some Other Race	0.9%
Two or More Races (Non-Hispanic Origin)	1.1%
Hispanic Origin*	

*Hispanic children may be of any race.

Number of Children Under the Age of 20 1990 & 2000

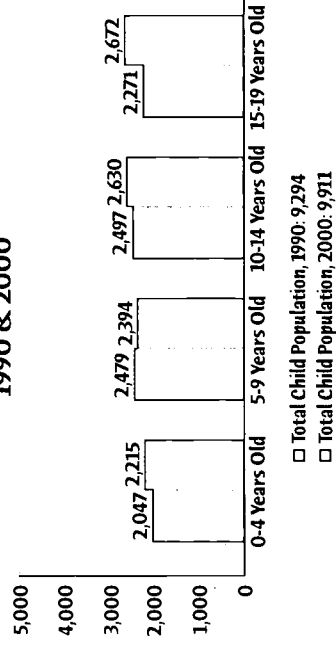

Health & Well-being

	Current Year	Base Year
% of Live Births (CY)	1999 447	1990 433
% of Low Birthweight Babies (CY)	1999 8.1	1990 6.7
% of Mothers who Received 1st Trimester Prenatal Care (CY)	1999 87.5	1990 86.5
% of Mothers who Smoked During Pregnancy (CY)	1999 23.5	1990 29.8
Non Marital Births as a % of All Births (CY)	1999 26.6	1990 17.3
Teen Birth Rate, Age 15-17 (CY)	1999 16.7	1990 21.7
Total # of Infant Deaths (CY)	1999 0	1990 3
Total # of Child Deaths, Age 1-14 (CY)	1999 1	1990 0
Total # of Teen Deaths by Accident, Homicide and Suicide (CY)	1999 1	1990 1
# of Children Enrolled in Hoosier Healthwise (SFY)	2000 1,720	1998 1,130
% Noncompliance with Youth Tobacco Access Laws (CY)	2000 0	1997 N/A

Education, Grades K-12

Public School Enrollment, K-12 (SY)	2000 6,092	1990 4,947
Non-Public School Enrollment (SY)	2001 582	1995 278
# of Home Schooled Children (SY)	2000 161	1990 15
# of Alternative School Participants (SY)	2001 45	1990 0
Total Per Pupil Expenditure (\$)	2000 \$6,086	1990 \$3,499
% of 10th Graders Passing the GQE Math Standard (SY)	2000 63.0	2000 63.0
% of 10th Graders Passing the GQE Language Standard (SY)	2000 70.0	2000 70.0
% of Graduates Passing the GQE (SY)	2000 93.4	2000 93.4
# of Public High School Graduates (SY)	2000 422	1990 410
% of High School Graduates (SY)	2000 89.2	1990 80.4
% of Freshman Class Graduating in 4 Years (SY)	2000 75.1	1990 81.8
% of Grads Intending 4-year College (SY)	2000 56.2	1990 51.0
% of Grads Intending Vocational/Tech School (SY)	2000 6.9	1990 8.2
# of Public School Student Dropouts (SY)	2000 55	1990 83
# of Expulsions and Suspensions (SY)	1999 1,223	1999 1,223

Juveniles and the Law

# of Juveniles Committed to the Dept. of Correction (CY)	2000 11	1994 2
# of Juvenile Status Case Filings (CY)	2000 159	1990 1
# of Juvenile Delinquency Case Filings (CY)	2000 240	1990 29

000000 136171

Percent of Households with Children Under 18 Headed by Parents and Others, Census 2000

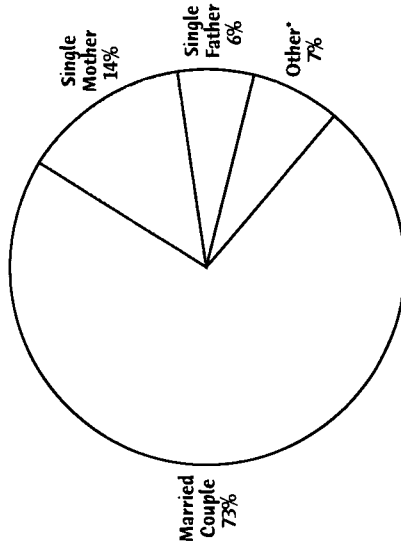

*"Other" includes households with children unrelated to the householder(s) and households with no adults present.

Number of Babies Born to Single Mothers Under Age 20 without a High School Diploma

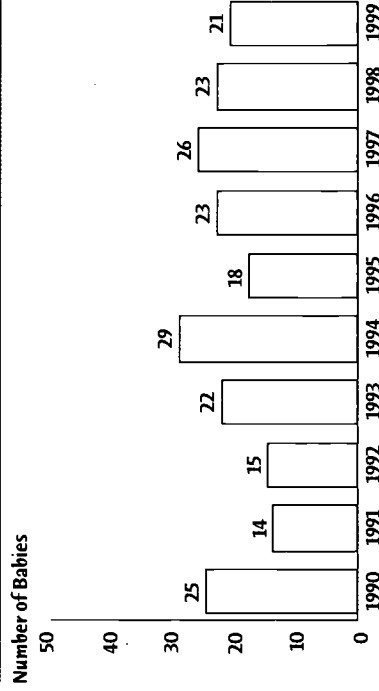

DATA YEAR DEFINITIONS

- SFY - State Fiscal Year: July 1-June 30
- SY - School Year: From the start of the school term in the fall through the end of the summer
- FFY - Federal Fiscal Year: October 1-September 30
- CY - Calendar Year: January 1 - December 31

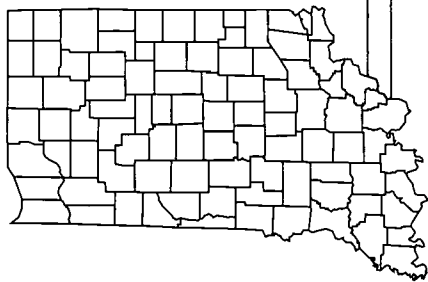

Hendricks County

Kids Count in
Indiana 2001



Economic Well-being

	Current Year	Base Year
% of Children in Poverty, Age 0-17 (CY)	1997 6.4	1990 4.2
Per Capita Income (CY)	1999 \$29,200	1990 \$19,278
Unemployment Rate (CY)	2000 1.7	1990 2.4
Monthly Average of Families Receiving TANF (SFY)	2000 66	1990 121
Monthly Average of Persons Issued Food Stamps (SFY)	2000 1,125	1990 845
% of Students Receiving Free Lunches / Text Books (SY)	2001 5.4	1991 4.9

Early Childhood

# of First Steps Children Served (FFY)	2000 314	1998 167
# of Licensed Child Care Centers (SFY)	2000 16	1990 10
# of Licensed Child Care Homes (SFY)	2000 46	1990 33
# of Registered Child Care Ministries (SFY)	2000 4	1993 4
# of Licensed Child Care Slots per 100 Children, Age 0-4 (SFY)	2000 31.6	1996 27.5

Child Protection

# of Reported Cases of Child Abuse Processed by CPS (SFY)	2000 127	1990 312
% of Child Abuse Cases Substantiated by CPS (SFY)	2000 67.0	1990 59.3
# of Reported Cases of Child Neglect Processed by CPS (SFY)	2000 138	1990 288
% of Child Neglect Cases Substantiated by CPS (SFY)	2000 63.0	1990 43.1
# of Child Physical Abuse Cases Substantiated by CPS (SFY)	2000 34	1990 23
# of Child Sexual Abuse Cases Substantiated by CPS (SFY)	2000 51	1990 77
Child Abuse and Neglect Rate (SFY)	2000 6.5	1990 26.6
# of Child Abuse and Neglect Deaths (SFY)	2000 0	1990 1
# of Juvenile CHINS Case Filings (CY)	2000 11	1990 20

Racial/Ethnic Characteristics of Children Age 0-17 in Hendricks County

One Race (Non-Hispanic Origin)	Percentage
White	95.3%
Black	0.8%
American Indian or Alaska Native	0.2%
Asian	0.7%
Native Hawaiian or Other Pacific Islander	0.0%
Some Other Race	0.2%
Two or More Races (Non-Hispanic Origin)	1.3%
Hispanic Origin*	1.6%

*Hispanic children may be of any race.

Number of Children Under the Age of 20 1990 & 2000

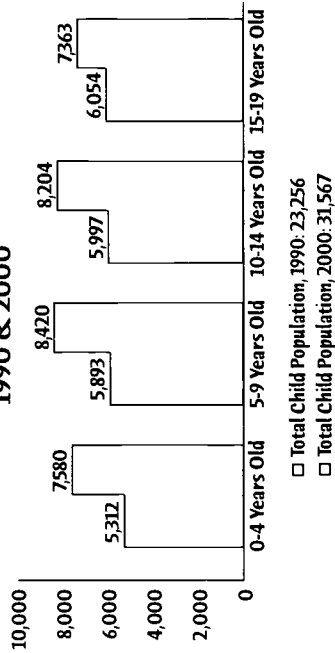

000000 136172

Health & Well-being

	Current Year	Base Year
Total # of Live Births (CY)	1999 1,262	1990 1,056
% of Low Birthweight Babies (CY)	1999 5.4	1990 4.8
% of Mothers who Received 1st Trimester Prenatal Care (CY)	1999 88.6	1990 85.2
% of Mothers who Smoked During Pregnancy (CY)	1999 12.5	1990 22.3
Non Marital Births as a % of All Births (CY)	1999 18.8	1990 11.8
Teen Birth Rate, Age 15-17 (CY)	1999 15.2	1990 19.7
Total # of Infant Deaths (CY)	1999 2	1990 6
Total # of Child Deaths, Age 1-14 (CY)	1999 5	1990 2
Total # of Teen Deaths by Accident, Homicide and Suicide (CY)	1999 8	1990 6
# of Children Enrolled in Hoosier Healthwise (SFY)	2000 1,793	1998 1,006
% Noncompliance with Youth Tobacco Access Laws (CY)	2000 10.0	1997 13.6

Percent of Households with Children Under 18 Headed by Parents and Others, Census 2000

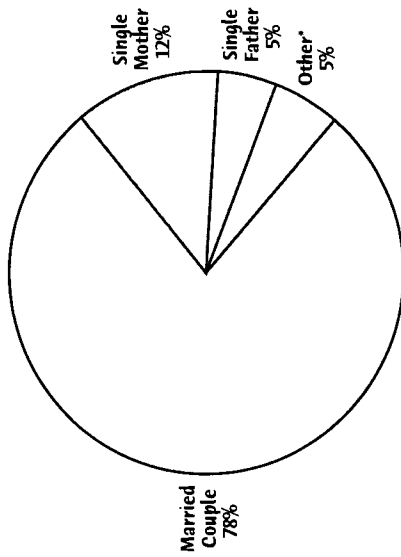

*"Other" includes households with children unrelated to the householder(s) and households with no adults present.

Education, Grades K-12

Public School Enrollment, K-12 (SY)	2000 18,363	1990 13,235
Non-Public School Enrollment (SY)	2001 2,055	1995 1,614
# of Home Schooled Children (SY)	2000 228	1990 16
# of Alternative School Participants (SY)	2001 314	1990 0
Total Per Pupil Expenditure (SY)	2000 \$5,692	1990 \$3,724
% of 10th Graders Passing the GOE Math Standard (SY)	2000 77.0	2000 77.0
% of 10th Graders Passing the GOE Language Standard (SY)	2000 82.0	2000 82.0
% of Graduates Passing the GOE (SY)	2000 98.2	2000 98.2
# of Public High School Graduates (SY)	2000 1,178	1990 1,079
% of High School Graduates (SY)	2000 94.3	1990 83.4
% of Freshman Class Graduating in 4 Years (SY)	2000 82.8	1990 86.0
% of Grads Intending 4-year College (SY)	2000 63.3	1990 36.3
% of Grads Intending Vocational/Tech School (SY)	2000 7.6	1990 5.6
# of Public School Student Dropouts (SY)	2000 77	1990 209
# of Expulsions and Suspensions (SY)	1999 1,804	1999 1,804

Juveniles and the Law

# of Juveniles Committed to the Dept. of Correction (CY)	2000 26	1994 10
# of Juvenile Status Case Filings (CY)	2000 180	1990 0
# of Juvenile Delinquency Case Filings (CY)	2000 413	1990 328

Number of Babies Born to Single Mothers Under Age 20 without a High School Diploma

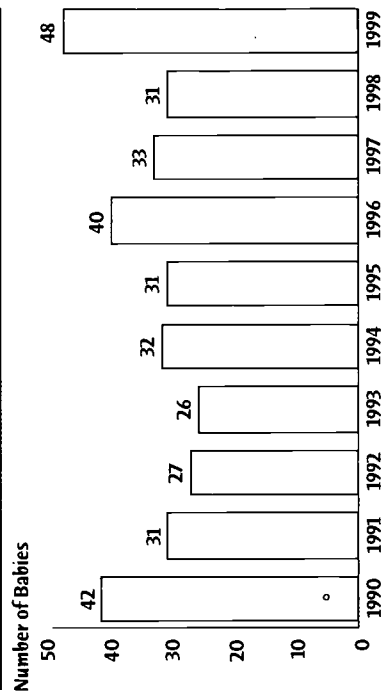

DATA YEAR DEFINITIONS

- SFY - State Fiscal Year: July 1-June 30
- SY - School Year: From the start of the school term in the fall through the end of the summer
- FFY - Federal Fiscal Year: October 1-September 30
- CY - Calendar Year: January 1 - December 31

231

230

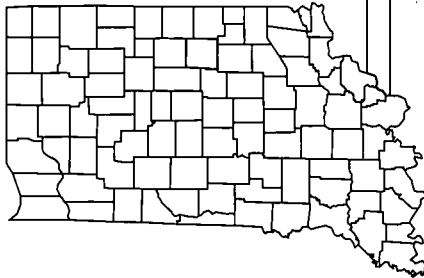

Henry County

Kids Count in Indiana 2001



Economic Well-being

	Current Year	Base Year
% of Children in Poverty, Age 0-17 (CY)	1997 15.4	1990 17.3
Per Capita Income (CY)	1999 \$23,773	1990 \$15,904
Unemployment Rate (CY)	2000 4.1	1990 9.3
Monthly Average of Families Receiving TANF (SFY)	2000 199	1990 491
Monthly Average of Persons Issued Food Stamps (SFY)	2000 2,748	1990 2,998
% of Students Receiving Free Lunches / Text Books (SY)	2001 18.9	1991 18.8

Early Childhood

# of First Steps Children Served (FFY)	2000 123	1998 82
# of Licensed Child Care Centers (SFY)	2000 2	1990 4
# of Licensed Child Care Homes (SFY)	2000 29	1990 14
# of Registered Child Care Ministries (SFY)	2000 3	1993 1
# of Licensed Child Care Slots per 100 Children, Age 0-4 (SFY)	2000 16.7	1996 18.5

Child Protection

# of Reported Cases of Child Abuse Processed by CPS (SFY)	2000 96	1990 160
% of Child Abuse Cases Substantiated by CPS (SFY)	2000 59.0	1990 63.1
# of Reported Cases of Child Neglect Processed by CPS (SFY)	2000 201	1990 308
% of Child Neglect Cases Substantiated by CPS (SFY)	2000 64.0	1990 58.4
# of Child Physical Abuse Cases Substantiated by CPS (SFY)	2000 26	1990 30
# of Child Sexual Abuse Cases Substantiated by CPS (SFY)	2000 31	1990 16
Child Abuse and Neglect Rate (SFY)	2000 16.2	1990 29.0
# of Child Abuse and Neglect Deaths (SFY)	2000 0	1990 0
# of Juvenile CHINS Case Filings (CY)	2000 43	1990 33

Racial/Ethnic Characteristics of Children Age 0-17 in Henry County

One Race (Non-Hispanic Origin)	96.4%
White	1.0%
Black	0.1%
American Indian or Alaska Native	0.2%
Asian	0.0%
Native Hawaiian or Other Pacific Islander	0.2%
Some Other Race	0.9%
Two or More Races (Non-Hispanic Origin)	1.2%
Hispanic Origin*	

*Hispanic children may be of any race.

Number of Children Under the Age of 20 1990 & 2000

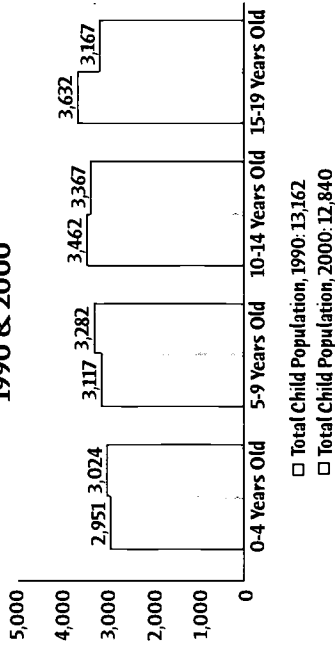

000000 136173

Health & Well-being

	Current Year	Base Year
Total # of Live Births (CY)	1999 609	1990 625
% of Low Birthweight Babies (CY)	1999 7.6	1990 6.4
% of Mothers who Received 1st Trimester Prenatal Care (CY)	1999 87.4	1990 86.5
% of Mothers who Smoked During Pregnancy (CY)	1999 26.8	1990 27.5
Non Marital Births as a % of All Births (CY)	1999 27.8	1990 17.9
Teen Birth Rate, Age 15-17 (CY)	1999 10.4	1990 17.9
Total # of Infant Deaths (CY)	1999 4	1990 4
Total # of Child Deaths, Age 1-14 (CY)	1999 3	1990 2
Total # of Teen Deaths by Accident, Homicide and Suicide (CY)	1999 0	1990 4
# of Children Enrolled in Hoosier Healthwise (SFY)	2000 2,719	1998 1,695
% Noncompliance with Youth Tobacco Access Laws (CY)	2000 40.0	1997 34.6

Percent of Households with Children Under 18 Headed by Parents and Others, Census 2000

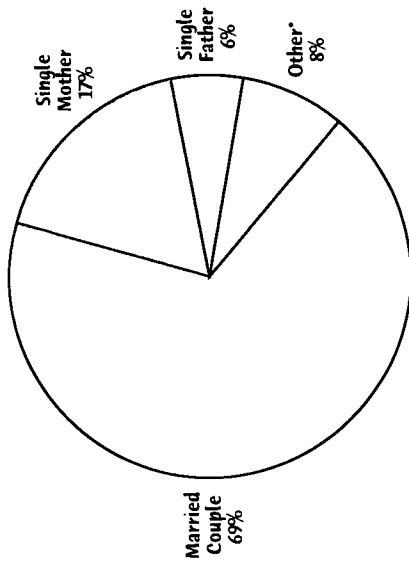

* "Other" includes households with children unrelated to the householder(s) and households with no adults present.

Education, Grades K-12

Public School Enrollment, K-12 (SY)	2000 8,491	1990 7,632
Non-Public School Enrollment (SY)	2001 69	1995 262
# of Home Schooled Children (SY)	2000 119	1990 11
# of Alternative School Participants (SY)	2001 447	1990 0
Total Per Pupil Expenditure (SY)	2000 \$7,325	1990 \$4,461
% of 10th Graders Passing the GQE Math Standard (SY)	2000 57.0	2000 57.0
% of 10th Graders Passing the GQE Language Standard (SY)	2000 69.0	2000 69.0
% of Graduates Passing the GQE (SY)	2000 93.5	2000 93.5
# of Public High School Graduates (SY)	2000 523	1990 699
% of High School Graduates (SY)	2000 90.4	1990 86.8
% of Freshman Class Graduating in 4 Years (SY)	2000 74.5	1990 85.5
% of Grads Intending 4-year College (SY)	2000 51.4	1990 44.2
% of Grads Intending Vocational/Tech School (SY)	2000 9.4	1990 8.4
# of Public School Student Dropouts (SY)	2000 68	1990 140
# of Expulsions and Suspensions (SY)	1999 1,693	1999 1,693

Juveniles and the Law

# of Juveniles Committed to the Dept. of Correction (CY)	2000 2	1994 5
# of Juvenile Status Case Filings (CY)	2000 9	1990 0
# of Juvenile Delinquency Case Filings (CY)	2000 64	1990 95

Number of Babies Born to Single Mothers Under Age 20 without a High School Diploma

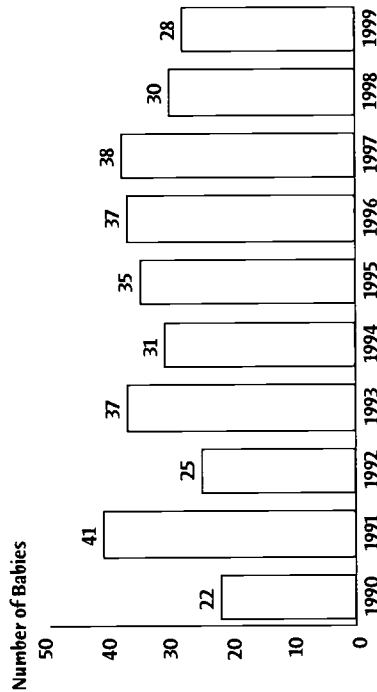

DATA YEAR DEFINITIONS

SFY – State Fiscal Year: July 1-June 30

SY – School Year: From the start of the school term in the fall through the end of the summer

FFY – Federal Fiscal Year: October 1-September 30

CY – Calendar Year: January 1 – December 31



2001



Howard County

Kids Count in Indiana 2001



Economic Well-being

	Current Year	Base Year
% of Children in Poverty, Age 0-17 (CY)	1997 15.1	1990 17.0
Per Capita Income (CY)	1999 \$27,623	1990 \$18,659
Unemployment Rate (CY)	2000 3.3	1990 7.3
Monthly Average of Families Receiving TANF (SFY)	2000 426	1990 1,026
Monthly Average of Persons Issued Food Stamps (SFY)	2000 4,374	1990 5,316
% of Students Receiving Free Lunches / Text Books (SY)	2001 24.0	1991 18.8

Early Childhood

# of First Steps Children Served (FFY)	2000 228	1998 149
# of Licensed Child Care Centers (SFY)	2000 10	1990 9
# of Licensed Child Care Homes (SFY)	2000 25	1990 6
# of Registered Child Care Ministries (SFY)	2000 12	1993 5
# of Licensed Child Care Slots per 100 Children, Age 0-4 (SFY)	2000 20.5	1996 21.1

Child Protection

# of Reported Cases of Child Abuse Processed by CPS (SFY)	2000 334	1990 493
% of Child Abuse Cases Substantiated by CPS (SFY)	2000 59.0	1990 57.8
# of Reported Cases of Child Neglect Processed by CPS (SFY)	2000 403	1990 724
% of Child Neglect Cases Substantiated by CPS (SFY)	2000 60.0	1990 64.0
# of Child Physical Abuse Cases Substantiated by CPS (SFY)	2000 86	1990 47
# of Child Sexual Abuse Cases Substantiated by CPS (SFY)	2000 112	1990 54
Child Abuse and Neglect Rate (SFY)	2000 20.5	1990 44.9
# of Child Abuse and Neglect Deaths (SFY)	2000 2	1990 1
# of Juvenile CHINS Case Filings (CY)	2000 67	1990 40

Racial/Ethnic Characteristics of Children Age 0-17 in Howard County

One Race (Non-Hispanic Origin)	83.9%
White	8.4%
Black	0.3%
American Indian or Alaska Native	1.0%
Asian	0.0%
Native Hawaiian or Other Pacific Islander	0.4%
Some Other Race	2.8%
Two or More Races (Non-Hispanic Origin)	3.1%
Hispanic Origin*	

*Hispanic children may be of any race.

Number of Children Under the Age of 20 1990 & 2000

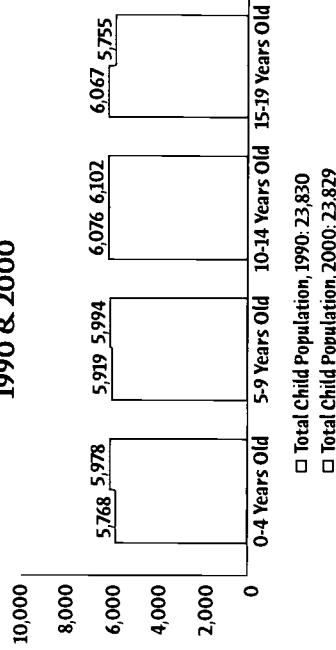

237

236

000000 136174

Health & Well-being

	Current Year	Base Year
Total # of Live Births (CY)	1999 1,249	1990 1,265
% of Low Birthweight Babies (CY)	1999 6.8	1990 7.3
% of Mothers who Received 1st Trimester Prenatal Care (CY)	1999 76.2	1990 78.1
% of Mothers who Smoked During Pregnancy (CY)	1999 18.9	1990 26.2
Non Marital Births as a % of All Births (CY)	1999 36.3	1990 28.4
Teen Birth Rate, Age 15-17 (CY)	1999 29.9	1990 42.4
Total # of Infant Deaths (CY)	1999 6	1990 16
Total # of Child Deaths, Age 1-14 (CY)	1999 4	1990 6
Total # of Teen Deaths by Accident, Homicide and Suicide (CY)	1999 2	1990 4
# of Children Enrolled in Hoosier Healthwise (SFY)	2000 4,763	1998 3,004
% Noncompliance with Youth Tobacco Access Laws (CY)	2000 20.0	1997 10.5

Percent of Households with Children Under 18 Headed by Parents and Others, Census 2000

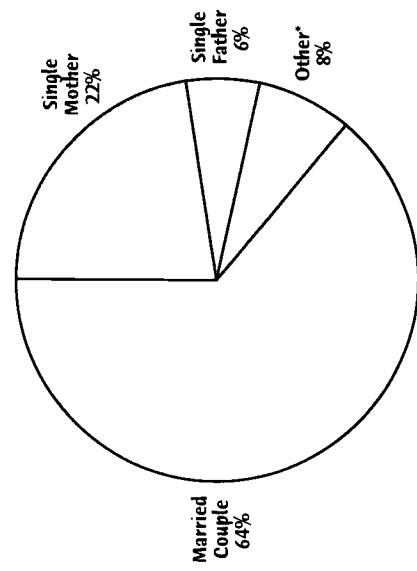

* "Other" includes households with children unrelated to the householder(s) and households with no adults present.

Education, Grades K-12

Public School Enrollment, K-12 (SY)	2000 13,853	1990 11,984
Non-Public School Enrollment (SY)	2001 1,361	1995 1,169
# of Home Schooled Children (SY)	2000 178	1990 4
# of Alternative School Participants (SY)	2001 580	1990 0
Total Per Pupil Expenditure (SY)	2000 \$7,473	1990 \$4,530
% of 10th Graders Passing the GQE Math Standard (SY)	2000 68.0	2000 68.0
% of 10th Graders Passing the GQE Language Standard (SY)	2000 74.0	2000 74.0
% of Graduates Passing the GQE (SY)	2000 95.6	2000 95.6
# of Public High School Graduates (SY)	2000 791	1990 1,239
% of High School Graduates (SY)	2000 96.1	1990 87.8
% of Freshman Class Graduating in 4 Years (SY)	2000 70.1	1990 103.2
% of Grads Intending 4-year College (SY)	2000 64.4	1990 32.6
% of Grads Intending Vocational/Tech School (SY)	2000 8.9	1990 6.7
# of Public School Student Dropouts (SY)	2000 43	1990 147
# of Expulsions and Suspensions (SY)	1999 5,685	1999 5,685

Juveniles and the Law

# of Juveniles Committed to the Dept. of Correction (CY)	2000 16	1994 40
# of Juvenile Status Case Filings (CY)	2000 101	1990 74
# of Juvenile Delinquency Case Filings (CY)	2000 407	1990 124

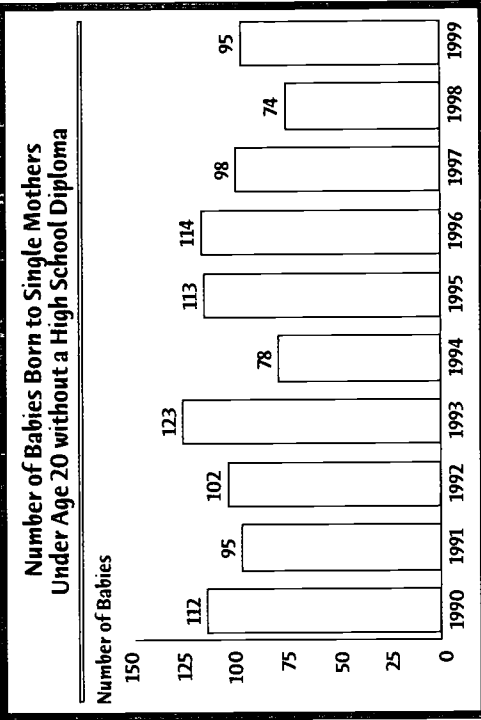

DATA YEAR DEFINITIONS

SFY - State Fiscal Year: July 1-June 30
 SY - School Year: From the start of the school term in the fall through the end of the summer
 FFY - Federal Fiscal Year: October 1-September 30
 CY - Calendar Year: January 1 - December 31

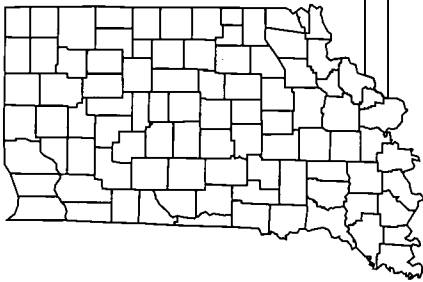

Huntington County

Kids Count in
Indiana 2001



Economic Well-being

	Current Year	Base Year
% of Children in Poverty, Age 0-17 (CY)	1997 10.2	1990 7.3
Per Capita Income (CY)	1999 \$24,185	1990 \$16,699
Unemployment Rate (CY)	2000 3.8	1990 5.2
Monthly Average of Families Receiving TANF (SFY)	2000 57	1990 130
Monthly Average of Persons Issued Food Stamps (SFY)	2000 1,038	1990 1,023
% of Students Receiving Free Lunches / Text Books (SY)	2001 11.6	1991 8.2

Early Childhood

# of First Steps Children Served (FFY)	2000 124	1998 88
# of Licensed Child Care Centers (SFY)	2000 2	1990 0
# of Licensed Child Care Homes (SFY)	2000 26	1990 26
# of Registered Child Care Ministries (SFY)	2000 4	1993 2
# of Licensed Child Care Slots per 100 Children, Age 0-4 (SFY)	2000 16.7	1996 14.4

Child Protection

# of Reported Cases of Child Abuse Processed by CPS (SFY)	2000 87	1990 182
% of Child Abuse Cases Substantiated by CPS (SFY)	2000 48.0	1990 48.9
# of Reported Cases of Child Neglect Processed by CPS (SFY)	2000 121	1990 198
% of Child Neglect Cases Substantiated by CPS (SFY)	2000 36.0	1990 35.9
# of Child Physical Abuse Cases Substantiated by CPS (SFY)	2000 14	1990 17
# of Child Sexual Abuse Cases Substantiated by CPS (SFY)	2000 28	1990 38
Child Abuse and Neglect Rate (SFY)	2000 8.5	1990 36.0
# of Child Abuse and Neglect Deaths (SFY)	2000 1	1990 0
# of Juvenile CHINS Case Filings (CY)	2000 16	1990 31

Racial/Ethnic Characteristics of Children Age 0-17 in Huntington County

One Race (Non-Hispanic Origin)	96.1%
White	0.3%
Black	0.6%
American Indian or Alaska Native	0.3%
Asian	0.0%
Native Hawaiian or Other Pacific Islander	0.1%
Some Other Race	1.1%
Two or More Races (Non-Hispanic Origin)	1.6%
Hispanic Origin*	

*Hispanic children may be of any race.

Number of Children Under the Age of 20 1990 & 2000

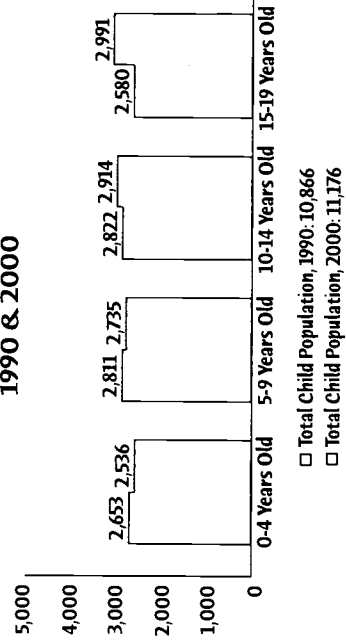

000000 136175

Health & Well-being

	Current Year	Base Year
Total # of Live Births (CY)	1999 526	1990 525
% of Low Birthweight Babies (CY)	1999 7.0	1990 6.7
% of Mothers who Received 1st Trimester Prenatal Care (CY)	1999 87.3	1990 80.0
% of Mothers who Smoked During Pregnancy (CY)	1999 25.5	1990 30.1
Non Marital Births as a % of All Births (CY)	1999 29.3	1990 20.4
Teen Birth Rate, Age 15-17 (CY)	1999 40.0	1990 30.4
Total # of Infant Deaths (CY)	1999 1	1990 3
Total # of Child Deaths, Age 1-14 (CY)	1999 2	1990 4
Total # of Teen Deaths by Accident, Homicide and Suicide (CY)	1999 2	1990 2
# of Children Enrolled in Hoosier Healthwise (SFY)	2000 1,524	1998 901
% Noncompliance with Youth Tobacco Access Laws (CY)	2000 N/A	1997 20.0

Percent of Households with Children Under 18 Headed by Parents and Others, Census 2000

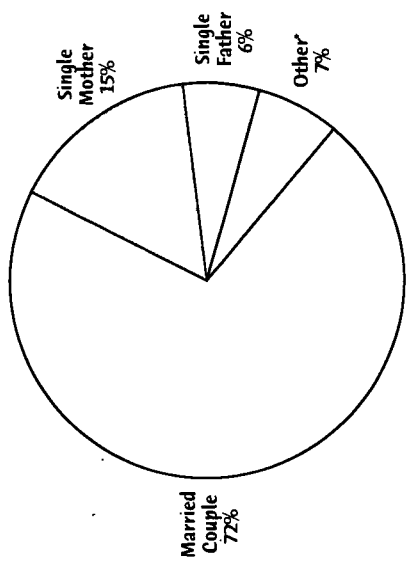

*'Other' includes households with children unrelated to the householder(s) and households with no adults present.

Education, Grades K-12

Public School Enrollment, K-12 (SY)	2000 6,548	1990 6,090
Non-Public School Enrollment (SY)	2001 307	1995 363
# of Home Schooled Children (SY)	2000 91	1990 17
# of Alternative School Participants (SY)	2001 27	1990 0
Total Per Pupil Expenditure (SY)	2000 \$6,134	1990 \$3,538
% of 10th Graders Passing the GQE Math Standard (SY)	2000 73.0	2000 73.0
% of 10th Graders Passing the GQE Language Standard (SY)	2000 73.0	2000 73.0
% of Graduates Passing the GQE (SY)	2000 96.2	2000 96.2
# of Public High School Graduates (SY)	2000 399	1990 474
% of High School Graduates (SY)	2000 90.4	1990 80.8
% of Freshman Class Graduating in 4 Years (SY)	2000 76.3	1990 90.5
% of Grads Intending 4-year College (SY)	2000 60.2	1990 38.4
% of Grads Intending Vocational/Tech School (SY)	2000 18.1	1990 4.8
# of Public School Student Dropouts (SY)	2000 50	1990 116
# of Expulsions and Suspensions (SY)	1999 1,776	1999 1,776

Juveniles and the Law

# of Juveniles Committed to the Dept. of Correction (CY)	2000 10	1994 6
# of Juvenile Status Case Filings (CY)	2000 0	1990 1
# of Juvenile Delinquency Case Filings (CY)	2000 141	1990 91

Number of Babies Born to Single Mothers Under Age 20 without a High School Diploma

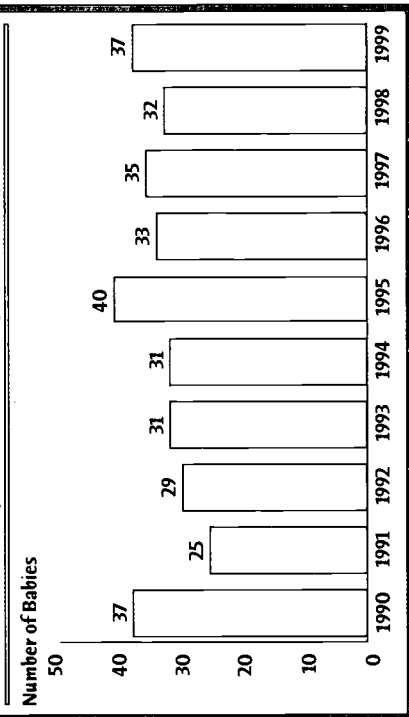

DATA YEAR DEFINITIONS

- SFY - State Fiscal Year: July 1-June 30
- SY - School Year: From the start of the school term in the fall through the end of the summer
- FFY - Federal Fiscal Year: October 1-September 30
- CY - Calendar Year: January 1 - December 31

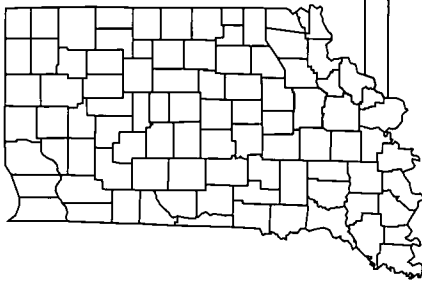

Jackson County

Kids Count in Indiana 2001



Economic Well-being

	Current Year	Base Year
% of Children in Poverty, Age 0-17 (CY)	1997 13.4	1990 13.5
Per Capita Income (CY)	1999 \$22,301	1990 \$14,878
Unemployment Rate (CY)	2000 2.7	1990 6.3
Monthly Average of Families Receiving TANF (SFY)	2000 90	1990 283
Monthly Average of Persons Issued Food Stamps (SFY)	2000 1,224	1990 1,966
% of Students Receiving Free Lunches / Text Books (SY)	2001 16.8	1991 16.3

Early Childhood

# of First Steps Children Served (FFY)	2000 116	1998 89
# of Licensed Child Care Centers (SFY)	2000 3	1990 3
# of Licensed Child Care Homes (SFY)	2000 44	1990 7
# of Registered Child Care Ministries (SFY)	2000 4	1993 3
# of Licensed Child Care Slots per 100 Children, Age 0-4 (SFY)	2000 21.3	1996 18

Child Protection

# of Reported Cases of Child Abuse Processed by CPS (SFY)	2000 133	1990 229
% of Child Abuse Cases Substantiated by CPS (SFY)	2000 53.0	1990 48.9
# of Reported Cases of Child Neglect Processed by CPS (SFY)	2000 234	1990 371
% of Child Neglect Cases Substantiated by CPS (SFY)	2000 39.0	1990 55.8
# of Child Physical Abuse Cases Substantiated by CPS (SFY)	2000 29	1990 15
# of Child Sexual Abuse Cases Substantiated by CPS (SFY)	2000 41	1990 21
Child Abuse and Neglect Rate (SFY)	2000 14.7	1990 54.4
# of Child Abuse and Neglect Deaths (SFY)	2000 1	1990 0
# of Juvenile CHINS Case Filings (CY)	2000 21	1990 72

Racial/Ethnic Characteristics of Children Age 0-17 in Jackson County

One Race (Non-Hispanic Origin)	94.5%
White	0.7%
Black	0.3%
American Indian or Alaska Native	1.1%
Asian	0.1%
Native Hawaiian or Other Pacific Islander	0.1%
Some Other Race	1.0%
Two or More Races (Non-Hispanic Origin)	2.3%
Hispanic Origin*	

*Hispanic children may be of any race.

Number of Children Under the Age of 20 1990 & 2000

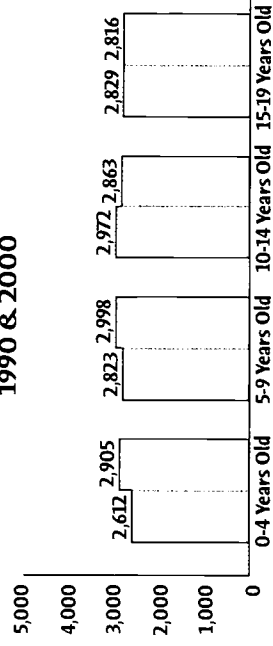

□ Total Child Population, 1990: 11,236
 □ Total Child Population, 2000: 11,582

248

000000 136176

Health & Well-being

Percent of Households with Children Under 18 Headed by Parents and Others, Census 2000

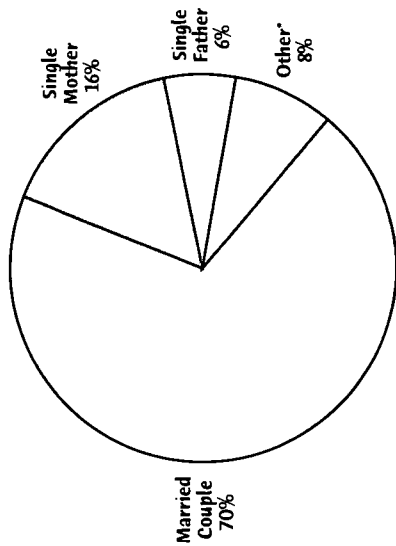

*"Other" includes households with children unrelated to the householder(s) and households with no adults present.

Number of Babies Born to Single Mothers Under Age 20 without a High School Diploma

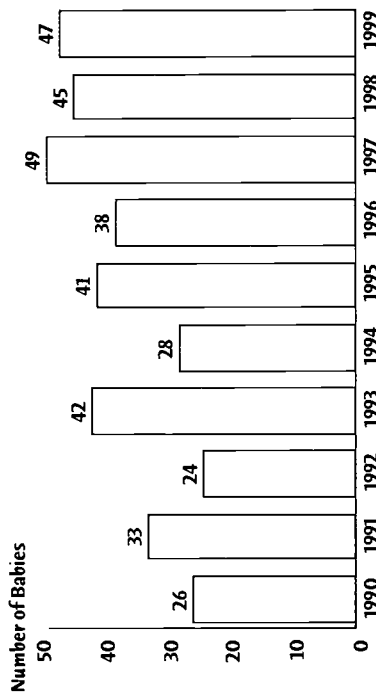

	Current Year	Base Year
total # of Live Births (CY)	1999 560	1990 524
% of Low Birthweight Babies (CY)	1999 8.0	1990 3.8
% of Mothers who Received 1st Trimester Prenatal Care (CY)	1999 78.9	1990 80.0
% of Mothers who Smoked During Pregnancy (CY)	1999 26.6	1990 27.9
Non Marital Births as a % of All Births (CY)	1999 27.5	1990 17.7
Teen Birth Rate, Age 15-17 (CY)	1999 36.7	1990 34.9
Total # of Infant Deaths (CY)	1999 5	1990 2
Total # of Child Deaths, Age 1-14 (CY)	1999 1	1990 1
Total # of Teen Deaths by Accident, Homicide and Suicide (CY)	1999 0	1990 3
# of Children Enrolled in Hoosier Healthwise (SFY)	2000 1,783	1998 1,067
% Noncompliance with Youth Tobacco Access Laws (CY)	2000 30.0	1997 N/A

Education, Grades K-12

Public School Enrollment, K-12 (SY)	2000 6,557	1990 5,968
Non-Public School Enrollment (SY)	2001 1,361	1995 790
# of Home Schooled Children (SY)	2000 104	1990 4
# of Alternative School Participants (SY)	2001 57	1990 0
Total Per Pupil Expenditure (SY)	2000 \$6,016	1990 \$3,578
% of 10th Graders Passing the GOE Math Standard (SY)	2000 65.0	2000 65.0
% of 10th Graders Passing the GOE Language Standard (SY)	2000 70.0	2000 70.0
% of Graduates Passing the GOE (SY)	2000 96.4	2000 96.4
# of Public High School Graduates (SY)	2000 393	1990 612
% of High School Graduates (SY)	2000 88.9	1990 79.5
% of Freshman Class Graduating in 4 Years (SY)	2000 61.8	1990 103.0
% of Grads Intending 4-year College (SY)	2000 48.1	1990 49.7
% of Grads Intending Vocational/Tech School (SY)	2000 2.3	1990 8.9
# of Public School Student Dropouts (SY)	2000 57	1990 126
# of Expulsions and Suspensions (SY)	1999 1,325	1999 1,325

Juveniles and the Law

# of Juveniles Committed to the Dept. of Correction (CY)	2000 6	1994 6
# of Juvenile Status Case Filings (CY)	2000 4	1990 5
# of Juvenile Delinquency Case Filings (CY)	2000 142	1990 184

DATA YEAR DEFINITIONS

SFY - State Fiscal Year: July 1-June 30

SY - School Year: From the start of the school term in the fall through the end of the summer

FFY - Federal Fiscal Year: October 1-September 30

CY - Calendar Year: January 1 - December 31

246543

247

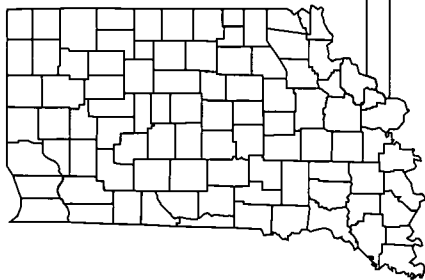

Jasper County

Kids Count in Indiana 2001



Economic Well-being

	Current Year	Base Year
% of Children in Poverty, Age 0-17 (CY)	1997 10.6	1990 10.1
Per Capita Income (CY)	1999 \$20,173	1990 \$15,054
Unemployment Rate (CY)	2000 4.1	1990 6.6
Monthly Average of Families Receiving TANF (SFY)	2000 60	1990 124
Monthly Average of Persons Issued Food Stamps (SFY)	2000 848	1990 1,085
% of Students Receiving Free Lunches / Text Books (SY)	2001 14.6	1991 12.8

Early Childhood

# of First Steps Children Served (FFY)	2000 62	1998 38
# of Licensed Child Care Centers (SFY)	2000 2	1990 0
# of Licensed Child Care Homes (SFY)	2000 16	1990 3
# of Registered Child Care Ministries (SFY)	2000 0	1993 0
# of Licensed Child Care Slots per 100 Children, Age 0-4 (SFY)	2000 13	1996 4.6

Child Protection

# of Reported Cases of Child Abuse Processed by CPS (SFY)	2000 78	1990 50
% of Child Abuse Cases Substantiated by CPS (SFY)	2000 50.0	1990 50.0
# of Reported Cases of Child Neglect Processed by CPS (SFY)	2000 93	1990 37
% of Child Neglect Cases Substantiated by CPS (SFY)	2000 56.0	1990 54.1
# of Child Physical Abuse Cases Substantiated by CPS (SFY)	2000 14	1990 7
# of Child Sexual Abuse Cases Substantiated by CPS (SFY)	2000 25	1990 6
Child Abuse and Neglect Rate (SFY)	2000 10.9	1990 10.3
# of Child Abuse and Neglect Deaths (SFY)	2000 0	1990 0
# of Juvenile CHINS Case Filings (CY)	2000 12	1990 13

Racial/Ethnic Characteristics of Children Age 0-17 in Jasper County

One Race (Non-Hispanic Origin)	94.6%
White	0.5%
Black	0.2%
American Indian or Alaska Native	0.2%
Asian	0.0%
Native Hawaiian or Other Pacific Islander	0.0%
Some Other Race	0.7%
Two or More Races (Non-Hispanic Origin)	3.7%
Hispanic Origin*	

*Hispanic children may be of any race.

Number of Children Under the Age of 20 1990 & 2000

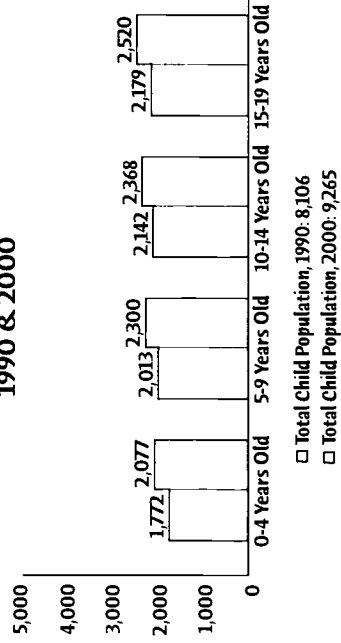

000000136177

Health & Well-being

	Current Year	Base Year
# of Live Births (CY)	1999 427	1990 379
% of Low Birthweight Babies (CY)	1999 6.6	1990 4.0
% of Mothers who Received 1st Trimester Prenatal Care (CY)	1999 84.8	1990 80.4
% of Mothers who Smoked During Pregnancy (CY)	1999 24.1	1990 29.0
Non Marital Births as a % of All Births (CY)	1999 28.8	1990 15.0
Teen Birth Rate, Age 15-17 (CY)	1999 20.8	1990 15.7
Total # of Infant Deaths (CY)	1999 0	1990 1
Total # of Child Deaths, Age 1-14 (CY)	1999 3	1990 6
Total # of Teen Deaths by Accident, Homicide and Suicide (CY)	1999 2	1990 2
# of Children Enrolled in Hoosier Healthwise (SFY)	2000 1,268	1998 748
% Noncompliance with Youth Tobacco Access Laws (CY)	2000 10.0	1997 N/A

Percent of Households with Children Under 18 Headed by Parents and Others, Census 2000

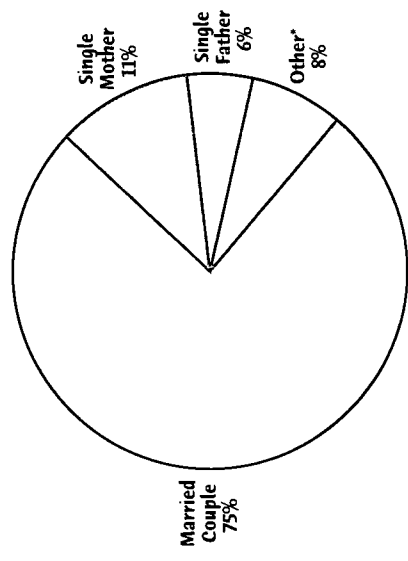

*"Other" includes households with children unrelated to the householder(s) and households with no adults present.

Education, Grades K-12

Public School Enrollment, K-12 (SY)	2000 4,892	1990 4,011
Non-Public School Enrollment (SY)	2001 537	1995 419
# of Home Schooled Children (SY)	2000 75	1990 3
# of Alternative School Participants (SY)	2001 46	1990 0
Total Per Pupil Expenditure (SY)	2000 \$5,955	1990 \$4,212
% of 10th Graders Passing the GQE Math Standard (SY)	2000 70.0	2000 70.0
% of 10th Graders Passing the GQE Language Standard (SY)	2000 75.0	2000 75.0
% of Graduates Passing the GQE (SY)	2000 95.1	2000 95.1
# of Public High School Graduates (SY)	2000 349	1990 304
% of High School Graduates (SY)	2000 90.9	1990 86.2
% of Freshman Class Graduating in 4 Years (SY)	2000 77.9	1990 83.3
% of Grads Intending 4-year College (SY)	2000 56.5	1990 28.2
% of Grads Intending Vocational/Tech School (SY)	2000 9.7	1990 8.3
# of Public School Student Dropouts (SY)	2000 40	1990 50
# of Expulsions and Suspensions (SY)	1999 871	1999 871

Juveniles and the Law

# of Juveniles Committed to the Dept. of Correction (CY)	2000 3	1994 5
# of Juvenile Status Case Filings (CY)	2000 6	1990 3
# of Juvenile Delinquency Case Filings (CY)	2000 49	1990 27

Number of Babies Born to Single Mothers Under Age 20 without a High School Diploma

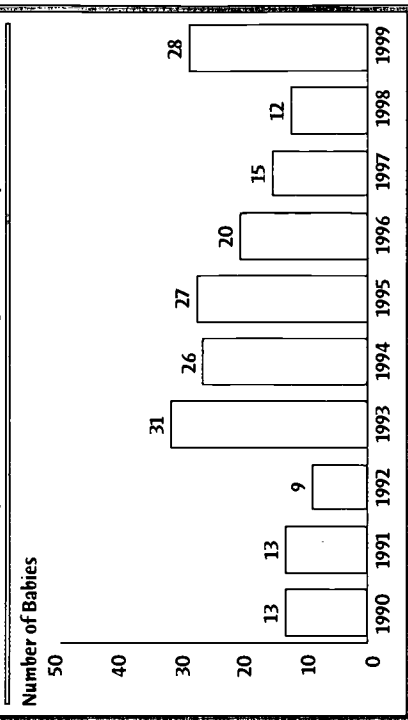

DATA YEAR DEFINITIONS

- SFY - State Fiscal Year: July 1-June 30
- SY - School Year: From the start of the school term in the fall through the end of the summer
- FFY - Federal Fiscal Year: October 1-September 30
- CY - Calendar Year: January 1 - December 31



Jay County

Kids Count in Indiana 2001



Economic Well-being

	Current Year	Base Year
% of Children in Poverty, Age 0-17 (CY)	1997 16.2	1990 11.9
Per Capita Income (CY)	1999 \$19,079	1990 \$13,505
Unemployment Rate (CY)	2000 3.9	1990 8.2
Monthly Average of Families Receiving TANF (SFY)	2000 36	1990 133
Monthly Average of Persons Issued Food Stamps (SFY)	2000 799	1990 1,341
% of Students Receiving Free Lunches / Text Books (SY)	2001 21.8	1991 18.7

Early Childhood

# of First Steps Children Served (FFY)	2000 77	1998 38
# of Licensed Child Care Centers (SFY)	2000 0	1990 2
# of Licensed Child Care Homes (SFY)	2000 24	1990 2
# of Registered Child Care Ministries (SFY)	2000 2	1993 0
# of Licensed Child Care Slots per 100 Children, Age 0-4 (SFY)	2000 18.1	1996 16

Child Protection

# of Reported Cases of Child Abuse Processed by CPS (SFY)	2000 34	1990 83
% of Child Abuse Cases Substantiated by CPS (SFY)	2000 24.0	1990 55.4
# of Reported Cases of Child Neglect Processed by CPS (SFY)	2000 49	1990 62
% of Child Neglect Cases Substantiated by CPS (SFY)	2000 27.0	1990 71.0
# of Child Physical Abuse Cases Substantiated by CPS (SFY)	2000 5	1990 8
# of Child Sexual Abuse Cases Substantiated by CPS (SFY)	2000 3	1990 8
Child Abuse and Neglect Rate (SFY)	2000 3.7	1990 20.4
# of Child Abuse and Neglect Deaths (SFY)	2000 0	1990 0
# of Juvenile CHINS Case Filings (CY)	2000 8	1990 35

Racial/Ethnic Characteristics of Children Age 0-17 in Jay County

One Race (Non-Hispanic Origin)	95.6%
White	0.5%
Black	0.1%
American Indian or Alaska Native	0.4%
Asian	0.1%
Native Hawaiian or Other Pacific Islander	0.0%
Some Other Race	0.7%
Two or More Races (Non-Hispanic Origin)	2.7%
Hispanic Origin*	

*Hispanic children may be of any race.

Number of Children Under the Age of 20 1990 & 2000

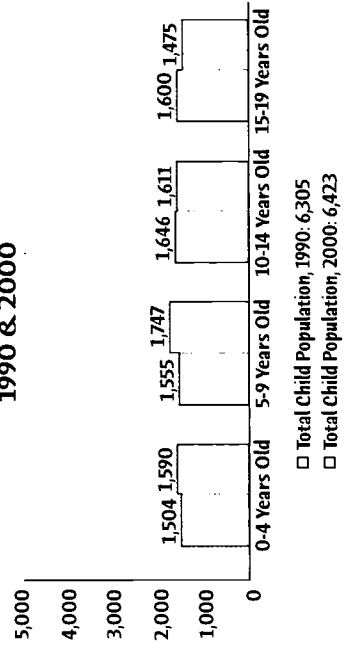

Health & Well-being

	Current Year	Base Year
% of Live Births (CY)	1999 331	1990 343
% of Low Birthweight Babies (CY)	1999 7.9	1990 4.4
% of Mothers who Received 1st Trimester Prenatal Care (CY)	1999 73.7	1990 77.5
% of Mothers who Smoked During Pregnancy (CY)	1999 17.2	1990 23.3
Non Marital Births as a % of All Births (CY)	1999 27.5	1990 20.7
Teen Birth Rate, Age 15-17 (CY)	1999 18.9	1990 36.1
Total # of Infant Deaths (CY)	1999 5	1990 1
Total # of Child Deaths, Age 1-14 (CY)	1999 1	1990 2
Total # of Teen Deaths by Accident, Homicide and Suicide (CY)	1999 2	1990 3
# of Children Enrolled in Hoosier Healthwise (SFY)	2000 1,218	1998 616
% Noncompliance with Youth Tobacco Access Laws (CY)	2000 N/A	1997 31.8

Education, Grades K-12

Public School Enrollment, K-12 (SY)	2000 3,916	1990 3,858
Non-Public School Enrollment (SY)	2001 0	1995 31
# of Home Schooled Children (SY)	2000 32	1990 4
# of Alternative School Participants (SY)	2001 25	1990 0
Total Per Pupil Expenditure (SY)	2000 \$6,362	1990 \$3,861
% of 10th Graders Passing the GQE Math Standard (SY)	2000 68.0	2000 68.0
% of 10th Graders Passing the GQE Language Standard (SY)	2000 68.0	2000 68.0
% of Graduates Passing the GQE (SY)	2000 82.9	2000 82.9
# of Public High School Graduates (SY)	2000 228	1990 295
% of High School Graduates (SY)	2000 91.7	1990 76.5
% of Freshman Class Graduating in 4 Years (SY)	2000 72.6	1990 86.5
% of Grads Intending 4-year College (SY)	2000 44.7	1990 42.9
% of Grads Intending Vocational/Tech School (SY)	2000 9.7	1990 8.2
# of Public School Student Dropouts (SY)	2000 23	1990 86
# of Expulsions and Suspensions (SY)	1999 604	1999 604

Juveniles and the Law

# of Juveniles Committed to the Dept. of Correction (CY)	2000 4	1994 2
# of Juvenile Status Case Filings (CY)	2000 19	1990 25
# of Juvenile Delinquency Case Filings (CY)	2000 45	1990 32

Percent of Households with Children Under 18 Headed by Parents and Others, Census 2000

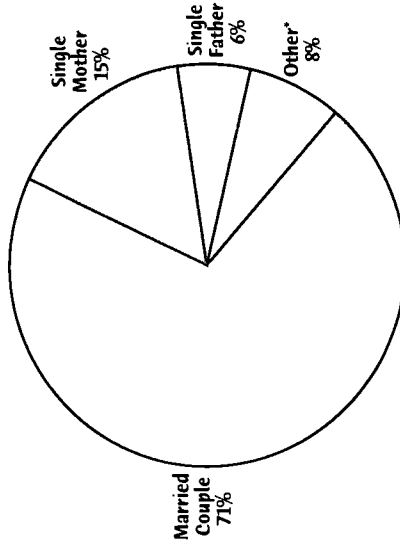

*"Other" includes households with children unrelated to the householder(s) and households with no adults present.

Number of Babies Born to Single Mothers Under Age 20 without a High School Diploma

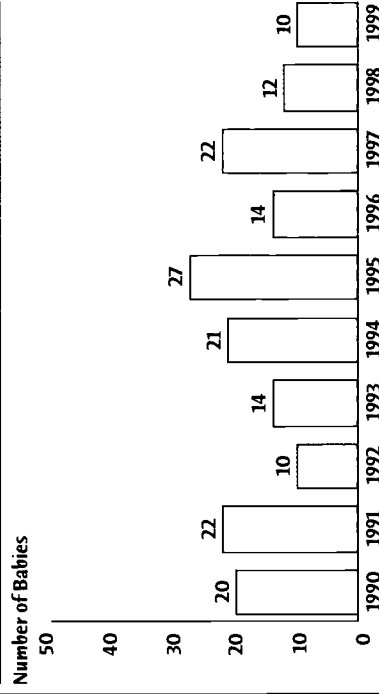

DATA YEAR DEFINITIONS

- SFY - State Fiscal Year: July 1-June 30
- SY - School Year: From the start of the school term in the fall through the end of the summer
- FFY - Federal Fiscal Year: October 1-September 30
- CY - Calendar Year: January 1 - December 31

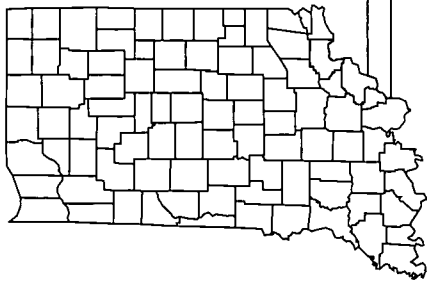

Jefferson County



Economic Well-being

	Current Year	Base Year
% of Children in Poverty, Age 0-17 (CY)	1997 17.6	1990 15.6
Per Capita Income (CY)	1999 \$20,207	1990 \$14,120
Unemployment Rate (CY)	2000 3.9	1990 6.9
Monthly Average of Families Receiving TANF (SFY)	2000 135	1990 297
Monthly Average of Persons Issued Food Stamps (SFY)	2000 1,535	1990 2,099
% of Students Receiving Free Lunches / Text Books (SY)	2001 22.8	1991 20.2

Early Childhood

# of First Steps Children Served (FFY)	2000 102	1998 86
# of Licensed Child Care Centers (SFY)	2000 3	1990 1
# of Licensed Child Care Homes (SFY)	2000 30	1990 8
# of Registered Child Care Ministries (SFY)	2000 4	1993 2
# of Licensed Child Care Slots per 100 Children, Age 0-4 (SFY)	2000 23.3	1996 18.1

Child Protection

# of Reported Cases of Child Abuse Processed by CPS (SFY)	2000 96	1990 132
% of Child Abuse Cases Substantiated by CPS (SFY)	2000 54.0	1990 57.6
# of Reported Cases of Child Neglect Processed by CPS (SFY)	2000 221	1990 135
% of Child Neglect Cases Substantiated by CPS (SFY)	2000 48.0	1990 42.2
# of Child Physical Abuse Cases Substantiated by CPS (SFY)	2000 25	1990 28
# of Child Sexual Abuse Cases Substantiated by CPS (SFY)	2000 27	1990 11
Child Abuse and Neglect Rate (SFY)	2000 20.4	1990 30.2
# of Child Abuse and Neglect Deaths (SFY)	2000 0	1990 0
# of Juvenile CHINS Case Filings (CY)	2000 192	1990 26

Racial/Ethnic Characteristics of Children Age 0-17 in Jefferson County

One Race (Non-Hispanic Origin)	Percentage
White	94.6%
Black	1.2%
American Indian or Alaska Native	0.1%
Asian	0.6%
Native Hawaiian or Other Pacific Islander	0.0%
Some Other Race	0.1%
Two or More Races (Non-Hispanic Origin)	1.7%
Hispanic Origin*	1.6%

*Hispanic children may be of any race.

Number of Children Under the Age of 20 1990 & 2000

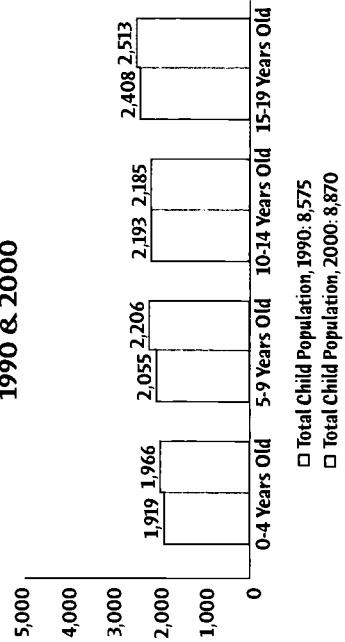

Health & Well-being

	Current Year	Base Year
Total # of Live Births (CY)	1999 364	1990 392
% of Low Birthweight Babies (CY)	1999 5.8	1990 5.4
% of Mothers who Received 1st Trimester Prenatal Care (CY)	1999 79.7	1990 68.6
% of Mothers who Smoked During Pregnancy (CY)	1999 30.8	1990 31.6
Non Marital Births as a % of All Births (CY)	1999 34.1	1990 24.5
Teen Birth Rate, Age 15-17 (CY)	1999 27.9	1990 31.4
Total # of Infant Deaths (CY)	1999 1	1990 3
Total # of Child Deaths, Age 1-14 (CY)	1999 2	1990 3
Total # of Teen Deaths by Accident, Homicide and Suicide (CY)	1999 4	1990 0
# of Children Enrolled in Hoosier Healthwise (SFY)	2000 1,781	1998 1,097
% Noncompliance with Youth Tobacco Access Laws (CY)	2000 0	1997 N/A

Education, Grades K-12

Public School Enrollment, K-12 (SY)	2000 5,165	1990 4,576
Non-Public School Enrollment (SY)	2001 628	1995 603
# of Home Schooled Children (SY)	2000 94	1990 2
# of Alternative School Participants (SY)	2001 234	1990 0
Total Per Pupil Expenditure (SY)	2000 \$6,391	1990 \$4,458
% of 10th Graders Passing the GQE Math Standard (SY)	2000 56.0	2000 56.0
% of 10th Graders Passing the GQE Language Standard (SY)	2000 65.0	2000 65.0
% of Graduates Passing the GQE (SY)	2000 98.4	2000 98.4
# of Public High School Graduates (SY)	2000 310	1990 301
% of High School Graduates (SY)	2000 90.1	1990 76.2
% of Freshman Class Graduating in 4 Years (SY)	2000 73.6	1990 81.4
% of Grads Intending 4-year College (SY)	2000 55.5	1990 35.2
% of Grads Intending Vocational/Tech School (SY)	2000 13.6	1990 10.2
# of Public School Student Dropouts (SY)	2000 37	1990 120
# of Expulsions and Suspensions (SY)	1999 1,134	1999 1,134

Juveniles and the Law

# of Juveniles Committed to the Dept. of Correction (CY)	2000 0	1994 0
# of Juvenile Status Case Filings (CY)	2000 31	1990 7
# of Juvenile Delinquency Case Filings (CY)	2000 89	1990 49

Percent of Households with Children Under 18 Headed by Parents and Others, Census 2000

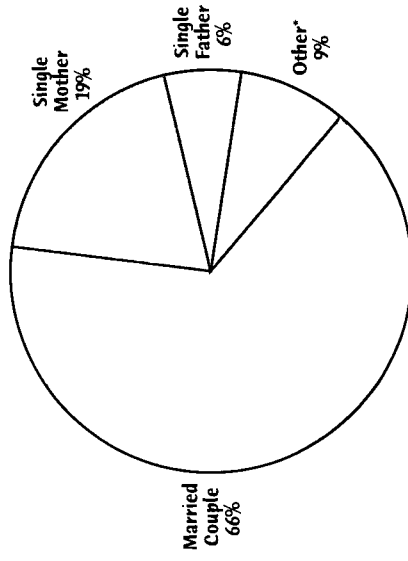

*"Other" includes households with children unrelated to the householder(s) and households with no adults present.

Number of Babies Born to Single Mothers Under Age 20 without a High School Diploma

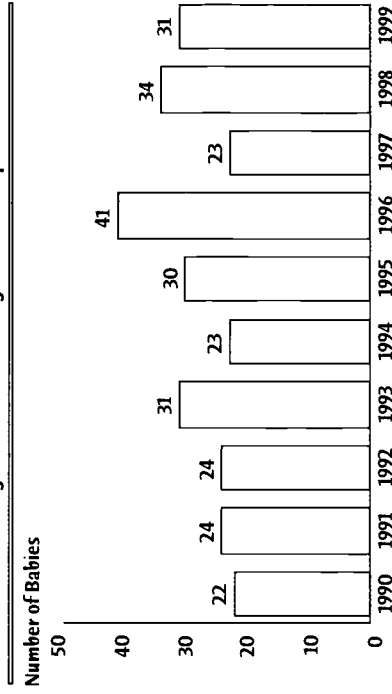

DATA YEAR DEFINITIONS

- SFY - State Fiscal Year: July 1-June 30
- SY - School Year: From the start of the school term in the fall through the end of the summer
- FFY - Federal Fiscal Year: October 1-September 30
- CY - Calendar Year: January 1 - December 31



Jennings County

Kids Count in Indiana 2001



Economic Well-being

	Current Year	Base Year
% of Children in Poverty, Age 0-17 (CY)	1997 13.8	1990 16.9
Per Capita Income (CY)	1999 \$21,262	1990 \$13,599
Unemployment Rate (CY)	2000 2.9	1990 5.7
Monthly Average of Families Receiving TANIF (SFY)	2000 63	1990 160
Monthly Average of Persons Issued Food Stamps (SFY)	2000 854	1990 1,882
% of Students Receiving Free Lunches / Text Books (SY)	2001 18.2	1991 19.8

Early Childhood

# of First Steps Children Served (FFY)	2000 87	1998 68
# of Licensed Child Care Centers (SFY)	2000 2	1990 3
# of Licensed Child Care Homes (SFY)	2000 18	1990 2
# of Registered Child Care Ministries (SFY)	2000 0	1993 0
# of Licensed Child Care Slots per 100 Children, Age 0-4 (SFY)	2000 15.6	1996 15.2

Child Protection

# of Reported Cases of Child Abuse Processed by CPS (SFY)	2000 60	1990 167
% of Child Abuse Cases Substantiated by CPS (SFY)	2000 70.0	1990 58.1
# of Reported Cases of Child Neglect Processed by CPS (SFY)	2000 167	1990 231
% of Child Neglect Cases Substantiated by CPS (SFY)	2000 89.0	1990 68.4
# of Child Physical Abuse Cases Substantiated by CPS (SFY)	2000 27	1990 20
# of Child Sexual Abuse Cases Substantiated by CPS (SFY)	2000 15	1990 25
Child Abuse and Neglect Rate (SFY)	2000 25.4	1990 54.2
# of Child Abuse and Neglect Deaths (SFY)	2000 2	1990 0
# of Juvenile CHINS Case Filings (CY)	2000 33	1990 24

Racial/Ethnic Characteristics of Children Age 0-17 in Jennings County

One Race (Non-Hispanic Origin)	96.3%
White	0.7%
Black	0.2%
American Indian or Alaska Native	0.3%
Asian	0.0%
Native Hawaiian or Other Pacific Islander	0.1%
Some Other Race	1.4%
Two or More Races (Non-Hispanic Origin)	1.0%
Hispanic Origin*	

*Hispanic children may be of any race.

Number of Children Under the Age of 20 1990 & 2000

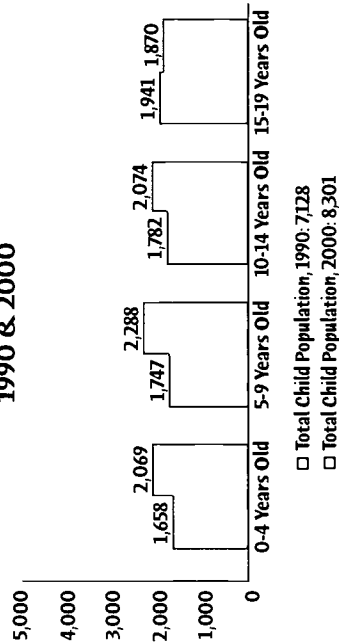

Health & Well-being

	Current Year	Base Year
Total # of Live Births (CY)	1999 423	1990 362
% of Low Birthweight Babies (CY)	1999 6.4	1990 5.8
% of Mothers who Received 1st Trimester Prenatal Care (CY)	1999 74.2	1990 74.3
% of Mothers who Smoked During Pregnancy (CY)	1999 27.0	1990 32.9
Non Marital Births as a % of All Births (CY)	1999 31.0	1990 21.5
Teen Birth Rate, Age 15-17 (CY)	1999 23.0	1990 30.5
Total # of Infant Deaths (CY)	1999 4	1990 3
Total # of Child Deaths, Age 1-14 (CY)	1999 3	1990 1
Total # of Teen Deaths by Accident, Homicide and Suicide (CY)	1999 1	1990 0
# of Children Enrolled in Hoosier Healthwise (SFY)	2000 1,675	1998 803
% Noncompliance with Youth Tobacco Access Laws (CY)	2000 N/A	1997 25.0

Percent of Households with Children Under 18 Headed by Parents and Others, Census 2000

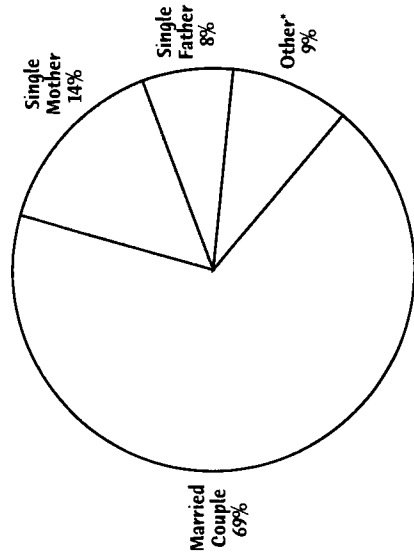

* "Other" includes households with children unrelated to the householder(s) and households with no adults present.

Education, Grades K-12

Public School Enrollment, K-12 (SY)	2000 4,921	1990 3,987
Non-Public School Enrollment (SY)	2001 203	1995 195
# of Home Schooled Children (SY)	2000 169	1990 12
# of Alternative School Participants (SY)	2001 28	1990 0
Total Per Pupil Expenditure (SY)	2000 \$6,256	1990 \$3,351
% of 10th Graders Passing the GQE Math Standard (SY)	2000 57.0	2000 57.0
% of 10th Graders Passing the GQE Language Standard (SY)	2000 65.0	2000 65.0
% of Graduates Passing the GQE (SY)	2000 100.0	2000 100.0
# of Public High School Graduates (SY)	2000 258	1990 351
% of High School Graduates (SY)	2000 86.0	1990 74.8
% of Freshman Class Graduating in 4 Years (SY)	2000 61.0	1990 84.2
% of Grads Intending 4-year College (SY)	2000 56.2	1990 46.3
% of Grads Intending Vocational/Tech School (SY)	2000 9.7	1990 7.4
# of Public School Student Dropouts (SY)	2000 50	1990 102
# of Expulsions and Suspensions (SY)	1999 1,211	1999 1,211

Juveniles and the Law

# of Juveniles Committed to the Dept. of Correction (CY)	2000 3	1994 0
# of Juvenile Status Case Filings (CY)	2000 0	1990 0
# of Juvenile Delinquency Case Filings (CY)	2000 63	1990 42

Number of Babies Born to Single Mothers Under Age 20 without a High School Diploma

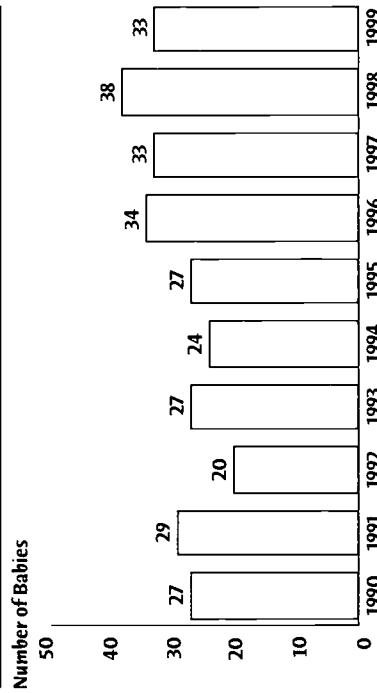

DATA YEAR DEFINITIONS

- SFY - State Fiscal Year: July 1-June 30
- SY - School Year: From the start of the school term in the fall through the end of the summer
- FFY - Federal Fiscal Year: October 1-September 30
- CY - Calendar Year: January 1 - December 31



Johnson County

Kids Count in Indiana 2001



Economic Well-being

	Current Year	Base Year
% of Children in Poverty, Age 0-17 (CY)	1997 8.0	1990 8.8
Per Capita Income (CY)	1999 \$28,230	1990 \$19,232
Unemployment Rate (CY)	2000 1.9	1990 3.0
Monthly Average of Families Receiving TANF (SFY)	2000 167	1990 310
Monthly Average of Persons Issued Food Stamps (SFY)	2000 2,465	1990 2,537
% of Students Receiving Free Lunches / Text Books (SY)	2001 9.5	1991 8.3

Early Childhood

# of First Steps Children Served (FFY)	2000 313	1998 180
# of Licensed Child Care Centers (SFY)	2000 14	1990 9
# of Licensed Child Care Homes (SFY)	2000 22	1990 18
# of Registered Child Care Ministries (SFY)	2000 4	1993 3
# of Licensed Child Care Slots per 100 Children, Age 0-4 (SFY)	2000 20.9	1996 18.6

Child Protection

# of Reported Cases of Child Abuse Processed by CPS (SFY)	2000 182	1990 353
% of Child Abuse Cases Substantiated by CPS (SFY)	2000 47.0	1990 66.3
# of Reported Cases of Child Neglect Processed by CPS (SFY)	2000 342	1990 217
% of Child Neglect Cases Substantiated by CPS (SFY)	2000 54.0	1990 60.4
# of Child Physical Abuse Cases Substantiated by CPS (SFY)	2000 32	1990 18
# of Child Sexual Abuse Cases Substantiated by CPS (SFY)	2000 54	1990 50
Child Abuse and Neglect Rate (SFY)	2000 9.1	1990 23.3
# of Child Abuse and Neglect Deaths (SFY)	2000 1	1990 1
# of Juvenile CHINS Case Filings (CY)	2000 97	1990 44

Racial/Ethnic Characteristics of Children Age 0-17 in Johnson County

One Race (Non-Hispanic Origin)	95.3%
White	0.8%
Black	0.2%
American Indian or Alaska Native	0.9%
Asian	0.0%
Native Hawaiian or Other Pacific Islander	0.1%
Some Other Race	1.0%
Two or More Races (Non-Hispanic Origin)	1.7%
Hispanic Origin*	

*Hispanic children may be of any race.

Number of Children Under the Age of 20 1990 & 2000

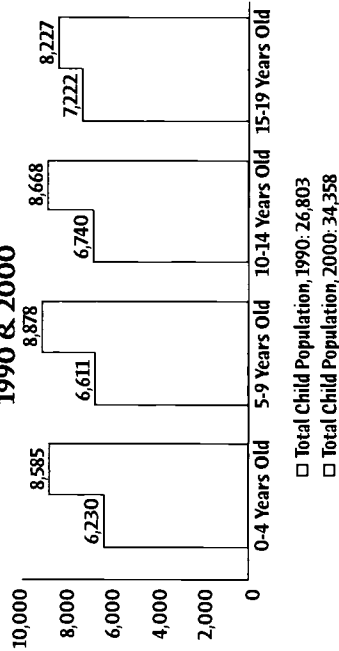

000000136181

Health & Well-being

	Current Year	Base Year
Total # of Live Births (CY)	1999 1,641	1990 1,288
% of Low Birthweight Babies (CY)	1999 7.2	1990 5.9
% of Mothers who Received 1st Trimester Prenatal Care (CY)	1999 89.1	1990 85.1
% of Mothers who Smoked During Pregnancy (CY)	1999 18.3	1990 23.0
Non Marital Births as a % of All Births (CY)	1999 23.4	1990 15.4
Teen Birth Rate, Age 15-17 (CY)	1999 18.5	1990 20.4
Total # of Infant Deaths (CY)	1999 15	1990 10
Total # of Child Deaths, Age 1-14 (CY)	1999 4	1990 9
Total # of Teen Deaths by Accident, Homicide and Suicide (CY)	1999 4	1990 4
# of Children Enrolled in Hoosier Healthwise (SFY)	2000 3,137	1998 1,647
% Noncompliance with Youth Tobacco Access Laws (CY)	2000 25.0	1997 N/A

Percent of Households with Children Under 18 Headed by Parents and Others, Census 2000

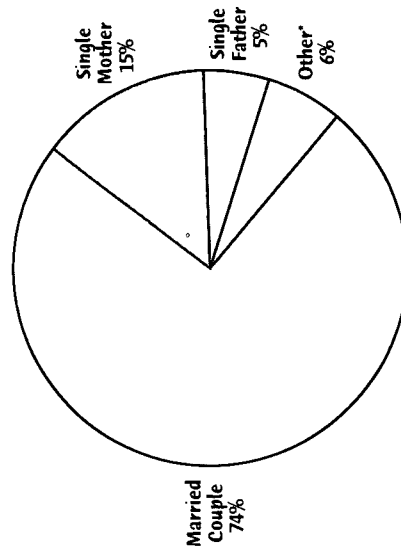

*"Other" includes households with children unrelated to the householder(s) and households with no adults present.

Education, Grades K-12

Public School Enrollment, K-12 (SY)	2000 20,413	1990 15,428
Non-Public School Enrollment (SY)	2001 1,014	1995 710
# of Home Schooled Children (SY)	2000 282	1990 0
# of Alternative School Participants (SY)	2001 135	1990 0
Total Per Pupil Expenditure (SY)	2000 \$5,471	1990 \$3,724
% of 10th Graders Passing the GQE Math Standard (SY)	2000 67.0	2000 67.0
% of 10th Graders Passing the GQE Language Standard (SY)	2000 75.0	2000 75.0
% of Graduates Passing the GQE (SY)	2000 96.8	2000 96.8
# of Public High School Graduates (SY)	2000 1,255	1990 1,236
% of High School Graduates (SY)	2000 93.9	1990 79.2
% of Freshman Class Graduating in 4 Years (SY)	2000 78.9	1990 88.7
% of Grads Intending 4-year College (SY)	2000 56.0	1990 15.7
% of Grads Intending Vocational/Tech School (SY)	2000 4.9	1990 5.4
# of Public School Student Dropouts (SY)	2000 90	1990 312
# of Expulsions and Suspensions (SY)	1999 3,729	1999 3,729

Juveniles and the Law

# of Juveniles Committed to the Dept. of Correction (CY)	2000 12	1994 9
# of Juvenile Status Case Filings (CY)	2000 26	1990 214
# of Juvenile Delinquency Case Filings (CY)	2000 646	1990 721

Number of Babies Born to Single Mothers Under Age 20 without a High School Diploma

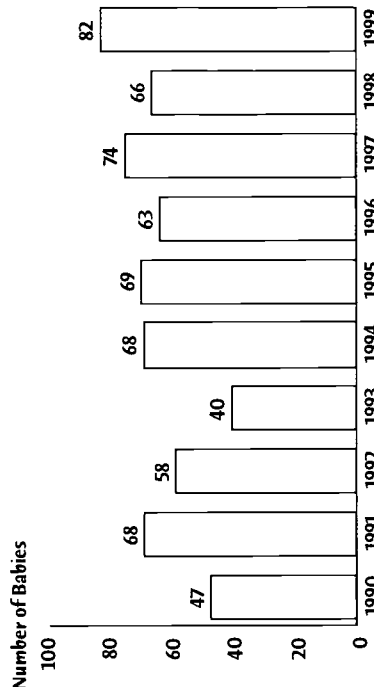

DATA YEAR DEFINITIONS

- SFY - State Fiscal Year: July 1-June 30
- SY - School Year: From the start of the school term in the fall through the end of the summer
- FFY - Federal Fiscal Year: October 1-September 30
- CY - Calendar Year: January 1 - December 31

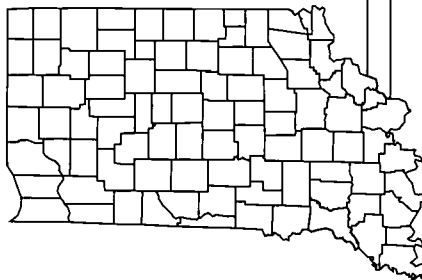

Knox County

Kids Count in Indiana 2001



Economic Well-being

	Current Year	Base Year
% of Children in Poverty, Age 0-17 (CY)	1997 20.6	1990 19.9
Per Capita Income (CY)	1999 \$22,759	1990 \$15,133
Unemployment Rate (CY)	2000 4.1	1990 7.5
Monthly Average of Families Receiving TANF (SFY)	2000 300	1990 462
Monthly Average of Persons Issued Food Stamps (SFY)	2000 3,258	1990 3,418
% of Students Receiving Free Lunches / Text Books (SY)	2001 29.2	1991 23.9

Early Childhood

# of First Steps Children Served (FFY)	2000 110	1998 85
# of Licensed Child Care Centers (SFY)	2000 7	1990 6
# of Licensed Child Care Homes (SFY)	2000 35	1990 15
# of Registered Child Care Ministries (SFY)	2000 5	1993 3
# of Licensed Child Care Slots per 100 Children, Age 0-4 (SFY)	2000 39.2	1996 31.3

Child Protection

# of Reported Cases of Child Abuse Processed by CPS (SFY)	2000 125	1990 125
% of Child Abuse Cases Substantiated by CPS (SFY)	2000 71.0	1990 48.0
# of Reported Cases of Child Neglect Processed by CPS (SFY)	2000 175	1990 315
% of Child Neglect Cases Substantiated by CPS (SFY)	2000 62.0	1990 28.6
# of Child Physical Abuse Cases Substantiated by CPS (SFY)	2000 42	1990 18
# of Child Sexual Abuse Cases Substantiated by CPS (SFY)	2000 47	1990 20
Child Abuse and Neglect Rate (SFY)	2000 22.0	1990 41.6
# of Child Abuse and Neglect Deaths (SFY)	2000 0	1990 0
# of Juvenile CHINS Case Filings (CY)	2000 21	1990 27

Racial/Ethnic Characteristics of Children Age 0-17 in Knox County

One Race (Non-Hispanic Origin)	95.4%
White	1.6%
Black	0.2%
American Indian or Alaska Native	0.4%
Asian	0.0%
Native Hawaiian or Other Pacific Islander	0.0%
Some Other Race	0.0%
Two or More Races (Non-Hispanic Origin)	1.2%
Hispanic Origin*	1.2%

*Hispanic children may be of any race.

Number of Children Under the Age of 20 1990 & 2000

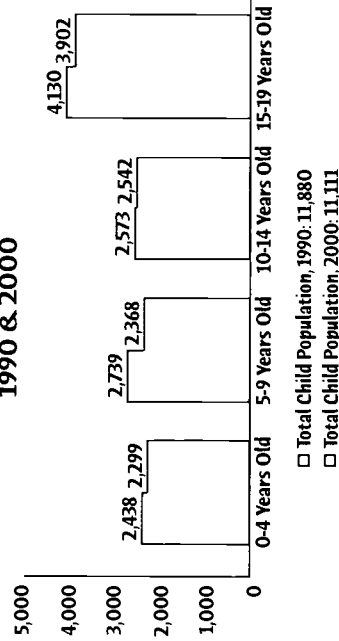

000000 136182

Health & Well-being

	Current Year	Base Year
Total # of Live Births (CY)	1999 473	1990 502
% of Low Birthweight Babies (CY)	1999 9.5	1990 7.2
% of Mothers who Received 1st Trimester Prenatal Care (CY)	1999 82.2	1990 75.4
% of Mothers who Smoked During Pregnancy (CY)	1999 30.0	1990 31.1
Non Marital Births as a % of All Births (CY)	1999 33.8	1990 22.5
Teen Birth Rate, Age 15-17 (CY)	1999 20.3	1990 32.4
Total # of Infant Deaths (CY)	1999 2	1990 4
Total # of Child Deaths, Age 1-14 (CY)	1999 6	1990 0
Total # of Teen Deaths by Accident, Homicide and Suicide (CY)	1999 3	1990 0
# of Children Enrolled in Hoosier Healthwise (SFY)	2000 3,128	1998 1,998
% Noncompliance with Youth Tobacco Access Laws (CY)	2000 60.0	1997 50.0

Percent of Households with Children Under 18 Headed by Parents and Others, Census 2000

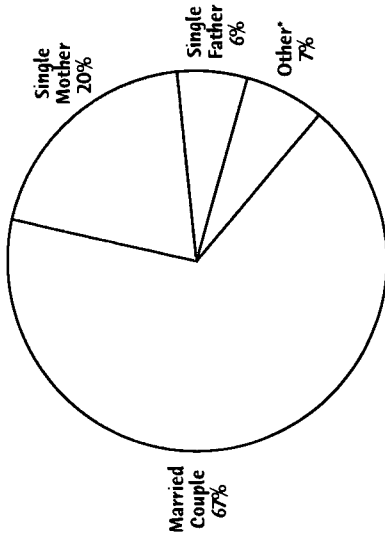

Other includes households with children unrelated to the householder(s) and households with no adults present.

Education, Grades K-12

Public School Enrollment, K-12 (SY)	2000 6,084	1990 5,484
Non-Public School Enrollment (SY)	2001 733	1995 589
# of Home Schooled Children (SY)	2000 54	1990 0
# of Alternative School Participants (SY)	2001 94	1990 0
Total Per Pupil Expenditure (SY)	2000 \$6,174	1990 \$3,881
% of 10th Graders Passing the GQE Math Standard (SY)	2000 65.0	2000 65.0
% of 10th Graders Passing the GQE Language Standard (SY)	2000 72.0	2000 72.0
% of Graduates Passing the GQE (SY)	2000 95.3	2000 95.3
# of Public High School Graduates (SY)	2000 403	1990 447
% of High School Graduates (SY)	2000 93.9	1990 79.2
% of Freshman Class Graduating in 4 Years (SY)	2000 73.5	1990 84.2
% of Grads Intending 4-year College (SY)	2000 22.3	1990 41.8
% of Grads Intending Vocational/Tech School (SY)	2000 3.5	1990 6.4
# of Public School Student Dropouts (SY)	2000 29	1990 101
# of Expulsions and Suspensions (SY)	1999 1,609	1999 1,609

Juveniles and the Law

# of Juveniles Committed to the Dept. of Correction (CY)	2000 6	1994 0
# of Juvenile Status Case Filings (CY)	2000 21	1990 0
# of Juvenile Delinquency Case Filings (CY)	2000 43	1990 74

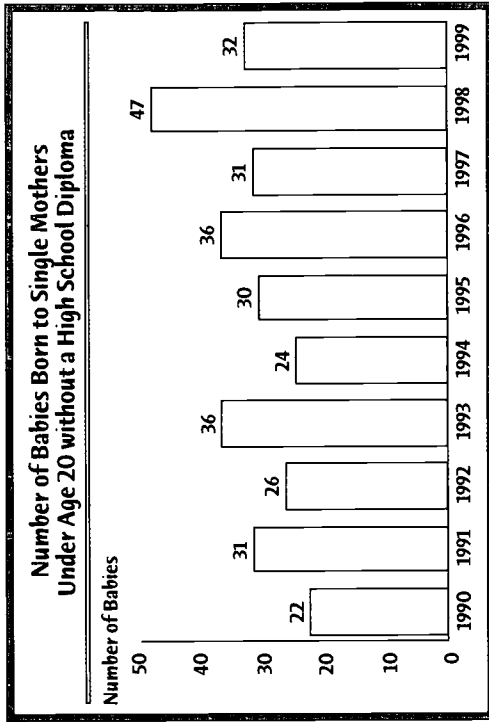

DATA YEAR DEFINITIONS

SFY - State Fiscal Year: July 1-June 30
 SY - School Year: From the start of the school term in the fall through the end of the summer
 FFY - Federal Fiscal Year: October 1-September 30
 CY - Calendar Year: January 1 - December 31

270

271

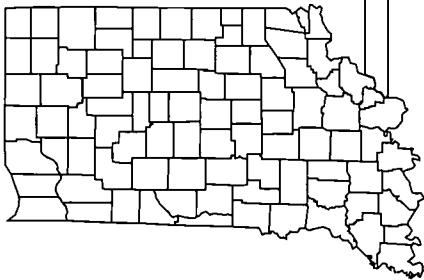

Kosciusko County

Kids Count in
Indiana 2001



Economic Well-being

	Current Year	Base Year
% of Children in Poverty, Age 0-17 (CY)	1997 8.6	1990 8.2
Per Capita Income (CY)	1999 \$25,826	1990 \$17,684
Unemployment Rate (CY)	2000 2.8	1990 3.8
Monthly Average of Families Receiving TANF (SFY)	2000 55	1990 173
Monthly Average of Persons Issued Food Stamps (SFY)	2000 1,064	1990 1,714
% of Students Receiving Free Lunches / Text Books (SY)	2001 15.8	1991 11.3

Early Childhood

# of First Steps Children Served (FFY)	2000 192	1998 141
# of Licensed Child Care Centers (SFY)	2000 4	1990 5
# of Licensed Child Care Homes (SFY)	2000 37	1990 24
# of Registered Child Care Ministries (SFY)	2000 3	1993 2
# of Licensed Child Care Slots per 100 Children, Age 0-4 (SFY)	2000 12.6	1996 11.8

Child Protection

# of Reported Cases of Child Abuse Processed by CPS (SFY)	2000 121	1990 158
% of Child Abuse Cases Substantiated by CPS (SFY)	2000 79.0	1990 59.5
# of Reported Cases of Child Neglect Processed by CPS (SFY)	2000 181	1990 172
% of Child Neglect Cases Substantiated by CPS (SFY)	2000 83.0	1990 65.1
# of Child Physical Abuse Cases Substantiated by CPS (SFY)	2000 35	1990 21
# of Child Sexual Abuse Cases Substantiated by CPS (SFY)	2000 60	1990 19
Child Abuse and Neglect Rate (SFY)	2000 12.3	1990 18.4
# of Child Abuse and Neglect Deaths (SFY)	2000 0	1990 0
# of Juvenile CHINS Case Filings (CY)	2000 14	1990 34

Racial/Ethnic Characteristics of Children Age 0-17 in Kosciusko County

One Race (Non-Hispanic Origin)	90.3%
White	0.7%
Black	0.2%
American Indian or Alaska Native	0.5%
Asian	0.0%
Native Hawaiian or Other Pacific Islander	0.1%
Some Other Race	1.1%
Two or More Races (Non-Hispanic Origin)	7.2%
Hispanic Origin*	

*Hispanic children may be of any race.

Number of Children Under the Age of 20 1990 & 2000

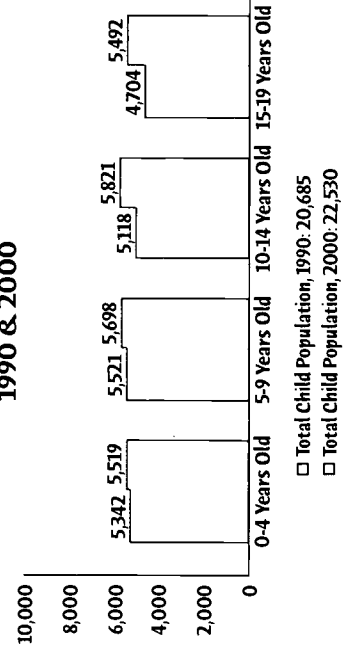

Health & Well-being

	Current Year	Base Year
Total # of Live Births (CY)	1999 1,134	1990 1,138
% of Low Birthweight Babies (CY)	1999 5.6	1990 5.6
% of Mothers who Received 1st Trimester Prenatal Care (CY)	1999 80.3	1990 75.0
% of Mothers who Smoked During Pregnancy (CY)	1999 21.3	1990 24.2
Non Marital Births as a % of All Births (CY)	1999 29.3	1990 17.1
Teen Birth Rate, Age 15-17 (CY)	1999 29.0	1990 32.2
Total # of Infant Deaths (CY)	1999 12	1990 8
Total # of Child Deaths, Age 1-14 (CY)	1999 2	1990 4
Total # of Teen Deaths by Accident, Homicide and Suicide (CY)	1999 5	1990 2
# of Children Enrolled in Hoosier Healthwise (SFY)	2000 2,714	1998 1,208
% Noncompliance with Youth Tobacco Access Laws (CY)	2000 60.0	1997 17.7

Education, Grades K-12

Public School Enrollment, K-12 (SY)	2000 14,118	1990 11,191
Non-Public School Enrollment (SY)	2001 814	1995 798
# of Home Schooled Children (SY)	2000 262	1990 22
# of Alternative School Participants (SY)	2001 256	1990 0
Total Per Pupil Expenditure (SY)	2000 \$6,489	1990 \$3,920
% of 10th Graders Passing the GQE Math Standard (SY)	2000 70.0	2000 70.0
% of 10th Graders Passing the GQE Language Standard (SY)	2000 71.0	2000 71.0
% of Graduates Passing the GQE (SY)	2000 97.3	2000 97.3
# of Public High School Graduates (SY)	2000 807	1990 828
% of High School Graduates (SY)	2000 79.7	1990 78.9
% of Freshman Class Graduating in 4 Years (SY)	2000 65.8	1990 78.1
% of Grads Intending 4-year College (SY)	2000 56.8	1990 36.3
% of Grads Intending Vocational/Tech School (SY)	2000 15.7	1990 11.7
# of Public School Student Dropouts (SY)	2000 224	1990 265
# of Expulsions and Suspensions (SY)	1999 3,711	1999 3,711

Juveniles and the Law

# of Juveniles Committed to the Dept. of Correction (CY)	2000 32	1994 16
# of Juvenile Status Case Filings (CY)	2000 0	1990 0
# of Juvenile Delinquency Case Filings (CY)	2000 114	1990 65

Percent of Households with Children Under 18 Headed by Parents and Others, Census 2000

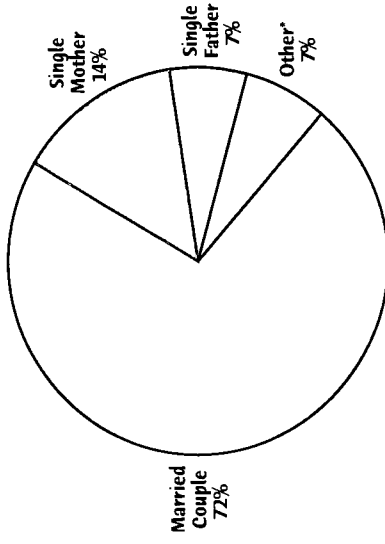

* "Other" includes households with children unrelated to the householder(s) and households with no adults present.

Number of Babies Born to Single Mothers Under Age 20 without a High School Diploma

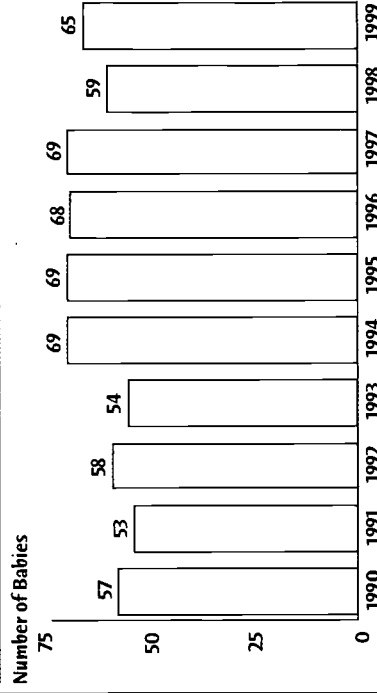

DATA YEAR DEFINITIONS

- SFY - State Fiscal Year: July 1-June 30
- SY - School Year: From the start of the school term in the fall through the end of the summer
- FFY - Federal Fiscal Year: October 1-September 30
- CY - Calendar Year: January 1 - December 31

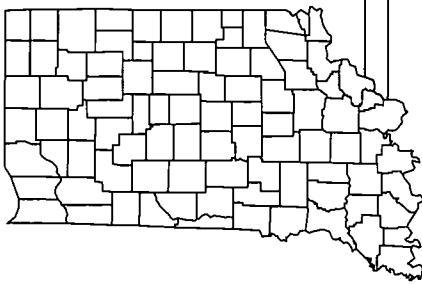

LaGrange County

Kids Count in Indiana 2001



Economic Well-being

	Current Year	Base Year
% of Children in Poverty, Age 0-17 (CY)	1997 11.8	1990 14.7
Per Capita Income (CY)	1999 \$19,215	1990 \$13,038
Unemployment Rate (CY)	2000 2.8	1990 6.3
Monthly Average of Families Receiving TANF (SFY)	2000 22	1990 65
Monthly Average of Persons Issued Food Stamps (SFY)	2000 387	1990 562
% of Students Receiving Free Lunches / Text Books (SY)	2001 12.8	1991 9.2

Early Childhood

# of First Steps Children Served (FFY)	2000 42	1998 56
# of Licensed Child Care Centers (SFY)	2000 0	1990 0
# of Licensed Child Care Homes (SFY)	2000 17	1990 6
# of Registered Child Care Ministries (SFY)	2000 4	1993 3
# of Licensed Child Care Slots per 100 Children, Age 0-4 (SFY)	2000 5.2	1996 6.6

Child Protection

# of Reported Cases of Child Abuse Processed by CPS (SFY)	2000 121	1990 104
% of Child Abuse Cases Substantiated by CPS (SFY)	2000 66.0	1990 53.8
# of Reported Cases of Child Neglect Processed by CPS (SFY)	2000 100	1990 126
% of Child Neglect Cases Substantiated by CPS (SFY)	2000 64.0	1990 54.8
# of Child Physical Abuse Cases Substantiated by CPS (SFY)	2000 29	1990 8
# of Child Sexual Abuse Cases Substantiated by CPS (SFY)	2000 51	1990 29
Child Abuse and Neglect Rate (SFY)	2000 12.4	1990 24.2
# of Child Abuse and Neglect Deaths (SFY)	2000 0	1990 0
# of Juvenile CHINS Case Filings (CY)	2000 33	1990 21

Racial/Ethnic Characteristics of Children Age 0-17 in LaGrange County

One Race (Non-Hispanic Origin)	94.7%
White	0.2%
Black	0.1%
American Indian or Alaska Native	0.2%
Asian	0.0%
Native Hawaiian or Other Pacific Islander	0.1%
Some Other Race	0.8%
Two or More Races (Non-Hispanic Origin)	3.9%
Hispanic Origin*	

*Hispanic children may be of any race.

Number of Children Under the Age of 20 1990 & 2000

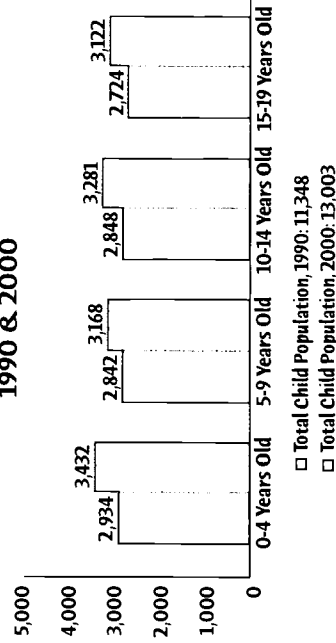

000000 136184

Health & Well-being

	Current Year	Base Year
total # of Live Births (CY)	1999 756	1990 559
% of Low Birthweight Babies (CY)	1999 5.7	1990 4.7
% of Mothers who Received 1st Trimester Prenatal Care (CY)	1999 45.8	1990 56.5
% of Mothers who Smoked During Pregnancy (CY)	1999 10.7	1990 16.6
Non Marital Births as a % of All Births (CY)	1999 11.5	1990 11.3
Teen Birth Rate, Age 15-17 (CY)	1999 14.1	1990 16.9
Total # of Infant Deaths (CY)	1999 3	1990 2
Total # of Child Deaths, Age 1-14 (CY)	1999 3	1990 2
Total # of Teen Deaths by Accident, Homicide and Suicide (CY)	1999 2	1990 3
# of Children Enrolled in Hoosier Healthwise (SFY)	2000 757	1998 423
% Noncompliance with Youth Tobacco Access Laws (CY)	2000 N/A	1997 N/A

Percent of Households with Children Under 18 Headed by Parents and Others, Census 2000

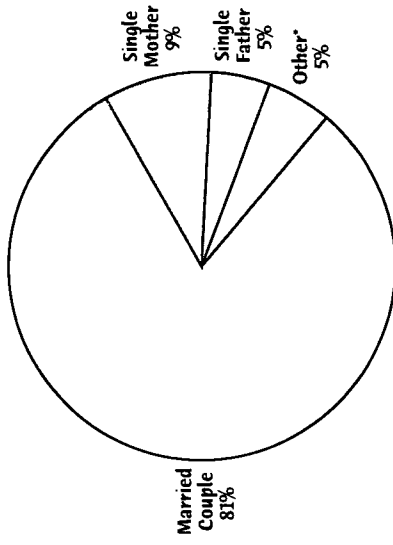

* "Other" includes households with children unrelated to the householder(s) and households with no adults present.

Education, Grades K-12

Public School Enrollment, K-12 (SY)	2000 6,380	1990 5,334
Non-Public School Enrollment (SY)	2001 1,564	1995 1,387
# of Home Schooled Children (SY)	2000 82	1990 6
# of Alternative School Participants (SY)	2001 0	1990 0
Total Per Pupil Expenditure (SY)	2000 \$5,914	1990 \$3,603
% of 10th Graders Passing the GOE Math Standard (SY)	2000 68.0	2000 68.0
% of 10th Graders Passing the GOE Language Standard (SY)	2000 74.0	2000 74.0
% of Graduates Passing the GOE (SY)	2000 97.7	2000 97.7
# of Public High School Graduates (SY)	2000 307	1990 317
% of High School Graduates (SY)	2000 92.0	1990 81.6
% of Freshman Class Graduating in 4 Years (SY)	2000 73.4	1990 84.1
% of Grads Intending 4-year College (SY)	2000 42.3	1990 45.0
% of Grads Intending Vocational/Tech School (SY)	2000 3.3	1990 7.5
# of Public School Student Dropouts (SY)	2000 32	1990 83
# of Expulsions and Suspensions (SY)	1999 1,167	1999 1,167

Juveniles and the Law

# of Juveniles Committed to the Dept. of Correction (CY)	2000 12	1994 2
# of Juvenile Status Case Filings (CY)	2000 0	1990 0
# of Juvenile Delinquency Case Filings (CY)	2000 196	1990 84

Number of Babies Born to Single Mothers Under Age 20 without a High School Diploma

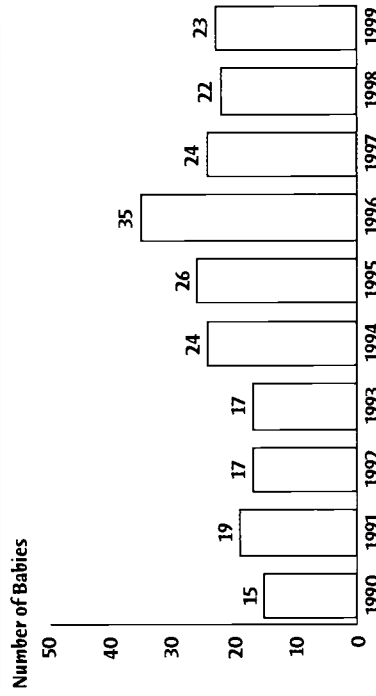

DATA YEAR DEFINITIONS

- SFY - State Fiscal Year: July 1-June 30
- SY - School Year: From the start of the school term in the fall through the end of the summer
- FFY - Federal Fiscal Year: October 1-September 30
- CY - Calendar Year: January 1 - December 31



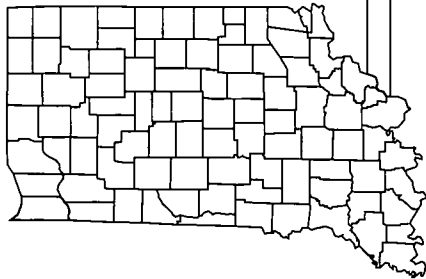

Lake County

Kids Count in Indiana 2001



Economic Well-being

	Current Year	Base Year
% of Children in Poverty, Age 0-17 (CY)	1997 20.0	1990 16.0
Per Capita Income (CY)	1999 \$25,328	1990 \$17,288
Unemployment Rate (CY)	2000 4.6	1990 6.5
Monthly Average of Families Receiving TANF (SFY)	2000 6,956	1990 11,245
Monthly Average of Persons Issued Food Stamps (SFY)	2000 48,537	1990 51,836
% of Students Receiving Free Lunches / Text Books (SY)	2001 30.3	1991 26.2

Early Childhood

# of First Steps Children Served (FFY)	2000 899	1998 545
# of Licensed Child Care Centers (SFY)	2000 55	1990 48
# of Licensed Child Care Homes (SFY)	2000 169	1990 90
# of Registered Child Care Ministries (SFY)	2000 47	1993 10
# of Licensed Child Care Slots per 100 Children, Age 0-4 (SFY)	2000 19.5	1996 16

Child Protection

# of Reported Cases of Child Abuse Processed by CPS (SFY)	2000 638	1990 1,272
% of Child Abuse Cases Substantiated by CPS (SFY)	2000 62.0	1990 44.3
# of Reported Cases of Child Neglect Processed by CPS (SFY)	2000 1,072	1990 1,275
% of Child Neglect Cases Substantiated by CPS (SFY)	2000 70.0	1990 48.7
# of Child Physical Abuse Cases Substantiated by CPS (SFY)	2000 244	1990 87
# of Child Sexual Abuse Cases Substantiated by CPS (SFY)	2000 154	1990 111
Child Abuse and Neglect Rate (SFY)	2000 8.8	1990 15.5
# of Child Abuse and Neglect Deaths (SFY)	2000 4	1990 8
# of Juvenile CHINS Case Filings (CY)	2000 623	1990 410

Racial/Ethnic Characteristics of Children Age 0-17 in Lake County

One Race (Non-Hispanic Origin)	51.3%
White	29.5%
Black	0.2%
American Indian or Alaska Native	0.7%
Asian	0.0%
Native Hawaiian or Other Pacific Islander	0.2%
Some Other Race	1.7%
Two or More Races (Non-Hispanic Origin)	16.4%
Hispanic Origin*	

*Hispanic children may be of any race.

Number of Children Under the Age of 20 1990 & 2000

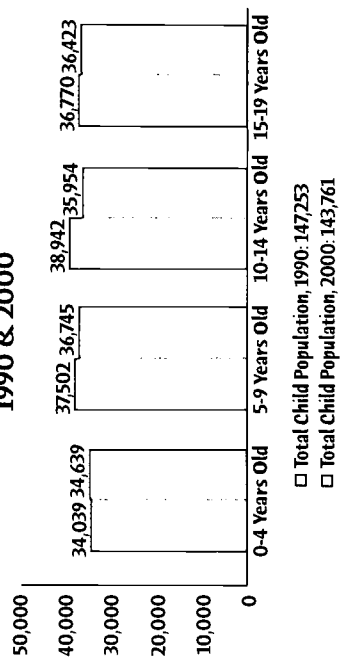

000000136185

Health & Well-being

	Current Year	Base Year
Total # of Live Births (CY)	1999 7,073	1990 7,523
% of Low Birthweight Babies (CY)	1999 9.1	1990 7.9
% of Mothers who Received 1st Trimester Prenatal Care (CY)	1999 75.7	1990 75.1
% of Mothers who Smoked During Pregnancy (CY)	1999 16.2	1990 25.4
Non Marital Births as a % of All Births (CY)	1999 47.6	1990 39.3
Teen Birth Rate, Age 15-17 (CY)	1999 29.6	1990 40.1
Total # of Infant Deaths (CY)	1999 62	1990 77
Total # of Child Deaths, Age 1-14 (CY)	1999 29	1990 36
Total # of Teen Deaths by Accident, Homicide and Suicide (CY)	1999 29	1990 26
# of Children Enrolled in Hoosier Healthwise (SFY)	2000 40,341	1998 31,382
% Noncompliance with Youth Tobacco Access Laws (CY)	2000 24.0	1997 41.0

Percent of Households with Children Under 18 Headed by Parents and Others, Census 2000

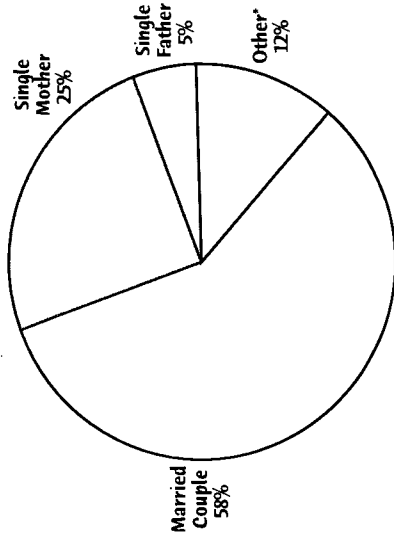

* "Other" includes households with children unrelated to the householder(s) and households with no adults present.

Education, Grades K-12

Public School Enrollment, K-12 (SY)	2000 82,524	1990 77,346
Non-Public School Enrollment (SY)	2001 9,472	1995 10,390
# of Home Schooled Children (SY)	2000 617	1990 2
# of Alternative School Participants (SY)	2001 970	1990 767
Total Per Pupil Expenditure (SY)	2000 \$7,360	1990 \$4,361
% of 10th Graders Passing the GQE Math Standard (SY)	2000 52.0	2000 52.0
% of 10th Graders Passing the GQE Language Standard (SY)	2000 61.0	2000 61.0
% of Graduates Passing the GQE (SY)	2000 93.8	2000 93.8
# of Public High School Graduates (SY)	2000 4,696	1990 5,894
% of High School Graduates (SY)	2000 88.1	1990 81.0
% of Freshman Class Graduating in 4 Years (SY)	2000 60.2	1990 72.7
% of Grads Intending 4-year College (SY)	2000 60.9	1990 39.8
% of Grads Intending Vocational/Tech School (SY)	2000 6.8	1990 6.8
# of Public School Student Dropouts (SY)	2000 878	1990 1,444
# of Expulsions and Suspensions (SY)	1999 40,477	1999 40,477

Juveniles and the Law

# of Juveniles Committed to the Dept. of Correction (CY)	2000 99	1994 64
# of Juvenile Status Case Filings (CY)	2000 210	1990 13
# of Juvenile Delinquency Case Filings (CY)	2000 1,822	1990 1,625

Number of Babies Born to Single Mothers Under Age 20 without a High School Diploma

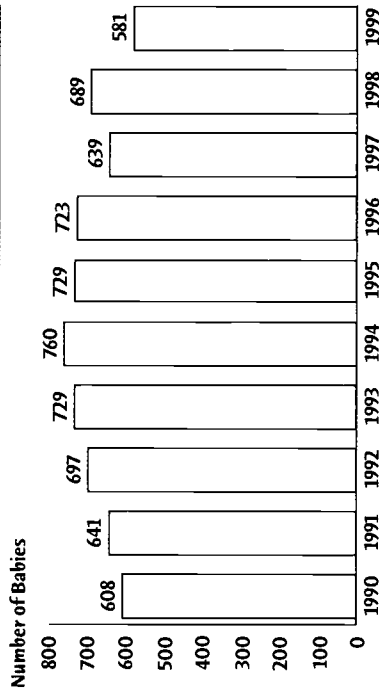

DATA YEAR DEFINITIONS

- SFY - State Fiscal Year: July 1-June 30
- SY - School Year: From the start of the school term in the fall through the end of the summer
- FFY - Federal Fiscal Year: October 1-September 30
- CY - Calendar Year: January 1 - December 31

283

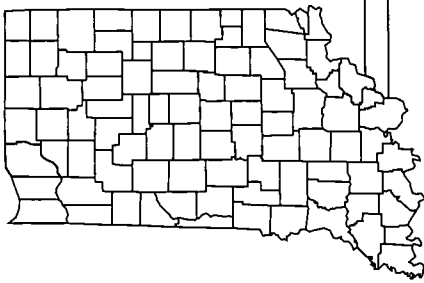

LaPorte County

Kids Count in Indiana 2001



Economic Well-being

	Current Year	Base Year
% of Children in Poverty, Age 0-17 (CY)	1997 15.5	1990 21.5
Per Capita Income (CY)	1999 \$23,538	1990 \$16,376
Unemployment Rate (CY)	2000 3.8	1990 5.5
Monthly Average of Families Receiving TANF (SFY)	2000 563	1990 1,121
Monthly Average of Persons Issued Food Stamps (SFY)	2000 5,747	1990 6,787
% of Students Receiving Free Lunches / Text Books (SY)	2001 20.5	1991 15.8

Early Childhood

# of First Steps Children Served (FFY)	2000 237	1998 177
# of Licensed Child Care Centers (SFY)	2000 8	1990 8
# of Licensed Child Care Homes (SFY)	2000 49	1990 17
# of Registered Child Care Ministries (SFY)	2000 3	1993 0
# of Licensed Child Care Slots per 100 Children, Age 0-4 (SFY)	2000 14.3	1996 12.1

Child Protection

# of Reported Cases of Child Abuse Processed by CPS (SFY)	2000 368	1990 501
% of Child Abuse Cases Substantiated by CPS (SFY)	2000 53.0	1990 54.3
# of Reported Cases of Child Neglect Processed by CPS (SFY)	2000 615	1990 646
% of Child Neglect Cases Substantiated by CPS (SFY)	2000 50.0	1990 47.7
# of Child Physical Abuse Cases Substantiated by CPS (SFY)	2000 115	1990 94
# of Child Sexual Abuse Cases Substantiated by CPS (SFY)	2000 81	1990 59
Child Abuse and Neglect Rate (SFY)	2000 18.6	1990 35.5
# of Child Abuse and Neglect Deaths (SFY)	2000 0	1990 3
# of Juvenile CHINS Case Filings (CY)	2000 92	1990 45

Racial/Ethnic Characteristics of Children Age 0-17 in LaPorte County

One Race (Non-Hispanic Origin)	80.0%
White	11.6%
Black	0.2%
American Indian or Alaska Native	0.4%
Asian	0.0%
Native Hawaiian or Other Pacific Islander	0.3%
Some Other Race	2.5%
Two or More Races (Non-Hispanic Origin)	4.9%
Hispanic Origin*	

*Hispanic children may be of any race.

Number of Children Under the Age of 20 1990 & 2000

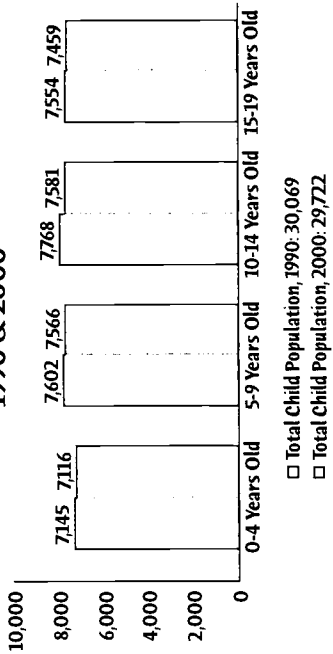

Health & Well-being

	Current Year	Base Year
% of Live Births (CY)	1,453	1,556
% of Low Birthweight Babies (CY)	1999 8.5	1990 6.2
% of Mothers who Received 1st Trimester Prenatal Care (CY)	1999 71.6	1990 75.8
% of Mothers who Smoked During Pregnancy (CY)	1999 25.2	1990 32.6
Non Marital Births as a % of All Births (CY)	1999 42.3	1990 31.0
Teen Birth Rate, Age 15-17 (CY)	1999 24.0	1990 41.3
Total # of Infant Deaths (CY)	1999 13	1990 12
Total # of Child Deaths, Age 1-14 (CY)	1999 5	1990 8
Total # of Teen Deaths by Accident, Homicide and Suicide (CY)	1999 1	1990 3
# of Children Enrolled in Hoosier Healthwise (SFY)	2000 6,361	1998 4,128
% Noncompliance with Youth Tobacco Access Laws (CY)	2000 25.0	1997 N/A

Percent of Households with Children Under 18 Headed by Parents and Others, Census 2000

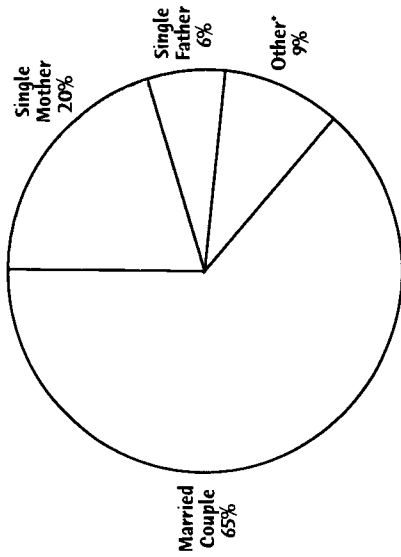

*"Other" includes households with children unrelated to the householder(s) and households with no adults present.

Education, Grades K-12

Public School Enrollment, K-12 (SY)	2000 17,808	1990 14,690
Non-Public School Enrollment (SY)	2001 2,288	1995 2,198
# of Home Schooled Children (SY)	2000 346	1990 4
# of Alternative School Participants (SY)	2001 1,072	1990 0
Total Per Pupil Expenditure (SY)	2000 \$6,845	1990 \$4,098
% of 10th Graders Passing the GQE Math Standard (SY)	2000 58.0	2000 58.0
% of 10th Graders Passing the GQE Language Standard (SY)	2000 67.0	2000 67.0
% of Graduates Passing the GQE (SY)	2000 88.8	2000 88.8
# of Public High School Graduates (SY)	2000 1,032	1990 1,248
% of High School Graduates (SY)	2000 95.6	1990 73.7
% of Freshman Class Graduating in 4 Years (SY)	2000 69.4	1990 72.3
% of Grads Intending 4-year College (SY)	2000 49.7	1990 29.3
% of Grads Intending Vocational/Tech School (SY)	2000 5.0	1990 3.0
# of Public School Student Dropouts (SY)	2000 60	1990 478
# of Expulsions and Suspensions (SY)	1999 7,029	1999 7,029

Juveniles and the Law

# of Juveniles Committed to the Dept. of Correction (CY)	2000 20	1994 7
# of Juvenile Status Case Filings (CY)	2000 84	1990 0
# of Juvenile Delinquency Case Filings (CY)	2000 587	1990 176

Number of Babies Born to Single Mothers Under Age 20 without a High School Diploma

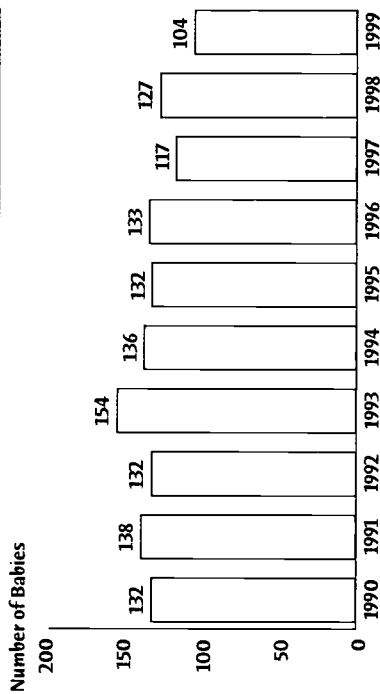

DATA YEAR DEFINITIONS

- SFY - State Fiscal Year: July 1-June 30
- SY - School Year: From the start of the school term in the fall through the end of the summer
- FFY - Federal Fiscal Year: October 1-September 30
- CY - Calendar Year: January 1 - December 31



Lawrence County



Economic Well-being

	Current Year	Base Year
% of Children in Poverty, Age 0-17 (CY)	1997 14.2	1990 12.6
Per Capita Income (CY)	1999 \$21,620	1990 \$15,103
Unemployment Rate (CY)	2000 4.8	1990 9.7
Monthly Average of Families Receiving TANF (SFY)	2000 101	1990 254
Monthly Average of Persons Issued Food Stamps (SFY)	2000 1,733	1990 2,300
% of Students Receiving Free Lunches / Text Books (SY)	2001 21.6	1991 16.2

Early Childhood

# of First Steps Children Served (FFY)	2000 138	1998 100
# of Licensed Child Care Centers (SFY)	2000 4	1990 3
# of Licensed Child Care Homes (SFY)	2000 49	1990 8
# of Registered Child Care Ministries (SFY)	2000 3	1993 0
# of Licensed Child Care Slots per 100 Children, Age 0-4 (SFY)	2000 27.6	1996 17.4

Child Protection

# of Reported Cases of Child Abuse Processed by CPS (SFY)	2000 104	1990 101
% of Child Abuse Cases Substantiated by CPS (SFY)	2000 66.0	1990 55.4
# of Reported Cases of Child Neglect Processed by CPS (SFY)	2000 157	1990 136
% of Child Neglect Cases Substantiated by CPS (SFY)	2000 61.0	1990 61.8
# of Child Physical Abuse Cases Substantiated by CPS (SFY)	2000 21	1990 8
# of Child Sexual Abuse Cases Substantiated by CPS (SFY)	2000 48	1990 13
Child Abuse and Neglect Rate (SFY)	2000 14.6	1990 19.1
# of Child Abuse and Neglect Deaths (SFY)	2000 0	1990 0
# of Juvenile CHINS Case Filings (CY)	2000 16	1990 10

Racial/Ethnic Characteristics of Children Age 0-17 in Lawrence County

One Race (Non-Hispanic Origin)	96.2%
White	0.5%
Black	0.2%
American Indian or Alaska Native	0.3%
Asian	0.0%
Native Hawaiian or Other Pacific Islander	0.1%
Some Other Race	1.1%
Two or More Races (Non-Hispanic Origin)	1.5%
Hispanic Origin*	

*Hispanic children may be of any race.

Number of Children Under the Age of 20 1990 & 2000

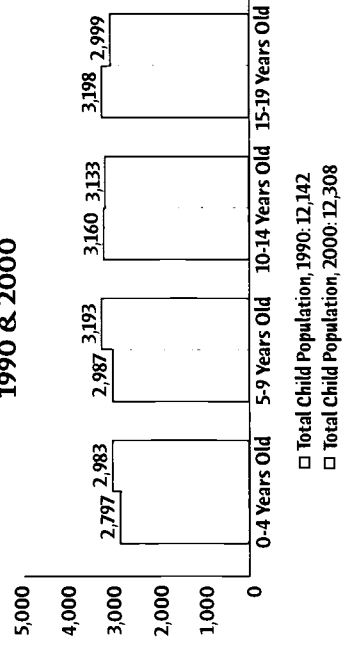

Health & Well-being

	Current Year	Base Year
Total # of Live Births (CY)	1999 571	1990 568
% of Low Birthweight Babies (CY)	1999 8.8	1990 6.3
% of Mothers who Received 1st Trimester Prenatal Care (CY)	1999 76.9	1990 75.8
% of Mothers who Smoked During Pregnancy (CY)	1999 23.8	1990 24.6
Non Marital Births as a % of All Births (CY)	1999 27.7	1990 22.2
Teen Birth Rate, Age 15-17 (CY)	1999 28.8	1990 35.3
Total # of Infant Deaths (CY)	1999 4	1990 2
Total # of Child Deaths, Age 1-14 (CY)	1999 4	1990 5
Total # of Teen Deaths by Accident, Homicide and Suicide (CY)	1999 1	1990 5
# of Children Enrolled in Hoosier Healthwise (SFY)	2000 2,564	1998 1,484
% Noncompliance with Youth Tobacco Access Laws (CY)	2000 10.0	1997 70.0

Education, Grades K-12

Public School Enrollment, K-12 (SY)	2000 7,434	1990 7,009
Non-Public School Enrollment (SY)	2001 358	1995 295
# of Home Schooled Children (SY)	2000 127	1990 0
# of Alternative School Participants (SY)	2001 21	1990 0
Total Per Pupil Expenditure (SY)	2000 \$6,483	1990 \$3,757
% of 10th Graders Passing the GQE Math Standard (SY)	2000 69.0	2000 69.0
% of 10th Graders Passing the GQE Language Standard (SY)	2000 73.0	2000 73.0
% of Graduates Passing the GQE (SY)	2000 93.0	2000 93.0
# of Public High School Graduates (SY)	2000 431	1990 524
% of High School Graduates (SY)	2000 92.4	1990 73.5
% of Freshman Class Graduating in 4 Years (SY)	2000 65.0	1990 85.5
% of Grads Intending 4-year College (SY)	2000 45.2	1990 46.5
% of Grads Intending Vocational/Tech School (SY)	2000 8.1	1990 8.2
# of Public School Student Dropouts (SY)	2000 43	1990 186
# of Expulsions and Suspensions (SY)	1999 1,720	1999 1,720

Juveniles and the Law

# of Juveniles Committed to the Dept. of Correction (CY)	2000 2	1994 7
# of Juvenile Status Case Filings (CY)	2000 20	1990 24
# of Juvenile Delinquency Case Filings (CY)	2000 130	1990 101



000000 136187

Percent of Households with Children Under 18 Headed by Parents and Others, Census 2000

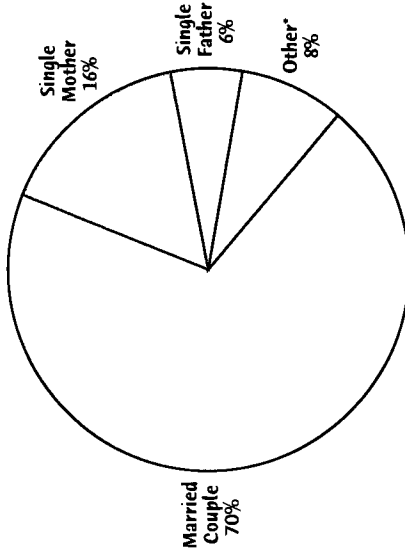

*"Other" includes households with children unrelated to the householder(s) and households with no adults present.

Number of Babies Born to Single Mothers Under Age 20 without a High School Diploma

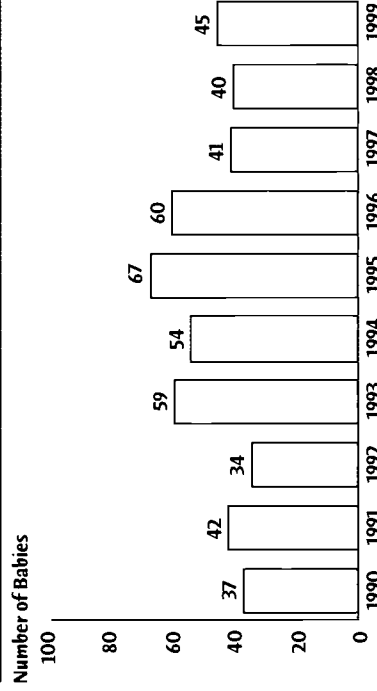

DATA YEAR DEFINITIONS

SFY - State Fiscal Year: July 1-June 30

SY - School Year: From the start of the school term in the fall through the end of the summer

FFY - Federal Fiscal Year: October 1-September 30

CY - Calendar Year: January 1 - December 31

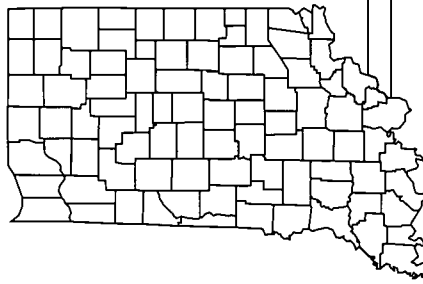

Madison County

Kids Count in Indiana 2001



Economic Well-being

	Current Year	Base Year
% of Children in Poverty, Age 0-17 (CY)	1997 17.0	1990 19.8
Per Capita Income (CY)	1999 \$23,759	1990 \$16,263
Unemployment Rate (CY)	2000 3.3	1990 6.0
Monthly Average of Families Receiving TANF (SFY)	2000 715	1990 1,492
Monthly Average of Persons Issued Food Stamps (SFY)	2000 7,363	1990 8,500
% of Students Receiving Free Lunches / Text Books (SY)	2001 25.9	1991 19.0

Early Childhood

# of First Steps Children Served (FFY)	2000 348	1998 265
# of Licensed Child Care Centers (SFY)	2000 11	1990 9
# of Licensed Child Care Homes (SFY)	2000 46	1990 25
# of Registered Child Care Ministries (SFY)	2000 11	1993 8
# of Licensed Child Care Slots per 100 Children, Age 0-4 (SFY)	2000 17	1996 12.8

Child Protection

# of Reported Cases of Child Abuse Processed by CPS (SFY)	2000 372	1990 569
% of Child Abuse Cases Substantiated by CPS (SFY)	2000 53.0	1990 58.7
# of Reported Cases of Child Neglect Processed by CPS (SFY)	2000 843	1990 958
% of Child Neglect Cases Substantiated by CPS (SFY)	2000 56.0	1990 57.9
# of Child Physical Abuse Cases Substantiated by CPS (SFY)	2000 128	1990 75
# of Child Sexual Abuse Cases Substantiated by CPS (SFY)	2000 71	1990 60
Child Abuse and Neglect Rate (SFY)	2000 21.6	1990 36.8
# of Child Abuse and Neglect Deaths (SFY)	2000 0	1990 1
# of Juvenile CHINS Case Filings (CY)	2000 58	1990 117

Racial/Ethnic Characteristics of Children Age 0-17 in Madison County

One Race (Non-Hispanic Origin)	85.7%
White	9.6%
Black	0.2%
American Indian or Alaska Native	0.4%
Asian	0.0%
Native Hawaiian or Other Pacific Islander	0.3%
Some Other Race	1.7%
Two or More Races (Non-Hispanic Origin)	2.1%
Hispanic Origin*	

*Hispanic children may be of any race.

Number of Children Under the Age of 20 1990 & 2000

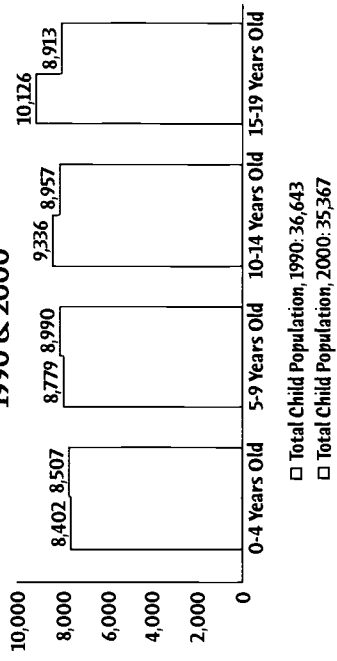

000000136188

Health & Well-being

	Current Year	Base Year
Total # of Live Births (CY)	1999 1,775	1990 1,809
% of Low Birthweight Babies (CY)	1999 8.5	1990 9.0
% of Mothers who Received 1st Trimester Prenatal Care (CY)	1999 83.1	1990 78.0
% of Mothers who Smoked During Pregnancy (CY)	1999 26.2	1990 34.3
Non Marital Births as a % of All Births (CY)	1999 41.7	1990 30.8
Teen Birth Rate, Age 15-17 (CY)	1999 29.9	1990 32.1
Total # of Infant Deaths (CY)	1999 12	1990 19
Total # of Child Deaths, Age 1-14 (CY)	1999 5	1990 7
Total # of Teen Deaths by Accident, Homicide and Suicide (CY)	1999 9	1990 5
# of Children Enrolled in Hoosier Healthwise (SFY)	2000 8,316	1998 5,303
% Noncompliance with Youth Tobacco Access Laws (CY)	2000 10.0	1997 15.2

Percent of Households with Children Under 18 Headed by Parents and Others, Census 2000

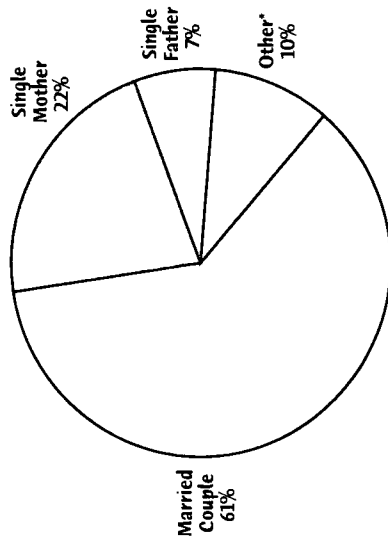

* "Other" includes households with children unrelated to the householder(s) and households with no adults present.

Education, Grades K-12

Public School Enrollment, K-12 (SY)	2000 20,043	1990 17,314
Non-Public School Enrollment (SY)	2001 1,904	1995 1,732
# of Home Schooled Children (SY)	2000 282	1990 8
# of Alternative School Participants (SY)	2001 772	1990 0
Total Per Pupil Expenditure (SY)	2000 \$6,879	1990 \$4,134
% of 10th Graders Passing the GQE Math Standard (SY)	2000 57.0	2000 57.0
% of 10th Graders Passing the GQE Language Standard (SY)	2000 66.0	2000 66.0
% of Graduates Passing the GQE (SY)	2000 92.6	2000 92.6
# of Public High School Graduates (SY)	2000 1,132	1990 1,643
% of High School Graduates (SY)	2000 84.9	1990 77.7
% of Freshman Class Graduating in 4 Years (SY)	2000 61.8	1990 80.9
% of Grads Intending 4-year College (SY)	2000 48.7	1990 49.7
% of Grads Intending Vocational/Tech School (SY)	2000 11.0	1990 6.0
# of Public School Student Dropouts (SY)	2000 224	1990 484
# of Expulsions and Suspensions (SY)	1999 12,404	1999 12,404

Juveniles and the Law

# of Juveniles Committed to the Dept. of Correction (CY)	2000 39	1994 28
# of Juvenile Status Case Filings (CY)	2000 495	1990 367
# of Juvenile Delinquency Case Filings (CY)	2000 836	1990 702

Number of Babies Born to Single Mothers Under Age 20 without a High School Diploma

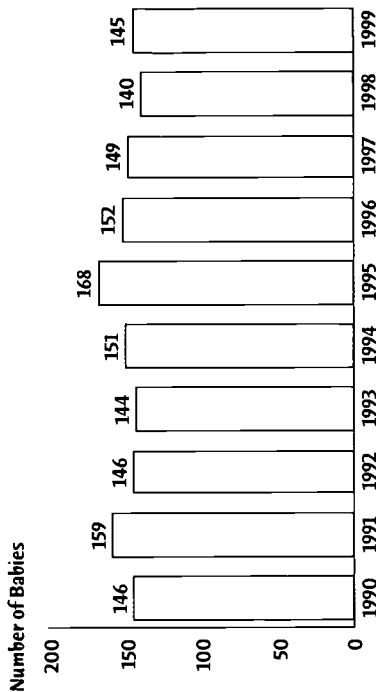

DATA YEAR DEFINITIONS

SFY - State Fiscal Year: July 1-June 30
 SY - School Year: From the start of the school term in the fall through the end of the summer
 FFY - Federal Fiscal Year: October 1-September 30
 CY - Calendar Year: January 1 - December 31

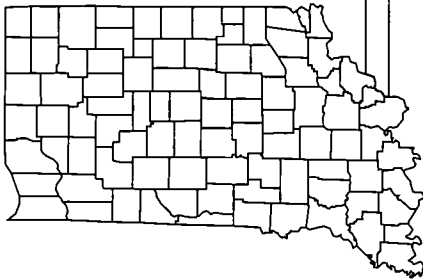

Marion County

Kids Count in Indiana 2001



Economic Well-being

	Current Year	Base Year
% of Children in Poverty, Age 0-17 (CY)	1997 19.5	1990 18.2
Per Capita Income (CY)	1999 \$30,685	1990 \$20,688
Unemployment Rate (CY)	2000 2.9	1990 3.7
Monthly Average of Families Receiving TANF (SFY)	2000 6,952	1990 10,394
Monthly Average of Persons Issued Food Stamps (SFY)	2000 55,647	1990 51,740
% of Students Receiving Free Lunches / Text Books (SY)	2001 33.0	1991 29.5

Early Childhood

# of First Steps Children Served (FFY)	2000 2,719	1998 1,411
# of Licensed Child Care Centers (SFY)	2000 142	1990 122
# of Licensed Child Care Homes (SFY)	2000 507	1990 254
# of Registered Child Care Ministries (SFY)	2000 104	1993 29
# of Licensed Child Care Slots per 100 Children, Age 0-4 (SFY)	2000 35.3	1996 30.3

Child Protection

# of Reported Cases of Child Abuse Processed by CPS (SFY)	2000 3,156	1990 5,210
% of Child Abuse Cases Substantiated by CPS (SFY)	2000 66.0	1990 48.8
# of Reported Cases of Child Neglect Processed by CPS (SFY)	2000 3,566	1990 4,007
% of Child Neglect Cases Substantiated by CPS (SFY)	2000 67.0	1990 44.5
# of Child Physical Abuse Cases Substantiated by CPS (SFY)	2000 1,051	1990 542
# of Child Sexual Abuse Cases Substantiated by CPS (SFY)	2000 1,034	1990 1,156
Child Abuse and Neglect Rate (SFY)	2000 21.9	1990 42.6
# of Child Abuse and Neglect Deaths (SFY)	2000 7	1990 12
# of Juvenile CHINS Case Filings (CY)	2000 1,430	1990 0

Racial/Ethnic Characteristics of Children Age 0-17 in Marion County

One Race (Non-Hispanic Origin)	
White	60.3%
Black	30.3%
American Indian or Alaska Native	0.2%
Asian	1.2%
Native Hawaiian or Other Pacific Islander	0.0%
Some Other Race	0.5%
Two or More Races (Non-Hispanic Origin)	2.8%
Hispanic Origin*	4.7%

*Hispanic children may be of any race.

Number of Children Under the Age of 20 1990 & 2000

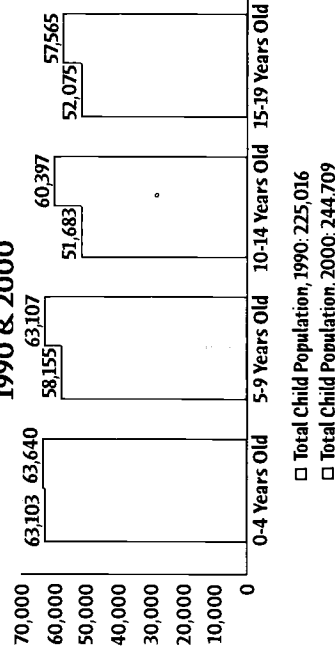

000000 136189

Health & Well-being

	Current Year	Base Year
Total # of Live Births (CY)	1999 14,183	1990 15,143
% of Low Birthweight Babies (CY)	1999 9.4	1990 8.2
% of Mothers who Received 1st Trimester Prenatal Care (CY)	1999 76.9	1990 75.7
% of Mothers who Smoked During Pregnancy (CY)	1999 21.1	1990 27.9
Non Marital Births as a % of All Births (CY)	1999 44.8	1990 36.0
Teen Birth Rate, Age 15-17 (CY)	1999 45.2	1990 61.5
Total # of Infant Deaths (CY)	1999 158	1990 188
Total # of Child Deaths, Age 1-14 (CY)	1999 50	1990 57
Total # of Teen Deaths by Accident, Homicide and Suicide (CY)	1999 36	1990 39
# of Children Enrolled in Hoosier Healthwise (SFY)	2000 64,639	1998 37,809
% Noncompliance with Youth Tobacco Access Laws (CY)	2000 18.0	1997 23.3

Percent of Households with Children Under 18 Headed by Parents and Others, Census 2000

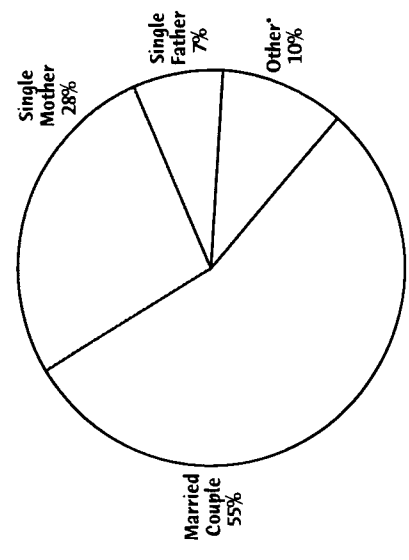

Education, Grades K-12

Public School Enrollment, K-12 (SY)	2000 125,853	1990 101,542
Non-Public School Enrollment (SY)	2001 26,389	1995 24,852
# of Home Schooled Children (SY)	2000 1,968	1990 16
# of Alternative School Participants (SY)	2001 6,354	1990 0
Total Per Pupil Expenditure (SY)	2000 \$7,481	1990 \$4,988
% of 10th Graders Passing the GOE Math Standard (SY)	2000 55.0	2000 55.0
% of 10th Graders Passing the GOE Language Standard (SY)	2000 62.0	2000 62.0
% of Graduates Passing the GOE (SY)	2000 94.4	2000 94.4
# of Public High School Graduates (SY)	2000 5,798	1990 6,724
% of High School Graduates (SY)	2000 89.9	1990 65.5
% of Freshman Class Graduating in 4 Years (SY)	2000 53.2	1990 73.2
% of Grads Intending 4-year College (SY)	2000 57.2	1990 41.9
% of Grads Intending Vocational/Tech School (SY)	2000 8.0	1990 14.6
# of Public School Student Dropouts (SY)	2000 989	1990 2,992
# of Expulsions and Suspensions (SY)	1999 53,625	1999 53,625

Juveniles and the Law

# of Juveniles Committed to the Dept. of Correction (CY)	2000 734	1994 599
# of Juvenile Status Case Filings (CY)	2000 1,041	1990 799
# of Juvenile Delinquency Case Filings (CY)	2000 5,032	1990 5,943

*"Other" includes households with children unrelated to the householder(s) and households with no adults present.

Number of Babies Born to Single Mothers Under Age 20 without a High School Diploma

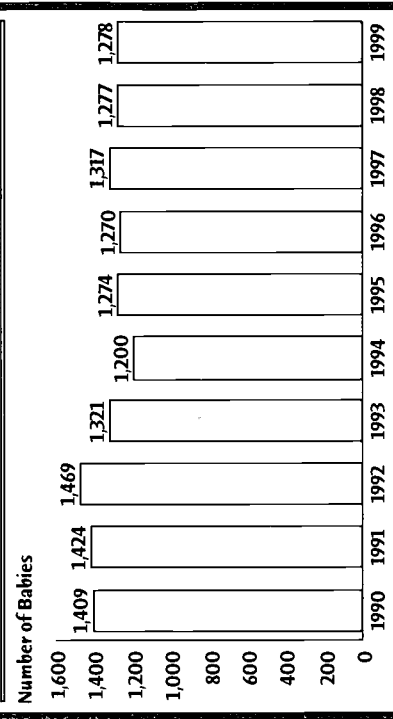

DATA YEAR DEFINITIONS

- SFY - State Fiscal Year: July 1-June 30
- SY - School Year: From the start of the school term in the fall through the end of the summer
- FFY - Federal Fiscal Year: October 1-September 30
- CY - Calendar Year: January 1 - December 31

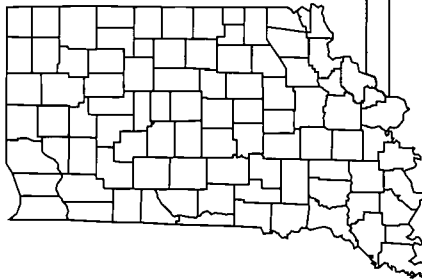

Marshall County

Kids Count in
Indiana 2001



Economic Well-being

	Current Year	Base Year
% of Children in Poverty, Age 0-17 (CY)	1997 10.3	1990 9.9
Per Capita Income (CY)	1999 \$23,314	1990 \$15,906
Unemployment Rate (CY)	2000 3.6	1990 5.4
Monthly Average of Families Receiving TANF (SFY)	2000 61	1990 115
Monthly Average of Persons Issued Food Stamps (SFY)	2000 1,183	1990 1,097
% of Students Receiving Free Lunches / Text Books (SY)	2001 17.7	1991 13.2

Early Childhood

# of First Steps Children Served (FFY)	2000 135	1998 74
# of Licensed Child Care Centers (SFY)	2000 3	1990 4
# of Licensed Child Care Homes (SFY)	2000 30	1990 17
# of Registered Child Care Ministries (SFY)	2000 2	1993 1
# of Licensed Child Care Slots per 100 Children, Age 0-4 (SFY)	2000 18	1996 16.2

Child Protection

# of Reported Cases of Child Abuse Processed by CPS (SFY)	2000 66	1990 224
% of Child Abuse Cases Substantiated by CPS (SFY)	2000 68.0	1990 62.9
# of Reported Cases of Child Neglect Processed by CPS (SFY)	2000 137	1990 341
% of Child Neglect Cases Substantiated by CPS (SFY)	2000 88.0	1990 60.4
# of Child Physical Abuse Cases Substantiated by CPS (SFY)	2000 23	1990 43
# of Child Sexual Abuse Cases Substantiated by CPS (SFY)	2000 22	1990 40
Child Abuse and Neglect Rate (SFY)	2000 12.8	1990 47.5
# of Child Abuse and Neglect Deaths (SFY)	2000 0	1990 2
# of Juvenile CHINS Case Filings (CY)	2000 117	1990 26

Racial/Ethnic Characteristics of Children Age 0-17 in Marshall County

One Race (Non-Hispanic Origin)	90.2%
White	0.3%
Black	0.4%
American Indian or Alaska Native	0.3%
Asian	0.0%
Native Hawaiian or Other Pacific Islander	0.1%
Some Other Race	1.2%
Two or More Races (Non-Hispanic Origin)	7.4%
Hispanic Origin*	

*Hispanic children may be of any race.

Number of Children Under the Age of 20 1990 & 2000

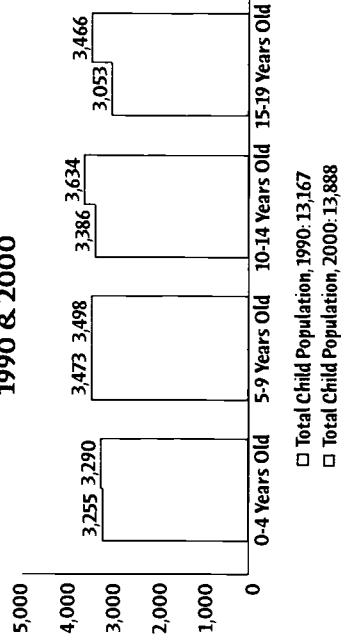

000000 136190

Health & Well-being

	Current Year	Base Year
Total # of Live Births (CY)	1999 680	1990 633
% of Low Birthweight Babies (CY)	1999 7.5	1990 5.5
% of Mothers who Received 1st Trimester Prenatal Care (CY)	1999 80.9	1990 76.7
% of Mothers who Smoked During Pregnancy (CY)	1999 21.8	1990 24.2
Non Marital Births as a % of All Births (CY)	1999 28.5	1990 19.7
Teen Birth Rate, Age 15-17 (CY)	1999 31.7	1990 22.5
Total # of Infant Deaths (CY)	1999 3	1990 7
Total # of Child Deaths, Age 1-14 (CY)	1999 5	1990 2
Total # of Teen Deaths by Accident, Homicide and Suicide (CY)	1999 3	1990 3
# of Children Enrolled in Hoosier Healthwise (SFY)	2000 1,731	1998 932
% Noncompliance with Youth Tobacco Access Laws (CY)	2000 40.0	1997 N/A

Percent of Households with Children Under 18 Headed by Parents and Others, Census 2000

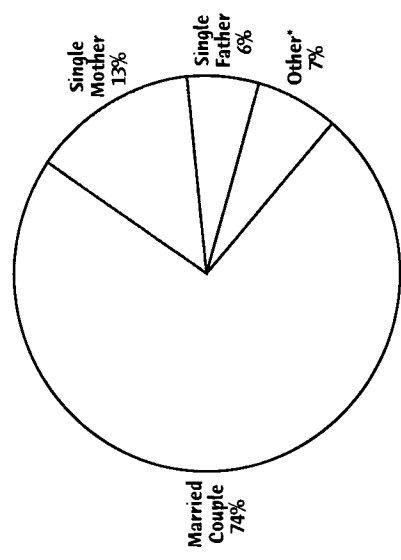

Education, Grades K-12

Public School Enrollment, K-12 (SY)	2000 7,853	1990 6,721
Non-Public School Enrollment (SY)	2001 1,365	1995 1,136
# of Home Schooled Children (SY)	2000 125	1990 5
# of Alternative School Participants (SY)	2001 62	1990 0
Total Per Pupil Expenditure (SY)	2000 \$5,879	1990 \$4,378
% of 10th Graders Passing the GQE Math Standard (SY)	2000 70.0	2000 70.0
% of 10th Graders Passing the GQE Language Standard (SY)	2000 73.0	2000 73.0
% of Graduates Passing the GQE (SY)	2000 99.6	2000 99.6
# of Public High School Graduates (SY)	2000 483	1990 450
% of High School Graduates (SY)	2000 91.0	1990 80.4
% of Freshman Class Graduating in 4 Years (SY)	2000 76.4	1990 79.2
% of Grads Intending 4-year College (SY)	2000 48.7	1990 30.3
% of Grads Intending Vocational/Tech School (SY)	2000 6.8	1990 9.0
# of Public School Student Dropouts (SY)	2000 58	1990 159
# of Expulsions and Suspensions (SY)	1999 1,679	1999 1,679

Juveniles and the Law

# of Juveniles Committed to the Dept. of Correction (CY)	2000 7	1994 8
# of Juvenile Status Case Filings (CY)	2000 43	1990 0
# of Juvenile Delinquency Case Filings (CY)	2000 80	1990 103

*"Other" includes households with children unrelated to the householder(s) and households with no adults present.

Number of Babies Born to Single Mothers Under Age 20 without a High School Diploma

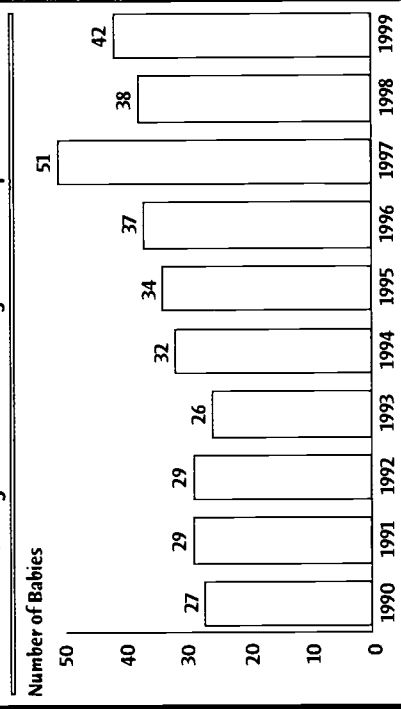

DATA YEAR DEFINITIONS

- SFY - State Fiscal Year: July 1-June 30
- SY - School Year: From the start of the school term in the fall through the end of the summer
- FFY - Federal Fiscal Year: October 1-September 30
- CY - Calendar Year: January 1-December 31

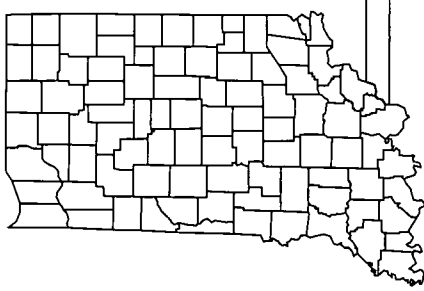

Martin County

Kids Count in Indiana 2001



Economic Well-being

	Current Year	Base Year
% of Children in Poverty, Age 0-17 (CY)	1997 16.9	1990 17.9
Per Capita Income (CY)	1999 \$20,595	1990 \$14,536
Unemployment Rate (CY)	2000 4.0	1990 6.4
Monthly Average of Families Receiving TANF (SFY)	2000 31	1990 96
Monthly Average of Persons Issued Food Stamps (SFY)	2000 607	1990 772
% of Students Receiving Free Lunches / Text Books (SY)	2001 23.5	1991 20.7

Early Childhood

# of First Steps Children Served (FFY)	2000 33	1998 23
# of Licensed Child Care Centers (SFY)	2000 1	1990 1
# of Licensed Child Care Homes (SFY)	2000 7	1990 2
# of Registered Child Care Ministries (SFY)	2000 0	1993 0
# of Licensed Child Care Slots per 100 Children, Age 0-4 (SFY)	2000 23.9	1996 20.4

Child Protection

# of Reported Cases of Child Abuse Processed by CPS (SFY)	2000 22	1990 48
% of Child Abuse Cases Substantiated by CPS (SFY)	2000 68.0	1990 54.2
# of Reported Cases of Child Neglect Processed by CPS (SFY)	2000 54	1990 98
% of Child Neglect Cases Substantiated by CPS (SFY)	2000 52.0	1990 69.4
# of Child Physical Abuse Cases Substantiated by CPS (SFY)	2000 7	1990 9
# of Child Sexual Abuse Cases Substantiated by CPS (SFY)	2000 8	1990 9
Child Abuse and Neglect Rate (SFY)	2000 16.0	1990 42.1
# of Child Abuse and Neglect Deaths (SFY)	2000 0	1990 0
# of Juvenile CHINS Case Filings (CY)	2000 9	1990 43

Racial/Ethnic Characteristics of Children Age 0-17 in Martin County

One Race (Non-Hispanic Origin)	98.2%
White	0.3%
Black	0.1%
American Indian or Alaska Native	0.1%
Asian	0.1%
Native Hawaiian or Other Pacific Islander	0.1%
Some Other Race	0.5%
Two or More Races (Non-Hispanic Origin)	0.7%
Hispanic Origin*	

*Hispanic children may be of any race.

Number of Children Under the Age of 20 1990 & 2000

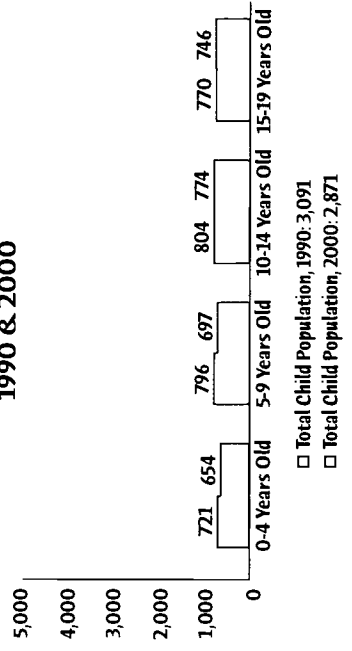

Health & Well-being

	Current Year	Base Year
Total # of Live Births (CY)	1999 155	1990 156
% of Low Birthweight Babies (CY)	1999 9.0	1990 6.4
% of Mothers who Received 1st Trimester Prenatal Care (CY)	1999 81.3	1990 64.1
% of Mothers who Smoked During Pregnancy (CY)	1999 22.6	1990 27.6
Non Marital Births as a % of All Births (CY)	1999 23.9	1990 12.8
Teen Birth Rate, Age 15-17 (CY)	1999 8.3	1990 8.6
Total # of Infant Deaths (CY)	1999 0	1990 1
Total # of Child Deaths, Age 1-14 (CY)	1999 0	1990 0
Total # of Teen Deaths by Accident, Homicide and Suicide (CY)	1999 0	1990 0
# of Children Enrolled in Hoosier Healthwise (SFY)	2000 787	1998 509
% Noncompliance with Youth Tobacco Access Laws (CY)	2000 N/A	1997 N/A

Percent of Households with Children Under 18 Headed by Parents and Others, Census 2000

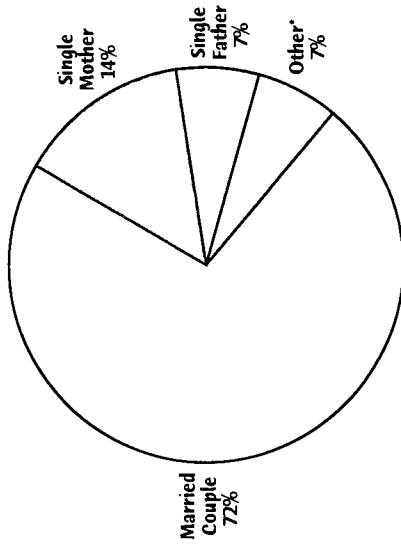

*"Other" includes households with children unrelated to the householder(s) and households with no adults present.

Education, Grades K-12

Public School Enrollment, K-12 (SY)	2000 1,847	1990 1,694
Non-Public School Enrollment (SY)	2001 20	1995 67
# of Home Schooled Children (SY)	2000 41	1990 0
# of Alternative School Participants (SY)	2001 0	1990 0
Total Per Pupil Expenditure (SY)	2000 \$6,268	1990 \$3,734
% of 10th Graders Passing the GQE Math Standard (SY)	2000 74.0	2000 74.0
% of 10th Graders Passing the GQE Language Standard (SY)	2000 75.0	2000 75.0
% of Graduates Passing the GQE (SY)	2000 96.1	2000 96.1
# of Public High School Graduates (SY)	2000 127	1990 147
% of High School Graduates (SY)	2000 89.2	1990 77.3
% of Freshman Class Graduating in 4 Years (SY)	2000 81.9	1990 98.7
% of Grads Intending 4-year College (SY)	2000 27.6	1990 42.1
% of Grads Intending Vocational/Tech School (SY)	2000 7.1	1990 6.9
# of Public School Student Dropouts (SY)	2000 16	1990 39
# of Expulsions and Suspensions (SY)	1999 297	1999 297

Juveniles and the Law

# of Juveniles Committed to the Dept. of Correction (CY)	2000 2	1994 1
# of Juvenile Status Case Filings (CY)	2000 39	1990 24
# of Juvenile Delinquency Case Filings (CY)	2000 41	1990 37

Number of Babies Born to Single Mothers Under Age 20 without a High School Diploma

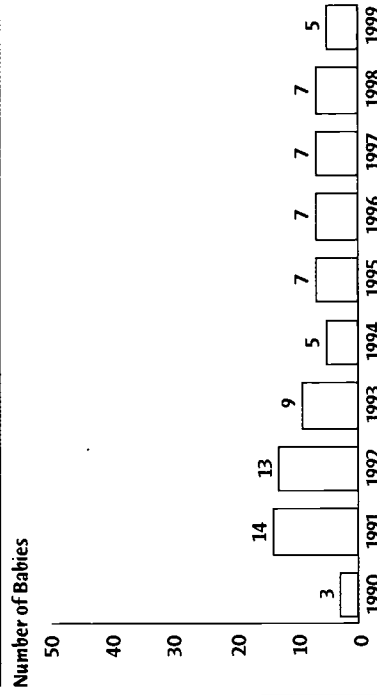

DATA YEAR DEFINITIONS

SFY - State Fiscal Year: July 1-June 30
 SY - School Year: From the start of the school term in the fall through the end of the summer
 FFY - Federal Fiscal Year: October 1-September 30
 CY - Calendar Year: January 1 - December 31

307

306

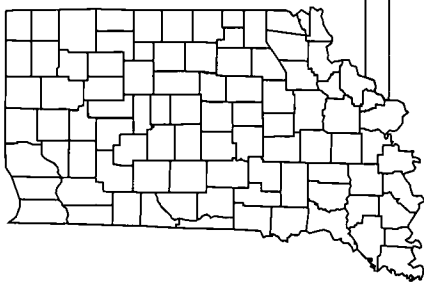

Miami County

Kids Count in Indiana 2001



Economic Well-being

	Current Year	Base Year
% of Children in Poverty, Age 0-17 (CY)	1997 16.2	1990 15.3
Per Capita Income (CY)	1999 \$20,718	1990 \$15,054
Unemployment Rate (CY)	2000 4.2	1990 6.3
Monthly Average of Families Receiving TANF (SFY)	2000 111	1990 265
Monthly Average of Persons Issued Food Stamps (SFY)	2000 1,560	1990 2,268
% of Students Receiving Free Lunches / Text Books (SY)	2001 18.2	1991 15.7

Early Childhood

# of First Steps Children Served (FFY)	2000 92	1998 65
# of Licensed Child Care Centers (SFY)	2000 2	1990 1
# of Licensed Child Care Homes (SFY)	2000 12	1990 1
# of Registered Child Care Ministries (SFY)	2000 4	1993 0
# of Licensed Child Care Slots per 100 Children, Age 0-4 (SFY)	2000 10.4	1996 9.3

Child Protection

# of Reported Cases of Child Abuse Processed by CPS (SFY)	2000 77	1990 132
% of Child Abuse Cases Substantiated by CPS (SFY)	2000 69.0	1990 62.9
# of Reported Cases of Child Neglect Processed by CPS (SFY)	2000 93	1990 151
% of Child Neglect Cases Substantiated by CPS (SFY)	2000 75.0	1990 63.6
# of Child Physical Abuse Cases Substantiated by CPS (SFY)	2000 38	1990 21
# of Child Sexual Abuse Cases Substantiated by CPS (SFY)	2000 15	1990 22
Child Abuse and Neglect Rate (SFY)	2000 13.2	1990 22.5
# of Child Abuse and Neglect Deaths (SFY)	2000 0	1990 0
# of Juvenile CHINS Case Filings (CY)	2000 14	1990 19

Racial/Ethnic Characteristics of Children Age 0-17 in Miami County

One Race (Non-Hispanic Origin)	92.2%
White	1.9%
Black	1.2%
American Indian or Alaska Native	0.3%
Asian	0.0%
Native Hawaiian or Other Pacific Islander	0.2%
Some Other Race	2.1%
Two or More Races (Non-Hispanic Origin)	2.1%
Hispanic Origin*	2.1%

*Hispanic children may be of any race.

Number of Children Under the Age of 20 1990 & 2000

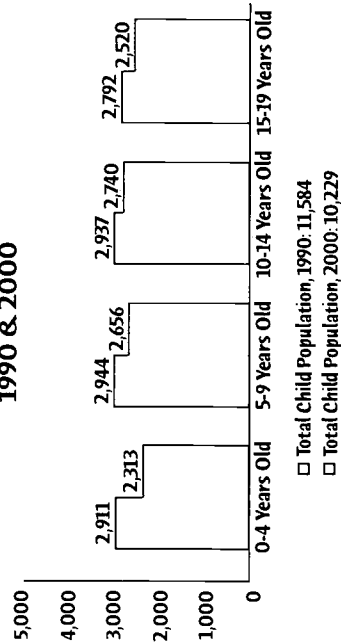

000000 136192

Birth & Well-being

	Current Year	Base Year
Total # of Live Births (CY)	1999 431	1990 610
% of Low Birthweight Babies (CY)	1999 6.5	1990 5.7
% of Mothers who Received 1st Trimester Prenatal Care (CY)	1999 77.3	1990 81.4
% of Mothers who Smoked During Pregnancy (CY)	1999 31.6	1990 27.4
Non Marital Births as a % of All Births (CY)	1999 33.9	1990 17.2
Teen Birth Rate, Age 15-17 (CY)	1999 28.2	1990 29.3
Total # of Infant Deaths (CY)	1999 2	1990 1
Total # of Child Deaths, Age 1-14 (CY)	1999 1	1990 0
Total # of Teen Deaths by Accident, Homicide and Suicide (CY)	1999 4	1990 1
# of Children Enrolled in Hoosier Healthwise (SFY)	2000 2,214	1998 1,329
% Noncompliance with Youth Tobacco Access Laws (CY)	2000 10.0	1997 N/A

Percent of Households with Children Under 18 Headed by Parents and Others, Census 2000

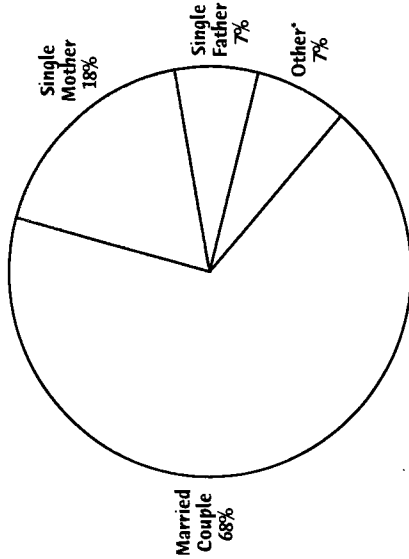

*"Other" includes households with children unrelated to the householder(s) and households with no adults present.

Education, Grades K-12

Public School Enrollment, K-12 (SY)	2000 7,627	1990 7,151
Non-Public School Enrollment (SY)	2001 126	1995 281
# of Home Schooled Children (SY)	2000 141	1990 0
# of Alternative School Participants (SY)	2001 94	1990 0
Total Per Pupil Expenditure (SY)	2000 \$6,039	1990 \$3,808
% of 10th Graders Passing the GQE Math Standard (SY)	2000 68.0	2000 68.0
% of 10th Graders Passing the GQE Language Standard (SY)	2000 70.0	2000 70.0
% of Graduates Passing the GQE (SY)	2000 97.1	2000 97.1
# of Public High School Graduates (SY)	2000 453	1990 596
% of High School Graduates (SY)	2000 88.6	1990 83.4
% of Freshman Class Graduating in 4 Years (SY)	2000 70.1	1990 89.2
% of Grads Intending 4-year College (SY)	2000 58.1	1990 49.4
% of Grads Intending Vocational/Tech School (SY)	2000 10.2	1990 5.0
# of Public School Student Dropouts (SY)	2000 68	1990 128
# of Expulsions and Suspensions (SY)	1999 1,511	1999 1,511

Juveniles and the Law

# of Juveniles Committed to the Dept. of Correction (CY)	2000 19	1994 7
# of Juvenile Status Case Filings (CY)	2000 24	1990 20
# of Juvenile Delinquency Case Filings (CY)	2000 122	1990 73

Number of Babies Born to Single Mothers Under Age 20 without a High School Diploma

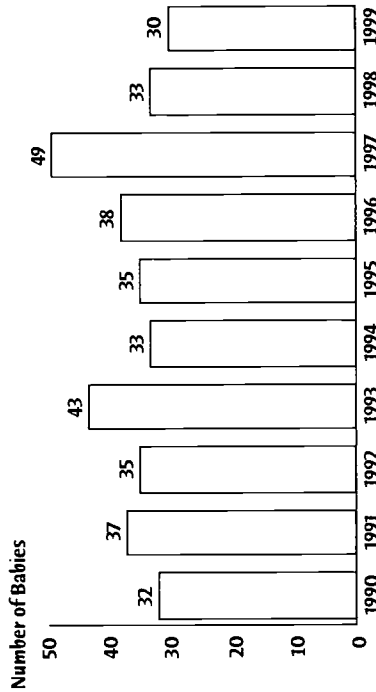

DATA YEAR DEFINITIONS

SFY - State Fiscal Year: July 1-June 30

SY - School Year: From the start of the school term in the fall through the end of the summer

FFY - Federal Fiscal Year: October 1-September 30

CY - Calendar Year: January 1 - December 31

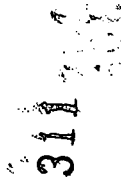



Monroe County

Kids Count in
Indiana 2001



Economic Well-being

	Current Year	Base Year
% of Children in Poverty, Age 0-17 (CY)	1997 14.1	1990 14.3
Per Capita Income (CY)	1999 \$23,957	1990 \$15,585
Unemployment Rate (CY)	2000 2.0	1990 3.2
Monthly Average of Families Receiving TANF (SFY)	2000 285	1990 688
Monthly Average of Persons Issued Food Stamps (SFY)	2000 4,037	1990 4,615
% of Students Receiving Free Lunches / Text Books (SY)	2001 16.8	1991 14.5

Early Childhood

# of First Steps Children Served (FFY)	2000 293	1998 248
# of Licensed Child Care Centers (SFY)	2000 18	1990 19
# of Licensed Child Care Homes (SFY)	2000 73	1990 59
# of Registered Child Care Ministries (SFY)	2000 11	1993 5
# of Licensed Child Care Slots per 100 Children, Age 0-4 (SFY)	2000 36.2	1996 30.7

Child Protection

# of Reported Cases of Child Abuse Processed by CPS (SFY)	2000 325	1990 220
% of Child Abuse Cases Substantiated by CPS (SFY)	2000 62.0	1990 43.2
# of Reported Cases of Child Neglect Processed by CPS (SFY)	2000 577	1990 233
% of Child Neglect Cases Substantiated by CPS (SFY)	2000 65.0	1990 33.0
# of Child Physical Abuse Cases Substantiated by CPS (SFY)	2000 117	1990 38
# of Child Sexual Abuse Cases Substantiated by CPS (SFY)	2000 84	1990 33
Child Abuse and Neglect Rate (SFY)	2000 26.9	1990 21.9
# of Child Abuse and Neglect Deaths (SFY)	2000 1	1990 1
# of Juvenile CHINS Case Filings (CY)	2000 219	1990 14

Racial/Ethnic Characteristics of Children Age 0-17 in Monroe County

One Race (Non-Hispanic Origin)	88.1%
White	3.7%
Black	0.2%
American Indian or Alaska Native	2.2%
Asian	0.0%
Native Hawaiian or Other Pacific Islander	0.6%
Some Other Race	2.8%
Two or More Races (Non-Hispanic Origin)	2.3%
Hispanic Origin*	

*Hispanic children may be of any race.

Number of Children Under the Age of 20

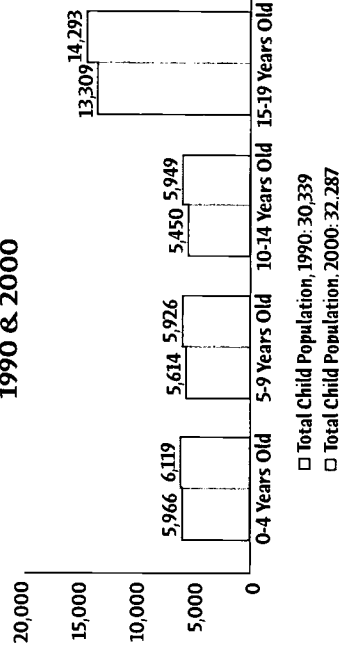

000000 136193

Health & Well-being

	Current Year	Base Year
Total # of Live Births (CY)	1999 1,261	1990 1,271
% of Low Birthweight Babies (CY)	1999 6.9	1990 5.1
% of Mothers who Received 1st Trimester Prenatal Care (CY)	1999 74.9	1990 80.1
% of Mothers who Smoked During Pregnancy (CY)	1999 18.6	1990 18.2
Non Marital Births as a % of All Births (CY)	1999 25.9	1990 18.0
Teen Birth Rate, Age 15-17 (CY)	1999 22.8	1990 30.6
Total # of Infant Deaths (CY)	1999 9	1990 8
Total # of Child Deaths, Age 1-14 (CY)	1999 3	1990 8
Total # of Teen Deaths by Accident, Homicide and Suicide (CY)	1999 1	1990 0
# of Children Enrolled in Hoosier Healthwise (SFY)	2000 4,497	1998 2,660
% Noncompliance with Youth Tobacco Access Laws (CY)	2000 30.0	1997 25.6

Percent of Households with Children Under 18 Headed by Parents and Others, Census 2000

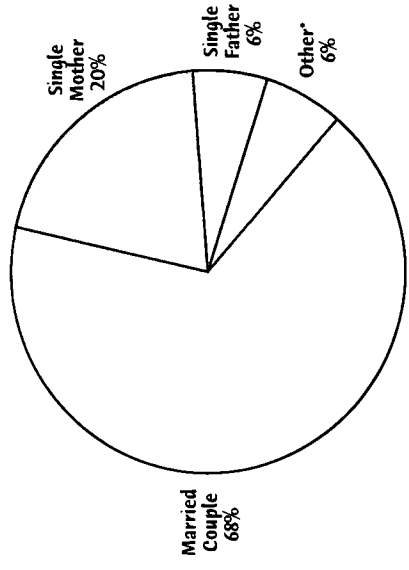

*"Other" includes households with children unrelated to the householder(s) and households with no adults present.

Education, Grades K-12

Public School Enrollment, K-12 (SY)	2000 13,208	1990 11,157
Non-Public School Enrollment (SY)	2001 1,827	1995 1,493
# of Home Schooled Children (SY)	2000 301	1990 5
# of Alternative School Participants (SY)	2001 295	1990 0
Total Per Pupil Expenditure (SY)	2000 \$6,532	1990 \$3,977
% of 10th Graders Passing the GQE Math Standard (SY)	2000 71.0	2000 71.0
% of 10th Graders Passing the GQE Language Standard (SY)	2000 75.0	2000 75.0
% of Graduates Passing the GQE (SY)	2000 94.8	2000 94.8
# of Public High School Graduates (SY)	2000 863	1990 798
% of High School Graduates (SY)	2000 86.5	1990 77.7
% of Freshman Class Graduating in 4 Years (SY)	2000 76.8	1990 89.7
% of Grads Intending 4-year College (SY)	2000 62.7	1990 41.7
% of Grads Intending Vocational/Tech School (SY)	2000 4.6	1990 8.2
# of Public School Student Dropouts (SY)	2000 140	1990 250
# of Expulsions and Suspensions (SY)	1999 2,457	1999 2,457

Juveniles and the Law

# of Juveniles Committed to the Dept. of Correction (CY)	2000 8	1994 3
# of Juvenile Status Case Filings (CY)	2000 94	1990 0
# of Juvenile Delinquency Case Filings (CY)	2000 218	1990 358

Number of Babies Born to Single Mothers Under Age 20 without a High School Diploma

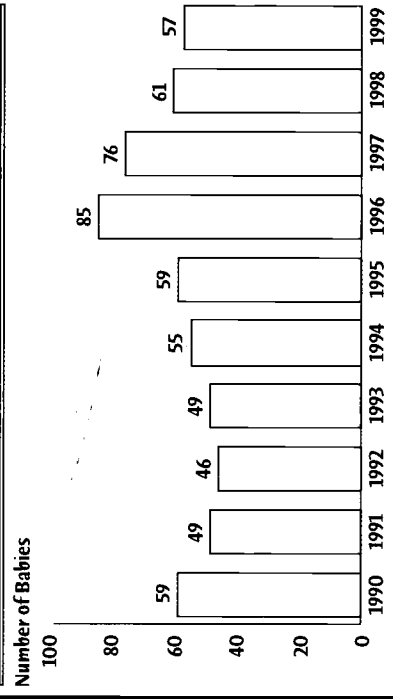

DATA YEAR DEFINITIONS

- SFY - State Fiscal Year: July 1-June 30
- SY - School Year: From the start of the school term in the fall through the end of the summer
- FFY - Federal Fiscal Year: October 1-September 30
- CY - Calendar Year: January 1 - December 31

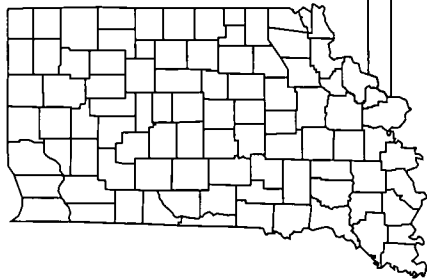

Montgomery County

Kids Count in
Indiana 2001



Economic Well-being

	Current Year	Base Year
% of Children in Poverty, Age 0-17 (CY)	1997 12.5	1990 11.8
Per Capita Income (CY)	1999 \$23,184	1990 \$16,639
Unemployment Rate (CY)	2000 2.7	1990 3.7
Monthly Average of Families Receiving TANF (SFY)	2000 127	1990 175
Monthly Average of Persons Issued Food Stamps (SFY)	2000 1,705	1990 1,181
% of Students Receiving Free Lunches / Text Books (SY)	2001 18.2	1991 11.8

Early Childhood

# of First Steps Children Served (FFY)	2000 135	1998 90
# of Licensed Child Care Centers (SFY)	2000 3	1990 3
# of Licensed Child Care Homes (SFY)	2000 21	1990 0
# of Registered Child Care Ministries (SFY)	2000 2	1993 1
# of Licensed Child Care Slots per 100 Children, Age 0-4 (SFY)	2000 21.6	1996 14.4

Child Protection

# of Reported Cases of Child Abuse Processed by CPS (SFY)	2000 98	1990 176
% of Child Abuse Cases Substantiated by CPS (SFY)	2000 60.0	1990 53.4
# of Reported Cases of Child Neglect Processed by CPS (SFY)	2000 248	1990 278
% of Child Neglect Cases Substantiated by CPS (SFY)	2000 34.0	1990 50.4
# of Child Physical Abuse Cases Substantiated by CPS (SFY)	2000 35	1990 33
# of Child Sexual Abuse Cases Substantiated by CPS (SFY)	2000 24	1990 10
Child Abuse and Neglect Rate (SFY)	2000 16.0	1990 45.7
# of Child Abuse and Neglect Deaths (SFY)	2000 0	1990 2
# of Juvenile CHINS Case Filings (CY)	2000 143	1990 36

Racial/Ethnic Characteristics of Children Age 0-17 in Montgomery County

One Race (Non-Hispanic Origin)	95.4%
White	0.9%
Black	0.3%
American Indian or Alaska Native	0.3%
Asian	0.0%
Native Hawaiian or Other Pacific Islander	0.2%
Some Other Race	1.2%
Two or More Races (Non-Hispanic Origin)	1.6%
Hispanic Origin*	

*Hispanic children may be of any race.

Number of Children Under the Age of 20 1990 & 2000

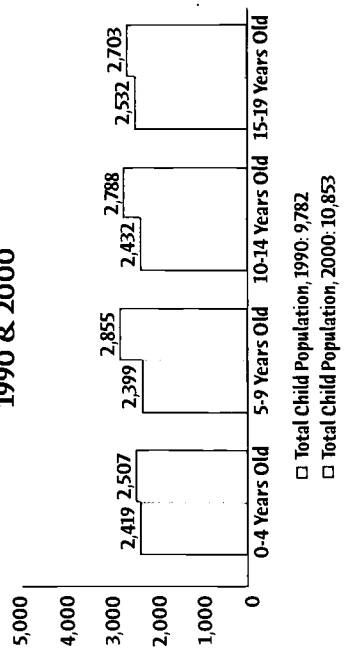

316

Health & Well-being

	Current Year	Base Year
# of Live Births (CY)	1999 534	1990 525
% of Low Birthweight Babies (CY)	1999 8.4	1990 5.5
% of Mothers who Received 1st Trimester Prenatal Care (CY)	1999 83.7	1990 78.9
% of Mothers who Smoked During Pregnancy (CY)	1999 30.3	1990 31.0
Non Marital Births as a % of All Births (CY)	1999 33.1	1990 14.9
Teen Birth Rate, Age 15-17 (CY)	1999 29.3	1990 17.9
Total # of Infant Deaths (CY)	1999 7	1990 5
Total # of Child Deaths, Age 1-14 (CY)	1999 1	1990 3
Total # of Teen Deaths by Accident, Homicide and Suicide (CY)	1999 3	1990 2
# of Children Enrolled in Hoosier Healthwise (SFY)	2000 2,013	1998 1,051
% Noncompliance with Youth Tobacco Access Laws (CY)	2000 N/A	1997 10.0

Education, Grades K-12

Public School Enrollment, K-12 (SY)	2000 6,698	1990 5,538
Non-Public School Enrollment (SY)	2001 108	1995 98
# of Home Schooled Children (SY)	2000 75	1990 5
# of Alternative School Participants (SY)	2001 215	1990 0
Total Per Pupil Expenditure (SY)	2000 \$6,455	1990 \$4,384
% of 10th Graders Passing the GQE Math Standard (SY)	2000 68.0	2000 68.0
% of 10th Graders Passing the GQE Language Standard (SY)	2000 71.0	2000 71.0
% of Graduates Passing the GQE (SY)	2000 94.3	2000 94.3
# of Public High School Graduates (SY)	2000 389	1990 412
% of High School Graduates (SY)	2000 89.3	1990 82.0
% of Freshman Class Graduating in 4 Years (SY)	2000 74.1	1990 87.5
% of Grads Intending 4-year College (SY)	2000 54.5	1990 43.5
% of Grads Intending Vocational/Tech School (SY)	2000 18.3	1990 4.7
# of Public School Student Dropouts (SY)	2000 51	1990 94
# of Expulsions and Suspensions (SY)	1999 832	1999 832

Juveniles and the Law

# of Juveniles Committed to the Dept. of Correction (CY)	2000 3	1994 2
# of Juvenile Status Case Filings (CY)	2000 0	1990 0
# of Juvenile Delinquency Case Filings (CY)	2000 118	1990 37

Percent of Households with Children Under 18 Headed by Parents and Others, Census 2000

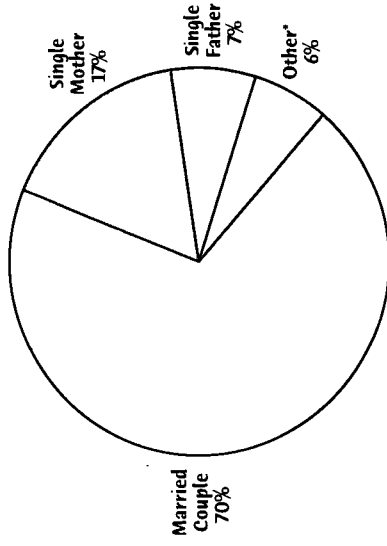

* "Other" includes households with children unrelated to the householder(s) and households with no adults present.

Number of Babies Born to Single Mothers Under Age 20 without a High School Diploma

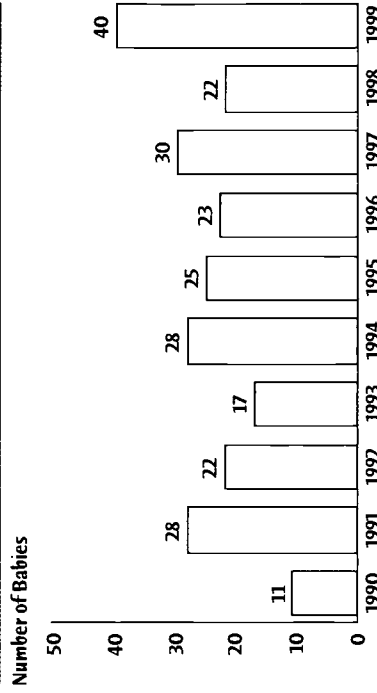

DATA YEAR DEFINITIONS

- SFY - State Fiscal Year: July 1-June 30
- SY - School Year: From the start of the school term in the fall through the end of the summer
- FFY - Federal Fiscal Year: October 1-September 30
- CY - Calendar Year: January 1 - December 31

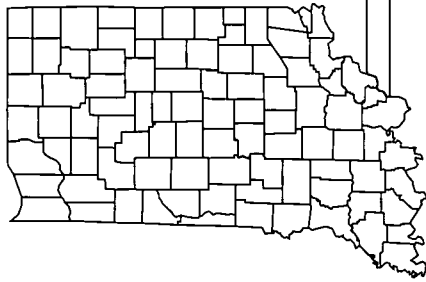

Morgan County

Kids Count in Indiana 2001



Economic Well-being

	Current Year	Base Year
% of Children in Poverty, Age 0-17 (CY)	1997 11.4	1990 8.4
Per Capita Income (CY)	1999 \$24,442	1990 \$16,134
Unemployment Rate (CY)	2000 2.4	1990 4.2
Monthly Average of Families Receiving TANF (SFY)	2000 165	1990 299
Monthly Average of Persons Issued Food Stamps (SFY)	2000 2,689	1990 2,629
% of Students Receiving Free Lunches / Text Books (SY)	2001 12.9	1991 11.5

Early Childhood

# of First Steps Children Served (FFY)	2000 175	1998 105
# of Licensed Child Care Centers (SFY)	2000 6	1990 4
# of Licensed Child Care Homes (SFY)	2000 20	1990 7
# of Registered Child Care Ministries (SFY)	2000 9	1993 4
# of Licensed Child Care Slots per 100 Children, Age 0-4 (SFY)	2000 13.9	1996 19

Child Protection

# of Reported Cases of Child Abuse Processed by CPS (SFY)	2000 155	1990 422
% of Child Abuse Cases Substantiated by CPS (SFY)	2000 65.0	1990 57.6
# of Reported Cases of Child Neglect Processed by CPS (SFY)	2000 178	1990 504
% of Child Neglect Cases Substantiated by CPS (SFY)	2000 61.0	1990 48.2
# of Child Physical Abuse Cases Substantiated by CPS (SFY)	2000 35	1990 70
# of Child Sexual Abuse Cases Substantiated by CPS (SFY)	2000 65	1990 88
Child Abuse and Neglect Rate (SFY)	2000 11.6	1990 54.3
# of Child Abuse and Neglect Deaths (SFY)	2000 4	1990 0
# of Juvenile CHINS Case Filings (CY)	2000 37	1990 51

Racial/Ethnic Characteristics of Children Age 0-17 in Morgan County

One Race (Non-Hispanic Origin)	Percentage
White	97.6%
Black	0.1%
American Indian or Alaska Native	0.2%
Asian	0.2%
Native Hawaiian or Other Pacific Islander	0.0%
Some Other Race	0.0%
Two or More Races (Non-Hispanic Origin)	0.9%
Hispanic Origin*	1.0%

*Hispanic children may be of any race.

Number of Children Under the Age of 20 1990 & 2000

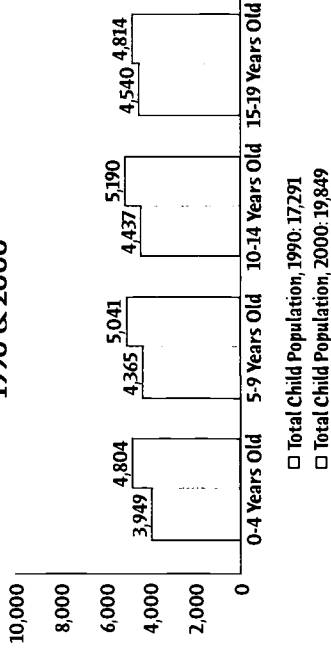

Health & Well-being

	Current Year	Base Year
total # of Live Births (CY)	1999 985	1990 877
% of Low Birthweight Babies (CY)	1999 8.9	1990 6.8
% of Mothers who Received 1st Trimester Prenatal Care (CY)	1999 85.7	1990 77.1
% of Mothers who Smoked During Pregnancy (CY)	1999 25.6	1990 34.0
Non Marital Births as a % of All Births (CY)	1999 27.4	1990 20.8
Teen Birth Rate, Age 15-17 (CY)	1999 20.6	1990 33.6
Total # of Infant Deaths (CY)	1999 5	1990 10
Total # of Child Deaths, Age 1-14 (CY)	1999 8	1990 1
Total # of Teen Deaths by Accident, Homicide and Suicide (CY)	1999 5	1990 3
# of Children Enrolled in Hoosier Healthwise (SFY)	2000 2,919	1998 1,659
% Noncompliance with Youth Tobacco Access Laws (CY)	2000 20.0	1997 25.0

Percent of Households with Children Under 18 Headed by Parents and Others, Census 2000

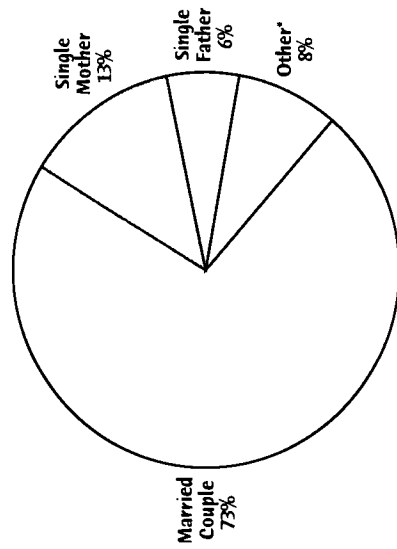

*"Other" includes households with children unrelated to the householder(s) and households with no adults present.

Education, Grades K-12

Public School Enrollment, K-12 (SY)	2000 11,340	1990 9,471
Non-Public School Enrollment (SY)	2001 723	1995 445
# of Home Schooled Children (SY)	2000 256	1990 4
# of Alternative School Participants (SY)	2001 83	1990 0
Total Per Pupil Expenditure (SY)	2000 \$5,782	1990 \$3,662
% of 10th Graders Passing the GQE Math Standard (SY)	2000 67.0	2000 67.0
% of 10th Graders Passing the GQE Language Standard (SY)	2000 70.0	2000 70.0
% of Graduates Passing the GQE (SY)	2000 98.1	2000 98.1
# of Public High School Graduates (SY)	2000 669	1990 784
% of High School Graduates (SY)	2000 82.0	1990 76.5
% of Freshman Class Graduating in 4 Years (SY)	2000 67.6	1990 82.6
% of Grads Intending 4-year College (SY)	2000 52.5	1990 35.0
% of Grads Intending Vocational/Tech School (SY)	2000 14.2	1990 7.0
# of Public School Student Dropouts (SY)	2000 164	1990 214
# of Expulsions and Suspensions (SY)	1999 3,189	1999 3,189

Juveniles and the Law

# of Juveniles Committed to the Dept. of Correction (CY)	2000 22	1994 10
# of Juvenile Status Case Filings (CY)	2000 56	1990 58
# of Juvenile Delinquency Case Filings (CY)	2000 190	1990 88

Number of Babies Born to Single Mothers Under Age 20 without a High School Diploma

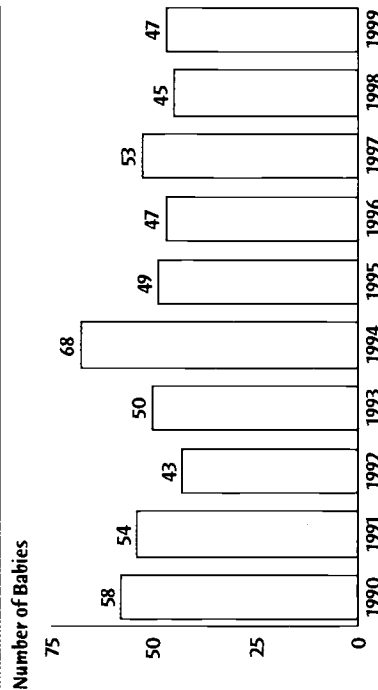

DATA YEAR DEFINITIONS

SFY - State Fiscal Year: July 1-June 30
 SY - School Year: From the start of the school term in the fall through the end of the summer
 FFY - Federal Fiscal Year: October 1-September 30
 CY - Calendar Year: January 1 - December 31



Newton County



Economic Well-being

	Current Year	Base Year
% of Children in Poverty, Age 0-17 (CY)	1997 14.0	1990 12.6
Per Capita Income (CY)	1999 \$18,835	1990 \$14,802
Unemployment Rate (CY)	2000 3.7	1990 4.6
Monthly Average of Families Receiving TANF (SFY)	2000 52	1990 83
Monthly Average of Persons Issued Food Stamps (SFY)	2000 587	1990 563
% of Students Receiving Free Lunches / Text Books (SY)	2001 16.2	1991 14.1

Early Childhood

# of First Steps Children Served (FFY)	2000 30	1998 18
# of Licensed Child Care Centers (SFY)	2000 1	1990 0
# of Licensed Child Care Homes (SFY)	2000 5	1990 2
# of Registered Child Care Ministries (SFY)	2000 0	1993 0
# of Licensed Child Care Slots per 100 Children, Age 0-4 (SFY)	2000 11.5	1996 1.8

Child Protection

# of Reported Cases of Child Abuse Processed by CPS (SFY)	2000 19	1990 72
% of Child Abuse Cases Substantiated by CPS (SFY)	2000 53.0	1990 45.8
# of Reported Cases of Child Neglect Processed by CPS (SFY)	2000 10	1990 44
% of Child Neglect Cases Substantiated by CPS (SFY)	2000 70.0	1990 54.5
# of Child Physical Abuse Cases Substantiated by CPS (SFY)	2000 6	1990 6
# of Child Sexual Abuse Cases Substantiated by CPS (SFY)	2000 4	1990 1
Child Abuse and Neglect Rate (SFY)	2000 4.0	1990 24.1
# of Child Abuse and Neglect Deaths (SFY)	2000 0	1990 0
# of Juvenile CHINS Case Filings (CY)	2000 25	1990 24

Racial/Ethnic Characteristics of Children Age 0-17 in Newton County

One Race (Non-Hispanic Origin)	93.9%
White	0.2%
Black	0.3%
American Indian or Alaska Native	0.2%
Asian	0.0%
Native Hawaiian or Other Pacific Islander	0.0%
Some Other Race	0.8%
Two or More Races (Non-Hispanic Origin)	4.6%
Hispanic Origin*	
*Hispanic children may be of any race.	

Number of Children Under the Age of 20 1990 & 2000

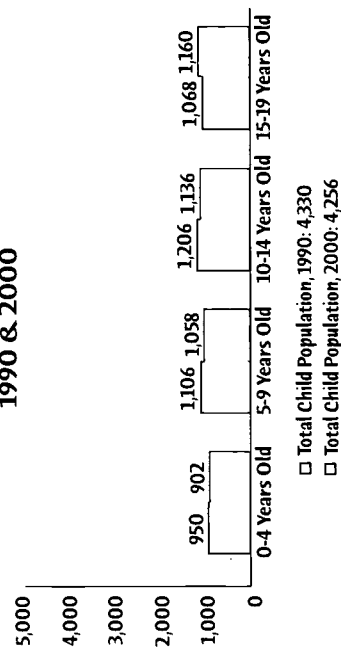

000000 136196

Health & Well-being

	Current Year	Base Year
Total # of Live Births (CY)	1999 208	1990 171
% of Low Birthweight Babies (CY)	1999 5.3	1990 7.6
% of Mothers who Received 1st Trimester Prenatal Care (CY)	1999 84.1	1990 81.8
% of Mothers who Smoked During Pregnancy (CY)	1999 29.8	1990 33.9
Non Marital Births as a % of All Births (CY)	1999 26.9	1990 21.1
Teen Birth Rate, Age 15-17 (CY)	1999 13.2	1990 12.1
Total # of Infant Deaths (CY)	1999 2	1990 0
Total # of Child Deaths, Age 1-14 (CY)	1999 2	1990 3
Total # of Teen Deaths by Accident, Homicide and Suicide (CY)	1999 1	1990 1
# of Children Enrolled in Hoosier Healthwise (SFY)	2000 669	1998 469
% Noncompliance with Youth Tobacco Access Laws (CY)	2000 N/A	1997 N/A

Percent of Households with Children Under 18 Headed by Parents and Others, Census 2000

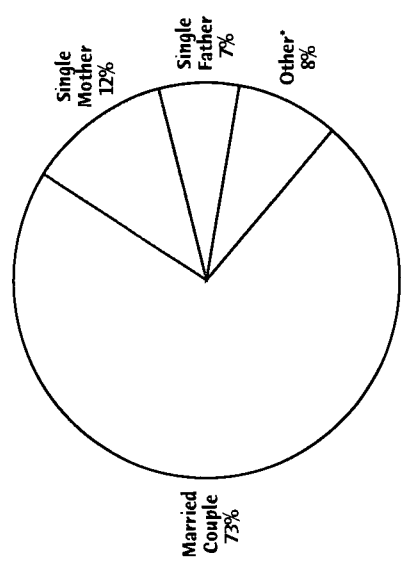

*"Other" includes households with children unrelated to the householder(s) and households with no adults present.

Education, Grades K-12

Public School Enrollment, K-12 (SY)	2000 2,877	1990 2,060
Non-Public School Enrollment (SY)	2001 54	1995 153
# of Home Schooled Children (SY)	2000 37	1990 0
# of Alternative School Participants (SY)	2001 35	1990 0
Total Per Pupil Expenditure (SY)	2000 \$6,482	1990 \$3,795
% of 10th Graders Passing the GQE Math Standard (SY)	2000 59.0	2000 59.0
% of 10th Graders Passing the GQE Language Standard (SY)	2000 69.0	2000 69.0
% of Graduates Passing the GQE (SY)	2000 93.4	2000 93.4
# of Public High School Graduates (SY)	2000 198	1990 196
% of High School Graduates (SY)	2000 91.0	1990 81.2
% of Freshman Class Graduating in 4 Years (SY)	2000 73.6	1990 81.0
% of Grads Intending 4-year College (SY)	2000 42.4	1990 36.2
% of Grads Intending Vocational/Tech School (SY)	2000 9.6	1990 6.5
# of Public School Student Dropouts (SY)	2000 20	1990 55
# of Expulsions and Suspensions (SY)	1999 627	1999 627

Number of Babies Born to Single Mothers Under Age 20 without a High School Diploma

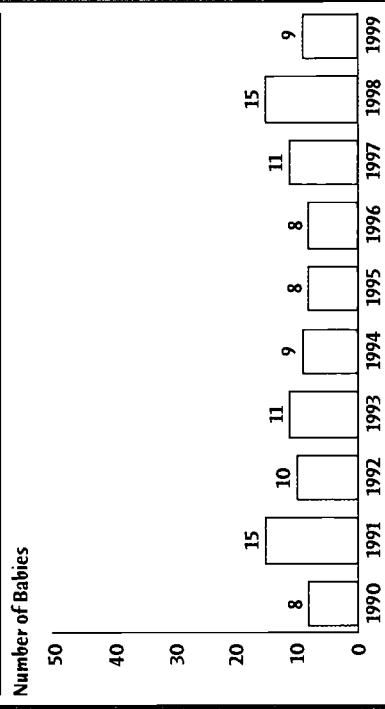

Juveniles and the Law

# of Juveniles Committed to the Dept. of Correction (CY)	2000 1	1994 0
# of Juvenile Status Case Filings (CY)	2000 0	1990 0
# of Juvenile Delinquency Case Filings (CY)	2000 79	1990 42

DATA YEAR DEFINITIONS

- SFY - State Fiscal Year: July 1-June 30
- SY - School Year: From the start of the school term in the fall through the end of the summer
- FFY - Federal Fiscal Year: October 1-September 30
- CY - Calendar Year: January 1 - December 31

326

327

Kids Count 2001

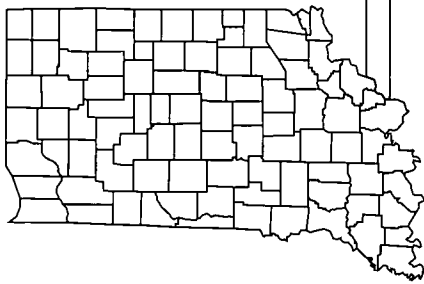

Noble County

Kids Count in Indiana 2001



Economic Well-being

	Current Year	Base Year
% of Children in Poverty, Age 0-17 (CY)	1997 9.1	1990 11.6
Per Capita Income (CY)	1999 \$23,095	1990 \$15,138
Unemployment Rate (CY)	2000 3.4	1990 7.9
Monthly Average of Families Receiving TANF (SFY)	2000 46	1990 116
Monthly Average of Persons Issued Food Stamps (SFY)	2000 820	1990 985
% of Students Receiving Free Lunches / Text Books (SY)	2001 17.5	1991 12.0

Early Childhood

# of First Steps Children Served (FFY)	2000 124	1998 105
# of Licensed Child Care Centers (SFY)	2000 4	1990 2
# of Licensed Child Care Homes (SFY)	2000 18	1990 6
# of Registered Child Care Ministries (SFY)	2000 4	1993 0
# of Licensed Child Care Slots per 100 Children, Age 0-4 (SFY)	2000 11.6	1996 12.4

Child Protection

# of Reported Cases of Child Abuse Processed by CPS (SFY)	2000 91	1990 167
% of Child Abuse Cases Substantiated by CPS (SFY)	2000 45.0	1990 74.3
# of Reported Cases of Child Neglect Processed by CPS (SFY)	2000 216	1990 147
% of Child Neglect Cases Substantiated by CPS (SFY)	2000 42.0	1990 68.7
# of Child Physical Abuse Cases Substantiated by CPS (SFY)	2000 28	1990 21
# of Child Sexual Abuse Cases Substantiated by CPS (SFY)	2000 13	1990 20
Child Abuse and Neglect Rate (SFY)	2000 10.5	1990 28.0
# of Child Abuse and Neglect Deaths (SFY)	2000 0	1990 1
# of Juvenile CHINS Case Filings (CY)	2000 35	1990 34

Racial/Ethnic Characteristics of Children Age 0-17 in Noble County

One Race (Non-Hispanic Origin)	Percentage
White	88.1%
Black	0.3%
American Indian or Alaska Native	0.3%
Asian	0.4%
Native Hawaiian or Other Pacific Islander	0.0%
Some Other Race	0.0%
Two or More Races (Non-Hispanic Origin)	0.9%
Hispanic Origin*	9.9%

*Hispanic children may be of any race.

Number of Children Under the Age of 20 1990 & 2000

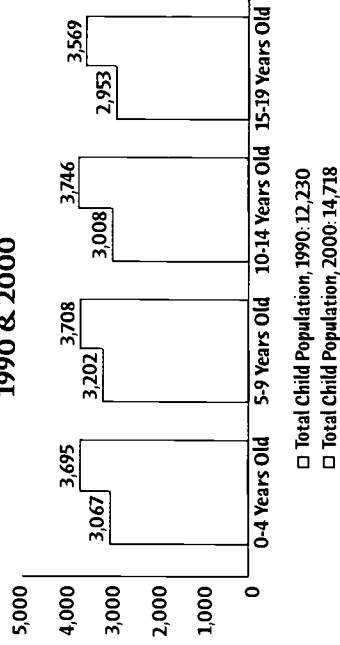

000000 136197

Health & Well-being

	Current Year	Base Year
Total # of Live Births (CY)	1999 725	1990 657
% of Low Birthweight Babies (CY)	1999 8.4	1990 7.5
% of Mothers who Received 1st Trimester Prenatal Care (CY)	1999 74.6	1990 78.5
% of Mothers who Smoked During Pregnancy (CY)	1999 24.7	1990 32.4
Non Marital Births as a % of All Births (CY)	1999 31.3	1990 19.2
Teen Birth Rate, Age 15-17 (CY)	1999 33.0	1990 33.8
Total # of Infant Deaths (CY)	1999 4	1990 11
Total # of Child Deaths, Age 1-14 (CY)	1999 3	1990 2
Total # of Teen Deaths by Accident, Homicide and Suicide (CY)	1999 1	1990 1
# of Children Enrolled in Hoosier Healthwise (SFY)	2000 1,647	1998 679
% Noncompliance with Youth Tobacco Access Laws (CY)	2000 50.0	1997 N/A

Percent of Households with Children Under 18 Headed by Parents and Others, Census 2000

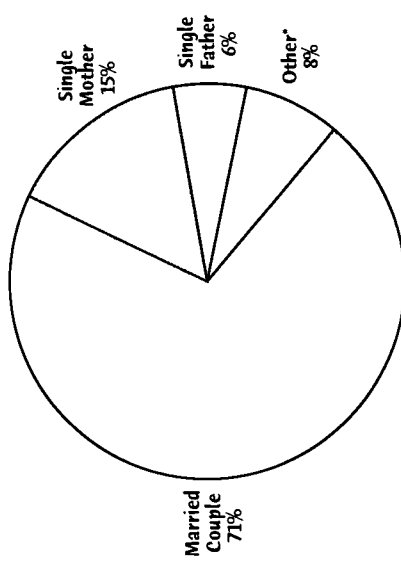

*"Other" includes households with children unrelated to the householder(s) and households with no adults present.

Education, Grades K-12

Public School Enrollment, K-12 (SY)	2000 7,952	1990 6,311
Non-Public School Enrollment (SY)	2001 586	1995 421
# of Home Schooled Children (SY)	2000 104	1990 2
# of Alternative School Participants (SY)	2001 158	1990 0
Total Per Pupil Expenditure (SY)	2000 \$5,842	1990 \$3,852
% of 10th Graders Passing the GQE Math Standard (SY)	2000 68.0	2000 68.0
% of 10th Graders Passing the GQE Language Standard (SY)	2000 71.0	2000 71.0
% of Graduates Passing the GQE (SY)	2000 94.2	2000 94.2
# of Public High School Graduates (SY)	2000 481	1990 438
% of High School Graduates (SY)	2000 88.4	1990 74.7
% of Freshman Class Graduating in 4 Years (SY)	2000 68.7	1990 69.9
% of Grads Intending 4-year College (SY)	2000 48.7	1990 24.2
% of Grads Intending Vocational/Tech School (SY)	2000 12.1	1990 1.6
# of Public School Student Dropouts (SY)	2000 73	1990 160
# of Expulsions and Suspensions (SY)	1999 1,996	1999 1,996

Juveniles and the Law

# of Juveniles Committed to the Dept. of Correction (CY)	2000 23	1994 6
# of Juvenile Status Case Filings (CY)	2000 20	1990 0
# of Juvenile Delinquency Case Filings (CY)	2000 88	1990 93

Number of Babies Born to Single Mothers Under Age 20 without a High School Diploma

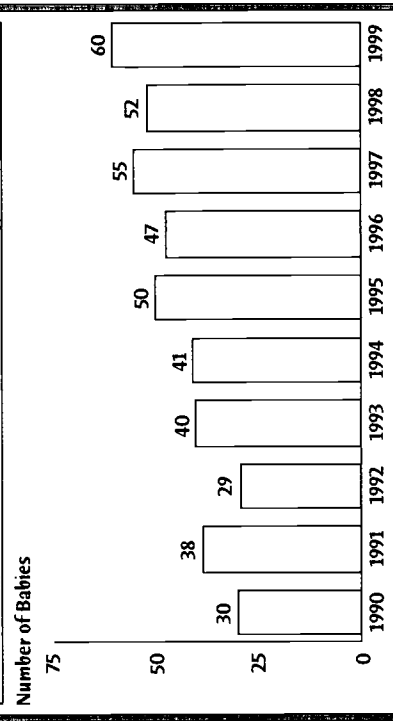

DATA YEAR DEFINITIONS

- SFY – State Fiscal Year: July 1-June 30
- SY – School Year: From the start of the school term in the fall through the end of the summer
- FFY – Federal Fiscal Year: October 1-September 30
- CY – Calendar Year: January 1 – December 31



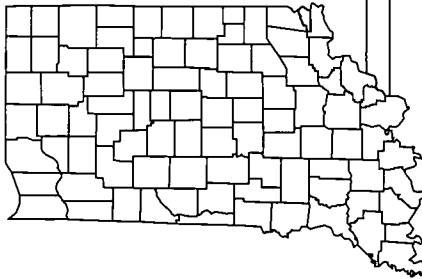

Ohio County



Economic Well-being

	Current Year	Base Year
% of Children in Poverty, Age 0-17 (CY)	1997 8.9	1990 8.6
Per Capita Income (CY)	1999 \$22,220	1990 \$13,292
Unemployment Rate (CY)	2000 3.6	1990 8.1
Monthly Average of Families Receiving TANF (SFY)	2000 9	1990 35
Monthly Average of Persons Issued Food Stamps (SFY)	2000 129	1990 227
% of Students Receiving Free Lunches / Text Books (SY)	2001 9.7	1991 15.0

Early Childhood

# of First Steps Children Served (FFY)	2000 11	1998 1
# of Licensed Child Care Centers (SFY)	2000 0	1990 0
# of Licensed Child Care Homes (SFY)	2000 4	1990 0
# of Registered Child Care Ministries (SFY)	2000 2	1993 0
# of Licensed Child Care Slots per 100 Children, Age 0-4 (SFY)	2000 13.9	1996 6.8

Child Protection

# of Reported Cases of Child Abuse Processed by CPS (SFY)	2000 15	1990 13
% of Child Abuse Cases Substantiated by CPS (SFY)	2000 60.0	1990 61.5
# of Reported Cases of Child Neglect Processed by CPS (SFY)	2000 33	1990 9
% of Child Neglect Cases Substantiated by CPS (SFY)	2000 67.0	1990 44.4
# of Child Physical Abuse Cases Substantiated by CPS (SFY)	2000 6	1990 4
# of Child Sexual Abuse Cases Substantiated by CPS (SFY)	2000 3	1990 1
Child Abuse and Neglect Rate (SFY)	2000 22.5	1990 14.5
# of Child Abuse and Neglect Deaths (SFY)	2000 0	1990 0
# of Juvenile CHINS Case Filings (CY)	2000 16	1990 3

Racial/Ethnic Characteristics of Children Age 0-17 in Ohio County

One Race (Non-Hispanic Origin)	98.8%
White	0.1%
Black	0.0%
American Indian or Alaska Native	0.1%
Asian	0.0%
Native Hawaiian or Other Pacific Islander	0.0%
Some Other Race	0.6%
Two or More Races (Non-Hispanic Origin)	0.4%
Hispanic Origin*	

*Hispanic children may be of any race.

Number of Children Under the Age of 20 1990 & 2000

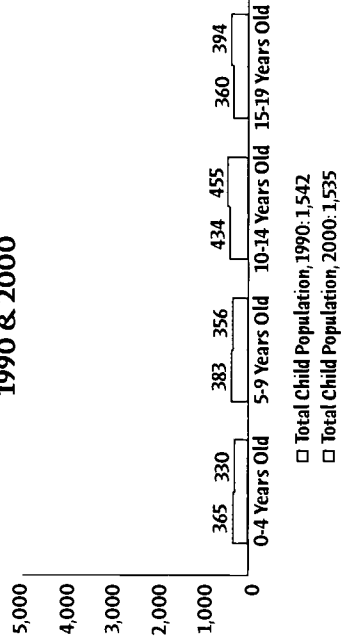

000000 136198

Health & Well-being

	Current Year	Base Year
Total # of Live Births (CY)	1999 53	1990 78
% of Low Birthweight Babies (CY)	1999 9.4	1990 9.0
% of Mothers who Received 1st Trimester Prenatal Care (CY)	1999 90.6	1990 79.2
% of Mothers who Smoked During Pregnancy (CY)	1999 30.2	1990 23.1
Non Marital Births as a % of All Births (CY)	1999 28.3	1990 17.9
Teen Birth Rate, Age 15-17 (CY)	1999 30.0	1990 10.2
Total # of Infant Deaths (CY)	1999 0	1990 1
Total # of Child Deaths, Age 1-14 (CY)	1999 0	1990 1
Total # of Teen Deaths by Accident, Homicide and Suicide (CY)	1999 0	1990 0
# of Children Enrolled in Hoosier Healthwise (SFY)	2000 216	1998 87
% Noncompliance with Youth Tobacco Access Laws (CY)	2000 N/A	1997 N/A

Percent of Households with Children Under 18 Headed by Parents and Others, Census 2000

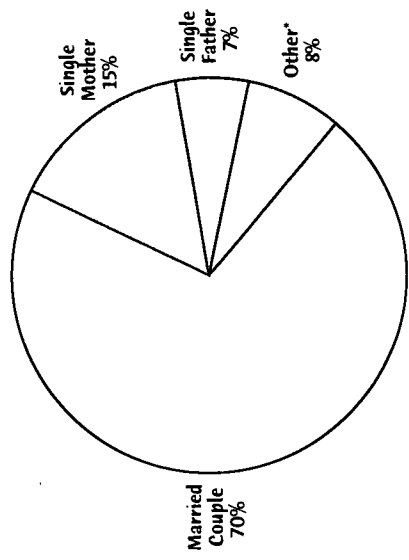

*"Other" includes households with children unrelated to the householder(s) and households with no adults present.

Education, Grades K-12

Public School Enrollment, K-12 (SY)	2000 1,050	1990 919
Non-Public School Enrollment (SY)	2001 0	1995 0
# of Home Schooled Children (SY)	2000 2	1990 0
# of Alternative School Participants (SY)	2001 0	1990 0
Total Per Pupil Expenditure (SY)	2000 \$5,540	1990 \$3,401
% of 10th Graders Passing the GQE Math Standard (SY)	2000 63.0	2000 63.0
% of 10th Graders Passing the GQE Language Standard (SY)	2000 69.0	2000 69.0
% of Graduates Passing the GQE (SY)	2000 98.5	2000 98.5
# of Public High School Graduates (SY)	2000 66	1990 70
% of High School Graduates (SY)	2000 78.4	1990 86.2
% of Freshman Class Graduating in 4 Years (SY)	2000 76.7	1990 107.7
% of Grads Intending 4-year College (SY)	2000 30.3	1990 32.3
% of Grads Intending Vocational/Tech School (SY)	2000 18.2	1990 7.2
# of Public School Student Dropouts (SY)	2000 18	1990 10
# of Expulsions and Suspensions (SY)	1999 231	1999 231

Juveniles and the Law

# of Juveniles Committed to the Dept. of Correction (CY)	2000 1	1994 0
# of Juvenile Status Case Filings (CY)	2000 0	1990 0
# of Juvenile Delinquency Case Filings (CY)	2000 56	1990 34

Number of Babies Born to Single Mothers Under Age 20 without a High School Diploma

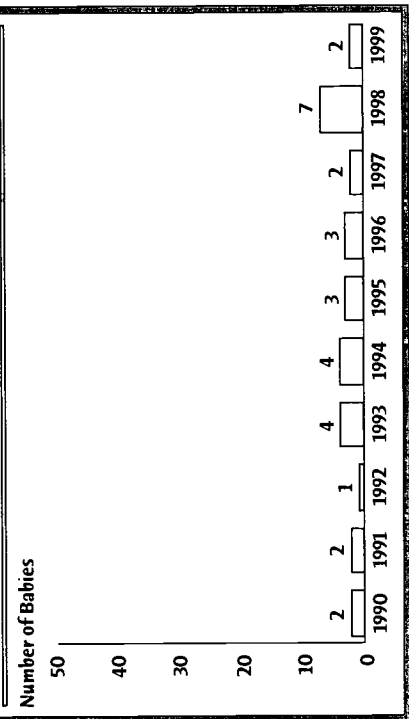

DATA YEAR DEFINITIONS

- SFY - State Fiscal Year: July 1-June 30
- SY - School Year: From the start of the school term in the fall through the end of the summer
- FFY - Federal Fiscal Year: October 1-September 30
- CY - Calendar Year: January 1 - December 31



Orange County

Kids Count in Indiana 2001



Economic Well-being

	Current Year	Base Year
% of Children in Poverty, Age 0-17 (CY)	1997 19.0	1990 19.4
Per Capita Income (CY)	1999 \$18,999	1990 \$13,088
Unemployment Rate (CY)	2000 6.2	1990 11.4
Monthly Average of Families Receiving TANF (SFY)	2000 76	1990 162
Monthly Average of Persons Issued Food Stamps (SFY)	2000 1,350	1990 1,461
% of Students Receiving Free Lunches / Text Books (SY)	2001 22.2	1991 24.4

Early Childhood

# of First Steps Children Served (FFY)	2000 57	1998 47
# of Licensed Child Care Centers (SFY)	2000 2	1990 1
# of Licensed Child Care Homes (SFY)	2000 25	1990 15
# of Registered Child Care Ministries (SFY)	2000 0	1993 0
# of Licensed Child Care Slots per 100 Children, Age 0-4 (SFY)	2000 38.6	1996 30.6

Child Protection

# of Reported Cases of Child Abuse Processed by CPS (SFY)	2000 70	1990 106
% of Child Abuse Cases Substantiated by CPS (SFY)	2000 46.0	1990 41.5
# of Reported Cases of Child Neglect Processed by CPS (SFY)	2000 143	1990 197
% of Child Neglect Cases Substantiated by CPS (SFY)	2000 35.0	1990 50.3
# of Child Physical Abuse Cases Substantiated by CPS (SFY)	2000 18	1990 16
# of Child Sexual Abuse Cases Substantiated by CPS (SFY)	2000 14	1990 12
Child Abuse and Neglect Rate (SFY)	2000 15.7	1990 56.0
# of Child Abuse and Neglect Deaths (SFY)	2000 0	1990 1
# of Juvenile CHINS Case Filings (CY)	2000 8	1990 9

Racial/Ethnic Characteristics of Children Age 0-17 in Orange County

One Race (Non-Hispanic Origin)	96.7%
White	0.6%
Black	0.2%
American Indian or Alaska Native	0.3%
Asian	0.0%
Native Hawaiian or Other Pacific Islander	0.5%
Some Other Race	0.9%
Two or More Races (Non-Hispanic Origin)	0.8%
Hispanic Origin*	

*Hispanic children may be of any race.

Number of Children Under the Age of 20 1990 & 2000

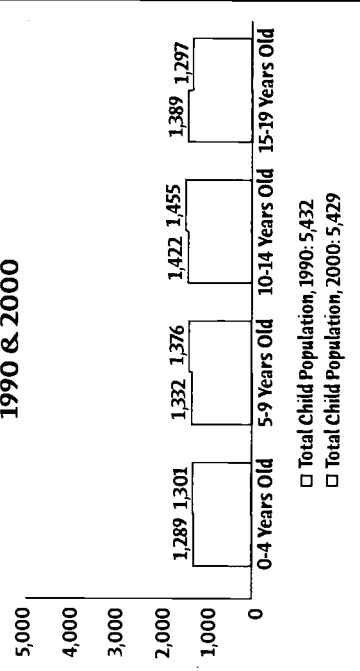

Health & Well-being

	Current Year	Base Year
Total # of Live Births (CY)	1999 245	1990 241
% of Low Birthweight Babies (CY)	1999 4.5	1990 6.2
% of Mothers who Received 1st Trimester Prenatal Care (CY)	1999 72.7	1990 79.2
% of Mothers who Smoked During Pregnancy (CY)	1999 24.1	1990 27.0
Non Marital Births as a % of All Births (CY)	1999 29.0	1990 17.0
Teen Birth Rate, Age 15-17 (CY)	1999 26.5	1990 30.1
Total # of Infant Deaths (CY)	1999 0	1990 0
Total # of Child Deaths, Age 1-14 (CY)	1999 3	1990 0
Total # of Teen Deaths by Accident, Homicide and Suicide (CY)	1999 0	1990 1
# of Children Enrolled in Hoosier Healthwise (SFY)	2000 1,545	1998 911
% Noncompliance with Youth Tobacco Access Laws (CY)	2000 40.0	1997 N/A

Percent of Households with Children Under 18 Headed by Parents and Others, Census 2000

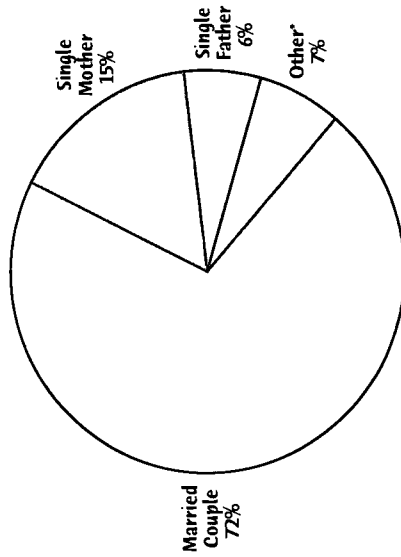

* "Other" includes households with children unrelated to the householder(s) and households with no adults present.

Education, Grades K-12

Public School Enrollment, K-12 (SY)	2000 3,377	1990 3,224
Non-Public School Enrollment (SY)	2001 33	1995 59
# of Home Schooled Children (SY)	2000 63	1990 3
# of Alternative School Participants (SY)	2001 25	1990 0
Total Per Pupil Expenditure (SY)	2000 \$5,766	1990 \$3,698
% of 10th Graders Passing the GQE Math Standard (SY)	2000 70.0	2000 70.0
% of 10th Graders Passing the GQE Language Standard (SY)	2000 71.0	2000 71.0
% of Graduates Passing the GQE (SY)	2000 98.4	2000 98.4
# of Public High School Graduates (SY)	2000 190	1990 245
% of High School Graduates (SY)	2000 90.5	1990 81.9
% of Freshman Class Graduating in 4 Years (SY)	2000 68.1	1990 81.9
% of Grads Intending 4-year College (SY)	2000 48.9	1990 21.5
% of Grads Intending Vocational/Tech School (SY)	2000 10.5	1990 12.8
# of Public School Student Dropouts (SY)	2000 23	1990 55
# of Expulsions and Suspensions (SY)	1999 740	1999 740

Juveniles and the Law

# of Juveniles Committed to the Dept. of Correction (CY)	2000 0	1994 7
# of Juvenile Status Case Filings (CY)	2000 4	1990 9
# of Juvenile Delinquency Case Filings (CY)	2000 32	1990 36

Number of Babies Born to Single Mothers Under Age 20 without a High School Diploma

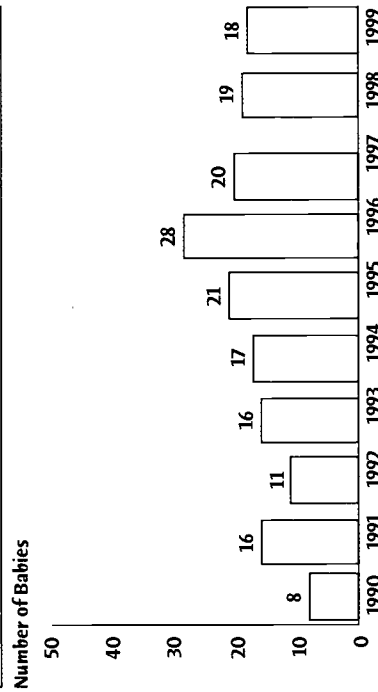

DATA YEAR DEFINITIONS

SFY - State Fiscal Year: July 1-June 30
 SY - School Year: From the start of the school term in the fall through the end of the summer
 FFY - Federal Fiscal Year: October 1-September 30
 CY - Calendar Year: January 1 - December 31



Owen County

Kids Count in Indiana 2001



Economic Well-being

	Current Year	Base Year
% of Children in Poverty, Age 0-17 (CY)	1997 16.9	1990 18.0
Per Capita Income (CY)	1999 \$17,944	1990 \$12,953
Unemployment Rate (CY)	2000 3.2	1990 5.7
Monthly Average of Families Receiving TANF (SFY)	2000 82	1990 117
Monthly Average of Persons Issued Food Stamps (SFY)	2000 1,159	1990 1,017
% of Students Receiving Free Lunches / Text Books (SY)	2001 24.0	1991 18.1

Early Childhood

# of First Steps Children Served (FFY)	2000 43	1998 32
# of Licensed Child Care Centers (SFY)	2000 1	1990 1
# of Licensed Child Care Homes (SFY)	2000 7	1990 4
# of Registered Child Care Ministries (SFY)	2000 1	1993 0
# of Licensed Child Care Slots per 100 Children, Age 0-4 (SFY)	2000 8.1	1996 4.6

Child Protection

# of Reported Cases of Child Abuse Processed by CPS (SFY)	2000 71	1990 145
% of Child Abuse Cases Substantiated by CPS (SFY)	2000 49.0	1990 46.2
# of Reported Cases of Child Neglect Processed by CPS (SFY)	2000 90	1990 162
% of Child Neglect Cases Substantiated by CPS (SFY)	2000 50.0	1990 28.4
# of Child Physical Abuse Cases Substantiated by CPS (SFY)	2000 18	1990 15
# of Child Sexual Abuse Cases Substantiated by CPS (SFY)	2000 17	1990 14
Child Abuse and Neglect Rate (SFY)	2000 14.9	1990 64.4
# of Child Abuse and Neglect Deaths (SFY)	2000 0	1990 0
# of Juvenile CHINS Case Filings (CY)	2000 58	1990 29

Racial/Ethnic Characteristics of Children Age 0-17 in Owen County

One Race (Non-Hispanic Origin)	96.8%
White	0.3%
Black	0.4%
American Indian or Alaska Native	0.2%
Asian	0.0%
Native Hawaiian or Other Pacific Islander	0.1%
Some Other Race	0.9%
Two or More Races (Non-Hispanic Origin)	1.3%
Hispanic Origin*	

*Hispanic children may be of any race.

Number of Children Under the Age of 20 1990 & 2000

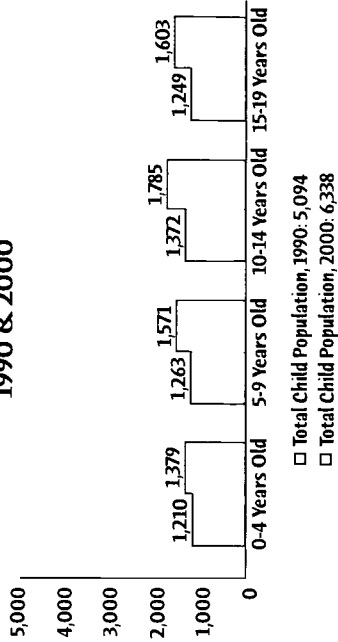

Health & Well-being

	Current Year	Base Year
Total # of Live Births (CY)	1999 263	1990 259
% of Low Birthweight Babies (CY)	1999 4.2	1990 4.6
% of Mothers who Received 1st Trimester Prenatal Care (CY)	1999 79.1	1990 74.4
% of Mothers who Smoked During Pregnancy (CY)	1999 30.8	1990 30.9
Non Marital Births as a % of All Births (CY)	1999 31.2	1990 19.3
Teen Birth Rate, Age 15-17 (CY)	1999 32.0	1990 27.0
Total # of Infant Deaths (CY)	1999 1	1990 3
Total # of Child Deaths, Age 1-14 (CY)	1999 3	1990 0
Total # of Teen Deaths by Accident, Homicide and Suicide (CY)	1999 1	1990 2
# of Children Enrolled in Hoosier Healthwise (SFY)	2000 1,750	1998 772
% Noncompliance with Youth Tobacco Access Laws (CY)	2000 N/A	1997 13.6

Education, Grades K-12

Public School Enrollment, K-12 (SY)	2000 3,100	1990 2,519
Non-Public School Enrollment (SY)	2001 52	1995 32
# of Home Schooled Children (SY)	2000 106	1990 49
# of Alternative School Participants (SY)	2001 215	1990 0
Total Per Pupil Expenditure (SY)	2000 \$6,230	1990 \$3,826
% of 10th Graders Passing the GQE Math Standard (SY)	2000 49.0	2000 49.0
% of 10th Graders Passing the GQE Language Standard (SY)	2000 61.0	2000 61.0
% of Graduates Passing the GQE (SY)	2000 98.9	2000 98.9
# of Public High School Graduates (SY)	2000 184	1990 182
% of High School Graduates (SY)	2000 93.5	1990 74.2
% of Freshman Class Graduating in 4 Years (SY)	2000 60.1	1990 83.1
% of Grads Intending 4-year College (SY)	2000 32.6	1990 32.7
% of Grads Intending Vocational/Tech School (SY)	2000 6.0	1990 3.8
# of Public School Student Dropouts (SY)	2000 15	1990 63
# of Expulsions and Suspensions (SY)	1999 1,618	1999 1,618

Juveniles and the Law

# of Juveniles Committed to the Dept. of Correction (CY)	2000 15	1994 3
# of Juvenile Status Case Filings (CY)	2000 12	1990 0
# of Juvenile Delinquency Case Filings (CY)	2000 77	1990 51

Percent of Households with Children Under 18 Headed by Parents and Others, Census 2000

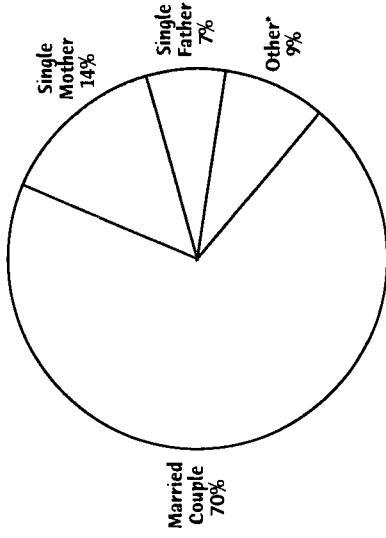

* "Other" includes households with children unrelated to the householder(s) and households with no adults present.

Number of Babies Born to Single Mothers Under Age 20 without a High School Diploma

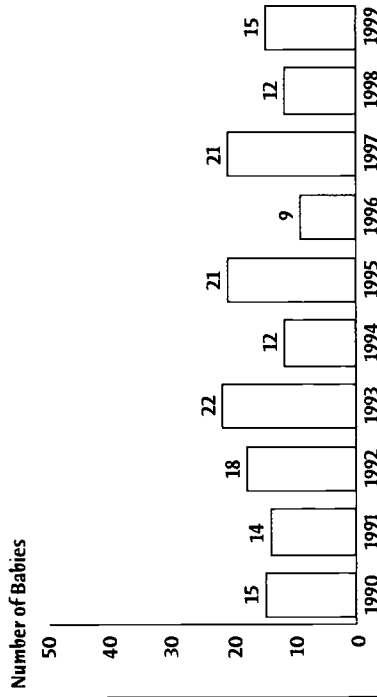

DATA YEAR DEFINITIONS

SFY - State Fiscal Year: July 1-June 30
 SY - School Year: From the start of the school term in the fall through the end of the summer
 FFY - Federal Fiscal Year: October 1-September 30
 CY - Calendar Year: January 1 - December 31

000000 136200

342,112

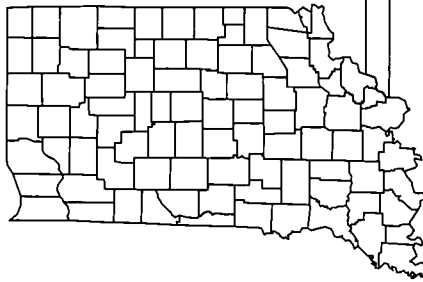

Parke County

Kids Count in Indiana 2001



Economic Well-being

	Current Year	Base Year
% of Children in Poverty, Age 0-17 (CY)	1997 19.4	1990 13.1
Per Capita Income (CY)	1999 \$19,985	1990 \$14,586
Unemployment Rate (CY)	2000 3.8	1990 6.2
Monthly Average of Families Receiving TANF (\$FY)	2000 61	1990 121
Monthly Average of Persons Issued Food Stamps (\$FY)	2000 772	1990 969
% of Students Receiving Free Lunches / Text Books (\$Y)	2001 23.5	1991 19.7

Early Childhood

# of First Steps Children Served (FFY)	2000 31	1998 23
# of Licensed Child Care Centers (SFY)	2000 0	1990 1
# of Licensed Child Care Homes (SFY)	2000 15	1990 1
# of Registered Child Care Ministries (SFY)	2000 0	1993 0
# of Licensed Child Care Slots per 100 Children, Age 0-4 (SFY)	2000 18.9	1996 9.8

Child Protection

# of Reported Cases of Child Abuse Processed by CPS (SFY)	2000 68	1990 91
% of Child Abuse Cases Substantiated by CPS (SFY)	2000 50.0	1990 90.1
# of Reported Cases of Child Neglect Processed by CPS (SFY)	2000 106	1990 98
% of Child Neglect Cases Substantiated by CPS (SFY)	2000 42.0	1990 88.8
# of Child Physical Abuse Cases Substantiated by CPS (SFY)	2000 14	1990 23
# of Child Sexual Abuse Cases Substantiated by CPS (SFY)	2000 20	1990 13
Child Abuse and Neglect Rate (SFY)	2000 19.6	1990 40.2
# of Child Abuse and Neglect Deaths (SFY)	2000 0	1990 0
# of Juvenile CHINS Case Filings (CY)	2000 10	1990 28

Racial/Ethnic Characteristics of Children Age 0-17 in Parke County

One Race (Non-Hispanic Origin)	
White	97.4%
Black	0.6%
American Indian or Alaska Native	0.1%
Asian	0.2%
Native Hawaiian or Other Pacific Islander	0.0%
Some Other Race	0.1%
Two or More Races (Non-Hispanic Origin)	0.8%
Hispanic Origin*	0.8%

*Hispanic children may be of any race.

Number of Children Under the Age of 20 1990 & 2000

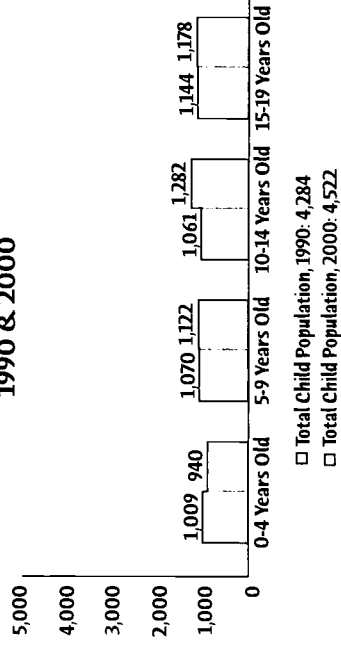

Health & Well-being

	Current Year	Base Year
% of Live Births (CY)	1999 170	1990 208
% of Low Birthweight Babies (CY)	1999 9.4	1990 6.3
% of Mothers who Received 1st Trimester Prenatal Care (CY)	1999 75.3	1990 77.1
% of Mothers who Smoked During Pregnancy (CY)	1999 31.2	1990 30.3
Non Marital Births as a % of All Births (CY)	1999 34.7	1990 23.1
Teen Birth Rate, Age 15-17 (CY)	1999 22.9	1990 16.3
Total # of Infant Deaths (CY)	1999 3	1990 1
Total # of Child Deaths, Age 1-14 (CY)	1999 1	1990 4
Total # of Teen Deaths by Accident, Homicide and Suicide (CY)	1999 0	1990 0
# of Children Enrolled in Hoosier Healthwise (SFY)	2000 989	1998 612
% Noncompliance with Youth Tobacco Access Laws (CY)	2000 N/A	1997 5.0

Education, Grades K-12

Public School Enrollment, K-12 (SY)	2000 2,705	1990 2,382
Non-Public School Enrollment (SY)	2001 152	1995 47
# of Home Schooled Children (SY)	2000 58	1990 0
# of Alternative School Participants (SY)	2001 0	1990 0
Total Per Pupil Expenditure (SY)	2000 \$5,831	1990 \$4,074
% of 10th Graders Passing the GQE Math Standard (SY)	2000 70.0	2000 70.0
% of 10th Graders Passing the GQE Language Standard (SY)	2000 76.0	2000 76.0
% of Graduates Passing the GQE (SY)	2000 97.2	2000 97.2
# of Public High School Graduates (SY)	2000 180	1990 218
% of High School Graduates (SY)	2000 88.1	1990 83.5
% of Freshman Class Graduating in 4 Years (SY)	2000 80.0	1990 90.5
% of Grads Intending 4-year College (SY)	2000 60.6	1990 37.4
% of Grads Intending Vocational/Tech School (SY)	2000 7.8	1990 11.7
# of Public School Student Dropouts (SY)	2000 27	1990 41
# of Expulsions and Suspensions (SY)	1999 515	1999 515

Juveniles and the Law

# of Juveniles Committed to the Dept. of Correction (CY)	2000 1	1994 1
# of Juvenile Status Case Filings (CY)	2000 0	1990 0
# of Juvenile Delinquency Case Filings (CY)	2000 55	1990 17

Percent of Households with Children Under 18 Headed by Parents and Others, Census 2000

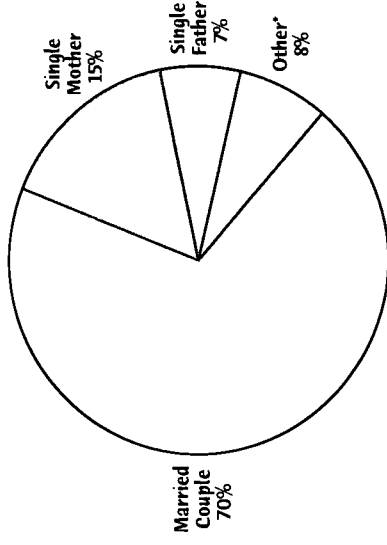

*"Other" includes households with children unrelated to the householder(s) and households with no adults present.

Number of Babies Born to Single Mothers Under Age 20 without a High School Diploma

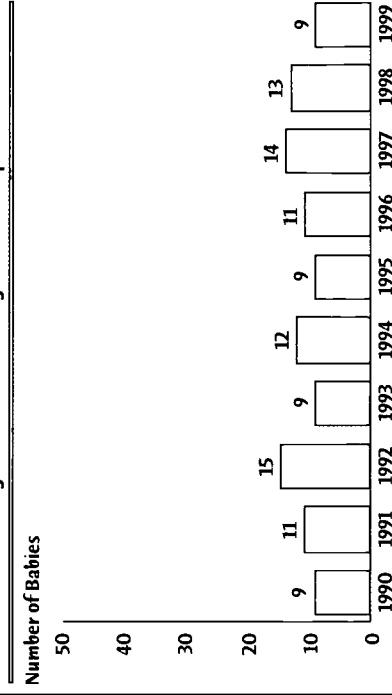

DATA YEAR DEFINITIONS

- SFY - State Fiscal Year: July 1-June 30
- SY - School Year: From the start of the school term in the fall through the end of the summer
- FFY - Federal Fiscal Year: October 1-September 30
- CY - Calendar Year: January 1 - December 31

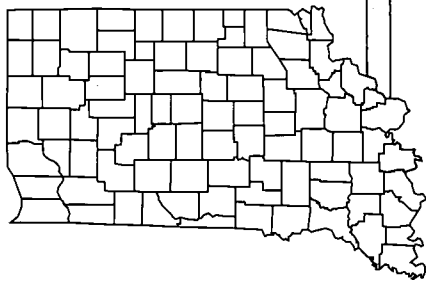

Perry County

Kids Count in Indiana 2001



Economic Well-being

	Current Year	Base Year
% of Children in Poverty, Age 0-17 (CY)	1997 11.3	1990 14.2
Per Capita Income (CY)	1999 \$20,788	1990 \$13,306
Unemployment Rate (CY)	2000 6.4	1990 9.6
Monthly Average of Families Receiving TANF (SFY)	2000 48	1990 130
Monthly Average of Persons Issued Food Stamps (SFY)	2000 662	1990 1,117
% of Students Receiving Free Lunches / Text Books (SY)	2001 17.2	1991 16.4

Early Childhood

# of First Steps Children Served (FFY)	2000 43	1998 25
# of Licensed Child Care Centers (SFY)	2000 2	1990 2
# of Licensed Child Care Homes (SFY)	2000 13	1990 0
# of Registered Child Care Ministries (SFY)	2000 0	1993 1
# of Licensed Child Care Slots per 100 Children, Age 0-4 (SFY)	2000 28.8	1996 14.3

Child Protection

# of Reported Cases of Child Abuse Processed by CPS (SFY)	2000 52	1990 58
% of Child Abuse Cases Substantiated by CPS (SFY)	2000 42.0	1990 41.4
# of Reported Cases of Child Neglect Processed by CPS (SFY)	2000 242	1990 82
% of Child Neglect Cases Substantiated by CPS (SFY)	2000 37.0	1990 52.4
# of Child Physical Abuse Cases Substantiated by CPS (SFY)	2000 9	1990 10
# of Child Sexual Abuse Cases Substantiated by CPS (SFY)	2000 13	1990 1
Child Abuse and Neglect Rate (SFY)	2000 23.0	1990 24.3
# of Child Abuse and Neglect Deaths (SFY)	2000 0	1990 1
# of Juvenile CHINS Case Filings (CY)	2000 25	1990 13

Racial/Ethnic Characteristics of Children Age 0-17 in Perry County

One Race (Non-Hispanic Origin)	97.9%
White	0.1%
Black	0.1%
American Indian or Alaska Native	0.1%
Asian	0.0%
Native Hawaiian or Other Pacific Islander	0.0%
Some Other Race	0.7%
Two or More Races (Non-Hispanic Origin)	1.0%
Hispanic Origin*	

*Hispanic children may be of any race.

Number of Children Under the Age of 20 1990 & 2000

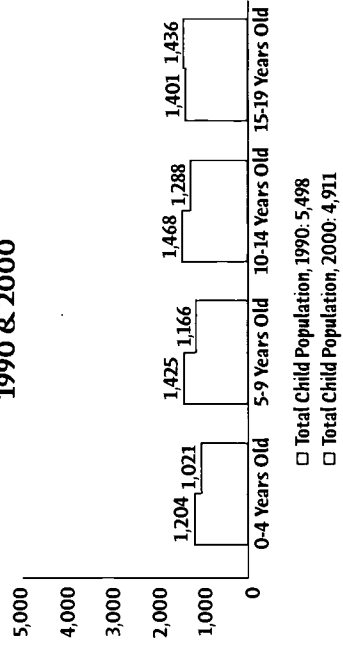

000000 136202

Percent of Households with Children Under 18 Headed by Parents and Others, Census 2000

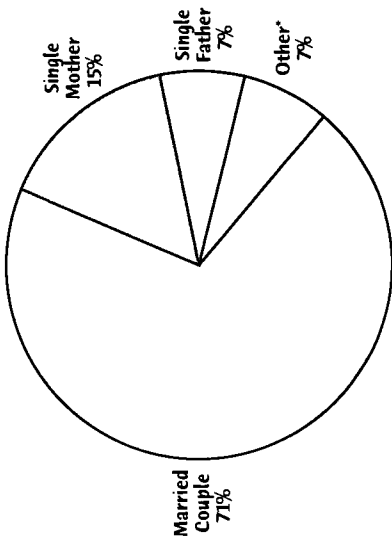

*"Other" includes households with children unrelated to the householder(s) and households with no adults present.

Number of Babies Born to Single Mothers Under Age 20 without a High School Diploma

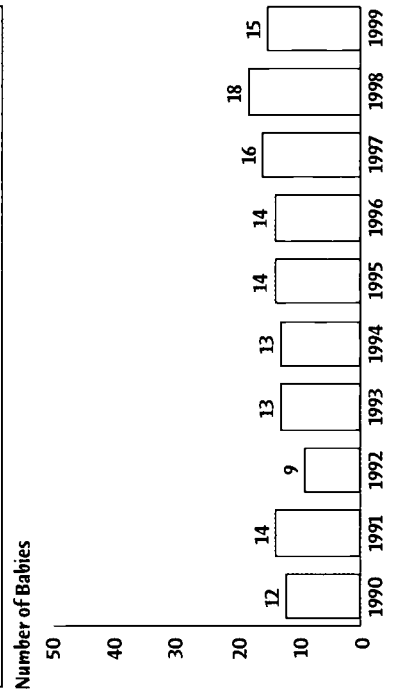

	Current Year	Base Year
Total # of Live Births (CY)	1999 203	1990 230
% of Low Birthweight Babies (CY)	1999 5.9	1990 3.0
% of Mothers who Received 1st Trimester Prenatal Care (CY)	1999 80.8	1990 86.4
% of Mothers who Smoked During Pregnancy (CY)	1999 30.0	1990 29.1
Non Marital Births as a % of All Births (CY)	1999 36.0	1990 15.7
Teen Birth Rate, Age 15-17 (CY)	1999 20.5	1990 21.2
Total # of Infant Deaths (CY)	1999 3	1990 1
Total # of Child Deaths, Age 1-14 (CY)	1999 2	1990 2
Total # of Teen Deaths by Accident, Homicide and Suicide (CY)	1999 2	1990 1
# of Children Enrolled in Hoosier Healthwise (SFY)	2000 861	1998 463
% Noncompliance with Youth Tobacco Access Laws (CY)	2000 20.0	1997 30.0

Education, Grades K-12

Public School Enrollment, K-12 (SY)	2000 3,173	1990 3,126
Non-Public School Enrollment (SY)	2001 16	1995 0
# of Home Schooled Children (SY)	2000 37	1990 0
# of Alternative School Participants (SY)	2001 0	1990 0
Total Per Pupil Expenditure (SY)	2000 \$5,974	1990 \$3,523
% of 10th Graders Passing the GQE Math Standard (SY)	2000 59.0	2000 59.0
% of 10th Graders Passing the GQE Language Standard (SY)	2000 69.0	2000 69.0
% of Graduates Passing the GQE (SY)	2000 84.5	2000 84.5
# of Public High School Graduates (SY)	2000 207	1990 295
% of High School Graduates (SY)	2000 88.4	1990 83.5
% of Freshman Class Graduating in 4 Years (SY)	2000 76.7	1990 98.3
% of Grads Intending 4-year College (SY)	2000 44.9	1990 25.2
% of Grads Intending Vocational/Tech School (SY)	2000 11.1	1990 2.7
# of Public School Student Dropouts (SY)	2000 30	1990 53
# of Expulsions and Suspensions (SY)	1999 412	1999 412

Juveniles and the Law

# of Juveniles Committed to the Dept. of Correction (CY)	2000 6	1994 9
# of Juvenile Status Case Filings (CY)	2000 1	1990 0
# of Juvenile Delinquency Case Filings (CY)	2000 14	1990 13

DATA YEAR DEFINITIONS

- SFY - State Fiscal Year: July 1-June 30
- SY - School Year: From the start of the school term in the fall through the end of the summer
- FFY - Federal Fiscal Year: October 1-September 30
- CY - Calendar Year: January 1 - December 31



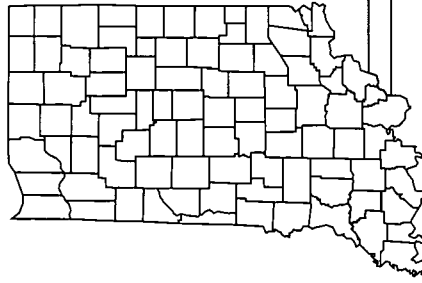

Pike County



Economic Well-being

	Current Year	Base Year
% of Children in Poverty, Age 0-17 (CY)	1997 16.3	1990 19.9
Per Capita Income (CY)	1999 \$21,369	1990 \$15,638
Unemployment Rate (CY)	2000 4.4	1990 6.8
Monthly Average of Families Receiving TANF (SFY)	2000 42	1990 118
Monthly Average of Persons Issued Food Stamps (SFY)	2000 662	1990 1,023
% of Students Receiving Free Lunches / Text Books (\$Y)	2001 19.9	1991 17.3

Early Childhood

# of First Steps Children Served (FFY)	2000 46	1998 33
# of Licensed Child Care Centers (SFY)	2000 1	1990 1
# of Licensed Child Care Homes (SFY)	2000 15	1990 4
# of Registered Child Care Ministries (SFY)	2000 0	1993 0
# of Licensed Child Care Slots per 100 Children, Age 0-4 (SFY)	2000 23.9	1996 8.8

Child Protection

# of Reported Cases of Child Abuse Processed by CPS (SFY)	2000 15	1990 44
% of Child Abuse Cases Substantiated by CPS (SFY)	2000 67.0	1990 70.5
# of Reported Cases of Child Neglect Processed by CPS (SFY)	2000 43	1990 41
% of Child Neglect Cases Substantiated by CPS (SFY)	2000 98.0	1990 46.3
# of Child Physical Abuse Cases Substantiated by CPS (SFY)	2000 7	1990 1
# of Child Sexual Abuse Cases Substantiated by CPS (SFY)	2000 3	1990 7
Child Abuse and Neglect Rate (SFY)	2000 16.7	1990 22.9
# of Child Abuse and Neglect Deaths (SFY)	2000 0	1990 0
# of Juvenile CHINS Case Filings (CY)	2000 52	1990 16

Racial/Ethnic Characteristics of Children Age 0-17 in Pike County

One Race (Non-Hispanic Origin)	
White	98.3%
Black	0.0%
American Indian or Alaska Native	0.1%
Asian	0.2%
Native Hawaiian or Other Pacific Islander	0.0%
Some Other Race	0.0%
Two or More Races (Non-Hispanic Origin)	0.5%
Hispanic Origin*	0.9%

*Hispanic children may be of any race.

Number of Children Under the Age of 20 1990 & 2000

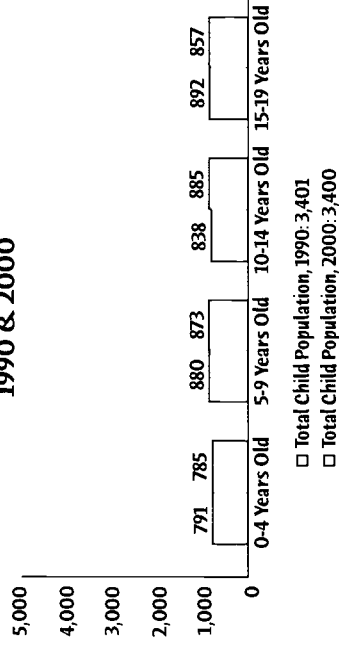

000000 136203

Health & Well-being

	Current Year	Base Year
Total # of Live Births (CY)	1999 168	1990 162
% of Low Birthweight Babies (CY)	1999 10.7	1990 3.7
% of Mothers who Received 1st Trimester Prenatal Care (CY)	1999 85.7	1990 83.8
% of Mothers who Smoked During Pregnancy (CY)	1999 26.8	1990 29.6
Non Marital Births as a % of All Births (CY)	1999 26.2	1990 19.8
Teen Birth Rate, Age 15-17 (CY)	1999 24.1	1990 11.1
Total # of Infant Deaths (CY)	1999 0	1990 1
Total # of Child Deaths, Age 1-14 (CY)	1999 1	1990 0
Total # of Teen Deaths by Accident, Homicide and Suicide (CY)	1999 0	1990 1
# of Children Enrolled in Hoosier Healthwise (SFY)	2000 843	1998 496
% Noncompliance with Youth Tobacco Access Laws (CY)	2000 N/A	1997 N/A

Percent of Households with Children Under 18 Headed by Parents and Others, Census 2000

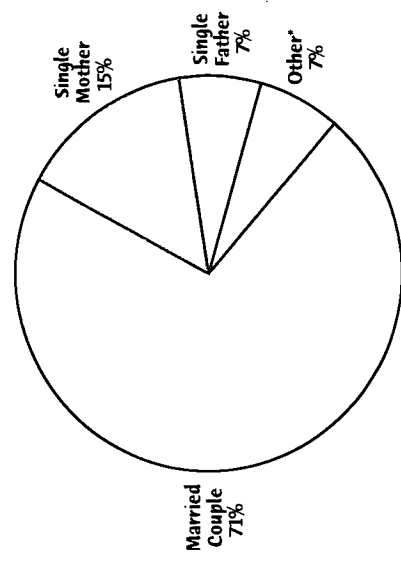

*"Other" includes households with children unrelated to the householder(s) and households with no adults present.

Education, Grades K-12

Public School Enrollment, K-12 (SY)	2000 2,156	1990 1,957
Non-Public School Enrollment (SY)	2001 0	1995 31
# of Home Schooled Children (SY)	2000 27	1990 0
# of Alternative School Participants (SY)	2001 43	1990 0
Total Per Pupil Expenditure (SY)	2000 \$6,021	1990 \$4,286
% of 10th Graders Passing the GQE Math Standard (SY)	2000 68.0	2000 68.0
% of 10th Graders Passing the GQE Language Standard (SY)	2000 72.0	2000 72.0
% of Graduates Passing the GQE (SY)	2000 97.8	2000 97.8
# of Public High School Graduates (SY)	2000 135	1990 161
% of High School Graduates (SY)	2000 92.9	1990 88.6
% of Freshman Class Graduating in 4 Years (SY)	2000 80.4	1990 91.0
% of Grads Intending 4-year College (SY)	2000 27.4	1990 51.8
% of Grads Intending Vocational/Tech School (SY)	2000 7.4	1990 3.9
# of Public School Student Dropouts (SY)	2000 11	1990 22
# of Expulsions and Suspensions (SY)	1999 231	1999 231

Number of Babies Born to Single Mothers Under Age 20 without a High School Diploma

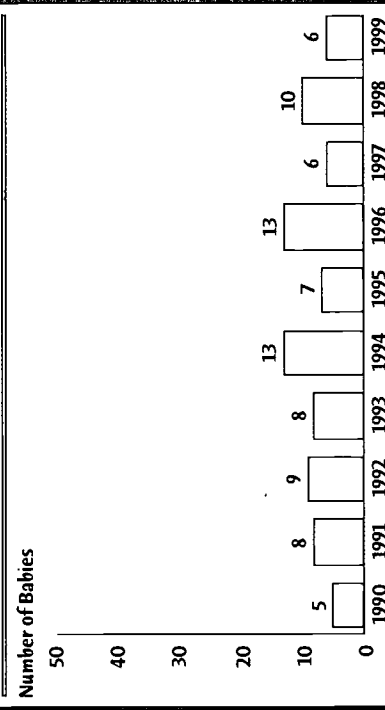

Juveniles and the Law

# of Juveniles Committed to the Dept. of Correction (CY)	2000 0	1994 0
# of Juvenile Status Case Filings (CY)	2000 2	1990 9
# of Juvenile Delinquency Case Filings (CY)	2000 14	1990 7

DATA YEAR DEFINITIONS

SFY - State Fiscal Year: July 1-June 30
 SY - School Year: From the start of the school term in the fall through the end of the summer
 FFY - Federal Fiscal Year: October 1-September 30
 CY - Calendar Year: January 1 - December 31

355

Kids Count 2001

354

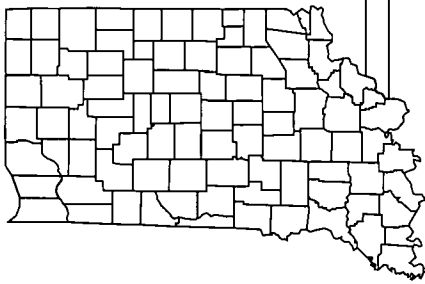

Porter County

Kids Count in Indiana 2001



Economic Well-being

	Current Year	Base Year
% of Children in Poverty, Age 0-17 (CY)	1997 8.3	1990 7.5
Per Capita Income (CY)	1999 \$28,584	1990 \$19,469
Unemployment Rate (CY)	2000 3.2	1990 4.0
Monthly Average of Families Receiving TANF (SFY)	2000 223	1990 507
Monthly Average of Persons Issued Food Stamps (SFY)	2000 3,245	1990 3,179
% of Students Receiving Free Lunches / Text Books (SY)	2001 10.9	1991 8.3

Early Childhood

# of First Steps Children Served (FFY)	2000 330	1998 196
# of Licensed Child Care Centers (SFY)	2000 10	1990 8
# of Licensed Child Care Homes (SFY)	2000 37	1990 20
# of Registered Child Care Ministries (SFY)	2000 6	1993 3
# of Licensed Child Care Slots per 100 Children, Age 0-4 (SFY)	2000 12.9	1996 10.1

Child Protection

# of Reported Cases of Child Abuse Processed by CPS (SFY)	2000 273	1990 624
% of Child Abuse Cases Substantiated by CPS (SFY)	2000 57.0	1990 71.8
# of Reported Cases of Child Neglect Processed by CPS (SFY)	2000 857	1990 831
% of Child Neglect Cases Substantiated by CPS (SFY)	2000 76.0	1990 72.4
# of Child Physical Abuse Cases Substantiated by CPS (SFY)	2000 98	1990 106
# of Child Sexual Abuse Cases Substantiated by CPS (SFY)	2000 58	1990 59
Child Abuse and Neglect Rate (SFY)	2000 20.5	1990 38.1
# of Child Abuse and Neglect Deaths (SFY)	2000 2	1990 0
# of Juvenile CHINS Case Filings (CY)	2000 195	1990 238

Racial/Ethnic Characteristics of Children Age 0-17 in Porter County

One Race (Non-Hispanic Origin)	89.3%
White	1.0%
Black	0.1%
American Indian or Alaska Native	0.9%
Asian	0.0%
Native Hawaiian or Other Pacific Islander	0.1%
Some Other Race	1.5%
Two or More Races (Non-Hispanic Origin)	7.0%
Hispanic Origin*	

*Hispanic children may be of any race.

Number of Children Under the Age of 20 1990 & 2000

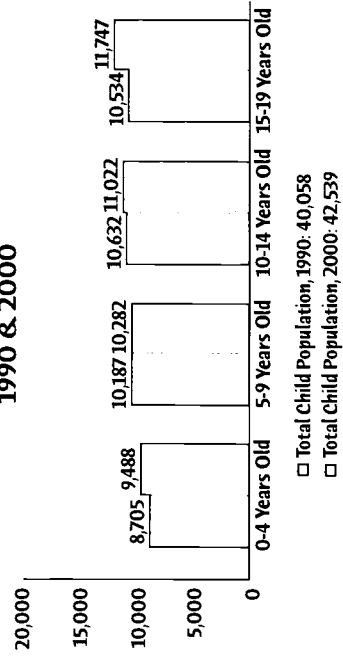

Health & Well-being

	Current Year	Base Year
Total # of Live Births (CY)	1999 1,815	1990 1,623
% of Low Birthweight Babies (CY)	1999 5.8	1990 5.1
% of Mothers who Received 1st Trimester Prenatal Care (CY)	1999 80.7	1990 81.4
% of Mothers who Smoked During Pregnancy (CY)	1999 17.4	1990 27.7
Non Marital Births as a % of All Births (CY)	1999 26.1	1990 15.8
Teen Birth Rate, Age 15-17 (CY)	1999 14.5	1990 11.2
Total # of Infant Deaths (CY)	1999 11	1990 15
Total # of Child Deaths, Age 1-14 (CY)	1999 3	1990 10
Total # of Teen Deaths by Accident, Homicide and Suicide (CY)	1999 10	1990 14
# of Children Enrolled in Hoosier Healthwise (SFY)	2000 4,208	1998 2,526
% Noncompliance with Youth Tobacco Access Laws (CY)	2000 45.0	1997 38.9

Percent of Households with Children Under 18 Headed by Parents and Others, Census 2000

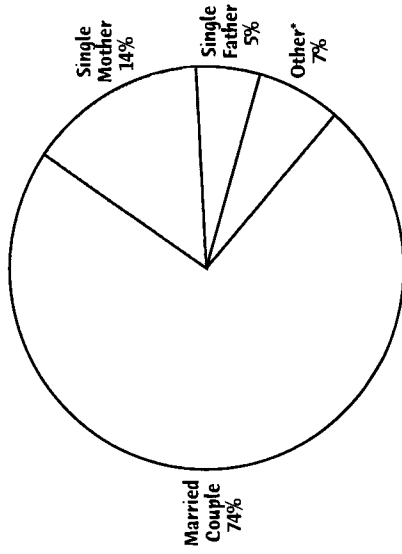

Other includes households with children unrelated to the householder(s) and households with no adults present.

Education, Grades K-12

Public School Enrollment, K-12 (SY)	2000 25,792	1990 22,223
Non-Public School Enrollment (SY)	2001 2,279	1995 1,606
# of Home Schooled Children (SY)	2000 275	1990 8
# of Alternative School Participants (SY)	2001 820	1990 0
Total Per Pupil Expenditure (SY)	2000 \$6,798	1990 \$4,167
% of 10th Graders Passing the GQE Math Standard (SY)	2000 71.0	2000 71.0
% of 10th Graders Passing the GQE Language Standard (SY)	2000 77.0	2000 77.0
% of Graduates Passing the GQE (SY)	2000 96.2	2000 96.2
# of Public High School Graduates (SY)	2000 1,833	1990 1,706
% of High School Graduates (SY)	2000 96.5	1990 85.8
% of Freshman Class Graduating in 4 Years (SY)	2000 81.5	1990 89.6
% of Grads Intending 4-year College (SY)	2000 66.9	1990 47.5
% of Grads Intending Vocational/Tech School (SY)	2000 4.6	1990 8.7
# of Public School Student Dropouts (SY)	2000 75	1990 281
# of Expulsions and Suspensions (SY)	1999 4,183	1999 4,183

Juveniles and the Law

# of Juveniles Committed to the Dept. of Correction (CY)	2000 20	1994 30
# of Juvenile Status Case Filings (CY)	2000 49	1990 0
# of Juvenile Delinquency Case Filings (CY)	2000 330	1990 326

Number of Babies Born to Single Mothers Under Age 20 without a High School Diploma

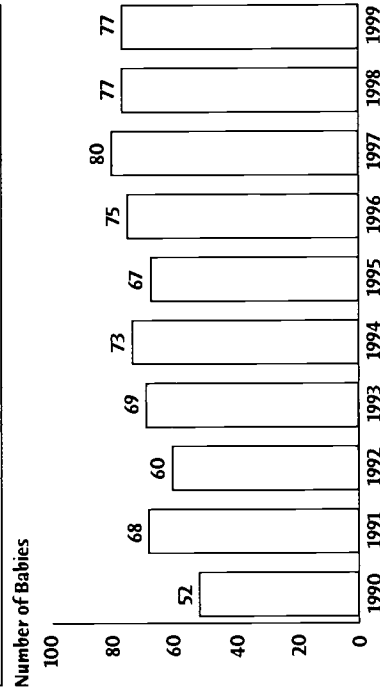

DATA YEAR DEFINITIONS

SFY – State Fiscal Year: July 1-June 30
 SY – School Year: From the start of the school term in the fall through the end of the summer
 FFY – Federal Fiscal Year: October 1-September 30
 CY – Calendar Year: January 1 – December 31





Posey County

Kids Count in Indiana 2001



Economic Well-being

	Current Year	Base Year
% of Children in Poverty, Age 0-17 (CY)	1997 11.1	1990 8.9
Per Capita Income (CY)	1999 \$26,748	1990 \$16,549
Unemployment Rate (CY)	2000 3.2	1990 4.7
Monthly Average of Families Receiving TANF (SFY)	2000 122	1990 217
Monthly Average of Persons Issued Food Stamps (SFY)	2000 1,219	1990 1,425
% of Students Receiving Free Lunches / Text Books (SY)	2001 13.3	1991 11.2

Early Childhood

# of First Steps Children Served (FFY)	2000 77	1998 57
# of Licensed Child Care Centers (SFY)	2000 3	1990 3
# of Licensed Child Care Homes (SFY)	2000 14	1990 2
# of Registered Child Care Ministries (SFY)	2000 1	1993 1
# of Licensed Child Care Slots per 100 Children, Age 0-4 (SFY)	2000 24.9	1996 20.6

Child Protection

# of Reported Cases of Child Abuse Processed by CPS (SFY)	2000 55	1990 56
% of Child Abuse Cases Substantiated by CPS (SFY)	2000 53.0	1990 46.4
# of Reported Cases of Child Neglect Processed by CPS (SFY)	2000 71	1990 65
% of Child Neglect Cases Substantiated by CPS (SFY)	2000 32.0	1990 21.5
# of Child Physical Abuse Cases Substantiated by CPS (SFY)	2000 20	1990 12
# of Child Sexual Abuse Cases Substantiated by CPS (SFY)	2000 9	1990 4
Child Abuse and Neglect Rate (SFY)	2000 7.3	1990 14.9
# of Child Abuse and Neglect Deaths (SFY)	2000 0	1990 0
# of Juvenile CHINS Case Filings (CY)	2000 7	1990 9

Racial/Ethnic Characteristics of Children Age 0-17 in Posey County

One Race (Non-Hispanic Origin)	96.8%
White	1.0%
Black	0.2%
American Indian or Alaska Native	0.2%
Asian	0.0%
Native Hawaiian or Other Pacific Islander	0.1%
Some Other Race	1.1%
Two or More Races (Non-Hispanic Origin)	0.6%
Hispanic Origin*	

*Hispanic children may be of any race.

Number of Children Under the Age of 20 1990 & 2000

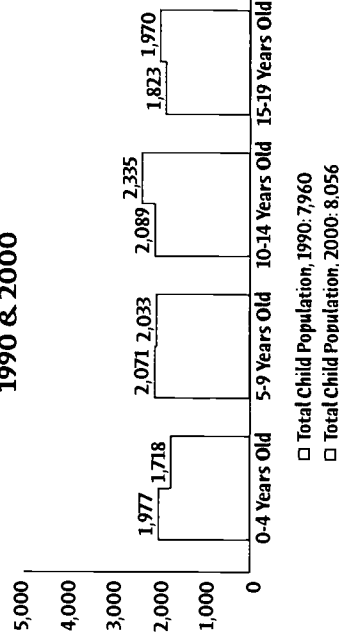

Health & Well-being

	Current Year	Base Year
Total # of Live Births (CY)	1999 289	1990 368
% of Low Birthweight Babies (CY)	1999 6.9	1990 6.5
% of Mothers who Received 1st Trimester Prenatal Care (CY)	1999 88.2	1990 91.3
% of Mothers who Smoked During Pregnancy (CY)	1999 22.5	1990 24.5
Non Marital Births as a % of All Births (CY)	1999 26.6	1990 13.6
Teen Birth Rate, Age 15-17 (CY)	1999 18.3	1990 19.4
Total # of Infant Deaths (CY)	1999 0	1990 2
Total # of Child Deaths, Age 1-14 (CY)	1999 2	1990 0
Total # of Teen Deaths by Accident, Homicide and Suicide (CY)	1999 1	1990 1
# of Children Enrolled in Hoosier Healthwise (SFY)	2000 1,325	1998 903
% Noncompliance with Youth Tobacco Access Laws (CY)	2000 N/A	1997 N/A

Percent of Households with Children Under 18 Headed by Parents and Others, Census 2000

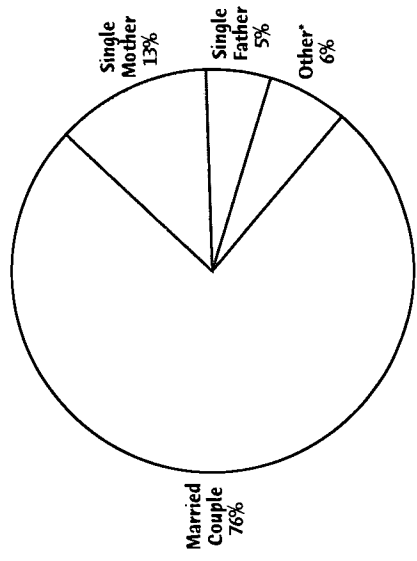

* "Other" includes households with children unrelated to the householder(s) and households with no adults present.

Education, Grades K-12

Public School Enrollment, K-12 (SY)	2000 4,753	1990 4,196
Non-Public School Enrollment (SY)	2001 534	1995 513
# of Home Schooled Children (SY)	2000 69	1990 0
# of Alternative School Participants (SY)	2001 137	1990 0
Total Per Pupil Expenditure (SY)	2000 \$7,061	1990 \$4,329
% of 10th Graders Passing the GOE Math Standard (SY)	2000 76.0	2000 76.0
% of 10th Graders Passing the GOE Language Standard (SY)	2000 79.0	2000 79.0
% of Graduates Passing the GOE (SY)	2000 95.2	2000 95.2
# of Public High School Graduates (SY)	2000 355	1990 332
% of High School Graduates (SY)	2000 96.1	1990 86.6
% of Freshman Class Graduating in 4 Years (SY)	2000 78.9	1990 92.5
% of Grads Intending 4-year College (SY)	2000 60.3	1990 42.9
% of Grads Intending Vocational/Tech School (SY)	2000 3.9	1990 4.0
# of Public School Student Dropouts (SY)	2000 15	1990 47
# of Expulsions and Suspensions (SY)	1999 1,147	1999 1,147

Juveniles and the Law

# of Juveniles Committed to the Dept. of Correction (CY)	2000 3	1994 5
# of Juvenile Status Case Filings (CY)	2000 13	1990 5
# of Juvenile Delinquency Case Filings (CY)	2000 59	1990 21

Number of Babies Born to Single Mothers Under Age 20 without a High School Diploma

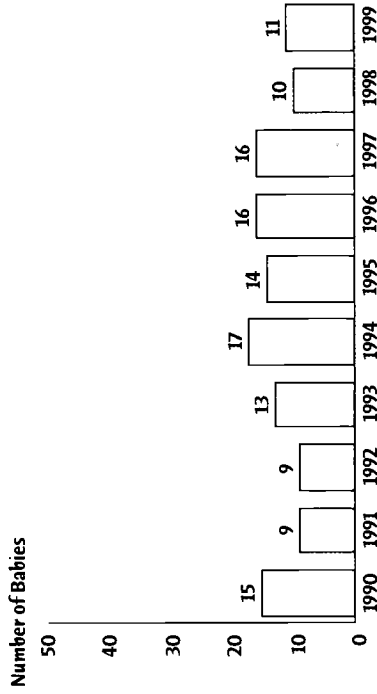

DATA YEAR DEFINITIONS

SFY - State Fiscal Year: July 1-June 30
 SY - School Year: From the start of the school term in the fall through the end of the summer
 FFY - Federal Fiscal Year: October 1-September 30
 CY - Calendar Year: January 1 - December 31

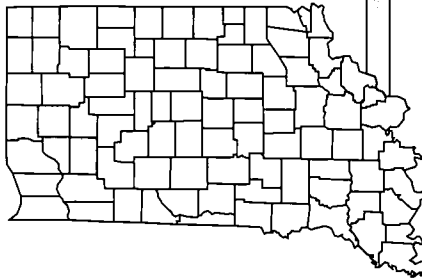

Pulaski County

Kids Count in Indiana 2001



Economic Well-being

	Current Year	Base Year
% of Children in Poverty, Age 0-17 (CY)	1997 14.9	1990 13.7
Per Capita Income (CY)	1999 \$22,030	1990 \$15,995
Unemployment Rate (CY)	2000 6.8	1990 6.2
Monthly Average of Families Receiving TANF (SFY)	2000 39	1990 98
Monthly Average of Persons Issued Food Stamps (SFY)	2000 617	1990 671
% of Students Receiving Free Lunches / Text Books (SY)	2001 17.3	1991 13.9

Early Childhood

# of First Steps Children Served (FFY)	2000 33	1998 26
# of Licensed Child Care Centers (SFY)	2000 0	1990 1
# of Licensed Child Care Homes (SFY)	2000 12	1990 6
# of Registered Child Care Ministries (SFY)	2000 1	1993 0
# of Licensed Child Care Slots per 100 Children, Age 0-4 (SFY)	2000 15.1	1996 11.5

Child Protection

# of Reported Cases of Child Abuse Processed by CPS (SFY)	2000 31	1990 29
% of Child Abuse Cases Substantiated by CPS (SFY)	2000 55.0	1990 72.4
# of Reported Cases of Child Neglect Processed by CPS (SFY)	2000 31	1990 14
% of Child Neglect Cases Substantiated by CPS (SFY)	2000 68.0	1990 14.3
# of Child Physical Abuse Cases Substantiated by CPS (SFY)	2000 13	1990 9
# of Child Sexual Abuse Cases Substantiated by CPS (SFY)	2000 4	1990 2
Child Abuse and Neglect Rate (SFY)	2000 10.1	1990 10.5
# of Child Abuse and Neglect Deaths (SFY)	2000 0	1990 0
# of Juvenile CHINS Case Filings (CY)	2000 140	1990 6

Racial/Ethnic Characteristics of Children Age 0-17 in Pulaski County

One Race (Non-Hispanic Origin)	Percentage
White	95.5%
Black	0.8%
American Indian or Alaska Native	0.3%
Asian	0.2%
Native Hawaiian or Other Pacific Islander	0.0%
Some Other Race	0.1%
Two or More Races (Non-Hispanic Origin)	1.1%
Hispanic Origin*	1.9%

*Hispanic children may be of any race.

Number of Children Under the Age of 20 1990 & 2000

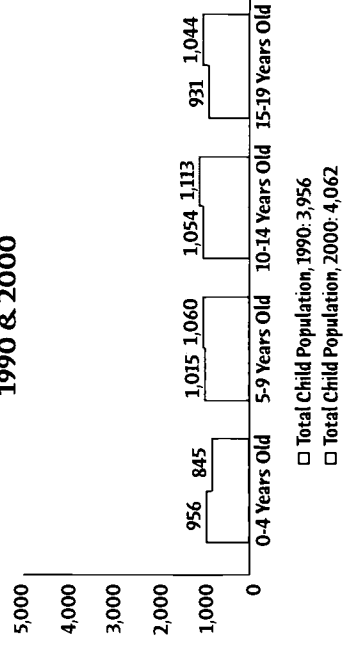

000000 136206

Health & Well-being

	Current Year	Base Year
Total # of Live Births (CY)	199	190
% of Low Birthweight Babies (CY)	9.8	2.3
% of Mothers who Received 1st Trimester Prenatal Care (CY)	84.5	73.7
% of Mothers who Smoked During Pregnancy (CY)	22.2	33.9
Non Marital Births as a % of All Births (CY)	28.4	17.4
Teen Birth Rate, Age 15-17 (CY)	26.7	44.6
Total # of Infant Deaths (CY)	2	2
Total # of Child Deaths, Age 1-14 (CY)	1	2
Total # of Teen Deaths by Accident, Homicide and Suicide (CY)	0	3
# of Children Enrolled in Hoosier Healthwise (SFY)	805	418
% Noncompliance with Youth Tobacco Access Laws (CY)	N/A	N/A

Percent of Households with Children Under 18 Headed by Parents and Others, Census 2000

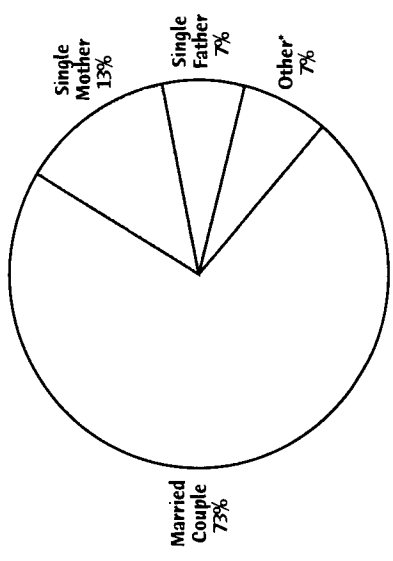

* "Other" includes households with children unrelated to the householder(s) and households with no adults present.

Education, Grades K-12

Public School Enrollment, K-12 (SY)	2000	2,581	1990	2,297
Non-Public School Enrollment (SY)	2001	50	1995	54
# of Home Schooled Children (SY)	2000	48	1990	2
# of Alternative School Participants (SY)	2001	0	1990	0
Total Per Pupil Expenditure (SY)	2000	\$6,245	1990	\$3,532
% of 10th Graders Passing the GQE Math Standard (SY)	2000	73.0	2000	73.0
% of 10th Graders Passing the GQE Language Standard (SY)	2000	79.0	2000	79.0
% of Graduates Passing the GQE (SY)	2000	92.2	2000	92.2
# of Public High School Graduates (SY)	2000	180	1990	140
% of High School Graduates (SY)	2000	92.2	1990	81.9
% of Freshman Class Graduating in 4 Years (SY)	2000	85.3	1990	71.8
% of Grads Intending 4-year College (SY)	2000	44.4	1990	38.9
% of Grads Intending Vocational/Tech School (SY)	2000	8.3	1990	4.9
# of Public School Student Dropouts (SY)	2000	16	1990	41
# of Expulsions and Suspensions (SY)	1999	313	1999	313

Juveniles and the Law

# of Juveniles Committed to the Dept. of Correction (CY)	2000	0	1994	0
# of Juvenile Status Case Filings (CY)	2000	10	1990	5
# of Juvenile Delinquency Case Filings (CY)	2000	29	1990	15

Number of Babies Born to Single Mothers Under Age 20 without a High School Diploma

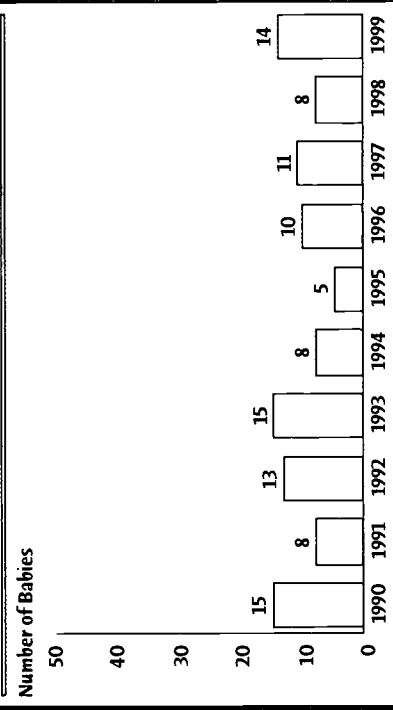

DATA YEAR DEFINITIONS

SFY - State Fiscal Year: July 1-June 30
 SY - School Year: From the start of the school term in the fall through the end of the summer
 FFY - Federal Fiscal Year: October 1-September 30
 CY - Calendar Year: January 1 - December 31

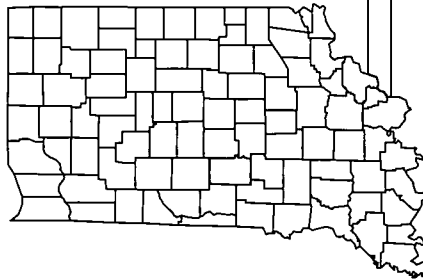

Putnam County

Kids Count in Indiana 2001



Economic Well-being

	Current Year	Base Year
% of Children in Poverty, Age 0-17 (CY)	1997 12.4	1990 10.7
Per Capita Income (CY)	1999 \$20,743	1990 \$14,170
Unemployment Rate (CY)	2000 2.1	1990 5.1
Monthly Average of Families Receiving TANF (SFY)	2000 48	1990 111
Monthly Average of Persons Issued Food Stamps (SFY)	2000 842	1990 1,135
% of Students Receiving Free Lunches / Text Books (SY)	2001 17.2	1991 14.3

Early Childhood

# of First Steps Children Served (FFY)	2000 89	1998 91
# of Licensed Child Care Centers (SFY)	2000 2	1990 3
# of Licensed Child Care Homes (SFY)	2000 26	1990 4
# of Registered Child Care Ministries (SFY)	2000 2	1993 1
# of Licensed Child Care Slots per 100 Children, Age 0-4 (SFY)	2000 16	1996 5.6

Child Protection

# of Reported Cases of Child Abuse Processed by CPS (SFY)	2000 96	1990 155
% of Child Abuse Cases Substantiated by CPS (SFY)	2000 54.0	1990 72.9
# of Reported Cases of Child Neglect Processed by CPS (SFY)	2000 261	1990 141
% of Child Neglect Cases Substantiated by CPS (SFY)	2000 56.0	1990 23.4
# of Child Physical Abuse Cases Substantiated by CPS (SFY)	2000 20	1990 17
# of Child Sexual Abuse Cases Substantiated by CPS (SFY)	2000 32	1990 45
Child Abuse and Neglect Rate (SFY)	2000 24.6	1990 38.8
# of Child Abuse and Neglect Deaths (SFY)	2000 0	1990 0
# of Juvenile CHINS Case Filings (CY)	2000 43	1990 8

Racial/Ethnic Characteristics of Children Age 0-17 in Putnam County

One Race (Non-Hispanic Origin)	96.0%
White	1.0%
Black	0.2%
American Indian or Alaska Native	0.3%
Asian	0.0%
Native Hawaiian or Other Pacific Islander	0.1%
Some Other Race	1.3%
Two or More Races (Non-Hispanic Origin)	1.1%
Hispanic Origin*	

*Hispanic children may be of any race.

Number of Children Under the Age of 20 1990 & 2000

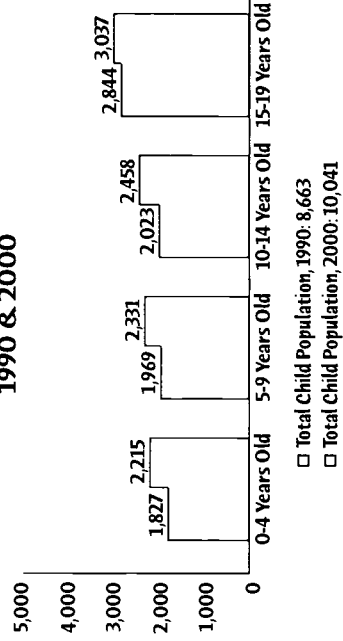

000000 136207

Health & Well-being

	Current Year	Base Year
total # of Live Births (CY)	1999 430	1990 394
% of Low Birthweight Babies (CY)	1999 6.3	1990 5.8
% of Mothers who Received 1st Trimester Prenatal Care (CY)	1999 86.0	1990 81.7
% of Mothers who Smoked During Pregnancy (CY)	1999 27.2	1990 29.4
Non Marital Births as a % of All Births (CY)	1999 29.8	1990 16.2
Teen Birth Rate, Age 15-17 (CY)	1999 18.1	1990 20.3
Total # of Infant Deaths (CY)	1999 2	1990 3
Total # of Child Deaths, Age 1-14 (CY)	1999 0	1990 2
Total # of Teen Deaths by Accident, Homicide and Suicide (CY)	1999 1	1990 0
# of Children Enrolled in Hoosier Healthwise (SFY)	2000 1,578	1998 710
% Noncompliance with Youth Tobacco Access Laws (CY)	2000 30.0	1997 5.0

Percent of Households with Children Under 18 Headed by Parents and Others, Census 2000

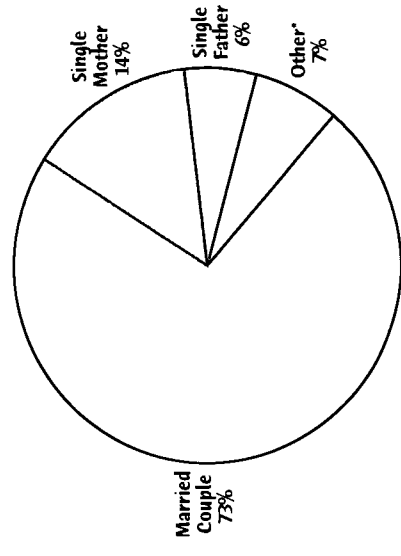

*"Other" includes households with children unrelated to the householder(s) and households with no adults present.

Education, Grades K-12

Public School Enrollment, K-12 (SY)	2000 6,708	1990 5,044
Non-Public School Enrollment (SY)	2001 30	1995 87
# of Home Schooled Children (SY)	2000 144	1990 5
# of Alternative School Participants (SY)	2001 0	1990 0
Total Per Pupil Expenditure (SY)	2000 \$6,991	1990 \$3,858
% of 10th Graders Passing the GQE Math Standard (SY)	2000 60.0	2000 60.0
% of 10th Graders Passing the GQE Language Standard (SY)	2000 69.0	2000 69.0
% of Graduates Passing the GQE (SY)	2000 93.0	2000 93.0
# of Public High School Graduates (SY)	2000 371	1990 443
% of High School Graduates (SY)	2000 92.9	1990 82.8
% of Freshman Class Graduating in 4 Years (SY)	2000 69.1	1990 94.7
% of Grads Intending 4-year College (SY)	2000 52.0	1990 32.0
% of Grads Intending Vocational/Tech School (SY)	2000 8.6	1990 13.6
# of Public School Student Dropouts (SY)	2000 33	1990 97
# of Expulsions and Suspensions (SY)	1999 1,751	1999 1,751

Juveniles and the Law

# of Juveniles Committed to the Dept. of Correction (CY)	2000 6	1994 7
# of Juvenile Status Case Filings (CY)	2000 25	1990 16
# of Juvenile Delinquency Case Filings (CY)	2000 89	1990 144

Number of Babies Born to Single Mothers Under Age 20 without a High School Diploma

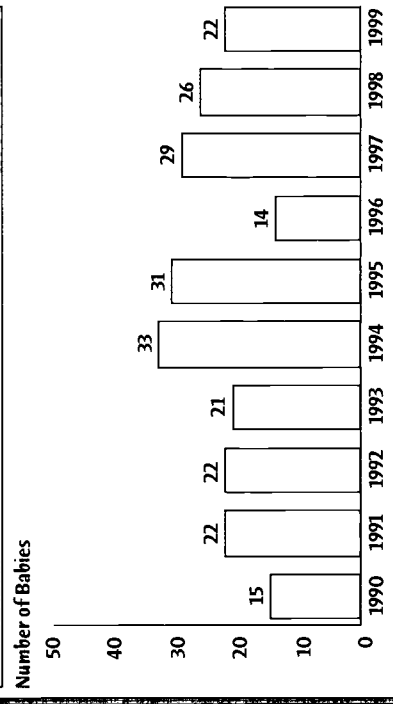

DATA YEAR DEFINITIONS

- SFY - State Fiscal Year: July 1-June 30
- SY - School Year: From the start of the school term in the fall through the end of the summer
- FFY - Federal Fiscal Year: October 1-September 30
- CY - Calendar Year: January 1 - December 31

371

370

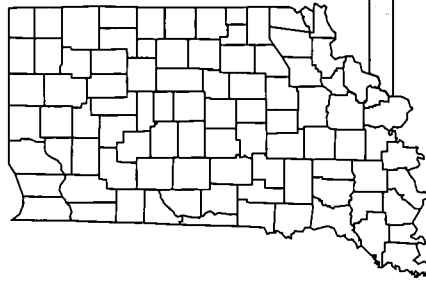

Randolph County

Kids Count in
Indiana 2001



Economic Well-being

	Current Year	Base Year
% of Children in Poverty, Age 0-17 (CY)	1997 17.9	1990 15.7
Per Capita Income (CY)	1999 \$21,545	1990 \$15,096
Unemployment Rate (CY)	2000 5.0	1990 10.2
Monthly Average of Families Receiving TANF (SFY)	2000 124	1990 218
Monthly Average of Persons Issued Food Stamps (SFY)	2000 1,516	1990 1,918
% of Students Receiving Free Lunches / Text Books (SY)	2001 19.4	1991 17.6

Early Childhood

# of First Steps Children Served (FFY)	2000 94	1998 59
# of Licensed Child Care Centers (SFY)	2000 0	1990 0
# of Licensed Child Care Homes (SFY)	2000 13	1990 3
# of Registered Child Care Ministries (SFY)	2000 2	1993 2
# of Licensed Child Care Slots per 100 Children, Age 0-4 (SFY)	2000 8.4	1996 10.1

Child Protection

# of Reported Cases of Child Abuse Processed by CPS (SFY)	2000 99	1990 89
% of Child Abuse Cases Substantiated by CPS (SFY)	2000 63.0	1990 39.3
# of Reported Cases of Child Neglect Processed by CPS (SFY)	2000 184	1990 153
% of Child Neglect Cases Substantiated by CPS (SFY)	2000 44.0	1990 45.8
# of Child Physical Abuse Cases Substantiated by CPS (SFY)	2000 30	1990 8
# of Child Sexual Abuse Cases Substantiated by CPS (SFY)	2000 32	1990 2
Child Abuse and Neglect Rate (SFY)	2000 20.7	1990 26.7
# of Child Abuse and Neglect Deaths (SFY)	2000 0	1990 0
# of Juvenile CHINS Case Filings (CY)	2000 40	1990 34

Racial/Ethnic Characteristics of Children Age 0-17 in Randolph County

One Race (Non-Hispanic Origin)	96.1%
White	0.3%
Black	0.1%
American Indian or Alaska Native	0.2%
Asian	0.0%
Native Hawaiian or Other Pacific Islander	0.1%
Some Other Race	1.2%
Two or More Races (Non-Hispanic Origin)	1.9%
Hispanic Origin*	

*Hispanic children may be of any race.

Number of Children Under the Age of 20 1990 & 2000

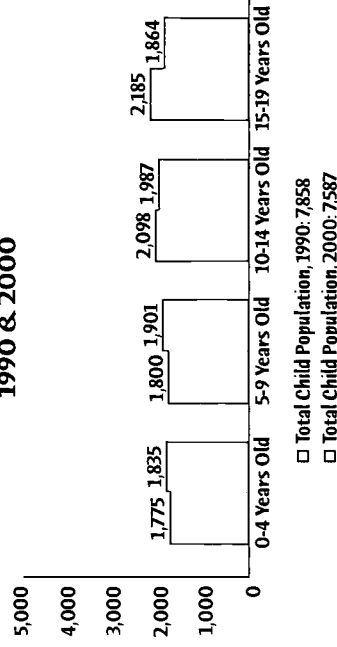

000000 136208

Birth & Well-being

	Current Year	Base Year
Total # of Live Births (CY)	1999 355	1990 341
% of Low Birthweight Babies (CY)	1999 7.6	1990 3.5
% of Mothers who Received 1st Trimester Prenatal Care (CY)	1999 80.3	1990 81.0
% of Mothers who Smoked During Pregnancy (CY)	1999 25.6	1990 26.7
Non Marital Births as a % of All Births (CY)	1999 28.2	1990 19.9
Teen Birth Rate, Age 15-17 (CY)	1999 25.0	1990 29.2
Total # of Infant Deaths (CY)	1999 4	1990 2
Total # of Child Deaths, Age 1-14 (CY)	1999 0	1990 1
Total # of Teen Deaths by Accident, Homicide and Suicide (CY)	1999 0	1990 3
# of Children Enrolled in Hoosier Healthwise (SFY)	2000 1,762	1998 1,151
% Noncompliance with Youth Tobacco Access Laws (CY)	2000 N/A	1997 35.3

Percent of Households with Children Under 18 Headed by Parents and Others, Census 2000

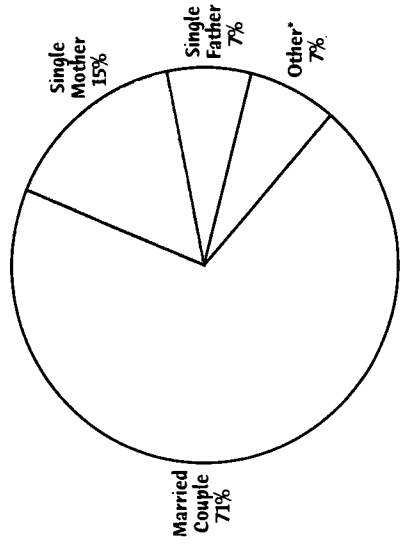

*"Other" includes households with children unrelated to the householder(s) and households with no adults present.

Education, Grades K-12

Public School Enrollment, K-12 (SY)	2000 4,939	1990 4,780
Non-Public School Enrollment (SY)	2001 0	1995 21
# of Home Schooled Children (SY)	2000 72	1990 1
# of Alternative School Participants (SY)	2001 34	1990 0
Total Per Pupil Expenditure (SY)	2000 \$6,583	1990 \$3,999
% of 10th Graders Passing the GQE Math Standard (SY)	2000 69.0	2000 69.0
% of 10th Graders Passing the GQE Language Standard (SY)	2000 75.0	2000 75.0
% of Graduates Passing the GQE (SY)	2000 93.4	2000 93.4
# of Public High School Graduates (SY)	2000 347	1990 411
% of High School Graduates (SY)	2000 93.5	1990 81.9
% of Freshman Class Graduating in 4 Years (SY)	2000 75.9	1990 82.4
% of Grads Intending 4-year College (SY)	2000 46.7	1990 50.3
% of Grads Intending Vocational/Tech School (SY)	2000 13.0	1990 11.2
# of Public School Student Dropouts (SY)	2000 24	1990 87
# of Expulsions and Suspensions (SY)	1999 566	1999 566

Juveniles and the Law

# of Juveniles Committed to the Dept. of Correction (CY)	2000 1	1994 1
# of Juvenile Status Case Filings (CY)	2000 21	1990 9
# of Juvenile Delinquency Case Filings (CY)	2000 52	1990 32

Number of Babies Born to Single Mothers Under Age 20 without a High School Diploma

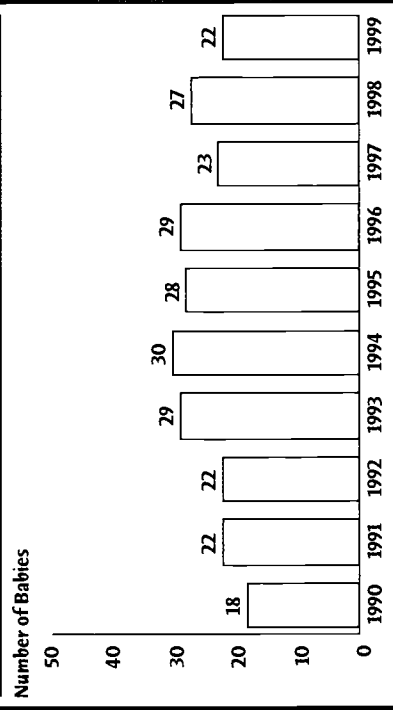

DATA YEAR DEFINITIONS

- SFY - State Fiscal Year: July 1-June 30
- SY - School Year: From the start of the school term in the fall through the end of the summer
- FFY - Federal Fiscal Year: October 1-September 30
- CY - Calendar Year: January 1 - December 31



Ripley County

Kids Count in
Indiana 2001



Economic Well-being

	Current Year	Base Year
% of Children in Poverty, Age 0-17 (CY)	1997 11.9	1990 13.0
Per Capita Income (CY)	1999 \$24,372	1990 \$16,213
Unemployment Rate (CY)	2000 2.7	1990 5.9
Monthly Average of Families Receiving TANF (SFY)	2000 33	1990 126
Monthly Average of Persons Issued Food Stamps (SFY)	2000 776	1990 1,298
% of Students Receiving Free Lunches / Text Books (SY)	2001 12.8	1991 13.9

Early Childhood

# of First Steps Children Served (FFY)	2000 50	1998 36
# of Licensed Child Care Centers (SFY)	2000 2	1990 0
# of Licensed Child Care Homes (SFY)	2000 15	1990 2
# of Registered Child Care Ministries (SFY)	2000 2	1993 1
# of Licensed Child Care Slots per 100 Children, Age 0-4 (SFY)	2000 20.7	1996 13.5

Child Protection

# of Reported Cases of Child Abuse Processed by CPS (SFY)	2000 60	1990 114
% of Child Abuse Cases Substantiated by CPS (SFY)	2000 58.0	1990 46.5
# of Reported Cases of Child Neglect Processed by CPS (SFY)	2000 227	1990 146
% of Child Neglect Cases Substantiated by CPS (SFY)	2000 79.0	1990 42.5
# of Child Physical Abuse Cases Substantiated by CPS (SFY)	2000 20	1990 7
# of Child Sexual Abuse Cases Substantiated by CPS (SFY)	2000 15	1990 7
Child Abuse and Neglect Rate (SFY)	2000 27.5	1990 33.3
# of Child Abuse and Neglect Deaths (SFY)	2000 0	1990 1
# of Juvenile CHINS Case Filings (CY)	2000 15	1990 15

Racial/Ethnic Characteristics of Children Age 0-17 in Ripley County

One Race (Non-Hispanic Origin)	
White	97.2%
Black	0.1%
American Indian or Alaska Native	0.4%
Asian	0.4%
Native Hawaiian or Other Pacific Islander	0.0%
Some Other Race	0.0%
Two or More Races (Non-Hispanic Origin)	0.6%
Hispanic Origin*	1.2%

*Hispanic children may be of any race.

Number of Children Under the Age of 20 1990 & 2000

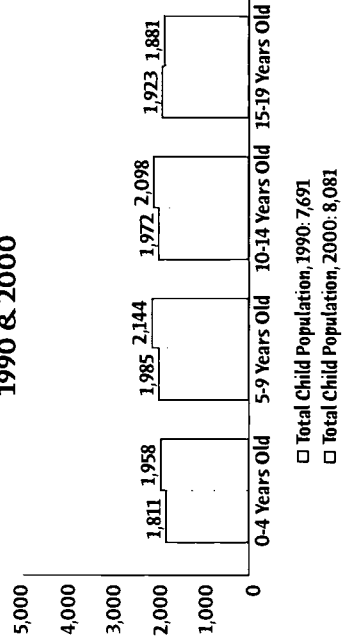

000000 136209

Health & Well-being

	Current Year	Base Year
% of Live Births (CY)	1999 334	1990 397
% of Low Birthweight Babies (CY)	1999 7.5	1990 4.3
% of Mothers who Received 1st Trimester Prenatal Care (CY)	1999 84.4	1990 68.9
% of Mothers who Smoked During Pregnancy (CY)	1999 26.9	1990 24.9
Non Marital Births as a % of All Births (CY)	1999 27.2	1990 15.1
Teen Birth Rate, Age 15-17 (CY)	1999 15.9	1990 32.6
Total # of Infant Deaths (CY)	1999 1	1990 1
Total # of Child Deaths, Age 1-14 (CY)	1999 0	1990 1
Total # of Teen Deaths by Accident, Homicide and Suicide (CY)	1999 0	1990 0
# of Children Enrolled in Hoosier Healthwise (SFY)	2000 1,252	1998 607
% Noncompliance with Youth Tobacco Access Laws (CY)	2000 10.0	1997 69.2

Percent of Households with Children Under 18 Headed by Parents and Others, Census 2000

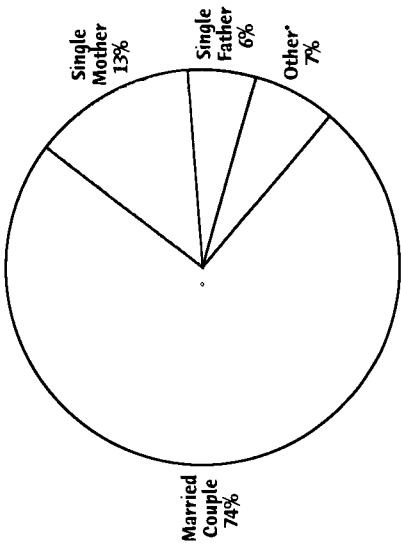

Other includes households with children unrelated to the householder(s) and households with no adults present.

Education, Grades K-12

Public School Enrollment, K-12 (SY)	2000 5,466	1990 3,013
Non-Public School Enrollment (SY)	2001 856	1995 602
# of Home Schooled Children (SY)	2000 79	1990 3
# of Alternative School Participants (SY)	2001 70	1990 0
Total Per Pupil Expenditure (SY)	2000 \$6,946	1990 \$4,058
% of 10th Graders Passing the GQE Math Standard (SY)	2000 66.0	2000 66.0
% of 10th Graders Passing the GQE Language Standard (SY)	2000 72.0	2000 72.0
% of Graduates Passing the GQE (SY)	2000 96.1	2000 96.1
# of Public High School Graduates (SY)	2000 330	1990 370
% of High School Graduates (SY)	2000 94.5	1990 85.2
% of Freshman Class Graduating in 4 Years (SY)	2000 76.2	1990 88.9
% of Grads Intending 4-year College (SY)	2000 50.9	1990 50.3
% of Grads Intending Vocational/Tech School (SY)	2000 6.7	1990 41.2
# of Public School Student Dropouts (SY)	2000 23	1990 81
# of Expulsions and Suspensions (SY)	1999 804	1999 804

Juveniles and the Law

# of Juveniles Committed to the Dept. of Correction (CY)	2000 6	1994 0
# of Juvenile Status Case Filings (CY)	2000 23	1990 0
# of Juvenile Delinquency Case Filings (CY)	2000 56	1990 32

Number of Babies Born to Single Mothers Under Age 20 without a High School Diploma

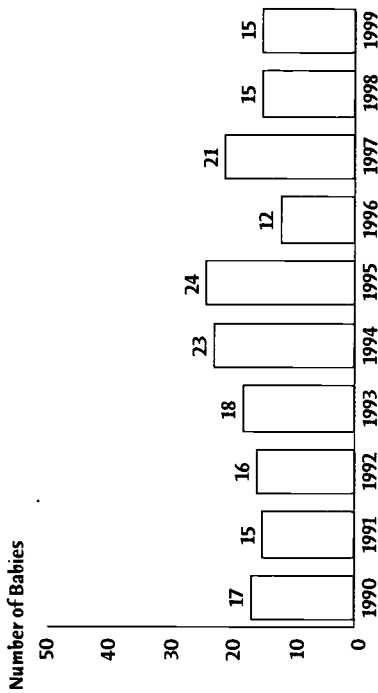

DATA YEAR DEFINITIONS

SFY - State Fiscal Year: July 1-June 30

SY - School Year: From the start of the school term in the fall through the end of the summer

FFY - Federal Fiscal Year: October 1-September 30

CY - Calendar Year: January 1 - December 31

378

379

Kids Count 2001

www.iyi.org

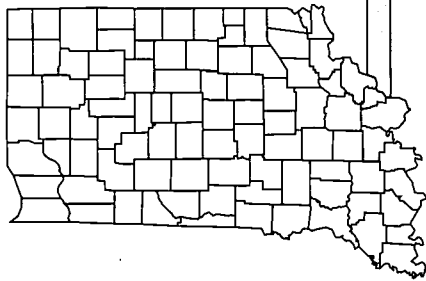

Rush County



Economic Well-being

	Current Year	Base Year
% of Children in Poverty, Age 0-17 (CY)	1997 12.3	1990 13.4
Per Capita Income (CY)	1999 \$21,542	1990 \$14,742
Unemployment Rate (CY)	2000 2.7	1990 6.7
Monthly Average of Families Receiving TANF (SFY)	2000 33	1990 115
Monthly Average of Persons Issued Food Stamps (SFY)	2000 594	1990 756
% of Students Receiving Free Lunches / Text Books (SY)	2001 18.2	1991 13.8

Early Childhood

# of First Steps Children Served (FFY)	2000 53	1998 48
# of Licensed Child Care Centers (SFY)	2000 1	1990 1
# of Licensed Child Care Homes (SFY)	2000 16	1990 6
# of Registered Child Care Ministries (SFY)	2000 1	1993 0
# of Licensed Child Care Slots per 100 Children, Age 0-4 (SFY)	2000 22.2	1996 26.6

Child Protection

# of Reported Cases of Child Abuse Processed by CPS (SFY)	2000 21	1990 78
% of Child Abuse Cases Substantiated by CPS (SFY)	2000 52.0	1990 53.8
# of Reported Cases of Child Neglect Processed by CPS (SFY)	2000 34	1990 97
% of Child Neglect Cases Substantiated by CPS (SFY)	2000 41.0	1990 36.1
# of Child Physical Abuse Cases Substantiated by CPS (SFY)	2000 8	1990 5
# of Child Sexual Abuse Cases Substantiated by CPS (SFY)	2000 3	1990 9
Child Abuse and Neglect Rate (SFY)	2000 5.0	1990 28.3
# of Child Abuse and Neglect Deaths (SFY)	2000 0	1990 0
# of Juvenile CHINS Case Filings (CY)	2000 12	1990 5

Racial/Ethnic Characteristics of Children Age 0-17 in Rush County

One Race (Non-Hispanic Origin)	Percentage
White	96.4%
Black	0.7%
American Indian or Alaska Native	0.2%
Asian	0.6%
Native Hawaiian or Other Pacific Islander	0.0%
Some Other Race	0.1%
Two or More Races (Non-Hispanic Origin)	1.2%
Hispanic Origin*	0.8%

*Hispanic children may be of any race.

Number of Children Under the Age of 20 1990 & 2000

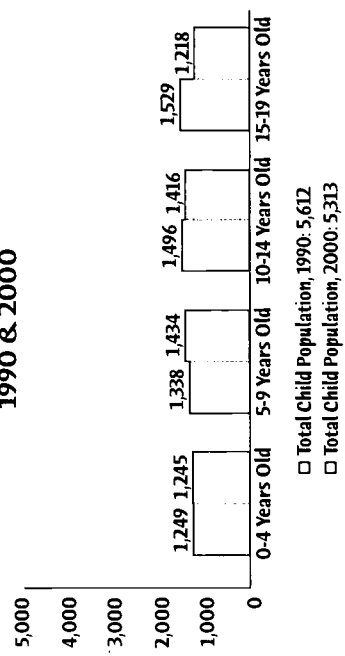

Health & Well-being

	Current Year	Base Year
Least # of Live Births (CY)	1999 238	1990 247
% of Low Birthweight Babies (CY)	1999 8.8	1990 5.7
% of Mothers who Received 1st Trimester Prenatal Care (CY)	1999 81.1	1990 83.8
% of Mothers who Smoked During Pregnancy (CY)	1999 27.7	1990 30.0
Non Marital Births as a % of All Births (CY)	1999 26.1	1990 19.8
Teen Birth Rate, Age 15-17 (CY)	1999 16.3	1990 30.1
Total # of Infant Deaths (CY)	1999 1	1990 4
Total # of Child Deaths, Age 1-14 (CY)	1999 3	1990 1
Total # of Teen Deaths by Accident, Homicide and Suicide (CY)	1999 1	1990 0
# of Children Enrolled in Hoosier Healthwise (SFY)	2000 923	1998 517
% Noncompliance with Youth Tobacco Access Laws (CY)	2000 N/A	1997 N/A

Education, Grades K-12

Public School Enrollment, K-12 (SY)	2000 2,709	1990 2,547
Non-Public School Enrollment (SY)	2001 437	1995 464
# of Home Schooled Children (SY)	2000 78	1990 3
# of Alternative School Participants (SY)	2001 0	1990 0
Total Per Pupil Expenditure (SY)	2000 \$6,339	1990 \$3,733
% of 10th Graders Passing the GQE Math Standard (SY)	2000 60.0	2000 60.0
% of 10th Graders Passing the GQE Language Standard (SY)	2000 67.0	2000 67.0
% of Graduates Passing the GQE (SY)	2000 97.5	2000 97.5
# of Public High School Graduates (SY)	2000 160	1990 266
% of High School Graduates (SY)	2000 87.2	1990 73.7
% of Freshman Class Graduating in 4 Years (SY)	2000 63.0	1990 90.5
% of Grads Intending 4-year College (SY)	2000 71.3	1990 42.2
% of Grads Intending Vocational/Tech School (SY)	2000 7.5	1990 7.3
# of Public School Student Dropouts (SY)	2000 29	1990 71
# of Expulsions and Suspensions (SY)	1999 860	1999 860

Juveniles and the Law

# of Juveniles Committed to the Dept. of Correction (CY)	2000 5	1994 3
# of Juvenile Status Case Filings (CY)	2000 10	1990 0
# of Juvenile Delinquency Case Filings (CY)	2000 34	1990 36

382

000000 136210

Percent of Households with Children Under 18 Headed by Parents and Others, Census 2000

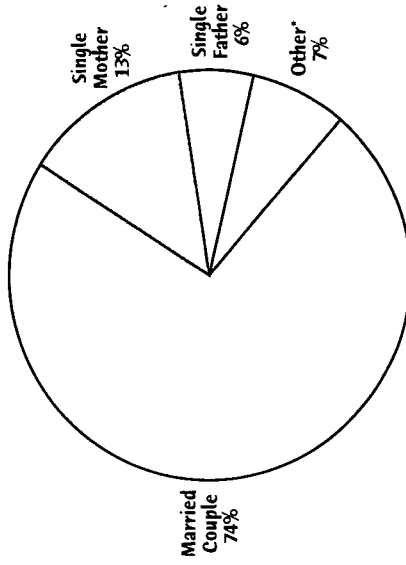

*"Other" includes households with children unrelated to the householder(s) and households with no adults present.

Number of Babies Born to Single Mothers Under Age 20 without a High School Diploma

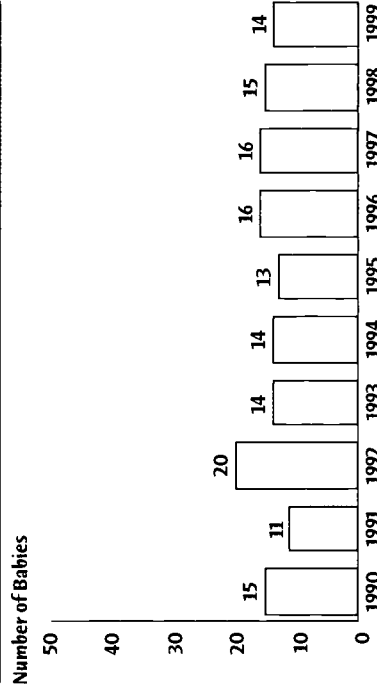

DATA YEAR DEFINITIONS

- SFY - State Fiscal Year: July 1-June 30
- SY - School Year: From the start of the school term in the fall through the end of the summer
- FFY - Federal Fiscal Year: October 1-September 30
- CY - Calendar Year: January 1 - December 31

383

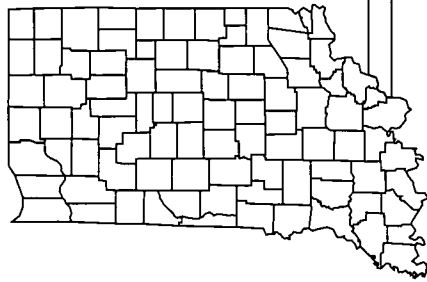

St. Joseph County

Kids Count in Indiana 2001



Economic Well-being

	Current Year	Base Year
% of Children in Poverty, Age 0-17 (CY)	1997 16.9	1990 13.8
Per Capita Income (CY)	1999 \$26,761	1990 \$17,790
Unemployment Rate (CY)	2000 3.4	1990 5.9
Monthly Average of Families Receiving TANF (SFY)	2000 1,864	1990 2,991
Monthly Average of Persons Issued Food Stamps (SFY)	2000 15,846	1990 13,835
% of Students Receiving Free Lunches / Text Books (SY)	2001 27.8	1991 23.1

Early Childhood

# of First Steps Children Served (FFY)	2000 698	1998 518
# of Licensed Child Care Centers (SFY)	2000 41	1990 56
# of Licensed Child Care Homes (SFY)	2000 182	1990 88
# of Registered Child Care Ministries (SFY)	2000 30	1993 17
# of Licensed Child Care Slots per 100 Children, Age 0-4 (SFY)	2000 27.5	1996 24.8

Child Protection

# of Reported Cases of Child Abuse Processed by CPS (SFY)	2000 590	1990 757
% of Child Abuse Cases Substantiated by CPS (SFY)	2000 59.0	1990 46.1
# of Reported Cases of Child Neglect Processed by CPS (SFY)	2000 709	1990 1,060
% of Child Neglect Cases Substantiated by CPS (SFY)	2000 55.0	1990 42.1
# of Child Physical Abuse Cases Substantiated by CPS (SFY)	2000 190	1990 88
# of Child Sexual Abuse Cases Substantiated by CPS (SFY)	2000 157	1990 153
Child Abuse and Neglect Rate (SFY)	2000 11.4	1990 27.5
# of Child Abuse and Neglect Deaths (SFY)	2000 0	1990 3
# of Juvenile CHINS Case Filings (CY)	2000 297	1990 174

Racial/Ethnic Characteristics of Children Age 0-17 in St. Joseph County

One Race (Non-Hispanic Origin)	71.9%
White	15.8%
Black	0.4%
American Indian or Alaska Native	1.2%
Asian	0.0%
Native Hawaiian or Other Pacific Islander	0.3%
Some Other Race	3.2%
Two or More Races (Non-Hispanic Origin)	7.1%
Hispanic Origin*	

*Hispanic children may be of any race.

Number of Children Under the Age of 20 1990 & 2000

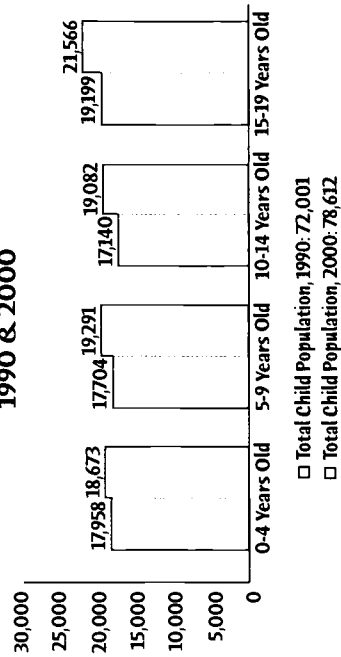

Health & Well-being

	Current Year	Base Year
% of Live Births (CY)	1999 3,873	1990 3,892
% of Low Birthweight Babies (CY)	1999 7.4	1990 7.1
% of Mothers who Received 1st Trimester Prenatal Care (CY)	1999 78.8	1990 78.4
% of Mothers who Smoked During Pregnancy (CY)	1999 17.1	1990 25.1
Non Marital Births as a % of All Births (CY)	1999 39.7	1990 32.4
Teen Birth Rate, Age 15-17 (CY)	1999 34.3	1990 42.1
Total # of Infant Deaths (CY)	1999 42	1990 43
Total # of Child Deaths, Age 1-14 (CY)	1999 17	1990 12
Total # of Teen Deaths by Accident, Homicide and Suicide (CY)	1999 13	1990 9
# of Children Enrolled in Hoosier Healthwise (SFY)	2000 18,321	1998 11,922
% Noncompliance with Youth Tobacco Access Laws (CY)	2000 30.0	1997 16.7

Education, Grades K-12

Public School Enrollment, K-12 (SY)	2000 39,314	1990 33,523
Non-Public School Enrollment (SY)	2001 8,757	1995 8,266
# of Home Schooled Children (SY)	2000 494	1990 39
# of Alternative School Participants (SY)	2001 1,505	1990 176
Total Per Pupil Expenditure (SY)	2000 \$7,318	1990 \$4,241
% of 10th Graders Passing the GQE Math Standard (SY)	2000 61.0	2000 61.0
% of 10th Graders Passing the GQE Language Standard (SY)	2000 69.0	2000 69.0
% of Graduates Passing the GQE (SY)	2000 95.6	2000 95.6
# of Public High School Graduates (SY)	2000 1,968	1990 2,354
% of High School Graduates (SY)	2000 84.8	1990 72.4
% of Freshman Class Graduating in 4 Years (SY)	2000 55.8	1990 68.9
% of Grads Intending 4-year College (SY)	2000 57.5	1990 31.0
% of Grads Intending Vocational/Tech School (SY)	2000 9.8	1990 7.8
# of Public School Student Dropouts (SY)	2000 520	1990 828
# of Expulsions and Suspensions (SY)	1999 19,035	1999 19,035

Juveniles and the Law

# of Juveniles Committed to the Dept. of Correction (CY)	2000 179	1994 124
# of Juvenile Status Case Filings (CY)	2000 200	1990 3
# of Juvenile Delinquency Case Filings (CY)	2000 1,261	1990 494

Percent of Households with Children Under 18 Headed by Parents and Others, Census 2000

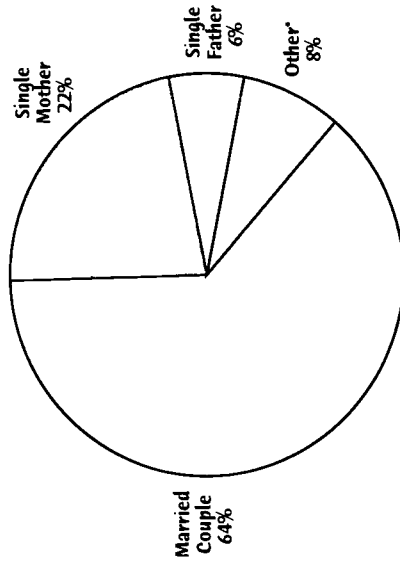

*"Other" includes households with children unrelated to the householder(s) and households with no adults present.

Number of Babies Born to Single Mothers Under Age 20 without a High School Diploma

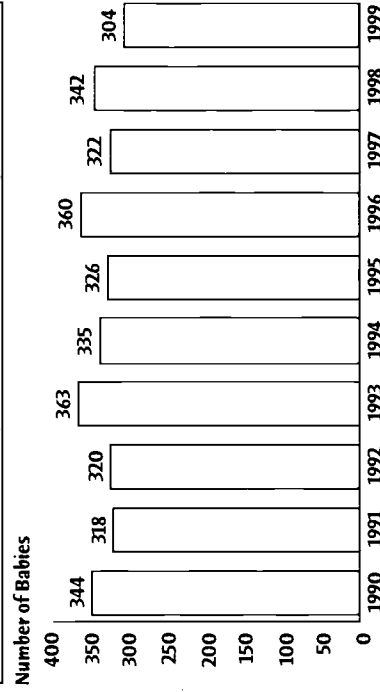

DATA YEAR DEFINITIONS

- SFY - State Fiscal Year: July 1-June 30
- SY - School Year: From the start of the school term in the fall through the end of the summer
- FFY - Federal Fiscal Year: October 1-September 30
- CY - Calendar Year: January 1 - December 31

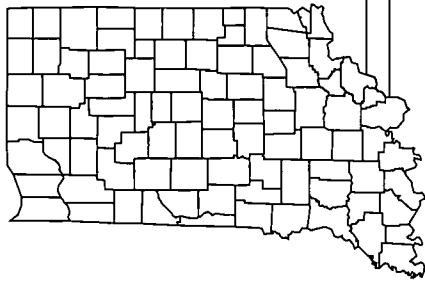

Scott County

Kids Count in Indiana 2001



Economic Well-being

	Current Year	Base Year
% of Children in Poverty, Age 0-17 (CY)	1997 20.4	1990 26.9
Per Capita Income (CY)	1999 \$19,990	1990 \$13,220
Unemployment Rate (CY)	2000 3.2	1990 8.6
Monthly Average of Families Receiving TANF (SFY)	2000 188	1990 327
Monthly Average of Persons Issued Food Stamps (SFY)	2000 1,848	1990 2,736
% of Students Receiving Free Lunches / Text Books (SY)	2001 30.7	1991 27.8

Early Childhood

# of First Steps Children Served (FFY)	2000 117	1998 117
# of Licensed Child Care Centers (SFY)	2000 4	1990 2
# of Licensed Child Care Homes (SFY)	2000 7	1990 12
# of Registered Child Care Ministries (SFY)	2000 2	1993 1
# of Licensed Child Care Slots per 100 Children, Age 0-4 (SFY)	2000 19.6	1996 12.9

Child Protection

# of Reported Cases of Child Abuse Processed by CPS (SFY)	2000 173	1990 104
% of Child Abuse Cases Substantiated by CPS (SFY)	2000 53.0	1990 47.1
# of Reported Cases of Child Neglect Processed by CPS (SFY)	2000 357	1990 151
% of Child Neglect Cases Substantiated by CPS (SFY)	2000 64.0	1990 34.4
# of Child Physical Abuse Cases Substantiated by CPS (SFY)	2000 37	1990 19
# of Child Sexual Abuse Cases Substantiated by CPS (SFY)	2000 54	1990 7
Child Abuse and Neglect Rate (SFY)	2000 50.3	1990 38.0
# of Child Abuse and Neglect Deaths (SFY)	2000 0	1990 0
# of Juvenile CHINS Case Filings (CY)	2000 21	1990 29

Racial/Ethnic Characteristics of Children Age 0-17 in Scott County

One Race (Non-Hispanic Origin)	97.5%
White	0.0%
Black	0.2%
American Indian or Alaska Native	0.2%
Asian	0.0%
Native Hawaiian or Other Pacific Islander	0.1%
Some Other Race	0.6%
Two or More Races (Non-Hispanic Origin)	1.4%
Hispanic Origin*	

*Hispanic children may be of any race.

Number of Children Under the Age of 20 1990 & 2000

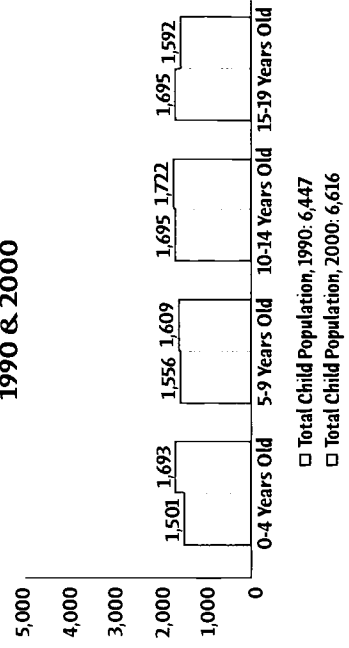

000000 136212

Health & Well-being

	Current Year	Base Year
Total # of Live Births (CY)	1999 306	1990 329
% of Low Birthweight Babies (CY)	1999 7.2	1990 6.4
% of Mothers who Received 1st Trimester Prenatal Care (CY)	1999 74.8	1990 70.8
% of Mothers who Smoked During Pregnancy (CY)	1999 36.9	1990 36.5
Non Marital Births as a % of All Births (CY)	1999 29.7	1990 23.4
Teen Birth Rate, Age 15-17 (CY)	1999 22.4	1990 32.5
Total # of Infant Deaths (CY)	1999 2	1990 2
Total # of Child Deaths, Age 1-14 (CY)	1999 0	1990 2
Total # of Teen Deaths by Accident, Homicide and Suicide (CY)	1999 2	1990 2
# of Children Enrolled in Hoosier Healthwise (SFY)	2000 1,875	1998 1,284
% Noncompliance with Youth Tobacco Access Laws (CY)	2000 30.0	1997 N/A

Percent of Households with Children Under 18 Headed by Parents and Others, Census 2000

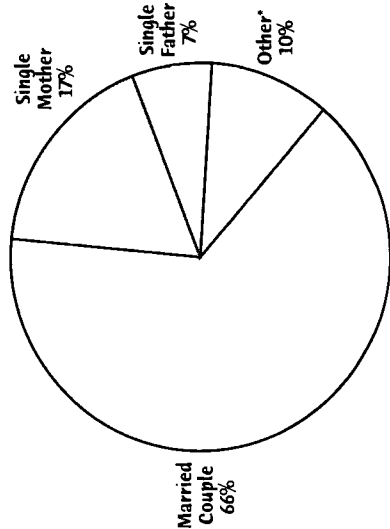

* "Other" includes households with children unrelated to the householder(s) and households with no adults present.

Education, Grades K-12

Public School Enrollment, K-12 (SY)	2000 4,106	1990 3,681
Non-Public School Enrollment (SY)	2001 0	1995 0
# of Home Schooled Children (SY)	2000 92	1990 0
# of Alternative School Participants (SY)	2001 68	1990 0
Total Per Pupil Expenditure (SY)	2000 \$5,950	1990 \$3,707
% of 10th Graders Passing the GQE Math Standard (SY)	2000 50.0	2000 50.0
% of 10th Graders Passing the GQE Language Standard (SY)	2000 65.0	2000 65.0
% of Graduates Passing the GQE (SY)	2000 97.9	2000 97.9
# of Public High School Graduates (SY)	2000 236	1990 279
% of High School Graduates (SY)	2000 85.9	1990 74.0
% of Freshman Class Graduating in 4 Years (SY)	2000 67.4	1990 80.2
% of Grads Intending 4-year College (SY)	2000 39.4	1990 36.6
% of Grads Intending Vocational/Tech School (SY)	2000 4.7	1990 6.9
# of Public School Student Dropouts (SY)	2000 42	1990 96
# of Expulsions and Suspensions (SY)	1999 1,020	1999 1,020

Juveniles and the Law

# of Juveniles Committed to the Dept. of Correction (CY)	2000 5	1994 6
# of Juvenile Status Case Filings (CY)	2000 0	1990 0
# of Juvenile Delinquency Case Filings (CY)	2000 57	1990 23

Number of Babies Born to Single Mothers Under Age 20 without a High School Diploma

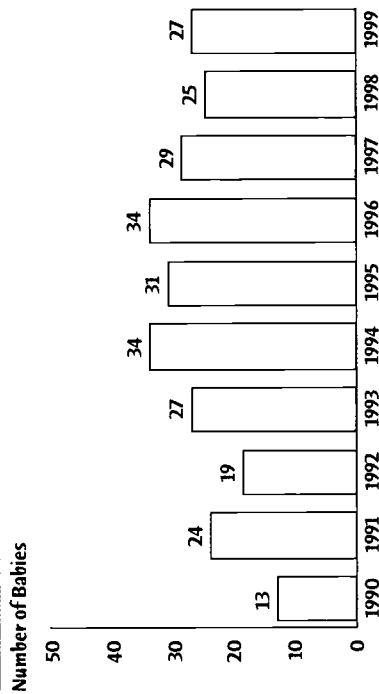

DATA YEAR DEFINITIONS

SFY - State Fiscal Year: July 1-June 30

SY - School Year: From the start of the school term in the fall through the end of the summer

FFY - Federal Fiscal Year: October 1-September 30

CY - Calendar Year: January 1 - December 31



Shelby County

Kids Count in Indiana 2001



Economic Well-being

	Current Year	Base Year
% of Children in Poverty, Age 0-17 (CY)	1997 10.5	1990 9.4
Per Capita Income (CY)	1999 \$24,447	1990 \$17,086
Unemployment Rate (CY)	2000 2.7	1990 5.8
Monthly Average of Families Receiving TANF (SFY)	2000 89	1990 246
Monthly Average of Persons Issued Food Stamps (SFY)	2000 1,412	1990 1,522
% of Students Receiving Free Lunches / Text Books (SY)	2001 12.1	1991 9.7

Early Childhood

# of First Steps Children Served (FFY)	2000 188	1998 112
# of Licensed Child Care Centers (SFY)	2000 3	1990 4
# of Licensed Child Care Homes (SFY)	2000 35	1990 0
# of Registered Child Care Ministries (SFY)	2000 1	1993 1
# of Licensed Child Care Slots per 100 Children, Age 0-4 (SFY)	2000 22.5	1996 18.2

Child Protection

# of Reported Cases of Child Abuse Processed by CPS (SFY)	2000 158	1990 327
% of Child Abuse Cases Substantiated by CPS (SFY)	2000 64.0	1990 48.9
# of Reported Cases of Child Neglect Processed by CPS (SFY)	2000 141	1990 252
% of Child Neglect Cases Substantiated by CPS (SFY)	2000 64.0	1990 37.3
# of Child Physical Abuse Cases Substantiated by CPS (SFY)	2000 38	1990 27
# of Child Sexual Abuse Cases Substantiated by CPS (SFY)	2000 63	1990 73
Child Abuse and Neglect Rate (SFY)	2000 16.5	1990 46.7
# of Child Abuse and Neglect Deaths (SFY)	2000 1	1990 0
# of Juvenile CHINS Case Filings (CY)	2000 59	1990 20

Racial/Ethnic Characteristics of Children Age 0-17 in Shelby County

One Race (Non-Hispanic Origin)	95.6%
White	0.8%
Black	0.3%
American Indian or Alaska Native	0.6%
Asian	0.0%
Native Hawaiian or Other Pacific Islander	0.1%
Some Other Race	1.0%
Two or More Races (Non-Hispanic Origin)	1.5%
Hispanic Origin*	

*Hispanic children may be of any race.

Number of Children Under the Age of 20 1990 & 2000

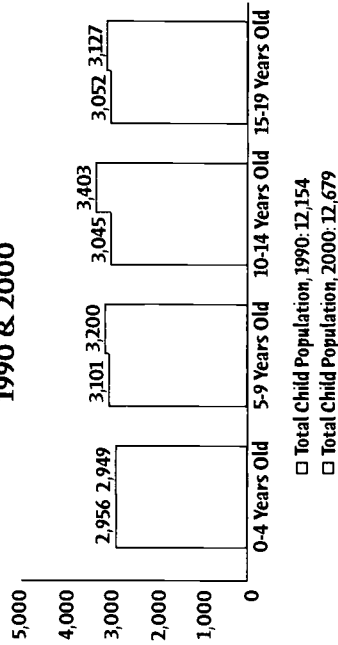

000000136213

Health & Well-being

Percent of Households with Children Under 18 Headed by Parents and Others, Census 2000

	Current Year	Base Year
Total # of Live Births (CY)	1999 606	1990 546
% of Low Birthweight Babies (CY)	1999 8.6	1990 6.8
% of Mothers who Received 1st Trimester Prenatal Care (CY)	1999 83.8	1990 84.7
% of Mothers who Smoked During Pregnancy (CY)	1999 30.5	1990 35.0
Non Marital Births as a % of All Births (CY)	1999 32.2	1990 21.6
Teen Birth Rate, Age 15-17 (CY)	1999 24.3	1990 29.2
Total # of Infant Deaths (CY)	1999 3	1990 7
Total # of Child Deaths, Age 1-14 (CY)	1999 4	1990 4
Total # of Teen Deaths by Accident, Homicide and Suicide (CY)	1999 2	1990 4
# of Children Enrolled in Hoosier Healthwise (SFY)	2000 2,024	1998 1,041
% Noncompliance with Youth Tobacco Access Laws (CY)	2000 N/A	1997 N/A

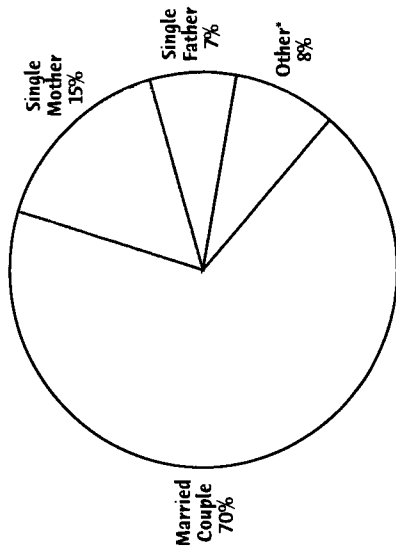

* "Other" includes households with children unrelated to the householder(s) and households with no adults present.

Education, Grades K-12

Public School Enrollment, K-12 (SY)	2000 7,865	1990 6,987
Non-Public School Enrollment (SY)	2001 209	1995 286
# of Home Schooled Children (SY)	2000 121	1990 19
# of Alternative School Participants (SY)	2001 307	1990 0
Total Per Pupil Expenditure (SY)	2000 \$5,546	1990 \$3,925
% of 10th Graders Passing the GQE Math Standard (SY)	2000 65.0	2000 65.0
% of 10th Graders Passing the GQE Language Standard (SY)	2000 70.0	2000 70.0
% of Graduates Passing the GQE (SY)	2000 95.6	2000 95.6
# of Public High School Graduates (SY)	2000 476	1990 544
% of High School Graduates (SY)	2000 88.3	1990 81.1
% of Freshman Class Graduating in 4 Years (SY)	2000 68.6	1990 73.3
% of Grads Intending 4-year College (SY)	2000 52.5	1990 35.6
% of Grads Intending Vocational/Tech School (SY)	2000 6.5	1990 7.5
# of Public School Student Dropouts (SY)	2000 71	1990 136
# of Expulsions and Suspensions (SY)	1999 1,871	1999 1,871

Number of Babies Born to Single Mothers Under Age 20 without a High School Diploma

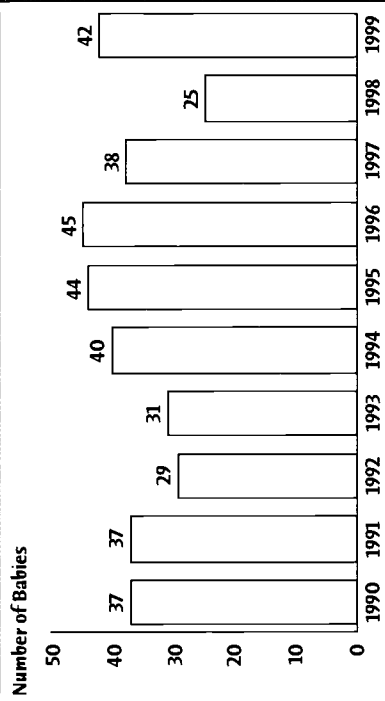

Juveniles and the Law

# of Juveniles Committed to the Dept. of Correction (CY)	2000 28	1994 8
# of Juvenile Status Case Filings (CY)	2000 20	1990 11
# of Juvenile Delinquency Case Filings (CY)	2000 125	1990 75

DATA YEAR DEFINITIONS

SFY - State Fiscal Year: July 1-June 30
 SY - School Year: From the start of the school term in the fall through the end of the summer
 FFY - Federal Fiscal Year: October 1-September 30
 CY - Calendar Year: January 1 - December 31



Spencer County

Kids Count in Indiana 2001



Economic Well-being

	Current Year	Base Year
% of Children in Poverty, Age 0-17 (CY)	1997 12.4	1990 10.7
Per Capita Income (CY)	1999 \$21,654	1990 \$14,651
Unemployment Rate (CY)	2000 4.2	1990 6.5
Monthly Average of Families Receiving TANF (SFY)	2000 30	1990 91
Monthly Average of Persons Issued Food Stamps (SFY)	2000 581	1990 904
% of Students Receiving Free Lunches / Text Books (SY)	2001 11.8	1991 10.6

Early Childhood

# of First Steps Children Served (FFY)	2000 31	1998 37
# of Licensed Child Care Centers (SFY)	2000 2	1990 2
# of Licensed Child Care Homes (SFY)	2000 12	1990 4
# of Registered Child Care Ministries (SFY)	2000 3	1993 3
# of Licensed Child Care Slots per 100 Children, Age 0-4 (SFY)	2000 16.8	1996 10

Child Protection

# of Reported Cases of Child Abuse Processed by CPS (SFY)	2000 37	1990 43
% of Child Abuse Cases Substantiated by CPS (SFY)	2000 76.0	1990 53.5
# of Reported Cases of Child Neglect Processed by CPS (SFY)	2000 56	1990 27
% of Child Neglect Cases Substantiated by CPS (SFY)	2000 64.0	1990 11.1
# of Child Physical Abuse Cases Substantiated by CPS (SFY)	2000 11	1990 11
# of Child Sexual Abuse Cases Substantiated by CPS (SFY)	2000 17	1990 4
Child Abuse and Neglect Rate (SFY)	2000 11.2	1990 12.2
# of Child Abuse and Neglect Deaths (SFY)	2000 0	1990 0
# of Juvenile CHINS Case Filings (CY)	2000 4	1990 5

396

Racial/Ethnic Characteristics of Children Age 0-17 in Spencer County

One Race (Non-Hispanic Origin)	96.3%
White	0.5%
Black	0.1%
American Indian or Alaska Native	0.3%
Asian	0.0%
Native Hawaiian or Other Pacific Islander	0.1%
Some Other Race	0.8%
Two or More Races (Non-Hispanic Origin)	1.9%
Hispanic Origin*	

*Hispanic children may be of any race.

Number of Children Under the Age of 20 1990 & 2000

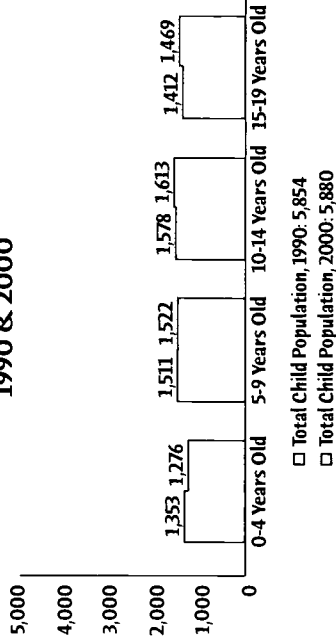

397

Health & Well-being

	Current Year	Base Year
Total # of Live Births (CY)	1999 237	1990 267
% of Low Birthweight Babies (CY)	1999 8.0	1990 5.6
% of Mothers who Received 1st Trimester Prenatal Care (CY)	1999 87.3	1990 89.0
% of Mothers who Smoked During Pregnancy (CY)	1999 16.5	1990 22.8
Non Marital Births as a % of All Births (CY)	1999 22.4	1990 10.1
Teen Birth Rate, Age 15-17 (CY)	1999 27.1	1990 9.4
Total # of Infant Deaths (CY)	1999 1	1990 3
Total # of Child Deaths, Age 1-14 (CY)	1999 0	1990 0
Total # of Teen Deaths by Accident, Homicide and Suicide (CY)	1999 2	1990 3
# of Children Enrolled in Hoosier Healthwise (SFY)	2000 820	1998 541
% Noncompliance with Youth Tobacco Access Laws (CY)	2000 20.0	1997 14.8

Percent of Households with Children Under 18 Headed by Parents and Others, Census 2000

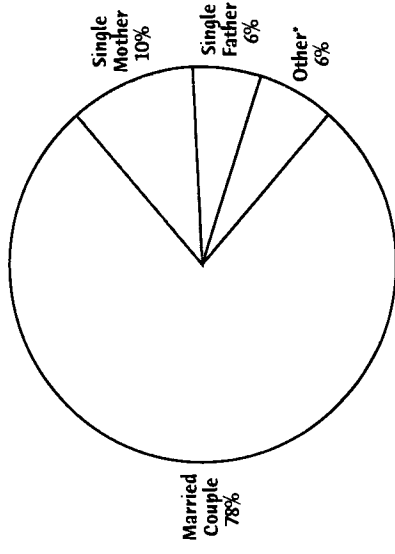

*"Other" includes households with children unrelated to the householder(s) and households with no adults present.

000000 136214

Education, Grades K-12

Public School Enrollment, K-12 (SY)	2000 3,894	1990 2,957
Non-Public School Enrollment (SY)	2001 194	1995 97
# of Home Schooled Children (SY)	2000 45	1990 2
# of Alternative School Participants (SY)	2001 216	1990 0
Total Per Pupil Expenditure (SY)	2000 \$5,965	1990 \$3,742
% of 10th Graders Passing the GQE Math Standard (SY)	2000 76.0	2000 76.0
% of 10th Graders Passing the GQE Language Standard (SY)	2000 76.0	2000 76.0
% of Graduates Passing the GQE (SY)	2000 98.8	2000 98.8
# of Public High School Graduates (SY)	2000 257	1990 273
% of High School Graduates (SY)	2000 91.8	1990 87.2
% of Freshman Class Graduating in 4 Years (SY)	2000 88.6	1990 94.1
% of Grads Intending 4-year College (SY)	2000 50.2	1990 30.0
% of Grads Intending Vocational/Tech School (SY)	2000 5.8	1990 6.8
# of Public School Student Dropouts (SY)	2000 26	1990 41
# of Expulsions and Suspensions (SY)	1999 532	1999 532

Juveniles and the Law

# of Juveniles Committed to the Dept. of Correction (CY)	2000 0	1994 0
# of Juvenile Status Case Filings (CY)	2000 0	1990 0
# of Juvenile Delinquency Case Filings (CY)	2000 19	1990 10

Number of Babies Born to Single Mothers Under Age 20 without a High School Diploma

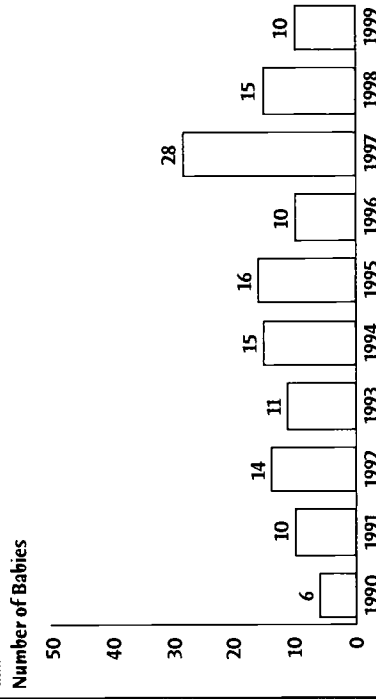

DATA YEAR DEFINITIONS

SFY - State Fiscal Year: July 1-June 30
 SY - School Year: From the start of the school term in the fall through the end of the summer
 FFY - Federal Fiscal Year: October 1-September 30
 CY - Calendar Year: January 1 - December 31

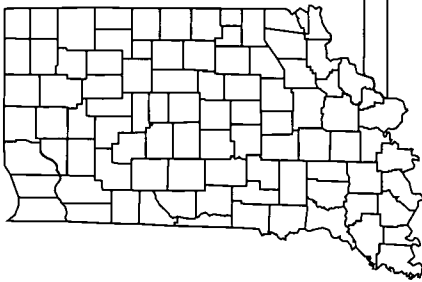

Starke County

Kids Count in Indiana 2001



Economic Well-being

	Current Year	Base Year
% of Children in Poverty, Age 0-17 (CY)	1997 22.0	1990 18.5
Per Capita Income (CY)	1999 \$16,793	1990 \$11,683
Unemployment Rate (CY)	2000 6.3	1990 7.4
Monthly Average of Families Receiving TANF (SFY)	2000 70	1990 185
Monthly Average of Persons Issued Food Stamps (SFY)	2000 1,389	1990 1,488
% of Students Receiving Free Lunches / Text Books (SY)	2001 28.4	1991 22.1

Early Childhood

# of First Steps Children Served (FFY)	2000 55	1998 31
# of Licensed Child Care Centers (SFY)	2000 1	1990 2
# of Licensed Child Care Homes (SFY)	2000 6	1990 2
# of Registered Child Care Ministries (SFY)	2000 0	1993 0
# of Licensed Child Care Slots per 100 Children, Age 0-4 (SFY)	2000 14.6	1996 7.9

Child Protection

# of Reported Cases of Child Abuse Processed by CPS (SFY)	2000 44	1990 94
% of Child Abuse Cases Substantiated by CPS (SFY)	2000 45.0	1990 80.9
# of Reported Cases of Child Neglect Processed by CPS (SFY)	2000 103	1990 132
% of Child Neglect Cases Substantiated by CPS (SFY)	2000 58.0	1990 81.8
# of Child Physical Abuse Cases Substantiated by CPS (SFY)	2000 8	1990 24
# of Child Sexual Abuse Cases Substantiated by CPS (SFY)	2000 12	1990 34
Child Abuse and Neglect Rate (SFY)	2000 12.4	1990 32.0
# of Child Abuse and Neglect Deaths (SFY)	2000 2	1990 0
# of Juvenile CHINS Case Filings (CY)	2000 21	1990 14

Racial/Ethnic Characteristics of Children Age 0-17 in Starke County

One Race (Non-Hispanic Origin)	94.4%
White	0.3%
Black	0.2%
American Indian or Alaska Native	0.2%
Asian	0.0%
Native Hawaiian or Other Pacific Islander	0.1%
Some Other Race	1.3%
Two or More Races (Non-Hispanic Origin)	3.5%
Hispanic Origin*	

*Hispanic children may be of any race.

Number of Children Under the Age of 20 1990 & 2000

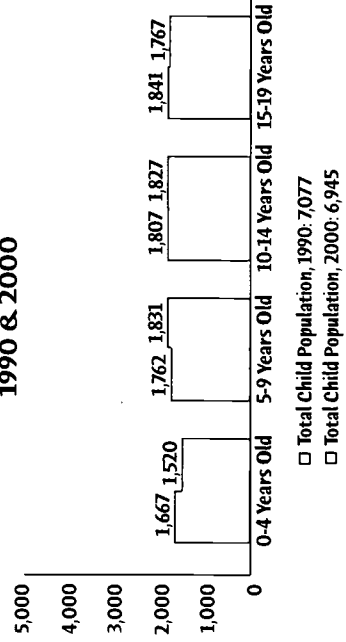

000000 136215

Health & Well-being

	Current Year	Base Year
Total # of Live Births (CY)	1999 297	1990 364
% of Low Birthweight Babies (CY)	1999 5.4	1990 5.2
% of Mothers who Received 1st Trimester Prenatal Care (CY)	1999 83.8	1990 81.3
% of Mothers who Smoked During Pregnancy (CY)	1999 27.9	1990 31.3
Non Marital Births as a % of All Births (CY)	1999 31.0	1990 20.6
Teen Birth Rate, Age 15-17 (CY)	1999 21.1	1990 45.4
Total # of Infant Deaths (CY)	1999 1	1990 2
Total # of Child Deaths, Age 1-14 (CY)	1999 5	1990 2
Total # of Teen Deaths by Accident, Homicide and Suicide (CY)	1999 3	1990 1
# of Children Enrolled in Hoosier Healthwise (SFY)	2000 1,683	1998 978
% Noncompliance with Youth Tobacco Access Laws (CY)	2000 N/A	1997 N/A

Percent of Households with Children Under 18 Headed by Parents and Others, Census 2000

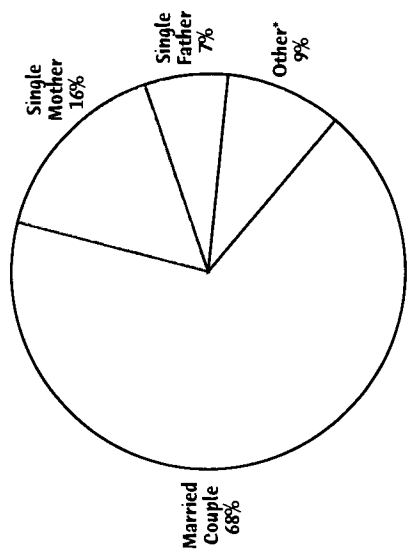

Other includes households with children unrelated to the householder(s) and households with no adults present.

Education, Grades K-12

Public School Enrollment, K-12 (SY)	2000 4,474	1990 3,484
Non-Public School Enrollment (SY)	2001 207	1995 124
# of Home Schooled Children (SY)	2000 134	1990 3
# of Alternative School Participants (SY)	2001 51	1990 0
Total Per Pupil Expenditure (SY)	2000 \$6,273	1990 \$3,706
% of 10th Graders Passing the GQE Math Standard (SY)	2000 53.0	2000 53.0
% of 10th Graders Passing the GQE Language Standard (SY)	2000 64.0	2000 64.0
% of Graduates Passing the GQE (SY)	2000 92.1	2000 92.1
# of Public High School Graduates (SY)	2000 253	1990 282
% of High School Graduates (SY)	2000 87.2	1990 66.9
% of Freshman Class Graduating in 4 Years (SY)	2000 68.9	1990 73.6
% of Grads Intending 4-year College (SY)	2000 42.7	1990 43.3
% of Grads Intending Vocational/Tech School (SY)	2000 5.9	1990 6.7
# of Public School Student Dropouts (SY)	2000 42	1990 127
# of Expulsions and Suspensions (SY)	1999 1,838	1999 1,838

Juveniles and the Law

# of Juveniles Committed to the Dept. of Correction (CY)	2000 11	1994 7
# of Juvenile Status Case Filings (CY)	2000 26	1990 0
# of Juvenile Delinquency Case Filings (CY)	2000 56	1990 54

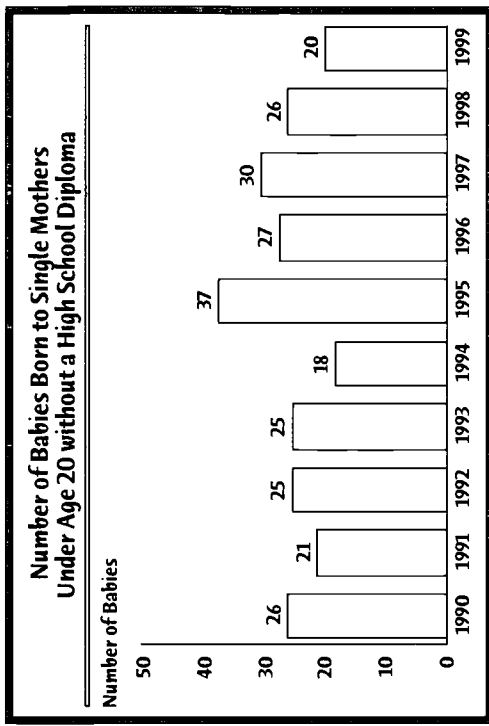

DATA YEAR DEFINITIONS

SFY - State Fiscal Year: July 1-June 30
 SY - School Year: From the start of the school term in the fall through the end of the summer
 FFY - Federal Fiscal Year: October 1-September 30
 CY - Calendar Year: January 1 - December 31

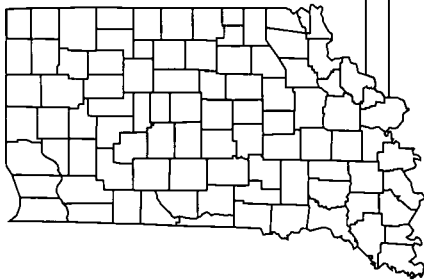

Steuben County

Kids Count in Indiana 2001



Economic Well-being

	Current Year	Base Year
% of Children in Poverty, Age 0-17 (CY)	1997 11.0	1990 5.0
Per Capita Income (CY)	1999 \$24,878	1990 \$16,495
Unemployment Rate (CY)	2000 3.4	1990 5.7
Monthly Average of Families Receiving TANF (SFY)	2000 42	1990 62
Monthly Average of Persons Issued Food Stamps (SFY)	2000 677	1990 861
% of Students Receiving Free Lunches / Text Books (SY)	2001 11.8	1991 11.2

Early Childhood

# of First Steps Children Served (FFY)	2000 84	1998 63
# of Licensed Child Care Centers (SFY)	2000 3	1990 4
# of Licensed Child Care Homes (SFY)	2000 21	1990 13
# of Registered Child Care Ministries (SFY)	2000 6	1993 4
# of Licensed Child Care Slots per 100 Children, Age 0-4 (SFY)	2000 15.6	1996 14

Child Protection

# of Reported Cases of Child Abuse Processed by CPS (SFY)	2000 88	1990 31
% of Child Abuse Cases Substantiated by CPS (SFY)	2000 51.0	1990 67.7
# of Reported Cases of Child Neglect Processed by CPS (SFY)	2000 260	1990 44
% of Child Neglect Cases Substantiated by CPS (SFY)	2000 56.0	1990 84.1
# of Child Physical Abuse Cases Substantiated by CPS (SFY)	2000 23	1990 3
# of Child Sexual Abuse Cases Substantiated by CPS (SFY)	2000 22	1990 9
Child Abuse and Neglect Rate (SFY)	2000 23.1	1990 10.7
# of Child Abuse and Neglect Deaths (SFY)	2000 0	1990 0
# of Juvenile CHINS Case Filings (CY)	2000 31	1990 25

Racial/Ethnic Characteristics of Children Age 0-17 in Steuben County

One Race (Non-Hispanic Origin)	95.0%
White	0.3%
Black	0.2%
American Indian or Alaska Native	0.2%
Asian	0.0%
Native Hawaiian or Other Pacific Islander	0.1%
Some Other Race	1.1%
Two or More Races (Non-Hispanic Origin)	3.0%
Hispanic Origin*	

*Hispanic children may be of any race.

Number of Children Under the Age of 20 1990 & 2000

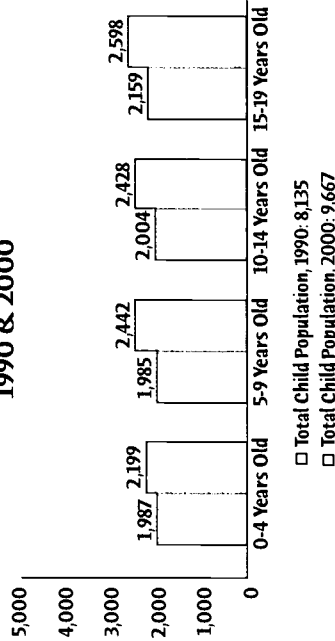

000000 136216

Health & Well-being

	Current Year	Base Year
Total # of Live Births (CY)	1999 403	1990 355
% of Low Birthweight Babies (CY)	1999 9.2	1990 5.1
% of Mothers who Received 1st Trimester Prenatal Care (CY)	1999 77.9	1990 77.0
% of Mothers who Smoked During Pregnancy (CY)	1999 25.6	1990 29.3
Non Marital Births as a % of All Births (CY)	1999 29.8	1990 19.2
Teen Birth Rate, Age 15-17 (CY)	1999 27.8	1990 25.3
Total # of Infant Deaths (CY)	1999 2	1990 1
Total # of Child Deaths, Age 1-14 (CY)	1999 3	1990 1
Total # of Teen Deaths by Accident, Homicide and Suicide (CY)	1999 2	1990 2
# of Children Enrolled in Hoosier Healthwise (SFY)	2000 1,336	1998 652
% Noncompliance with Youth Tobacco Access Laws (CY)	2000 10.0	1997 N/A

Percent of Households with Children Under 18 Headed by Parents and Others, Census 2000

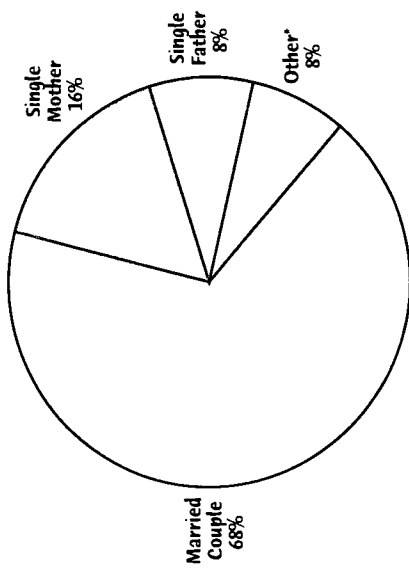

* "Other" includes households with children unrelated to the householder(s) and households with no adults present.

Education, Grades K-12

Public School Enrollment, K-12 (SY)	2000 5,003	1990 4,054
Non-Public School Enrollment (SY)	2001 21	1995 95
# of Home Schooled Children (SY)	2000 113	1990 4
# of Alternative School Participants (SY)	2001 134	1990 0
Total Per Pupil Expenditure (SY)	2000 \$6,201	1990 \$3,793
% of 10th Graders Passing the GQE Math Standard (SY)	2000 71.0	2000 71.0
% of 10th Graders Passing the GQE Language Standard (SY)	2000 76.0	2000 76.0
% of Graduates Passing the GQE (SY)	2000 97.5	2000 97.5
# of Public High School Graduates (SY)	2000 278	1990 261
% of High School Graduates (SY)	2000 95.5	1990 79.0
% of Freshman Class Graduating in 4 Years (SY)	2000 74.5	1990 79.1
% of Grads Intending 4-year College (SY)	2000 62.2	1990 34.3
% of Grads Intending Vocational/Tech School (SY)	2000 4.3	1990 5.2
# of Public School Student Dropouts (SY)	2000 15	1990 73
# of Expulsions and Suspensions (SY)	1999 1,060	1999 1,060

Juveniles and the Law

# of Juveniles Committed to the Dept. of Correction (CY)	2000 6	1994 0
# of Juvenile Status Case Filings (CY)	2000 12	1990 2
# of Juvenile Delinquency Case Filings (CY)	2000 93	1990 34

Number of Babies Born to Single Mothers Under Age 20 without a High School Diploma

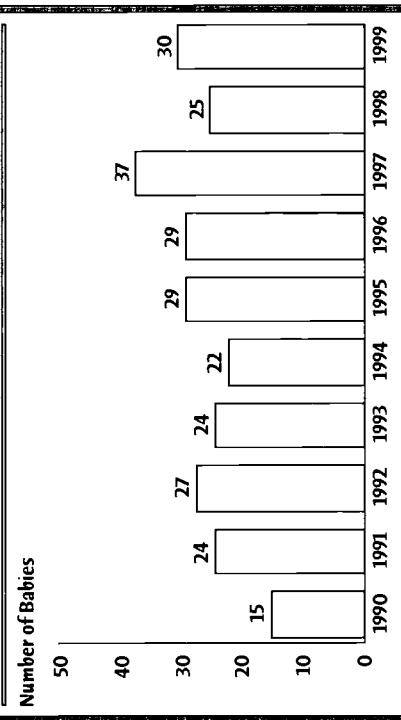

DATA YEAR DEFINITIONS

- SFY - State Fiscal Year: July 1-June 30
- SY - School Year: From the start of the school term in the fall through the end of the summer
- FFY - Federal Fiscal Year: October 1-September 30
- CY - Calendar Year: January 1 - December 31

407

Kids Count 2001

0406

www.iyi.org



Sullivan County

Kids Count in
Indiana 2001



Economic Well-being

	Current Year	Base Year
% of Children in Poverty, Age 0-17 (CY)	1997 19.9	1990 15.4
Per Capita Income (CY)	1999 \$19,420	1990 \$14,593
Unemployment Rate (CY)	2000 6.2	1990 7.2
Monthly Average of Families Receiving TANF (SFY)	2000 83	1990 120
Monthly Average of Persons Issued Food Stamps (SFY)	2000 1,504	1990 1,422
% of Students Receiving Free Lunches / Text Books (SY)	2001 23.4	1991 17.8

Early Childhood

# of First Steps Children Served (FFY)	2000 38	1998 39
# of Licensed Child Care Centers (SFY)	2000 1	1990 1
# of Licensed Child Care Homes (SFY)	2000 27	1990 5
# of Registered Child Care Ministries (SFY)	2000 0	1993 0
# of Licensed Child Care Slots per 100 Children, Age 0-4 (SFY)	2000 27.9	1996 20.6

Child Protection

# of Reported Cases of Child Abuse Processed by CPS (SFY)	2000 37	1990 37
% of Child Abuse Cases Substantiated by CPS (SFY)	2000 59.0	1990 70.3
# of Reported Cases of Child Neglect Processed by CPS (SFY)	2000 129	1990 78
% of Child Neglect Cases Substantiated by CPS (SFY)	2000 56.0	1990 93.6
# of Child Physical Abuse Cases Substantiated by CPS (SFY)	2000 12	1990 6
# of Child Sexual Abuse Cases Substantiated by CPS (SFY)	2000 10	1990 2
Child Abuse and Neglect Rate (SFY)	2000 18.1	1990 19.7
# of Child Abuse and Neglect Deaths (SFY)	2000 0	1990 0
# of Juvenile CHINS Case Filings (CY)	2000 37	1990 19

Racial/Ethnic Characteristics of Children Age 0-17 in Sullivan County

One Race (Non-Hispanic Origin)	97.0%
White	0.4%
Black	0.2%
American Indian or Alaska Native	0.2%
Asian	0.0%
Native Hawaiian or Other Pacific Islander	0.1%
Some Other Race	0.9%
Two or More Races (Non-Hispanic Origin)	1.1%
Hispanic Origin*	

*Hispanic children may be of any race.

Number of Children Under the Age of 20 1990 & 2000

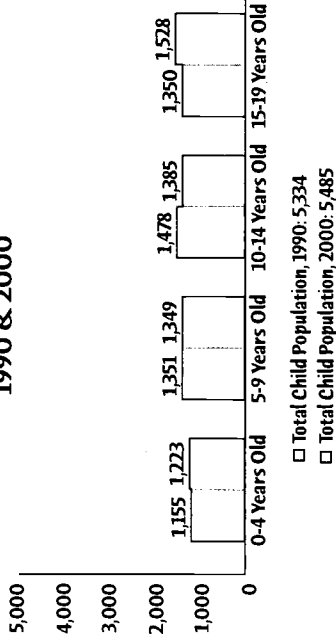

Health & Well-being

	Current Year	Base Year
# of Live Births (CY)	1999 256	1990 227
% of Low Birthweight Babies (CY)	1999 9.4	1990 5.3
% of Mothers who Received 1st Trimester Prenatal Care (CY)	1999 85.9	1990 84.6
% of Mothers who Smoked During Pregnancy (CY)	1999 27.7	1990 21.6
Non Marital Births as a % of All Births (CY)	1999 30.5	1990 15.9
Teen Birth Rate, Age 15-17 (CY)	1999 20.0	1990 30.3
Total # of Infant Deaths (CY)	1999 0	1990 1
Total # of Child Deaths, Age 1-14 (CY)	1999 2	1990 0
Total # of Teen Deaths by Accident, Homicide and Suicide (CY)	1999 1	1990 2
# of Children Enrolled in Hoosier Healthwise (SFY)	2000 1,454	1998 879
% Noncompliance with Youth Tobacco Access Laws (CY)	2000 0	1997 N/A

Percent of Households with Children Under 18 Headed by Parents and Others, Census 2000

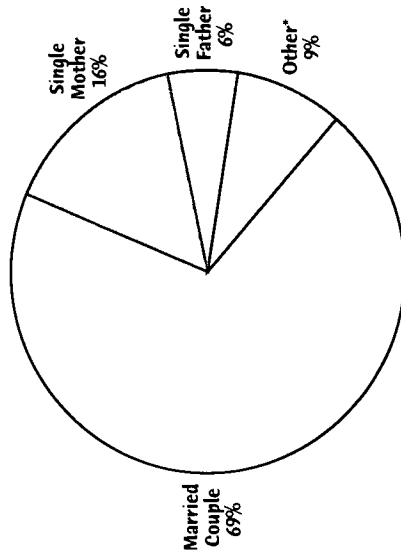

*"Other" includes households with children unrelated to the householder(s) and households with no adults present.

Education, Grades K-12

Public School Enrollment, K-12 (SY)	2000 3,542	1990 3,237
Non-Public School Enrollment (SY)	2001 0	1995 0
# of Home Schooled Children (SY)	2000 57	1990 0
# of Alternative School Participants (SY)	2001 0	1990 0
Total Per Pupil Expenditure (SY)	2000 \$6,985	1990 \$4,609
% of 10th Graders Passing the GQE Math Standard (SY)	2000 63.0	2000 63.0
% of 10th Graders Passing the GQE Language Standard (SY)	2000 66.0	2000 66.0
% of Graduates Passing the GQE (SY)	2000 97.2	2000 97.2
# of Public High School Graduates (SY)	2000 246	1990 291
% of High School Graduates (SY)	2000 90.0	1990 88.7
% of Freshman Class Graduating in 4 Years (SY)	2000 76.2	1990 95.7
% of Grads Intending 4-year College (SY)	2000 40.2	1990 15.2
% of Grads Intending Vocational/Tech School (SY)	2000 6.5	1990 11.4
# of Public School Student Dropouts (SY)	2000 29	1990 33
# of Expulsions and Suspensions (SY)	1999 539	1999 539

Juveniles and the Law

# of Juveniles Committed to the Dept. of Correction (CY)	2000 2	1994 1
# of Juvenile Status Case Filings (CY)	2000 4	1990 0
# of Juvenile Delinquency Case Filings (CY)	2000 64	1990 31

Number of Babies Born to Single Mothers Under Age 20 without a High School Diploma

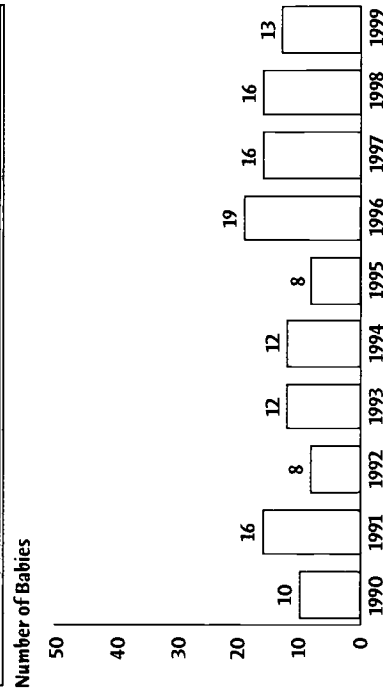

DATA YEAR DEFINITIONS

- SFY - State Fiscal Year: July 1-June 30
- SY - School Year: From the start of the school term in the fall through the end of the summer
- FFY - Federal Fiscal Year: October 1-September 30
- CY - Calendar Year: January 1 - December 31

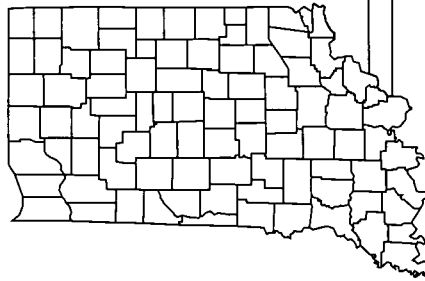

Switzerland County

Kids Count in
Indiana 2001



Economic Well-being

	Current Year	Base Year
% of Children in Poverty, Age 0-17 (CY)	1997 18.5	1990 20.4
Per Capita Income (CY)	1999 \$16,295	1990 \$11,682
Unemployment Rate (CY)	2000 9.9	1990 8.0
Monthly Average of Families Receiving TANF (SFY)	2000 24	1990 64
Monthly Average of Persons Issued Food Stamps (SFY)	2000 386	1990 530
% of Students Receiving Free Lunches / Text Books (SY)	2001 25.6	1991 28.5

Early Childhood

# of First Steps Children Served (FFY)	2000 11	1998 9
# of Licensed Child Care Centers (SFY)	2000 1	1990 0
# of Licensed Child Care Homes (SFY)	2000 8	1990 0
# of Registered Child Care Ministries (SFY)	2000 0	1993 0
# of Licensed Child Care Slots per 100 Children, Age 0-4 (SFY)	2000 26.8	1996 13

Child Protection

# of Reported Cases of Child Abuse Processed by CPS (SFY)	2000 20	1990 17
% of Child Abuse Cases Substantiated by CPS (SFY)	2000 65.0	1990 76.5
# of Reported Cases of Child Neglect Processed by CPS (SFY)	2000 87	1990 17
% of Child Neglect Cases Substantiated by CPS (SFY)	2000 47.0	1990 76.5
# of Child Physical Abuse Cases Substantiated by CPS (SFY)	2000 5	1990 7
# of Child Sexual Abuse Cases Substantiated by CPS (SFY)	2000 8	1990 1
Child Abuse and Neglect Rate (SFY)	2000 22.4	1990 16.0
# of Child Abuse and Neglect Deaths (SFY)	2000 0	1990 0
# of Juvenile CHINS Case Filings (CY)	2000 7	1990 7

Racial/Ethnic Characteristics of Children Age 0-17 in Switzerland County

One Race (Non-Hispanic Origin)	97.7%
White	0.4%
Black	0.1%
American Indian or Alaska Native	0.0%
Asian	0.0%
Native Hawaiian or Other Pacific Islander	0.1%
Some Other Race	0.2%
Two or More Races (Non-Hispanic Origin)	1.5%
Hispanic Origin*	

*Hispanic children may be of any race.

Number of Children Under the Age of 20 1990 & 2000

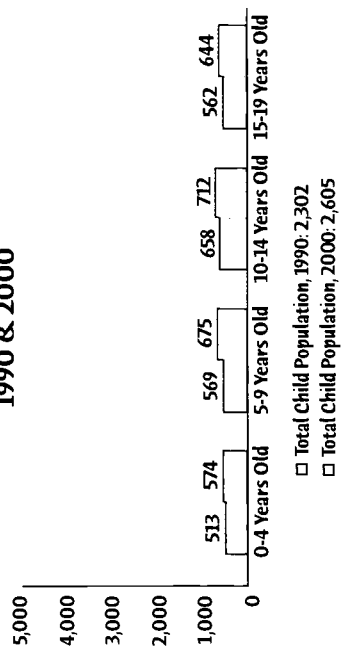

412

Health & Well-being

	Current Year	Base Year
# of Live Births (CY)	1999 103	1990 98
% of Low Birthweight Babies (CY)	1999 5.8	1990 5.1
% of Mothers who Received 1st Trimester Prenatal Care (CY)	1999 76.7	1990 64.9
% of Mothers who Smoked During Pregnancy (CY)	1999 30.1	1990 29.6
Non Marital Births as a % of All Births (CY)	1999 30.1	1990 16.3
Teen Birth Rate, Age 15-17 (CY)	1999 15.0	1990 24.7
Total # of Infant Deaths (CY)	1999 0	1990 1
Total # of Child Deaths, Age 1-14 (CY)	1999 0	1990 0
Total # of Teen Deaths by Accident, Homicide and Suicide (CY)	1999 1	1990 1
# of Children Enrolled in Hoosier Healthwise (SFY)	2000 519	1998 295
% Noncompliance with Youth Tobacco Access Laws (CY)	2000 N/A	1997 N/A

Education, Grades K-12

Public School Enrollment, K-12 (SY)	2000 1,650	1990 1,297
Non-Public School Enrollment (SY)	2001 0	1995 0
# of Home Schooled Children (SY)	2000 50	1990 0
# of Alternative School Participants (SY)	2001 23	1990 0
Total Per Pupil Expenditure (SY)	2000 \$6,330	1990 \$3,793
% of 10th Graders Passing the GQE Math Standard (SY)	2000 50.0	2000 50.0
% of 10th Graders Passing the GQE Language Standard (SY)	2000 63.0	2000 63.0
% of Graduates Passing the GQE (SY)	2000 95.4	2000 95.4
# of Public High School Graduates (SY)	2000 87	1990 97
% of High School Graduates (SY)	2000 83.4	1990 78.7
% of Freshman Class Graduating in 4 Years (SY)	2000 75.0	1990 85.8
% of Grads Intending 4-year College (SY)	2000 48.3	1990 53.4
% of Grads Intending Vocational/Tech School (SY)	2000 3.5	1990 6.3
# of Public School Student Dropouts (SY)	2000 22	1990 25
# of Expulsions and Suspensions (SY)	1999 433	1999 433

Juveniles and the Law

# of Juveniles Committed to the Dept. of Correction (CY)	2000 1	1994 0
# of Juvenile Status Case Filings (CY)	2000 4	1990 0
# of Juvenile Delinquency Case Filings (CY)	2000 25	1990 18

414

000000 136218

Percent of Households with Children Under 18 Headed by Parents and Others, Census 2000

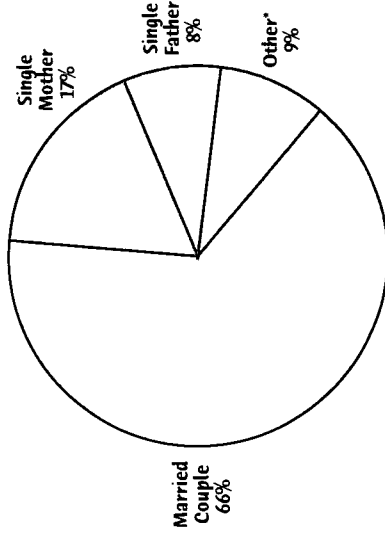

*"Other" includes households with children unrelated to the householder(s) and households with no adults present.

Number of Babies Born to Single Mothers Under Age 20 without a High School Diploma

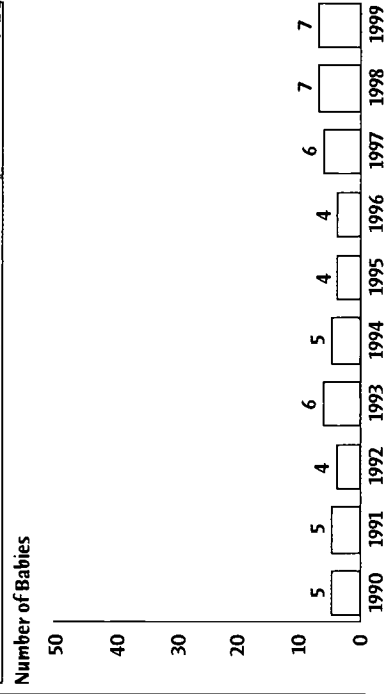

DATA YEAR DEFINITIONS

- SFY - State Fiscal Year: July 1-June 30
- SY - School Year: From the start of the school term in the fall through the end of the summer
- FFY - Federal Fiscal Year: October 1-September 30
- CY - Calendar Year: January 1 - December 31

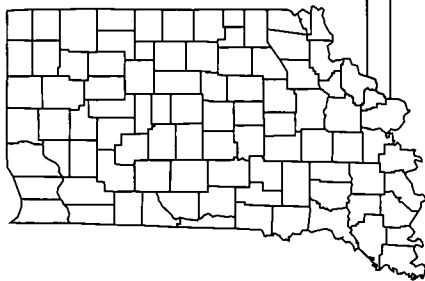

Tippecanoe County



Economic Well-being

	Current Year	Base Year
% of Children in Poverty, Age 0-17 (CY)	1997 12.2	1990 10.6
Per Capita Income (CY)	1999 \$24,175	1990 \$16,217
Unemployment Rate (CY)	2000 2.3	1990 2.8
Monthly Average of Families Receiving TANF (SFY)	2000 362	1990 547
Monthly Average of Persons Issued Food Stamps (SFY)	2000 4,628	1990 4,288
% of Students Receiving Free Lunches / Text Books (SY)	2001 16.5	1991 13.7

Early Childhood

# of First Steps Children Served (FFY)	2000 257	1998 149
# of Licensed Child Care Centers (SFY)	2000 15	1990 12
# of Licensed Child Care Homes (SFY)	2000 86	1990 88
# of Registered Child Care Ministries (SFY)	2000 9	1993 3
# of Licensed Child Care Slots per 100 Children, Age 0-4 (SFY)	2000 26.8	1996 25.9

Child Protection

# of Reported Cases of Child Abuse Processed by CPS (SFY)	2000 323	1990 509
% of Child Abuse Cases Substantiated by CPS (SFY)	2000 40.0	1990 60.9
# of Reported Cases of Child Neglect Processed by CPS (SFY)	2000 969	1990 1,026
% of Child Neglect Cases Substantiated by CPS (SFY)	2000 34.0	1990 54.2
# of Child Physical Abuse Cases Substantiated by CPS (SFY)	2000 52	1990 115
# of Child Sexual Abuse Cases Substantiated by CPS (SFY)	2000 76	1990 92
Child Abuse and Neglect Rate (SFY)	2000 15.3	1990 54.9
# of Child Abuse and Neglect Deaths (SFY)	2000 1	1990 1
# of Juvenile CHINS Case Filings (CY)	2000 112	1990 74

Racial/Ethnic Characteristics of Children Age 0-17 in Tippecanoe County

One Race (Non-Hispanic Origin)	83.8%
White	3.1%
Black	0.3%
American Indian or Alaska Native	3.0%
Asian	0.0%
Native Hawaiian or Other Pacific Islander	0.4%
Some Other Race	1.8%
Two or More Races (Non-Hispanic Origin)	7.6%
Hispanic Origin*	

*Hispanic children may be of any race.

Number of Children Under the Age of 20

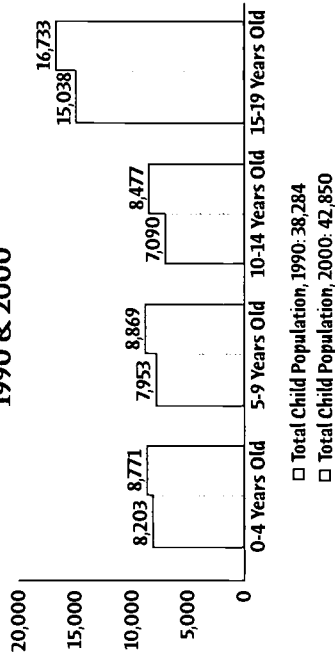

Health & Well-being

	Current Year	Base Year
Total # of Live Births (CY)	1999 1,838	1990 1,829
% of Low Birthweight Babies (CY)	1999 6.4	1990 5.2
% of Mothers who Received 1st Trimester Prenatal Care (CY)	1999 85.8	1990 86.9
% of Mothers who Smoked During Pregnancy (CY)	1999 13.8	1990 21.2
Non Marital Births as a % of All Births (CY)	1999 28.5	1990 18.3
Teen Birth Rate, Age 15-17 (CY)	1999 20.4	1990 33.2
Total # of Infant Deaths (CY)	1999 16	1990 15
Total # of Child Deaths, Age 1-14 (CY)	1999 5	1990 8
Total # of Teen Deaths by Accident, Homicide and Suicide (CY)	1999 6	1990 9
# of Children Enrolled in Hoosier Healthwise (SFY)	2000 5,674	1998 3,207
% Noncompliance with Youth Tobacco Access Laws (CY)	2000 10.0	1997 30.0

Education, Grades K-12

Public School Enrollment, K-12 (SY)	2000 18,793	1990 15,330
Non-Public School Enrollment (SY)	2001 2,094	1995 1,589
# of Home Schooled Children (SY)	2000 147	1990 5
# of Alternative School Participants (SY)	2001 1,053	1990 0
Total Per Pupil Expenditure (SY)	2000 \$6,733	1990 \$4,352
% of 10th Graders Passing the GQE Math Standard (SY)	2000 74.0	2000 74.0
% of 10th Graders Passing the GQE Language Standard (SY)	2000 75.0	2000 75.0
% of Graduates Passing the GQE (SY)	2000 95.9	2000 95.9
# of Public High School Graduates (SY)	2000 1,131	1990 1,136
% of High School Graduates (SY)	2000 87.4	1990 85.4
% of Freshman Class Graduating in 4 Years (SY)	2000 74.5	1990 85.3
% of Grads Intending 4-year College (SY)	2000 64.5	1990 67.6
% of Grads Intending Vocational/Tech School (SY)	2000 6.4	1990 11.2
# of Public School Student Dropouts (SY)	2000 175	1990 191
# of Expulsions and Suspensions (SY)	1999 2,601	1999 2,601

Juveniles and the Law

# of Juveniles Committed to the Dept. of Correction (CY)	2000 22	1994 20
# of Juvenile Status Case Filings (CY)	2000 562	1990 15
# of Juvenile Delinquency Case Filings (CY)	2000 378	1990 67

Percent of Households with Children Under 18 Headed by Parents and Others, Census 2000

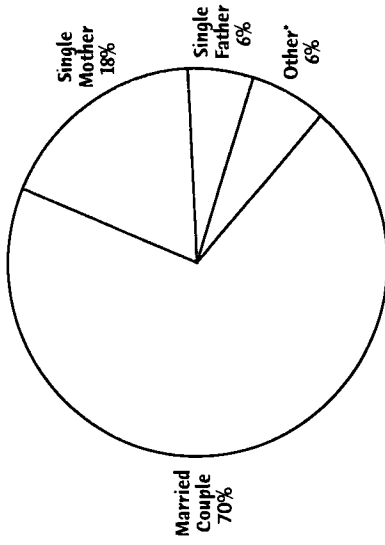

*"Other" includes households with children unrelated to the householder(s) and households with no adults present.

Number of Babies Born to Single Mothers Under Age 20 without a High School Diploma

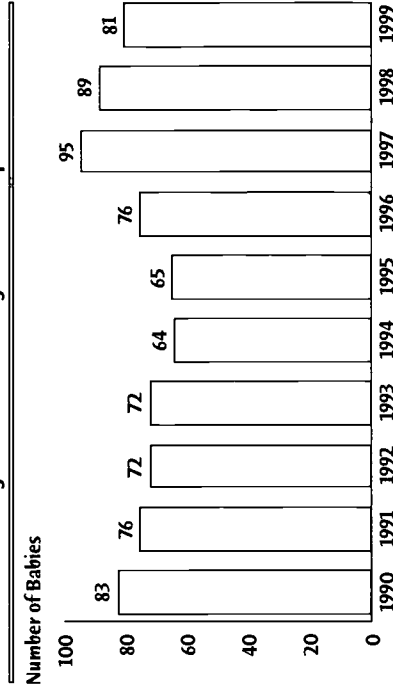

DATA YEAR DEFINITIONS

- SFY - State Fiscal Year: July 1-June 30
- SY - School Year: From the start of the school term in the fall through the end of the summer
- FFY - Federal Fiscal Year: October 1-September 30
- CY - Calendar Year: January 1 - December 31

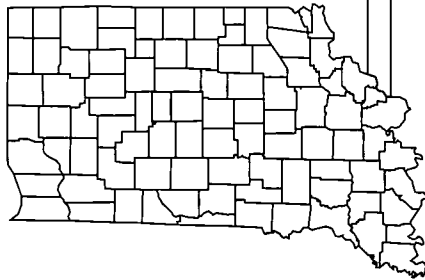

Tipton County

Kids Count in Indiana 2001



Economic Well-being

	Current Year	Base Year
% of Children in Poverty, Age 0-17 (CY)	1997 9.7	1990 8.1
Per Capita Income (CY)	1999 \$25,269	1990 \$17,328
Unemployment Rate (CY)	2000 2.6	1990 5.8
Monthly Average of Families Receiving TANF (SFY)	2000 23	1990 68
Monthly Average of Persons Issued Food Stamps (SFY)	2000 403	1990 643
% of Students Receiving Free Lunches / Text Books (SY)	2001 9.2	1991 11.9

Early Childhood

# of First Steps Children Served (FFY)	2000 36	1998 28
# of Licensed Child Care Centers (SFY)	2000 0	1990 2
# of Licensed Child Care Homes (SFY)	2000 1	1990 0
# of Registered Child Care Ministries (SFY)	2000 2	1993 2
# of Licensed Child Care Slots per 100 Children, Age 0-4 (SFY)	2000 1	1996 2

Child Protection

# of Reported Cases of Child Abuse Processed by CPS (SFY)	2000 13	1990 33
% of Child Abuse Cases Substantiated by CPS (SFY)	2000 62.0	1990 72.7
# of Reported Cases of Child Neglect Processed by CPS (SFY)	2000 31	1990 17
% of Child Neglect Cases Substantiated by CPS (SFY)	2000 74.0	1990 41.2
# of Child Physical Abuse Cases Substantiated by CPS (SFY)	2000 4	1990 3
# of Child Sexual Abuse Cases Substantiated by CPS (SFY)	2000 4	1990 11
Child Abuse and Neglect Rate (SFY)	2000 7.4	1990 10.0
# of Child Abuse and Neglect Deaths (SFY)	2000 0	1990 1
# of Juvenile CHINS Case Filings (CY)	2000 0	1990 10

Racial/Ethnic Characteristics of Children Age 0-17 in Tipton County

One Race (Non-Hispanic Origin)	96.5%
White	0.2%
Black	0.2%
American Indian or Alaska Native	0.3%
Asian	0.0%
Native Hawaiian or Other Pacific Islander	0.1%
Some Other Race	0.7%
Two or More Races (Non-Hispanic Origin)	1.8%
Hispanic Origin*	

*Hispanic children may be of any race.

Number of Children Under the Age of 20 1990 & 2000

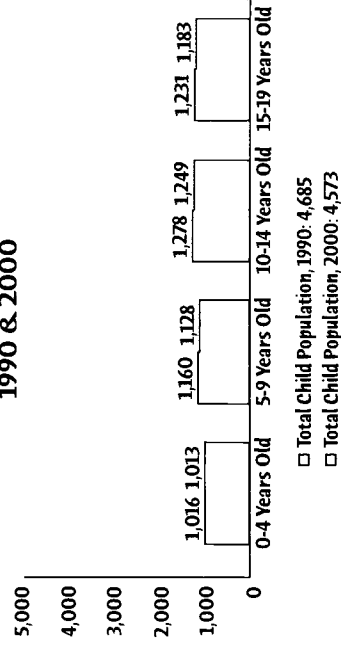

Health & Well-being

	Current Year	Base Year
Total # of Live Births (CY)	1999 177	1990 211
% of Low Birthweight Babies (CY)	1999 7.9	1990 6.2
% of Mothers who Received 1st Trimester Prenatal Care (CY)	1999 89.8	1990 84.5
% of Mothers who Smoked During Pregnancy (CY)	1999 10.2	1990 22.3
Non Marital Births as a % of All Births (CY)	1999 20.3	1990 14.7
Teen Birth Rate, Age 15-17 (CY)	1999 15.8	1990 22.0
Total # of Infant Deaths (CY)	1999 0	1990 2
Total # of Child Deaths, Age 1-14 (CY)	1999 1	1990 0
Total # of Teen Deaths by Accident, Homicide and Suicide (CY)	1999 0	1990 0
# of Children Enrolled in Hoosier Healthwise (SFY)	2000 401	1998 281
% Noncompliance with Youth Tobacco Access Laws (CY)	2000 N/A	1997 10.5

Education, Grades K-12

Public School Enrollment, K-12 (SY)	2000 2,923	1990 2,631
Non-Public School Enrollment (SY)	2001 154	1995 144
# of Home Schooled Children (SY)	2000 37	1990 3
# of Alternative School Participants (SY)	2001 26	1990 0
Total Per Pupil Expenditure (SY)	2000 \$6,005	1990 \$3,789
% of 10th Graders Passing the GQE Math Standard (SY)	2000 75.0	2000 75.0
% of 10th Graders Passing the GQE Language Standard (SY)	2000 76.0	2000 76.0
% of Graduates Passing the GQE (SY)	2000 97.3	2000 97.3
# of Public High School Graduates (SY)	2000 220	1990 254
% of High School Graduates (SY)	2000 94.3	1990 83.6
% of Freshman Class Graduating in 4 Years (SY)	2000 87.3	1990 84.7
% of Grads Intending 4-year College (SY)	2000 61.8	1990 35.1
% of Grads Intending Vocational/Tech School (SY)	2000 13.2	1990 7.9
# of Public School Student Dropouts (SY)	2000 14	1990 44
# of Expulsions and Suspensions (SY)	1999 1,246	1999 1,246

Juveniles and the Law

# of Juveniles Committed to the Dept. of Correction (CY)	2000 1	1994 4
# of Juvenile Status Case Filings (CY)	2000 5	1990 0
# of Juvenile Delinquency Case Filings (CY)	2000 11	1990 18

Percent of Households with Children Under 18 Headed by Parents and Others, Census 2000

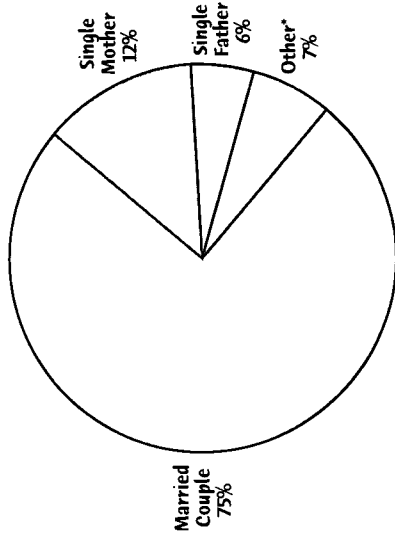

Other includes households with children unrelated to the householder(s) and households with no adults present.

Number of Babies Born to Single Mothers Under Age 20 without a High School Diploma

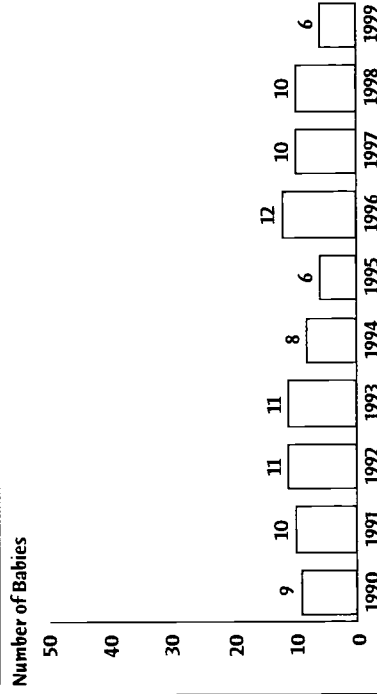

DATA YEAR DEFINITIONS

- SFY – State Fiscal Year: July 1-June 30
- SY – School Year: From the start of the school term in the fall through the end of the summer
- FFY – Federal Fiscal Year: October 1-September 30
- CY – Calendar Year: January 1 – December 31

422

423



Union County

Kids Count in Indiana 2001



Economic Well-being

	Current Year	Base Year
% of Children in Poverty, Age 0-17 (CY)	1997 14.5	1990 11.6
Per Capita Income (CY)	1999 \$18,730	1990 \$13,600
Unemployment Rate (CY)	2000 3.4	1990 8.1
Monthly Average of Families Receiving TANF (SFY)	2000 18	1990 82
Monthly Average of Persons Issued Food Stamps (SFY)	2000 259	1990 530
% of Students Receiving Free Lunches / Text Books (SY)	2001 19.8	1991 15.8

Early Childhood

# of First Steps Children Served (FFY)	2000 26	1998 31
# of Licensed Child Care Centers (SFY)	2000 1	1990 0
# of Licensed Child Care Homes (SFY)	2000 2	1990 1
# of Registered Child Care Ministries (SFY)	2000 0	1993 0
# of Licensed Child Care Slots per 100 Children, Age 0-4 (SFY)	2000 19.6	1996 0

Child Protection

# of Reported Cases of Child Abuse Processed by CPS (SFY)	2000 16	1990 14
% of Child Abuse Cases Substantiated by CPS (SFY)	2000 94.0	1990 71.4
# of Reported Cases of Child Neglect Processed by CPS (SFY)	2000 21	1990 18
% of Child Neglect Cases Substantiated by CPS (SFY)	2000 71.0	1990 50.0
# of Child Physical Abuse Cases Substantiated by CPS (SFY)	2000 4	1990 3
# of Child Sexual Abuse Cases Substantiated by CPS (SFY)	2000 11	1990 5
Child Abuse and Neglect Rate (SFY)	2000 15.3	1990 14.8
# of Child Abuse and Neglect Deaths (SFY)	2000 0	1990 0
# of Juvenile CHINS Case Filings (CY)	2000 6	1990 5

Racial/Ethnic Characteristics of Children Age 0-17 in Union County

One Race (Non-Hispanic Origin)	98.0%
White	0.2%
Black	0.4%
American Indian or Alaska Native	0.1%
Asian	0.0%
Native Hawaiian or Other Pacific Islander	0.2%
Some Other Race	0.7%
Two or More Races (Non-Hispanic Origin)	0.3%
Hispanic Origin*	

*Hispanic children may be of any race.

Number of Children Under the Age of 20 1990 & 2000

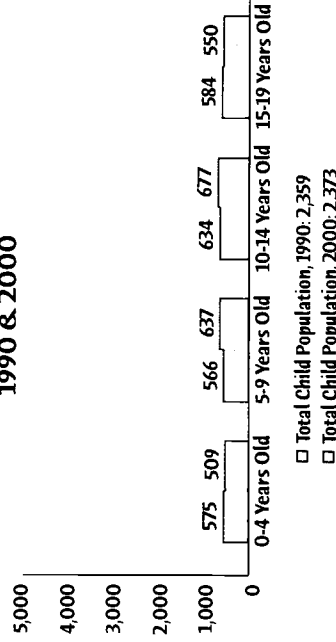

000000136221

Health & Well-being

	Current Year	Base Year
Total # of Live Births (CY)	1999 55	1990 89
% of Low Birthweight Babies (CY)	1999 1.8	1990 7.9
% of Mothers who Received 1st Trimester Prenatal Care (CY)	1999 89.1	1990 86.0
% of Mothers who Smoked During Pregnancy (CY)	1999 25.5	1990 32.6
Non Marital Births as a % of All Births (CY)	1999 23.6	1990 11.2
Teen Birth Rate, Age 15-17 (CY)	1999 20.0	1990 5.4
Total # of Infant Deaths (CY)	1999 1	1990 0
Total # of Child Deaths, Age 1-14 (CY)	1999 1	1990 1
Total # of Teen Deaths by Accident, Homicide and Suicide (CY)	1999 0	1990 0
# of Children Enrolled in Hoosier Healthwise (SFY)	2000 421	1998 246
% Noncompliance with Youth Tobacco Access Laws (CY)	2000 N/A	1997 5.0

Percent of Households with Children Under 18 Headed by Parents and Others, Census 2000

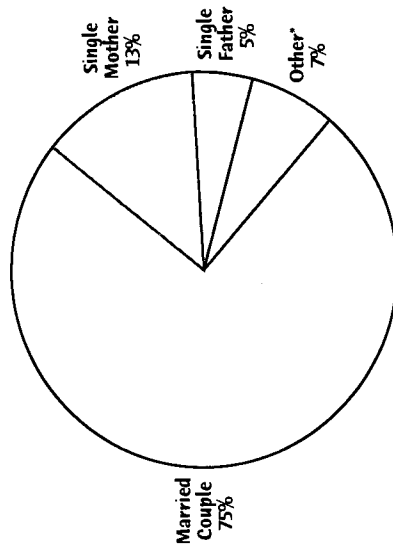

* "Other" includes households with children unrelated to the householder(s) and households with no adults present.

Education, Grades K-12

Public School Enrollment, K-12 (SY)	2000 1,552	1990 1,404
Non-Public School Enrollment (SY)	2001 0	1995 0
# of Home Schooled Children (SY)	2000 35	1990 0
# of Alternative School Participants (SY)	2001 0	1990 0
Total Per Pupil Expenditure (SY)	2000 \$6,005	1990 \$3,462
% of 10th Graders Passing the GQE Math Standard (SY)	2000 65.0	2000 65.0
% of 10th Graders Passing the GQE Language Standard (SY)	2000 76.0	2000 76.0
% of Graduates Passing the GQE (SY)	2000 91.4	2000 91.4
# of Public High School Graduates (SY)	2000 81	1990 114
% of High School Graduates (SY)	2000 94.8	1990 91.0
% of Freshman Class Graduating in 4 Years (SY)	2000 71.1	1990 80.9
% of Grads Intending 4-year College (SY)	2000 48.2	1990 43.8
% of Grads Intending Vocational/Tech School (SY)	2000 3.7	1990 9.1
# of Public School Student Dropouts (SY)	2000 6	1990 12
# of Expulsions and Suspensions (SY)	1999 399	1999 399

Juveniles and the Law

# of Juveniles Committed to the Dept. of Correction (CY)	2000 4	1994 0
# of Juvenile Status Case Filings (CY)	2000 10	1990 0
# of Juvenile Delinquency Case Filings (CY)	2000 8	1990 6

Number of Babies Born to Single Mothers Under Age 20 without a High School Diploma

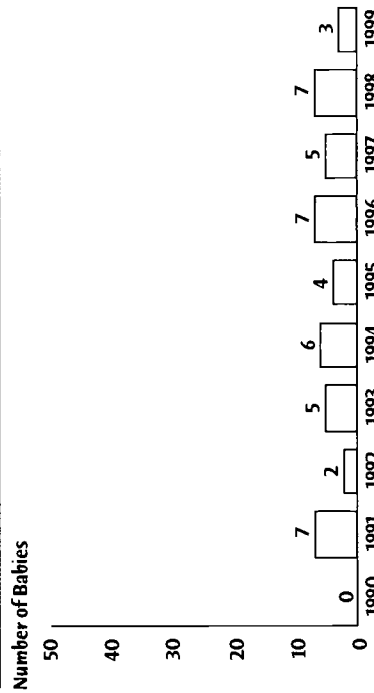

DATA YEAR DEFINITIONS

- SFY - State Fiscal Year: July 1-June 30
- SY - School Year: From the start of the school term in the fall through the end of the summer
- FFY - Federal Fiscal Year: October 1-September 30
- CY - Calendar Year: January 1 - December 31

426

427



Vanderburgh County

Kids Count in
Indiana 2001



Economic Well-being

	Current Year	Base Year
% of Children in Poverty, Age 0-17 (CY)	1997 18.7	1990 17.1
Per Capita Income (CY)	1999 \$28,247	1990 \$19,330
Unemployment Rate (CY)	2000 3.3	1990 5.5
Monthly Average of Families Receiving TANF (SFY)	2000 1,278	1990 2,088
Monthly Average of Persons Issued Food Stamps (SFY)	2000 12,513	1990 11,943
% of Students Receiving Free Lunches / Text Books (SY)	2001 26.3	1991 23.5

Early Childhood

# of First Steps Children Served (FFY)	2000 398	1998 298
# of Licensed Child Care Centers (SFY)	2000 25	1990 18
# of Licensed Child Care Homes (SFY)	2000 199	1990 132
# of Registered Child Care Ministries (SFY)	2000 19	1993 8
# of Licensed Child Care Slots per 100 Children, Age 0-4 (SFY)	2000 47.6	1996 40.8

Child Protection

# of Reported Cases of Child Abuse Processed by CPS (SFY)	2000 480	1990 764
% of Child Abuse Cases Substantiated by CPS (SFY)	2000 63.0	1990 47.8
# of Reported Cases of Child Neglect Processed by CPS (SFY)	2000 890	1990 921
% of Child Neglect Cases Substantiated by CPS (SFY)	2000 62.0	1990 51.0
# of Child Physical Abuse Cases Substantiated by CPS (SFY)	2000 152	1990 94
# of Child Sexual Abuse Cases Substantiated by CPS (SFY)	2000 149	1990 131
Child Abuse and Neglect Rate (SFY)	2000 22.1	1990 39.5
# of Child Abuse and Neglect Deaths (SFY)	2000 2	1990 3
# of Juvenile CHINS Case Filings (CY)	2000 255	1990 156

Racial/Ethnic Characteristics of Children Age 0-17 in Vanderburgh County

One Race (Non-Hispanic Origin)	82.7%
White	11.8%
Black	0.1%
American Indian or Alaska Native	0.8%
Asian	0.0%
Native Hawaiian or Other Pacific Islander	0.5%
Some Other Race	2.6%
Two or More Races (Non-Hispanic Origin)	1.4%
Hispanic Origin*	

*Hispanic children may be of any race.

Number of Children Under the Age of 20 1990 & 2000

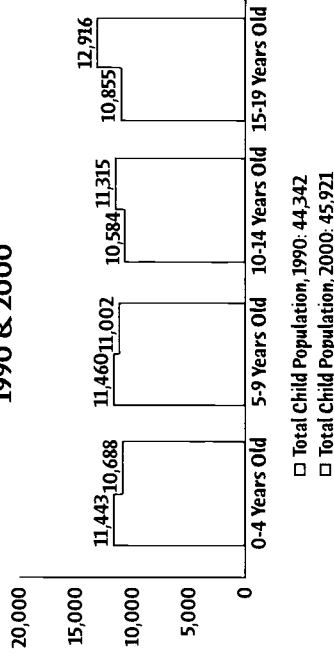

Health & Well-being

	Current Year	Base Year
Total # of Live Births (CY)	1999 2,281	1990 2,557
% of Low Birthweight Babies (CY)	1999 7.0	1990 7.0
% of Mothers who Received 1st Trimester Prenatal Care (CY)	1999 86.7	1990 84.4
% of Mothers who Smoked During Pregnancy (CY)	1999 25.2	1990 27.0
Non Marital Births as a % of All Births (CY)	1999 41.3	1990 28.9
Teen Birth Rate, Age 15-17 (CY)	1999 44.0	1990 48.9
Total # of Infant Deaths (CY)	1999 14	1990 38
Total # of Child Deaths, Age 1-14 (CY)	1999 6	1990 6
Total # of Teen Deaths by Accident, Homicide and Suicide (CY)	1999 8	1990 5
# of Children Enrolled in Hoosier Healthwise (SFY)	2000 11,433	1998 7,866
% Noncompliance with Youth Tobacco Access Laws (CY)	2000 0	1997 42.5

Percent of Households with Children Under 18 Headed by Parents and Others, Census 2000

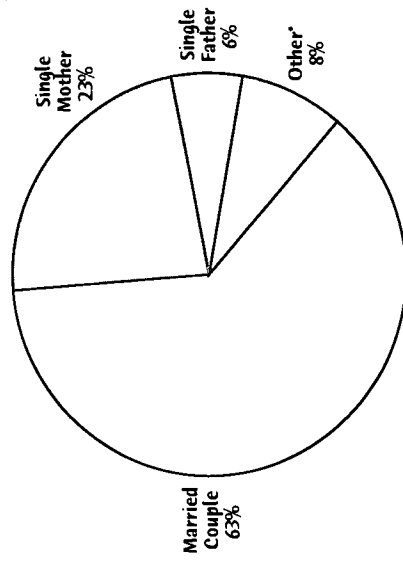

*"Other" includes households with children unrelated to the householder(s) and households with no adults present.

Education, Grades K-12

Public School Enrollment, K-12 (SY)	2000 22,904	1990 20,793
Non-Public School Enrollment (SY)	2001 6,159	1995 5,965
# of Home Schooled Children (SY)	2000 209	1990 2
# of Alternative School Participants (SY)	2001 4,903	1990 12
Total Per Pupil Expenditure (SY)	2000 \$6,748	1990 \$4,409
% of 10th Graders Passing the GQE Math Standard (SY)	2000 61.0	2000 61.0
% of 10th Graders Passing the GQE Language Standard (SY)	2000 70.0	2000 70.0
% of Graduates Passing the GQE (SY)	2000 89.0	2000 89.0
# of Public High School Graduates (SY)	2000 1,421	1990 1,504
% of High School Graduates (SY)	2000 91.2	1990 72.2
% of Freshman Class Graduating in 4 Years (SY)	2000 73.3	1990 87.0
% of Grads Intending 4-year College (SY)	2000 62.7	1990 32.8
% of Grads Intending Vocational/Tech School (SY)	2000 8.6	1990 11.7
# of Public School Student Dropouts (SY)	2000 153	1990 513
# of Expulsions and Suspensions (SY)	1999 4,380	1999 4,380

Juveniles and the Law

# of Juveniles Committed to the Dept. of Correction (CY)	2000 67	1994 47
# of Juvenile Status Case Filings (CY)	2000 34	1990 63
# of Juvenile Delinquency Case Filings (CY)	2000 329	1990 349

Number of Babies Born to Single Mothers Under Age 20 without a High School Diploma

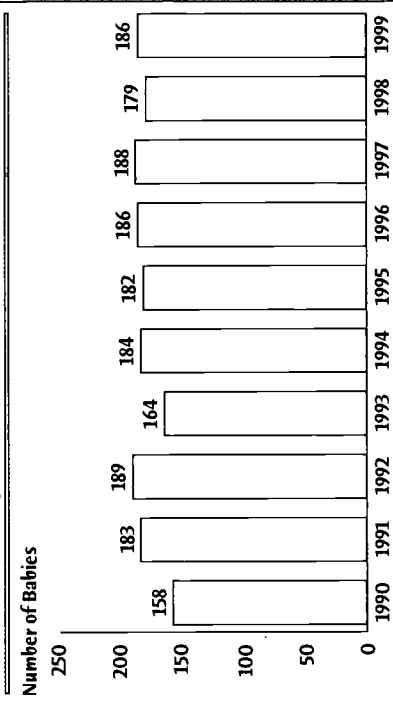

DATA YEAR DEFINITIONS

SFY - State Fiscal Year: July 1-June 30
 SY - School Year: From the start of the school term in the fall through the end of the summer
 FFY - Federal Fiscal Year: October 1-September 30
 CY - Calendar Year: January 1 - December 31

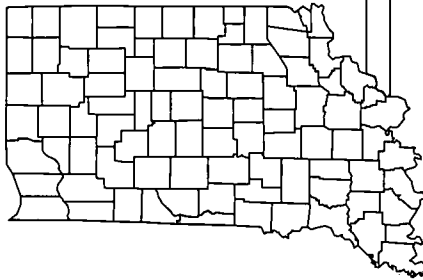

Vermillion County

Kids Count in Indiana 2001



Economic Well-being

	Current Year	Base Year
% of Children in Poverty, Age 0-17 (CY)	1997 15.5	1990 14.8
Per Capita Income (CY)	1999 \$21,599	1990 \$14,792
Unemployment Rate (CY)	2000 5.9	1990 6.6
Monthly Average of Families Receiving TANF (SFY)	2000 45	1990 156
Monthly Average of Persons Issued Food Stamps (SFY)	2000 697	1990 1,118
% of Students Receiving Free Lunches / Text Books (SY)	2001 21.7	1991 18.9

Early Childhood

# of First Steps Children Served (FFY)	2000 27	1998 24
# of Licensed Child Care Centers (SFY)	2000 1	1990 1
# of Licensed Child Care Homes (SFY)	2000 14	1990 0
# of Registered Child Care Ministries (SFY)	2000 1	1993 0
# of Licensed Child Care Slots per 100 Children, Age 0-4 (SFY)	2000 23.6	1996 11.1

Child Protection

# of Reported Cases of Child Abuse Processed by CPS (SFY)	2000 46	1990 62
% of Child Abuse Cases Substantiated by CPS (SFY)	2000 43.0	1990 53.2
# of Reported Cases of Child Neglect Processed by CPS (SFY)	2000 64	1990 117
% of Child Neglect Cases Substantiated by CPS (SFY)	2000 41.0	1990 62.4
# of Child Physical Abuse Cases Substantiated by CPS (SFY)	2000 10	1990 3
# of Child Sexual Abuse Cases Substantiated by CPS (SFY)	2000 10	1990 9
Child Abuse and Neglect Rate (SFY)	2000 11.0	1990 35.1
# of Child Abuse and Neglect Deaths (SFY)	2000 0	1990 0
# of Juvenile CHINS Case Filings (CY)	2000 6	1990 24

432

Racial/Ethnic Characteristics of Children Age 0-17 in Vermillion County

One Race (Non-Hispanic Origin)	96.9%
White	0.4%
Black	0.4%
American Indian or Alaska Native	0.1%
Asian	0.0%
Native Hawaiian or Other Pacific Islander	0.1%
Some Other Race	1.1%
Two or More Races (Non-Hispanic Origin)	1.1%
Hispanic Origin*	1.1%

*Hispanic children may be of any race.

Number of Children Under the Age of 20 1990 & 2000

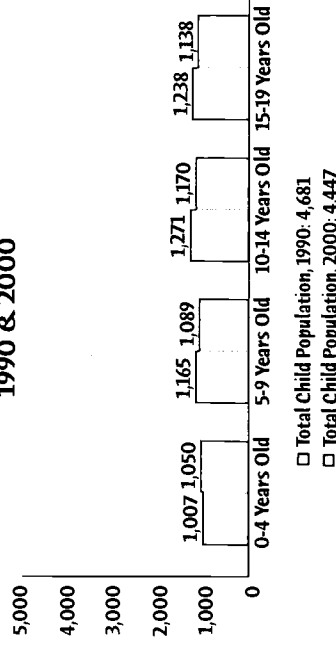

433

Health & Well-being

	Current Year	Base Year
Total # of Live Births (CY)	1999 213	1990 191
% of Low Birthweight Babies (CY)	1999 9.9	1990 5.2
% of Mothers who Received 1st Trimester Prenatal Care (CY)	1999 79.8	1990 77.0
% of Mothers who Smoked During Pregnancy (CY)	1999 26.8	1990 30.9
Non Marital Births as a % of All Births (CY)	1999 31.0	1990 18.8
Teen Birth Rate, Age 15-17 (CY)	1999 20.5	1990 27.7
Total # of Infant Deaths (CY)	1999 1	1990 0
Total # of Child Deaths, Age 1-14 (CY)	1999 2	1990 0
Total # of Teen Deaths by Accident, Homicide and Suicide (CY)	1999 1	1990 0
# of Children Enrolled in Hoosier Healthwise (SFY)	2000 1,007	1998 549
% Noncompliance with Youth Tobacco Access Laws (CY)	2000 N/A	1997 21.1

Education, Grades K-12

Public School Enrollment, K-12 (SY)	2000 2,889	1990 2,317
Non-Public School Enrollment (SY)	2001 90	1995 110
# of Home Schooled Children (SY)	2000 32	1990 0
# of Alternative School Participants (SY)	2001 25	1990 0
Total Per Pupil Expenditure (SY)	2000 \$6,621	1990 \$4,011
% of 10th Graders Passing the GQE Math Standard (SY)	2000 60.0	2000 60.0
% of 10th Graders Passing the GQE Language Standard (SY)	2000 72.0	2000 72.0
% of Graduates Passing the GQE (SY)	2000 93.5	2000 93.5
# of Public High School Graduates (SY)	2000 200	1990 265
% of High School Graduates (SY)	2000 83.1	1990 80.8
% of Freshman Class Graduating in 4 Years (SY)	2000 69.4	1990 86.0
% of Grads Intending 4-year College (SY)	2000 39.0	1990 51.2
% of Grads Intending Vocational/Tech School (SY)	2000 3.0	1990 13.1
# of Public School Student Dropouts (SY)	2000 40	1990 52
# of Expulsions and Suspensions (SY)	1999 1,232	1999 1,232

Juveniles and the Law

# of Juveniles Committed to the Dept. of Correction (CY)	2000 2	1994 0
# of Juvenile Status Case Filings (CY)	2000 0	1990 0
# of Juvenile Delinquency Case Filings (CY)	2000 69	1990 25

Percent of Households with Children Under 18 Headed by Parents and Others, Census 2000

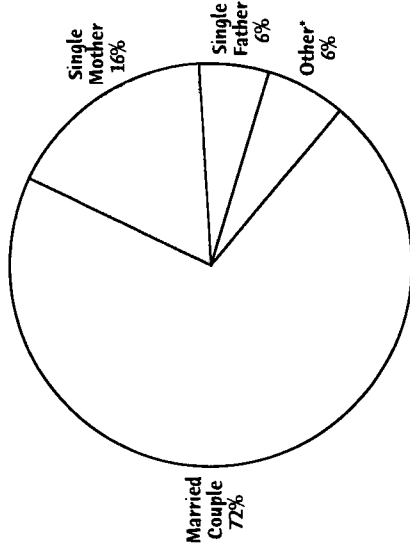

* "Other" includes households with children unrelated to the householder(s) and households with no adults present.

Number of Babies Born to Single Mothers Under Age 20 without a High School Diploma

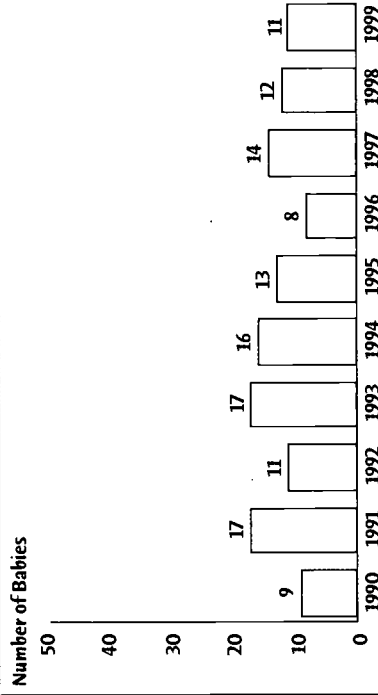

DATA YEAR DEFINITIONS

- SFY - State Fiscal Year: July 1-June 30
- SY - School Year: From the start of the school term in the fall through the end of the summer
- FFY - Federal Fiscal Year: October 1-September 30
- CY - Calendar Year: January 1 - December 31

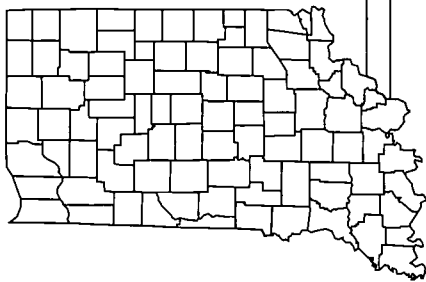

Vigo County

Kids Count in Indiana 2001



Economic Well-being

	Current Year	Base Year
% of Children in Poverty, Age 0-17 (CY)	1997 21.1	1990 18.5
Per Capita Income (CY)	1999 \$22,689	1990 \$15,676
Unemployment Rate (CY)	2000 4.8	1990 5.0
Monthly Average of Families Receiving TANF (SFY)	2000 701	1990 1,106
Monthly Average of Persons Issued Food Stamps (SFY)	2000 7,952	1990 7,373
% of Students Receiving Free Lunches / Text Books (SY)	2001 27.3	1991 22.3

Early Childhood

# of First Steps Children Served (FFY)	2000 216	1998 192
# of Licensed Child Care Centers (SFY)	2000 9	1990 14
# of Licensed Child Care Homes (SFY)	2000 166	1990 89
# of Registered Child Care Ministries (SFY)	2000 4	1993 3
# of Licensed Child Care Slots per 100 Children, Age 0-4 (SFY)	2000 37.5	1996 28.7

Child Protection

# of Reported Cases of Child Abuse Processed by CPS (SFY)	2000 291	1990 390
% of Child Abuse Cases Substantiated by CPS (SFY)	2000 49.0	1990 45.4
# of Reported Cases of Child Neglect Processed by CPS (SFY)	2000 721	1990 508
% of Child Neglect Cases Substantiated by CPS (SFY)	2000 37.0	1990 40.4
# of Child Physical Abuse Cases Substantiated by CPS (SFY)	2000 58	1990 50
# of Child Sexual Abuse Cases Substantiated by CPS (SFY)	2000 85	1990 56
Child Abuse and Neglect Rate (SFY)	2000 17.2	1990 31.8
# of Child Abuse and Neglect Deaths (SFY)	2000 3	1990 0
# of Juvenile CHINS Case Filings (CY)	2000 94	1990 97

Racial/Ethnic Characteristics of Children Age 0-17 in Vigo County

One Race (Non-Hispanic Origin)	87.7%
White	6.5%
Black	0.3%
American Indian or Alaska Native	0.9%
Asian	0.0%
Native Hawaiian or Other Pacific Islander	0.3%
Some Other Race	2.8%
Two or More Races (Non-Hispanic Origin)	1.5%
Hispanic Origin*	

*Hispanic children may be of any race.

Number of Children Under the Age of 20 1990 & 2000

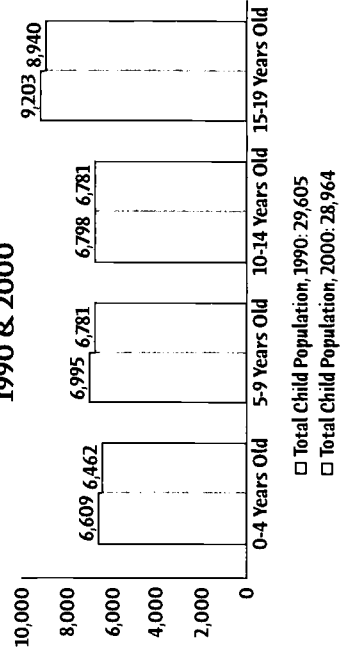

Health & Well-being

	Current Year	Base Year
Total # of Live Births (CY)	1999 1,300	1990 1,488
% of Low Birthweight Babies (CY)	1999 8.1	1990 6.5
% of Mothers who Received 1st Trimester Prenatal Care (CY)	1999 84.4	1990 75.8
% of Mothers who Smoked During Pregnancy (CY)	1999 28.2	1990 28.7
Non Marital Births as a % of All Births (CY)	1999 38.6	1990 30.6
Teen Birth Rate, Age 15-17 (CY)	1999 26.0	1990 37.9
Total # of Infant Deaths (CY)	1999 14	1990 23
Total # of Child Deaths, Age 1-14 (CY)	1999 6	1990 3
Total # of Teen Deaths by Accident, Homicide and Suicide (CY)	1999 4	1990 3
# of Children Enrolled in Hoosier Healthwise (SFY)	2000 8,100	1998 5,291
% Noncompliance with Youth Tobacco Access Laws (CY)	2000 45.0	1997 21.1

Education, Grades K-12

Public School Enrollment, K-12 (SY)	2000 16,652	1990 14,991
Non-Public School Enrollment (SY)	2001 1,105	1995 1,050
# of Home Schooled Children (SY)	2000 213	1990 10
# of Alternative School Participants (SY)	2001 533	1990 159
Total Per Pupil Expenditure (SY)	2000 \$5,876	1990 \$3,828
% of 10th Graders Passing the GQE Math Standard (SY)	2000 61.0	2000 61.0
% of 10th Graders Passing the GQE Language Standard (SY)	2000 70.0	2000 70.0
% of Graduates Passing the GQE (SY)	2000 99.0	2000 99.0
# of Public High School Graduates (SY)	2000 864	1990 1,094
% of High School Graduates (SY)	2000 81.1	1990 85.4
% of Freshman Class Graduating in 4 Years (SY)	2000 64.4	1990 77.6
% of Grads Intending 4-year College (SY)	2000 57.1	1990 39.0
% of Grads Intending Vocational/Tech School (SY)	2000 9.4	1990 4.1
# of Public School Student Dropouts (SY)	2000 245	1990 455
# of Expulsions and Suspensions (SY)	1999 4,410	1999 4,410

Juveniles and the Law

# of Juveniles Committed to the Dept. of Correction (CY)	2000 19	1994 32
# of Juvenile Status Case Filings (CY)	2000 103	1990 157
# of Juvenile Delinquency Case Filings (CY)	2000 344	1990 286

Percent of Households with Children Under 18 Headed by Parents and Others, Census 2000

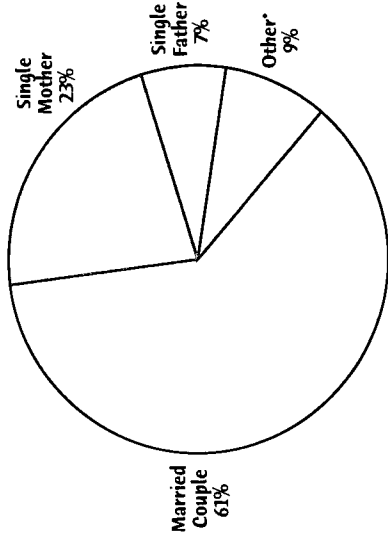

*"Other" includes households with children unrelated to the householder(s) and households with no adults present.

Number of Babies Born to Single Mothers Under Age 20 without a High School Diploma

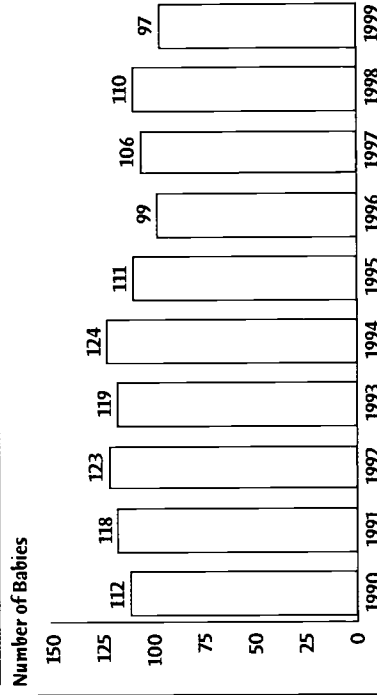

DATA YEAR DEFINITIONS

SFY - State Fiscal Year: July 1-June 30
 SY - School Year: From the start of the school term in the fall through the end of the summer
 FFY - Federal Fiscal Year: October 1-September 30
 CY - Calendar Year: January 1 - December 31



Wabash County

Kids Count in Indiana 2001



Economic Well-being

	Current Year	Base Year
% of Children in Poverty, Age 0-17 (CY)	1997 11.2	1990 10.4
Per Capita Income (CY)	1999 \$23,144	1990 \$16,032
Unemployment Rate (CY)	2000 3.3	1990 6.4
Monthly Average of Families Receiving TANF (SFY)	2000 39	1990 180
Monthly Average of Persons Issued Food Stamps (SFY)	2000 857	1990 1,208
% of Students Receiving Free Lunches / Text Books (SY)	2001 16.2	1991 12.2

Early Childhood

# of First Steps Children Served (FFY)	2000 67	1998 48
# of Licensed Child Care Centers (SFY)	2000 3	1990 2
# of Licensed Child Care Homes (SFY)	2000 23	1990 12
# of Registered Child Care Ministries (SFY)	2000 4	1993 1
# of Licensed Child Care Slots per 100 Children, Age 0-4 (SFY)	2000 16.6	1996 13.8

Child Protection

# of Reported Cases of Child Abuse Processed by CPS (SFY)	2000 97	1990 193
% of Child Abuse Cases Substantiated by CPS (SFY)	2000 61.0	1990 81.3
# of Reported Cases of Child Neglect Processed by CPS (SFY)	2000 106	1990 108
% of Child Neglect Cases Substantiated by CPS (SFY)	2000 70.0	1990 75.0
# of Child Physical Abuse Cases Substantiated by CPS (SFY)	2000 23	1990 10
# of Child Sexual Abuse Cases Substantiated by CPS (SFY)	2000 36	1990 24
Child Abuse and Neglect Rate (SFY)	2000 15.1	1990 27.8
# of Child Abuse and Neglect Deaths (SFY)	2000 0	1990 0
# of Juvenile CHINS Case Filings (CY)	2000 24	1990 32

Racial/Ethnic Characteristics of Children Age 0-17 in Wabash County

One Race (Non-Hispanic Origin)	95.9%
White	0.5%
Black	0.6%
American Indian or Alaska Native	0.4%
Asian	0.0%
Native Hawaiian or Other Pacific Islander	0.1%
Some Other Race	1.0%
Two or More Races (Non-Hispanic Origin)	1.4%
Hispanic Origin*	

*Hispanic children may be of any race.

Number of Children Under the Age of 20 1990 & 2000

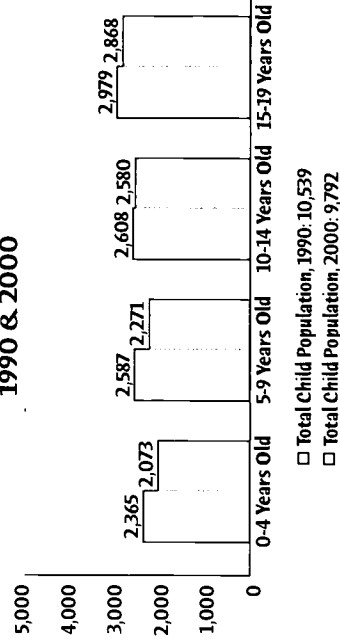

401

000000 136225

Health & Well-being

Percent of Households with Children Under 18 Headed by Parents and Others, Census 2000

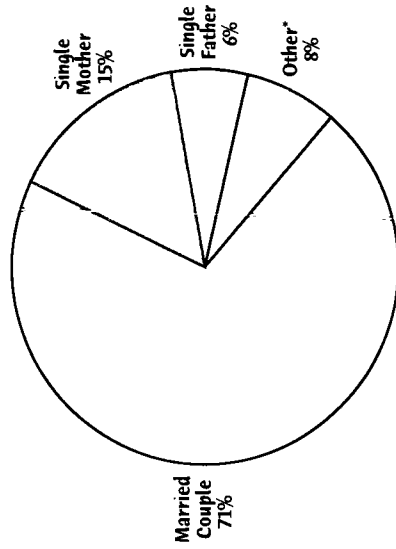

*"Other" includes households with children unrelated to the householder(s) and households with no adults present.

Number of Babies Born to Single Mothers Under Age 20 without a High School Diploma

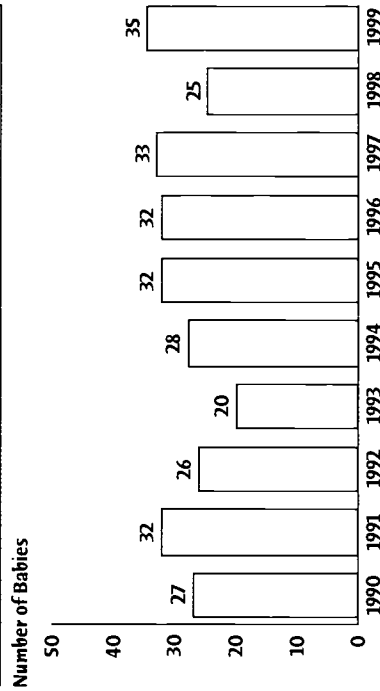

	Current Year	Base Year
% of Live Births (CY)	1999 444	1990 461
% of Low Birthweight Babies (CY)	1999 9.2	1990 3.5
% of Mothers who Received 1st Trimester Prenatal Care (CY)	1999 81.5	1990 73.3
% of Mothers who Smoked During Pregnancy (CY)	1999 30.0	1990 32.3
Non Marital Births as a % of All Births (CY)	1999 30.2	1990 20.6
Teen Birth Rate, Age 15-17 (CY)	1999 29.1	1990 23.1
Total # of Infant Deaths (CY)	1999 4	1990 0
Total # of Child Deaths, Age 1-14 (CY)	1999 4	1990 4
Total # of Teen Deaths by Accident, Homicide and Suicide (CY)	1999 0	1990 1
# of Children Enrolled in Hoosier Healthwise (SFY)	2000 1,613	1998 777
% Noncompliance with Youth Tobacco Access Laws (CY)	2000 50.0	1997 N/A

Education, Grades K-12

Public School Enrollment, K-12 (SY)	2000 6,068	1990 5,698
Non-Public School Enrollment (SY)	2001 231	1995 249
# of Home Schooled Children (SY)	2000 87	1990 4
# of Alternative School Participants (SY)	2001 37	1990 0
Total Per Pupil Expenditure (SY)	2000 \$7,181	1990 \$4,311
% of 10th Graders Passing the GQE Math Standard (SY)	2000 68.0	2000 68.0
% of 10th Graders Passing the GQE Language Standard (SY)	2000 69.0	2000 69.0
% of Graduates Passing the GQE (SY)	2000 95.4	2000 95.4
# of Public High School Graduates (SY)	2000 392	1990 432
% of High School Graduates (SY)	2000 90.5	1990 79.0
% of Freshman Class Graduating in 4 Years (SY)	2000 69.9	1990 82.1
% of Grads Intending 4-year College (SY)	2000 49.0	1990 46.7
% of Grads Intending Vocational/Tech School (SY)	2000 9.2	1990 7.5
# of Public School Student Dropouts (SY)	2000 50	1990 126
# of Expulsions and Suspensions (SY)	1999 2,447	1999 2,447

Juveniles and the Law

# of Juveniles Committed to the Dept. of Correction (CY)	2000 30	1994 9
# of Juvenile Status Case Filings (CY)	2000 0	1990 12
# of Juvenile Delinquency Case Filings (CY)	2000 189	1990 0

DATA YEAR DEFINITIONS

SFY - State Fiscal Year: July 1-June 30

SY - School Year: From the start of the school term in the fall through the end of the summer

FFY - Federal Fiscal Year: October 1-September 30

CY - Calendar Year: January 1 - December 31

442

443

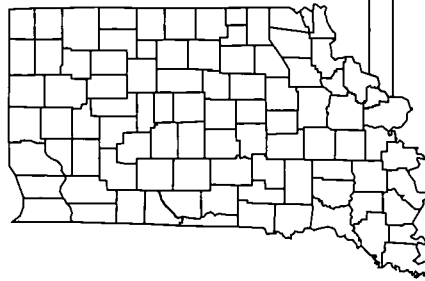

Warren County

Kids Count in Indiana 2001



Economic Well-being

	Current Year	Base Year
% of Children in Poverty, Age 0-17 (CY)	1997 10.7	1990 11.1
Per Capita Income (CY)	1999 \$19,157	1990 \$14,283
Unemployment Rate (CY)	2000 3.4	1990 4.7
Monthly Average of Families Receiving TANF (SFY)	2000 9	1990 43
Monthly Average of Persons Issued Food Stamps (SFY)	2000 229	1990 387
% of Students Receiving Free Lunches / Text Books (SY)	2001 12.9	1991 15.1

Early Childhood

# of First Steps Children Served (FFY)	2000 21	1998 8
# of Licensed Child Care Centers (SFY)	2000 1	1990 0
# of Licensed Child Care Homes (SFY)	2000 4	1990 3
# of Registered Child Care Ministries (SFY)	2000 0	1993 0
# of Licensed Child Care Slots per 100 Children, Age 0-4 (SFY)	2000 26.5	1996 10.2

Child Protection

# of Reported Cases of Child Abuse Processed by CPS (SFY)	2000 27	1990 40
% of Child Abuse Cases Substantiated by CPS (SFY)	2000 52.0	1990 72.5
# of Reported Cases of Child Neglect Processed by CPS (SFY)	2000 27	1990 36
% of Child Neglect Cases Substantiated by CPS (SFY)	2000 41.0	1990 88.9
# of Child Physical Abuse Cases Substantiated by CPS (SFY)	2000 9	1990 6
# of Child Sexual Abuse Cases Substantiated by CPS (SFY)	2000 5	1990 8
Child Abuse and Neglect Rate (SFY)	2000 11.7	1990 27.6
# of Child Abuse and Neglect Deaths (SFY)	2000 0	1990 0
# of Juvenile CHINS Case Filings (CY)	2000 11	1990 9

Racial/Ethnic Characteristics of Children Age 0-17 in Warren County

One Race (Non-Hispanic Origin)	98.4%
White	0.2%
Black	0.2%
American Indian or Alaska Native	0.1%
Asian	0.0%
Native Hawaiian or Other Pacific Islander	0.0%
Some Other Race	0.3%
Two or More Races (Non-Hispanic Origin)	0.8%
Hispanic Origin*	

*Hispanic children may be of any race.

Number of Children Under the Age of 20 1990 & 2000

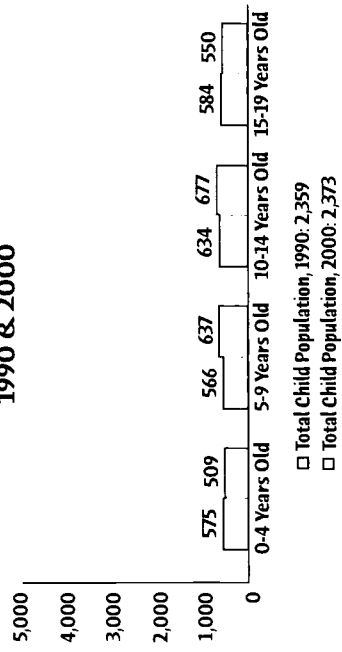

445

000000 136226

Percent of Households with Children Under 18 Headed by Parents and Others, Census 2000

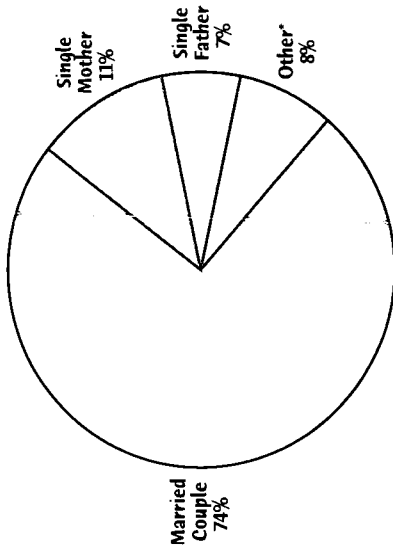

*"Other" includes households with children unrelated to the householder(s) and households with no adults present.

Number of Babies Born to Single Mothers Under Age 20 without a High School Diploma

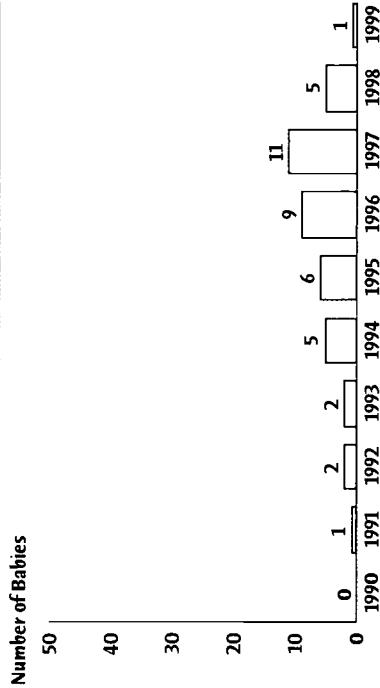

	Current Year	Base Year
% of Live Births (CY)	1999 81	1990 91
% of Low Birthweight Babies (CY)	1999 9.9	1990 5.5
% of Mothers who Received 1st Trimester Prenatal Care (CY)	1999 81.5	1990 82.2
% of Mothers who Smoked During Pregnancy (CY)	1999 23.5	1990 25.3
Non Marital Births as a % of All Births (CY)	1999 22.2	1990 16.5
Teen Birth Rate, Age 15-17 (CY)	1999 5.3	1990 10.9
Total # of Infant Deaths (CY)	1999 0	1990 2
Total # of Child Deaths, Age 1-14 (CY)	1999 0	1990 1
Total # of Teen Deaths by Accident, Homicide and Suicide (CY)	1999 0	1990 0
# of Children Enrolled in Hoosier Healthwise (SFY)	2000 363	1998 183
% Noncompliance with Youth Tobacco Access Laws (CY)	2000 N/A	1997 30.0

Education, Grades K-12

Public School Enrollment, K-12 (SY)	2000 1,337	1990 1,181
Non-Public School Enrollment (SY)	2001 0	1995 0
# of Home Schooled Children (SY)	2000 26	1990 0
# of Alternative School Participants (SY)	2001 0	1990 0
Total Per Pupil Expenditure (SY)	2000 \$6,103	1990 \$4,087
% of 10th Graders Passing the GQE Math Standard (SY)	2000 54.0	2000 54.0
% of 10th Graders Passing the GQE Language Standard (SY)	2000 59.0	2000 59.0
% of Graduates Passing the GQE (SY)	2000 85.7	2000 85.7
# of Public High School Graduates (SY)	2000 70	1990 93
% of High School Graduates (SY)	2000 91.3	1990 89.4
% of Freshman Class Graduating in 4 Years (SY)	2000 75.3	1990 78.2
% of Grads Intending 4-year College (SY)	2000 48.6	1990 43.5
% of Grads Intending Vocational/Tech School (SY)	2000 5.7	1990 18.8
# of Public School Student Dropouts (SY)	2000 8	1990 11
# of Expulsions and Suspensions (SY)	1999 325	1999 325

Juveniles and the Law

# of Juveniles Committed to the Dept. of Correction (CY)	2000 0	1994 2
# of Juvenile Status Case Filings (CY)	2000 0	1990 0
# of Juvenile Delinquency Case Filings (CY)	2000 21	1990 16

DATA YEAR DEFINITIONS

- SFY - State Fiscal Year: July 1-June 30
- SY - School Year: From the start of the school term in the fall through the end of the summer
- FFY - Federal Fiscal Year: October 1-September 30
- CY - Calendar Year: January 1 - December 31

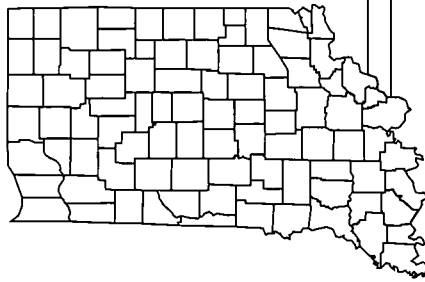

Warrick County

Kids Count in Indiana 2001



Economic Well-being

	Current Year	Base Year
% of Children in Poverty, Age 0-17 (CY)	1997 9.2	1990 8.7
Per Capita Income (CY)	1999 \$26,616	1990 \$17,991
Unemployment Rate (CY)	2000 3.5	1990 4.6
Monthly Average of Families Receiving TANF (SFY)	2000 94	1990 234
Monthly Average of Persons Issued Food Stamps (SFY)	2000 1,325	1990 1,546
% of Students Receiving Free Lunches / Text Books (SY)	2001 11.3	1991 11.1

Early Childhood

# of First Steps Children Served (FFY)	2000 160	1998 105
# of Licensed Child Care Centers (SFY)	2000 5	1990 4
# of Licensed Child Care Homes (SFY)	2000 48	1990 19
# of Registered Child Care Ministries (SFY)	2000 2	1993 0
# of Licensed Child Care Slots per 100 Children, Age 0-4 (SFY)	2000 22.9	1996 28

Child Protection

# of Reported Cases of Child Abuse Processed by CPS (SFY)	2000 124	1990 142
% of Child Abuse Cases Substantiated by CPS (SFY)	2000 52.0	1990 35.2
# of Reported Cases of Child Neglect Processed by CPS (SFY)	2000 299	1990 144
% of Child Neglect Cases Substantiated by CPS (SFY)	2000 46.0	1990 38.9
# of Child Physical Abuse Cases Substantiated by CPS (SFY)	2000 38	1990 19
# of Child Sexual Abuse Cases Substantiated by CPS (SFY)	2000 27	1990 10
Child Abuse and Neglect Rate (SFY)	2000 14.1	1990 21.2
# of Child Abuse and Neglect Deaths (SFY)	2000 0	1990 1
# of Juvenile CHINS Case Filings (CY)	2000 13	1990 11

Racial/Ethnic Characteristics of Children Age 0-17 in Warrick County

One Race (Non-Hispanic Origin)	96.0%
White	1.1%
Black	0.2%
American Indian or Alaska Native	0.8%
Asian	0.1%
Native Hawaiian or Other Pacific Islander	0.1%
Some Other Race	1.0%
Two or More Races (Non-Hispanic Origin)	0.8%
Hispanic Origin*	

*Hispanic children may be of any race.

Number of Children Under the Age of 20 1990 & 2000

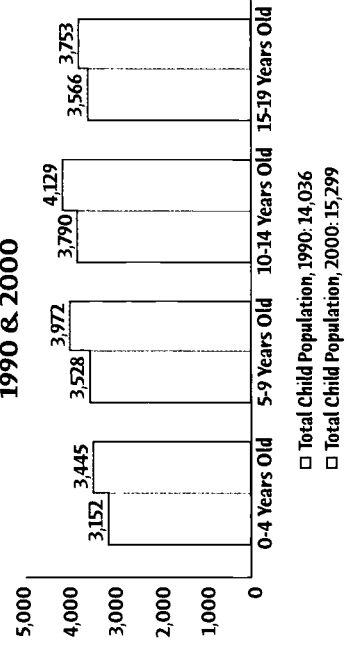

000000 136227

Health & Well-being

	Current Year	Base Year
Total # of Live Births (CY)	1999 599	1990 635
% of Low Birthweight Babies (CY)	1999 7.7	1990 3.3
% of Mothers who Received 1st Trimester Prenatal Care (CY)	1999 87.3	1990 88.7
% of Mothers who Smoked During Pregnancy (CY)	1999 20.9	1990 22.0
Non Marital Births as a % of All Births (CY)	1999 24.5	1990 15.3
Teen Birth Rate, Age 15-17 (CY)	1999 14.3	1990 18.1
Total # of Infant Deaths (CY)	1999 2	1990 3
Total # of Child Deaths, Age 1-14 (CY)	1999 2	1990 6
Total # of Teen Deaths by Accident, Homicide and Suicide (CY)	1999 1	1990 4
# of Children Enrolled in Hoosier Healthwise (SFY)	2000 1,837	1998 1,156
% Noncompliance with Youth Tobacco Access Laws (CY)	2000 N/A	1997 14.8

Percent of Households with Children Under 18 Headed by Parents and Others, Census 2000

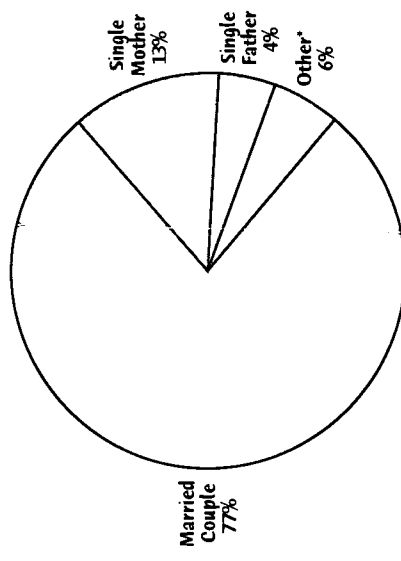

*"Other" includes households with children unrelated to the householder(s) and households with no adults present.

Education, Grades K-12

Public School Enrollment, K-12 (SY)	2000 9,031	1990 8,115
Non-Public School Enrollment (SY)	2001 389	1995 277
# of Home Schooled Children (SY)	2000 130	1990 7
# of Alternative School Participants (SY)	2001 155	1990 0
Total Per Pupil Expenditure (SY)	2000 \$5,579	1990 \$3,704
% of 10th Graders Passing the GOE Math Standard (SY)	2000 71.0	2000 71.0
% of 10th Graders Passing the GOE Language Standard (SY)	2000 78.0	2000 78.0
% of Graduates Passing the GOE (SY)	2000 90.5	2000 90.5
# of Public High School Graduates (SY)	2000 603	1990 642
% of High School Graduates (SY)	2000 83.5	1990 79.7
% of Freshman Class Graduating in 4 Years (SY)	2000 83.5	1990 83.6
% of Grads Intending 4-year College (SY)	2000 62.0	1990 29.7
% of Grads Intending Vocational/Tech School (SY)	2000 13.1	1990 7.6
# of Public School Student Dropouts (SY)	2000 122	1990 157
# of Expulsions and Suspensions (SY)	1999 837	1999 837

Juveniles and the Law

# of Juveniles Committed to the Dept. of Correction (CY)	2000 14	1994 6
# of Juvenile Status Case Filings (CY)	2000 21	1990 0
# of Juvenile Delinquency Case Filings (CY)	2000 67	1990 112

Number of Babies Born to Single Mothers Under Age 20 without a High School Diploma

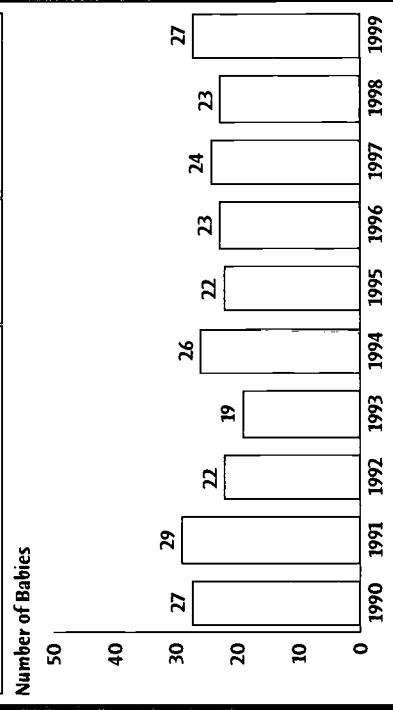

DATA YEAR DEFINITIONS

- SFY - State Fiscal Year: July 1-June 30
- SY - School Year: From the start of the school term in the fall through the end of the summer
- FFY - Federal Fiscal Year: October 1-September 30
- CY - Calendar Year: January 1 - December 31

450

Kids Count 2001

451

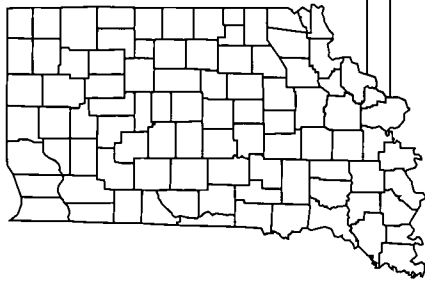

Washington County

Kids Count in Indiana 2001



Economic Well-being

	Current Year	Base Year
% of Children in Poverty, Age 0-17 (CY)	1997 17.4	1990 18.1
Per Capita Income (CY)	1999 \$19,940	1990 \$13,399
Unemployment Rate (CY)	2000 4.5	1990 6.9
Monthly Average of Families Receiving TANF (SFY)	2000 90	1990 228
Monthly Average of Persons Issued Food Stamps (SFY)	2000 1,458	1990 1,701
% of Students Receiving Free Lunches / Text Books (SY)	2001 20.9	1991 21.3

Early Childhood

# of First Steps Children Served (FFY)	2000 76	1998 56
# of Licensed Child Care Centers (SFY)	2000 2	1990 1
# of Licensed Child Care Homes (SFY)	2000 30	1990 5
# of Registered Child Care Ministries (SFY)	2000 1	1993 0
# of Licensed Child Care Slots per 100 Children, Age 0-4 (SFY)	2000 28.4	1996 18.1

Child Protection

# of Reported Cases of Child Abuse Processed by CPS (SFY)	2000 118	1990 48
% of Child Abuse Cases Substantiated by CPS (SFY)	2000 44.0	1990 93.8
# of Reported Cases of Child Neglect Processed by CPS (SFY)	2000 164	1990 16
% of Child Neglect Cases Substantiated by CPS (SFY)	2000 27.0	1990 100.0
# of Child Physical Abuse Cases Substantiated by CPS (SFY)	2000 10	1990 18
# of Child Sexual Abuse Cases Substantiated by CPS (SFY)	2000 42	1990 5
Child Abuse and Neglect Rate (SFY)	2000 12.5	1990 9.3
# of Child Abuse and Neglect Deaths (SFY)	2000 0	1990 0
# of Juvenile CHINS Case Filings (CY)	2000 24	1990 7

Racial/Ethnic Characteristics of Children Age 0-17 in Washington County

One Race (Non-Hispanic Origin)	97.5%
White	0.2%
Black	0.1%
American Indian or Alaska Native	0.1%
Asian	0.0%
Native Hawaiian or Other Pacific Islander	0.1%
Some Other Race	0.7%
Two or More Races (Non-Hispanic Origin)	1.2%
Hispanic Origin*	

*Hispanic children may be of any race.

Number of Children Under the Age of 20 1990 & 2000

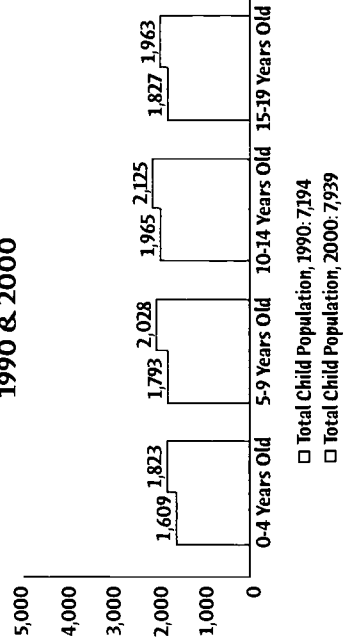

452

453

000000136228

Percent of Households with Children Under 18 Headed by Parents and Others, Census 2000

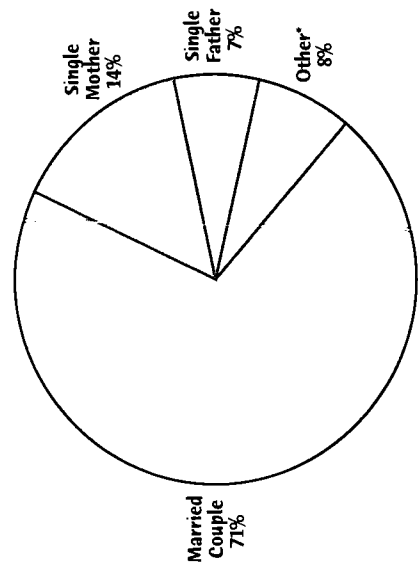

* "Other" includes households with children unrelated to the householder(s) and households with no adults present.

Number of Babies Born to Single Mothers Under Age 20 without a High School Diploma

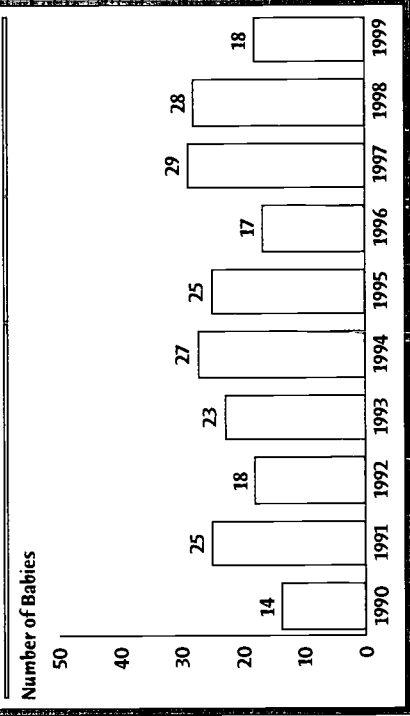

	Current Year	Base Year
Total # of Live Births (CY)	1999 324	1990 304
% of Low Birthweight Babies (CY)	1999 5.2	1990 5.6
% of Mothers who Received 1st Trimester Prenatal Care (CY)	1999 76.9	1990 83.7
% of Mothers who Smoked During Pregnancy (CY)	1999 25.0	1990 35.5
Non Marital Births as a % of All Births (CY)	1999 25.9	1990 15.5
Teen Birth Rate, Age 15-17 (CY)	1999 21.9	1990 21.7
Total # of Infant Deaths (CY)	1999 0	1990 2
Total # of Child Deaths, Age 1-14 (CY)	1999 4	1990 3
Total # of Teen Deaths by Accident, Homicide and Suicide (CY)	1999 1	1990 0
# of Children Enrolled in Hoosier Healthwise (SFY)	2000 1,626	1998 1,120
% Noncompliance with Youth Tobacco Access Laws (CY)	2000 30.0	1997 N/A

Education, Grades K-12

Public School Enrollment, K-12 (SY)	2000 4,822	1990 3,174
Non-Public School Enrollment (SY)	2001 95	1995 88
# of Home Schooled Children (SY)	2000 94	1990 2
# of Alternative School Participants (SY)	2001 67	1990 0
Total Per Pupil Expenditure (SY)	2000 \$5,774	1990 \$3,963
% of 10th Graders Passing the GQE Math Standard (SY)	2000 58.0	2000 58.0
% of 10th Graders Passing the GQE Language Standard (SY)	2000 69.0	2000 69.0
% of Graduates Passing the GQE (SY)	2000 96.2	2000 96.2
# of Public High School Graduates (SY)	2000 288	1990 307
% of High School Graduates (SY)	2000 88.2	1990 80.2
% of Freshman Class Graduating in 4 Years (SY)	2000 66.1	1990 79.3
% of Grads Intending 4-year College (SY)	2000 44.8	1990 47.4
% of Grads Intending Vocational/Tech School (SY)	2000 6.9	1990 9.4
# of Public School Student Dropouts (SY)	2000 43	1990 82
# of Expulsions and Suspensions (SY)	1999 1,304	1999 1,304

Juveniles and the Law

# of Juveniles Committed to the Dept. of Correction (CY)	2000 1	1994 1
# of Juvenile Status Case Filings (CY)	2000 10	1990 0
# of Juvenile Delinquency Case Filings (CY)	2000 77	1990 124

DATA YEAR DEFINITIONS

- SFY - State Fiscal Year: July 1-June 30
- SY - School Year: From the start of the school term in the fall through the end of the summer
- FFY - Federal Fiscal Year: October 1-September 30
- CY - Calendar Year: January 1 - December 31

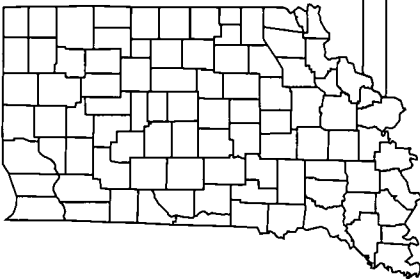

Wayne County

Kids Count in Indiana 2001



Economic Well-being

	Current Year	Base Year
% of Children in Poverty, Age 0-17 (CY)	1997 20.2	1990 20.8
Per Capita Income (CY)	1999 \$24,134	1990 \$15,918
Unemployment Rate (CY)	2000 4.0	1990 8.8
Monthly Average of Families Receiving TANF (SFY)	2000 383	1990 1,088
Monthly Average of Persons Issued Food Stamps (SFY)	2000 4,631	1990 6,753
% of Students Receiving Free Lunches / Text Books (SY)	2001 25.7	1991 21.4

Early Childhood

# of First Steps Children Served (FFY)	2000 180	1998 175
# of Licensed Child Care Centers (SFY)	2000 12	1990 8
# of Licensed Child Care Homes (SFY)	2000 35	1990 14
# of Registered Child Care Ministries (SFY)	2000 7	1993 1
# of Licensed Child Care Slots per 100 Children, Age 0-4 (SFY)	2000 21	1996 19.3

Child Protection

# of Reported Cases of Child Abuse Processed by CPS (SFY)	2000 222	1990 350
% of Child Abuse Cases Substantiated by CPS (SFY)	2000 54.0	1990 63.4
# of Reported Cases of Child Neglect Processed by CPS (SFY)	2000 426	1990 551
% of Child Neglect Cases Substantiated by CPS (SFY)	2000 44.0	1990 53.0
# of Child Physical Abuse Cases Substantiated by CPS (SFY)	2000 43	1990 47
# of Child Sexual Abuse Cases Substantiated by CPS (SFY)	2000 76	1990 36
Child Abuse and Neglect Rate (SFY)	2000 17.6	1990 40.6
# of Child Abuse and Neglect Deaths (SFY)	2000 2	1990 0
# of Juvenile CHINS Case Filings (CY)	2000 80	1990 99

Racial/Ethnic Characteristics of Children Age 0-17 in Wayne County

One Race (Non-Hispanic Origin)	87.8%
White	6.1%
Black	0.2%
American Indian or Alaska Native	0.5%
Asian	0.0%
Native Hawaiian or Other Pacific Islander	0.5%
Some Other Race	2.9%
Two or More Races (Non-Hispanic Origin)	1.8%
Hispanic Origin*	

*Hispanic children may be of any race.

Number of Children Under the Age of 20 1990 & 2000

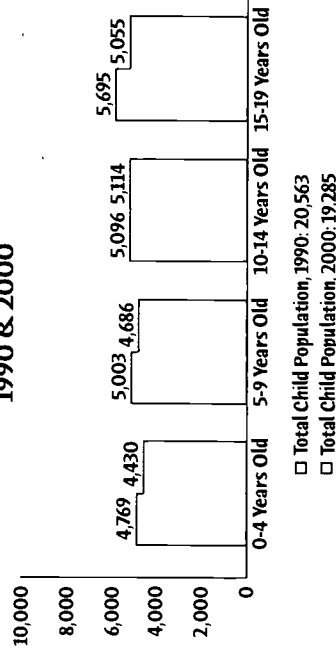

Health & Well-being

	Current Year	Base Year
Total # of Live Births (CY)	1999 906	1990 939
% of Low Birthweight Babies (CY)	1999 8.7	1990 6.8
% of Mothers who Received 1st Trimester Prenatal Care (CY)	1999 75.5	1990 67.7
% of Mothers who Smoked During Pregnancy (CY)	1999 29.6	1990 32.5
Non Marital Births as a % of All Births (CY)	1999 45.3	1990 33.7
Teen Birth Rate, Age 15-17 (CY)	1999 31.6	1990 40.1
Total # of Infant Deaths (CY)	1999 17	1990 8
Total # of Child Deaths, Age 1-14 (CY)	1999 4	1990 4
Total # of Teen Deaths by Accident, Homicide and Suicide (CY)	1999 1	1990 3
# of Children Enrolled in Hoosier Healthwise (SFY)	2000 4,814	1998 3,115
% Noncompliance with Youth Tobacco Access Laws (CY)	2000 20.0	1997 22.7

Percent of Households with Children Under 18 Headed by Parents and Others, Census 2000

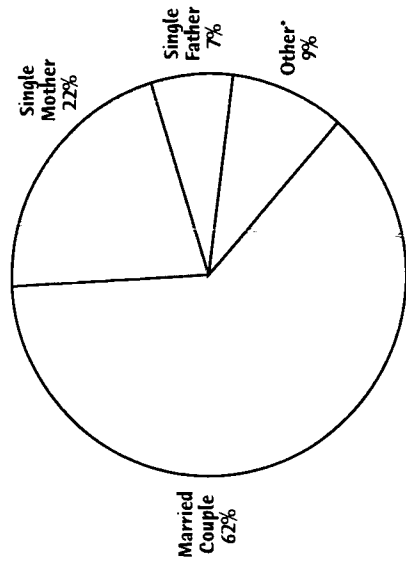

*"Other" includes households with children unrelated to the householder(s) and households with no adults present.

Education, Grades K-12

Public School Enrollment, K-12 (SY)	2000 11,711	1990 11,087
Non-Public School Enrollment (SY)	2001 717	1995 562
# of Home Schooled Children (SY)	2000 216	1990 3
# of Alternative School Participants (SY)	2001 381	1990 0
Total Per Pupil Expenditure (SY)	2000 \$6,808	1990 \$4,003
% of 10th Graders Passing the GQE Math Standard (SY)	2000 59.0	2000 59.0
% of 10th Graders Passing the GQE Language Standard (SY)	2000 66.0	2000 66.0
% of Graduates Passing the GQE (SY)	2000 96.3	2000 96.3
# of Public High School Graduates (SY)	2000 649	1990 901
% of High School Graduates (SY)	2000 84.6	1990 73.6
% of Freshman Class Graduating in 4 Years (SY)	2000 66.6	1990 86.0
% of Grads Intending 4-year College (SY)	2000 52.1	1990 38.3
% of Grads Intending Vocational/Tech School (SY)	2000 14.2	1990 10.7
# of Public School Student Dropouts (SY)	2000 145	1990 311
# of Expulsions and Suspensions (SY)	1999 3,195	1999 3,195

Juveniles and the Law

# of Juveniles Committed to the Dept. of Correction (CY)	2000 30	1994 17
# of Juvenile Status Case Filings (CY)	2000 11	1990 0
# of Juvenile Delinquency Case Filings (CY)	2000 110	1990 105

Number of Babies Born to Single Mothers Under Age 20 without a High School Diploma

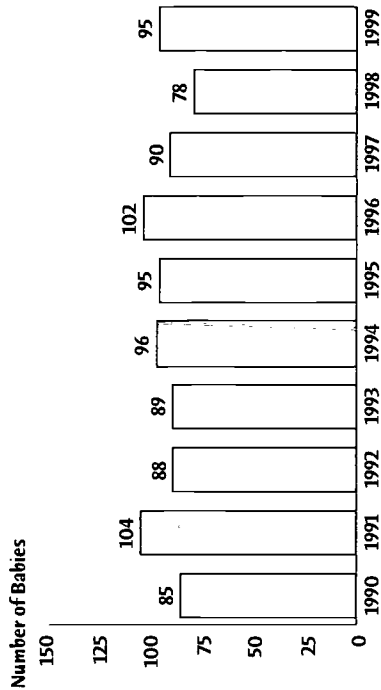

DATA YEAR DEFINITIONS

SFY – State Fiscal Year: July 1-June 30

SY – School Year: From the start of the school term in the fall through the end of the summer

FFY – Federal Fiscal Year: October 1-September 30

CY – Calendar Year: January 1 – December 31

3,459

458

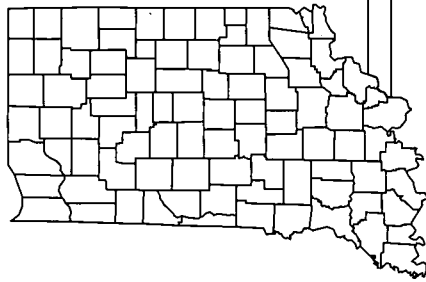

Wells County

Kids Count in Indiana 2001



Economic Well-being

	Current Year	Base Year
% of Children in Poverty, Age 0-17 (CY)	1997 8.0	1990 6.6
Per Capita Income (CY)	1999 \$25,016	1990 \$17,317
Unemployment Rate (CY)	2000 2.6	1990 4.5
Monthly Average of Families Receiving TANF (SFY)	2000 34	1990 75
Monthly Average of Persons Issued Food Stamps (SFY)	2000 493	1990 638
% of Students Receiving Free Lunches / Text Books (SY)	2001 9.5	1991 7.6

Early Childhood

# of First Steps Children Served (FFY)	2000 41	1998 34
# of Licensed Child Care Centers (SFY)	2000 0	1990 2
# of Licensed Child Care Homes (SFY)	2000 25	1990 22
# of Registered Child Care Ministries (SFY)	2000 4	1993 0
# of Licensed Child Care Slots per 100 Children, Age 0-4 (SFY)	2000 15.1	1996 17.3

Child Protection

# of Reported Cases of Child Abuse Processed by CPS (SFY)	2000 92	1990 55
% of Child Abuse Cases Substantiated by CPS (SFY)	2000 47.0	1990 52.7
# of Reported Cases of Child Neglect Processed by CPS (SFY)	2000 184	1990 58
% of Child Neglect Cases Substantiated by CPS (SFY)	2000 48.0	1990 60.3
# of Child Physical Abuse Cases Substantiated by CPS (SFY)	2000 19	1990 5
# of Child Sexual Abuse Cases Substantiated by CPS (SFY)	2000 24	1990 6
Child Abuse and Neglect Rate (SFY)	2000 17.8	1990 14.4
# of Child Abuse and Neglect Deaths (SFY)	2000 0	1990 0
# of Juvenile CHINS Case Filings (CY)	2000 23	1990 20

Racial/Ethnic Characteristics of Children Age 0-17 in Wells County

One Race (Non-Hispanic Origin)	96.2%
White	0.1%
Black	0.1%
American Indian or Alaska Native	0.2%
Asian	0.1%
Native Hawaiian or Other Pacific Islander	0.1%
Some Other Race	1.2%
Two or More Races (Non-Hispanic Origin)	2.1%
Hispanic Origin*	

*Hispanic children may be of any race.

Number of Children Under the Age of 20 1990 & 2000

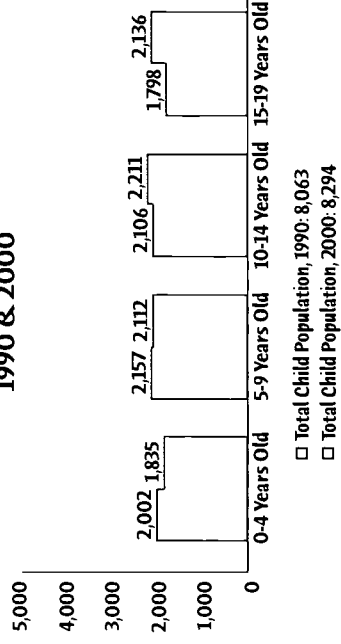

Health & Well-being

	Current Year	Base Year
Total # of Live Births (CY)	1999 317	1990 392
% of Low Birthweight Babies (CY)	1999 6.3	1990 5.1
% of Mothers who Received 1st Trimester Prenatal Care (CY)	1999 83.0	1990 88.3
% of Mothers who Smoked During Pregnancy (CY)	1999 20.2	1990 21.9
Non Marital Births as a % of All Births (CY)	1999 20.2	1990 14.8
Teen Birth Rate, Age 15-17 (CY)	1999 18.2	1990 44.3
Total # of Infant Deaths (CY)	1999 1	1990 2
Total # of Child Deaths, Age 1-14 (CY)	1999 3	1990 2
Total # of Teen Deaths by Accident, Homicide and Suicide (CY)	1999 2	1990 1
# of Children Enrolled in Hoosier Healthwise (SFY)	2000 841	1998 406
% Noncompliance with Youth Tobacco Access Laws (CY)	2000 10.0	1997 21.1

Education, Grades K-12

Public School Enrollment, K-12 (SY)	2000 5,158	1990 4,503
Non-Public School Enrollment (SY)	2001 217	1995 178
# of Home Schooled Children (SY)	2000 54	1990 18
# of Alternative School Participants (SY)	2001 55	1990 0
Total Per Pupil Expenditure (SY)	2000 \$5,725	1990 \$4,364
% of 10th Graders Passing the GQE Math Standard (SY)	2000 75.0	2000 75.0
% of 10th Graders Passing the GQE Language Standard (SY)	2000 81.0	2000 81.0
% of Graduates Passing the GQE (SY)	2000 96.0	2000 96.0
# of Public High School Graduates (SY)	2000 374	1990 354
% of High School Graduates (SY)	2000 91.6	1990 89.0
% of Freshman Class Graduating in 4 Years (SY)	2000 81.7	1990 87.0
% of Grads Intending 4-year College (SY)	2000 48.1	1990 38.4
% of Grads Intending Vocational/Tech School (SY)	2000 14.4	1990 8.5
# of Public School Student Dropouts (SY)	2000 35	1990 44
# of Expulsions and Suspensions (SY)	1999 1,185	1999 1,185

Juveniles and the Law

# of Juveniles Committed to the Dept. of Correction (CY)	2000 10	1994 8
# of Juvenile Status Case Filings (CY)	2000 18	1990 9
# of Juvenile Delinquency Case Filings (CY)	2000 57	1990 37

Percent of Households with Children Under 18 Headed by Parents and Others, Census 2000

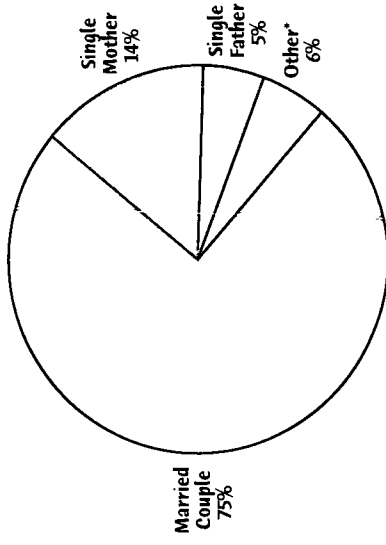

*"Other" includes households with children unrelated to the householder(s) and households with no adults present.

Number of Babies Born to Single Mothers Under Age 20 without a High School Diploma

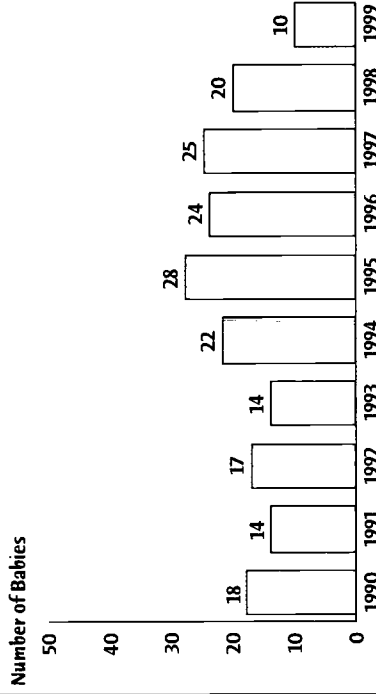

DATA YEAR DEFINITIONS

- SFY - State Fiscal Year: July 1-June 30
- SY - School Year: From the start of the school term in the fall through the end of the summer
- FFY - Federal Fiscal Year: October 1-September 30
- CY - Calendar Year: January 1 - December 31

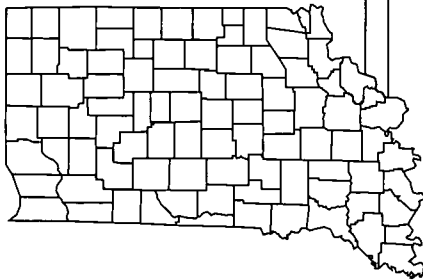

White County



Economic Well-being

	Current Year	Base Year
% of Children in Poverty, Age 0-17 (CY)	1997 13.6	1990 8.1
Per Capita Income (CY)	1999 \$22,027	1990 \$16,159
Unemployment Rate (CY)	2000 3.4	1990 6.0
Monthly Average of Families Receiving TANF (SFY)	2000 67	1990 95
Monthly Average of Persons Issued Food Stamps (SFY)	2000 968	1990 641
% of Students Receiving Free Lunches / Text Books (SY)	2001 20.0	1991 10.6

Early Childhood

# of First Steps Children Served (FFY)	2000 45	1998 35
# of Licensed Child Care Centers (SFY)	2000 1	1990 1
# of Licensed Child Care Homes (SFY)	2000 29	1990 3
# of Registered Child Care Ministries (SFY)	2000 1	1993 0
# of Licensed Child Care Slots per 100 Children, Age 0-4 (SFY)	2000 23	1996 18.5

Child Protection

# of Reported Cases of Child Abuse Processed by CPS (SFY)	2000 26	1990 77
% of Child Abuse Cases Substantiated by CPS (SFY)	2000 35.0	1990 74.0
# of Reported Cases of Child Neglect Processed by CPS (SFY)	2000 80	1990 53
% of Child Neglect Cases Substantiated by CPS (SFY)	2000 66.0	1990 56.6
# of Child Physical Abuse Cases Substantiated by CPS (SFY)	2000 9	1990 21
# of Child Sexual Abuse Cases Substantiated by CPS (SFY)	2000 0	1990 12
Child Abuse and Neglect Rate (SFY)	2000 9.2	1990 18.5
# of Child Abuse and Neglect Deaths (SFY)	2000 0	1990 0
# of Juvenile CHINS Case Filings (CY)	2000 29	1990 8

Racial/Ethnic Characteristics of Children Age 0-17 in White County

One Race (Non-Hispanic Origin)	90.4%
White	0.3%
Black	0.3%
American Indian or Alaska Native	0.3%
Asian	0.0%
Native Hawaiian or Other Pacific Islander	0.1%
Some Other Race	1.0%
Two or More Races (Non-Hispanic Origin)	7.6%
Hispanic Origin*	

*Hispanic children may be of any race.

Number of Children Under the Age of 20 1990 & 2000

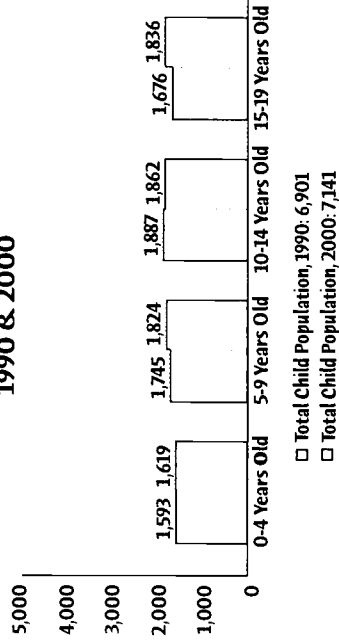

000000 136231

Health & Well-being

	Current Year	Base Year
Total # of Live Births (CY)	1999 354	1990 309
% of Low Birthweight Babies (CY)	1999 4.8	1990 5.5
% of Mothers who Received 1st Trimester Prenatal Care (CY)	1999 84.7	1990 85.3
% of Mothers who Smoked During Pregnancy (CY)	1999 24.9	1990 28.2
Non Marital Births as a % of All Births (CY)	1999 31.9	1990 19.1
Teen Birth Rate, Age 15-17 (CY)	1999 23.7	1990 34.9
Total # of Infant Deaths (CY)	1999 1	1990 3
Total # of Child Deaths, Age 1-14 (CY)	1999 1	1990 0
Total # of Teen Deaths by Accident, Homicide and Suicide (CY)	1999 1	1990 2
# of Children Enrolled in Hoosier Healthwise (SFY)	2000 1,367	1998 801
% Noncompliance with Youth Tobacco Access Laws (CY)	2000 N/A	1997 N/A

Percent of Households with Children Under 18 Headed by Parents and Others, Census 2000

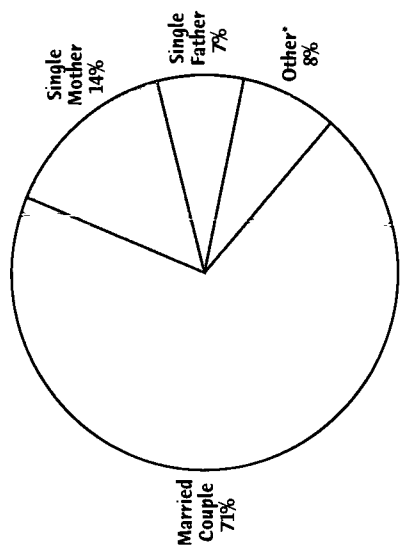

* "Other" includes households with children unrelated to the householder(s) and households with no adults present.

Education, Grades K-12

Public School Enrollment, K-12 (SY)	2000 5,572	1990 4,916
Non-Public School Enrollment (SY)	2001 71	1995 0
# of Home Schooled Children (SY)	2000 80	1990 0
# of Alternative School Participants (SY)	2001 50	1990 0
Total Per Pupil Expenditure (SY)	2000 \$5,682	1990 \$3,706
% of 10th Graders Passing the GQE Math Standard (SY)	2000 66.0	2000 66.0
% of 10th Graders Passing the GQE Language Standard (SY)	2000 70.0	2000 70.0
% of Graduates Passing the GQE (SY)	2000 89.2	2000 89.2
# of Public High School Graduates (SY)	2000 380	1990 365
% of High School Graduates (SY)	2000 87.9	1990 80.3
% of Freshman Class Graduating in 4 Years (SY)	2000 78.4	1990 88.2
% of Grads Intending 4-year College (SY)	2000 44.7	1990 32.6
% of Grads Intending Vocational/Tech School (SY)	2000 7.6	1990 9.9
# of Public School Student Dropouts (SY)	2000 55	1990 84
# of Expulsions and Suspensions (SY)	1999 901	1999 901

Juveniles and the Law

# of Juveniles Committed to the Dept. of Correction (CY)	2000 0	1994 0
# of Juvenile Status Case Filings (CY)	2000 5	1990 0
# of Juvenile Delinquency Case Filings (CY)	2000 24	1990 41

Number of Babies Born to Single Mothers Under Age 20 without a High School Diploma

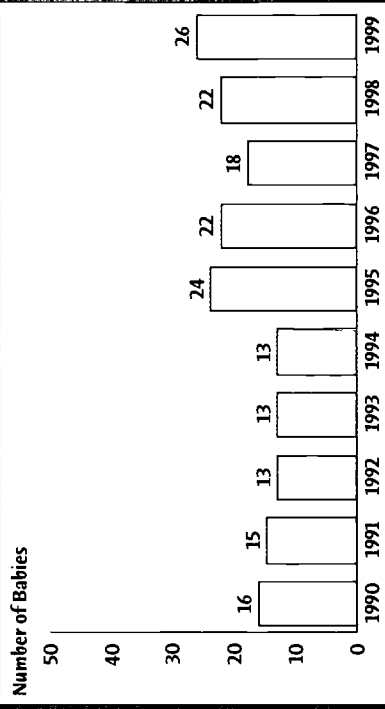

DATA YEAR DEFINITIONS

SFY - State Fiscal Year: July 1-June 30
 SY - School Year: From the start of the school term in the fall through the end of the summer
 FFY - Federal Fiscal Year: October 1-September 30
 CY - Calendar Year: January 1 - December 31

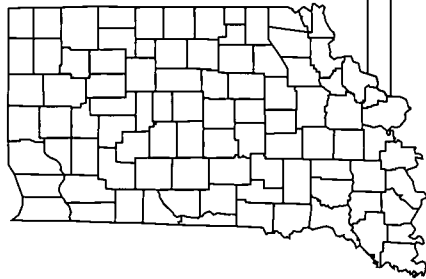

Whitley County

Kids Count in Indiana 2001



Economic Well-being

	Current Year	Base Year
% of Children in Poverty, Age 0-17 (CY)	1997 7.2	1990 6.1
Per Capita Income (CY)	1999 \$24,657	1990 \$16,808
Unemployment Rate (CY)	2000 2.9	1990 6.0
Monthly Average of Families Receiving TANF (SFY)	2000 33	1990 53
Monthly Average of Persons Issued Food Stamps (SFY)	2000 535	1990 346
% of Students Receiving Free Lunches / Text Books (SY)	2001 6.4	1991 6.8

Early Childhood

# of First Steps Children Served (FFY)	2000 78	1998 63
# of Licensed Child Care Centers (SFY)	2000 4	1990 0
# of Licensed Child Care Homes (SFY)	2000 20	1990 16
# of Registered Child Care Ministries (SFY)	2000 3	1993 1
# of Licensed Child Care Slots per 100 Children, Age 0-4 (SFY)	2000 28.7	1996 23.8

Child Protection

# of Reported Cases of Child Abuse Processed by CPS (SFY)	2000 38	1990 63
% of Child Abuse Cases Substantiated by CPS (SFY)	2000 71.0	1990 73.0
# of Reported Cases of Child Neglect Processed by CPS (SFY)	2000 88	1990 24
% of Child Neglect Cases Substantiated by CPS (SFY)	2000 78.0	1990 75.0
# of Child Physical Abuse Cases Substantiated by CPS (SFY)	2000 14	1990 3
# of Child Sexual Abuse Cases Substantiated by CPS (SFY)	2000 13	1990 8
Child Abuse and Neglect Rate (SFY)	2000 11.3	1990 10.8
# of Child Abuse and Neglect Deaths (SFY)	2000 0	1990 0
# of Juvenile CHINS Case Filings (CY)	2000 7	1990 8

Racial/Ethnic Characteristics of Children Age 0-17 in Whitley County

One Race (Non-Hispanic Origin)	96.9%
White	0.3%
Black	0.4%
American Indian or Alaska Native	0.2%
Asian	0.0%
Native Hawaiian or Other Pacific Islander	0.1%
Some Other Race	0.8%
Two or More Races (Non-Hispanic Origin)	1.3%
Hispanic Origin*	

*Hispanic children may be of any race.

Number of Children Under the Age of 20 1990 & 2000

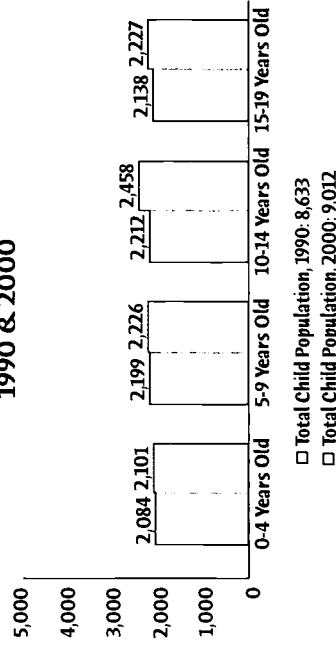

Health & Well-being

	Current Year	Base Year
Total # of Live Births (CY)	1999 418	1990 434
% of Low Birthweight Babies (CY)	1999 7.2	1990 5.5
% of Mothers who Received 1st Trimester Prenatal Care (CY)	1999 84.9	1990 88.4
% of Mothers who Smoked During Pregnancy (CY)	1999 20.8	1990 23.0
Non Marital Births as a % of All Births (CY)	1999 24.4	1990 13.6
Teen Birth Rate, Age 15-17 (CY)	1999 13.5	1990 7.8
Total # of Infant Deaths (CY)	1999 4	1990 1
Total # of Child Deaths, Age 1-14 (CY)	1999 2	1990 0
Total # of Teen Deaths by Accident, Homicide and Suicide (CY)	1999 1	1990 3
# of Children Enrolled in Hoosier Healthwise (SFY)	2000 862	1998 371
% Noncompliance with Youth Tobacco Access Laws (CY)	2000 30.0	1997 N/A

Percent of Households with Children Under 18 Headed by Parents and Others, Census 2000

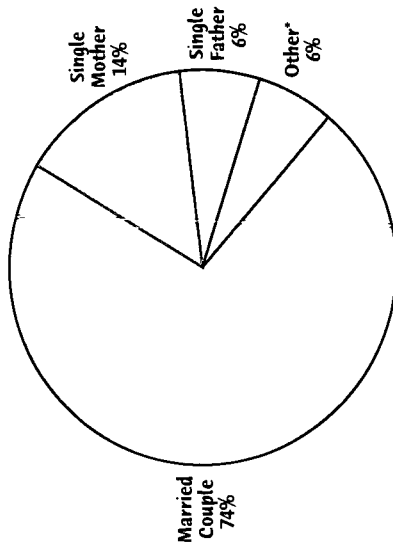

*"Other" includes households with children unrelated to the household(s) and households with no adults present.

Education, Grades K-12

Public School Enrollment, K-12 (SY)	2000 4,989	1990 3,335
Non-Public School Enrollment (SY)	2001 126	1995 26
# of Home Schooled Children (SY)	2000 67	1990 1
# of Alternative School Participants (SY)	2001 121	1990 0
Total Per Pupil Expenditure (SY)	2000 \$6,232	1990 \$4,225
% of 10th Graders Passing the GQE Math Standard (SY)	2000 66.0	2000 66.0
% of 10th Graders Passing the GQE Language Standard (SY)	2000 72.0	2000 72.0
% of Graduates Passing the GQE (SY)	2000 98.2	2000 98.2
# of Public High School Graduates (SY)	2000 330	1990 379
% of High School Graduates (SY)	2000 89.1	1990 89.4
% of Freshman Class Graduating in 4 Years (SY)	2000 80.9	1990 96.2
% of Grads Intending 4-year College (SY)	2000 55.8	1990 39.7
% of Grads Intending Vocational/Tech School (SY)	2000 8.2	1990 8.8
# of Public School Student Dropouts (SY)	2000 41	1990 62
# of Expulsions and Suspensions (SY)	1999 1,163	1999 1,163

Juveniles and the Law

# of Juveniles Committed to the Dept. of Correction (CY)	2000 1	1994 2
# of Juvenile Status Case Filings (CY)	2000 28	1990 3
# of Juvenile Delinquency Case Filings (CY)	2000 75	1990 50

Number of Babies Born to Single Mothers Under Age 20 without a High School Diploma

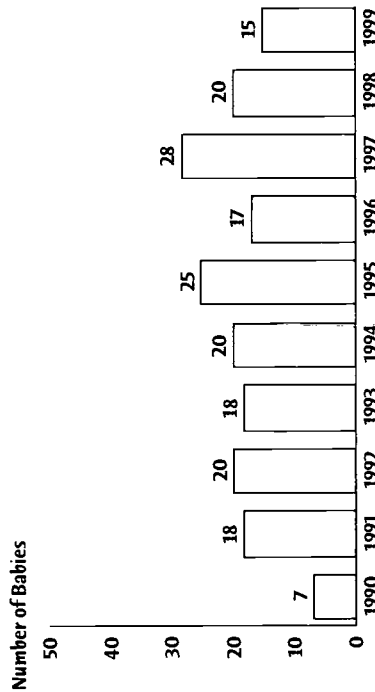

DATA YEAR DEFINITIONS

SFY - State Fiscal Year: July 1-June 30
 SY - School Year: From the start of the school term in the fall through the end of the summer
 FFY - Federal Fiscal Year: October 1-September 30
 CY - Calendar Year: January 1 - December 31



*Please note our new address effective January 1, 2002:
603 E. Washington Street, Suite 800
Indianapolis, Indiana 46204*



U.S. Department of Education
Office of Educational Research and Improvement (OERI)
National Library of Education (NLE)
Educational Resources Information Center (ERIC)



NOTICE

Reproduction Basis



This document is covered by a signed "Reproduction Release (Blanket)" form (on file within the ERIC system), encompassing all or classes of documents from its source organization and, therefore, does not require a "Specific Document" Release form.



This document is Federally-funded, or carries its own permission to reproduce, or is otherwise in the public domain and, therefore, may be reproduced by ERIC without a signed Reproduction Release form (either "Specific Document" or "Blanket").

EFF-089 (3/2000)

PS030299