

## DOCUMENT RESUME

ED 461 283

FL 025 221

AUTHOR Zelasko, Nancy F., Ed.  
TITLE NABE News, 1996-1997.  
INSTITUTION National Association for Bilingual Education, Washington, DC.  
PUB DATE 1997-00-00  
NOTE 282p.; Published eight times per year.  
PUB TYPE Collected Works - Serials (022)  
JOURNAL CIT NABE News; v20 n1-8 1996-1997  
EDRS PRICE MF01/PC12 Plus Postage.  
DESCRIPTORS Acculturation; American Indians; Asian Americans; \*Bilingual Education; Bilingual Teachers; Book Reviews; Childrens Literature; Computer Uses in Education; Cultural Pluralism; Early Childhood Education; Educational Technology; Elementary Secondary Education; English Only Movement; English (Second Language); Enrollment Rate; Federal Legislation; Foreign Countries; Gifted; Higher Education; Hispanic Americans; Indigenous Populations; Internet; Language Maintenance; \*Language Minorities; Language of Instruction; Legislators; \*Limited English Speaking; Literacy Education; Literature Appreciation; \*Parent Participation; Portfolios (Background Materials); \*Public Policy; Reading Instruction; Second Language Instruction; Teacher Education; Teacher Qualifications; Trend Analysis; Uncommonly Taught Languages; Writing Instruction

IDENTIFIERS Australia

## ABSTRACT

The eight issues of the newsletter of the National Association for Bilingual Education contain articles on these topics in relation to bilingual education: federal policy and policy formation; teacher qualifications; the English-only movement; parent involvement; reading instruction; the effect of foreign-language schools on children's acculturation; education of American Indians; Asian/Pacific education concerns; cultural literacy; federal resource allocation; global learning networks; early childhood education; pre-literate older (late elementary/secondary school) students; learning culture through children's literature; electronic portfolios for student assessment; using graphic organizers for bilingual literacy education; communication with and within families; gifted education; Internet search tools; writing instruction; empowering language minority children in the mainstream; court litigation; learning strategy instruction; biculturalism; school-to-work programs; teacher education; and educational technology. Book reviews, resource listings, and professional announcements are also included in each issue. (MSE)

**NABE News, 1996-1997**

**Nancy F. Zelasko, Editor**

**Volume 20 Numbers 1-8**

U.S. DEPARTMENT OF EDUCATION  
Office of Educational Research and Improvement  
EDUCATIONAL RESOURCES INFORMATION  
CENTER (ERIC)

- This document has been reproduced as received from the person or organization originating it.
- Minor changes have been made to improve reproduction quality

---

- Points of view or opinions stated in this document do not necessarily represent official OERI position or policy.

PERMISSION TO REPRODUCE AND  
DISSEMINATE THIS MATERIAL HAS  
BEEN GRANTED BY

**N. Zelasko**

TO THE EDUCATIONAL RESOURCES  
INFORMATION CENTER (ERIC)

1



# NABE NEWS

*The news magazine about educational equity and excellence through bilingual education*

September 15, 1996

National Association for Bilingual Education

Volume 20, Number 1

## You Can Shape the Future: Vote on November 5th!

The upcoming elections are an opportunity for NABE members to shape the future. The results of all elections — for school board members, local and state governing bodies, Congressional representatives and President — will determine the extent to which educational opportunity and excellence are provided for linguistically and culturally diverse students. Continuing NABE's tradition of providing balanced information for our members, we are printing the following excerpts from the Republican and Democratic party platforms.

### *Democratic Party Platform*

#### **Education**

Today's Democratic Party knows that education is the key to opportunity. In the new global economy, it is more important than ever before. Today, education is the fault line that separates those who will prosper from those who cannot. President Clinton and Democrats in Congress have spared no effort over the last four years to improve the quality of American education and expand the opportunity for all Americans to get the education they need to succeed.

Every step of the way, we have been opposed by Republicans intent on cutting education. Now, they want to cut education from Head Start through college scholarships. They want to undermine our public schools and make borrowing for college more difficult for millions of students.

Today's Democratic Party will stand firmly against the Republican assault on education. Cutting education as we move into the 21st century would be like cutting defense spending at the height of the Cold War. We must do more to expand educational opportunity — not less.

*Strengthening public schools.* We increased Head Start funding to expand early education for more children who need it. We passed Goals 2000 to help schools set high standards, and find the resources they need to succeed: the best books, the brightest teachers, the most up-to-date technology. We restructured federal education programs and eliminated federal regulations to give local schools, teachers, and principals the flexibility and help they need to meet those standards. We've worked to make sure our children have the best teachers by expanding teacher education. We applaud the work of state and local Democrats to develop innovative solutions to make sure our children get the best possible education.

In the next four years, we must do even more to make sure America has the best public schools on earth. If we want to be the best, we should expect the best: We must hold students, teachers, and schools to the highest standards. Every child should be able to read by the end of the third grade. Students should be required to demonstrate

CONTINUED ON PAGE 10

### *Republican Party Platform*

#### **Education**

*At the center of all that afflicts our schools is a denial of free choice. Our public schools are in trouble because they are no longer run by the public. Instead, they're controlled by narrow special interest groups who regard public education not as a public trust, but as political territory to be guarded at all costs.*

-- Bob Dole, July 17, 1996, in Minneapolis.

The American people know that something is terribly wrong with our education system. The evidence is everywhere: children who cannot read, graduates who cannot reason, danger in schoolyards, indoctrination in classrooms.

To this crisis in our schools, Bill Clinton responds with the same liberal dogmas that created the mess: more federal control and more spending on all the wrong things. He opposes family rights in education and opportunity scholarships for poor children. When it comes to saving our schools, he flunks.

Americans should have the best education in the world. We spend more per pupil than any other nation, and the great majority of our teachers are dedicated and skilled educators, whose interests are ignored by political union bosses. Our goal is nothing less than a renaissance in American education, begun by returning its control to parents, teachers, local school boards and, through them, to communities and local taxpayers.

Our formula is as simple as it is sweeping: the federal government has no constitutional authority to be involved in school curricula or to control jobs in the work place. That is why we will abolish the Department of Education, end federal meddling in our schools, and promote family choice at all levels of learning. We therefore call for prompt repeal of the Goals 2000 program and the School-To-Work Act of 1994, which put new federal controls, as well as unfunded mandates, on the States. We further urge that federal attempts to impose outcome- or performance-based education on local schools be ended.

We know what works in education, and it isn't the liberal fads of

CONTINUED ON PAGE 10

# NABE NEWS

Published by the  
**National Association for  
Bilingual Education**

**Editor:**

Nancy F. Zelasko, Ph.D.

**Desktop Publishing & Layout:**

Jeff Spence

## NABE NEWS REPRINT AND EDITORIAL POLICY

Readers are welcome to reprint non-copy-righted articles which appear in *NABE NEWS* at no charge, provided proper credit is given both to the author(s) and to *NABE NEWS* as the source publication.

All articles printed in *NABE NEWS*, unless written by an Association staff person or a member of the current NABE Executive Board of Directors, are solely the opinion of the author or authors, and do not represent the official policy or position of the National Association for Bilingual Education. Selection of articles for inclusion in *NABE NEWS* is not an official endorsement by NABE of the point(s) of view expressed therein.

## TABLE OF CONTENTS

DNC/GOP Platforms.....	1
Message from the President.....	3
<i>ESL in Bilingual Ed.</i> column.....	5
English-Only.....	7
NABE Order Form.....	8
<i>Parental Involvement</i> column.....	9
Why José Can't Read.....	11
Teacher of the Year contest.....	13
Assistant of the Year contest.....	15
Upcoming Events.....	16
<i>Asian/Pacific Ed.</i> column.....	17
<i>Book Review</i> column.....	19
Educator Resources.....	21
Membership Application.....	27
Announcements.....	28

## PUBLICATION SCHEDULE

Volume 20 of *NABE NEWS* will be published in 8 issues; publication dates are:

Issue 1	09/15/96	Issue 5	03/15/97
Issue 2	11/01/96	Issue 6	05/01/97
Issue 3	12/15/96	Issue 7	06/15/97
Issue 4	02/01/97	Issue 8	08/01/97

All advertising and copy material must be received in the NABE office **ONE MONTH** prior to publication date to be considered for inclusion.

## NABE NEWS ADVERTISING

### Display Advertising Rates

(Camera-Ready)

Full Page (7.5" x 10")	\$850
2/3-Page (4.75" x 10")	\$700
1/2-Page (7.5" x 4.5")	\$550
1/3-Page (4.75" x 4.75")	\$425
1/3-Page (2.25" x 10")	\$425
1/4-Page (3.5" x 4.75")	\$325
1/6-Page (2.25" x 4.75")	\$250

### Classified Advertising

\$1.25 per word; maximum 100 words

### Advertising Discounts (for multiple insertions)

10% for second-third; 15% for fourth-fifth;  
20% for sixth-eighth

NABE reserves the right to reject any advertisements which it deems inappropriate and/or inconsistent with the goals of the Association. For additional information, contact NABE at (202) 898-1829 x136.

## NABE

The National Association for Bilingual Education (NABE) is a tax-exempt, non-profit professional association founded in 1975 to address the educational needs of language-minority Americans.

### NABE NATIONAL OFFICE

1220 L Street, N.W., Suite 605

Washington, DC 20005-4018

PHONE (202) 898-1829

FAX (202) 789-2866

E-mail: NABE@nabe.org

### James J. Lyons, Executive Director

Nancy F. Zelasko, Deputy Director  
Jaime Zapata, Associate Director for Legislation  
Jeff Spence, Information Systems Director  
Carolyn Riddick, Office Manager  
Celia Torres, Membership Specialist  
Mina Cousins, Membership Specialist  
Ronald Williams, Office Assistant  
Teresa Sola, Receptionist

## NABE EXECUTIVE BOARD

1996 - 1997

### President

Janice Jones Schroeder  
3402 Northstar  
Anchorage, AK 99518  
(907) 563-6650

### Vice President

Mary F. Jew  
San Francisco USD  
300 Seneca Avenue, Room 6  
San Francisco, CA 94112  
(415) 469-4777

### Secretary/Treasurer

David E. Báez  
Director, Foreign Language & Bilingual  
Education  
Buffalo Public Schools  
731 City Hall  
Buffalo, NY 14202  
(716) 851-3704

### Member-at-Large

Joe J. Bernal  
6410 Laurelhill  
San Antonio, TX 78229  
(210) 342-8026

### Member-at-Large

María Estela Brisk  
School of Education  
Boston University  
605 Commonwealth Avenue  
Boston, MA 02215  
(617) 353-3260  
brisk@acs.bu.edu

### Member-at-Large

Nga Dinh Duong  
21724 58th Avenue West  
Mountlake Terrace, WA 98043  
(206) 771-2095

### Member-at-Large

Hermán S. García  
Department of C & I  
College of Education  
New Mexico State University  
Las Cruces, NM 88003  
(505) 646-2115  
hgarcia@cnmailsvr.nmsu.edu

### Member-at-Large

Susan García  
18094 East Ohio, #102  
Aurora, CO 80012  
(303) 745-7116

### Parent Representative

Adela B. Holder  
Silver Consolidated School District  
2810 N. Swan Street  
Silver City, NM 88061  
(505) 388-1527  
sncadavi@arriba.nm.org

# Message From The President

## *Working Together for Real Change*

by *Janice Jones Schroeder*

As the new school year begins, what real change will there be in the education of language-minority children? In order to meet the mandates of Goals 2000 and the education reform movement, educators must have four goals:

- quality in addition to equity;
- accountability;
- input/output; and
- partnership of the family, school, and community.

The issue of quality in education is an area in which I believe bilingual educators must take a more active leadership role. Laws are in place to assure equity in education, but it must be the educators themselves who ensure quality. We educators must have high expectations, not only of ourselves, but of our children as well. The curriculum and teaching style must also be compatible with the student's culture. This may require changing from the "same for all" method of teaching.

We, as bilingual educators, must first hold ourselves accountable for the quality of education for our children. This may mean that bilingual educators assume the responsibility for seeing that excellence is maintained in other aspects of their students' curricula. Bilingualism should be



*1996-1997 NABE Executive Board President,  
Janice Jones Schroeder*

part of the content area for all curricula, so it will be up to the bilingual teacher to educate "mainstream" teachers and administrators in addition to their own students. We all must continue to hold local or state school boards, school administrators, and policy makers accountable for upholding educational quality for our nation's children.

One of the benchmarks of Goals 2000 is "all children must come to school ready to learn." Learning is an innate natural process for each human being. Children learn in the informal environment of their home and community before they arrive at the school's doorstep. Our task as educators must be to guide the learning process, both

informal and formal. We cannot change the input, but we must work to facilitate the education of the whole child, not fragmented portions. This is the only way we can realize change in the output.

parents must be involved in their children's education. research tells us that students achieve higher grades when their parents are actively involved. To increase the involvement of our language-minority parents in the education process, we must take a different approach to what is meant by parent involvement. communication from the school to the home must be improved. The teachers and administrators must understand that the school represents the community. We must educate parents and community members of their rights, roles, and responsibilities related to the education of their children. Education is a lifelong process. To ensure this, teachers and other adults in the community must be made aware that education does not start and stop at the doors of the school.

We must work together for the betterment of all children, which in turn guarantees a greater nation. As bilingual educators, we must begin to "walk our talk" if we expect real change to occur in our nation's schools.

• NABE •

## **NABE '97**

February 4-8, 1997  
Albuquerque, NM

### **Preregistration Information**

**In mid-September, conference preregistration materials will be mailed to all current NABE members, and all NABE '96 attendees (regardless of membership status).**

**If you are not a member, or did not attend NABE '96 in Orlando, you can add your name and address to the mailing list by telephoning NABE and dialing 130 for the Conference department.**

# DISCOVER PERMA-BOUND BOOKS

## FOR YOUR BILINGUAL STUDENTS



**W**hen looking for a great selection of affordable titles for bilingual students, our Pre-Kindergarten-12 selection is great - including over 2,000 books in Spanish, plus Chinese, Vietnamese, French, German, Italian, and more.

- ❖ TRANSLATIONS
- ❖ ORIGINAL WORKS
- ❖ SHORT STORIES
- ❖ NOVELS
- ❖ SCIENCE
- ❖ DICTIONARIES
- ❖ BILINGUAL READERS
- ❖ VALE - IBM WRITING TO READ

Now Available! Books in Spanish to accompany Accelerated Reader Program.

One PERMA-BOUND book will outlast seven to ten paperbacks at about one-third the cost-and they're unconditionally guaranteed. If you're ever dissatisfied with a PERMA-BOUND book for any reason we'll replace it.

VANDALIA ROAD ❖ JACKSONVILLE, ILLINOIS 62650

CALL TOLL FREE: 1-800-637-6581 TOLL FREE FAX: 1-800-551-1169

**PERMA-BOUND**

# ESL in Bilingual Education

Column Editor: Dr. Jack Milon, University of Nevada, Reno

## *Language-Minority Students Deserve Qualified Teachers*

*by Dr. Jack Milon*

The Congress seems to be moving toward legislation that will increasingly exclude many language-minority students from the education that they need. It is clear that the differences between the interests of teachers in ESL programs and teachers in bilingual education programs are almost irrelevant when compared with the interests which we share. The socially-endorsed political activities taking place in the communities in which we live and teach determine how we do our jobs. The nature of these activities is largely determined by monolingual majority-language speakers who seem to have little tolerance for the populations from which we draw our students.

Whether we are classified by our districts as ESL teachers or bilingual education teachers, we almost surely deal with students with similar characteristics. Compared to the children in "other" classes or programs our students are more likely to be poor; they are more likely not to be Caucasian; they are more likely to be labeled "at risk;" and they and their families are more likely to be viewed as less than fully responsible and productive members of the community. These descriptors are accurate for Haitians in the Northeast, Hmong in the Northwest, Mexicanos in the Southwest, and Samoans in Hawaii.

One of the things which happens to our students and their families is that they get the short shrift in the political process at all levels. To the degree with which we are identified professionally as well as socially with the populations we serve, we too are more likely to get the short shrift from our elected or appointed representatives.

While we may differ on the merits of our respective programs for particular children speaking particular languages in particular situations, surely we can agree that the large number of school-age children

living in the United States who do not speak English as a native language should be provided with services that will help them to succeed in their schools and in their communities. It makes sense that our different orientations toward language pedagogy will lead us to prefer different approaches to the delivery of those services. But we should consider the fact that whatever differences we ourselves see between our group identities, we are often essentialized by those elements of the community which are not sympathetic to our students and by extension are not sympathetic to us as their teachers.

I personally have never found that strong supporters of English-Only or Official English were interested in distinguishing between ESL teachers and bilingual education teachers, let alone between bilingual teachers and bilingual education teachers. This is despite the fact that their rejection of bilingual education teachers could be rationalized on principled grounds. Their animosity toward ESL teachers is most often simply grounded in intolerance complemented by ignorance.

An example of our mutual interdependence surfaced recently at the state level in Nevada. In July, the Nevada State Commission on Professional Standards in Education held a meeting in Carson City which included discussion of and action on a proposed amendment to the "Endorsement or Limited Endorsement to Teach Program of Bilingual Education" (NDOE, 1966). It was the only meeting required before the decision of the Commission becomes binding.

At that meeting, the Commission voted 6 to 2 for a proposal which will completely neutralize the bilingual endorsement which they passed in March of 1994. The original "Nevada Bilingual Endorsement — NAC 391.242" was criticized at the time as being extremely weak, but it did contain the requirement that a person receiving the bilingual endorsement on their teaching license must "(b) Demonstrate, by exami-

nation approved by the commission, oral and written proficiency in the native language" (NDOE, March, 1994). Though there was some disappointment that the examination in question was not specified, it appeared to be a straightforward and transparently logical requirement. It did not, and still doesn't, seem unreasonable for a State Commission on Professional Standards in Education to require that persons be asked to demonstrate in some way that they are bilingual in order to receive a bilingual endorsement on their teaching license.

At the July meeting two and a half years later, the Commission added language to NAC 391.42 which explicitly removed the requirement for teachers acquiring a bilingual endorsement to demonstrate proficiency in the other language for at least two years. Section 1.(b) was rewritten as follows: "(b) Demonstrate, by examination approved by the commission, oral and written proficiency in the native language, when available, and allow 2 years from the date of issuance of license to take the examination" (NDOE, July, 1996b). The amendment guarantees that teachers who apply for the bilingual endorsement on their licenses will not be required to demonstrate proficiency in the other language (in Nevada this means Spanish) for at least two years after being hired. After two years it will be possible to administer tests for competence in the other language, but only IF the Commission (presumably acting through the Nevada Department of Education) is able to create or choose a test in that time.

Since the Commission has been unable or unwilling to decide on a language proficiency test over the two and a half years since March of 1994, the suggestion that it will not do so over the next three years is not as preposterous as it may initially sound. This possibility raises the fear that teachers who are not in fact bilingual will acquire the bilingual endorsement and will

CONTINUED ON PAGE 6

be hired as bilingual teachers. Since they will not be required to demonstrate competence in the other language when hired, and since it will not be their fault if the Commission does not come up with a competency test, the possibility arises that teachers who have been hired without demonstrating competence will be "grandfathered" in with a bilingual endorsement without having any bilingual skills at all.

No bilingual education teachers or ESL teachers attended this crucial public meeting. The lack of ESL teachers was unfortunate, but partially understandable due to the fact that there was little effective public notice of the hearing. In addition, it was held in the middle of a hot July day, and teachers with ESL endorsements were not directly affected. There was actually a bit more justification for the lack of attendance by bilingual teachers since the bilingual endorsement does not yet exist. There are NO bilingual program teachers in Nevada outside of Clark County (Las Vegas), which is almost four hundred miles away.

## SEQUOIA UNION HIGH SCHOOL DISTRICT

### Bilingual (Spanish) teachers

All high school subjects  
for 1997-98 school year

Must qualify for  
California Single Subject  
Credential

**Please send letter  
and resume to:**

Certificated Personnel  
Sequoia Union High  
School District  
480 James Avenue  
Redwood City, CA 94062

(415) 369-1411, ext. 2223

FAX (415) 306-8868

The bilingual teachers in Clark County (who are teaching without the bilingual endorsement) are supported with federal rather than state funds. In the rest of Nevada there are teachers who are bilingual, but they are not teaching in bilingual programs endorsed by the Nevada Department of Education and certainly not in programs supported with state funds. The nearest teachers directly effected by this first and last Commission meeting were almost four hundred desert miles away.

Hopefully, at other meetings in Nevada and at meetings in other states, we ESL teachers will be able to overcome barriers that have inhibited us in the past. We need to find ways to vigorously support concepts in the political arena that are fundamentally sound and pedagogically rational. Requiring individuals who are endorsed as bilingual teachers to demonstrate that they are competent in two languages would presumably qualify as one of those concepts. It doesn't require a prophetic gift to understand that in this case it would serve our own self interests for us, as ESL professionals, to support our colleagues in bilingual programs.

We face the same kinds of political pressures from unsympathetic institutional bodies. For example, at the July meeting of the Commission on Professional Standards it was pointed out that the most current report on the status of ESL teachers from the State Department of Education showed that only about one-third of the teachers who were teaching ESL in the State of Nevada had a regular ESL Endorsement. It is a disgraceful figure, one which is tolerated in part because the students served by ESL teachers are the poor, at-risk, non-white segment of the school population which is extended little tolerance by the language-majority community. It is inconceivable that the Commission would accept a situation where two-thirds of the licensed science teachers for instance did not have a science endorsement.

Hopefully, we can find a way to translate our interlocking interests into political action at the local, state and national levels. There will be a chance for Nevada's ESL teachers to do that in September when the Commission meets in Las Vegas. There the Commission will hold the second of

two required meetings called to pass an amendment which will allow elementary teachers to receive a teaching license with a bilingual endorsement without doing an internship (student teaching) and without, of course, demonstrating any degree of competence in the children's own language (NDOE, July, 1996a). ESL teachers would be well-advised to show up in significant numbers in support of their colleagues in bilingual education.

### References

- Nevada Department of Education. (March, 1994). "NAC 391.242 Endorsement or limited endorsement to teach program of bilingual education." Carson City, NV: Superintendent of Public Instruction.
- Nevada Department of Education. (No Month, 1996). "Notice of Hearing for the Amendment and Adoption of Regulations of the Commission on Professional Standards in Education." Carson City, NV: Superintendent of Public Instruction.
- Nevada Department of Education. (July, 1996a). "Commission on Professional Standards in Education Proposed Amended Regulation: LCB File No. NAC391.098 Elementary license: Endorsement." Carson City, NV: Superintendent of Public Instruction.
- Nevada Department of Education. (July, 1996b). "Commission on Professional Standards in Education Proposed Amended Regulation: LCB File No. NAC 391.242 Endorsement or limited endorsement to teach program of bilingual education." Carson City, NV: Superintendent of Public Instruction.

*Jack Milon is an Associate Professor of English as a Second Language at the University of Nevada, Reno.*

**Editor's Note:** Contributions to the *ESL in Bilingual Education* column should be sent to Dr. Jack Milon, Department of Curriculum and Instruction/282, College of Education, University of Nevada, Reno, NV 89557-0214. Fax: (702) 784-6298, or e-mail: [jpmilon@unr.edu](mailto:jpmilon@unr.edu)



# Official-English = English-Only

## *H.R. 123 through the Eyes of a Gold Star Mother*

by Jaime A. Zapata

On September 10, seventy-three year old María Castañón, a Gold Star mother whose son lost his life in Vietnam, walked into a camera-filled room on Capitol Hill. She took several steps towards the podium, and then asked her translator to allow her to deliver all her remarks in Spanish before beginning to interpret. The room fell to an attentive hush. The woman who had traveled all the way from Corpus Christi was speaking from the heart.

She was here as an American, as a mother with several sons who served in the military and one son who made the ultimate sacrifice in the name of a nation María has called her own since birth. She was here because she understood the true impact of English-Only legislation, and she was extremely concerned.

Congress is less than three weeks from ending its 104th session, and much remains on its agenda. In fact, more than half of the fiscal year 1996 appropriations bills are still unresolved. These bills must be signed into law by the end of the fiscal year (September 30th), or government agencies will shut down. Without these funding measures, or a presidentially-approved continuing resolution (CR), key federal programs such as those under the Department of Education, will grind to a halt. Sadly, the nation's chief legislative body has chosen instead to devote its time to considering English-Only bills — legislation which is at best unnecessary and counter-productive, and at worst un-American, xenophobic, and racist.

Last month, an English-Only bill (H.R. 123), ironically dubbed "The Language Empowerment Act of 1996," was approved by the U.S. House of Representatives. María Castañón realizes all too well that this legislation would have harsh repercussions on Americans like her, and on our nation as a whole.

Mrs. Castañón's experience growing up in rural Texas was not an uncommon

one. She remembers a time when there were "white-only" restaurants, and when even the barbershops were off limits to Mexican-Americans. She also recalls that school buses in her hometown were instructed to only pick up the White children, not Mexican-American or African-American children. Since in rural Texas the schools were simply too far away to walk to, she was, in effect, denied an education.

Mrs. Castañón finished her formal schooling with a second grade education, but she never gave up. Through sheer self-determination, she used the letters she had learned in her two short years of school and taught herself how to read and write in

*"English-Only is a step backwards...back to the days when we weren't allowed on the school bus with the white students."*

Spanish. After getting married and raising a family, she decided to go back to school, to both further her education and be an example to her eight children. It was during this time, in September of 1966, that her son was killed in Vietnam. Following his death, she began experiencing health difficulties and was unable to continue her education.

Mrs. Castañón conveys her message with a clarity of purpose that seems to transcend language barriers. She is limited-English proficient, yet with the help of bilingual ballots and other information available in Spanish, she is a proud and full participant in the American electoral and political process. In Mrs. Castañón's words "the right to vote is a precious one," and she has exercised that right since the 1940's.

Like many others, this admirable woman sees the English-Only movement as "a step backwards." However, when Speaker Newt Gingrich (R-GA) made a rare appearance on the floor of the House to speak

in favor of H.R. 123, he ignored Americans like her. Instead, he referred to the English language as a key component of being "American". Other supporters argued that the bill was about "English as the official language of government" and that it would have little or no impact on private citizens. Their misguided remarks do a great dishonor to Mrs. Castañón, to the memory of her son, and to millions of minority-language Americans.

María Castañón knows that English-Only is not just symbolic as some have said and that it wrongfully portrays English as that which binds our nation together. She realizes that Americans are bound by their belief in liberty, and by the concepts embodied in our Constitution. She realizes that for over two-hundred years, Americans have drawn strength from their diversity, and kept government from regulating language. And, she sees English-Only as a very real threat.

She has only to think back to her childhood, or to that of her children — all of whom have gone on to higher education and practice professions throughout Texas. She recalls that they were chastised by their teachers for speaking in Spanish, and marvels at the short-sightedness of individuals who don't see multilingualism as the asset that it truly is. She fears that English-Only will only make it more acceptable to discriminate against language-minorities, and eventually lead our nation "back to the days when [Mexicans] weren't allowed on the school bus with the White students." And, she opposes it — with incomparable determination.

María Castañón understands that rhetoric can only hide the undeniable ugliness of English-Only. She understands that it is un-American, and she adds her voice to that of the millions who see beyond the short-sightedness, and mean spirited motivation of English-Only proponents.

Raúl Yzaguirre, President of the National Council of La Raza, stated:

*"Mrs. Castañón is a remarkable woman but her story is*



# NABE PRODUCTS ORDER FORM

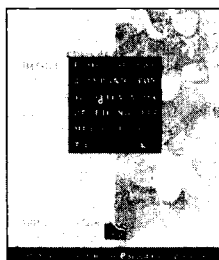
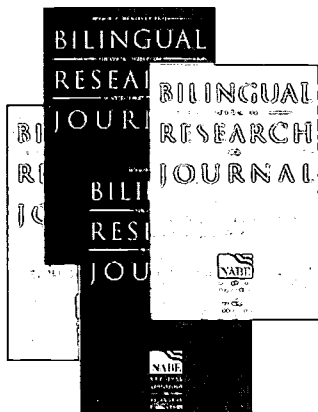

ITEM	PRICE	#	TOTAL
<b><i>Bilingual Research Journal</i></b>	\$13.00		
Vol. 19, #3&4, Spring/Summer 1995 Special issue: Role of ESL in Bilingual Education			
Vol. 19, #1, Fall 1994 Special issue: Native American Issues			
Vol. 16, #1&2, Spring/Summer 1995 Special issue: Ramirez study			
[earlier issues available (call for details)]			
<b><i>NABE Annual Conference Journal</i></b>	\$7.00		
1989-90 issue			
1991-92 issue			
1993-94 issue			
<b><i>1996 Annual Conference Program</i></b>	\$5.00		
<b><i>NABE News</i></b>	\$5.00		
write issue date or volume/number here			
write issue date or volume/number here			
write issue date or volume/number here			
[current volume always available; earlier issues may also be available (call for specifics)]			
<b><i>Professional Standards for the Preparation of Bilingual/Multicultural Education Teachers</i></b>	\$5.00		
<b>NABE logo pins</b>	\$5.00		
<b>NABE canvas tote bags</b>	\$7.00		
<b>VIDEO: Making Connections: Learning, Language and Technology</b>	\$7.00		
<b>TOTAL</b>			

- Prices include shipping by USPS first class mail. Special shipping available - call for pricing.
- Payment must accompany all orders. Make checks and purchase orders payable to NABE.
- Credit card orders may also be placed by phone (202 - 898-1829) during business hours.

## SHIPPING INFORMATION

Name \_\_\_\_\_ Company \_\_\_\_\_

Address \_\_\_\_\_

City/State/Zip \_\_\_\_\_ Phone \_\_\_\_\_

## PAYMENT INFORMATION

Check#: \_\_\_\_\_ PO#: \_\_\_\_\_ CC#: \_\_\_\_\_ ExpDate: \_\_\_\_\_

MAIL TO: NABE PRODUCTS, Suite 605, 1220 L Street NW, Washington, DC 20005-4018

# Parental Involvement

Column Editor: Aurelio Montemayor, M.Ed., Intercultural Development Research Associates, TX

## *Valuing Parents: Preaching to the Choir?*

*by Aurelio M. Montemayor, M.Ed.*

The Valuing Paradigm has been part of IDRA's philosophy since its inception and it permeates the concepts of bilingual education that NABE encourages and defends. The term "valuing" is a somewhat-clunky-but-useful antonym to "deficit" as used, for example, in the Coca-Cola Valued Youth Program. The word expresses a paradigm of unlimited high regard for both children and adults. The "valuing" concept undergirds the best of what we observe in bilingual classrooms.

Valuing assumes tremendous potential. Applied to adults it means parents want the best for their children in education, career choices, and future economic security. They want happiness and tranquility; they want to be viewed as capable and intelligent, regardless of background, educational experiences and economic status. Most parents will do what is best for their children, if given the information they need and if treated with dignity and worth. A teacher with high expectations for all her students will neither despair if some fail to meet the expected standards, nor lose the unlimited high regard because some are less than good students. Likewise, the person working with parents will not lose the fundamental valuing because some parents don't follow up on some agreed-upon task. Valuing doesn't assume or expect perfection. The reality, that some people do not act in their their children's best interests, is dealt with as it is experienced and observed. These assumptions are not new or foreign to the NABE family; but the point to be made is that we can encounter teachers and educators within our own ranks who unconsciously act out of negative assumptions when relating to the adult population who speaks a language other than English. We might have some choir members who agree with our valuing model towards adults. Our stand was and continues to be: the message

cannot prejudice the public against the population we wish to serve. We ultimately produced materials that met our positive philosophy and are effective media messages. It was instructive once more to see that creating materials that give dignity, worth, and positive value to persons depicted in media is not an easy task. Vigilance and persistence are required. The choir we think we are preaching to might not be totally of the same faith, as highlighted in the next example.

### **A Teacher's Conference: Parents as Allies or Threats?**

Picture the context: A group of bilingual parents presenting to a group of bilingual educators and advocates about a bilingual education conference for parents by parents. As part of the PR for the conference, and as a tool for parent leadership training, a group of parents presented at the local bilingual association's spring conference. Most attendees were teachers and the parents' session was well-attended. The parents presented the rationale for an educational conference for parents by parents and took turns reviewing the topics and process of the planned conference. Two of the participants took issue with the presenters because some of the topics referred to situations where children need the parents to be strong advocates. One teacher told the parents that teachers had a difficult time, too. Another administrator was seriously bothered that there were topics on the agenda that seemed to be critical of the schools and some teachers. He asked, "What is this program for, anyway?" Several members of the audience jumped to the parents' defense. One teacher responded that it was high time that parents were organizing themselves and learning about more aggressive advocacy for their children. The audience was overwhelmingly on the parents' side. What the incident pointed out was that some people will go along with a positive view of parents only as long as they stay within certain bounds and stick to particular top-

ics. These parents, who were presenting, trembling and drenched in nervous perspiration, were just trying out their fledgling wings in saying that things were less than perfect in their children's schools. They had experienced excessive reactions from some teachers and principals when they had gone to discuss problems their children were having in school. This spurred them to have some of those same issues discussed at their conference. These parents and the teachers are not inherently antagonists. The whole community needs to join in the efforts to create excellent schools. Yet it was difficult for those two bilingual educators to see it and empathize with these parents. They felt threatened and attacked. The unlimited high regard can go out the window when we feel our institutional or professional allegiance challenged.

### **A Prayer: Freedom Through Validation, Not Shaming**

More pernicious, because less obvious, was what happened at the conference itself. There were two incidents: one minor, that maybe only I would take notice of, the other much larger. The prayer offered by a parent at the beginning of the conference was a poem that hinged on the guilt of the listener for not spending enough time in prayer and religious activity. It ended with protagonist not allowed into heaven because he hadn't had enough time for "prayerful activity" and so now the one to let him in didn't have the time to open the pearly gates. I have no desire to impinge on anyone's religious beliefs, but would have preferred a prayer, if there was to be one, that would empower and uplift the group, rather than push guilt buttons — the archetypical deficit view of humans as sinners.

### **A Speech: Responsibility Good — Guilt Bad**

A greater problem was a major speaker who made a charming, engaging, humor-

CONTINUED ON PAGE 25

competency and achievement for promotion or graduation. Teachers in this country are among the most talented professionals we have. They should be required to meet high standards for professional performance and be rewarded for the good jobs they do. For the few who don't measure up to those high standards, there should be a fair process to get them out of the classroom and out of the profession. And we should get rid of the barriers that discourage talented young people from becoming teachers in the first place. We should not bash teachers. We should applaud them, and find ways to keep the best teachers in the classroom. Schools should be held accountable for results. We should redesign or overhaul schools that fail. We should expand public school choice, but we should not take American tax dollars from public schools and give them to private schools. We should promote public charter schools that are held to the highest standards of accountability and access. And we should continue to ensure that America provides quality education to children with disabilities, because high-quality public education is the key to opportunity for all children.

*Teaching values in schools.* Today's Democratic Party knows our children's education is not complete unless they learn good values. We applaud the efforts of the Clinton-Gore Administration to promote character education in our schools. Teaching good values, strong character, and the responsibilities of citizenship must be an essential part of American education.

*Safe schools and healthy students.* If young people do not have the freedom to learn in safety, they do not have the freedom to learn at all. Over the last four years, we have worked hard to keep schools safe and drug-free, and students healthy. When Senator Dole and Speaker Gingrich led Republican efforts to cut school safety funding, President Clinton and Democrats in Congress wouldn't let them get away with it. When Senator Dole and Speaker Gingrich led Republican efforts to destroy the nation's school lunch program, President Clinton and Democrats in Congress stopped them cold. Now, we must work together at every level of government to launch a major rebuilding effort to make sure our children go to school in high-quality facilities where they can learn. We must help schools set the highest standards for good behavior and discipline in our schools. Children cannot learn — and teachers cannot teach — without order in the classroom.

*Technology in the classroom.* We must bring the 21st century into every classroom in America. There is a vast realm of knowledge waiting for our children to tap into. Computers are powerful tools to teach students to read better, write better, and understand math. President Clinton and Vice President Gore understand that technological literacy is essential to success in the new economy. The only way to achieve that for every student is to give them all access to a computer, good software, trained teachers, and the Internet — and Clinton and Gore have launched a partnership with high-tech companies, schools, state, and local governments to wire every classroom and library to the Information Superhighway by the year 2000.

*Preparing students for jobs.* We passed School-to-Work so young people can learn the skills they need to get and keep high wage jobs. The Republican Congress is trying to destroy it, and we pledge to stop them. We want to keep working with the private sector, to encourage community partnerships that build the bridge between a good education and a good job.

*Higher education for all Americans.* Finally, we must make sure that every American has the opportunity to go to college. Higher education is the key to a successful future in the 21st century. The typical worker with a college education earns 73 percent more than

CONTINUED ON PAGE 25

the last thirty years. It's discipline, parental involvement, emphasis on basics including computer technology, phonics instead of look-say reading, and dedicated teaching.

Abstinence education in the home will lead to less need for birth control services and fewer abortions. We support educational initiatives to promote chastity until marriage as the expected standard of behavior. This education initiative is the best preventive measure to avoid the emotional trauma of sexually-transmitted diseases and teen pregnancies that are serious problems among our young people. While recognizing that something must be done to help children when parental consent or supervision is not possible, we oppose school-based clinics, which provide referrals, counseling, and related services for contraception and abortion.

We encourage a reform agenda on the local level and urge State legislators to ensure quality education for all through programs of parental choice among public, private, and religious schools. That includes the option of home schooling, and Republicans will defend the right of families to make that choice. We support and vigorously work for mechanisms, such as opportunity scholarships, block grants, school rebates, charter schools, and vouchers, to make parental choice in education a reality for all parents.

On the federal level, we endorse legislation - like the Watts-Talent Low-Income Educational Opportunity Act, which is part of the Community Renewal Act of 1996, and the Coats-Kasich Educational Choice and Equity Act - to set up model programs for empowering the families who need good schooling the most.

We will continue to work for the return of voluntary prayer to our schools and will strongly enforce the Republican legislation that guarantees equal access to school facilities by student religious groups. We encourage State legislatures to pass statutes which prohibit local school boards from adopting policies of denial regarding voluntary school prayer.

We endorse Bob Dole's pledge that all federal education policies will be guided by his Education Consumers Warranty. The Education Consumer's Warranty says that all American children should expect to:

- attend a safe school;
- be free from educational malpractice at the hands of bad schools, incompetent teachers, timid principals, and intrusive bureaucrats;
- find out exactly how well they and their school are doing (in terms of achievement) in relation to how well they ought to be doing;
- learn the three R's through proven methods;
- learn the nation's history and democratic values and study the classics of western civilization;
- attend a school that is free to innovate and isn't tied down by federal red tape;
- be confident that their high school diploma signifies a solid education, suitable for college or a good job;
- choose the school that's right for them;
- know that their tax dollars are reaching the classroom, not being siphoned off into overhead and bureaucracy; and,
- count on being able to arrive at college prepared to do freshman-level work.

To reinforce our American heritage, we believe our nation's Governors, State legislators, and local school boards should support requiring our public schools to dedicate one full day each year solely to studying the Declaration of Independence and the Constitution.

America's families find themselves on a college treadmill: the

CONTINUED ON PAGE 22

# Why José Can't Read Very Well

by Pat Temple

When I hear people proclaim that Hispanic and other language-minority children should be put in a class with native speakers and learn to read in English, or when I hear politicians imply that bilingual education's only reason for existence is to foster ethnic pride and provide therapy for low self-esteem, I am appalled.

I think back to the time when my own children were young and the long discussions we parents had about whether they were ready to start school. We all knew the importance of their first year. We didn't want our children placed in a low group because we feared they would be less challenged. Once children were enrolled there, they might be trapped forever.

Nor did we want to risk the chance that they might think of themselves as somehow inferior to the children placed above them, to hate or become indifferent to school, or even worse, to give up because school just didn't interest them.

We wanted them to excel, to start their learning years as confident students able and eager to complete. We worked hard to help our children develop physically, emotionally, and socially because we realized that the self-concept they developed in that first year would set the stage for all their future years.

Developing a wide range of background knowledge as well as acquiring abundant oral language was an important part of the readiness we were building. We worked hard to get them ready, and if we doubted their readiness many of us waited an extra year to enroll them.

We refused to let our children fail.

There is a stark contrast between this protective nurturing and the cold stance of "English Only" supporters who advocate placing young children in a classroom where they don't even understand the language.

Because they do not understand the language they cannot be successful beginning readers, and because we are forcing them to process content-area information in a language they do not understand they will fall behind in science, social studies, and problem-solving as well. They will see other children doing well, and they will think that they are inferior to them.

But these children are ready to learn. It's just that they are not ready in English; they are ready in their first language. If we insist that they sit in English language classrooms, we place them at a disadvantageous position from which they will likely never recover: we are denying them the learning for which they are ready.

At the same time we do our own English-speaking children a disservice by falsely teaching them that they are superior to these language-minority children; not a very good mind-set for building a fair and just society where all our citizens, regardless of their native language, have an equal chance at the "American dream."

Reading is a complex skill. We all know that it is much more than just decoding words. "No two people ever read the same page," "You never read the same book twice" and similar adages point up the fact that each person brings a different set of experi-

ences and beliefs to the reading table, and each combines what they already know, their feeling and opinions with what the author has written to gain new knowledge.

Each reader will comprehend a little differently because each reader starts with her own personal readiness for reading. The more "ready" a student is, the more layers of relevant information she can access in her own mind, and the greater will be her comprehension.

Try reading this paragraph and you will see what I mean:

*With the development of ion-exchange and solvent extraction techniques the availability of rare-earth metals has improved. Seventeen isotopes of gadolinium are now recognized. It can be prepared by the reduction of the anhydrous fluoride with metallic calcium. It has a metallic luster and is malleable and ductile. At room temperature, gadolinium crystallizes in the hexagonal close-packed form.*

Unless you are already a pretty knowledgeable chemist, it didn't mean much to you. That is because the chemist has the background knowledge to understand it. Most readers are not chemists, and so do not. In order to comprehend a passage, the reader must already have a pretty good idea of what the passage is about. Smart teachers understand this; that is why they focus so much of their reading lesson on the pre-read part.

Fortunately for English readers our written language is extremely redundant. If a child misses one clue to identify a word, she still has many chances to be successful by picking up on others. This passage about our nation's Civil War should give you an idea of what this means.

*Pr\_sidnt L\_nc\_\_n was our nation's pr\_s\_d\_nt during the C\_vil \_\_. M\_\_ny men died in bat\_l\_. Fin\_\_ly the N\_\_th d\_fe\_t\_\_ the S\_\_th. At l\_\_st the sl\_ves w\_re fr\_\_*

Because of our acquired knowledge of language, spelling and American history -- knowledge which language-minority children may not have -- reading this is easy for us, but not for them.

Phonics clues are helpful for decoding. For example when an English-speaking child discovers that "ow" can sound like the "ow" in "cow" or like "ow" in "slow," she can use that information to decode all "ow" words. When she sees "A crow sat on the fence," she can try one pronunciation and if need be, the other until the sentence has meaning for her.

For children who do not have command of the language, pronouncing the word correctly is a useless task. Decoding must bring meaning in order to be value to the reader.

Many textbook lessons focus on using context plus consonants to decode new words. For instance, a child who reads the new word "troop" in the sentence, "She spoke to the Boy Scout troop." would note the consonants "tr" and "p," and then, thinking through the words that s/he knew with "tr\_p" spelling, could conclude that the word must be "troop."

A second language learner who does not have access in his own mind to very much vocabulary, obviously can not benefit from this technique.

CONTINUED ON PAGE 12

*If you need equitable assessments for Spanish-speaking individuals, you need Bateria-R*

*Test cognitive abilities in Spanish*

# BATERIA-R

**Woodcock-Muñoz Pruebas de habilidad cognitiva-Revisada**

**A**s a psychologist, you know that valid and reliable assessment of Spanish-speaking individuals is a key civil rights and educational issue.

The first step in bringing equity to assessment of Spanish-speaking individuals is the Bateria Woodcock-Muñoz Pruebas de habilidad cognitiva-Revisada

Now have all of the features of the Woodcock-Johnson-Revised Tests of Cognitive Ability in Spanish:

- Measure 7 distinct cognitive abilities: Long-Term Retrieval, Short-Term Memory, Processing Speed, Auditory Processing, Visual Processing, Comprehension-Knowledge, Fluid Reasoning, Quantitative Processing
- Measure Oral Language
- Measure 5 differential aptitudes: Reading, Mathematics, Written Language, Knowledge, Oral Language
- Determine intra-cognitive discrepancies and aptitude/achievement or intra-achievement discrepancies when used with the Bateria-R Tests of Achievement (in press).
- Nationally recognized author team: Dr. Richard W. Woodcock and Dr. Ana F. Muñoz-Sandoval

The Bateria-R is being developed to provide you with a conormed test of ability and achievement specifically designed for use with Spanish-speaking subjects ages 2 to 90+. Bateria Woodcock-Muñoz Pruebas de habilidad cognitiva-Revisada

**For more information, phone 1.800.323.9540**

**Riverside Publishing**  
A HOUGHTON MIFFLIN COMPANY

Copyright © 1996 by The Riverside Publishing Company. All rights reserved.

Books for young readers usually have an abundance of picture so that they can be used as clues to decoding. How will picture of a little girl crying help them decode "The little girl was lost." if for them a little girl is a "muchacha" and to be lost is "estar perdida?"

Prior knowledge of word order benefits native English readers. If a child sees sentence that begins with "The,"s/he knows intuitively that the next word will probably be a noun or possibly an adjective. The child can then focus on the picture or use context clues to help decode the words that follows.

Repetition in children's books is often used to ease decoding. Currently "Big Books"— oversized books that a teacher can hold up for all the class to read together — as well as folk tales all employ a lot of repetition to aid with reading. In the classroom the relief new readers feel when they come to the repetitive part of a story is almost palpable. It represents a break from the hard task of decoding word by word. Listen to how much louder children will sing the chorus than the stanzas of a song to truly appreciate how helpful repetition is. But this provides little help for the students who doesn't know what the words they are repeating mean.

Rhyming provides another helpful clue for native English readers. From my own classroom experience I can testify that in the order of acquiring second language skills, rhyming is one of the last to be accomplished. It is an advanced language skill and not available to second language beginner readers.

Early second language learners pick up a lot of phrases that are useful to them. At the same time they have no idea of how to separate these phrases into individual words. This makes for difficult decoding.

Evidence of this can be seen in their written work. For example, in a class of 4th and 5th grade Hispanic children I found these variant spellings for "Once upon a time:"

- "Unes supana time,"
- "Wons opon a time,"
- "Onec pat a time," and
- "One so ponet time."

For young non-native English-speaking children, learning to read in English is a Herculean if not impossible task. It is an inefficient and cruel task to force on them , and content area learning is sacrificed as part of the process.

On the other hand, much current research shows that reading skills learned in the first learned in the first language easily transfer to English when the child is ready. Could anyone doubt the advantages of learning to read and keeping up the content-area skills in the first language until enough English is acquired to transition? There is an additional bonus in that the children will end up literate in two languages.

The children should be taught to read in their first language because that is the language they are ready to read in. It is the best way to rebuild successfully readers.

It has nothing to do with building language-minority children's self-esteem; it has everything to do with preventing its destruction.

*Pat Temple is a fifth grade bilingual education teacher at Brady School in Aurora, Illinois.*

**• BILINGUAL RESOURCES • ART ACTIVITIES • ASSESSMENT •**

*Imagine...*

*bringing the woodcarvers of Oaxaca, the yarn painters of the Sierra Madres, and the weavers of Guatemala to your classroom!*



**Let CRIZMAC's bilingual resources bring the art and culture of the world to you.**

Call **1-800-913-8555** today to place your order.  
For your free catalog, call or write to  
**CRIZMAC Art & Cultural Education Materials**  
P.O. Box 65928 • Tucson, AZ 85728-5928

**• COMPUTER SOFTWARE • DISCUSSION QUESTIONS • FOLK ART •**

STUDENT BOOKLETS • TEACHER GUIDES • GAMES • TEACHING BOARDS • PUPPETS

LESSON PLANS • LANGUAGE ARTS • MAPS • POSTERS • VHS PROGRAMS • TIMELINES

# NABE 1997

## BILINGUAL TEACHER OF THE YEAR CONTEST

**INTRODUCTION:** In recognition of the efforts that bilingual classroom teachers make on behalf of linguistic-minority students, the National Association for Bilingual Education (NABE) established the *Bilingual Teacher of the Year Competition*. Each year, NABE and its affiliate organizations honor an outstanding bilingual teacher nominated by one of the NABE affiliates.

**AWARD:** The winner of NABE's 1997 Bilingual Teacher of the Year competition will receive a \$2,500 scholarship to further his/her education and/or to use for the students in his/her class. In addition, the winner will be flown to the 1997 NABE Conference in Albuquerque, New Mexico, to receive his/her award.

**NOMINATIONS:** Only NABE affiliates in good standing are eligible to nominate candidates. Nominations should be made and the winner will be chosen without regard to age, sex, race, national origin, handicapping conditions, or religion. Affiliates may use any method they choose for selecting candidates. Each affiliate may nominate only one candidate. The candidate must be a current NABE member in good standing and a current member of the NABE affiliate. Nominations which do not comply with these requirements will not be considered.

**QUALIFICATIONS:** Candidates must be exceptionally skilled and dedicated teachers in a bilingual program for pre-Kindergarten through grade twelve. Only bilingual classroom teachers who work full-time with students and have at least three years of experience qualify. Candidates must have distinguished themselves as leaders and outstanding teachers. Candidates should enjoy the respect and admiration of students, parents, and co-workers. They should play active and useful roles in their communities as well as in their schools. Finally, candidates should be poised and articulate and willing and able to grant public interviews and make presentations. He/she should be fluently bilingual. The most important qualification to consider is the candidate's proven ability to inspire limited English proficient students of various backgrounds and abilities to excel.

**PRESENTATION OF MATERIALS:** As part of the nomination process, the NABE affiliate is responsible for submitting a portfolio of materials for their candidate to be used by the selection committee in its deliberations. Material should be typed, double-spaced, and each section should be a maximum of four pages. Videos are acceptable as supplementary material, provided that six copies of the video are submitted. All materials become property of NABE and will not be returned. **Six (6) complete copies** of the following materials with no more than 24 total pages (in each copy) must be submitted:

- ◆ **Nomination Information** - a cover letter signed by a NABE affiliate officer and the attached Data Sheet providing basic information about the candidate.
- ◆ **Biographical Sketch** - a 4-page (maximum) narrative prepared by the teacher describing his/her formative environment and specific events or experiences leading to his/her involvement in education, particularly in bilingual education.
- ◆ **Photograph** - a photograph of the candidate (preferably 5" x 7" glossy black and white) must be submitted for publication in program. In addition, a minimum of three photographs of the teacher's classroom should be submitted.
- ◆ **Philosophy of Education** - a 4-page (maximum) statement by the candidate reflecting his/her commitment to the profession including a description of the candidate's educational values and belief in the effectiveness of bilingual education.
- ◆ **Professional Development** - a 4-page (maximum) description of the candidate's academic preparation and participation in professional organizations and service committees, commissions, task forces, workshops and conferences, etc.
- ◆ **Community Service** - a 4-page (maximum) description of the candidate's participation in organizations as well as personal efforts to improve education and social conditions of the community.
- ◆ **Recommendations** - One letter of recommendation from the teacher's immediate supervisor and a maximum of five (5) other letters of recommendation.

**DEADLINE:** All nominations must be **RECEIVED** by **November 1, 1996** at the address listed below. The winner will be notified by January 1, 1997. For additional information, contact:

Dr. Nancy F. Zelasko  
Deputy Director and Conference Coordinator  
National Association for Bilingual Education  
1220 L Street, NW -- Suite 605  
Washington, DC 20005-4018

15

NABE 1997 DATA SHEET  
BILINGUAL TEACHER OF THE YEAR/  
BILINGUAL INSTRUCTIONAL ASSISTANT OF THE YEAR

**Indicate Competition:** \_\_\_\_\_ Teacher of the Year \_\_\_\_\_ Instructional Assistant of the Year

**Name:** \_\_\_\_\_ **NABE Membership ID #:** \_\_\_\_\_

**Position/Title:** \_\_\_\_\_

**Years in Present Position:** \_\_\_\_\_ **Grade Level(s):** \_\_\_\_\_

**Languages Spoken:** \_\_\_\_\_

**Name of School:** \_\_\_\_\_

**School Address:** \_\_\_\_\_

**School Telephone Number:** \_\_\_\_\_ **School Fax Number:** \_\_\_\_\_

**Name of School Principal:** \_\_\_\_\_

**Home Address:** \_\_\_\_\_

\_\_\_\_\_ **Home Telephone Number:** \_\_\_\_\_

**Previous Work Experience:** \_\_\_\_\_

**Summary of Academic Training/Preparation**

Dates	Institution Name & Address	Degree/Certificate Earned
_____	_____	_____
_____	_____	_____
_____	_____	_____

**I hereby give my permission for any or all materials submitted by me for consideration for the Bilingual Teacher of the Year/Bilingual Instructional assistant of the Year Award to be shared with persons involved in promoting this award:**

\_\_\_\_\_ (Signature of Candidate)



## NABE 1997

# BILINGUAL INSTRUCTIONAL ASSISTANT OF THE YEAR CONTEST

**INTRODUCTION:** In recognition of the significant role that instructional assistants play in the education of linguistic-minority students, the National Association for Bilingual Education (NABE) established the *Bilingual Instructional Assistant of the Year Competition*. Each year NABE and its affiliate organizations honor an outstanding bilingual instructional assistant nominated by one of the NABE affiliates.

**AWARD:** The winner of NABE's 1997 Bilingual Instructional Assistant of the Year competition will receive a \$2,500 scholarship to further his/her education, and will be flown to the 1997 NABE Conference in Albuquerque, New Mexico to receive his/her award.

**NOMINATIONS:** **Only NABE affiliates in good standing are eligible to nominate candidates.** Nominations should be made and the winner will be chosen without regard to age, sex, race, national origin, handicapping conditions, or religion. Affiliates may use any method they choose for selecting candidates. Each affiliate may nominate only one candidate. The candidate must be a current NABE member in good standing and a current member of the NABE affiliate.

**QUALIFICATIONS:** Candidates must be exceptionally skilled and dedicated instructional assistants in a bilingual program for pre-Kindergarten through grade twelve. Only instructional assistants who work half-time or more with students and have at least three years of experience qualify. Candidates must be fluently bilingual. Nominees should also be participating in, or planning to participate in, a professional development program including one leading to certification as a bilingual teacher. The most important qualification, however, is the candidate's proven ability to inspire bilingual children to excel.

**PRESENTATION OF MATERIALS:** As part of the nomination process, the NABE affiliate is responsible for submitting a portfolio of materials for their candidate to be used by the selection committee in its deliberations. Material should be typed, double-spaced, and each section should be a maximum of four pages. Videos are acceptable as supplementary material, provided that six copies of the video are submitted. All materials become property of NABE and will not be returned. **Six (6) complete copies** of the following materials with no more than 24 total pages (in each copy) must be submitted:

- ◆ **Nomination Information** - a cover letter signed by a NABE affiliate officer and the attached Data Sheet providing basic information about the candidate.
- ◆ **Biographical Sketch** - a 4-page (maximum) narrative prepared by the teacher describing his/her formative environment and specific events or experiences leading to his/her involvement in education, particularly in bilingual education.
- ◆ **Photograph** - a photograph of the candidate (preferably 5" x 7" glossy black and white) must be submitted for publication in program. In addition, a minimum of three photographs of the instructional assistant's classroom should be submitted.
- ◆ **Philosophy of Education** - a 4-page (maximum) statement by the candidate reflecting his/her commitment to the profession including a description of the candidate's educational values and belief in the effectiveness of bilingual education.
- ◆ **Professional Development** - a 4-page (maximum) statement of the candidate's academic preparation and plans to advance his/her educational goals, including a information about the professional development program he/she is presently enrolled in or would enroll in if chosen as the recipient of NABE's Instructional Assistant of the Year Award. There should also be a description of the candidate's participation in professional organizations, service committees, commissions, task forces, workshops and conferences.
- ◆ **Community Service** - a 4-page (maximum) description of the candidate's participation in organizations as well as personal efforts to improve education and social conditions of the community.
- ◆ **Recommendations** - One letter of recommendation from the instructional assistant's immediate supervisor and a maximum of five (5) other letters of recommendation.

**DEADLINE:** All nominations must be **RECEIVED** by **November 1, 1996** at the address listed below. The winner will be notified by January 1, 1997. For additional information, contact:

Dr. Nancy F. Zelasko  
Deputy Director and Conference Coordinator  
National Association for Bilingual Education  
1220 L Street, NW -- Suite 605  
Washington, DC 20005-4018

# Upcoming Events

**October 2-4, 1996 - National Puerto Rican Coalition, Inc. 16th Annual Conference.** Washington, DC. Contact (202) 223-3915.

**October 10-12, 1996 Colorado Association for Bilingual Education Annual Conference. "Working Together, Learning Together"** Breckenridge Hilton, Breckenridge, CO. Contact Annette Gaddis (303) 556-5044.

**October 18, 1996 - Puerto Rican Legal Defense and Education Fund. 14th Annual Awards Banquet.** Plaza Hotel, New York, NY. Contact (800) 328-2322.

**October 23-25, 1996 - Border Walking: A Bilingual Special Education Conference.** New Mexico State University's Borderlands Center for Educational Studies. Holiday Inn de Las Cruces, Las Cruces, NM. Contact (505) 646-5973.

**October 25-28, 1996 - The Second Language Research Forum.** Tucson, AZ. Contact SLRF96@ccit.arizona.edu.

**October 26-29, 1996 - Hispanic Association of Colleges and Universities's 10th Annual Meeting.** JW Marriott Hotel, Washington, DC. Contact HACU's National Headquarters at (210) 692-3805.

**October 27-29, 1996 - Tri-Country Conference of Translators' Associations.** Marriott Colorado Springs Hotel, Colorado Springs, CO. Contact American Translators Association at (703) 683-6100.

**October 30-November 3, 1996 - American Translators Association's 37th Annual Conference.** Broadmoor Hotel, Colorado Springs, CO. Contact American Translators Association at (703) 683-6100.

**November 6-10, 1996 - The National Association for Multicultural Education's 6th Annual Conference.** Roseville, MN. Contact Carolyn O'Grady at (612) 638-9432.

**November 13-16, 1996 - 24th Annual Texas Association for Bilingual Education Conference. "Bilingual Education:**

**A Multicultural Vision for the New Millenium."** Fort Worth Convention Center, Fort Worth, Texas. Contact TABE at (888) 255-4875.

**December 8-11, 1996 - International Early Childhood Conference on Children with Special Needs.** Hyatt Regency and Phoenix Civic Plaza, Phoenix, AZ. Contact Division of Early Childhood, Council for Exceptional Children at (410) 269-6801.

« NABE »

## Special Event?

Mail or fax event announcements to the attention of Editor, NABE NEWS or send by e-mail to NABE\_NEWS@nabe.org. Events may be listed once free of charge.

## NABE '97: Building Learning Communities through Technology, Language and Culture

Albuquerque Convention Center, Albuquerque, New Mexico

February 4th through February 8th, 1997

### Preliminary Schedule of Events

	Monday 2/3	Tuesday 2/4	Wednesday 2/5	Thursday 2/6	Friday 2/7	Saturday 2/8
MORNING		OBEMLA Institute	School Visits OBEMLA Institute	School Visits Presentations Keynote Exhibits	School Visits Presentations Keynote Exhibits	Community Day Activities Presentations Keynote Exhibits
AFTERNOON		OBEMLA Institute	NABE Intensive Sessions OBEMLA Institute	Presentations Exhibits Institutes Special Interest Group Meetings	Presentations Awards Luncheon Exhibits Institutes Special Interest Group Meetings	Presentations Community Day Activities Exhibits Institutes
EVENING	Registration Open (5 - 8 pm)	Registration	Keynote and Opening Ceremonies	Cultural Event	Cultural Event	Annual Banquet and Dance

# Asian/Pacific American Education Concerns

Column Editors: Ji-Mei Chang, San Jose State University, CA, and  
Janet Y.H. Lu, ARC Associates, Inc., Oakland, CA

## *Foreign-Language Schools: Aid or Hindrance to the Americanization Process?*

by Alan R. Shoho

In recent years foreign-language schools have experienced a revival in America. The primary reasons for the renaissance of foreign-language schools has been the immigration of new ethnic groups (e.g., Ukrainians and other former Soviet Union ethnic groups, Pacific Islanders such as Filipinos, and Southeast Asian groups such as Laotian Hmongs, Vietnamese, and Cambodians) and foreign corporations who relocate employees and their families to America.

At same time as foreign-language schools are growing, public schools are struggling to create an educational environment conducive for immigrant and foreign-country children. Adding fuel to this debate is the resurrection of an Americanization movement that occurred in the 1920's and 1930's. These concurrent events have created political and social turmoil (through ballot measures like Proposition 187 in California and English-Only measures in numerous states) that threaten to further divide America. This study attempts to shed light on the 1990's Americanization movement by examining the experiences of Japanese-American students in Hawaii during the 1930's as they attended public and Japanese-language schools concurrently.

From 1885 until 1924, when the Immigration Quota Act of 1924 — more commonly known as the "Japanese Exclusion Act" — was enacted, Japanese laborers arrived and eventually settled as immigrants in Hawaii and the mainland United States. The establishment of Japanese-language schools in Hawaii were directly linked to Japanese immigration. These schools were built in communities throughout the territory to meet the needs of Japanese immigrants and their children.

In the aftermath of World War I, Japa-

nese-language schools in Hawaii were embedded in controversy. The controversy was accentuated by the Americanization movement sweeping across America. Japanese-language schools were perceived as breeding grounds for anti-American values. This perception was grounded by the public's fear of anticipated conflicts with Japan, and the lack of understanding by the general public to the social value given to the Japanese-language schools by its clientele. During the 1920's and 1930's, one of the primary goals of Hawaii's public schools was to promote the Americanization of "Niseis" (first generation born in America and thus, American citizens by birthright). To effectively Americanize children of Japanese immigrants, public schools were asked to ingrain American values (based on the Anglo conformity theory) as a measure of social control (Shoho, 1990). The sociocultural implications of the Americanization movement meant that children of immigrants had to unquestionably accept American customs at the expense of their ancestral customs (Carlson, 1987). As a result of the campaign, the general public became increasingly suspicious of Japanese-language schools and their agenda. This apprehension led to the perception that Japanese-language schools were hindering the Americanization of Japanese-Americans.

### **Methodology**

An oral history case study approach was used to examine the influence of Japanese-language schools on the Americanization of Niseis in Hawaii. The primary data gathering method for this study was the collection of oral testimonies from study participants. The oral testimonies were initiated using a semi-structured interview schedule designed to gather information from study participants about their educational experiences at Japanese-language school. Interviews were transcribed

and member checked for accuracy and reflection. Another primary data source involved the examination of historical documents such as government reports and Territorial Department of Public Instruction documents.

### **Participants**

There were 60 study participants (26 females and 34 males) involved in this study. All participants were Niseis who were educated in Hawaiian public schools and attended Japanese-language schools. Ages ranged from 61 to 80 years, with the average age being 70. The average length of attendance for study participants at a Japanese-language school was 8 years.

### **Data Analysis**

To analyze the data gathered from study participants and historical documents, the constant comparative approach was used to generate "theory" (Glaser & Strauss, 1967). The constant comparative approach involves analyzing data, formulating categories and recognizing patterns, making preliminary interpretations and constantly refining those interpretations throughout the study. To the extent possible, the results of the data analysis were verified by key informant study participants and triangulated with other data sources (such as Territorial Department of Public Instruction and Japanese-language school records). Using Erickson's frame of qualitative data analysis, the purpose of the data analysis was to "generate empirical assertions largely through induction" and to establish an "evidentiary warrant" for systematically examining and confirming, as well as disconfirming, data and analyzing negative cases (Erickson, 1986). The data analysis advanced through multiple stages until identified categories became "theoretically saturated" (Strauss, 1987).

CONTINUED ON PAGE 18

### Findings

In general, the research findings indicate that Japanese-language schools in the 1930's enhanced the Americanization of Niseis. There was no evidence to support the assertion that learning the Japanese language and its associated cultural traits predisposed its students to anti-American attitudes or behaviors. On the contrary, the intrinsic value of the Japanese-language school extended beyond language instruction and cultural appreciation. Students learned ethics and values for good citizenship (which were consistent with American societal and family norms). The findings are discussed in two sections addressing the Japanese-language school's effect on the Americanization process, and its curriculum and instruction.

### Effect on Americanization Process

Based on the evidence provided by study participants and by historical documents, Japanese-language schools played an invaluable role in the Americanization process. The value of Japanese-language schools was illustrated by study participants who claimed that if students were not good citizens at home, they could not become good American citizens. Attendance aided the Americanization process by creating a home environment which minimized misunderstandings resulting from a lack of communication, due to a common medium between parent and child. Japanese-language schools actually facilitated the Americanization process by incorporating lessons consistent with American values. Lessons in "shushin" (ethics), filial piety, and "on" (an obligation incurred which is repaid) equipped students with the necessary means for the responsibilities associated with American citizenship (Shoho, 1990). The following comments by study participants illustrate the contribution of Japanese-language schools to the Americanization of Niseis:

*I think it [Japanese-language school] facilitated [Americanization]. They stressed law abiding, respect of elders, and even going through college. . . Obey the law, respect the law, be industrious, try your best, a lot of initiative, help your boss all you can, etc. — these are*

*all Japanese things that we never had in English school. I can't think of Japanese courses without a lot of different points — morals, etc.*

*It [Japanese-language school] facilitated [Americanization]. In Japanese school they taught us values that are applicable in any situation. It was basically to learn the Japanese language, but it wasn't to teach Japanese history as we see Japanese history. The home was the central unit, and our lessons used to revolve around that.*

Along with the positive views of study participants previously cited, another piece of evidence was found in a 1930 Hawaii Department of Public Instruction subcommittee report on foreign-language schools. Japanese-language schools were cited as:

*. . . performing an important and useful function: They constitute a bridge between two cultures, and enable Hawaii's youth of Oriental parentage to continue in a knowledge of the language of their parents. This will be increasingly important as commercial and other contacts increase between the Orient and America. It is important that the influence of these schools shall be in no sense anti-American, for obviously the future of Hawaii's Oriental youth lies in America and any influence which tends to alienate them is harmful to them, and of course, injurious to the commonwealth. There is ample room for the development of a program of education in Oriental language and culture without going into the dangerous ground of anti-American propaganda (p. 8).*

It is worth noting that the first paragraph of this 1930 report could have been written in the 1990's. The direct benefits of Japanese-language school were demonstrated during World War II when Japanese-Americans acted as interpreters and

code translators in a special Pacific theater unit of the Military Intelligence Service (MIS). At the conclusion of World War II, General Charles Willoughby, Chief of Staff of Intelligence in the Pacific, stated that the contributions of Japanese-American MISers "shortened the war in the Pacific by two years" (Rademaker, 1951) and saved one million lives (Harrington, 1979).

Indirect benefits of the Japanese-language schools during World War II were tied to lessons in shushin, filial piety, and a "Yamato damashii" ("never say die," "go for broke") spirit. Despite the lack of physical stature, Japanese-Americans enthralled with the Yamato damashii spirit battled against all odds to achieve their objective. One World War II veteran study participant said:

*I remember when I went into the Army. The Haoles [Caucasians] were all big. Our bags were sixty pounds, helmet — two and a half pounds. And I weighed 108 pounds. When we had training and when the landing craft hit the ground, we had to charge across the sand to the other side. Many times we wanted to give up but we gave that extra effort. We were brought up to give that extra effort.*

According to study participants, the lessons at the Japanese-language schools contributed to their success as defenders of America. Japanese-American combat units such as the 100th Battalion and the 442nd Regimental Combat Team were recognized as the most decorated units during World War II. Within these combat units, more than 90 percent of Japanese-American veterans had attended Japanese-language schools.

### Curriculum and Instruction

The curriculum of Japanese-language schools in the 1930's was radically different from what it had initially been in the early 1900's. Supplementing language instruction, the curriculum included Japanese history, geography, "kendo" (Japanese fencing) and judo for boys; sewing, flower arrangement, tea ceremony, and etiquette for girls. According to study par-

CONTINUED ON PAGE 23

# NABE NEWS Book Reviews

Column Editor: Dr. António Simões, Fairfield University, CT

## *Little Brazil*

Reviewed by Dora Tellier-Robinson

Margolis, Maxine L. (1994). *Little Brazil: An Ethnography of Brazilian Immigrants in New York City*. Princeton, New Jersey: Princeton University Press.

In her book *Little Brazil*, Professor Maxine Margolis introduces a little-known and growing ethnic group that is just starting to become a factor among immigrants to the United States: Brazilians. The book gives us a comprehensive picture of the who, what, and why of this group that is still, to a very large extent, "invisible." There may be as many as 350,000 to 400,000 Brazilians in the country as a whole with 80,000 to 100,000 in the New York metropolitan area. The 1990 census counted 94,023 foreign-born Brazilians in the United States. Professor Margolis states that even conservative estimates of the undercount of Brazilians in the United States as a whole range from 33% to over 80%.

Professor Margolis points out that the Brazilians who come to this country do not fit the popular stereotype of illegal immigrants from a third world country. While it is true that a large number of these Brazilians are or were at some time undocumented, they by no means represent the poorest segments of Brazilian society fleeing poverty in their homeland. The author wisely states that her findings are only applicable to the group she studied, Brazilians in New York City. As a Brazilian who lives in the United States, my experience is that many of her conclusions are also valid for other areas in the East such as New Jersey and Washington, D.C., although New York may attract a higher proportion of better educated upper-middle class Brazilians than some other areas.

Professor Margolis found that Brazilians in New York are overwhelmingly middle or lower middle-class, reasonably well-educated, and white. According to the author, these Brazilians see themselves as economic migrants who, because of hyper inflation and worsening real wages in Brazil, have been unable to find employment befitting their educational level. Many of these immigrants see themselves as sojourners who will be here just long enough to save the money necessary to buy a house or apartment. They do this by working long hours at jobs that they would never consider doing in Brazil.

Most of the women in Professor Margolis's study, more than 80%, have worked at least for a time as housekeepers or babysitters. A large proportion of the men in her study, 30%, have worked in restaurants, usually as dishwashers, bus boys or waiters. They are willing to take on these relatively low status jobs offering little in the way of benefits. By working long hours, often at two jobs, and living very frugally, they are able to earn the money to put at least a down payment on their house or apartment in a relatively short time. By looking on themselves as sojourners,

CONTINUED ON PAGE 20

## *Affirming Diversity*

Reviewed by Susan M. Polonco

Nieto, Sonia. (1996). *Affirming Diversity: The Sociopolitical Context of Multicultural Education*. Second Edition. White Plains, New York: Longman Publishers U.S.A.

Sonia Nieto made an invaluable contribution to the fields of multicultural and bilingual/multilingual education with the first edition of *Affirming Diversity: The Sociopolitical Context of Multicultural Education* in 1992. With the second edition in 1996, Nieto has made improvements and changes to an already formidable book. *Affirming Diversity* offers an interesting and fresh approach to the numerous issues that are often associated with multicultural education. The book is divided into three parts: the first section explains the rationale for using the case study method and looks at important terminology used in the book; the second section develops what Nieto calls a conceptual framework and a sociopolitical context for multicultural education; and the third section looks at the implications of the diversity that we have in this country and what that means for educators and students alike.

Twelve qualitative case studies of students from different backgrounds and circumstances are folded into different chapters that correspond to the pertinent issues covered in that section of the book. The case studies explore the various backgrounds of home, community, experiences, and school, and look at how those factors affect academic achievement. Issues such as expectations, racial identity, self-motivation, native language maintenance, the stresses of immigration, and family support are just some of the revelatory topics that are explored through the case studies. This pairing of case studies with chapters allows the reader to enter into the world of the student participant and understand the elements that affect that particular student, whether it is racial identity, the importance of keeping a culture alive, or simply trying to find out where they see themselves in relation to their classmates or their learning community. The case studies also emphasize the accessible nature of this kind of qualitative research methodology in education, and can be used as a good model for those interested in doing a similar qualitative research project. My own doctoral research was based on the qualitative case study methods that Nieto discusses and introduces in *Affirming Diversity*.

Aside from the strength and illustrative nature of the case studies, the central chapters of the book concentrate on social, educational, and cultural issues and how they affect the experiences of the student. By calling into question the motivations behind tracking, curricular decisions related to how schools choose to deal with cultural and linguistic diversity, and discussing the different learning styles students may have that are specific to their

CONTINUED ON PAGE 20

cultural or linguistic heritage, Nieto prompts a complex discussion of these factors and what they mean in the context of multicultural education. Chapter Six on "Linguistic Diversity in the Multicultural Classroom" is perhaps one of the best introductions to bilingual education programs and their place in the educational landscape of this decade that I have ever read. Nieto systematically introduces the reader to the variety of bilingual program models that exist, and their proposed objectives. For many readers who have no prior exposure to the various models of bilingual programs, this chapter is invaluable because it explains the politics and obstacles that all too often overshadow a proper focus on the educational integrity of bilingual education in this country.

Nieto does not avoid entering into the controversies that surround bilingual and multicultural education.

*Multicultural education is a process of comprehensive school reform and basic education for all students. It challenges and rejects racism and other forms of discrimination in schools and society and accepts and affirms the pluralism (ethnic, racial, linguistic, religious, economic, and gender among others) that students, their communities, and teachers represent. Multicultural education permeates the curriculum and instructional strategies used in schools, as well as interactions among teachers, students, and parents, and the very way that schools conceptualize the nature of teaching and learning (Nieto, p. 307).*

Rather, Nieto's definitions of what multicultural education has the potential to be are all evidence of a more complex and less superficial treatment of the educational components and underlying philosophies behind them that are necessary for true multicultural education to exist in our schools.

*Affirming Diversity* looks at the definitions of school achievement and failure in a new way, and the reader is able to come away from reading Nieto's extensive analyses with a more complete picture of the role that multicultural education has in educational reform. By educational reform, Nieto is referring to her more broadly based and conceptualized definition of multicultural education mentioned above. It is this more complete picture that is the sociopolitical context of multicultural education, and it is impossible to discuss this book without spurring some extremely interesting conversations about race, ethnicity, culture, and language. As an educator, I have had the opportunity to incorporate *Affirming Diversity* into graduate classes on multicultural and bilingual education. The combination of the case studies and the cogent issues that the twelve chapters discuss in Nieto's book allows students and teachers alike to question and recognize some of their own biases and analyze them. The potential benefits that could result from such introspection are a more inclusive and expansive definition of and approach to multicultural education in the schools.

*Susan Polonco works at Fairfield University in Connecticut.*

« NABE »

these Brazilians are able to deal more easily with their sudden loss of status.

There are two occupations that have become synonymous with Brazilians in New York, as the people who work in these occupations are largely Brazilian. Most of the shoe-shine "boys" in Manhattan, 90-95%, and most of the Go-Go "girls," 80%, working in the New York area are Brazilian.

Professor Margolis points out that one of the most striking features of the Brazilian immigrant scene in New York is the "lack of community ethos and community associations." She cites several reasons for this lack of community. The first is a lack of a physical community; there is no Brazilian residential neighborhood in New York City. The famous "Little Brazil" on 46th Street caters to Brazilian tourists in New York. Even Astoria, the neighborhood that is home to many of New York's Brazilians, is mainly Greek in character.

Time in New York and social class are also barriers to the formation of a cohesive Brazilian community in New York. What Professor Margolis calls "the Brazilian elite," the top level executives of Brazilian companies in New York, usually have contact with other members of the "elite" and disdain the new immigrants as being of a very low class, despite evidence that most Brazilian immigrants in New York were middle class in their own country. Another group of long term Brazilian residents in New York, the middle-class functionaries of these same Brazilian corporations and agencies, according to Professor Margolis, tend to socialize mainly with their peers, American, Brazilian, or otherwise, and have little contact with the new immigrants.

The main exception to this lack of community is the Brazilian churches. These are, in the main, evangelical sects with small churches scattered around the city. They attract members from among the new immigrants and seem to give them a sense of community not found elsewhere. There is also a Catholic church in Manhattan with masses in Portuguese. Brazilians in New York are approximately 75% Catholic and 23% Protestant.

Perhaps the most fundamental reason for the lack of unity among the Brazilians lies with the immigrants themselves. Professor Margolis quotes one immigrant: "We don't have an immigrant spirit because we are not immigrants." Most of the Brazilians in

CONTINUED ON PAGE 24

### Book Review Submission Guidelines

Reviews for publication in the **Book Review** column and sample materials from publishers should be sent to the attention of Dr. Beti Leone, Book Review column editor, at NABE, 1220 L Street, NW, #605, Washington, DC, 20005.

Reviews may also be sent via e-mail to [NABE\\_NEWS@nabe.org](mailto:NABE_NEWS@nabe.org).

Packages should be clearly marked **BOOK REVIEW MATERIAL**; two complete sets of materials must be submitted.

# Resources for Bilingual Educators

**Ace Reading Series - in bilingual French/English and Spanish/English.** A redesigned program which includes a multilingual feature in the software. The new format provides an opportunity for students to first practice reading comprehension skills in their native language. By offering the English translation in the same program, students can begin to transfer the reading skills into English with more confidence. The four programs in the series: "Ace Detective," "Ace Explorer," "Ace Inquirer," and "Ace Reporter" are available for either Macintosh or Windows or a hybrid Mac/Win CD-ROM. Single Version \$99. Lab Pack, Network, and Site Licensing available. Contact Mindplay, 160 W. Fort Lowell, Tucson, AZ 85705 (800) 221-7911.

**Big Books of Traditional Spanish Folk Songs and Audio Cassettes.** Includes such titles as "De Colores," "Mi Rancho," "Las Mañanitas," and "Los Pollitos." Big Books in Spanish and English available for many other titles. Big Books include free black-line masters for creating matching child-size Little Books. Books are \$15 each; \$12 with purchase of 5 or more. Audio cassettes are \$6.00 each for Spanish cassettes; \$11 each for all other cassettes. Contact Nellie Edge Resources, P.O. Box 12399, Salem, OR 97309-0399 (503) 399-0040.

**Con Respeto: Bridging the Distances Between Culturally Diverse Families and Schools,** by Guadalupe Valdés. An ethnographic portrait of ten Mexican immigrant families, with a special focus on mothers, that describes how such families go about the business of surviving and learning to succeed in a new world. The author examines what appears to be a lack of interest in education by Mexican parents and shows, through extensive quotations and numerous anecdotes, that these families are both rich and strong in family values, and that they bring with them clear views of what constitutes success and failure. The book's conclusion questions the merit of typical family intervention programs designed to promote school success and suggests that these interventions — because they do not genuinely respect the values of diverse families — may have long-term negative consequences for children. ISBN: 0-8088-3526-4. Contact Teachers College Press, 1234 Amsterdam Avenue, New York, NY 10027.

**The Giant and the Rabbit: Six Bilingual Folktales from Hispanic Culture,** with storyteller Sarah Barchas. The 70-minute storytelling cassette contains six memorable folktales reflecting the richness and diversity of Hispanic culture. The 36-page illustrated guidebook is for students as well as teachers. It contains bilingual story summaries, activities, and vocabulary. It also includes annotated suggested further related readings for each of the stories. ISBN: 0-9632621-6-5. \$12.95 for cassette/guidebook package; additional guidebooks for \$3.95 each. Contact High Haven Music, P.O. Box 246, Sonoita, AZ 85637-0246 (520) 455-5769.

**Henry y Mudge: el primer libro and Henry Y Mudge con Barro hasta el Rabo.** Two books from the recently-launched Ready-to-Read Series, *Libros Colibrí*. These two books are targeted for ages 508 and are available for \$3.99 each. Contact Simon & Schuster Consumer Group, 1230 Avenue of the Americas, New York, NY 10020 (212) 698-2809.

**Learning Together: Two-Way Bilingual Immersion Programs and Profile of Effective Two-Way Bilingual Education: Sixth Grade.** New videos from the National Center for Research on Cultural Diversity and Second Language Learning. *Learning Together* provides a clear, concise overview of two-way bilingual programs, including a discussion of criteria for successful implementation. Classroom scenes illustrate the discussion. *Profile* showcases bilingual teacher María Dorrego and her sixth graders in a two-way bilingual immersion class. Scenes feature students engaged in academic tasks in both the Spanish and English portions of the day. Dorrego explains her pedagogical style and instructional strategies which help the students achieve high levels of linguistic and academic sophistication in both languages. \$40/video. Contact: National Center for Research on Cultural Diversity and Second Language Learning, Center for Applied Linguistics, 1118 22nd St., NW, Washington, DC 20037 (202) 429-9292.

**Parents and Counselors Together (PACT).** Materials created to promote educational success and an understanding of the college transition process for parents, students and counselors. The publication is organized in modules for ease of presentation and includes materials to be copied and disseminated to participants. Manual and handouts are also available in Spanish. Contact National Association of College Admission Counselors, 1631 Prince Street, Alexandria, VA 22314-2818 (703) 836-2222.

**Unraveling the "Model Minority" Stereotype: Listening to Asian American Youth,** by Stacey J. Lee. A year-long ethnographic study at a high school in an East Coast urban center found that Asian American students divided themselves into four self-defined identity groups: Asian American, Asian, Korean, and Asian new wave, and that each group had a unique reaction to the model minority stereotype. The author explains how the model minority stereotype promotes a kind of invisibility. The experiences of the students, presented in their own words, provide a uniquely authentic inside perspective on identity and interethnic relations in an American community. ISBN: 0-8077-3509-4. Contact Teachers College Press, 1234 Amsterdam Avenue, New York, NY 10027.

*All resources are listed solely for the information of the NABE membership. Listing does not imply endorsement of the resource by the National Association for Bilingual Education. For more information about any listed resource, contact the publisher directly.*

more they work to pay tuition, the faster it seems to increase. Tuition has escalated far in excess of inflation, in defiance of market factors, and shows no sign of slowing down. Billions of dollars are wasted on regulations, paperwork, and "political correctness," which impedes the ability of the faculty to teach. We call for a national reassessment of the economics of higher education, to stop the treadmill and restore fiscal accountability to higher education. Congressional Republicans budgeted a 50 percent increase in student loans while fighting Bill Clinton's intrusion of Big Government into their financing. Heeding the outcry from the nation's campuses, we will end the Clinton Administration's perverse direct lending program. We support proposals to assist families to prepare for the financial strains of higher education, like the American Dream Savings Account, passed by congressional Republicans but vetoed.

To protect the nation's colleges and universities against intolerance, we will work with independent educators to create alternatives to ideological accrediting bodies. We believe meeting the higher education needs of America will require new institutions that are flexible, able to apply new technologies, willing to provide access to all those who need it, cost-effective and that place no burden on the American taxpayer.

**Immigration**

As a nation of immigrants, we welcome those who follow our laws and come to our land to seek a better life. New Americans strengthen our economy, enrich our culture, and defend the nation in war and in peace. At the same time, we are determined to reform the system by which we welcome them to the American family. We must set immigration at manageable levels, balance the competing goals of

uniting families of our citizens and admitting specially talented persons, and end asylum abuses through expedited exclusion of false claimants.

Bill Clinton's immigration record does not match his rhetoric. While talking tough on illegal immigration, he has proposed a reduction in the number of border patrol agents authorized by the Republicans in Congress, has opposed the most successful border control program in decades (Operation Hold the Line in Texas), has opposed Proposition 187 in California which 60 percent of Californians supported, and has opposed Republican efforts to ensure that non-citizens do not take advantage of expensive welfare programs. Unlike Bill Clinton, we stand with the American people on immigration policy and will continue to reform and enforce our immigration laws to ensure that they reflect America's national interest.

We also support efforts to secure our borders from the threat of illegal immigration. Illegal immigration has reached crisis proportions, with more than four million illegal aliens now present in the United States. That number, growing by 300,000 each year, burdens taxpayers, strains public services, takes jobs, and increases crime. Republicans in both the House and Senate have passed bills that tighten border enforcement, speed up deportation of criminal aliens, toughen penalties for overstaying visas, and streamline the Immigration and Naturalization Service.

Illegal aliens should not receive public benefits other than emergency aid, and those who become parents while illegally in the United States should not be qualified to claim benefits for their offspring. Legal immigrants should depend for assistance on their sponsors, who are legally responsible for their financial well-being, not the American taxpayers. Just as we require "deadbeat dads" to provide for the children they bring into the world, we should require "dead-beat sponsors" to provide for the immigrants they bring into the country. We support a constitutional amendment or constitutionally-valid legislation declaring that children born in the United States of parents who are not legally present in the United States or who are not long-term residents are not automatically citizens.

We endorse the Dole/Coverdell proposal to make crimes of domestic violence, stalking, child abuse, child neglect and child abandonment committed by aliens residing in this country deportable offenses under our immigration laws.

We call for harsh penalties against exploiters who smuggle illegal aliens and for those who profit from the production of false documents. Republicans believe that by eliminating the magnet for illegal immigration, increasing border security, enforcing our immigration laws, and producing counterfeit-proof documents, we will finally put an end to the illegal immigration crisis. We oppose the creation of any national ID card.

**Language Policy and Civil Rights**

America's ethnic diversity within a shared national culture is one of our country's greatest strengths. While we benefit from our differences, we must also strengthen the ties that bind us to one another. Foremost among those is the flag. Its deliberate desecration is not "free speech," but an assault against our history and our hopes. We support a constitutional amendment that will restore to the people, through their elected representatives, their right to safeguard Old Glory. We condemn Bill Clinton's refusal, once again, to protect and preserve the most precious symbol of our Republic.

English, our common language, provides a shared foundation which has allowed people from every corner of the world to come together to build the American nation. The use of English is indis-

CONTINUED ON PAGE 25



**FERNÁNDEZ USA**  
publishing Co.

**invites you to examine  
our best sellers:**

**Mi Libro de Español, levels 1 - 6,  
a complete language arts program, \$9.95 each**

**Prácticas de Ortografía, levels 1 - 6,  
a comprehensive spelling series, \$6.95 each**

**Mis Ejercicios de Español, levels 1 - 5,  
daily language arts activities, \$8.95 each**

**Call us for a complimentary copy  
of one of the above titles:  
1 - 800 - 814 - 8080**

**Teacher's Guide / Answer Key are now available!**

**FERNÁNDEZ USA publishing Co.  
1210 E. 223rd Street, Suite 309  
Carson, CA 90745**

**GENUINE SPANISH FOR  
SPANISH SPEAKERS!**



ticipants, Japanese-language schools promoted greater understanding and peace between the United States and Japan, contributed meaningful ethical lessons, and enhanced the ethnic identity of Niseis. For parents, Japanese-language schools assisted in at least four ways: by translating Eastern concepts to the West; by providing Niseis with character education; by providing a form of daycare; and by equipping Niseis with an economic tool for future utility. The item identified by study participants as being the most beneficial was shushin (ethics). According to a female study participant, "If not for my Japanese school background, I don't think I could be a good American. I think they really taught shushin. They don't have that today. Because of the shushin, we turned out to be better Americans." Shushin formed the foundation of Japanese-language schools and was explained by Niyekawa-Howard (1974) in the following manner:

*Shushin, which refers to "ethics" or "morals," had been an important subject in the curriculum of the schools in Japan. It is in shushin that Japanese children are taught Japanese values, such as filial piety, respect for elders and superiors, obligation, perseverance, frugality, loyalty to one's group and country, courage, courtesy, etc..*

As study participants recollected their Japanese-language school days, there was a sense of *deja vù* towards shushin. Most of the study participants felt that public schools should instill a sense of shushin like they experienced into today's students.

*For the most part, the values taught in shushin were consistent with public school values. The lone exception was reflected in the concepts of individuality versus conformity. Unlike the public school where the American ideal of rugged individualism was valued, the lessons of the Japanese-language school emphasized group conformity. Japanese-language students were taught*

*to "enryo" (i.e., be submissive) to group goals. This emphasis on group conformity is illustrated by the Japanese metaphor, "the nail that sticks out, gets hammered down" (Shoho, in press).*

Instructional methods at the Japanese-language school were similar but more intense than at the public school. Delivering the curriculum was accomplished through rote memory learning methods. In the classroom the "sensei" (teacher) was the absolute authority whose word was never to be questioned. The lecture-recitation approach was standard among Japanese-language school teachers, but in the case for lessons in shushin. In the case of shushin lessons, study participants mentioned how teachers used stories and games to relay morals to students. The use of alternative methods, such as stories and games to relay educational messages provides a partial explanation behind the popularity of shushin lessons. The divergence away from rote memory learning techniques was a welcomed relief to Japanese-language school attendees.

According to study participants, the benefits derived from Japanese-language school stretched beyond the ability to communicate in a foreign language. Armed with the ability to communicate in English and Japanese, students were drawn emotionally closer to their immigrant parents who, for the most part, communicated exclusively in Japanese.

### Conclusions and Implications

Based on the findings, Japanese-language schools promoted rather than hindered the Americanization of Japanese-Americans. Besides language instruction, students were exposed to character education which stressed values consistent with American norms. The evidence suggest that shushin lessons had a positive influence on the ethnic identity and self-esteem of Japanese-Americans. The implication of this finding is that foreign-language schools fill a critical need by addressing issues that public schools are reluctant to delve into (i.e. values, ethics, and morals). Historical documents showed that the general public's distrust of Japanese-language schools was unwarranted. Cited as a pub-

lic liability by Japanese-language school opponents, the educational utility of Japanese-language schools was justified by the performances of Japanese-American combat units during World War II. Complementing the battlefield performance of Japanese-American soldiers was the fact that there were no documented acts of anti-American activities by any Japanese American.

This study also discredits the assertion made by opponents of the foreign-language schools and bilingual education that learning a foreign language (or continuing the use of the first language) and its accompanying cultural traits predisposes a person to unloyal acts. On the contrary, Japanese-language schools enhanced the concept of loyalty to one's country (America) while raising the level of understanding and appreciation for one's ancestral country (Japan).

In addition to aiding the Americanization process, Japanese-language schools enabled Japanese Americans to act as transmitters of the American culture for their parents. Based on this study, the promotion of the home language enhanced the opportunities for communication, understanding, and linkages between the ancestral and adopted cultures.

The implication of this finding for schools today is that by encouraging new immigrants and their families to appreciate their ancestral culture, a greater attachment for the adopted culture is instilled. Such encouragement by schools acts to broaden teachers' awareness of diverse cultures and values. It also enhances the school's effectiveness in facilitating the tolerance of differences while at the same time maximizing the Americanization of newly-arrived immigrants and their youngsters. For many children of immigrants, the frustration of not having a common medium to communicate and understand school lessons could do irreparable damage academically and socially. The continuation of bilingual education is very important to the language, literacy, cognitive, social, and emotional development of these children who otherwise have limited support structures for school learning. To help minimize the damaging effects of forced assimilation, an implication of this

CONTINUED ON PAGE 24

study supports the continuing development of private foreign-language schools to serve the community as Japanese-language schools did during the 1930's. These foreign-language schools act as a safe haven where children of immigrants learn to appreciate their ancestry and gradually become productive citizens. It would be a dark day in American history if bilingual education and foreign-language schools were ever abolished (as was attempted in the 1920's and 1930's).

The final implication of this study pertains to the extreme shortage of bilingual school personnel, especially in Asian languages. Foreign-language schools represent an available community resource for public schools. As foreign-language schools develop according to ethnic community needs, public schools should proactively initiate discussions to incorporate the expertise of ethnic community bilingual teachers to assist in the development of language and cultural awareness. It would be prudent for school districts to invest in this available resource by encouraging and assisting bilingual community teachers to become certified public school teachers.

### References

- Carlson, R. A. (1987). *The Americanization syndrome: A quest for conformity*. London: Croom Helm.
- Erickson, F. (1986). "Qualitative methods in research on teaching." In M.C. Whitrock (Ed.) *Handbook of research on teaching* (3rd ed.) (pp. 119-161). New York: Macmillan.
- Glaser, B. G. & Strauss, A. L. (1967). *The discovery of grounded theory*. New York: Aldine.
- Governor's Advisory Committee on Education (1930). *Subcommittee no. 7, report no. 1, foreign-language schools*. Honolulu, Hawaii: Governor's Advisory Committee on Education.
- Harrington, J. D. (1979). *Yankee samurai: The secret role of Nisei in America's Pacific victory*. Detroit: Pettigrew Enterprises, Inc..
- Niyekawa-Howard, A. M. (1974). "History of the Japanese-language school." *Educational Perspectives*, 13, 6-14.
- Rademaker, J. A. (1951). *These are Americans: The Japanese in Hawaii in world war II* (Palo Alto: Pacific Books, 1951), 86; quoted in Dorothy Ochiai Hazama and Jane Okamoto Komeiji, *Okage sama de: The Japanese in Hawai'i 1885-1985* (Honolulu: Bess Press, 1986), 166-167.
- Shoho, A. R. (1990). *Americanization through public education of Japanese Americans in Hawaii: 1930-1941*. Unpublished doctoral dissertation, Arizona State University, Tempe, AZ.
- Shoho, A. R. (in press). "A cross-cultural analysis of math Olympians from China, Taiwan and the United States." *International Journal of Educational Research*.
- Strauss, A. L. (1987). *Qualitative analysis for social scientists*. Cambridge: Cambridge University Press.

*Editor's Note: The author's use of the term "Americanization" refers to one's becoming a participating, productive member of society and in no way implies the more common connotation of having to give up one's native language and culture in order to do so.*

*Alan R. Shoho received his Ed.D. from Arizona State University and is currently an Assistant Professor of Educational Leadership at The University of Texas at San Antonio. His research interests focus on alienation theory of marginalized groups; the creativity of educational leaders and factors related to creating effective educational environments; and cross-cultural issues. He is President of the American Educational Research Association's Special Interest Group on Research on the Education of Asian and Pacific Americans.*

**Editor's Note:** Contributions to the Asian/Pacific American Education Concerns column should be sent to Janet Lu, MRC/NC, 1212 Broadway #400, Oakland, CA 94912. (510) 834-9458, FAX (510) 763-1490. You may send E-mail via the Internet to: JANET\_LU@arcoakland.org

• NABE •

the study felt that they were in the United States for the limited time necessary to earn the money to accomplish some goal back in Brazil, and that sooner or later -- preferably sooner -- they would return.

One of the first things that Brazilians learn upon arrival in the United States is that they are often confused with Hispanics and that Americans think that they speak Spanish. This, combined with the fact that many Brazilians are here illegally, helps to contribute to their "invisibility." This confusion about the ethnicity of Brazilians exists not only in the popular mind but also in the U.S. Census Bureau, which uses the designations Hispanic and Latino interchangeably.

Professor Margolis refers to a phenomenon that she calls "yo-yo" migration. In this scenario, Brazilians live in this country for a time and either earn sufficient money to attain their goal in Brazil or simply become homesick and decide to go back. Once in Brazil, they find that the situation there has not improved much and they still have trouble finding good paying jobs commensurate with their skills. This leads to frustration which in turn leads some of them to re-emigrate.

Brazilians have become a part of New York's ethnic mix. Professor Margolis ends her book by predicting that Brazilians, as other immigrant groups before them, will stop thinking of themselves as sojourners and start thinking of themselves as immigrants. She predicts that they will become "transnationals" who, while continuing to think of themselves as Brazilians, will see their future tied to that of their adopted land. In other words, Brazilians are here to stay. The experiences of the Brazilians Professor Margolis describes are similar to those of many Brazilians of my acquaintance. I "know" many of the people described in her book. In fact, I am one of the sojourners who stayed and made a life in this country.

*Dora Tellier-Robinson works at New York University.*

• NABE •

NABE '97  
February 4-8, 1997

one without. America has the best higher education in the world. We do not need to change it — we need to make it available for all Americans. Our goal must be nothing less than to make the 13th and 14th years of education as universal as the first 12.

Over the last four years, the Democratic Party under President Clinton has put an unprecedented college opportunity strategy in place: We reformed the student loan program, to make college more affordable for 5.5 million students — and we saved money for the taxpayers by eliminating the middleman, cutting red tape, and cutting the cost of student loan defaults in half. We have expanded Pell Grant college scholarships for deserving students. And the President's national service program has already helped 45,000 Americans earn money for college by helping their communities. *Tax cuts for college.* Over the next four years, we want to go even further: We should expand work-study so one million students a year can work their way through college by the year 2000. We should allow people to use money from their IRA to help pay for college. We should give a \$1000 honor scholarship for the top 5 percent of graduates in every high school. And we must make 14 years of education the standard for every American. The Democratic Party wants to create a \$10,000 tax deduction for families to help pay for education after high school. And we want to create a \$1,500 tax cut for Americans, modeled after Georgia's successful HOPE scholarships, to guarantee the first year of tuition at a typical community college, and the second year if individuals earn it by maintaining a B average. No tax cut will do more to raise American incomes than a tax cut to pay for college.

CONTINUED ON PAGE 26

PARENTAL INVOLVEMENT

ous and bilingual presentation and got a strong ovation when he was done. The gist of the presentation was that parents are ultimately responsible for their children and if the children go bad, it is the parent's fault. I don't disagree with concept of parental responsibility. I take great issue with the use of "guilt" as a means to increase parent commitment to their children. Those most vulnerable seem to be those who are already sensitive to the issue. The ones who might most need to hear the message are not present. Encouragement and support of parent leadership is more apt to be nurtured by acknowledgment of parent efforts, strengths and achievements in the face of difficult economic and social conditions. It's an easy and cheap shot to make parents feel guilty; it's the common attack of schools with bad faith toward families, many times used as a smoke screen to deflect attention from being accountable for the instruction that goes on during the school day.

Valuable Lessons Learned

The parent committee which planned

and managed the conference has been meeting this summer to evaluate the events. At one meeting, I chose to give my reaction to the speech mentioned above. It was a surprise to most of them. As I had expected, most of them thought it was a good speech and had not analyzed it for its content. After I gave my explanation, one parent leader said that she had initially disagreed with my analysis when I began talking, but as I explained carefully she came around to my point of view. As leadership training, it was an important moment. The contrast of the two points of view, valuing and deficit, was clear to all the committee. They now understood more clearly how pernicious and prevalent is the self- and peer-criticism among parents. It was a serendipitous and appropriate learning, "Aha!"

The bilingual education community plays an important part, not just in the education of children whose home language is other than English, but also in the support, validation, and weaving of those families into the marvelous rebozo and multicolored mantilla that this country

pensable to all who wish to participate fully in our society and realize the American dream. As Bob Dole has said: "For more than two centuries now, English has been a force for unity, indispensable to the process of transforming untold millions of immigrants from all parts of the globe into citizens of the most open and free society the world has ever seen." For newcomers, learning the English language has always been the fastest route to the mainstream of American life. That should be the goal of bilingual education programs. We support the official recognition of English as the nation's common language. We advocate foreign language training in our schools and retention of heritage languages in homes and cultural institutions. Foreign language fluency is also an essential component of America's competitiveness in the world market.

The sole source of equal opportunity for all is equality before the law. Therefore, we oppose discrimination based on sex, race, age, creed, or national origin and will vigorously enforce anti-discrimination statutes. We reject the distortion of those laws to cover sexual preference, and we endorse the Defense of Marriage Act to prevent states from being forced to recognize same-sex unions. Because we believe rights inhere in individuals, not in groups, we will attain our nation's goal of equal rights without quotas or other forms of preferential treatment. We scorn Bill Clinton's notion that any person should be denied a job, promotion, contract or a chance at higher education because of their race or gender. Instead, we endorse the Dole-Canady Equal Opportunity Act to end discrimination by the federal government. We likewise endorse this year's Proposition 209, the California Civil Rights Initiative, to restore to law the original meaning of civil rights.

• NABE •

FROM PAGE 9

always has been and continues to be. To achieve this we have to be constantly vigilant of what messages we give to parents, and what unconscious but nevertheless influential feelings and attitudes we have toward our families who don't fit the middle-class, English-speaking mold. Our media messages about our families, our relationship to assertive parents, our speeches to them and our prayers for them should support their liberation from institutionalized prejudices and economic disadvantage. We must reiterate in word and in deed that the parents of our bilingual children are valuable and worthy of praise and that we welcome their aggressive leadership to create excellent schools for all children.

**Editor's Note:** Contributions for the Parental Involvement column should be sent directly to the editor, Aurelio Montemayor, at: IDRA, 5835 Callaghan Road, Suite 350, San Antonio, TX 78228. (210) 684-8180; FAX (210) 684-5389. Email: amontmyr@txdirect.net

• NABE •



**Immigration**

Democrats remember that we are a nation of immigrants. We recognize the extraordinary contribution of immigrants to America throughout our history. We welcome legal immigrants to America. We support a legal immigration policy that is pro-family, pro-work, pro-responsibility, and pro-citizenship, and we deplore those who blame immigrants for economic and social problems.

We know that citizenship is the cornerstone of full participation in American life. We are proud that the President launched Citizenship USA to help eligible immigrants become United States citizens. The Immigration and Naturalization Service is streamlining procedures, cutting red tape, and using new technology to make it easier for legal immigrants to accept the responsibilities of citizenship and truly call America their home.

Today's Democratic Party also believes we must remain a nation of laws. We cannot tolerate illegal immigration and we must stop it. For years before Bill Clinton became President, Washington talked tough but failed to act. In 1992, our borders might as well not have existed. The border was under-patrolled, and what patrols there were, were under-equipped. Drugs flowed freely. Illegal immigration was rampant. Criminal immigrants, deported after committing crimes in America, returned the very next day to commit crimes again.

President Clinton is making our border a place where the law is respected and drugs and illegal immigrants are turned away. We have increased the Border Patrol by over 40 percent; in El Paso, our Border Patrol agents are so close together they can see each other. Last year alone, the Clinton Administration removed thousands of illegal workers from jobs across the country. Just since January of 1995, we have arrested more than 1,700 criminal aliens and prosecuted them on federal felony charges because they returned to America after having been deported.

However, as we work to stop illegal immigration, we call on all Americans to avoid the temptation to use this issue to divide people from each other. We deplore those who use the need to stop illegal immigration as a pretext for discrimination. And we applaud the wisdom of Republicans like Mayor Giuliani and Senator Domenici who oppose the mean-spirited and short-sighted effort of Republicans in Congress to bar the children of illegal immigrants from schools — it is wrong, and forcing children onto the streets is an invitation for them to join gangs and turn to crime. Democrats want to protect American jobs by increasing criminal and civil sanctions against employers who hire illegal workers, but Republicans continue to favor inflammatory rhetoric over real action. We will continue to enforce labor standards to protect workers in vulnerable industries. We continue to firmly oppose welfare benefits for illegal immigrants. We believe family members who sponsor immigrants into this country should take financial responsibility for them, and be held legally responsible for supporting them.

**Language Policy and Civil Rights**

Today's Democratic Party knows we must renew our efforts to stamp out discrimination and hatred of every kind, wherever and whenever we see it. We deplore the recent wave of burnings that has targeted African-American churches in the South, as well as other houses of worship across the country, and we have established a special task force to help local communities catch and prosecute those responsible, prevent further arsons, and rebuild their churches. We believe everyone in America should learn English so they can fully share in our daily life, but we strongly oppose divisive efforts like English-only legislation, designed to erect barriers between us and force people away from the culture and heritage of which they are

rightly proud. We must remember we do not have an American to waste. We continue to lead the fight to end discrimination on the basis of race, gender, religion, age, ethnicity, disability, and sexual orientation. The Democratic Party has always supported the Equal Rights Amendment, and we are committed to ensuring full equality for women and to vigorously enforce the Americans with Disabilities Act. We support continued efforts, like the Employment Non-Discrimination Act, to end discrimination against gay men and lesbians and further their full inclusion in the life of the nation.

Over the last four years, President Clinton and the Democrats have worked aggressively to enforce the letter and spirit of civil rights law. The President and Vice President remain committed to an Administration that looks like America, and we are proud of the Administration's extraordinary judicial appointments — they are both more diverse and more qualified than any previous Administration. We know there is still more we can do to ensure equal opportunity for all Americans, so all people willing to work hard can build a strong future. President Clinton is leading the way to reform affirmative action so that it works, it is improved, and promotes opportunity, but does not accidentally hold others back in the process. Senator Dole has promised to end affirmative action. He's wrong, and the President is right. When it comes to affirmative action, we should mend it, not end it.

« NABE »

OFFICIAL ENGLISH

*not unique. Hundreds of thousands of men and women like her have experienced discrimination and segregation so prevalent against Hispanics throughout most of this century...Yet despite the discrimination, the segregation, and the denial of even a basic education, these men and women have played by the rules, contributed their utmost to society, and in the case of Gold Star mothers and their families, paid the ultimate price of having a son die for his country. It is unfathomable that today we stand on the brink of depriving Mrs. Castañón and others like her once again of help in exercising their rights or receiving their due benefits. What little assistance we provide to these citizens — whether it is bilingual ballots or essential information on social security, taxes or health care in languages other than English — would be eliminated if this legislation is passed. The State of Texas and the United States committed a grave injustice when they denied Hispanics an education, and injustice which parenthetically has yet to be rectified as future generations of Hispanic children continue to have the lowest levels of educational attainment of any group in this country. Let us not compound this injustice by passing this divisive, offensive, and unnecessary bill."*

In every way, María Castañón is a shining American example of determination, hard work, and patriotism. NABE commends her efforts, and thanks her for her remarkable leadership on behalf of language-minorities.

*Jaime A. Zapata is NABE's Associate Director for Legislation and Public Affairs.*

« NABE »



# NATIONAL ASSOCIATION FOR BILINGUAL EDUCATION

## MEMBERSHIP APPLICATION

### 1 Membership Type *(check one only)*

- \$48 Individual Membership
- \$30 Discounted Individual Membership
- Parent:** **must not** be professional educator and **must** have a child currently enrolled in a bilingual education program. A letter written on school stationery from either the teacher or a school administrator must accompany the NABE membership application.
  - College/University Student:** **must not** be professional educator and **must** be enrolled on **full-time** basis. A copy of an official college or university document showing current enrollment status must accompany the NABE membership application.
  - Paraprofessional:** **Must** be working as an instructional aide in a public school system. A letter on school stationery from the supervising teacher or a school administrator must accompany the NABE membership application.
- \$43 Combined Membership Name of Affiliate: \_\_\_\_\_
- \$125 Institutional Membership
- \$1000 Lifetime Membership

Memberships are valid for one year from the date of processing, and include one year subscription to NABE publications (except Lifetime, valid for life of member and includes lifetime subscription). Organizational membership is non-voting; all other memberships are voting. All memberships are non-transferrable and may not be cancelled. Membership dues are non-refundable.

### Name and Address Information

- Mr.
- Mrs.
- Ms.
- Dr.
- \_\_\_\_\_
- Last First Middle*

### 2 Preferred Mailing Address: Business Home

**Business Address**

Position: \_\_\_\_\_

Division: \_\_\_\_\_

Organization: \_\_\_\_\_

Street Address: \_\_\_\_\_

City: \_\_\_\_\_ State: \_\_\_\_\_ Zip: \_\_\_\_\_

Phone: (\_\_\_\_) \_\_\_\_\_ Ext. \_\_\_\_\_

Fax: (\_\_\_\_) \_\_\_\_\_ E-Mail: \_\_\_\_\_

### Home Address

Street Address: \_\_\_\_\_

City: \_\_\_\_\_ State: \_\_\_\_\_ Zip: \_\_\_\_\_

Phone: (\_\_\_\_) \_\_\_\_\_

### 4 I am involved with bilingual education as *(check one)*

- Administrator
- College Instructor
- Consultant
- Full-Time Student
- Paraprofessional
- Parent/Community member
- Publisher Staff
- School Board Member
- Teacher
- Other

### 5 I work in this type of organization *(check one)*

- Commercial organization
- College/university
- Local school district
- State education agency
- Other

### 6 I usually work with this level of student *(check one)*

- Early childhood
- Elementary
- Secondary
- Higher education
- Adult

### 7 I want to participate in the following Special Interest Group *(check one)*

- Adult/Vocational Education
- Asian & Pacific Islanders
- Critical Pedagogy
- Early Childhood Education
- Elementary Education
- ESL in Bilingual Education
- Gifted Education
- Global Education
- Higher Education
- Instructional Technology
- Language/Culture Retention
- Language Policy
- Parent & Community
- Policy Makers
- Professional Development
- Research & Evaluation
- Secondary Education
- Special Education

### 8 Payment Information

\$ \_\_\_\_\_ Membership dues

\$ \_\_\_\_\_ Contribution to help NABE counter the English-only movement

- Check or money order Check# \_\_\_\_\_
- Institutional purchase order # \_\_\_\_\_
- MasterCard  VISA ExpirationDate: \_\_\_\_/\_\_\_\_/\_\_\_\_
- Automatic Renewal:** Check this box if you are paying by credit card, and you want NABE to automatically renew your membership annually, charging your credit card the standard renewal amount. This permission will remain in effect until you cancel it in writing.

\$ \_\_\_\_\_ **TOTAL DUE**

**9 SIGNATURE:** \_\_\_\_\_ **29** **DATE:** \_\_\_\_/\_\_\_\_/\_\_\_\_

# ANNOUNCEMENTS

## NABE '97 Information

**Conference dates:** February 4 - 8, 1996

**Location:** Albuquerque, New Mexico

**Deadlines:** Early bird deadline is November 1, 1996.  
Pre-registration deadline is December 15, 1996.

- ◆ Preregistration materials will automatically be mailed in September to all current members.
- ◆ Materials will also automatically be mailed to all NABE '96 conference registrants, regardless of membership status.
- ◆ Non-members who did not attend NABE '96 may obtain preregistration materials by calling NABE at (202) 898-1829 or by sending e-mail (with full name and mailing address) to NABE97@nabe.org

### Bilingual Essay Awards Contest

- ◆ NABE's Nationwide Writing Contest for Bilingual Students is in the process of being restructured.
- ◆ Plans call for the 1997 contest to be announced at NABE '97.
- ◆ Look for further information in the February 1 issue of *NABE News*.

#### ***NABE NEWS***

National Association for Bilingual Education  
Suite 605  
1220 L Street, N.W.  
Washington, D.C. 20005-4018

NON-PROFIT ORG.  
U.S. POSTAGE  
PAID  
WASHINGTON, DC  
PERMIT NO. 4555

KATHLEEN M. MARCOS  
ERIC CLEARINGHOUSE ON LANGUAGES &  
1118 22ND ST NW  
WASHINGTON DC 20037-1214





# NABE NEWS

The news magazine about educational equity and excellence through bilingual education

November 1, 1996

National Association for Bilingual Education

Volume 20, Number 2

## LEP Enrollments in California Increase by Almost 5% in 1996

by Dr. Reynaldo F. Macías

The California Department of Education recently released preliminary data from the spring 1996 language census. The number of limited English proficient (LEP) students in California public schools in the spring of 1996 was 1,323,787, an increase of 60,805 (4.8%) over spring of 1995 (see the accompanying graph).

Most of the increase was at the elementary school level. About 913,063 (69%) of the LEP enrollment was in grades Kindergarten to 6. About 410,862 (31%) were in grades 7 through 12 and ungraded. These figures represent a 5.2% increase at the elementary level and a 4% growth over spring 1995 at the secondary (plus ungraded) level.

The language backgrounds of the students ranked similarly in size to the last several years, with Spanish language background LEP students being the largest group (1,051,126; 79.4%), followed by Vietnamese (47,883; 3.6%), Hmong (31,156; 2.4%), Filipino (Tagalog) (20,950; 1.6%), and Khmer (Cambodian)

(20,646; 1.6%) language backgrounds.

The number of LEP students that were re-classified as fluent English proficient also rose from the previous year, from 72,074 in 1995 to 81,733 in spring 1996. This represented about 6.2% of the LEP enrollment. In 1995, the number of reclassified students represented about 5.7% of the LEP enrollment for that year. Over the last four years there has been a steady increase in the proportion of reclassified students. Over the 5 year period between 1992 and 1996 about 327,442 LEP students were re-designated as fluent English proficient.

The data on instructional services, and staffing were not yet available at press time. Reports on these data will be included in subsequent issues of *LMRI News*.

For more information, please contact Deborah Camillo, Educational Demographics Unit, CA Dept. of Education, at 916-323-5118, or [dcamillo@cde.ca.gov](mailto:dcamillo@cde.ca.gov).

*Dr. Macías is the director of the Linguistic Minority Research Institute at the University of California, Santa Barbara. Reprinted from LMRI News, Vol. 6, No. 1, September 1996.*

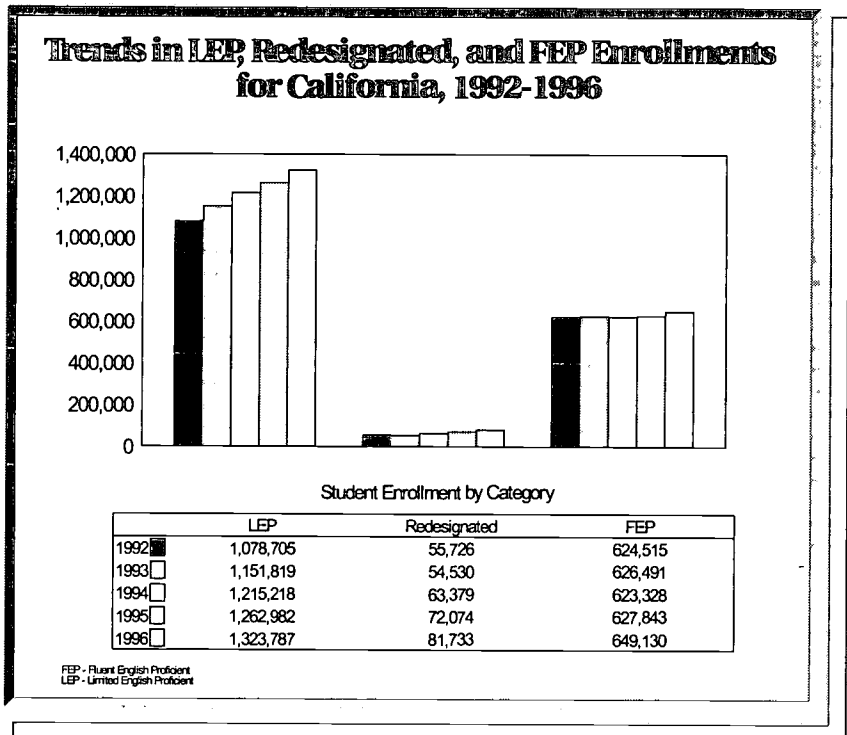

### ISSUE HIGHLIGHTS

Language Minorities and the 104th Congress.....3

Meet the NABE Board.....19

Higher Education Act.....23

# NABE NEWS

Published by the  
**National Association for  
Bilingual Education**

**Editor:**

Nancy F. Zelasko, Ph.D.  
**Desktop Publishing & Layout:**  
Jeff Spence

## NABE NEWS REPRINT AND EDITORIAL POLICY

Readers are welcome to reprint non-copy-righted articles which appear in *NABE NEWS* at no charge, provided proper credit is given both to the author(s) and to *NABE NEWS* as the source publication.

All articles printed in *NABE NEWS*, unless written by an Association staff person or a member of the current NABE Executive Board of Directors, are solely the opinion of the author or authors, and do not represent the official policy or position of the National Association for Bilingual Education. Selection of articles for inclusion in *NABE NEWS* is not an official endorsement by NABE of the point(s) of view expressed therein.

## TABLE OF CONTENTS

California LEP Enrollments.....	1
Congress and Minority-Language Communities.....	3
<i>American Indian</i> column.....	5
Upcoming Events.....	6
Research SIG Call for Papers.....	6
<i>Asian/Pacific American</i> column.....	7
Educator Resources.....	9
<i>Brave New Schools</i> .....	11
<i>Language Profession</i> column.....	13
NABE Order Form .....	14
<i>Book Review</i> columns.....	15
<i>Technology</i> column.....	17
<i>Meet the NABE Board</i> .....	19
Dreamkeepers.....	21
<i>Higher Ed Legislation</i> column.....	23
Resolutions Requested.....	24
<i>ESL In Bilingual Ed</i> column.....	25
SIG: Early Childhood.....	27
<i>Meet the NABE Interns</i> .....	29
Membership Application.....	31
Announcements.....	32

## PUBLICATION SCHEDULE

Volume 20 of *NABE NEWS* will be published in 8 issues; publication dates are:

Issue 1	09/15/96	Issue 5	03/15/97
Issue 2	11/01/96	Issue 6	05/01/97
Issue 3	12/15/96	Issue 7	06/15/97
Issue 4	02/01/97	Issue 8	08/01/97

All advertising and copy material must be received in the NABE office **ONE MONTH prior to publication date** to be considered for inclusion.

## NABE NEWS ADVERTISING

### Display Advertising Rates

(Camera-Ready)

Full Page (7.5" x 10")	\$850
2/3-Page (4.75" x 10")	\$700
1/2-Page (7.5" x 4.5")	\$550
1/3-Page (4.75" x 4.75")	\$425
1/3-Page (2.25" x 10")	\$425
1/4-Page (3.5" x 4.75")	\$325
1/6-Page (2.25" x 4.75")	\$250

### Classified Advertising

\$1.25 per word; maximum 100 words

### Advertising Discounts (for multiple insertions)

10% for second-third; 15% for fourth-fifth;  
20% for sixth-eighth

NABE reserves the right to reject any advertisements which it deems inappropriate and/or inconsistent with the goals of the Association. For additional information, contact NABE at (202) 898-1829 x136.

## NABE

The National Association for Bilingual Education (NABE) is a tax-exempt, non-profit professional association founded in 1975 to address the educational needs of language-minority Americans.

### NABE NATIONAL OFFICE

1220 L Street, N.W., Suite 605  
Washington, DC 20005-4018

PHONE (202) 898-1829

FAX (202) 789-2866

E-mail: NABE@nabe.org

### James J. Lyons, Executive Director

Nancy F. Zelasko, Deputy Director  
Jaime Zapata, Associate Director for Legislation  
Jeff Spence, Information Systems Director  
Carolyn Riddick, Office Manager  
Celia Torres, Membership Specialist  
Mina Cousins, Membership Specialist  
Ronald Williams, Office Assistant  
Teresa Sola, Receptionist

32

## NABE EXECUTIVE BOARD

1996 - 1997

### President

Janice Jones Schroeder  
12015 Winding Creek Way  
Germantown, MD 20874-1955  
(301) 601-9405  
nabepres@aol.com

### Vice President

Mary F. Jew  
San Francisco USD  
2550 - 25th Avenue  
San Francisco, CA 94116  
(415) 759-2950  
mjew@sfsud.k12.ca.us

### Secretary/Treasurer

David E. Báez  
Director, Foreign Language & Bilingual  
Education  
Buffalo Public Schools  
731 City Hall  
Buffalo, NY 14202  
(716) 851-3704  
dbaez@erie.wnyric.org

### Member-at-Large

Joe J. Bernal  
6410 Laurelhill  
San Antonio, TX 78229  
(210) 342-8026  
bowlngod@ix.netcom.com

### Member-at-Large

María Estela Brisk  
School of Education  
Boston University  
605 Commonwealth Avenue  
Boston, MA 02215  
(617) 353-3260  
brisk@acs.bu.edu

### Member-at-Large

Nga Dinh Duong  
21724 58th Avenue West  
Mountlake Terrace, WA 98043  
(206) 771-2095

### Member-at-Large

Hermán S. García  
Department of C & I  
College of Education  
New Mexico State University  
Las Cruces, NM 88003  
(505) 646-2115  
hgarcia@cnmailsvr.nmsu.edu

### Member-at-Large

Susan García  
18094 East Ohio, #102  
Aurora, CO 80012  
(303) 745-7116  
susangarcia@unitedwaydenver.org

### Parent Representative

Adela B. Holder  
Silver Consolidated School District  
2810 N. Swan Street  
Silver City, NM 88061  
(505) 388-1527  
sncadavi@arriba.nm.org



# 104th Congress and Minority-Language Communities

by Jaime A. Zapata

At the end of the 104th Congress, at long last, the news from Capitol Hill is positive! After a great deal of effort, NABE and its partner organizations scored several crucial victories. In the immigration arena, the Gallegly amendment was excluded from the compromise package which was recently signed into law by President Clinton. English-Only legislation, which loomed dangerously on the Congressional horizon, was not brought up in the Senate. And, last but certainly not least, federal funding for bilingual education programs was restored to FY 1995 levels.

## Gallegly & The Immigration Reform Package

On September 30, 1996 President Clinton signed into law what could be described as a "softened" immigration reform bill. Below are some of the key changes made to the legislation before reaching the President for his signature.

The Gallegly amendment — which was by far the greatest sticking point in the negotiations — was pulled on the last day of the conference on the Immigration Reform bill, and was voted on as a separate piece of legislation. The Gallegly stand-alone bill (H.R. 4134) was passed by the House in a vote of 254 to 175, with Speaker Newt Gingrich (R-GA) speaking in favor of the legislation on the House floor. It is important to note, however that the Senate did not take any action on Rep. Gallegly's bill before its final adjournment and the legislation is now defunct for the year.

Also worth mentioning as part of the immigration debate, is the removal of clauses curbing student aid eligibility to legal immigrants. The "deeming" provisions which had been proposed in the Senate bill would have required legal immigrants to include their sponsor's income when applying for student financial aid, and would have made thousands of them ineligible for Pell Grants, student loans, work study, and other forms of federal student aid. At the urging of House members, the Clinton Administration, and

organizations such as NABE, the Senate agreed to exempt higher education programs from the deeming restrictions. The final immigration measure signed by the President also does not require legal immigrants to secure co-signers for their student loans.

## English-Only

After the unfortunate events on August 1st of this year, when the House of Representatives approved an Official English/English-Only bill by a vote of 259 to 169, NABE and its partner organizations turned their attention to the Senate in an effort to halt the progress of this nefarious legislation. The outcome was extremely encouraging. Through the efforts of NABE members and the collaboration of key Senators, the House-passed Official-English/English-Only bill (H.R. 123) was made to stall in a Senate committee. S.356, Senator John Shelby's (R-AL) English-Only bill, was not brought to the Senate floor. With the adjournment of Congress, the English-Only bills introduced during the 104th session will now have to be reintroduced in the 105th Congress, and begin the legislative process from step one.

## Appropriations

Perhaps the best (and most directly rewarding) of all news for NABE members comes in the form of appropriations. On September 30th, President Clinton signed an omnibus appropriations bill which will provide funding for several federal agencies for the remainder of FY 1997. Pressured by a tight Congressional schedule, and the need to bolster the image of candidate Bob Dole on the issue of education, Republican Hill leaders agreed to a \$3.5 billion increase for education funding. Among the programs impacted by this move was bilingual education.

NABE moved quickly, meeting with key legislators and ensuring that key Congressional allies made the case for bilingual education both to the White House and to Hill appropriators. Our efforts paid off.

Under the measure, Title VII programs will be funded at \$156.7 million for FY 1997. That amount represents an increase

of \$28.7 million over FY 1996 funding, and is just slightly above FY 1995 levels. There is one caveat: the entire amount appropriated to the bilingual education account is intended for instructional services, and there is no funding specifically allocated for support services or professional development. It is worth noting, however, that Congressional appropriators did include language in the omnibus bill's report allowing for a reprogramming request to be filed by the Secretary of the Department of Education. NABE will continue to work with the Secretary and the appropriators to secure adequate funding for *all* bilingual education program components.

## Outlook

The coming session of Congress will surely hold many challenges for NABE, but I am convinced that, just as this David of advocacy organizations managed to accomplish so much in the most Goliath-like of Congresses in a long time, with your support our victories will continue!

*Jaime A. Zapata is the NABE Associate Director for Legislation and Public Affairs.*

• NABE •

## NABE Action Alerts Now Available By E-Mail

NABE sends special Action Alerts to members and subscribers to inform them of the latest developments in Washington concerning bilingual education. These action alerts are now available by e-mail.

To subscribe to the Action Alert list, send e-mail to:

**majordomo@nabe.org**,  
containing **ONLY** the following  
line in the body of the  
message:

**subscribe actionalert**  
**<your e-mail address>**

# DISCOVER PERMA-BOUND BOOKS

## FOR YOUR BILINGUAL STUDENTS



**W**hen looking for a great selection of affordable titles for bilingual students, our Pre-Kindergarten-12 selection is great - including over 2,000 books in Spanish, plus Chinese, Vietnamese, French, German, Italian, and more.

- ❖ TRANSLATIONS
- ❖ ORIGINAL WORKS
- ❖ SHORT STORIES
- ❖ NOVELS
- ❖ SCIENCE
- ❖ DICTIONARIES
- ❖ BILINGUAL READERS
- ❖ VALE - IBM WRITING TO READ

Now Available! Books in Spanish to accompany Accelerated Reader Program.

One PERMA-BOUND book will outlast seven to ten paperbacks at about one-third the cost-and they're unconditionally guaranteed. If you're ever dissatisfied with a PERMA-BOUND book for any reason we'll replace it.

34

VANDALIA ROAD ❖ JACKSONVILLE, ILLINOIS 62650

CALL TOLL FREE: 1-800-637-6581 TOLL FREE FAX: 1-800-551-1169

**PERMA-BOUND**

# American Indian Bilingual Education

Column Editor: Jon Reyhner, Northern Arizona University

## Replacing Thing-a-ma-jig

by Cindy May

**T**hing-a-ma-jig" is a word we use when we cannot recall the right word for something. In his book *Replacing Thing-a-ma-jig*, Jim MacDiarmid attributes our inability to recall such words to a faulty process of language acquisition. Our inability to recall a word not only affects our ability to communicate but also inhibits our ability to express the knowledge we possess. The author believes that meaningful language development is essential to the acquisition of knowledge, and he proposes his Developmental Language Process (DLP) as the way for teachers to aid their students' language development.

As the name implies, DLP is a *process*, not a *program*. As a process, DLP can be used to teach almost any concept. In fact, it is the development of a concept that is the first of the ten stages of DLP. The stages, which the author describes in detail, are: concept development, basic listening, basic speaking, listening comprehension, creative speaking, basic reading, reading comprehension, basic writing, creative writing, and extension activities.

Two types of skills are components of all stages of DLP. The first skill type is intellectual and includes the skills of comparing, contrasting, classifying and so forth. The second skill type is visual, including recognition/discrimination, memory, and sequencing.

DLP can be used with students of all ages and abilities. As the author points out, as students get older and "wiser," educators too often take shortcuts in their teaching process. They make assumptions concerning the ability of their students, especially limited English proficient (LEP) students, and omit what would be the first few stages of DLP. They assign content-based reading (Stage 7) and expect students to comprehend a new concept. They fail to first introduce the concept, motivate the students, make the learning relevant, provide concrete examples, and so forth, and then wonder why the students cannot comprehend the assigned reading. According to MacDiarmid, by being faithful to the ten stages of DLP teachers can increase the likelihood of student success.

The basic principle of DLP is the progression from concrete to symbolic to abstract. This progression helps the student to visualize a concept, which is just one part of DLP that would be especially helpful for instruction in a bilingual/multicultural setting. As MacDiarmid points out, teachers, especially secondary teachers, often rely almost exclusively on one of the most abstract vehicles for teaching, the textbook.

In the first four chapters MacDiarmid provides an explanation of each of the stages of DLP and a practical example of how each stage can be applied in the classroom. In each of the remaining chapters the author addresses the relationship between DLP and a specific area of education including reading, whole language, phonics, high frequency words, grammar, bilingual education,

and assessment.

In the chapter on bilingual education and biculturalism the author makes use of the stages of DLP as a means to incorporate multiple languages and cultures in the teaching/learning process. For the beginning second language (L2) learner, L2 is used in only Stage 2 (Basic Listening) and Stage 3 (Basic Reading). As the learner acquires the second language other stages are added. Although DLP is not specifically designed for second language learners, the author's primary experience is with the Inuit of Northern Canada, and it is with their needs in mind that many of the practical applications of DLP are made.

The book has ten short chapters describing DLP and over 100 pages of sample activities for language and skills development for each of the ten DLP stages. The last 80 pages of this 353-page book include sample lessons and templates, a story unit, word lists, a list of language concepts, and an informal reading inventory.

After reading the book and personally applying some of the activities, I believe the design of the Developmental Language Process is such that it can be successfully used with second language learners. The structure and logical progression of the process along with the concrete hands-on activities provide the additional tools often needed by second language learners.

Good teachers use all of the stages of DLP some of the time, and some of the stages all of the time. The author would challenge us to increase our awareness and use of each stage. Incorporating DLP into our teaching strategies will add additional time to lesson planning, especially in the beginning, and to actual implementation of lessons. One question arises, especially from secondary teachers, as to how they will get through their required curriculum if they spend the extra time needed for DLP. This is the old depth versus breadth question with the added question of how important is it to cover the curriculum if LEP students are left behind in the process. I believe the increased time will produce positive results in student performance.

*Cindy May is completing a Masters Degree in Bilingual/Multicultural Education at Northern Arizona University. "Replacing Thing-a-ma-jig: The Developmental Language Process" (2nd Ed.) by Jim MacDiarmid was published in 1995 in Canada by the Lowe-Martin Group and is available from International Language Development Consultants Ltd., 2044 Arrowsmith Dr., Suite 304B, Gloucester, Ontario, Canada K1J 7V8.*

**Editor's Note:** Contributions to the American Indian Bilingual Education column should be sent to Jon Reyhner, Center for Excellence in Education, Northern Arizona University, P.O. Box 5774, Flagstaff, AZ 86011-5774, or E-mail to: jon.reyhner@nau.edu, (520) 523-0580, fax: (520) 523-1929.

# Upcoming Events

**November 21-26, 1996 - National Council of Teachers of English Annual Convention.** Chicago Hilton and Palmer House. Contact Don Robbins at (217) 328-3870.

**November 22-24, 1996 - Annual Conference of the American Council on the Teaching of Foreign Languages.** Philadelphia, PA. Contact ACTFL at 6 Executive Plaza, Yonkers, NY 10701-6801 (914) 963-8830.

**December 8-11, 1996 - International Early Childhood Conference on Children with Special Needs.** Hyatt Regency/Phoenix Civic Plaza, Phoenix, AZ. Contact Council for Exceptional Children at (410) 269-6801.

**December 27-30, 1996 - National Science Teachers Association Global Conference.** San Francisco Convention Center. Contact Ellie Snyder at (703) 243-7100.

## NABE '97

February 4 - 8, 1997

Albuquerque,  
New Mexico

## Research & Evaluation Special Interest Group *Call for Presentations*

NABE's Research and Evaluation Special Interest Group (SIG) is sponsoring two 2-hour poster sessions at the NABE '97 Conference in Albuquerque. The two poster sessions will be held on Friday, February 7 and Saturday, February 8 from 3:30 pm - 5:30 pm. Besides the actual poster display, we will have presentations of 30 minutes in length, with 20 minutes for each presenter and 10 minutes for discussion with the audience.

Interested persons are invited to submit proposals for these two sessions. The proposal should contain a 150-word abstract which (1) includes the title; (2) defines the topic; and (3) describes the objectives, methodology, and significance. Emphasis is on empirical research or well-documented theoretical or practical perspectives.

Name of Presenter(s): \_\_\_\_\_

Affiliation: \_\_\_\_\_

Address: \_\_\_\_\_

Phone: \_\_\_\_\_ Fax: \_\_\_\_\_ E-mail: \_\_\_\_\_

DUE DATE: DECEMBER 16, 1996

SUBMIT TO: Dr. Virginia González, NABE Research & Evaluation SIG Chair  
Department of Educational Psychology  
College of Education  
The University of Arizona  
Tucson, AZ 85721

Phone: (520) 621-1549

Fax: (520) 621-2909

E-mail: virginia@ccit.arizona.edu

# Asian/Pacific American Education Concerns

Column Editors: Ji-Mei Chang, San Jose State University, CA, and  
Janet Y. H. Lu, ARC Associates, Inc., Oakland, CA

## *Critical Problem Posing: An Empowering Literacy Intervention*

by Judy Sugishita

To honor Asian Pacific Heritage Month, a San Francisco-based Asian community group held a writing contest in which they invited young people to submit their literacy "voices and visions" of "Growing Up Asian in America" (*San Jose Mercury and News*, May 21, 1996, pp. 1D, 6D). Over 1500 entries were received, with organizers commenting that "Many teens welcomed the opportunity to describe their experiences growing up in this country — a topic they said they often didn't get a chance to broach at school or at home" (*San Jose Mercury and News*, May 23, 1996, p. 1D). The published entries revealed powerful personal stories written around such themes as discrimination, difference, poverty, and the struggle of selves. Indeed, they affirmed the desire of many Asian youths to voice their feelings and experiences associated with growing up as a minority in a white-dominated society.

The writing contest met a social and educational gap similar to the broader educational problem I investigated in my research of the literacy methodology known as "critical problem posing." Problem posing, a teaching strategy that integrates writing and reading instruction into a multidisciplinary curriculum, is based on the critical study of social themes and topics derived from students' own life knowledge and experiences. Like the literacy contest, problem posing offers students a venue to express their own knowledge and opinions around topics personally meaningful to their lives. Although this methodology has been researched in the context of adult education, few studies have taken it to the elementary classroom setting. The purpose of my qualitative ethnographic study, therefore, was to engage a group of five fifth-grade Vietnamese students in the process of critical problem

posing in order to record their voices, literacy growth, and increased empowerment as students and citizens in a democratic society. Below are details of the research plan, theoretical rationale, methodology, procedural implementation, and educational implications of this investigation.

### **Theoretical Rationale and Qualitative Research Questions**

Grounded in the educational movement known as the critical postmodern paradigm, problem posing is a pedagogy that changes the emphasis of classroom instruction from teacher-centered to student-centered learning. Giroux (1991) calls this shift in educational rationales a "border revolt," in which postmodern teachers relinquish their long-held claim to power, voice, and knowledge in their classrooms and allow students to create new knowledge through discussion, dialogue, recursion, and reflection.

Critical postmodern educators such as Doll (1993), Freire (1970, 1973), Giroux (1991), and Shor (1992) further maintain that education is linked to white-dominant political, social, and economic systems. Further, Cummins (1986), Kozol (1992), McLaren (1989) and Ogbu (1978) are among those who maintain that political and economic influences in schools negatively affect nondominant-student academic performance in covert, but significant ways. Ogbu (1978) theorizes that there exists a "contextual interaction" between the student, the school, and the outer society that is a causal factor of school failure.

Postmodernists who subscribe to the contextual interaction theory of language-minority student (LMS) school failure reject the notions of student genetic inferiority and cultural deficit. Post-modernists promote democratic respect for and tolerance of minority students' language and cultural beliefs in their classrooms. These

educators confront the inequalities and inequities in American school and social life by engaging students and their fellow professionals in discussions that help expose and correct those problems.

Dewey (in Baker, 1966) first coined the term "problemizing" to describe this practice of critically examining and openly discussing schools and social problems. More recently, the libertarian Brazilian educator Freire (1973) coined the term "problem posing" to describe this literacy strategy. The Freirian (1970) five-step process of critical problem posing involves:

- 1) gathering student histories;
- 2) selecting generative (emotion-laden) words and themes;
- 3) using picture codifications of situation-problems;
- 4) reflecting and dialoging within a loosely constructed agenda; and
- 5) using discovery word cards or thematic instruction to advance literacy instruction, social activism, and citizenship.

Central to problem posing is the examination of broad social themes and topics. Three of these critical themes: knowledge and power, culture and race, and voice in schools and society, helped to frame the questions brought to this study, including:

- 1) Knowledge and Power: What culturally specific understandings do Vietnamese LMS hold regarding knowledge ownership in schools and how do those beliefs affect their school and social interactions and achievement?
- 2) Culture and Race. What "gaps" or shortfalls exist between school and social realities versus the American ideals of democratic opportunity, equality, equity, and freedom, as perceived by Vietnamese LMS?
- 3) Minority Student Voice. What

CONTINUED ON PAGE 8

problems do Vietnamese LMS voice and what problems are silenced by the dominant power forces found in schools and the outer society?

### Critical Qualitative Ethnography

The personal nature of these study questions required finding a research methodology that would allow a close and cooperative relationship to be established between participants and the researcher. The qualitative ethnographic research methodology facilitates this kind of co-researching relationship to develop in the context of long term field studies. By spending many months getting to know my participants in the context of their school and home lives, I was able to move from the status of a detached outsider to that of a trusted co-learner, advocate, and mentor.

Research data were collected in this study using a variety of qualitative sources including lessons, personal interviews, and my own research notes and observations. This multidimensional collection strategy provided a contextual and holographic image of the realities that participants experienced at school, at home, and in the community. In the following section, I describe the procedural implementation of problem posing and my use of qualitative research methods in gathering and recording the powerful stories of human struggle and survival unveiled by my participants.

### Research Setting, Participants, and Implementation

This study was conducted in a San Jose, California public elementary school from January to May of 1995. The research participants, two boys and three girls, spoke Vietnamese at home and were classified as language minority students. The implementation of this study took place during small group sessions held three times weekly for 45 minutes. My procedural design followed the basic format of the five-step Freirian problem posing model described above. I began the first phase of the process, the gathering of student histories, by sharing my own personal and professional history with the participants. During this session, I showed pictures of my family and encouraged participants to

ask questions about my life. The literature book, *Dear Mr. Henshaw* (Cleary, 1983) provided examples of personal inquiries that were redirected at the participants. Some of these questions included: (1) What is your family like? (2) Where do you live? (3) What bothers you? and, (4) What do you wish? Unfortunately, the students remained reluctant to share personal opinions and details of their lives and I was left with only glimpses of the fantastic stories I knew were hidden beneath their silence.

As we continued to meet, I encouraged the students to share their personal histories, hoping to move closer to Freire's (1970) second phase of problem posing: finding a generative, or emotion-laden topic. After many days of fruitless discussions, I realized that I needed a fun way to decontextualize my critical inquiries. I decided to create a game in which students worked with question cards and playing tokens as prompts for our discussions. The game worked beautifully! Questions such as, "What do you think is unfair about your home, school, and community life?" drew responses that were rich in details and insights. The specific question that prompted an emotional "generative" topic was, "How did your family come to the United States?" Initially, when the participant Ta drew this card he looked at it in silence. When I reminded him that he could pass on any question, he safely responded by saying, "I don't know how they came over here." This was a cue for another highly verbal participant, Mark, to say, "Well, I know how my parents came over!" As Mark excitedly shared his story, the other members of the group began adding what they knew of their families' escapes from Communist Vietnam. Stories of death and near-starvation were excitedly and unveiled. Interestingly, however, when I asked Mark if his parents often spoke of these events, he replied, "No, never! I don't even know how I know all this stuff!" The others nodded in agreement. I knew by these responses that we had broken the silence surrounding this painful and buried part of the Vietnamese American experience and that immigration would be our generative study topic.

Having uncovered a generative topic, we were ready to begin the third phase of the Freirian model: studying a picture codi-

fication of the situation problem. Intensive library research produced a newspaper article entitled "The End of a Dream" (*San Jose Mercury and News*, 3/17/96) which contained a picture of Vietnamese refugees clinging to the roof of a building, threatening to jump to their deaths if the U. S. government closed their resettlement camp and returned them to Vietnam. Discussion and reflection around this codification produced insightful journal entries, such as the one that read:

"I think at least some people should be able to immigrate over here. This country is supposed to be the land of the free. . . that means it will accept anyone. I really think we should live up to our name, don't you?"

After studying the codification and news article, I approached Freire's fourth problem posing step: creating a thematic study agenda. Using another article that described the imminent deportation of a Vietnamese military hero, Major Nguyen An, we continued to broaden our understanding of U. S. immigration and deportation laws. As we discussed An's plight, the participants grew eager to meet this local hero and, after many attempts, I arranged his visit to our school. This event marked our entry into the fifth phase of problem posing, reaching into the community, while also providing a dramatic culmination to our study.

### Educational Implications and Conclusions

During problem posing, the research group learned a lot about the topic of immigration and demonstrated their growth in personal empowerment and efficacy. For example, the study participants wrote and delivered a presentation on immigration to their fellow fifth-grade classmates. When An visited, they proudly used their home language to ask him questions about the Vietnam War. They smiled proudly as they sought An's autograph, and photographed him as he write with a pencil clamped between metal hooks. One participant visited a local Vietnamese community center to seek ways of starting a petition movement to support An.

# Resources for Bilingual Educators

**Common Values**, by Jewell Reinhart Coburn. These values-rich stories for student, parent and teacher feature multilingual content (English, Chinese, Hmong, Khmer, Lao, Spanish, Vietnamese). They are classroom ready, an instruction guide is included. They provide exciting tools for teaching values through folk stories, journal keeping and story writing. Includes: *Southeast Asian Trilogy: Beyond the East Wind* (10 Vietnamese stories), *Encircled Kingdom* (23 Lao stories, 1 multilingual) *Khmers, Tigers and Talismans* (8 Cambodian stories) and *Lani and the Secret Mountain*, a Chinese story about bravery and self-sacrifice. Contact Shen's Books and Supplies, 821 South First Avenue, Arcadia, CA 91006. <http://www.shens.com>.

**Conflicts in World Cultures**. Designed to accommodate language-minority students in sheltered social studies classes, this integrated language, social studies, and culture unit for middle school world studies classes explores the Incas and Spanish conquistadors, the Reformation, the opening of Japan to international trade, and the Ethiopian resistance to colonization. In each lesson students relate new information to prior knowledge, practice and apply new knowledge, and review what they have studied. The develop academic language skills through social studies vocabulary, reading, and writing tasks. All lessons emphasize student participatory activities and the cooperative learning approach. Student readings, cartoons, worksheets, and graphic organizers are included, as are instructions and materials for sentence strip activities, role plays, craftwork, jigsaws, and background information for the teacher. \$15.00 + 10% shipping and handling. Send check or purchase order to the National Center for Research on Cultural Diversity and Second Language Learning, Center for Applied Linguistics, 1118 22nd Street, N.W., Washington, DC 20037. (202) 429-9292.

**Integrating Language and Culture in the Social Studies: A Training Packet**. This packet of materials is designed to help trainers prepare social studies and English as a second language teachers to teach social studies material to language-minority students and to use the curriculum unit, *Conflicts in World Cultures*, and lesson design in the classrooms. The packet provides a sample training session agenda and familiarizes the teachers with the approach of integrating language and content instruction. The packet shows teachers how to help students explore, learn, practice, and verify social studies knowledge while developing their English language skills. \$8.00 + 10% shipping and handling. Send check or purchase order to the National Center for Research on Cultural Diversity and Second Language Learning, Center for Applied Linguistics, 1118 22nd Street, N.W., Washington, DC 20037. (202) 429-9292.

**Looking In, Looking Out: Redefining Child Care and Early Education in a Diverse Society**. This report provides new research and insights regarding 1) the implications of our changing demographics for the role child-care plays in supporting the

well-being of children and families; 2) principles of care regarding race, culture, language, dialogue, and partnership with parents which every program can and should implement; 3) effective classroom strategies for addressing racial, cultural, and linguistic diversity in child care settings; 4) professional development, recruitment and training strategies related to the principles; and a call for dialogue and action throughout the early childhood field. \$27.00 + shipping and handling, discounts for quantity. Contact California Tomorrow, Fort Mason Center, Building B, San Francisco, CA 94123 (415) 441-7631.

**The Metamorphosis of English: Versions of Other Languages**, by Richard M. Swiderski. The author expands and extends our understanding of the "predatory" aspects of the English language as he shows how English acquires and is transformed by the myriad other languages with which it comes into contact. Swiderski's examples begin with major world languages, especially Spanish and Chinese, and then go on to look at the less considered connections with remote and extinct languages. Through Swiderski's lens, English takes on the look of an agglutinative museum of linguistic artifacts in danger of having no describable identity or common fabric. Each speaker's variety of English is as individual as his/her genetic makeup; it is both so universal and so dissimilar that "English" as we know it may be endangered as a separate language. \$49.95. ISBN: 0-89789-468-5. Contact Greenwood Publishing Group, 88 Post Road West, Westport, CT 06881-5007 (203) 226-3571 x 391.

**Native Voices Online**. Offers insightful articles on Native Voices and its award winning film library. The Native Voices Home Page provides a quick and easy way to order films and to find more out about the program and its members. [NV@sesame.kusm.montana.edu](mailto:NV@sesame.kusm.montana.edu).

**Of Borders and Dreams: A Mexican-American Experience of Urban Education**, by Chris Liska Carger. This is the story of Alejandro Juárez, Jr., a Mexican-American youth, his family, and their experiences in a bureaucratic and frustrating public school system. The story follows Alejandro and his ESL teacher, Chris Carger, as she sets forth with his mother on a journey to provide him with the education he needs and deserves. ISBN: 0-8077-3522-1. Contact Teachers College Press, 1234 Amsterdam Avenue, New York, NY 10027.

**Transitions**, by Darrell Kipp and Joe Fisher. This film by Blackfeet producers explores the relationship between language, thought, and culture, and examines the impact of language loss in native American communities. The film chronicles the disappearance of the Blackfeet tribal language during the period of 1890-1990, with an analysis of why the Mother tongue was destroyed. The film points out the tremendous loss that is only now beginning to be realized not only by tribal members but the society around them. The film also illustrates the commonality of language loss

Through problem posing, the participants began to explore the silence that surrounded the Vietnamese American history and understand their place in American society. They began to appreciate the struggles that confronted their immigrant parents and started to see them as problematic in a society that claimed to be democratic and equal to all citizens. For the first time, they read about a war that was not discussed in their history textbooks and confronted a Vietnamese hero who had helped save American lives during that silenced part of American history. Through problem posing, the participants celebrated their cultural history in a transformative way.

Postmodern critical teachers do not condemn the American way of life in their critical examination of its problems. Rather, by using problem posing with their LMS, they are empowered to affect change and transformation in themselves, their students, their society, and in their world. In short, critical postmodern teachers enlighten and activate reforms by confronting problem and realities through the dialogic and recursive process of examination, reflection, and knowledge creation. I close with the hope that educators of the twenty-first century will engage in critical teaching as described below by Freire (1973):

"Democracy and democratic education are founded on faith in men, on the belief that they not only can but should discuss the problems of their country, of their continent, their world, their work, the problems of democracy itself. Education is an act of love, and thus an act of courage" (p. 38).

#### References

- Baker, M. C. (1966). *Foundations of John Dewey's educational theory*. New York: Atherton Press.
- Cleary, B. (1983). *Dear Mr. Henshaw*.

New York: Dell.

- Cummins, J. (1986). *Empowering minority students: A framework for intervention*. Harvard Educational Review. 18-36.
- Doll, W. E., Jr. (1993). *A post-modern perspective on curriculum*. New York: Columbia University Press.
- Freire, P. (1970). *Pedagogy of the oppressed*. New York: Seabury Press.
- Freire, P. (1973). *Education for critical consciousness*. New York: Seabury.
- Giroux, H. A. (1983). *Ideology culture and the process of schooling*. Philadelphia: Temple University Press.
- "Growing up Asian in America." (1966, May 21). *San Jose Mercury and News*. pp. 1D, 6D.
- Kozol J. (1992). *Savage inequalities: Children in American Schools*. New York: Harper Perennial.
- McLaren, P. (1989). *Life in schools: An introduction to critical pedagogy in the foundations of education*. New York: Longman.
- Ogbu, J. (1978). *Minority education and caste: The American system in cross-cultural perspective*. New York: Academic Press.
- Shor, I. (1992). *Empowering education: Critical teaching for social change*. Chicago: The University of Chicago Press.
- "The end of a dream: U. N. tells boat people to give up hope of asylum." (1995). *San Jose Mercury and News*. pp. 1A and 26 A.

*Judy Sugishita is an ESL teacher, doctoral student at the University of San Francisco, and educational researcher affiliated with the Academy for Critical Research, San Jose State University.*

**Editor's Note:** Contributions to the Asian/Pacific American Education Concerns column should be sent to Janet Lu, MCR/NC, 1212 Broadway, #400, Oakland, CA 94912. (510) 834-9438, FAX (510) 763-1490. Email: janet\_lu@arcoakland.org

• NABE •

Readers are welcome to reprint any NABE NEWS original material free of charge as long as proper credit is given to both the author and NABE NEWS as the source.

amongst Indian tribes and other groups in America. 30 minutes. \$99.95 1/2" VHS (educational use); \$149.95 3/4", \$39.95 1/2" VHS (home use only); \$4.00 Teacher's study guide. Contact Native Voices Public Television, VCB Room 222, Montana State University, Bozeman, MT 59717 (406) 994-6218.

**Under Attack The Case Against Bilingual Education**, by Stephen D. Krashen. In this empirically grounded monograph, Stephen D. Krashen answers the critics of bilingual education. His book examines the following issues: 1) Does the research show that bilingual education doesn't work? (No); 2) Is English in trouble? (No); 3) Are most parents and teachers against bilingual education? (No); 4) Will bilingual education work for languages other than Spanish? (Yes); 5) What about those who succeed without bilingual education?; 6) Is bilingual education good for English? (Yes!); and 7) Can bilingual education be improved? (Yes!). ISBN: 0-9652808-2-9. \$16.00 + \$3.00 shipping; CA residents add 8.25% sales tax. Contact Language Education Associates, P.O. Box 7416, Culver City, CA 90233. Fax (310) 568-9040.

All resources are listed solely for the information of the NABE membership. Listing does not imply endorsement of the resource by the National Association for Bilingual Education. For more information about any listed resource, contact the publisher directly.

• NABE •

## Correction

NABE News apologizes to Susan M. Poglinco, author of the review of *Affirming Diversity* in NABE News v. 20, #1, for misspelling her name and incorrectly listing her affiliation. Ms. Poglinco is a Research Associate with MDRC (Manpower Demonstration Research Corporation) in New York City.



# NABE NEWS Book Reviews

Column Editor: Dr. António Simões, Fairfield University, CT

## *Brave New Schools: Challenging Cultural Illiteracy Through Global Learning Networks*

*Reviewed by Sonia Nieto*

*Brave New Schools: Challenging Cultural Illiteracy Through Global Learning Networks* by Jim Cummins and Dennis Sayers. (1995) New York: St. Martins Press, 372 pp.

Think of the pivotal issues defining education in the United States at the end of the twentieth century, and three will likely come to mind: school reform, cultural and linguistic diversity, and educational technology. Although all three are often reflected in the news, and discussed extensively in schools and communities, they are rarely spoken of in the same breath. The effectiveness and quality of our schools has been a primary concern of many citizens, especially since the much-ballyhooed *A Nation at Risk* was published in 1983. An equally riveting and even more contentious issue is the growing cultural and linguistic diversity of our nation, and consequently of our schools. The educational ramifications of this increasing diversity have been far-reaching, from legislation requiring schools to deny educational access to immigrant youths, to calls to abolish bilingual education. Finally, technological advances taking place at a frenetic pace are proving to be either inspiring or intimidating to educators because of their potential impact on teaching and learning.

*Brave New Schools* is a book different from any other that I have read because it attempts to focus in a central and connected way on all three of these concerns. Given the fragmented way in which educational reform, diversity, and technology have been treated until now, it is a noble and important attempt, and the result is well worth the effort. The authors of this volume, Jim Cummins and Dennis Sayers, have written a thoroughly researched,

highly readable book that provides a remarkably cohesive and comprehensive treatment of what may at first seem irreconcilable issues. I believe they are successful for three major reasons. First, both Cummins and Sayers are well known in their respective fields as well as for their progressive views on education in general. This combination brings both an intellectual authority and a committed passion to the book. Jim Cummins is an internationally recognized leader in the area of cultural and linguistic diversity, especially in bilingual education, and Dennis Sayers has been a pioneer in global networking for classroom use, particularly among bilingual/bicultural communities. Whatever their individual endeavors, however, they have both been concerned primarily with the moral imperative of education. Their orientation to social Justice and equity in education is evident on every page of this book. For example, they are keenly aware that technology can either improve or worsen the existing educational disparities between rich and poor children. Thus, they make it clear at the very outset that technology must be seen as a means to an end, never as an end in itself. As they state in their introduction, "The kinds of intercultural collaboration we are proposing derive their impact and momentum not from technology but from a vision of how education can enact, in microcosm, a radical restructuring of power relations both in domestic and global arenas" (p. 6).

Second, the book is also successful because Cummins and Sayers provide a theoretically grounded discussion and critique of current educational reform efforts as well as a fascinating history of intercultural learning networks. They argue that educational reform can only be effective when the underlying causes of underachievement, causes inextricably linked to social inequality, are actively challenged. One way in which this can be

done, as they illustrate in their book, is through teaching partnerships across cultures that take advantage of culturally appropriate education and communications technology. But, as Cummins and Sayers repeatedly remind readers, communications technology need not be limited to the Internet, which may be inaccessible to many classroom teachers. Communication can take place through the regular postal service, audio and videotapes, and simple letters. Teaching and learning partnerships are not, however, simply new versions of the rather passive practice of writing to "pen pals;" instead, these partnerships result in cultural exchanges and joint projects that focus on burning issues of concern to students in different geographical locations. These projects tend to be successful because achievement and critical inquiry are promoted by captivating student interests and building on their cultural and linguistic strengths.

To illustrate the point, Cummins and Sayers review the history of the intercultural learning networks founded by Celeste Freinet, a rural teacher in southern France who, in 1924, was the founder of the Modern School Movement which remains the largest long distance global learning network in history, and Mario Lodi, an educator who adapted Freinet's ideas to Italian schools in the 1950s. Making this history available to readers in North America is one of the greatest contributions of the book because until now most educators here have had little or no knowledge of these pioneering educators. Yet the legacy of Freinet and Lodi is a rich one that can still be seen in classrooms around the world. Furthermore, one is reminded when reading the words of Freinet and Lodi that much of what is touted as "progressive" or "transformative education" has a long history indeed; it did not begin in the 1990s, or even in the 1970s, when

CONTINUED ON PAGE 12

such innovations as the "Open Classroom," bilingual education, and other educational alternatives were instituted. In the writings of Freinet and Lodi, one hears the same committed passion as one reads in Paulo Freire, Sylvia Ashton-Warner, and others who came later. Both Freinet and Lodi, for instance, were concerned with respecting and using their students' cultures and languages in the project of their learning, thus building bridges between their home and school cultures. Both of these educators were equally committed to placing their students' writing and reading within significant, goal-directed, and critical inquiry. These concerns are remarkably familiar to anybody who espouses critical literacy, bilingual education, and teaching with a multicultural perspective.

The third reason for the success of this book is the eminently useful guide to the Internet for parents and teachers included in the second part. Rather than just a technical guide, however, it's placed within a transformative pedagogical orientation, one that is explicit in its objective to prepare students to participate meaningfully in the democratic process. The authors first review "collaborative" versus "coercive" relations of power, and then sketch a scenario in which Olga Reyes, a fictional fifth-grade teacher and involved parent, learns to use the Internet both in her own classroom and in her role as a parent. The authors lead the reader through several explorations that Ms. Reyes has on the Internet, explaining each step of the way and indicating how the resources she discovers can be used for enhancing classroom instruction, establishing long-distance networks, and for advancing her own

professional development. Even the timid Internet user and those who are unfamiliar or intimidated by it will benefit from this sketch. Finally, Cummins and Sayers end their book with an extensive and impressive list of Internet Resources for teachers and parents, and with suggestions for specific problems they may encounter.

The vision that is evident throughout *Brave New Schools* is one of hopeful and positive change. Given the sometimes overwhelmingly negative messages found in even the most radical and progressive education books, this is indeed a welcome vision because it focuses on what teachers and parents *can* do rather than on only the obstacles they need to confront. The obstacles are real ones, and Cummins and Sayers do not downplay or avoid them. Obstacles notwithstanding, however, teachers, students, and parents need to be motivated by the terrain of possibility, a terrain in which all students are capable of high quality learning that springs from their particular cultural framework and can lead to critical and collaborative inquiry. In this sense, Chapter 2 (From the Inner City to the Global Village) is the most inspiring part of the book. Here, eight portraits of "brave new schools" that have established long-distance teaching partnerships are described. These portraits graphically illustrate how teachers and students use communications technology to build literacy and intellectual skills as well as to promote intercultural understanding and solidarity. They include an international proverbs project (part of *De Orilla a Orilla*, a network co-founded by Sayers) that not only compiled and compared proverbs from a variety of cultures, but also critically analyzed them; a project in which a single letter written by a Bosnian youngster in a refugee camp in Croatia and sent through a modem had a dramatic impact on other children around the world; and a partnership in which children from a number of countries collaborated to help bring rope pumps to a community in Nicaragua. These are poignant examples of how technology can be used to foster critical inquiry and social change, and they are the very heart of this important book.

Technology is too often either embraced or dismissed uncritically by educators, but Cummins and Sayers demonstrate in their book that this can no longer be the case. If we are serious about providing an excellent education that builds on the backgrounds, experiences, and interests of students and that helps promote critical and collaborative inquiry, then we need to become advocates for using technology for progressive rather than merely functional ends. That is, the major message of this book, and it is a message that needs to be heard and heeded immediately.

*Sonia Nieto teaches at the University of Massachusetts, Amherst.*

• NABE •

• BILINGUAL RESOURCES • ART ACTIVITIES • ASSESSMENT •  
 • LESSON PLANS • LANGUAGE ARTS • MAPS • POSTERS • VHS PROGRAMS • TIMELINES •  
 • PUPPETS • TEACHING BOARDS • GAMES • TEACHER GUIDES • STUDENT BOOKLETS

*Imagine...*  
*bringing the woodcarvers of*  
*Oaxaca, the yarn painters*  
*of the Sierra Madres, and*  
*the weavers of Guatemala to*  
*your classroom!*



Let CRIZMAC's bilingual resources bring the art and culture of the world to you.

Call 1-800-913-8555 today to place your order.  
 For your free catalog, call or write to  
 CRIZMAC Art & Cultural Education Materials  
 P.O. Box 65928 • Tucson, AZ 85728-5928  
 • COMPUTER SOFTWARE • DISCUSSION QUESTIONS • FOLK ART •

**NABE '97**  
 February 4-8, 1997  
 Preregistration deadline is December 15th!  
 Call (202) 898-1829 for materials.

# The Language Profession

Edited by The Joint National Committee on Languages (JNCL)

## *When the Pendulum Swings, Who Gets Cut?*

by J. David Edwards, Ph.D.

The 104th Congress has adjourned *sine die*. This Congress was unique in a number of aspects: 1) the 1994 "Republican revolution" took control of Congress away from the Democrats for the first time in over four decades; 2) the "Contract with America" clearly detailed a Republican congressional agenda quite different from that of the minority party and the Administration in power; 3) significant ideological differences over the role of the federal government in accomplishing the Constitution's mandate "to promote the general welfare" resulted in financial gridlock, governmental shut-downs, and a series of impasses between an activist House, a moderate Senate and a committed Administration; 4) strong House leadership bolstered by influential new first and second term Representatives challenged traditional House rules and moderate Committee Chairmen to pursue an ambitious legislative agenda; and 5) with elections approaching, the "centrist" nature of the democratic process, the moderation of the Senate and the surprising determination of the White House achieved compromises that produced national policies.

What does this mean for education, languages and international education? While we are not as well off as we were in 1994, our programs, funding and reforms continue to exist. The House's attempts to eliminate the Department of Education, the National Endowments for the Arts and Humanities, international education exchanges, and education reform were unsuccessful. The House leadership and its allies were not able to make good on their boast that Goals 2000 and the Clinton education reforms would be "killed in the cradle."

Among the small federal education programs of importance to our profession that were targeted for elimination through bud-

get reductions, but survived, were: professional development (\$310 million); star schools (\$30 million); foreign language assistance (\$5 million); international education exchange (\$5 million); and the national writing project (\$3 million). A number of programs that were seriously reduced in last year's budget fiasco were restored for FY 1997: education for the disadvantaged (\$7.7 billion); bilingual education (\$157 million); immigrant education (\$100 million); adult education (\$355 million); higher education financial assistance (\$7.6 billion); international education and foreign language studies (\$60 million); research (\$73 million); FIPSE (\$18 million); FIE (\$40 million); and education technology (\$267 million).

Finally, the House passed the English Language Empowerment Act making English the official language of the U.S. government, but it died in the Senate. Legislation to phase out the National Endowments over the next few years never got out of committee. The Senate rejected the House-passed Gallegly Amendment prohibiting public education to the children of illegal immigrants as part of the immigration reform compromise approved in the final days of the 104th Congress. As the result of serious disagreements, block grant proposals passed by both the House and Senate dealing with vocational and adult education languished in a conference committee.

Another implication of the political climate since 1994 is that in many instances state and local politics have mirrored national politics, or vice versa. Budget reductions, fiscal conservatism, devolution, and attacks on social programs including education, have resulted in a further diminution of resources and faltering reforms. While a majority of the states have developed guidelines that reflect the national

standards, concerns about assessment, equity, technology and, perhaps most pressing, professional development, have been put on hold. Professionally, within the education community, competition for scarce resources has exacerbated policy differences and produced political trade-offs. Within the language and international studies communities the need to defend current initiatives, reforms and policies has required much of our attention and organizational resources inhibiting our ability to get on with addressing the concerns of the twenty-first century.

In the United States, extreme swings of the political pendulum are often corrected within one or two election cycles. The compromises that characterized the end of the 104th Congress may indicate that the political system is beginning to adjust. On the other hand, moves toward the political center during an election year are not unusual. Consequently, it is our responsibility as citizens, parents, and educators to determine where the candidates really stand on the issues of importance to our nation, our children and our students and to hold them accountable once elected.

*Dr. J. David Edwards is the Executive Director of JNCL-NCLIS.*

**Editor's Note:** *The Joint National Committee on Languages/National Council on Languages and International Studies represents more than 60 national and regional language organizations united in their support of language policies which promote the development of bilingualism by all Americans. NABE is a member of JNCL/NCLIS and NABE Deputy Director Nancy Zelasko serves as a member of the Board of Directors of JNCL.*

•NABE•

Subscribe to NABE's ACTIONALERT electronic mailing list to keep up to date with Congressional developments affecting education - send email to [cnabe@nabe.org](mailto:cnabe@nabe.org) with "subscribe actionalert" as the subject.



# NABE PRODUCTS ORDER FORM

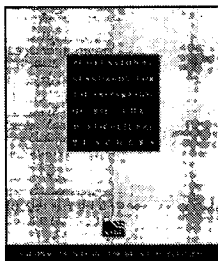

ITEM	PRICE	#	TOTAL
<b>Bilingual Research Journal</b>	\$13.00		
Vol. 19, #3&4, Spring/Summer 1995 Special issue: Role of ESL in Bilingual Education			
Vol. 19, #1, Fall 1994 Special issue: Native American Issues			
Vol. 16, #1&2, Spring/Summer 1995 Special issue: Ramirez study			
[ earlier issues available (call for details)]			
<b>NABE Annual Conference Journal</b>	\$7.00		
1989-90 issue			
1991-92 issue			
1993-94 issue			
<b>1996 Annual Conference Program</b>	\$5.00		
<b>NABE News</b>	\$5.00		
write issue date or volume/number here:			
write issue date or volume/number here:			
write issue date or volume/number here:			
[current volume always available; earlier issues may also be available (call for specifics)]			
<b>Professional Standards for the Preparation of Bilingual/Multicultural Education Teachers</b>	\$5.00		
<b>NABE logo pins</b>	\$5.00		
<b>NABE canvas tote bags</b>	\$7.00		
<b>VIDEO: Making Connections: Learning, Language and Technology</b>	\$7.00		
<b>TOTAL</b>			

- Prices include shipping by USPS first class mail. Special shipping available - call for pricing.
- Payment must accompany all orders. Make checks and purchase orders payable to NABE.
- Credit card orders may also be placed by phone (202 - 898-1829) during business hours.

## SHIPPING INFORMATION

Name \_\_\_\_\_ Company \_\_\_\_\_

Address \_\_\_\_\_

City/State/Zip \_\_\_\_\_ Phone \_\_\_\_\_

## PAYMENT INFORMATION

Check#: \_\_\_\_\_ PO#: \_\_\_\_\_ CC#: \_\_\_\_\_ ExpDate: \_\_\_\_\_

MAIL TO: NABE PRODUCTS, Suite 605, 1220 L Street NW, Washington, DC 20005-4018

# NABE NEWS Book Reviews

Column Editor: Dr. António Simões, Fairfield University, CT

## *Second Language Practice: Classroom Strategies for Developing Communicative Competence*

*Reviewed by Miriam Eisenstein Ebsworth, Ph.D.*

*Second Language Practice: Classroom Strategies for Developing Communicative Competence*, edited by Duquette, Georges. (1995). Bristol, PA: Multilingual Matters, Ltd., pp. 153.

**S***econd Language Practice: Classroom Strategies for Developing Communicative Competence*, edited by Georges Duquette, is a recent addition to the growing list of teacher references which seek to connect communicative theory with classroom practice. *Second Language Practice* is a collection of articles highlighting particular language skills and issues in communicative language teaching. In the introduction the editor stresses the need for clarity in how to implement communicative theory in the classroom and creates the expectation that *Second Language Practice* will provide it.

Despite this practical orientation, the chapters in Duquette's anthology are most successful in addressing the theoretical underpinnings of each issue addressed. For example, the first chapter of the book, written by Glenwood Irons, focuses on "Strategies for Beginning Listening Comprehension." The importance of listening is discussed along with the role of listening in various methodologies. Although the author of this chapter makes the somewhat naive statement that listening is hard to evaluate because it is a less "observable skill" than speaking, reading or writing," he does provide a substantial background section on listening com-

CONTINUED ON PAGE 16

### Book Review Submission Guidelines

Reviews for publication in the **Book Review** column and sample materials from publishers should be sent to the attention of Dr. Beti Leone, Book Review column editor, at NABE, 1220 L Street, NW, #605, Washington, DC, 20005.

Reviews may also be sent via e-mail to NABE\_NEWS@nabe.org.

Books from publishers should be clearly marked **BOOK REVIEW MATERIAL**; two complete sets of materials must be submitted.

## *Reflective Teaching in Second Language Classrooms*

*Reviewed by Thomas J. Foran*

*Reflective Teaching in Second Language Classrooms* by Richards, Jack C., and Lockhart, Charles. (1994). New York: Cambridge University Press, pp. 218.

**T**eachers in second language classrooms are constantly searching for ways to improve interactions with their students while instructors in teacher education programs try to locate texts for their courses that will enable pre- and in-service teachers to understand the complexities of second language methodology. *Reflective Teaching in Second Language Classrooms* by Jack C. Richards and Charles Lockhart provides for the above and goes far beyond what is presently on the market in this field. What makes this text special is its emphasis on the reflective approach. Richards explains: "Reflective teaching goes hand-in-hand with critical self-examination and reflection as a basis for decision making, and teachers' and learners' roles" (p. ix).

The metacognitive or reflective aspect of the book is especially evident in the Introduction and first two chapters (Approaches to Classroom Investigation and Teaching, and Exploring Teachers' Beliefs). Here the reader is asked to answer specific questions about teaching before going into what the teaching process is meant to be. Each question is then followed by a notation showing the chapter in which this area of teaching is discussed. This overview is very helpful not only for the reader but for use as a planning tool for the instructor using the text in a class situation. All the techniques used later in the text fall under the following five assumptions cited in the Introduction:

- An informed teacher has an extensive knowledge base about teaching.
- Much can be learned about teaching through self-inquiry.
- Much of what happens in teaching is unknown to the teacher.
- Experience is insufficient as a basis for development.
- Critical reflection can trigger a deeper understanding of teaching. (pp. 1-2)

Action research is one approach to classroom investigation from a list of six such approaches (Teaching Journals, Lesson Reports, Surveys and Questionnaires, Audio and Video Recordings, Observation, and Action Research) which Richards and Lockhart discuss in depth. This follows their focus on reflective teaching and outlines for the reader steps which can be followed in order to become involved in teacher-initiated classroom investigation. Appendix 7 (pp. 27-28), based on work done by Kemper

CONTINUED ON PAGE 26

prehension which goes on for about nine pages. However, actual information on classroom practice is limited to a one page outline of a course in which listening plays a role and a suggestion of two texts which include a listening component. The chapter ends with two additional pages of general discussion.

Unfortunately, this is one of many chapters in *Second Language Practice* that are deficient in the degree to which they actually provide teachers with concrete examples of how to design communicative practice for learners. The chapter on receptive skills teaching is another case in point. It consists of a background section followed by a discussion of objectives. Then a brief general outline of an activity is provided in terms of a framework from which lessons could be developed. Once again, the chapter is long on theory and short on concrete examples.

A much more successful chapter in this regard is the contribution of Christina Bratt Paulston and Gail Britanik on task-based group work. In this case a brief background section introduces a concrete discussion of classroom procedures followed by a number of specific classroom activities. Rich detail is provided so that teachers could adapt and create task-based group work for their second language students based on the models suggested.

The second chapter of *Second Language Practice* on increasing comprehension skills through listening and asking questions (by Bourque and Jaques) also devotes substantial time to examples of classroom activities. Nevertheless, this chapter presents a problem that relates to another claim made for *Second Language Practice*, that specific chapters and skills will address particular learner proficiency levels. In fact, one of the purported selling points of this book is that specific activities will be geared to each of five levels of adult second language proficiency. The "basic" stage is represented by levels 1 and 2, the "intermediate" stage, by levels 3 and 4, and the "advanced" stage by level 5. No additional clarification of these levels is offered, and any further definition of which learners fit into which levels is left to the reader to decide.

Chapter two is listed as appropriate for absolute beginners, i.e., level 1 students.

Real beginners are indeed an under-represented group and additions to the literature on appropriate communicative activities are welcome. But in light of the intended level, some of the activities suggested seem rather difficult. For example, based on 20 words from a story which has yet to be read, groups of four students must create a possible story. After reading the story, the students must determine which of the groups' original stories is closest to the actual story. This is a marvelous, creative, and communicative exercise. However, its appropriateness for beginners is questionable.

The remaining chapters in *Second Language Practice* are an assortment of theoretical perspectives and discussions followed by ideas for activities, outlines of activities, and in some cases actual examples of activities. Certainly, *Second Language Practice* contains much useful information for second language teachers. A reading of the book cover to cover will provide teachers with an understanding of communicative teaching principles as they apply to various skills and issues. In fact, Majhanovich and Hu do an excellent job of discussing the construct of communicative competence referent to grammatical accuracy and the complexity for pedagogy introduced by situational variables. These issues have been raised before, but they are relevant to the discussion. The suggested activities are traditional, namely peer interviews, problem-solving conversations, dialogue journals and debates, but concrete examples are given.

Under level 5, entitled "Refining Literacy Skills" is a chapter called "Correction of Speech Errors: Some Suggestions." This rather perplexing chapter which focuses on oral language recommends three kinds of corrections: gestural correction (pictures are provided), peer correction, and the echoing correction technique. Several of the suggested gestures are still unclear to this reader and some of the pictures were less illuminating than the written descriptions. Further, despite the communicative focus of *Second Language Practice*, the article begins and ends with a comment critical of communicative methodology for not providing sufficient error correction. The last sentence consists of an exhortation for L2 pedagogy to "try to

integrate different (communicative and grammatical) approaches" (p.111). Missing from this chapter is any reference to the debate about the degree to which error correction actually promotes interlanguage development (see Allwright & Bailey, 1991). Also absent is the crucial consideration that some of the American gestures suggested here to cue correction could have the potential to be misunderstood by learners from other cultures and must be introduced with care.

The final chapter of the *Second Language Practice* text, the only one not referenced as relevant to a particular level, deals with the issue of evaluation. Here Dicks and Rehorick describe the "MOCAP," an instance of a portfolio approach which they define broadly as a selection made by students and teachers intended to represent student performance. This chapter makes a real contribution to the existing literature. While portfolio use for writing assessment is well-known, its use in evaluating oral communication is less common. Thus, the MOCAP "thematically based evaluation package" is an interesting approach, worthy of consideration. This final contribution to *Second Language Practice* is clear and accessible.

Despite such exceptions, ultimately, the chapters of *Second Language Practice* represent a broad range of quality which taken as a whole do little to add to existing knowledge on communicative teaching or to present it in a novel way. Further, as we have seen, suggested activities are not as closely matched to learner level as the book's orientation indicates. In addition to the limitation of the chapters intended for beginning learners, most chapters addressed to intermediate and advanced learners while appropriate for them, could easily be adapted for other levels.

Texts for real beginners may indeed be scarcer than those for higher levels, but many books are readily available which will be helpful to a second language teacher who seeks to develop communicative practice for learners. For example, Krashen and Terrell's well-known text on *The Natural Approach* (1983) which is repeatedly referenced by author after author in *Second Language Practice* gives excellent examples of comprehension-based activi-

CONTINUED ON PAGE 30

# Technology and Language Minority Students

Column Editor: Dr. Dennis Sayers, University of California Educational Research Center

## *Partner Class Clearinghouses and Project-Oriented Activities*

by Dr. Dennis Sayers

There are basically two approaches to making global learning networks a reality in classrooms: 1) establishing team-teaching partnerships between as few as two teachers who tailor-make their activities to suit the necessities of their students; or 2) creating wider collaborations encompassing many classes, often in several countries, all of which agree to work toward a common learning goal based on a shared project. In this column, I summarize a number of the most successful efforts to establish global learning networks in either —and often both — of these directions. I have relied extensively upon an updated key section from the "Guide to the Internet for Parents and Teachers" found in *Brave New Schools* by Jim Cummins of the Ontario Institute for Studies in Education and Dennis Sayers of the University of California Educational Research Center.

### Academy One

The National Public Telecomputing Network (NPTN) works to establish "Free-Nets," which are public-access computer systems based in communities around the world (a complete listing may be found at [http://www.nptn.org:80/about.fn/By\\_State.txt.html](http://www.nptn.org:80/about.fn/By_State.txt.html)). Free-Nets share resources over the Internet, and one of their most active components is Academy One, a cluster of project-oriented activities for parents, educators, and students who have access to electronic mail. Recent projects have included: simulation projects such as NESPUT (National Educational Space Simulations Using Telecommunications); science- and math-oriented projects (Save the Beaches, the Bird Migration Watch, and Math Olympics); foreign language projects in French, German, and Spanish; and the NPTN Health and Wellness Clinic (physicians around the world respond to students' questions on medical issues). Contact Academy One at [info@nptn.org](mailto:info@nptn.org) or explore the NPTN Web site at <http://www.nptn.org/cyber.serv/AOneP/>

### BookRead Suite of LISTSERVs

**BR\_Match:** The BookRead Matchmakers LISTSERV run by Western Carolina University as a spin-off of the BookRead project which puts K-12 teachers and students in touch with authors. BR\_Match extends this idea by arranging for partner-class exchanges between teachers and students reading the same book. A low-cost project.

**Subscriptions:** [listproc@micronet.wcu.edu](mailto:listproc@micronet.wcu.edu)

**Participation:** [br\\_match@micronet.wcu.edu](mailto:br_match@micronet.wcu.edu)

**BR\_Review:** Devoted to student-authored book reviews, this LISTSERV also provides an archive of previous reviews.

**Subscriptions:** [listproc@micronet.wcu.edu](mailto:listproc@micronet.wcu.edu)

**Participation:** [br\\_review@micronet.wcu.edu](mailto:br_review@micronet.wcu.edu)

**BR\_Cafe:** A virtual "coffee shop" (or better yet, "milk bar") where students can discuss informally the books they are reading. In order to participate, a student must submit a review to the BR\_Review list as their "ticket of admission" to the BR\_Cafe.

**Subscriptions:** [listproc@micronet.wcu.edu](mailto:listproc@micronet.wcu.edu)

**Participation:** [br\\_cafe@micronet.wcu.edu](mailto:br_cafe@micronet.wcu.edu)

### Classroom Connect Teacher Contact Database

Building on teacher Sally Laughon's pioneering effort to place teachers in touch with collaborators around the world, *Classroom Connect* magazine has created a partner class registry, searchable by grade level and content area, that is updated daily.

**URL:** <http://www.classroom.net/contact/>

### DeweyWeb

Based on the John Dewey's philosophy of active learning, this World Wide Web site is sponsored by Interactive Communications and Simulations (ICS) and the University of Michigan. It provides activities to encourage students' awareness of global education issues, ranging from simulations to interactions with youth in other countries. A low- to moderate-cost project.

**URL:** <http://ics.soe.umich.edu>

### ELDERS

A discussion list on intergenerational learning that also matches young people with elder mentors. ELDERS is managed by Elaine Dabbs of Sydney, Australia and Pat Davidson of the Isle of Wight, United Kingdom. A no- to low-cost project.

**Subscriptions:** [listserv@sjuvm.stjohns.edu](mailto:listserv@sjuvm.stjohns.edu)

**Participation:** [elders@sjuvm.stjohns.edu](mailto:elders@sjuvm.stjohns.edu)

### European Schools Project

Perhaps the most ambitious telecomputing project in Europe, ESP links 300 secondary schools in 21 countries. Based at the University of Amsterdam and codirected by Profs. Henk Sligte, Pauline Meijer, and Aad Nienhuis, ESP is best known for its "Teletrips," which are multilingual projects between partner schools focusing on a common curricular topic. Teletrips are designed to foster collaboration between domain-specific teachers, foreign language educators, and educational computer specialists. Thus, a multilingual and intercultural focus is maintained throughout all ESP activities, much as in *Orillas* and I\*EARN projects (see below). Recent "teletrips" have centered on such controversial topics "The Image of the Other" (immigration issues in a European context), "Pollution," "Stories on World War II," "Power Plants," and "Water Quality."

**URL:** <http://www.educ.uva.nl/ESP>

### Global SchoolNet Foundation

From humble beginnings with the grassroots FrEdMail confederation of electronic bulletin boards, the nonprofit Global SchoolNet (GSN) Foundation is now a major force in educational networking, with corporate backing which helps to underwrite a range of no-cost services to educators and students. Founded by Al Rogers, a pioneer of educational telecomputing, GSN offers an entire range of networking activities and continues to define the philosophy, design, culture, and content of educational networking on the Internet. Its stated goals include the development of a low cost, community-based, distributed electronic data communications network owned by public agencies such as schools, libraries, cities, and other community service organizations, with the goal of providing all citizens equal and free or low-cost access to the basic tools of information access, retrieval, and transmission that are so important in our age of information.

Two GSN resources are especially useful for teachers interested in learning about promising multi-class projects available through e-mail and/or Internet access. HILITES is an e-mail based project announcement mailing list which can be joined by sending the message "subscribe hilites" to <majordomo@gsn.org>. Through this service, teachers can announce projects or receive project announcements from other teachers using a time-tested format provided by GSN.

**URL:** <http://www.gsn.org/gsn/proj/hilites/index.html>

To assist teachers in designing effective multi-class projects, GSN also maintains an archive of past projects.

**URL:** <http://archives.gsn.org/hilites/>

Finally, if a teacher has a web browser and Internet access and doesn't wish to receive e-mailings of project announcements, GSN maintains an up-to-date Projects Registry webpage, sponsored by Walden University, with upcoming multi-class projects organized by starting dates.

**URL:** <http://www.gsn.org/gsn/proj/index.html>

However, GSN provides services to educators far beyond e-mail based project announcements and registries. Chief among these is the Global Schoolhouse at <http://www.gsh.org/>, underwritten by Microsoft Corporation, where a range of advanced technology resources are being harnessed for classroom use. Soon to be announced features of the Global Schoolhouse include a registry of school webpages and a service to help teachers design effective webpages for their schools.

For more information on GSN and Global Schoolhouse, contact Al Rogers at <al@gsn.org> or visit the webpage.

**URL:** <http://www.gsn.org>.

### I\*EARN: International Education and Resource Network

The purpose of I\*EARN (the International Education and Resource Network) is to enable elementary and secondary students to make a meaningful contribution to the health and welfare of the planet. Its coordinators explain, "We want to see students go beyond both simply being 'pen-pals' and working on strictly academic work to use telecommunications in joint student projects designed to make a difference in the world as part of the educational process." I\*EARN is expanding to additional international sites and now includes about 500 schools in over 20 countries.

I\*EARN projects generally utilize three forms of interaction: (1) video-speaker telephones (low-cost, using regular telephone lines, slow-scan, black and white); (2) electronic mail; and (3) on-line conferencing exchanges.

Participants can join existing structured on-line projects or work with others internationally to create their own projects within the following subject areas: environment and science; arts and literature; social studies, economics, and politics; and interdisciplinary projects. Project facilitators provide on-line support for each project. Further, I\*EARN uses extensive on-line conferencing as a means of creating "rooms" for project work. The contents of these rooms are shared automatically with all the international networks that are part of the Association for Progressive Computing, thus minimizing costs and maximizing involvement by students and teachers around the world. Examples of recent student projects include:

- "The Contemporary," a student-run international news magazine.
- "A Vision," an award-winning literary journal.
- "Planetary Notions," an environmental newsletter.
- "Liberty Bound," a human rights newsletter.
- "ICARUS," an ozone measurement project and newsletter.
- The Holocaust/Genocide Project and Newsletter.
- The Rainforest Project.
- Support for children in Bosnia and Somalia.
- Building wells for clean water in Nicaragua.
- The Family Project, a cross-cultural comparison to promote intergenerational learning.

This is a moderate-cost project. For more information, contact Ed Gragert, I\*EARN Director at ED1@igc.apc.org; or you can get additional information at the webpage, or contact them at International Education and Resource Network (I\*EARN), 345 Kear Street, Yorktown Heights, NY 10598, Phone: 914-962-5864.

**URL:** <http://www.igc.apc.org/iearn/>

### IECC — Intercultural Email Classroom Connections Lists

IECC was originally a single LISTSERV but has grown so rapidly (presently, with 2,000 participants in 30 countries) that it has subdivided into five LISTSERVs, which will be described separately. They are:

- IECC
- Partner Class Announcement Service
- IECC-PROJECTS
- Multiclass Project Announcement Service
- IECC-SURVEYS
- Multiclass Survey Announcement Service
- IECC-HE
- Higher Education Partner Class Announcement Service
- IECC-DISCUSSION
- Discussion about Intercultural Exchanges

To receive daily e-mail announcements, send the word "subscribe" to the subscription addresses below. Each of these LISTSERVs is independent and has different goals; they must be subscribed to separately. A no- to low-cost project.



# Meet the NABE Executive Board

## *Adela Holder — NABE Parent Representative*

**A**dela Holder was born in Chihuahua, Chihuahua, Mexico. Her family moved to Juárez when she was three years old. She entered school in the United States for the first time as a twelve-year-old ESL student at El Paso Technical High School while continuing her secondary education in Juárez; and graduated from both high schools. She spoke no English when she entered El Paso Tech. One of her memories of her early days at Tech was that of receiving a failing grade in Spanish I. This was mystifying to her since she spoke, read, and wrote Spanish with the highest proficiency. It seemed she was not proficient in interpreting it into English which was how the teacher perceived Spanish should be taught.

Adela used her own experiences as a springboard to becoming an effective teacher of linguistics. She received B.A. and M.A. degrees from the University of Texas at El Paso and spent the first five years of her career teaching linguistics at that institution. Her students included many of the members of UTEP's national champion track teams who were learning English. Adela entered public school teaching as an English teacher at Socorro High School in Texas. She then worked with the Pecos and Kermit schools in Texas and in these positions helped develop formal bilingual programs. At Kermit she became the administrator of the bilingual and migrant program. She served two years as a consultant to a Title VII project working with five school districts in the El Paso, Texas area.

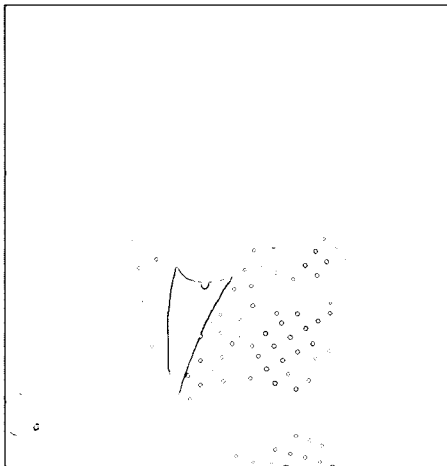

*Adela Holder,  
NABE Executive Board  
Parent Representative*

In 1990, Adela became an employee of the Silver Consolidated Schools in Silver City, New Mexico. She has served as the bilingual director for the district since 1991. In this capacity she has been instrumental in the development of the district's bilingual project. It has grown from serving 182 students in 1990 to 1,756 students in 1996. The training of inservice teachers to provide instruction to bilingual students has been recognized on a state and regional basis. This project has been presented to educators from California, Texas, Arizona and New Mexico.

Adela has been active in her state and national bilingual organizations. She currently serves as the President of the New Mexico Association of Bilingual Education. It is easy to get Adela into a conversation about her family. Her three children

have been and are enrolled in bilingual programs. Her oldest daughter, Ingrid, is a college sophomore studying to be a bilingual speech pathologist. Her son is a junior and her daughter a freshman in high school. All three of her children have met the criteria to be classified as bilingual students during their educational experiences. Her husband, Dr. Harrell Holder, is a pioneer in the field of bilingual education and has established programs from scratch in three districts where he has served as superintendent. Her only sister entered teaching as a bilingual instructor in 1995-96.

"The Holder family lives and breathes bilingual education on a daily basis," says Adela, "rarely do we spend even an hour without discussing the subject. We are always looking for new and better ways to improve our programs."

Adela believes that two language acquisition is a necessity for all students. "In our area it is difficult to function in most jobs with only one language. I do not view bilingual education as a compensatory program but rather as a program for everyone. Our schools need to be producing bilingual doctors, lawyers, engineers, social workers, and teachers. This is the future and I want to help our students achieve this goal. I pledge to use my influence as the Parent Representative on the NABE Board to help achieve this dream for our children."

◀ NABE ▶

## **Contacting NABE Electronically**

**You can currently contact NABE at a number of specific electronic mailboxes.**

**For general information or questions, write to [NABE@nabe.org](mailto:NABE@nabe.org)**

**To reach the Newsletter Department, write to: [NABE\\_NEWS@nabe.org](mailto:NABE_NEWS@nabe.org)**

**Conference-related mail should be sent to: [NABE97@nabe.org](mailto:NABE97@nabe.org)**

**Membership questions should be sent to: [MEMBERSHIP@nabe.org](mailto:MEMBERSHIP@nabe.org)**

**IECC:** Intended for teachers seeking partner classrooms for international and cross-cultural electronic mail exchanges. This list is *not* for discussion or for people seeking individual pen-pals.

**Subscriptions:** [iecc-digest-request@stolaf.edu](mailto:iecc-digest-request@stolaf.edu)

Once subscribed, teachers are welcomed to request for a K-12 partner classroom in an e-mail message to [<IECC@stolaf.edu>](mailto:IECC@stolaf.edu). Use a descriptive subject. For example:

“Seeking Spanish-speaking 9th-grade classroom” or “Looking for 12 6th-grade students in Pakistan.”

In the body of the message, be sure to include information about the local classroom and preferences for a partner classroom. IECC suggests giving the following details:

- Who you are, where you are
- How many students you have
- How many students you would like to connect with
- When you would like to connect
- Other special interests
- Desired country/culture (area within a country if appropriate)
- Desired language

**IECC-PROJECTS:** An electronic mailing list where people may announce or request help with specific multi-class projects that involve e-mail, internationally or cross-culturally.

**Subscriptions:** [iecc-projects-digest-request@stolaf.edu](mailto:iecc-projects-digest-request@stolaf.edu)

**Participation:** [iecc-projects@stolaf.edu](mailto:iecc-projects@stolaf.edu)

**IECC-SURVEYS:** Devoted to student questionnaires on a variety of topics

**Subscriptions:** [iecc-digest-surveys-request@stolaf.edu](mailto:iecc-digest-surveys-request@stolaf.edu)

**Participation:** [iecc-surveys@stolaf.edu](mailto:iecc-surveys@stolaf.edu)

**IECC-DISCUSSION:** Intended for general discussion about questions, issues, and observations in the Intercultural Email Classroom Connections.

**Subscriptions:** [iecc-discussion-digest-request@stolaf.edu](mailto:iecc-discussion-digest-request@stolaf.edu)

**Participation:** [iecc-discussion@stolaf.edu](mailto:iecc-discussion@stolaf.edu)

**IECC-HE:** The newest mailing list of the IECC suite of LISTSERVs intended for teachers seeking partner teachers in institutions of higher education for international classroom electronic mail exchanges.

**Subscriptions:** [iecc-he-digest-request@stolaf.edu](mailto:iecc-he-digest-request@stolaf.edu)

**Participation:** [iecc-he@stolaf.edu](mailto:iecc-he@stolaf.edu)

The IECC maintains a registry and informational website.

**URL:** <http://www.stolaf.edu/network/iecc/>

### KIDLINK

The KIDLINK global networking project focuses on youth from 10 to 15 years of age. Since 1990, KIDLINK estimates that 70,000 students from 88 countries have participated in their activities. Kidlink operates 25 public mailing lists in six languages at [<LISTSERV@LISTSERV.NODAK.EDU>](mailto:LISTSERV@LISTSERV.NODAK.EDU). The organization also operates a private network for interactive dialog (“chat”), and an online art exhibition site. The Kidlink mailing list is a read-only announcement service for the organization.

**Subscriptions:** [listserv@listserv.nodak.edu](mailto:listserv@listserv.nodak.edu)

**Participation:** [kidlink@listserv.nodak.edu](mailto:kidlink@listserv.nodak.edu)

KIDLINK announcement postings are archived on the World Wide Web.

**URL:** <http://www.kidlink.org/KIDLINK/listmail.html>.

For more information about Kidlink and its multi-lingual activities and projects, visit their main webpage.

**URL:** <http://www.kidlink.org>

### KIDSPHERE

The oldest of the Internet-based global learning networks, KIDSPHERE was formed by Robert Carlitz to provide a global network for the use of children and teachers in grades K-12. It is a very open forum. Parents and educators can expect discussion on a wide range of topics on every aspect of education, from the specifics of special projects to more expansive explorations of educational philosophy. KIDSPHERE is a monitored list (meaning that offensive or irrelevant messages are intercepted by a moderator). Most discussion takes place between teachers, but parents and students often appear. It is a very busy discussion group, and subscribers should be careful to “unsubscribe” if they will be away for significant periods. A no-to-low cost project.

**Subscriptions:** [kidsphere-request@vms.cis.pitt.edu](mailto:kidsphere-request@vms.cis.pitt.edu)

**Participation:** [kidsphere@vms.cis.pitt.edu](mailto:kidsphere@vms.cis.pitt.edu)

### K12NET

An alternative for schools without direct Internet access for joining a low-cost yet far-ranging global learning network. In K12NET, schools set up their own electronic bulletin board systems that store messages from students and teachers during the day and at night call up the closest K12NET BBS, passing e-mail back and forth. This system permits communication with parents, teachers, and students in many countries, especially nations where direct Internet connections are not readily available. Though K12NET is not on the Internet itself, its e-mail is passed to and from the Internet and appears on newsgroups and gophersites, thus opening up e-mail-based services such as gophermail. A no- to low-cost project.

**URL:** [http://www.vivanet.com/freenet/k/K12Net/intro\\_to.html](http://www.vivanet.com/freenet/k/K12Net/intro_to.html)

### NICKNACKS

NickNacks is a collection of webpages which offer detailed tips on designing and participating in collaborative projects using Internet resources, including such intricate but essential topics as how to handle files from distant colleagues who use a different computer platform, and the ins and outs of exchanging differing file formats. NickNacks also provides many links to resources at other websites which have proved useful in networked learning activities. Developed and maintained by Nancy Schubert, a parent volunteer.

**URL:** <http://www1.minn.net:80/~schubert/NickNacks.html>

### ORILLAS

*De Orilla a Orilla* (Spanish for “From Shore to Shore”) is a teacher-researcher project that has concentrated on documenting promising practices for intercultural and multilingual learning over global learning networks. Since 1985, *Orillas* has been an international networking project to promote team-teaching partnerships and group projects designed to effect social change.

# Dreamkeepers

by Dr. Lourdes Díaz Soto

A Native American proverb states that “we should be like water, which is lower than all things, yet stronger than even the rocks.” I would like to share examples of educational experiences that strong families, like water, relayed to me during a four-year period. The families I interviewed have asked that schools shift their emphasis on shame to an emphasis on compassion. Their experiences have led me to ask: Has the American Dream become a nightmare for young home-language speakers?

I have organized this presentation into three sections. First, I will ask you to examine issues of power by viewing daily realities bilingual families face in America. Then, I will share “los consejos” — the advice families provided in order to change schools into caring and compassionate places. And finally, I will conclude by asking you to dream with us about the many possibilities we have as collaborators, as “practicing angels,” and courageous warriors.

John F. Kennedy said, “The greatest enemy of the truth is very often not the lie — deliberate, continued and dishonest, but the myth — present, persuasive, and unrealistic.” Bilingual families in America have lived the daily realities of a rising neo-conservative agenda. America is experiencing a popular construction of a national identity that is monolingual and monocultural. Power relations continue to impact the quality of children’s educational programs. The ultimate outcome for children has meant a monolingual, monocultural education. This racist climate has tended to dominate bilingual children’s education and has perpetrated what Freire described as “cultural invasion.” Cultural invasion means that “invaders penetrate the cultural context of another group, in disrespect of the latter’s potentialities; they impose their own view of the world.”

It’s been my experience that bilingual families are often knowledgeable about best educational practices.<sup>1</sup> Families have provided advice about bilingual education to schools that is congruent with research

evidence. The more powerful, oppressive elements, however, have obscured the families’ advice and wisdom, allowing children’s home languages and cultures to be devalued.

These power relations have at least three major elements of oppression: a) an English-only xenophobic environment; b) language domination, and c) cultural invasion. These oppressive elements systematically silence children and families. I would like to share examples from a contemporary community.

*Listeners heard about the “Blue E” on the local radio station. The “Blue E” referred to a proposed city ordinance. The idea was to encourage local merchants to post a “Blue E” on their doorways. This “Blue E” indicated the merchant’s support for the English-only elements in the community and their willingness to price goods based upon the English language proficiency of the prospective buyer. For example, if the store clerk detected and accent or felt that your English was not up to par, you were expected to pay an additional 10-20% on your purchase since this signified additional ‘paper work’ and expense for the merchant.*

*They changed my name to Lucy. They couldn’t pronounce the ‘z’ in Luz. I used to get whacks on my head for not spelling my name the way they wanted it spelled.*

*All of a sudden some of the kids started calling me ‘nigger.’ I didn’t know what that meant at first...but I was excited to think that I was making friends so fast. I felt the kids really liked me. I have a brother seven years older who walked me to school so he could meet my new ‘friends.’ Finally he heard it one day and told me. “Nigger is not the same as ‘negrita,’” he told me. I was crushed because I had thought it was a nickname, a sign of friendship, not ridicule.*

*Then I came to the U.S. when I was in eight grade. I was the only Hispanic....They thought I was somewhat retarded....So they decided to put me in Special Education.*

These are just some of the examples of the type of oppression the families I interviewed experienced. Just as the Carlisle Native American Indian School practiced genocide, so have schools today continued to perpetrate the educational genocide of bicultural children. It is important to note that in a democratic society an individual can be bilingual and bicultural and still be loyal to American ideals.

The “consejos,” the advice and wisdom strong bilingual families have imparted to schools is congruent with research findings. The experiences families shared led them to conclude that there is a need for schools to shift from paradigms of shame to paradigms of compassion. They had very specific advice and I will highlight four consejos:

1. *The implementation of programs capable of preserving home languages and cultures.* First, families expressed the need for schools to assist in preserving languages and cultures. An education capable of keeping home languages and cultures intact was viewed as a means of enhancing intergenerational communication.
2. *Integrate caring/humanistic approaches.* The families you met here expressed ongoing and long-standing painful experiences because of ignorance, intolerance and racism. If schools implemented a caring humanistic curriculum, the families reasoned, then children would no longer be recipients of rejection but recipients of a caring attitude reflecting positive human attributes.
3. *Accept the fact that schools are not the only knowledge brokers.* Families have a wealth of information and wisdom they can share with schools.
4. *Model ways of encouraging “linguistic and cultural integrity.”* The Agueybana (courageous) families modeled ways of allowing children to develop self-confidence and self-respect by affording a learning environment

CONTINUED ON PAGE 22

that maintained an atmosphere of what they referred to as "linguistic and cultural integrity." Not only was linguistic and cultural knowledge imparted to children within the bilingual family structure, but it was shared with the community as large gifts are shared with friends and relatives.

Access and quality programs for all children in the "mythical" America is an educational, civil, and human right. Yet we know that children continue to feel that schools and communities devalue the language and culture of their families. Who stands to win when children's talents, family wisdom, cultural knowledge, and linguistic knowledge is disregarded and ignored?

We know that most nations of the world have included second language learning opportunities for children. Danish schools, Swedish lower schools, French early childhood schools, African, Australian, and Canadian schools, Hungarian nursery schools; Italian elementary schools; Greek primary schools; and children in Luxembourg learn German and French in elementary schools. Luxembourg teachers are expected to be competent in four languages.

The ability of schools and communities to view themselves as co-workers with families and teachers to transform the oppression dominating language-minority families. The challenge for the new millennium will be to explore and implement models that can restore power to bilingual families, children, schools, and communities.

My brother George survived a devastating and terminal illness

for seven years. Many loving family members, friends, volunteers, nurses and even strangers helped to care for George. He called us all his "practicing angels." As I watched my brother struggle because he loved life and wanted to cling to his world with so many loving family members and friends...I found the goodness in humanity and the possibilities that we has as collaborative and as "practicing angels."

In our busy lives we forget that there is an inherent wisdom in all the people who touch our lives. Our own children and families, our students, our colleagues, and members of our respective communities. It may be that we need to stop and reflect and ask ourselves:

What wisdom can we share? How can we collectively and in solidarity improve the lives of children and families? I am asking you today to dream about the many possibilities we have to learn from each other as "practicing angels" and courageous warriors. We need to learn to inspire each other as we face many challenges and daily realities. I am optimistic that we can teach children about compassion, wisdom, and solidarity and that they will find the key to solving the major issues they will face in the new millennium.

Where is our democratic America? Where is the America that so many of us long for? It seems to me that so many families in America pin their hopes on educational equity and freedom for their children, as they dream the American Dream. It is up to each one of us as "practicing angels" and courageous warriors to continue to support each other because we are important in the lives of children.

<sup>1</sup> Soto, L. D. (1996). *Language, Culture, and Power. Bilingual Families Struggle for Quality Education*. New York: SUNY Press.

*Dr. Lourdes Díaz Soto teaches at The Pennsylvania State University.*

**Editor's Note:** *The preceding article is taken from a presentation made by Dr. Díaz Soto at the NABE '96 Annual Conference Early Childhood Education Institute and was contributed by NABE's Early Childhood Education Special Interest Group.*

\* NABE \*

## Publishers & Materials Developers

Do you have new products to tell NABE members about?

Send a sample of your material to the NABE NEWS Editor at NABE, 1220 L Street, NW, Suite 605, Washington, DC 20005-4018.

Materials will be listed ONCE, free of charge, in the Resources for Bilingual Educators column.



**FERNÁNDEZ USA**  
publishing Co.

**is proud to announce**  
**Diccionario Academia Enciclopédico**  
**in CD Rom for IBM and MAC**

a comprehensive resource in Spanish  
for students and teachers

- 67,000 entries
- 4,000 visual images
- 600 sounds

enlarge, copy, download, print.  
Introductory price: \$89.00

Call us for information and a brochure  
1 - 800 - 814 - 8080

FERNÁNDEZ USA publishing Co.  
1210 E. 223rd Street, Suite 309  
Carson, CA 90745

**GENUINE SPANISH FOR  
SPANISH SPEAKERS!**

# Higher Education Legislation

Column Editor: The Hispanic Association of Colleges and Universities (HACU)

## *Higher Education Act to be Reauthorized*

*by Jacob Fraire*

The 105th Congress will soon reauthorize the Higher Education Act (HEA) of 1965. The reauthorization process formally begins early next year after the new Congress convenes and committee assignments are established for the House and Senate education committees. However, the Clinton Administration already has begun to work on its reauthorization plan.

David Longanecker, who is Assistant Secretary for Postsecondary Education at the U.S. Department of Education (ED), recently announced the Administration's plan for the HEA reauthorization. In a two-hour meeting with representatives from numerous higher education associations, Dr. Longanecker stated that he and ED Undersecretary Marshall "Mike" Smith co-chair an internal steering committee which will formulate the Administration's HEA recommendations. ED also revealed that nine staff-level "task forces" had been created to iron out issues ranging from student financial aid to tax-related proposals to institutional eligibility matters.

Dr. Longanecker stated the reauthorization should address the challenges that higher education will face in the next decade. One such challenge, explained the Assistant Secretary, is a substantial growth in the number and percent of adults expected to be enrolled in postsecondary education. He said the increase in the percent of high school graduates may pose a "tremendous strain in the [higher education] system." A former analyst at the

Congressional Budget Office, Dr. Longanecker said another challenge is the lack of financial resources resulting from a constrained budget, which is expected to be the case until FY 2002. As the meeting went from the abstract to the more specific, Department officials addressed the issue of providing students access to remedial education courses. "We are not interested in removing [student] aid from remedial education," quipped the Assistant Secretary, adding "We want remedial education to work better." Dr. Longanecker hinted that ED favors maintaining remedial educational instruction at institutions offering degree programs. HACU welcomes the Department's news and will continue to encourage the Administration and Congress to support the provision of financial aid to students enrolled in remedial courses.

In a surprising statement, Dr. Longanecker also disclosed that the Department will support "the idea" of two major loan programs co-existing. The Clinton Administration has for four years attempted to replace the existing Federal Family Education Loan Program (FFELP) with its favored direct loan program. Their plan has been stymied by the GOP-controlled Congress, albeit direct loan volume has grown substantially in the past three years. In academic year 1996-97, an estimated \$9 billion in direct student loans will be borrowed. The Administration has conceded it will administer both FFELP and direct lending.

The Administration also appears to have reversed its position with regard to Title III (Strengthening Institutions) grants.

Asked about ED's views on Title III, Dr. Longanecker responded, "We strongly believe in institutional development aid." He said ED would not propose any major changes to institutional-based programs. In the President's FY 1995 budget request, the Administration proposed major cuts to Title III funding. The budget plan also called for the gradual elimination of these grants. HACU welcomes the Department's new outlook on the need for aid to developing institutions.

While last week's meeting was designed primarily for Washington-based associations, ED plans to take its reauthorization program to the general public. ED will host a series of hearings across the nation to discuss the reauthorization. At press time the hearing schedule had not been announced, but the following cities are likely candidates to host a hearing: Atlanta, Chicago, Boston, Phoenix, San Francisco, and Washington. All hearings will take place in the first two weeks of December. ED will also publish in *The Federal Register* a "Call for Comments" notice, in which they will seek comments and recommendations from the general public over an array of reauthorization issues.

The Clinton Administration, if re-elected, plans to submit its HEA recommendations to the Congress in April 1997. The President's tax-related proposals, such as the new HOPE scholarships, may be sent to the Congress earlier in the year.

*Reprinted with permission from "Capitol Notes," October 15, 1996.*

**Editor's Note:** *In the coming months, NABE will be collaborating with several organizations in preparation for the upcoming reauthorization by Congress of the Higher Education Act. Among these organizations is the Hispanic Association of Colleges and Universities (HACU). This column appeared in a recent HACU publication.*

### **NABE Legislative Policy Hotline**

For the latest information about national educational policy matters, call the NABE Hotline at (202) 898-1829 and dial/ask for extension 138, the Legislative Policy section; follow the recorded instructions.

# RESOLUTIONS REQUESTED

Resolutions to be considered at the NABE General Membership Meeting on Saturday, February 8, 1996, during the 26th Annual International Bilingual/Multicultural Education Conference in Albuquerque, New Mexico, should be submitted in advance to José Delgado, Chair of the NABE Resolutions Committee. NABE procedures state that "the Maker and the Seconder of the proposed resolution must be NABE members in good standing." The 1997 Resolutions Committee, "composed of the appointed chair and a representative from each affiliate in good standing," will be considering resolutions for presentation to the NABE membership. All members and affiliates wishing to submit resolutions should follow the format presented below and either mail them to the addresses printed below to be received by January 17, 1997, or bring them to the NABE Conference Office in the Albuquerque Convention Center by noon on Wednesday, February 5, 1997.

## National Association for Bilingual Education: 1997 Resolutions

Mr. Chairman, I/we wish to submit the following resolutions:

Whereas: \_\_\_\_\_  
\_\_\_\_\_  
\_\_\_\_\_

Be it resolved that: \_\_\_\_\_  
\_\_\_\_\_  
\_\_\_\_\_

Rationale: \_\_\_\_\_  
\_\_\_\_\_  
\_\_\_\_\_

Submitted by: \_\_\_\_\_ Seconded by: \_\_\_\_\_

If other than individual, submitted by (name of group): \_\_\_\_\_

Person to be contacted regarding resolution:

Name: \_\_\_\_\_ Phone: \_\_\_\_\_

Address: \_\_\_\_\_

City: \_\_\_\_\_ State: \_\_\_\_\_ Zip: \_\_\_\_\_

**Attention: Two copies of this form are to be brought to the NABE Conference Office in the Albuquerque Convention Center by NOON on February 5, 1997, or mailed to arrive no later than January 17, 1997, to:**

José Delgado, Jr.  
Chairman, NABE Resolutions Committee  
1220 L Street, NW #605  
Washington, DC 20005-4018

## FOR NABE OFFICIAL USE ONLY

Resolution No.: \_\_\_\_\_ Approved: \_\_\_\_\_ Disapproved: \_\_\_\_\_

Reason for Disapproval: \_\_\_\_\_

Amendment for Re-editing Needed: Yes \_\_\_\_\_ No \_\_\_\_\_

NABE Membership Action: Carried \_\_\_\_\_ Failed \_\_\_\_\_ Date \_\_\_\_/\_\_\_\_/\_\_\_\_

54

# ESL in Bilingual Education

Column Editor: Dr. Jack Milon, University of Nevada, Reno

## *When Language Is Not the Issue*

by Dr. John Milon

As ESL teachers, we need to vigorously resist attempts to frame discussion of education issues which involve children who are not native speakers of English mainly in terms of language. By allowing the arguments and discussions about ESL and bilingual education to be framed this way, we allow those who oppose both bilingual education and the teaching of English to speakers of other languages the luxury of avoiding the really critical issues involved in working with these children — race and poverty. Language competence is probably the least important issue in the discussions and we, as ESL teachers, should not allow ourselves to be distracted by it.

In October 1996, a very attractive, clearly middle-class, young woman — who is obviously Hispanic — sat silently on a chair in a chain drugstore in Reno after a meeting wearing a dress, hose, heels, etc. She was approached by an elderly white couple. Without any preamble the female said, "If you dirty Mexicans can't read, you should go back to Mexico." The remark was apparently prompted by her proximity to a sign which requested that people who were attempting to get prescriptions filled should form a single line. The young woman was not waiting for a prescription; she was merely sitting. As the elderly couple left, the young woman looked around for some human contact, possibly even support, in the face of the assault. She found that the people in the store who are close enough to have possibly heard the remark were looking elsewhere. After a few moments of shocked inaction, the young woman got up from the chair and followed the elderly couple outside. She confronted them on the sidewalk, informing them that she was a second-generation Nevadan, that she had bathed a few hours earlier, that she was only a few credits away from a college

degree and that she did not understand why the woman had made such ugly remarks. The elderly woman's response was a curt demand to, "get out of our way."

These kinds of vicious encounters are hopefully infrequent (it was a first for the young woman involved), but this one was certainly not unique, as subsequent discussion in class revealed. I use the anecdote here because it is clear that language was not an issue at all. The young woman (who is, in fact, bilingual in Spanish and English) had not spoken a word that could have been heard by the couple — and she speaks perfect, vaguely-Californian unaccented English anyway. In this instance poverty should not have been a factor either. Whether she was wearing a dress or a CK sweatshirt, she was obviously comfortable financially. In this case, what attracted the attention of the couple could only have been her skin color.

The racism that we have to deal with on a daily basis has to be acknowledged as central to all of our educational endeavors when working with the students who are in ESL and bilingual programs. Issues of race and ethnicity are central to all discussions of ESL and bilingual education and must be acknowledged as being so. It is also important that they be acknowledged in the specific language of ethnicity and race. For example, Valencia (1991) makes an impassioned statement about the cowardly nature of intolerance as it affects Chicano school success: In spite of the mounting evidence that bilingual education helps to promote Chicano school success, there is a growing anti-bilingual intolerance making its cowardly way through the nation (p. 322).

The question arises as to whether the intolerance is directed at bilingual education or at Chicanos. On the one hand, the intolerance can be passed off as a possibly principled pedagogical objection to a particular methodology. On the other, it has to be confronted as intolerance toward a particular group of people of color. Are all

objections to bilingual education or instruction in English as a second language based on racist sentiments? It should be very obvious that they are not. It is equally obvious that it would be ludicrous to believe that none of the objections to bilingual education are based on racist beliefs. It seems that we must deal with the issue of racism each time we discuss ESL and bilingual education and deal with it as a central issue. We must acknowledge our responsibility to attempt to do so each and every time, no matter how unsuccessful we may prove to be.

As Americans begin to more openly entertain the proposition that poverty is in fact a form of socially-constructed and socially-accepted violence enacted upon children, we begin to pay attention to the relationships between the successes of minority children in ESL/bilingual programs and their socio-economic status. In a recent article, Krashen (1996) discusses the predictive (as opposed to causative) nature of socio-economic status in terms of the school success of language-minority children. Neither Krashen nor anyone else would claim that poverty causes academic failure. But it would be foolish to ignore the evidence that poor children do not do as well in school as rich children.

The prognosis for school-recognized displays of academic success among poor children of color, especially in terms of measurable skills in the form of standardized test scores, is very poor. But some poor children of color do well in school. The prognosis for wealthy colorless children is much better, but not all White, high SES children do well in school by any means. As with race and ethnicity, the issue of SES must be brought incessantly to the foreground in any discussion of ESL and bilingual programs.

Those of us who are ESL professionals committed to bilingual education must not allow opponents of either ESL or bilingual education to frame the debate solely or

CONTINUED ON PAGE 30

and Kelly (1992), is helpful in addressing the classroom implications of this technique. All of the appendices in the book, for that matter, give extra information and can be used by students to experiment with various ideas presented in the text.

Teacher's beliefs and the sources of these beliefs, the basis of Chapter 2, appear to be the core of the text. The culture of teaching is explored here. The authors quote Feiman-Nemser and Floden (1986: 508) to further their definition of the culture of teaching:

Teaching cultures are embodied in the work-related beliefs and knowledge teachers share — beliefs about appropriate ways of acting on the job and rewarding aspects of teaching, and knowledge that enables teachers to do their work (p. 30).

These beliefs are listed as beliefs about the English language, learning, teaching, program and curriculum, and language

teaching as a profession. The readers are then asked to consider their own belief systems while research on the derivation of belief systems (Kindsvatter, Willen, and Ishler 1988) is discussed suggesting several sources:

- Their own experience as language learners.
- Experience of what works best.
- Established practice.
- Personality factors.
- Educationally based or research-based principles.
- Principles derived from an approach or method (pp. 30-31).

The authors handle each belief system listed above with examples from their own teaching, questions for the reader, and a section of discussion questions which would fit well within the format of a methodology course.

Although most texts cover mainly the point of view of the instructor, this book stays within its reflective format by considering the point of view of the learner. The focus on the second language learner echoes the preceding chapter by dealing with learner belief systems, beliefs about teaching, language learning, appropriate classroom behavior, self, and goals. Cognitive styles (concrete, analytical, communicative, and authority-oriented) and learning strategies take up the remainder of Chapter 3. This enables the reader to become involved in what the authors call an "action research case study" (pp. 69-71). Through the steps of Initial Reflection, Planning, Action, Observation, and Reflection, the reader can come full circle in reflecting on something that occurred in a second language class or pre- or in-service training session. This technique can be carried on as a journal activity, an individual investigation task, a classroom observation task or a peer observation task.

Having been involved in a discussion of both the teachers' and learners' beliefs concerning language learning and language teaching, the teacher must now make certain decisions about the delivery of information. The authors cite Shavelson (1973: 143-5):

Any teaching act is the result of a decision, either conscious or unconscious...What distin-

guishes the exceptional teacher is not the ability to ask, say, a higher-order question, but the ability to decide when to ask such a question (p. 70).

Planning lessons now involves the teacher's set of beliefs and the teacher's understanding of the learners' sets of beliefs. This is possible through reflection on the part of the teacher, on the one hand dealing metacognitively through *self-reflection*, and on the other hand, through a more intimate knowledge of the students' beliefs through investigation as outlined above. The text suggests several ways to accomplish this goal of planning lessons to suit the differing variables. These include: planning decisions, interactive decisions, and evaluative decisions as ways or combinations of ways to involve both the teacher's and students' sets of beliefs on the most functional way to approach second language learning methodology and second language learning itself.

In the first four chapters, Richards and Lockhart have discussed what it means to be a reflective teacher. To do so, teachers must take into account their own belief systems, investigate the belief systems of the students and then combine these factors into an approach which is both interactive and introspective. There is then an understanding from where the second language learners' needs stem from along with a commitment to deal with the underlying personalities of these learners. The lesson is geared to take all of this into account. Pre- and in-service teachers can benefit from the above knowledge and use it to change the ways in which they will deliver instruction.

The remainder of the book sets a more traditional tone. The role of the teacher (Chapter 5) takes into consideration the setting of the teaching and the role the teacher plays in the instructional process. A curriculum developer and a counselor play different roles in the learning process and will affect the learner in different ways. The use of the "action research case study" continues to be an integral part of the set-up of the text and guides the reader through a reflective exercise to further examine each topic at hand. Openings, Sequencing, Pacing, and Closure as as-

CONTINUED ON PAGE 30

## SEQUOIA UNION HIGH SCHOOL DISTRICT

### Bilingual (Spanish) teachers

All high school subjects for 1997-98 school year

Must qualify for California Single Subject Credential

**Please send letter and resume to:**

Certificated Personnel  
Sequoia Union High School District  
480 James Avenue  
Redwood City, CA 94062

(415) 369-1411, ext. 2223

FAX (415) 306-8868



# Early Childhood Education SIG

SIG Co-Chairs: Mary Margarita Contie, Creative Beginnings, and  
Vilma Williams, Council for Early Childhood Professional Recognition

## *New Directions in Early Childhood Education: The Messengers, Dreamkeepers, Architects and the Promise*

by Mary Margarita Contie and Amie Beckett

"We need a vision and we also need hope to sustain us through these dire times."

— Lily Wong Fillmore, 1996

A panel of national leaders heralded new directions in early childhood education for diverse populations at the Early Childhood Institute held during the 1996 NABE convention in Orlando. Discussion centered around a position statement, "Responding to Linguistic and Cultural Diversity: Recommendations for Effective Early Childhood Education/Repuesta a la Diversidad Lingüística y Cultural: Recomendaciones para una Educación Infantil Eficaz," which was released in November 1995 by the National Association for the Education of Young Children.<sup>1</sup> The report contained recommendations for culturally and linguistically supportive programs and practices; working with children and families; and professional preparation. Strong support for the instructional use of the home language was articulated in the position statement. NAEYC membership is approximately 88,000 nationwide, so this policy statement will have an impact on early childhood programs in general, not only those that have traditionally provided bilingual education.

NABE officially endorsed the position statement and invited three groups of panelists to provide their perspectives. The Messengers, Sue Bredecamp and Delia Pompa, defined policy agendas relating to linguistic and cultural diversity in early childhood programs. The Dreamkeepers, Lourdes Díaz-Soto, Patricia Spaulding and Alice Paul, more fully articulated the vision behind the positions. According to the policy statement, "The nation's children all deserve an early childhood education that is responsive to their families; communities' racial, ethnic, and cultural backgrounds." Statements by Lily Wong-Fillmore and Louise Derman-Sparks reinforced this message, as did a report on the National Latino Children's Agenda by Becky Barrera. Later the Architects, Parker Anderson and Josué Cruz, discussed the implications of these new directions for early childhood programs.

### **National Latino Children's Agenda**

Two years ago we reported the initiation of an effort in Washington DC to address the disproportionate and alarming statistics that face Latino children. The National Latino Children's Agenda sponsored *La promesa de un futuro brillante*, a national summit on Latino children. The summit created an opportunity for dialogue among government representatives, corporate and foundation

executives, elected officials, and community leaders. Youth were also an integral part of the planning. As Lily Wong Fillmore once said, "When children are born, they are loaded with possibilities — but that's all they have. We believe that it is up to the adults in the infants world — it's parents first and the teacher later, to take the possibility and develop it. It is the parents' responsibility to teach, to guide, to shape children in every way, so that they eventually behave the way we expect our children to behave."

The youth at the summit issued a call for clarification of educators' roles. Upon request, the entire audience stood, raised their right hands, and promised to be mentors, to teach language, culture, and history; to guide Latino youth toward opportunities, and to include them in implementation of community programs.

Bibi Lobo reminded the group, "This powerful session highlighted the possibilities and contributions that our Latino youth can make if adults will just take time to listen, support and include them in decisions that are made for them."

The keynote for the summit was Dr. Antonia Novello, former U.S. Surgeon General, whose passionate words lit a fire of enthusiasm and pride among participants. She also offered the caveat, "Thinking that others will treat you well because you are an advocate is like thinking a bull will not charge because you are vegetarian." A common vision and dedication to the task is essential for progress in our advocacy efforts. We can not afford disunity— even when we do not agree on all the issues. Indeed, disagreement is healthy for all of us, if we recognize shared vision and engage in discussion of differences so that we all can grow.

There are those who make the dreams come true, they keep the promise, and improve the future for all our children. How can their message become reality? First, we can assume that all are eager and capable learners. We can follow the lead of the Puerto Rican physician who provided care for children with AIDS by setting up a care facility, then a home, where children received medical care while loving adults watched over them every day of their short lives. Perhaps we should keep alive wonderful traditions such as the corridos from a California group that tell the sad realities of today's street violence. Whatever our choices, we must move forward seeking solutions, standing and working together for a common humanity where dignity, honor, and respect are a part of every step we take. What will you do? How will you move the agenda forward for our newest human beings? Tú, qué harás? En tus manos es el futuro — it is your hand that will guide the future.

<sup>1</sup>Available in English and in Spanish versions from NAEYC: (800)424-2460.

CONTINUED ON PAGE 30

Research on *Orillas* has validated projects (using both qualitative and quantitative research designs) that have raised self-esteem among Puerto Rican students in the United States involved in partner-class activities with schools in Puerto Rico (Sayers, 1991 & 1994), as well as projects that promote intergenerational literacy learning and parental involvement in global learning networks<sup>1</sup> (Sayers & Brown, 1994). As a result of this research, *Orillas* has published articles recommending promising networking practices<sup>2</sup> (e.g., Figueroa, Sayers & Brown, 1990).

Parents or teachers should contact *Orillas* if they are interested in participating in learning projects over global learning networks that

1. Promote bilingualism and learning another language.
2. Validate traditional forms of knowledge, such as the oral traditions associated with folklore, folk games, proverbs, and learning from elders through oral history.
3. Advance anti-racist multicultural education.
4. Develop new approaches to teaching and learning that encourage students, parents, and communities to take action for social justice and environmental improvement.

*Orillas* operates over various networks; thus, cost for participation ranges from no-cost to low and moderate cost, depending on the type of service provider available to a parent or teacher. Write the co-directors Kristin Brown at <krbrown@igc.apc.org>, Enid Figueroa at <efiguero@orillas.upr.fred.org>, or Dennis Sayers at <sayers@acflcluster.nyu.edu> for more information.

URL: <http://oeonline.com>.

#### PITSCO LAUNCHSITES

Pitsco's extremely useful website for educators maintains several webpages with dozens of links for teachers interested in class-to-class partnerships and multi-class projects and activities.

URL: <http://www.pitsco.com/p/keysites.html>

URL: <http://www.pitsco.com/p/keylists.html>

URL: <http://www.pitsco.com/p/collab.html>

URL: <http://www.pitsco.com/p/onactivities.html>

#### TCHR-SL

For teachers of learners of English as a Second or Foreign Language, this partner-class clearinghouse is based at Latrobe University in Australia. By subscribing to this LISTSERV, an ESL or EFL teacher can find teacher collaborators for curriculum projects in countries around the world through which their students can perfect their English language skills while engaging in intercultural learning.

Subscriptions: [announce-sl@latrobe.edu.au](mailto:announce-sl@latrobe.edu.au)

#### TERC

TERC pioneered in the development of educational networking in K-12 with its creation of the National Geographic Kids Network (elementary and middle-grades science curriculum) and Global Lab, a worldwide network of teachers and students involved in collaborative environmental investigations. Two key projects currently under way include LabNet, an electronic community of K-12 science and math educators dedicated to supporting and

encouraging inquiry-oriented, project-based learning; and Testbed for Telecollaboration, which is building on TERC's work in curriculum and software development by supporting teachers and students in collaborative investigations, especially in collecting, sharing, analyzing, and visualizing data.

Participating Testbed projects use the Alice Network Software, a powerful set of data analysis tools developed by TERC. Other current work includes Investigations, an elementary mathematics curriculum; Tabletop, a computer tool for logic, information, graphing, and data analysis; and CamMotion, a new combination of video and computer technologies. These are just a few of more than 30 projects. TERC also runs a Web site at <http://www.terc.edu>. These are moderate- to higher-cost projects. For more information on the many projects sponsored by TERC and to subscribe to the TERC newsletter *Hands On!* contact TERC Communications, 2067 Massachusetts Avenue Cambridge, MA 02140, Phone: 617/547-0430, Fax: 617/349-3535, E-mail: [communications@terc.edu](mailto:communications@terc.edu)

#### WILD ONES

Maintained by the Wildlife Preservation Trust, this website offers teachers and students the opportunity to design and participate in collaborative projects focused on environmental concerns. "Teachers Connection" features participation ranging from professional naturalists and researchers to elementary school children, with a print magazine, *The Wild Times*, as a supplementary resource.

URL: <http://www.columbia.edu/cu/cerc/WildOnes>

#### References

- Sayers, D. & Brown, K. (1994). Putting a human face on educational technology: Intergenerational bilingual literacy through parent-child partnerships in long-distance networks. In D. Spener, ed., *Adult biliteracy in the United States*, pp. 171-189. Washington: Copublished by the Center for Applied Linguistics and Delta Systems Company.
- Figueroa, E., Sayers, D. & Brown, K. (1990). Red multilingue para el aprendizaje: De Orilla a Orilla (A multilingual learning network: From Shore to Shore). *Micro Aula: El maestro y la computadora (Micro-classroom: The teacher and the computer)*, 8, 27-30.

"Brave New Schools" by Jim Cummins of the Ontario Institute for Studies in Education and Dennis Sayers of the University of California Educational Research Center is published by St. Martin's Press (ISBN 0-312-12669-7), and is soon to appear in its second edition.

**Editor's Note:** Contributions to the Technology and Language Minority Students column should be sent to Dr. Dennis Sayers, University of California Educational Research Center, 351 E. Barstow Avenue, #101, Fresno, CA 93710. (209) 228-2050; FAX (209) 288-2055. E-mail: [DSAYERS@panix.com](mailto:DSAYERS@panix.com).

• NABE •

# Meet the NABE Interns

Emma Nava

**Age:** 24

**Born:** Valparaiso, Zacatecas, Mexico

**Languages:** Spanish/English

**Education:** Senior,

California State University Long Beach

**Major:** Human Development, (emphasis on Education)



Emma, an immigrant from Mexico, was raised in Oxnard, California. It is from her parents that she first learned who she was and her responsibility not only to herself but to her family and community. Her parents have always been a major influence in her life; she has taken their values and applied them in her attempt to understand herself, as a Mexican, a woman, and now as a citizen of the United States. They gave her the motivation to do her best in her studies and her work in the community.

While in high school, Emma participated in the Upward Bound Program at California Lutheran University in Thousand Oaks. It was then that she first realized the importance of obtaining a higher education and its significance to accomplishing her career goals.

When she was applying to colleges, a teacher asked what she was going to study. Enthusiastically she said, "I would like to be a math teacher!" The teacher responded, "You're not good enough in math to become a teacher." She determined to prove him wrong.

After graduating from Rio Mesa High School, she ventured to Long Beach to attend California State University, Long Beach, determined to become a math teacher, and believing that teaching was the only way to positively impact education. Through her experience at the university, she realized there were other equally important options in the field of education, and changed her major to Human Development, with an emphasis on education.

In the Fall of 1996, Emma was selected by the Washington Center as a participant in the Minority Leaders Fellowship Program in Washington, DC. Because she wanted to learn about the government's impact on education, she accepted a placement offer from NABE. She chose NABE for its reputation of having a long-standing commitment to education. Before coming to NABE, Emma's experience in educational policy was limited to the post-secondary level. She hopes to learn about the links between K-12 education and college enrollment of language-minority students.

In the Spring of 1997, Emma will be completing the first step in this journey — she will obtain her bachelor's degree in Human Development. Her goal is to influence the educational system through both the administrative and instructional processes. She hopes to improve educational policies to facilitate educational opportunities for her community. As a professional, she will stress the importance of establishing and developing strong networks between those who strive to create a better environment for people seeking to better themselves through education.

## Experience in Washington DC with NABE

The advantages of bilingual education to this society have been downplayed for a long time. This has made NABE's work extremely difficult and, more than ever, crucial to the success of

minority-language communities. While with NABE, Emma has received a crash course in the legislative process and has been introduced to NABE's work as an advocacy organization. "I was able to experience lobbying first-hand. In a collective effort to defeat the 'English-Only' legislation, I joined NABE and other advocacy organizations to visit Senators' offices alerting them to the detrimental effects of such legislation and ensuring their support in opposition. Next, I learned about the federal budget process, and its impact on programs such as bilingual education. Finally, I have attended meetings with Congressional representatives and their staff to focus on issues from 'English-Only' to immigration and bilingual education funding. NABE stresses the importance of bilingual education at the local level, and reminds these key Congressional Members that in order to meet the needs of language-minorities in their districts, adequate funding for bilingual education must be allocated."

Emma admits that she shares many people's frustration with American politics. "I never thought these issues had a significant impact on my life. I thought that because I was not a US citizen that I could not participate in the process at the local, state, or federal level. I never took the time to learn about the federal legislative process, nor did I stay updated on the latest bills in Congress. Although I had seen the impact at the local level, I never thought I would be in the midst of impacting federal decisions." Now as an American citizen and NABE Intern, she is optimistic about becoming and staying involved in the process.

While in Washington, Emma attended the House debate on the immigration reform bill, as well as the Gallegly bill, which would have allowed states to bar undocumented children from attending public schools. "This was important to me because of my background. As an immigrant, I take issues related to immigration very personally. I was able to witness how immigrants are viewed and portrayed in the halls of Congress."

Emma is very disappointed to learn that Congressional representatives are so narrow-minded when it comes to making decisions for a diverse country. "With regard to immigration, they do not really understand why people risk so much to come to the United States. The current immigration reform bill will not discourage people from illegally immigrating; it will simply create and perpetuate an underclass with little or no resources to address such important issues as safety, education, and health. And the Gallegly bill will greatly impact the children for whom NABE attempts to provide educational opportunity. NABE is the voice for the minority-language communities which would otherwise be summarily excluded under this type of legislation, by a Congress which has forgotten that our nation was built by immigrants." To Emma, many representatives seem out of touch with the spirit of entrepreneurship, responsibility, and freedom that immigrants and minority-language individuals bring to our nation and how this strengthens American society as a whole. "That's why I am here — to change all this."

NABE is proud to welcome Emma to the Fall 1996 Policy Intern Program and looks forward to a long and fruitful relationship with this outstanding young woman.

◀ NABE ▶

ties for beginning learners as does the recent *Word of Mouth* by Earle Carlin and Proctor (1996). *The CALLA Handbook* (Chamot & O'Mally: 1994) is filled with concrete examples of activities for practicing language learning strategies. There are also a variety of general texts on second language learning which effectively link theory and practice (see Long & Richards, 1987; Ramírez, 1995; Scarcella & Oxford, 1992).

In the final analysis, *Second Language Practice*, despite some relevant and interesting chapters, cannot be recommended as an alternative to existing texts. Perhaps it could be revised to more closely adhere to its promised format and level-by-level orientation. The ambiguity about what proficiency levels mean could be more fully explored in terms of learner proficiency in various skill areas. Reference could be made to existing scales such as ACTFL or FSI or to scores on common norm-referenced tests such as TOEFL. In its current state *Second Language Practice* remains an uneven grabbag of collected articles, stronger on explanation of communicative theory than exposition of classroom practice.

---

**ESL IN BILINGUAL ED** FROM PAGE 25

even principally in terms of academic skills and standardized test scores. The issues of race and ethnicity and poverty are central to the discussion and they must be acknowledged each time.

#### References

- Krashen, S. (1996). "Socio-economic status as de facto bilingual education." *Bilingual Basics*, Fall: 1, 2 & 9.
- Valencia, R. (1991). "Conclusions: Towards Chicano school success." In Valencia, R. (Ed.). (1991). *Chicano school failure and success: Research and policy agendas for the 1990s* (pp. 321-325). London: Falmer Press.

**Editor's Note:** Contributions to the *ESL in Bilingual Education* column should be sent to Dr. Jack Milon, Department of Curriculum and Instruction/282, College of Education, University of Nevada, Reno, NV 89557-0214. (702) 784-6298, or email <milon@scs.unr.edu>.

« NABE »

---

**SIG: EARLY CHILDHOOD** FROM PAGE 27

Mary Contie is co-chair of NABE's Early Childhood Education Special Interest Group. Contact her at Creative Beginnings, 12819 Path Finder Lane, San Antonio, TX 78230 (210) 681-8563. Vilma Williams, the Co-Chair, can be contacted at The Council for Early Childhood Professional Recognition, CDA Training Services, 1341 G Street, NW, #400, Washington, DC 20011 (202) 265-9090x225. Amie Ann Beckett is Secretary of the SIG; contact her at 4524 65th Street, Apt. B, Lubbock, TX 79414, (806) 742-2364.

« NABE »

#### References

- Allwright, R. & K. Bailey. 1991. *Focus on the Language Classroom: An Introduction to Classroom Research for Language Teachers*. Cambridge: Cambridge U. Press.
- Chamot, A. & J.M. O'Mally. *The CALLA Handbook*. Reading, MA: Addison Wesley Publishing Co.
- Krashen, S. & T. Terrell. 1983. *The Natural Approach: Language Acquisition in the Classroom*. Oxford: Pergamon.
- Long, M. & J. Richards. *Methodology in TESOL*. New York: Newbury House.
- Ramírez, A. 1995. *Creating Context for Second Language Acquisition: Theory and Methods*. White Plains, NY: Longman.
- Scarcella, R. & R. Oxford. 1992. *The Tapestry of Language Learning*. Boston: Heinle & Heinle.

Miriam Eisenstein Ebsworth, Ph.D., works at New York University.

« NABE »

---

**REVIEW: REFLECTIVE TEACHING** FROM PAGE 26

pects of a lesson are discussed in Chapter 6 (The Structure of a Language Lesson), followed by five excellent appendices which engage the reader in specific activities dealing with structuring a language lesson. Along with help in putting together a well-formulated language lesson, there are suggestions for effective interaction during this lesson (Interaction in the Second Language Classroom — Chapter 7). Diagrams of the teacher's action zone and a listing and definition of interactional patterns assist the reader in visualizing the interdependence of structure and interaction in the effective language classroom.

In *Reflective Teaching in Second Language Classrooms* Richards and Lockhart have found two markets. The veteran teacher looking to improve the delivery of instruction to second language learners will find many suggestions that will lead to introspection and review of past practices. This reader will be able to use some of the many new ideas to become more creative and productive. The other group that will benefit from this text is the pre- and in-service teacher using this book as a text in a methodology course. Through interactions with a leader and peers, this text will be a good base for discussion, research and trial. Both sets of readers will benefit from exposure to this book and that long-term benefit is well defined by the authors in the Epilogue:

The concept of reflective teaching...as with other inquiry-oriented approaches to teaching, makes different assumptions about the nature of teacher development. The process of reflecting upon one's own teaching is viewed as an essential component in developing knowledge and theories of teaching, and is hence a key element in one's professional development. This process is one which continues throughout a teacher's career.

Thomas J. Foran teaches at Fairfield University in Connecticut.

« NABE »

# NATIONAL ASSOCIATION FOR BILINGUAL EDUCATION

## MEMBERSHIP APPLICATION

**1**

### Membership Type (check one only)

- \$48 Individual Membership**  
 **\$30 Discounted Individual Membership**
- Parent:** **must not** be professional educator and **must** have a child currently enrolled in a bilingual education program. A letter written on school stationery from either the teacher or a school administrator must accompany the NABE membership application.
  - College/University Student:** **must not** be professional educator and **must** be enrolled on **full-time** basis. A copy of an official college or university document showing current enrollment status must accompany the NABE membership application.
  - Paraprofessional:** **Must** be working as an instructional aide in a public school system. A letter on school stationery from the supervising teacher or a school administrator must accompany the NABE membership application.
- \$43 Combined Membership** Name of Affiliate: \_\_\_\_\_  
 **\$125 Institutional Membership**  
 **\$1000 Lifetime Membership**

**4**

### I am involved with bilingual education as (check one)

- Administrator
- College Instructor
- Consultant
- Full-Time Student
- Paraprofessional
- Parent/Community member
- Publisher Staff
- School Board Member
- Teacher
- Other

**5**

### I work in this type of organization (check one)

- Commercial organization
- College/university
- Local school district
- State education agency
- Other

**6**

### I usually work with this level of student (check one)

- Early childhood
- Elementary
- Secondary
- Higher education
- Adult

**7**

### I want to participate in the following Special Interest Group (check one)

- Adult/Vocational Education
- Asian & Pacific Islanders
- Critical Pedagogy
- Early Childhood Education
- Elementary Education
- ESL in Bilingual Education
- Gifted Education
- Global Education
- Higher Education
- Instructional Technology
- Language/Culture Retention
- Language Policy
- Parent & Community
- Policy Makers
- Professional Development
- Research & Evaluation
- Secondary Education
- Special Education

### Name and Address Information

- 2**
- Mr.
  - Mrs.
  - Ms.
  - Dr.
- \_\_\_\_\_ .  
Last First Middle

**3** Preferred Mailing Address:  Business  Home  
**Business Address**

Position: \_\_\_\_\_  
Division: \_\_\_\_\_  
Organization: \_\_\_\_\_  
Street Address: \_\_\_\_\_  
City: \_\_\_\_\_ State: \_\_\_\_\_ Zip: \_\_\_\_\_  
Phone: (\_\_\_\_) \_\_\_\_\_ Ext. \_\_\_\_\_  
Fax: (\_\_\_\_) \_\_\_\_\_ E-Mail: \_\_\_\_\_

### Home Address

Street Address: \_\_\_\_\_  
City: \_\_\_\_\_ State: \_\_\_\_\_ Zip: \_\_\_\_\_  
Phone: (\_\_\_\_) \_\_\_\_\_

**8**

### Payment Information

\$ \_\_\_\_\_ Membership dues  
\$ \_\_\_\_\_ Contribution to help NABE counter the English-only movement

- Check or money order Check# \_\_\_\_\_
- Institutional purchase order # \_\_\_\_\_
- MasterCard  VISA ExpirationDate: \_\_\_\_/\_\_\_\_/\_\_\_\_
- Automatic Renewal: Check this box if: you are paying by credit card, and you want NABE to automatically renew your membership annually, charging your credit card the standard renewal amount. This permission will remain in effect until you cancel it in writing.

\$ \_\_\_\_\_ **TOTAL DUE**

**9**

**SIGNATURE:** \_\_\_\_\_ **DATE:** \_\_\_\_/\_\_\_\_/\_\_\_\_



# ANNOUNCEMENTS

## NABE '97 SPEAKERS

### Keynote Speakers:

Hillary Clinton, First Lady of the United States\*  
Harry Wong, Educational Consultant and Author  
Joe Bird, Chief of the Cherokee Nation\*  
Rita Moreno and Edward James Olmos, California Hispanic Dropout Project

### Major Speakers:

Virginia Collier and Wayne Thomas, George Mason University  
Jim Cummins, Ontario Institute for Studies in Education  
Ruben Donato, University of Colorado, Boulder  
Steve Krashen, University of Southern California  
Peter Negroni, Springfield, MA Public Schools\*  
Sammy Quintana, National School Boards Association  
Bill Rojas, San Francisco Public Schools  
Kathleen Ross, Heritage College\*  
Dennis Sayers, California State University, Fresno  
Leanna Trail, California State University, San Bernardino

\* invited

### *NABE NEWS*

National Association for Bilingual Education  
Suite 605  
1220 L Street, N.W.  
Washington, D.C. 20005-4018

NON-PROFIT ORG.  
U.S. POSTAGE  
PAID  
WASHINGTON, DC  
PERMIT NO. 4555

KATHLEEN M. MARCOS  
ERIC CLEARINGHOUSE ON LANGUAGES & LINGUI  
1118 22ND ST NW  
WASHINGTON DC 20037-1214

62





# NABE NEWS

The news magazine about educational equity and excellence through bilingual education

December 15, 1996

National Association for Bilingual Education

Volume 20, Number 3

## NABE Announces *Bilingual Education: Portraits of Success* Project

Many creative and successful bilingual education programs are being implemented throughout the United States. However, information about their successes is not readily available to share with the public, in general, and the print, electronic and television media, in particular. In an effort to acquire both achievement data and anecdotal information about successful bilingual programs, as well as outstanding personnel, students and graduates, a collaborative effort has been initiated by the organizations listed below to launch the *Bilingual Education: Portraits of Success Project*.

One of the goals of this project is to develop a database that can be accessed electronically by the general public, practitioners, researchers, legislators, and advocates to highlight and further explore the triumphs of bilingual education. This is a long-term evolving project that will require:

- collection and analysis of existing published information,
- development of criteria for inclusion into the database,
- identification of additional programs, staff, and students that meet such criteria, and

- configuration of a database that eventually can be directly accessed through the World Wide Web.

The information contained in the database will be available for dissemination and analysis to promote excellence in bilingual education and to broaden the support for bilingual education programs and schools. To achieve the goals of this project we are starting a national network of organizations to collaborate in this effort. You are invited to participate by sharing accomplishments. Institutions of higher education are encouraged to contribute with studies and/or knowledge of existing excellence in bilingual education.

We welcome your participation at the *Bilingual Education: Portraits of Success* Forum at NABE '97 in Albuquerque, New Mexico.

Contributions should be sent to Dr. María Estela Brisk, School of Education, Boston University, 605 Commonwealth Ave. Boston, MA 02215; Internet: brisk@acs.bu.edu; fax: 617-232-8907.

• NABE •

### Project Steering Committee

**María Estela Brisk, Chairperson**  
NABE Board Member, Boston University

**Donna Christian**  
President, Center for Applied Linguistics

**Minerva Gorena**  
Associate Director, National Clearinghouse for Bilingual Education (NCBE)

**Delia Pompa**  
Director, Office of Bilingual Education and Minority Languages Affairs (OBEMLA)

**Charlene Rivera**  
Director, The George Washington University, Center for Equity and Excellence in Education

**Nancy Zelasko**  
Deputy Director, NABE  
**Madeleine deMatteis**  
Graduate student assistant, Boston University

### ISSUE HIGHLIGHTS

Reading Instruction for Pre-literate Student.....5

Successful Practices.....15

### In Memoriam

Pauline Martz Rojas, a pioneer in bilingual education, passed away Friday, December 6 at age 98. Dr. Rojas's distinguished career began when, after receiving her bachelor's degree in English from the University of North Dakota in 1917, she chose to go to Puerto Rico as part of a government program to teach English. There they wanted her to teach all the classes in English, but she insisted that core classes be taught in the native language as the students studied English as a second language. In 1941, Dr. Rojas was recruited by the Dade County Public Schools in Florida to start a similar program in Miami. She taught in the program until she retired in 1961. Dr. Rojas was also an author of the *Miami Linguistic Readers*. NABE honored Dr. Rojas as a Pioneer in Bilingual Education in 1989.

# NABE NEWS

Published by the  
**National Association for  
Bilingual Education**

**Editor:**  
Nancy F. Zelasko, Ph.D.  
**Desktop Publishing & Layout:**  
Jeff Spence

## NABE NEWS REPRINT AND EDITORIAL POLICY

Readers are welcome to reprint non-copy-righted articles which appear in *NABE NEWS* at no charge, provided proper credit is given both to the author(s) and to *NABE NEWS* as the source publication.

All articles printed in *NABE NEWS*, unless written by an Association staff person or a member of the current NABE Executive Board of Directors, are solely the opinion of the author or authors, and do not represent the official policy or position of the National Association for Bilingual Education. Selection of articles for inclusion in *NABE NEWS* is not an official endorsement by NABE of the point(s) of view expressed therein.

## TABLE OF CONTENTS

• <i>Portraits of Success</i> Project.....	1
• <i>Message from the President</i> .....	3
• Schifini: Reading Instruction.....	5
• Voice Silenced Communication.....	7
• <i>Asian/Pacific American</i> .....	9
• <i>Administration</i> .....	11
• <i>Technology</i> .....	13
• <i>Successful Practices</i> .....	15
• <i>Higher Ed Legislation</i> .....	21
• NABE Order Form .....	22
• <i>Book Reviews</i> .....	23
• <i>SIG: Asian/Pacific American</i> .....	25
• <i>American Indian</i> .....	27
• <i>Parental Involvement</i> .....	29
• <i>SIG: Gifted/Talented</i> .....	31
• <i>Upcoming Events</i> .....	33
• <i>Membership Application</i> .....	35
• <i>Announcements</i> .....	36

## PUBLICATION SCHEDULE

Volume 20 of *NABE NEWS* will be published in 8 issues; publication dates are:

Issue 1	09/15/96	Issue 5	03/15/97
Issue 2	11/01/96	Issue 6	05/01/97
Issue 3	12/15/96	Issue 7	06/15/97
Issue 4	02/01/97	Issue 8	08/01/97

All advertising and copy material must be received in the NABE office **ONE MONTH prior to publication date** to be considered for inclusion.

## NABE NEWS ADVERTISING

### Display Advertising Rates

(Camera-Ready)

Full Page (7.5" x 10")	\$850
2/3-Page (4.75" x 10")	\$700
1/2-Page (7.5" x 4.5")	\$550
1/3-Page (4.75" x 4.75")	\$425
1/3-Page (2.25" x 10")	\$425
1/4-Page (3.5" x 4.75")	\$325
1/6-Page (2.25" x 4.75")	\$250

### Classified Advertising

\$1.25 per word; maximum 100 words

### Advertising Discounts (for multiple insertions)

10% for second-third; 15% for fourth-fifth;  
20% for sixth-eighth

NABE reserves the right to reject any advertisements which it deems inappropriate and/or inconsistent with the goals of the Association. For additional information, contact NABE at (202) 898-1829 x136.

## NABE

The National Association for Bilingual Education (NABE) is a tax-exempt, non-profit professional association founded in 1975 to address the educational needs of language-minority Americans.

### NABE NATIONAL OFFICE

1220 L Street, N.W., Suite 605

Washington, DC 20005-4018

PHONE (202) 898-1829

FAX (202) 789-2866

E-mail: NABE@nabe.org

### James J. Lyons, Executive Director

Nancy F. Zelasko, Deputy Director  
Jaime Zapata, Associate Director for Legislation  
Jeff Spence, Information Systems Director  
Carolyn Riddick, Office Manager  
Celia Torres, Membership Specialist  
Mina Cousins, Membership Specialist  
Ronald Williams, Office Assistant  
Teresa Sola, Receptionist

## NABE EXECUTIVE BOARD

1996 - 1997

### President

Janice Jones Schroeder  
12015 Winding Creek Way  
Germantown, MD 20874-1955  
(301) 601-9405  
nabepres@aol.com

### Vice President

Mary F. Jew  
San Francisco USD  
2550 - 25th Avenue  
San Francisco, CA 94116  
(415) 759-2950  
mjew@sfsud.k12.ca.us

### Secretary/Treasurer

David E. Báez  
Director, Foreign Language & Bilingual  
Education  
Buffalo Public Schools  
731 City Hall  
Buffalo, NY 14202  
(716) 851-3704  
dbaez@erie.wnyric.org

### Member-at-Large

Joe J. Bernal  
6410 Laurelhill  
San Antonio, TX 78229  
(210) 342-8026  
bowlngod@ix.netcom.com

### Member-at-Large

María Estela Brisk  
School of Education  
Boston University  
605 Commonwealth Avenue  
Boston, MA 02215  
(617) 353-3260  
brisk@acs.bu.edu

### Member-at-Large

Nga Dinh Duong  
21724 58th Avenue West  
Mountlake Terrace, WA 98043  
(206) 771-2095

### Member-at-Large

Hermán S. García  
Department of C & I  
College of Education  
New Mexico State University  
Las Cruces, NM 88003  
(505) 646-2115  
hgarcia@cnmailsvr.nmsu.edu

### Member-at-Large

Susan García  
18094 East Ohio, #102  
Aurora, CO 80012  
(303) 745-7116  
susangarcia@unitedwaydenver.org

### Parent Representative

Adela B. Holder  
Silver Consolidated School District  
2810 N. Swan Street  
Silver City, NM 88061  
(505) 388-1527  
sncadavi@arriba.nm.org



# Message From The President

## Walk the Walk

by Janice Jones Schroeder



NABE Executive Board President,  
Janice Jones Schroeder

As many of you are aware, I resigned my position in Alaska and moved to the Washington, D.C. area. This move was so that I could devote all my time, energy and voice to the duties of the President and language-minority children in this country. An equally important reason was to honor our ancestors who fought (often with their lives) defending the preservation of culture and the right to speak the language given by the Creator. Among all the reasons, though, was an undefined yearning for change, and I knew in some private core of myself that it had something to do with surrender. In moving into the unknown, I am learning that when hanging on to the familiar, I have what is familiar and, in letting go, I have no idea what comes next. Life becomes a cloud rolling overhead, changing shapes moment by moment. It's an eagle, a drummer, a buffalo, a hunter, a dancer, and the only thing I know for sure about it is that I am, hopefully optimistic that change will be positive.

To this end, I will share some of the highlights of my journey. I attended the three Regional conferences on Improving America's Schools (St. Louis in September; San Francisco in October; Atlanta in November) sponsored by the U.S. Department of Education. I tried to personally speak to every participant and invite them to our exciting conference. I was keynote speaker at the National Indian Education Conference. This was indeed an honor beyond words. I also attended and spoke at Colorado State Annual Bilingual Conference. We, the NABE Board, recently rewrote our mission statement and added a vision statement.

What I have experienced in my travels has been both refreshing and exciting. These are exciting times we are living in. And there are so many dedicated and willing change agents — parents, teachers, administrators, and school board members. They all share a common vision: *We have to get to the point of putting our children first.* Obviously, we have a way to go. But, as with all visionaries, they are optimistic that the current school reform movement is for the betterment of all children; that every child will have equal access to quality education where there are high expectations and standards for all children.

The key elements of change that everyone seems to be talking about are collaboration, increased parent involvement, building partnerships with community members and teachers/administrators, accountability, technology, standards, assessment, preparing our students for the world of work, and more decision-making at the local level.

Will the power stay where it always has been? Teacher empowerment and decision-making, granting of increased authority and responsibility, is an empty phrase if it is not accompanied by

retraining. There has to be a real commitment of not only time for retraining but also money allocated to pay for that retraining. Teachers need time to reflect, play, and change. A teacher cannot give his/her students greater responsibility for their learning if that teacher does not feel that s/he has a say over the school's philosophy and operation of the school in which s/he teaches. Like the old Indian saying: "one has to have power to give power."

Because of changing family patterns in our society, the mobility of families, the growing number of single parents, TV, and the fast pace of our changing society, the relationship between teachers and parents has changed. The educational success of our children is dependent on the quality of cooperation and teamwork of parents and educators. This teamwork cannot be over emphasized and must include strong positive communication.

The technological developments over the next several years will vastly accelerate and expand the way we think, behave, and live our lives. The world's population of tools and gadgets, with built-in computational control and information-processing capabilities, is exploding: telephones, fax machines and computers. As this higher-order intelligence permeates the average products and systems, higher-level thinking skills will become an inherent part of working, living, and our total environment.

At a time when the world is becoming smaller, truly a global village, we need to enrich our students' lives with teachings from multiple perspectives.

Change has been a long time coming to our public schools, and accountability has rarely been part of the fabric. Let us not run from accountability but rather feed off accountability. Let it be the fuel that motivates us to keep our walk on course. Let it be the source of inspiration to ourselves and others and, in the end, it will be the source of our success. Let our *armor* be in our vision and mission. Let us dialogue as to what our mission of bilingual education is so that we better articulate the issues of change for our language-minority students. Let us be dedicated to our mission with a consuming fervor. Let our *weapons* be the most current, substantive research and data. Let us advance bilingual educational research into the "Educate America School Reform Movement." Let us feast off the achievement and joy of our children. Let us be risk-takers in our public school reform. Let us be leaders who took the *Dare*.

*"Let us relate the school to life and above all to the life of the child." -- John Dewey; 1900*

**Editor's Note:** President Schroeder instructed the NABE News editor to print this disclaimer clarifying that the fact that three sentences did not begin with capital letters in her September 15, 1996 "Message from the President" was staff's fault and not hers.

# DISCOVER PERMA-BOUND BOOKS

## FOR YOUR BILINGUAL STUDENTS



**W**hen looking for a great selection of affordable titles for bilingual students, our Pre-Kindergarten-12 selection is great - including over 2,000 books in Spanish, plus Chinese, Vietnamese, French, German, Italian, and more.

- ❖ TRANSLATIONS
- ❖ ORIGINAL WORKS
- ❖ SHORT STORIES
- ❖ NOVELS
- ❖ SCIENCE
- ❖ DICTIONARIES
- ❖ BILINGUAL READERS
- ❖ VALE - IBM WRITING TO READ

Now Available! Books in Spanish to accompany Accelerated Reader Program.

One PERMA-BOUND book will outlast seven to ten paperbacks at about one-third the cost-and they're unconditionally guaranteed. If you're ever dissatisfied with a PERMA-BOUND book for any reason we'll replace it.

66

VANDALIA ROAD ❖ JACKSONVILLE, ILLINOIS 62650  
 CALL TOLL FREE: 1-800-637-6581 TOLL FREE FAX: 1-800-551-1169

**PERMA-BOUND**

# Reading Instruction for the Pre-literate and Struggling Older Student

by Alfredo Schifini, Ph.D.

Across the nation schools are undergoing a profound change with regard to the nature of the students we serve. Apart from the burgeoning numbers of second language learners, classrooms are experiencing a formidable shift to a student population that is both linguistically and culturally diverse. Rapidly increasing numbers of second language learners come from language and cultural groups never before dealt with. Declining socioeconomic levels of students born in the United States and the arrival of newcomers with a variety of educational levels complicate existing issues of language development, literacy and academic inclusion. Nowhere are these concerns more critically felt than among older, preliterate and struggling readers. As students progress through the grade levels the demands of academically rigorous subject matter combined with greater dependence on expository text make the attainment of literacy skills imperative.

## Who Are the Older Preliterate and Less Proficient Readers?

An increasingly visible number of these students appear in grades four through eight. Demographic upheaval in the world has resulted in large numbers of immigrant newcomers who arrive as upper graders. Youngsters from remote areas of developing countries and from war torn regions tend to be under-schooled and may have little or no literacy skills in their native language. Besides immigrants, many continuing second language learners, that is, those educated solely in our schools, are still preliterate or struggling readers in the fourth grade and above. Although most have strong command of the social domain of the English language, they experience difficulties in reading and writing in the academic setting. In a large-scale California study, most schools surveyed reported that continuing English learners entered high school with fourth to sixth grade academic skills (Minicucci

and Olsen, 1992). Records examined revealed that English learners in grades 7-12 who had been educated in our elementary schools missed large blocks of instruction in the lower grades. Furthermore, substantial number of native speakers of English are still struggling or are non-readers in the higher grades. One can only attempt to sort out the reasons for such an alarming dilemma. Transient students are exposed to different pedagogical approaches to reading as they move from grade to grade and school to school. As a result, the students can often have a fragmented and incomplete reading experience. Lack of a consistent and organized reading program providing early intervention for individualized help could also be a factor.

Scholars have examined societal issues that may contribute to the lack of literacy attainment of some students. In the 1960's a deficit hypothesis attempted to explain the growing inequalities in the life opportunities of youth from different social classes and racial groups (Deutsch, Katz, & Jensen, 1968). Recently, anthropologists have pointed out that success may be culture-bound. School achievement might be largely determined in terms of the values of the majority group (Giroux, 1983, 1988; McLaren, 1989). Perspectives on the issue of linguistic and cultural differences and literacy attainment continue to be debated. There is a consensus, however, that the school curriculum must develop language and literacy while promoting self-esteem. Oral and written language skills can be used to separate or unite students. The categorizing of people begins at school and is carried over into the larger society. Unfortunately, this sorting and ranking of learners can form the basis of negative self-fulfilling prophecies. Teachers of less proficient readers must embrace the unique strengths that these youngsters bring to school. It is essential that all students be perceived as capable of constructing meaning with text over time.

## Affective Concerns, such as Perceived Student Status, are Tied to Literacy

Affect plays a large role in propelling

students to success in language and literacy development (Edelsky, Draper, & Smith, 1983; Heath, 1983). Particular attention to affective concerns, such as student attitudes, feelings of self-efficacy, etc., must be addressed when dealing with struggling older readers. It is important to consider:

- Classroom environment is an invaluable tool in expanding and supporting literacy development (Laughlin & Ivener, 1988).

Advertisements, brochures, bumper stickers, comics, drawings, magazines, messages, murals, newspapers, photos, postcards, posters, recipes, etc. should be used to provide high interest, relevant sources of print and points of departure for oral discussion. Materials of interest to older students from diverse backgrounds are a priority. Atwell (1987) shares that it is necessary to let go of the neatly put together traditional bulletin boards and give way to student work. Students need to view the classroom as theirs. Older students need to see their place in this common space by publishing their work to celebrate progress. It is only recently that teachers of older students have begun to publish student work. Creating a literate environment (Atwell, 1985) is an interactive process where everyone talks about reading and writing. When readers of all proficiency levels interact using a variety of resources to create a room environment based on their curiosities and interests, the payoff for all learners is enhanced.

- Native language print in the learning environment validates students' home language and encourages parental and community involvement in class activities and events.

Not just any print, however, is effective in engaging students who are in a multicultural environment (Ivener, 1990). Environmental print, whether in the students' primary language or English, must be functional and meaningful. Students should be observed at various times throughout the day to determine if the interaction with the

CONTINUED ON PAGE 6

print is purposeful.

- Encouragement of students fosters motivation.

This is particularly the case when the support comes from those who are significant in the life of the learner (Clark, 1984; Halliday, 1975). Teachers of older less proficient readers must be willing to accept responses and support active participation. Acceptance and inclusion involved in social contexts and literacy events with more proficient readers and writers. Reading and writing workshops, shared reading and literature studies provide real reasons to communicate with others, share ideas, and gain confidence with books.

### **Older Students Bring a Wider Variety of Linguistic and World Knowledge to Print**

Reading, simply stated, is bringing one's language and world knowledge to print. Many students experiencing difficulties with text in the upper grades possess a wide range of language abilities that they easily use in social settings. Some have suggested that there is a fundamental distinction between conversation and academic aspects of language (Bruner, 1975; Cummins, 1984). Scholars point out the distinction between contextualized and decontextualized language as a fundamental principle of language and literacy development. Social language is supported by gestures and face-to-face interaction. At times, educators have interpreted the control of surface features of language (grammar, pronunciation, syntax and vocabulary) as an indicator of overall language proficiency. Students in the upper grades confront tasks that require high levels of cognition that are minimally supported by interpersonal cues. It is important to note that the distinction between academic and social language is not necessarily one of oral versus written language. Academic language is closely associated with background knowledge. Reading comprehension in both native and second language is greatly facilitated by background knowledge of the topic in the text (Barnitz, 1985; McNeil, J.D., 1992; Rigg, 1986). Generally speaking, activities that build background knowledge with text and which foster academic language de-

velopment tend to involve more than one of the five senses, integrate the four modes of language, and are motivating. The following suggestions are particularly helpful with older less proficient readers:

- Reading aloud to children.

Reading aloud to children provides a model for the reading process while students witness and cultivate the joy of reading (Mooney, 1990; Trelease, 1989). It also serves to familiarize learners with story structure (Morrow, 1993). Read aloud is a vital strategy that enables students to have access to the core curriculum because they gain meaning with classroom text that they can not yet read independently due to their decoding ability. When choosing what to read to students, one should look for a wide range of texts that reflect different genre and literary styles. Such books will provide a rich source of academic language input and serve as a springboard for discussion and collaborative talk. A mix of narrative and high interest informational texts is necessary. Age appropriate materials that contain good visuals should be selected. Have the students work in small groups to make observations or predictions about visuals from the text. Encourage students to record their inferences, predictions, observations, etc. Students might also collect and describe additional pictures and real objects related to the theme. Less proficient readers need to engage with the text. They must connect with the content. Therefore, from time to time news clippings, jokes, or reference books may be chosen for read alouds. For struggling older readers it is advisable to read to them on a daily basis individually or in a small group. Parents, community members, older students, etc. may be recruited to read to the children.

- Use writing activities to focus students' prior knowledge.

Writing activities, before, during and after reading help sustain reading comprehension. For example, quick-writes used before reading act as a brainstorming activity that help students to unlock and focus their existing knowledge of the concepts found in the text. Quick-writes convey the message to students that writing is thinking. Quick-writes used as a post reading activity assist youngsters to synthesize and summarize the material read. Journal

entries and responding to writing prompts also help students focus what they already know about a topic. Students of all reading levels should be encouraged to share their thoughts. This may require several grouping approaches. Those learners totally new to print can dictate their thoughts and share orally.

- Use multimedia presentations.

The use of audio cassettes, etc. build background knowledge and provide a rich source of language input. Multimedia can enhance a teachers' ability to read aloud to children. Recent technology such as CD ROM provide a variety of stories that can support a wide range of reading abilities.

### **Direct Skill Instruction Should Be Tied to Successful Experiences With Text**

Shared book experience is an invaluable tool in replicating story readings that take place in literate homes (Holdaway, 1979). Predictable and patterned books with mature story lines should be chosen. With older readers, standard-size books may be used. The visuals should have an impact on the reader and enable the learners to predict events. Follow the readings with activities that focus on constructing meaning, such as possible alternative interpretations and/or endings, etc. Shared books should be read and reread. Returning to the text after several days or weeks is a good tactic (Clay, 1991). Books might also be put on tape for extended support in a listening center. Skills such as letter recognition, sight words, phonetic elements and structural analysis can be taught through the language of the stories.

Guided reading can be used with older readers for supporting and developing independence in reading. In the context of a small homogeneous group settings, students gain success in reading texts with the teacher that pose too great of a challenge for them to read initially on their own. Children should not, however, be introduced to guided reading as an initial reading strategy. First dedicate time to shared reading experiences, exposure to stories, poems, chants, songs and other sources of oral language development. Texts should be chosen based on the learners' interests and their potential for success with the

# Voice Silenced Communication and Interpretation

## *A Cost-Effective Use of Technology to Increase Parental Involvement-One School's Experience*

**Editor's Note:** NABE recently heard about an innovative approach to parent involvement and simultaneous communication being used in a school district in California. We were referred by the district to Talk, Inc. After discussions with company representatives, NABE asked them to write an article for the newsletter.

COMMUNIS: from the Latin definition: "Common," Webster's Ninth New Collegiate Dictionary

### **The Problem**

It is no accident that both the words "communicate" and "community" derive from the same Latin base, for it is impossible to establish and maintain a sense of community without communication. It is this simple fact that has, more than any other factor, inhibited the involvement of non-English speaking parents in the education of their children in U.S. schools.

Substantial federal, local and state funds and personnel have been invested in efforts to find better ways to stimulate parent involvement. The usual solution is to provide an interpreter at the various programs established for parents. Most frequently, a presentation is made in English, with periodic, time-consuming pauses to permit an interpreter to provide a bilingual translation. This approach not only increases the length of the presentation, it raises the risk of loss of interest due to lack of continuity and flow of the presentation.

The problems are compounded when the community includes a diversity of language groups. In multilingual communities, presentations to parents from different linguistic groups commonly occur on different day or nights, and often at different facilities in the community. Staff and, in some cases, volunteers, must not only spend time finding facilities and scheduling meetings, but they are also often burdened with making the same presentation two, three and even more times to different language groups. Burnout is not an infrequent result, and cost of routine meetings becomes a major factor. Fur-

thermore, if questions arise from one audience and not another, different groups of parents may actually get more or less information on the same subject. Perhaps most important, rather than encouraging a parental community spirit, parents feel even greater isolation when segregated into individual language groups.

The vast majority of parents, whether English proficient or not, are vitally interested in the education of their children. It remains the goal of the educator/communicator to ensure that parents receive clear, informative, interesting, consistent, and understandable information on an "as-needed" basis. The challenge to educators then, at least in regard to parental involvement, is to find a means to communicate with parents in their own language in the least threatening and most "normal" fashion. It is also desirable to ensure that all parents receive identical information, while at the same time removing any stigma, real or imagined, associated with isolation by language group. Unless these challenges are met, integrating all parents into a cohesive community, in the truest sense of the concept, will prove difficult, if not impossible. The first critical step is to find a communication approach that permits simultaneous interpretation in a variety of languages without disruption.

### **The Technology**

In one school district in central California, it was determined that, in order to meet the needs of educators/communicators, a simultaneous communication system had to possess all of the following characteristics:

1. portable;
2. durable;
3. reliable and dependable;
4. user-friendly;
5. capable of transmitting at least five languages simultaneously;
6. capable of accommodating a large number of listeners; and
7. affordable.

Simultaneous interpretation, of course, is not a new concept. Agencies such as the

United Nations have been using soundproof booths for many years. But booths are permanent fixtures; requiring not only the booth structure, but also permanent installations of amplifiers, transmitter, and receiving stations.

It was obvious that a new technological approach was needed. The solution came from the profession of court reporting. A voice silencing device called the "Stenomask" has been used for over forty years in verbatim recording of courtroom and deposition proceedings. The system permits the user to breathe and speak into a microphone imbedded in a "mask." With minimal proper training, the speaker's voice is completely silenced to anyone beyond a foot or so away. Simultaneous transmission therefore occurs without disrupting any public discourse. In the court reporting application, speech is transmitted though a wire connection from the microphone to a tape recorder.

Working closely with the manufacturer of the Stenomask, a wireless transmitting/receiving system was developed that met all of the requirements listed above. Known as a TALK System (TS), the Stenomask is connected to a transmitter about the size of a pager, which is capable of simultaneous voice transmission to a nearly unlimited number of listeners, each equipped with earphones attached to a wireless receiver of about the same size. The system, in its shockproof carrying case, is very sturdy and light enough to be transported easily by a first grader.

The district has experienced no down time due to equipment failure. Neither parents nor children have had any difficulty operating the simple receivers, and the district has continued to use lay people from the community as interpreters, including parents children or other volunteers. They have had no problem operating either the voice silencer or the transmitter. Because the system transmits a signal in the low FM frequency range, outside interference is virtually eliminated. The makers of the Stenomask have exclusive

CONTINUED ON PAGE 8

use of five frequencies, so simultaneous transmission in up to five different languages is possible in the same room. Thus, while the primary presenter speaks in English, one interpreter may be transmitting in Spanish, while another may be transmitting in the same room to a different group of listeners in Japanese. The cost of the system has proven to be reasonable; it has paid for itself in less than two years.

When the equipment was first purchased in the district, it was stored in a central location. School personnel could check a system out on an as-needed basis. Since schools had different requirements based

both on programs offered and the language characteristics of the parents, some schools borrowed the equipment more frequently than others. It was possible to identify the schools, with the greatest need, and assistance in procuring their own TALK Systems was provided at the district level. Equipment is also still stored centrally for use by the schools in the district with less frequent need. Because the benefits have been so great, the district has continued to purchase additional receivers annually.

### The Results

The Talk System has now been in use in district for nearly two years, with stunning results, including

- better communication between District faculty/administration and the multi-lingual parent population,
- increased parental involvement,
- reduced staff time, and
- dramatically reduced cost.

Presentations which previously took a week or more to reach all parents are now offered at one time to all parent groups irrespective of their primary language or command of English. No additional non-productive time is spent in solving logistical problems; only one meeting room at a time needs to be scheduled. Staff and faculty are therefore able to devote more time and energy to their most important activity: education.

A decided, and unexpected, sociological benefit has also resulted: because parents equipped with the appropriate receiver can sit anywhere in the room and still hear a simultaneous interpretation of a presentation, they are no longer segre-

gated into a "language group." Rather than sitting together, parents often disperse randomly throughout the room. Even without a common language they attempt to communicate with and get to know other parents with children enrolled in the school district. The sense and spirit of a "parental community" is greatly enhanced.

While actual figures depicting cost reduction are difficult to obtain, school principals and administrators in the district have estimated savings in excess of 50% to hold parent meetings. In schools where the equipment has been used extensively, it has paid for itself in a matter of months.

In addition to the usual community developed sources of funds, both Title VII and Title I funds have been accessed by the district to support equipment purchases. Both programs provide funds for parental involvement. These grants have been used to purchase the TS for this district and others, as well.

Simultaneous interpretation afforded by voice silenced communication system provides a major stimulus for increasing parent understanding and involvement. Such a system is likely to prove beneficial to any community or school district where a significant number of parents may have limited English language proficiency.

*TALK Systems can be contacted at 11285 Elkins Road, Suite H-5, Roswell, GA 30076 Tel: (770) 663-3080.*

*NABE will use the Talk System as the official simultaneous interpretation device for NABE '97; it will also be demonstrated in the Exhibit Hall.*

• NABE •

### ARIZONA STATE UNIVERSITY COLLEGE OF EDUCATION

#### ASSISTANT PROFESSOR OF BILINGUAL EDUCATION

The Division of Curriculum and Instruction invites applications for an Assistant Professor of Bilingual Education. This is a full time, academic year, tenure-track faculty position.

#### ESSENTIAL FUNCTIONS

Develop graduate and undergraduate courses in bilingual education and teach in Spanish and English; conduct research and/or other scholarly activities that will produce publications in refereed journals and professional presentations; work with colleagues in the college and local schools that emphasize cross-disciplinary collaboration.

#### QUALIFICATIONS REQUIRED

Doctorate in education or related field by August 15, 1997; native or native-like communication proficiency in Spanish and English and ability to teach in both languages; successful experience in teaching (K-12 or university); expertise in one or more of the following areas: mathematics education, science education, social sciences education, language arts education, reading education, second language development in children and adolescents, bilingual education; experience in adapting content instruction for second language learners; research potential in bilingual education and/or evidence of scholarly production based on collaborative research or development with bilingual programs in schools. DESIRED. Public school teaching experience (K-8); experience working with linguistically and culturally diverse populations in US Southwest; experience in teacher preparation programs.

#### APPLICATION DEADLINE

February 1, 1997 or every week after until position is filled. Send a letter of interest, research and publications plan, curriculum vitae, graduate transcripts, and the names and addresses of three (3) references to:

Alfinio Flores, Chair,  
Search Committee for Bilingual Education  
Curriculum and Instruction  
Arizona State University  
Tempe, AZ 85287-0911

**NABE**  
**'97**

**February 4-8, 1997**  
**Albuquerque Convention Center**  
**Albuquerque, New Mexico**

**E-mail: NABE97@nabe.org**

# Asian/Pacific American Education Concerns

Column Editors: Ji-Mei Chang, San Jose State University, CA, and Janet Y. H. Lu, ARC Associates, Inc., Oakland, CA

## Learning Chinese/Chinese-American History and Culture through Children's Literature

by Marilyn Mei-Ying Chi

Chinese-American children's literature provides wealth of resources for students to study the Chinese and Chinese-American cultures and modern history. The purpose of this article is to describe how specific children's literature can be used by teachers to introduce Chinese/Chinese-American history and culture. The following four books may be used as teaching materials for Chinese and Chinese-American cultures and history in China and the United States from 1839 to 1997: Laurence Yep's *Dragonwings* (1975) and *Dragon's Gate* (1993), Bette Bao Lord's *In the Year of the Boar and Jackie Robinson* (1984) and Song Nan Zhang's *A Little Tiger in The Chinese Night* (1993). A brief illustration of Chinese modern history concurrently with Chinese-American as well as U. S. history from 1839 to the present can be found in Chi (1996).

The years 1839 to 1997 are extremely crucial in Chinese and Chinese-American modern history. After the meeting of the East and the West, China's attempt to stop British trade in opium led to the Opium War in 1839. Hong Kong was ceded to the British for 155 years, until 1997. Since 1839, China has suffered from drought, famine, civil rebellions, and wars with Western nations and Japan. At the same time, news of gold in America — most notably of the California Gold Rush in 1849 — enticed the villagers, mainly of the Kwangtung province in southeastern China, to San Francisco to make a better life. The Chinese called San Francisco "the Golden Mountain." In addition, through the study of themes and symbolism in these novels, students will be able to better understand the commonality and transformations of the beliefs, values, customs, and religion among Chi-

nese and Chinese-Americans.

### Theoretical Grounding

Literature has long been seen as a powerful vehicle for fostering cultural awareness and appreciation because it tells the stories of human events and of the human condition, not simply the facts. Literature does more than change minds, it changes people's hearts; and people with changed hearts are people who can move the world (Huck, Helper, & Hickman, 1995; Norton, 1990, 1995; Pepper, 1976; Rasinski & Padak, 1990; Tway, 1989). Historical fiction creates a powerful sense of history in which students can explore the joys, conflicts, and sufferings of those who lived before us (Levstik, 1990; Tunnell & Ammon, 1993). Using historical fiction in the classroom stimulates in-depth investigation of historical time periods and settings. Furthermore, students can identify with main characters as they see the characters take charge of situations in which the students may find themselves. It provides subtle role models for students and gives them opportunities to exercise judgment and decision-making. Exploring themes through historical fiction helps students see how a similar theme can be realized in several different time periods.

Autobiography is another extraordinarily powerful genre for the young, not only for the light it sheds on the past, but also for examples of human understanding. By reading about men and/or women who exhibited struggle, sorrow, and strength in times of adversity, students develop a keen understanding of how human events results from human action. Strong narratives offer accurate and picturesque details, a sense of period, and a grasp of historical issues, trends, and social types. The students develop social sensitivity to the needs of others and realize that people have similarities as

well as differences.

Pepper (1976), in his study of Native American Indian children, suggests that teachers teach the true history of the different minority groups and the value of these cultures to all children in order to improve the self-concept of minority students in mainstream settings. Through Chinese-American literature, Chinese-American students are able to learn to identify with people from their own cultural heritage who have created the stories, whether from the past or the present (A. Chi, 1993; M. Chi, 1993). From the past, Chinese-American students discover myths, legends, fables, and folktales that clarify the values and beliefs of the people. They discover the great stories on which whole cultures have been explored. From the present, they discover the threads that weave the past with the present and the themes and values that continue to be important to people. Moreover, they can better understand the social and cultural conflicts that results from differences in beliefs, values, customs, and religion.

### The Meeting of Cultures and Chinese/Chinese-American History through Chinese-American Children's Literature

Laurence Yep's historical fiction novels provide powerful examples of Chinese-American children's literature. Two of his novels, *Dragonwings* (1975) and *Dragon's Gate* (1993), portray the Chinese-American's experience of discrimination, violence and injustice against them in the United States. They not only recapture the history, reality and spirit of the Chinese community in the Chinatown of San Francisco and the Sierras from 1867 to 1910, but they also carry subtle messages on issues important to people of dual racial and cultural heritages. Bette Bao Lord's *In the Year of the Boar and*

CONTINUED ON PAGE 10

*Jackie Robinson* (1984) is another good historical fiction novel based on the author's personal life experience as a newcomer to America. It portrays a ten-year-old Chinese girl's struggle to build a life in a new country in Brooklyn, New York in the year of Boar, 1947, right after World War II. America was indeed a land full of wonders, but the little girl did not know any English to make friends. Through Jackie Robinson, a black baseball hero who made a difference in America, she found America a land of opportunity. In addition, Song Nan Zhang's *A Little Tiger in The Chinese Night* (1993) is an exemplary autobiography that tells the story of his life and history from 1945 to the present, mostly in China after World War II. His autobiography portrays the twists and turns of Chinese contemporary politics — from the Great Leap forward to the Cultural Revolution, and from the relaxing of policies following the death of Mao to the clampdown at Tiananmen Square. His life story provides rare insight into the hopes and disappointments, and dreams and nightmares, that almost every Chinese experienced at that time.

The four novels stated above portray the experience of Chinese-Americans and Chinese in the periods of the 1860's, the 1900's, the 1940's, and the 1940's to the present in China and America. They not only stimulate in-depth investigation of historical settings, people and events, but also illuminate processes of historical change and continuity. The journey of dream-making in China and America by the protagonists — Moon Shadow in *Dragonwings*, Otter in *Dragon's Gate*, Shirley Temple Wong in *In the Year of the Boar and Jackie Robinson*, and Song Nan Zhang in *A Little Tiger in The Chinese Night* — reveals the way the Chinese and Chinese-Americans saw themselves, their beliefs and values, their fears, frustrations and dreams and, most importantly, the way they interpreted their own times and cultures. It is this educator's whole-hearted hope that through discussing the four historical fiction/autobiographical novels and related materials, Chinese-American youngsters can develop a keener understanding of why their ancestors left their homeland they

called "the Middle Kingdom," to go to the new country, "the Golden Mountain;" and how their ancestors struggled through the social and cultural conflicts of those times. Moreover, it is hoped that young Chinese-Americans will find themselves, solve their own complex puzzles resulting from their bicultures, and challenge and act upon their beliefs and values to change the world, East and West.

#### References

- Chi, A. K-C. (1993). "I just want to be free." *Dystopia*. San Jose, CA: Lynbrook.
- Chi, M. M-Y. (1996). "East Meets West Since 1839: The Meeting of Cultures and Chinese/Chinese-American History through Chinese-American Children's Literature." In J. M. Chang & D. Lin (Eds.), *The fourth annual conference proceedings: Balancing academic achievement and social growth* (pp. 52-60). Rockville, MD: Chinese American Educational Research & Development Association.
- Chi, M. M-Y. (1993). "Asserting Asian-American children's self and cultural identity through Asian-American children's literature." *Social Studies Review*, 32, 50-55.
- Huck, C. S., Helper, S., & Hickman, J. (1995). *Children's Literature in the Elementary School* (6th ed.). Orlando, FL: Harcourt Brace.
- Levstik, L. (1990). "From outside in: America's children's literature from 1920-1940." *Theory and Research in Social Education*, 18, 327-343.
- Norton, D. E. (1990). "Teaching multicultural literature in the reading curriculum." *The Reading Teacher*, 44, 28-40.
- Norton, D. E. (1995). *Through the Eyes of a Child* (4th ed.). New York, NY: Macmillan.
- Pepper, F. C. (1976). "Teaching the American Indian child in mainstream settings." In R. L. Jones (Ed.), *Mainstreaming and the Minority Child*. Reston, VA: The Council for Exceptional Children.
- Rasinski, T. V., & Padak, N. D. (1990). "Multicultural learning through children's literature." *Language*

*Arts*, 67, 576-580.

- Tunnell, M., & Ammon R. (Ed.). (1993). *The Story of Ourselves: Teaching history through children's literature*. Portsmouth, NH: Heinemann.
- Tway, E. (1989). "Dimensions of multicultural literature for children." In M. K. Rudman (Ed.), *Children's literature: resource for the classroom*. Needham Heights, MA: Christopher-Gordon.

#### Children's Literature References

- Lord, B. B. (1984). *In the Year of the Boar and Jackie Robinson*. New York: Harper & Row.
- Yep, L. (1975). *Dragonwings*. New York: Harper & Row.
- Yep, L. (1993). *Dragon's Gate*. New York: Harper Trophy.
- Zhang, Song Nan (1993). *A Little Tiger in the Chinese Night*. Plattsburgh, NY: Tundra.

*Dr. Marilyn Mei-Ying Chi is a professor of Language/Literacy Education and the Coordinator of the Chinese Bilingual Teaching Credential Program in the Division of Teacher Education at San Jose State University. She studies the development of bilingual and biliterate ability in multiple contexts as well as the perception of bi- or multi-languages/culture among Asian children.*

**Editor's Note:** Contributions to the Asian/Pacific American Education Concerns column should be sent to Janet Lu, MCR/NC, 1212 Broadway, #400, Oakland, CA 94912. (510) 834-9438, FAX (510) 763-1490. Email: janet\_lu@arcoakland.org

\* NABE \*

**NABE '97**

**February 4 - 8, 1997**

**Albuquerque,  
New Mexico**



# Administration of Bilingual Education Programs

Column Editor: Dr. Jaime A. Castellano, Palm Beach County S.D., West Palm Beach, FL

## *Shifting the Paradigm: What Does This Mean for the Changing Faces of School Children?*

by Dr. Jaime A. Castellano

The American public school system is as diverse as it has ever been. Students today are increasingly different from one another linguistically, culturally, and economically. No public school district is immune from this fact. Shifting the paradigm begins with the acknowledgement and examination of how our own culture may color our perceptions of others. This is a form of "Cultural Therapy" that will allow educators to recognize diversity as a strength and build a system of practices that will empower those children they have been charged to lead.

### **Linking Successful Practices**

There is an abundance of research which details and documents educational practices successfully implemented in schools throughout the United States identified as linguistically, culturally, and economically diverse. The key to success for these schools includes the linking of successful practices which match the needs of the school and its surrounding community.

Gove Elementary School (located in the Glades, a far west section of the Palm Beach County, Florida, School District—recognized as one of the most economically depressed in Florida) has initiated a number of practices to reverse a cycle of failure historically associated with its location and environment.

Lead by their visionary principal, Mrs. Margarita Pinkos, and a group of ambitious teachers, they have set out to implement a course of study for their students that embraces change, fosters an appreciation for bilingualism, and takes advantage of their physical environment in the Glades.

Gove is one of two elementary schools in Palm Beach County which capitalized on the fact that the majority of its student

population, 54%, is Spanish-speaking and initiated a dual-language program in grades K-2. In this program, native Spanish-speakers can take pride in the fact that their language has been deemed important enough by the school that it is used for instruction. At the same time, their monolingual-English counterparts are learning a new language designed to make them proficient in listening, speaking, reading, and writing Spanish. The ultimate goal of the dual-language program is to produce generations of children who are bilingual, thus preparing them to participate and compete in a diverse economic society.

Gove has also maximized their resources by forming partnerships with other agencies and community groups to provide additional services and learning opportunities for its students. It has teamed up with Pine Jog, a hands-on science based environmental agency, to become an environmental model school. Through a fine arts grant it has been able to open up its campus every Tuesday and Thursday night and Saturday mornings to offer enrichment-type activities the students and their parents otherwise could not afford or be exposed to. Thus, they are improving the "quality of life" for an entire school community.

A pre-Kindergarten program which targets migrant students provides those early experiences deemed necessary to have a successful Kindergarten year. Finally, Gove is home to a program designed to attract the potentially gifted minority population. Identified students spend the fourth grade immersed in curriculum and instruction emphasizing higher-order thinking skills, enrichment and acceleration.

Palmetto Elementary School, located in West Palm Beach, Florida, is a Title I school with 83% of its students qualifying for the free and/or reduced lunch program. Test scores hover around the 35th-40th percentile on nationally standardized

norm-referenced tests; approximately 70% of the students speak Spanish, with 50% of these students identified as limited English proficient.

The principal, Dr. Jaime A. Castellano, acknowledges that the two greatest resources the school has are the language and culture of the students and their community. One of the most powerful attributes of effective schools for disadvantaged students is the demonstration of respect for students' cultural and linguistic backgrounds.

As a result, Palmetto has instituted a New-Comers Instructional Program for students new to the country or school district who speak little or no English. Because maintaining concept development and cognitive academic language proficiency is a priority, students are taught in Spanish for two hours a day. They also receive English as a second language and attend fine arts classes with their homeroom classmates.

Students enrolled in grades 1-3, who already speak Spanish, participate in a Spanish for Spanish-speakers program emphasizing reading and writing. The aim is to accelerate these language functions to keep pace with their listening and speaking skills. Program teachers collaborate closely with homeroom teachers and both have high expectations for students.

Students in grades 1-3 who do not speak Spanish participate in the Spanish as a second language program where the emphasis is on basic interpersonal communication skills. Finally, Palmetto is the only elementary school in Palm Beach County to offer a gifted and/or accelerated program for academically-talented and creative LEP students. Working with well-known consultants in the field of gifted education they have been able to offer services to students who would otherwise be unable to participate in the traditional

CONTINUED ON PAGE 12

gifted programs due to their inability to speak English.

Linking successful practices with self-selected educational programs highlights meaning and understanding. In the Palm Beach County School District this paradigm shift is becoming the norm as more and more schools are becoming successful in meeting the challenges of the changing faces of children.

### Meeting Students' Diverse Educational Needs

José is a second grade student who cannot read and whose writing is barely legible; however, he has a sharp auditory sense and can remember just about anything. John is in Kindergarten and has cerebral palsy. He has average intellectual and cognitive ability, but poor fine motor skills. He has difficulty holding a crayon and using scissors. María, a fifth grader, is functioning at a third-grade level. Although she is identified as learning-disabled, she has had one of the lead roles in the theatrical production, "James and the Giant Peach." Tony is gifted, but yet failing four subjects.

These students, with their diverse educational needs, pose a growing concern for teachers across America. In every classroom we find that the educational needs of students are just as diverse as the students themselves. Is it possible for one teacher to accommodate the various learning styles of the 25-35 students he/she has been

assigned? Perhaps implementing a "best practices" approach to learning will allow us to meet the challenge. It would also behoove teachers to present skills within the context of real-world investigations, building on prior knowledge while making the lessons comprehensible. Using experiences of students as a foundation for learning implies the efficient use of academic learning time.

### Community Links

Maximizing resources through volunteer programs and partnerships with local businesses and community groups to provide goods and services to children and families invokes collaboration to meet the constant changing needs of children. Extending parent outreach beyond education to social services will strengthen the bond among the family, school, and community.

Using ethnic media sources to form community links encourages parents to participate in school activities and to form organizations, rather than merely assisting as volunteers. It is also important to foster respect for the language and culture of the community despite the economic or sociocultural background of students and families.

### Human Resources

The School District of Palm Beach County, Florida, has more than 200 community language facilitators in over 100 schools. They serve as cultural ambassadors between the home, school and community. Their responsibilities are numerous and include, among other things, oral and written translations, tutoring, assisting parents in the registration process, disseminating information to parents in their native language, administering informal language screenings, and record-keeping.

Community Language Facilitators (CLF) receive regular inservice training on increasing their effectiveness at the school site. Many times they are the only link between non-English speakers and the school administration with all its bureaucracy. To say the least, they are a very important human resource.

At the district level, there is a cadre of translators whose work is critical to the

overall mission of the school district. The respect that is placed on language is evident in their relationship with the American Translators Association. Palm Beach County is the only school district in the United States, to our knowledge, to have direct formal ties with them.

Furthermore, in our attempts to reach as many students as possible in assuring that they are successful in school, the district has instituted a homework hotline in English, Spanish, and Creole. This service also has the capability to provide homework assistance in a number of other languages as well.

School districts throughout the United States employ teacher assistants and/or instructional assistants in order to best serve the students. They can be found in the regular classroom, particularly at the primary level, in ESL or bilingual programs, and in special education classrooms. This army of support is crucial to the backbone of a school or school district, despite the fact that they are typically the lowest paid employees in the system.

I guess the bottom line is collaboration. A school that runs like a well oiled machine emphasizes unity from diversity, and a commitment to a shared vision. A common bond is shared by all — that bond is the children.

### Summary and Conclusion

School districts across the United States are changing — linguistically, culturally, and economically. Those who accept this fact will be better prepared to meet the diverse needs of their student population; those who don't maintain a status quo mentality. What separates successful schools from unsuccessful schools serving a diverse student population is well documented in the research and related literature. We all must do a better job if we are to mold generations of citizens for the future. Our children are depending on us.

**Editor's Note:** Contributions to the Administration of Bilingual Education Programs column should be sent to the column editor, Dr. Jaime A. Castellano, at Palmetto Elementary School, 835 Palmetto Street, West Palm Beach, FL 33405. (407) 533-6372.

**Readers are welcome to reprint any NABE NEWS original material free of charge as long as proper credit is given to both the author and NABE NEWS as the source.**

# Technology and Language Minority Students

Column Editor: Dr. Dennis Sayers, University of California Educational Research Center

## *Electronic Portfolios: A New Idea in Assessment*

by Anna Maria D. Lankes

**Column Editor's Note:** This month's column focuses on the promising potential of computer-based portfolio assessment, a key topic in bilingual education programs where student mobility is the rule rather than the exception.

### Introduction

Teachers and administrators are showing increased interest in becoming part of a "new wave" of assessment in the classroom; assessment which includes authentic and performance-based measures. These methods of assessment allow students to demonstrate desired performance through real-life situations (Meyer, 1992). Such methods of assessment are not limited to multiple-choice and standardized tests, but include projects which require students to demonstrate their problem-solving skills as well as their skills in analyzing and synthesizing information. Several school districts across the United States have reported improved student performance associated with new assessment programs (Herman, 1992). Many schools are developing new methods for measuring students' progress in both the elementary and secondary classroom. One of these new assessment measures, the portfolio, has become increasingly popular, and technology is helping with its creation and management.

### What is a Portfolio?

A portfolio at the K-12 education level is essentially a collection of a student's work which can be used to demonstrate his or her skills and accomplishments. An educational portfolio is more than just a group of projects and papers stored in a file folder. It includes other features such as teachers' evaluations and student self-reflections. According to the Northwest Evaluation Association, a portfolio is "a purposeful collection of student work that exhibits the student's efforts, progress, and achievements. The collection must include student participation in selecting contents, the criteria for selection, the criteria for judging merit, and evidence of student self-reflection" (Paulson, Paulson, & Meyer, 1991). A portfolio may be used to demonstrate a student's achievements in specific subject areas such as mathematics and science or it may be used across the curriculum to assess abilities in all subject areas.

### Why Use a Portfolio?

**Developmental Portfolios:** A teacher who is interested in documenting a student's improvements in writing or mathematics throughout a school year can have the student keep a developmental portfolio containing samples of the student's work along with self-evaluations of specific assignments. Such a portfolio pro-

vides specific documentation which can be used for student evaluations and parent conferences.

**Teacher Planning:** Teachers may use an existing portfolio system in order to receive information about an incoming class of students. The teacher may gain a better understanding of the ability levels of his or her students prior to the start of the school year and plan accordingly.

**Proficiency Portfolios:** Central Park East Secondary School in New York City uses portfolios as a means for determining graduation eligibility. Students at this school are required to complete fourteen portfolios which demonstrate their competence and performance in areas such as science and technology, ethics and social issues, community service, and history (Gold & Lanzoni, 1993).

**Showcase Portfolios:** A showcase portfolio can document a student's best work accomplished during an entire educational career. It can include the research papers, art work, and science experiments which best represent the student's skills and abilities.

**Employment Skills Portfolios.** Businesses across the country are increasingly interested in viewing student portfolios in order to evaluate a prospective employee's work readiness skills. Students in the Michigan public schools, for example, are creating employability skills portfolios to demonstrate their skills to prospective employers (Stemmer, Brown, & Smith, 1992).

**College Admission Portfolios:** Colleges and universities are using showcase portfolios to determine eligibility for admission. By requiring portfolios from prospective students, college or university admissions officers are better able to assess applicants' potential for success at their institutions.

### Technology and the Creation of Computer-Based Portfolios

How to store and manage portfolio materials is a concern shared by many educators interested in implementing portfolio programs. In order to keep portfolios which would include papers, projects, and video and audio tapes for a class of students for 13 years (K-12), a school would need several additional classrooms to store this wealth of information. Many educators have been reluctant to implement portfolio assessment programs in their schools because of storage concerns like these. A likely solution to this problem is the creation and storage of portfolios using computer technology.

The terms "computer-based portfolio" and "electronic portfolio" are used to describe portfolios saved in electronic format. Electronic portfolios contain the same types of information as the portfolios discussed earlier, but the information is collected, stored, and managed electronically. Since current technology allows for the capture and storage of information in the form of

CONTINUED ON PAGE 14

text, graphics, sound, and video, students can save writing samples, solutions to mathematics problems, samples of art work, science projects and multimedia presentations in one coherent document. A single computer with a large storage capacity can store portfolios for all of the students in a class. With more students creating multimedia projects, however, a floppy or even a hard disk might not suffice for storage. An alternative is to store student portfolios on a CD-ROM (a compact disk which stores text, sound, graphics and video). A CD-ROM can store approximately 650 MB of information or 300,000 sheets of typed text. This might include all of the portfolios for an entire grade level of students. A computer-based portfolio program also allows for easy transfer of information. An individual computer disk or CD-ROM could be created to transport a student's documents from teacher to teacher or school to school.

### Solutions and Examples

There are several commercially available portfolio programs which offer teachers the ability to track student achievement. Aurbach's "Grady Profile" is one program which provides a template for teachers and students to enter work samples. Programs may include writing samples, standardized test scores, oral communication skills, and mathematics assessments. Other software programs, such as Roger Wagner Publishing's "HyperStudio" and Claris' "FileMaker Pro," allow teachers to create their own templates for portfolio assessment. Educators can use these programs to customize portfolios to suit the needs of their classes. For example, one high school English portfolio might include outlines and drafts for each writing assignment, while another might include only the finished product along with self-reflections by the student.

One school which is involved in creating electronic portfolios for all its students is East Syracuse-Minoa High School in East Syracuse, New York. Students at this high school are creating electronic portfolios which can be sent to colleges as part of the admissions process and to potential employers to determine workplace readiness. This electronic portfolio, called "The Portfolio Manger," was created in "HyperStudio" and contains traditional information about students (transcripts, letters of recommendation, and work history) as well as student-selected work samples (writing samples, multimedia research papers, art work, and video clips from a performance in the school play). The students are responsible for updating and selecting the work samples they include in the portfolio and can select virtually any piece of work that they believe best represents their skills and abilities. Currently, students begin creating portfolios during their sophomore year and continue updating and revising the work samples throughout their high school careers. Upon completion, the portfolio can be distributed in computer disk, CD-ROM, video tape, or print versions.

### Summary

The implementation of computer-based portfolios for student assessment is an exciting educational innovation. This method of assessment not only offers an authentic demonstration of accomplishments, but also allows students to take responsibility for the

work they have done. In turn, this motivates them to accomplish more in the future. A computer-based portfolio system offers many advantages for both the education and the business communities and should continue to be a popular assessment tool in the "information age."

### References

- "Alternative assessment and technology." (1993). *ERIC Digest*. ERIC Clearinghouse on Information & Technology, Syracuse, NY. (ED 365 312)
- Barrett, H. C. (1994). "Technology-supported assessment portfolios." *Computing Teacher*, 21(6), 9-12. (EJ 479 843)
- Brewer, G. (1994). *FileMaker Pro*
- Gold, J. (Producer & Director), & Lanzoni, M. (Ed). (1993). *Graduation by Portfolio—Central Park East Secondary School*.
- Grady, M. P. (1991). *Grady Profile*.
- Herman, J. L. (1992). "What research tells us about good assessment." *Educational Leadership*, 49(8), 74-78. (EJ 444 324)
- Hunter, B. & Others. (1993). "Technology in the classroom: Preparing students for the information age." *Schools in the Middle*, 2(4), 3-6. (EJ 465 259)
- McLellan, H. (1993). "Evaluation in a situated learning environment." *Educational Technology*, 33(3), 39-45. (EJ 461 596)
- Meyer, C. A. (1992). "What's the difference between 'authentic' and 'performance' assessment?" *Educational Leadership*, 49(8), 39-40. (EJ 444 312)
- Paulson, L. F., Paulson P. R., & Meyer C. (1991). "What makes a portfolio a portfolio?" *Educational Leadership*, 48(5), 60-63. (EJ 421 352)
- Saylor, K. & Overton, J. (1993). *Kentucky Writing and Math Portfolios*. Middlesboro, KY: Middlesboro Intermediate School. (ED 361 382)
- Stemmer, P., Brown, B., & Smith, C. (1992). "The employability skills portfolio." *Educational Leadership*, 49(6), 32-35. (EJ 441 170)
- Wagner, R. (1993). *HyperStudio*.

*Anna Maria D. Lankes is a Systems Consultant in Computer Assisted Instruction at the OCM BOCES. She can be contacted by e-mail at <amlankes@ericir.syr.edu>*

*This publication was prepared as an ERIC Digest ( ED390377) in December of 1995 with funding from the Office of Educational Research and Improvement, U.S. Department of Education. The opinions expressed in this report do not necessarily reflect the positions or policies of OERI or the Department of Education.*

**Editor's Note:** Contributions to the Technology and Language Minority Students column should be sent to Dr. Dennis Sayers, University of California Educational Research Center, 351 E. Barstow Avenue, #101, Fresno, CA 93710. (209) 228-2050; FAX (209) 288-2055. E-mail: DSAYERS@panix.com.

# Successful Practices

Column Editor: Anne Homza, Boston Public Schools, Boston, MA

## Using Graphic Organizers to Develop Bilingual Literacy Processes

by Dr. Anne Homza

Graphic organizers are powerful literacy scaffolds for bilingual learners engaged in developing literacy in two languages. This article provides a glimpse of how teachers and students are successfully employing several kinds of graphic organizers as strategic tools to enhance literacy processes.

### Graphic Organizers and Pre-Reading Processes

A group of fifth-grade bilingual students crowds over a table, engaged in a serious discussion in English and Vietnamese as they work together over a large piece of chart paper. These children, half of whom will be mainstreamed next year, are working cooperatively on the construction of a Venn diagram in preparation for a literature unit on "Shiloh" by Phyllis Reynolds Taylor. The bilingual classroom and ESL teachers who will teach the unit together are helping the students elicit their background knowledge in order to subsequently improve their comprehension of the story, which deals with a boy's rescue of a dog from an abusive owner. The Venn diagram compares the treatment of dogs in the US and in Vietnam. (See Figure 1.)

In this brief vignette, bilingual students are using a kind of graphic organizer to enhance their learning. Graphic organizers are "visual representations of knowledge" (Bromley, Irwin-DeVitis, & Modlo; 1995, p. 6). They structure information by highlighting and arranging critical aspects of a concept, topic or process into a visual pattern. The use of a graphic organizer is basically a strategy that students can employ to improve their learning — learning of concepts as well as learning of processes.

The Vietnamese students who create the Venn diagram prior to reading a story are activating their background knowledge about a particular idea. Schema theory suggests that this kind of retrieval of prior knowledge calls up one's existing framework of knowledge, facilitating the incorporation and efficient structuring and filing of new information. So, first these bilingual, bicultural students are able to tap into their knowledge of how dogs are treated in their two different cultures. Then, using the Venn diagram as a visual tool to strategically structure their ideas, they actively sort this information out in a collaborative setting that allows for the use of their two languages. Finally, this process prepares these students to comprehend the conflicts and challenges in *Shiloh*, a book written from a purely American perspective. Far from being an end in itself the graphic organizer promotes a pre-reading thinking process that aids in later reading comprehension.

Similarly, a multilingual group of parents who are participating

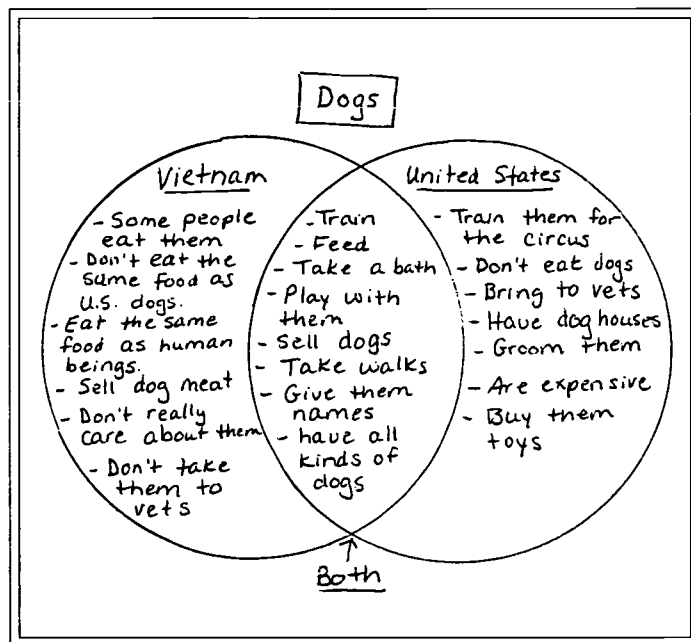

Figure 1. This is the pre-reading Venn diagram created by a group of fifth-grade Vietnamese bilingual students preparing to read *Shiloh*. Venn diagrams are conceptual graphic organizers used to visualize similarities and differences. Shared attributes of the objects of comparison are written in the overlapping section of the circles while attributes that are not shared, i.e., that are different or unique, are written in the other parts of the circles. In this case, characteristics of the treatment of dogs in Vietnam are found to the left and those in the US are found to the right, common characteristics are in the middle.

in an intergenerational literacy program are preparing to read a short article in English on ways parents can help their children succeed in American schools. The parents are all ESL learners, come from eight different countries and speak Spanish, Portuguese and Vietnamese as their native languages. After discussing their thoughts about the topic with each other and with the bilingual teachers and tutors in their native languages in same-language groups, they share their ideas with the whole class. They contribute ideas in either their native language or in English, and all ideas are written in English on the blackboard by the teacher in a brainstormed web. When all ideas have been shared, a multilingual discussion ensues in which the organization of the ideas is discussed and the web is rearranged to show how the ideas can be structured. Prepared with activated schemas, a visual representation of how that knowledge can be organized and new English vocabulary, the parents then begin to read the article. In addition to increasing their knowledge about the topic and improving their English skills, these parents are learning a valuable pre-reading process that will ultimately improve their reading comprehension.

CONTINUED ON PAGE 16

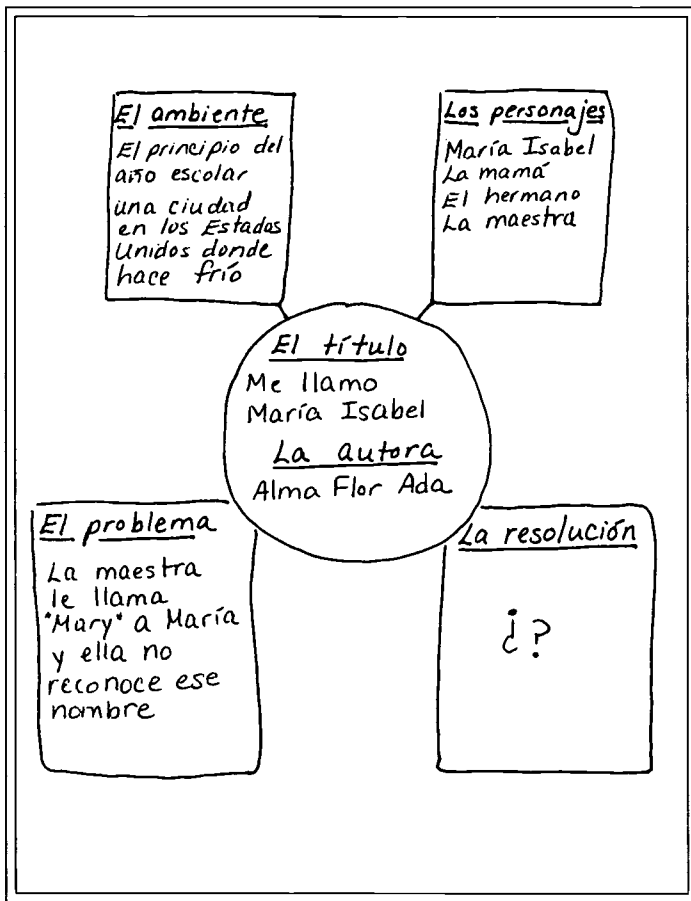

Figure 2. After hearing a read-aloud of *Me llamo María*, a group of middle school literacy students contribute to this story map. Story maps describe the structure of a fictional work and typically identify Title, Author, Setting, Characters, Problem and Solution.

**Graphic Organizers During Reading**

Spanish-speaking middle school students in a Title I native language literacy program designed for students who enter US schools with limited schooling in their own country have just listened to a read-aloud of Chapter One of Alma Flor Ada's "*Me llamo María Isabel*." After the teacher's brief presentation of a pre-formatted story map hand-drawn with colored marker on a large piece of chart paper at the front of the class, the students enthusiastically contribute their ideas in Spanish. The teacher writes their ideas on the graphic organizer. (See Figure 2.) Following the discussion involved in the completion of the first parts of this conceptual graphic organizer, the students take out their literature journals and reflect on the protagonist's situation and predict what might happen next.

With the use of a graphic organizer during a reading, students are checking their comprehension. In addition, with this graphic organizer they are being introduced to story grammar: setting, characters, problem, action and solution. Familiarity with this typical structure of fiction will enhance their understanding not only of *Me llamo María Isabel* but of countless other future fictional pieces in Spanish and in English. Indeed, the use of graphic organizers can be particularly powerful for students who are developing literacy in two languages because an organizer itself is structurally cross-lingual. That is, the visual structure alone provides information about a pattern in a way that is not language-dependent. So, for example, when these Spanish-speaking middle school students read texts in English, they can easily use a strategy incorporating the same graphic organizer. Finally, in addition to helping the students check their comprehension and become familiar with story grammar, the construction of an incomplete story map during the process of reading helps them actively engage in reflection and prediction, strategies involved in the process of reading that they need to learn.

Graphic organizers may also be used during reading to foster more specific kinds of thinking and reflection. Many teachers have found them helpful to promote character analysis, for example. A fifth-grade Vietnamese student created the Venn diagram in Figure 3 while reading *Shiloh*. In this visual structure she compares Judd and Marty, two central characters in the book. Similarly, Figure 4 shows a character attribute web created by a fifth-grade Spanish-speaking student to reflect on Caleb, one of the characters in *Sarah, sencilla y alta*, the Spanish version of *Sarah, Plain and Tall*, by Patricia MacLachlan (1988).

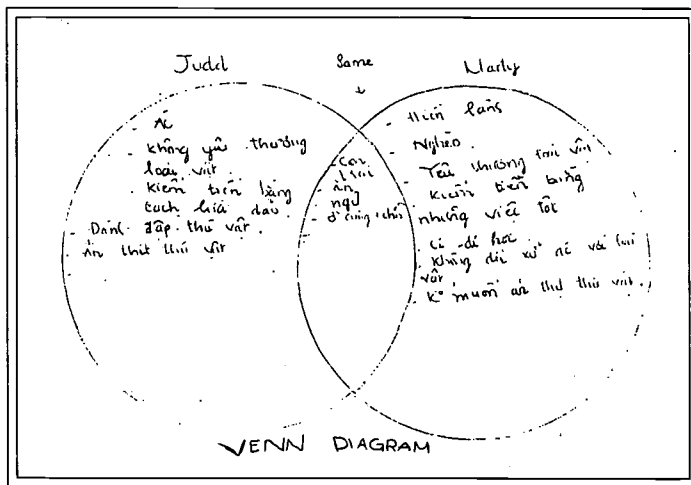

Figure 3. While reading a book in English, a fifth-grade Vietnamese bilingual student creates this Venn diagram in Vietnamese to compare two characters.

**Graphic Organizers in Post-Reading**

In a Cape Verdean bilingual sixth grade the teacher has written "courage - coragen" in a circle on the blackboard and asks the students to recall some of the many biographical and other non-fiction articles they have recently read in English. The students enthusiastically contribute the titles and the teacher writes these on the board, constructing the first tier of a conceptual graphic organizer. Then the teacher asks

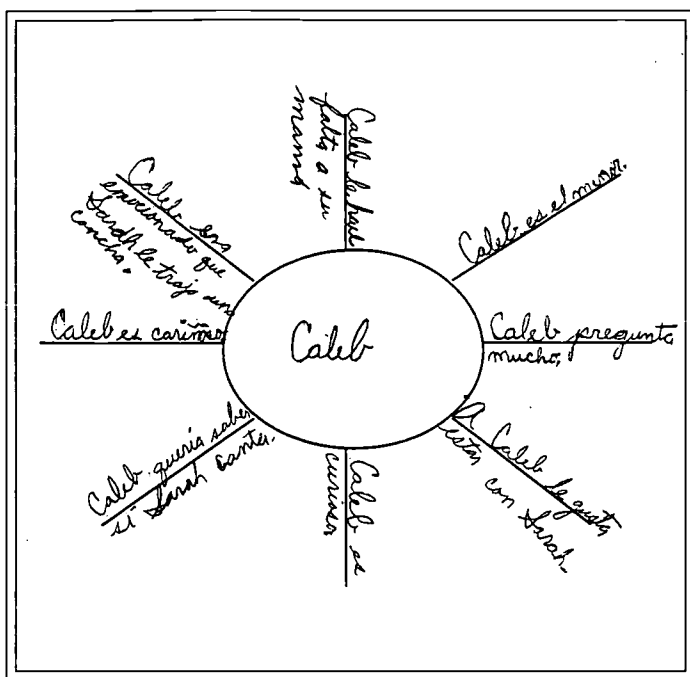

Figure 4. In this character attribute web a fifth grade Spanish bilingual student describes the character Caleb in Sarah, sencilla y alta. Descriptions of this character are clustered around his name. Simple concept or attribute webs like this display words and ideas around a central topic or concept.

the students to share their ideas about examples of courageous behaviors presented in each reading. Slowly, by writing the students' ideas, another tier of the graphic organizer is completed. This part of the graphic organizer is in Cape Verdean Creole. (See Figure 5.)

In this classroom Cape Verdean students have been focusing on the theme of "courage" in their recent readings. While their readings have been accomplished in English, the discussion surrounding the readings has been in Cape Verdean Creole, allowing students to best demonstrate and extend their comprehension. By reflecting on all of their readings and relating each one to the theme of "courage" in specific ways, the students have distilled an aspect of their learning and comprehension of these readings. This post-reading process of analysis and synthesis is fostered through the use of the graphic organizer.

Because the actual text in the graphic organizer in Figure 5 is bilingual, it makes obvious one of the characteristics of developing bilingual literacy: the bilingual nature of the process of reading. In order to best learn to engage in effective pre-reading, during-reading and post-reading strategies, bilingual students need to be given opportunities to use their native language. As the vignettes presented here demonstrate, literacy processes such as activating prior knowledge, reflecting, predicting, comprehending, analyzing, synthesizing and evaluating are thinking processes that can often be successfully fostered in and through the native language for developing biliterate students. After all, the thinking processes involved in reading are themselves cross-lingual; they are not specific to a particular language. When developing bilin-

CONTINUED ON PAGE 18

gual students learn to employ particular strategies in the process of reading, these strategies can be applied to reading text in either of their languages. This is why bilingual students' two languages can be involved in the active creation of graphic organizers, especially if the graphic organizers are employed when students are reading English text.

**Graphic Organizers and Other Literacy Processes**

A Spanish bilingual third-grade student uses a graphic organizer to engage in a pre-writing process for her self-selected personal narrative about "Mis vacaciones en Puerto Rico" ("My vacation in Puerto Rico"). Putting her title in the center of the page she quickly writes down ideas of things she would like to include in her piece. (See Figure 6.) Later, as she writes, she will check off the information already included.

This kind of pre-writing brainstorming is a very common use of graphic organizers. As students' own writing become more detailed and complex, pre-writing graphic organizers do as well. And, as students are exposed to different kinds of graphic organizers they learn to use more varied tools to help them to structure and clarify their own ideas. In addition to the various conceptual graphic organizers presented above, there are several graphic organizers related to chronology: cause and effect flow charts (see

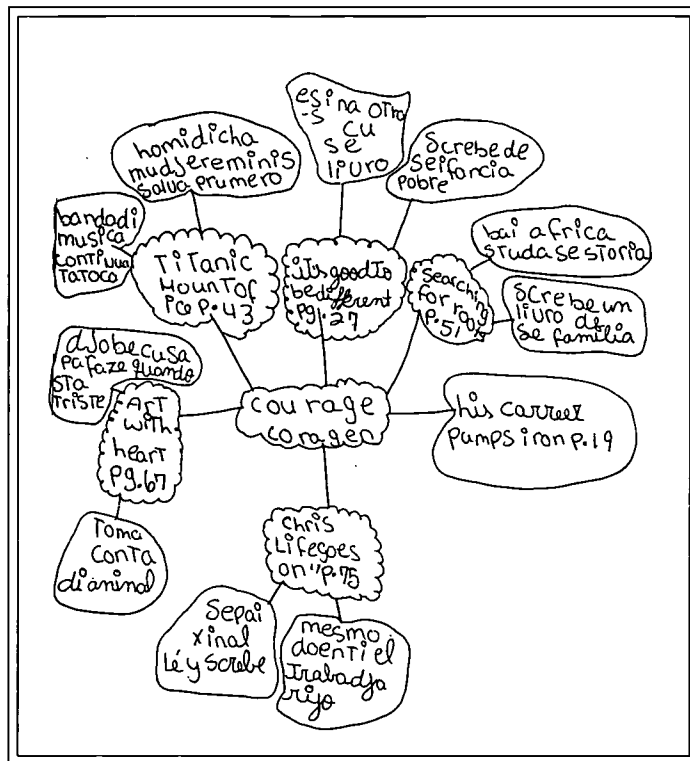

Figure 5. Cape Verdean middle school bilingual students studying the concept of courage create this concept web after reading several biographical and other non-fiction texts. The first tier of cloud-shaped bubbles around the central concept represent the titles of the readings. The second tier bubbles describe in Creole the aspects of courage exemplified in each reading. Multi-tiered concept or attribute webs of this type display several types of information related to a central topic or concept.

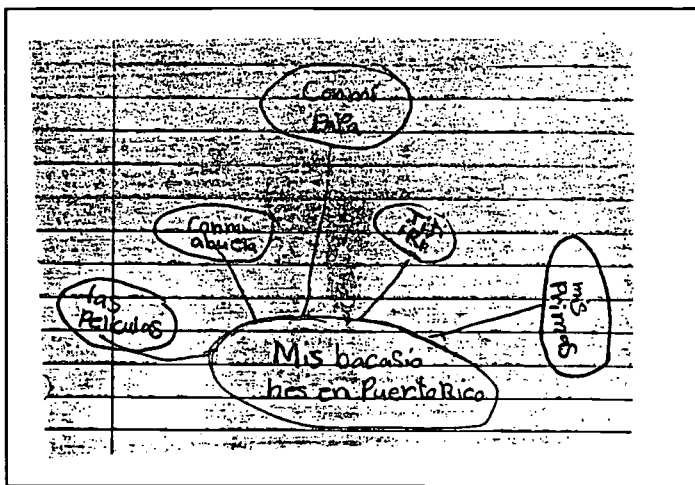

Figure 6. This is a pre-writing brainstorm web created by a Spanish bilingual third grader preparing to write about "My Vacation in Puerto Rico." Such a web is basically a concept or attribute web, similar to those described above in Figures 4 and 5. When used as a pre-writing tool such webs aid writers in their pre-writing rehearsal and organization of ideas.

Figure 7) and cyclical organizers (see Figure 8). A third chronological graphic organizer is described below.

In a project stemming from work with Chamot and O'Malley's (1992) Building Bridges text, Haitian students use a sample timeline to learn about their own family history. (See Figure 9.) Interviewing their parents in Kreyol, students engage their families in their own learning while parents share important facts and memories. The use of the timeline for the interviews helps students structure oral information in a written form. It also helps them to understand the sequence of events in their parents' and their own lives, enabling them later to organize a chronological presentation of their family history in oral or written form.

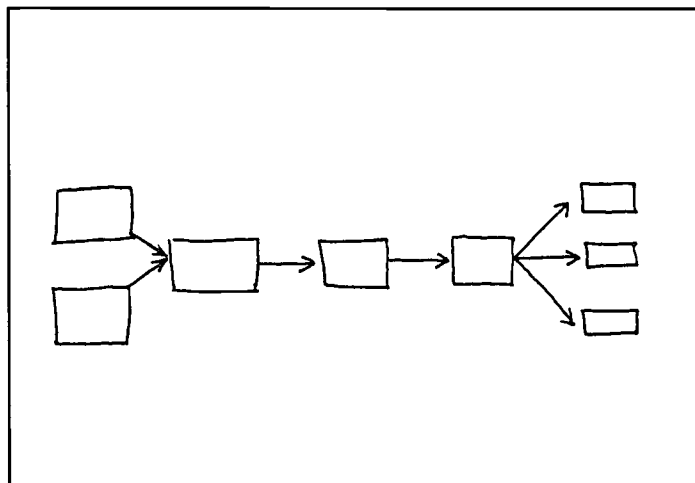

Figure 7. This cause and effect flow chart is a chronological graphic organizer that displays relationships among sequential events. Such a graphic organizer can be used to document a character's behavior and analyze the consequences of that behavior. In reading non-fiction texts it might be used to structure events involved in a particular social or physical phenomenon such as immigration or erosion, for example. As a pre-writing tool, this kind of graphic organizer could help to clarify thinking for an autobiographical essay.

Third grade Vietnamese bilingual students who are preparing to undertake a collaborative research project about the history of their neighborhood brainstorm numerous questions as they work together in small groups speaking to each other in both English and Vietnamese. In order to structure and focus their investigation, the teacher asks them to first group questions of a similar nature together and then come up with a name, in English, for the category that results. Ultimately, the class creates a hierarchical graphic organizer categorizing their questions that extends the length of an entire classroom wall. (See Figure 10 for an excerpt of their graphic organizer.) The classroom project will ultimately be a written English document containing sections or chapters on each of these areas of investigation.

There rarely is one right way to arrange information in a graphic organizer, so teachers most adept with this tool recognize that flexibility is critical. Teacher-modelling, in-depth whole-class training and practice with pre-formatted graphic organizers are important introductions to the use of graphic organizers. Indeed, such use of graphic organizers will help students comprehend, remember and learn. However, when students are encouraged to actively construct their own graphic organizers they can extend their thinking processes. In a Spanish bilingual fifth grade, students brainstorm what they know about Veteran's Day as a pre-writing exercise. Instead of writing students' ideas on the blackboard or on chart paper the teacher quickly writes each idea on a 3"x5" Post-It™ sheet and sticks it to the blackboard. After all ideas are contributed and appear in a huge unstructured mass of yellow sheets on the board, students collaborate on devising a way to organize the information into a structure that makes sense for their writing. The interaction and discussion that accompanies this process, along with the ease with which the 3"x5" sheets are moved about enables students to engage in a sophisticated process of organizing ideas in preparation for writing. If, as they engage in the process of writing, they discover that the organization does not work, their process of revision can be similarly helped by reviewing and possibly rearranging the graphic organizer.

**Summary and Concluding Remarks**

The above vignettes have shown that:

- Graphic organizers are visual tools that enhance learning by structuring important information.
- The visual patterns of graphic organizers are cross-lingual and therefore can support learning in any language.
- When used in interactive settings in which bilingual students are permitted to read, write, listen and speak in two languages, graphic organizers can promote active learning and the construction of knowledge.
- Bilingual students in a wide variety of contexts can use graphic organizers as strategic tools to develop literacy processes in two languages.

Try using some of the graphic organizers presented in this article with your students as they engage in the processes of reading and writing. However, please note that the graphic organizers described here are a mere sampling of the variety of possible ways to structure knowledge and organize information and pro-



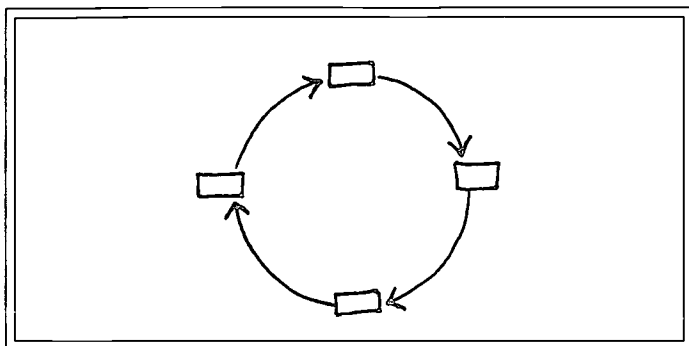

Figure 8. This cyclical graphic organizer is used to display occurrences that repeat themselves in cycles. Non-fiction readings about the life-cycle of a frog or the water cycle can be graphically structured with this kind of format.

cesses. The effective use of graphic organizers extends beyond the development of literacy processes to include the teaching of concepts and discipline-specific processes across the content areas. Please consult the additional readings listed below.

### Additional Readings

*A to EZ Handbook for Bilingual Teachers: Staff development guide.* (1993). New York: Macmillan/McGraw-Hill. This guide, produced to accompany the reading series by the same publisher provides a wealth of practical information. The section on graphic organizers, while short on description, provides many useful samples of a wide variety of graphic organizer formats.

Bromley, K., Irwin-DeVitis, L. and Modlo, M. (1995). *Graphic organizers: Visual Strategies for Active Learning.* New York: Scholastic Professional Books. This 120-page guide is written in a very accessible style and the numerous samples of graphic organizers make it practical and very teacher-friendly.

### References

- Ada, A. F. (1993). *Me llamo María Isabel.* NY: Simon and Schuster.
- Bromley, K., Irwin-DeVitis, L. and Modlo, M. (1995). *Graphic Organizers: Visual strategies for active learning.* New York: Scholastic Professional Books.
- Chamot, A. and O'Malley, M. (1992). *Building bridges.* Boston: Heinle and Heinle.
- MacLachlan, P. (1988). *Sarah, sencilla y alta.* Barcelona: Editorial Noguer, S. A.
- Naylor, P. R. (1996). *Shiloh.* NY: Dell.

Anne Homza, Ed.D. is a Bilingual Literacy Resource Specialist in the Boston Public Schools. She gratefully acknowledges the generous contributions of students and teachers from the Boston Public Schools and the Boston University/Chelsea Public Schools Intergenerational Literacy Project to this article.

**Editor's Note:** Future submissions for the **Successful Practices in Bilingual Education** column may be sent to Anne Homza, c/o BPS Office of Bilingual Education, 26 Court Street, 6th floor; Boston, MA 02108.

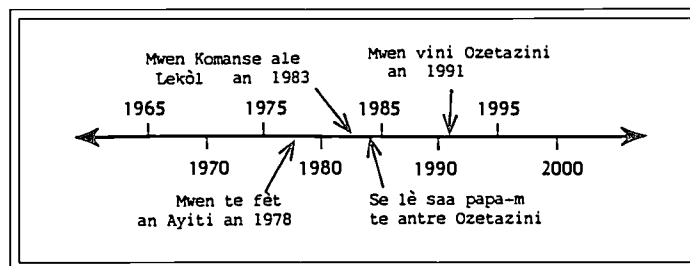

Figure 9. Haitian middle school students use timelines to help them learn about their family history. First, they are given a model like this one as a sample and then are supplied with two blank timelines so that they can structure oral interviews with their parents. Timelines are examples of chronological graphic organizers that are used to display a sequence of events.

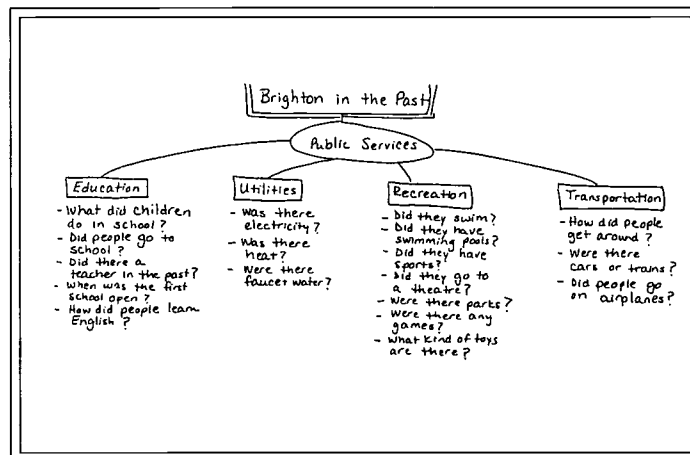

Figure 10. This is part of a graphic organizer created by third grade Vietnamese bilingual students who are preparing to study the history of their neighborhood. After brainstorming questions about Brighton in the past, the students group related questions together and label them (with the teacher's assistance) to create a hierarchical graphic organizer. Hierarchical graphic organizers are useful when information can be arranged into categories and subcategories. In this example, the children group Education, Utilities, Recreation and Transportation under the broad category Public Services. (Public Services was only one of six main categories subsumed under the main topic of Brighton in the past. The complete graphic organizer was large enough to cover an entire classroom wall!)

## NABE Legislative Policy Hotline

For the latest information about national educational policy matters, call the NABE Hotline at (202) 898-1829 and dial/ask for extension 138, the Legislative Policy section; follow the recorded instructions.

book. The use of texts at an appropriate level is extremely important in choosing a title. Essential reading strategies develop over time, as teachers guide the students to use the semantic (meaning), syntactic (parts of speech) and grapho-phonemic cues (spelling-sound relationships) to gain understanding of text.

**Independent Reading.** Students should be encouraged to take risks in reading. They can apply the skills and strategies previously acquired when easy-to-read patterned text are made available for independent reading. Students should be encouraged to take home books with a strong visual text correspondence and read them silently and aloud with others. Student made books and Language Experience Stories can also be sent home for independent reading practice. Care should be taken in the selection of text for independent reading by older less able readers. When second language learners begin to read in English, they will be more successful in reading what they can say and understand. The selection of independent reading ma-

terials should be preceded by oral language development with the content of the text to ensure comprehension. Again, choosing texts at an appropriate level is important. With older readers who are fluent in English or native speakers, similar care should be exercised not to select text that will frustrate them and undermine confidence.

**Reading skills development.** Students who are new to the United States who have never been in school and speak a language that is not represented by Roman letters will require more teacher directed lessons. If necessary, they can begin at the basic level of phonemic awareness with songs, poems, chants, music, etc. With all older, less proficient readers, it will be necessary to determine what each student needs in terms of skills; e.g., knowledge of the English sound system, blending and segmentation, knowledge of the spelling patterns most frequently used to represent those sounds, and common irregular sight words. Comprehension strategies must begin to show students how ideas are organized in text. Instructional approaches already in place in most early childhood reading settings can be adapted. For example, youngsters may start by "reading" wordless and/or predictable books with mature themes. Dictated stories and journal entries will facilitate letter and word recognition. Shared reading experiences will be relevant if they incorporate ideas that the students are familiar with. In both cases, close attention must be paid to building requisite background knowledge and ensuring comprehension. Students should respond to text in several ways that enable them to use language for realistic and meaningful purposes.

#### Final Thoughts

There are no simple answers to the complex literacy issues of older, less proficient readers. No one single type of instructional approach is called for. Nonetheless, commonalities in instructional programs for older readers do exist. Some are as follows:

- Relevant, quality multi-cultural literature and informational text that is used to foster academic language development and comprehension. For the most part,

these texts will be read aloud.

- Books at various levels are selected when reading with youngsters for intentional instruction. I.e., how to cope with text challenges.
- Ample opportunities are afforded students to read easy-to-read patterned and trade books. Independent reading takes place in pairs or small groups. Youngsters read student-authored books that are made from collaborative chart stories, Language Experience Stories and other forms of shared writing.
- Choral reading, reader's theater, paired reading, etc., are used to motivate students by engaging them in the content of the text and building reading fluency.
- School and classroom libraries abound and represent an array of genre and levels of difficulty and reflect cultural diversity.

#### References

- Atwell, N. (1985). Predictable Books for Adolescent Readers. *Journal of Reading*. October, 18-22.
- Atwell, N. (1987). *In the Middle: Writing, Reading and Learning with Adolescents*. Upper Montclair, NJ: Boynton/Cook.
- Barnitz, J. (1985). *Reading Development of Nonnative Speakers of English*. Orlando, FL: Harcourt, Brace, Jovanovich, and the Center for Applied Linguistics.
- Bruner, J. S. (1975). Language as an instrument of thought. In A. Davies (Ed.), *Problems of language and learning*. London: Heinemann.
- Clark, M. M. (1984). Literacy at home and at school: Insights from a study of young fluent readers. In H. Goelman, A. Oberg, & F. Smith (Eds.), *Awakening to literacy*. London: Heinemann.
- Clay, M. (1991). *Becoming Literate: The Construction of Inner Control*. Portsmouth, NH: Heinemann.
- Cummins, J. (1984). *Bilingualism and special education: Issues in assessment and pedagogy*. Clevedon, UK: Multilingual Matters.
- Deutsch, M., Katz, I., & Jensen, A. R.

## SEQUOIA UNION HIGH SCHOOL DISTRICT

### Bilingual (Spanish) teachers

All high school subjects  
for 1997-98 school year

Must qualify for  
California Single Subject  
Credential

### Please send letter and resume to:

Certificated Personnel  
Sequoia Union High  
School District  
480 James Avenue  
Redwood City, CA 94062

(415) 369-1411, ext. 2223

FAX (415) 306-8868

# Higher Education Legislation

Column Editor: The Hispanic Association of Colleges and Universities (HACU)

## First Up: Budget Bill

by Jacob Fraire

When the 105th Congress convenes in mid-January, legislators will face an array of unfinished legislative business from 1996 and new legislation, such as the reauthorization of the Higher Education Act (HEA). However important these measures might be, the Congress will first consider its FY 1998 Budget resolution and legislation to balance the federal budget. The House and Senate Budget Committees are preparing themselves for a full blown debate over a budget reconciliation bill, which is expected to require huge cuts to entitlement programs such as the federal student loans. It is too early to tell how much in cuts the budget reconciliation bill will propose. In recent years, the Congress has proposed cuts to the student loan programs totaling

over \$3 billion over five years. At a meeting at the Department of Education (ED) last month, the higher education community discussed the upcoming budget with Administration officials and was told that the Administration fully expects to enter into a debate with the Congress over budget reconciliation legislation. ED staff would not say what proposals they plan to submit to the Congress, but conceded their proposal would include changes to both the Federal Family Educational Loan Program (FFELP) and Federal Direct Student Loan Program (FDSLPL). Because savings from entitlement programs are generated only through changes to statutory language, FFELP and FDSLPL could face major changes during both the budget reconciliation and HEA reauthorization bills.

The reauthorization will take a back seat to the budget debate. The House education committee may wait until the spring

before considering the HEA. Their deadline for receipt of recommendations from the higher education community has not changed, however. *The committee must receive all HEA proposals by January 31, 1997.* The Hispanic Association of Colleges and Universities plans to submit its reauthorization proposals in mid-January. To that end, we invite our HSI members and associate members to a reauthorization seminar in Miami, Florida on January 13-14, 1997. Florida International University will host this HEA meeting.

*Excerpted from HACU's "Capitol Notes" (December 1, 1996).*

« NABE »

## Intern and Fellowship Positions Available at NABE

The NABE Policy Internship and Fellowship Program is a rigorous apprenticeship for individuals interested in policy issues of education, multiculturalism, language diversity or civil rights.

The heart of the NABE Policy program is direct participation of interns and fellows in NABE's central policy activities including:

- ◆ policy research and analysis
- ◆ advocacy before Congress
- ◆ collaboration with other national education or civil rights organizations
- ◆ administrative duties

Interns and fellows must have outside support to participate; no financial assistance is available from NABE.

To apply, please send a cover letter and resume, a short writing sample, and letter(s) of recommendation to: Jaime A. Zapata, Associate Director for Legislation and Public Affairs, at NABE.

Assistant Professor  
Exceptional Education  
Department  
Buffalo State College  
Appointment Date:  
September 1, 1997

Undergraduate cross-  
categorical special education  
program; graduate level  
specializations.

Send applications to:  
Dr. J. Bondurant-Utz, Search  
Chair, Buffalo State College,  
1300 Elmwood Avenue,  
Buffalo, New York 14222.  
Application screening will  
begin December 1, 1996 and  
continue until position is  
filled. An Equal  
Opportunity-Affirmative  
Action Employer.



# NABE PRODUCTS ORDER FORM

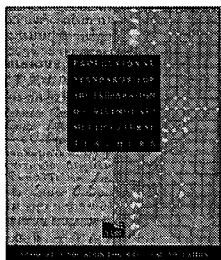
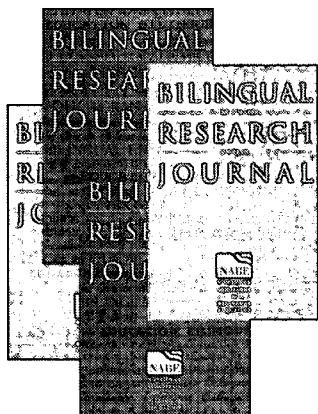

ITEM	PRICE	#	TOTAL
<b>Bilingual Research Journal</b>	\$13.00		
Vol. 19, #3&4, Spring/Summer 1995 Special issue: Role of ESL in Bilingual Education			
Vol. 19, #1, Fall 1994 Special issue: Native American Issues			
Vol. 16, #1&2, Spring/Summer 1995 Special issue: Ramirez study			
[earlier issues available (call for details)]			
<b>NABE Annual Conference Journal</b>	\$7.00		
1989-90 issue			
1991-92 issue			
1993-94 issue			
<b>1996 Annual Conference Program</b>	\$5.00		
<b>NABE News</b>	\$5.00		
write issue date or volume/number here			
write issue date or volume/number here			
write issue date or volume/number here			
[current volume always available; earlier issues may also be available (call for specifics)]			
<b>Professional Standards for the Preparation of Bilingual/Multicultural Education Teachers</b>	\$5.00		
<b>NABE logo pins</b>	\$5.00		
<b>NABE canvas tote bags</b>	\$7.00		
<b>VIDEO: Making Connections: Learning, Language and Technology</b>	\$7.00		
<b>TOTAL</b>			

- Prices include shipping by USPS first class mail. Special shipping available - call for pricing.
- Payment must accompany all orders. Make checks and purchase orders payable to NABE.
- Credit card orders may also be placed by phone (202 - 898-1829) during business hours.

## SHIPPING INFORMATION

Name \_\_\_\_\_ Company \_\_\_\_\_

Address \_\_\_\_\_

City/State/Zip \_\_\_\_\_ Phone \_\_\_\_\_

## PAYMENT INFORMATION

Check#: \_\_\_\_\_ PO#: \_\_\_\_\_ CC#: \_\_\_\_\_ **84** ExpDate: \_\_\_\_\_

MAIL TO: NABE PRODUCTS, Suite 605, 1220 L Street NW, Washington, DC 20005-4018



# NABE NEWS Book Reviews

Column Editor: Dr. Beti Leone, Paterson Public Schools, Paterson NJ

## *Negotiating Identities: Education for Empowerment in a Diverse Society*

Reviewed by Dr. Joan Wink and Terry Becker

*Negotiating Identities: Education for Empowerment in a Diverse Society.* Jim Cummins. Ontario, CA: California Association for Bilingual Education, 1996. pp. 290. ISBN:1-889094-00-5.

If you liked *Empowering Minority Students* (1989), you're going to love the revision, *Negotiating Identities: Education for Empowerment in a Diverse Society*. Cummins thought it might take him two years to publish this updated version; it actually took seven years. It is worth the wait. In the ensuing years, Cummins has backed away from the term, "empowerment," because of its patronizing use in some circles. He also acknowledges that the use of the word "minority" carries derisive connotations about one's value and worth. However, the theme of the use and/or abuse of power in the classroom and community is even more powerful in the new 1996 book. Here is the point: "...human relationships are at the heart of schooling" (p. 1). What we (teachers) do matters. The connections we create in classrooms are central to students' growth as they negotiate their own identities. These interactions trigger a process whereby students create their own sense of self. Furthermore, these human relationships can have a negative or positive effect. Throughout the book, the implication is clear: students may be failing not because they are non-native speakers of English, but rather because of what is being communicated to them by their teachers. The social messages we send to students have the potential to send a student's spirits soaring or crashing.

Just as in 1989 we all tried to understand and explain "empowerment," so once again we will all now be called upon to clarify "negotiating identities." Cummins says that human relationships are the ways we negotiate identities in our classrooms. These relationships are evident when students transform their own self-images, discover who they are, and redefine themselves, thus creating the future. And, none of this takes place in a vacuum. These new and emerging identities are surrounded by the powerful relationships between teachers and students.

Chapter One, "Identity and Empowerment," demonstrates the centrality of human relationships in the classroom and in students' achievement. When teachers respect and like students, the students negotiate their identity to higher levels of human potentiality. When teachers don't like and respect students, the students have the potential to become less than they were before they entered that classroom. The interactions between students and educators is never neutral; these human connections either

CONTINUED ON PAGE 24

## *Thinking Stories: English- Spanish Stories and Thinking Activities*

Reviewed by Dr. Beti Leone

*Thinking Stories: English-Spanish Stories and Thinking Activities, Books 1-3,* by Jackie Scott. San Luis Obispo, CA: Dandy Lion Publications, 1994.

Thinking skills have long been in high demand — for all ages, at all language proficiency levels, and across all subject and content areas. Recently, they have come back into vogue and are mentioned in many of the new K-12 content standards, such as those published by the National Council of Teachers of Mathematics (NCTM) and other professional teachers' organizations. In fact, one of the six basic assumptions underlying the K-4 NCTM math curriculum/standards is that school math curricula should "emphasize the development of children's mathematical thinking and reasoning abilities." Concern for thinking skills grows out of our understanding about what students need to know and know how to do. The NCTM standards state that "an individual's future uses and needs for mathematics make the ability to think, reason, and solve problems a primary goal for the study of mathematics" (NCTM, 1989: 18). Scott's books help develop these abilities.

### Description

The three books in this series will provide primary teachers with hours of hands-on activities for both their English and Spanish-speaking students. Each book offers four original stories written in both English and Spanish, four follow-up activities relating the story to a thinking skill, and additional thinking activities that teach analogies, sequencing, categorizing, deductive thinking, comparison, and more. Each book also includes an accompanying teacher's guide for each of the four stories, and this guide includes objectives for teaching the story, a statement of the thinking problem at hand, ideas for introducing the lesson or story, ideas for discussion, follow-up activities, and related stories. The stories will easily capture children's attention and most involve manipulatives to solve the problems. Each teacher's guide also has reproducible pages for carrying out the thinking activity, and these pages are in both English and Spanish.

### Review

Most appealing to primary school bilingual/ESL teachers and their students are the humorous, easy to understand stories; the simple, cartoon-like illustrations accompanying the stories; and the ready-made support in each story's teacher guide. This

CONTINUED ON PAGE 32

encourage or discourage collaboration and self-development.

Chapter Two, "The Evolution of Xenophobia: Cultural Diversity as the Enemy Within," is a history of bilingual education in the United States. It also looks at the discourse which is being used in the political arena to blame and frame bilingual education. Cummins demonstrates how coercive relationships of power are used in the sociopolitical context to subvert the achievement of bilingual students.

Chapter Three, "The Two Faces of Language Proficiency," has many similarities to the 1989 rendition of Cummins' quadrants and the role of context in cognitively-demanding texts. He emphasizes the point that language and content are acquired more readily when students are challenged cognitively and supported with contextual and linguistic supports. Cummins supports this with the later research (i.e., Collier, Klesmer, and Cummins) which suggests that it may even take longer than six years for students to achieve academic and linguistic parity with native speakers of English in the classroom. The new twist comes near the end of the chapter, where Cummins relates academic skills to the social messages students receive in schools; thus, encouraging students to "mentally withdraw from academic effort" (p. 65).

Chapter Four, "Accelerating Academic Language Learning," looks at the demographics and concludes that bilingual education is no longer on the margins of education; rather, the numbers of students demonstrate that bilingual education is now mainstream. All teachers are now content and academic language instructors. Cummins explores ways to reverse the negative patterns of interactions for bilingual students. He shares an array of strategies and techniques which will serve teachers only to the extent that they are able to facilitate collaborative relationships with students. Affirmation and respect for students is a catalyst for academic development. Cummins concludes this chapter with a four part instructional framework for creating such an academic environment.

Chapter Five, "Bilingual Education: What Does the Research Say?," once again confirms that there is overwhelm-

ing evidence demonstrating the effectiveness of bilingual education. Why then do schools and the public still think the evidence is sparse, and even conflicting? Cummins looks for his answers in the theoretical basis of the oppositional views and the predictions which come from each. This chapter has much that was in *Empowering Minority Students*, but all is viewed through a more complex lens which helps us to see more clearly the importance of the socio-political context in teaching and learning with bilingual students.

Chapter Six, "The Deep Structure of Educational Reform," looks critically at massive educational reform movements and their limited success. He argues that the reason for this is that very little has changed in the interactions between teachers and students and between schools and communities. Cummins looks to the work of Jonathan Kozol to cite clear examples of the coercive power relations which still exist in schools. Cummins' Framework for Intervention (1989) has been updated and placed in the larger context of ways in which schools reflect society. Cummins calls on teachers to redefine their pedagogical assumptions and transform the power relations so that equity is encouraged.

Chapter Seven, "Collaborative Empowerment at the Preschool, Elementary, and Secondary Levels," highlights real-life examples of programs that work effectively to create collaborative interactions between teachers and culturally diverse students. These programs demonstrate their effectiveness because teachers have seriously examined their own roles in the lives of students. In this chapter, Cummins demonstrates concrete ways in which theory turns into practice. The programs mentioned are a testimony to authentic reform and shared leadership.

Chapter Eight, "Disinformation in the Information Age: The Academic Critics of Bilingual Education," brings home the point that disinformation is not misinformation. Disinformation is a systematic attempt to spread false information in an attempt to sabotage bilingual educators. Cummins' goal in this chapter is to place the discussion in the broader context of the fear of loss of power by those who have traditionally held it. He demonstrates that, for those who have read the data, the value of bilingual education for minority and majority language students is clear. "It is difficult to avoid the conclusion that there is a sociopolitical agenda at work in the opposition (of academic critics) to bilingual education" (pg. 212).

Chapter Nine, "Babel Babble: Reframing the Discourse of Diversity," takes us beyond the 1989 edition. It also receives the award for the best chapter title. Cummins powerfully speaks his convictions: the politics of greed and exploitation are the enemy, not cultural diversity, nor even critical literacy. He places this discussion in the framework of coercive and collaborative relations of power as he points to the new realities of the next millennium.

Human connections are the most important thing in schools. The interactions between teachers and students have a profound effect on students and our world. This updated version of *Empowering* brings us an added gift: the power of the endnotes! You don't want to miss these at the end of each chapter.

*Joan Wink is Associate Professor of Education at California State University, Stanislaus and Terry Becker is a graduate student in the Multilingual Education Master's program at California State University, Stanislaus.*

\* NABE \*

### Book Review Submission Guidelines

Reviews for publication in the **Book Review** column should be sent to Dr. Beti Leone, Book Review column editor, at NABE, 1220 L Street, NW, #605, Washington, DC, 20005, or by e-mail to NABE\_NEWS@nabe.org.

Books from publishers should be clearly marked **BOOK REVIEW MATERIAL** and sent to the same address; two complete sets of materials must be submitted.

# Asian/Pacific American Education SIG

SIG Chair: Rose Marie del Rosario, Genesis Network, Inc., Miami Beach, FL

## *Use of Anecdotal Data in Studying and Understanding Filipino-American Experiences in Public Schools*

by Dr. Rose Marie del Rosario

The purpose of this article is to emphasize the importance of anecdotal data in studying and understanding an individual student who belongs to a small (minority) group that fits any of the following descriptions:

1. the group's population in a school, district, and/or community may be deemed "statistically insignificant" and/or too few show discernable patterns of group behavior, characteristics and experiences;
2. while the group may be composed of a relatively large number in the community (i.e., as Asians), a subgroup identity (Filipino-Americans) may exhibit cultural traits which set its members apart from the larger category;
3. the subgroup may represent "a minority within minority" (e.g., Ilocanos, Cebuanos, or other distinct ethnic identity among the Filipinos); and/or
4. in addition to any or all of the above, the student's situation may present unique challenges in assessing and addressing his or her special learning needs.

### **What is Anecdotal Data?**

*Webster's New World Dictionary* defines an "anecdote" as "originally, little known, entertaining facts of history or biography; a short account of some happening usually personal or biographical." The definition implies that anecdotal data is a compilation of short stories or essays which highlights meaningful observations or happenings in a student's life. It represents *qualitative research information* to help study and understand the particular needs of a student; in turn, the teacher can creatively develop educational tools and identify resources that will maximize learning and social development.

Anecdotal data has the potential of providing valuable information which is not obtainable from standard resources on minority cultures. Information generated provides powerful insights into what inspires a student to learn in and adapt to a setting where the linguistic and social environment is different from what is familiar. Anecdotal data is useful in developing appropriate teaching and learning strategies, as well as affirming the student's abilities and accomplishments. This data serves as a way to gauge the student's performance and (re)evaluate teaching goals/objectives.

### **Who Compiles the Anecdotal Data?**

Ideally, the teacher in charge of the student's curriculum serves as the primary writer and compiler of anecdotes. S/he encourages other teachers, the school counselor, parents, tutors, school staff and others who interact closely with the students to write or share

anecdotes. In addition to becoming aware of the main features of the student's racial or ethnic identity, the teacher reviews anecdotal information on a regular basis to see how well a student is developing socially and achieving academically, as well as to (re)define expectations, teaching strategies and learning goals. Anecdotal may be included in the student's portfolio.

For purposes of this article, Filipino-Americans are exemplified. The discussion indicates the fitness of using anecdotal data to study and understand a student belonging in this ethnic group.

### **General Profile of Filipino-Americans**

Filipino-Americans comprise one of the largest immigrant groups in the United States. While their migration history in the North, Central and South American continents is traceable to circa the late 1500's, when the Philippines were under Spanish colonial rule, Filipinos' population growth in this country has remained relatively silent and unnoticed when compared with other Asian and "new" immigrants. Today, "visible" Filipino communities are found in large metropolitan areas such as Los Angeles, San Francisco, San Jose, New York, Jersey City, Chicago, Seattle and New Orleans. Through cultural integration and intermarriage, Filipinos have blended well with the native population of Hawaii and Guam. And, as one examines recent U.S. Census data on Asian-Americans, it becomes poignantly clear that Filipinos are scattered throughout America.

In rural and urban communities where the Asians represent a (very) small percent of the local population, Filipino-Americans tend to merge in White, middle-class neighborhoods. They tend to be individuals who have moved to seize economic opportunities, young families who wish to provide better educational and social opportunities for their children, and/or those who wish to join family members who are already living in the area.

### **Philippine Political and Migration History Revisited**

A brief look at Philippine history provides an important backdrop in studying and understanding Filipino-Americans. For instance, an analysis of U.S.- Philippine relations from the end of the Spanish-American war in 1898 to the present reflects a unique history of political and social linkages which do not exist with other Asian countries. Highlights of this relationship include the following:

1. The Philippines were among the Caribbean, Central and South American countries "liberated" by the U.S. after more than three centuries of Spanish colonial rule.
2. The U.S. governed the Philippines from 1898 to 1946, granting the island republic a commonwealth status from the 1935 until the Philippine Independence in 1946.

CONTINUED ON PAGE 26

- Filipino and American soldiers fought side by side against Japan during World War II. This alliance continues to serve as a "friendly" force in support of Filipino immigration policies.
- The Philippines have remained a strategic military outpost for the U.S. A large proportion of foreign aid to the Philippines deals with military armament and maintenance.
- The U.S. educational system was introduced in the Philippines at the beginning of the 20th Century. To this day, English language and American textbooks are used as primary modes of instruction (Tagalog, Spanish and other Filipino dialects are also used in many private and public schools).
- The U.S. Peace Corps and numerous Christian missionary workers are actively involved in the Philippines.

Filipino migration into the U.S. is generally classified in these major "waves:"

*The early 1920's:* Able-bodied young women were recruited to work in agricultural farms, canneries and labor-intensive industries. Some women were hired as domestic workers. Very few from this immigration wave are alive today. Many have close ties with Mexican-Americans through intermarriage and labor experiences.

*Post-WWII to circa 1960:* Many Filipino soldiers and their families were able to gain U.S. entry and citizenship privileges. American soldiers who married Filipinas petitioned for admission for their wives and children into the country.

*1950's 1975:* Filipinos were recruited to fill shortages in specific professional occupations. This wave represents the largest number of doctors, nurses and their families to migrate in the U.S.

*Post 1975 to the present:* Recent immigrants include many classes of people including family members of Filipinos who have gained U.S. permanent residency or citizenship status, wives and children of American citizens, political refugees from the Marcos regime, and those who have been granted professional or student visas.

It is speculated that many illegal immigrants, including those from the Philippines, have come during this period.

These waves imply significant differences in the economic, political, educational and social backgrounds of Filipino immigrants. In turn, these diverse backgrounds influence the readiness of their children to enter the U.S. educational system. For instance, imagine a third-generation American-born who is a monolingual English-speaker and has few or no ties with the native culture of her or his grandparents. Also, imagine that while some Filipino-Americans come from families that are highly educated and economically sufficient, others are poor and have varied ranges of academic and language (native and/or English) competencies.

#### **Ethnic Diversity Among Filipino-Americans**

The geographic make-up of the Philippines has an effect on the maintenance of its rich, ethnic diversity. Composed of more than 7,000 islands (about 4,000 are said to be inhabited), this nation has more than 100 languages and dialects. An average Filipino speaks two or more native tongues. They identify one another by linguistics, generational lines on both maternal and paternal sides of the family, regional or provincial areas of residence, and subethnic characteristics. Extended family relationships, education and "management of impressions" are highly valued.

The relative isolation of many island communities and the tenacity to resist colonial rule have contributed much to keep the Filipino culture alive. However, more than 300 years of Spanish rule had a significant impact on the people's cultural character — their religion (approximately 85% of Filipinos are Roman Catholics, around 9% are Moros, and 6% Christians and other religions), inter- and intra-ethnic interactions, and expressions and interpretations of everyday life. It is not surprising that the mainstream Filipino has more in common with Spanish-speaking rather than Asiatic countries.

The question of "racial" or "cultural" identity presents an interesting dilemma for Filipinos. Usual responses for new immigrants included *Malay* or *Malaystan*;

*Pacific Islander; Pilipino; Cavitenno, Ilocano, Pampangano, Cebuano, Ibanag, Moslem, Igorot,* or other linguistic or tribal identity; and, Filipino-Chinese, Filipino-Spanish, Filipino-Spanish-Chinese or other combinations to reflect their mixed heritage. Some Filipino-Americans find themselves at ease with the "Hispanic" category due to historical and Spanish ties. However, rarely does a newcomer know that he or she is an "Asian" or "Asian-American" — this information comes only after being told or corrected about the American perspective.

Filipino-Americans represent a wide array of subethnic identities. Although they use English and/or Tagalog (language spoken in the Manila vicinity) as modes of communication, an American-born may not necessarily be able to talk to a newcomer who speaks no English or Tagalog, no matter how eloquent the latter may be in another native dialect. And, due to regional ethnic differences, immigrants from the same "wave" may not necessarily share similar surface and deep (sub)cultural sentiments.

#### **Value and Anecdotal Data**

Little is known about the experiences of many linguistic ethnic minorities who have recently migrated in America. In spite of the advances in multicultural education theories, educators are continuously seeking viable ways to assess students' needs, study and understand their culture, and address each student's needs to maximize learning and social development.

In schools where they represents a very small number (such as rural areas and small towns in the midwest, northeast and southeast), "Asian," "Pacific Islander" and "Filipino" profiles do not provide adequate information to assess learning needs and determining appropriate teaching strategies. When used to measure success or achievement, profiles may do more harm than good because they may support stereotypes and myths. Because of the individualized nature in compiling short essays about a student, anecdotal data tends to break down misconceptions. Rather, the data highlights individual strengths and abilities which support a teacher's desire to facilitate learning.



# American Indian Bilingual Education

Column Editor: Jon Reyhner, Northern Arizona University

## *Australian Indigenous Language Efforts*

by Gloria Delany-Barmann

At the beginning of European settlement in Australia, there were approximately 250 languages spoken by the Aboriginal and Torres Strait Islander peoples. Today, only about a third of those languages are still spoken. The extent of the endangerment of this remaining third is documented in the upcoming 13th edition of the *Ethnologue: Guide to the World's Languages*; of the 208 languages in the world listed as having ten or fewer speakers, 102 are Australian indigenous languages.

A recent Australian government commissioned report, *The Land Still Speaks*, by Graham McKay (1996), reviews in 290 pages the language maintenance and revitalization efforts in Australia and successful indigenous language programs overseas. The main purpose of the report is to discover effective ways of promoting and developing indigenous languages.

One strategy employed to achieve this goal was a pilot study of four Aboriginal and Torres Strait Islander language communities (Barkly Tableland, Kempsey, Ringers Soak, and Saibai) with either language revitalization or language maintenance efforts. A significant amount of the report is dedicated to reporting this pilot study. McKay notes that,

*While most people...tended to see the term 'language maintenance activities' as including only formally organized language programs and activities, Saibai Island Council, in its response, made explicit what other communities assume: that traditional ceremonies and other traditional activities (they mention dancing, singing and story-telling — others would include hunting) are an important means of keeping the traditional language strong. At the same time, the people of Saibai include church services and tombstone unveiling in this arena, showing that Christianity and other post-contact developments have been firmly adopted by members of the community in the ongoing development of their indigenous culture and life. The church has become part of their heritage...but not the school... (p. 110).*

When discussing language maintenance and revitalization efforts sociolinguistic factors must be taken into consideration. McKay posits the notion that:

*A language 'dies' or 'is lost' when its speakers choose to abandon it for another language. Any consideration of language maintenance then must take into account the perceptions and needs of speakers, the situation they find themselves in, and other languages they are using or in contact with, as well as their aims and intentions (p. 219).*

It is from within this framework that the information regarding language maintenance and revitalization efforts in the four

communities is addressed. McKay provides the contextual information needed for the reader to develop a fuller understanding of the choices that the four language communities made in regard to their languages. For example, he discusses historical contexts, language contact situations, and the political and economic factors that either enable or constrain language maintenance.

The report is well organized. It provides a concise executive summary in the preface that helps situate the reader. McKay furthers this contextualization by giving an overview of specific reports on indigenous language loss and language maintenance and revitalization efforts in Australia. He also carefully explains some basic linguistic terminology for laypersons who do not possess linguistic expertise.

*The Land Still Speaks* also includes a review of selected literature on language maintenance by Bratt-Paulston, Dorian, Fishman, Giles & Johnson, Guyette, Kulick, Martin-Jones, McConvell, Muhlhauser, and Thieberger. Though there is not enough space in this column to present a complete review of the literature, McKay does provide enough of an overview of the literature to give the reader an idea of the different perspectives regarding issues of language maintenance.

Throughout McKay's study of language maintenance in the four communities are principles and recommendations presented out of numerical order, which is a little confusing at first. For example, the first recommendation to appear in the text, in the discussion of language maintenance intervention in Australia, is recommendation number fourteen. Despite the fact that it seemed "out of place" numerically, it was located in the text where it made the most sense. This recommendation states:

*That, on a State-by-State basis, 15 per cent of the combined funding under the Aboriginal Languages Education Strategy (ALES) and the Aboriginal Literacy Strategy (ALS) be allocated to ALES to provide specific impetus for activities in indigenous languages rather than programs of English literacy (p.13).*

McKay adds that the 15 percent is a minimum allocation, not a maximum, and that indigenous language programs could easily warrant greater expenditure. Having the principles and recommendations located within the text gives the reader a better understanding of how the recommendations relate to the review. An entire list of principles and recommendations in numerical order is located at the end of the report.

While the principles and recommendations are specific to Australia, a majority of the 19 principles and 25 recommendations contain elements that could form part of recommendations for language maintenance efforts in other parts of the world. The principles are categorized as general, residence, community leadership and training, language use in communities, language teach-

CONTINUED ON PAGE 28

The following is a summary of several anecdotes about an eighth grader in a Georgia middle school. To maintain confidentiality, her name has been changed.

Zenaida is the only Filipino-American in the entire school. According to Zenaida, she thought she knew English when she arrived in the U.S. two years ago but lost confidence in speaking and writing it when she heard the Americans speaking "correct" English. She recently exited from the district's English as a Second Language program but complains that the class did little to remove her heavy accent.

Zenaida felt out of place in her ESL class because the teacher's focus was on Spanish-English. She claims that all the English she learned, she already knew from going to a public school in the Philippines.

Zenaida's mother met her step-father (an African-American) in the military base outside Manila where she worked. After a short courtship, her mother and stepfather got married and moved to Georgia. Zenaida and her two younger brother came a year later. According to Zenaida, she was very disappointed in finding that the U.S. is not what she thought it to be.

A home visit revealed some possible explanations regarding Zenaida's problems with discipline, language acquisition, and low grades. The family lives in the midst of the town's African-American community which is plagued with high crime, prostitution and violence. Zenaida and her brothers are considered "odd

balls" and have been victims of physical assault (she refused to identify the perpetrators for fear of retaliation). No one seems to know what her parents do for living, but Zenaida claims that they work all the time.

Attempts to provide Asian tutors for Zenaida have not worked. She indicated that the tutors have difficulty understanding her, expect too much and wonder why she is not like other Asians.

The P.E. coach is the only teacher that seems think that Zenaida is a good student. Although she refuses to play in any sports for girls, Zenaida enjoys keeping score and seems to have a good grasp of the rules for softball, volleyball and soccer.

Although there are other Filipino-American families in the community, Zenaida insist that her family does not have anything to do with any of them. "Their noses are up in the the air for our taste," is how she described them.

The above anecdotal data has been derived from a series of short essays submitted to the lead teacher. This example demonstrates that anecdotal data provides an opportunity to humanize a student's situation in the process of delivering a good education.

Dr. Rose Marie del Rosario, Chair of NABE's Asian/Pacific American Education Special Interest Group, can be contacted at Genesis Network, Inc., 3901 Indian Creek Drive, #506, Miami Beach, FL 33140 (305) 672-3090.

\* NABE \*

## INDIAN

FROM PAGE 27

ing programs, broadcasting and language, research, and administrative divisions. Recommendations include establishing funding priorities, indigenous language broadcasting, indigenous languages as a "core subject" in curricula, establishing a publication program, use of interpreters, calls for further research, and so forth.

The review also lists and explains issues that have a strong influence on language maintenance and development efforts for Aboriginal and Torres Strait Islander languages. Just as with the principles and recommendations, several of the issues can be generalized to language maintenance efforts in various parts of the world. For example, the issues of indigenous control, the participation of elders, training of local teachers, working with linguists in mutually supportive ways, literacy in indigenous languages, and indigenous language teaching are not context-specific to Aboriginal and Torres Strait Islander languages. Indeed, they are issues that are evident in language maintenance and revitalization efforts all over the world. McKay brings these issues into focus and

briefly discusses all of them.

This review does not limit its discussion to the four areas in the pilot study. It also provides a complete survey of language maintenance activities in Australia and of selected programs overseas. For example, the review examines language maintenance activities regarding the Maori language in New Zealand, the Hualapai Bilingual/Bicultural Program in Arizona, Mohawk language programs in Canada, and language maintenance programs in Oaxaca, Mexico.

What was most evident throughout the report is the notion that "Language maintenance cannot be entrusted largely to the school, though family and community language use can be supported and strengthened by the school language program" (p. 66). This view reflects part of sociolinguist Joshua Fishman's (1991) theoretical paradigm for minority-language maintenance. Though many of the programs reviewed in this report had a school component, they were not dependent upon schools for language maintenance and revitalization efforts. Community involvement and sup-

port are essential to such efforts.

## References

- Fishman, J. (1991). *Reversing language shift: Theoretical and empirical foundations of assistance to threatened languages*. Clevedon, Avon, England: Multilingual Matters.
- McKay, G. (1996). *The land still speaks*. (Commissioned Report No. 14). Canberra, Australia: Australian Government Publishing Service (GPO Box 84, Canberra ACT 2601 1, Australia).

Gloria Delany-Barmann works at Northern Arizona University.

**Editor's Note:** Contributions to the American Indian Bilingual Education column should be sent to Jon Reyhner, Center for Excellence in Education, Northern Arizona University, P.O. Box 5774, Flagstaff, AZ 86011-5774, or E-mail to: jon.reyhner@nau.edu, (520) 523-0580, fax: (520) 523-1929.

# Parental Involvement in Bilingual Education

Column Editor: Aurelio Montemayor, IDRA, San Antonio, TX

## *Hispanic Families: Communication — Outreach and Language*

*by Aurelio Montemayor, M. Ed.*

For any plan to have an effective family involvement program for Hispanic families requires a strong focus on the process of communication and reaching out to them. An especially pressing concern for Hispanic parents is language, both in terms of literacy and limited proficiency in English.

Telephone contact and home visits are key to encouraging family involvement. Establish core groups of parents who can help with calling and coordinating transportation, etc. In communicating with students and their families, involve the larger neighborhood and religious leaders, social service workers, recreational or community center counselors, and others.

Make special efforts in the areas of reception and telephone communications in your school to ensure that parents with little English can call the school (and the school can call them), and feel welcome coming to the school. Be aware that there are areas of sensitivity within the language itself. Spanish-speaking people, even those whose educations are limited, know their culture is rich, that great works have been produced in Spanish, and they enjoy hearing the language spoken well. But class distinctions are more sharply drawn in Spanish-speaking societies, and parents will be aware if a speaker or translator depreciates them (for being poor, e.g., or for speaking less-educated Spanish).

Written messages sent to the home should be in both clear and simple English and Spanish. The message should be easily understood, and have a friendly tone when read aloud. Above all, meetings should not merely be announced — families should be *invited* to participate. An invitation, when properly presented, is something most Hispanic families have difficulty ignoring.

Depending on their age and background, parents may have been punished, insulted,

or humiliated for speaking Spanish. Positive experiences can paradoxically recall these hurts. If this happens, acknowledge the reality of those experiences. But don't leave parents with these feelings; when the time seems right, accentuate a positive incident or success of the program.

School staff may also be uneasy with or resentful of a language and culture they don't understand. Seek common ground, reiterate agreed upon goals and the school's commitment to parent participation, look for imaginative and inclusive ways to value language and culture.

### **Communication Do's and Don't's**

Communications also need to be culturally appropriate, and this is somewhat more difficult to define, but these guidelines may help:

- **Do** consider the family member who presents himself/herself (or themselves) in place of the parent as a valid representative of the family.
- **Don't** dismiss a grandparent or uncle, or even a godparent, with rigid requirements for a legal parent/guardian to be present.
- **Do** shake hands, inquire after other family members' well-being, and listen attentively to responses, before introducing your subject or asking the questions you need answered.
- **Don't** assume that efficiency is more important than civility. In many Hispanic homes, impersonal interviews are perceived as insulting.
- **Do** connect to the family's inherent concern for the education of the child, assume the positive, and speak as if the concern is shared.
- **Don't** reflect negative value judgments with your actions, body language, or facial expressions. Focus on the positive.

We are interested in hearing from other language minority groups about the applicability of these concepts to them. What are the experiences that other language groups have had in successful outreach? What are the do's and don'ts with other groups? We welcome comments and responses that we could publish here as ongoing dialogue about these issues.

The preceding article was excerpted from *Hispanic Families As Valued Partners: An Educator's Guide*. Montecel, María Robledo; Gallagher, Aurora; Montemayor, Aurelio M.; Villareal, Abelardo; Adame-Reyna, Ninta; Supik, Josie D. Intercultural Development Research Association. 1993. San Antonio.

**Editor's Note:** Contributions for the Parental Involvement column should be sent directly to the editor, Aurelio Montemayor, at: IDRA, 5835 Callaghan Road, Suite 350, San Antonio, TX 78228. (210) 684-8180; FAX (210) 684-5389. Email: [amontmyr@txdirect.net](mailto:amontmyr@txdirect.net)

◀ NABE ▶

**Attend the  
Parent Institute at  
NABE '97!**

**February 4-8, 1997**

**Albuquerque  
Convention Center**

**Albuquerque,  
New Mexico**

BILINGUAL RESOURCES • ART ACTIVITIES • ASSESSMENT •  
 LESSON PLANS • LANGUAGE ARTS • MAPS • POSTERS • VHS PROGRAMS • TIMELINES

Imagine...  
 bringing the woodcarvers of  
 Oaxaca, the yarn painters  
 of the Sierra Madres, and  
 the weavers of Guatemala to  
 your classroom!



Let CRIZMAC's bilingual  
 resources bring the  
 art and culture of the  
 world to you.

Call 1-800-913-8555 today to place your order.  
 For your free catalog, call or write to  
 CRIZMAC Art & Cultural Education Materials  
 P.O. Box 65928 • Tucson, AZ 85728-5928  
 COMPUTER SOFTWARE • DISCUSSION QUESTIONS • FOLK ART

STUDENT BOOKLETS • TEACHER GUIDES • GAMES • TEACHING BOARDS • PUPPETS



**FERNÁNDEZ USA**  
 publishing Co.

and  
**FERNÁNDEZ editores, México**  
 in its 54th year of publishing  
 for the Hispanic children  
 of the Americas  
 wish the NABE membership  
 a happy and healthy  
 holiday season  
 and success  
 and prosperity in 1997!

**FERNÁNDEZ USA publishing Co.**  
 1210 E. 223rd Street, Suite 309  
 Carson, CA 90745  
 1 - 800 - 814 - 8080

**GENUINE SPANISH FOR  
 SPANISH SPEAKERS!**

- (1968). *Social class, race and psychological development*. New York: Holt, Rinehart.
- Edelsky, C., Draper, K., & Smith, K. (1983). Hookin' 'em in the start of school in a "whole language" classroom. *Anthropology and Education Quarterly*, 14. pp. 257-281.
- Giroux, H. (1983). *Theory and resistance in education: A pedagogy for the opposition*. London: Heinemann.
- Giroux H. (1988). *Teachers as intellectuals*. South Hadley, MA: Bergin & Garvey.
- Halliday, M.A.K. (1975). *Learning how to mean: Explorations in the development of language*. London: Edward Arnold.
- Heath, S. B. (1983). *Ways with words*. Cambridge, UK: Cambridge University Press.
- Holdaway, (1979). *The foundations of literacy*. Sydney: Ashton Scholastic.
- Ivener, B. L. (1990, Summer). *Primary grade childrens use of the environment and the social context of their spontaneous writing*. Unpublished doctoral dissertation. University of New Mexico, Albuquerque.
- Loughlin, C., & Ivener, B. L (1988, April). *Literacy behaviors of kindergarten and primary children in high stimulus-level literacy environments*. Paper presented at the Research Symposium of the Association for Childhood Education International, Salt Lake City, UT.
- McLaren, P. (1989). *Life in schools: An introduction to critical pedagogy in the foundations of education*. White Plains, NY: Longman.
- McNeil, J. D. (1992). *Reading comprehension: New directions for classroom practice*. (3rd Ed). New York: Harper, Collins.
- Minicucci, C., & Olsen, L. (1992). Programs for secondary limited English proficient students: A California study. *Focus*, Vol. 5, Washington DC: National Clearinghouse for Bilingual Education.
- Mooney, M. E. (1990). *Reading to, with, and by children*. Katonah, NY: Richard C. Owens.
- Morrow, (1993). *Literacy development in the early years: Helping children read and write*. (2nd Ed). Needham Heights, MA: Allyn & Bacon.
- Rigg, P. (1986). Reading in ESL: Learning from kids. In P. Rigg & D. S. Enright (Eds.). *Children and ESL: Integrating perspectives* (pp. 55-92). Washington, DC: Teachers of English to Speakers of Other Languages.
- Trelease, J. (1989). *The new read-aloud handbook*. New York: Penguin.
- Dr. Alfredo Schifini has been a secondary teacher, an elementary reading specialist and school administrator. He is currently professor of Curriculum and Instruction at California State University, Los Angeles, teaching courses in language arts methods and language development. He has trained K-12 teachers across the country in language and literacy development in bilingual and multilingual settings and Specially Designed Academic Instruction in English. Dr. Schifini has served as the National Curriculum consultant to the Guatemalan and Nicaraguan Ministries of Education and was a Fulbright Scholar.*

Article reprinted with the permission of Scholastic

# Gifted and Talented Students SIG

SIG Chair: Jaime Castellano, Palm Beach County P.S., West Palm Beach, FL

## *Gifted Education Update*

**N**ABE's Gifted Education Special Interest Group held both its first annual business meeting and Institute at the NABE '96 conference. The Institute, coordinated by Dr. Jaime A. Castellano and Dr. Eva Díaz, included presentations by practitioners, administrators, and university professors and researchers with an active interest in gifted education programs for bilingual students. In all, there were eight sessions — with representation from Illinois, Florida, Texas, Arizona, and Connecticut — conducted by leaders in the field such as Dr. Ernesto Bernal, Dr. Virginia González, Dr. Eva Díaz, and Dr. Jaime García.

During the SIG business meeting, the following goals were reviewed, discussed, and approved:

- To educate parents, teachers, and administrators on issues of gifted education and how to advocate for inclusionary practices ensuring that students who are ethnically, culturally, and linguistically diverse have access to local, state, and federal programs.
- To serve as a clearinghouse to disseminate information to those needing to make informed decisions about giftedness and its relationship to bilingual education.
- To network with teacher training institutions and related educational personnel, in addition to national research centers on gifted education, to exchange information which benefits all children, particularly those who are linguistically diverse.
- To increase the amount of research and/or literature on the identification and education of gifted limited English proficient (LEP) students.

### **NABE Action Alerts Now Available By E-Mail**

NABE sends special Action Alerts to members and subscribers to inform them of the latest developments in Washington concerning bilingual education. These action alerts are now available by e-mail.

To subscribe to the Action Alert list, send e-mail to:

**majordomo@nabe.org**,  
containing ONLY the following line in the body of the message:

**subscribe actionalert <your e-mail  
address>**

A common thread of the discussion during the business meeting was the issue of identification and assessment of LEP students for gifted education programs. One participant expressed her frustration, echoed by many others, that one of her responsibilities was to identify potential candidates for her district's gifted program, but she had no idea how to go about the identification process. It was the consensus of the group that identification and assessment of LEP students are the most pressing issues which prevent bilingual students from participating in gifted education programs.

The Gifted Education SIG will be coordinating an Institute at NABE '97 in Albuquerque and extends an invitation to conference attendees to participate in the Institute and the SIG business meeting. The information to be provided will be timely, practical, and will address the current trends in the field.

*Gifted Education SIG Chair Dr. Jaime A. Castellano can be contacted at 911 Orange Drive, Lake Park, FL 33403 (561) 845-7062.*

◀ NABE ▶

### **POSITION AVAILABLE IN BILINGUAL SPECIAL EDUCATION**

The City College Department of Education has available a full-time, tenure-track position for a teacher educator in the area of bilingual special education. The College expects to make the appointment in the Department of Education's Bilingual Education Program at the level of Assistant Professor beginning September 1, 1997.

Applicants must have earned a doctorate including formal preparation in the fields of Bilingualism and Bilingual Education, and be fluent and literate in English and either Cantonese, Haitian, Mandarin or Spanish. In addition, the successful candidate will have experimental research preparation in, and a familiarity with cross-categorical approaches to, Special Education. The candidate will also have the ability to prepare teachers who will work with children of different levels of special needs.

The successful candidate will teach and perform research in the area of Bilingual Special Education, supervise student teachers, advise students, and participate in the relevant bodies of faculty governance. Salary will be at the Assistant Professor level, commensurate with experience.

A resume and letter of application should be received by the City College Department of Education no later than January 3, 1997. We regret that we are unable to respond to telephone, fax, or electronic-mail inquiries (no exceptions). Please address hard copy correspondence only to:

Professor Ricardo Otheguy  
Department of Education  
City College of New York  
New York, NY 10031

combination of story, visual, and how-to ideas makes the books very "user-friendly." An example can best illustrate.

In Book 3, the first bilingual story, "The School for Bears" ("La escuela para osos"), is about a school for all the animals in the forest. The story goes like this: Mrs. Bear is getting on in her years, is sometimes forgetful, and often confuses one bear with the other. Her problem is more difficult because she has four red bear cubs, four blue ones, four yellow ones, and four green ones, and bears of each color sit together in the same row. She finally realizes that she can't have two bears of the same color sit side by side or in front or back of each other. So, she takes out her seating chart and pictures of her students to try to solve her problem. The story ends with a question for the listeners/readers: "Do you think that you could figure this out? Cut out the bears and place them in their rows correctly. You'll be doing Mrs. Bear a big favor."

The objectives mentioned in the teacher's guide for this story are

- to promote confidence in problem-solving skills;
- to promote flexibility of thought;
- to provide opportunities for the formulation of strategies; and
- to improve the student's attention to detail.

Also, because the story isn't finished until the problem is solved, one of the follow-up activities is to finish the story. This could fulfill other objectives, such as creative elaboration of detail and concluding with emphasis and clarity. For future thinking lessons and tie-in's to other classes, two book lists related to the story are included after each story, one in English, the other in Spanish.

There are many ways that these thinking stories can be used, for both instruction and assessment (see "Benefits" below). When I taught first and second grades,

I used some thinking activities very similar to these, but they did not revolve around stories, making them more like a string of exercises. However, as more and more language researchers have discovered, the narrative genre is a universally recognized form, appealing and meaningful for all ages and language backgrounds. Stories add a context that can be more easily connected to students' own lives and stories. For this reason, the bilingual thinking stories lend themselves well to use in a variety of settings. They can be integrated into classes in mathematics, social studies, science, art, health, and literature, all of which require their own types of thinking. For example, in "The Moving Company" ("La compañía de mudanza"), the stated objectives relate to attributes of objects and making relationships, but one obvious use of the material not mentioned is related to the development of metalinguistic awareness. The made-up words (*vincas*, *nipos*, *urpas*, and *flitos*) are all very intriguing in the story and form categories that readers/listeners then must figure out. However, the fact that made-up words were used in an important way in the story is significant in its own right and could be utilized in a follow-up activity that focuses on discovering ways we make up words for different purposes, in a variety of everyday situations, across the content areas.

Although the stories are "pretend" and imaginative, they point to the very authenticity of real-life drama and situations needing problem solving on a daily basis. As such, they help both teachers and students connect thinking skills to the world outside the classroom and school, one of the most important if not the most important characteristic of a successful learning/teaching program.

#### Criticisms

As for criticisms, I have few. The Spanish translations by Carmen Ibarra are good. However, I believe that a truly excellent thinking activity could be to expose children to a broader range of vocabulary, which would also stimulate language development in both languages and increase their metalinguistic functional abilities at the same time. One

example would be a follow-up activity devoted to word study to encourage children to think about other ways to say something, drawing on their own experiences and the diversity that is part of most classrooms of Spanish-speakers. This would also be educational for English-speaking students since they would quickly understand that not all Spanish-speakers come from the same place, have the same customs, nor the same words for things. For instance, in the story "The Analogy Machine" ("La máquina de analogías"), besides the words "hierba" and "césped" for "grass," which are mentioned in the story, the word "sacate" could be introduced. Before the end of the first reading of the story, many teachers may need to clarify these words anyway, depending upon the speech register used by students in their class. This emphasis on diversity of students would stimulate divergent thinking as well, an important thinking skill that is essential in day-to-day classroom problem solving and conflict resolution. Another example of lexical variation that would be familiar for many youngsters would be the diminutive form for "cookies," "galleticas," to offer a real world alternative to "galletitas," the form used in the book. Later editions certainly could add to discussion ideas and activities, especially related to language variation in Spanish.

The only other criticism relates to what may be called a lack of diversity of sociocultural themes and characters. While the stories are in many ways culturally-sensitive, referring to the princess in one story as a green-eyed, black-haired (not blonde) beauty, it was still her beauty that was referred to, rather than her intelligence, strength, or wit. Also in the same story it might be considered a too predictable theme that she leaves home in order to get married, rather than to get a job in town or across the country, or to study to become a scientist or artist. In the story about the children jumping on the bed, all three sets of triplets were boys. What are the odds that this family would have only sons and no daughters? Are boys more often found jumping on beds? Perhaps in make-believe stories, it doesn't really matter.

CONTINUED ON PAGE 34

# Upcoming Events

December 27-30, 1996 - *National Science Teachers Association Global Conference*. San Francisco Convention Center. Contact Ellie Snyder (703) 243-7100.

January 10, 1997. Deadline for Call for Papers for *Fourth Annual Stabilizing Languages Symposium: Sharing Effective Language Renewal Practices*. May 2-3, 1997, Flagstaff, AZ. Contact Jon Reyhner at (520) 523-0580.

January 27 - 30, 1997 - *Twentieth Annual Statewide Conference for Teachers of Linguistically and Culturally Diverse Students*. "Education: A Work in Progress." Hyatt Oak Brook, Oak Brook, Illinois. Contact the Illinois Resource Center at 847-803-3112.

February 15-19, 1997 - *Association of Teacher Educators 77th Annual Meeting*. "Democratic Education for the 21st Century: A Critical Look at the Past, Present, and Future." Washington, DC. Contact ATE, 1900 Association Drive, Suite ATE, Reston, VA 20191-1502.

February 20-22, 1997 - *Hispanic Association for Higher Education of New Jersey 19th Annual Conference*. "Education Under Siege: Revolución Ahora." Long Branch, NJ. Contact Nancy Cintrón at (908) 445-2678.

February 26 - March 1, 1997 - *California Association for Bilingual Education 22nd Annual Conference*. "Advancing World Class Standards for Learning and Leadership." San Diego, CA. Contact CBE at 660 South Figueroa Street, Suite 1040, Los Angeles, CA 90017 (213) 532-3850.

February 26 - March 1, 1997 - *American Association of Colleges of Teacher Education 49th Annual Meeting*. "Leadership for Transforming the Profession: Fulfilling the Commitment to Children, Communities, and the Common Good." Hyatt Regency, Phoenix, AZ. Contact AACTE at One Dupont Circle, Suite 610, Washington, DC 20036.

March 6-7, 1997 - *Massachusetts Association for Bilingual Education Annual Conference*. "Making Connections." Leominster, MA. Contact MABE at (508) 434-9542.

March 7-8, 1997 - *Luso-American Education Foundation Conference on Portuguese American Education*. University of California, Berkeley. Contact Mily Sena at (510) 828-3883.

March 7-11, 1997 - *National Association of Secondary School Principals Annual Conference*. Orlando, FL. Contact NASSP at (703) 860-7262.

March 11 - 15, 1997 - *Teachers of English to Speakers of Other Languages 31st Annual Convention*. "Creating Magic with TESOL '97." Orlando, FL. Contact TESOL at (703) 836-0774.

March 14, 1997 - *Korean American Educators 13th Annual Conference*. Los Angeles, CA. Contact Elena Paul at (818) 224-4354.

March 22-25, 1997 - *Association for Supervision and Curriculum Development 52nd Annual Conference*. Baltimore, MD. Contact ASCD at (800) 933-2723.

March 26-29, 1997 - *The National Association for Asian and Pacific American Education 19th Annual Conference*. "The Challenge of Change: Families, Communities, & Schools." Boston, MA. Contact Hiep Chu at (617) 287-5653.

◀ NABE ▶

## Special Events Planners

Mail or fax event announcements to the attention of NABE News Editor or send them by email to <NABE\_NEWS@nabe.org>. Events may be listed once free of charge.

# NABE '97

**Twenty-Sixth Annual  
International Bilingual/Multicultural  
Education Conference**

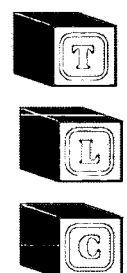

**February 4th - 8th, 1997  
Albuquerque Convention Center  
Albuquerque, New Mexico**

**Benefits: How the Bilingual Stories Came to Be**

Perhaps the most significant benefits of the three thinking stories books are explained best by the author herself as she tells how the books came about:

"I have been teaching on the Mexican-American border in Nogales, Arizona. It has been my job for the last ten years to identify young children for the district's gifted program. For many years I followed the state's mandated procedures for testing, but I found only a few children who tested in the gifted range. I knew there were many bright children in our community and that I had to find a better way to allow them to demonstrate their abilities. I finally decided to start working in all the primary classrooms with all the children, presenting lessons that would allow them to use their intelligence in ways that were meaningful to them. My job was to not only present the lessons, but also to observe the children in their thinking activities and note intelligent behaviors as they worked their problems. After four years of using this observation procedure, I was able to identify many bright children. By observing all primary children as they tackled problems in logic, deductive reasoning, non-verbal activities, creativity and math, I have been able to see children thinking on a variety of levels. I have been able to note those children who are salient in each area of thinking" (from the Introduction).

While developing the method used in the thinking stories books, Scott observed more than 2,000 children. She believes that her approach to identifying gifted children is more valid because "we are looking at the whole child and observing over a long period of time and in many different learning and problem-solving

situations." She also believes that this type of assessment must be available in the native language of the child, because children need to think in their first language. She has presented the books themselves at least fifty times with children in Kindergarten, first and second grades.

In summary, these bilingual thinking stories and activities

- 1) help teachers bring out the best in our bilingual children;
- 2) offer alternative ways of understanding and identifying students' thinking abilities;
- 3) show teachers how to create, use, and integrate these and other thinking activities into the daily curriculum; and
- 4) utilize students' primary language (Spanish) to develop cognitive abilities needed for all future learning and life skills.

So, Dandy Lion, when do you plan to publish more thinking stories? And will future editions also be available in other languages, too, in addition to Spanish-English?

**References**

National Council of Teachers of Mathematics, 1989. *Curriculum and Evaluation Standards for School Mathematics*. Reston, VA: NCTM.

*Beti Leone teaches in an adult bilingual literacy program in Paterson, New Jersey and trains ESL and bilingual teachers in field-based reflective teaching methodology.*

« NABE »

**CLASSIFIED**

**Administrative Specialist, Second Language Programs, Clark County School District. Salary \$48,156 - \$61,416. Requires Master's Degree, Nevada Administrative Endorsement, and 5 years licensed teaching experience to include at least 2 years contracted administrative experience related to the position. Please call (702) 799-5252 to request an application no later than 1/29/97. Submit completed application to Ms. Hilary Porter, Administrative Personnel, 2832 E. Flamingo Road, Las Vegas, NV 89121 no later than 2/10/97. M/F/D/EOE**

**Colorado Teacher Vacancy. Middle School ESL Teacher. Would you like the opportunity to live in the heart of the Rocky Mountains and teach wonderful children? Lake County School District R-1 in Leadville, Colorado has an immediate opening for a Middle School ESL Teacher. Must have or qualify for a Colorado Teaching Certificate/License. Position open until filled. For information or application, please call the administration office at 719-486-6813.**

**DON'T MISS NABE '97!****Keynote Speakers**

Joe Bird, Chief of the Cherokee Nation\*  
 Al Gore, Vice President of the United States\*  
 Rita Moreno and Edward James Olmos, California Hispanic Dropout Project

**Major Speakers**

Virginia Collier & Wayne Thomas, George Mason University  
 Jim Cummins, Ontario Institute for Studies in Education  
 Ruben Donato, University of Colorado, Boulder  
 Lily Wong Fillmore, University of California, Berkeley  
 Stephen Graymorning, University of Montana  
 Steve Krashen, University of Southern California  
 Sammy Quintana, National School Boards Association  
 Bill Rojas, San Francisco Public Schools  
 Kathleen Ross, Heritage College\*  
 Dennis Sayers, California State University, Fresno  
 Leanna Trail, California State University, San Bernardino  
 Guadalupe Valdés, Stanford University

\* invited



# NATIONAL ASSOCIATION FOR BILINGUAL EDUCATION

## MEMBERSHIP APPLICATION

**1**

### Membership Type (check one only)

- \$48 Individual Membership
- \$30 Discounted Individual Membership
  - Parent:** must not be professional educator and must have a child currently enrolled in a bilingual education program. A letter written on school stationery from either the teacher or a school administrator must accompany the NABE membership application.
  - College/University Student:** must not be professional educator and must be enrolled on full-time basis. A copy of an official college or university document showing current enrollment status must accompany the NABE membership application.
  - Paraprofessional:** Must be working as an instructional aide in a public school system. A letter on school stationery from the supervising teacher or a school administrator must accompany the NABE membership application.
- \$43 Combined Membership Name of Affiliate: \_\_\_\_\_
- \$125 Institutional Membership
- \$1000 Lifetime Membership

Memberships are valid for one year from the date of processing, and include one year subscription to NABE publications (except Lifetime, valid for life of member and includes lifetime subscription). Organizational membership is non-voting; all other memberships are voting. All memberships are non-transferrable and may not be cancelled. Membership dues are non-refundable.

### Name and Address Information

- 2**
- Mr.
  - Mrs.
  - Ms.
  - Dr.
- \_\_\_\_\_
- Last First Middle

- 3** Preferred Mailing Address:  Business  Home
- Business Address**

Position: \_\_\_\_\_

Division: \_\_\_\_\_

Organization: \_\_\_\_\_

Street Address: \_\_\_\_\_

City: \_\_\_\_\_ State: \_\_\_\_\_ Zip: \_\_\_\_\_

Phone: (\_\_\_\_) \_\_\_\_\_ Ext. \_\_\_\_\_

Fax: (\_\_\_\_) \_\_\_\_\_ E-Mail: \_\_\_\_\_

### Home Address

Street Address: \_\_\_\_\_

City: \_\_\_\_\_ State: \_\_\_\_\_ Zip: \_\_\_\_\_

Phone: (\_\_\_\_) \_\_\_\_\_

**4**

### I am involved with bilingual education as (check one)

- Administrator
- College Instructor
- Consultant
- Full-Time Student
- Paraprofessional
- Parent/Community member
- Publisher Staff
- School Board Member
- Teacher
- Other

**5**

### I work in this type of organization (check one)

- Commercial organization
- College/university
- Local school district
- State education agency
- Other

**6**

### I usually work with this level of student (check one)

- Early childhood
- Elementary
- Secondary
- Higher education
- Adult

**7**

### I want to participate in the following Special Interest Group (check one)

- Adult/Vocational Education
- Asian & Pacific Islanders
- Critical Pedagogy
- Early Childhood Education
- Elementary Education
- ESL in Bilingual Education
- Gifted Education
- Global Education
- Higher Education
- Instructional Technology
- Language/Culture Retention
- Language Policy
- Parent & Community
- Policy Makers
- Professional Development
- Research & Evaluation
- Secondary Education
- Special Education

**8**

### Payment Information

\$ \_\_\_\_\_ Membership dues

\$ \_\_\_\_\_ Contribution to help NABE counter the English-only movement

- Check or money order Check# \_\_\_\_\_
  - Institutional purchase order # \_\_\_\_\_
  - MasterCard  VISA Expiration Date: \_\_\_\_/\_\_\_\_/\_\_\_\_
- □ □ □ - □ □ □ □ - □ □ □ □ - □ □ □ □

**Automatic Renewal:** Check this box if: you are paying by credit card, and you want NABE to automatically renew your membership annually, charging your credit card the standard renewal amount. This permission will remain in effect until you cancel it in writing.

\$ \_\_\_\_\_ **TOTAL DUE**

**9**

**SIGNATURE:** \_\_\_\_\_ **DATE:** \_\_\_\_/\_\_\_\_/\_\_\_\_

# ANNOUNCEMENTS

## NABE '97 CONFERENCE SPONSORS TO-DATE

### Diamond Sponsors

Houghton-Mifflin Company  
Scholastic, Inc.

### Gold Sponsors

Embassy of Mexico  
Macmillan/McGraw-Hill School Division  
Simon & Schuster Publishing Group  
Talk, Inc.

### Silver Sponsors

Hampton-Brown Books  
Harcourt Brace School Publishers  
SRA /McGraw-Hill  
Scott Foresman/Addison-Wesley  
SpanPress

### Conference Supporters

American Federation of Teachers  
Fannie Mae Foundation  
Jostens Learning  
US West Communications

### Special Event Sponsors

Scholastic, Inc.  
*Bilingual Instructional Assistant of the Year*  
*Bilingual Teacher of the Year*  
*NABE '97 Conference Poster*  
Albuquerque Hispano Chamber of Commerce  
*Community Education Festival*  
Embassy of Mexico  
*Educational Trips for Bilingual Teacher of the Year and*  
*Bilingual Instructional Assistant of the Year*  
Celebration Press  
*Registration Tote Bags*  
Embassy of Spain  
*Scholarship Award for Bilingual Teacher of the Year*  
Talk, Inc.  
*Simultaneous Interpretation Equipment*  
US West Communications  
*Telecommunications*

### Cooperating Agencies

Albuquerque Convention & Visitors Bureau  
Albuquerque Hispano Chamber of Commerce  
Albuquerque Public Schools  
Belen Public Schools  
Comprehensive Regional Assistance Center,  
New Mexico Highlands University  
Las Lunas Public Schools  
New Mexico Association for Bilingual Education  
University of New Mexico

### NABE NEWS

National Association for Bilingual Education  
Suite 605  
1220 L Street, N.W.  
Washington, D.C. 20005-4018

NON-PROFIT ORG.  
U.S. POSTAGE  
PAID  
WASHINGTON, DC  
PERMIT NO. 4555

KATHLEEN M. MARCOS  
ERIC CLEARINGHOUSE ON LANGUAGES & L  
1118 22ND ST NW  
WASHINGTON DC 20037-1214





# NABE NEWS

The news magazine about educational equity and excellence through bilingual education

February 1, 1997

National Association for Bilingual Education

Volume 20, Number 4

## Education Under Fire *Changes in the 105th Congress? Not Hardly!*

by J. David Edwards, Ph.D.

**E**lections tend to force most candidates toward the moderation of the political center. But what happens after the elections are over? Legislatively, last year was characterized by a highly ideological House of Representatives committed to the elimination of education reform, educational exchanges, the national endowments, foreign language assistance, bilingual education, and professional development, among other things. In addition, the House also passed the English Language Empowerment Act making English the official language of the United States' government and an immigration bill which would deny public education to the children of undocumented aliens.

In the intense negotiations that characterized the end of the 104th Congress, however, a much more moderate Senate and a determined Administration prevailed and federal education spending was actually increased by over \$3.5 billion. NEH and educational exchanges both received reprieves and were funded at \$110 and \$185 million (M) respectively. Goals 2000 received \$141M more than last year. Professional development was increased by \$35M to \$310M (\$300 million less than the President requested). Bilingual educa-

tion increased by almost \$40M (still less than two years ago). Foreign languages and international studies in higher education increased to \$60M, while foreign language assistance was reduced to \$5M. Research gained \$12M and technology education was a big winner with an increase of over \$220M.

Finally, the House and Senate couldn't reach agreement on block grants. Official English legislation died in the Senate. In the immigration bill, the Senate's unwillingness to accept and the President's willingness to veto resulted in the removal of the provision denying public education to undocumented children. And bills phasing out NEA and NEH died in committee.

One thing is certain, national education policy is no longer the bipartisan, noncontroversial issue it has been in the past. The divisions are severe and serious. Make no mistake, attacks on education are not going to cease in the 105th Congress. They may become more subtle and incremental. But to cite the rhetoric and policies of the leadership in the House of Representatives, all of whom will be back in the 105th Congress — they are committed to eliminating the Department of Education; getting rid of the National Endowments for the Arts and Humanities; making education policy the sole province of the states; killing education reform and standards in

CONTINUED ON PAGE 6

## Looking to the 21st Century *The Unified Teacher Education Model*

by Dr. Sylvia Sánchez and  
Dr. Eva Thorp

**T**he growing diversity in the school age population has posed a tremendous educational challenge for schools nationwide. Preservice and inservice training for teachers has had to be reconceptualized to meet the unique needs of all students in today's schools.

In 1994, Dr. Eva Thorp and Dr. Sylvia Sánchez of George Mason University in Virginia began working with early childhood education, early childhood special education, and bilingual/multicultural/ESL faculty to discuss a new concept of collaboration among the disciplines — one that was to lead to the establishment

of an integrated teacher training model. Following an initial meeting, a university-community design group was formed to foster support and guidance from preschools, local school districts, and community agencies serving young children in the development of a new preservice training program. The goal was a model that would prepare teachers to work with culturally, linguistically, and ability diverse young children and their families in a variety of inclusive classroom and community settings.

Today, the Unified Teacher Education Model (UTEM) is in its second year of operation. UTEM rests on a philosophical foundation and is committed to an integrated approach that is supportive of

CONTINUED ON PAGE 38

### ISSUE HIGHLIGHTS

*Portraits of Success*.....5

NABE '98

Call for Papers.....17



# NABE NEWS

Published by the  
**National Association for  
Bilingual Education**

**Editor:**  
Nancy F. Zelasko, Ph.D.  
**Desktop Publishing & Layout:**  
Jeff Spence

## NABE NEWS REPRINT AND EDITORIAL POLICY

Readers are welcome to reprint non-copy-righted articles which appear in *NABE NEWS* at no charge, provided proper credit is given both to the author(s) and to *NABE NEWS* as the source publication.

All articles printed in *NABE NEWS*, unless written by an Association staff person or a member of the current NABE Executive Board of Directors, are solely the opinion of the author or authors, and do not represent the official policy or position of the National Association for Bilingual Education. Selection of articles for inclusion in *NABE NEWS* is not an official endorsement by NABE of the point(s) of view expressed therein.

## TABLE OF CONTENTS

Education Under Fire.....	1
Unified Teacher Model.....	1
Message from the President.....	3
Portraits of Success.....	5
Technology.....	7
Higher Ed Legislation.....	9
Asian/Pacific American.....	11
Bilingual Educator Resources.....	13
NABE Order Form .....	16
Call for '98 Papers.....	17
Successful Practices.....	21
American Indian.....	25
Administration.....	27
Parental Involvement.....	29
Upcoming Events.....	30
Separate and Unequal.....	31
Book Reviews.....	33
Membership Application.....	39
Announcements.....	40

## PUBLICATION SCHEDULE

Volume 20 of *NABE NEWS* will be published in 8 issues; publication dates are:

Issue 1	09/15/96	Issue 5	03/15/97
Issue 2	11/01/96	Issue 6	05/01/97
Issue 3	12/15/96	Issue 7	06/15/97
Issue 4	02/01/97	Issue 8	08/01/97

All advertising and copy material must be received in the NABE office **ONE MONTH prior to publication date** to be considered for inclusion.

## NABE NEWS ADVERTISING

### Display Advertising Rates (Camera-Ready)

Full Page (7.5" x 10")	\$850
2/3-Page (4.75" x 10")	\$700
1/2-Page (7.5" x 4.5")	\$550
1/3-Page (4.75" x 4.75")	\$425
1/3-Page (2.25" x 10")	\$425
1/4-Page (3.5" x 4.75")	\$325
1/6-Page (2.25" x 4.75")	\$250

### Classified Advertising

\$1.25 per word; maximum 100 words

### Advertising Discounts (for multiple insertions)

10% for second-third; 15% for fourth-fifth;  
20% for sixth-eighth

NABE reserves the right to reject any advertisements which it deems inappropriate and/or inconsistent with the goals of the Association. For additional information, contact NABE at (202) 898-1829 x136.

## NABE

The National Association for Bilingual Education (NABE) is a tax-exempt, non-profit professional association founded in 1975 to address the educational needs of language-minority Americans.

### NABE NATIONAL OFFICE

1220 L Street, N.W., Suite 605  
Washington, DC 20005-4018

PHONE (202) 898-1829

FAX (202) 789-2866

E-mail: NABE@nabe.org

### James J. Lyons, Executive Director

Nancy F. Zelasko, Deputy Director  
Jaime Zapata, Associate Director for Legislation  
Jeff Spence, Information Systems Director  
Carolyn Riddick, Office Manager  
Celia Torres, Membership Specialist  
Mina Cousins, Membership Specialist  
Ronald Williams, Office Assistant  
Teresa Sola, Receptionist

## NABE EXECUTIVE BOARD

1996 - 1997

### President

Janice Jones Schroeder  
429 Wabash Ave.  
Kenmore, NY 14217  
(716) 875-1882  
nabepres@aol.com

### Vice President

Mary F. Jew  
San Francisco USD  
2550 - 25th Avenue  
San Francisco, CA 94116  
(415) 759-2950  
mjew@sfusd.k12.ca.us

### Secretary/Treasurer

David E. Báez  
Director, Foreign Language & Bilingual  
Education  
Buffalo Public Schools  
731 City Hall  
Buffalo, NY 14202  
(716) 851-3704  
dbaez@erie.wnyric.org

### Member-at-Large

Joe J. Bernal  
6410 Laurehill  
San Antonio, TX 78229  
(210) 342-8026  
bowlngod@ix.netcom.com

### Member-at-Large

María Estela Brisk  
School of Education  
Boston University  
605 Commonwealth Avenue  
Boston, MA 02215  
(617) 353-3260  
brisk@acs.bu.edu

### Member-at-Large

Nga Dinh Duong  
21724 58th Avenue West  
Mountlake Terrace, WA 98043  
(206) 771-2095

### Member-at-Large

Hermán S. García  
Department of C & I  
College of Education  
New Mexico State University  
Las Cruces, NM 88003  
(505) 646-2115  
hgarcia@cnmailsvr.nmsu.edu

### Member-at-Large

Susan García  
18094 East Ohio, #102  
Aurora, CO 80012  
(303) 745-7116  
susangarcia@unitedwaydenver.org

### Parent Representative

Adela B. Holder  
Silver Consolidated School District  
2810 N. Swan Street  
Silver City, NM 88061  
(505) 388-1527  
sncadavi@arriba.nm.org

# Message From The President

## Whose Child Is This?

by Doris W. Betts

One day in wise King Solomon's court, guards led in a child and a throng of grumbling citizens. Some claimed to own part of this child but many didn't want even one ear or a finger. "Whose child is this?" King Solomon asked.

"Not my child!" said one. "It's the wrong color!"

Another said, "No, my child's eyes look different."

Said a third, "My child's grown, this can't be mine."

The king was puzzled, because to him the child kept changing — the skin from dark to light; hair curly or straight; eye color, size and gender. To him the child looked both male and female, aged 5 to 25.

"Not mine!" called a citizen. "My child's gifted and talented!"

"Not mine!" said another, "I'd never dress my child in worn-out clothes!"

One woman wore a chip on her shoulder big as a stick of stovewood. "Too quiet for mine!" she shouted. "My boy has a right to carry a knife." "My girl can smoke anyplace she chooses!"

Solomon ordered her to join the others arguing to one side. He called up older citizens, already shaking their gray heads. "Not mine!" they chorused, "because I've finished raising my children and taxes are too high already!"

The king hoped a man in academic robes would claim the child, but the educator said, "No, that's not my child but I do recognize him. Or her. That's a per-pupil. I only study theoretical per-pupils in the abstract."

Next, some merchants said that since 100 percent of good children in the good old days were perfect students, they'd never hire this modern, imperfect child.

Religious leaders now came forward, in sacred garments, giving ecumenical nods and smiles.

"Oh King, that IS our child," they said, "at least one-seventh is ours. Once a week



NABE Executive Board President  
Janice Jones Schroeder

we'll offer this child spiritual nourishment, but (you understand, Oh King) full-time children would track in mud where we worship."

"Surely," King Solomon said, "you teachers have something to say."

The teachers edged forward; many looked tired.

"This child could be my pupil," said one, squinting. "I teach so many their faces blur."

Others said, "Is this the first-grader who needs glasses? The middle-schooler who plays hooky or sleeps in class? Is her father suing me for low grades? Does his mother have a big chip on her shoulder?"

Everyone said it: "Not my child!"

The social worker was overworking in the child's bad neighbor; the police man was busy arresting the child's older siblings; a senator flung the child a government grant; rock singers and slam-dunkers posed for TV and offered to be role models when they found the time.

Then a brawling unruly mob poured in, yelling, "That's MY child! I'll take him! Give her to me!"

Poverty came shouting ahead of his gang of Ignorance, Despair, Crime, Racism, Unemployment, Drugs and Rage. These ruffians grabbed for the child with greedy, dirty hands.

"STOP!" roared the king, and he ordered guards to banish this rabble.

Then, quietly, he called his subjects out of their separate self-interest groups, and ordered each to look carefully at the child.

All stared at this child and grew silent. It was like looking into a mirror at themselves long ago; like looking through a window at tomorrow.

Those with brown faces saw a brown child; blue eyes gazed into blue. Hispanic, Native American, Asian and the freckled-faced Joneses all ran together in the child's face. Grandparents foresaw a grown-up child who would fix their cars, treat their cancers. Merchants saw future workers and customers. Politicians looked beyond new voters and widened their vision to see all of America.

One-at-a-time, people began pulling up chairs; they said to the teachers: "Here, you sit down! You can't do this educating by yourself! That's not your child, not even my child; it's OUR child."

Together they began planning to give this child schools, books, computers, to provide music and art, to teach the child to think and dance, to write poems, to make just laws.

They were so busy they hardly noticed when wise King Solomon left.

He didn't mind. He was tired.

Sometimes the hardest job any ruler has is just to help people find again how wise they are at heart.

### WHAT HAPPENS IF WE STOP CARPING AND START TO SEE THE NATION'S FUTURE?

*Reprinted with permission from the author.*

**Editor's Note:** Doris W. Betts is an Alumni Distinguished Professor of English at the University of North Carolina - Chapel Hill. She read this piece on Saturday, January 11, 1997 at inaugural ceremonies for state officials.

• NABE •

**1998 NABE Conference  
Call for Papers  
begins on page 17!**

# DISCOVER PERMA-BOUND BOOKS

## FOR YOUR BILINGUAL STUDENTS



**W**hen looking for a great selection of affordable titles for bilingual students, our Pre-Kindergarten-12 selection is great - including over 2,000 books in Spanish, plus Chinese, Vietnamese, French, German, Italian, and more.

- ❖ TRANSLATIONS
- ❖ ORIGINAL WORKS
- ❖ SHORT STORIES
- ❖ NOVELS
- ❖ SCIENCE
- ❖ DICTIONARIES
- ❖ BILINGUAL READERS
- ❖ VALE - IBM WRITING TO READ

Now Available! Books in Spanish to accompany Accelerated Reader Program.

One PERMA-BOUND book will outlast seven to ten paperbacks at about one-third the cost-and they're unconditionally guaranteed. If you're ever dissatisfied with a PERMA-BOUND book for any reason we'll replace it.

102

VANDALIA ROAD ❖ JACKSONVILLE, ILLINOIS 62650

CALL TOLL FREE: 1-800-637-6581 | TOLL FREE FAX: 1-800-551-1169

**PERMA-BOUND**

# Bilingual Education: Portraits of Success Project

Column Editor: Dr. María Estela Brisk, Boston University, Boston, MA

## *Reporting Success in Bilingual Education: A Survey*

by María Estela Brisk and Madeleine deMatteis

The idea of collecting information on success in bilingual education is long overdue. Bilingual education has been present in schools in the United States for a very long time. From the 19th century through the 1950's, it was mostly the work of parochial schools, individual community projects, or specific ethnic groups' efforts to maintain their language and culture. Since the late 1960's, bilingual education programs have been developed as a federal and state response to the needs of the growing number of students of diverse language backgrounds. In the last ten years, programs serving both English-speakers as well as speakers of other languages have emerged in response to English-speaking parents' interest in bilingualism for their children, as well as the desire to integrate language-minority and English-speaking students.

Research has supported the benefits of bilingual education both for speakers of other languages as well as for English-speakers. However, there is not much documentation available on successful bilingual programs and individuals in these programs. There are some studies that have reported on successful programs for language-minority students, be they in bilingual education, ESL, or sheltered English. Five of the six successful schools included in Lucas, Henze and Donato's study offered courses in both English and the native language.<sup>1</sup> Carter and Chatfield report on the bilingual program at the Lauderbach Community School in California.<sup>2</sup> More recently, a study commissioned by the Office of Educational Research and Improvement of the U.S. Department of Education reported on school reform efforts that have led to effective schooling for language-minority students: the schools chosen for the study included successful Transitional Bilingual Education (TBE), Two-Way Bilingual, ESL and Sheltered English programs.<sup>3</sup> García synthesizes the findings of several studies on successful practices<sup>4</sup> and characteristics of effective teachers in bilingual education programs.<sup>5</sup>

Despite studies such as those listed above, there is still much information to be gathered. So far, most studies of success include programs for speakers of other languages but do not focus exclusively on bilingual education programs. Sometimes the information available has been synthesized from longer reports into articles, thus a lot of the valuable detail is lost. Moreover, the research conducted so far reflects only a limited number of states. Finally, while there have been some studies done on successful programs, there is a dearth of information about particular teachers or students who stand out as successful examples of bilingual education.

Individual states have publicized their successes. Massachusetts, for example, has produced a video<sup>6</sup> as well as a monograph

highlighting programs and successful graduates.<sup>7</sup> New York State's Department of Bilingual Education has recently launched a major effort to report success among students and parents in bilingual education and free-standing ESL programs in the state through their newsletter *The BEST (The Bilingual/ESL Success Times)*.<sup>8</sup> On a wider scale, the Office of Bilingual Education and Minority Languages Affairs (OBEMLA) of the U.S. Department of Education is in the process of creating a database on success in Title VII programs, teachers, and students. The George Washington University Center for Equity and Excellence in Education has developed guiding principles reflecting the "conditions that create an optimal environment for the education" of bilingual students who have limited English proficiency. Their goal is go have schools and communities use these principles when evaluating and developing programs for bilingual learners.<sup>9</sup> There may be other documents and efforts to report on bilingual education success, but they are not easy to locate and are not centralized.

The Bilingual Education Portrait of Success project seeks to focus specifically on bilingual education and fill in the existing gaps by:

- reporting success only in relation to bilingual education,
- gathering information on successful bilingual teachers, students, and graduates,
- covering the whole country,
- networking with existing databases,
- centralizing the information, and
- making it accessible to the public.

This is a long term project which requires the collaboration of educators and advocates throughout the country.

### References

- <sup>1</sup>Lucas, T., Henze, R., & Donato, R. (1990). "Promoting the success of Latino linguistic minority students in high schools." *Harvard Educational Review*, 60, 315-340.
- <sup>2</sup>Carter, T. & Chatfield, M. (1986). "Effective schools for language minority students." *American Journal of Education*, 97, 200-233.
- <sup>3</sup>Berman, P., Minicucci, C., McLaughlin, B., Nelson, B. & Woodworth, K. (1996). *School Reform and Student Diversity: Case Studies of Exemplary Practices for LEP Students*. Washington, D.C.: National Clearinghouse for Bilingual Education.
- <sup>4</sup>García, E.E. (1988). "Attributes of effective schools for language minority students." *Education and Urban Society*, 20(4), 387-398.
- <sup>5</sup>García, E.E. (1991). "Effective instruction for language minority students: The teacher." *Journal of Education*, 173(2), 130-142.

## SEQUOIA UNION HIGH SCHOOL DISTRICT

### Bilingual (Spanish) teachers

All high school subjects  
for 1997-98 school year

Must qualify for  
California Single Subject  
Credential

**Please send letter  
and resume to:**

Certificated Personnel  
Sequoia Union High  
School District  
480 James Avenue  
Redwood City, CA 94062

(415) 369-1411, ext. 2223  
FAX (415) 306-8868

## Education/Teachers Las Vegas, Nevada

The Clark County School  
District is seeking bilingual  
(Spanish) educators for the  
1997-98 school year.

We will be opening 11 new  
schools.

Interested parties **must be  
able to meet licensure  
requirements.**

For further information or to  
schedule an interview,

**call (702) 799-5096  
between 8:00 am and  
4:00 pm PST, Monday  
through Friday.**

the cradle; making English the nation's official language; and ensuring our children's futures by balancing the budget through education cuts.

While a few of the more extreme ideologues lost, most of last year's House freshmen are returning to Congress. Joining them will be seventy-two new Representatives. In the 105th, the House's composition will be 227 Republicans, 207 Democrats, and one Independent. Consequently, the nature and policies of this august body should not change very much.

Because it has different rules and represents larger constituencies, the Senate is generally more moderate than the House. Certainly, this has been the case for the last two years. Some of the strongest supporters of education and languages have been moderate Republicans such as James Jeffords, Mark Hatfield, Arlen Specter, William Cohen and Nancy Kassenbaum. Three of these moderates retired (two were replaced by conservatives). Also retiring were three of languages' greatest champions: Paul Simon, Bill Bradley and Claiborne Pell. The Senate now has fifteen new members, totaling 55 Republicans and 45 Democrats. And despite the Senate's natural moderation, the results of this election will produce a shift to the right for that body.

Finally, during its first two years, the Clinton Administration accomplished greater and more sweeping education reforms than any administration since Lyndon Johnson's Great Society. Goals 2000: the Educate America Act, the School to Work Opportunities Act, the Improving America's Schools Act, a revised Head Start program, major changes in student financial assistance and the National Service Corps were all initiated and enacted under President Clinton. The President vetoed last year's extreme cuts in the education budget and insisted on this year's increases. His commitment to education was a key element in Clinton's campaign and is a significant component in his agenda for his final term.

Already the "spin doctors" are interpreting the results of the election to make any public theme or mandate unclear. What seems likely is that where education is concerned, neither the President nor the House will move very far from their positions of the last two years. What may change is that a less moderate Senate is now more likely to side with the House than with the President in the debate and decisions that will effect national education policy. It is possible that this scenario could be mitigated by a loud and clear message from the American public supporting the national role in education. But that's up to you.

*Dr. J. David Edwards is the Executive Director, JNCL-NCLIS. The Joint National Committee on Languages/National Council on Languages and International Studies represents more than 60 national and regional language organizations united in their support of language policies which promote the development of bilingualism by all Americans. NABE is a member of JNCL/NCLIS and NABE Deputy Director Nancy Zelasko serves as a member of the Board of Directors of JNCL.*

« NABE »

## SUCCESS

FROM PAGE 5

<sup>6</sup>Massachusetts Coalition for Bilingual Education (1993). *Quality Bilingual Education*. (video).

<sup>7</sup>Brisk, M.E. (1994a). *Portraits of success; Resources supporting bilingual learners*. Boston: Massachusetts Association for Bilingual Education.

<sup>8</sup>For a copy of *The Best*, contact Carmen A. Pérez Hogan, Coordinator, Office of Bilingual Education, Rm. 367 EBA, Washington Ave., Albany, NY 12234.

<sup>9</sup>The George Washington Center for Equity and Excellence in Education (1996). *Promoting excellence: Ensuring academic success of limited English proficient students*.

*Dr. María Estela Brisk teaches in the School of Education at Boston University. She can be contacted at (617) 353-3260 or by e-mail at <brisk@acs.bu.edu>*



# Technology and Language Minority Students

Column Editor: Dr. Dennis Sayers, University of California Educational Research Center

## *Confronting an Embarrassment of Riches: Internet Search Tools*

by Dr. Dennis Sayers

In the year since Jim Cummins and I published *Brave New Schools: Challenging Cultural Illiteracy through Global Learning Networks* (New York: St. Martin's Press), much has changed on the Internet. Our initial goal with *Brave New Schools* was certainly ambitious. We sought to combine two distinct kinds of resources: first, a theoretical overview which offered educators a pedagogical rationale for involving their classes in global learning networks; and second, a practical, thoroughly annotated handbook detailing 800 of the best Internet resources available for parents, teachers, and students. Now, as the second edition is about to appear, we believe our framework remains sound — yet we are certain the Internet has grown so rapidly that no single volume could begin to capture the vast array of information resources that learners and teachers can find.

The key word here is *vast*. As a worldwide information resource, the Internet is best imagined as a very special library; yet unlike any library ever seen. Whenever you enter the Internet, there is an initial foyer containing numerous doors. One door usually leads to the reference room (the best place to start, I will suggest), and most of the other doors lead to the library's stacks and special collections. Open any of these doors and there are dozens of information resources there for the asking (and for downloading into a visitor's personal computer). But in each room there are also many other doors leading to other stacks and specialized collections. Indeed, some of these portals are "teleporting" doors; by opening them, a visitor to an Internet library in one country may be beamed, like a *Star Trek* denizen, to another collection in a different nation, where other stacks, doors, and teleports await endless exploration.

If all this sounds dizzying and more

than a little overwhelming, it is precisely because it is. If there were no way to search the Internet so as to quickly locate information resources — that is, if there were no automated reference tools — then using the Internet would be like being locked in the Library of Congress forever...but with no card catalog. (To continue with the analogies drawn from television series, this is where the theme for *Twilight Zone* would be playing).

In this brief article, I offer an overview of the various automated reference tools — most often called "search engines" — useful for mining the Internet's resources. Every Internet search engine consists of two essential elements: (a) a database of links, whether compiled by humans or by "robot" programs which have roamed the Internet, listing current addresses to information resources around the world, and (b) a searching component where a visitor may type a search term to discover "hits" within the search engine's database. For this article, I have relied extensively on the newly revised second edition of *Brave New Schools*, and have added specialized search tools for bilingual, ESL, and foreign language educators.

### **Building a Basic Internet Reference Shelf**

In any library, the reference room has certain well-worn volumes that are much in demand since they explain how to use other essential reference tools available on shelves nearby. Similarly, some of the most helpful Internet reference tools are pages on the World Wide Web (often termed "WWW" or simply "The Web") which can lead you to other Internet search tools. These reference tools frequently offer invaluable guidance as to the most effective use of an abundant array or resource services. Any of these "search gateway" webpages provide such essential assistance that many Internet-savvy educators select a favorite gateway

webpage and then set up their "information browser" programs (usually either *Netscape's Navigator* or *Microsoft's Explorer*) so that this is the first webpage (or "homepage") they see whenever they explore the Internet.

Perhaps the most complete search gateway webpage is "Internet Navigation" from Rice University, long a leader in networked resources for the academic community (To access this webpage, type "<http://riceinfo.rice.edu/Internet/>" [without the quotes] into your information browser program). The "Internet Navigation" webpage is organized into five general areas, with clickable links to numerous Internet search tools listed under each of these major headings:

- Find resources by subject
- Find resources by keyword
- Find resources by location
- Find resources by type
- Find forums, newsgroups, and mailing lists by Dr. Dennis Sayers
- Find people

Nearly all of the various search tools which I will discuss in the remainder of this article have links on the Rice University "Internet Navigation" webpage. In addition, "Internet Navigation" provides several links to helpful articles on advanced search strategies.

Another extremely useful general resource is the service provided by *CiNet's Search.Com* (<http://www.search.com/>) which allows visitors to search the Internet for all the major search engines appropriate to their topic of interest. Selecting "Education," "Health," or any of 25 different subject areas on this webpage will provide a computer user with a dozen or more subject-specific search engines to "test drive" in her or his quest for germane Internet information resources.

Finally, there are certain websites on the Internet which bilingual, ESL, and foreign language educators can count on to have searchable databases of resources

CONTINUED ON PAGE 8

for language learning and intercultural education. Chief among these are the websites of the *National Clearinghouse for Bilingual Education* (<http://www.ncbe.gwu.edu/>), the *ERIC Clearinghouse on Languages and Linguistics* of the Center for Applied Linguistics (<http://www.cal.org/ericll/>), and the *Links to all ERIC Sites* webpage (<http://www.aspensys.com/eric/barak.html>) where all 16 federally-funded ERIC education clearinghouses, comprising the largest educational database in the world, can be accessed.

### Subject-Oriented Internet Search Tools

In this category, we find the Internet search tools which are the most human labor intensive. *Yahoo!* is the oldest and most widely known among the subject-oriented search engines (<http://www.yahoo.com/search.html>). When a visitor types "bilingual education" in the search descriptor area of this webpage, these are four of the dozens of clickable links that will be provided within seconds.

1. *Business and Economy: Products and Services: Education: Languages: English as a Second Language*
  - *Bilingual Language-Speech-Hearing Association (BiLaSHA)* - foreign accent modification training to ESL professionals and speech therapists.
  - *Dynamic English* - course in English as a second language (ESL) on CD-ROM. Emphasis is on listening and a systematic presentation of language in context. Teacher guide and bilingual support is available.
2. *Education: Languages: German*
  - *Association of Parents for Bilingual Education (NCBE)* - non-profit organization of parents who canvass for immersion methods in teaching German as a second language in South Tyrol. Links to related sites.
3. *Government: Executive Branch: Departments and Agencies: Department of Education*
  - *National Clearinghouse for Bi-*

*lingual Education* - educating linguistically and culturally diverse students. Site includes all NCBE publications, plus databases, journal articles, and many links to related sites.

Each of these "hits" is indicated by a "button" which is filed on one of three specific subject-specific shelves; for example the NCBE button is filed under the shelf labeled *Government: Executive Branch: Departments and Agencies: Department of Education*. By clicking on the NCBE "button," the visitor will be teleported to the website indicated (which happens to be <http://www.ncbe.gwu.edu/>), but without the visitor's having to know the exact Internet address. But if she or he wishes, the visitor can choose to click on the shelf itself, and will then be taken to the *Yahoo!* area where the NCBE link is filed along with all the other links to Executive Branch agencies of the U.S. government. Many educators find *Yahoo!* an especially useful resource because its organization is so like that of the familiar library card catalogue.

This kind of superordinate and subordinate categorization is only possible through human intervention. *Yahoo!* employs hundreds of Internet reference librarians whose job it is to visit websites around the clock and to categorize them on *Yahoo!'s* shelves. To support their efforts, *Yahoo!* sells small advertising billboards, or "banners," which appear at the top of every page of *Yahoo!* search results. Indeed, every search engine described in this article supports its labor- or computer-intensive efforts through "banner" advertising.

Some labor-intensive search engines provide not only categorizations but searchable reviews of websites; principal among these are *Magellan* (<http://www.mckinley.com/>) and *Excite's NetReviews* (<http://www.excite.com/>). Finally, other labor-intensive subject-oriented guides authored by experts are available at *The Argus Clearinghouse* (<http://www.clearinghouse.net/>) and at Ohio State University's *FAQ's* (Frequently Asked Questions) Search Engine (<http://www.cis.ohio-state.edu/hypertext/faq/usenet/FAQ-List.html>).

### Full-Text Search Engines

If *Yahoo!*, *Magellan*, and *The Argus Clearinghouse* depend on intensive evaluation of websites by expert reference librarians, other Internet search tools rely on brute computer force to compile vast databases of searchable webpages. Digital Corporation's *Alta Vista* (<http://altavista.digital.com/>) has carved out a special niche in this category of Internet search tools, but *Infoseek* (<http://www.infoseek.com/>) and *Excite* (<http://www.excite.com/>) have a growing number of adherents. Day in and day out, *Alta Vista*, *Excite*, and *Infoseek* gather webpages automatically throughout the world. *Alta Vista*, for example, currently provides surprisingly rapid full-text searches of 11 billion words found in over 22 million webpages; typing in the phrase "bilingual education" yields no less than 5,000 clickable links to webpages on the Internet which use this phrase, all produced in no less than 3 seconds. The word "Hmong," to offer another telling example, reveals 2,000 different webpages which mention the language or culture of this Southeast Asian immigrant group with large communities in Fresno, California, throughout Minnesota, and in various other states.

### "Meta-" Search Engines

The reader will recall that *CiNet's Search.Com* allows computer users to search the Internet for search engines with databases appropriate to a particular topic, which can then be searched one-by-one. It was only a matter of time until someone designed a *metasearch* engine that would automatically search other search engines, report back the findings, eliminate duplicates, and collate the results, providing a report with clickable links to pertinent Internet resources. Two such search engines are *Metacrawler* at <http://metacrawler.cs.washington.edu>, a metasearch tool which searches eight of the major search engine databases (*Open Text*, *Lycos*, *WebCrawler*, *InfoSeek*, *Excite*, *Inktomi*, *Alta Vista*, *Yahoo!*, and *Galaxy*) and *Use It!* at <http://www.he.net/~kamus/useen.htm> which offers visitors the choice of searching all these databases as well as search engines in other languages.

# Higher Education Legislation

Column Editor: Hispanic Association of Colleges and Universities (HACU)

## *Education Department Convenes Regional Meetings*

*by Jacob Fraire*

In anticipation of the reauthorization of the Higher Education Act (HEA), the Department of Education (ED) has held six regional meetings to discuss policies and programs under the Act. HACU has been actively involved with providing input for all of the sessions. ED Assistant Secretary for Postsecondary Education David Longanecker led the discussion at each meeting. He and his staff traveled to: Atlanta, GA; Phoenix, AZ; San Francisco, CA; Chicago, IL; and Boston, MA.

HACU president Antonio Flores testified on behalf of Hispanic-Serving Institutions (HSIs) at the last meeting, held in Washington, DC. At the other meetings, HACU's comments and recommendations were presented by HSI presidents Dr. Modesto Maidique of Florida Interna-

tional University; Dr. John Córdova of South Mountain Community College; José Robledo of Los Angeles City College; and Dr. Ted Martínez of Richard Daley College.

The meetings began with Dr. Longanecker presenting ED's goals and principles for the reauthorization. According to the Assistant Secretary, the Department's reauthorization agenda will be driven by four principles:

- Access — opportunity with responsibility;
- Support of effective education — high standards/high achievement;
- Simplification of program delivery and improvement of management; and
- Improvement of outreach to potential students and linkages to employment and elementary/secondary education programs.

For the remainder of the meetings, ED officials listened to representatives from the multiple sectors of higher education and various administrative offices on campuses. The central theme presented by the HSI presidents is that Hispanic Americans historically have been under-served by federal programs, especially those under the HEA. Members also expressed concern over the tremendously high rate of dropouts among Hispanics. According to a recent report by the Census Bureau, only 57 percent of Hispanics ages 25 to 29 have graduated from high school — nearly the same rate as that of thirty years ago. HACU encourages all HSIs to submit their comments and recommendations to ED for the reauthorization. ED plans to submit its HEA proposals to the Congress in April 1997.

*Reprinted with permission from "Capitol Notes."*

Computer Curriculum Corporation (CCC) a leading provider of interactive, multimedia-based software, is helping students learn worldwide. CCC provides comprehensive courseware in a full range of subject areas for the K-12 market. Its software combines the latest instructional technology with integrated teacher tools for assessing student needs and tracking progress. CCC's educational software adapts to each student's learning style, talking them through the curriculum at a pace that's right for them.

CCC is launching our newest development to address the needs of the Bilingual child, "Vamos a Leer!" (VAL), the new Spanish reading program now under development, is designed to help millions of young children who speak Spanish with ease but who have not yet learned the art of reading. VAL contains stories written in Spanish, a storyteller read, an interactive read, and post-reading activities, including comprehension checks, creative response, and personal response.

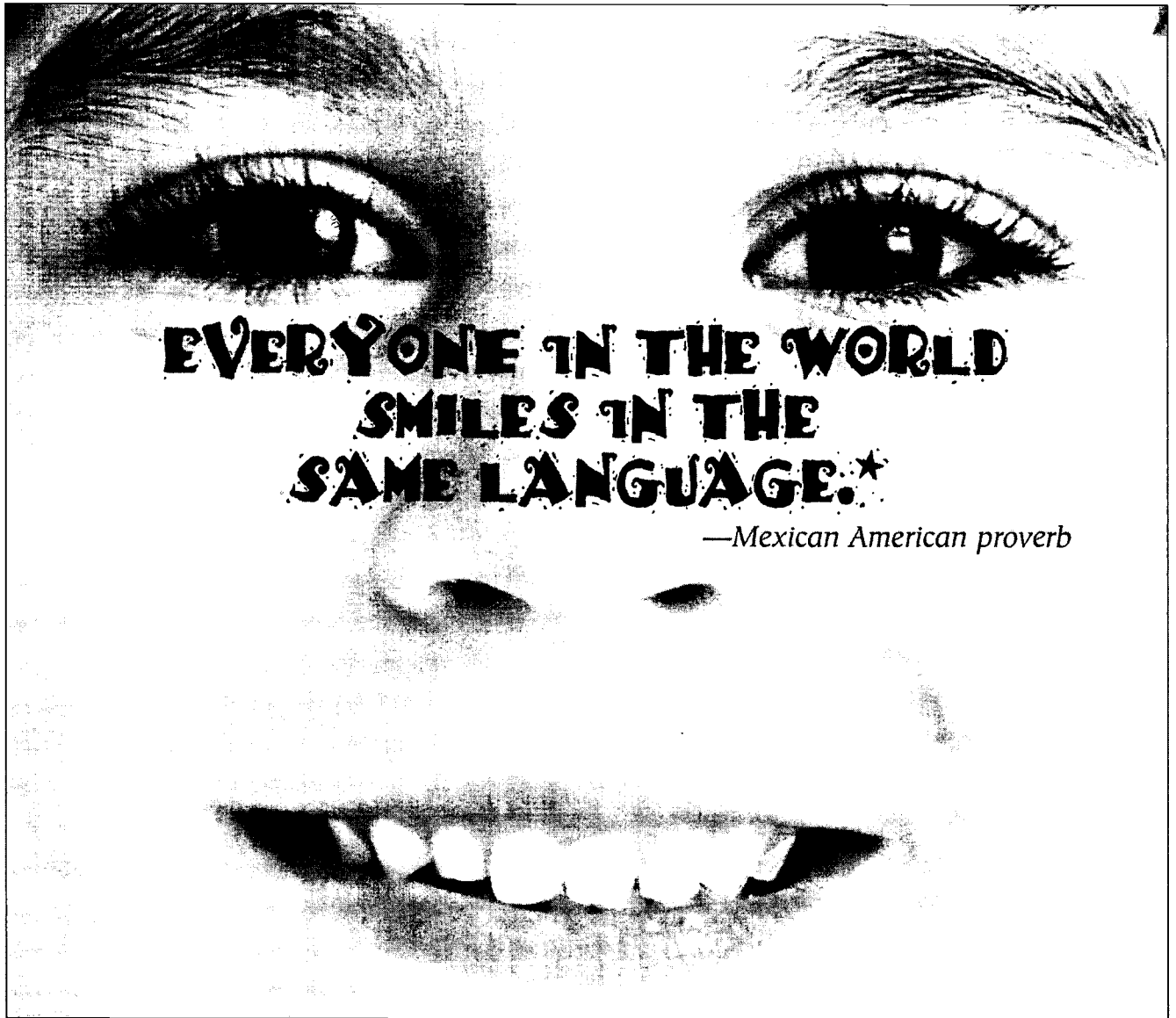

**EVERYONE IN THE WORLD  
SMILES IN THE  
SAME LANGUAGE.\***

—Mexican American proverb

**A** smile speaks volumes, but it can't convey everything we need to know and say. At Houghton Mifflin, we are committed to fulfilling all your bilingual education needs. We now offer parallel instruction, in Spanish and English, in three content areas.

### **Mathematics**

- **Matemáticas de Houghton Mifflin/ Houghton Mifflin Mathematics**
- **Conexiones/Connections**
- **Libreros de matemáticas/ Mathematics Bookshelf**
- **Math Every Day/ Spanish Edition**

### **Reading/ Language Arts**

- **¡Sí puedo!/Early Success**
- **Invitaciones/ Invitations to Literacy**
- **Transitions in Literacy**
- **Students Acquiring English Handbook**

### **Social Studies**

- **Nosotros, el pueblo/ We the People**
- **Estudios Sociales de Houghton Mifflin/ Houghton Mifflin Social Studies**

\* *Todos en el mundo sonreímos en la misma lengua.*



**Houghton Mifflin**

Call toll-free: 800-733-2828 or visit us on the World Wide Web at: [www.eduplace.com](http://www.eduplace.com)

108

# Asian/Pacific American Education Concerns

Column Editors: Ji-Mei Chang, San Jose State University, CA, and  
Janet Y. H. Lu, ARC Associates, Inc., Oakland, CA

## *Reflections on the APA Column: Cultivating and Integrating a Relevant Knowledge Base*

by Ji-Mei Chang, Janet Lu, and  
Ward Shimizu

The Asian and Pacific American (APA) education column was created in February 1995 in response to the growing need for an accurate and reliable knowledge base regarding the educational needs of individuals from APA ethnic and language groups. This column serves as a cross-disciplinary forum for discussing issues and concerns relevant to APA groups. We would like to thank those of you who have contributed articles to this column and are looking forward to receiving articles in the future that present effective practices, current research findings, concerns, and issues related to APA individuals. We also like to thank the *NABE News* Editor and the Board Members of NABE for their continuing support of our effort to provide this APA column on a regular basis.

The APA column articles have been critical in addressing the extreme paucity of research literature related to APA issues; as such, they have been disseminated at various state and national meetings, workshops, and graduate programs in higher education. Over the past two years, authors from various disciplines have provided us with invaluable information about current research conducted among APA students as well as the educational realities of different groups of APA students in our school systems across the country. While many APA students receive attention for their academic success, we cannot ignore those APA students who are not so-called "model minority" students. For example, some groups of APA students with limited English language proficiency have had fewer or limited opportunities to learn in our schools, and they may be placed at risk of

school failure. Furthermore, these students are at the mercy of school personnel to provide them with an optimal learning environment.

In the current article, we address a few selected issues from three aspects: school personnel, K - 12 students, and researchers. These issues are presented in an attempt to invite potential contributors to this column to share their insights, experiences, and recommendations with us.

### **School Personnel: The Continued Shortage of Qualified APA Personnel in the Field of Education**

We face an urgent need of strengthening the recruitment of prospective APA school personnel. There are three factors contributing to the necessity of recruiting APA individuals into teacher credentialing programs:

1. the increasing number APA students who speak languages other than English as their first language,
2. a shortage of qualified APA bilingual educators, and
3. increasing availability of programs, such as California's Bilingual Cross-cultural Language Academic Development Program.

Although some universities have initiated credentialing programs for some Asian languages, the pool of APA teachers must increase as well in order to effectively meet the needs of APA students. However, two existing conditions have hindered current recruitment efforts:

1. a lack of well-designed, organized efforts to recruit and retain Asian and Pacific American individuals into the teaching profession; and
2. a shortage of financial resources to attract qualified individuals to the credentialing program.

Furthermore, these two conditions have conspired to limit the number of APA bilingual programs in the educational system.

### **K - 12 APA Students: The Critical Need to Balance Academic Achievement and Social Growth**

There are sharp differences between APA individuals who function in mainstream society and those who struggle to make it. In general, for APA students from non-mainstreamed environments to achieve a balance between academic development and social growth will require a collaborative effort to combat traditional Asian beliefs and practices. Achieving such a balance is likely to be a lifelong process for many APA students, particularly when they require increased opportunities to link support from home, school, and community for social and academic development. For example, some Chinese families may over-emphasize their children's academic learning and at the same time overlook their children's social growth during formal schooling. We must support our children and youth in developing a positive bicultural identity and self-concept, along with academic learning. Field-based observations and research have shown that many educators and related school personnel have neither effective intervention strategies nor appropriate service programs for Chinese students who face challenges in their academic and social growth. Therefore, parents and school personnel need to strengthen their network in order to adequately address the various needs of the increasing number of immigrant Chinese students enrolling in school.

CONTINUED ON PAGE 12

**NABE Board Elections in April!**

### Researchers: The Need to Establish a Cross-Disciplinary Approach to Cultivate and Integrate the APA Knowledge Base

The limited number of APA researchers in the fields of education and other social sciences calls for a concerted effort in sharing research findings from various related fields concerning the overall well-being of APA individuals. Drawing upon research evidence and experts in related fields may help inform educational research and practice. Through a collaborative and supportive atmosphere, we are more likely to overcome the challenge of understanding the specific language, issues, and methods unique to each discipline. The ultimate goal is to systematically recruit, retain, and mentor APA graduate students, as well as advancing scholars, in the field of education and related fields. Many APA researchers may need assistance in pooling all possible resources while forming new hypotheses, conducting responsive educational research, and advancing their scholarly pursuit.

### Concluding Remarks

The aforementioned issues are not intended to be inclusive. We continue expanding these issues as we interact with different groups of authors and readers. In the last part of this article, we briefly present three areas reflecting what we envision as feasible projects and articles for the APA column in 1997. We openly invite potential contributors to this column in the following areas:

- *Research findings.* We would like to publish research findings conducted among APA individuals by any researchers, including teachers or other school personnel across the country that have relevancy to APA educational concerns. We hope school administrators or university faculty members will help us recruit such research reports.
- *Effective practices.* We invite field practitioners to share with us their successful practices and concerns of APA ethnic groups. We would like to help practitio-

ners disseminate information in order to generate more opportunities for APA individuals to learn or to advance in their formal schooling.

- *Information regarding APA related associations or organizations.* Asian and Pacific American communities are amongst the most diverse in this country. Asian and Pacific Americans encompass dozens of unique cultures and languages, and each has a unique story to tell. There are many community and educational organizations established to assist APAs in telling their stories. We invite members of these organizations to prepare a one paragraph regarding their mission statement or vision of the organization, information of annual activities, scholarships, and contact persons. The purpose is to establish and maintain a network of educators and community people who can speak about Asian and Pacific American issues, especially in the field of education. This project may also broaden the network for APA individuals in related fields to collaboration across disciplines.

## Tucker Summer Fellowship

The Center for Applied Linguistics invites applications for the 1997 G. Richard Tucker Summer Fellowship. The fellowship pays a stipend pays travel expenses for an eight-week summer residency in Washington, DC while the Fellow works with CAL senior staff members on one of CAL's existing research projects or on a suitable project suggested by the Fellow. Priority will be given to proposals that focus on language education or on language issues related to minorities in the United States or Canada.

The competition is open to candidates for a master's or doctoral degree in any field which is concerned with the study of language. Minorities are especially encouraged to apply. Applicants must be currently enrolled in a degree program in the United States or Canada and must have completed the equivalent of at least one year of full-time graduate study. Applications must be received on or before April 25, 1997. For further information contact Grace S. Burkart at the Center for Applied Linguistics, 1118 22nd Street, N.W., Washington, DC 20037. Telephone (202) 429-9292. Internet: grace@cal.org

*Ji-Mei Chang is a Professor in the Division of Special Education & Rehabilitative Services at San Jose State University, who conducts research among multi-ethnic groups of students labeled as LEP in public schools. Janet Lu is a Senior Educational Specialist for the Southwest Center for Educational Equity, a project of ARC Associates in Oakland, CA. Ward Shimizu is a doctoral student in the Division of Teaching and Learning at the University of Miami. He has served as an editorial assistant for this APA column since 1995.*

**Editor's Note:** Contributions to the Asian/Pacific American Education Concerns column should be sent to Janet Lu, MCR/NC, 1212 Broadway, #400, Oakland, CA 94912. (510) 834-9438, FAX (510) 763-1490. Email: janet\_lu@arcoakland.org

# Resources for Bilingual Educators

**Editor's Note:** *This issue's Resources Column contains a list of companies exhibiting at the NABE '97 Conference. Readers are encouraged to contact these companies for information on the materials, products and services they provide.*

A. B. Dick Company  
5700 W. Touhy Avenue  
Niles, IL 60714

AIMS International Books, Inc.  
7709 Hamilton Ave.  
Cincinnati, OH 45231

Alta Book Center/Alta Book Company  
14 Adrian Court  
Burlingame, CA 94010

Am. Assc. for the Advancement of Science-Ed. & HR Prog  
1200 New York Avenue, N.W.  
Washington, DC 20005

American Federation of Teachers  
555 New Jersey Avenue, NW  
Washington, DC 20001

Andujar Communication Technologies, Inc.  
7946 Ivanhoe Avenue, Suite 302  
La Jolla, CA 92037

Arte Público Press  
University of Houston  
4800 Calhoun, TX 77204-2090

BCI/Learning Systems  
600 Jefferson  
Suite 500  
Houston, TX 77002

BUENO Center, University of Colorado  
Education Building  
Campus Box 249  
Boulder, CO 80309

Ballard & Tighe, Inc.  
480 Atlas Street  
Brea, CA 92621-3117

Bilingual Educational Services, Inc.  
2514 So. Grand Avenue  
Los Angeles, CA 90007

Bilingual Review/Press  
Arizona State University, PO Box 872702  
Hispanic Research Center  
Tempe, AZ 85287-2702

CTB/McGraw-Hill  
20 Ryan Ranch Road  
Monterey, CA 93940

Cantos Para Todos  
P.O. Box 657  
Silver City, NM 88062

Chandler's Inc.  
651 Central Avenue  
Highland Park, IL 60035

Childcraft Education Corp.  
2920 Old Tree Drive  
Lancaster, PA 17603

Cinco Punto Press  
2709 Louisville  
El Paso, TX 79930

Close Up Foundation - Program for New Americans  
44 Canal Center Plaza  
Alexandria, VA 22314

Computer Curriculum Corporation  
8445 Freeport Parkway  
Suite 400  
Irving, TX 75063

Crizmac Art & Cultural Education Materials  
P.O. Box 65928  
Tucson, AZ 85728-5928

Cultural Resources  
650 Columbia S.  
#212  
San Diego, CA 92101

Curriculum Associates, Inc.  
5 Esquire Road  
P.O. Box 2001  
North Billerica, MA 01862-0901  
Davidson & Associates  
19840 Pioneer Avenue  
Torrance, CA 90503

Del Bilingual Publications  
7551 W. Turquoise Avenue  
Peoria, AZ 85345

Developmental Studies Center  
2000 Embarcadero  
Suite 305  
Oakland, CA 94606

Dominie Press, Inc.  
1949 Kellogg Avenue  
Carlsbad, CA 92008

ERIC/Clearinghouse on Rural Education & Small Schools  
P.O. Box 1348  
Charleston, WV 25325-1348

Educational Testing Service  
40 N. Central  
Suite 700  
Phoenix, AZ 85004

Embassy of Spain  
2375 Pennsylvania Avenue, N.W.  
Washington, DC 20037-1736

Estrellita  
P.O. Box 20803  
Oxnard, CA 93034-0803

Fairfield Language Technologies  
122 S. Main Street  
Suite 400  
Harrisonburg, VA 22801

Family Language Action Council, Inc.  
476 East South Temple  
Suite 120  
Salt Lake City, UT 84111

Fannie Mae Foundation  
3900 Wisconsin Avenue, NW  
Washington, DC 20016

Fernández USA Publishing Co.  
1210 East 223rd Street  
Suite 309  
Carson, CA 90745

First Virtual Corporation  
3393 Octavius # 102  
Santa Clara, CA 95054

Flame Co.  
31 Marble Avenue  
Pleasantville, NY 10570

Franklin Learning Resources  
122 Burrs Road  
Mt. Holly, NJ 08060

Global Ideas  
614 W. Main  
Houston, TX 77006

Greater Dallas Hispanic Chamber of Commerce Partners...  
4622 Maple Avenue  
Suite 208  
Dallas, TX 75219-1001

## RESOURCES

- Grupo Editorial Norma  
P.O. Box 195040  
San Juan, PR 00919-5040
- Hampton-Brown Books  
26385 Carmel Rancho Blvd.  
Suite 200  
Carmel, CA 93923
- Harcourt Brace Educational Measurement  
555 Academic Court  
San Antonio, TX 78204-0952
- Harcourt Brace School Publishers  
6277 Sea Harbor Drive  
Orlando, FL 32887
- Heinemann  
361 Hanover Street  
Portsmouth, NH 03801-3959
- Heinle & Heinle Publishers  
20 Park Plaza  
Boston, MA 02116
- Hispanic Link News Service  
1420 N Street, NW  
101-A  
Washington, DC 20005
- Host Corporation  
8000 NE Parkway Drive  
Suite 201  
Vancouver, WA 98662
- Houghton Mifflin Company  
222 Berkeley Street  
Boston, MA 02116-3764
- Instituto Lationamericano de la  
Comunicación Educativa (ILCE)  
Calle del Puente No. 45  
Mexico, D.F. 14380,
- Intercultural Center for Reseach in Edu-  
cation (INCRE)  
366 Massachusetts Avenue  
Suite 202  
Arlington, MA 02174
- Intercultural Development Research As-  
sociation  
5835 Callaghan Road  
Suite 35  
San Antonio, TX 78228
- International Book Distributors  
24 Hudson Street  
Kinderhook, NY 12106
- Isleta Gaming Palace  
11000 Broadway SE  
Albuquerque, NM 87105
- Jostens Learning  
7878 N. 16th Street  
Suite 100  
Phoenix, AZ 85020
- Juniper Learning, Inc.  
P.O. Drawer O  
Española, NM 87532
- KJW Enterprises  
6939 Oakland Avenue South  
Minneapolis, MN 55423
- Kagan Cooperative Learning  
1160 Calle Cordillera  
Suite 302  
San Clemente, CA 92673  
LIBROS U.S.A.  
67 Meadowview Road  
Orinda, CA 94563
- Lake Educational Technologies  
220 Oleander  
Suite 100  
El Paso, TX 79922-1728
- Language Education Associates  
P.O. Box 7416  
Culver City, CA 90233-7416
- Latin American Book Source, Inc.  
48 Las Flores Drive  
Chula Vista, CA 91910
- Lectorum Publications, Inc.  
111 8th Avenue  
Suite 804  
New York, NY 10011
- Lee & Low Books  
95 Madison Avenue  
New York, NY 10016
- Libros Hispanoamericanos  
10922 Anja Way  
Lakeside, CA 92040-2717
- Lindy Enterprises, Inc.  
506 Main Street  
Humble, TX 77338-4659
- Los Andes Publishing, Inc.  
P.O. Box 2344  
La Puente, CA 91746
- Macmillan/McGraw-Hill  
1221 Avenue of the Americas  
13th Floor  
New York, NY 10020
- Mariuccia Iaconi Book Imports, Inc.  
970 Tennessee Street  
San Francisco, CA 94107
- McDougal, Littel & Company  
2488 E. Glenhaven Drive  
Phoenix, AZ 85048
- Mimosa Publications  
P.O. Box 26609  
San Francisco, CA 94126-6609
- Multilingual Matters  
1900 Frost Road  
Suite 101  
Bristol, PA 19007-1598
- NINOS  
2025 North Main Avenue  
San Antonio, TX 78212
- National Clearinghouse for Bilingual Edu-  
cation  
1118 22nd Street NW  
Washington, DC 20037
- National Latino Children's Agenda  
1611 West Sixth Street  
Austin, TX 78703
- National Latino Communications Center  
3171 Los Feliz Blvd.  
Suite 200  
Los Angeles, CA 90039
- National Textbook Company  
4255 West Touhy Ave.  
Lincolnwood, IL 60646-1975
- Native Monthly Reader  
P.O. Box 122  
Crestone, CO 81131
- Newsbank-Noticias en Español  
5020 Tamiami Trail N.  
Suite 110  
Naples, FL 33940
- Newsweek Educational Program  
2280 Grass Valley Hwy.  
#308  
Auburn, CA 95603
- Nienhuis Montessori USA, Inc.  
320 Pioneer Way  
Mountain View, CA 94041
- Ol' Stone Press  
700 North Stone Avenue  
Tucson, AZ 85705
- Optical Data School Media  
6904 North 32nd Street  
McAllen, TX



Pan Asian Publications (USA), Inc.  
29564 Union City Blvd.  
Union City, CA 94587

Peace Corps  
1990 K Street, N.W.  
Washington, DC

Peace Works, Inc.  
3812 North First Street  
Fresno, CA 93726

Penguin USA  
111 8th Avenue, Suite 804  
New York, NY 10011

Perma-Bound Books  
Vandalia Road  
Jacksonville, IL 62650

Pin Man - PR Incentives  
3739A S. Peoria Avenue  
Tulsa, OK 74105

Polaroid Education Program  
1080 E. Grist Mill Place  
Unit 8A  
Midvale, UT 84047

Premier School Agendas  
593 Skippack Pike  
Suite 300  
Blue Bell, PA 19422

Prentice Hall Regents  
1 Lake Street  
Upper Saddle River, NJ 07458

Pro-Data Services, Inc.  
Puerto Nuevo  
645 Andalucia Avenue  
San Juan, PR 00920

Programa para Comunidades  
Mexicanas en el Extranjero  
Homero 213, Piso 13  
Col. Chapultepec Morales  
Mexico, DF 11570

Red Crane Books  
2008 Rosina Street  
Suite B  
Santa Fe, NM 87505

Rho Desigus - California  
833 - 17th street, #7  
Santa Monica, CA 90403  
Rigby  
P.O. Box 797  
Crystal Lake, IL 60039-0797

Rigby Professional Development  
P.O. Box 797  
Crystal Lake, IL 60039-0797

SITESA/MEXICO  
San Marcos 102  
Mexico City, D.F. 14000  
Mexico City, D.F., 14000

SRA - McGraw-Hill  
250 Old Wilson Bridge  
Suite 310  
Worthington, OH 43085

Santillana Publishing Company  
2105 NW 86th Avenue  
Miami, FL 33172

Scholastic, Inc.  
555 Broadway  
New York, NY 20012-3999

ScottForesman/Addison Wesley  
1900 East Lake Avenue  
Glenview, IL 60025

Silver Burdett Ginn  
299 Jefferson Rd.  
Parsippany, NJ 07054

Simon & Schuster  
Worldwide Plaza, 309 West 49th Street  
15th Floor  
New York, NY 10019

Sing Spell Read & Write  
1000 112th Cicle North Suite 100  
St. Petersburg, FL 33716

Smith and Kraus Publishers  
162 Kirkland Mail Center  
Cambridge, MA 02138

Southwestern Bell Telephone Company  
One Bell Plaza  
Room 3040  
Dallas, TX 75202

SpanPress, Inc.  
5722 S. Flamingo Road  
#277  
Cooper City, FL 33330  
Steck-Vaughn  
P.O. Box 26015  
Austin, TX 78755

TALK Systems, Inc.  
11285 Elkins Road, H-5  
Roswell, GA 30076

The Learning Company  
6493 Kaiser Drive  
Fremont, CA 94555

U.S. Department of Education  
600 Independence Ave., S.W.  
Switzer Bldg., Rm. 5090  
Washington, DC 20202

U.S. Patent and Trademark Office  
2121 Crystal Drive, Suite 0100  
Arlington, VA 22202

US West Communications  
P.O. Box 1355  
Albuquerque, NM 87102

University of Texas at Austin - McDonald  
Observatory  
2609 University Avenue  
#3-118  
Austin, TX 78712

Vision Wear International  
1080 So. State St. #2  
Orem, UT 84058

Williams Sound Corporation  
10399 W. 70th Street  
Eden Prairie, MN 55344

Wright Group  
19201 120th Avenue, NE  
Bothwell, WA 98011

# Thanks!

**NABE thanks all  
of its exhibitors  
and sponsors  
from NABE '97,  
and urges its  
readership to  
patronize these  
supporting  
organizations for  
both your  
personal and  
educational needs**

113



# NABE PRODUCTS ORDER FORM

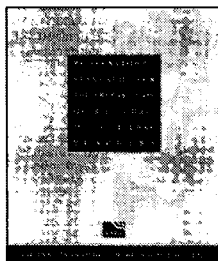
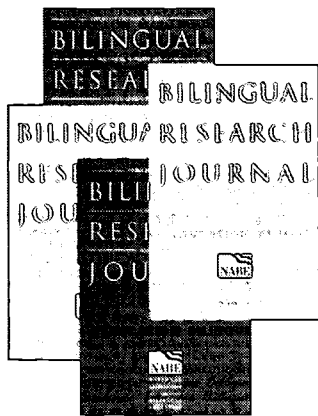

ITEM	PRICE	#	TOTAL
<b>Bilingual Research Journal</b>	\$13.00		
Vol. 19, #3&4, Spring/Summer 1995 Special issue: Role of ESL in Bilingual Education			
Vol. 19, #1, Fall 1994 Special issue: Native American Issues			
Vol. 16, #1&2, Spring/Summer 1995 Special issue: Ramirez study			
[ earlier issues available (call for details)]			
<b>NABE Annual Conference Journal</b>	\$7.00		
1989-90 issue			
1991-92 issue			
1993-94 issue			
<b>1996 Annual Conference Program</b>	\$5.00		
<b>NABE News</b>	\$5.00		
write issue date or volume/number here			
write issue date or volume/number here			
write issue date or volume/number here			
[current volume always available; earlier issues may also be available (call for specifics)]			
<b>Professional Standards for the Preparation of Bilingual/Multicultural Education Teachers</b>	\$5.00		
<b>NABE logo pins</b>	\$5.00		
<b>NABE canvas tote bags</b>	\$7.00		
<b>VIDEO: Making Connections: Learning, Language and Technology</b>	\$7.00		
<b>TOTAL</b>			

- Prices include shipping by USPS first class mail. Special shipping available - call for pricing.
- Payment must accompany all orders. Make checks and purchase orders payable to NABE.
- Credit card orders may also be placed by phone (202 - 898-1829) during business hours.

## SHIPPING INFORMATION

Name \_\_\_\_\_ Company \_\_\_\_\_

Address \_\_\_\_\_

City/State/Zip \_\_\_\_\_ Phone \_\_\_\_\_

## PAYMENT INFORMATION

Check#: \_\_\_\_\_ PO#: \_\_\_\_\_ CC#: \_\_\_\_\_ ExpDate: \_\_\_\_\_

114

MAIL TO: NABE PRODUCTS, Suite 605, 1220 L Street NW, Washington, DC 20005-4018



# NABE '98

February 24 - 28, 1998  
Dallas, Texas

## A CALL FOR PAPERS AND PRESENTATIONS FOR NABE '98

The 27th Annual Conference of the National Association for Bilingual Education will be held February 24-28, 1998, at the Dallas Convention Center in Dallas, TX. In addition to inviting nationally and internationally known keynote and major speakers, NABE is soliciting presentations from the field, including collaborative presentations which include teachers and students, which focus on the following:

### **Pedagogical Practices in Teaching Bilingual Education**

Models, methods and materials for teaching students using the native language throughout the curriculum

### **Pedagogical Practices in Teaching English as a Second Language**

Models, methods and materials for teaching English as a second language

### **Developmental Bilingual Education**

Models, methods and materials for bilingual education programs with the goal of bilingualism, including two-way bilingual education

### **Educational Reforms and Linguistic Minority Students**

School-based management, competency testing, competency-based curriculum, effective schools

### **Bilingual Education Personnel**

Demand for, training, certification, recruitment and retention of qualified bilingual education teachers, instructional assistants, administrators, professors and other personnel

### **Linguistic Minority Families and Education**

Adult literacy, parents as partners in education, home-school language use and development, early childhood education

### **Technology and Linguistic Minority Students**

Accessibility to and applications of various types of high technology in teaching non-English-language-background students

### **Linguistic Minority Students and Other Education Programs**

Special Education, Title 1, Migrant Education, HeadStart, Vocational Education, Adult Education, Foreign Language Education, Native American Education, Refugee and Immigrant Education

### **Policies Affecting Bilingual Education and Linguistic Minority Americans**

Demographic trends, dropouts, English-Only/English-Plus movement, health, social and economic issues, international perspectives, refugees, school finance

# NABE '98 — Call for Presentations

## Instructions

### Proposal Preparation Guidelines

1. **PROPOSAL FORM** (attached): Submit THREE (3) copies with all items completed and carefully proofread for publication in program.

2. **ABSTRACT**: Submit THREE (3) copies of a 300-word abstract of the presentation for review by readers. Abstracts, except those for symposia, should have no author identification or affiliation either in the title or in the body of the abstract in order to ensure anonymous review. Abstracts should be typed on one 8-1/2" x 11" paper (one side only). All abstracts should define the title or topic of the presentation, objectives, methodology, significance, and other pertinent information. **At the top of the page, state the title/topic of the presentation and the type of session.**

**NOTE**: Please keep in mind that NABE receives far more proposals than it can accept. In order for the readers to fairly judge the quality of a proposed presentation, proposals should clearly indicate what the session will cover and how; the title should reflect what is to be done in the presentation; and the appropriate type of presentation should be selected.

3. NABE encourages presentations in languages other than English. In these cases, the title and the 50-word description should be in the language of the presentation. However, the abstract must be submitted in English.

4. Conference registration material is automatically sent to current NABE members. If any proposed presenter is not a current NABE member, attach a sheet of paper containing the name(s) and mailing address(es).

5. **POSTCARD**: Please enclose a self-addressed stamped postcard to receive acknowledgement of receipt of your proposal.

6. Submit all proposals to:

**NABE '98 PROGRAM COMMITTEE**  
NABE National Office  
1220 L Street, NW, Suite 605  
Washington, DC 20005-4018  
(202) 898-1829

**ALL PROPOSALS MUST BE POST-MARKED NO LATER THAN JUNE 2, 1997.**

### Types of Presentations

**WORKSHOPS (2 Hours)**: Intensive sessions in which participants develop methods or materials, design research studies, analyze research data, confront and solve actual teaching or research problems. Workshops provide participants with the opportunity to actively participate. Emphasis is on providing hands-on experiences. Typically there is little lecturing; the workshop leader structures the activity and guides the work of the participants. The abstract should include the goal of the workshop, a summary of the theoretical background, and a description of activities to be conducted during the workshop.

**PAPERS (45 Minutes)**: A description and/or discussion of something the presenter is doing or has done relating to the theory or practice of bilingual education. Emphasis is on empirical research or well-documented theoretical/practical perspectives. Also acceptable are critical reviews of literature, policy studies, well-documented historical studies, critiques, etc. Both qualitative and quantitative research from all disciplines are acceptable. The abstract should include the main premise of the paper, a summary of supporting evidence, and the conclusion. Presenters are encouraged to use handouts and audio-visual aids and to present a summary of the paper rather than reading a prepared text.

**DEMONSTRATIONS (45 Minutes)**: Presentations which show a specific teaching or testing technique. After a brief description underlying theory, the session is devoted to demonstrating how something is done. Presenters are encouraged to use handouts and audio-visual aids. The abstract should include an explanation of the purpose of the demonstration and a description of what will be demonstrated and how it will be done.

**SYMPOSIA (2 Hours)**: Panel presentations which provide a forum for a group of scholars, teachers, administrators, politicians, or business and government representatives to discuss specific pedagogical, policy, or research issues from a variety of perspectives with alternative solutions presented. Symposia allow for large group settings. The abstract should include a description of the topic, along with the names, titles, affiliations and specific contributions to the symposium of each of the presenters. The symposium should provide sufficient time for presentation and discussion.

### General Policies

1. The Program Committee will select presentations based on the quality of the proposal, as well as the need for ethnolinguistic, geographic, and topic representation in the program.

2. It is the responsibility of presenter(s) to appear at the NABE Conference and make the agreed upon presentation. If unforeseen circumstances arise which prevent the presenter(s) from appearing at a scheduled session, it is the presenter's responsibility to arrange for someone to take his/her place and to send notice of the replacement to the NABE '98 Program Committee.

3. **ALL PRESENTERS WILL BE REQUIRED TO REGISTER FOR THE NABE CONFERENCE.** There will be NO complimentary registration for presenters nor will any honoraria be paid to presenters.

4. All meeting rooms will be equipped with an overhead projector and screen. Other audio-visual equipment may be rented through NABE by indicating the type of equipment needed on the proposal form. Payment must be made to NABE prior to the conference.

5. Publishers and commercial developers of educational materials wishing to make presentations must be NABE '97 Exhibitors or Sponsors in order to be considered for inclusion on the program. Commercial session slots are allotted on the basis of sponsorship level.

6. Only proposals which conform to all the requirements stated in this Call for Papers will be considered for inclusion in the program. Severe constraints on time and funds do not allow for follow-up calls or correspondence. Presenters should **READ INSTRUCTIONS CAREFULLY** and follow them exactly.

7. NABE reserves the right to edit material for the conference program, including presentation titles and descriptions, as necessary.

8. NABE reserves the right to videotape, audiotape, and/or publish conference presentations and sell such products. Submission of a proposal for presentation indicates the presenter's permission to do so without further written approval.

*Notification of acceptance or rejection  
will be mailed by November 15, 1997.*

# NABE '98 — Call for Presentations

## *Presentation Proposal Form*

POSTMARK DEADLINE: JUNE 2, 1997

PLEASE TYPE OR PRINT CAREFULLY - COMPLETE BOTH SIDES OF THIS FORM

A. TITLE: \_\_\_\_\_  
(limited to 15 words)

B. NAME OF PRESENTER	AFFILIATION	STATE	MEMBER?	
			Yes	No
1. _____	_____	_____	<input type="checkbox"/>	<input type="checkbox"/>
2. _____	_____	_____	<input type="checkbox"/>	<input type="checkbox"/>
3. _____	_____	_____	<input type="checkbox"/>	<input type="checkbox"/>
4. _____	_____	_____	<input type="checkbox"/>	<input type="checkbox"/>
5. _____	_____	_____	<input type="checkbox"/>	<input type="checkbox"/>

C. DESCRIPTION — 50-WORD DESCRIPTION FOR PUBLICATION IN THE PROGRAM:  
(DESCRIPTIONS LONGER THAN 50 WORDS WILL BE EDITED)

\_\_\_\_\_

\_\_\_\_\_

\_\_\_\_\_

\_\_\_\_\_

\_\_\_\_\_

D. PLACE AN "X" BEFORE THE TYPE OF PRESENTATION SUBMITTED :

- |   |   |
|---|---|
| <input type="checkbox"/> DEMONSTRATION (45 minutes) | <input type="checkbox"/> PAPER (45 minutes) |
| <input type="checkbox"/> SYMPOSIUM (2 hours)        | <input type="checkbox"/> WORKSHOP (2 hours) |

E. LANGUAGE(S) OF PRESENTATION: \_\_\_\_\_

F. LANGUAGE GROUP(S) COVERED IN THE PRESENTATION:

- All Language Groups
- Some Language Groups (specify): \_\_\_\_\_
- One Language Group (specify): \_\_\_\_\_

(COMPLETE OTHER SIDE)

# NABE '98 — Call for Presentations

## *Presentation Proposal Form*

**G. PLACE AN "X" BEFORE THE TOPIC OF THE PRESENTATION:**

<input type="checkbox"/> Language Acquisition <input type="checkbox"/> Literacy <input type="checkbox"/> Math <input type="checkbox"/> Science <input type="checkbox"/> Social Studies <input type="checkbox"/> Personnel (Supply/Demand/Preparation) <input type="checkbox"/> Parental Family Involvement <input type="checkbox"/> Greater Societal Issues <input type="checkbox"/> Education Reform <input type="checkbox"/> Other (specify): _____	<b>LEVEL</b> <input type="checkbox"/> Early Childhood <input type="checkbox"/> Elementary <input type="checkbox"/> Secondary <input type="checkbox"/> Post Secondary <input type="checkbox"/> Adult	<b>APPROACH</b> <input type="checkbox"/> 2-Way DBE <input type="checkbox"/> Other BE <input type="checkbox"/> ESL  <b>TECHNOLOGY</b> <input type="checkbox"/> YES <input type="checkbox"/> NO
--	--	--

**H. SESSION SPONSOR (Check if any apply):**

**NABE SIG**  
(Name of SIG and Chairperson): \_\_\_\_\_

**NABE '98 Exhibitor**  
(Name of Company and Contact Person): \_\_\_\_\_

**NABE '98 Sponsor**  
(Name of Company and Contact Person): \_\_\_\_\_

**I. AUDIO-VISUAL EQUIPMENT ORDER:** All rooms will be equipped with an overhead projector and screen at no cost. Presenters needing other AV equipment must indicate on this form and submit payment prior to the conference. Requests for equipment made after June 2, 1997, cannot be guaranteed and will be charged at a higher rate.

VHS Cassette Videotape Player/Monitor (\$25)  
 Slide Projector (\$10)  
 Audio Cassette Player (\$5)  
 Microcomputer/LCD Projection to Screen (\$40)  
 Type of computer needed: \_\_\_\_\_ IBM Compatible \_\_\_\_\_ Apple/Macintosh  
 Model and configuration: \_\_\_\_\_

Modem connection/Internet access (\$ TBD)  
 Other: (Specify - Information on price will be included with acceptance letter): \_\_\_\_\_

**J. CONTACT PERSON (Mailing address of presenter to whom all correspondence should be sent):**

Last name: \_\_\_\_\_ First name: \_\_\_\_\_

Affiliation: \_\_\_\_\_

Street: \_\_\_\_\_

City: \_\_\_\_\_ State: \_\_\_\_\_ Zip: \_\_\_\_\_

Work Telephone: ( ) \_\_\_\_\_ Home Telephone ( ) \_\_\_\_\_

Fax: ( ) \_\_\_\_\_ Email: \_\_\_\_\_

**Remember to attach a list of the names and addresses of presenters if they are *NOT* members of NABE.**

RETURN PROPOSALS POSTMARKED NO LATER THAN JUNE 2, 1997 TO:  
**NABE '98 PROGRAM COMMITTEE**  
 1220 L STREET, N.W., SUITE 605  
 WASHINGTON, DC 20005-4018

118



# Successful Practices

Column Editor: Dr. Anne Homza, Boston Public Schools, Boston, MA

## *Pre-Writing Processes and Strategies: Rehearsal, Reflection and "Living Between the Lines"*<sup>1</sup>

by Anne Homza, Ed.D.

Imagine for a moment what you might see if you were to peek in on classrooms for bilingual students where successful practice is employed in the teaching of writing. No doubt your images include students engaged in writing. Now, glimpse into the following real classrooms where writing is being successfully taught. What do students who are "engaged in writing" actually do?

- A Honduran first grader, sitting alone on the classroom rug, talks to himself in Spanish while taking blank sheets of paper from a stack in front of him.
- Sitting with her teacher, a deaf fourth-grade student enthusiastically signs in American Sign Language to her teacher.
- Haitian preschoolers sitting in groups draw and chatter among themselves in Creole and English.
- A first-grade student from Puerto Rico writes independently in her journal in Spanish.
- Vietnamese fifth graders page through their literature notebooks, re-reading their reflections on the novel in English they have been reading for the last several weeks.
- A group of Lebanese students discuss various topics together in Lebanese-dialect Arabic.
- A special-needs third grader from the Dominican Republic writes a word in Spanish in the middle of a page and draws a circle around it. He then creates a web of other Spanish words surrounding this central word.
- On a daily basis for several weeks, pairs of second-grade students from Puerto Rico and the Dominican Republic observe the tadpoles in the classroom.
- A high school student with only five years of formal schooling reads a Spanish murder mystery quietly to himself.

How is it that students involved in such a broad array of activities can be said to be "engaged in writing"? They appear to be arranging papers, conversing, drawing, reading or sketching webs.

The activities described above and their relation to writing can be best understood in light of the changed context of writing instruction. Since Graves' and Calkins' work with monolingual students (1983, 1986, 1991), classroom instruction in writing has undergone a profound change. Instead of focusing on single-draft-products with a primary concern for correctness of form and mechanics, successful writing teachers help students develop, organize and articulate their ideas through an approach that emphasizes the *process* of writing. By helping students see the complex task of writing as a series of recursive steps involving

pre-writing, drafting, revision, editing and publishing, teachers assist students to become writers. In this Writing Workshop approach, students learn ways to choose and develop topics, to organize and articulate ideas, write with authentic purpose, and revise for clarity of content and style. Form and mechanics are learned within the context of this multi-faceted process.

Rather than attempting to describe the entire process approach to writing, this article focuses on the examination of *pre-writing strategies* which successful teachers of writing teach their students to use. It is in this context then that the nine examples above can be understood: together they illustrate the variety of ways in which students can engage in the pre-writing phase of the writing process. Whether your classroom writing approach is based on the Writing Workshop model or is more traditional, teaching your students various pre-writing strategies will enhance their growth as writers.

### **What is Pre-Writing?**

Pre-writing, sometimes called rehearsal, is the part of the writing process in which a writer plans and develops her topic. Ideas are tested out and organized in a very preliminary way. Pre-writing is thinking, reflecting and rehearsing. It is part of the writing process that may or may not involve putting pen to paper (or fingers to keyboard). In fact, as discussed in the sections that follow, the process of pre-writing can take many forms.

### **Conversations, Dialogues and Monologues as Pre-Writing**

The Lebanese students described above who engage in conversations are discussing topics that they will later write about in point-of-view essays in English. These unstructured conversations serve to prepare them for their writing because they can test out their ideas and practice building persuasive arguments. Fielding questions and challenges from conversational partners in a situation like this prepares writers to clarify, extend and defend their ideas. Sometimes these students' conversations are in Arabic and other times they are in English. While discussion in Arabic aids the students to develop ideas and concepts, pre-writing discussions in English help them rehearse the specific language forms needed to express themselves.<sup>2</sup> When preparing to write in the second language, bilinguals' use of both languages in pre-writing conversations of this sort would enhance *both* the content and the language of the written product.

The fourth-grade student conversing with her teacher in American Sign Language (ASL) is discussing the birth of her new baby brother the previous night. Like the Lebanese students, this deaf fourth grader will be writing in English, her second language.

CONTINUED ON PAGE 22

However, unlike the hearing Lebanese students, she does not have the opportunity to rehearse in English. The teacher confers with her in ASL in a dialogue, asking questions for clarification and elaboration, thus preparing this young writer for the drafting phase of the writing process. As Roen (1989) has noted, the mental process of pre-writing helps "inexperienced writers marshal and allocate their cognitive resources" (p. 199). Once this student knows what she wants to say, she will have freed up some of her cognitive resources. She can then devote her attention to how to encode her meaning into written English in the next phase of the writing process.

The Honduran first grader mentioned above is practicing an oral pre-writing activity that I have used successfully with young beginning bilingual writers.<sup>3</sup> After a student has chosen his topic, I sit with him and ask him to tell me his story. I listen, ask questions, and make comments. At the end of the story, I ask the student to retell the story and, this time, after each idea or event that I hear I hand the child a sheet of blank paper and say, "that sounds like your first page," or "I guess that part would go on your next page," and so on. At the end of the child's second oral rehearsal of the story, he then has several blank pages that we staple together. The child then re-tells the story to himself one more time, turning the pages of his blank "book" as he does so. Each blank page acts as a concrete prompt to help him remember the next event or idea in the story. Following this one-on-one oral rehearsal, the child begins the drafting phase of his story, typically encoding the story in pictures before adding text.

While initially this type of pre-writing rehearsal is both time- and labor-intensive, it is a only temporary scaffold. In time, children learn to employ this oral rehearsal with blank pieces of paper alone, as the Honduran student described above is doing. Over several weeks of daily Writing Workshops, he has had the opportunity to tell his story ideas to the teacher who, at the beginning, would ask him questions as he talked and would hand him sheets of paper for each idea as he retold the story a second time. Now this student no longer needs the teacher's assistance in this pre-writing process. Not only does he take the pages he needs, but, as he tells himself his own story, he also anticipates questions that future readers of his story might ask. As a result, this developing writer is able to provide the background information and appropriate details that make his story clear and understandable. His pre-writing process has developed from a dialogue to a monologue. Eventually, this monologue becomes "inner speech" (Vygotsky, 1962, p. 149) or thought as his pre-writing process becomes a purely mental process. This is a clear example of the Vygotskian (1978) notion of the *zone of proximal development*: What the child is able to do in collaboration one day, he ultimately is able to do independently. The pre-writing that began as an interactive or *interpsychological* process becomes an independent or *intrapsychological* process (Vygotsky, 1981a, as cited in Wertsch and Stone, 1985).

#### Drawing as Pre-Writing

The Haitian preschool students who are drawing and talking with each other are also engaged in pre-writing. Their "writing" will be generated through a process similar to a Language Expe-

rience Approach — after rehearsing their stories through drawing, they will dictate their ideas to the teacher who will encode them as ideas in print. When these developing bilingual children dictate in Creole, the teacher writes the story in Creole; when the story is dictated in English, it is written in English. In developmental terms for pre-literate children, drawing itself is an early form of writing. However, for the teacher who is building a bridge to literacy for young children, their drawings can come to serve as the pre-writing phase in the development of a written text. So, for beginning writers drawing is, on the one hand, an effective way to encode thoughts, ideas, and images while, on the other hand, it is a process that can stimulate the generation and organization of ideas.

The Haitian bilingual teacher in the classroom described above audiotaped the children's talk as they drew and, in comparing this language to the actual oral dictation of the stories, she found that the dictated stories were more detailed. In particular, she noted that the children used descriptors in their dictations that had been rehearsed and encoded only in the pictures. Therefore, the pictures themselves served to enhance the students' development of their stories in a very specific way.

Students who are in the beginning stages of encoding print by themselves also use drawing in their pre-writing process. While many of my former Spanish bilingual first-grade students would draw a sequence of pictures before writing any words, one student's pre-writing process was particularly striking. This child would spend several days, or sometimes even an entire week, in Writing Workshop drawing a very detailed sequence of pictures. While drawing and thinking and planning he was slow and methodical. Then, when all the pictures were completed, in one single session he would return to the first page and proceed to the last, quickly adding his Spanish print to each page. His pre-writing process took much longer than his actual drafting of the printed words. Over time, however, as his pre-writing process became more internalized, this student would employ drawing as pre-writing less, a development which is generally the case with beginning writers. While drawing may still be employed later to illustrate stories after the drafting phase, the pre-writing process becomes transformed into a mental process. As another student expressed it to me at the end of first grade when I asked him what his advice would be to other writers, "Never write without thinking."

#### Reading as Pre-Writing

Reading is a powerful form of pre-writing, particularly when it is focused and purposeful. The Vietnamese fifth graders mentioned above who are reading and re-reading their own entries in their literature notebooks are preparing to write a final essay on *Shiloh*, (Naylor, 1996) the novel that they had just finished reading. Their reading has a specific purpose: to generate ideas to use in their essays. While reviewing their entries they look for themes that seem to repeat themselves or for ideas that resonate with their own personal experiences on a significant level. After this and other pre-writing strategies, the students draft, revise, and edit their work and the final essays go far beyond plot retellings and deal with topics such as "Keeping Secrets," "How People Change," and "Lying."



The high school student described above who is reading the murder mystery in Spanish also has a specific writing goal. He has just abandoned his process of drafting a narrative that deals with his childhood experiences with violence. When the teacher observes his reluctance to write about his experiences in an autobiographical form, he suggests that the student skim through a novel to observe how the author has written in the third person. This pre-writing exercise helps this student employ a particular form and genre for his ideas. By adopting a fictionalized third person stance toward his very difficult topic, the student creates the emotional distance necessary to articulate his powerful ideas and experiences.

### Writing as Rehearsal

Writing itself can be rehearsal for writing. The first-grade student writing in her daily morning journal in Spanish is actually engaged in a pre-writing process for later writing. In fact, traces of written rehearsal for subsequent Writing Workshop drafts were often evident in the journals of several students in this first grade bilingual class. Ideas that began as musings or unconnected ideas proved to be actual first steps in the planning and organization process that preceded a draft. What is interesting about this particular example of rehearsal is that in the afternoon of that same day, during Writing Workshop, this student begins a draft of a story in English that is directly based on her Spanish journal rehearsal. This pre-writing-then-drafting process continues for several days as this six-year-old rehearses in written Spanish in the morning what she later adds to her piece in English in the afternoon. By attending to the development of her story content in Spanish in her journal writing she is then able to apply all of her energies to the English encoding process later. The teachers in the classroom have not taught her this strategy, it was one she develops herself, and it is a successful one at that. What the teachers have done to enhance bilingual pre-writing processes is to create a highly literate bilingual environment that has daily, predictable routines for reading and writing.

It is interesting to note that this child has not been assigned to write in English during the Writing Workshop, the language choice is entirely up to her. Furthermore, she has not received any direct instruction in English literacy skills, since the focus of the bilingual program in this first grade is native language literacy. However, what this developing bilingual student has learned about the writing process obviously applies cross-linguistically for her. So, in addition to learning how to allocate her cognitive resources during the writing process, she has learned to manipulate and apportion her linguistic resources as well.

### Graphic Organizers in the Pre-Writing Process

The use of webs and other graphic organizers in pre-writing is another way to help students devote their energies to different aspects of the writing process at different times. The experience of the special-needs Dominican student mentioned above is a case in point. In some ways this student's earlier writing was fairly similar to that of other inexperienced writers. While he was able to construct brief stories, his ideas would often be underde-

veloped and disorganized, resulting in writing that could be confusing. Furthermore, once he had labored over the production of a series of sentences in a linear form on the page, it was very difficult for him to see how then to rearrange his ideas into a more logical form during the revision process. Now, as he uses the webbing strategy as part of his pre-writing process, he is better able to generate his ideas first and concern himself with organization later. As he generates his ideas he can write them down in any order; this promotes a brainstorming, stream-of-consciousness type of thinking that is expansive and creative. Once he has jotted down all his ideas in the web he then begins to decide which ideas to include and expand upon and which ideas to reject. Finally, he can think about how to arrange and sequence his ideas. Since the structure of the web is loose, it promotes a kind of flexible thinking that allows this student to envision various possible ways to organize his draft.

### Experiences Are the Beginning of the Pre-Writing Process

The Latino students mentioned above who share the experience of observing the metamorphosis of tadpoles to frogs are also involved in a pre-writing process. For several weeks, during a daily period of observation and reflection, they have the opportunity to think and plan what they will later write about this metamorphosis. As part of their pre-writing process they may also choose to draw diagrams of what they observe or take notes or write down their feelings in their journals, but the experience itself is the true genesis of the writing process. In this classroom the teacher is communicating to the children a significant lesson about the writing process: that it is experience itself combined with one's reflection on and interpretation of that experience that is really at the heart of the writing process.

It is the human urge to understand, articulate and often transform experience that is at the core of writing. It is what provides both the meaning and the motivation in writing. Successful teachers of writing for bilingual and multicultural students therefore ask themselves: What are we asking our students to write about? What thinking skills are we teaching them to use in the pre-writing and writing process? Why? The critical part about teaching students to use experience as part of the pre-writing process is two-fold. On the one hand we want to help our students develop the skills useful to understand experience, so in the classroom we teach them how to analyze, compare, critique, interpret and synthesize as they prepare to write about classroom-based experiences. On the other hand, however, and ultimately more significant, we want our students to use these skills as they live their own lives outside of the classroom, in order to make sense of their experiences and to be able to transform their lives and their world. Being able to generate ideas and organize thoughts in the pre-writing process is important for the development of writers. However, this ability is most powerful in contexts in which students are taught to be sophisticated and critical thinkers writing about topics of genuine interest to them in ways that contribute not only to their own growth but also to change in their world.

CONTINUED ON PAGE 24

### Concluding Remarks

Engaging in a pre-writing process helps beginning writers become better writers. Therefore, successful teachers of writing for bilingual students teach students a variety of ways to structure and improve the development and organization of their ideas in the pre-writing process. With explicit instruction as well as modelling, students can learn to use conversations, writing, drawing and reading in their planning and rehearsal for writing. Effective writing teachers working with bilingual students encourage them to tap their two languages throughout the pre-writing process to enhance their writing in general.

Although with practice writers become better at pre-writing, the process never disappears. It may, however, go "underground." What may be learned as a highly structured visible or audible process becomes an internalized mental process. As Calkins (1986) has suggested, when students who are asked to write regularly about topics of their own choosing begin to internalize the pre-writing process, they begin to "live between the lines." Thinking, analyzing, questioning, critiquing and reflecting become empowering ways of being in the world and interpreting one's experiences.

### Endnotes

<sup>1</sup>"Living Between the Lines" is the title of one of Lucy Calkins' books about writing with children. Her work has signifi-

cantly influenced my understanding of how we all learn to write and I am greatly indebted to her. Please see the reference section for the complete citation.

<sup>2</sup>These observations are reported in Bou-Zeineddine, A. (1994).

<sup>3</sup>This technique was first demonstrated to me by Mary Ellen Giacobbe at a workshop at the Frost School in Lawrence, Massachusetts in the fall of 1987.

### References

- Bou-Zeineddine, A. (1994). *Effect of the pre-writing discussion language, Arabic/English, on six adult students' writing in English*. (Doctoral dissertation, Boston University, 1994).
- Calkins, L. M. (1991). *Living between the lines*. Portsmouth, NH: Heinemann.
- Calkins, L. M. (1986). *The art of teaching writing*. Portsmouth, NH: Heinemann.
- Graves, D. (1983). *Writing: Teachers and children at work*. Portsmouth, NH: Heinemann.
- Naylor, P. R. (1996). *Shiloh*. NY: Dell.
- Roen, D. H. (1989). "Developing effective assignments for second language writers." In D. M. Johnson and D. H. Roen (Eds.), *Richness in writing: Empowering ESL students*. New York: Longman.
- Vygotsky, L. (1962). *Thought and language*. (E. Hanfmann and G. Vaker, Trans.). Cambridge, MA: MIT Press. (Original work published 1934.)
- Vygotsky, L. S. (1978). *Mind in society: The development of higher psychological processes*. Edited by M. Cole, V. John-Steiner, S. Scribner, E. Souberman. Cambridge, MA: Harvard University Press.
- Wertsch, J. V. and Stone, C. A. (1985). "The concept of internalization in Vygotsky's account of the genesis of higher mental functions." In J. V. Wertsch (Ed.), *Culture and communication: Vygotskian perspectives* (pp. 162-179). Cambridge, England: Cambridge University Press.

Anne Homza, Ed.D. is a Bilingual Literacy Resource Specialist in the Boston Public Schools. She thanks the following teachers whose practices are highlighted in this article: Cynthia Barbera, Noreen Cataldo, Flor García, Jennifer Garvey, Solange Marsan, Chi Tran and Angel Velázquez.

This NABE News column, designed to give teachers practical ideas to use in their classrooms, highlights classroom practices that enhance teaching and learning for bilingual students. If you know about any "successful practices" that you would like to share with NABE members in this column, please contact column editor Anne Homza. c/o BPS Office of Bilingual Education, 26 Court Street, 6th floor; Boston, MA 02108.

**Editor's Note:** Future submissions for the Successful Practices in Bilingual Education column may be sent to Anne Homza, c/o BPS Office of Bilingual Education, 26 Court Street, 6th floor; Boston, MA 02108.

STUDENT BOOKLETS • TEACHER GUIDES • GAMES • TEACHING BOARDS • PUPPETS • BILINGUAL RESOURCES • ART ACTIVITIES • ASSESSMENT • LESSON PLANS • LANGUAGE ARTS • MAPS • POSTERS • VHS PROGRAMS • TIMELINES • COMPUTER SOFTWARE • DISCUSSION QUESTIONS • FOLK ART

*Imagine...*  
*bringing the woodcarvers of Oaxaca, the yarn painters of the Sierra Madres, and the weavers of Guatemala to your classroom!*



Let CRIZMAC's bilingual resources bring the art and culture of the world to you.

Call 1-800-913-8555 today to place your order.  
 For your free catalog, call or write to  
 CRIZMAC Art & Cultural Education Materials  
 P.O. Box 65928 • Tucson, AZ 85728-5928

# American Indian Bilingual Education

Column Editor: Jon Reyhner, Northern Arizona University

## *A Review of Native Americans in Children's Literature*

by Brian A. Bell

**N***ative Americans in Children's Literature* (Oryx Press, 1995) is authored by Jon C. Stott, professor of children's literature at the University of Alberta in Edmonton, Canada. The Foreword to the book was written by well-known Abenaki author Joseph Bruchac. The book contains categorized lists of well over 100 books by and about Native Americans along with short synopses and critiques to help language arts teachers find stories to use in their classrooms. The appendix gives ideas for units to incorporate Native American children's literature into the classroom.

The first chapter deals with stereotypes and misrepresentations of Native Americans in literature. Stott gives a well thought out treatment of how Indians were stereotyped in early American literature and how that same literature helped create some of the stereotypes that are alive today. The second chapter deals with picture books. Stott advises writers of Native American stories to choose a specific tribe and then portray that tribe accurately without stereotypes, avoiding what he refers to as the "Generic Indian." His definition of a generic Indian includes the most basic stereotypes such as feather headdresses, bows and arrows, totem poles, and so forth. He defines storytelling as gently presented lessons that members of the audience could apply to themselves without public ridicule and that children could use as guides for their own maturation and socialization processes. There is also a fine description of traditional European fables.

Stott not only confronts the differences in cultures, but he also brings out the commonalities that all cultures possess throughout the world. Storytelling or fables can be traced back to nearly every culture on earth, past or present. All cultures recognize the importance of teaching their youth through stories.

The third chapter deals with the advantages of telling stories orally and the effects of translation. Oral stories have numerous advantages over written stories. Volume, pitch, tone, and changes in voice are all lost once a story becomes written. A common practice of translators, unfortunately, has been to change supernatural beings into either elves or fairies to better fit into the more mainstream cultures.

The fourth chapter gives the bulk of the book's information. This section deals with cultures in conflict, changes that have materialized, and how this conflict has influenced the content of some of the culture's works. Stott compares oral stories with their "European" counterpart, the novel. He states that oral stories unite people into a group while the novel creates individualism and isolates people. Storytelling is a group activity whereas reading novels is a solitary occupation. Isolation has even become a dominant theme of classic novels such as *Moby Dick*,

*The Old Man and the Sea*, and *White Fang*.

Another difference mentioned by Stott is the chronological order followed by both cultures. Anglo (Euro-American) stories tend to be linear, methodically following time from one moment to the next, while many Native American stories do not follow this format. To someone unfamiliar with Native American stories, they appear to lack order and jump without reason to unrelated happenings with no regard to sequence.

A quote by author Maria Chona (Tohono O'odham) illustrates another difference. When she was asked about the conciseness of her stories she was quoted as saying "The story is very short...because we understand so much." Traditional stories dealt with familiar materials, and the listeners were expected to visualize and supply the details. In contrast, the novel supplied the reader with great detail, and conflicts arose when Native American stories began to be written. As they were written, the stories were completed in great detail with the result that their accuracy was questioned and the audience was no longer allowed to use their imagination.

Stott's epilogue discusses the works of Inuit author Michael Kusugak. Kusugak's ability to bring traditional stories into a modern setting is exceptional. Kusugak's four books: *A Promise is a Promise*, *Hide and Sneak*, *Baseball Bats for Christmas*, and *Northern Lights: The Soccer Trails* can be used to in the classroom to bridge the gap between cultures. Another strength of Stott's book is the appendix where he shows how to incorporate traditional Native American stories into a language arts curriculum. Several different approaches are discussed. The lessons start at a low level and work their way up to higher levels, and teachers should find a level their students would feel comfortable at and simply start there, modifying the lesson plans as the teacher sees fit to meet the local situation. Stott points out that it is important to relate the stories to non-Indian stories with similar themes and character types and to review the books used to ensure the accuracy and the respect of the cultures the stories portray.

All in all, *Native Americans in Children's Literature* is a well thought out book with a great deal of insight. The book as a whole is geared more toward literature that can be used at the elementary and junior high level.

*Brian A. Bell works at Many Farms High School in Many Farms, Arizona on the Navajo Reservation/Nation.*

**Editor's Note:** Contributions to the American Indian Bilingual Education column should be sent to Jon Reyhner, Center for Excellence in Education, Northern Arizona University, P.O. Box 5774, Flagstaff, AZ 86011-5774, or E-mail to: [jon.reyhner@nau.edu](mailto:jon.reyhner@nau.edu), (520) 523-0580, fax: (520) 523-1929.

• NABE •

# Cemanahuac Educational Community Scholarship Competition for Summer 1997

The Cemanahuac Educational Community, located in colonial Cuernavaca, Mexico, is pleased to offer one two-week scholarship to a NABE member to study Spanish and Latin American studies in an atmosphere of total immersion. Cemanahuac is one of the most academic schools of its kind in Mexico, and students come from all 50 states, Canada, Europe, and Asia. During the summer Cemanahuac offers special workshops and seminars for teachers, under the title, "Mesoamerica in the Classroom" throughout the summer. The scholarship award includes registration, tuition and housing with a Mexican family (double room) for two weeks, all meals, a field study trip, and a certificate of attendance; the dollar value of this award is about \$770.00. The scholarship does not include transportation to Mexico City or transfers to Cuernavaca from the Mexico City airport. The winner can elect to study for a longer period of time at a reduced fee, and academic credit is available at the graduate or undergraduate level.

*Applicants should give evidence of the following professional and educational characteristics:*

1. Applicants should currently be working in an educational setting where enhanced Spanish language skills will enable them to better meet the needs of their students and their families.
2. Applicants should demonstrate commitment to bilingual education by active membership in professional groups that promote successful bilingual education and must be a current NABE member.
3. Applicants should demonstrate professional involvement in seminars, classes, graduate study, etc., that educate others about the need for bilingual education and increase awareness of the special needs of the children with whom they are working.
4. Since this study period is concentrated, preference will be given to those who have some basic Spanish, either two years of high school Spanish or one year of college Spanish.

Applications will be reviewed and the winner will be selected by staff of the Cemanahuac Educational Community. Deadline for applications is April 15, 1997, and the scholarship winner will be notified by telephone by May 15, 1997. All applicants will receive notification as soon as possible by US mail after May 15 of the decision.

Applications can be mailed to the address listed below; e-mail application forms are also available.

An alternate winner will be named, and should the winner be unable to accept the award, the alternate recipient will be given the scholarship. Applications can be submitted by US mail (keep in mind that it takes three weeks for letters to reach Cuernavaca from the United States), fax, or e-mail.

For a brochure about Cemanahuac, call 800-247-6651.

For an application, please contact:

Vivian B. Harvey, Educational Programs Coordinator  
Apartado 5-21  
Cuernavaca, Morelos  
MEXICO  
(52-73) 18-6407 or 12-6419  
FAX (52-73) 12-5418  
CompuServe: 74052,2570  
Internet: 74052.2570@compuserve.com  
<http://www.cemanahuac.com>

# Administration of Bilingual Education Programs

Column Editor: Dr. Jaime A. Castellano, Palm Beach County S.D., West Palm Beach, FL

## *Empowering Language-Minority Students in the Mainstream Through Self Assessment and Contracted Learning*

by Laura Schraeder

*Column Editor's Note:* Assessing bilingual and/or ESL students who are enrolled in regular education classes at the junior high or middle school level is no easy task. This issue is further compounded when teachers rely solely on traditional standardized measures or teacher-made tests and quizzes that do not take into account the students' limited English proficiency. How then do we accurately assess middle school bilingual and ESL students?

The intent of the article written by Laura Schraeder, a middle school language arts teacher at Glenside Middle School in Glendale Heights, IL, is to demonstrate how both the use of self-assessment and contract learning serve to empower language-minority students in the mainstream classroom.

This article comes at a point in time when thousands of middle school educators are still struggling with the idea of how to fairly assess those linguistically diverse students enrolled in their classrooms. Empowering students extends itself beyond taking responsibility for learning. Including them and asking for their input in gauging if learning has taken place empowers them even more.

In an effort to assess a child's learning, teachers across the nation wrestle with the theory of authentic assessment versus traditional testing. Consequently, one of the most frequently posed questions of today's educators is "How do we know children learn?" Historically, the obvious answer lay in a myriad of both standardized and teacher-generated test scores. Personally, I find it rather distressful that a child's entire academic future lies in state based on a set of well-designed isolated data. What is even worse is that children equate learning or not learning with such results. "I know I'm smart because I got a good score on a test." "My teacher gave me a good grade. That's how I know I did well" (Glazer, 1994). All too often, our students echo these words to let us know they depend on us to tell them they are intelligent and are learning.

Unfortunately, for years, teachers passed judgment on their students without giving them a chance to say anything in their defense regarding their learning. How can we assume whether a child learns or not? How can we determine to what extent internalization and long-term learning

occur? Have we ever asked our students if they feel they are learning, or the degree to which they think they are learning? Do we dare?

These questions are even more difficult to answer with regard to language-minority students due to linguistic acquisition barriers masking performance. Hence, these students as well as their mainstream counterparts need the opportunity to share in the evaluation process with their teachers. In order to do this, we must become risk-takers encouraging our students to join us by putting some "skin in the game." We need to take a back seat view and admit that education is changing. No longer does the spot light shine on the teacher; it shines on our students, all of them. Moreover, the necessity to include our students in the assessment process is imperative. After all, to what degree is authentic assessment authentic if we do all the assessing? We can take great pains to develop real life assessments yet, if the students do not assume ownership from beginning to end, what do they gain? Why should we speak for them? Are they not capable of defending their learning and its importance?

Believing that students can share in the evaluation process motivated me to take a chance. Like many middle level educators serving both mainstream and language-minority students, I always assumed the role of pilot regarding grades and assessment. However, one day the light of change illuminated the horizon and I decided to train some co-pilots, my students.

Initially, I provided my students with examples of rubrics and various checklists I designed to furnish a foundation from which they could build a framework. After using these for the first few writing assignments, I instructed my students to create their own evaluation tool for the next one. Needless to say, my students had a virtual field day; for they could not believe their good fortune. I might even go as far as to say that some of my more astute students thought I had taken leave of my senses. Yet they willingly jumped on the "create your own evaluation bandwagon." Submitted assessment sheets ranged from "start with 100 points and subtract 1 point for every error" to well thought out checklists and rubrics. Somehow, however, that did not matter. The important thing was that the students took control and spoke out about their work. Wholeheartedly, I respected their first attempts and graded their work according to each individual student's chosen standards and criteria. Eighty-five students created eighty-five different evaluations. Each time the students devised their own rubrics, the more confidence they gained. Weaning them away from dependence on me fostered independence and self-esteem especially in my language-minority students. Positive attitudes soon replaced these students' once-felt anxiety; for they quickly realized comparison to anyone or competition with anyone simply did not exist

CONTINUED ON PAGE 28

(Richard-Amato, 1988). For example, if their rubrics did not reflect numerous grammatical or syntactical criteria because they felt overall content was more important, so be it. Since they did not fear overbearing criticism from me, they were free to communicate their true feelings about their work. How else do language-minority students acquire language? Redlining and circling every mistake would only raise their affective filters resulting in shut down (Crawford, 1993). Therefore, rather than risking this, we conferred about areas needing improvement. In so doing, my students' self-esteem and confidence level remained in tact. Gentle doses of constructive criticism void of negativism promote learning and are much more effective for ESL students (García, 1976).

All my students gravitated toward frequent opportunities to tell me how they felt about their learning and why. During classroom reflective discussions, students frequently expressed comments such as "I really need to understand the assignment in order to do this." As teachers, we know that part of any well-constructed evaluation tool hinges on whether the students fulfill the assignment or task. Many of my language-minority students verbalized that they must think about their work before selecting criteria for me to assess. They must decide what aspects of the assignment are important and their degree of importance, not me. The onus of proving their learning rests with them. Such primitive reflection forces them to confront their work objectively. Thus, the responsibility to point me in the right direction becomes theirs. No longer are they able to turn in a finished task leaving the final judgment with me. It is for them to see the project through from its initial planning stage to its inevitable evaluation.

Delighted by my students' overwhelming positive response to self assessed learning, I decided to continue empowering them by pursuing yet another instructional venue: contracted learning. Contracted learning encourages students to exercise their bargaining power with their teachers regarding project choice or various project requirements such as due dates, a project's progress, or a project's con-

tents. In addition, it provides opportunities for students to live up to their word or experience the consequences if they do not.

Using a previously-designed research project proved extremely beneficial in my initial implementation of this concept. After carefully reviewing the project's components, works cited list, notes, outline, rough draft, and final copy with my students, creating a suitable contract fell into place. Every student was to research a topic of his or her choice and then choose a due date for each facet of the project within a pre-determined window of time. Seemingly, the chance to choose provided every student a flexible avenue on which to determine his or her personal time frame. Moreover, it served as a time line guide for the students rather than an absolute. Overwhelmingly, the students responded enthusiastically to the opportunity to choose their personal time frame, for they would have ownership not only in the final assessment of their work but also in the time line during which they assimilated it. Throughout the next few weeks, all my students adhered to their chosen dates for each section or knowingly suffered the penalties resulting from their inability to do so. When the project window closed, sixty-eight percent of my students of which nineteen were limited in their English proficiency, successfully met all their contractual obligations. The remaining thirty-two percent faltered at least once.

What do these statistics mean? What did I really want my students to gain from this learning experience? Did I simply want them to learn to choose dates on which I collected parts of their projects, or was there more? Truly, I hoped to teach them to make responsible decisions with the understanding that, based on their actions regarding those decisions, either positive or negative consequences follow. I believe I accomplished this. Obviously, the majority of both my mainstream and language-minority students comprehend decision-making; therefore, contracted learning served as an opportunity to apply their understanding.

How then does self-assessment and contracted learning empower language-minority students in the mainstream? First,

both strategies require the students to exercise responsible behavior. They make the choices, not the teacher. Moreover, they must live up to these choices in order to establish credibility. Second, students are able to comfortably work at their own pace and judge their work according to what they deem important. Consequently, by not overshadowing language-minority students with criticism or "pigeon holing" them to conform to mainstream learning stereotypes, they acquire and internalize language faster. Both self-assessment and contracted learning stress individualization opposed to compelling students to all learn the same way within the same time frame. Third, language-minority students' confidence and self-esteem levels rise substantially. They readily gain a sense of independence and soon realize what they can do rather than what they can not do. No longer are they on the outside looking in; for they are experiencing equal decision-making opportunities while exercising control over their learning as do their mainstream peers.

Therefore, providing the opportunity to choose—whether in the assessment or contracted learning realm—encourages student utilization of higher-level thinking skills. Regardless of culture, all children can think, reason, decide, and learn when given the opportunity to do so. Challenging students to be introspective about their learning enables our students to be risk-takers and exercise their uninhibited adventuresome spirits. When all is said and done, if it were not for all our students' willingness to sail through uncharted waters with us, it really would not matter what type of vessel we provided or how astute we think we are at its navigation.

#### References

- Crawford, James. (1993). *Bilingual Education: History Politics, Theory, and Practice*. Los Angeles: Bilingual Educational Services, Inc.
- García, Ricardo, L. (1976). *Learning in Two Languages*. Bloomington: Phi Delta Kappa Educational Foundation.
- Glazer, Susan, M. "How You Can Use

CONTINUED ON PAGE 38

# Parental Involvement in Bilingual Education

Column Editor: Aurelio Montemayor, IDRA, San Antonio, TX

## *Hispanic Family Involvement: An Interview with Gilbert Quesada*

by Aurelio Montemayor, M. Ed.

The following interview with Gilbert Quesada, Director of Special Programs for the South San Antonio Independent School District in San Antonio, Texas, is taken from an IDRA publication "Hispanic Families As Valued Partners — An Educator's Guide." For more information about the publication contact Aurelio M. Montemayor at IDRA; the address is printed at the end of this column.

### *What are the secrets of your success involving Hispanic families in your schools? What advice would you give a fellow administrator?*

I advise a fellow administrator who wants to increase parent involvement to "Be open-minded." Be very positive about getting parents involved.

Develop a model, or adopt one. Either way, you can be creative and innovative. In the model that I would develop, I would have goals and objectives, a plan for resources, and a timeline. Everything would be mapped out; every month, every day of the week.

If funds are available, hire a parent involvement coordinator. If not, find a staff member, and if that's not feasible, put it in your own job description, and you do it.

Be sure to plan an evaluation component, and make sure it's being carried out, so that at the end of the school year, we can evaluate the program and see what we've done.

The principals of the schools play a key role. Many of the federal programs we applied for several years ago emphasized having the principal on board, and we learned from those programs that this is critical. If principals are receptive, if they want parents to be involved, they'll find ways to make it happen. And if they don't, then the attitude of the principal can be a barrier.

Other barriers? I would say that 20 years ago, the attitude was very close to racism.

Now there are many more Hispanic administrators and other staff, and I would say everyone is much more sensitive to Hispanic families. But stereotypical views still exist. Some principals, some school personnel, think these families don't care about the education of their children.

Hispanic families do value school, they do value education — highly, very highly. But somehow this isn't communicated to the school, or the school may know it, and yet they're not working together, the home and the school.

There are two subtle problems here: one, the principal and others at the school are going to be judged by test scores and other standards set by the state, and they know they're not going to be judged by the degree and quality of parent involvement in their school. Then, on the other hand, many Hispanic parents have the traditional attitude, "the school knows best," and they don't put themselves or their concerns forward. Each side needs to recognize the great resource it has in the other.

For example, we needed to raise money for our school district, and because of all our existing parent programs, we were able to organize parents and other members of the community into committees, and have each one look at a particular area — curriculum and instruction, for example, facilities — and we met as a group, and then in committees, and again as a group. The committees decided what needed to be done in each area, and as a group, we worked out orders of priority and a plan. The involvement of all those parents and the clarity of purpose we were able to achieve helped us gain support for our bond election.

That's why I have high hopes for site-based management. With site-based management, the parents will choose the principal! They'll need training, of course, in how to exercise these new rights they have. And we have to give it time.

I've learned some lessons about involving Hispanic parents. First, the hardest thing

is to physically get to a meeting place to do something: to have the place, that is, and to get people to come. We used to ask migrant farm worker parents to let us meet in their living rooms. It was just the only way they felt comfortable enough to come. But finding a meeting place was always a problem to be solved, and then we wanted some ongoing programs for parents, too. We were able to buy a big portable building with one of our grants, and this became the Parent Development Center, and here we can weave together many strands of involvement and support — we have an excellent counseling program, we have GED classes for parents, we have workshops and meetings on subjects of special interest to parents — we had our public health nurses give a class in CPR, that sort of thing. I'm most eager to offer training for our families in survival skills, and getting a job.

Then, getting people to come. We have superintendents and counselors and a full-time parent involvement coordinator (a parent), who make phone calls and, even more important, home visits. It's very important to create a network of parents, so they all make plans to come together.

You have to work with parents' schedules. This takes commitment. I have counselors and supervisors who will go from house to house beginning at 5:00 am and on until 8:00 pm or 9:00 pm.

Finally, there's more involvement in the earlier grades. Everyone in the family comes to see a child graduate from kindergarten! We've built strong involvement at some middle schools. There's more to be done to involve parents at all secondary levels.

**Editor's Note:** Contributions for the **Parental Involvement** column should be sent directly to the editor, Aurelio Montemayor, at: IDRA, 5835 Callaghan Road, Suite 350, San Antonio, TX 78228. (210) 684-8180; FAX (210) 684-5389. Email: [amontmyr@txdirect.net](mailto:amontmyr@txdirect.net)

• NABE •

Join NABE's Action Alert mailing list at [actionalert@mabe.org](mailto:actionalert@mabe.org)!

# Upcoming Events

**February 14-16, 1997 - *Storytelling: Culture as Prevention '97.*** Substance Abuse Prevention Conference. Mesa, AZ. Contact (520) 771-1352.

**February 15-19, 1997 - *Association of Teacher Educators 77th Annual Meeting.*** "Democratic Education for the 21st Century: A Critical Look at the Past, Present, and Future." Washington, DC. Contact ATE, 1900 Association Drive, Suite ATE, Reston, VA 20191-1502.

**February 20-22, 1997 - *Hispanic Association for Higher Education of New Jersey 19th Annual Conference.*** "Education Under Siege: Revolución Ahora." Long Branch, NJ. Contact Nancy Cintrón at (908) 445-2678.

**February 26 - March 1, 1997 - *California Association for Bilingual Education 22nd Annual Conference.*** "Advancing World Class Standards for Learning and Leadership." San Diego, CA. Contact CABE at 660 South Figueroa Street, Suite 1040, Los Angeles, CA 90017 (213) 532-3850.

**February 26 - March 1, 1997 - *American Association of Colleges of Teacher Education 49th Annual Meeting.*** "Leadership for Transforming the Profession: Fulfilling the Commitment to Children, Communities, and the Common Good." Hyatt Regency, Phoenix, AZ. Contact AACTE at One Dupont Circle, Suite 610, Washington, DC 20036.

**March 6-7, 1997 - *Massachusetts Association for Bilingual Education Annual Conference.*** "Making Connections." Leominster, MA. Contact MABE at (508) 434-9542.

**March 7-8, 1997 - *Luso-American Education Foundation Conference on Portuguese American Education.*** University of California, Berkeley. Contact Mily Sena at (510) 828-3883.

**March 7-11, 1997 - *National Association of Secondary School Principals Annual Conference.*** Orlando, FL. Contact NASSP at (703) 860-7262.

**March 11 - 15, 1997 - *Teachers of English to Speakers of Other Languages 31st Annual Convention.*** "Creating Magic with TESOL '97." Orlando, FL. Contact TESOL at (703) 836-0774.

**March 14, 1997 - *Korean American Educators 13th Annual Conference.*** Los Angeles, CA. Contact Elena Paul at (818) 224-4354.

**March 22-25, 1997 - *Association for Supervision and Curriculum Development 52nd Annual Conference.*** Baltimore, MD. Contact ASCD at (800) 933-2723.

**March 26-29, 1997 - *The National Association for Asian and Pacific American Education 19th Annual Conference.*** "The Challenge of Change: Families, Communities, & Schools." Boston, MA. Contact Hiep Chu at (617) 287-5653.

**April 3-6, 1997 - *National Science Teachers Association Conference.*** New Orleans, LA. Contact (703) 312-9221.

**April 10-13, 1997 - *Central States Conference and the Ohio Foreign Language Association Joint Conference.*** "Building Community." Columbus, OH. Contact Rosalie Cheatham at (501) 569-8159.

**April 12-16, 1997 - *National Association of Elementary School Principals Annual Conference.*** San Antonio, TX. Contact (703) 684-3345.

**April 17-19, 1997 - *National Council of Teachers of Mathematics Annual Conference.*** Minneapolis, MN. Contact (703) 620-9840.

## NABE '98

February 24 - 28, 1998  
Dallas, Texas

Mark your calendars now!



# Separate and Unequal: The Educational Track for Children Who Do Not Understand English

by Carmen Sánchez Sadek, Ph.D.

Nearly a half-century ago the landmark Supreme Court decision in *Brown vs. Board of Education* legally ended the practice of separate and unequal public schooling for children of different races. But today, in the schools and classrooms across the United States, million of children still receive, in practice, separate and unequal education opportunities. These children belong to different racial groups. Their common trait is that they do not understand or speak English. In California alone more than a million children do not fully understand English and cannot express themselves coherently, clearly or fluently in English. Separate and unequal schooling in public schools is what awaits these children in this state and most others.

How and why is the education that non-English-speaking children receive separate and unequal? A description of a real classroom perhaps helps to explain. One of my friends volunteers weekly at a Los Angeles public school. As a retired bilingual Kindergarten teacher, she reads stories to young children in pre-school and Kindergarten classrooms. In the English-speaking classrooms, students listen to her stories and successfully ask and answer questions. These children are developing mentally to their fullest capacity. They take full advantage of the many communication opportunities provided through the language they understand and speak best — English.

In another classroom, however, there are many Spanish-speaking students who seldom hear Spanish from their teacher. The classroom teacher, a bilingual teacher, does not offer instruction through the only language these children understand and speak best — Spanish. As a result, my friend — who reads stories in Spanish in this class — faces a group of children greatly stunted in their cognitive development and school achievement. These children neither ask nor answer questions. They hardly ever give their complete names

when asked. They rarely participate in communications derived from the stories read. Recently, my friend began her session by reminding the children they were going to listen to a story in Spanish. One very young boy in the group announced — in Spanish, of course — that he did not speak Spanish at all! “Yo no hablo español!”

How to promote maximum cognitive development in children of all ages is no mystery: children must talk. The early years are crucial. A very large body of knowledge tells educators how to maximize mental development in young children, from birth to nursery school, through preschool, Kindergarten and up to second grade. Maximum cognitive development requires language communication and stimulation.

Listening with full understanding, asking and answering questions, expressing feelings, verbalizing what they sense, believe, value, imagine, think and think for these are the communication activities that help children develop mentally. These communication activities also help children link languages to what they recognize, observe, distinguish and categorize, analyze, and judge. Cognitive growth hinges on language and perceptual development, not on visual stimulation alone.

Taking away language and communication and perceptual development from any children turn deaf and dumb when we take language and communication away from them. This is what happens to non-English speaking children when we talk to and teach them in language they neither understand nor can use to respond.

A child be denied verbal stimulation—receiving real messages, asking and receiving answers in a language they comprehend—and not to be stunted mentally. Children who cannot hear — because they do not understand English — show little or no interest in their surroundings, participate less, have few friends, and develop feelings of alienation from teachers and authority. Children who do not talk — because the cannot respond in English — are less alert and aware of the expectations

adults have for them. These children are left out when it comes to learning. No one can learn what they can understand. They cannot understand if they cannot talk and ask about, discuss, debate, or render an opinion about the issue at hand.

While talking to and teaching non-English-speaking students only through English, educators also down play or ignore the students' only tolls for understanding and communication: their primary language or mother tongue. In so doing, educators are very likely to extinguish a key component of mental growth and healthy social development: self talk i.e., the inner language for communication with oneself. Self talk requires language. These unspoken thoughts help in the development of a positive self-image and self-esteem. In many Public school classrooms the non-English -speaking students are left in a mental vacuum; bewildered, unable to make connection and understand relationships about the world. All the while, their age group English-speaking peers learn, grow, succeed, and are rewarded for meeting expectations.

Educators seem surprised by the well-documented and excessive failure of non-English-speaking students. Commissions are formed to study the causes of educational failure. The failure, however, is no accident. It is programmed. It happens by design. In public schools across America, educators operate under different educational rules for different children.

English-speaking children are placed in developmental programs with clearly defined grade-level expectations and age-appropriate standards for success. These children grow normally, developing language and mental capacities appropriately for their age level. Non-English-speaking children are usually placed in non-developmental programs that violate the rules of language and mental growth. In these programs educators ignore the huge body of knowledge they are paid to understand and apply.

CONTINUED ON PAGE 38

### Search Engines for Electronic Discussion Groups

Thus far I have concentrated on Internet search tools useful for locating a range of information resources. In the remainder of this article, I will focus on those search tools which can be helpful in discovering the myriad of human resources accessible over the Internet. There are two major classes of search tools in this arena, corresponding to the two technological means which are used to facilitate communication over the Internet among people with similar interests: (a) *electronic mail-based discussion groups*, and (b) *USENET newsgroup-based discussion groups*. In both cases, people with common interests share their concerns, questions, and expertise with one another.

*Electronic mail-based discussion groups* are made possible by a key characteristic of digital communication: one copy of an e-mail message can be instantly "broadcast" to any number of recipients who have listed themselves in an electronic mailing list, hosted by a network somewhere on the Internet. Electronic mail-based discussion groups are created and maintained by "robot" computer programs on this host computer (for example, Listserv, Listproc, and Majordomo) which automatically create and update mailing lists for discussion groups. These list manager programs receive and automatically process e-mail commands issued by subscribers and directed to the discussion group's *management address*. Aside from its management address, each discussion group has a *participation address* where subscribers direct their actual messages to the group. Any message sent to the participation address by one subscriber is duplicated and sent to every other subscriber, creating a worldwide virtual forum in each subscriber's personal electronic mailbox.

*Liszt.Com* is the major search engine for electronic mail-based discussion groups. Its database is something like *Alta Vista's* in that *Liszt.Com* automatically queries Internet host computers around the world asking for the latest information on discussion group mailing lists maintained by each network. At present, the *Liszt.Com* offers a searchable database of more than 65,000 discussion

groups on over 2,000 Internet hosts.

Like electronic mail-based discussion groups, *USENET newsgroups* facilitate conversations between people with common interests. However, newsgroups do not operate through e-mail; that is, newsgroups do not work by filling electronic mailboxes around the world with a copy of each message sent by any subscriber (thus saturating a great deal of Internet "bandwidth," the cyberspace equivalent of killing far too many trees for newsprint). In order to participate in one of the USENET educational newsgroups, a user's Internet Service Provider (AT&T, America Online, CompuServe, Prodigy, or a local service provider) must subscribe to a "newsfeed" for a particular newsgroup, rather than the user herself or himself, as is the case with electronic mail-based discussion groups. To participate in a newsgroup, a user must literally "go to the source" by logging into her or his Service Provider and visiting the newsgroup area there. While theoretically this is a more efficient system for conducting discussion, newsgroups are not as widely used for educational purposes as are electronic mail-based discussion groups.

*DejaNews* is the only widely used search engine designed exclusively for newsgroups (<http://search.dejanews.com/>); however, many of the most popular search engines for Internet information resources also have special settings permitting searches of USENET newsgroups, notably *Alta Vista* (<http://altavista.digital.com/>), *Infoseek* (<http://www.infoseek.com/>), and *Excite* (<http://www.excite.com/>).

### Search Engines for Locating Individuals

Generally, the most efficient way to locate anyone's electronic mail address is simply to give them a telephone call and ask. However, there are automated search engines that will locate electronic mail addresses as well as current phone numbers and street addresses if these are available through regular "Information" directory assistance services. Chief among these are *WhoWhere?* at (<http://www.whowhere.com/>) and *Yahoo!'s People Search* at (<http://www.yahoo.com/search/people/>). For example, a search of

*Yahoo!* revealed the author's current e-mail addresses as

dmsayers@ucdavis.com

dennis\_sayers@hotmail.com

dsayers@panix.com

and correctly identified his former and now obsolete e-mail address as [sayers@acfcluster.nyu.edu](mailto:sayers@acfcluster.nyu.edu)

### Privacy Issues

The ability of Internet search engines to find nearly any reference to an individual and his or her professional and casual communications over the Internet may be disturbing to some computer users now, and will become unsettling to many more in the future. Not everyone wants their home phone number available to anyone on the Internet. And what if a potential future employer searched for everything you've written or anything that's been written about you? If these issues are a concern — and they should be — a useful reference is the document prepared by *CINet* on privacy in the digital age which can be found at <http://www.cnet.com/Content/Features/Dlife/Privacy2/ss02.html>, which offers specific guidance on how to unlist, remove, and otherwise render unsearchable specific personal information.

### Conclusion

We, as bilingual and second language educators, are uniquely positioned to assume leadership in the productive use of networked resources to encourage critical intercultural learning. Yet this historic opportunity can only be seized if we recognize the importance of mastering the many automated search tools at our fingertips for locating, sifting through, and evaluating Internet resources, separating the wheat from the chaff for our students and their families as they seek to bridge two worlds.

**Editor's Note:** *Contributions to the Technology and Language Minority Students column should be sent to Dr. Dennis Sayers, University of California Educational Research Center, 351 E. Barstow Avenue, #101, Fresno, CA 93710. (209) 228-2050; FAX (209) 288-2055. E-mail: DSAYERS@panix.com.*

# NABE NEWS Book Reviews

Column Editor: Dr. Beti Leone, Paterson Public Schools, Paterson, NJ

## *Critical Pedagogy: Notes From the Real World*

Reviewed by Brenda Betts, Ph.D.

*Critical Pedagogy: Notes From the Real World* by Joan Wink, 1996.

In her remarkable new book, *Critical Pedagogy: Notes From the Real World*, Joan Wink has successfully combined a discussion of both theory and practice in education to create new understandings and possibilities for the teacher, student, school community, and university. The great contribution of this highly readable and engaging text is that it is relevant and practical for both the practitioner and the researcher. Many authors have discussed the need to combine both perspectives into a complimentary whole, but few have actually accomplished this formidable task. Wink has provided an important service by making various perspectives of the school experience, critical theory, sophisticated terminology and concepts accessible to all readers.

Wink has made critical pedagogy a valuable tool for her readers by sharing her experiences as a teacher, parent, and professor in the on-going process of learning, unlearning, and relearning. Without revealing her own definition of critical pedagogy, readers are invited to bring their own meanings and experiences to the text and, in collaboration with it, create their own definitions of critical pedagogy. The fast-paced text is divided into five chapters, to be read chronologically. It is a compilation of thoughtfully selected, personal vignettes intertwined with the research literature on teaching and learning. The result of this considerable effort is a narrative rich in thought-provoking, informative, and amusing experiences combined with a thorough review of the academic and political issues surrounding literacy and school success.

In the Introduction, we meet Jonathan, a bright and privileged child who did not learn to read until the fifth grade, although he received considerable support and numerous opportunities for reading from his family and school. Jonathan's vignette encourages us to value the contradictions, changes, and subsequent conflicts that are fundamental for teaching and learning. It also reminds us that it is by reflecting on and re-thinking our assumptions that teaching and learning can become active and meaningful.

In Chapter 1, "Critical Pedagogy: How in the World did I Get into This," we meet the Benson kids and find out about Wink's need to learn, relearn, and unlearn during her first teaching assignment. This is the beginning of critical pedagogy. In Chapter 2, "Critical Pedagogy: What in the World Is It," Wink uses

CONTINUED ON PAGE 34

## *Bilingual Study Guide and Latino Voices*

Reviewed by Dr. René Cisneros

*Latino Art and Culture: Bilingual Study Guide and Latino Voices: Artists and Community* (A video presentation) National Museum of American Art, Smithsonian Institution, 1996. Washington, D.C. 20560; (202) 357-4836

*Latino Art and Culture* is a multimedia set of instructional resources produced by the National Museum of American Art of the Smithsonian Institution in Washington, DC. The set of resources includes four components: 1) a Spanish/English bilingual Study Guide, 2) a portfolio of ten 8¼" by 11" color reproductions of works of art by Latina/o artists, 3) a set of fourteen color slides, and 4) an English/Spanish bilingual videotape entitled *Latino Voices: Artists and Community*. The Bilingual Study Guide forms the organizing and conceptual backbone of the set of the instructional resources, while the portfolio of reproductions of works of art, the slides, and the video serve as supporting instructional materials.

### Goals

The overall goals for the *Latino Art and Culture* set of multimedia instructional resource as stated in the Study Guide are threefold:

- to stimulate an interest in U.S. Latino art and culture,
- to develop an increased awareness of the role of the visual arts in reflecting social, cultural, and political history, and
- to develop critical and analytical thinking skills.

Each of the three parts of the instructional package are described and then critiqued below.

### The Bilingual Study Guide

*Description:* The 68-page Bilingual Study Guide is made up of four instructional units with the following titles: "Artistic tradition in the Southwest;" "Mixing cultures and blending influences;" "Making a new life in the United States;" and "Expressions of social concern." Each instructional unit follows the same format. First there is a definition of the theme for each unit. For example, for Unit One on "Artistic tradition in the Southwest," there is a definition of the early "santos" (images of saints) tradition in New Mexico. It is followed by a discussion of the works of art and their historical and socio-cultural context. In Unit One, for example, there is a discussion of the art work of Pedro Antonio Fresquís, the 18th century "santero" (an artist who creates the santos) that reflects on the life and beliefs of 18th

CONTINUED ON PAGE 36

vignettes to explain and demonstrate many of the political issues and terminology relating to literacy including conscientization, cultural capital, codification, dialectic, dialogue, discourse, hegemony, hidden curriculum, literacies, praxis, problem posing, grooming, naming, school, marginalize, silence, voice, and socialize. Critical pedagogy shows how the connections and consequences between literacy and societies are complicated, powerful, and frequently ominous.

In Chapter 3, "Critical Pedagogy: Where in the World Did It Come From," the historical background of critical pedagogy is explored through the works of Freire, Gramsci, Marx, the Frankfurt School of Critical Theory, Skutnabb-Kangas, Vygotsky, Dewey, Ada, McCaleb, Giroux, McLaren, Cummins, and Krashen. In Chapter 4, "Critical Pedagogy: How in the World Do You Do It," the focus is on doing critical pedagogy. (The irony, of course, is the need for more than that; we need to do and to live critical pedagogy.) Principles of problem posing, including the teacher's role, are discussed in a relevant context pointing toward suggestions for reflective practice. As part of this discussion, educational beliefs and behaviors of three approaches to instruction — the transmission model, the generative model, and the transformative model — are examined. Finally, the four phases of lesson design models for critical pedagogy are thoroughly explored, and the rationale and implementation of critical activities within the

### Book Review Submission Guidelines

Reviews for publication in the **Book Review** column should be sent to Dr. Beti Leone, Book Review column editor, at NABE, 1220 L Street, NW, #605, Washington, DC, 20005, or by e-mail to NABE\_NEWS@nabe.org.

Books from publishers should be clearly marked **BOOK REVIEW MATERIAL** and sent to the same address; **two** complete sets of materials must be submitted.

community are also explained.

In Chapter 5, "Critical Pedagogy: Why in the World Does It Matter," there are suggestions for teaching students of the 21st century. Schools are experiencing many contradictions and changes because societal changes are reflected in schools. Critical pedagogy teaches us to look again, to see again, and to know in new ways, because diversity of thought is beneficial for schools and for society. With a caring heart, a critical eye, courage, patience, and time, teachers can make a difference in the lives of their students, schools, and communities.

Wink's expertise as a teacher, parent, author, and professor are chronicled in her poignant and inspiring thirty-year journey through classrooms, schools, and communities. As Wink documents her own experiences and feelings as both a participant and an observer in this process, she invites readers to re-examine their own beliefs and preconceptions. This book serves many purposes: to inspire the novice and re-ignite in experienced teachers an enthusiasm and pride in the teaching profession; to facilitate equitable school environments and instruction; to foster understanding; to support the researcher in the timeless search for the effective implementation of theory; and, to inform those outside of education about the complexities and challenges of daily life in schools and the larger, but often silent, political agenda.

*Critical Pedagogy: Notes From the Real World* is currently being read and discussed in courses for the CLAD, BCLAD, and Multilingual Master's degree in the Department of Teacher Education at California State University, Stanislaus. Students' positive responses to the text include an appreciation for Wink's honesty, her engaging narrative style, her straightforward explanations, her commitment and enthusiasm for the teaching profession, and her concern for her students and their families. Wink's colleagues eagerly recommend this important text because it readily facilitates reflective class discussions and student participation in the teaching and learning process. This fascinating and articulate book is essential reading for teachers, parents, community members, and scholars.

*Brenda Betts, Ph.D., is a member of the Department of Teacher Education, California State University, Stanislaus.*

**FERNÁNDEZ USA**  
publishing Co.

and  
**FERNÁNDEZ editores, México**  
in its 54th year of publishing  
for the Hispanic children  
of the Americas  
wish the NABE membership  
a happy and healthy  
holiday season  
and success  
and prosperity in 1997!

FERNÁNDEZ USA publishing Co.  
1210 E. 223rd Street, Suite 309  
Carson, CA 90745  
1 - 800 - 814 - 8080

**GENUINE SPANISH FOR  
SPANISH SPEAKERS!**

# MEXICO

al reconocer el esfuerzo de los maestros bilingües en beneficio de la educación de los mexicanos que viven en los Estados Unidos.

te invita a conocer los siguientes programas:

**Intercambio de profesores México-EUA para el verano de 1997**

**Cursos de capacitación para maestros bilingües en EUA**

**Educación para adultos: alfabetización, primaria y secundaria**

**Libros y materiales educativos en español**

Asiste al pabellón mexicano, o infórmate en el consulado de México más cercano a tu localidad.

## The TALK System™

TALK System technology is a cost effective method of providing wireless, voice silenced communication. Presentations can be transmitted simultaneously to as many as five multilingual groups. Improve the connection between your school and language minority parents by using the TALK System.

“There can be no  
community  
without  
communication.”

**Gold Sponsor of NABE '97**



TALK Systems, Inc., 11285 Elkins Road, Suite H-6A, Roswell, Georgia 30076 770-663-3080 FAX 770-663-3082

century New Mexico. Each unit ends with a set of learning activities. Unit One ends with seven learning activities which include, among others, a small-group activity to study the Mexican American and American Indian cultural images in *Cocina Jaiteca*; a work of art by Larry Yañez; a writing activity based on *Death comes to the Archbishop* by Willa Cather, a novel about two French missionaries in New Mexico in the mid 1800's; and an art activity to make a "bulto" (a three-dimensional religious image) out of contemporary recycled materials, much like the art work of Carlos Santisteban, the Denver sculptor who creates santos out of recycled welded automobile parts. In summary, the Bilingual Study Guide is well-organized and clearly written and the learning activities are appropriate for secondary school students.

*Critique:* According to the director of the National Museum of Art, the instructional kit was designed to be used across the curriculum, integrating art with history, social studies and literature and to encourage students to explore art as it relates to past and current issues in American life. In my opinion, the Bilingual Study Guide was more successful in relating Latina/o art to its historical, social and cultural context than it was in integrating Latina/o art across the curriculum. That is, conceptually, the Bilingual Study Guide is outstanding in the way that it relates the art of Latina and Latino artists to their own historical, social, and cultural context. Regarding the integration of Latina/o art across the curriculum, it is true that the learning activities given at the end of each instructional unit do link Latina/o art to other content areas such as literature and social studies. However, besides the actual learning activities that link art to other content areas, no rationale, guidelines, or plan are provided for integrating Latina/o across the curriculum. At the very least a model of a thematic unit could have been provided to illustrate how a theme from Latina/o art could be integrated across the whole curriculum in a secondary school.

## Publishers & Materials Developers

Do you have new products to tell NABE members about?

Send a sample of your material to the NABE NEWS Editor at NABE, 1220 L Street, NW, Suite 605, Washington, DC 20005-4018.

Materials will be listed ONCE, free of charge, in the Resources for Bilingual Educators column.

## The Art Work Reproductions and Slides

*Description:* Two sets of art work reproductions are part of the set of *Latino Art and Culture* instructional kit. The first set consists of ten printed reproductions in full color, each one representing a piece of art by a Latino artist. The printed reproductions measure 8¼" by 11", an excellent size for study up-close by individuals, small groups of students, demonstrations by a teacher to a small group of students, and for thematic bulletin boards on Latino art and culture. The second set of art work reproductions consists of 14 slides, each one portraying a work of art by one Latina/o artist. The slides are ideal for showing the art work to larger groups of students, for example a class of 35 or more students. In all, the art works of a total of 23 Latina and Latino artists are reproduced for the instructional kit.

*Critique:* The quality of the printed reproductions and the slides is very good. I suggest that each printed reproduction be encased in a transparent plastic sleeve to protect the print when used with students. Unfortunately, no suggestions are given for using the printed art reproductions and slides to teach each of the units. An art teacher might be experienced in the use of slides and printed reproductions of art work in an art class. However, the mainstream teachers from other content areas who are integrating Latina/o art across the curriculum could use some guidance for successfully integrating the art work reproductions and slides in the classroom.

## The Video

The multimedia resource package has a 26-minute video in English, with subtitles in Spanish, entitled *Latino Voices: Artists and Community*. It features an impressive sequence of conversations with seven Latina/o artists (Carmen Lomas Garza, Agueda Martínez, John Valadez, Pepón Osorio, Joseph Rodríguez, Maria Castagliola, and María Brito) talking about themselves and their art work and representing the artist experience in the three major Latino communities: Mexican American, Puerto Rican and Cuban American. Each conversation stands on its own. That is, the video is not organized conceptually and thematically in the same manner as the Bilingual Study Guide. Consequently, perhaps the best way to utilize the video is not as a video that is watched completely from beginning to end, but instead as a set of supplementary documented conversations, each seen individually in conjunction with the study of the artist in one of the units in the Bilingual Study Guide. In other words, it is not a video that hangs together as other documentary videos do. It is more of a string of documented conversations that need to be tied in to the instruction of the concepts and learning activities found in the *Latino Art and Culture Bilingual Study Guide*.

*Critique:* The video's technical production is uneven. The incorporation of music to accompany the text and visual images is sometimes abruptly started or ended. The narrator's script is read too fast in the introduction to the Mexican American section of the video. The last two parts of the video are smoother and the reading of the script is better paced and more fluent. The changes, during transitions from one artist to another, and from one section of the video to the other, are also abrupt and not smoothly connected. These technical details, nevertheless, do not detract

significantly from the video, for the most part.

However, my main criticism is that the video does not have the cohesive devices needed for it to stand on its own as a whole video, that can be viewed as a whole documentary about Latino voices. It keeps a structure that is more of a series of conversations with artists. Somehow, the editing and organization, transitions, and narrator's introduction for each artist and section of the video do not succeed in forming a unit, a whole video. The editor of the video should have found some common threads of experience in the artists' stories or added parallel verbal and nonverbal framing to each story that could have helped the video hang together. Also, there is a need to connect the video to the Study Guide or to provide a separate instructor's guide (with transcript) for the video.

### Recommendations

My critical recommendations are as follow:

1. *Background discussion.* A discussion of the goals and procedures for studying Latino art across the curriculum is needed to explain the rationale and ways of teaching Latino art, linking it to school curriculum in all areas: literature, social studies, history, science, and other subjects. This background would help teachers across the curriculum to deliver the lesson more effectively.
2. *More activities.* Additional activities could be suggested for each area of the curriculum, to once again connect art to the social, cultural, political, and everyday lives of the middle, secondary, and adult students who will use the video and guide.
3. *Model unit.* A model thematic unit showing how Latino art is taught and integrated across the curriculum, with the video, the slides, and the art reproduction plates is also needed. This would be accompanied by the rationale and procedures for using the entire set of components.
4. *Video transcript and connections.* In addition to a complete video transcript, it would be helpful if a set of suggested activities, for each section of the study guide, which tie the video to the study guide, were included. Since the units in the study guide provide little or no reference to the video, slides, and art reproduction plates, the instructor is left on his or her own to make do and improvise these connections. These connections should include concrete ideas for integrating the art package across the curriculum and for teaching the language and culture to students at varying L<sub>1</sub> and L<sub>2</sub> proficiency levels.
5. *Additional study guides.* The video needs a study guide or manual of its own, as do the slides and art reproduction plates, in addition to a study guide for the entire instructional package. Such an instructor's guide for the visuals, video, slides, and art reproduction plates could include a transcript of each artist's story about his/her own art, production of art, creative influences, etc. Also, cross-references are needed for the various media and the study guide, with suggested instructional activities that would link the visuals — their themes, images, and symbolic

values — to the themes and topics discussed in the main study guide. This would include a rationale and guidelines for linking the visuals to each other and to the study guide's themes about the social, cultural, and political history of Latino art in the US.

### Conclusion

Despite these criticisms, I recommend the *Latino Art and Culture* multimedia resource package for both children and adults at a variety of ages and grade levels. It succeeds in bringing together a variety of multimedia documents that can be used in the classroom to stimulate interest in Latino art and culture, and to increase the awareness of the role of visual arts in reflecting the social, cultural and political history of Latinos in the U.S. The suggested learning activities in the Bilingual Study Guide also help facilitate critical and thinking skills. Especially impressive are the videotaped conversations by the artists as they talk about themselves and their work and the conceptual organization of the thematic units in the Bilingual Study Guide.

*Dr. René Cisneros works at Boricua College in New York City, teaching bilingual/ESL teachers, and conducting research on bilingualism and topics related to U.S. Spanish language and culture.*

◀ NABE ▶

#### New York University - School of Education Department of Teaching and Learning Assistant or Associate Professor Tenure Track Bilingual Education

Multilingual Multicultural Studies (MMS) comprised of programs in Bilingual Education, Foreign Language Education, and the Teaching of English to Speakers of Other Languages (TESOL), is seeking an Assistant or Associate Professor of Bilingual Education beginning, Fall 1997. MMS is committed to research and practice in promoting an understanding of the value of cultural diversity and developing multilingual ability.

The selected candidate will have leadership responsibility for the program in bilingual education. The candidate will be expected to develop curriculum, advise students, and teach courses in such areas as bilingual/multicultural education, computer-assisted language instruction, language teaching across the curriculum and applied linguistics. The candidate will contribute to research development in MMS, grant writing, and doctoral dissertation advisement that draws on a broad range of quantitative and qualitative methodologies. The candidate will have a doctorate in one of the three MMS program areas. Applied Linguistics, Cross-Cultural Communication, or a related field. The candidate should possess functional ability in Spanish and have a background in bilingual education. Knowledge of other languages is desirable and active participation in urban public schools is crucial.

Applicants should submit a letter of application, curriculum vitae and the names and telephone numbers of three references. Review of applications will begin January 22, 1997, and continue until the position is filled. Salary and rank will be commensurate with experience. Send materials to Professor John S. Mayher, Chair, Search Committee, Department of Teaching and Learning, New York University, 239 Greene Street, Room 635, New York, NY 10003.

NYU encourages applications from women and members of minority groups.  
<<http://www.nyu.edu/education>>

the home language, inclusive practices, collaboration, family-centered practices, and developmentally-appropriate practices in instruction and assessment.

UTEM involves a two-year, full-time program of study with a non-standard scheduling format. University course work alternates on a weekly basis with field-based internships in a broad range of early intervention and early education placements throughout the two-year program. Each semester provides an opportunity for intensive study of one age group: birth to 3, 3-5, and 5-8. Students completing the program are awarded a masters degree with licensure in Early Childhood education, Early Childhood Special Education and English as a Second Language.

University course work is organized into five strands linking curriculum materials and field experiences. These strands are:

1. Transforming Schools and Communities;
2. Universality/Diversity in Child and Family Development;
3. Language Acquisition, Communication, Literacy and Literature;
4. Developmentally-Appropriate Programs and Practices; and
5. Transdisciplinary Perspectives on Assessment and Evaluation.

The strands consolidate the major theories and understandings of the separate disciplines. Interwoven throughout each strand is an appreciation for child and family diversity; an emphasis on collaboration with family, other caregivers, and related professionals; and an emphasis on technological adaptations and applications in early childhood education and intervention.

*The community's partnership with the university provides feedback on all aspects of the program. UTEM is accepting applications for admission into the program for the Fall 1997 semester. Application review begins April 1, 1997. Limited financial assistance is available through graduate assistantships. Please direct questions or requests for information to Dr. Eva K. Thorp or Dr. Sylvia Y. Sánchez at (703) 993-1976 or e-mail to <ethorp@wpgate.gmu.edu> or <ssanche2@gmu.edu>.*

« NABE »

- Tests and Portfolios, Too." *Teaching PreK-8* Sept. 1994: 152-154.
- Hill, Bonnie. "Ways to Make Student Portfolios More Meaningful & Manageable." *Instructor* July/August 1994: 118-121.
- Larisey, Marian, M. "Student Self-Assessment: A Tool for Learning." *Adult Learning* July/August 1994: 9-10.
- Malehorn, Hal. "Ten Measures Better Than Grading." *ClearingHouse* July/August 1994: 323-324.
- Ogle, Donna. "Assessments: Helping Our Students See Their Learning." *Teaching PreK-8* October 1994: 100-101.
- Richard-Amato, Patricia. (1988). *Making It Happen*. New York: Longman.
- Statman, Daniel. "Self-Assessment, Self-Esteem, and Self-Acceptance." *Journal of Moral Education* Nov. 1993: 55- 62.
- Wilson, Linda. "What Gets Graded is What Gets Valued." *The Mathematics Teacher*. Sept. 1994: 412-414.

**Editor's Note:** Contributions to the Administration of Bilingual Education Programs column should be sent to the column editor, Dr. Jaime A. Castellano, at Palmetto Elementary School, 835 Palmetto Street, West Palm Beach, FL 33405. (407) 533-6372.

« NABE »

## SEPARATE/UNEQUAL FROM PAGE 31

In effect non-English-speaking students are expected to put their minds aside — not to learn the academic concepts other children their age learn—because first they must learn English. This is equivalent to retaining students in the same grade until they know enough English to learn reading, math, science, and social studies exclusively through that language. Unfortunately, these children never catch up to their age group with such a severe gap in instruction. Eventually, they fail to graduate. The harmful effects of such an educational program are well documented.

The practice of separate and unequal public schooling for children who cannot understand, speak, or learn through the English language only should cease. In California, such practices have been eliminated through clear and precise policies by the State Board of Education and through legal compliance directives from the State Department of Education.

Teachers and administrators, as well as school board members, should enforce the laws on the books, such as the laws in the California Education Code. Teachers, administrators and board members must be held accountable for fully enforcing the laws that further education for all children and excluded none. But policies, directives, laws, and court mandates are not enough. Each of us must understand the critical norms in child and language development that such practice violate.

*Carmen Sánchez Sadek, Ph.D., is an Educational Consultant/Program Evaluator in California.*

« NABE »

**Subscribe to NABE's ACTIONALERT  
electronic mailing list to keep up to date with  
Congressional developments affecting education -  
send email to <nabe@nabe.org> with  
"subscribe actionalert" as the subject.**



# NATIONAL ASSOCIATION FOR BILINGUAL EDUCATION

## MEMBERSHIP APPLICATION

1

### Membership Type *(check one only)*

- \$48 Individual Membership
- \$30 Discounted Individual Membership
  - Parent:** must not be professional educator and must have a child currently enrolled in a bilingual education program. A letter written on school stationery from either the teacher or a school administrator must accompany the NABE membership application.
  - College/University Student:** must not be professional educator and must be enrolled on full-time basis. A copy of an official college or university document showing current enrollment status must accompany the NABE membership application.
  - Paraprofessional:** Must be working as an instructional aide in a public school system. A letter on school stationery from the supervising teacher or a school administrator must accompany the NABE membership application.
- \$43 Combined Membership Name of Affiliate: \_\_\_\_\_
- \$125 Institutional Membership
- \$1000 Lifetime Membership

Memberships are valid for one year from the date of processing, and include one year subscription to NABE publications (except Lifetime, valid for life of member and includes lifetime subscription). Organizational membership is non-voting; all other memberships are voting. All memberships are non-transferrable and may not be cancelled. Membership dues are non-refundable.

### Name and Address Information

- 2
- Mr.
  - Mrs.
  - Ms.
  - Dr.
- \_\_\_\_\_
- Last    First    Middle

3 Preferred Mailing Address:       Business       Home

**Business Address**

Position: \_\_\_\_\_

Division: \_\_\_\_\_

Organization: \_\_\_\_\_

Street Address: \_\_\_\_\_

City: \_\_\_\_\_ State: \_\_\_\_\_ Zip: \_\_\_\_\_

Phone: (\_\_\_\_) \_\_\_\_\_ Ext. \_\_\_\_\_

Fax: (\_\_\_\_) \_\_\_\_\_ E-Mail: \_\_\_\_\_

### Home Address

Street Address: \_\_\_\_\_

City: \_\_\_\_\_ State: \_\_\_\_\_ Zip: \_\_\_\_\_

Phone: (\_\_\_\_) \_\_\_\_\_

4 I am involved with bilingual education as *(check one)*

- Administrator
- College Instructor
- Consultant
- Full-Time Student
- Paraprofessional
- Parent/Community member
- Publisher Staff
- School Board Member
- Teacher
- Other

5 I work in this type of organization *(check one)*

- Commercial organization
- College/university
- Local school district
- State education agency
- Other

6 I usually work with this level of student *(check one)*

- Early childhood
- Elementary
- Secondary
- Higher education
- Adult

7 I want to participate in the following Special Interest Group *(check one)*

- Adult/Vocational Education
- Asian & Pacific Islanders
- Critical Pedagogy
- Early Childhood Education
- Elementary Education
- ESL in Bilingual Education
- Gifted Education
- Global Education
- Higher Education
- Instructional Technology
- Language/Culture Retention
- Language Policy
- Parent & Community
- Policy Makers
- Professional Development
- Research & Evaluation
- Secondary Education
- Special Education

8

### Payment Information

\$ \_\_\_\_\_ Membership dues

\$ \_\_\_\_\_ Contribution to help NABE counter the English-only movement

- Check or money order    Check# \_\_\_\_\_
- Institutional purchase order # \_\_\_\_\_
- MasterCard                       VISA    ExpirationDate: \_\_\_\_\_/\_\_\_\_\_/\_\_\_\_\_
- Automatic Renewal: Check this box if: you are paying by credit card, and you want NABE to automatically renew your membership annually, charging your credit card the standard renewal amount. This permission will remain in effect until you cancel it in writing.

\$ \_\_\_\_\_ TOTAL DUE

9

SIGNATURE: \_\_\_\_\_ DATE: \_\_\_\_\_/\_\_\_\_\_/\_\_\_\_\_



to: NABE, 1220 L STREET NW, SUITE 605, WASHINGTON, DC 20005-4018

# ANNOUNCEMENTS

## NABE '97 CONFERENCE SPONSORS

### Diamond Sponsors

Houghton-Mifflin Company  
Scholastic, Inc.

### Gold Sponsors

Embassy of Mexico  
Macmillan/McGraw-Hill School Division  
Simon & Schuster Publishing Group  
Talk, Inc.

### Silver Sponsors

Hampton-Brown Books  
Harcourt Brace School Publishers  
SRA /McGraw-Hill  
Scott Foresman/Addison-Wesley  
SpanPress  
US West Communications

### Conference Supporters

American Federation of Teachers  
Fannie Mae Foundation  
Isleta Gaming Palace  
Jostens Learning

### Special Event Sponsors

Scholastic, Inc.  
*Bilingual Instructional Assistant of the Year*  
*Bilingual Teacher of the Year*  
*NABE '97 Conference Poster*  
Albuquerque Hispano Chamber of Commerce  
*Community Education Festival*  
Embassy of Mexico  
*Educational Trips for Bilingual Teacher of the Year and*  
*Bilingual Instructional Assistant of the Year*  
Celebration Press  
*Registration Tote Bags*  
Embassy of Spain  
*Scholarship Award for Bilingual Teacher of the Year*  
Talk, Inc.  
*Simultaneous Interpretation Equipment*  
US West Communications  
*Telecommunications*

### Cooperating Agencies

Albuquerque Convention & Visitors Bureau  
Albuquerque Hispano Chamber of Commerce  
Albuquerque Public Schools  
Belen Public Schools  
Comprehensive Regional Assistance Center,  
New Mexico Highlands University  
Las Lunas Public Schools  
New Mexico Association for Bilingual Education  
University of New Mexico

### ***NABE NEWS***

National Association for Bilingual Education  
Suite 605  
1220 L Street, N.W.  
Washington, D.C. 20005-4018

NON-PROFIT ORG.  
U.S. POSTAGE  
PAID  
WASHINGTON, DC  
PERMIT NO. 4555

KATHLEEN M. MARCOS  
ERIC CLEARINGHOUSE ON LANGUAGES & LINGUI  
1118 22ND ST NW  
WASHINGTON DC 20037-1214





# NABE NEWS

The news magazine about educational equity and excellence through bilingual education

March 15, 1997

National Association for Bilingual Education

Volume 20, Number 5

## NABE Establishes BEST

### Bilingual Education Student Trust Fund Announced at NABE '97

by Jaime de la Isla

The establishment of a new trust fund known as BEST—Bilingual Education Student Trust—was officially announced at the NABE'97 Conference held in Albuquerque, New Mexico, February 4-8, 1997. Mr. Richard Robinson, President and CEO of Scholastic, Inc., made this special announcement before a capacity crowd at the Albuquerque Convention Center during the first general assembly. This educational trust fund will invest prize monies and disperse awards to future winners of NABE's Nationwide Writing Contest for Bilingual Students. As the lead corporate sponsor of BEST, Mr. Robinson pledged \$25,000 for scholarship awards to be presented to essay winners. NABE presented its 1996 Corporate Responsibility Award to Richard Robinson and Scholastic, Inc. in recognition of their efforts to promote educational excellence for bilingual students.

Approximately 135 bilingual students throughout the country have received scholarship awards since the inception of the Nationwide Writing Contest for Bilingual Students in 1982. Jaime de la Isla, Assistant Superintendent in Houston and

national coordinator of the NABE essay contest, introduced Mr. Robinson to the audience. Mr. de la Isla explained that the program has provided an academic challenge to tens of thousands of bilingual students in schools across the nation, affording them an all too rare opportunity to win national recognition for their important language-learning accomplishments. Through the efforts of Dr. Kathy Escamilla at the University of Colorado at Denver to identify and survey former essay winners, NABE is clearly aware that the essay contest and scholarship program has made a profound impact on the lives of its past winners. During his presentation, Mr. de

la Isla announced modifications in the program. This year, the deadline for submission of essays for national judging will be June 15, 1997. Essays will be judged during the summer and awards will be announced in the Fall. He also announced a new, permanent theme for the essays: "Proud to Be Bilingual." Bilingual educators throughout the country will receive details of this year's contest in the spring.

The NABE essay contest and scholarship program has been built upon the successful partnership between NABE and *The Coca-Cola Company*, with the support of Apple Computer, Inc. for the past

CONTINUED ON PAGE 30

## In Memorium

*It is with great sadness that NABE announces that Dr. Ramón L. Santiago passed away after a long battle with cancer on March 12, 1997. Dr. Santiago served NABE for two decades in the official positions of Treasurer, Vice President, President-Elect, President, Past President, and Conference Chairperson as well as the unofficial positions of advisor, mentor, and supporter. He was a recipient of a 1991 NABE Pioneer Award and was the 1996 NABE Honoree. The following is reprinted from NABE's 1996 Conference Program.*

Dr. Ramón Santiago was the unanimous and enthusiastic choice of the Association's Executive Board of Directors as 1996 NABE Honoree. His nomination, made by the three most tenured Association staff — Carolyn Riddick, Office Manager; Jim Lyons, Executive Director & Legislative and Policy Counsel; and Nancy Zelasko, Deputy Director & Conference Director — summed up his contribution to NABE in the following few words: *Ramón*

*Santiago is the foundation of NABE.*

Ramón Santiago says that his "life with NABE" is the result of fate, "many people-made miracles and a few that were divine."

In 1952, the Santiago family — Ramon, his parents, five sisters and two brothers — moved from the Island of Puerto Rico to New York City. Ramón couldn't enroll in junior high school because of missing school records. He occupied his time serving

CONTINUED ON PAGE 37

### ISSUE HIGHLIGHTS

**NABE '98  
Call for Papers..... 21**

**Student Writing Contest  
Application..... 30**

# NABE NEWS

Published by the  
National Association for  
Bilingual Education

**Editor:**  
Nancy F. Zelasko, Ph.D.  
**Desktop Publishing & Layout:**  
Jeff Spence

## NABE NEWS REPRINT AND EDITORIAL POLICY

Readers are welcome to reprint non-copy-righted articles which appear in *NABE NEWS* at no charge, provided proper credit is given both to the author(s) and to *NABE NEWS* as the source publication.

All articles printed in *NABE NEWS*, unless written by an Association staff person or a member of the current NABE Executive Board of Directors, are solely the opinion of the author or authors, and do not represent the official policy or position of the National Association for Bilingual Education. Selection of articles for inclusion in *NABE NEWS* is not an official endorsement by NABE of the point(s) of view expressed therein.

## TABLE OF CONTENTS

<b>BEST Established</b> .....	1
<b>Memoriam: Ramón Santiago</b> .....	1
<i>Message from the President</i> .....	3
<b>NABE '97</b> .....	5
<b>Supreme Court &amp; AZ Case</b> .....	7
<b>NABE Order Form</b> .....	8
<b>Bilingual NEWS</b> .....	9
<b>Portraits of Success Project</b> .....	10
<i>Administration</i> .....	13
<i>Asian/Pacific American</i> .....	17
<i>ESL in Bilingual Education</i> .....	19
<i>Call for '98 Papers</i> .....	21
<i>Successful Practices</i> .....	25
<b>1997 Writing Contest</b> .....	29
<i>Parental Involvement</i> .....	31
<i>Book Reviews</i> .....	33
<b>Upcoming Events</b> .....	39
<i>American Indian</i> .....	41
<b>Membership Application</b> .....	43
<b>Announcements</b> .....	44

## PUBLICATION SCHEDULE

Volume 20 of *NABE NEWS* will be published in 8 issues; publication dates are:

Issue 1	09/15/96	Issue 5	03/15/97
Issue 2	11/01/96	Issue 6	05/01/97
Issue 3	12/15/96	Issue 7	06/15/97
Issue 4	02/01/97	Issue 8	08/01/97

All advertising and copy material must be received in the NABE office **ONE MONTH** prior to publication date to be considered for inclusion.

## NABE NEWS ADVERTISING

### Display Advertising Rates (Camera-Ready)

Full Page (7.5" x 10")	\$850
2/3-Page (4.75" x 10")	\$700
1/2-Page (7.5" x 4.5")	\$550
1/3-Page (4.75" x 4.75")	\$425
1/3-Page (2.25" x 10")	\$425
1/4-Page (3.5" x 4.75")	\$325
1/6-Page (2.25" x 4.75")	\$250

### Classified Advertising

\$1.25 per word; maximum 100 words

### Advertising Discounts (for multiple insertions)

10% for second-third; 15% for fourth-fifth;  
20% for sixth-eighth

NABE reserves the right to reject any advertisements which it deems inappropriate and/or inconsistent with the goals of the Association. For additional information, contact NABE at (202) 898-1829 x136.

## NABE

The National Association for Bilingual Education (NABE) is a tax-exempt, non-profit professional association founded in 1975 to address the educational needs of language-minority Americans.

### NABE NATIONAL OFFICE

1220 L Street, N.W., Suite 605  
Washington, DC 20005-4018

PHONE (202) 898-1829

FAX (202) 789-2866

E-mail: NABE@nabe.org

**James J. Lyons, Executive Director**  
Nancy F. Zelasko, Deputy Director  
Jaime Zapata, Associate Director for Legislation  
Jeff Spence, Information Systems Director  
Carolyn Riddick, Office Manager  
Celia Torres, Membership Specialist  
Mina Cousins, Membership Specialist  
Ronald Williams, Office Assistant  
Teresa Sola, Receptionist

## NABE EXECUTIVE BOARD 1996 - 1997

### President

Janice Jones Schroeder  
429 Wabash Avenue  
Kenmore, NY 14217  
(716) 875-1882  
nabepres@aol.com

### Vice President

Mary F. Jew  
San Francisco USD  
300 Seneca Avenue  
San Francisco, CA 94112  
(415) 469-4000  
mjew@sfusd.k12.ca.us

### Secretary/Treasurer

David E. Báez  
Director, Foreign Language & Bilingual  
Education  
Buffalo Public Schools  
731 City Hall  
Buffalo, NY 14202  
(716) 851-3704  
dbaez@buffnet.net

### Member-at-Large

Joe J. Bernal  
6410 Laurelhill  
San Antonio, TX 78229  
(210) 342-8026  
bowlingod@ix.netcom.com

### Member-at-Large

María Estela Brisk  
School of Education  
Boston University  
605 Commonwealth Avenue  
Boston, MA 02215  
(617) 353-3260  
brisk@acs.bu.edu

### Member-at-Large

Nga Dinh Duong  
21724 58th Avenue West  
Mountlake Terrace, WA 98043  
(206) 771-2095

### Member-at-Large

Hermán S. García  
Department of C & I  
College of Education  
New Mexico State University  
Las Cruces, NM 88003  
(505) 646-2115  
hgarcia@cnmailsvr.nmsu.edu

### Member-at-Large

Susan García  
18094 East Ohio, #102  
Aurora, CO 80012  
(303) 745-7116  
susangarcia@unitedwaydenver.org

### Parent Representative

Adela B. Holder  
Silver Consolidated School District  
2810 N. Swan Street  
Silver City, NM 88061  
(505) 388-1527  
sncadavi@arriba.nm.org

# Message From The President

## Sharing our Stories

by Janice Jones Schroeder

Another NABE conference is behind us. From the feedback that I have heard in my travels, it was one of our best conferences ever! Again, a lot of thanks to all the individuals that contributed to the success of the conference. I trust that each of you benefited from the conference and you were able to find something of interest and personal growth. Meeting and greeting old and new friends. And maybe you were able to enjoy a taste of the Southwest (i.e., the chiles). There were several changes in the conference format this year, namely the half day institutes and the community day. In case you got home and realized that there were comments you could or should have made on your evaluation, we would appreciate your feedback. We are always looking for ways to improve the conference and do welcome any constructive comments. Feel free to write or e-mail me directly.

After the conference was over, I flew directly to Alaska, to participate in their annual bilingual conference. There were three speakers who I especially enjoyed and I have their permission to share excerpts from their speeches with you. I also attended the California Association for Bilingual Education conference, where more than 12,000 were in attendance. Congratulations to CABE!

### *Voices of the Wisdomkeepers*

by Larry (Kuuyux) Merculieff  
(excerpts from speech given at Alaska's Annual Bilingual Multiculture Equity Education Conference)

I am an Aleut, born and raised on St. Paul Island in the Pribilofs. My Aleut name, *Kuuyux*, was given to me by the only living Aleut medicine man. I believe that the issues and questions you explore in this forum are some of the most important we can consider in our lives. I applaud all of you who take the time to be at this conference. I was blessed to have had a

traditional upbringing as well as a Western education. I have spent my life in both worlds. My work in the past few years is involved in bringing messages from the Wisdomkeepers in an effort to build bridges between peoples with different worldviews and group mediation.

I listen to the elders very carefully and I pay attention to the wisdom of their advice — which is rarely offered. Among my people, it is considered undignified to single oneself out in a group or to talk too much. One of my good friends and respected elders told me that anyone who has to get up in front of a group and read from a piece of paper has no business being in front of the group. I am violating these great wisdoms here today because of requests for copies of my presentation and because talking is what a keynote speaker does. So I hope my teachers forgive me for my temporary insanity in doing what I am about to do. The other editorial note that I wish to make is that I have agreed to serve as a messenger for what we call Wisdomkeepers, and part of the obligation I have taken on is to offer some important messages at every forum I make presentations. As a matter of fact, the messages I am about to share with you concern the kinds of things being considered at this conference — multiculturalism, equity, parity between the genders, youth, partnerships, intercultural relations, and visions for the future. Some of you may have heard me present this message before. That is okay because the elders understand that repetition is the mother of learning. This is why, as a child, I listened to the elders tell the same stories over and over again in a variety of ways. I learned something every telling, and I continue to learn from them in the remembering. Sto-

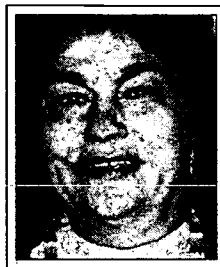

NABE Executive  
Board President  
Janice Jones  
Schroeder

ries from elders have a quality which is much like looking at a diamond — what we see is a diamond, but what it reflects back to us depends on the position and lightning we use to look and our frame of mind in the moment. The Wisdomkeepers want people to know that we are moving into a Fifth World or a Shift of the Ages. The Wisdomkeepers around the world know it is a time of reconnection of the four sacred colors and changes which will be unprecedented in human history. As we move into the World of the Fifth Hoop, there will be dramatic changes in our life guiding paradigms, our worldview, our institutional structures, our spirituality, our technological-educational-and economic systems, our sense of time, our relationships, our career paths, our emotional and physical senses, and the physical realities expressed by Mother Earth. There will be large climactic changes, unusual weather phenomena, increased frequency and intensity of earthquakes/volcanic/floods/wind storms and the like. This may sound like the end to some, but the Wisdomkeepers know this time to be one of new beginnings and renewed hope for the enlightenment of humankind. Our people have always known that life begets death which begets life and new beginnings are always marked by death of something old. It may be a spiritual death, a physical death, an emotional death — but it is all death of the old which is necessary to bring something new.

*The signs and manifestations of this time are many:*

- The nature and quality of relationships between friends, colleagues, and family are changing for everyone.
- Our sleep patterns are changing.
- Young people are beginning to speak with the wisdom of elders.
- Women are being restored to their place as the original healers throughout the world, and moving into positions of leadership in ways not experienced for thou-

CONTINUED ON PAGE 20

# DISCOVER PERMA-BOUND BOOKS

## FOR YOUR BILINGUAL STUDENTS



**W**hen looking for a great selection of affordable titles for bilingual students, our Pre-Kindergarten-12 selection is great - including over 2,000 books in Spanish, plus Chinese, Vietnamese, French, German, Italian, and more.

- ❖ TRANSLATIONS
- ❖ ORIGINAL WORKS
- ❖ SHORT STORIES
- ❖ NOVELS
- ❖ SCIENCE
- ❖ DICTIONARIES
- ❖ BILINGUAL READERS
- ❖ VALE - IBM WRITING TO READ

Now Available! Books in Spanish to accompany Accelerated Reader Program

One PERMA-BOUND book will outlast seven to ten paperbacks at about one-third the cost-and they're unconditionally guaranteed. If you're ever dissatisfied with a PERMA-BOUND book for any reason we'll replace it.

142 VANDALIA ROAD ❖ JACKSONVILLE, ILLINOIS 62650  
CALL TOLL FREE: 1-800-637-6581 TOLL FREE FAX: 1-800-551-1169

**PERMA-BOUND**

# NABE '97 Conference — Simply Enchanting

by Nancy F. Zelasko, Ph.D.

NABE Deputy Director & Conference Coordinator

**N**ABE '97 — the 26th Annual International Bilingual/Multicultural Education Conference — attracted more than 6,000 people to Albuquerque, New Mexico, *The Land of Enchantment*, last month. Drawing upon the most multicultural, multilingual gathering in America, NABE '97 focused on the theme of *Building Learning Communities Through Technology, Language, and Culture*.

The five-day event included more than 200 workshops, symposia, papers and demonstrations; a major materials and educational products exhibition; a technology lab; school visits to exemplary programs for language-minority students, and a National Professional Development Institute sponsored by the U.S Department of Education, Office of Bilingual Education and Minority Languages Affairs.

"This conference was a demonstration of the power of learning communities and the essential role of 'TLC' (technology, language and culture) in enabling all children and their families to fully participate as partners with schools and the wider community to the benefit of our nation," stated James J. Lyons, NABE Executive Director.

The Opening Ceremonies for NABE '97 included a welcoming reception sponsored by the Albuquerque Hispano Chamber of Commerce, the Albuquerque Convention & Visitors Bureau, and the City of Albuquerque.

One of the highlights of NABE's 26th Annual Conference included an announcement by Richard Robinson, President of Scholastic, Inc., regarding the establishment of the BEST —The Bilingual Education Student Trust (see article on page 1 of this issue). The BEST will invest prize monies and disperse awards to future winners of NABE's Nationwide Writing Contest for Bilingual students.

The conference's keynote speakers all emphasized the importance of bilingual education and bilingualism, technology, and families to the future of the United States. Albuquerque Mayor Martin Chávez, California Department of Education Deputy Superintendent Henry Der, Navajo Nation Vice President Tom Atcitty and representatives from the California Hispanic Drop Out Prevention Project each stressed the need for native language instruction and development for the benefit of students, their families, and our country.

Featured speakers included:

- Drs. Virginia Collier and Wayne Thomas, authors of the largest and most comprehensive study on the effectiveness of bilingual education;
- Stephen Krashen, researcher and author of *The Case Against Bilingual Education*
- Leanna Traill, New Zealand Literacy Expert
- Bill Rojas, Superintendent, San Francisco Unified School District
- Rubén Donato, Professor, University of Colorado

- L. Ling-Chi Wang, Professor, University of California, Berkeley
- Kathleen Ross, President, Heritage College
- Stephen Greymorning, Professor, University of Montana
- Sammy Quintana, President, National School Boards Association
- Dave Williams, Vice President, Intel
- Lily Wong Fillmore, Professor, University of California, Berkeley
- Guadalupe Valdés, Professor, Stanford University

The NABE '97 Technology Lab, located in the Exhibit hall, was a new feature of the NABE Conference, and offered attendees hands-on access to the Internet and World Wide Web. The NABE Instructional Technology Special Interest Group (SIG) provided Lab assistants to help attendees whose Internet or computer experience was limited. Developers of the Bilingual Education Network Web site assembled a special new Web site just for the NABE '97 Technology Lab. In addition, the *Network New Mexico* NetDay project (a local non-profit organized as part of a national project to connect the country's schools to the Internet) offered exhibits and hands-on demonstrations in their exhibit area adjacent to the Lab. NABE would like to thank the following organizations whose assistance and support made this Lab possible: US West Communications Services Incorporated, Apple Computer Incorporated, Compaq Computer Corporation, Intel Corporation, Albuquerque Public Schools Technology Department, Network New Mexico and, of course, NABE's Instructional Technology SIG, chaired by Ana Bishop.

Other conference highlights included the following:

- Presentation of the NABE Honoree Award to Drs. Virginia Collier and Wayne Thomas of George Mason University in recognition of their significant contributions to the body of research on bilingual education.
- Presentation of the NABE Citizens of the Year Award to Representative Xavier Becerra, Senator John McCain and Senator Edward Kennedy for their leadership in protecting language rights and their many contributions to the field of bilingual education.
- Presentation of the NABE President's Award to the Government of Mexico for its longstanding support of bilingual education programs and its proactive efforts to improve social conditions for Mexican-Americans and other language-minority individuals residing in the U.S.
- Recognition of the 1997 Bilingual Teacher of the Year, Ezekial "Zeke" Pérez, a Bilingual Kindergarten Teacher in the Houston Independent School District.
- Recognition of the 1997 Bilingual Instructional Assistant of the Year, Phyllis Garanzuay, from Walla Walla, Washington.
- Outstanding school visits to model programs for language-minority and language-majority students, a student art exhibition and a variety of student entertainment

CONTINUED ON PAGE 6

by Albuquerque-area school children.

As always, the NABE Exhibit Hall — with more than 300 booths — was one of the busiest places at the conference. Exhibitors and job fair employers represented showcased a wide array of educational materials, products and services as well as career opportunities. NABE would like to gratefully acknowledge NABE '97 Diamond Sponsors, Scholastic, Inc. and Houghton Mifflin Company for their continued generous support. Gold Sponsors included the Government of Mexico, Macmillan/McGraw-Hill, Simon & Schuster, and



Talk Systems, Inc. Among the Silver Sponsors were Hampton-Brown Books, Harcourt Brace School Publishers, SRA/McGraw-Hill, ScottForesman-Addison Wesley/Celebration Press, Southwestern Bell Telephone, SpanPress, and US West Communications. Conference Supporters included the American Federation of Teachers, Coors Brewing Company, the Fannie Mae Foundation, the Isleta Gaming Palace, and Jostens Learning.

Additional support came from Scholastic, Inc., sponsor of the Bilingual Instructional Assistant of the Year and

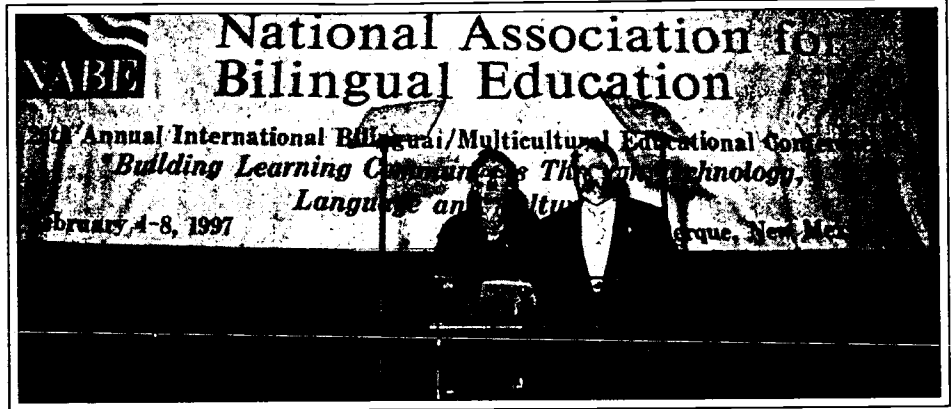

Bilingual Teacher of the Year contests as well as the 1997 conference poster. The Greater Dallas Convention and Visitors Bureau sponsored the exhibitors' lounge and the Dallas Community sponsored the post-banquet dance. CelebrationPress, was this year's sponsor of the registration tote bags. Apple Computer, Compaq Computer, and Intel made generous donations of computers and equipment for the technology lab, registration, and concurrent sessions; Coors Brewing Company sponsored an outstanding evening of entertainment on Friday. The Embassy of Mexico provided an educational trip for the Bilingual Teacher and Bilingual Instructional Assistant of the Year; and the Embassy of Spain which donated a scholarship to a summer institute in Spain for the Bilingual Teacher of the Year. The Navajo Nation generously sponsored Thursday evening's Pow-Wow. Speakers' appearances were supported by the Albuquerque Public Schools, Pan Asian Publications, and Simon & Schuster.

As you come into contact with these companies throughout the year, express your appreciation for their support of NABE and bilingual education.

The conference would not have been a success without the support of the Albuquerque Public Schools, which provided countless contributions including transportation for the school visits, and the dedication of all the volunteers who spent more than a year planning for NABE '97. Deepest appreciation goes to Paul Martínez, NABE '97 Local Conference Committee Chairperson, and the staff of the Southwest Comprehensive Center at

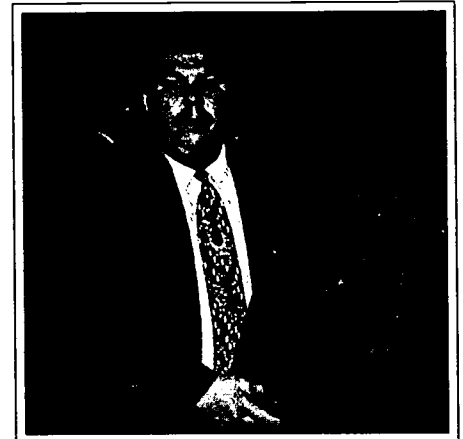

New Mexico Highlands University.

Special thanks also to Theresa and Leroy Lucero and to Susan López (School Visits), Andrew González (Session Monitors), Lorenzo Montoya (Special Events), Janet Kahn (Student Artwork), Reeve Love and Virginia Durán Ginn (Student Entertainment), Yvonne McCloud (VIP Committee) and Cathy Gonzales and Genaro Roybal (Community Education Festival).

NABE '98 — NABE's 27th Annual Conference — will be held February 24-28, 1998 at the Dallas Convention Center in Dallas, Texas. Mark your calendars now!

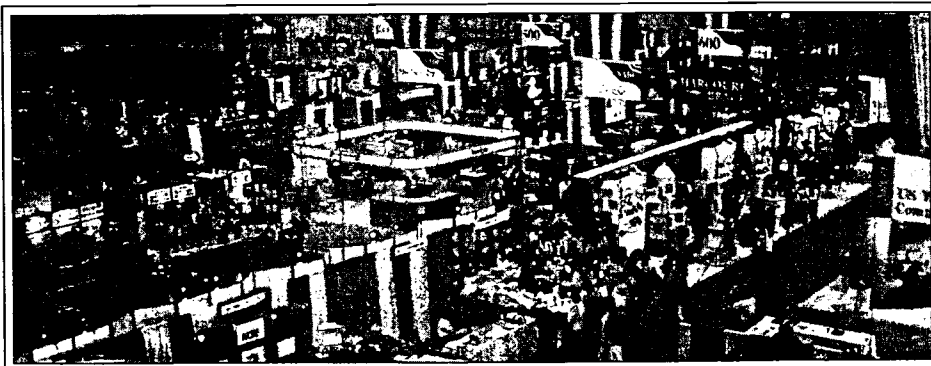



# Supreme Court Punts in Arizona Case

by James Crawford

On March 3, 1997 the U.S. Supreme Court declined to rule on the constitutionality of Arizona's English Only amendment — in effect, dismissing the case after eight years of litigation without ruling on its merits.

Article 28 of Arizona's constitution — also known as Proposition 106, adopted by voters in 1988 — requires all levels of state and local government to “act in English and no other language.” Two lower federal courts have overruled the measure as a violation of the First Amendment right to freedom of speech for state employees and elected officials. But the Supreme Court threw out those decisions on procedural grounds.

The unanimous, 35-page opinion by Justice Ruth Bader Ginsburg sets new limits for federal court review of state laws — an apparent victory for foes of “judicial activism.” Clearly, during oral arguments last December, the justices were more intent on sending such a message than on reviewing the constitutional issues raised by *Arizonans for Official English v. Arizona* (Case No. 95-974).

For now the practical impact will be negligible, according to Arizona's attorney general, Grant Woods. A separate challenge to Article 28, *Ruiz v. Symington*, is under consideration by the Arizona Supreme Court and the measure has already been ruled unconstitutional by a lower state judge. So, until that case is resolved, the English Only amendment will not be enforced, Woods told the *Arizona Daily Star*.

Any decision by the Arizona Supreme Court could, of course, be appealed to the U.S. Supreme Court — further delaying a final disposition of the case.

In the decision Justice Ginsburg cited several flaws in the rulings of the federal district court for Arizona and the Ninth U.S. Circuit Court of Appeals:

- Maria-Kelly Yñiguez, the Spanish-speaking state employee who brought the case, suffered no injury under the English Only policy and left her job in 1990.

Thus the lower courts should have recognized there was no longer any “case or controversy” — a requirement in federal litigation — and should have dismissed the case as “moot.”

- After Governor Rose Mofford decided not to appeal the district court's ruling against Article 28, the Ninth Circuit erred in allowing the political action committee that sponsored Proposition 106 to do so. Ginsburg expressed “grave doubts” about the legal “standing” of the group, *Arizonans for Official English*.
- A 1989 opinion by Arizona's attorney general minimized the restrictive impact of Article 28, arguing that it would not prohibit employees from using languages other than English “to facilitate the delivery of government services.” But this narrow reading, which seemed to contradict the express wording of the English Only amendment, was rejected by the federal courts. Instead, they should have deferred to the Arizona Supreme Court on how to interpret the measure, Ginsburg said.

Theoretically, it might still be possible for other aggrieved employees — who still work for the state of Arizona — to file another lawsuit in federal court alleging injury under Article 28. But Peter Tiersma, of Loyola Law School, says that according to Ginsburg's opinion, federal judges “would have to await an authoritative interpretation from the Arizona court.”

The *Ruiz v. Symington* case, now before the Arizona Supreme Court, includes as plaintiffs several state lawmakers currently in office. These include senators Victor Soltero (D-Tucson) and Joe-Eddie López (D-Phoenix) and Rep. Linda Aguirre (D-Phoenix). This lawsuit, which had been on hold pending a ruling by the U.S. Supreme Court, is expected to proceed expeditiously.

Meanwhile, back in Washington, the political impact of the decision is diffi-

cult to gauge. Last year Congressional opponents of English Only legislation argued against voting on such measures until the Supreme Court had ruled in the Arizona case. The House went ahead and passed H.R. 123, the “English Language Empowerment Act of 1996,” by a 259-169 vote. But the Senate failed to act before adjournment and so the bill died.

H.R. 123 has been reintroduced in the 105th Congress. But thus far it appears to lack influential backers. The lead sponsor, Rep. Randy “Duke” Cunningham (R-CA), has a new committee assignment and no longer chairs the subcommittee on Early Childhood, Youth, and Families, which has jurisdiction of the bill. The new chairman, Rep. Frank Riggs (R-CA), is said to have little interest in English Only legislation. The same is true of Rep. William Goodling (R-PA), chairman of the full committee on Education and the Workforce, which would have to approve the bill. At this writing no action has been scheduled. As became clear last summer however, all of this could change quickly under pressure from the House Republican leadership.

Sen. Richard Shelby (R-AL.) reintroduced a Senate version of the bill, S. 323, on February 13. But again a supportive committee chairman, Sen. Ted Stevens (R-AK), has moved on to greener pastures (Appropriations). His replacement at the helm of the Governmental Affairs Committee, Sen. Fred Thompson (R-TN) is not known as an English Only proponent. More important, Thompson will have his hands full this year running an investigation into campaign finance abuses in the 1996 election.

The Supreme Court decision in *Arizonans for Official English v. Arizona* is available at <<http://supct.law.cornell.edu/supct/html/95-974.ZS.html>> (synopsis), and <<http://supct.law.cornell.edu/supct/html/95-974.ZO.html>> (opinion).

*James Crawford is an author who writes on language policy issues. He may be contacted via E-mail at the following address: <73261.1120@compuserve.com>.*

• NABE •



# NABE PRODUCTS ORDER FORM

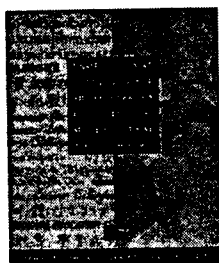

ITEM	PRICE	#	TOTAL
<b>PUBLICATIONS</b>			
<i>Bilingual Research Journal</i>	\$13.00		
Vol. 20, #1, Winter 1996 Current Journal Issue			
Vol. 19, #3&4, Spring/Summer 1995 Special issue: Role of ESL in Bilingual Education			
Vol. 19, #1, Fall 1994 Special issue: Native American Issues			
Vol. 16, #1&2, Spring/Summer 1995 Special issue: Ramirez study			
[ earlier issues available (call for details)]			
<i>NABE Annual Conference Journal</i>	\$7.00		
1989-90 issue			
1991-92 issue			
1992-93 issue			
<i>1997 Annual Conference Program</i>	\$5.00		
<i>NABE News</i>	\$5.00		
write issue date or volume/number here			
write issue date or volume/number here			
[current volume always available; earlier issues may also be available (call for specifics)]			
<i>Professional Standards for the Preparation of Bilingual/Multicultural Teachers</i>	\$5.00		
<b>PRODUCTS</b>			
NABE logo pins	\$5.00		
NABE bumper stickers			
"Proud to be Bilingual"	\$1.00		
"Orgulloso de ser Bilingüe"	\$1.00		
NABE canvas tote bags	\$5.00		
VIDEO: Making Connections: Learning, Language and Technology	\$7.00		
<b>TOTAL</b>			

- Prices include shipping by USPS first class mail. Special shipping available - call for pricing.
- Payment must accompany all orders. Make checks and purchase orders payable to NABE.
- Orders shipped to the District of Columbia must include 6% sales tax.
- Credit card orders may also be placed by phone (202 - 898-1829) during business hours.

## SHIPPING INFORMATION

Name \_\_\_\_\_ Company \_\_\_\_\_

Address \_\_\_\_\_

City/State/Zip \_\_\_\_\_ Phone \_\_\_\_\_

## PAYMENT INFORMATION

Check#: \_\_\_\_\_ PO#: \_\_\_\_\_ CC#: 146 ExpDate: \_\_\_\_\_

MAIL TO: NABE PRODUCTS, Suite 605, 1220 L Street NW, Washington, DC 20005-4018

# Bilingualism in the NEWS

## WI Governor Opposes State's English-Only Bill

By Georgia Pabst

**G**ov. Tommy Thompson on Wednesday, April 2, called the bill that would declare English the official state language divisive and said he opposed it.

"We have more important things to worry about, such as technology and (academic) standards, and this just divides," he told students during a visit to a math class at Bay View High School.

"Let the House of Representatives debate it. They don't have anything to do," he said with a grin.

Asked specifically whether he was against the measure, he said: "I'm against it.... We're trying to bring people together, and this would increase divisions. We have to work together."

Assembly Assistant Majority Leader Bonnie Ladwig (R-Racine) and Sen. Gary Drzewiecki (R-Pulaski) have reintroduced the measure in the Legislature this year. A similar bill cleared an Assembly committee in the last session but the full Assembly never debated it.

Kevin Keane, a spokesman for the governor, said Thompson had never stated his position on the bill before because he had never been asked about it.

Ladwig said Thompson's opposition disappointed her. She said she was not sure whether he has read the bill completely or whether he was relying only on what others have told him about it.

"I strongly disagree with people who say it's divisive and racist," she said. "To me, that's not the case at all. It brings the people of Wisconsin together. We're trying to build a common bond, and communication is extremely important."

Ladwig added that more than 200 languages were spoken in Wisconsin.

Some of the bill's opponents, including Rep. Antonio Riley (D-

Milwaukee), condemned the bill at a hearing Tuesday in Madison. Riley said the bill could mean that important information on disease and other health problems in Milwaukee's growing Hispanic and Hmong communities might not get printed.

The bill would require state and local governments to print materials in English, but they could print the materials in other languages as well, according to Ladwig.

### Math Scores Improve

Thompson came to the school to push for academic standards and proficiency tests, such as the math proficiency test that MPS seniors must pass.

By this time last year, 60% of the seniors at Bay View had passed the test; this year, 85% of the seniors have passed.

The school has helped its students improve their scores by offering tutoring sessions after school and extra math classes. Students who have passed the test also act as mentors for other students, providing them tips on preparing for the test.

Thompson noted that MPS received a lot of criticism around the country the first year it administered the test — when only 21% of the students passed on their first attempt.

Last year, 97% of MPS seniors met their math proficiency requirement. This year, 75% of the seniors have passed the exam, according to MPS officials. The test is given in December and March, and those who failed in December have another chance to take the exam next week.

"We salute MPS and the hard work of the faculty and students," Thompson told a class of juniors and seniors. "You set the standards for those who will follow."

Thompson also praised MPS and retiring Superintendent Robert Jasna for raising academic standards, pushing for proficiency testing and serving as an example to the rest of the nation.

## Official English? Why bother?

**T**wo Republican state lawmakers — Rep. Bonnie Ladwig of Racine and Sen. Gary Drzewiecki of Pulaski — apparently enjoy a surplus of idle time. How else to explain the energy they lavish on at best a needless effort to declare English Wisconsin's official language? Commendably, Republican Gov. Tommy Thompson is opposing this measure, which he aptly terms divisive.

Though toned down from earlier versions, the bill still has a racist whiff that mustn't gain the force of law. And it still might clog vital government communica-

tion with immigrants.

The argument Drzewiecki presented in behalf of the bill at a hearing the other day actually amounts to an argument against it. He noted that his ancestors spoke Polish, but that, when they came to America, they had to learn English so as to handle such basics as reading signs.

"They learned," he intoned. "They worked. They were willing to do so."

Bingo. Please note they achieved that feat without an edict declaring English to be Wisconsin's official language. Just as Drzewiecki's ancestors needed no such

law, today's immigrants don't need one, either.

Or is the senator arguing that today's arrivals are somehow different? If so, he should cite the evidence. The signs we see suggest that today's newcomers are just as eager to learn English as were Drzewiecki's forebears.

For instance, so many recent arrivals flock to Milwaukee Area Technical College courses teaching English as a second language that the school winds up turning away hundreds for lack of room. In fact, if

CONTINUED ON PAGE 28

147

# Bilingual Education: Portraits of Success Project

Column Editor: Dr. María Estela Brisk, Boston University, Boston, Mass.

## A Call for Nominations

by María Estela Brisk and  
Madeleine deMatteis

At NABE '97 we presented the concept of the project and its connections with other efforts in the field. The call for nominations was distributed and the audience had the opportunity to comment and give suggestions. María Brisk reiterated that purpose of this project is to report success in relation to *bilingual education* rather than with respect to language-minority children in general. It is a long term project that will require data collection, establishment of criteria for selection, establishment of a database and dissemination strategies. It will also link to existing efforts, such as those reported by Delia Pompa, Minerva Gorena, and Charlene Rivera.

Delia Pompa, Director of OBEMLA, informed the audience on Title VII efforts to develop a database on successful Title VII programs. OBEMLA has three main motivations or reasons behind collecting this type of information:

- to be able to testify before Congress and document both large and small successes (such as when a kid wins a science fair);
- to promote improvement among Title VII programs; and
- to show the quality of Title VII programs on a theoretical and pedagogical basis.

*The Bilingual Education: Portraits of Success Project* will cross-reference its information with the OBEMLA database. Information on OBEMLA's project can be found on its Web page <<http://www.ed.gov/offices/OBEMLA/>>.

Minerva Gorena, Associate Director of NCBE, explained that NCBE has publications, newsletters, and a web page. The NCBE can provide synthesized information as well as information in full text about success in bilingual education. They will also have links to NABE. NCBE's role in the project will be to lend their resources,

including their weekly newsletter on the Web <<http://www.ncbe.gwu.edu>>.

Charlene Rivera, Director of The George Washington University Center for Equity and Excellence in Education, explained their Promoting Excellence Project. The Center has developed a set of guidelines for schools to develop programs for bilingual students. She maintains that it is important to create a national dialogue about how language-minority children can be included in the discussion of excellence and education reform.

By joining these other efforts, NABE's Portraits of Success Project can bring to the table of education reform and excellence the specific relevance of bilingual education not only as supported by federal funding but the multiple state and local accomplishments.

Donna Christian, President of the Center for Applied Linguistics, closed the session with a few reminders:

- this is a developing project;
- we need everyone's contribution;
- it's important that the evidence of success be clear;
- we do not want to perpetuate the comparison of one program or model against another, so do not present your program in contrast to another; and
- because the purposes of this project are to inform the public and to have more sharing of information among educators, make the evidence you provide clear enough for the general public but also valuable enough for people in the field.

The audience contributed with a number of useful comments which are reflected in the new call for nominations form and in present efforts to expand our steering committee and more clearly define its role.

We invite all to participate in the first stage of this project by nominating a successful program or individual using the nomination form which follows.

Criteria for final selection into the database will be developed from a combination of established indicators and additional input from the field. The criteria for nomination that should be attached to the form are very important to us.

For more details about the project check our column in the *NABE News* beginning with the December 15, 1996 issue.

Steering Committee: María Estela Brisk, NABE Executive Board Member, Chairperson; Donna Christian, President, Center for Applied Linguistics; Minerva Gorena, Associate Director, National Clearinghouse for Bilingual Education (NCBE); Mary Jew, NABE Vice-President, San Francisco USD Delia Pompa, Director, Office of Bilingual Education and Minority Language Affairs (OBEMLA); Charlene Rivera, Director, The George Washington University, Center for Equity and Excellence in Education; Nancy Zelasko, Deputy Director, NABE; Graduate student assistant:, Madeleine deMatteis, Boston University.

• NABE •

### Bilingual Education

### Portraits of Success

### Nominations form and instructions

on

pages 11 and 12!

**NATIONAL ASSOCIATION FOR BILINGUAL EDUCATION**  
**BILINGUAL EDUCATION *PORTRAITS OF SUCCESS* PROJECT**  
**CALL FOR NOMINATIONS**

Nomination for:     school     program     teacher     student     graduate

other: \_\_\_\_\_

Name of nominee (if an individual): \_\_\_\_\_

Contact (person submitting form): \_\_\_\_\_

Title or relationship to nominee: \_\_\_\_\_

Organization: \_\_\_\_\_

Address: \_\_\_\_\_

City: \_\_\_\_\_

State: \_\_\_\_\_

Zip: \_\_\_\_\_

Phone: ( ) \_\_\_\_\_

Fax: ( ) \_\_\_\_\_

e-mail: \_\_\_\_\_

### 1. General Information

School (program) name: \_\_\_\_\_

School Address: \_\_\_\_\_

City: \_\_\_\_\_

State: \_\_\_\_\_

Zip: \_\_\_\_\_

School District: \_\_\_\_\_

Congressional District: \_\_\_\_\_

Principal: \_\_\_\_\_

Bilingual Program Director: \_\_\_\_\_

Number of students in school: \_\_\_\_\_ Grades: K 1 2 3 4 5 6 7 8 9 10 11 12

Number of students in bilingual program: \_\_\_\_\_ in grades: \_\_\_\_\_

Home language of students (if more than one, give number of students by language group):  
\_\_\_\_\_

Sources of Funding:     Federal     District/local     State     Private

Does your program receive Title VII funding?     yes     no

Has the nominated school, program, or individual previously appeared in any article,  
dissertation or study?     yes     no    If so, please cite below:  
\_\_\_\_\_

**2. Program Description** *(for school and program nominations):*

Please attach a typed description that explains the characteristics of your program and provides evidence of the program's success. Include information such as instructional approaches, language use (L1/L2 allocation), interaction between bilingual program and the larger school community, services for bilingual students, and any other feature you consider relevant. Please be sure to explain the criteria used for nominating this program as a successful one, whether it be student outcomes, awards to students or staff, presence of characteristics consistent with effective schools research, or a combination of the above.

**3. Individual Success Story** *(for teacher, student or graduate nominations):*

Please attach a typed description of the nominee that explains his/her participation in a bilingual program and provides evidence of his/her success. Include anecdotal information, if possible, on how this person has benefited from or made a difference in a bilingual program. Please be sure to explain the criteria used for nominating this individual as an exemplar of success in bilingual education, whether it be academic or professional achievement, personal growth, awards received, contributions to the bilingual program, or a combination of the above.

**4. Additional Contact Persons**

Please list any other individuals who would be available to add information to this nomination.

<u>Name</u>	<u>Title or Relationship to Nominee</u>	<u>Phone</u>
_____	_____	_____
_____	_____	_____
_____	_____	_____

**AUTHORIZATION STATEMENT**

"I hereby give NABE permission to publish and share this information with others and certify that its release does not violate the Federal Educational Records Privacy Act (FERPA)."

Signature: \_\_\_\_\_ Date: \_\_\_\_\_

Name: \_\_\_\_\_

nominee     program director     other: \_\_\_\_\_

**Return form to:**  
**María Estela Brisk**  
 School of Education, Boston University,  
 605 Commonwealth Ave., Boston, MA 02215 --- fax: (617) 353-3924

150

# Administration of Bilingual Education Programs

Column Editor: Dr. Jaime A. Castellano, Palm Beach County SD, West Palm Beach, FL

## *Reporting Content Area Progress of Non-English and Limited English Proficient Students Enrolled in English-Only Classes*

by Dr. Jaime Castellano

Little José has been enrolled in a third grade classroom in a large Florida school district for the past 15 weeks. He arrived with no record of formal schooling in his native country. The school district labeled José as non-English speaking, and gave him ESOL (English to Speakers of Other Languages) services, but only on a fragmented basis. José's teacher spoke no Spanish and taught all content areas in English. Today, José still struggles.

When second quarter report cards were issued in January of 1997, José's teacher was told by her principal to give him letter grades in the content areas. This caused a dilemma for his teacher. Her conscience felt that this was inappropriate. She knew it was unfair to issue letter grades to José in reading, language, composition, science, and social studies when he could not understand, let alone read, write, and speak the English language.

José's teacher consulted with the school's ESOL para-professional, district level staff members, and her university professor for advice and direction. After reflecting on the information she gathered, she took the ideas to her principal, in hopes of developing a more appropriate assessment system for José.

Her suggestions fell on deaf ears. The principal insisted that letter grades be given. The teacher's value system was challenged. She became tense and lost sleep because of what she was asked to do, however in the end the letter grades were issued. This story is played out time and time again throughout the United States, and is characteristic of a recurring dilemma that teachers and administrators face when non-English and limited English proficient students are enrolled in English only classes.

With regards to grading ESL/ESOL students, Winograd (1991) states that one of

the major issues facing teachers is that of setting standards of student performance. How does one define an "A"? Although some schools chose not to grade ESL students, in most grades are a reality, and sooner or later ESL/ESOL students are going to have to be subject to them. While grading students at lower levels can put off, in upper levels student mastery and achievement eventually needs to be aligned with the rest of the system.

As an educator with experience in teaching, coordinating, and administering both bilingual and ESOL programs, I believe that initially letter grades should not be used with non-English and limited English proficient students in measuring achievement in the content areas. This is particularly important when the student does not possess age appropriate or grade level literacy in their native language.

During my first four years as a Title VII Director, I was employed by a middle-class suburban school district that assigned content area letter grades to its LEP students regardless of how "new" they were to the United States. The students' lack of English proficiency within the language/literacy functions of speaking, reading, and writing was not considered.

As a result, many middle school LEP students were labeled "at risk" due primarily to their failing, or near failing grades in science, social studies, writing, language arts, and other language intensive classes. It was evident that their teachers, as content area specialists, had little knowledge of how to best assist these students. Issues of self-esteem, pride, discouragement, fairness, and respect were raised by the Bilingual/ESL team. How could the teachers in good faith continue to fail these students if in doing so, they may contribute to maintaining a status quo mentality and a self-fulfilling prophecy for them?

The elementary teachers were more responsive and depended on Carol, the ESL teacher, for guidance and support with regard to how best to assist non-English and limited English proficient students. At the elementary level, all sixty ESL students were bused to one school. Carol had a wealth of experience, advanced training, and was both trusted and respected by her colleagues. She considered every ESL child her "baby" and closely monitored their progress by staying in regular contact with their homeroom, or regular education teachers. The nurturing environment that Carol created for her students, in combination with her advocacy and expertise, won over many of her co-workers who willingly worked with her to be as responsive and fair as possible.

Through work with dedicated teachers like Carol, we created a series of checklists that were used in lieu of letter grades for those ESL students who spoke little to no English (See figures 1-5). These checklists covered the content areas of reading/writing, science, social studies, and math, and served as a progress report for all primary stakeholders: students, teachers, parents, and administrators.

We did not reinvent the wheel. Rather, we collected similar checklists that had been reported in the research and related literature on bilingual education, alternative assessment, English as a second language, and literacy development. We solicited checklists from other school districts as well, and finally pulled information from these various sources to create what you see in Figures 1-5.

The checklists, which include room for narrative comments as well, are not meant to be summative in nature. They are a formative type of informal assessment to be used until the student has demonstrated the BICS and CALP necessary to compete with his grade level peers in an English

CONTINUED ON PAGE 14

only classroom. The checklist is a structured assessment technique that is an accepted practice in many disciplines found within the public school framework.

The specific skills found under each of the predominant language functions (listening, speaking, reading, and writing) were deemed essential, and associated directly with the content area under which they are listed, although some skills overlap across content areas. It was determined that a successful student should demonstrate these skills in any classroom, regardless of the language used for instruction. We also wanted to restrict our checklists to just one page to make the checklist less burdensome and more teacher friendly.

What we created served our needs. Although our checklists could be improved upon, we realized that this format was one hundred times better than what previously existed. We also discovered that, at the middle school level particularly, teachers experienced a sense of relief that they no longer had to issue letter grades to their non-English and limited English proficient students. Some even responded that it took a shorter period of time to complete the checklists and write a sentence or two, than to calculate a series of grades for these students.

When I relocated to Florida, I secured a position as an elementary principal in a school of 500 students with 50% identified as LEP. While reviewing the students' report cards after the first quarter, I discovered the word "ESOL" written in the space designated for reading, math, science, and social studies grades. The academic progress of our Category A & B students (non-English and limited English proficient) students was not being documented.

I again reinstated the use of the check-

lists. I believed that they were an improved system for documenting Category A & B student progress, and would provide valuable information for the ESOL teachers in the planning of instruction in both BICS and CALP. The details the checklists provided would also be incremental in informing both subsequent ESOL and regular teachers the skills in which students needed more assistance, as well as the skills the students already mastered.

As an administrator concerned with accountability, the checklists also served as documentation of what was occurring in the ESOL program. It gave teachers direction in what needed to be taught, and provided a gauge as to how individual students were progressing.

When ESOL teachers are directed to issue letter grades by their principals or supervisors, Rhodes and Shanklin (1992) suggest the following guidelines:

1. Grade selected student work, work that is selected because it is the student's best work or because it is most representative of the student's reading and writing. Grade a minimum amount of work.
2. Grade what you consider important for students to be learning. If learning to make reading an integral part of their lives is important, find a way to grade it.
3. Grade both process and product in student work. Students frequently make progress in the processes of reading and writing before the learning shows up in their products.
4. Carefully define and communicate to students what you will grade in their work. This is im-

portant in teaching, not just in evaluation.

5. Involve students in the grading process. If we want to develop students' ability to critique their own work, we must provide opportunities for them to learn how to do so.
6. Remember that the fundamental goal of reading and writing should be to improve reading and writing. Critique your current grading practices — and those you develop on the future — with this goal in mind.

Strickland (1990) adds the following suggestions for modifying grades:

1. Adjusting the time available for completion of tests and assignments. For many ESL students, reading the test and understanding the questions can take up half the class period.
2. Administer tests orally rather in written form.
3. Use an interpreter during testing if possible.
4. Modify the test format from narrative to short answer.
5. Alter course requirements to focus on those that are the most important with less critical requirements omitted.

As I travel throughout the United States, speaking at state and national conferences, and consulting with school districts, I see that reporting content area progress of non-English and limited English proficient students is a very real concern. It is a dilemma that never seems to go away. The teachers and students may change, but the problem remains the same. What can we do about this? Are checklists the answer? Maybe yes, maybe no. What we do know however, is that a checklist is better than doing nothing at all. What do you think?

**Editor's Note:** Contributions to the Administration of Bilingual Education Programs column should be sent to the column editor, Dr. Jaime A. Castellano, at Palmetto Elementary School, 835 Palmetto Street, West Palm Beach, FL 33405. (407) 533-6372.

**The NABE World Wide Web site is now open!**

Point your browser to:  
<http://www.nabe.org>

for the latest information about NABE  
and bilingual education.



## Sample Format for Checklists

STUDENT NAME: \_\_\_\_\_

--	--	--	--

TEACHER: \_\_\_\_\_ DATE: \_\_\_\_\_

GRADE: \_\_\_\_\_ QUARTER:    1            2            3            4

Please use the following code in determining the student's progress.

**B - Beginning**

**D - Developing**

**M - Mastered**

Quarters

Criteria

1        2        3        4

Written Comments

**Listening**

Quarter 1

**Speaking**

Quarter 2

**Reading**

Quarter 3

**Writing**

Quarter 4

	1	2	3	4	
<b>Listening</b>					Quarter 1
<b>Speaking</b>					Quarter 2
<b>Reading</b>					Quarter 3
<b>Writing</b>					Quarter 4

## PREDOMINATE LANGUAGE FUNCTIONS REQUIRED FOR ENGLISH AS A SECOND LANGUAGE (ESOL) STUDENTS BY AREA

(to be inserted under Criteria column in Checklist)

### **READING AND WRITING FUNCTIONS**

#### **LISTENING**

1. Listens attentively to class activity
2. Understands explanations
3. Follows directions for classwork

#### **SPEAKING**

1. Answers questions
2. Asks for classification/assistance
3. Participates in discussions
4. Presents oral reports

#### **READING**

1. Displays interests in books
2. Reads to perform a task
3. Displays an extended vocabulary
4. Selects reading material with confidence
5. Rereads for comprehension
6. Understands parts of a book: table of contents, index, etc.
7. Follows directions for assignments
8. Uses reference materials

#### **WRITING**

1. Spaces letters and words correctly
2. Writes words and sentences that can be read by others
3. Revises written work
4. Able to express ideas in print
5. Spells some words in a conventional way
6. Uses basic punctuation and capitalization
7. Understands the basic mechanics of the writing process
8. Can check spelling by using a dictionary

### **SOCIAL STUDIES**

#### **LISTENING**

1. Understands explanations

#### **SPEAKING**

1. Answers questions
2. Asks for clarification
3. Participates in discussions
4. Presents oral reports

#### **READING**

1. Understands specialized vocabulary
2. Understands information/explanations in textbooks
3. Finds information from graphs, charts, and tables
4. Follows directions for experiments
5. Finds information in reference materials
6. Reading at varied rates (skim & scan)

#### **WRITING**

1. Writes answers to questions
2. Writes reports
3. Labels maps, graphs, and charts

### **SCIENCE**

#### **LISTENING**

1. Understands explanation
2. Listens for specific information
3. Understands explanations without concrete references
4. Following directions for experiments

#### **SPEAKING**

1. Answers questions
2. Asks for clarification
3. Participates in discussions
4. Explains and demonstrates a process

#### **READING**

1. Understands specialized vocabulary
2. Understands information/explanations
3. Follows directions for explanations
4. Finds information in reference materials

#### **WRITING**

1. Writes answers to questions
2. Notes observations
3. Describes experiments
4. Writes reports

### **MATH**

#### **LISTENING**

1. Understands explanations
2. Listens for specific information
3. Understands explanations without concrete reference
4. Understands oral numbers
5. Understands oral word problems

#### **SPEAKING**

1. Answers questions
2. Asking for clarification
3. Explains how an answer was derived

#### **READING**

1. Understands specialized vocabulary
2. Understands information/explanations in textbooks
3. Reads mathematical notations
4. Understands written word problems

#### **WRITING**

1. Writes answers to questions
2. Writes verbal input numerically

# Asian/Pacific American Education Concerns

Column Editors: Ji-Mei Chang, San Jose State University, CA, and  
Janet Y.H. Lu, ARC Associates, Inc., Oakland, CA

## *Building a Network Concerning Asian and Pacific American (APA) Students in Our Schools: An Initial Listing*

by Ji-Mei Chang and  
Janet Y. H. Lu

In response to one of the projects envisioned for 1997 Asian/Pacific American (APA) columns in *NABE News*, we are presenting the following professional associations which address the wide range of issues concerning individuals within the Asian/Pacific American communities. Knowing that Asian and Pacific Americans are among the most diverse in this country, each association serves its unique role(s) in advocating for their memberships. Together, they are aimed at promoting excellence in education for all students. We continue to invite members of professional associations and organizations to send us information so that we can establish a broad network of APAs who can speak about Asian and Pacific American issues, especially in the field of education. Through such a network, we also hope to assist individual members interested in conducting research employing participants of APA descent to overcome the challenge of understanding the specific language, issues, and research methodologies unique to each discipline. We would like to acknowledge Alan R. Shoho, Morris Lai, and Stella Yu-Mei Kwoh in submitting information about their associations.

### **The National Association for Bilingual Education (NABE)**

National Association for Bilingual Education (NABE) has been a strong advocate for equitable and excellent educational opportunities for APA students and their families.

In this last ten years, NABE has provided numerous opportunities for APA educators to participate in various activities. Some of these are: (1) A Special Interest Group (SIG) was created for APAs about eight years ago. Anyone who joins

NABE membership may indicate a desire to participate in the APA SIG. The SIG submits at least one article per year for publication in *NABE News*. The SIG is also entitled to organize one academic session in NABE's annual conference program. APA educators also have the opportunity to discuss concerns at a business meeting organized by the SIG chairperson during the annual conference; (2) NABE has collaborated with NAAPAE to schedule a one-day institute focusing on the education of APA students at the annual conference since 1990; and (3) The APA column was created in February 1995 in response to the growing educational needs of individuals from APA ethnic and language groups. The column articles have been critical in addressing the extreme paucity of research literature related to APA issues. The co-editors make an effort to recruit authors to submit articles that present effective practices, current research findings, concerns.

The APA SIG Chairperson for 1997-98 is Rose Marie Rosario, Southeast Desegregation Assistance Center; her phone number is (305)-669-0114.

### **The National Association for Asian and Pacific American Education (NAAPAE)**

NAAPAE was established in 1977 to promote the needs of Asian and Pacific American (APA) students. Its principal objectives are to: (1) Increase public awareness of Asian and Pacific American educational concerns and needs; (2) Advocate for educational programs and policies that meet the needs of APA students; (3) Promote the inclusion of Asian and Pacific American history and culture in the school curriculum; (4) Maintain a network of educators and community people for the sharing of information and resources; (5) Encourage research on APA educational issues; and (6) Promote the participation

of educators familiar with APA concerns in diverse educational roles. NAAPAE sponsors an annual conference held in a different location every year. The event is designed to promote the exchange of ideas among participants and to provide them with the information and contacts necessary to further their involvement in the education of APAs.

NAAPAE publishes a newsletter four times a year. NAAPAE also has established a scholarship fund to assist two high school seniors (\$500 each) and two college juniors or seniors (\$1,000 each) with their education. The scholarships are awarded annually during the NAAPAE conference.

The current president for 1995-97 is Sally Chou, Principal of Galileo Math & Science Academy in San Francisco. For further information please write to NAAPAE Headquarters, 1212 Broadway, Suite 400, Oakland, CA 94612 The contact phone is (510) 834-9455, Fax: (510) 763-1490 or e-mail: NAAPAE@aol.com

### **The Hawai'i Educational Research Association (HERA)**

An affiliate of the American Educational Research Association, HERA provides a forum for sharing issues, insights, and research findings with educational researchers, administrators, teachers, and others who want to improve educational practice. This year's annual conference was held on January 25, 1997 at the East-West Center, adjacent to the University of Hawai'i at Manoa campus with keynote speakers Richard Shavelson (Dean of the School of Education at Stanford University) and Mary Brandt (Evaluation specialist with the Hawai'i Department of Education).

The annual membership dues of \$15 include a subscription to the *Pacific Educational Research Journal* (PERJ), which

CONTINUED ON PAGE 18

invites original manuscripts featuring theoretical, empirical, or applied research with a) implications for the education of populations indigenous to the Pacific and the Pacific Rim or, b) relevance to educational issues specific to the Pacific area.

The HERA contact is Shuqiang Zhang, president <szhang@hawaii.edu> Hawai'i Educational Research Association (HERA) c/o Dept. of Educational Psychology University of Hawai'i, 1776 University Avenue, Honolulu, HI 96822. The HERA Home Page is <<http://www2.hawaii.edu/hera/>>. Contact for PERJ is Editor, Pacific Educational Research Journal at the same address as above. The Editors can be reached through Kathleen Berg <kberg@hawaii.edu> and Morris Lai <lai@hawaii.edu>.

### The Asian Pacific American Heritage Council (APAHC)

The mission of APAHC is to:

1. educate the public concerning the past, present, and future status of Asian/Pacific Islander Americans;
2. foster, encourage, and participate in educational, cultural, and civic programs that concern Asian and Pacific Islander Americans;
3. publicize the many contributions that Asian Americans have made to the United States; and
4. urge action by the public and private sectors on key Asian Pacific American policy issues.

The Asian Pacific American Heritage Council publishes an annual commemorative booklet that contains articles and resource materials. It also sponsors annual and fundraising events for scholarships, Congressional workshops on issues concerning Asian and Pacific Islander Americans, and a Career Fair. The Council members represent Americans of Asian descent from the Pacific Rim, including Cambodia, China, Guam, Hong Kong, India, Indonesia, Japan, Korea, the Philippines, Taiwan, Samoa, Thailand, and Vietnam.

Carole Chun Huang has served as president of the Council since 1991. For more information please write to Asian Pacific American Heritage Council, Inc., 730 Ridge Drive, McLean, VA 22101. The contact phone is (202) 659-2311.

### Pacific Education, Advocacy, Research, and Learning Institute (P.E.A.R.L. Institute)

The P.E.A.R.L. Institute, a non-profit organization, was founded in 1993 to establish a forum for Asian-American and Pacific Rim Cultures to better understand each other in family matters, personal relations, social and educational exchanges, and other related areas. Currently, there are two offices in the State of California, one in San Diego County, another in the San Francisco Bay area. The institute develops programs that are designed to address cross-cultural understanding in the following areas: (1) Programs with cross-cultural focuses that provide national and international training and continuing education credits; (2) Research on topics specifically focused on cross-cultural and Pacific Rim issues; (3) Empirical studies to determine the nature and the scope of issues related to cross-cultural concerns and specific populations; and (4) Current activities include workshops, seminars, and consultation on multi-cultural projects; for instance, individual and family mental health concerns, special education, and bilingual education.

The P.E.A.R.L. Institute Contact people are: Dr. Yuhwa Eva Lu, 200 Caldecott Ln. #215, Oakland, CA 94618, Tel. 510-642-0329, Fax 510-643-5138, or Dr. Stella Yu-Mei Kwoh, 341 Pacific Avenue, Piedmont, CA 94611, Tel. 510-658-2550, Fax 510-658-3336.

### Research on the Education of Asian and Pacific Americans (REAPA)

The purpose of this Special Interest Group (SIG) of the American Educational Research Association (AERA) is to provide a formal structure within AERA for interdisciplinary communication among members concerned with educational issues related to Asian and Pacific Americans. Membership benefits include: two newsletters per year (contact Don Mizokawa at U. of Washington <mizokawa@u.washington.edu>), opportunity to join the SIG-REAPA e-mail discussion group (e-mail Eunsook Hong at UNLV <ehong@nevada.edu> for further information, and to meet other educators who have a common interest in

educational issues affecting Asian and Pacific Americans.

The membership meets once a year in Spring (March/April) at the AERA Annual Meeting. At the annual meeting, the SIG-REAPA sponsors a substantive program addressing educational research on Asian and Pacific Americans. The program is comprised of sessions involving research papers, symposiums, and invited speakers. This year the SIG-REAPA will sponsor six sessions. During AERA, the SIG-REAPA also sponsors a business meeting where an annual review of the finances, membership, and initiatives are reported. The SIG-REAPA also sponsors a SIG dinner at a moderately priced Asian/Pacific restaurant in the hosting city. The SIG dinner provides an excellent opportunity for members to network, develop, and support each other's interest in Asian and Pacific American educational research.

At the present time, the membership is approximately 135 members. The membership is mainly comprised of university researchers and educators, although the SIG-REAPA welcomes anyone who is interested in the educational welfare and research of Asian and Pacific Americans. The current president for 1996-1997 is Dr. Alan R. Shoho at the University of Texas at San Antonio. For those interested in joining the SIG-REAPA, the membership dues are: \$7/year, \$5 students; \$12/2 years, \$8 students; \$15/3 years, \$10 students. Contact: A. Lin Goodwin, Box 216, Teachers College, Columbia University, New York, NY 10027, e-mail: <alg25@columbia.edu>.

### The Chinese American Educational Research and Development Association (CAERDA)

CAERDA was founded on September 28, 1992 to promote excellence in education for all students, particularly among Chinese and Chinese Americans. CAERDA, a non-profit, non-political, international organization, emphasizes and pursues educational research and development. Its major goals are: (1) to encourage members to participate in educational research and development; (2) to inform members of grant opportunities for engaging in educational research; (3) to

CONTINUED ON PAGE 38

# ESL in Bilingual Education

Column Editor: Dr. John P. Milton, University of Nevada, Reno

## *Some Thoughts on the Future*

*by Dr. John P. Milton*

Recent participation here in Nevada in a local school district's Bilingual Task Force has reminded me once again that the interests of teachers who are involved in bilingual education programs and teachers who are involved in English as a Second Language programs are often identical, almost always quite similar, but... occasionally ...in conflict. Educators in bilingual education and ESL programs in the United States understand that no program of bilingual education could be considered successful or acceptable unless one of the results of the program was a continual increase in the students' ability in English, culminating in fluency. The undisputed need to have English competence as a goal in bilingual programs is not always understood by community members who are not well informed. We all have stories about the parents who supported the bilingual program until they found out that instruction in French and German was not being offered. We are familiar with the parents who scoff at the idea of putting their children in a bilingual program... because Bryan and Allyson can speak English perfectly well. One of my recent favorites is a letter to the editor decrying the loss of primacy for the English language which existed in the old days. It seems that back when the letter writer was in school, the immigrant children had to learn English right away. Nowadays immigrant children seem to avoid learning English at all, and when they are required to learn English, they do it through programs that relegate English to a subordinate status (i.e. English as a Second Language) rather than giving it the primary status that it used to have and still deserves. Maybe it is all a public relations problem. Perhaps we could call ourselves TLTSHLF teachers as in "The Language They Should Have Learned First".

The layman's confusion about the characteristics of bilingual education and ESL programs finds a reflection in the confusion among some ESL teachers about their roles in a bilingual program. The confusion is not nearly as amusing for two reasons. First, professional careers and lives are at stake. Second, in the case of the local ESL teachers, it was a concern that arose among individuals with a long history of support for bilingual education programs. ESL teachers understand that the goals of bilingual education programs can not be met without the students in those programs actively developing English language competence. Some of the ESL teachers with whom I served on the local task force have only recently come to grips with the fact that in Nevada it is possible to choose a model of bilingual education which would be committed to fluency in English without being committed to the use of teachers who were certificated or endorsed only in ESL. In other words, the goals of an ESL program can be met within a bilingual program with teachers certificated or endorsed in bilingual education rather than ESL. Most of the ESL teachers on the task force are bilingual, so they themselves would have little difficulty getting a bilingual endorsement on their teaching licenses. The issue is most serious among certificated/endorsed ESL teachers who are not bilingual in the local language (in Nevada it would be Spanish). Tension between bilingual education teachers and ESL teachers arises because in Nevada while almost all certificated/endorsed bilingual teachers will have been trained in ESL methodology, not many ESL teachers have been trained in bilingual methodology. So reasonably enough, some local ESL teachers have begun to wonder about a niche for themselves if the bilingual programs which they support are approved. They have a commitment to a specialty. They have devoted the time necessary to develop expertise in a particular field. They have

cultivated a sense of solidarity with a professional cadre working to help non-native speakers of English eventually become fluent. In short, they have carved out a place for themselves in the professional community of language teachers. They find themselves asking a question which unsettles them. What is the role of a monolingual ESL teacher within the kind of powerful bilingual education model which they can support? Sometimes the answer they arrive at is disturbing—not much. The development of English language competence in a bilingual program is the responsibility of the bilingual education teacher, who is usually trained in ESL methodology. There seems to be little place for the ESL specialist who is not bilingual. A powerful bilingual education model largely does away with the need for monolingual ESL specialists for either push-in or pull-out programs. Those roles can be taken over by the regular (i.e., one who is bilingual and ESL trained) classroom teacher. A full-blown bilingual program obviates the need for in-take centers or pre-placement centers. For example, in a two-way-immersion model it would be pointless to prepare students for a bilingual classroom by isolating them in classrooms containing only students who did not speak English. Even ESL teachers who support bilingual education are concerned about what role they themselves will have in a particular bilingual program. They know that in those programs children will be learning English as well as their own languages. The question that arises for these teachers is: Who will be providing instruction in English in Bilingual Programs to the children who are not native-speakers of English? Certainly there will always be a place for ESL teachers in districts with diverse communities. Such districts rarely offer bilingual programs in all of the languages spoken by the students. Even in Nevada, for example, which is not one of the more diverse states in the

CONTINUED ON PAGE 42

sands of years. More and more Tribes are run by women. This trend is not limited to Native Americans.

- It is a time when whole communities are going into healing, and traditional healing ways are returning, sometimes being brought back by those who are not even part of the local culture. I attended a healing drum ceremony conducted by a woman healer. I witnessed old pains and rage being released in this healing drum ceremony. A few months later, the Aleuts and Eyaks of this area brought in a traditional drum maker and now they have fifty drums in a community where there were none.
- It is the time of the appearance of the White Buffalo.
- It is a time when Wisdomkeepers are beginning to talk and people are listening. I attended a sacred Sun Ceremony held by a Mayan Priest who conducted this ceremony for the first time in mixed company in 500 years.
- As people are developing new ears to listen, they are asking for traditional knowledge and wisdom in the areas of science, education, and environmental management, and health. It is getting so that Native peoples can't keep up with the demand for sharing what is in them.

The paradigms of the Reverse World will be reversed again as we move into this Shift of the Ages. We teach how to make a living when we used to teach how to live. We contemplate the mystery of life when we used to contemplate the mystery of death. We have forgotten what death means and so we fear it. Our science and



*NABE Executive Board President Janice Jones Schroeder with Walter Turcik, AKABE Past President, at NABE '97*

medicine is focused on trying to understand the mystery of life. We cringe at the sight of an animal being killed in a subsistence way of life, and so we develop food systems which sanitizes death, believing that assembly line death of animals is more humane...in forgetting the mysteries of death, we have forgotten how to live. We focus on goal setting when we used to focus on process or how to get where we are going. We fear darkness when it used to be a place of healing. We fear darkness so much that we light up all our streets so that we no longer

can see the stars. We serve our jobs when our work used to serve us. We think first, then feel second when we used to feel from our hearts first, then our minds would act on these feelings. We focus on the needs of today's generations when our decisions used to be based on affects of seven generations.

As people dedicated to our youth, our cultures, and a truly egalitarian world where all humans are respected and honored, these messages contain a road map for creating the changes you seek.

I believe that the pathway to excellence for the new millennia, the very noble and beautiful theme of this conference, is to reflect on our lives and how we may have unwittingly accepted the opposite of what we are trying to achieve and thus create the reality we have experienced to this point. I know, beyond a shadow of a doubt, that when each of us does this, we will find all the answers and solutions we need to move into this wonderful new time.

### **Our Native Elders: An Important Resource Group**

by Rachel Craig (Inupiaq Elder and a Bilingual Teacher).

Part of speech given at Alaska Annual

Bilingual Multiculture Equity Education Conference

In our traditional times, the elders of our community were the teachers and leaders. They were so well respected that the citizenry even refrained from walking in front of them. This was a way of showing respect, so as not to interrupt their train of thought or to disrupt their concentration. A walkway was provided behind the elders for those who had to move around in their job.

When a child was disruptive in the community, s/he was taken home to his mother with instructions to keep them home until they learned not to be disruptive. The children's tasks were important. Not only were they helping their parents, but they were learning to carry on traditions and become a contributing member of the community.

Suddenly one day, this learning pattern was disrupted by people who spoke a foreign language. In short time, the traditional teachers were replaced by approved certified teachers from the political division which seemed to have money and the law behind them. Punitive measures were used in their disciplinary efforts, and many of our parents talked about standing in the corner, being hit with rulers by the teachers, having their mouths washed with soap, and many times writing one hundred lines of 'I will not speak Eskimo' when they were found to have used their Native language on the school grounds. It was their first language, and even I experienced some of that in the early years of my education. This disciplinary method did not make any of us experts in the Western knowledge, mainly because we were studying lives lived in a very foreign lifestyle and value systems. I don't think they ever took time to explain to us why they threatened us this way. Only much later in our own research did we find out that they were trying to educate us to assimilate us into the industrial society. We didn't know what an industrial society was because there was no industry at home, and we didn't understand the term. I do hope that primary education today is more relevant than that. Time passed by, and the first students became our parents and grandparents. When our generation entered the work force, we had a lot of work to do. By then our Native language was spoken only by the older generations, and although some of us could understand the language, we hardly ever spoke it. Our parents had inadvertently become an extension of the Bureau of Indian Affairs and were speaking only English to us mainly because they wanted us to have a happier schooling experience than they did. They didn't know that this was killing the Native language skills of their children's generation.

Since then, many methods and theories have been used to instill the use of the Native language in our children with varied success

# NABE '98

February 24 - 28, 1998  
Dallas, Texas

## A CALL FOR PAPERS AND PRESENTATIONS FOR NABE '98

The 27th Annual Conference of the National Association for Bilingual Education will be held February 24-28, 1998, at the Dallas Convention Center in Dallas, TX. In addition to inviting nationally and internationally known keynote and major speakers, NABE is soliciting presentations from the field, including collaborative presentations which include teachers and students, which focus on the following:

### **PEDAGOGICAL PRACTICES IN TEACHING BILINGUAL EDUCATION**

Models, methods and materials for teaching students using the native language throughout the curriculum

### **PEDAGOGICAL PRACTICES IN TEACHING ENGLISH AS A SECOND LANGUAGE**

Models, methods and materials for teaching English as a second language

### **DEVELOPMENTAL BILINGUAL EDUCATION**

Models, methods and materials for bilingual education programs with the goal of bilingualism, including two-way bilingual education

### **EDUCATIONAL REFORMS AND LINGUISTIC MINORITY STUDENTS**

School-based management, competency testing, competency-based curriculum, effective schools

### **BILINGUAL EDUCATION PERSONNEL**

Demand for, training, certification, recruitment and retention of qualified bilingual education teachers, instructional assistants, administrators, professors and other personnel

### **LINGUISTIC MINORITY FAMILIES AND EDUCATION**

Adult literacy, parents as partners in education, home-school language use and development, early childhood education

### **TECHNOLOGY AND LINGUISTIC MINORITY STUDENTS**

Accessibility to and applications of various types of high technology in teaching non-English-language-background students

### **LINGUISTIC MINORITY STUDENTS AND OTHER EDUCATION PROGRAMS**

Special Education, Title 1, Migrant Education, HeadStart, Vocational Education, Adult Education, Foreign Language Education, Native American Education, Refugee and Immigrant Education

### **POICIES AFFECTING BILINGUAL EDUCATION AND LINGUISTIC MINORITY AMERICANS**

Demographic trends, dropouts, English-Only/English-Plus movement, health, social and economic issues, international perspectives, refugees, school finance

# NABE '98 — Call for Presentations

## Instructions

### Proposal Preparation Guidelines

1. **PROPOSAL FORM** (attached): Submit THREE (3) copies with all items completed and carefully proof-read for publication in program.

2. **ABSTRACT**: Submit THREE (3) copies of a 300-word abstract of the presentation for review by readers. Abstracts, except those for symposia, should have no author identification or affiliation either in the title or in the body of the abstract in order to ensure anonymous review. Abstracts should be typed on one 8-1/2" x 11" paper (one side only). All abstracts should define the title or topic of the presentation, objectives, methodology, significance, and other pertinent information. **At the top of the page, state the title/topic of the presentation and the type of session.**

**NOTE:** Please keep in mind that NABE receives far more proposals than it can accept. In order for the readers to fairly judge the quality of a proposed presentation, proposals should clearly indicate what the session will cover and how; the title should reflect what is to be done in the presentation; and the appropriate type of presentation should be selected.

3. NABE encourages presentations in languages other than English. In these cases, the title and the 50-word description should be in the language of the presentation. However, the abstract must be submitted in English.

4. Conference registration material is automatically sent to current NABE members. If any proposed presenter is not a current NABE member, attach a sheet of paper containing the name(s) and mailing address(es).

5. **POSTCARD**: Please enclose a self-addressed stamped postcard to receive acknowledgement of receipt of your proposal.

6. Submit all proposals to:

**NABE '98 PROGRAM COMMITTEE**  
NABE National Office  
1220 L Street, NW, Suite 605  
Washington, DC 20005-4018  
(202) 898-1829

**ALL PROPOSALS MUST BE POSTMARKED  
NO LATER THAN JUNE 2, 1997.**

### Types of Presentations

**WORKSHOPS (2 Hours):** Intensive sessions in which participants develop methods or materials, design research studies, analyze research data, confront and solve actual teaching or research problems. Workshops provide participants with the opportunity to actively participate. Emphasis is on providing hands-on experiences. Typically there is little lecturing; the workshop leader structures the activity and guides the work of the participants. The abstract should include the goal of the workshop, a summary of the theoretical background, and a description of activities to be conducted during the workshop.

**PAPERS (45 Minutes):** A description and/or discussion of something the presenter is doing or has done relating to the theory or practice of bilingual education. Emphasis is on empirical research or well-documented theoretical/practical perspectives. Also acceptable are critical reviews of literature, policy studies, well-documented historical studies, critiques, etc. Both qualitative and quantitative research from all disciplines are acceptable. The abstract should include the main premise of the paper, a summary of supporting evidence, and the conclusion. Presenters are encouraged to use handouts and audio-visual aids and to present a summary of the paper rather than reading a prepared text.

**DEMONSTRATIONS (45 Minutes):** Presentations which show a specific teaching or testing technique. After a brief description underlying theory, the session is devoted to demonstrating how something is done. Presenters are encouraged to use handouts and audio-visual aids. The abstract should include an explanation of the purpose of the demonstration and a description of what will be demonstrated and how it will be done.

**SYMPOSIA (2 Hours):** Panel presentations which provide a forum for a group of scholars, teachers, administrators, politicians, or business and government representatives to discuss specific pedagogical, policy, or research issues from a variety of perspectives with alternative solutions presented. Symposia allow for large group settings. The abstract should include a description of the topic, along with the names, titles, affiliations and specific contributions to the symposium of each of the presenters. The symposium should provide sufficient time for presentation and discussion.

### General Policies

1. The Program Committee will select presentations based on the quality of the proposal, as well as the need for ethnolinguistic, geographic, and topic representation in the program.

2. It is the responsibility of presenter(s) to appear at the NABE Conference and make the agreed upon presentation. If unforeseen circumstances arise which prevent the presenter(s) from appearing at a scheduled session, it is the presenter's responsibility to arrange for someone to take his/her place and to send notice of the replacement to the NABE '98 Program Committee.

3. **ALL PRESENTERS WILL BE REQUIRED TO REGISTER FOR THE NABE CONFERENCE.** There will be NO complimentary registration for presenters nor will any honoraria be paid to presenters.

4. All meeting rooms will be equipped with an overhead projector and screen. Other audio-visual equipment may be rented through NABE by indicating the type of equipment needed on the proposal form. Payment must be made to NABE prior to the conference.

5. Publishers and commercial developers of educational materials wishing to make presentations must be NABE '97 Exhibitors or Sponsors in order to be considered for inclusion on the program. Commercial session slots are allotted on the basis of sponsorship level.

6. Only proposals which conform to all the requirements stated in this Call for Papers will be considered for inclusion in the program. Severe constraints on time and funds do not allow for follow-up calls or correspondence. Presenters should **READ INSTRUCTIONS CAREFULLY** and follow them exactly.

7. NABE reserves the right to edit material for the conference program, including presentation titles and descriptions, as necessary.

8. NABE reserves the right to videotape, audiotape, and/or publish conference presentations and sell such products. Submission of a proposal for presentation indicates the presenter's permission to do so without further written approval.

*Notification of acceptance or rejection  
will be mailed by November 15, 1997*



# NABE '98 — Call for Presentations

## *Presentation Proposal Form*

**POSTMARK DEADLINE: JUNE 2, 1997**

PLEASE TYPE OR PRINT CAREFULLY - COMPLETE BOTH SIDES OF THIS FORM

**A. TITLE:** \_\_\_\_\_  
(limited to 15 words)

B. NAME OF PRESENTER	AFFILIATION	STATE	MEMBER?	
			Yes	No
1. _____	_____	_____	<input type="checkbox"/>	<input type="checkbox"/>
2. _____	_____	_____	<input type="checkbox"/>	<input type="checkbox"/>
3. _____	_____	_____	<input type="checkbox"/>	<input type="checkbox"/>
4. _____	_____	_____	<input type="checkbox"/>	<input type="checkbox"/>
5. _____	_____	_____	<input type="checkbox"/>	<input type="checkbox"/>

**C. DESCRIPTION — 50-WORD DESCRIPTION FOR PUBLICATION IN THE PROGRAM:**  
 (DESCRIPTIONS LONGER THAN 50 WORDS WILL BE EDITED)

\_\_\_\_\_

\_\_\_\_\_

\_\_\_\_\_

\_\_\_\_\_

\_\_\_\_\_

**D. PLACE AN "X" BEFORE THE TYPE OF PRESENTATION SUBMITTED :**

- |   |   |
|---|---|
| <input type="checkbox"/> DEMONSTRATION (45 minutes) | <input type="checkbox"/> PAPER (45 minutes) |
| <input type="checkbox"/> SYMPOSIUM (2 hours)        | <input type="checkbox"/> WORKSHOP (2 hours) |

**E. LANGUAGE(S) OF PRESENTATION:** \_\_\_\_\_

**F. LANGUAGE GROUP(S) COVERED IN THE PRESENTATION:**

- All Language Groups
- Some Language Groups (specify): \_\_\_\_\_

(COMPLETE OTHER SIDE)

161

# NABE '98 — Call for Presentations

## *Presentation Proposal Form*

**G. PLACE AN "X" BEFORE THE TOPIC OF THE PRESENTATION:**

<input type="checkbox"/> Language Acquisition <input type="checkbox"/> Literacy <input type="checkbox"/> Math <input type="checkbox"/> Science <input type="checkbox"/> Social Studies <input type="checkbox"/> Personnel (Supply/Demand/Preparation) <input type="checkbox"/> Parental Family Involvement <input type="checkbox"/> Greater Societal Issues <input type="checkbox"/> Education Reform <input type="checkbox"/> Other (specify): _____	<b>LEVEL</b> <input type="checkbox"/> Early Childhood <input type="checkbox"/> Elementary <input type="checkbox"/> Secondary <input type="checkbox"/> Post Secondary <input type="checkbox"/> Adult	<b>APPROACH</b> <input type="checkbox"/> 2-Way DBE <input type="checkbox"/> Other BE <input type="checkbox"/> ESL  <b>TECHNOLOGY-RELATED</b> <input type="checkbox"/> YES <input type="checkbox"/> NO
--	--	--

**H. SESSION SPONSOR (Check if any apply):**

NABE SIG  
(Name of SIG and Chairperson): \_\_\_\_\_

NABE '98 Exhibitor  
(Name of Company and Contact Person): \_\_\_\_\_

NABE '98 Sponsor  
(Name of Company and Contact Person): \_\_\_\_\_

**I. AUDIO-VISUAL EQUIPMENT ORDER:** All rooms will be equipped with an overhead projector and screen at no cost. Presenters needing other AV equipment must indicate on this form and submit payment prior to the conference. Requests for equipment made after submission of this proposal cannot be guaranteed and will be charged at a higher rate.

VHS Cassette Videotape Player/Monitor (\$25)  
 Slide Projector (\$10)  
 Audio Cassette Player (\$5)  
 Microcomputer/LCD Projection to Screen (\$40)  
 Type of computer needed: \_\_\_\_\_ IBM Compatible \_\_\_\_\_ Apple/Macintosh  
 Model and configuration: \_\_\_\_\_

Modem connection/Internet access (\$ TBD)  
 Other: (Specify - Information on price will be included with acceptance letter): \_\_\_\_\_

**J. CONTACT PERSON (Mailing address of presenter to whom all correspondence should be sent):**

Last name: \_\_\_\_\_ First name: \_\_\_\_\_

Affiliation: \_\_\_\_\_

Street: \_\_\_\_\_

City: \_\_\_\_\_ State: \_\_\_\_\_ Zip: \_\_\_\_\_

Work Telephone: ( ) \_\_\_\_\_ Home Telephone ( ) \_\_\_\_\_

Fax: ( ) \_\_\_\_\_ Email: \_\_\_\_\_

Remember to attach a list of the names and addresses of presenters if they are *NOT* members of NABE.

RETURN PROPOSALS POSTMARKED NO LATER THAN JUNE 2, 1997 TO:  
 NABE '98 PROGRAM COMMITTEE  
 1220 L STREET, N.W., SUITE 605  
 WASHINGTON, DC 20005-4018

162

# Successful Practices

Column Editor: Dr. Anne Homza, Boston Public Schools, Boston, MA

## Learning Strategy Instruction in the Bilingual/ESL Classroom

by Robin Stergis, Ed.D and Jeanne Perrin, M.Ed.

### Taking a Look at Learning Strategy Instruction

As you enter the foyer of the middle school, the brightly colored Learning Strategy poster proclaiming "Listen Selectively" is difficult to miss. This is the fifth in a series of learning strategy of the month posters which grace the walls of corridors and classrooms in both English and Haitian Creole. These posters serve as not so subtle reminders of learning strategy instruction based on the *Cognitive Academic Language Learning Approach (CALLA)* going on daily in ESL and bilingual classrooms.

Created by Ana Chamot and J. Michael O'Malley (1987), CALLA is based on research suggesting that effective instruction for English language learners integrates language and content (Genesse, 1987; Mohan, 1986) and includes explicit instruction in learning strategies to accomplish academic tasks (Chamot & O'Malley, 1987, 1994, 1996; Oxford, 1990). Originally designed to help English language learners make a successful transition to monolingual-English classrooms, CALLA has been adapted to different instructional settings including bilingual education classrooms (Chamot & O'Malley, 1994). Let's take a look inside several such classes.

### Haitian Students are Taught to Listen Selectively

In a seventh grade beginning ELS class, Haitian bilingual students are being introduced to a unit entitled "Welcome to School" with learning objectives of school vocabulary, reading a school map and listening to school announcements. The learning strategy being introduced is Listen Selectively, a metacognitive learning strategy which helps students to plan their own learning. In the instruction of metacognitive learning strategies, students are first asked in their native language to reflect on the following questions:

- How do I learn?
- How can I learn better?

Students and teacher then discuss action steps to plan what the students will do to achieve the learning goals. The teacher guides the students through a discussion of what it means to listen selectively, such as attending to key words and phrases, words or themes that repeat or words that give clues, such as first, finally, for example, and so forth. Then the students listen as the teacher reads, in this case, school announcements, and fill in a chart which they have previewed before the listening activity. The chart provides the students with a framework to begin practicing the listening strategy. (See Figure 1.)

WHAT	WHEN	WHO	WHERE
Spanish Club	a. 3:30	members	b. 2:15
c. ESL	tomorrow 6th period	students in 6th period	d. LIBRARY
football game	e. SATURDAY	f. 2:00	football field
g. TEACHERS	h. 3:00	all teachers	cafeteria
band meeting	Thursday 7:30 a.m.	i. MORNING	j. MUSCI

Figure 1. This chart from *Building Bridges: Content and Learning Strategies for ESL*, is used to help students learn to listen selectively.

### Vietnamese Students Learn How to Use What They Know

Sixth grade Vietnamese bilingual students begin an investigative unit on Native Americans in the U.S. The bilingual classroom teacher introduces the unit with pictures and a film strip and then teaches in Vietnamese the learning strategy of Elaborate Prior Knowledge, or "Use what you know." Elaborate Prior Knowledge, a cognitive learning strategy, is reinforced by instructing students to use what they know in order to establish conceptual connections between previously acquired knowledge and new information. In the teaching of cognitive strategies, students are instructed to reflect on the questions:

Topic: Native American Indians		
Know	Want to know	Learn
What do you already know about the topic?	What do you want to know about the topic?	What did you learn about the topic?
When the Indians first came to American they saw the pilgrims and then they teach the pilgrims how to plant, seeds and hunting. I know about the Indians come to American first I know that the Indians have chief. Indians have tent. They have a lot of corn.	How Indians work look like? I want to learn about the art of Indians. What kind of clothes did the Indians wear? How did they know to speak?	I learn that the Indians come to American first. They spoke many languages. They have a lot of different tribe. They play game called stickball. The southern Indians hunt fish at night. The northern use blowgun to hunt animals. live in teepee, longhouse, and small houses. They make bread from corn. They eat fruit and vegetable like squash, tomatoes, pineapple, corn, and many more. They use corn to feed.

Figure 2. This K/W/L chart is shown in the finished version. Typically, students complete the K (know) and W (want to know) columns prior to the beginning of instruction and the L (learn) column at the conclusion of the unit.

- How can I understand?
- How can I remember?

The teacher guides the students through writing two columns of a K/W/L chart to elicit students' prior knowledge on the topic. Once the chart is completed, students use both Vietnamese and English to orally share with the group what they already know about Native American history, culture and customs and what they would like to learn. In the example shown, a K/W/L chart is used to reinforce Elaborate Prior Knowledge. (See Figure 2.)

### Haitian Students are Taught to Summarize

In another Haitian bilingual class, students summarize the story "The First Thanksgiving" using a story map. The ESL teacher reads the story orally to the class, and then using their text, students summarize the action by completing a story map. The use of a graphic organizer, such as a story map, is another way to help students remember and reflect upon what they have read through the cognitive learning strategy of Summarize. (See Figure 3.)

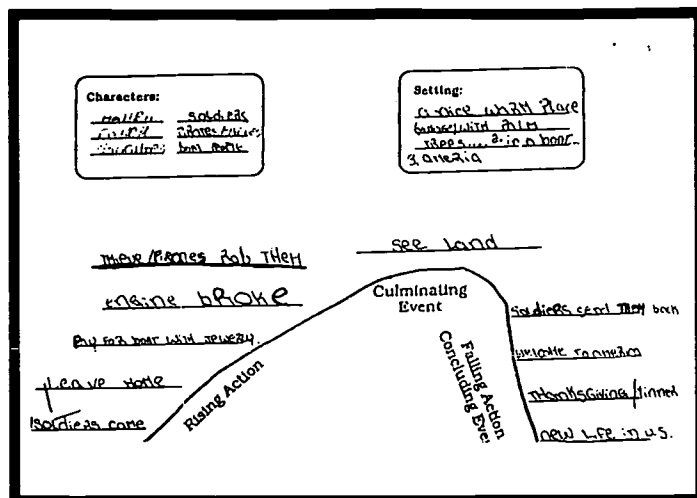

Figure 3. This story map is used to help students learn to summarize a story from their Social Studies lesson.

### Vietnamese Students Learn to Cooperate

In the Vietnamese bilingual program, students continue their study of Native Americans. Students are instructed to work in pairs to complete a Venn diagram based on an eight page reading of "American Indians of the Eastern Woodlands" from the National Geographic Society. The students compare Northeast Native Americans with Southeast Native Americans. The Social-Affective learning strategy of Cooperate is employed to assist students in better understanding new written information. As students work together, they share knowledge of vocabulary and check one another to ensure the collected information is complete, accurate and makes sense. (See Figure 4.)

Social-Affective learning strategies are designed to assist students in accomplishing academic tasks through collaboration and peer support. In the instruction of Social-Affective strategies, students are asked to reflect on the following questions:

- How can I help others learn?
- How can others help me learn?

In all learning strategy instructions, students are typically asked to reflect on their learning experiences and their use of learning strategies to accomplish classroom tasks. At the completion of the unit on Native Americans, the students' responses to the question "How does cooperating with a partner help you learn?" are as follows:

- Because we can share ideas and learn to work together
- I help my partner to get smart and work hard and not say the wrong words. And we have to cooperate the work — we do it for homework and classwork
- When I work by myself I feel lonely. But when I work with a partner I feel happy.

### Getting Started with Learning Strategy Instruction

As teachers in the Transitional Bilingual Education (TBE) Program of the Boston Public Schools (BPS), we have spent several years implementing learning strategy instruction in bilingual and ESL classrooms. Learning strategy instruction is designed to provide students with problem-solving techniques to

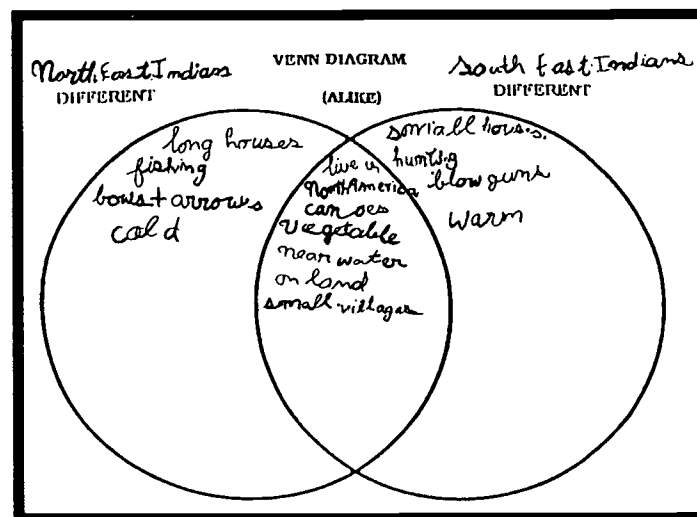

Figure 4. This Venn diagram is used to help students learn to cooperate as they compare two Native American tribes.

accomplish content-area tasks and is ideally suited to bilingual classroom settings. Learning strategies represent higher-order thinking skills that can be promoted in students' native languages. With teacher guidance and support, students can apply learning strategies to a variety of academic tasks in their native language and English.

We decided to implement learning strategy instruction based on the difficulties some of our students were experiencing in accomplishing academic-language tasks such as analyzing and synthesizing information. Previous attempts at assisting these students did not achieve the desired results so we looked for an approach that would provide our students with the tools for academic success in both bilingual and monolingual classroom settings.

Our efforts were directed at students who were enrolled in Vietnamese and Haitian TBE classes in two middle schools and three high schools. Bilingual teachers in these schools had

received extensive training and follow-up support in learning strategy instruction. Participating teachers also attended workshops and graduate courses in the areas of ESL and bilingual education methods and materials and multicultural education.

We created a series of classroom activities that were designed to reinforce learning strategies from classroom units in *Building Bridges: Content and Learning Strategies for ESL* (Chamot, O'Malley & Kupper, 1992). This CALLA-based series was used by TBE teachers in our schools. The classroom activities focused on the three types of CALLA learning strategies: metacognitive, cognitive and social-affective.

### Involving the Whole School Community in Learning Strategy Instruction

We found that learning strategy instruction provides an effective vehicle for interdisciplinary collaboration among teachers in our schools. CALLA-trained TBE staff have presented the learning strategy approach to colleagues during after school workshops and monthly school-based meetings. These sessions provided a valuable opportunity for teachers from different academic specialties to share knowledge and expertise regarding the learning needs of their students. Content area, special education and foreign language staff discussed applications of learning strategy instruction to their respective classroom settings.

School staff from a variety of disciplines and programs collaborated to organize school-wide learning strategy activities. Grade-level field trips were planned with learning strategy activities. With administrative support, learning strategy of the month posters in students' native languages and English were displayed throughout school buildings. (See Figure 5.) The district-wide after-school cable T.V. show, designed to help students with homework assignments, introduced learning strategy activities across grade levels and languages.

### Involving Parents in Learning Strategy Instruction

We provide an opportunity for parents and their children to practice CALLA-based learning strategies that were emphasized in TBE classrooms. We created a series of cooperative tasks centered around the home and community for parents and their children. All of the activities were designed to reinforce CALLA-based metacognitive, cognitive and social-affective learning strategies.

We introduced the activities to parents at the school-based monthly meetings of the bilingual parent advisory council (PAC). Parent coordinators were present to translate information and to discuss the activities with parents. During our meetings with parents, we always began by discussing CALLA and its implementation. We then introduced and modeled a particular activity and its corresponding learning strategy. We also participated with parents in the activities before asking them to try them at home. Parents were asked to implement one of the activities with their children and report on its effectiveness at a future meeting. While our emphasis was on the oral engagement of parents and their children, parents were also invited to keep a written record of their impressions of the activities in a log or journal.

For each activity, we prepared a one-page handout for parents

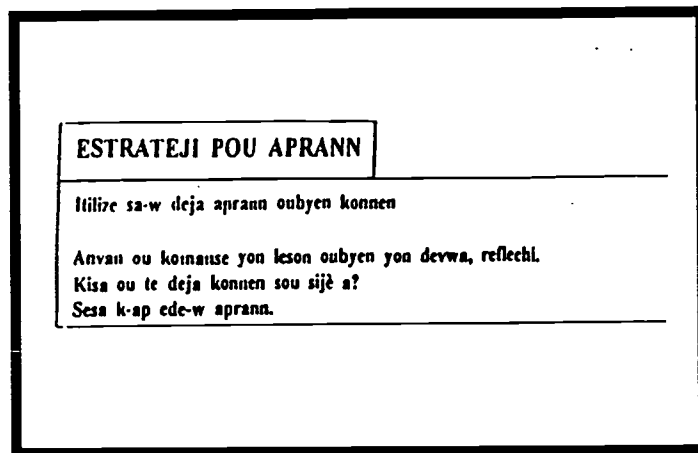

Figure 5. This learning strategy poster in Haitian Creole reinforces the cognitive learning strategy "use what you know" or Elaborate Prior Knowledge.

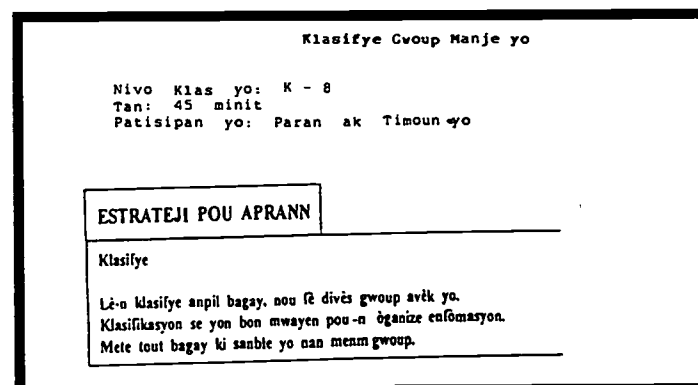

Figure 6. This handout for Haitian parents provides instructions for an activity that reinforces the cognitive learning strategy "classify."

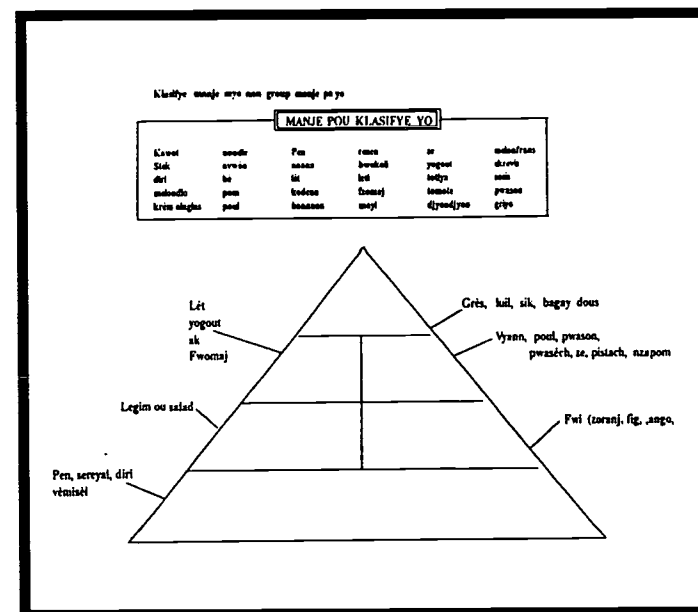

Figure 7. This food pyramid was distributed to Haitian parents to assist them in an activity with their children that reinforces the cognitive learning strategy "classify." Here the families discussed the food they ate and assigned them to categories in the food pyramid.

written in the native language and English. The topic, the time required, the suggested grade level of children and the procedures for doing the activity were indicated. Following CALLA procedures, the particular learning strategies to be reinforced were named and defined. Each handout included space for parents and their children to record their ideas in written form on charts, tables or graphic organizers. (See figures 6 & 7.)

Generally, the learning strategy activities for families helped to establish connections between parents and their children's education. Parents who were introduced to the activities and implemented them with their children found them to be an effective method of assisting with school work. In addition, student enthusiasm and motivation for classwork and were clearly heightened with this approach.

### Recommendations for Learning Strategy Instructions

We have the following suggestions for teachers who are interested in implementing learning strategy instruction in their classrooms:

- Teach learning strategies in students' native languages; then introduce similar learning strategy activities in English.
- Provide students with a repertoire of learning strategies for each academic task.
- Choose learning strategies to reflect subject-matter and instructional goals.
- Ensure that students have ongoing guidance and support in order for them to develop proficiency in the use of learning strategies.
- Become knowledgeable about learning strategy instruction through professional training and peer support.

### Concluding Remarks

Overall, our experience suggests that learning strategy instruction assists bilingual and ESL students in accomplishing academic tasks. However, the above examples are just a sampling of the learning strategies that we teach in bilingual and ESL classrooms. There are additional metacognitive, cognitive and social-affective learning strategies that we have found effective in assisting our students to achieve academically. For additional resources and to

learn more about other learning strategy activities, we recommend *The CALLA Handbook*, cited below.

### References

- Chamot, A.U. & O'Malley, J.M. (1987). "The Cognitive Academic Language Learning Approach: A bridge to the mainstream." *TESOL Quarterly*, 21, pp. 227-249.
- Chamot, A.U. & O'Malley, J.M. (1994). *The CALLA Handbook, Implementing the Cognitive Academic Language Learning Approach*. Reading, MA: Addison-Wesley Publishing Company.
- Chamot, A.U. & O'Malley, J.M. (1996). "The Cognitive Academic Language Learning Approach: A model for linguistically diverse classrooms." *The Elementary School Journal*, 96, (3), pp. 259-273.
- Chamot, A.U. & O'Malley, J.M. & Kupper, L. (1992). *Building Bridges, Content and Learning Strategies for ESL*. Boston, MA: Heinle and Heinle.
- Genesee, F. (1987). *Learning Through Two Languages: Studies of Immersion and Bilingual Education*. Rowley, M.A.: Newbury House.
- Mohan, B.A. (1986). *Language and Content*. Reading, MA: Addison-Wesley.
- Oxford, R. (1990). *Language Learning Strategies: What Every Teacher Should Know*. New York: Newbury House.

*Robin Stergis, Ed.D., has experience as a bilingual program supervisor, ESL teacher and college instructor. Jeanne Perrin, M.Ed., has served as an administrator, staff developer and consultant in the bilingual/ESL program of the Boston Public Schools. They gratefully acknowledge the contributions of teachers and students from the Boston Public Schools.*

**Editor's Note:** Future submissions for the **Successful Practices in Bilingual Education** column may be sent to Anne Homza, c/o BPS Office of Bilingual Education, 26 Court Street, 6th floor; Boston, MA 02108.

• NABE •

### OFFICIAL ENGLISH?

FROM PAGE 9

Drzewiecki's goal is to step up the pace at which immigrants learn English, financing more such courses is a surer means than establishing an official language.

One difference between then and now is skin color. Like most immigrants then, Drzewiecki's ancestors were white. Today's immigrants tend to be of color. Is that the difference motivating Drzewiecki to feel that today's immigrants need a law

that would have been of no use to his ancestors? We hope not, though other explanations are not readily apparent.

To the extent that this bill actually does anything beyond sending out anti-immigrant vibes, it's likely to do ill — for instance, by blocking clear communications to immigrants about immunizations. Such an outcome is not certain, but it can't be ruled out. By the way, government

communication in German, Polish and other languages used to be commonplace.

Drzewiecki and Ladwig should scrap this divisive, foolish, needless bill.

**These articles reprinted  
with permission.**

© 1997

**Milwaukee Journal Sentinel.  
All rights reserved.**

# 1997 Nationwide Writing Contest for Bilingual Students

The National Association for Bilingual Education (NABE) and Scholastic, Inc. are proud to announce the 1997 Nationwide Writing Contest for Bilingual Students. This is the 16th anniversary of NABE's highly successful and popular student essay program. This year, bilingual students throughout the country have an opportunity to submit essays on the topic *Proud To Be Bilingual*. Award scholarships are being provided by The BEST (The Bilingual Education Student Trust), of which Scholastic, Inc. is a founding sponsor.

**THE DEADLINE FOR SUBMISSION IS JUNE 15, 1997**

**TOPIC:** Proud To Be Bilingual

**CATEGORIES:**

- Elementary: Grades 3-5
- Middle/Junior High: Grades 6-8
- High School: Grades 9-11

**PRIZES/AWARDS:**

- National First Place Winner in Each Category: \$5,000 educational trust
- National Second Place Winner in Each Category: \$2,500 educational trust
- National Third Place Winner in Each Category: \$1,000 educational trust

**ELIGIBILITY:** Participation is limited to students who are learning English as a new language through a bilingual education program where content instruction is provided in both English and the student's native language. Previous winners are not eligible to participate.

**CRITERIA:** Each essay will be judged on (1) development of the theme, (2) originality, (3) content and clarity of expression, and (4) grammar and mechanics.

**RULES:** Only entries which comply with the following rules will be considered.

*Language:* All essays must be written in English, however all First Place winners must be prepared to present their essays in English and their native language at an awards ceremony.

*Subject:* All essays must address the theme, *Proud To Be Bilingual*, to be eligible for consideration.

*Length:* The number of words MUST be recorded at the end of each essay. The length of the essay MUST be:

- Grades 3-5: 150-200 words
- Grades 6-8: 250-350 words
- Grades 9-11: 350-500 words

*Application Form:* An application form, containing the name of the contestant, his/her native language, home address with zip code, telephone number with area code, grade, name, and address of school, name of bilingual teacher and school principal, and name of the school district must be stapled to the essay. Names should not appear on the essay. Essays become the property of NABE and will not be returned. NABE serves the right to publish all essays.

*Format:* The essay must be handwritten IN INK or preferably, for high school students, typed, DOUBLE-SPACED.

*Submissions:* A maximum of three essays per grade category will be accepted from the same school. A cover letter on school stationary signed by the principal should accompany the submissions.

**JUDGING:** A panel of judges selected but the Houston Independent School District will determine the first, second, and third place national winners in each grade category. Send essay to:

**NABE '97 Nationwide Writing Contest  
Houston Independent School District, Office of School Administration  
3830 Richmond Avenue, Houston, Texas 77027**

(713) 892-6800

167

# NABE 1997 Nationwide Writing Contest for Bilingual Students Application Form

1. Attach a copy of this form to each essay.
2. Names should not appear on the essay.
3. A maximum of three essays per grade category will be accepted from the same school.
4. A cover letter on school stationery, signed by the principal, should accompany the submissions.

Name of Contestant: \_\_\_\_\_

Grade: \_\_\_\_\_

Home Address: \_\_\_\_\_

City: \_\_\_\_\_ State: \_\_\_\_\_ Zip: \_\_\_\_\_

Home Phone: \_\_\_\_\_

Name of School: \_\_\_\_\_

Name of Bilingual Teacher: \_\_\_\_\_

Name of Principal: \_\_\_\_\_

School Address: \_\_\_\_\_

City: \_\_\_\_\_ State: \_\_\_\_\_ Zip: \_\_\_\_\_

School Phone: \_\_\_\_\_ School Fax Number: \_\_\_\_\_

Name of School District: \_\_\_\_\_

**BEST ESTABLISHED**

FROM PAGE 1



Richard Robinson, President & CEO,  
Scholastic, Inc.

test for Bilingual Students as an opportunity to foster educational advancement of talented bilingual students. Unlike so many large American companies, *The Coca-Cola* people recognized the global importance of multilingualism and the tremendous accomplishments of bilingual students.

Mr. Rudy Beserra, Assistant Vice President and Director of

five years. Coca-Cola became the lead sponsor in 1991 and over the years expanded the value of scholarships to bilingual students. NABE was truly proud to announce at the conference banquet that the recipient of its 1997 Corporate Responsibility Award was *The Coca-Cola Company*.

In making this announcement during banquet ceremonies, Jim Lyons, NABE Executive Director, stated that "The Coca-Cola people saw the National Writing Con-

Corporate Latin Affairs, received the award on behalf of *The Coca-Cola Company*. Mr. Beserra was also honored for his vision of more opportunities for more bilingual students which have now come to fruition with the establishment of BEST.

In the coming months, NABE will be working closely with Scholastic, Inc. and the *Coca-Cola Company* to create a Board of Trustees for BEST. The board will be composed of nationally-recognized leaders from the fields of education, government, business, and entertainment.

• NABE •

Check NABE's Web site at  
<<http://www.nabe.org>>  
beginning in May for  
up-to-date information about  
the Writing Contest and the BEST!



# Parental Involvement in Bilingual Education

Column Editor: Aurelio Montemayor, IDRA, San Antonio, TX

## *An Interview with Silvia Glass Elementary Principal, Southwest Enrichment Center*

### *What are the key elements in increasing the involvement of Hispanic families in their children's educations?*

In large and small ways, the school needs to manifest the importance of parents' contributions, and celebrate their cultural values.

Some of the specific ways schools can do this are to

- Conduct bilingual meetings;
- Send and receive bilingual correspondence; and
- Make parents feel comfortable and welcome in school.

### *Do you feel there are campus or institutional barriers to Hispanic family involvement?*

Yes, and I think they differ between the urban and rural parts of the school district:

For the urban part, there is lack of parent or community "ownership" of schools. For the rural part, there is no public transportation, homes are far apart in a large area, some families have no phone, and it is difficult to conduct home visits.

### *What successes have you had in your campus family involvement programs?*

Our reading program involving the parents, *Ranger Reading Stars*, was developed by a teacher working on a mid-management degree. A 3" x 5" card is sent home to document time spent reading at home. The program really helps develop interest and skills in reading, and involves the home in a positive way. The PTA has taken it over as a community project.

One reason our outreach programs have been successful, I think, is that faculty share in decision making, and come up with ideas. We send a "GO" folder home every Monday with information on what's happening that week, and parents sign off ("GO" stands for "Get Organized").

We have four family skating parties every school year, and teachers, administrators, and families all attend. The parents volunteer their time to make the party a success.

Room parents (we have mothers and fathers) are seen as extensions of the teacher, and help with development of teaching materials, and reading to children. Parents collaborate in writing the guidelines for this participation (we call it "PALS").

Parents also work in the office, help the nurse, and decorate the cafeteria around themes.

Parents come to the classroom to talk about the care of pets or farm animals, and to demonstrate other skills or knowledge.

Our PTA has the largest enrollment in the district — 200 to 800 parents regularly attend meetings — and they are very active and supportive.

We have open house twice a year, and 1200 to 2000 parents come. We also have a big turnout for our annual awards ceremony.

### *What are the easiest aspects of parent involvement and what are the hardest?*

Easiest aspects are those that bring parents out for sports and other extracurricular activities. Everyone comes when a child is performing! Some parents are an integral part of their children's activities, and it's easy to gain or extend their participation.

Hardest aspects are those that deal with academics: parents sometimes feel intimidated, or that there is a great gulf between the school and themselves, especially if they have few years of education. Many Hispanic families have the traditional attitude, "the school knows best." I feel that this attitude and the intimidation many parents feel has been reinforced by the slow movement of Hispanics into positions of authority.

One way that we tried to bridge this gap was to recognize a student of the week: that student then got to have a parent with him or her all day. The teachers got uncomfortable with this, and asked me to stop, but there were few parent complaints. Now the teachers think they'd like to try it again.

### *What advice would you give your fellow principals about increasing the involvement of Hispanic families in their schools?*

Don't be discouraged! Developing a program like this is very time-consuming and frustrating. Parents will hold back at first. The school's interest in their contribution has to be kept in front of them, constantly. Cultivating a core group of parents helps. Word of mouth — and a consistent program of calls and visits, and a network of parents who call and visit each other — will build participation. School and the family have to work together: schools also want what's best for children.

(This interview is taken from an IDRA publication *Hispanic Families As Valued Partners — An Educator's Guide*. For more information about the publication contact Aurelio M. Montemayor. IDRA, 5835 Callaghan, Suite 350, San Antonio, Texas 78228. phone: (210)684-8180, fax: (210)684-5389, e-mail: [amontmyr@idra.org](mailto:amontmyr@idra.org))

**Editor's Note:** Contributions for the Parental Involvement column should be sent directly to the editor, Aurelio Montemayor, at: IDRA, 5835 Callaghan Road, Suite 350, San Antonio, TX 78228. (210) 684-8180; FAX (210) 684-5389. Email: [amontmyr@idra.org](mailto:amontmyr@idra.org).

• NABE •

<http://www.nabe.org>



NABE Executive Board President Janice Jones Schroeder with Pauline Duncan at NABE '97

rates. Our children and their children are supposed keep our languages alive by; learning, maintain, and passing it on to the next generation. I don't think this will happen unless there is active support both in the community and the home. The children have to hear the language spoken and absorb its nuances just as we did from our grandparents. I really think the lifestyle has to go with it, or it becomes just an intellectual knowledge learned from a book.

One day we woke up as our children were vandalizing in the community.

No ones property was safe any more. The children were still helping the elders, but now they wanted to be paid by them for any work they did. On top of all this our young men were committing suicide. This was a real shock to us. Suicide has never been a part of the Inupiaq culture. Be that what it may, we in the leadership positions had to set a course to eliminate suicides from our region if we could.

In the organizational meeting, we listened to our elders. At this point, the direction became easier to follow. We listed what we called the Inupiaq values that the elders said we should never forget to do. Actually, they are universal values, but we wanted our youth to accept them as their own, and so we called them the Inupiaq Values. We decided that every school, every home, and every establishment would get a copy of our Inupiaq Values and hang them up in a prominent place so they could see them daily and internalize them. We wanted everyone to begin to know that we were Inupiaq and that we were proud to share this knowledge.

The second thing we needed to do was to empower our elders as leaders and teachers of our societal mores again. We traveled to all our villages and explained the Inupiaq Values to them, and asked them if our interpretation of the values was correct. They were impressed with our work and proud that we knew that much about our traditional culture. We then asked them if they would be willing to work together as an Elders Council for their village. The duties of this Council would be advisory. They would advise the younger generations from their long life experiences and from information they remembered receiving from their elders. The Elders of each community took the challenge and formed an Elders Council for their village. We did encounter one problem: power. It is really difficult to give up powers that you have enjoyed wielding to someone else, even if those people are your elders. What they don't realize is that if they listened to the elders and used their power of influence where necessary to affect the elders' wishes, they would be gaining the elders' and community's support from back home. Then the elders' success would become

their success, and what could be better than that? The big thing with village Elders' Council is the Inupiaq Day activities in their schools. It is a chance to instruct a captive audience on the fine points of the ancient Inupiaq philosophy and advise the students to live according to the teachings of their forefathers. Our elders consider a person who is well conversant in the Inupiaq language as well as in the English language a very invaluable person to them for that person can help both sides understand the difficult issues they face and serve to bridge the cultures.

Their charge to us is that we must not let this culture flame die out which we had re-ignited as a way of bringing balance to our lives. Having taught us, they expect us to defend their position and our culture in circles of discussion wherever we are. It is wise to follow the advice of the elders. We are promised a long life if we do so. Sometimes the path may seem very difficult and unending, but it is worth supporting the good advice of our Elders. It is wonderful to have given our Elders the empowerment they always had from time immemorial.

---

### Poem

by Pauline Duncan

(Alaska Bilingual Teacher of the Year, given as part of her acceptance speech)

---

*A long time ago Tlingit children used to play all along  
the Sitka Bay.*

*The beach was their playground and treasures were  
everywhere to be found.*

*Tlingit legends and stories were told to children as they  
sat spellbound with Tlingit music in the background.*

*Herring and salmon swam and spawned as children  
gathered alder rounds.*

*Mothers and children gathered together to pick berries and  
tea, while fathers and sons gathered from the sea.*

*There were no schools to be found, but elders were all  
around.*

*The bear and deer walked by the shrubs and calmly  
chewed on skunk cabbage and devil's club.*

*Tlingit children did not eat candy and cake; subsistence  
food was all they could partake.*

*There were many trees tall and short. The trees grew  
abundantly all around from Sitka Bay to Hoonah  
Sound.*

*The Tlingit language and culture was shared throughout  
their land. When it was forbidden they could not  
understand.*

*Smokehouses, camps and canoes lined the beaches as  
Tlingit children watched whales breach.*

*There were no streets or lights found in Sitka Bay as  
children played yesterday.*

*A long time ago, Tlingit children used to play all along  
the Sitka Bay.*

# NABE NEWS Book Reviews

Column Editor: Dr. Beti Leone, Paterson Public Schools, NJ

## *Attributes of Effective Programs and Classrooms Serving English Language Learners*

*Reviewed by Dr. Beti Leone*

*Attributes of Effective Programs and Classrooms Serving English Language Learners.* Diane August & Lucinda Pease-Alvarez. Santa Cruz, CA and Washington, D.C.: National Center for Research on Cultural Diversity and Second Language Learning/Center for Applied Linguistics, 1996. pp. 50.

Diane August and Lucinda Pease-Alvarez have done us all a great service with the publication of their new "occasional paper," *Attributes of Effective Programs and Classrooms for English Language Learners*, which can be obtained through the Center for Applied Linguistics: (202) 429-9292. This very practical paper has immediate use for teachers, teacher educators, administrators, policy-makers, and researchers. It is not only useful, but it is also solidly grounded in the latest research about effective programs and classrooms for bilingual students. This research and theoretical foundation is well-documented for those wishing to follow up on any of the references cited throughout the paper.

The main point of the paper is explained in the overview to the document:

*"While local approaches to school improvement are not new, they have not been the focus of reform efforts that address the special needs and strengths of English language learners. Indeed, these students have generally been bypassed in recent school reform and restructuring efforts (Olsen et al, 1994). This paper is an attempt to specify the various conditions, including school-wide and classroom practices, that maximize English language learners' opportunities to meet challenging outcome expectations. These conditions or attributes are coupled with exemplars that provide concrete examples of effective practice. Practitioners can use the attributes and exemplars as benchmarks with which to compare their programs and practices and make improvements as they find necessary. This model for school change has been used successfully in a variety of settings and is recommended as an alternative to top-down methods for altering school performance."*

The sources for the attributes are primarily two: 1) an extensive review of the literature on effective schooling, especially effective schooling for language minority and second language learners; and 2) the findings from case study research. This research, by

CONTINUED ON PAGE 34

## *Policy and Practice in Bilingual Education: A Reader Extending the Foundations*

*Reviewed by René Cisneros, Ph.D.*

*Policy and Practice in Bilingual Education: A Reader Extending the Foundations.* Edited by Ofelia García and Colin Baker. Clevedon: Multilingual Matters Ltd. 1995, pp. 280.

As the title indicates, *Policy and Practice in Bilingual Education: A Reader Extending the Foundations* is a reader, a collection of seminal articles in bilingual education, which invites one to read beyond the essential elements of bilingual education. Designed to stand on its own, the *Reader* does link with a companion text, *Foundations of Bilingual Education and Bilingualism* (Multilingual Matters, 1993). This review focuses only on the *Reader* edited by García and Baker.

The *Reader* distinguishes itself in two spheres: for the quality of its content and its potential for interaction. On a scale of 1 to 4, it merits the highest score of "4 stars." With regards to content, the articles in the *Reader* represent the best quality in the field. The articles are influential and represent recent contributions to the literature on bilingualism and bilingual education. Also, the breadth of the articles reveals that there is a lot more to bilingual education than effective teaching in the first and second languages. In addition, the analyses by the *Reader's* authors are not superficial; they go beyond the 'how' and delve into the 'why,' examining underlying assumptions, meanings, and implications. Not surprisingly, the various authors take a pro-active stance and advocate for reform. Many critically analyze key issues and propose paths that can be taken to reform bilingual classroom and schools and to empower bilingual teachers, students, and parents.

With regards to the interactive format of the *Reader*, the set of student questions and activities that follow each article are exceptional in their pedagogy and creativity. The questions and activities engage students in reviewing the essence of the articles and then extrapolating and applying these articles to students' own contexts and experience. The activities also give students practice in common methods of research — ethnographic, observation, surveys, interviews, and content analysis. In keeping with current educational practices, the student activities require cooperative learning groups, direct observation, critical reflection, and assuming advocacy roles. The exceptional quality of the interactive format of the *Reader* certainly sets it apart from other readers in the field. The editors must be congratulated for their success in this area. They are obviously and keenly in tune both to research in bilingual education and to mediating instruction for bilingual educators.

CONTINUED ON PAGE 35

Pease-Alvarez and McLaughlin, also provided a rich source for the real-life, authentic exemplars or vignettes which illustrate each attribute in the School Change Model, the outline or centerpiece of the document. Expert practitioners, whose knowledge and experience were invaluable in the writing of the paper, were also consulted for the project.

### A Challenging Project

One of the interesting points about the project, explained in the introduction to the paper, was the difficulty "selecting attributes associated with effective schooling for English language learners." One reason for this is that "studies that do take ELL's into account offer a paucity of empirical evidence...to show that specific attributes improve student performance." That is, there is "very little outcome data." Other problems were that some criteria have been vague and other criteria difficult to measure. Also, what is effective in one context with one group of students may not be so effective in another context with a different set of learners. Finally, many of the criteria and instruments used in effective schools research about effective learning and teaching have never been validated for English language learners and do not even deal with important variables such as language and culture background and features known to promote L2 learning.

Other design problems of these studies include a lack of diverse data collection measures, a lack of "user-friendly" format to the studies themselves, and a lack of guidelines on how to analyze the data and make connections between program quality and student outcomes. Because of all these challenges with past studies on effective schooling (and others not mentioned here), the authors of this study (and researchers who participated in the research relevant to this project), August and Pease-Alvarez consider the attributes identified in the document to be "working hypotheses, which need to be tested for their validity" (p. 2).

### How to Use the Paper

Besides the very important point that the attributes reported in this paper are working hypotheses, the authors mention other important points to frame our reading:

1. *Other Attributes.* There are, most probably, other effective attributes of effective programs and classrooms for ELLs overlooked here;
2. *Clearly Defined.* Selected criteria referred to in the study are clarified through definitions and elaboration of general concepts;
3. *No Simple Implementation.* Readers should not assume that a simple "implementation of attributes approach" can work, but should see the attributes as benchmarks;
4. *Benchmarks.* The attributes are benchmarks;" that is, they are a guide against which school staff can compare their own program and classroom policies and practice with the those described in the vignettes, which are considered exemplary;
5. *Successful Change.* The most successful school change efforts have been those which have involved broad-based support of persons considered "key actors" in the schools, and which involve four elements, based on work by

Goldenberg and Sullivan (1994): "goals that are set and shared; indicators that measure success; assistance by capable others; and leadership that supports and pressures" (p. 4).

### The School Change Model

To give a more complete picture of this very important study, the outline of the school change model is included here.

#### Part I. School-wide Culture, Policies, and Practice

1. School Culture
2. School-wide Policy and Organization
3. Home/School/Community Partnerships
4. Curriculum
5. Student Assessment
6. Staff Knowledge Base
7. Professional Development
8. Program Evaluation

#### Part II. Classroom Practices

1. Creating a Challenging & Responsive Learning Environment
2. Designing and Delivering Instruction
3. Providing a Framework and Context for Instruction
4. Creating Opportunities for Extended Dialogue

In the School Change Model, each of the above subcategories has additional subcategories (the number indicated in parentheses) to delineate the criteria and examples further. For example, in the last subcategory, "Creating Opportunities for Extended Dialogue," the four subcategories are

- "Teachers are responsive to student contributions."
- "Teachers use a variety of discourse strategies."
- "Teachers encourage all students to participate in the full range of instructional activities."
- "Teachers encourage students to respond in the language appropriate to the lesson but do not devalue students' contributions in their own language."

In the entire model, there are fifty attributes. With the introduction of each attribute there is a careful discussion of the concepts relevant to the general area, such as school culture, curriculum, or providing a framework and context for instruction. These discussions echo the initial introduction to the entire paper which elaborate the major issues related to educating language minority children:

- the need for school change,
- characteristics of second language learners,
- native language use,
- equity issues, and
- systemic reform.

For each of these fifty attributes, there is at least one scenario or exemplar to illustrate the attribute. One scenario is included below as an example.

#### *Creating Opportunities for Extended Dialogue*

"Teachers encourage students to respond in the language appropriate to the lesson but do not devalue students' contributions in their own language."

CONTINUED ON PAGE 36

### Organization of the Book

The *Reader* is divided into four sections:

1. policy and legislation on bilingualism in schools and bilingual education;
2. implementation of bilingual policy in schools: structuring schools;
3. using bilingualism in instruction: structuring classrooms; and
4. using the bilingualism of the school community: teachers and parents.

### Policy and Legislation

The section of the *Reader* on policy and legislation focuses on articles that examine the role of political realities and social and power structures in bilingual education policy. It includes articles by Lyons, Casanova, Skutnabb-Kangas, and Cummins. Lyons writes an engaging and concise chronology of federal bilingual education policy, beginning with the role played by Texas Senator Ralph Yarborough introducing the 1967 American Bilingual Education Act and concluding with Senator Ted Kennedy's congressional efforts at the beginning of the 1990's. Casanova's crisp article relates national politics and policy to research on bilingual education. For example, she elaborates on the irony that the loss of public policy's support for bilingual education has increased while "evidence supporting positive effects for bilingual education continues to mount" (1996: p.18). She explains political realities such as the role of a Republican agenda in discrediting bilingual education, without a shred of scientific evidence on which to base their attacks and their creation of an emotional sentiment against the bilingual Hispanic and Chinese populations in the U.S.

Skutnabb-Kangas' thought-provoking chapter on multilingualism and the education of minority children is lucid in explaining the relationships among language policy and social and power structures. Her definition of linguisticism and evaluations of the necessary preconditions for successful bilingual education programs are a 'must' reading for all serious students of bilingualism and bi-

lingual education. Cummins chapter reflects on the resistance to bilingual education in the U.S. He explains that much more is needed than instruction in the students' first language or more effective teaching of English. He points out the social and historical causes that underlie the underachievement of students from bilingual communities. In his concise article, Cummins urges educators to develop a relationship of collaboration and partnership with bilingual communities and to develop a pedagogy that permits bilingual students to generate their own knowledge.

### Structuring Schools

The "Structuring Schools" section contains works which consider how bilingual education policy has been implemented in a variety of settings in the U.S., Canada, and Europe. The articles are analyses of the assumptions underlying various theoretical models, policy decisions, and programmatic practices. The articles have depth, yet they are accessible. Included are articles by Corson, Morrison, García and Otheguy, Cummins, Genesee, Baetens Beardsmore, and Baker.

Corson analyzes and elaborates on the linguistic and cultural community beyond the school boundary and proposes strategies teachers can use to integrate such community resources in bilingual schools. The history, structure, goals, and implementation of a dual language program in New York City are discussed in an article by Morrison García and Otheguy, on the other hand, demonstrate how bilingual education issues are conceptualized by educators who are members of the same ethnic bilingual community as the students served and how these conceptualizations are understood differently from those by outsiders. A theoretical framework for schooling that empowers minority communities is advanced by Cummins when he analyzes the relationships among teachers and students and school and community. In other articles, Genesee and Cummins invite us to understand the setting, rationale and implementation of second language programs in Canada: Genesee focuses on immersion programs while Cummins on heritage language programs. Extending the

discussion of the structure of language programs beyond North American contexts, Baetens Beardsmore and Baker, in separate articles, open windows to understanding' implementation of language policy in European schools. Baetens Beardsmore presents the language policy and program efforts of the European Communities Commission across Europe and Baker discusses a Welsh-medium school in Wales.

The language program examples from the U.S., Canada, and Europe add breadth to this section on policy implementation and the structuring of schools and they also help mediate an understanding of the role of context and policy in program implementation.

### Structuring the Classroom

The articles on structuring bilingual classrooms focus on using two languages, bi-literacy, self-directed and cooperative learning. They offer fresh, original ideas, and are also inspiring and hopeful. Together, they provide a kind of theoretical and practical guide for bilingual educators.

The first article in this section is Jacobson's seminal piece on issues related to choices for instruction with two languages in bilingual education, issues that need to be researched further. There are also three challenging articles on biliteracy. Hornberger seeks to establish a repertoire of possibilities for creating effective learning contexts for bilingual literacy. Delgado-Gaitán's case study demonstrates the importance and role of socially constructed reading activities, carefully explaining the role of social interaction in creating meaning from experience and texts. Reyes follows with a critical analysis of the possible shortcomings in the adoption of a monolingual whole language approach for the bilingual classroom; i.e. "a lock-stock-and-barrel" use of whole language without modification for linguistically and culturally diverse students.

The section ends with three more articles on structuring the bilingual classroom. Christian et al discuss two approaches and a variety of strategies for integrating language and content in bilin-

CONTINUED ON PAGE 36

gual education, ESL, and foreign language settings. Mackey explains the context, rationale, and design of a revolutionary concept and program for elementary and secondary school second language classrooms, based on individual growth and using self-directed multimedia. Jacob and Mattson draw on theory, research, and interviews conducted with teachers across the country to analyze the structure of cooperative learning in heterogenous classrooms, heterogenous in grade level, language background, and language proficiency.

#### Teachers and Parents

The *Reader* closes with "a golden touch," or as the Spanish saying goes, "cierra con broche de oro." The last section of García & Baker's *Reader* focuses on the teacher-parent-community link, the indispensable link for effective bilingual schooling. In her article, Ada acknowledges the lack of societal support for bilingual education and the vulnerability it engenders for bilingual education teachers and parents. She then advocates for an empowering process she calls "creative education." Her process resonates with Freire's and Giroux's models for "transformative education." Faltis keenly outlines an approach for developing school-community relationships in a culturally and linguistically diverse environment. Torres-Guzmán analyzes assumptions made by researchers studying middle class parental involvement in the schools. She demonstrates how the schema of middle class parental involvement fails to account for the linguistic and cultural needs of inner city schools, and how such schema determine the consequent and infelicitous home school interaction that often results in these schools. Finally, Moll, in his article on community analysis, presents a most promising challenge: in a pro-active vein, Moll leads minority communities into the future as he advocates that parents' and community's 'funds of knowledge,' their cultural practices and bodies of knowledge, be used by teachers as points of departure to develop bilingual students' academic achievement.

#### Application

All in all, the *Reader* is a highly useful, excellent collection. I have used it together with the companion Foundations text (Baker, 1993) to teach graduate bilingual education students in New York City, and found that it very nicely extends the concepts introduced in the Foundations text. In the graduate classes I taught, the students had different kinds and amounts of experience in mainstream and bilingual programs. The choice of questions and activities at the end of each article in the *Reader* allowed all students to use their prior experience in bilingual education as a point of departure to expand their expertise further. Most impor-

tantly, the *Reader* impacted the students. I witnessed the graduate students, each in accordance with their own context and experience, reflect on the readings and connect them to their experience, consider and pursue classroom-based research, and begin to advocate for a restructuring of their own classrooms and schools.

The *Reader* consists of an outstanding collection of articles on bilingual education theory and practice. It expands on the Foundations book, providing complete texts of articles by leaders in the field. Each article is followed by carefully constructed questions and activities for further exploration of the topics. The questions and activities are well designed and appropriate for graduate level classes. As I mentioned in the introduction, I give the *Reader* the highest rating of "4 stars," on a scale of 1 to 4.

*René Cisneros, Ph.D., is an Educational Facilitator at Boricua College, a bilingual and bicultural college in New York City. He also does research on bilingualism and education and consults with school districts and other community organizations.*

- NABE -

#### BOOK REVIEW: *PROGRAMS* FROM PAGE 34

*Exemplar: To enable student comprehension and participation in classroom activities, teachers at the Community School of Rochester seldom, if ever, insist that students use only English when interacting with one another. Students who share the same native language are often grouped together or paired so that they can rely on their first language when engaged in collaborative activities. Teachers in many of these classrooms also encourage their students to read and write in their native language so that they can express themselves fully about a given topic or issue. More experienced or able English language learners who read and write these languages are often asked to translate these writings and share the translations with their less English-fluent classmates.*

In summary, the paper by August and Pease-Alvarez, *Attributes of Effective Programs and Classrooms Serving English Language Learners*, is an extremely useful, authentic, and well-informed tool for all types of educators. As the authors point out in their conclusion, "we have offered a vision of what is occurring and therefore actually possible in the schools and classrooms that serve this student population" (p. 43). However, the attributes should not be seen as a set of prescriptions, caution the authors. They are "working hypotheses," based on theory, research, and experiential knowledge" (p. 44). For this reason, I look forward to reading about school communities which have taken the 'next step:' "the development of a variety of methods — records, self-report, and observation — to collect information on how a current program is operating, so school staff can compare it with the criteria contained in this model" (p. 3).

*Beti Leone is a teacher educator in New Jersey and trains ESL and bilingual teachers in field-based reflective teaching methodology.*

- NABE -

#### Book Review Submission Guidelines

Reviews for publication in the **Book Review** column should be sent to Dr. Beti Leone, Book Review column editor, at NABE, 1220 L Street, NW, #605, Washington, DC, 20005, or by e-mail to NABE\_NEWS@nabe.org.

Books from publishers should be clearly marked **BOOK REVIEW MATERIAL** and sent to the same address; two complete sets of materials must be submitted.

174

as guide and translator for his parents, relatives, and friends, accompanying them to the hospital, job interviews, and government offices.

Ramón was finally admitted to a junior high school by "fabricating" his educational record. He said he had finished the 8th grade in Puerto Rico, a fabrication which allowed him to attend school with his older brother Tony. Ramón and Tony were assigned to an all-Puerto Rican homeroom, whose members stayed together all day for all subjects. With no guidance provided to the Puerto Rican students on high school options, Ramón followed his brother to Brooklyn Automotive where he entered a special vocational program oriented towards college and joined the Boys' Club of New York.

Fate presented Ramón an important choice upon graduation from Brooklyn Automotive — accept a job as a mechanic or participate in a Boy's Club-sponsored pilot educational program through which city youth were awarded scholarships to out-of-state private boarding schools. Ramón turned down the job and enrolled in the Phillips Exeter Academy in Exeter, New Hampshire.

After two years of Exeter, Ramón was awarded a four-year scholarship to Yale University. At Yale, Ramón joined Dwight Hall, a service fraternity and began teaching English as a Second Language (ESL) to Puerto Rican adults in New Haven. "Teaching ESL in New Haven was my first exposure to language teaching," explains Ramón, "and it changed my life. Ramón switched his Yale major from mechanical engineering to English literature. He attended the University of Michigan one summer to study English as a Foreign Language *a la Lado-Fries*, received a Master's degree in the Art of Teaching from Yale in 1963, and returned to his native Puerto Rico to teach ESL at the University of Puerto Rico.

In 1966, Ramón, now married to Ramonita Adorno, returned to New York City with a University of Puerto Rico faculty development grant to finish his doctorate in ESL and applied linguistics at Teachers College, Columbia University. "Doctor" Ramón Santiago returned to UPR in 1970.

Ramón's first encounter with NABE

transpired even before there was a NABE. At a 1974 TESOL Convention in Denver, Ramón was appointed to a committee on the role of ESL in bilingual education. The committee's first meeting was to be at the 1974 Bilingual Conference in New York City where the nonexistent NABE was about to become an official organization. Ramón paid \$10 in dues, went back to Puerto Rico, and did not hear from NABE for two years.

In 1975, Ramón moved from Puerto Rico to Iran where he taught ESL. The next year, Carolyn Ebel, Director of the Bilingual/ESL (BESL) Center in New Holland, Pennsylvania successfully recruited Ramón. Ramón's first assignment



*Dr. Ramón Santiago*

was to attend NABE '76 in San Antonio, Texas. The rest of the year, Ramón conducted workshops around the state of Pennsylvania; his automotive background served him well since his workshop tours were self-driven in the BESL Center's massive materials display van.

In 1977, a group of Pennsylvania friends and colleagues nominated Ramón for NABE Treasurer. During the following years, Ramón served in all of the Association's leadership positions: Treasurer, Vice President, President-Elect, President, Past President, and Conference Chairperson. As Treasurer and Vice President, Ramón established a "mini" NABE office in New Holland, where

Carolyn Ebel published the newsletter and where Olga Otero assisted him in computerizing (punchcards back then) the Associate's membership list.

Contrary to rumor, Ramón did not mortgage his house to bail NABE out of difficult financial straits. He did, however, make a short-term loan to NABE of \$20,000 after he sold his home in Puerto Rico. Ramón says that "thankfully, the Association paid every penny back."

In 1980, Ramón moved to Washington, D.C. to found and direct a Title VII-funded bilingual education service center (BESC) at Georgetown University. At the same time, Ramón taught courses in the theory and practice of bilingual education as an adjunct professor of linguistics at Georgetown. Upon moving to the nation's capitol, Ramón worked with NABE's 6th President, Ricardo Fernández, to establish the Association's first national office. He hired the first office director, Carolyn Ebel, and selected and trained the Association's office manager, Carolyn Riddick.

NABE's three most tenured employees were major beneficiaries of Ramón's mentoring in the 1980's. In addition to NABE office manager Riddick, Nancy Zelasko learned from Ramón at the GUBESC where she served as the Center's assistant director. And in 1982, when Jim Lyons accepted a small legal retainer to serve as the Association's Legislative and Policy Counsel, Ramón was Jim's connection to literally thousands of people in the field of bilingual education he had not met. For Carolyn, Nancy, and Jim, Ramón functioned as a fount of information, contacts, and ideas. Ramón's answers to any and all questions, especially ones about the "people of NABE," had a certain uniformity — they were truthful, insightful, leavened with wit, and always delivered in a way that accentuated the positive.

Ramón continued to help build and organize NABE in countless ways during the 1980's. He worked to clean up and computerize Association membership, to recruit new members, to make the Association's newsletter an excellent publication, to streamline Association elections, and to encourage the continuing

CONTINUED ON PAGE 38

participation of former board members, particularly past presidents. On a moment's notice, often in the middle of an unexpected crisis, Ramón would step in to help write scripts for conference events, proof and edit NABE publications, serve as a policy advisor, or do anything else that demanded speed and intellect.

Ramón also contributed something else to the Association and the field — courage and integrity. Time after time in the 1980's, Ramón was called to serve as spokesperson in the nation's capitol for the field of bilingual education. Ramón told Administration officials, Members of Congress and their staffs, and the national press the truth about bilingual education. He did so knowing that the truth was not music to the ears of some of his listeners, and that the truth could do more than set him free; it could precipitate a professional and financial free-fall. Nevertheless, Ramón spoke out, over and over again, to help national policy makers understand the need and benefits of bilingual education.

When Georgetown University lost the federal contract for the Title VII bilingual

education resource center in 1989, Ramón turned to private consulting. He conducted training sessions in bilingual education, ESL, crosscultural communication, program development, and program administration. He also conducted needs assessments of programs for language-minority populations, and evaluated migrant education programs, district-wide bilingual programs, and university teacher training programs across the country. He also served as NABE's advertising and Job Fair coordinator.

In 1991, Ramón, Ramonita, and their two children relocated to New York City where Ramón accepted an appointment as Professor of Education and Director of the ESL Program at Lehman College, City University of New York. Once again Ramón is working with former NABE President Ricardo Fernández, now President Lehman College.

Ramón's *Curriculum Vitae* is fourteen pages long. He has taught at the undergraduate and graduate levels at Georgetown University, Temple University, Immaculate College, Millersville State Col-

lege, and the University of Puerto Rico. Some of the many school systems that have sought his counsel include New York City, Newark, Miami, Washington, D.C., St. Croix, and San Rafael, California. Ramón has also published widely, including two reading series in Spanish and numerous books and journal articles. His record of community involvement is equally extensive.

"I don't regret one minute of the time I have spent with NABE, and plan to remain involved as long as I can," Ramón says.

In recognition of his significant contributions to the field of bilingual education and unique role in the Association's development, NABE is pleased to recognize Dr. Ramón L. Santiago as the NABE Honoree for 1996.

*Dr. Santiago was buried in his native Puerto Rico. Messages of condolence can be sent to his family at 3130 Grand Concourse, Apt. 4J, Bronx, NY 10458.*

« NABE »

## ASIAN/PACIFIC AMERICAN

FROM PAGE 18

enhance understanding of educational issues, and to promote educational development for Chinese and Chinese American students; (4) to create opportunities for scholarly discourse regarding research findings, learning, collaboration, and cooperation among members; and (5) to establish a network for those who are committed to educational research and development.

Since its inception, CAERDA has contributed to its members: (1) exchange and advancement of ideas, research or professional projects through the CAERDA-sponsored events, newsletters, journal, as well as individual consultations through e-mailings; (2) opportunities to seek for placement or grants information; and (3) community services, such as the publication for Chinese parents, *En Route to College*; and a long term professional development activity for private and community-based Chinese school teachers in Northern California.

CAERDA sponsors two major annual events: (1) a mid-year reception on a Thursday evening during the annual meeting of the American Educational Research Association (AERA), and (2) an international conferences on the third Saturday of September; they have been held in Washington, D.C. (1993), New York (1994), Chicago, Illinois (1995), and San Jose, California (1996). The fifth conference will be held in Houston, Texas (1997).

The members of CAERDA are from various countries, such as Canada, Hong Kong, Japan, People's Republic of China, Republic

of China (Taiwan), Singapore, and the United States. They are mostly ethnic Chinese professors, researchers, K-12 field practitioners in private and public schools, educational administrators, graduate students and parents. Each member receives two publications in Chinese: *New Waves: Educational Research & Development*, a journal launched in June, 1996 and published as a bimonthly journal, and a newsletter, four times a year including information on conferences, grant opportunities and job announcements, as well as other related issues. The English publication is currently being developed to increase interdisciplinary communication through a web page.

The current president for 1996-1997 is Dr. Ji-Mei Chang of San Jose State University. For those interested in joining CAERDA, the membership dues are: \$20/year regular and \$10/year students. For additional information please access the web page at <http://www.ttu.edu/~educpsy> or write to CAERDA, P. O. Box 5592, Rockville, MD 20855.

**Editor's Note:** Contributions to the Asian/Pacific American Education Concerns column should be sent to Janet Lu, MCR/NC, 1212 Broadway, #400, Oakland, CA 94912. (510) 834-9438, FAX (510) 763-1490. Email: [janet\\_lu@arcoakland.org](mailto:janet_lu@arcoakland.org)

• NABE •



# Upcoming Events

March 22-25, 1997 — *Association for Supervision and Curriculum Development 52nd Annual Conference*. Baltimore, MD. Contact ASCD at (800) 933-2723.

March 26-29, 1997 — *The National Association for Asian and Pacific American Education 19th Annual Conference*. "The Challenge of Change: Families, Communities, & Schools." Boston, MA. Contact Hiep Chu at (617) 287-5653.

April 3-6, 1997 — *National Science Teachers Association Conference*. New Orleans, LA. Contact (703) 312-9221.

April 10-13, 1997 — *Central States Conference and the Ohio Foreign Language Association Joint Conference*. "Building Community." Columbus, OH. Contact Rosalie Cheatham at (501) 569-8159.

April 11-13, 1997 — *New York State Association for Bilingual Education Annual Conference* "Bilingual Education:

*High Standards for All Students."* Rye Town Hilton, Rye Brook, NY. Contact Carmen Sotomayor Kasper at (516) 242-1128, ext. 241.

April 12-16, 1997 — *National Association of Elementary School Principals Annual Conference*. San Antonio, TX. Contact (703) 684-3345.

April 17-19, 1997 — *National Council of Teachers of Mathematics Annual Conference*. Minneapolis, MN. Contact (703) 620-9840.

May 4-9, 1997 — *Interantional Reading Association Annual Conference*. Georgia World Congress Center, Atlanta, GA. Contact IRA at (302) 731-1600.

May 2-3, 1997 — *Stablizing Indigenous Languages Sumposium*. de Bois Conference Center, Flagstaff, AZ. Contact Jon Reyhner at (520) 523-0580.

May 21-22, 1997 — *New Jersey TESOL/BE 27th Annual Conference* "NJTESOL/

*BE: The Multicultural Connection."* Brunswick Hilton and Towers, Brunswick, NJ. Contact Mihri Napoliello at (201) 200-3375.

June 19-21, 1997 — *National Association of Latino Elected Officials 14th Annual Conference*. Hyatt Regency, Miami, FL. Contact NALEO at (213) 262-8503.

June 23-27, 1997 — *15th Annual Multicultural Summer Institute*. The University of Findlay, OH. Contact Jean Nye at (419) 424-4774.

## Special Events Planners

Mail or fax event announcements to the attention of NABE News Editor or send them by email to <NABE\_NEWS@nabe.org>.

Events may be listed once free of charge.



HOW CAN YOU  
TAKE A BITE  
OUT OF YOUR  
TRAVEL EXPENSES?

JUST ASK ALAMO.<sup>SM</sup>

As a member, you can enjoy great rates, quality cars, and friendly service. Look to Alamo to meet your travel needs. For reservations, call your Professional Travel Agent or access us at <http://www.goalamo.com> or call Alamo Rent A Car. Be sure to request I.D. Number 195167 and Rate Code **BY**.

1-800-354-2322

177

## 50% TOWARDS AN UPGRADE

- Certificate is valid for 50% toward upgrade charges. Just reserve a compact car or above for up to 14 days in the U.S.A. or Canada.
- Only one certificate per rental; not to be used in conjunction with any other discounted, promotional or convention rates, or an Alamo Express Plus<sup>SM</sup> rental.
- Please make your reservation at least 24 hours before arrival and be sure to request Coupon Code UB76.
- Travel Agents: Please include /SI-C-UB76 in the car sell.
- Due to high demand, this offer is subject to availability at time of reservation and the upgrade is subject to availability at time of rental as certain car types may not be available. Offer may not be available during peak periods and holidays.
- You must present this certificate at the Alamo counter on arrival and it is void once redeemed.
- Certificate has no cash value and does not include taxes, time and mileage, or any optional items.
- Any unused portion is non-refundable and reproductions will not be accepted. Expired or lost certificates cannot be replaced.
- Subject to Alamo's conditions at the time of rental.
- Offer valid through December 15, 1996.

For reservations, call your Professional Travel Agent or access us at <http://www.goalamo.com> or call Alamo Rent A Car at 1-800-354-2322. Be sure to request I.D. # 195167 and Rate Code **BY**.

UB76

Alamo

© 1995, Alamo Rent-A-Car, Inc.

41839AS1195

# Because Learning for All Is Your Goal...

Segunda edición  
**Aprenda**  
La prueba de logros en español



Give your Spanish-speaking students equal access to excellence in achievement testing. Choose *Aprenda: La prueba de logros en español, Segunda edición (Aprenda 2)*, created to meet the needs of your K-12 students by assessing them in their native language.

- Quality comparable to its companion English language test, *Stanford 9*
- Selections written and illustrated by well-known Hispanic authors and illustrators
- Multiple-choice and open-ended formats
- Component to assess English as a second language
- Support materials in Spanish and English



Call us for a free  
*Aprenda 2* sampler brochure

**HARCOURT® Educational**  
**BRACE Measurement**

555 ACADEMIC COURT, SAN ANTONIO, TEXAS 78204-2498

1-800-211-8378

170

# American Indian Bilingual Education

Column Editor: Jon Reyhner, Northern Arizona University

## *NABE's 1997 American Indian Institute*

*by Dr. Jon Reyhner*

The Native American Institute at this year's NABE conference in Albuquerque, coordinated by Michelle Paisano-Schwebach and Anita Tsinnajinnie, had a very interesting variety of presentations. Because of the way sessions were scheduled concurrently, I was not able to get to all of them, but I was able to attend one strand of presentations that concentrated on Laguna and Cochiti Pueblo efforts in New Mexico to maintain and revive their languages, which represent two different dialects of the Keres language family.

Christine Sims of The Linguistic Institute for Native Americans talked about the history of Native American language development and efforts currently under development in New Mexico. She related how the 1970s were a period of development of linguistic coursework, orthography and materials for school programs that focused on teachers and paraprofessionals working in schools.

However, according to Sims, "Schools have not produced fluent speakers of language." She finds that there is now increasing recognition that "It takes a whole community to preserve a language" and that language is transmitted by individuals rather than by school programs. Today, in the 1990s, Sims sees the focus changing to community-based language planning, materials development, and heritage language teaching that is centering on fluent speakers of the language and elders. In the same span of years from the 1970s to the 1990s, children ceased coming to school speaking her native language of Acoma and other American Indian languages. She finds that community members are often "in denial" about the endangered state of their language, and they need to understand what is going on in their community that is contributing to language loss.

Sims' experiences have told her that writing a language, computers, language tapes, and "canned" approaches brought in from the outside will not keep a language alive. Community members need to actually use the language with other speakers, and fluent speakers need to learn the best methods for language teaching. Knowing how to speak a language and being able to teach it are two different things, and the purpose of teaching indigenous languages is so a child can become an integral part of the community and connect with other speakers and access their wisdom. For example, at Cochiti older fluent-speaking women are meeting with younger women in their homes and doing things together while at the same time teaching and using the language so that the less fluent women are learning the Keres language.

According to Sims, recent language teaching methods that have been adapted for use in these Keres communities discourage translation and promote immersion. Learners who are immersed in a new language absorb its sounds and rhythms. If translation is used, the learner tends to ignore the language they do not understand and wait for the translation.

In the immersion method it is important not to put the initial emphasis on correct pronunciation, but rather to "get across meaning." It is a given that the learners will not understand everything at the start, and things need to be kept simple. As Stephen Krashen notes, beginning lessons need to be shaped around simple activities that are interesting to the learner. Fluent speakers need time, planning, and training to teach their language effectively to others.

According to Leanne Hinton's experience with the Master-Apprentice model in California, described in her 1994 book *Flutes of Fire*, it takes about 500 hours of instruction/practice for the learner to achieve basic communicative fluency in their new language. Learners need someone they can go to for help, and it takes a

lifetime to become fully fluent in a language.

Relearning indigenous languages is part of a healing process for communities that are facing social problems. A Cochiti Pueblo language activist noted that one of the major things she has done is turn off the television during supertime so that her family could talk. In another Keres community a fluent speaker posted a "Laguna Only" sign in her home. The idea of reviving an indigenous language is not about going back to the way things were 100 years ago. New words have to be developed to talk about new foods, computers, and the like.

Christine Sims is currently a consultant for the Laguna Middle School Language Immersion Project in New Mexico. At Laguna they have been identifying language issues, community resources, and training needs. They are providing instruction for basic conversational language use and find that three years of middle school instruction is not enough for fluency.

A key with middle school students is to "create a positive attitudinal foundation for language learning." The students need to recognize that they "are a very special group of kids." Children have to want to learn the language. Laguna is taught the first thing in the morning at the school during "prime time," the first hour every morning for three days a week, rather than in the afternoon when the students are less alert. There are ten students per class with a team of fluent speakers. The "best way for children to learn the language is to hear fluent speakers use it among themselves."

Students also attended a one week summer immersion camp, and fluent speakers received two months of training before the camp was held. Issues discussed in the training included "how and when do you correct someone in a positive way," "how do we group ourselves," and "how do we check what kids have learned." The camp

CONTINUED ON PAGE 42

US, the establishment of bilingual programs in Spanish, which is the majority minority language, would not preclude a critical need for ESL teachers in schools which enroll children who are native speakers of Russian, Korean, Tongan, Tagalog, Mandarin, etc. While some of Nevada's ESL teachers have legitimate concerns, especially those who are in districts where there is very little language diversity and they are not fluent in the most common minority language, most will not be threatened professionally by the establishment of bilingual education, assuming bilingual education, ever does get established in Nevada. It is difficult to blame them though for finding little comfort in assurances that Nevada is highly unlikely to be swamped anytime soon by a tidal wave of support for in-depth bilingual education programs. In Nevada, ESL jobs, even those held by teachers who do not speak Spanish, are pretty safe for the time being.

**Editor's Note:** Contributions to the ESL in Bilingual Education column should be sent to Dr. Jack Milon, Department of Curriculum and Instruction/282, College of Education, University of Nevada, Reno, NV 89557-0214. (702) 784-6298, or email <milon@scs.unr.edu>.

- NABE -

## Intern and Fellowship Positions Available at NABE

The NABE Policy Internship and Fellowship Program is a rigorous apprenticeship for individuals interested in policy issues of education, multiculturalism, language diversity or civil rights.

The heart of the NABE Policy program is direct participation of interns and fellows in NABE's central policy activities including:

- ◆ policy research and analysis
- ◆ advocacy before Congress
- ◆ collaboration with other national education or civil rights organizations
- ◆ administrative duties

Interns and fellows must have outside support to participate; no financial assistance is available from NABE.

To apply, please send a cover letter and resume, a short writing sample, and letter(s) of recommendation to: Jaime A. Zapata, Associate Director for Legislation and Public Affairs, at NABE.

You may also check the NABE Web site at <http://www.nabe.org> beginning in June for more information.

was planned hour by hour to provide the children with a maximum exposure to Laguna.

The participants were surprised at how much the kids learned in one week, but the instructors needed to be prepared for a "silent period" at the beginning when students did not utter a word and then for a period of time when they mimicked their teachers. Optimally, one speaker of the language is needed for every child.

By the second day of the camp, children wanted to try speaking Laguna. Kids were not discouraged from answering in English, but they were answered back in Laguna. Oral language was emphasized, and a lot of tangible objects and visual aides were used to make clear the meaning of what was being talked about. At both Laguna and Cochiti there is no written use of the language, everything is done as it was done traditionally, that is orally. Lessons started by focusing on kids being able to identify who they were: their Indian name, their clans (everyone is related and relations are very important), greetings (how the community shows respect and courtesy for each other), and telling time (a natural way to learn numbers). The use of traditional greetings brought on an attitudinal change in the learners. Traditional cooking was also taught along with table manners. Lessons focused on practical things that students could use right away.

I have read and listened to a lot of information about teaching American Indian languages in the past few years, and I am finding out that programs showing success across the continent tend to share some common characteristics. These characteristics were discussed again and again in the sessions at this year's Native American Institute at NABE's annual meeting in Albuquerque.

**Editor's Note:** Contributions to the American Indian Bilingual Education column should be sent to Jon Reyhner, Center for Excellence in Education, Northern Arizona University, P.O. Box 5774, Flagstaff, AZ 86011-5774, or E-mail to: [jon.reyhner@nau.edu](mailto:jon.reyhner@nau.edu), (520) 523-0580, fax: (520) 523-1929.

- NABE -

# CLASSIFIED

## ASSISTANT PROFESSOR

The Department of Urban Education at the University of Houston-Downtown invites applications for the position of Assistant Professor of Bilingual Education beginning in the fall of 1997. Successful candidates will have: an earned doctorate, bilingual certification, three years public school teaching experience in a bilingual classroom and proficiency in both Spanish and English. Salary range is \$30,000 to \$35,000. Review of applications is ongoing and will continue until position is filled. Send letter of application, resume and the names of three references to:

Dr. Helen Allen, Associate Professor, University of Houston - Downtown, One Main Street, Houston, Texas 77002. EEO/AA

# NATIONAL ASSOCIATION FOR BILINGUAL EDUCATION

## MEMBERSHIP APPLICATION

### 1 Membership Type *(check one only)*

- \$48 Individual Membership
- \$30 Discounted Individual Membership
- Parent: must not be professional educator and must have a child currently enrolled in a bilingual education program. A letter written on school stationery from either the teacher or a school administrator must accompany the NABE membership application.*
  - College/University Student: must not be professional educator and must be enrolled on full-time basis. A copy of an official college or university document showing current enrollment status must accompany the NABE membership application.*
  - Paraprofessional: Must be working as an instructional aide in a public school system. A letter on school stationery from the supervising teacher or a school administrator must accompany the NABE membership application.*
- \$43 Combined Membership Name of Affiliate: \_\_\_\_\_
- \$125 Institutional Membership
- \$1000 Lifetime Membership

Memberships are valid for one year from the date of processing, and include one year subscription to NABE publications (except Lifetime, valid for life of member and includes lifetime subscription). Organizational membership is non-voting; all other memberships are voting. All memberships are non-transferrable and may not be cancelled. Membership dues are non-refundable.

### Name and Address Information

- Mr.
- Mrs.
- Ms.
- Dr.
- \_\_\_\_\_
- Last First Middle*

### 3 Preferred Mailing Address: Business Home

**Business Address**

Position: \_\_\_\_\_

Division: \_\_\_\_\_

Organization: \_\_\_\_\_

Street Address: \_\_\_\_\_

City: \_\_\_\_\_ State: \_\_\_\_\_ Zip: \_\_\_\_\_

Phone: ( ) \_\_\_\_\_ Ext. \_\_\_\_\_

Fax: ( ) \_\_\_\_\_ E-Mail: \_\_\_\_\_

### Home Address

Street Address: \_\_\_\_\_

City: \_\_\_\_\_ State: \_\_\_\_\_ Zip: \_\_\_\_\_

Phone: ( ) \_\_\_\_\_

### 4 I am involved with bilingual education as *(check one)*

- Administrator
- College Instructor
- Consultant
- Full-Time Student
- Paraprofessional
- Parent/Community member
- Publisher Staff
- School Board Member
- Teacher
- Other

### 5 I work in this type of organization *(check one)*

- Commercial organization
- College/university
- Local school district
- State education agency
- Other

### 6 I usually work with this level of student *(check one)*

- Early childhood
- Elementary
- Secondary
- Higher education
- Adult

### 7 I want to participate in the following Special Interest Group *(check one)*

- Adult/Vocational Education
- Asian & Pacific Islanders
- Critical Pedagogy
- Early Childhood Education
- Elementary Education
- ESL in Bilingual Education
- Gifted Education
- Global Education
- Higher Education
- Instructional Technology
- Language/Culture Retention
- Language Policy
- Parent & Community
- Policy Makers
- Professional Development
- Research & Evaluation
- Secondary Education
- Special Education

### 8 Payment Information

\$ \_\_\_\_\_ Membership dues

\$ \_\_\_\_\_ Contribution to help NABE counter the English-only movement

- Check or money order Check# \_\_\_\_\_
- Institutional purchase order # \_\_\_\_\_
- MasterCard  VISA Expiration Date: \_\_\_\_/\_\_\_\_/\_\_\_\_
- --  --
- Automatic Renewal:** Check this box if: you are paying by credit card, and you want NABE to automatically renew your membership annually, charging your credit card the standard renewal amount. This permission will remain in effect until you cancel it in writing.

\$ \_\_\_\_\_ **TOTAL DUE**

**9 SIGNATURE:** \_\_\_\_\_ **DATE:** \_\_\_\_/\_\_\_\_/\_\_\_\_

## ANNOUNCEMENTS

### NABE gratefully acknowledges the Sponsors of NABE '97

#### Diamond Sponsors

Houghton-Mifflin Company  
Scholastic, Inc.

#### Gold Sponsors

Embassy of Mexico  
Macmillan/McGraw-Hill School Division  
Simon & Schuster Publishing Group  
Talk Systems, Inc.

#### Silver Sponsors

Hampton-Brown Books  
Harcourt Brace School Publishers  
SRA /McGraw-Hill  
Scott Foresman/Addison-Wesley  
Southwestern Bell Telephone  
SpanPress  
US West Communications

#### Conference Supporters

American Federation of Teachers  
Coors Brewing Company  
Fannie Mae Foundation  
Isleta Gaming Palace  
Jostens Learning

#### **NABE NEWS**

National Association for Bilingual Education  
Suite 605  
1220 L Street, N.W.  
Washington, D.C. 20005-4018

NON-PROFIT ORG.  
U.S. POSTAGE  
PAID  
WASHINGTON, DC  
PERMIT NO. 4555



# NABE NEWS

The news magazine about educational equity and excellence through bilingual education

May 1, 1997

National Association for Bilingual Education

Volume 20, Number 6

## Bilingual Education: Portraits of Success Project NABE's Student Essay Writing Contest

by Martha Loera de Olivas and  
Dr. Kathy Escamilla

The NABE essay contest started in 1982 and was created by Dr. Jaime de la Isla, who continues to serve as the NABE Chairperson of this contest. Jaime created the contest to help connect NABE directly to its constituents (language minority students and their families) and to highlight student achievement in bilingual classrooms. The contest was created to honor students in three categories (elementary, middle and high school) and was designed to encourage students to write about the benefits of being bilingual. At each grade level, there are three winners.

NABE's national essay contest has had a proud tradition with humble beginnings. In the early 1980's, winners received savings bonds (\$250 for first place, \$150 for second, and \$100 for third) and first-place winners received a trip to the national NABE Conference. In the 1990's, thanks to the support of *The Coca-Cola Company* and Apple Computer, Inc., winners began to receive significant educational scholarships (\$5,000 for first-place, \$2,500 for second, and \$1,000 for third) and the

first-place winners were provided with an Apple computer system, in addition to a trip to the national NABE Conference.

Essays are submitted each year from virtually all states. Since 1982, 42 students, representing 15 states, have won first, second, or third-place in the contest. Winners represent at least ten different linguistic groups, with Spanish being the most common.

At its meeting in Denver in July 1996, the Board discussed revising the contest. During this discussion the following questions were raised: 1) What impact has this contest had on students? 2) Where are these winners now and what are they doing? 3) What value do they give to bilingualism in their lives?

Former NABE President Kathy Escamilla and Martha Loera de Olivas, a doctoral student from the University of Colorado at Boulder, embarked on a year-long project to locate former contest winners. Results are reported below and serve to reaffirm our faith in the efficacy of bilingual education programs.

### Data Collection

Copies of the winning essays were used as a starting point for contacting schools that the winners attended when they won the contest. All schools were contacted by phone to obtain an address and the name of their respective principal. A survey was developed for completion by contest winners. Letters were sent to school principals requesting their assistance in locating and forwarding a student survey to contest winners. These surveys were designed to gather information on what these students have accomplished from the time they became essay contest winners to the present. A total of 42 letters and surveys

were mailed to elementary, middle and high schools. Eighteen surveys were returned. Some students could not be located, but we are still in the process of trying to find them. This project continues to search for more students.

During this process we were delighted by the willingness of most school principals to help us locate the contest winners. We were also impressed with the pride that the schools took in talking about these students. We are grateful to these schools for their assistance with this project and their work with language minority students.

### Where Are These Students Now?

Of the eighteen winners for whom surveys were returned, one student, Vanessa R., is still in elementary school. Four — Janet F., María Luisa M., Josie O. and Karla R. — are in high school. Thirteen are attending college, have graduated, are pursuing higher studies, or have started employment with a professional firm. The following is a synopsis of those students who are in college or have already graduated. All had access to bilingual education programs at critical times during their public schools careers. All students gave us their permission to publish their success stories.

### Lourdes A.

Lourdes, a Spanish-speaker from Puerto Rico, won in 1991 when she was a senior at Holyoke High School in Massachusetts. She graduated *summa cum laude* in accounting from Bentley College in 1996. Lourdes is currently employed as an auditor at Price Waterhouse LLP. She plans to pursue an MBA in the near future.

CONTINUED ON PAGE 22

### ISSUE HIGHLIGHTS

NABE '98  
Dissertation Contest  
Announcement..... 9

Bilingual Portraits of  
Success:  
School To Work..... 16

# NABE NEWS

Published by the  
**National Association for  
Bilingual Education**

**Editor:**  
Nancy F. Zelasko, Ph.D.  
**Desktop Publishing & Layout:**  
Jeff Spence

## NABE NEWS REPRINT AND EDITORIAL POLICY

Readers are welcome to reprint non-copy-righted articles which appear in *NABE NEWS* at no charge, provided proper credit is given both to the author(s) and to *NABE NEWS* as the source publication.

All articles printed in *NABE NEWS*, unless written by an Association staff person or a member of the current NABE Executive Board of Directors, are solely the opinion of the author or authors, and do not represent the official policy or position of the National Association for Bilingual Education. Selection of articles for inclusion in *NABE NEWS* is not an official endorsement by NABE of the point(s) of view expressed therein.

## TABLE OF CONTENTS

Message from the President .....	3
Asian/Pacific American column .....	5
'98 Dissertation Contest .....	9
NABE Order Form .....	10
Book Review column .....	11
American Indian column .....	13
Upcoming Events .....	15
Portraits of Success column .....	16
Bilingual Educator Resources .....	19
Parental Involvement column .....	25
Language Proficiency column .....	27
Technology column .....	29
Membership Application .....	31
Announcements .....	32

## PUBLICATION SCHEDULE

Volume 20 of *NABE NEWS* will be published in 8 issues; publication dates are:

Issue 1	09/15/96	Issue 5	03/15/97
Issue 2	11/01/96	Issue 6	05/01/97
Issue 3	12/15/96	Issue 7	06/15/97
Issue 4	02/01/97	Issue 8	08/01/97

All advertising and copy material must be received in the NABE office **ONE MONTH prior to publication date** to be considered for inclusion.

## NABE NEWS ADVERTISING

### Display Advertising Rates (Camera-Ready)

Full Page (7.5" x 10")	\$850
2/3-Page (4.75" x 10")	\$700
1/2-Page (7.5" x 4.5")	\$550
1/3-Page (4.75" x 4.75")	\$425
1/3-Page (2.25" x 10")	\$425
1/4-Page (3.5" x 4.75")	\$325
1/6-Page (2.25" x 4.75")	\$250

### Classified Advertising

\$1.25 per word; maximum 100 words

### Advertising Discounts (for multiple insertions)

10% for second-third; 15% for fourth-fifth;  
20% for sixth-eighth

NABE reserves the right to reject any advertisements which it deems inappropriate and/or inconsistent with the goals of the Association. For additional information, contact NABE at (202) 898-1829 x136.

## NABE

The National Association for Bilingual Education (NABE) is a tax-exempt, non-profit professional association founded in 1975 to address the educational needs of language-minority Americans.

### NABE NATIONAL OFFICE

1220 L Street, N.W., Suite 605  
Washington, DC 20005-4018

PHONE (202) 898-1829

FAX (202) 789-2866

E-mail: NABE@nabe.org

### James J. Lyons, Executive Director

Nancy F. Zelasko, Deputy Director  
Jaime Zapata, Associate Director for Legislation  
Jeff Spence, Information Systems Director  
Carolyn Riddick, Office Manager  
Celia Torres, Membership Specialist  
Ronald Williams, Office Assistant  
Teresa Sola, Receptionist

## NABE EXECUTIVE BOARD 1996 - 1997

### President

Janice Jones Schroeder  
429 Wabash Avenue  
Kenmore, NY 14217  
(716) 875-1882  
nabepres@aol.com

### Vice President

Mary F. Jew  
San Francisco USD  
300 Seneca Avenue  
San Francisco, CA 94112  
(415) 469-4000  
mjew@sfusd.k12.ca.us

### Secretary/Treasurer

David E. Báez  
Director, Foreign Language & Bilingual  
Education  
Buffalo Public Schools  
731 City Hall  
Buffalo, NY 14202  
(716) 851-3704  
dbaez@buffnet.net

### Member-at-Large

Joe J. Bernal  
6410 Laurelhill  
San Antonio, TX 78229  
(210) 342-8026  
bowlngod@ix.netcom.com

### Member-at-Large

María Estela Brisk  
School of Education  
Boston University  
605 Commonwealth Avenue  
Boston, MA 02215  
(617) 353-3260  
brisk@acs.bu.edu

### Member-at-Large

Nga Dinh Duong  
21724 58th Avenue West  
Mountlake Terrace, WA 98043  
(206) 771-2095  
nguyen@cks.ssd.k12.wa.us

### Member-at-Large

Hermán S. García  
Department of C & I  
College of Education  
New Mexico State University  
Las Cruces, NM 88003  
(505) 646-2115  
hgarcia@cnmailsvr.nmsu.edu

### Member-at-Large

Susan García  
18094 East Ohio, #102  
Aurora, CO 80012  
(303) 745-7116  
susangarcia@unitedwaydenver.org

### Parent Representative

Adela B. Holder  
Silver Consolidated School District  
2810 N. Swan Street  
Silver City, NM 88061  
(505) 388-1527  
sncadavi@arriba.nm.org

184



# Message From The President

## Sharing our Stories: The Wisdom of Our Elders

by Janice Jones Schroeder

Since we last visited, I have had the opportunity to represent NABE at many of our State Affiliate's annual conferences. Additionally, I represented NABE at the National Association for Asian and Pacific American Education Conference and Southeastern Utah Bilingual Conference. The states that I attended their annual conferences were: California, New York, North Dakota and Washington. The state of Utah has recently started a State Bilingual Association. They have elected officers — Toni Turk was elected president — and are in the process of working on their by-laws. Their goal is to become a NABE affiliate as soon as possible. So let us extend a warm NABE welcome to Utah.

By traveling to the various conferences, and listening to individuals sharing their stories, underscores how much we all have in common. To this end, shouldn't we be focusing on the things that we all have "in common," rather than letting our differences divide us?

When I have been asked to speak on various topics at these conferences, I was often faced with the question, "Why do we have bilingual educational programs in our schools? What is their purpose?" I now must ask each of you the same thought provoking question. *Do our bilingual programs:*

- instill cultural pride?
- teach the language of our ancestors with an understanding for the student, why they should be learning their languages?
- teach the connection, through the history, to our past?
- instill a sense of pride?
- teach the culture values?
- build a stronger bond between generations?

If you can answer to the affirmative to the above questions, are your bilingual programs working? How many of you feel that your program is not only working, but is very successful?



NABE Executive Board President  
Janice Jones Schroeder and NYSABE Past  
President Susan Pien Hsu

Let us not get caught up in the Western meaning of success. For instance: we now teach how to make a living, when we used to teach how to live. We focus on goal setting, when we used to focus on the process of how to get to where we are going. We serve our jobs, when our work used to serve us. We try to heal the symptoms, when we used to work at healing the root cause.

As people dedicated to our youth, our cultures, and truly a better world, where all humans are respected and honored, we need not only use the knowledge of our elders but we need to use their wisdom to understand this knowledge. The stories of our elders are like looking at a diamond. What we see is the diamond but what it reflects back depends on the position and light we use to look at it and our frame of mind at the moment.

The wisdom keepers say that nothing can be created outside before first it is created inside. We trash our environment because we are trashing ourselves inside. We fragment our thinking, because we are fragmented inside. We cannot teach our children how to live, until we learn how to live ourselves. We cannot help to empower our people or communities until we empower ourselves. I believe the pathway to excellence for the new millennia is to reflect how we may have unwittingly accepted the opposite of what we are trying to achieve and thus created the reality we have experienced.

I'd like to share with you excerpts from New York State Association for Bilingual Education's teacher aide of the year honoree Palmira Medina's acceptance speech given at their recent annual conference.

*My parents came to New York City when I was three years old. In 1976, we moved to Buffalo, NY. I attended Hermán Badillo Academy. I was placed in a bilingual classroom. In 1981, I graduated from Badillo and upon graduation, I received the bilingual education award. I attended the only bilingual high school in Buffalo. There I continued receiving the skills and education that the bilingual program offered.*

*I give thanks to bilingual education, because without it, I would have forgotten my native language. Bilingual education helped me transition into a dominant English world. Today, I can say that I am a successful product of bilingual education and I can truly call myself a bilingual individual. I thank all those great teachers for educating me in two languages. Due to their dedication as bilingual teachers, today I am proud to say 'Soy Bilingüe.'*

*I am an advocate of bilingual education and when others might say we have failed, I say we have succeeded and have done our jobs. Even though bilingual education has been at risk, we are still strong.*

*I am thankful to God for giving me the knowledge to be able to educate children. I believe that sharing personal experiences with the students is important in order to educate them. Our students look up to us as their role models. I talk to them and let them know that I am a product of bilingual education and that I went through struggles during my education. I remind them to always keep in mind that there are no failures. If you want something bad enough, you must strive to get it. Believe in yourself and believe that you can succeed.*

*Knowing that I have made a difference in the lives of children has encouraged me to continue in the field of education.*

• NABE •

# DISCOVER PERMA-BOUND BOOKS

## FOR YOUR BILINGUAL STUDENTS



**W**hen looking for a great selection of affordable titles for bilingual students, our Pre-Kindergarten-12 selection is great - including over 2,000 books in Spanish, plus Chinese, Vietnamese, French, German, Italian, and more.

- ❖ TRANSLATIONS
- ❖ ORIGINAL WORKS
- ❖ SHORT STORIES
- ❖ NOVELS
- ❖ SCIENCE
- ❖ DICTIONARIES
- ❖ BILINGUAL READERS
- ❖ VALE - IBM WRITING TO READ

186

Now Available! Books in Spanish to accompany Accelerated Reader Program.

One PERMA-BOUND book will outlast seven to ten paperbacks at about one-third the cost-and they're unconditionally guaranteed. If you're ever dissatisfied with a PERMA-BOUND book for any reason we'll replace it.

VANDALIA ROAD ❖ JACKSONVILLE, ILLINOIS 62650

CALL TOLL FREE: 1-800-637-6581 TOLL FREE FAX: 1-800-551-1169

**PERMA-BOUND**

# Asian/Pacific American Education Concerns

Column Editors: Ji-Mei Chang, San Jose State University, CA, and  
Janet Y.H. Lu, ARC Associates, Inc., Oakland, CA

## *Quest for Bilingualism and Biculturalism: An Alternative Approach*

by Lu Chang

Changing demographics in many parts of the country indicate that linguistic and cultural diversity has become the norm in many schools. More than ever before, the interdependent global economy requires that the younger generation be prepared with bilingual and cross-cultural skills so that they can remain competitive and productive in a multicultural and multilingual society. There has always been a strong desire among immigrant language minority groups in the United States to learn English, to maintain their home language, culture and identity, and to become bilingual and bicultural (Fishman, 1966). Immigrant groups believe that a sense of identity is vital because it provides a positive self-concept and a sense of intergenerational cultural continuity.

A variety of efforts have been made by many immigrant groups in the United States to help the younger generation in their pursuit of bilingualism and biculturalism. Among the numerous efforts, the establishment of their own language schools to teach the younger generation the ethnic language and culture has prevailed (Fishman, 1966, 1979, 1980 & 1985). For example, Chinese American communities have made continuous efforts to create opportunities for the younger generation to maintain their home language, culture and identity. This article provides information on such an endeavor in the quest for bilingualism and biculturalism by using data collected from 796 teachers, parents and students in four Chinese language schools in Northern California.

### **Theoretical Framework**

Many scholars and researchers (Fishman et al, 1966; Sue, 1973; Fishman & Markman, 1979; Fishman, 1980 & 1985; Ogbu, 1986 & 1991; Ferdman, 1990; & Banks, 1991) have examined issues related to language, culture and identity. This paper primarily uses Joshua Fishman's theory on the relationship between language, culture and ethnicity as its conceptual framework since it is most relevant to this study.

According to Fishman (1985), there are several ways in which language is related to culture: "language itself is part of the culture, every language provides an index of the culture with which it is most intimately associated, and every language becomes symbolic of the culture with which it is intimately associated" (p. xi). The linkage between language, culture and identity is vital because it shows "the essence of identity, of authenticity, of uniqueness" (Fishman & Markman, 1979: p. 10).

As early as 1966, Fishman (1966) points out that ethnicity designates a constellation of primordial awareness, sentiments,

and attachments by means of which man has traditionally recognized the discriminada that relate him to some other men while distinguishing him from others (p. 402).

Fishman (1985) defines ethnicity as the collective intergenerational cultural continuity, the link between an individual and the group and a sense of belonging based on language, culture and race. He further argues that language, culture and ethnicity are inter-connected, and "language-and-ethnicity collectivities should be seen as the basic building blocks of all human society" (p. 5).

Among the various determinants of ethnic identity, cultural factors such as values, norms, attitudes and traditions are important elements (Sue, 1973). These cultural factors become increasingly important as new generations of immigrant students grow up in the United States. As they enter American public schools, their experiences at home and the expectations from the school can create confusion for them. These students are often caught between two cultures and feel a sense of not belonging to either one of them. This conflict can seriously impair the growth of their sense of identity because, by failing to identify themselves with their ethnic culture, they may be giving up the basic roots of their existence (Banks, 1990). Ferdman (1990) argues that identity is closely associated with group membership and involves those parts of the self — behaviors, beliefs, values, and norms. that a person considers to define himself or herself socially as a member of a particular ethnic group — and the value placed on those features in relation to other groups. A secure sense of identity is important because it provides a positive self-concept and a sense of historical continuity.

Community-based language schools are significant because they are committed to teaching the ethnic language and cultural practices, as well as enhancing identity (Fishman 1966). According to Fishman (1966), ethnic language schools are product of the encounter between immigrants and the mass American culture. They are usually private schools organized within the ethnic community in order to teach the ethnic language and culture to the younger generation, and to strengthen their identity. The establishment of these schools is not only an attempt to provide opportunities for the younger generation to identify themselves with the cultural traditions of their parents and ancestors, but also a demonstration of their desire to maintain the ethnic language, culture and identity and to become bilingual and bicultural in the United States (Bradunas & Topping, 1988). These schools are significant because they help minority families alleviate the sense of marginality and maintain their ethnic pride (Fishman, 1979). Language minority children come to know who they are, benefit from both cultures, and learn both languages by attending these schools.

CONTINUED ON PAGE 6

Chinese language schools in the United States have had a history of over one hundred years (Jung, 1972). In a recent study, Chao (1996) reports that there were 635 Chinese schools nationwide with 82,000 students in 1996. In the Greater Bay Area of Northern California alone, the number of schools has swelled to 85 with 18,000 students. At the present, these language schools are generally supplementary to the public schools and are organized by parents and community volunteers. They have provided rich resources for the present study.

As Fishman (1966, 1979 & 1985) has repeatedly stressed, ethnic and linguistic diversity are important resources in American society; language, culture and ethnicity are interwoven; and bilingualism and biculturalism are desirable in a multilingual and multicultural world.

**Pursuing Bilingualism and Biculturalism:  
A Case of Chinese Language Schools**

This article reports research findings obtained from a study of multiple perspectives on the maintenance of language, culture and ethnicity in community—based Chinese language schools. Specifically, it addresses perspectives of parents, teachers, and students regarding the following two areas:

- their reasons to be involved in the Chinese school; and
- their perspectives on the success of the school in maintaining Chinese language, culture and identity.

The study obtained data collected from 796 teachers, parents and students in four Chinese language schools in Northern California. Sub-samples consist of 427 parents, 331 students, and 38 teachers. This section of the paper describes the methodology of the study, including research setting, instrumentation, data collection and analysis, and results and discussion.

Table 1 presents the research setting of the study, including the geographical location, socio-economic status, and educational level of the general areas where the four schools are located (U.S. Census Report, 1990).

School A, a weekend Cantonese school located in the rural central valley of Northern California, is affiliated with a Chinese Baptist church. Classes are held on Saturday mornings from 9:30 - 11:45. School B, established in 1888 and located in San Francisco's Chinatown, is one of the oldest and most traditional Chinese language schools in the United States. It is a weekday afternoon school that offers language and culture classes everyday from 4:00 pm - 6:00 pm. School C, located in a well-established area with relatively high socio-economic status, is the oldest Chinese school for new immigrants in Northern California with a history of thirty-three years. Classes meet on Friday evenings from 7:00 - 9:00. School D, also located in a well-established area, is only nine years old. Classes meet on Saturday mornings. Table 2 is a summary of the general characteristics of the schools.

**Table 2: General Characteristics of the Schools**

School	Founded	Grade level	Number of students	Class schedule
School A	1983	K-10	96	Saturday mornings
School B	1888	K-12	260	Mon.-Fri. 4:00 pm - 6:00 pm
School C	1963	K-9	480	Fridays 7:00 pm - 9:00 pm
School D	1988	K-11	550	Saturday mornings

**Table 1: The Research Setting**

School	Location	Socio-economic status, measured by median household income (state median: \$35,798)	Level of education, measured by % w/ bachelor's degree or higher among people above 25 years (state average: 23.4%)
School A	rural central valley	\$27,433	14.1%
School B	inner city Chinatown	\$33,414	35%
School C	suburban	\$55,333	52.1%
School D	suburban	\$64,587	65.1%

**Research Setting**

The study was supported by the then-President of the Association of Northern California Chinese Schools and three former Chinese school principals who were very knowledgeable about issues related to Chinese language schools. Following their advice, four schools, each representing unique characteristics, were selected to represent a broader spectrum of Chinese language schools.

**Instrumentation**

The study primarily utilized the survey research method. Survey instruments used in Kim's (1992) investigation of Korean language schools were modified and adapted. Specifically, instruments used in this study included: (1) teachers' questionnaire; (2) parents' questionnaire; and (3) students' questionnaire. The majority of the questions required multiple choice responses, rank-order responses, checklists, dichotomous questions, and Likert scales. All questionnaires were pilot tested. Questionnaires for parents and teachers were provided in both Chinese and English versions. The researcher translated the questionnaires from English to Chinese. As suggested by the four principals, the students' questionnaires were provided in English only. All questionnaires were reviewed by university professors, principals, parents and teachers. Questionnaires in Chinese were reviewed by those who were fluent in both languages.

**Data Collection and Analysis**

The researcher conducted the entire survey herself. First of all, the principals informed their teachers, parents and students of the study in order to seek their cooperation. All participants received

detailed instructions on how the questionnaires should be completed.

Teachers completed their survey during regular teachers' meetings. Students responding to the survey were fourth grade and above since some questions would be too difficult for younger students to answer. One class from each grade level was randomly selected. They completed the questionnaires in class.

Parents of students in one class from each grade level at each school were randomly selected to participate in the parent survey. Parents' questionnaires were sent home with the students, together with a cover letter with instructions. Students were responsible for bringing the questionnaires back to the school the following week.

As a result, a total of 1,546 questionnaires were distributed, with 796 completed. The return rate was 51%.

Descriptive statistics were utilized as the major approach to interpret data from all questionnaires. The statistical analyses were completed by using the Statistical Package for Social Sciences.

### Results and Discussion

Results of the study are organized in response to specific research questions. First, parents and teachers were asked to rank order their reasons why they were involved in the Chinese school. Tables 3 and 4 present a summary of their responses.

**Table 3: Parents' Reasons to Send Children to Chinese Schools (n=427)**

Reasons my children can:	1	2	3	4	5	no answer
appreciate their language & culture heritage	244 57%	161 37.6%	20 4.7%	0 0.0%	2 0.5%	0 0.0%
feel proud & increase self-esteem	213 49.8%	174 40.7%	32 7.5%	1 0.2%	4 0.9%	3 0.7%
speak with family & relatives	199 46.5%	193 45.1%	9 2.1%	11 2.6%	12 2.8%	3 0.7%
speak with other Chinese	159 37.1%	227 53%	25 5.8%	8 1.9%	4 0.9%	4 0.9%
increase their job opportunities	152 35.5%	189 44.2%	66 15.4%	12 2.8%	5 1.2%	3 0.7%

(1=strongly agree, 5=strongly disagree)

Table 3 is a summary of the reasons why parents send their children to the Chinese school. The majority of parents felt that they wanted their children to appreciate the Chinese language and culture and to feel proud of being who they are. Parents also felt strongly that attending Chinese schools would enable their children to speak with family members and relatives.

As shown in Table 4, teachers taught at the Chinese school because they wanted the students to feel proud of their language and culture and to become bilingual and bicultural.

Students were asked why they were attending the Chinese

school. They were provided with ten possible choices and were asked to check all that apply. Results are presented in Table 5.

**Table 4: Teachers' Reasons to Teach at the Chinese School (n=38)**

Reasons	Number of Responses	
	True	Untrue
Make students feel proud of their language and culture.	33 (86.8%)	5 (13.2%)
I feel the responsibility to pass on language and cultural heritage.	31 (81.6%)	7 (18.4%)
I believe in bilingualism/biculturalism.	27 (71.1%)	11 (28.9%)
Community service.	23 (60.5%)	15 (39.5%)
My children go to the school.	17 (44.7%)	21 (55.3%)

As shown in the table below, an overwhelming 87% indicated that they attended the Chinese school because their parents wanted them to. As a matter of fact, several students commented in their questionnaires that they were forced to attend the Chinese school, and they wanted to make their parents happy. Over 71% indicated that they attended the Chinese school because they were Chinese. Over 50% of them indicated that they wanted to learn the Chinese language and to increase their future job opportunities.

**Table 5: Students' Reasons to Attend Chinese School (n=331)**

Reasons	Number of responses
My parents want me to.	288 (87%)
I am Chinese.	237 (71.6%)
I want to learn Chinese language.	190 (57.4%)
I want to increase my job opportunities.	168 (50.8%)
I want to communicate with other Chinese.	161 (48.6%)
I want to be bilingual and bicultural.	158 (47.7%)
I want to communicate with family & friends.	138 (41.7%)
I want to learn Chinese culture.	118 (35.6%)
I want to be with my friends.	102 (30.8%)

Second, to determine the general degree of satisfaction with the Chinese school, all groups were asked how successful they felt the school was in (a) teaching the Chinese language; (b) teaching the Chinese culture; and (c) maintaining ethnic identity. Table 6 is a summary of their responses.

Table 6 shows a consistent pattern in the responses of the various groups. In general, all three groups held positive opinions towards the effectiveness of the Chinese school in maintaining Chinese language, culture and identity. They expressed general satisfaction with the schools. Even though 87% of the students felt they attended the Chinese school upon their parents' requests (see Table 5), over 40% of the students indicated that they felt the school was very successful in maintaining the Chinese language, culture and identity.

CONTINUED ON PAGE 8

**Table 6: Success of the Chinese School**

Rating: Number of people

	Teachers n=38	Parents n=427	Students n=331
Chinese language	1: 2 (5.3%)	1: 65 (15.2%)	1: 39 (11.8%)
	2: 28 (73.7%)	2: 265 (61.9%)	2: 131 (39.6%)
	3: 5 (13.2%)	3: 90 (21%)	3: 116 (35%)
	4: 3 (7.9%)	4: 4 (0.9%)	4: 26 (7.9%)
	5: 0	5: 2 (0.5%)	5: 14 (4.2%)
Chinese culture	1: 2 (5.3%)	1: 57 (13.3%)	1: 27 (8.2%)
	2: 20 (52.6%)	2: 217 (50.7%)	2: 114 (34.4%)
	3: 14 (36.8%)	3: 131 (30.6%)	3: 136 (41.4%)
	4: 2 (5.35%)	4: 18 (4.2%)	4: 28 (8.5%)
	5: 0	5: 2 (0.5%)	5: 23 (6.9%)
Identity	1: 2 (5.3%)	1: 64 (15%)	1: 46 (13.9%)
	2: 17 (44.7%)	2: 217 (50.7%)	2: 124 (37.5%)
	3: 17 (44.7%)	3: 120 (28%)	3: 128 (38.7%)
	4: 2 (5.35%)	4: 20 (4.7%)	4: 12 (3.6%)
	5: 0	5: 5 (1.2%)	5: 12 (4.5%)

(1=strongly agree, 5=strongly disagree)

The above results present an interesting phenomenon: even though the four schools differ in structures and geographical locations, the participants differ in educational backgrounds and socio-economic status, there has emerged a strong desire from parents and teachers: they want to pass on the rich Chinese language and cultural heritage to the younger generation. Students also feel that it is important to keep their Chinese identity. It is the perception of all three groups of participants that ethnic language schools may make a positive contribution to the maintenance of ethnic language, culture and identity.

#### Implications for School Practice and Future Research

School age children in the United States live in a very complex environment, with many options open to them and many factors that influence them. Affected by both the American culture and the ethnic culture, language minority children face double challenges. In order to enable them to function in both languages and cultures, it is important that these children develop a sense of self-worth and identity.

Based on the findings of the study, this section of the paper offers recommendations for school practice and future research.

1. The lack of bilingual and multicultural resources has been a widely-discussed topic by field practitioners, educators, administrators and researchers. This study shows that the tremendous potential in the community language schools may serve as bilingual and multicultural resources. Thus, collaborative efforts between the public schools and the community-based language schools are necessary in order to fully tap into this potential.
2. Students' experience in the community language school is an integral part of their total educational experience. Being sensitive to the contrasting cultural values be-

tween the ethnic culture and the American culture, and the differences in learning styles and teaching styles between public schools and community-based language schools, teachers will be able to understand the unique characteristics of the students who attend both public schools and community language schools, and help them more effectively.

3. Because of the recent decision by the College Board and Educational Testing Service to develop foreign language achievement tests in Japanese and Chinese, a study of the communication and partnership collaboration between community-based language schools and public schools appears to be necessary. Such a study may have policy implications in bilingual and cross-cultural education.

#### A Closing Note

As the United States continues to grow more diverse linguistically and culturally, and more and more children from diverse backgrounds attend public schools and at the same time attend community-based language schools, it is important that the total educational experience of these students be studied in order to help them fully develop their potential. As a bilingual person and an educator, it is my belief that community-based language schools make a positive contribution to the maintenance of the ethnic language, culture and identity. Community language schools may serve as an alternative approach in the quest for helping the younger generation become bilingual and bicultural.

#### References

- Banks, J. A. (1991). *Teaching strategies for ethnic studies*. Boston: Allyn and Bacon.
- Bradunas, E. & Topping, B. E. (1988). *Ethnic heritage and language schools in America*. (Library of Congress, Washington, DC: American Folklife Center.
- Ferdman, B. M. (1990). "Literacy and cultural identity", *Harvard Educational Review*, 60 (2), pp. 181-204.
- Fishman, J. A., Nahirny, V. C., Hofman, J. E. & Hayden, R. G. (1966). *Language loyalty in the United States*. The Hague: Mouton & Co.
- Fishman, J. A. & Markman, B. (1979). *The ethnic mother tongue school in the United States: assumptions, findings and directory*. New York: Yeshiva University.
- Fishman, J. A. (1980). "Ethnic community mother tongue schools in the U.S.A.: dynamics and distributions", *International Migration Review*, 14 (2), pp. 235-247.
- Fishman, J. A. (1985). *The rise and fall of the ethnic revival*. The Hague: Mouton & Co.
- Chao, J. (1997, March 2). "Chinese school days: language links kidsto culture." *San Francisco Chronicle, Metro*.
- Jung, R. K. (1972). "The Chinese language school in the U.S.," *School and Society*, pp. 309-312.
- Kim, C. H. (1992). *Korean schools in California: a description of their role and function in maintaining Korean language and culture*. Unpublished doctoral dissertation, University of the Pacific.

# 1998 NABE Bilingual Education Outstanding Dissertations Competition

## ELIGIBILITY

The competition is open to those who have completed doctoral dissertations in the field of bilingual education between June 1, 1994 and August 1, 1997. Studies using any research approach (historical, experimental, survey, etc.) are eligible. Each study will be assessed in light of the research approach used, the scholarly quality of the dissertation, and the significance of its contribution to knowledge in the bilingual education field.

## APPLICATION

Those who wish to apply should seek application information from their professors or from:

Alfredo G. de los Santos Jr., Chair  
NABE Outstanding Dissertations Competition - 1998  
Maricopa Community Colleges  
2411 West 14th Street  
Tempe, AZ 85281-6941  
(602) 731-8101

## RECOGNITION

In effect, there will be two types of winners:

- (a) the semifinalists — the writers of the top seven to ten abstracts from which the three finalists will be selected, and
- (b) the three finalists — the writers of the dissertations selected by a panel of judges as first, second, and third place winners.

All semifinalists will be presented at the 27th Annual International Bilingual-Bicultural Education Conference of the National Association for Bilingual Education in Dallas, Texas, on 24-28 February 1998. The National Association for Bilingual Education will pay for the travel expenses and per diem to the convention for the three finalists.

## DEADLINE

Six (6) copies of the dissertation abstract prepared as directed in the guidelines must be received by **September 5, 1997**. Send them to the competition chair at the above address.



# NABE PRODUCTS ORDER FORM

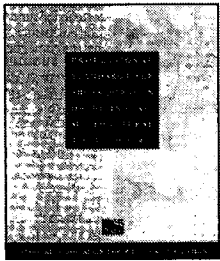
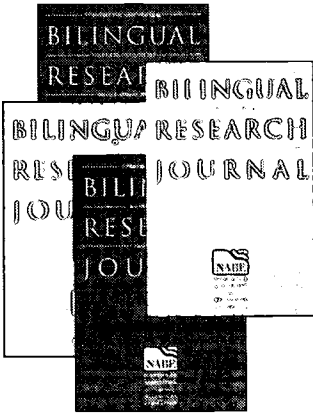

ITEM	PRICE	#	TOTAL
<b>PUBLICATIONS</b>			
<i>Bilingual Research Journal</i>	\$13.00		
Vol. 20, #1, Winter 1996 Current Journal Issue			
Vol. 19, #3&4, Spring/Summer 1995 Special issue: Role of ESL in Bilingual Education			
Vol. 19, #1, Fall 1994 Special issue: Native American Issues			
Vol. 16, #1&2, Spring/Summer 1995 Special issue: Ramirez study			
[ earlier issues available (call for details)]			
<i>NABE Annual Conference Journal</i>	\$7.00		
1989-90 issue			
1991-92 issue			
1992-93 issue			
<i>1997 Annual Conference Program</i>	\$5.00		
<i>NABE News</i>	\$5.00		
write issue date or volume/number here			
write issue date or volume/number here			
[current volume always available; earlier issues may also be available (call for specifics)]			
<i>Professional Standards for the Preparation of Bilingual/Multicultural Education Teachers</i>	\$5.00		
<b>PRODUCTS</b>			
NABE logo pins	\$5.00		
NABE bumper stickers			
"Proud to be Bilingual"	\$1.00		
"Orgulloso de ser Bilingüe"	\$1.00		
NABE canvas tote bags	\$5.00		
<b>VIDEO: Making Connections: Learning, Language and Technology</b>	\$7.00		
<b>TOTAL</b>			

- Prices include shipping by USPS first class mail. Special shipping available - call for pricing.
- Payment must accompany all orders. Make checks and purchase orders payable to NABE.
- Orders shipped to the District of Columbia must include 6% sales tax.
- Credit card orders may also be placed by phone (202 - 898-1829) during business hours.

## SHIPPING INFORMATION

Name \_\_\_\_\_ Company \_\_\_\_\_

Address \_\_\_\_\_

City/State/Zip \_\_\_\_\_ Phone \_\_\_\_\_

## PAYMENT INFORMATION

Check#: \_\_\_\_\_ PO#: \_\_\_\_\_ CC#: \_\_\_\_\_ ExpDate: \_\_\_\_\_

192

MAIL TO: NABE PRODUCTS, Suite 605, 1220 L Street NW, Washington, DC 20005-4018





# NABE NEWS Book Reviews

Column Editor: Dr. Beti Leone, Paterson Public Schools, NJ

## *Language Minority Students in the Mainstream Classroom*

Reviewed by Beti Leone, Ph.D.

*Language Minority Students in the Mainstream Classroom*, by Angela L. Carrasquillo and Vivian Rodríguez. Philadelphia: Multilingual Matters, 1996. pp. 187.

In *Language Minority Students in the Mainstream Classroom*, Carrasquillo and Rodríguez have succeeded in giving us a very useful, "user-friendly" book that teaches us about 1) issues involved with teaching limited English proficient students in the mainstream classroom, 2) who these students are, 3) the cultural and linguistic diversity that these students bring with them, 4) alternatives to mainstreaming, 5) background rationale and guidelines for integrating oral and written language instruction, 6) instructional strategies for guiding LEP students in their oral and written English development, and 7) instructional strategies for integrating language and content in social studies, science, and mathematics learning. Their final chapter takes a serious look at the mainstream teacher's role in LEP students' development of linguistic, cognitive, and academic skills.

The authors tell us that this book grew out of their experience teaching teachers in the New York/New Jersey metropolitan area and their need for a book that would assist mainstream educators "to integrate language and content areas into classrooms where there are language minority students who are not totally proficient in the English language." Often, mainstream educators can only take one course devoted to teaching language minority students as part of their general education training prior to beginning to teach. Although this is a lot to offer in one book, it certainly does address a need that all bilingual/TESL teacher educators have. Carrasquillo and Rodríguez have not only done what they set out to do, but they have done it very well. Most teachers already teaching in multilingual, multicultural schools, as well as administrators in these schools, will find this a handy book to keep nearby for the very useful teaching ideas and information and also for the clear explanations of background issues and theoretical research support for these practical applications.

In Chapter 1, the authors give important background information about the process of "mainstreaming," a term which, they point out, does not always mean the same thing to everyone. As part of this discussion, they identify three groups of LEP students who are mainstreamed, with brief descriptions about programming for each group. They also give "guiding principles" for mainstream classrooms, including important "shoulds" such as providing "a full range of educational opportunities," "opportunities for interaction with English proficient peers," and "opportu-

CONTINUED ON PAGE 28

## *Languages in America: A Pluralist View*

Review by René Cisneros, Ph.D.

*Language in America: A Pluralist View*, by Susan Dicker. Philadelphia: Multilingual Matters, 1996. pp. 278.

In writing the rationale for her book, Susan Dicker explains that even though support for language pluralism appears often in the media, there is a need for a book that elaborates and extends the discourse, and uses the wealth of scholarly knowledge in language learning and bilingualism to counter the rhetoric of language restrictionism imposed by the movement for "Official-English."

Dicker points out that proponents of "Official-English" are people with a political ideology, not with expertise in language learning or bilingualism. She adds that advocates of monolingualism have little research and scholarship on their side. For these reasons her book, *Languages in America: A Pluralist View*, is written with two goals in mind. First, the book examines the movement for English monolingualism in detail and reveals its inherent weaknesses. Second, it seeks to examine language pluralism, the antithesis of "Official-English," to show how language pluralism has enriched life in the United States, and to propose a future with language pluralism.

The author stresses that the book is written especially for the layperson and it reads easily, in a "reader-friendly" style. No expertise is needed to understand her clear interpretation of the research. Therefore, the book brings to the layperson the research on language learning and bilingualism, together with sociological and historical information, to explain what language diversity means and the important role it has in American society.

### Contents

*Languages in America* is divided into eight logically-organized chapters with discussions ranging from language and identity to the possibilities of a pluralistic, multilingual America. In between are found chapters on the melting pot mythology, misconceptions about language learning, languages in the schools, the "Official-English" movement and challenges to it, and multilingualism in the US.

Chapter One, on language and identity, addresses the role that language plays in identifying people and connecting them to each other. It is an appropriate first chapter because it immediately focuses on the speakers of languages. This is important because any attempt to restrict languages is clearly an attempt to target for attack and repress its speakers. Chapter Two shows that the melting pot mythology is a false representation of the immigrant

CONTINUED ON PAGE 12

experience and demonstrates, through the example of the Chinese experience, that being economically successful does not necessarily mean giving up one's native language. Chapter Three discusses linguistic theories and research that debunk eight common misconceptions about first and second language acquisition, and clearly explains the role of both optimal timing and quantity of exposure to a second language in developing cognitive skills and higher-level literacy.

Chapter Four is an analysis of languages in the schools, including both additive and subtractive instructional approaches for second languages. Dicker clearly points out the double standard that characterizes second language instruction in the US when she writes, "the efforts of native English-speaking Americans to become bilingual by acquiring a second language are met with enthusiasm; the efforts of non-native English-speaking Americans and immigrants to become bilingual by maintaining their native languages while acquiring English are considered counterproductive to their adaptation to American society." The author concludes by stating that dual language programs are the most promising, because they promote additive bilingualism for both the native and non-native English-speakers.

Chapter Five analyzes the "Official-English" movement, in its historical context of American language policy and the conservative social movements of nativism. It reveals the anti-immigrant sentiment at the core of the US English organization, the organization that leads the restriction of languages in the US. The author concludes that such restrictionism does "little to help the immigrant learn English or adjust to life in the new country," but rather has the effect of making the lives of minority language speakers "more difficult and devoid of dignity."

Chapter Six presents the defense of language pluralism as a continuing process, sometimes meeting success, sometimes failure, and reviews the public policy challenges posed by "Official-English" by the states of New Mexico, Arizona, Hawaii, and the commonwealth of Puerto Rico. This chapter clearly reveals that there is a profound lack of understanding about what language pluralism is and what

it can become in the United States.

Chapter Seven takes us beyond the United States to see how people in other nations deal with language diversity in a proactive and meaningful manner, focusing on the contexts of Canada, Switzerland, and India. The concluding chapter, Chapter Eight contemplates what the United States would look like if it could transcend its monolingualism.

### Critique

*Languages in America* is carefully thought out and logically organized, each chapter supporting and building up to the next. The rationale and plan for the book are clearly stated in the introduction. Furthermore, it has clarity and coherence. The author is sensitive to the issues of language diversity and responds to them in a most professional and informed way. All of the chapters are linked to the professional research literature: they are grounded in the important issues of bilingualism in its variety of settings and functions in bilingual communities. The author understands the professional literature well and integrates the dynamics of the ideological, social, historical, political, economic, and cultural issues embedded in language pluralism. In addition to her obvious commitment to high professional standards in her writing, the author also demonstrates a personal commitment to linguistic pluralism. She tells of her experience growing up with various languages in her home and family networks. In sum, the book, in a user-friendly manner, explains what language diversity means and the important role it has in American society.

I recommend *Languages in America* to all educators working with students in linguistically diverse communities. The book can also be used as a college textbook in education and liberal arts. I am using the book for an undergraduate course on cognitive development at Boricua College where I use various readings from *Languages in America*, primarily to develop understanding of higher level critical thinking and secondarily, to instill in the bilingual students a more informed and positive understanding of linguistic pluralism, particularly their own linguistic circumstances. So far, the response

from students and colleagues has been overwhelmingly enthusiastic.

I believe that Dicker has felicitously met her goals of 1) publishing a book that elaborates and extends the discourse on language pluralism; 2) using the wealth of scholarly knowledge in language learning and bilingualism research to counter the rhetoric of language restrictionism; and, 3) opening windows of possibilities for a pluralistic and multilingual America. The author ends the book with the following words:

"Language is power. Controlling a people's language is one way that those in power maintain control over others. As we watch the development of language policy in the United States, we are also watching the future of the nation (p. 250)."

*René Cisneros is a teacher, teacher educator, and researcher in the New York/New Jersey metro area in bilingual education, bilingualism, and language learning. He currently is a professor at Boricua College.*

• NABE •

## Book Review Submission Guidelines

Reviews for publications in the **Book Review** column be sent to Dr. Beti Leone, Book Review column editor, at NABE  
1220 L Street, NW, #605,  
Washington, DC, 20005,  
or by e-mail to  
NABE-NEWS@nabe.org.

Books from publishers should be clearly marked **BOOK REVIEW MATERIAL** and sent to the same address; **two complete sets of materials must be submitted.**

# American Indian Bilingual Education

Column Editor: Jon Reyhner, Northern Arizona University

## *The Inner World of the Native American Child*

by Ed Tennant

If, as *Time Magazine* wrote not long ago, the typical mainstream American child is "struggling through the jagged landscape of modern childhood," then the Native American student is struggling through a split-screen landscape, a confusing and discomfiting no-man's land between the mainstream and the home culture. In the classroom, this struggle can be seen in the children's silence, their shyness, their hesitancy to begin building a two-way bridge between the cultures.

Most Native American students, even those in urban areas, wrestle with the challenge of trying to harmonize their Native cultural value system with the often conflicting value system of the school and larger society. This demanding process is called acculturation. Much of the process takes place in the deepest recesses of the child's soul. In classrooms, that struggle is often not seen for what it is. For that reason, it too often goes unaddressed.

Even when teachers recognize that a student's withdrawal into an innerworld is the result of cross-cultural distress, often they feel ill equipped to draw the student out of that inner world. Few educational resources have addressed this delicate challenge.

One recent book, however, has. The book has been described by Jim Cummins, of the Ontario Institute for Studies in Education, as "unique in North American literature on bilingual/multicultural education." That book is *The Inner World of the Immigrant Child* by Dr. Cristina Igoa. Replace the word "Immigrant" in the title with "Culturally Diverse" and you will find that the contents of this rich and sensitive book apply as well to Native American children as they do children from other countries.

Dr. Igoa's personal odyssey as a child, fleeing the war torn Philippines with her family, adapting to a new life and lan-

guage first in Colombia and later in the United States, has given her an insight and an empathy into a child's struggle with cultural identity. What is unique about her later life as a teacher and the author of *The Inner World* is that she used this experience to draw culturally diverse children out of their protective prisons of silence into a comfortable bicultural world. In her book, Dr. Igoa explains step-by-step in a simple, poetic style, how she developed her methods for working with children who are struggling to adapt to mainstream culture. She stresses how important it is to develop rapport with the students. More importantly, she illustrates how to build that rapport: listening to them attentively, patiently, and responsively, offering them simple, non-threatening ways to "tell their stories."

Inviting a child to communicate the depths of his or her inner vision is a complex, at times frustrating, task. Each child responds to the invitation in a different way. But Dr. Igoa begins the invitation the same way with every child: setting up a safe and secure learning situation, a "nest" in which the child can feel comfortable taking the first tentative steps out into a world full of shadowy specters.

The children you meet in *The Inner World* are real—Dennis, Qiu Liang, Alice, Cindy, Rosario, and Yoong. They each have a story of emergence that begins in Dr. Igoa's classroom and ends years later when she searches each one of them out to learn how they now perceive the acculturation they went through as a child.

When each of these children arrived in her classroom, they were young, uprooted, and felt displaced. Once they were provided with a "nest" where they felt not only secure, but welcome, Dr. Igoa encouraged them to "tell a story," which always turned out to be "their story." She invited the children when they were ready to tell their story in pictures on blank film strips. She then encouraged them to add a recorded audio narrative with sound ef-

fects. As children became more comfortable with the process and with each other, they would proudly play their filmstrip productions for their classmates.

The story might be about "The Lonely Bear," but it really was about Rosario who "had no friends to play with." As Dr. Igoa takes us through each child's unique story of feeling lonely, unlikable, or rejected, she teaches us how to interpret the feelings behind the symbols and, more importantly, how to respond to them in a way that makes school an uplifting intervention in that child's life.

Part One of *The Inner World* presents the personal stories of the children mentioned above. In Part Two, Dr. Igoa synthesizes how she applied theory to practice and then further refined that theory based on her classroom experience. What evolved from this work with culturally diverse children is a methodology she calls CAP, a Cultural Academic Psychological approach for teaching children who are struggling with acculturation.

The process begins with "dialogic intervention." This is the way a caring person parent, teacher, or counselor intervenes in a positive way when a person expresses negative perceptions that threaten to block their progress. Then the cultural and psychological aspects of the methodology are applied in order to lay the foundation for the academic growth. Only when the child feels in harmony with all three of these aspects of self, notes the author, will the child feel "fully alive" in school. In the rest of Part Two, Dr. Igoa show us how to put the three dimensions of CAP into practice. She shows us how to set the stage for the culturally diverse child, how to "build the nest," how to encourage a home library.

She explains how to validate a child's culture, how to involve parents in the acculturation of their children, how to set up peer bonding, study groups, and a buddy system. She shows how to help the chil-

CONTINUED ON PAGE 14

dren assume responsibility for their education. Dr. Igoa completes Part Two with one chapter on Schoolwork and another on Cultural Continuity. The first examines traditional academic intervention and how it can be adapted to better serve the needs of the culturally diverse child. The second is a parting reminder that the acculturation process should not replace the home culture, but rather validate it. Anyone who contributes to the education of Native American children—parents, teachers, counselors will find a host of valuable insights and practices in this book.

#### References

Ed Tennant is Director of Educational Research Associates, Inc. in Albuquerque, NM and is the author of *The Eye of Awareness: Life Values Across Cultures*.

Dr. Igoa's book, *The Inner World of the Immigrant Child*, can be ordered from: Lawrence Erlbaum Associates, Inc., Publishers, 10 Industrial Ave., Mahwah, NJ, 07430-2262. Call toll free: 1-800-926-6579.

**Editor's Note:** Send contributions to the American Indian Bilingual Education column to Jon Reyhner, Center for Excellence in Education, Northern Arizona University, P.O. Box 5774, Flagstaff, AZ 86001-5774, or send by E-mail to: JON\_REYHNER@mail.cee.nau.edu, (520) 523-0580, fax: (520) 523-1929.

◀ NABE ▶

Ogbu, J. U. & Matute-Bianchi, M.E. (1986). "Understanding socio-cultural factors: knowledge, identity, and school achievement." In *Beyond language: social & cultural factors in schooling language minority students* (pp. 73-142). UCLA: Evaluation, Dissemination & Assessment Center.

Ogbu, J. U. (1991). "Understanding cultural diversity and learning," *Educational Researcher*, 21(8), pp. 5-14.

Sue, D. W. (1973). "Ethnic identity: the impact of two cultures on the psychological development of Asians in American." In S. Sue & N. Wagner (Eds.). *Asian-Americans: psychological perspectives*. Palo Alto: Science and Behavior Books, Inc.

U.S. Bureau of the Census. (1990). *Statistical abstract of the United States (109th ed.)*, Washington, D. C.: U.S. Government Printing Office.

Lu Chang is an Assistant Professor of Education at College of Notre Dame in Belmont, California. She is also Coordinator of Single Subject Cross-cultural Language and Academic Development Credential Program.

**Editor's Note:** Contributions to the Asian/Pacific American Education Concerns column should be sent to Janet Lu, MCR/NC, 1212 Broadway, #400, Oakland, CA 94912. (510) 763-1490. Email: janet\_lu@arcoakland.org

◀ NABE ▶

## Oxnard School District

Oxnard, California

**Assistant Superintendent -  
Human Resources/Information & Support  
Services/Pupil Services**

The Oxnard School District is a K-8, year-round school system serving approximately 14,400 students (largely minority) through its fourteen elementary and three intermediate schools.

**Education/Experience:** A Master's degree and a valid, appropriate administrative credential are required. A minimum of four years school-related experience and four years administrative or supervisory experience are also required. Bilingual a plus.

**Salary:** \$87,963

**Closing Date:** June 11, 1997

**To Apply:** Send resume, cover letter and the names and phone numbers of five work-related references to Heather Renschler, Ralph Andersen & Associates, 1435 River Park Drive, Suite 400, Sacramento, California 95815 or e-mail at [raa@ralphandersen.com](mailto:raa@ralphandersen.com). For more detailed information call (916) 929-5575.

AA/EOE

**RALPH ANDERSEN & ASSOCIATES**

## REPRINT PERMISSION

Readers are  
welcome to reprint any  
NABE NEWS  
original material  
free of charge  
as long as proper credit  
is given to  
both the author and  
NABE NEWS  
as the source.

# Upcoming Events

May 2-3, 1997 - *Stabilizing Indigenous Languages Symposium*. de Bois Conference Center, Flagstaff, AZ. Contact Jon Reyhner at (520) 523-0580.

May 4-9, 1997 - *International Reading Association Annual Conference*. Georgia World Congress Center, Atlanta, GA. Contact IRA at (302) 731-1600.

May 21-22, 1997 - *New Jersey TESOL/BE 27th Annual Conference "NJTESOL/BE: The Multicultural Connection."* Brunswick Hilton and Towers, Brunswick, NJ. Contact Mihri Napoliello at (201) 200-3375.

June 2-27, 1997 - *18th Annual American Indian Language Development Institute "Linguistic Diversity & Pluralism: Family, Community, and Tribal Perspectives."* Tucson, AZ. Contact AILDI at (520) 621-1068

June 9-11, 1997 - *Kansas State Department of Education 1997 Migrant-ESOL-Bilingual Conference*. Wichita, KS. Contact Kansas Dept. of Education at (913) 296-2306.

June 19-21, 1997 - *National Association of Latino Elected Officials 14th Annual Conference*. Hyatt Regency, Miami, FL. Contact NALEO at (213) 262-8503.

June 23-27, 1997 - *15th Annual Multicultural Summer Institute*. The University of Findlay, OH. Contact Jean Nye at (419) 424-4774.

July 1-6, 1997 - *National Education Association Annual Conference*. Atlanta, GA. Contact NEA at (202) 822-7000.

July 12-19, 1997 - *Multicultural Education Conference "Explore Cross-Cultural Education: From the Navajo and Hopi Perspectives"*. Hopi Reservation and Navajo Nation in northern Arizona. Contact Jennifer Hartin at (800) 426-8315, x 4.

July 16-18, 21-25, 28-Aug. 1 - *Summer Institutes for Intercultural Communication*. Offering a range of workshops on intercultural communication and multicultural education. Contact The Intercultural Communication Institute, 8835 S.W. Canyon Lane, Suite 238, Portland, OR 97225 (503) 297-4622.

July 17-18, 1997 - *Center for Language Minority Education and Research Two-Way Bilingual Immersion Conference*. Asilomar Conference Center, Pacific Grove, CA. Contact Judy Lambert at (916) 657-3826.

July 18-19, 1997 - *Hispanic Student Leadership Conference*. Washington, DC. Contact HSLC at (301) 270-4945.

July 20-23, 1997 - *National Council of La Raza 29th Annual Conference, "Latinos: No Challenges Unmet - No Issues Unanswered."* Navy Pier, Chicago, IL. Contact NCLR at (202) 785-1670.

July 29 - August 2, 1997 - *24th Annual Linguistic Association of Canada and the United States Forum*. York University, Toronto, Ontario, Canada. Contact Ruth Brend at (313) 665-2787.

August 1-3, 1997 - *Third Annual Conference on Teaching Spanish to Native Speakers*. Las Cruces, NM. Contact NMSU at (505) 646-7876 fax.

August 1-4, 1997 - *American Association of Teachers of Korean 3rd Annual Conference*. Phoenix, AZ. Contact John Koo at (602) 965-7126.

## Special Events?

Send announcements of upcoming events to Editor, NABE NEWS at the national office, or email NABE\_NEWS@nabe.org. Events may be listed once free of charge.

# NABE '98

February 24 - 28, 1998  
Dallas, Texas

Mark your calendars now!

# Bilingual Education: Portraits of Success Project

Column Editor: Dr. María Estela Brisk, Boston University, Boston, Mass.

## *School-to-Work Programs for Bilingual Students Anyone? In Search for Exemplary Practices*

*by Joyce Malyn-Smith, Ed.D.*

School-to-Work provides a unique opportunity for bilingual/bicultural students to explore and experience the world of high skill/high wage careers. The School-to-Work Opportunities Act of 1994 establishes a national framework for the development of School-to-Work systems within states to enable youth to identify and navigate paths to productive and progressively more rewarding roles in the world of work. One of the key elements of this movement is that School-to-Work systems are for "all students." As defined by the Act, "all students" means both male and female students from a broad range of backgrounds and circumstances, including disadvantaged students, students with diverse racial, ethnic, or cultural backgrounds, American Indians, Alaska Natives, native Hawaiians, students with disabilities, students with limited-English proficiency, migrant children, school dropouts, and academically talented students.

Ensuring that School-to-Work systems developed in our states and communities effectively serve "all students" is a challenge faced by each and every state and local community receiving federal

STWOA funds. Ensuring that School-to-Work systems meet the interests and needs of bilingual students and provides real opportunities to develop the skills and knowledge needed to thrive in a high skill/high wage career, is the challenge faced by all advocates for bilingual populations.

To further learning and sharing in this field we are seeking nominations of examples of best programs and practices in school-to-work for bilingual students. These examples will become part of an information bank of resources for bilingual communities in School-to-Work. Selected examples will be shared with the NABE community in an upcoming issue. We encourage examples of successful programs and strategies related to all aspects of school-to-work for bilingual communities. Such strategies may include school-based learning; work-based learning and connecting activities; successful examples and strategies to recruit and engage bilingual employers, parents and community members in school-to-work; as well as strategies that work to build for the inclusion of bilingual students in school-to-work programs. Please return the Nomination Form by September 15, 1997.

Our goal is to formalize this intersection through the development of a com-

munity of learners who can help influence policy and practice in this field. Initially we will share information on best practice, issues, barriers, and incentives. Together, we will develop and share strategies to advocate for the inclusion of bilingual students in School-to-Work systems. We look forward to hearing about your success stories and your interests as we work together to provide bilingual students and their advocates with information to help navigate the world of school-to-work.

*Joyce Malyn-Smith, Ed.D., is Senior Project Director at the Center for Education, Employment and Community Education Development Center, Inc., in Newton, MA. She can be contacted at 55 Chapel Street, Newton, MA 02158 ; e-mail: JoyceM@edc.org.*

**Editor's Note:** Contributions to the Bilingual Education: Portraits of Success column should be sent to Dr. María Estela Brisk, School of Education, Boston University, 605 Commonwealth Ave. Boston, MA 02215; To contact via Internet: brisk@acs.bu.edu; fax: 617-232-8907.

\* NABE \*

## NABE Action Alerts now available through the Internet

NABE sends special Action Alerts to members and subscribers to inform them of the latest developments in Washington concerning bilingual education. These Action Alerts are now available by e-mail. Before the end of the summer, current Action Alerts will also begin to be posted on the NABE World Wide Web site.

To subscribe to the Action Alert electronic mailing list, send an e-mail message to: <majordomo@nabe.org>, with the following text as the body of the message:  
subscribe actionalert <your e-mail address goes here>.

NABE's Web site can be accessed at <<http://www.nabe.org>>. 198

# NATIONAL ASSOCIATION FOR BILINGUAL EDUCATION

Bilingual Education *Portraits of Success* Project  
Call for Nominations for  
School-To-Work Programs for Bilingual Students

Nomination for:  school  program  teacher  student  graduate  
 other: \_\_\_\_\_

Name of nominee (if an individual): \_\_\_\_\_

Contact (person submitting form): \_\_\_\_\_

Title or relationship to nominee: \_\_\_\_\_

Address: \_\_\_\_\_

City: \_\_\_\_\_ State: \_\_\_\_\_ Zip: \_\_\_\_\_

Phone: (\_\_\_\_) \_\_\_\_\_ Fax: (\_\_\_\_) \_\_\_\_\_ e-mail: \_\_\_\_\_

## 1. General Information

School (program) name: \_\_\_\_\_

School Address: \_\_\_\_\_

City: \_\_\_\_\_ State: \_\_\_\_\_ Zip: \_\_\_\_\_

School District: \_\_\_\_\_

Congressional District: \_\_\_\_\_

Principal: \_\_\_\_\_

Bilingual Program Director: \_\_\_\_\_

Number of students in school: \_\_\_\_\_

Grades (circle): K 1 2 3 4 5 6 7 8 9 10 11 12

Number of students in bilingual program: \_\_\_\_\_ in grades: \_\_\_\_\_

Home language of students (If more than one, give # of students by language group):  
\_\_\_\_\_

Sources of Funding:  Federal  District/local  State  Private

Does your program receive Title VII funding?  yes  no

Has the nominated school, program, or individual previously appeared in any article, dissertation or study?

yes       no      If so, please cite below:

---

---

**2. Program Description**(for school and program nominations): Please attach a typed description that explains the characteristics of your program and provides evidence of the program's success. Include information such as instructional approaches, language use (L1/L2 allocation), interaction between bilingual program and the larger school community, services for bilingual students, and any other feature you consider relevant. Please be sure to explain the criteria used for nominating this program as a successful one, whether it be student outcomes, awards to students or staff, presence of characteristics consistent with effective schools research, or a combination of the above.

**3. Individual Success Story** (for teacher, student or graduate nominations): Please attach a typed description of the nominee that explains his/her participation in a bilingual program and provides evidence of his/her success. Include anecdotal information, if possible, on how this person has benefited from or made a difference in a bilingual program. Please be sure to explain the criteria used for nominating this individual as an exemplar of success in bilingual education, whether it be academic or professional achievement, personal growth, awards received, contributions to the bilingual program, or a combination of the above.

**4. Additional Contact Persons**

Please list any other individuals who would be available to add information to this nomination.

Name	Title or Relationship to Nominee	Phone
------	----------------------------------	-------

---

**AUTHORIZATION STATEMENT**

"I hereby give NABE permission to publish and share this information with others and certify that its release does not violate the Federal Educational Records Privacy Act (FERPA)."

Signature: \_\_\_\_\_ Date: \_\_\_\_\_

Name: \_\_\_\_\_

nominee     program director     other: \_\_\_\_\_

<b>Return form to:</b>	María Estela Brisk School of Education Boston University 605 Commonwealth Avenue Boston, MA 02215 fax: (617) 353-3924      200
------------------------	---



# Resources for Bilingual Educators

by Nicole Pichard

**Alphabet Around the Year.** A complete classroom-tested curriculum for teaching each letter of the alphabet around the school year. Letters are introduced every two weeks based on their thematic relationship to that week's studies, seasons and holidays. Suggested topics and literature selections are intended to capture the curiosity of preK-1st grade students, with a variety of reading, writing, math, science, social studies, and art activities provided to connect content areas with the alphabet theme. \$24.95. Send check or purchasing order to Teacher Created Materials, Inc., 6421 Industry Way, Westminster, CA 92683-3608. For more information, product samples or digital images, contact Kathleen Gould (800) 858-7339 x159.

**Developmentally Appropriate Practice in Early Childhood Programs**, edited by Sue Bredekamp and Carol Copple. This new 1997 edition expands and clarifies the definition of "developmentally appropriate practice" and aims to help early childhood professionals view working with young children as a constant process of professional decision making. The book gives more explicit recognition to the role of social and cultural contexts in influencing children's development, identifies twelve fundamental, empirically-based principles of child development and learning, and offers other insights into developmentally appropriate practice. \$8. Available through NAEYC, through Resource Sales. (800) 424-2460, ext. 604, order #234.

**Encyclopedia of African-American Education.** Through several hundred alphabetically arranged entries, this reference offers a comprehensive overview of significant issues, policies, historical events, laws, persons, and theories related to African-American education from the early years of this country to the present day. The entries are written by expert contributors, and each entry includes a bibliography of works for further reading. A selected, general bibliography concludes the volume. \$95.00. Greenwood Publishing Group. (800) 225-5800.

**Enhancing the Reading Engagement of African American and Hispanic Learners in Inner-City Schools: A Curriculum Guide for Teacher Training**, by Ruby L. Thompson and Gloria A. Mixon. A curriculum guide published by the National Reading Research Center which offers suggestions for adapting reading instruction to the needs of African American and Latino students. The guide is intended as the basis for a course on multicultural education or for individual staff development workshops. \$4. Send check to the National Reading Research Center, Dissemination/Publications, 318 Aderhold Hall, University of Georgia, Athens, GA 30602-7125 (cite instructional resource no. 21). Available for a limited time only.

**How to Manage Learning Centers in the Classroom.** A new K-6 resource is designed to help teachers and students reach their

common goal of making the classroom exciting, motivating, and empowering. It starts with the basics of getting organized, preparing materials and actually creating the learning center, then moves into student-focused issues like goal setting, positive reinforcement and time management. Ideas for over 15 curriculum centers are included, along with assessment tools for gauging and ensuring students' progress. \$24.95. Send check or purchasing order to Teacher Created Materials, Inc., 6421 Industry Way, Westminster, CA 92683-3608. For more information, product samples or digital images, contact Kathleen Gould (800) 858-7339 x159.

**How to Manage Your Multi-Age Classroom.** This resource is written for grades 3-5 and clearly defines the multi-age philosophy, curriculum and classroom management through easy-to-understand explanations and instructional examples. Tips for organizing curriculum, grouping students and for encouraging parental involvement are provided. Authentic assessment techniques are also discussed as well as the advantages and disadvantages of the multi-age classroom. \$12.95. Send check or purchasing order to Teacher Created Materials, Inc., 6421 Industry Way, Westminster, CA 92683-3608. For more information, product samples or digital images, contact Kathleen Gould (800) 858-7339 x159.

**HyperStudio for Terrified Teachers, Kid Pix for Terrified Teachers.** These are the first titles in a new series of user-friendly tutorials that clearly explain how to use and teach today's most popular classroom software. *Hyperstudio* is available for grades 3-5 and grades 6-8 and is structured into a series of beginning, intermediate and advanced lessons for Mac and PC platforms. *Kid Pix* is available for grades K-2 and grades 3-5 for Mac and PC platforms. \$19.95 each. Send check or purchasing order to Teacher Created Materials, Inc., 6421 Industry Way, Westminster, CA 92683-3608. For more information, product samples or digital images, contact Kathleen Gould (800) 858-7339 x159.

**Improving Schooling for Language-Minority Children: A Research Agenda**, edited by Diane August and Kenji Hakuta. The report of a committee of experts which focuses on the question of how we effectively teach children from homes in which a language other than English is spoken. The book reviews a broad range of studies, trying to construct a strong and credible knowledge base to inform the activities of those who educate children as well as those who fund and conduct research. It provides perspective on the history of bilingual education in the U.S.; summarizes relevant research on the development of a second language, literacy, and content knowledge; reviews past evaluation studies; explores what we know about effective schools and classrooms; examines research on the education of teachers of culturally and linguistically diverse students; critically reviews the system for the collection of education statistics as it relates to this student population; and recommends changes in the infrastructure that supports research on these students. \$54.95. Contact National Academy

Press, 2101 Constitution Avenue, N.W., Washington, DC 20055 (800) 624-6242 or (202) 334-2451 fax.

**Internet for Teachers and Parents.** A 256 page reference for teaching and learning with the global technology network known as the Internet. There are eight comprehensive sections serving as a helpful roadmap to understanding and applying cyberspace how-to's. Includes glossary, hands-on-activities, Internet-related lesson plans, and explores interesting topics such as Netiquette, Netics, and safe surfing. Information gathering and communicating via email are also discussed. \$19.95 Send check or purchasing order to Teacher Created Materials, Inc., 6421 Industry Way, Westminster, CA 92683-3608. For more information, product samples or digital images, contact Kathleen Gould (800) 858-7339 x159.

**Language, Culture, and Power. Bilingual Families and the Struggle for Quality Education,** by Lourdes Díaz Soto. Over a nine-year period, the author collected data from bilingual families residing in "Steel Town" Pennsylvania regarding their educational experiences. When the local school board and school superintendent decided to eliminate its nationally recognized, twenty year old program, the bilingual families organized themselves to speak out. In the ensuing political struggle, the voices of the bilingual community leaders, bilingual educators, and the bilingual children were disregarded. The author exposes the painful conflicts surrounding education of language and ethnic minority children, and the resistance of many Anglos towards parents and communities of such sources of knowledge. Soto argues that this is as much of a political issue as it is an educational one. \$14.95. Send check or purchasing order to SUNY, State University of New York Press, State University Plaza, Albany, NY 12246.

**Learning Center Activities Series: Science, Reading Skills, Math, Writing, Holidays, and Brainteasers, Puzzles, and Games.** Hands-on activities which serve as learning center resources and guides for creating skill-specific activities. \$9.95 each. Send check or purchasing order to Teacher Created Materials, Inc., 6421 Industry Way, Westminster, CA 92683-3608. For more information, product samples or digital images, contact Kathleen Gould (800) 858-7339 x159.

**Living in a Multi-Cultural World Video Series.** The goal of this innovative, new four volume video series is to teach students the basics of getting along with people from other cultural and ethnic backgrounds and to be able to face this challenge enthusiastically. Each video offers students a different perspective on getting along in a multi-cultural world. The four videos, *Interpersonal Relationships in a Multi-Cultural World*, *Communication Skills in a Multi-Cultural World*, *Developing Friendships in a Multi-Cultural World*, and *Overcoming Prejudice in a Multi-Cultural World*, can be bought in the series or separately. \$329 +8% shipping and handling. Send check or purchase order to Ready Reference Press, P.O. Box 5249, Santa Monica, CA 90409. (800) 424-5627.

**On Behalf of the Wolf and the First Peoples,** by Joseph Marshall III. Provocative essays providing insight on being a Native

American in a white man's world — which was once a Native American world. \$13.95 + \$3.75 shipping and handling. Send check or purchase order to 2008 Rosina Street, Suite B, Santa Fe, NM 87505. (800) 922-33992.

**One Child, Two Languages,** by Patton O. Tabors, Ed.D. Written expressly for teachers, this highly readable guide offers the specific techniques needed to facilitate the natural progression of second language acquisition in preschool children. Teachers will learn how to create a supportive classroom environment for the children learning English as a second language — with effective ways to measure progress, address individual differences, and work with parents — while acknowledging the importance of children's home languages and cultures. \$24.95 + shipping and handling. Send check or purchasing order to Brookes Publishing Co., P.O. Box 10624, Baltimore, MD 21285-0624. (800) 638-3755. [custser@pbrookes.com](mailto:custser@pbrookes.com)

**Portfolios Through the Year.** This is a year-round assessment resource for grades 3-6 teachers including a variety of unit projects to be completed throughout the year which guide students through the writing and assessment process by using specific rubrics for each lesson. It also utilizes peer-conferencing, peer-editing, self-evaluation, and reassessment exercises for students to revise and polish their final submissions. \$11.95. Send check or purchasing order to Teacher Created Materials, Inc., 6421 Industry Way, Westminster, CA 92683-3608. For more information, product samples or digital images, contact Kathleen Gould (800) 858-7339 x159.

**Preschool Arts and Crafts.** This book has original poems and easy-to-follow instructions which promise many hours of creative expression through drawing, cutting, pasting, molding and painting activities which can be done at school or home using everyday materials, recycled containers, and items found in nature. Ages 3-5. \$12.95. Send check or purchasing order to Teacher Created Materials, Inc., 6421 Industry Way, Westminster, CA 92683-3608. For more information, product samples or digital images, contact Kathleen Gould (800) 858-7339 x159.

**Preschool Games.** A 304 page resource on making difficult transitions for preschoolers easier though hundreds of enjoyable games and miniactivities designed to transition students in a manner where the teacher is still in charge of the situation. The games can also help calm children, get them interested in something, help focus their attention, and even diffuse emergency situations. \$24.95. Send check or purchasing order to Teacher Created Materials, Inc., 6421 Industry Way, Westminster, CA 92683-3608. For more information, product samples or digital images, contact Kathleen Gould (800) 858-7339 x159.

**Reading in a Bag, Writing in a Bag, Art in a Bag.** These are three new titles added to Teacher Created Materials' series of home/school resource books for grades 1-3. The child develops a positive attitude towards his or her own skill development through real-world applications outside the classroom further enriched by their parents' involvement. \$9.95 each. Send check or purchasing

order to Teacher Created Materials, Inc., 6421 Industry Way, Westminster, CA 92683-3608. For more information, product samples or digital images, contact Kathleen Gould (800) 858-7339 x159.

**Relaciones Familiares I. Family Connections I**, the colorful guides to early learning for families of young children, are now available in a Spanish-language version. Research shows that when families are involved in their children's education, children learn more in school, are less likely to drop out, and are more likely to become successful adults. The guides enable schools to help parents know and believe: "You are your child's first and most important teacher." They include messages to parents, activities for them to do with their youngsters, and short read-aloud selections. For information and free samples call Robert Childers or Patricia Penn at (800)624-9120, or write to The Family Connections Program, AEL, P.O. Box 1348, Charleston, WV 25325-1348.

**Research in Reading Recovery**. Editors Stanley Swartz and Adria Klein collect in one place much of the best research available on reading recovery. The compilation represents current thinking and new insights on topics such as: an inquiry-based model for education literacy teachers, sustained effects of reading recovery on the cognitive behavior of children, factors affecting students' progress in reading, an early intervention literacy program in Spanish, reading recovery and its effects on children with learning disabilities, and oral language assessment and development in reading recovery. \$19.50. Send check or purchasing order to 361 Hanover St., Portsmouth, NH 03801-3912. (800) 541-2086.

**Simple Cooking Fun**. This book is a unique blend of well-loved children's literature and related recipes. Much more than a cookbook, when a child cuts an apple into eight parts, names each part as one-eighth, calls each eighth a wedge and then cooks for ten minutes as a part of an applesauce recipe, there is a great deal of math going on. Other hidden ingredients include science, reading, social studies and fine arts. Ages 5-9. \$12.95. Send check or purchasing order to Teacher Created Materials, Inc., 6421 Industry Way, Westminster, CA 92683-3608. For more information, product samples or digital images, contact Kathleen Gould (800) 858-7339 x159.

**Teaching Reading and Writing in Spanish in the Bilingual Classroom**, by Yvonne and David Freeman. The authors present a thoughtful and readable discussion of literacy theory, review traditional methods of teaching reading in Spanish, and for each method suggest a positive literature-based alternative. The book also provides concrete, step-by-step suggestions to bilingual teachers for ways to help their students develop full literacy in two languages. A unique feature of the book is its inclusion of lists of children's literature in Spanish. \$28.50. Send check or purchasing order to 361 Hanover St., Portsmouth, NH 03801-3912. (800) 541-2086.

**Texas School Finance Reform: An IDRA Perspective**, by Dr. José A. Cárdenas. Cárdenas, the founder and director emeritus of

IDRA, chronicles the 28 year history of school finance reform in Texas. Beginning with a description of the Texas system in 1950, the account covers court cases, legislation, and advocacy efforts and concludes with the status and future of school finance reform. Personal vignettes sprinkled throughout offer glimpses of those special untold moments that impacted history. Much of this volume- including the myths of school finance and lessons learned- relate to reform efforts in other states as well. \$30.00. Send check or purchasing order to IDRA, 5835 Callaghan, Suite 350, San Antonio, TX 78228-1190. (210) 684-8180. idra@idra.org

**This Old Man/Este Viejito**. First in a new series of bilingual individual song packages, this traditional old English song is shared in format of song/chant/song with children's chorus in English on one side, Spanish adaptation on the other. Children can read along as they sing along using the attractive illustrated bilingual songbook which includes music. For bilingual, ESL/SSL. Approx. 16 mins. Grades preK - 2. \$9.95 single, \$18.75 set of five. Order direct from High Haven Music, P.O. Box 246, Sonoita, AZ 85673-0246. (800) 438-1637, or Educational Record Center (800) 223-7672. Also available through Professional Media Service and Baker & Taylor.

**Through Students' Eyes. Combating Racism in United States Schools**, by Karen B. McLean Donaldson. This book explores racism in American high schools and provides possible solutions to this widespread problem. The major part of Dr. Donaldson's work focuses on the role of the arts in antiracist/multicultural education. Among other insights, Donaldson explores the re-education of teachers in an anti-racist, interdisciplinary curriculum development and implementation pilot study. \$49.95. Greenwood Publishing Group. (800) 225-5800

**Welcome to the United States: A Guidebook for Refugees**. Provides refugees being resettled in the United States with general information about what they will encounter and what services they will need during their first months in the country. The guide aims to help these US-bound refugees develop realistic expectation about employment, education, health, and other aspects of life in the United States. Order English and other language versions from Refugee Service Center, Center for Applied Linguistics, 1118 22nd Street NW, Washington, DC 20037. (202) 429-9292.

*Nicole Pichard is an Intern in NABE's Policy Education Program this summer. She is majoring in Latin American Studies at Wesleyan University in Connecticut.*

*Resources are listed for the information of the NABE membership. Listing does not imply endorsement of the resource by the National Association for Bilingual Education. If you want more information about any item listed in this column, you must contact the publisher/developer directly.*

**Claudia B.**

Claudia, a Native American who was fluent in Cree and Crow while learning English, won in 1992 when she was a 7th grader at Rocky Boy Elementary in Montana. She is presently attending Stone Child College where she plans to pursue a degree in either business or psychology.

**Isabel G.**

Isabel, a Spanish-speaker from Mexico, won in 1995 when she was an 11th grader at Sierra Vista High School in California. She is presently attending Watterson College in California where she is pursuing a degree in Computer Information Systems.

**Patricia F.**

Patricia, a Spanish-speaker from Mexico, won in 1993 when she was a 10th grader at West Las Vegas High School in New Mexico. Patricia is presently attending the University of New Mexico where she is majoring in Biology. She plans to attend Medical School.

**Aaron J.**

Aaron, a Navajo-speaker from Arizona, won in 1991 when he was an 8th grader at Tuba City Junior High School. Aaron is presently attending Northern Arizona University where he is majoring in elementary education. He plans to become a bilingual elementary teacher.

**Joseph M.**

Joseph, a Spanish-speaker from New Mexico, won in 1985 when he was a 4th grader at Pojoaque Elementary School in New Mexico. Joseph is currently attending the University of New Mexico where he is majoring in Architectural Engineering. Joseph works for the Vigil Law Firm.

**Sabino M.**

Sabino, a Spanish-speaker from Mexico, won in 1994 when he was a 12th grader at Río Grande High School in New Mexico. Sabino is presently attending The University of New Mexico under a Regent's Scholarship. He is majoring in Electrical Engineering and plans to work for General Motors in Mexico.

**Paloma R.**

Paloma, a Spanish-speaker from Wisconsin, won in 1990 when she was a 6th grader at Wisconsin Avenue School in Wisconsin. She is presently attending Duluth Business University. Paloma plans to become a medical assistant first, and then apply to Medical School.

**Axel R.**

Axel, a Spanish-speaker from Nicaragua, won in 1983 when he was a 5th grader at Wisconsin Avenue School in Wisconsin. He is now a senior at UCLA where he is majoring in premedicine. Axel is in the process of applying to medical school.

**Deborah R.**

Deborah, a Cherokee-speaker from Oklahoma, won in 1986 when she was a 10th grader at Oaks Mission School in Oklahoma. She graduated from the University of Oklahoma in 1993 with a degree in Journalism and Mass Communication. Deborah is presently working for Radio Tashkent in the Republic of Uzbekistan and also owns her own business.

**Peggy S.**

Peggy, a Chinese-speaker from China, won in 1984 when she was a 3rd grader at Ynez Elementary School in California. Peggy is now a senior at UCLA completing a degree in biology. She has applied and been accepted to several medical schools.

**Denise V.**

Denise, a Spanish-speaker from New Jersey, won in 1988 as a 5th grader at Franklin School in New Jersey. Denise is currently a student at Rutgers University, Newark where she is pursuing a degree in education. She plans to become a secondary history teacher.

**Rebecca Y.**

Rebecca, a Chinese-speaker from China, won in 1988 as a 10th grader at Sierra Vista High School. She graduated from UCLA in 1994 with a degree in economics/business. Rebecca is currently employed at Glenfed Brokerage, an investment firm located in Los Angeles. She plans to pursue an MBA in the near future.

**How Did Winning NABE's Essay Contest Impact Student Lives?**

Winning a national contest is not something that happens every day for many bilingual/ESL students, but when something of this magnitude is accomplished, it certainly makes an impact not only on the student, but also on those who contributed to making a student's essay a winning one. The following is a synopsis of how students felt as they were given the good news.

- Lourdes says, "winning the essay was very inspiring" and it became the impetus for moving forward. Even though her English-speaking skills were quite limited, the speech she delivered in Albuquerque was "marvelous."
- Claudia was "just another student," but after winning the essay, she began to be recognized as a talented and special student.
- Isabel cannot forget how two of the most important people were there when she needed them the most, one was her teacher who flew with her to Arizona and the other was her mother who risked crossing the border to see Isabel present her essay.
- Janet reported that winning the essay not only opened a world of opportunities, but it also permitted her to see the future with a new set of eyes.
- Patricia mentioned that having received the good news from her mother on Christmas Eve became the best Christmas present ever.
- Aaron could not believe the good news that his teacher had given him, but it all became real when First Lady Barbara Bush presented him with his award.
- Joseph felt that the winning essay was not only representing himself, but also his family and the whole state of New Mexico as well. He is certain that having won the essay contest facilitated his acceptance into the University of New Mexico.
- Sabino remembers how the winning essay brought prestige to

him. Since then, Sabino's outlook on life has changed.

- Paloma acquired a sense of security and confidence after having won the contest. She said she began to feel capable of conquering any obstacle.
- Axel became a double winner in 1983. He not only won the essay contest, but his mother brought into this world a little sister for him.
- Deborah, although quite surprised, felt proud of herself.
- Peggy felt like a very lucky person and she began to see herself not only as a good writer, but also as the best writer possible.
- Denise, being a 5th grader, could not really grasp how becoming a winner would change her life. Today, she reflects on how winning the essay inspired her to become a teacher.
- Rebecca remembers that winning the contest became the biggest event in her family. To top it off, her mother translated the essay into Chinese and published it in a major newspaper in China!

In analyzing the comments that students included as they reflected on how winning this essay contest contributed positively to their educational career, cultural and linguistic affirmation was an important factor and a determinant in the academic success of these students. This essay contest was an important event for these students in creating a sense of ethnic and linguistic pride, a positive affirmation of who they are and a sense of knowing that they have the skills to compete in an event at a national level. Winning the contest also impacted their educational and personal lives as well.

#### Reflections on Bilingual Education and the Value of Bilingualism in Their Lives

In the 1990s, when political winds are not blowing in favor of bilingual education it becomes imperative to search for bilingual students who credit their success to a sound and quality bilingual program during their schooling. Because of the

quality bilingual education that many of these students received, they have reached positions in life which are not considered to be the norm for limited English speakers. The following synopsis reflects not only what students said about bilingual education in their winning essays, but what they say about bilingual education in 1996. Hopefully, these reflections will lift our spirits and our morale, and give us the

*Open your eyes! Don't waste the opportunity to become somebody!*

*Think of your future and you will see that bilingual education is the key that will open the door where you had hid your dreams to let them come true.*

*Take bilingual education as a special gift, because that's what it really is; a very special gift.*

additional energy needed to continue the battle against opponents of bilingual education.

- Lourdes reflects that "being bilingual is a heritage that will help you and me to profess our beliefs in two languages."
- Isabel wrote "I was delivering a powerful message that bilingual education works" as she delivered her speech in Phoenix.
- Janet urges bilingual students to "Open your eyes! Don't waste the opportunity to become somebody!. Think of your future and you will see that bilingual educa-

tion is the key that will open the door where you had hid your dreams to let them come true. Take bilingual education as a special gift, because that's what it really is; a very special gift."

- Patricia urges students to place great emphasis on learning their native language and culture. When students do this, they will be able to communicate with the older generation.
- Aaron's mother and her passion for her profession as a bilingual teacher is what really motivated him to work towards an education degree in order to become a bilingual (Navajo-English) elementary teacher. Aaron is contemplating going back to the reservation to teach a new generation of students.
- Joseph's rich cultural background was the inspiration for stating that "Bilingual education to me was an affirmation of not only who I was but also of those attributes that contributed to what I have become. Those attributes were inclusive of my rich heritage background of my Hispanic, my French, my Spanish and my Scotch-Irish lineage."
- Maria says, "Bilingual education began to formulate my new experiences of success in school. There was never a year in which I was not an honor roll student. Bilingual education opened a whole new spectrum of light for me. An array of rainbows through the music makes me a leader and an ambassador of my culture...my serenades are a gift for your enjoyment. Your pay is the song of your soul through the simple clapping of your hands."
- Sabino adds that bilingual education "should be available to every student in this country... with my education, it will be gratifying to help make these two countries (the United States and Mexico) the best places in the world in which to live."

CONTINUED ON PAGE 24

- Josie expressed that bilingual education is “not just learning another language and leaving your old language behind. I don’t care in what language it is, as long as I understand it.”
- Paloma feels that bilingual education is so important today, and will be more important in the future. “With the growing barriers between language it is not only important to know another way of communication with others, but also important to have an open mind to different cultures, and acceptance of your own.”
- Karla says, “I am a child of two languages. As I become older this is going to help me in many ways, for to be bilingual is not only important but is to have a treasure that others do not have. I am very proud to know two languages, two cultures.”
- Axel adds that bilingual education can teach you that the United States is a nation that gives you opportunities. “I used to be ashamed of speaking Spanish until our teacher read an article about Chang-Díaz,” the first and only Latino astronaut in the history of America in the Space Program. Since that day he decided to be proud of his Nicaraguan heritage.
- Vanessa says that bilingual education is important because it will help us go and figure out the puzzles and mazes that are out there in the big world. I want to travel to other parts of the world to learn more language. Bilingual education is the key that will open the doors of the world for me.
- Deborah comments that as time passes, it seems that there are fewer and fewer people speaking their native language. “Children are now taught English first; a native language is taught in schools as a second language instead of being taught at home as it used to be. We are losing something. Many do not see it because

it is happening gradually from generation to generation. I do not know what the future holds for me or for the generations to come, but I will try my hardest not to lose this gift of knowing my Indian language.”

- Peggy recommends to “Always try your best. Don’t be lazy, just do it. Sometimes you can do better than you expected. My educa-

be it in English and Spanish, or any other combination, gives an individual an opportunity to transcend all cultural barriers and get to know what is really important — the individual.”

- Rebecca expressed that “Bilingual education is the opportunity to our future. Bilingual education opened the door to me to my American dream. Without it, I would not have the basic skills to communicate to the rest of the world. We, as young American immigrants, are entitled to the very basic human rights of learning to speak English and to find our place in our new home. We have to have bilingual education to give us the equal footing to achieve in life, and to find our own way to make the United States a better place to live.”

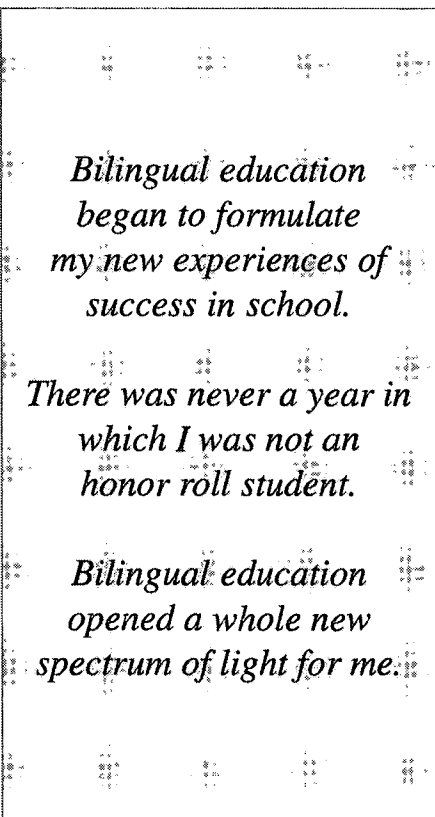

**Closing Thoughts**

There is no doubt that bilingual education works. These students are only a handful of successful cases for whom bilingual education has made a tremendous impact. We note that there are thousands more capable and bright students who have also become successful, but whose essays did not make it to NABE’s national contest level. These student voices should be heard as well, and we need to collect and tell their stories in other research projects. As bilingual educators we share and welcome the opportunity of educating the next generation of successful bilingual students.

tion helps me become a better and useful person and provides me with a good future.”

- Denise says, “I think that all Americans should have the opportunity to learn more than one language in order to help the country remain a leader...If we are capable and smart enough to land on the moon, why can’t we offer the opportunity to our citizens to educate themselves. I think Congress should pass a law mandating that every school system in the nation have a foreign language program starting in kindergarten. Bilingual education,

**Editor’s Note:** Contributions to the Bilingual Education: Portraits of Success column should be sent to Dr. María Estela Brisk, School of Education, Boston University, 605 Commonwealth Ave. Boston, MA 02215; To contact Via Internet: [brisk@acs.bu.edu](mailto:brisk@acs.bu.edu); fax: 617-232-8907.

• NABE •

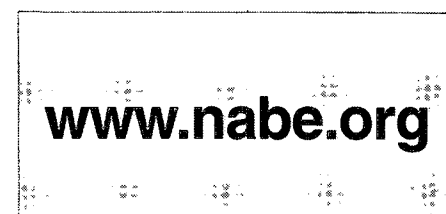

# Parental Involvement in Bilingual Education

Column Editor: Aurelio Montemayor, IDRA, San Antonio, TX

## *Hispanic Parents in their Own Words - Part One*

by Aurelio Montemayor

**H**ispanic parents were interviewed in different parts of the country as part of an effort by IDRA to record what they say in their own words.

### **What do you remember about your parents? About your grandparents?**

**M**y maternal grandfather was a trapeze artist, and my mother was born in a circus that used to travel from Bolivia to Ecuador and Peru. She was also a trapeze artist, but actually it was my father who had the bohemian spirit. He was a musician, and always made his living by his music. He was the type, if he made some money, he would take us all on vacation for three months! My mother was a saver and artist of the possible who could make a four-course meal out of a potato. So if you looked under the pillow of my father, you would find sheet music, and if you looked under the pillow of my mother, you would find money to last the week, or the month. One thing I remember distinctly about my paternal grandfather (who was a carpenter and violinist), was that he had the most beautiful handwriting, and a passion for spelling. He was obsessive about spending time with each grandchild, helping us write and spell.

**W**hat I will always remember about my mother is that she was very devout. Because she was Baptist, and my father Catholic, they saw each other for ten years before he could get permission from his parents to marry her. They settled the religious question by my mother's raising the two daughters Baptist and my father's raising the two sons Catholic. I don't know what would have happened if they hadn't had an even number of children!

**M**y father was born in a small town in Texas and my mother was born in Baton Rouge, Louisiana. When she was young, her mother took in washing, and she used to help prepare the giant vats of starch and hot water. While her mother was gone during the day, she helped her grandmother take care of her younger brothers and sisters. After my mother and father married, they had a fruit stand and then a taco stand. We were very close, and I think that's why I have such a close relationship with my daughter. I could talk with my mother about anything, and I'll never forget her marvelous sense of humor.

**I** was born in Puerto Rico. My father was a farmer for 20 years, and he loved to ride horses. He could ride beautifully, too. My

oldest brother was a jockey in Puerto Rico. My mother was always sick—she suffers from high blood pressure and heart disease—so I also had a second set of parents, my mother's godmother and her husband. They were wonderful to me, and provided for me very well, and spent time teaching me games. When we moved over here, it was to a county in New York State where they still have farms and also big estates, and it was weird, because it was similar to our life in the country in Puerto Rico, but it was a completely American, English-speaking world.

**A**ll of us, my wife and I and our brothers and sisters, and all our family, were born and grew up in the small towns on the border, and around here in South Texas—Del Rio, Castroville, Hondo, Von Orme, Lytle...In my wife's family, she has three sisters and four brothers, and in my family, I have seven sisters and six brothers. What I remember about my father was that he went to work every morning. Every morning.

**M**y father worked in another town in Nicaragua, and came home on the weekends. We looked forward to his coming, because he brought us little things, even though sometimes he was irritable. We'd be wondering, my two sisters and I, "How will he be?" At that time, we didn't know it was because of his blood-sugar...that it was part of his illness. One time we made a trip, I remember, renting a car with the whole neighborhood inside, and leaving early—4:00 or 5:00 in the morning. We took a drive through the countryside to a big estate...I think sometimes we don't give our children these times, when they need them most, within the family.

### **What have you learned from your parents or grandparents that you want to teach your children?**

**B**ecause of the closeness we had as a family, I think I learned not to be afraid. And that's something I want to pass on to my daughter: to be herself. To be independent. Not to be afraid of taking the next step.

**O**ne thing I understood from my mother, and that her father taught her, and before that, was the importance of what is taught in the home. Especially for them, because it was common then in our home countries to have little school, and everything was taught at home. I have the idea, though, even here, that when my daughter goes to school, she takes something from home with her, that she already knows how to behave herself in class and at the table, and so on.

My wife has taught our children to cook, and I've taught them car mechanics, as my father taught me. How to take things apart and put them back together. It's good to know these things! My father was a good mechanic, and I find this very satisfying, like solving a puzzle.

My father always saw a definite connection between school and success. I am trying to pass on to my children the importance of going all the way through college. My kids have grown up around the arts and artists, because of my work as an arts administrator, and they're both very interested in the arts. Although he had never mentioned it, my father when he was young was a talented cartoonist, and someone recruited him once to work at Walt Disney Studios. His parents didn't believe a serious living could be made that way. This is something that I'm trying not to pass on to my children, although I know I have the same fears as any other parents that artists mostly starve!

My grandfather never believed in credit or borrowing. When we reached a certain age, he would give each of us a quarter a week, and he taught us, "Never overspend your limit. Whatever

you have, you spend now and you save for later." When he died, he died owing nobody nothing. He was 108 years old. I teach my children the same way, with a dollar a week. I teach them always to respect their elders. And younger people, too, because they learn from you.

What I learned from my mother that I want to pass on to my children is consistency and self-discipline. She had that! What you start, you finish. From my father, that there is a world without limits, that every day, you can live in the same house and yet open the windows on a different landscape.

**Editor's Note:** Contributions for the Parental Involvement column should be sent directly to the editor, Aurelio M. Montemayor, at: IDRA, 5835 Callaghan, Suite 350, San Antonio, Texas 78228. phone: (210)684-8180, fax: (210) 684-5389, e-mail: amontmyr@idra.org).

« NABE »

## Intern and Fellowship Positions Available at NABE

The NABE Policy Internship and Fellowship Program is a rigorous apprenticeship for individuals interested in policy issues of education, multiculturalism, language diversity or civil rights.

The heart of the NABE Policy program is direct participation of interns and fellows in NABE's central policy activities including:

- ◆ policy research and analysis
- ◆ advocacy before Congress
- ◆ collaboration with other national education or civil rights organizations
- ◆ administrative duties

Interns and fellows must have outside support to participate; no financial assistance is available from NABE.

To apply, please send a cover letter and resume, a short writing sample, and letter(s) of recommendation to Jaime A. Zapata, Associate Director for Legislation and Public Affairs, at NABE.

You may also check the NABE Web site at <http://www.nabe.org> beginning in June for more information.



# The Language Profession

Column Editor: Dave Edwards, JMCC

## *Results of the JNCL/NCSSFL State Survey Released*

The 1996 JNCL/NCSSFL State Survey was designed to assess support for foreign languages, bilingual education, and English as a Second Language (ESL) at the state level. In August, 250 surveys were distributed to foreign language supervisors, and TESOL affiliates in all fifty states. Seventy-eight, or 31%, of the surveys were completed and returned. Of those returned, 76% were from the state departments of education. The remaining 24% of the completed surveys came from the various state associations. There were many special circumstances affecting data collected, among them: fiscal year differences, budgetary difficulties, staff turnover, and state politics. Also, the guarantee of anonymity proved to be an important concern for a number of respondents. Despite written assurances of strict confidentiality, 24% of those surveyed still submitted written requests for anonymity. Some respondents (from varying geographic locations and language specialties) specifically declined to answer portions of the survey for fear of reprisal. Clearly this demonstrates an anxiety existing in the field that should not be overlooked. Based on preliminary calculations, the following information is a summary of the survey's findings.

### **Staff**

As a national trend, nearly two thirds of all state Departments of Education downsized their total staff in the fiscal year. This downsizing had a small, but significant, affect on foreign languages, bilingual education and ESL. Though this figure is disturbingly high, it is important to note that foreign languages fared much better than other disciplines in state department job losses.

Of the staff members who have multiple program responsibilities 25% of their time was reportedly spent on foreign languages, just over half on bilingual education, and 45% on ESL. The survey did not inquire if the time distribution was a decision of the staff person or a supervisor. There was an average of 3.1 staff members in the state's Departments of Education whose primary tasks were reported to be related to foreign language instruction. This figure doubled for ESL and bilingual education staff.

### **Sources and Support**

For most states (65%) the biggest reported supporters were their state Board of Education. The largest percentage of reported critics were the state legislators. Forty percent of state governors made no public comments about language instruction. This information indicates two immediate needs: 1) the need to educate governors on the importance of language instruction and the 2) the need to inform legislators (and reverse their opinions) about the importance of language instruction.

Bilingual education and ESL were similar in their sources of support. Neither received overwhelming amounts of positive attention from any source and both received a fair amount of

public criticism. Of the support generated for the two programs, most came from state Boards of Education. Again, the biggest critics were the legislators. Half of all governors have taken no public stand on ESL or bilingual education.

### **Funding**

Seventy-one percent of all states reported increases in overall education budgets; 25% reported decreases; and only 4% stayed the same as last fiscal year specifically for foreign language education programs. Of those states that do allocate money for foreign language instruction, the vast majority saw no change in monies allocated. Conversely, 40% of states do earmark funds for bilingual education and ESL. Of these 40% that allocate funds for bilingual education and ESL, 50% saw an increase in spending. None saw a decrease in bilingual education or ESL spending.

### **Cooperation With ED Department and Affiliates**

Half of those responding to the survey commented that the relationship between the state department of education and the state's foreign language association is one of frequent and clear communication. A majority (60%) said that the state's Department of Education and their foreign language associations reach agreement—most of the time. These percentages drop dramatically when compared with bilingual education and ESL. Only one third and less than one fourth of bilingual education and ESL associations (respectively) reported having frequent and clear communication with their states' Department of Education. Most reported only occasional communication.

### **Advocacy**

Foreign language associations, the survey suggests, are more mobilized and active than their ESL and bilingual education counterparts. They reported higher percentages of successful impact on policy makers. Most respondents agree that the language community is not working together to advocate for programs and influence policy makers. Seventy-six percent of the respondents described their state's foreign language, bilingual education and ESL communities as not working together at all and two thirds of those surveyed reported that the language community as a whole was not working with broader coalitions (i.e. other educators, arts, or humanities) in the fight for education funding.

*The Joint National Committee on Languages/National Council on Languages and International Studies represents more than 60 national and regional language organizations united in their support of language policies which promote the development of bilingualism by all Americans. NABE is a member of JNCL/NCLIS.*

nities for all teachers to consider language demands of all students." They also pose four difficult questions or issues schools and teachers need to address and then discuss the six major functions of mainstream teachers, based on effective teaching research: "a facilitator of learning" and "of the acquisition of English," "a model of a proficient English language user," "a representative of mainstream culture," "a mediating agent in children's acculturation," and "an advocate of students' needs and strengths."

In Chapter 2, issues of assessment and linguistic, cognitive, and academic development are considered, including a good overview of LEP student statistics for the US: numbers of students, language groups, state regulations. The rest of the chapter is devoted to language, academic, and assessment issues for LEP students, including a list of factors to consider when planning for students' cognitive and academic development. Multiple instrument assessment is recommended and the authors give details and suggestions for various approaches used as part of this assessment.

In Chapter 3, cultural and linguistic diversity are covered. Diversity is discussed in general and then ethnic groups are described, to include those groups most heavily represented in US schools: Hispanic; Asian-Pacific Islander; American Indian, Eskimo, and Aleut; Haitian; Russian; and Arab. After this section, the authors provide concrete suggestions on how to organize a multiculturally-sensitive classroom.

In Chapter 4, program alternatives to mainstreaming are dealt with, including background about second language learning, bilingualism, second language proficiency, and the role of the native language in second language learning, topics that all teachers of English language learners need to understand well. After this comprehensive discussion, the authors lay out recommended English as a second language methodology, giving a solid understanding of sheltered instruction, among the various topics included.

Chapter 5 builds on Chapter 4, focusing on the integrated development of oral and written language processes of listening, speaking, reading, and writing in English

as a second language. This chapter provides background information and rationale, theories, principles, and guidelines for developing these oral and written language processes.

In Chapters 6-9, concrete instructional strategies are provided which can assist mainstream teachers as they facilitate English language development for English language learners, in general and through subject area classes as well. In Chapter 6, reading strategies (prereading, guided reading, and post-reading), literacy through literature, and writing strategies are offered. Chapter 7 follows with the integration of language and social studies, Chapter 8 with the integration of language and science, and Chapter 9 with the integration of language and mathematics. In these last three chapters, some basic concepts are explained (e.g. cognitively demanding language, integrating language and content) and many useful strategies are presented and illustrated. Of all three chapters, perhaps the strongest is the chapter on language and science instruction, at least in the number of concrete examples and visuals presented.

Chapter 10 wraps up the book by focusing on teachers and their role in developing students' linguistic, cognitive, and academic skills. The focus here is on organization and delivery of instruction, knowledge base including familiarity with students' L-1 and cultural backgrounds, learning styles, and classroom management; and high expectations and the ability to involve parents and create appropriate environments. There is also a final section on the development of reflective, cooperative, intrinsically-motivated practitioners, which the authors state is key to the implementation of successful instructional practices.

### Recommendations

In only 187 pages, Carrasquillo and Rodríguez have given us a lot, all of which will be immediately useful for teachers of language minority students in mainstream classrooms. However, there are a few areas that I would recommend they expand and I have one format suggestion as well.

**Language Experience:** The section on the language experience approach could be expanded and an example could be added for clarity. Ideas on how to build on

students' home, community, and school experiences to create an LEA lesson would also be very useful.

**Cultural Background:** Additional information that is positive and informative about various cultures would be useful, such as the excellent chart on "Strategies for teaching Muslim students," in Chapter 3. Although there is much diversity among Spanish-speaking cultures, some basic material for teachers not informed about various Hispanic or Latino students and corresponding teaching strategies to help mainstream teachers would be very important. Also, the list of recommended books for teachers to learn about students' cultural backgrounds (Chapter 3, p. 53) could be expanded to include various cultures and language backgrounds, and both male and female perspectives.

**Alternatives to Mainstreaming:** The chapter about second language learning and various program models is very useful, but perhaps it would be helpful to also address issues such as concrete ways that ESL and mainstream teachers can daily support the native language even if they do not speak the students' native language, thus promoting bilingualism after entry into mainstream classes. Another issue might be how alternative approaches can and do connect and work together or in sequence, to provide the most effective possible instruction for LEPs. A chart, such as the one used by the California State Department of Education, showing how students can progress from L-1 instruction, to ESL with partial mainstreaming, and then to SDAIE ("sheltered" English across content areas) and more mainstreaming, and finally full mainstreaming, would illustrate this well.

**Integrating Math:** This section could be made stronger by adding a few brief but concrete sketches of sample lessons or units showing how to integrate math and language in literature, social studies, science classes via a thematic approach, such as the "Coming of Age" example at the end of Chapter 7 on social studies. Also, examples of how math can support literature, social studies, and science lessons (e.g., math problem solving and "word problems"), perhaps referring to specific NCTM math standards, might be incorporated.

CONTINUED ON PAGE 30

# Technology and Language-Minority Students

Column Editor: Dr. Dennis Sayers, Univ. of Calif. Education Research Center

## *Teachers will Teach as They are Taught Themselves: Teacher Education, Bilingualism, and Technology*

by Dr. Dennis Sayers

The findings of a recent assessment of educational technology within our public schools and teacher education programs by the U.S. Congress Office of Technology Assessment (1995) shows the distance yet to be covered in integrating technology tools into our practice of teaching. While the United States has more computers in its schools than do other nations, fully half of these — located principally in elementary schools — are deteriorating 8-bit computers incapable of handling software programs written in the past four years; when this factor is taken into consideration, the U.S. is rapidly falling behind other industrialized nations. Most teachers, and even fewer bilingual program teachers, do not employ any form of educational technology in their teaching. Few teachers routinely use computers with students; where computers are utilized, low-level drill and practice software predominate, followed by word processing, and both of these activities are conducted primarily in laboratory settings, not in classrooms themselves. The classroom use of multimedia tools and computer-based information technologies to create local and global communities of learning is a rarity.

In teacher education programs — and sadly, this is especially true in programs preparing bilingual teachers — the picture is equally disturbing. Teacher educators rarely model technology use in their own teaching or as a central aspect of the field placements they arrange. When educational technology does compose a significant part of coursework, it usually appears in a separate course focused on educational technology machinery and not on its effective integration in curriculum development. This situation is exacerbated by a scarcity of funds for improving the

technology skills of teacher education faculty and for upgrading (and maintaining) technology resources. It is against this backdrop that we must consider how an exemplary technology in education program for future and current bilingual classroom practitioners ought to be designed.

*Teachers will teach as they are taught themselves.* This seeming commonplace saying should form the overarching goal of any “technology in education” program in a school of education. Indeed, I will assert that, conceived and implemented properly, the technology in education component — far from playing the peripheral, isolated role it has traditionally assumed within teacher education programs — can serve as a pivotal catalyst for educational renewal of both K-12 education and the preparation and improvement of educators. Briefly, such a program will:

1. provide the basic technology in education course mandated by NCATE and implemented in 18 states for all teaching credential candidates, utilizing standards developed by such professional organizations as the International Society for Technology in Education;
2. offer a full certificate program in educational technology with a stress on bilingual and multicultural approaches where feasible;
3. collaborate closely with fellow teacher education faculty to integrate the utilization of educational technology tools in every subject-area specialization, thus permitting prospective and current teachers to observe and experience a full range of technology-mediated teaching models across the curriculum;
4. in similar fashion, collaborate with faculty in the school of arts

and sciences who also work with future teachers (especially at the secondary level) in content area coursework;

5. additionally, collaborate with cooperating schools and teachers where prospective teachers are placed for their practicums to help provide a technology-rich mentoring relationship;
6. to assist in attaining the previous three objectives, provide a “model course” every semester for future teachers which focuses on technology integration within a particular subject-area specialization (rotating between literacy, social studies, mathematics, science or creative arts instruction, ideally co-taught with content-area professors), thus creating an ongoing context that teacher education faculty can visit to observe integrated technology-mediated teaching, together with collaborating faculty within the school of arts and science as well as educators at cooperating schools;
7. establish a networked community via the Internet which permits teacher education faculty and K-12 mentoring teachers to create *teleapprenticeships* for future teachers during their field placements;
8. provide as part of this networked community a *support component for first-year teachers* to maintain contact with teacher education faculty during a decisive moment in their new careers; of course, this first-year teachers support network would additionally provide crucial feedback for teacher educators to improve their own practice; and

CONTINUED ON PAGE 30

rated into other chapters covering these 3 subject areas.

**Teachers' Roles:** In Chapter 10, a section devoted to teachers working together, focusing especially on concrete strategies for educators and schools wishing to encourage long-term building of positive and effective collaboration between mainstream, bilingual, and ESL teachers (including other support personnel in school), would be extremely helpful. Because of the often fragmented nature of language minority students' instructional "menu," this collaboration, both before mainstreaming as well as after mainstreaming, can only help to promote students' linguistic, cognitive, academic, and personal-social growth and success. (More examples of effective home-school collaboration strategies would also be useful in Chapter 10.)

**Format:** Large sections of print in the book (e.g., reading strategies in Chapter 6) could be made more reader friendly by using sub-headings such as questions and answers, a chart, table, or list to summarize important points and add a visual aesthetic for the reader (e.g., see Figures 1.1, 1.2, 1.3). This would make texts clearer, text structure more evident, and key ideas more emphatic. Other features that would help are end-of-chapter summaries, questions for discussion, and a separate reference list for instructional materials.

### Conclusion

Despite these criticisms, I recommend *Language Minority Students in the Mainstream Classroom*, for university teacher educators and for administrators, faculty, and staff working in multilingual, multicultural schools and districts. Carrasquillo and Rodríguez have given us a book that we all have been looking for: a book that is readable, theoretically grounded, and practical. It is a book that I especially recommend for pre-service and in-service mainstream teachers, administrators, and other educators, who may not have much background about how to teach English language learners. As I collaborate with the Paterson School District in Northern New Jersey, I plan to recommend that schools implementing the new ESL curriculum purchase a copy of the book, so that a basic guide is available for mainstream teachers working to improve language and academic instruction for all language minority students.

« NABE »

### Book Review Submission Guidelines

Reviews for publications in the **Book Review** column should be sent to Dr. Beti Leone, Book Review column editor, at NABE, 1220 L Street, NW, #605, Washington, DC, 20005, or by e-mail to <NABE\_NEWS@nabe.org>.

Books from publishers should be clearly marked **BOOK REVIEW MATERIAL** and sent to the same address; **two** complete sets of materials must be submitted.

9. develop a research agenda to assess the role of technology in fostering the improvement of both K-12 teaching practice and professional development.

Additionally, each of the above components of the technology in education program must assist all teacher educators and future bilingual teachers in particular to respond productively to the learning opportunities offered by a linguistically- and culturally-diverse student population and by the diversity found in our own communities.<sup>1</sup>

### Notes

<sup>1</sup> A framework for such an ambitious program is outlined in *Brave New Schools: Challenging Cultural Illiteracy through Global Learning Networks* (1995, 1997) which I co-authored with Jim Cummins.

### References

- Office of Technology Assessment. U.S. Congress. (1995). *Teachers & technology: Making the connection*. Washington, DC: U.S. Government Printing Office. Available at <www.ota.gov.>
- Cummins, J. & Sayers, D. (1995; second edition, 1997). *Brave New Schools: Challenging Cultural Illiteracy through Global Learning Networks*. New York: St. Martin's Press. ISBN: 0-312-16358-4

**Editor's Note:** Contributions to the **Technology and Language-Minority Students** column should be sent to Dr. Dennis Sayers, University of California Educational Research Center, 351 E. Barstow Avenue, #101, Fresno, CA 93710. (209) 228-2050; FAX (209) 288-2055. E-mail: DSAYERS@panix.com.

« NABE »

## NABE E-mail Addresses

Main address:

<NABE@nabe.org>

Newsletter:

<NABE\_NEWS@nabe.org>

Conference:

<NABE98@nabe.org>

Membership:

<MEMBERSHIP@nabe.org>

212

# NATIONAL ASSOCIATION FOR BILINGUAL EDUCATION

## MEMBERSHIP APPLICATION



### Membership Type (check one only)

- \$48 Individual Membership**
- \$30 Discounted Individual Membership**
  - Parent:** must not be professional educator and must have a child currently enrolled in a bilingual education program. A letter written on school stationery from either the teacher or a school administrator must accompany the NABE membership application.
  - College/University Student:** must not be professional educator and must be enrolled on full-time basis. A copy of an official college or university document showing current enrollment status must accompany the NABE membership application.
  - Paraprofessional:** Must be working as an instructional aide in a public school system. A letter on school stationery from the supervising teacher or a school administrator must accompany the NABE membership application.
- \$43 Combined Membership Name of Affiliate:** \_\_\_\_\_
- \$125 Institutional Membership**
- \$1000 Lifetime Membership**

Memberships are valid for one year from the date of processing, and include one year subscription to NABE publications (except Lifetime, valid for life of member and includes lifetime subscription). Organizational membership is non-voting; all other memberships are voting. All memberships are non-transferrable and may not be cancelled. Membership dues are non-refundable.

### Name and Address Information

- Mr.
  - Mrs.
  - Ms.
  - Dr.
- \_\_\_\_\_ Last \_\_\_\_\_ First \_\_\_\_\_ Middle

**3 Preferred Mailing Address:**  Business  Home

**Business Address**

Position: \_\_\_\_\_

Division: \_\_\_\_\_

Organization: \_\_\_\_\_

Street Address: \_\_\_\_\_

City: \_\_\_\_\_ State: \_\_\_\_\_ Zip: \_\_\_\_\_

Phone: ( ) \_\_\_\_\_ Ext. \_\_\_\_\_

Fax: ( ) \_\_\_\_\_ E-Mail: \_\_\_\_\_

### Home Address

Street Address: \_\_\_\_\_

City: \_\_\_\_\_ State: \_\_\_\_\_ Zip: \_\_\_\_\_

Phone: ( ) \_\_\_\_\_



### I am involved with bilingual education as (check one)

- Administrator
- College Instructor
- Consultant
- Full-Time Student
- Paraprofessional
- Parent/Community member
- Publisher Staff
- School Board Member
- Teacher
- Other



### I work in this type of organization (check one)

- Commercial organization
- College/university
- Local school district
- State education agency
- Other



### I usually work with this level of student (check one)

- Early childhood
- Elementary
- Secondary
- Higher education
- Adult



### I want to participate in the following Special Interest Group (check one)

- Adult/Vocational Education
- Asian & Pacific Islanders
- Critical Pedagogy
- Early Childhood Education
- Elementary Education
- ESL in Bilingual Education
- Gifted Education
- Global Education
- Higher Education
- Instructional Technology
- Language/Culture Retention
- Language Policy
- Parent & Community
- Policy Makers
- Professional Development
- Research & Evaluation
- Secondary Education
- Special Education



### Payment Information

\$ \_\_\_\_\_ Membership dues

\$ \_\_\_\_\_ Contribution to help NABE counter the English-only movement

- Check or money order Check# \_\_\_\_\_
  - Institutional purchase order # \_\_\_\_\_
  - MasterCard  VISA ExpirationDate: \_\_\_\_/\_\_\_\_
- □ □ □ - □ □ □ □ - □ □ □ □ - □ □ □ □

**Automatic Renewal:** Check this box if: you are paying by credit card, and you want NABE to automatically renew your membership annually, charging your credit card the standard renewal amount. This permission will remain in effect until you cancel it in writing.

\$ \_\_\_\_\_ **TOTAL DUE**



**SIGNATURE:** \_\_\_\_\_ **213** **DATE:** \_\_\_\_/\_\_\_\_/\_\_\_\_



## ANNOUNCEMENTS

# NABE Is On the Web!

The NABE World Wide Web site is now open to the public!

The NABE Web site, unveiled for the first time during NABE '97, is now available for public access at <http://www.nabe.org>.

Currently, visitors to the site can send email to NABE staff, receive information about NABE membership and download membership applications, and get up-to-date information about NABE '98, the Association's next Annual Conference.

Although it is officially 'open for business', the site is still under construction and will probably be so for some time. You should 'bookmark' the NABE site in your WWW browser, and check back often. In the near future, the site will include:

- Detailed contact information about NABE's Executive Board and staff
- Listings of and links to NABE's Affiliate organizations
- Upgrades to the Membership section allowing visitors to join or renew online
- Details about and access to NABE's *Portraits of Success* database of successful bilingual education programs
- A special "NABE Members Only" section where members can view **current** and past issues of NABE NEWS online
- Details about NABE's new student education trust fund, the BEST (Bilingual Education Student Trust)
- The latest information about NABE '98, including
  - ◆ Exhibitor information
  - ◆ Contest/competition information and applications
  - ◆ Information about and links to housing and transportation providers
  - ◆ (by early fall) registration information and on-line registration forms.

Please visit the site and spread the word that it is now available. In addition, please send us your comments and suggestions. We hope to constantly make additions and improvements to the site, based in part on your suggestions and requests -- let us know what you think by email at [nabe@nabe.org](mailto:nabe@nabe.org).

### **NABE NEWS**

National Association for Bilingual Education  
Suite 605  
1220 L Street, N.W.  
Washington, D.C. 20005-4018

NON-PROFIT ORG.  
U.S. POSTAGE  
PAID  
WASHINGTON, DC  
PERMIT NO. 4555



# NABE NEWS

The news magazine about educational equity and excellence through bilingual education

June 15, 1997

National Association for Bilingual Education

Volume 20, Number 7

## Federal Funding for Title VII Programs NABE Gears up for FY 1998 Appropriations

by Jaime A. Zapata

Last month, legislators crafted a federal budget plan to end the national deficit by the year 2002. The measure was heralded by both the White House and Congressional Republicans as a bipartisan approach to balancing the federal budget. The bill included several controversial provisions, and lacked the support of various legislators including House Minority Leader Richard Gephardt (D-MO). Gephardt was particularly opposed to the tax-cuts and tax-credits in the package, and expressed concern about both the feasibility and long-term economic ramifications of the bill.

The long negotiation process finally came to an end at the beginning of June, with a budget agreement which was approved by both Congress and the President. This turn of events brings excellent news, and a major opportunity, for bilingual education.

### Bilingual Education Made Priority

Budget resolutions are the result of months of negotiations between Congress and the White House. They authorize funding for the priorities set by the President and the nation's chief legislative body. In

the area of education, the current resolution's priorities are Pell grants, education reform, child literacy initiatives, and *bilingual education*. This is particularly significant because budget resolutions provide a guide for Congressional appropriators in their allocation of discretionary funds. It is expected that both chambers will take up Appropriation measures in the near future, and that the legislation will be submitted to President Clinton in the coming months.

### FY 1998 Appropriations

As reflected in the budget, Congress and the Administration continue to pay close attention to bilingual education program funding. Nowhere is this more the case than in the congressional appropriations arena. In light of this, NABE continues to work closely with such key legislators as Rep. Rubén Hinojosa (D-TX), who chairs the Congressional Hispanic Caucus' Education Task Force and who is currently circulating two separate letters (see pages 19 and 24) in support of bilingual education. The letters, which have already been signed on to by the entire Congressional Hispanic Caucus, support the FY 1998 Administration request for Title VII funding and underscore the importance of adequate funding for *all* bilingual education program components.

### A Call to Action

If we are to be effective in securing greatly needed funds, then we must act in unison and act now! Contact the House and Senate Appropriations Committees to urge the Senators and Representatives on these panels to support the Administration's FY 1998 request of \$199 million in funding for bilingual education.

Along with this article, you will find a list of members of the House and Senate Committees on Appropriations. Call as many members on the committee as possible (especially those whose name appears with an asterisk next to it). It is up to us to ensure that our teachers, our schools and, most importantly, our children will have the tools they need to succeed!

### COMMITTEE STAFF

#### Senate Committee on Appropriations

Majority Staff Director: Mr. J. Keith Kennedy (202) 224-3471  
Minority Staff Director: Mr. James H. English (202) 224-7200

#### Senate Appropriations Committee Subcommittee on Labor, Health and Human Services, and Education

Majority Staff Counsel: Ms. Bettilou Taylor (202) 224-7216  
Minority Staff Director: Ms. Marsha Simon (202) 224-7288

#### House Committee on Appropriations

Majority Staff Director: Mr. James W. Dyer (202) 225-2771  
Minority Staff Director: Mr. Scott Lilly (202) 225-3481

#### House Appropriations Committee Subcommittee on Labor, Health and Human Services, and Education

Majority Staff Director: Mr. Anthony McCann (202) 225-3508  
Minority Staff Contact: Ms. Sheryll Smith (202) 225-3481

### ISSUE HIGHLIGHTS

Appropriations Committee Members .....21

NABE '98 Dissertation Contest Announcement ..... 38

# NABE NEWS

Published by the  
**National Association for  
Bilingual Education**

**Editor:**

Nancy F. Zelasko, Ph.D.

**Desktop Publishing & Layout:**

Jeff Spence

Devora Kimelman-Block

## NABE NEWS REPRINT AND EDITORIAL POLICY

Readers are welcome to reprint non-copy-righted articles which appear in *NABE NEWS* at no charge, provided proper credit is given both to the author(s) and to *NABE NEWS* as the source publication.

All articles printed in *NABE NEWS*, unless written by an Association staff person or a member of the current NABE Executive Board of Directors, are solely the opinion of the author or authors, and do not represent the official policy or position of the National Association for Bilingual Education. Selection of articles for inclusion in *NABE NEWS* is not an official endorsement by NABE of the point(s) of view expressed therein.

## TABLE OF CONTENTS

Message for the President .....	3
Administration column .....	5
Bilingual Educator Resources .....	7
Book Review column .....	9
Meet NABE Interns .....	13
NABE Order Form .....	18
CHC Letter on Appropriation .....	19
Appropriations Committee Members ...	21
CHC Letter on Appropriation .....	24
Asian/Pacific American column .....	27
Parental Involvement column .....	31
Technology column .....	33
Upcoming Events .....	37
'98 Dissertation Contest .....	38
Membership Application .....	39
Announcements .....	40

## PUBLICATION SCHEDULE

Volume 20 of *NABE NEWS* will be published in 8 issues; publication dates are:

Issue 1	09/15/96	Issue 5	03/15/97
Issue 2	11/01/96	Issue 6	05/01/97
Issue 3	12/15/96	Issue 7	06/15/97
Issue 4	02/01/97	Issue 8	08/01/97

All advertising and copy material must be received in the NABE office **ONE MONTH** prior to publication date to be considered for inclusion.

## NABE NEWS ADVERTISING

### Display Advertising Rates

(Camera-Ready)

Full Page (7.5" x 10")	\$850
2/3-Page (4.75" x 10")	\$700
1/2-Page (7.5" x 4.5")	\$550
1/3-Page (4.75" x 4.75")	\$425
1/3-Page (2.25" x 10")	\$425
1/4-Page (3.5" x 4.75")	\$325
1/6-Page (2.25" x 4.75")	\$250

### Classified Advertising

\$1.25 per word; maximum 100 words

### Advertising Discounts (for multiple insertions)

10% for second-third; 15% for fourth-fifth;  
20% for sixth-eighth

NABE reserves the right to reject any advertisements which it deems inappropriate and/or inconsistent with the goals of the Association. For additional information, contact NABE at (202) 898-1829 x136.

## NABE

The National Association for Bilingual Education (NABE) is a tax-exempt, non-profit professional association founded in 1975 to address the educational needs of language-minority Americans.

### NABE NATIONAL OFFICE

1220 L Street, N.W., Suite 605

Washington, DC 20005-4018

PHONE (202) 898-1829

FAX (202) 789-2866

E-mail: NABE@nabe.org

### James J. Lyons, Executive Director

Nancy F. Zelasko, Deputy Director

Jaime Zapata, Associate Director for Legislation

Jeff Spence, Information Systems Director

Carolyn Riddick, Office Manager

Celia Torres, Membership Specialist

Ronald Williams, Office Assistant

## NABE EXECUTIVE BOARD

1996 - 1997

### President

Janice Jones Schroeder

429 Wabash Avenue

Kenmore, NY 14217

(716) 875-1882

nabepres@aol.com

### Vice President

Mary F. Jew

San Francisco USD

300 Seneca Avenue

San Francisco, CA 94112

(415) 469-4000

mjew@sfsud.k12.ca.us

### Secretary/Treasurer

David E. Báez

Director, Foreign Language & Bilingual  
Education

Buffalo Public Schools

731 City Hall

Buffalo, NY 14202

(716) 851-3704

dbaez@buffnet.net

### Member-at-Large

Joe J. Bernal

6410 Laurelhill

San Antonio, TX 78229

(210) 342-8026

bowngod@ix.netcom.com

### Member-at-Large

María Estela Brisk

School of Education

Boston University

605 Commonwealth Avenue

Boston, MA 02215

(617) 353-3260

brisk@acs.bu.edu

### Member-at-Large

Nga Dinh Duong

21724 58th Avenue West

Mountlake Terrace, WA 98043

(206) 771-2095

nguyen@cks.ssd.k12.wa.us

### Member-at-Large

Hermán S. García

Department of C & I

College of Education

New Mexico State University

Las Cruces, NM 88003

(505) 646-2115

hgarcia@cnmailsvr.nmsu.edu

### Member-at-Large

Susan García

18094 East Ohio, #102

Aurora, CO 80012

(303) 745-7116

susangarcia@unitedwaydenver.org

### Parent Representative

Adela B. Holder

Silver Consolidated School District

2810 N. Swan Street

Silver City, NM 88061

(505) 388-1527

sncadavi@arriba.nm.org

216



# Message From The President

## *One Person Can Make a Difference*

by Janice Jones Schroeder

**A**nother school year is winding down. And so is my tenure as NABE President. Reflecting back on this year, as bilingual educators, what difference have we made in the life of a child?

A little less than a year ago, in my first column in the NABE newsletter, I shared with you my goals that I wanted to accomplish, this year as President. Since this is my last article as President, I felt it only appropriate that I revisit those goals and to examine how much was accomplished.

To this end I offer the following:

**Goal:** Continue to advocate for the culture and linguistic rights of children and their parents.

**Accomplishment:** Resigned my job in Alaska, to be free to accept speaking invitations that required extensive travel. Represented NABE as keynote speaker, guest speaker, and conducted workshops, on behalf of language minority children and their parents.

**Goal:** Increase collaboration and develop a better partnership with our state affiliates.

**Accomplishment:** On behalf of NABE, accepted all invitations to speak and attend the affiliate's conferences and roundtables. Rendered technical assistance to individuals in the state of Utah in their establishment of their State Bilingual Association.

**Goal:** Increase cooperative working relationship between the Board of Directors and the SIG's.

**Accomplishment:** Worked with the Native American Caucus, to establish the Alaska Native/American Indian SIG.

**Goal:** Enhance proactive role and increase the awareness of bilingual education.

**Accomplishment:** Disseminated information on "what is bilingual education" through presentations and speaking engagements at the U.S. Department of Education Regional Conferences: Improving American Schools. Attended and spoke at nontraditional bilingual conferences. Conducted workshops on bilingual and multicultural education.

**Goal:** Increase parent participation and empower parents of their right, roles and responsibilities.

**Accomplishment:** Spoke to various parent groups and conducted workshops for parents at various conferences. Board member, Adela Holder, coordinated and conducted a successful parent institute at NABE.

**Goal:** Increase membership.

**Accomplishment:** Through a successful NABE '97 conference we now have the largest number of members ever.

**Goal:** Become more proactive in fund raising.

**Accomplishment:** Worked to increase number of exhibitors at the conferences. Did not do as much in this area as I had anticipated due to time constraints.

This has been an interesting year. The office of President has afforded me the opportunity to meet a lot of wonderful individuals — parents, teachers, grandparent, elders, students, and individuals — all working for the common betterment of the bilingual students. It is to them and the many friends that have never wavered in their support and belief in me, that I have had the strength and courage to continue the work that I so strongly believe in. We have traveled many miles, but the journey is not over...we will continue our work together for the many miles yet to come.

I would like to thank the many individuals that volunteered their time and energy that spelled success for NABE '97 conference. To the state affiliate presidents and the SIG chairpersons for their commitment to bilingual education, you are to be applauded. A very special thanks to the NABE staff for all their hard work. Lastly, and most importantly, to the members of the Board of Directors for all the many hours that they have donated to ensure that the language minority children will have a better future. It is to all these individuals and their commitment that I feel good leaving the office and the future of bilingual education in their hands.

I would like to share two parables with you.

Once a mother received a telephone call from her daughter. The daughter requested her mother drive up to her house she had something special to share with her. The mother got up the next morning to drive up the coast to her daughter's house. The fog started to roll in, making driving very difficult. The mother arrived at her daughter's house. As they started driving the mother complained, what could be so important to bring her out in such inclement weather. At that point, the daughter suggested that she should drive because she was used to the road and driving in those weather conditions.

The mother pulled over and they switched drivers. Shortly down the road, the fog rolled back. After driving for a short distance, appeared a cascade of yellow daffodils covering the entire mountain side.



*NABE Executive Board  
President  
Janice Jones Schroeder*

# DISCOVER PERMA-BOUND BOOKS

## FOR YOUR BILINGUAL STUDENTS



**W**hen looking for a great selection of affordable titles for bilingual students, our Pre-Kindergarten-12 selection is great - including over 2,000 books in Spanish, plus Chinese, Vietnamese, French, German, Italian, and more.

- ❖ TRANSLATIONS
- ❖ ORIGINAL WORKS
- ❖ SHORT STORIES
- ❖ NOVELS
- ❖ SCIENCE
- ❖ DICTIONARIES
- ❖ BILINGUAL READERS
- ❖ VALE - IBM WRITING TO READ

Now Available! Books in Spanish to accompany Accelerated Reader Program.

One PERMA-BOUND book will outlast seven to ten paperbacks at about one-third the cost-and they're unconditionally guaranteed. If you're ever dissatisfied with a PERMA-BOUND book for any reason we'll replace it.

218

VANDALIA ROAD ❖ JACKSONVILLE, ILLINOIS 62650  
 CALL TOLL FREE: 1-800-637-6581 TOLL FREE FAX: 1-800-551-1169

**PERMA-BOUND**

# Administration of Bilingual Education Programs

Column Editor: Dr. Jaime A. Castellano, West Palm Beach County Public Schools, FL

## *Trading Places: Walking in Their Shoes*

by *Laura Schrader*

**Column Editor's Note:** *How does the average mainstream teacher instill sensitivity in her monolingual English-speaking students towards their struggling limited English proficient classmates? Mrs. Laura Schrader, a middle school language arts teacher, shares an experience that can best be described as a win-win situation. Tapping into the value system of middle schoolers is a bold endeavor. They are often characterized as mean, cruel, and more interested in pleasing their peer group. Raising their consciousness and increasing their sensitivity towards their bilingual and ESL classmates is surely a challenge; difficult, but not impossible. As you will read, these students learned some very valuable lessons.*

Amidst the dog days of summer, new and exciting learning opportunities await as children happily renew acquaintances at the initial sound of a fresh school year's bell. Abounding with anticipation, students and teachers scurry to class anxious to meet the unknown challenges lying ahead. The final bell rings, and students readily respond to roll call in order to make that all important first impression — except for one. For in the middle of an energetic, enthusiastic class sits a totally silent unfamiliar Hispanic face. Unknowingly, his sparkling, dark brown eyes and radiant smile captivate his peers, who fix their sights on him as does a predator on its unsuspecting prey. Breaking the overshadowing silence, cruel comments such as "What's the matter?", "Cat got your tongue?" emanate from all corners of the classroom. Sensitive, the teacher calmly responds to her students' remarks with, "He can't answer. He doesn't speak English." Embarrassment and shame now replace the earlier impermeable silence.

How many times do we, as mainstream teachers, encounter scenarios similar to this during the course of a school year? For many of us, such encounters elicit frustration and helplessness. Yet in this day and age when inclusion is a driving force geared to provide equal educational opportunities for limited English proficient (LEP) students in the mainstream, teachers must learn to combat their own anxiety as well as that of their students. Fortunately we have a virtual arsenal of proven instructional strategies like cooperative and collaborative learning from which to draw. However all the teaching modalities in the world have thus far failed, in my opinion, to address one prevalent problem: how does the average mainstream teacher instill sensitivity in her native English-speaking students toward their struggling limited English proficient counterparts?

Due to dramatic societal and economic changes during the past thirty years, molding students psychologically and emotionally is probably the most difficult task facing educators today. As a result,

we have more impact on the lives of all our students than ever before and face some of the greatest challenges one of which is acculturation on both sides. What does that mean? What are the implications of such an overbearing task? Altruistically speaking, if we are to prepare our students to compete in this global economy of ours and be productive contributors, then a sincere effort to heighten consciousness across the board regarding the linguistic challenges of the limited English proficient student is imperative. But how?

Facing this dilemma as a mainstream middle level language arts instructor, I sought an answer. Believing that experience is a far better teacher than I proved to be crucial in my quest. Traditional linguistic philosophy primarily focuses on limited English proficient students' acquisition of English, and the difficulties they face. What about the other side of the coin? What would happen if native English-speaking mainstream students suddenly found themselves in the shoes of their LEP peers? How would they react to a classroom environment void of their primary language? How would they feel?

Being a French major afforded me the opportunity to initiate this very simulation. I began my experiment by speaking fluent French at the beginning of each class. My native English-speaking students did not know what to make of my unexpected language change. Bewilderment enveloped the classroom like a thick pea soup fog. Paint mutterings asking "what is she saying?", or "Is she for real?" came from everyone except my mainstream LEP students. Somehow I think they understood what I was doing and why. They reacted with smiles, not to be insensitive, but to let me know that they appreciated their mainstream peers' sudden frustration. After about ten minutes, I stopped, looked at my students, and asked, "How do you feel?" Overwhelmingly, the students told me how lost and confused they felt. From their initial reactions, my experiment had succeeded. In just a few minutes, my mainstream students experienced their LEP peers' apprehension regarding new language introduction first-hand.

An interesting discussion ensued in which they expressed a rudimentary understanding of exactly how difficult learning a new language must be. Their comments focused on the premise that since English was the only language with which they were familiar, they believed everyone knew how to speak it. Moreover, they seemed to equate knowing English with intelligence. It became obvious to me that my students needed exposure to more than just how to write an essay. Inadvertently, they stumbled across the fact that many native English-speaking students do not encounter second language learning opportunities until high school. Therefore, expecting them to comprehend and empathize with the LEP students' linguistic plight any earlier is unreasonable. For how can anyone truly understand someone else's experience unless he or

she has walked in their shoes? Yet, like so many mainstream teachers, I falsely assumed they could. Not only did my simulation foster a new awareness among my students, but for me, it reinforced an often forgotten axiom, "Do not assume anything."

With this in mind and with my students' curiosity about second language acquisition peaked, I asked them if they wanted to learn some French. The class's decision was unanimous. Since, I needed to find a way to integrate French minimally but meaningfully into an already comprehensive Language Usage curriculum, I chose to teach my students the appropriate French responses to their Daily Oral Language activity, a grammar based editing exercise. First I taught them to listen carefully to the questions I asked in French. Once they understood the questions, they were ready to learn the answers. I pointed to various parts of the sentences containing errors and taught them how to say the corrections in French; employing a form of a Total Physical Response (TPR) activity. After much practice and repetition, my students slowly began to supply the appropriate responses to the appropriate questions. At no time during their oral Participation did I unduly criticize them or degrade their accents. After all, perfection was not important. What was important was their willingness to take a chance and try something totally different and unfamiliar in front of their classmates. As a means of motivation, I first complemented the student's effort and then modeled the response's pronunciation by correctly repeating what the student said. In so doing, the student felt secure in his/her attempt and still gained gentle coaching through positive reinforcement. Needless to say, my native English-speaking students gravitated to learning their new second language like paper clips to a magnet, picking it up quickly. As for my LEP students, they enjoyed the experience immensely because everyone, for at least the first few minutes of every class period, was on the same page. No one had the edge. No longer did they bear the burden of being the only ones who did not understand; for, no one did. Everyone was learning together.

Reflecting on my avant-garde approach to generating sensitivity among my mainstream students toward their LEP peers reminds me of several key instructional aspects to any second language acquisition. First, I gave my students messages they understood. By using a familiar daily language activity, my native English-speaking students were easily able to transfer from their primary language, English, to their secondary language, French. Moreover, because the activity was grammar-based, and the students had a sound understanding of grammatical structure, according to Stephen Krashen, "their language organs generalized rules from verbal stimuli, not empirically, but 'according to innate principles' of universal grammar" (Crawford, 1993). The students were able to extract meaning from the activity regardless of the language. Second, I submerged them in French for only short bits of time while still maintaining English. Vacillating between languages made comprehensible input of French possible because of an already established English foundation. Although English was the primary language during the simulation, the comprehensible input theory pans out (Crawford, 1993). It does not matter which language is primary or secondary; the results are the same depending on how sound the foundation is in the primary language (Baker, 1993). Unfortunately, mainstream teachers often forget

this fundamental premise when assisting LEP students. Third, to ignore the roles of affective domain and affective filter in any second language acquisition experience is to totally disregard the students emotionally. Learning a second language is risky business under the best of circumstances; fostering and maintaining a nonthreatening, self-esteem building, academic climate is imperative. Bearing this in mind, I never sacrificed an anxiety-free classroom environment for flawless responses by over-criticizing my students' attempts (Richard-Amato, 1988). Since my goal was to promote sensitivity among my students, striving for second language perfection would only have undermined my efforts. In addition, keeping my mainstream students' affective filters to a minimum allowed for maximum language acquisition. Thus, their knowledge of French improved with time and practice; as their initial anxiety ceased and their self-confidence rose. By trading places, my native English-speaking students experienced a sneak preview of what their LEP classmates view in full while gaining sensitivity for their struggle.

Frequently, we as mainstream teachers focus too much on the differences between our mainstream students and our mainstream LEP students. We must remember that all language acquisition is an ongoing process requiring nurturing and patience. It is not a matter of how many home-runs our students score, but that they are willing to step up to bat at all.

#### References

- Baker, Colin. (1995). *Foundations of Bilingual Education and Bilingualism*. Philadelphia: Multilingual Matters Ltd.
- Crawford, James. (1993). *Bilingual Education: History, Politics, Theory, and Practice*. Los Angeles: Bilingual Educational Services, Inc.
- García, Ricardo, L. (1976). *Learning in Two Languages*. Bloomington: Phi Delta Kappa Educational Foundation.
- Goerss, Katherine, V. (1993). *Letters from the Middle*. Columbus: National Middle School Association.
- Krashen, Stephen. (1996, Winter/Spring). "An Overview of Bilingual Education." *Bilingual Basics*, pp. 1-5.
- A Matter of Time*. (1994). New York: Carnegie Corporation.
- Richard-Amato, Patricia. (1988). *Making It Happen*. New York: Longman.
- Turning Point*. (1990). New York: Carnegie Corporation.

**Editor's Note:** Contributions to the Administration of Bilingual Education Programs column should be sent to the column editor, Dr. Jaime A. Castellano, at (561) 753-9440 x8755.

• NABE •

# NABE '98

## February 24 - 28

### Dallas, TX

220

# Resources for Bilingual Educators

by Ana Tinajero

**All the Colours of the Earth (Bilingual Edition)** by Sheila Hamanaka. Children come in all colors of the earth, in every shade of you and me. With soaring text and majestic art, Sheila Hamanaka celebrates the dazzling diversity of children laughing, loving and glowing with life. Available in Arabic, Bengali, Chinese Gujarati, Somali, Turkish, Urdu, Vietnamese and Yoruba. ISBN: 1-85269-325-8. This book can be purchased for \$17.99 by writing to Aims International Books, Inc., 7709 Hamilton Ave., Cincinnati, Ohio 45231-3103 or call 1-800-733-2067 or fax to 513-521-5592.

**Authentic Assessment for English Language Learners: Practical Approaches for Teachers** by J. Michael O'Malley and Lorraine Valdez Pierce. This is an essential, comprehensive, and practical resource for designing authentic assessment for K-12 and adult and for using teacher-made assessments. The book gives step-by-step guidelines for planning and using portfolios. It saves time by making assessments part of instruction and also informs instruction by using assessment to monitor student learning and supports self- and peer assessment. The instructional activities used for assessment include: Oral Language, Writing, Reading and Content Areas. ISBN: 0-201-59151-0. This book can be purchased for \$24.00. To order call 1-800-552-2259 or write to Addison Wesley Longman, School Services, 1 Jacob Way, Reading, MA 01867.

**Cultural Debates Grades 6-12 (Mac CD/Windows CD)**. Through a breathtaking original video of an Indonesian tribe, this CD-ROM generates cultural debates on technology. This new CD-ROM engages your class in critical thinking and problem-solving through multimedia and cooperative learning. With *Cultural Debates*, your students will have exciting debates about issues that face all cultures. Your students learn about a unique culture by watching video case studies. They also draw on their own knowledge to understand the similarities and differences between their culture and this rainforest community. *Cultural Debates* can be purchased for \$179.00 by calling 1-800-342-0236 or faxing to DEPT. CFDB 1-617-926-6222. Send orders to Tom Snyder Productions, 80 Coolidge Hill Road, Watertown, MA 02172-2817 or by e-mail to [www.teachtsp.com](http://www.teachtsp.com).

**Educating All our Students; Improving Education for Children from Culturally and Linguistically Diverse Backgrounds**. This report describes four characteristics of effectively organized schools serving students at risk of educational failure. It also identifies areas of school-based research and development that merit additional investigation. For copies of the report call Elvia Ontiveros, National Center for Research on Education, Diversity, and Excellence, at (408) 459-3500 or e-mail: [Center@cats.ucsc.edu](mailto:Center@cats.ucsc.edu).

**Education of Hispanics in Early Childhood: Of Roots and Wings**, by Eugene E. García. This article helps further our understanding of life in a diverse society, especially that of Hispanics

growing up in the United States in their early childhood years. The historical pattern of the education of Hispanics in the United States is a continuous story of underachievement and it does not need to continue to be that way. The three voices in this article address issues of the past, present, and future, which recognize the multiple selves that make up García's persona and is a reality for all of us. We as individuals are diverse, along with the many cultures we belong to or represent. Eugene E. García also talks about issues related to the education of Hispanics in early childhood with the varied voices within him. Effective early childhood education for linguistically and culturally diverse children encourages them to take risks, construct meaning, and seek reinterpretation of knowledge within the compatible social contexts. Within this nurturing environment, skills are tools for acquiring knowledge, not ends in themselves, and the language of the child is an incredible resource. This knowledge base recognizes that educators must be additive in an approach to these students. Reprints of this article may be purchased by sending a check for \$5.00 with the requested article title to NAEYC, Attn: Public Affairs, Institute of Scientific Information, 3501 Market St., Philadelphia, PA 19104 or by calling 215-386-0100, X5136.

**Funding for Justice: Money, Equity, and the Future of Public Education**, edited by Stan Karp, Robert Lowe, Barbara Miner, and Bob Peterson. This book is a valuable, practical resource on an issue that touches every school and community. Going beneath the legal jargon and complex funding formulas, *Funding for Justice* presents the complicated issues of school finance in readable form for teachers and parents as well as policy makers and education advocates. ISBN: 0-942961-21-8. Single copies are \$5.00/each, 6-99 copies \$4.00/each, 100-499 copies \$3.00/each, and over 500 copies \$2.00/each plus shipping and handling. To order call 1-800-669-4192 or mail to Rethinking Schools, 1001 E. Keefe Ave., Milwaukee, WI 53212.

**Little Havana Blues: A Cuban-American Literature Anthology**, edited by Virgil Suarez and Delia Poey. *Little Havana Blues* is the first comprehensive anthology of Cuban-American literature. As such, it includes most of the representative narrators, essayists and poets who have come to forge a literary identity within the United States since their parents left Cuba to go into exile. These writers are here staking their claim on part of the American mosaic, with Pulitzer Prizes and other awards in hand. But in their Americanism they are not rejecting their heritage or their Hispanic culture; rather they are Cubanizing, tropicalizing and expanding the realm of American culture and letters. Their vision is inclusive rather than exclusive, their sources go deep into Anglo- and Hispano-European tradition and as deeply into Afro-Caribbean and mestizo culture, not to mention their love affair with popular culture and its icons. ISBN: 1-55885-160-7. This paperback can be ordered for \$16.95. Phone orders: 1-800-633-ARTE/(713) 743-2998, Fax orders: (713) 743-2847 or mail order to ARTE PUBLICO PRESS, University of Houston, 4800 Calhoun, Houston, Texas 77204-2090.

CONTINUED ON PAGE 8

*Metamorphosis of English Versions of Other Languages*, by Richard M. Swiderski. Through Swiderski's lens, English takes on the look of an agglutinative museum of linguistic artifacts in danger of having no describable identity or common fabric. Each speaker's variety of English is as individual as his or her genetic makeup; it is both so universal and so dissimilar that "English" as we know it may be endangered as a separate language. ISBN: 0-89789-468-5. The review copies are available by calling 203-226-3571, X391 or by writing to Greenwood Publishing Group Inc., 88 Post Road West, P. O. Box 5007, Westport, CT 06881-5007.

*Milagros: Symbols of Hope*, by Nancy Walkup and Sharon Warwick. This is a completely bilingual book for grades 3-8. From Ancient Greece and Rome to the contemporary Americas, the delicate craft of milagro-making has played an important role in many cultures. The story of a young Mexican boy and his venture to the shop of a milagro maker will entertain your students as they learn about the strength and significance of these tiny works of art. Further exploration into the craft and its universal connections will surprise students and help them to identify with the content. The package includes one VHS tape, a comprehensive teacher's guide, three art production activities, a poster, student booklets and samplings of actual milagros. This set can be purchased for \$93.00 by calling 1-800-913-8555 or faxing to 1-520-323-6194. Orders can also be sent to CRIZMAG Art and Cultural Education Material, P. O. Box 65928, Tucson, AZ 85728-5928.

*Passage to Freedom: The Sugihara Story*, written by Ken Mockizuki and illustrated by Dom Lee. This is a true story of Chiune Sugihara, the "Japanese Schindler," who, with his family's encouragement, saved thousands of Jews in Lithuania during World War II. It is also one of the most important stories to emerge from the ruins of the Holocaust. ISBN: 1-880000-49-0. This book can be ordered for \$15.95. For classroom and library orders, call 1-800-345-5946; fax 212-727-3035 or send to Lectorum Publications, Inc., 111 Eighth Avenue, Room 804, New York, NY 10011. For the trade, call 1-800-658-1934; fax 510-658-1934 or write to Publishers Group West, 4065 Hollis Street, Emeryville, CA 94662.

*Teach Me Chinese: Take a Musical Journey Through the Day*, by Judy Mahoney. Join Marie and her family as they introduce children to Chinese through days of the week, singing alphabet and counting songs, learning parts of the body and common expressions. This 20-page book and 25-minute audio cassette can be purchased for \$12.95. To order call 1-800-456-4656, fax to 612-933-0512 or send to Teach Me Tapes, Inc., 9900 Bren Rd. E., B1-100, Minnetonka, MN 55343-9664.

*Translation Services Directory*, published by the American Translators Association. This directory includes the profiles of nearly 1,400 professional translators and interpreters, their languages, and their areas of specialization. It is the most efficient resource to use in locating skilled translators and interpreters and contains 131 areas of specialization, running the gamut from advertising to zoology, and 97 language combinations, from Afrikaans to Yiddish. The TSD costs \$75.00 for non-members of the American

Translators Association and \$60.00 for members. To order, contact the American Translators Association, 1800 Diagonal Road, Suite 220, Alexandria, VA 22314; 703-683-6100 or fax to 703-683-6122.

*Understanding Latino Families: Scholarship, Policy, and Practice*, by Ruth Zambrana. Researchers, family support workers, planners, scholars, and students will find this book an invaluable resource. Offering an integrated, culturally sensitive focus, it presents a dynamic new approach on the strengths of Latino/Hispanic groups, the structural processes that impede their progress, and the cultural and familial processes that enhance their intergenerational adaptation and resiliency. A leading group of scholars clearly presents social and demographic profiles of Latino groups in the United States, empirical and conceptual reviews of Latino family approaches, and practice and policy implications from the studies of Latino social programs. Discussed are salient topics such as the economic well-being of Latino families, prospects for Latino children and adolescents, the adjustment of Central American refugees, and Latino child and family health concerns. To order call 312-341-0900, X129 at Sage Publications.

*Ana Tinajero is a Bilingual Teacher at Ramona Elementary School in the Ysleta Independent School District in El Paso, Texas. She is a Summer Fellow in NABE's Policy Education Program.*

*Resources are listed for the information of the NABE membership. Listing does not imply endorsement of the resource by the National Association for Bilingual Education. If you want more information about any item listed in this column, you must contact the publisher/developer directly.*

◀ NABE ▶

## **Publishers and Materials Developers**

*Do you have new products to tell  
NABE Members about?*

Send a sample of your material to the NABE  
NEWSEditor at NABE, 1220 L Street, NW,  
Suite 605, Washington, DC 20005-4018.

Materials will be listed ONCE free of charge  
in the Resources for Bilingual Educators  
column.

222

# NABE NEWS Book Reviews

Column Editor: Dr. Beti Leone, Paterson Public Schools, NJ

## *Educating for Diversity: An Anthology of Multicultural Voices*

Reviewed by Brenda Betts, Ph.D.

*Educating for Diversity: An Anthology of Multicultural Voices*, by Grant, Carl A., Ed. Boston, MA: Allyn and Bacon, 1995. 424 pages. ISBN 0-205-16573-7.

**E***ducating for Diversity: An Anthology of Multicultural Voices* is an urgent call for the celebration of diversity in multiple contexts because editor and scholar Carl Grant is an advocate for the recognition of and appreciation for the numerous contributions of Americans from all cultural and linguistic backgrounds. This exceptional text can serve as a catalyst for change because it addresses all the critical issues in the process of affirming diversity — the needs, challenges, solutions, and benefits.

This book is an informative and thought-provoking collection of essays written by experienced and knowledgeable educators. The purpose of this powerful and comprehensive book is to provide a valuable resource for students and teachers of multicultural education. The heart of the text is the seventeen vignettes that provide a short, but accurate, history and include selected topics about various cultures. To facilitate an understanding and respect for multiple perspectives and avoid stereotypes, editor Grant wisely selected authors to write about their own backgrounds and experiences. These collective voices are informative, authentic, and compelling. The twenty-eight chapters are divided into four sections.

### **Diversity Redux**

In Part One, *Diversity Redux*, the first two chapters prepare the reader for the study of diversity by presenting a discussion of the critical issues to be studied in multicultural education, and the important role that educational institutions can play in fostering the idea that all populations have important things to learn from one another.

In Chapter One, *Praising Diversity in School: Social and Individual Implications*, editor and author Carl Grant emphasizes the positive aspects of diversity and the need for education and educational policy in the United States to respond to the issues of both social/political diversity and human/individual diversity. The United States benefits from and is strengthened by the contributions of many groups and the awareness, acceptance, and affirmation of cultural and ethnic differences. Grant advocates that the K-12 educational system become more active in promot-

## *Teaching Reading and Writing in Spanish in the Bilingual Classroom*

Reviewed by Beti Leone, Ph.D.

*Teaching Reading and Writing in Spanish in the Bilingual Classroom*, by Yvonne S. Freeman and David E. Freeman. Portsmouth, NH: Heinemann, 1997. pp. 256.

**I**n *Teaching Reading and Writing in Spanish in the Bilingual Classroom*, Freeman and Freeman have succeeded in giving us a book that teaches us about the reading process, about the writing process and, at the same time, about how reading and writing come together in the K-12 Spanish-English bilingual classroom in the US. They deal specifically with reading and writing in Spanish and English, as well as contextualizing these processes with concrete classroom examples, based on their years of experience with real bilingual learners and teachers in real bilingual classrooms. The book is written in English and a Spanish translation will soon appear.

### **Contrasting Views**

There are many aspects of the book that are very intelligent and practical, and one of these is the essential distinction they make early in the book (Chapter Two) in their discussion of two approaches to reading instruction: a word-recognition approach and a socio-psycholinguistic approach. Most effectively, they explain and illustrate this distinction by referring throughout the chapter to two teachers, Alicia and Celia. We “see” (through clear, detailed description) Alicia’s classroom and how Alicia’s teaching is backed by a word-recognition approach, and how Celia’s teaching is backed by a socio-psycholinguistic approach. The authors then proceed to give evidence as to the research base and the effectiveness of the socio-psycholinguistic approach, as they continue to compare and contrast the two teachers’ teaching. This full, extended example is very powerful and also very accessible for persons learning to teach reading, especially in the context of the current phonics versus whole language debate.

One example of this contrast between Alicia’s and Celia’s teaching is a conversation between each teacher and her students which illustrates the authors’ effectiveness in elucidating basic teaching concepts by means of practical classroom applications and examples (Freeman & Freeman, 1997: 28, 30).

Alicia: *¿Qué notan ustedes en estas palabras?* (What did you notice about these words?)

Feliciana: *Un pato pone huevos.* (A duck lays eggs.)

CONTINUED ON PAGE 10

223

CONTINUED ON PAGE 29

ing social equality and cultural pluralism because current social issues and discrimination must be examined to bring about change in society and to correct inequities. Accurate knowledge must be provided and multiple perspectives must be examined to increase the understanding of and appreciation for the numerous positive contributions of all groups in our society. The role of schools is becoming more important due to the increasing weakness of other social institutions, so the curriculum needs to reflect the school and classroom diversity. The individual culture that every child brings to school must be accepted and affirmed because experiences in school influence the development of student self-identity. Many students experience a dual role or "double consciousness" because students of color often see themselves through the eyes of others, usually the dominant group. Cultural and linguistic background are influential factors in academic success, so they must be valued by the school. Society socializes students based on their gender, so schools need to provide policies and practices that encourage development and opportunities based on abilities and goals, not gender.

In Chapter Two, *Population Dynamics and Ethnic Attitudes: The Context of American Education in the Twenty-First Century*, author Michael C. Thornton emphasizes that the increase in the number of Americans from diverse cultures, languages, and perspectives brings many challenges and conflicts to our society. Therefore, educational institutions need to prepare our society for the changes brought through this increased diversity, but educational institutions are ill-prepared to deal with the changing demographics and the multiple perspectives of the population. We need a better understanding of how to deal with this new situation because programs have not been developed that adequately convey the diversity and complexity of American life. This chapter explores how the new demographics appear to have affected intergroup relations and attitudes. Implications for the nature of education and educational institutions as they attempt to accomplish the task of making a society tolerant of diversity where it is valued, and perhaps seen as indispensable to a healthy world, are examined.

Schools play a critical role in reaching this goal because they are in the unique position to educate all Americans.

#### **American Diversity: Ethnic Vignettes**

In Part Two (Chapters 3-19), *American Diversity: Ethnic Vignettes*, seventeen vignettes provide a large collection of information and resources about some of the ethnic groups in the United States. Each author provides an accurate history and shares personal experiences. Grant instructed these authors to "Imagine there is a group of teachers seated before you. What would you want them to know about your ethnic background and cultural history that would be useful as they teach students about your cultural background?" Rather than a stereotypic sketch of each group, the authors wrote about the ideas and concepts most important to them. The chapters in Part Two provide excellent background information and an important starting point for further reading, research, and discussion.

In Chapter Three, *African-American Culture and Contributions in American Life*, author Geneva Gay reminds the reader that African-Americans have a rich and distinct cultural heritage that has improved the quality of life for all Americans. African, European, and American customs, values and traditions have been meshed together to create another cultural system. African-Americans developed this system to satisfy their emotional, social, political, economic, and aesthetic needs to create a new identity. Their contributions to American life have been underestimated. The implications for education are the need to: study the place of African-Americans in the history, culture, and development of the United States; acknowledge their contributions to American life; allow African-American students to tell their own stories in their own voices according to their own cultural styles and aesthetics; and, make the African-American experience accessible to all students.

In Chapter Four, *Diversity and Our Dilemma: Reflections of an African-American Couple*, authors Kimberly Cash Tate and William F. Tate, candidly reveal their experiences and feelings about moving from a city with a high population of African-Americans to work in a predomi-

nantly White university. Their insightful discussion demonstrates the challenges and sacrifices made by this couple in their goal of contributing to a more diverse campus environment.

In Chapter Five, *The Central American Experience*, authors Lillian Rodríguez Post and Kathryn Price tell Lillian's compelling story as an immigrant from Nicaragua to the United States. The complex reasons and conditions for immigration are explained. The adjustments and transitions experienced by immigrants from South America to the United States are discussed in relationship to concerns about family members left behind, differences in the school systems, difficulties learning a new language, the challenges of maintaining a bilingual and bicultural home where both languages and cultures have equal status, feelings of isolation, and the strategies used by Lillian to make a successful transition to life in the United States.

In Chapter Six, *The Role of Social History in Research and Practice: One Chicana's Perspective*, author Lillian Vega Castañeda emphasizes the need for the socio-historic context of the student to be understood and acknowledged in the academic setting. This way the teacher becomes aware that students acquire knowledge in a variety of ways, in different situations, and that how students learn is largely determined by their informal learning and communication in the home/community context prior to formal schooling.

In Chapter Seven, *Footholds on an Icy Slope: One Chinese-American Story*, author Amy Ling recounts that as she learned English in school, she learned to embrace the value system of the dominant culture. Yet, because she looked different from White Americans, she felt a huge gulf between her interior and her exterior, so she became self-estranged. As an adult, it was her reading the literature of other Chinese-Americans that caused her to awake to her sense of self. She realized that all Asians have been made to feel self-alienated and depreciated by the attitude of superiority that has historically been fostered on people of color in the United States. Ling believes that it is the responsibility of the educators of multicultural students to provide them with their histories, their writers, and their appropriate



models because minority groups that are ignorant of these are cut off from a foundation for the future.

In Chapter Eight, *The Cuban American Experience in Exile*, author Andrea B. Bermúdez discusses the feelings of disfranchisement experienced by Cuban-Americans who were forced to leave their homeland. The exile experience is long and lonely as proficiency in handling the patterns of the new culture are learned and understood. This is explained in a model of adjustment in a socio-cultural continuum. In the early 1960s, Cuban-Americans in Florida successfully participated in one of the first bilingual programs in the nation. The success of Cuban-Americans is evident in their proportionally high income, low unemployment rate, and thriving businesses.

In Chapter Nine, *The Hawaiian Islanders*, author David Pedro explains that the assimilation of cultures among the many different Hawaiian racial groups is the most noteworthy quality of the Islanders. They consider themselves to be Hawaiians, an identity which supports a delicate balance of all minorities, allows the continuous mixing of cultural factors, and allows each group to retain its racial-ethnic uniqueness. The "aloha spirit" is a way of life based on acceptance of the equality and dignity of all human beings.

In Chapter Ten, *The Japanese American Experience*, author Kishio Matoba documents that Japanese-Americans are active in every sector of our society, spanning a wide range of achievements and accomplishments. However, because they look different from White Americans, they still experience the frustration and racism of other minority groups.

In Chapter Eleven, *The Jewish Americans*, author Nathan Glazer reports that Jews have been most successful in education and are prominent in many professions because they have eagerly embraced educational opportunities, in spite of past discrimination and exclusionary practices by the mainstream culture.

In Chapter Twelve, *The Korean Americans*, author Harold Chu emphasizes that Korean-American students are caught in the middle of a transition because there is a strong contrast between their separate worlds of home and school. Although

Koreans have great respect for learning and scholastic achievement, the Korean student is likely to behave in a passive, nonparticipatory manner unless called on to answer by the teacher. These students need to understand that they can develop new values and cultural orientation in America while understanding and developing cultural traits in the Korean family and community. Helpful information on behaviors, relationships, and the implications for education are provided.

In Chapter Thirteen, *The Mexican Americans*, author Esteban Hermán García describes his struggle and resistance in school because he felt as though he was constantly put down and not completely accepted in school. He was punished for speaking Spanish and his identity was assailed in the school environment. He compares the differences between the context of his Spanish-speaking home community and his frustrations in attending the local schools.

In Chapter Fourteen, *The Middle Eastern Americans*, authors Barazandeh "Baraz" Samiian and G. Pritch Smith are concerned with the consequences of the cultural illiteracy about the Middle East that is perpetuated in U.S. schools and society. Although recent multicultural education programs have focused on the largest ethnic groups, unfortunately the history, traditions, and contributions of Middle Easterners are typically left out of the school curricula. Generally, teachers are unaware of how to meet the needs of these students.

In Chapter Fifteen, *The Iranian Americans*, authors Barazandeh "Baraz" Samiian and G. Pritch Smith provide a fascinating description of some of the highlights of Iranian history and culture. Educators need to know far more about Iranian history and culture to enable Iranian-American students to find an appropriate balance between Eastern and Western cultures so they may benefit from educational institutions and opportunities.

In Chapter Sixteen, *The Arab Americans*, authors Patty Adeeb and G. Pritch Smith explain that students of Arab heritage face many of the same problems as those students from non-mainstream cultures because the cultural and behavioral norms and the curricula of U.S. schools

have been based primarily on Western traditions. The three million Arab-Americans are a very heterogeneous group without one religion, ideology, national identity, or sense of history and heritage. Their differences are often noted without an attempt to understand the rationale that explains their value. Educators need to understand Arab-Americans and their contributions to dispel myths and stereotypes.

In Chapter Seventeen, *Seasons in Retrospect: An Ojibwe Woman Looks at Fifty Years*, author Rosemary Ackley Christensen provides a tantalizing glimpse of her worldview and emphasizes that young Indian men and women need to know about the strong Ojibwe leaders in the twentieth century.

In Chapter Eighteen, *The American Indians*, authors Joseph Coburn, Patricia A. Locke, Anita B. Pfeiffer, Jack B. Ridley, Sharon M. Simon, and Henri Mann remind us of the uniqueness of the American-Indian experience and the physical and cultural destruction that took place from the forcible removal of tribes from their native lands and subsequent relocation to reservations. Currently, there are more than 300 tribes and 187 languages reflecting enormous diversity among the tribes.

In Chapter 19, author Pazcual Villarronga presents a poem and interpretation of his life as a Puerto Rican. This is a poem to tell people that what we are will always be important and cannot be taken away if we are unwilling to give it up. The knowledge of who we are must be maintained and celebrated. We should keep our own culture, but as we learn about other cultures, we may decide to include them and we may become a mixture of cultures.

### Diversity Among the Diverse

In Part III, *Diversity Among the Diverse* (Chapters 20-22), we learn about the issues and needs of three more diverse populations that until recently have not been acknowledged as specific groups with special needs.

In Chapter Twenty, *Waiting to Excel: Biraciality in the Classroom*, author Evelyn Reed explains the unique challenge faced by biracial students. Identity formation is a major issue for biracial individuals be-

CONTINUED ON PAGE 12

cause they need to identify with a racial group and group characteristics to develop a healthy and independent personality, but biracial children are under constant pressure to choose their racial identification between those of their parents. Biracial students' attitudes and perceptions about race develop differently from children in single-race families.

In Chapter Twenty-One, *Challenges for Educators: Lesbian, Gay, and Bisexual Families*, author James T. Sears tells us that the traditional American family represents a minority of all households in the United States. Fewer than one in four students come to school from a home occupied by both biological parents. Ignorance and myths fuel misunderstandings about many types of families.

In Chapter Twenty-Two, *Culturally and Linguistically Diverse Students with Mild Disabilities*, author Cheryl A. Utley focuses on the commonalities between multicultural and special education and the extent to which these two disciplines complement each other. She also discusses issues affecting the classification and subsequent placement of culturally and linguistically diverse students in special education, and makes recommendations for special and regular educators to serve culturally and linguistically diverse students with mild disabilities.

### **Diversity in the Schools: Applying What We Know**

In Part Four, *Diversity in the Schools: Applying What We Know*, the authors of the last six chapters (Ch. 23-28) provide recommendations and implications for the development of culturally affirming curriculum and school policy.

In Chapter Twenty-Three, *Challenging Customs, Canons, and Content: Developing Relevant Curriculum for Diversity*, author Gloria Ladson-Billings discusses a variety of curriculum conceptions, offers useful definitions of curriculum, outlines the national curriculum debate, and suggests some relevant curricula for diversity.

In Chapter Twenty-Four, *The Power of Culturally Affirming Instruction*, authors Valerie Ooka Pang and Robertta H. Barba affirm that schools and educational institutions need to view culturally diverse

students as being "culture rich" and not "at risk." Effective instruction uses students' prior knowledge and connects it to new information because learning is a collaborative, on-going process of constructing meaning.

In Chapter Twenty-Five, *School Policy and Student Diversity*, author Robert Crumpton reminds us that significant numbers of students of color are experiencing academic failure because our education strategies are not keeping pace with the nation's changing demographics. By the year 2000, the K-12 public schools will be more than 50 percent minority. The purpose of this chapter is to describe how schools have been responding to the challenges of the increase in minority populations, and analyze some of the trends in the school reform movement and the development of public policy to meet the needs of students of color.

In Chapter Twenty-Six, *Ethnic Labeling and Mislabeled*, authors Harry N. Rivlin and Dorothy M. Fraser remind us that learning is an aspect of both social psychology and individual psychology. Students bring their family, community, and culture with them into the classroom. Socio-economic and cultural backgrounds are important influences on student learning. When a student's cultural or linguistic background is different than the majority, it is not a handicap. The culture, values, and customs of an ethnic group may be different than the majority, but not superior or inferior. Labels and generalizations may actually hide more than they reveal because there are a range of factors that contribute to a student's sense of ethnicity and individuality.

In Chapter Twenty-Seven, *Cultural and Gender Identity in Early Childhood: Anti-Bias, Culturally Inclusive Pedagogy with Young Learners*, authors Beth Blue Swadener, Betsy Cahill, Mary Smith Arnold, and Monica Miller Marsh raise a number of issues and questions regarding anti-bias education with young children, and discuss observations and recommendations based on the literature and their collective experiences working with young children, early childhood educators, and parents.

In Chapter Twenty-Eight, *An Interpretation of Multicultural Education and Its*

*Implications for School-Community Relationships*, author Kathleen Densmore outlines various rationales that have been offered for why we need multicultural education and various policies that have been implemented accordingly, noting some of their successes and failures. She also suggests that a key reason behind the limited and mixed success of multicultural education has been the insufficient attention given to the school-community relationship, and she offers some guidelines for future directions. An understanding of the context of multicultural education must include an examination of the historical relations between our educational institutions and students of color. Multicultural education is intended to affirm the worth and dignity of those students who have been historically marginalized. However, multicultural education has been concentrated in areas of curriculum and instruction, but systemic racial and social inequity is the problem facing us today.

### **Summary**

Specific themes and topics reoccur throughout the chapters of this book: the contributions of cultural and linguistic groups have not been understood and appreciated due to the persistence of inaccurate histories and stereotypes; discrimination and exclusionary attitudes and practices have been observed and experienced in school and society; marginalized groups have felt demeaned and diminished, creating negative influences on self-identities; cultural and linguistic diversity are positive because they strengthen the United States; the social context of school is very powerful for the acquisition of knowledge and self-identity; and multicultural education is an effective and necessary component of educational curriculum and policy for the remediation of past misunderstandings and the improvement of future relationships and collaborations.

An important goal of multicultural education is to develop respect and harmony among all people. The need for the acceptance and affirmation of diversity is immediate and essential. It is imperative to promote inclusive patterns of interaction and inclusionary policies in educational institutions and society because our inter-

CONTINUED ON PAGE 36

# Meet the Members of NABE's Summer 1997 Policy Education Program

The NABE Policy Education Program (PEP) program provides participants with an opportunity to deepen their understanding of the federal legislative and administrative process. Through direct involvement in NABE's policy-related activities, PEP participants help shape the policies that govern education and social programs affecting language minorities.

NABE is committed to helping bright young people become proactive and informed leaders who will effectively tackle the challenges confronting our communities. The PEP is NABE's chief tool in youth leadership development, and is representative of the Association's resolve to empower tomorrow's leaders and bilingual education advocates.

NABE is pleased to welcome the members of our Summer '97 Policy Education Program.

## Fellows

Ana Cristina Esqueda  
Born in El Paso, Texas  
Languages: Spanish/English  
Profession: Bilingual Teacher



Ana Cristina graduated this May from the University of Texas at El Paso with her Master's Degree as an Instructional Specialist in Bilingual Education with an emphasis in Math and Science. She is currently a bilingual Kindergarten teacher in the two-way dual language immersion program at the Alicia R. Chacón International School in the

Ysleta Independent School District in El Paso. As a product of a bilingual home, Ana Cristina understands the importance of bilingualism and believes that all children should have the opportunity to learn more than one language, and learn in their native language.

Ana Cristina's family is Mexican-American. Her father was born in Chihuahua, México, and moved to El Paso at the age of ten. His formal schooling went as far as high school. Her mother was born and raised in Ciudad Juárez, Chihuahua, México, and did not have the opportunity to finish high school. Born in El Paso, Ana Cristina spent the first six months of her life in Ciudad Juárez. Then her parents moved to El Paso, where Ana Cristina attended three different elementary schools in the Ysleta Independent School District from Kindergarten through sixth grade.

When she entered school as a native Spanish-speaker, there was no bilingual Kindergarten classroom so Ana Cristina was placed in a monolingual English classroom knowing no English. She struggled and fought with the unknown language and found herself unable to relate to or communicate with her peers or the

school environment. This made it very difficult because she was not given the opportunity to share or learn about her native culture, traditions and language. Ana Cristina was both surprised and afraid because people would not speak to her like her mother did at home. Fortunately, her brother, who was two years older than she, was able to help her at home for he had learned English at school. She asked her mother why no one spoke "our language" and her mother told her that they did not know the language and that she would have to learn English to communicate at school but would always continue to speak and learn in Spanish at home.

Ana Cristina recalls watching Sesame Street, cartoons, and after-school television programs, and using her father and brother as resources to learn English and the American culture. Her father had been in the US for almost twenty-five years so he was fluent in the language; but did not speak English frequently because her mother did not speak or understand English at that time. By third grade Ana Cristina had been totally immersed into English, but she never left behind her Spanish language or Mexican culture, traditions and customs. She went to Loretto Academy during her Middle and High School years and graduated in 1989. At that time she decided to continue her education and go on to college, something she was greatly encouraged to do by her mother.

Children have always been very important to Ana Cristina for she thinks they are wonderful in every way. She had always wanted to be a teacher so that she could be around children and, more importantly, be there for the bilingual children so that they would never have to go through the struggles and frustrations that she experienced as a child. But Ana Cristina knew what teachers' salaries were and decided to pursue a major in Business Administration. After one year of Business Administration courses, she knew that it was not right for her; she did not enjoy it and was always thinking of being a teacher.

So Ana Cristina decided to change career paths and become a bilingual teacher. She no longer cared about the difference in salary for it would be far more satisfying to be able to help her community by being with the children who needed her most. Ana Cristina finished her Bachelor's Degree and graduated in May 1994 as an Instructional Specialist in Bilingual Education. After a year of teaching she realized she had to go further and pursue a her Master's Degree. In May of this year, she graduated with her Master's Degree as an Instructional Specialist in Bilingual Education with an emphasis in Math and Science.

Ana Cristina's ambition to help all children in bilingual education has made her seek further opportunities. She was accepted to be a fellow in NABE's Policy Education Program. It is here where she will be given the opportunity to work on legislative and policy issues which affect all bilingual children.

Ana Cristina says that one of the greatest feelings that fills you deeply with joy and tremendous satisfaction is when you know that you have given hope and opportunity to a bilingual child. This

CONTINUED ON PAGE 14

child, with a smile on his/her face, will always be proud to be bilingual and never forget his/her culture which is one of our most valuable treasures that we own.

Ana María Tinajero  
 Born in El Paso, Texas  
 Languages: Spanish/English  
 Profession: Bilingual Kindergarten Teacher



Ana Tinajero is a native of El Paso, Texas. She graduated from the University of Texas at El Paso with her Bachelor's Degree in Education with a Reading Specialization and is currently taking classes for her Masters as an Instructional Specialist in Reading.

Ana has just completed her second year of teaching in a bilingual Kindergarten class at Ramona School in the Ysleta Independent School District and enjoys it very much. She attended Ramona Elementary as a child and has very positive memories about that experience. Ana entered Kindergarten speaking only Spanish and a few words of English. Her parents insisted that their children maintain their native language and speak only Spanish at home. Thus, she was placed in a bilingual classroom and remained there for most of her elementary schooling.

Ana was very determined to learn English and she did. Unfortunately, after the elementary grades, all of her schooling was in English with very limited opportunities to use Spanish for academic purposes. She spoke English almost exclusively at school and with her friends. At home, her parents insisted that she, along with her brothers and sister, speak Spanish. They reminded their children constantly of the importance of knowing two languages — of being bilingual.

Unfortunately, after her elementary years Ana didn't practice her Spanish very much and she forgot a lot of it. It was so much easier to speak English. Speaking Spanish became a struggle. She couldn't find the words to express her thoughts and ideas like she could in English.

Ana enrolled in several bilingual education courses at the University and her thoughts about the value of bilingualism began to change. Perhaps this was a turning point in her life. But the real turning point came when her first year teaching assignment was a bilingual Kindergarten class! She now realizes the importance of speaking two languages and is totally committed to changing the educational program to make sure that our children don't lose their native language while acquiring a second one. This is why she decided to become a bilingual educator. She wants her students to be proud of being bilingual, of speaking two languages — English and their mother tongue.

As a Fellow in NABE's Policy Education Program, Ana will collaborate with other national education groups and civil rights organizations. Her experiences in Washington, DC will help expand her knowledge of the policy-making process at the federal level and its implications on different minority groups living in

this country as well as gain a strong awareness of the multiple issues affecting minorities in this nation and take an active role in the search for possible solutions for these issues.

Ana is very excited that she has been given the opportunity to learn more about legislation and policy which affects children in many ways. She is looking forward to learning a lot and going back to her school, as well as her community, and sharing all the knowledge she has acquired in this once in a lifetime experience.

### Intern Coordinator

Susanna Shin  
 Born in Silver Spring, Maryland  
 Languages: Korean/English/limited Spanish  
 Junior, Smith College, MA  
 Professional Goal: Teaching Marine Biology to children

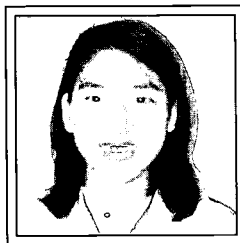

"Being able to lay down the foundation of a child's education is a privilege that I want to take part in." Ever since she can remember, Susanna has wanted to become an elementary school teacher. This rising junior is faithfully pursuing that dream now. She is currently pursuing an Elementary Teacher Certification, while simultaneously pursuing her

love for marine biology. Along with certification, Susanna is working toward a degree in Biological Sciences with a concentration in Marine Studies at Smith College, an all-women's school in Northampton, Massachusetts. Ultimately, she hopes to teach marine biology to young children. She hopes that her language and cultural background will prove to be an asset to her as a teacher in the future.

In spite of the fact that many Korean-Americans today have little grasp of the Korean culture, Susanna, an American-born Korean, has made it a priority to discover and immerse herself in the Korean culture. Fortunately, but not without difficulty, she has had the opportunity to learn the language and traditions with the help of her grandmother and parents. "I think it is very important and also very valuable to hold on to your ethnic heritage. I identify myself with Korean-Americans, and it's a part of who I am." In an effort to help other Korean-Americans retain their heritage, she has been involved with a program at Smith called "Culture Camp". The program brings interracially adopted Korean children together to help them learn the Korean language, songs, and traditions. Susanna serves as a counselor at Culture Camp and as a "Big Sister" for two young Korean children who have been adopted by a Caucasian family. Her time with Alyssa and Barrett has been and will continue to be an invaluable experience to her.

Bilingual education is very important to Susanna. She is committed to raising awareness in both her school and home communities of the issues that affect language minority students. She especially hopes to see more Korean immigrants take part in the benefits that bilingual education has to offer: bilingualism and a sound education.

Susanna is not new to NABE. She returns this summer as the Internship Coordinator of the Policy Education Program, after spending last summer as a Policy Intern. She is dedicated to making this internship a worthwhile and enjoyable experience for this summer's group of interns. This year's interns are characterized not only for their intelligence and incredible potential, but also for their many diverse backgrounds. From Puerto Rico to Perú, from the west to the east, this all-women group of interns will undoubtedly be an asset to NABE and to bilingual education. Their projects range from interviews on Capitol Hill to research on various issues related to bilingual education. With the help of technology, much of their research will be done on the Internet, making their work more efficient and effective. Susanna's responsibilities as intern coordinator will include overseeing the interns and the various projects that they will be working on throughout the summer. She will deal with their day-to-day activities and organize their schedules. She is excited to be back at NABE and hopes that this summer will be as rewarding as last.

### Interns

Betsy Cory

Born in Santa Rosa, California

Graduate of Loyola Marymount University, CA

Professional Goal: Work with bilingual and health educational policy



"As we become a more ethnically diverse society, bilingual education will be essential for the future and the progress of millions of America's youth," remarks Betsy Cory. Born and raised in California, Betsy saw first hand how the inequalities of our educational institutions affect California's youth.

At a young age, Betsy was labeled a "slow learner" by her first grade teacher. This label created a self-fulfilling prophecy that hindered her performance in school until her fourth grade teacher made a connection with her, showing her that she was a very capable and intelligent person. Seeing her own progress in school due to the power of one teacher's encouragement, Betsy soon realized the importance of teachers' making a positive connection with all children, regardless of their race, creed, or gender.

By the time Betsy was in high school, she was asked to organize and facilitate "Colors Day," a multi-cultural awareness day where high school students of all different backgrounds could come together and break down the barriers of existing ignorance and prejudice. Upon high school graduation, Betsy journeyed down south to Loyola Marymount University in Los Angeles, a more diverse climate that deals with many highly debatable issues regarding education in a multicultural and multilingual society. At Loyola Marymount, Betsy took several education classes that focused on issues of multicultural and bilingual education. For two years, she served as a teacher's assistant in Los Angeles Unified School District, one of the most ethnically diverse and

complex school systems in the country. For one semester, she served as a teacher's assistant in an ESL class, seeing first hand the strength of bilingual education. In her last year of college, Betsy took a job with Planned Parenthood of Los Angeles. At Planned Parenthood, she worked with a diverse population of students throughout the greater Los Angeles area, educating them in regards to responsible sex, sexuality, the power of one's choice, and the differing value systems that exist in such a multicultural and multilingual city as Los Angeles. This job helped give her a more holistic view of the problems and challenges that exist in our educational systems today.

Betsy considers herself an optimist and believes nothing is impossible if you believe in yourself and what you are working for. "I get most of my inspiration from those who are doing remarkable things for our youth," she comments. One of her favorite quotes that holds true to her own personal value system is one by Adrienne Rich:

*When those who have the power to name and to socially construct reality choose not to see you or hear you, whether you are dark-skinned, old, disabled, female, or speak with a different accent or dialect than theirs, when someone with the authority of a teacher, say, describes the world and you are not in it, there is a moment of psychic disequilibrium, as if you looked into the mirror and saw nothing.*

Iris J. Cruz

Born in Bayamón, Puerto Rico

Languages: Spanish/English

Senior, Niagara University, NY

Professional Goal: Play important role in policy making



Iris is a product of the bilingual education program in the City School District of Rochester in New York. In 1989 her family migrated to the States where she was able to improve her language skills and become proficient in English. She took a very active role in the community during her high school career with a strong focus on education (specifically bilingual education).

Iris was the President of the Organization of Latin American Students (OLAS), where she advocated for the rights and interests of bilingual students within the school district, working very closely with the Hispanic community. In her college career she served as Treasurer and Correspondent Secretary of the Hispanic association (Levante La Raza) on her campus.

Iris' main interests are education and the representation of Latino women in government at both state and federal levels. "To play an important role in the policy-making process is the key element in achieving your goals and making sure your community's voice is heard." This is what led Iris to accept this internship with NABE. She plans to do more research to expand her knowledge and relate it to her own experiences and be able to educate others

## POLICY EDUCATION PROGRAM

and advocate for bilingual education.

During her high school career, Iris was a participant of the Puerto Rican/Hispanic Youth Leadership Institute Program in Albany, New York, where she was able to learn and experience the English-Only movement's arguments against bilingual education. "This experience made me more assertive and confident in the defense of bilingual education. We can not let the government overlook our interests and needs."

Iris is also a participant of the Women in Public Policy Program at The Washington Center this summer where she will be taking a course in Women's Issues of the Nineties: Domestic Violence.

Carla Gutiérrez

Born in Lima, Perú

Languages: Spanish/English

Senior, Williams College, MA

Professional goal: Contribute to the redistribution of wealth in America



If only three words were to describe Carla, they would be bicultural, Latina and bilingual. As an immigrant from Perú, Carla has been conscious of her internal transformation during the last seven years. "As everyone else, I have been molded by my experiences, thus I have changed from being exclusively a Peruvian from Lima to carrying within

my body a mixture of cultures and a mixture of languages."

Carla recalls her high school years in Brookline, Massachusetts, as the most challenging experience of her life. English was a strange, new sound for Carla, and she became mute and powerless. Silence threatened her confidence and self-reliance. Her need to overcome her silence led Carla to value her native language, her new one, and different means of expression as she never had done before. That is how this 21-year-old senior at Williams College became interested in art and dance as communication tools. She is currently a Studio Art and Math double major with a passionate political agenda. "Very few people believe that I am a Studio Art major due to the active political role I have played representing VISTA, the Latina/o Organization, and other minority groups at my college. The power that art carries, as the voices of different communities, is what attracts me to it. Art can be very political and it can definitely contribute to social change." The concept of public art, in which the dialogue between artist and people is constant and direct, is what characterizes Carla's art. In public art projects the artists work closely with people to make a difference within the communities themselves or to become the communities' voice through images. Carla declares that, "grassroots programs which have given special emphasis to visual arts have proven to be very successful."

Her ties to her native country have played a major role during the last few years. Carla's parents reside in Perú and she had the opportunity to live there for eight months before this summer. Being unfamiliar with women's issues in Perú, Carla pursued an

internship with the largest feminist group in Lima: Manuela Ramos. Her first-hand exposure to extremely poor women's reality allowed Carla to comprehend the critical magnitude of economics and its prevalence over political, social and racial issues. When asked about her experience working with Manuela Ramos, Carla remembers: "We needed to help these women solve immediate problems like, for example, the lack of food on their tables and milk for their children. There was not a lot of time left to address other important issues as reproduction or abuse. The experience was extremely rewarding and frustrating at the same time." Carla does not have specific plans for the future, although understanding the relationship between the current social structures and the economies in Latin America and the United States is a long-term priority. "To promote social change is my number one priority." Carla is certain that each of our daily acts should contribute to change towards equality. However, she is convinced that the social equality that shall prevail will celebrate our differences as people and the extraordinary diversity of this country.

Bilingualism is an essential piece of Carla's identity. She believes that one has to seek out information to become truly aware of the issues that affect us so deeply. While interning at NABE, Carla will learn about those millions of language minority children who, unlike Carla, do not have the academic opportunities their potential deserves.

Nicole Pichard

Born in New York City, New York

Languages: Spanish/English

Junior, Wesleyan University, CT

Professional goal: Work with social issues

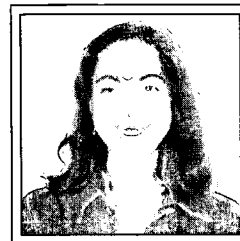

Born in New York City, at age three Nicole moved with her family to Chile, her father's native country. Two years later the family came back to the US and settled in Bethesda, Maryland, where they still live.

Nicole is double-majoring in Latin American and African-American Studies at Wesleyan University where she is an active member of the Latino community. Her sophomore year she was accepted to live in La Casa de Albizu Campos, the special interest house on campus for Latino students. She is also involved with Ajúa Campos, Caliente, and Nosotras, all Latino organizations on campus.

Nicole's interest in issues concerning Latinos blossomed her freshman year at Wesleyan. "Growing up I always strongly identified as *Chilena* and one of the reasons why I chose to go to Wesleyan was because I felt that there was a strong Latino community there that I had lacked in my small high school. Once I started getting involved with the Latino organizations on campus I really began to identify with Latino political issues. I also became involved with the Student of Color community in general and have become much more aware of and interested in the struggle of people of color around the nation."

Nicole's interest in bilingual education stems from her own experiences. While Spanish is her first language, she has never had formal instruction in it and taught herself to read and write in Spanish. Nicole is a strong advocate of bilingual education. "I have so many Latino friends who are like I once was — able to speak fluently but lacking the same skills in reading and writing. If I had not had the time or resources to teach myself these skills, I would be like them. I wish that I had had some form of bilingual education growing up in which I would have been able to develop my Spanish skills along with my English skills." She sees bilingual education as imperative not only for helping language minority children, but also for preserving and developing their native tongues. "I love Spanish. It is a beautiful language and I see it as tragic when an individual's native tongue dies out and is replaced solely by English. That is one of the reasons why I was so attracted to NABE."

Nicole is excited to be participating as an intern in NABE's Policy Education Program this summer and hopes to expand her knowledge not only of bilingual education and other issues that affect people of color, but also of the American legislative system. Although still unsure of what career she will pursue in the future, Nicole notes that she plans to work with minority communities. "The NABE internship will be a good chance for me to see if legislation and advocacy are the paths I want to pursue in the future to further our struggle as people of color in the US."

Susan Williams

Born in Richmond, VA

Languages: Spanish/English

Graduate of George Washington University, DC

Professional Goal: Bilingual Elementary School Teacher



Susan Williams is a 1997 graduate of The George Washington University, earning a BA in Human Services with a minor in Spanish. The service-learning component of her college education provided her with the opportunity to gain first-hand experience at various non-profit organizations in Washington, DC.

These include Martha's Table, which provides meals for more than 800 of the District's homeless, as well as child care, literacy programs, and adult education classes; Emmaus Services for the Aging, an advocate for elderly which offers seniors a variety of services through its outreach program; and several DC Public Schools including Stevens Elementary and Oyster Bilingual Elementary School. It was this latter experience that sparked her desire to become an intern at NABE this summer. Eventually, she would like to earn a Masters in Bilingual Elementary Education and become a bilingual educator.

A native of Richmond, Virginia, Susan has always been particularly concerned about the prejudice and discrimination that still pervade her city, as well as the nation. Recently in her hometown, attention from the media, police, and city officials has been devoted to various neighborhoods in an effort to improve racial

relations among the predominately African-American and Anglo residents. However, Susan concedes that her city has a long way to go. According to her, "The most obvious way to increase cultural understanding and appreciation is through education." Therefore, with a future career as an elementary school teacher, she hopes to play an integral part in unifying her community across all racial and economic divides.

Additionally, Susan has a passion for languages. Ideally, she would love to be able to speak every language because she believes that communication is the key to developing cultural appreciation. However, she admits, "Even though I've taken Spanish classes for ten years, I wouldn't consider myself fluent. Forty-five minutes of instruction a day is not enough which is why I believe bilingual education is so important." As she learned through her internship at Oyster, two-way developmental bilingual education programs not only prepare students for the global market they will face when entering the business world, but also foster understanding and mutual respect of other cultures from an early age.

As an intern with NABE, Susan hopes to learn more about how legislative decisions made on Capitol Hill affect bilingual classrooms throughout the nation. She would also like to increase her knowledge of the obstacles facing implementation of bilingual programs, such as teacher shortage and lack of public acceptance. In the future, Susan hopes to use her experience at NABE to work towards establishing bilingual education programs in communities that do not have them.

**Editor's Note:** NABE is delighted that two more outstanding young women will be joining the Policy Education Program later this summer. Nancy San Jose and Yolanda Bueno will be introduced in a later issue of NABE NEWS.

• NABE •

## REPRINT PERMISSION

**Readers are welcome to  
reprint any NABE NEWS  
original material free of  
charge as long as proper  
credit is given to both the  
author and NABE NEWS  
as the source.**



# NABE PRODUCTS ORDER FORM

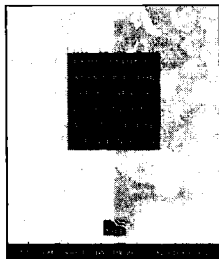
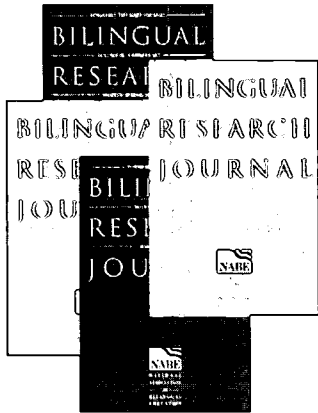

ITEM	PRICE	#	TOTAL
<b>PUBLICATIONS</b>			
<i>Bilingual Research Journal</i>	\$13.00		
Vol. 20, #1, Winter 1996 Current Journal Issue			
Vol. 19, #3&4, Spring/Summer 1995 Special issue: Role of ESL in Bilingual Education			
Vol. 19, #1, Fall 1994 Special issue: Native American Issues			
Vol. 16, #1&2, Spring/Summer 1995 Special issue: Ramirez study			
[earlier issues available (call for details)]			
<i>NABE Annual Conference Journal</i>	\$7.00		
1989-90 issue			
1991-92 issue			
1992-93 issue			
<i>1997 Annual Conference Program</i>	\$5.00		
<i>NABE News</i>	\$5.00		
write issue date or volume/number here			
write issue date or volume/number here			
[current volume always available; earlier issues may also be available (call for specifics)]			
<i>Professional Standards for the Preparation of Bilingual/Multicultural Education Teachers</i>	\$5.00		
<b>PRODUCTS</b>			
NABE logo pins	\$5.00		
NABE bumper stickers			
"Proud to be Bilingual"	\$1.00		
"Orgulloso de ser Bilingüe"	\$1.00		
NABE canvas tote bags	\$5.00		
VIDEO: Making Connections: Learning, Language and Technology	\$7.00		
<b>TOTAL</b>			

- Prices include shipping by USPS first class mail. Special shipping available - call for pricing.
- Payment must accompany all orders. Make checks and purchase orders payable to NABE.
- Orders shipped to the District of Columbia must include 6% sales tax.
- Credit card orders may also be placed by phone (202 - 898-1829) during business hours.

## SHIPPING INFORMATION

Name \_\_\_\_\_ Company \_\_\_\_\_

Address \_\_\_\_\_

City/State/Zip \_\_\_\_\_ Phone \_\_\_\_\_

## PAYMENT INFORMATION

Check#: \_\_\_\_\_ PO#: \_\_\_\_\_ CC#: \_\_\_\_\_ ExpDate: \_\_\_\_\_

232

MAIL TO: NABE PRODUCTS, Suite 605, 1220 L Street NW, Washington, DC 20005-4018



# Congress of the United States

Washington, DC 20515

May 22, 1997

The Honorable John Porter  
Chairman  
House Appropriations Subcommittee on Labor, HHS, and Education  
Washington, D.C. 20515

Dear Mr. Chairman:

We are writing to strongly urge your support of the Administration's FY 1998 request for \$199 million in funding for bilingual education programs, including \$160 million for instructional services, \$14 million for support services, and \$25 million for professional development.

Arguably, no federal education program has been as important to language-minority communities over the past 27 years as bilingual education. Millions of language-minority students have stayed in school, graduated, and gone on to college because of the Title VII-funded programs. It is a claim that very few other educational programs can make.

Federal support for bilingual education is essential in the effort to ensure that limited-English-proficient (LEP) students are given the opportunity to be full and successful participants in our system of public education. Over the last decade, the number of LEP students in our schools more than doubled, and their numbers are projected to continue to increase faster than those of any other group in our school population. In light of this, adequate federal support for bilingual education and all of its program components is of the utmost importance.

Funding is especially critical in the areas of Title VII professional development and support services. These programs play a major role in the continued success of Title VII funded bilingual education programs. Over the last two fiscal years, however, their funding has been far from adequate.

Support services are essential to the systematic education reform of LEP students. The money allocated for support services will be used to fund technical assistance for local educational agencies, research, dissemination, and to assist a national clearinghouse to collect, analyze, synthesize, and distribute information about programs for LEP/bilingual students.

Furthermore, to improve student performance, we must improve teacher performance— that means training. Professional development funds will be used to help address the shortage of trained bilingual educators that exist throughout our nation, especially in urban areas. Through fellowships and teacher training monies that provide aid in the training and updating of skills for

both current and future educators, Title VII professional development programs address the needs of children whose special language and educational needs would otherwise go unmet.

Children truly are the future of our nation, and bilingual education is a solid investment in our kids. As Members of Congress, we must address the needs of all our children. We thank you for the attention lent to this important matter, and once again we urge your full support for the Administration's request of \$199 million in FY 1998 funds for bilingual education, with \$160 million allocated for instructional services, \$14 million for support services, and \$25 million for professional development.

Sincerely,

James R. ...

Robert ...

Lydia ...

...

Rubin ...

...

...

...

...

Ed Pastor

...

...

Robert A. Underwood

Matthew ...

...

...

# Senate Appropriations Committee

Hon. Ted Stevens (R-AK)  
(Full committee chairman)  
T: (202) 224-3004  
senator\_stevens@stevens.senate.gov  
Ms. Liz Connell

Hon. Thad Cochran (R-MS) \*  
T: (202) 224-5054  
senator@cochran.senate.gov  
Ms. Anne Copland

Hon. Arlen Specter (R-PA)\*  
(Subcommittee chairman)  
T: (202) 224-4254  
Ms. Solange Bythol

Hon. Pete V. Domenici (R-NM)  
T: (202) 224-6621  
senator\_domenici@domenici.senate.gov  
Ms. Christine Morden

Hon. Christopher (Kit) Bond (R-MO) \*  
T: (202) 224-5721  
Ms. Leanne Jerome

Hon. Slade Gorton (R-WA)  
T: (202) 224-3441  
senator\_gorton@gorton.senate.gov  
Ms. Kristen Michal

Hon. Mitch McConnell (R-KY)  
T: (202) 224-2541  
F: (202) 224-2499  
senator@mcconnell.senate.gov  
Ms. Robin Bowen

Hon. Conrad Burns (R-MT)  
T: (202) 224-2644  
F: (202) 224-8594  
conrad\_burns@burns.senate.gov  
Mr. Paul Van Remortel

Hon. Richard C. Shelby (R-AL)  
T: (202) 224-5744  
F: (202) 224-3416  
Mr. Reid Cavnar

Hon. Judd Gregg (R-NH) \*  
T: (202) 224-3324  
F: (202) 224-4952  
mailbox@gregg.senate.gov  
Ms. Alyssa Shooshan

Hon. Robert F. Bennett (R-UT)  
T: (202) 224-5444  
E-mail: none  
Ms. Corine Larson

Hon. Ben Nighthorse Campbell (R-CO)  
T: (202) 224-5852  
F: (202) 224-1933  
Ms. Raissa G. Quintal

Hon. Lauch Faircloth (R-NC) \*  
T: (202) 224-3154  
senator@faircloth.senate.gov  
Mr. Sean Callinicos

Hon. Kay Bailey Hutchison (R-TX) \*  
T: (202) 224-5922  
F: (202) 224-0776  
senator@hutchison.senate.gov  
Mr. Quin Dodd

Hon. Robert C. Byrd (D-WV) \*  
(Ranking Minority Member on Full  
Committee)  
T: (202) 224-3954  
F: (202) 224-8070  
Mr. Eli Gabriel

Hon. Daniel K. Inouye (D-HI) \*  
T: (202) 224-3934  
Mr. Pat DeLeon

Hon. Ernest F. Hollings (D-SC)  
T: (202) 224-6121  
senator@hollings.senate.gov  
Ms. Laura Morris

Hon. Patrick J. Leahy (D-VT)  
T: (202) 224-4242  
senator\_leahy@leahy.senate.gov  
Ms. Margaret Whitney

Hon. Dale Bumpers (D-AR) \*  
T: (202) 224-4843  
senator@bumpers.senate.gov  
Ms. Mary Ann Chaffee

Hon. Frank R. Lautenberg (D-NJ)  
T: (202) 224-4744  
F: (202) 224-9707  
Mr. Dan Katz

Hon. Tom Harkin (D-IA) \*  
(Ranking Minority Member of Subcom-  
mittee)  
T: (202) 224-3254  
F: (202) 224-9369  
tom\_harkin@harkin.senate.gov  
Mr. Richard Bender

Hon. Barbara A. Mikulski (D-MD)  
T: (202) 224-4654  
F: (202) 224-5223  
senator@mikulski.senate.gov  
Ms. Lynne Layrence

Hon. Harry Reid (D-NV) \*  
T: (202) 224-3542  
F: (202) 224-7327  
senator\_reid@reid.senate.gov  
Ms. Sue Mabry

Hon. Herb Kohl (D-WI) \*  
T: (202) 5653  
senator\_kohl@kohl.senate.gov  
Mr. Steve Kimball

Hon. Patty Murray (D-WA) \*  
T: (202) 224-2621  
F: (202) 224-0238  
senator\_murray@murray.senate.gov  
Mr. Mike Egan

Hon. Byron Dorgan (D-ND)  
T: (202) 224-2551  
F: (202) 224-1193  
senator@dorgan.senate.gov  
Ms. Jenifer Urff

Hon. Barbara Boxer (D-CA)  
T: (202) 224-3553  
senator@boxer.senate.gov  
Ms. Kimberly Miller

Members listed in order of seniority  
within party.

\* = Subcommittee on Labor, HHS, and  
Education member

T = Telephone

F = Fax

E-mail

Staff Contact

# House Appropriations Committee

Hon. Bob Livingston (R-LA)\*  
(Full Committee Chair)  
T: (202) 225-3015  
F: (202) 225-0739  
Mr. Stan Skocki

Hon. Joseph M. McDade (R-PA)  
T: (202) 225-3731  
F: (202) 225-9594  
Ms. Teresa Baker

Hon. C.W. Bill Young (R-FL)\*  
T: (202) 225-5961  
F: (202) 225-9764  
Mr. Douglas Gregory

Hon. Ralph Regula (R-OH)  
T: (202) 225-3876  
F: (202) 225-3059  
Mr. Richard Graves/Ms. Barbara  
Wainman

Hon. Jerry Lewis (R-CA)  
T: (202) 225-5861  
F: (202) 225-6498  
Home Page: [http://www.house.gov/  
jerrylewis/](http://www.house.gov/jerrylewis/)  
Ms. Elizabeth Kavalich

Hon. John Edward Porter (R-IL)\*  
(Subcommittee Chairman)  
T: (202) 225-4835  
Ms. Suzanne Myers

Hon. Harold Rogers (R-KY)  
T: (202) 225-4601  
F: (202) 225-0940  
Ms. Mary Miller

Hon. Joe Skeen (R-NM)  
T: (202) 225-2365  
F: (202) 225-9599  
Mr. Mike Kozeliski

Hon. Frank Wolf (R-VA)  
T: (202) 225-5136  
F: (202) 225-0437  
Ms. Lori Beth Feld Hua

Hon. Tom DeLay (R-TX)  
T: (202) 225-5951  
Ms. Kristen Simmonds

Hon. Jim Kolbe (R-AZ)  
T: (202) 225-2542  
E-mail: [jimkolbe@hr.house.gov](mailto:jimkolbe@hr.house.gov)  
Mr. Frank McNaught/ Jason Isaak

Hon. Ron Packard (R-CA)  
T: (202) 225-3906  
F: (202) 225-0134  
E-mail: [rpackard@hr.house.gov](mailto:rpackard@hr.house.gov)  
Home Page: [http://www.house.gov/  
packard/welcome.html](http://www.house.gov/packard/welcome.html)  
Mr. Eric Mondero

Hon. Sonny Callahan (R-AL)  
T: (202) 225-4931  
F: (202) 225-0562  
E-mail: [callahan@hr.house.gov](mailto:callahan@hr.house.gov)  
Home Page: [http://www.house.gov/  
callahan/](http://www.house.gov/callahan/)  
Mr. Mike Sharp

Hon. James T. Walsh (R-NY)  
T: (202) 225-3701  
F: (202) 225-4042  
Ms. Martha Carmen

Hon. Charles H. Taylor (R-NC)  
T: (202) 225-6401  
F: (202) 226-6405  
E-mail: [chtaylor@hr.house.gov](mailto:chtaylor@hr.house.gov)  
Ms. Kendra Turchiarolo

Hon. David L. Hobson (R-OH)  
T: (202) 225-4324  
Home Page: [http://www.house.gov/  
hobson/welcome.html](http://www.house.gov/hobson/welcome.html)  
Ms. Jenifer Cutcher

Hon. Ernest J. Istook, Jr. (R-OK) \*  
T: (202) 225-2132  
F: (202) 226-1463  
E-mail: [istook@hr.house.gov](mailto:istook@hr.house.gov)  
Mr. Bill Duncan

Hon. Henry Bonilla (R-TX) \*  
(202) 225-4511  
(202) 225-2237  
Ms. Christine Pellerin

Hon. Joe Knollenberg (R-MI)  
T: (202) 225-5802  
F: (202) 226-2356  
Mr. Deron Zeppelin

Hon. Dan Miller (R-FL) \*  
T: (202) 225-5015  
F: (202) 226-0828  
E-mail: [miller13@hr.house.gov](mailto:miller13@hr.house.gov)  
Ms. Danielle Doane

Hon. Jay Dickey (R-AR) \*  
T: (202) 225-3772  
F: (202) 225-1314  
E-mail: [jdickey@hr.house.gov](mailto:jdickey@hr.house.gov)

Ms. Jennifer Hartman

Hon. Jack Kingston (R-GA)  
T: (202) 225-5831  
F: (202) 226-2269  
Home Page: [http://www.gasou.edu/  
first\\_district/](http://www.gasou.edu/first_district/)  
Ms. Adam Sullivan

Hon. Mike Parker (R-MS)  
T: (202) 225-5865  
F: (202) 225-5886  
Home Page: [http://www.house.gov/  
parker/](http://www.house.gov/parker/)  
Ms. Pat Holland

Hon. Rodney Frelinghuysen (R-NJ)  
T: (202) 225-5034  
E-mail: [njeleven@hr.house.gov](mailto:njeleven@hr.house.gov)  
Mr. Ed Krenik

Hon. Roger F. Wicker (R-MS) \*  
T: (202) 225-4306  
F: (202) 225-3549  
Mr. Chris Pedigo

Hon. Michael Forbes (R-NY)  
T: (202) 225-3826  
E-mail: [mpforbes@hr.house.gov](mailto:mpforbes@hr.house.gov)  
Home Page: [http://www.house.gov/  
forbes/welcome.html](http://www.house.gov/forbes/welcome.html)  
Ms. Mary Frances Valentino/Monte  
Ward

Hon. George R. Nethercutt, Jr. (R-WA)  
T: (202) 225-2006  
Ms. Erica Horton

Hon. Mark W. Neumann (R-WI)  
T: (202) 225-3031  
F: (202) 225-3393  
E-mail: [mneumann@hr.house.gov](mailto:mneumann@hr.house.gov)  
Home Page: [http://www.house.gov/  
neumann/welcome.html](http://www.house.gov/neumann/welcome.html)  
Mr. Scott Heins

Hon. Randy "Duke" Cunningham (R-CA)  
T: (202) 225-5452  
F: (202) 225-2558  
Home Page: [http://www.house.gov/  
cunningham/](http://www.house.gov/cunningham/)  
Mr. Frank Purcell

Hon. Todd Tiahrt (R-KS)  
T: (202) 225-6216  
F: (202) 225-3489  
E-mail: [tiahrt@hr.house.gov](mailto:tiahrt@hr.house.gov)

Home Page: <http://www.house.gov/tiahrt/welcome.html>

Mr. Chris Israel/ Jeff Kahrs  
Hon. Zach Wamp (R-TN)  
T: (202) 225-3271  
F: (202) 225-3494

Home Page: <http://www.house.gov/wamp/>  
Ms. Claire McVay

Hon. Tom Latham (R-IA)  
T: (202) 225-5476  
F: (202) 225-3301  
Home Page: <http://www.house.gov/latham/>  
Mr. Paul Zurawaski

Hon. Anne Northup (R-KY)  
T: (202) 225-5401  
F: (202) 225-0279  
Ms. Juliane Carter

Hon. Robert Aderholt (R-AL)  
T: (202) 225-4876  
F: (202) 225-5587  
Mr. Mark Busching

Hon. David R. Obey (D-WI) \* (Ranking  
Minority Member on Full Commit-  
tee & Subcommittee)  
T: (202) 225-3365  
Ms. Christina Hamilton

Hon. Sidney R. Yates (D-IL)  
T: (202) 225-2111  
F: (202) 225-3493  
Ms. Maura Reidy

Hon. Louis Stokes (D-OH) \*  
T: (202) 225-7032  
F: (202) 225-1339  
Ms. Angela Vincent

Hon. John P. Murtha (D-PA)  
T: (202) 225-2065  
E-mail: [murtha@hr.house.gov](mailto:murtha@hr.house.gov)  
Home Page: <http://www.house.gov/murtha/>  
Ms. Colette Marchesini

Hon. Norman D. Dicks (D-WA)  
T: (202) 225-5916  
Mr. Colin Sheldon

Hon. Martin Olav Sabo (D-MN)  
T: (202) 225-4755  
E-mail: [msabo@hr.house.gov](mailto:msabo@hr.house.gov)  
Home Page: <http://www.house.gov/sabo/welcome.html>  
Ms. Jessica Savran

Hon. Julian C. Dixon (D-CA)  
T: (202) 225-7084  
F: (202) 225-4091  
Ms. Sally Johnson

Hon. Vic Fazio (D-CA)  
T: (202) 225-5716  
E-mail: [dcaucus@hr.house.gov](mailto:dcaucus@hr.house.gov)  
Home Page: <http://www.house.gov/fazio/welcome.html>  
Mr. Duncan McPetridge

Hon. W.G. (Bill) Hefner (D-NC)  
T: (202) 225-3715  
Mr. David Perry

Hon. Steny H. Hoyer (D-MD) \*  
T: (202) 225-4131  
F: (202) 225-4300  
Ms. Lisa Levine

Hon. Alan B. Mollohan (D-WV)  
F: (202) 225-7564  
Mr. Christopher Lee

Hon. Marcy Kaptur (D-OH)  
T: (202) 225-4146  
F: (202) 226-7711  
Ms. Susan E. Role

Hon. David E. Skaggs (D-CO)  
T: (202) 225-2161  
E-mail: [skaggs@hr.house.gov](mailto:skaggs@hr.house.gov)  
Ms. Sue Hardesty

Hon. Nancy Pelosi (D-CA) \*  
T: (202) 225-4965  
F: (202) 225-8259  
E-mail: [sfnancy@hr.house.gov](mailto:sfnancy@hr.house.gov)  
Home Page: <http://www.house.gov/pelosi/welcome.html>  
Mr. Steve Morin

Hon. Peter J. Visclosky (D-IN)  
T: (202) 225-2461  
F: (202) 225-2493  
Mr. Chris Safferg

Hon. Thomas M. Foglietta (D-PA)  
T: (202) 225-4731  
F: (202) 225-0088  
Ms. Toni Cooper

Hon. Esteban Edward Torres (D-CA)  
T: (202) 225-5256  
F: (202) 225-9711  
Ms. Elizabeth Kuffner

Hon. Nita M. Lowey (D-CA) \*  
T: (202) 225-6506  
F: (202) 225-0546  
Ms. Jennifer Luray

Hon. Jose Serrano (D-NY)  
T: (202) 225-2341  
F: (202) 225-6001  
Mr. Forrest Hayes

Hon. Rosa L. DeLauro (D-CT)  
T: (202) 225-3661  
Ms. Catorina McDonald

Hon. James P. Moran (D-VA)  
T: (202) 225-4376  
F: (202) 225-0017  
E-mail: [repmoran@hr.house.gov](mailto:repmoran@hr.house.gov)  
Ms. Anstice Brand

Hon. John W. Olver (D-MA)  
T: (202) 225-5335  
F: (202) 226-1224  
E-mail: [olver@hr.house.gov](mailto:olver@hr.house.gov)  
Ms. Debra Drake

Hon. Ed Pastor (D-AZ)  
T: (202) 225-4065  
E-mail: [edpastor@hr.house.gov](mailto:edpastor@hr.house.gov)  
Mr. Blake Gable

Hon. Carrie P. Meek (D-Fl)  
T: (202) 225-4506  
F: (202) 225-0777  
Home Page: <http://www.house.gov/meek/welcome.htm>  
Ms. Tola Thompson

Hon. David E. Price (D-NC)  
T: (202) 225-1748  
F: (202) 225-2014  
Ms. Kimberly Manno

Hon. Chet Edwards (D-TX)  
T: (202) 225-6105  
F: (202) 225-0350  
Mr. Brady King

Members listed in order of seniority  
within party.

\* = Subcommittee on Labor, HHS, and  
Education member

T: Telephone  
F: Fax  
E-mail/Home Page  
Staff Contact

# Congress of the United States

Washington, DC 20515

May 21, 1997

The Honorable John Edward Porter  
Chairman  
Subcommittee on Labor, Health and Human Services  
and Education  
House Committee on Appropriations  
2358 Rayburn HOB  
U.S. House of Representatives  
Washington, D.C. 20515-6024

Dear Mr. Chairman:

As Members of the Congressional Hispanic Caucus (CHC), we are writing to urge you to fully fund or increase funding for a number of education programs that specifically address the unique needs of disadvantaged Hispanic students and youth. Indeed, we implore you to join forces with us to combat a problem which has reached a national crisis.

According to a Census Bureau report released this week, Hispanics drop out of school at a rate twice the average. Today, more than half of Hispanics over 25 do not have a high school diploma and Hispanic youth drop out at a younger age. Hispanics under age 18 are now the largest minority in their age group and they are projected to represent 25 percent of the school age population by the year 2030. The educational crisis of the Hispanic community should be a national concern and we are calling on your Subcommittee to take a leadership role in addressing this crisis.

Some say that there is no coherent educational strategy, either nationally or locally, for addressing the Hispanic dropout rate. Researchers and educators are however, heartened by marked improvements in the dropout rate when certain programs are implemented. It is these proven programs for which we ask your close consideration. They include: Bilingual Education; TRIO; the High School Equivalency Program and the College Assistance Migrant Program (HEP-CAMP); Hispanic-Serving Institutions (HSIs); and Early Head Start and Head Start.

- **Bilingual Education:** No federal education program has been more important to the CHC over the past two decades than the Bilingual Education Act. Although bilingual education serves children of varied language backgrounds, more than three-quarters of the students who participate in bilingual education are Hispanic. Millions of Hispanic students and families have stayed in school, graduated and gone on to college because of Title VIII of the Improving America's Schools Act. We support the Administration's request for a total of \$199 million for bilingual education in FY 1998, including \$14 million for support services and \$25 million for professional development.

- **TRIO:** For over twenty years, TRIO has served disadvantaged Hispanics and students of all backgrounds by promoting programs that raise high school achievement and college enrollment rates. Alumni of this successful program includes current and former Members of Congress, educators, entrepreneurs and other contributing citizens. We ask that you support the expansion of the TRIO Programs over time to serve 10% of the eligible students. Currently, the TRIO Programs serve less than 5% of the eligible population. We request funding in the amount of \$525 million for the TRIO Programs, which would provide important outreach and support services to an additional 36,662 students.
- **HEP-CAMP:** The High School Equivalency Program and the College Assistance Migrant Program provide unique services to some of the most disadvantaged youth in our country and do so with incredible success rates. No other federal programs have the tremendous success rates that HEP and CAMP do. Sixty nine percent of HEP students successfully complete the program. A large majority of them go on to higher education. Of those students, 40 percent enroll in technical, vocational schools, 37 percent at two-year colleges, and 23 percent at 4-year institutions. The only limitations to what HEP and Camp can accomplish are their meager funding levels. Currently only 12 percent of the eligible students participate in the HEP Program. Statistics for CAMP are even more staggering. Out of potential 244,000 eligible students, at the current level of funding, only 4,500 students or two percent will receive services. These numbers represent an enormous loss in human potential and a significant deficit for our economy.
- **Hispanic Servicing Institutions (HSIs):** HSIs are institutions of higher education where the Hispanic enrollment is at least 25 percent of the total student enrollment. Historically, these schools have played a pivotal role in the education of Hispanics. This is evidenced by the enrollment of 60% of the Hispanic college students in America in some 160 HSIs. These institutions have limited funds to support their growing student bodies. We ask that the Committee consider increasing funding for HSIs to \$50 million.
- **Head Start:** Hispanic children continue to be under served by Head Start. Although Hispanic children are 28% of all poor children, they are only 15% of children participating in Head Start. We support increased funding for the Head Start Program, including the Early Head Start component. We support the President's goal to serve 1 million children by 2002 and to continue comprehensive early childhood development services. We support the Administration's \$108 million request for Even Start, to permit the expansion of local programs that help young children develop the skills required for success in elementary school while enabling their parents to gain basic literacy skills.

These successful programs are essential if we as a nation are to address the needs of our fastest growing and most deprived student population. As you undertake the deliberative process and

prior to recommending FY 1998 marks, we ask that you carefully consider the federal responsibility to assure opportunity. It is critically important that the programs like those mentioned above, all of which preserve opportunity and the possibility of upward mobility, be protected.

Thank you for considering our funding requests.

Sincerely,

*James D. ...*

*Joseph S. ...*

*[Signature]*

*Robert A. Underwood*

*J. E. ...*

*Ricardo ...*

*Lucille Royal-Blair*

*Luis V. ...*

*Carlos Rosas-Barcelo*

*Ed Pastor*

*Rubin Hinojosa*

*Esteban ...*

*Vydia M. ...*

*Matthew G. Martinez*

*Henry B. ...*

*[Signature]*



# Asian/Pacific American Education Concerns

Column Editors: Ji-Mei Chang, San Jose State University, CA, and  
Janet Y.H. Lu, ARC Associates, Inc., Oakland, CA

## *A Practical Guide for Working with Asian and Pacific American Students*

by Yee Wan

Asian and Pacific American (APA) students are often portrayed as the "model minority." They are viewed as high achievers, quiet, studious, disciplined, respecting authority, and having few or no problems in school (Kiang, Lan & Sheehan, 1995; Osajima, 1988; & Suzuki, 1989). The stereotypes can be misleading, and failure to recognize this can impede the effectiveness of classroom teaching and the learning of APA students.

The purpose of this article is to challenge the stereotypical image of Asian and Pacific American students. The paper outlines the most common stereotypes that many teachers have of them. It also identifies some general cultural behavioral patterns that do exist across the different groups of APA students and the implication of these general patterns for teachers. Finally, it presents recommendations for teachers to promote equitable participation in the schooling experiences of APA students.

Recognizing the diversity that exists among APA students prior to working with them can better prepare teachers to respond to the students' needs. Teachers may have observed that some behavioral patterns of APA students are incongruent with their expectations and personal experiences. The unfamiliarity may easily lead teachers to rely on limited information and treat students based on the existing stereotypes.

To avoid such biased practices, teachers have to make a conscious effort to identify their interaction pattern with APA students in the classroom. Below are two common stereotypes with examples of how they can affect classroom interactions.

### **Stereotypes of Asian and Pacific American Students**

#### *Stereotype I - All APA Cultures Are the Same*

Many teachers assume that all Asian and Pacific American cultures are quite similar and that all APA students can work well with one another. The reality is that each APA sub-group has its own language, holidays, customs, cuisine, costumes, ceremonies, religions, etc. For example, the languages that are spoken by the Chinese students depend on the geographical location of their origin. Students may not be able to communicate with one another in their native language due to dialectal differences. In general, Chinese students from Hong Kong speak Cantonese while those from mainland China speak Mandarin, and those from Taiwan speak both Mandarin and Taiwanese. The use of eating utensils also varies among the different APA groups. Unlike the Chinese, Japanese, Korean, and Vietnamese who all use chopsticks and bowls, Cambodian, Hmong, Laotian, Indonesian use forks and spoons (Indochinese Mental Health Project, 1980). Teachers cannot make the assumption that all the APA students know how to use chopsticks and bowls in their meals.

Another difference in APA customs is the celebration of the New Year. The Chinese and Vietnamese celebrate their New Year in February while Cambodians and Laotians celebrate their New Year in April (Indochinese Mental Health Project, 1980). Very often, teachers only share information about the Chinese and Vietnamese New Year celebrations and leave out the other APA groups. This misleads mainstream students into thinking that all APA groups celebrate their new year in February, and may hurt the feelings of those APA students whose cultural uniqueness is not acknowledged.

In addition to cultural practices, teachers also need to be sensitive in observing the interaction among different groups of APA students. The historical relationship between the different Asian sub-groups sometimes affects APA students' interaction in the school setting. For example, Pang's (1990) study revealed an incident in which a Cambodian student refused to receive help from a Vietnamese student who had been in the country longer. The rationale was that Vietnam and Cambodia had been in war for many years and there is a great deal of mistrust between the two groups. Another example is the ambivalent relationship between Japanese and Korean students. Korea was once colonized by Japan. Therefore, Japanese and Korean students may not necessarily develop bonds. Teachers must be aware that if they use the term "Asian culture" without referring to a specific Asian group, this will mislead the students into believing that all the Asian cultures are the same. It can also increase the chances of miscommunication in classroom settings.

#### *Stereotype II - All Asian and Pacific American Students Are High Achievers*

The "model minority" stereotype obscures the differences between Asian groups in academic achievement, and thus can cause neglect of underachieving APA students. According to Pang's (1995) study of the Seattle School District between 1986-87, the high school dropout rates of Vietnamese (11.8%) and other Southeast Asian (17.9%) students were twice or more than those of Japanese (5.1%) and Chinese (5.3%) students. Furthermore, the CTBS Scores of the Oakland Unified School District between 1990-91 showed disparity among ethnic groups within the district. In the area of reading, 69% of the Asian students fell below 50 percentile

CONTINUED ON PAGE 28

(national average) versus 22% of the white students (Commission for Positive Change in the Oakland Public Schools, 1991).

### General Cultural Behavioral Patterns

Up to this point, this article has discussed stereotypes that fail to acknowledge the differences among the Asian cultures and students; but some general cultural patterns do exist among Asian and Pacific American sub-groups. These include controlling one's expression and dealing with confrontational situations.

#### *Reading Non-Verbal Cues*

According to the author's observation in working with pre-service and in-service teachers, many teachers repeatedly express that they have difficulties reading non-verbal cues from Asian and Pacific American students. They state that APA students appear to be calm and wear a neutral facial expression during class. For example, Asian students do not demonstrate as much excitement when responding to teacher's comments or competitive games, and they also initiate fewer questions when compared to their native-born American counterparts. This can cause misunderstanding in the classroom. APA students have the concept of school being a formal learning environment and they respect teachers as authority figures. If they may appear to control their emotions, it is their way of demonstrating their seriousness in learning. However, American teachers may expect stimulated learners to be animated and expressive. Oftentimes, attentive APA students are perceived as bored, uninterested, unmotivated, unengaged, etc. Since non-verbal behaviors play a significant role in the communication process, learning about the cultural behaviors of the students can prevent teachers from making unnecessary assumptions and hence facilitate the learning process. Teachers should also keep in mind that the students' behavior often reflects their degree of acculturation; there are many APA students who are well adjusted in American schools.

#### *Dealing with Confrontation*

Very often, Asian and Pacific American students are misunderstood because of their desire to make compromises at school.

Teachers and other students may feel that APA students are not willing to take a stand on confrontational issues and lack the courage to stand up for themselves. This behavior can make them become the targets of harassment. APA students are often afraid to report to the teacher in the event of harassment. Many feel vulnerable in defending themselves at school (Kiang, Lan, & Sheehan, 1995).

In most traditional Asian cultures, direct confrontation is discouraged. Individuals who openly argue or defend themselves in public are considered immature and lacking in self-control. Confrontational behaviors often result in physical punishment at home and this prevents children from demonstrating aggressive behaviors. In the case of confrontational situations, APA students also face a dilemma of cultural conflicts between the home culture and school culture. Their behavior is a reflection of what is acceptable in their cultural frame of reference.

These common cultural patterns among APA students seem more prevalent among foreign-born or first-generation immigrant students. Acknowledging these can help teachers create an equitable classroom environment that allows all students to grow to their fullest potential.

### Strategies that Promote Equitable Classroom Participation

The following guidelines may assist teachers in addressing the needs of Asian and Pacific American students. These include 1) equipping ourselves and the students with knowledge of effective cross-cultural communication skills, 2) instilling an empowering curriculum in the classroom, and 3) building a strong connection to students' homes and communities.

#### *Cross-Cultural Competence*

1. Respect students' cultural boundaries when communicating with them. When conflicts occur, teachers can have students express their thoughts through writing. Teachers should allow limited English proficient students to write down their feelings in their native languages or have bilingual students take dictation for the limited English proficient

students.

2. Build a personal connection to students' cultural heritage. Teachers can learn about students' names, whether they are native born or foreign born, their place of origin, their academic experiences, a few words of students' native languages, etc. Teacher can design a survey and have students fill it out at the beginning of the school year. The survey can include information such as the name that each student prefers to be called in class, and the names of the cities and countries in which they were born. Teachers can show appreciation to linguistic diversity by having the students teach them and other students words in another language. At appropriate times, teachers can infuse learning opportunities by asking "How do you say 'Thank You' in your home language?" Then the teacher and other fellow students can repeat after the bilingual student.
3. Equip students with the skills to identify effective communication strategies in cross-cultural settings. For example, teachers can share some real life examples using role play or class discussion such as "Nguyet was invited to her American friend Heather's house for a party. When Nguyet had finished her first glass of juice, she wanted a second one. However, when Heather's mom went around the room asking who would like to have more to drink, Nguyet said 'no' to her. That's what she usually does when she visits her relatives. Nguyet then wondered why she did not get her second drink." The teacher can use this example to analyze Nguyet's behavior. In many APA cultures, directness can be considered as immature behavior in social settings. It is the custom of some Asian cultures to offer food to guests a few times before they

Alicia: *Sí, pero no estamos hablando de las palabras. Estamos viendo las letras de las palabras. ¿Tienen algo en común las letras de las palabras?* (Yes, but we are not talking about the words. We are looking at the letters of the words. Do the letters in the words have anything in common?) (28)

Marco: *Todas las palabras terminan en la letra o.* (All the words end with the letter o.)

Alicia: *Muy bien, Marco. ¿Cuántas sílabas hay en cada palabra?* (Very good, Marco. How many syllables are there in each word?)

Todos: *Dos.* (All: Two.)

Celia: *¿Qué recuerdan?* (What do you remember?)

Felicia: *Muchos pájaros diferentes vienen de huevos.* (Many birds come from eggs.)

Susana: *Como El Patito Feo.* (Like The Ugly Duckling.)

Celia: *¿El Patito Feo?* (The Ugly Duckling?)

Susana: *Sí, en El Patito Feo, habían huevos de patos y uno de un cisne... La mamá se confundió... Hablamos de cómo se confundió la semana pasada cuando estábamos discutiendo el libro.* (Yes, in The Ugly Duckling, there were duck eggs and one swan egg... The mother got mixed up... We talked about how the mother got mixed up when we were talking about the book last week.)

Celia: *Sí, muy bien, Susana. Hiciste una comparación muy interesante entre los dos libros. ¿Qué más recuerdan de Las Gallinas No Son Las Nicas?* (Very good, Susana. You made an interesting comparison between the two books. What else do you remember from Chickens Aren't the Only Ones?)

Francisco: *Muchos animales nacen de los huevos.* (Many animals are born from eggs.)

One of the significant aspects about the above examples (and other ones throughout the book), is the difference in the way the two teachers focus on meaning and use language to intervene or mediate as their students read. The first teacher, Alicia, who uses a word recognition approach

(based on phonics, sight words, etc.), intervenes and is concerned with correcting and preventing students' reading errors. The second teacher, Celia, who uses a socio-psycholinguistic approach, mediates and is concerned with helping students "make sense out of books they have chosen to read" (54). In the socio-psycholinguistic approach, strategies for comprehension are the focus, and the authors devote a good portion of Chapter 2 to the explanation and illustration of reading comprehension strategies.

The authors carefully point out this crucial difference throughout their book. In teaching based on a socio-psycholinguistic theory, we assume that "meaning is constructed and reconstructed in the process of reading and writing, and during these processes, readers and writers are changed" (49). That is, learning to read is part of learning language. In fact, this is the key to their entire book and the socio-psycholinguistic approach: "reading, like oral language, is a naturally acquired socio-psycholinguistic process" (35).

When discussing the research background for a socio-psycholinguistic approach to reading, the authors state that reading miscue research is the basis for this approach and that miscue research has been done with readers in many, many languages. Thus, they quote Goodman and others as to the universality of the process of reading, pointing out that the approach to teaching reading needs to be the same across languages, too. Nevertheless, after presenting a brief historical overview of Spanish reading methods used in Spanish-speaking countries, they explain and illustrate (in Chapters 3 and 4) the many synthetic and analytic approaches used to teach reading in Spanish.

Synthetic methods, which begin with "the parts" and move to "the whole," include a variety of methods. Some begin with letter names (the alphabetic method), others begin with words that represent sounds (the onomatopoeic method), others begin with the sounds that letters make (the phonics or phonetic method), and still others begin with syllables (the syllabic method). The beauty of the book, however, lies in the fact that the authors do not just tell about these various methods; nor

do they just tell and exemplify these methods. After each method and each detailed example or "scenario," they both analyze the method and then follow up with a positive alternative to each method, which shows how these parts can be taught within a meaning-based approach (an integrated method), so that students still learn the letters names, sounds, syllables, and so forth. Just as the first scenario of each method includes classroom talk, the positive alternatives presented include the teacher and student talk that goes on in the classroom. Seeing this talk helps the reader understand the differences between the two contrasting views about reading and ways that these differences of philosophy are realized in a real classroom. There is also a discussion of some commercially-developed reading programs, such as "hooked on phonics," "zoo-phonics," and "Estrellita."

Chapter 4 begins with analytic methods and moves to whole language ("el lenguaje integral"). Analytic methods, based on "the whole" which is then analyzed into parts, include a variety of methods. Some methods use a combination of both synthesis and analysis, such as the "generative word method;" others begin with the visual whole (the global or visual concept "ideovisual" method). With the global method, they discuss two very different variations: one in which readers analyze wholes into parts, a second one where they do not. Regarding the second variation, the authors state that "elements of sight reading and 'language experience' are evident in this version of the method" (109). In this chapter, they also discuss the lexical method (often called "the whole word method," but not to be confused with whole language); the eclectic or mixed method (where a host of different methods are used and which is common in US bilingual literacy programs); and the whole language approach. They also discuss Spanish language basal reading programs published for US schools, referring to early basal programs and to newer ones which reflect more current reading theory and contain quality literature and theme-based approaches. Because the whole language approach or philosophy is based on socio-psycholinguistic views of reading, they

CONTINUED ON PAGE 30

explain this method in great detail, with many examples of the implementation of whole language in bilingual classrooms, including several scenarios with classroom talk and ideas for literature for Spanish-English bilingual whole language classrooms.

Chapters 5 and 6 are devoted to the teaching of writing with a wealth of materials for teachers including a checklist for effective writing instruction (in both English and Spanish) and many examples of student writing in both Spanish and English. Information is also provided about the two prevalent contrasting views concerning writing instruction ("traditional" and "process writing" approaches); about nonalphabetic and alphabetic writing systems; and about stages in writing development (prephonetic, phonetic, phonic, and syntactic-semantic). With the examples of student writing, the authors carefully explain a child's thinking strategies behind the use of spellings that may not yet be conventional spellings. With the explanation and illustration of the different stages of writing, they also give many suggestions for assisting students who are at each of the stages.

Chapter 6, "Spanish Writing Development," is a descriptive chapter, which provides in-depth discussion of children's Spanish language writing development, informed by well-known studies such as Ferreiro and Teberosky's studies (1979, 1982) about stages, Edelsky's studies (1989, 1986) about functions of writing in Spanish (building on Halliday, 1975), as well as by their own studies. These many Spanish writing examples, with accompanying explanations of the writing, are very helpful to persons not familiar with children's development of a wide variety of purposes of writing and what this writing looks like in Spanish. Also, when reviewing these studies, the authors point out parallels to children's spelling development in English.

Finally, Chapter 7, "Putting Reading and Writing Together to Develop Biliterate Bicultural Students," is devoted to giving a clear, expanded picture of what it means for Spanish speakers to be biliterate and bicultural in the US. Quotes from bilingual teachers from a variety of Spanish language and cultural backgrounds intro-

duce the chapter, followed by a presentation of Collier's framework for language acquisition in school: combining language development, academic development, and cognitive development mediated by social and cultural processes. Again, with their strong examples from actual personal accounts, the authors have illustrated this chapter by referring to specific bilingual teachers throughout the chapter while explaining Collier's theoretical model. The value of these examples, and one of the clear strengths of the book, lies in the authors' ability to connect theory to practice and to personalize their writing for the reader. Persons referred to in this final chapter all have had diverse literacy and first language backgrounds, diverse bilingual environments and schooling histories, yet all have become biliterate and bicultural. The authors also include extended examples of actual first-second and third-fourth grade bilingual classrooms, showing how integrated (whole language) literacy instruction unfolds over a period of several days, and the many strategies (talking, questions, discussion, reading aloud, poetry) used to promote language, academic, and cognitive development for the diverse population of Spanish-speaking children. At the same time, this is an additional way the authors bring in the bicultural aspect: via the many materials, lists, and references provided, though primarily for younger students. Some of the materials are literature by well-known Spanish writers, such as Pablo Neruda and Alma Flor Ada, others are related to the teaching themes exemplified in the chapter: alike/different and agriculture.

In conclusion, *Teaching Reading and Writing in Spanish in the Bilingual Classroom* by Yvonne and David Freeman is a very useful, well-documented, and "reader-friendly" book. I do, however, have three suggestions for helpful background information that might be included for bilingual teachers. I would like to see more about developing bicultural students, referring to ways teachers can and do affirm their students' own cultures as well as expand knowledge of their ethnic, racial, linguistic, and cultural heritages, similar to the way Samaniego and Alarcón do in their high school-college Spanish for native speakers textbook, *Mundo 21*. This

would help teachers learn how to enhance students' understanding of culture and to reflect back their homeland cultures and their US bicultural contexts.

It may also be useful to include a section devoted to the Spanish language in the US ("US Spanish") and examples of how this impacts on biliteracy instruction (Elías-Olivares et al, 1985; Colombi & Alarcón, 1997). For example, questions and issues may include "What makes up US Spanish?" (heterogeneity, variation); "What authentic US Spanish materials are available?" (Spanish in US public life); "What is the best way to teach Spanish to young adult native speakers?" (interface with foreign language classes); and "What is the role of the Spanish-speaking community?" (family and neighborhood participation). These are but a few ideas.

Finally, teachers may be interested in learning about and seeing samples of writing in Spanish beyond the elementary school level. Especially useful would be the inclusion of information and examples of Spanish written discourse (for many academic purposes), with a comparison of written discourse in English and Spanish. Although much of the research on Spanish for native speakers (SNS) focuses on the post-secondary level of instruction (Valdés et al., 1981; Merino et al., 1993), there are studies that deal with K-12 bilingual concerns related to SNS (español para hispanohablantes).

Despite the need for more information about Spanish for native speakers in the US, the new Heinemann book, *Teaching Reading and Writing in Spanish in the Bilingual Classroom*, by Yvonne and David Freeman, fills a great need in the bilingual teacher education literature. The fact that many of the tables, lists, and other resources in the book are in both Spanish and English is one of many important and very helpful aspects of the book. All in all, it is a book that many bilingual teachers and teacher educators will find a "best friend."

#### References

- Colombi, C. & Alarcón, F. 1997. *La enseñanza del español a hispanohablantes: Praxis y teoría*. Boston: Houghton Mifflin Co.

CONTINUED ON PAGE 32

# Parental Involvement in Bilingual Education

Column Editor: Aurelio Montemayor, IDRA, San Antonio, TX

## *Hispanic Parents in their Own Words - Part 2*

*by Aurelio Montemayor*

*Hispanic parents were interviewed in different parts of the country as part of an effort by IDRA to record what they say in their own words.*

For me, school is like a church. I think they need to do more to impress the significance of school on children. There, you learn not to waste your time. I tell my children, "Look at me!" I left school because I thought at the time that I needed to work to help my mother, but I didn't realize in leaving school that I was losing capacity to work. Now I have no preparation. I only went to the 6th grade in Nicaragua, and my first husband went as far as the 2nd. I've been widowed twice. My second husband was Puerto Rican, from here. He studied and then took training as a chef. I used to marvel at how he could calculate in his head without paper. He said he had always been good in mathematics, but lazy in English, and his brother the reverse, so they helped each other.

I had a teacher in 2nd grade who was very patient and understanding, and even though we had large classes, she always made time for individual help, and she would go over and over something until you understood it. When I passed to the 3rd grade, she cried. In high school, I had a special chemistry teacher, and he helped me memorize symbols and other things I had trouble remembering. Now I'm in a pharmacy technician training course. He was someone you could talk to, and sometimes a group of us would eat our lunch with him because he helped us understand our personal problems and just life itself.

I graduated from high school here in New York City. When we came here, I was so happy because many people spoke Spanish, and it was like being home in Puerto Rico. When we were living in upstate New York, out of 1400 students, there were six minorities, me and my three brothers, and a Black brother and sister. But our fellow students helped us and tutored us. They wanted us to learn. Now I work as a school aide, with students from Kindergarten to 6th grade. When I was in the 3rd grade, in Puerto Rico, I had a teacher who used to tell me, "You will be someone," and she made me work harder than the others. When I go to the island, I always stop by to see her.

We have suffered enough, and we don't want to see our children suffer. Without school, they will suffer. They need school. They need an education. We're very proud of our oldest daughter, who says that with God's help, she's going to be a teacher. I would like to see the others in professions, too.

There was never any doubt when we were growing up that my brothers and sisters and I would go to college, even though my father had only gone to the 6th grade. After coming here from México, he went to trade school and became an expert meat-cutter. There was a counselor at the high school who was a wonderful influence on my whole family. She wanted to send me to a private high school in San Antonio, but finances didn't permit it, and the idea of boarding school seemed very strange to us because we hadn't known anything like it. We had a grocery store, and when three of us were in college at the same time, my father took a full-time job as well and mother ran the store. He worked very hard to pay our way through college, and I always knew he had such aspirations for me. And now my daughter has received a five-year scholarship to the University of Texas.

My mother always emphasized the value of education, and no matter how scarce money was in our house, she tried to find us good schools. From the 1st grade to the 6th grade, I went to a private school for the Chinese community. Besides classes in English and Spanish, we had classes in Chinese twice a week, and every morning, we sang the Ecuadorian national anthem, facing that flag, then the Chinese national anthem, facing that flag (it was the nationalist one, of course, not the communist one). Of 500 students, about 30 or 40 were not Chinese. I remember the teachers were so disciplined, and their attention was so trained and concentrated on us students, that it seemed personal. There were twenty categories of grades on the report card, and if you received a "red number," then your father had to come to school with you the following Monday and appear before the director. When my father had to go to the school one time, I realized that the school wasn't just calling me on the carpet, but us. Of course, when I got to high school, and went to a public school, I learned many more things because it was the Sixties, and we were demonstrating in the streets. The police were beating the students and firing on them, and the economic situation was bad and worsening, so I came to the United States when I was 17. And when I reached New York, I saw the police beating students. But I continued in school, and I think it must have been because of the influence of my mother. Now I'm an architect, and I've passed through the first phase, in which I arrived at this profession by a logical process concluding, "people will always have to live somewhere," and through the second, in which I thought I needed big buildings with which to identify, and now, I can enjoy the interplay of discipline and precision, and creative problem-solving, and real free-wheeling, and art...when all this comes together, you can produce something beautiful, something that will last. So I'll tell my sons, it's not just a high-school education that you need, but a college education, and it's not just something nice to have, but a life saver.

- Elías-Olivares, L., Leone, E. A., Cisneros, R., & Gutiérrez, J. 1985. *Spanish language use and public life in the United States*. New York: Mouton Publishers.
- Merino, B., Trueba, H., & Samaniego, F. 1993. *Language and culture in learning: Teaching Spanish to native speakers of Spanish*. New York: Falmer Press.
- Samaniego, F.A., Alarcón, F.X., & Rojas, N. 1995. *Mundo 21*. Lexington, MA: D.C. Heath & Co..
- Valdés, G., Lozano, A., & García-Moya, R. 1981. *Teaching Spanish to the Hispanic bilingual: Issues, aims, and methods*. New York: Teachers College Press.

*Beti Leone is a teacher educator in New Jersey, who has taught in bilingual & ESL K-12, adult, and university teacher education classrooms and written and published on topics in bilingual education, US Spanish, and bilingual/ESL teacher education.*

« NABE »

### Book Review Submission Guidelines

Reviews for publications in the **Book Review** column be sent to Dr. Beti Leone, Book Review column editor, at NABE  
1220 L Street, NW, #605, Washington, DC, 20005,  
or by e-mail to NABE-NEWS@nabe.org.

Books from publishers should be clearly marked **BOOK REVIEW MATERIAL** and sent to the same address; **two** complete sets of materials must be submitted.

The scene was breathtaking. The two stopped the car and walked down the path that lead toward the house. On a stand was the following message; the following are answers to questions that I am sure you want to ask. Who planted all these flowers? The answer: I did. How could one person plant all these flowers? Answer: one at a time.

As the two left for the drive back home, the mother still perplexed as to how one person changed the world forever. The mother commented, all the time I have wasted and the differences that I could have made. What can I do? I will start tomorrow.

The daughter replied, Why not start today?

After a bad storm, a man went out for a walk on the beach. The storm had littered the beach with thousands of starfish. He tried walking the beach and found there was no place that did not have starfish. He saw this little boy picking up starfish and throwing them back into the ocean. The man asked the boy, What are you doing? The boy replied, I am throwing the starfish back into the ocean so they will live. The man said, there are thousands of starfish, how can you possibly make a difference. The boy bending down and picking up another starfish and throwing it into the ocean replied, "It made a difference to that one!"

On this note, I would like to leave you with this thought. Change is never easy. This year, we the NABE Board of Directors, have revised the organization's mission statement. These changes were necessary in order to bring the organization into alignment with the current trends, issues and needs of the individuals we represent. We have made these changes, not *just for the children of today...but for the children...seven generations unborn.*

« NABE »

*This interview is taken from an IDRA publication "Hispanic Families As Valued Partners — An Educator's Guide." For more information about the publication contact Aurelio M. Montemayor. IDRA. 5835 Callaghan, Suite 350. San Antonio, Texas 78228. phone: (210)684-8180, fax: (210)684-5389, e-mail: amontmyr@idra.org.*

**Editor's Note:** Contributions for the **Parental Involvement** column should be sent directly to the editor, Aurelio M. Montemayor, at: IDRA. 5835 Callaghan, Suite 350. San Antonio, Texas 78228. phone: (210)684-8180, fax: (210)684-5389, e-mail: amontmyr@idra.org.

« NABE »

NABE '98

February 24-28, 1997

Dallas, TX

246

# Technology and Language-Minority Students

Column Editor: Dr. Dennis Sayers, Univ. of Calif. Education Research Center

## *Teaching Machines and Gaining Critical Distance: Paulo Freire and Educational Technology*

by Dennis Sayers, Kristin Brown  
and Enid Figueroa

As educators around the globe struggle to come to terms with Paulo Freire's vast legacy, we would do well not to overlook his radical innovations in the use of educational technology to create contexts for critical learning and action. This is especially important as we seek to sustain his vision in years to come in a world where technology plays a constantly increasing role, both in schools and throughout the wider society.

We are co-founders, a dozen years ago, of *De Orilla a Orilla* (From Shore to Shore), a multilingual global learning network using a range of technologies to create partnerships between distant teachers and their classrooms. *Orillas* has sought to link community-based learning with global action for social justice by extending an educational networking model first developed by the French educators Celestin and Elise Freinet in 1924 [see note, below]. We view Freire's work as that of a pioneer in forging what we have called "a pedagogy of distancing" with important implications for collaborative critical inquiry between distant classes, whether over the Internet or through "low-tech" exchanges via national postal services (Cummins & Sayers, 1995).

As we know, Freire's literacy campaigns made extensive use of slides and slide projectors. Slides were chosen since they could be projected and viewed by the whole Culture Circle as representations of key community concerns — called "generative themes" — which literacy workers had identified after weeks of research with local residents. Significantly, Freire chose not to display photographs but instead to create slides that were line drawings of local realities. This decision was based on the assumption that a more abstract por-

trayal of these day-to-day elements would evoke in the Culture Circle participants a greater sense of distance from the images than would a familiar, life-like photograph. In this simple act of creating graphic depictions that are one step removed from the lives of learners (yet still grounded in their everyday realities), a process of distancing was initiated that would lead to shared critical reflection and ultimately to decisive, active engagement to transform those realities. Freire wrote that

[when a] representation is projected as a slide, the learners effect an operation basic to the act of knowing: *they gain distance from the knowable object*. This experience is undergone as well by the educators, so that educators and learners together can reflect critically on the knowable object which mediates between them. (Freire, 1969, p. 15)

Freire described one such slide to illustrate the importance he placed on technology-mediated dialogue. The slide showed participants in a Culture Circle gathered around a slide projector, viewing and discussing one of the previous slides.

This slide represents the working of a Culture Circle. Upon seeing it, the participants easily identify with the process it depicts. They discuss culture as the systematic acquisition of knowledge, but also of the democratization of culture... The participants analyze the working of their Culture Circle, its dynamic sense, the creative force of dialogue and of conscientization (Freire, 1969, p. 142).

For Freire, audiovisual technology played a large role in fostering the kind of reflective distancing conducive to

conscientization and transformative social action. Certainly, this point was not lost on the military junta which sought to extirpate his influence in Brazil. Not surprisingly, they burned all the printed literacy materials they could lay their hands on, and thus joined ranks with book burners from reactionary regimes throughout history frightened by "subversive" ideas contained in published materials. But the military government took a further step which shows they appreciated the dangers in Freire's use of educational technology: They also destroyed the *slide projectors* whose only crime was to display images for thousands of Culture Circles.

We must be critical of technology's uses in our educational practice, especially when we are confronted daily with examples of its abuses, including technology-heavy school privatization schemes, biased computer-"assisted" standardized testing, and the general "remediation for the poor/enrichment for the rich" mindset. Yet among the many things we have learned from Paulo Freire is that our critical stance should not lead us to overlook technology's potential to promote reflective, socially-engaged learning.

[Note: Paulo Freire recognized affinities between his work and that of the Freinets. He once said "I am flattered to have my work associated with that of Celestin Freinet," and acknowledged Freinet as "one of the great contemporaries in education for freedom" (cited in Lee, 1983).]

### References

- Cummins, J. & Sayers, D. (1995) *Brave New Schools: Challenging Cultural Illiteracy through Global Learning Networks*. New York: St. Martin's Press.
- Freire, P. (1969) *La educación como práctica de la libertad*. Mexico DF:

CONTINUED ON PAGE 35

accept it. Teachers then can point out that in order to communicate with others effectively, one has to learn about others' communication style.

4. Develop intercultural knowledge among students from diverse background to facilitate their adaptation process between home and school (Gougeon, 1993). Teacher can select topics of students' interest to openly discuss the different cultural interpretation that exist between different ethnic groups. The topics for discussion can be respect, friendship, non-verbal behavior, conflict situation, authority, education, etc.

#### *Curriculum Development*

1. Avoid making assumptions about APA students' academic abilities and what they already know when planning for instruction and activities (Feng, 1994; Oei & Lyon, 1996). For example, not all children have experienced a Thanksgiving meal.
2. Encourage APA students to develop skills in all areas, including verbal, social and leadership skills.
3. Teach questioning techniques through the use of games. Some Asian students may feel intimidated about asking questions because it can be perceived as challenging authority figures. Knowing how to ask questions and practicing questioning techniques can prepare students to become strategic and active learners.
4. Incorporate self-confidence and self-esteem building activities in the classroom. The primary goal should be to foster a sense of self-pride and self-acceptance as the product of one's cultural experiences.
5. Introduce positive role models of Asian and Pacific origin through inviting guest speakers from local communities, and shared success stories of people from a broad range of professions.

6. Provide opportunities for Asian and Pacific American students to develop leadership skills through delegating classroom chores, establishing a conflict resolution system and having students play the role of conflict managers, and engaging students in cooperative group activities.
7. Use multicultural literature to build respect for cultural diversity and examine the harmful effect of stereotypes. Through the use of literature, teachers can point out the common experiences that exist among all the groups and include discussions on the stereotypes of Asians that are portrayed in literature, textbooks, television, or films.
8. Utilize students' expertise. Each student can be the expert or the consultant on his/her own culture. If the class is studying a topic on heroes, teacher can encourage the consultants to research the individuals from their own culture who had made a difference in other people's life.
9. Connect school learning to real-world issues. Many textbooks do not sufficiently address immigrant experiences and their contribution in the United States. Teachers can include additional information about immigration of the prominent ethnic groups where the students reside. Students can identify an ethnic group of their interest in the local community. They can research the place of origin of the immigrant group, their settlement in the U.S., their struggle, and their contribution in the U.S.

#### *Home-School Connection*

1. Work collaboratively with APA families to achieve identified common goals. Teachers can identify several goals that are valued in the Asian and Pacific American families, and reinforce those goals at school. For example, encourage APA students to show respect to older people in

their families, particularly their parents, and maintain their native languages (Feng, 1994).

2. Make frequent contact with APA parents. Teachers can reward an APA student by making a phone call to his/her parent or writing a note to describe the child's progress at school.
3. Use descriptive or narrative statements rather than using relative terms (e.g. good, very good, excellent) when reporting APA students' school progress to their parents. Teachers should use concrete examples to describe what students have accomplished. Since praise is given only when one does an outstanding job in most Asian cultures, commenting that a student did "good" may mean "excellent" to an APA parent.

#### **Conclusion**

The myth of Asian and Pacific American students being the "model minority" is still prevalent in the education arena. However, the growing needs of the recent Asian immigrant groups challenge the existing stereotypes. This paper provided guidelines and activity ideas that teachers can incorporate into daily teaching practices to promote equitable participation of all Asian and Pacific American students in their schooling experiences. The guidelines include gaining knowledge in cross-cultural communication skills, developing a curriculum that would empower students, and building a strong connection to student's homes and communities. Educators should make a conscious effort to address the individual needs of the Asian and Pacific American student population. The goal is to enable all students to achieve academic success and to equip them with the skills needed for participating in the mainstream society.

#### **References**

- Brewer, M. B., & Kramer, R. M. (1985). "The psychology of intergroup attitudes and behavior." In M. R. Rosenzweig, & L. W. Porter (Eds.), *Annual Review of Psychology*, 36, 219-243.

CONTINUED ON PAGE 35



Commission for Positive Change in the Oakland Public Schools. (1991). *Good education in Oakland: Preparing for positive change*. Oakland, CA: Author.

Feng, J. (1994). *Asian-American children: What teachers should know*. Washington, DC: Office of Educational Research and Improvement. (ERIC Document Reproduction Service No. ED 369 577).

Gougeon, T. D. (1993). "Urban schools and immigrant families: Teacher perspectives." *The Urban Review*, 25(4), 251-287.

Indochinese Mental Health Project. (1980). *Social/cultural customs: Similarities and differences between Vietnamese, Cambodian, Hmong, Lao*. PA: Bureau of Research and Training, Office of Mental Health.

Kiang, P. N., Lan, N., & Sheehan, R. (1995). "Don't ignore it: Documenting racial harassment in a fourth-grade Vietnamese bilingual classroom." *Equity and Excellence in Education*, 28(1), 31-35.

Oei, T. Y. & Lyon, G. (1996). "In our own words." *Teaching Tolerance*, 5(2), 48-59.

Osajima, K. (1988). "Asian Americans as the model minority: An analysis of the popular press image in the

1960s and 1980s." In G. Y. Okihiro, S. Hune, A. A. Hansen, & J. M. Liu (Eds.), *Reflections on shattered windows: Promises and prospects for Asian American studies* (pp. 165-174). Pullman: Washington State University Press.

Pang, V. O. (1990). "Asian-American children: A diverse population." *The Educational Forum*, 55 (1), 49-65.

Pang, V. O. (1995). "Asian Pacific American students: A diverse and complex population." In J. A. Banks & C. A. McGee Banks (Eds.), *Handbook of research on multicultural education* (pp. 412-424). New York, NY: Simon & Schuster Macmillan.

Suzuki, B. (1989, November-December). "Asian Americans as the 'model mi-

nority' outdoing Whites? or media hype?" *Change*, 13-19.

*Dr. Yee Wan is an assistant professor in the Teacher Education Department at California State University, Dominguez Hills. She teaches courses in language acquisition, multicultural education, and social studies methods. In addition, she has taught in elementary Cantonese bilingual classrooms.*

**Editor's Note:** Contributions to the Asian/Pacific American Education Concerns column should be sent to Janet Lu, MCR/NC, 1212 Broadway, #400, Oakland, CA 94912. (510) 763-1490 via Email: janet\_lu@arcoakland.org.

\* NABE \*

## TECHNOLOGY — FROM PAGE 33

Siglo XXI Editores.

Freire, P. (1975) *Cultural Action for Freedom*. Cambridge, MA: Harvard Educational Review.

Lee, W. (1983). "Celestin Freinet, the unknown reformer." *Educational Forum*, 48\_ (1), 97-113.

**Editor's Note:** Contributions to the Technology and Language-Minority Students column should be sent to Dr. Dennis Sayers, University of California Educational Research Center, 351 E. Barstow Avenue, #101, Fresno, CA 93710. (209) 228-2050; FAX (209) 288-2055. E-mail: DSAYERS@panix.com.

\* NABE \*

## NABE Action Alerts now available through the Internet

NABE sends special Action Alerts to members and subscribers to inform them of the latest developments in Washington concerning bilingual education. These Action Alerts are now available by e-mail. Before the end of the summer, current Action Alerts will also begin to be posted on the NABE World Wide Web site.

To subscribe to the Action Alert electronic mailing list, send an e-mail message to:

<majordomo@nabe.org>,

with the following text as the message body:

subscribe actionalert <your e-mail address goes here>.

NABE's Web site can be accessed at

<<http://www.nabe.org>>.

dependency is mutually beneficial and an integral part of American history and culture.

Over the last few semesters, I have used Grant's book in my own teacher education classes because it has so much authentic information about many cultural groups. As a starting point for class discussion, each of the chapters in Part Two were assigned to small groups of students in my multicultural education courses. The requirement was for the teachers to learn more about each culture and make an interactive presentation to the class using the new information and understandings. This approach to learning about diversity was very successful because students presented a variety of interactive approaches to instruction, increased their knowledge, and shared their new appreciation of the cultural group with all of the students enrolled in the course. In addition to this activity, several Portuguese students made a presentation on many aspects of Portuguese culture as well as their personal and family experiences as Portuguese immigrants and first generation Americans. There are several thriving Portuguese communities in the San Joaquin Valley, so many Portuguese students attend the local

schools. It is essential for teachers to understand the historical background, culture, and customs of this group. The presentation was very comprehensive, dynamic, and well received by the class. As evidenced by the extensive preparation and enthusiastic presentation, the Portuguese students obviously enjoyed talking about their culture and customs. In this assignment, new knowledge was created in a meaningful social context. For the cultural groups that are not represented in the text, this activity proved to be an effective strategy for including additional cultural groups, particularly of those students enrolled in the class. Other suggestions include inviting guest speakers, using technology, multi-media, and field trips to ethnic celebrations.

Editor Carl Grant has successfully created an authentic and comprehensive text for the study of diversity. His text has been adopted for numerous education courses throughout the California State University campuses. Both instructors and students praise the content, resources, and adaptability of the chapters. Grant has provided an accurate and informative picture of the challenges and rewards of multicultural education.

*Brenda Betts, Ph.D., is an Assistant Professor in the Department of Teacher Education, California State University-Stanislaus, Turlock, CA. Or via E-mail: [bbetts@toto.csustan.edu](mailto:bbetts@toto.csustan.edu).*

◀ NABE ▶

### Book Review Submission Guidelines

Reviews for publications in the **Book Review** column be sent to Dr. Beti Leone, Book Review column editor, at NABE

1220 L Street, NW, #605,  
Washington, DC, 20005,  
or by e-mail to

<[NABE\\_NEWS@nabe.org](mailto:NABE_NEWS@nabe.org)>

Books from publishers should be clearly marked **BOOK REVIEW MATERIAL** and sent to the same address; **two** complete sets of materials must be submitted.

## Intern and Fellowship Positions Available at NABE

The NABE Policy Internship and Fellowship Program is a rigorous apprenticeship for individuals interested in policy issues of education, multiculturalism, language diversity or civil rights.

The heart of the NABE Policy program is direct participation of interns and fellows in NABE's central policy activities including:

- ◆ policy research and analysis
- ◆ advocacy before Congress
- ◆ collaboration with other national education or civil rights organizations
- ◆ administrative duties

Interns and fellows must have outside support to participate; no financial assistance is available from NABE.

To apply, please send a cover letter and resume, a short writing sample, and letter(s) of recommendation to Jaime A. Zapata, Associate Director for Legislation and Public Affairs, at NABE.

You may also check the NABE Web site at <http://www.nabe.org> beginning in June for more information.

# Upcoming Events

**June 19-21, 1997 - National Association of Latino Elected Officials 14th Annual Conference.** Hyatt Regency, Miami, FL. Contact NALEO at (213) 262-8503.

**June 23-27, 1997 - 15th Annual Multicultural Summer Institute.** The University of Findlay, OH. Contact Jean Nye at (419) 424-4774.

**July 1-6, 1997 - National Education Association Annual Conference.** Atlanta, GA. Contact NEA at (202) 822-7000.

**July 12-19, 1997 - Multicultural Education Conference "Explore Cross-Cultural Education: From the Navajo and Hopi Perspectives."** Hopi Reservation and Navajo Nation in northern Arizona. Contact Jennifer Hartin at (800) 426-8315, option 4.

**July 16-18, 21-25, 28-Aug. 1 - Summer Institutes for Intercultural Communication.** Offering a range of workshops on intercultural communication and also multicultural education. Contact The Intercultural Communication Institute, 8835 S.W. Canyon Lane, Suite 238, Portland, OR 97225 (503) 297-4622.

**July 17-18, 1997 - Center for Language Minority Education and Research Two-Way Bilingual Immersion Conference.** Asilomar Conference Center, Pacific Grove, CA. Contact Judy Lambert at (916) 657-3826.

**July 18-19, 1997 - Hispanic Student Leadership Conference.** Washington, DC. Contact HSLC at (301) 270-4945.

**July 20-23, 1997 - National Council of La Raza 29th Annual Conference, "Latinos: No Challenges Unmet - No Issues Unanswered."** Navy Pier, Chicago, IL. Contact NCLR at (202) 785-1670.

**July 29 - August 2, 1997 - 24th Annual Linguistic Association of Canada and the United States Forum.** York University, Toronto, Ontario, Canada. Contact Ruth Brend at (313) 665-2787.

**August 1-3, 1997 - Third Annual Conference on Teaching Spanish to Native Speakers.** Las Cruces, NM. Contact NMSU at (505) 646-7876 fax.

**August 1-4, 1997 - American Association of Teachers of Korean 3rd Annual Conference.** Phoenix, AZ. Contact John Koo at (602) 965-7126.

• NABE •



HOW CAN YOU  
TAKE A BITE  
OUT OF YOUR  
TRAVEL EXPENSES?

JUST ASK ALAMO.<sup>SM</sup>

As a member, you can enjoy great rates, quality cars, and friendly service. Look to Alamo to meet your travel needs. For reservations, call your Professional Travel Agent or access us at <http://www.goalamo.com> or call Alamo Rent A Car. Be sure to request I.D. Number 195167 and Rate Code BY.

1-800-354-2322

251

## 50% TOWARDS AN UPGRADE

- Certificate is valid for 50% toward upgrade charges. Just reserve a compact car or above for up to 14 days in the U.S.A. or Canada.
- Only one certificate per rental; not to be used in conjunction with any other discounted, promotional or convention rates, or an Alamo Express Plus<sup>SM</sup> rental.
- Please make your reservation at least 24 hours before arrival and be sure to request Coupon Code UB76.
- Travel Agents: Please include /SI-C-UB76 in the car sell.
- Due to high demand, this offer is subject to availability at time of reservation and the upgrade is subject to availability at time of rental as certain car types may not be available. Offer may not be available during peak periods and holidays.
- You must present this certificate at the Alamo counter on arrival and it is void once redeemed.
- Certificate has no cash value and does not include taxes, time and mileage, or any optional items.
- Any unused portion is non-refundable and reproductions will not be accepted. Expired or lost certificates cannot be replaced.
- Subject to Alamo's conditions at the time of rental.
- Offer valid through December 15, 1996.

For reservations, call your Professional Travel Agent or access us at <http://www.goalamo.com> or call Alamo Rent A Car at 1-800-354-2322. Be sure to request I.D. # 195167 and Rate Code BY.

UB76

Alamo

© 1995, Alamo Rent-A-Car, Inc.

41839AS1195

# 1998 NABE Bilingual Education Outstanding Dissertations Competition

## **ELIGIBILITY**

The competition is open to those who have completed doctoral dissertations in the field of bilingual education between June 1, 1994 and August 1, 1997. Studies using any research approach (historical, experimental, survey, etc.) are eligible. Each study will be assessed in light of the research approach used, the scholarly quality of the dissertation, and the significance of its contribution to knowledge in the bilingual education field.

## **APPLICATION**

Those who wish to apply should seek application information from their professors or from:

Alfredo G. de los Santos Jr., Chair  
NABE Outstanding Dissertations Competition - 1998  
Maricopa Community Colleges  
2411 West 14th Street  
Tempe, AZ 85281-6941  
(602) 731-8101

## **RECOGNITION**

In effect, there will be two types of winners:

- (a) the semifinalists — the writers of the top seven to ten abstracts from which the three finalists will be selected, and
- (b) the three finalists — the writers of the dissertations selected by a panel of judges as first, second, and third place winners.

All semifinalists will be presented at the 27th Annual International Bilingual-Bicultural Education Conference of the National Association for Bilingual Education in Dallas, Texas, on 24-28 February 1998. The National Association for Bilingual Education will pay for the travel expenses and per diem to the convention for the three finalists.

## **DEADLINE**

Six (6) copies of the dissertation abstract prepared as directed in the guidelines must be received by **September 5, 1997**. Send them to the competition chair at the above address.

# NATIONAL ASSOCIATION FOR BILINGUAL EDUCATION

## MEMBERSHIP APPLICATION

### 1 Membership Type *(check one only)*

- \$48 Individual Membership**
- \$30 Discounted Individual Membership**
- Parent: must not** be professional educator and **must** have a child currently enrolled in a bilingual education program. A letter written on school stationery from either the teacher or a school administrator must accompany the NABE membership application.
  - College/University Student: must not** be professional educator and **must** be enrolled on **full-time** basis. A copy of an official college or university document showing current enrollment status must accompany the NABE membership application.
  - Paraprofessional: Must** be working as an instructional aide in a public school system. A letter on school stationery from the supervising teacher or a school administrator must accompany the NABE membership application.
- \$43 Combined Membership** Name of Affiliate: \_\_\_\_\_
- \$125 Institutional Membership**
- \$1000 Lifetime Membership**

### 4 I am involved with bilingual education as *(check one)*

- Administrator
- College Instructor
- Consultant
- Full-Time Student
- Paraprofessional
- Parent/Community member
- Publisher Staff
- School Board Member
- Teacher
- Other

### 5 I work in this type of organization *(check one)*

- Commercial organization
- College/university
- Local school district
- State education agency
- Other

### 6 I usually work with this level of student *(check one)*

- Early childhood
- Elementary
- Secondary
- Higher education
- Adult

### 7 I want to participate in the following Special Interest Group *(check one)*

- Adult/Vocational Education
- Asian & Pacific Islanders
- Critical Pedagogy
- Early Childhood Education
- Elementary Education
- ESL in Bilingual Education
- Gifted Education
- Global Education
- Higher Education
- Instructional Technology
- Language/Culture Retention
- Language Policy
- Parent & Community
- Policy Makers
- Professional Development
- Research & Evaluation
- Secondary Education
- Special Education

Memberships are valid for one year from the date of processing, and include one year subscription to NABE publications (except Lifetime, valid for life of member and includes lifetime subscription). Organizational membership is non-voting; all other memberships are voting. All memberships are non-transferrable and may not be cancelled. Membership dues are non-refundable.

### Name and Address Information

- Mr.
- Mrs.
- Ms.
- Dr.
- \_\_\_\_\_
- Last First Middle*

### 3 Preferred Mailing Address: Business Home

**Business Address**

Position: \_\_\_\_\_

Division: \_\_\_\_\_

Organization: \_\_\_\_\_

Street Address: \_\_\_\_\_

City: \_\_\_\_\_ State: \_\_\_\_\_ Zip: \_\_\_\_\_

Phone: (\_\_\_\_) \_\_\_\_\_ Ext. \_\_\_\_\_

Fax: (\_\_\_\_) \_\_\_\_\_ E-Mail: \_\_\_\_\_

**Home Address**

Street Address: \_\_\_\_\_

City: \_\_\_\_\_ State: \_\_\_\_\_ Zip: \_\_\_\_\_

Phone: (\_\_\_\_) \_\_\_\_\_

### 8 Payment Information

\$ \_\_\_\_\_ Membership dues

\$ \_\_\_\_\_ Contribution to help NABE counter the English-only movement

- Check or money order Check# \_\_\_\_\_
- Institutional purchase order # \_\_\_\_\_
- MasterCard  VISA ExpirationDate: \_\_\_\_/\_\_\_\_/\_\_\_\_
- --

**Automatic Renewal:** Check this box if: you are paying by credit card, and you want NABE to automatically renew your membership annually, charging your credit card the standard renewal amount. This permission will remain in effect until you cancel it in writing.

\$ \_\_\_\_\_ **TOTAL DUE**

**9 SIGNATURE:** \_\_\_\_\_ **DATE:** \_\_\_\_/\_\_\_\_/\_\_\_\_

# ANNOUNCEMENTS

## Bilingual Education Around the Nation

### The Good:

- NABE's work with Congress and the Administration results in Bilingual Education's (Title VII) being named one of four education priorities in the federal budget resolution.
- The New Mexico Legislature passes a memorial resolution condemning anti-immigrant policies such as CA Proposition 187; recognizing the contribution of America's immigrants and restating its commitment to cultural diversity.
- Massachusetts rejects attempt to curtail bilingual education.

### The Bad:

- Stephanie Schwartz of the United Teachers of Los Angeles (UTLA) submits a referendum to eliminate UTLA support of bilingual education.

### The Ugly:

- Ron Unz, a California businessman and former Republican candidate for governor, launches his "English for the Children" initiative which seeks to eliminate bilingual education in California.

**Check NABE's Web Site at <<http://www.nabe.org>> for details and developments!**

### **NABE NEWS**

National Association for Bilingual Education  
Suite 605  
1220 L Street, N.W.  
Washington, D.C. 20005-4018

NON-PROFIT ORG.  
U.S. POSTAGE  
PAID  
WASHINGTON, DC  
PERMIT NO. 4555

KATHLEEN M. MARCOS  
ERIC CLEARINGHOUSE ON LANGUAGES & LINGUISTICS  
1118 22ND ST NW  
WASHINGTON DC 20037-1214

254





# NABE NEWS

The news magazine about educational equity and excellence through bilingual education

August 1, 1997

National Association for Bilingual Education

Volume 20, Number 8

## Federal Funding for Bilingual Education Increased NABE Scores Victory in FY 1998 House and Senate Appropriations

by Jaime A. Zapata

**A**s this article is being written, House and Senate Appropriations Committee members have concluded their respective mark-ups of FY 98 federal funding bills. After two years of funding hurdles and appropriations battles, the news for bilingual education couldn't be more welcome. House and Senate Appropriations Committee members have agreed to the request of the Administration, the Congressional Hispanic Caucus, and NABE of \$199 million in funds for bilingual education programs (see Table 1). Of particular importance is the fact that the funds include a considerable increase for both bilingual education support services and professional development. NABE members will recall the lengthy negotiations that took place during the last two years which left these two essential program components severely lacking in funds.

### A Difficult Task Accomplished

In the past, the House Appropriations Subcommittee on Labor, HHS, Education, and Related Agencies has been a great obstacle in the effort to secure adequate funding for all bilingual education

program components. This year, the battle was just as difficult, but NABE was well prepared. After two years of great efforts, Bilingual Education was included in the President's Budget as a protected priority. But more importantly, from Massachusetts to Texas, from New York to California, NABE members made their presence felt. Phone calls, faxes, letters — subcommittee members seemed to hear about bilingual education from across the nation. To all of you, a big round of applause, and a heartfelt thank you. *You* made the difference.

### Other Programs

As in the case of Title VII, the news for most education programs was quite good (see Table 1). Increases were recommended by the subcommittee for such important programs as Title I, Migrant Education, and TRIO. In fact, most key programs were either level-funded or received increases. But the battle does not end here.

### What's Next?

The House plans to plans to move the

measure to floor consideration by the end of the summer. This means contacting your Member of Congress as soon as possible, and urging them to ensure that the final Fiscal Year 1998 bill includes the \$199 million for bilingual education recommended by the House Subcommittee.

The Senate also plans to tackle its version of the Appropriations measure in the very near future. While that chamber has been much more supportive of bilingual education program, NABE urges its members to contact their Senators in support of the House recommendation of \$199 million in FY 98 funds, with the respective amounts for each Title VII program component.

### Lessons Learned

It can't be stressed enough. NABE members CAN and DO make a difference. If we work together, we can move mountains. Together, we can ensure that our children and our communities ARE a priority for our elected officials and our government as a whole. Together, we can win!

• NABE •

## 1997-98 NABE Board Takes Office

**N**ABE is pleased to announce the results of the elections for members of the 1997-98 NABE Executive Board and the subsequent Board Members' election of officers during the Board's first meeting in Washington, DC the last weekend of July.

Dr. Josefina Tinajero, Assistant Dean and Professor of Bilingual Education at the University of Texas at El Paso, has been elected President of NABE. David Báez, Director of Bilingual Education and

Foreign Languages in the Buffalo, NY Public Schools, will serve as Vice President, and Susan García, a Division Manager at United Way of Denver, CO, is Secretary/Treasurer. Joining them are Members-at-Large Dr. Joe J. Bernal (San Antonio, TX), Nga Dinh Duong (Tacoma, WA), Mary F. Jew (San Jose, CA), Dr. Hermán García (Las Cruces, NM), Dr. Paul Martínez (Albuquerque, NM), and Parent Representative Adela Holder (Silver City, NM).

• NABE •

### ISSUE HIGHLIGHTS

NABE's Policy Education Program ..... 5

Bilingual Teacher and Instructional Assistant of the Year Contests ..... 13



# NABE NEWS

Published by the  
**National Association for  
Bilingual Education**

**Editor:**

Nancy F. Zelasko, Ph.D.  
**Desktop Publishing & Layout:**  
Jeff Spence  
Devora Kimelman-Block

## NABE NEWS REPRINT AND EDITORIAL POLICY

Readers are welcome to reprint non-copy-righted articles which appear in *NABE NEWS* at no charge, provided proper credit is given both to the author(s) and to *NABE NEWS* as the source publication.

All articles printed in *NABE NEWS*, unless written by an Association staff person or a member of the current NABE Executive Board of Directors, are solely the opinion of the author or authors, and do not represent the official policy or position of the National Association for Bilingual Education. Selection of articles for inclusion in *NABE NEWS* is not an official endorsement by NABE of the point(s) of view expressed therein.

## TABLE OF CONTENTS

Federal Funding Increased .....	1
NABE Board Takes Office .....	1
Message from the President .....	3
Message from the Ex.Dir. ....	3
Policy Education Program .....	5
Meet NABE Interns .....	6
Bilingual Educator Resources .....	9
Book Review column .....	11
Teacher/Assist. of the Year Contests ....	13
Equal Access .....	17
ESL in Bilingual Ed. Column .....	19
NABE Order Form .....	20
American Indian Column .....	21
Upcoming Events .....	23
'98 Dissertation Contest .....	24
Membership Application .....	27
Announcements .....	28

## PUBLICATION SCHEDULE

Volume 21 of *NABE NEWS* will be published in 8 issues; publication dates are:

Issue 1	09/15/97	Issue 5	03/15/98
Issue 2	11/01/97	Issue 6	05/01/98
Issue 3	12/15/97	Issue 7	06/15/98
Issue 4	02/01/98	Issue 8	08/01/98

All advertising and copy material must be received in the NABE office **ONE MONTH prior to publication date** to be considered for inclusion.

## NABE NEWS ADVERTISING

### Display Advertising Rates (Camera-Ready)

Full Page (7.5" x 10")	\$850
2/3-Page (4.75" x 10")	\$700
1/2-Page (7.5" x 4.5")	\$550
1/3-Page (4.75" x 4.75")	\$425
1/3-Page (2.25" x 10")	\$425
1/4-Page (3.5" x 4.75")	\$325
1/6-Page (2.25" x 4.75")	\$250

### Advertising Discounts (for multiple insertions)

2-3 insertions: 10% off total; 4-7 insertions: 15% off total; 8 insertions: 20% off total

NABE reserves the right to reject any advertisements which it deems inappropriate and/or inconsistent with the goals of the Association. For additional information, contact NABE at (202) 898-1829 x136.

## NABE

The National Association for Bilingual Education (NABE) is a tax-exempt, non-profit professional association founded in 1975 to address the educational needs of language-minority Americans.

### NABE NATIONAL OFFICE

1220 L Street, N.W., Suite 605  
Washington, DC 20005-4018  
PHONE (202) 898-1829  
FAX (202) 789-2866  
E-mail: NABE@nabe.org

**James J. Lyons, Executive Director**  
Nancy F. Zelasko, Deputy Director  
Jaime Zapata, Associate Director for Legislation  
Jeff Spence, Information Systems Director  
Carolyn Riddick, Office Manager  
Celia Torres, Membership Specialist  
Ronald Williams, Membership/Accounting Assist.  
Elena P. Williams, Conference & Pub. Assistant  
Yara Alma-Bonilla, Journalist Fellow

## NABE EXECUTIVE BOARD 1997 - 1998

### President

Josefina Tinajero  
University of Texas  
El Paso College of Education  
500 W. University Avenue  
El Paso, TX 79968  
p: (915) 747-5552 - f: (915) 747-5755  
tinajero@utep.edu

### Vice President

David E. Báez  
Director, Foreign Language & Bilingual Ed.  
Buffalo Public Schools  
731 City Hall  
Buffalo, NY 14202  
p: (716) 851-3704 - f: (716)851-3882  
dbaez@buffnet.net

### Secretary/Treasurer

Susan García  
18094 East Ohio, #102  
Aurora, CO 80012  
p: (303) 561-2397 - f: (303) 455-6462  
susan.garcia@unitedwaydenver.org

### Member-at-Large

Joe J. Bernal  
6410 Laurehill  
San Antonio, TX 78229  
p: (210) 342-8026 - f: (210) 342-8026  
bowlngod@ix.netcom.com

### Member-at-Large

Nga Dinh Duong  
21724 58th Avenue West  
Mountlake Terrace, WA 98043  
p: (206) 771-2095 - f: (253) 596-2214  
nguyen@cks.ssd.k12.wa.us

### Member-at-Large

Hermán S. García  
Department of C & I  
College of Education  
New Mexico State University  
Las Cruces, NM 88003  
p: (505) 646-2115 - f: (505) 646-5436  
hgarcia@cmailsvr.nmsu.edu

### Member-at-Large

Mary F. Jew  
496 Thatcher Lane  
San Mateo, CA 94404  
p: (415) 349-8388

### Member-at-Large

Paul E. Martínez  
New Mexico Highlands University  
Southwest Comprehensive Center  
500 Laser Road, N.E., Suite B  
Rio Rancho, NM 87124  
p: (505) 891-6111 - f: (505) 891-5744  
pmartinez@cesdp.nmhu.edu

### Parent Representative

Adela B. Holder  
Silver Consolidated School District  
2810 N. Swan Street  
Silver City, NM 88061  
p: (505) 388-1527 - f: (505) 538-5885  
sncadavi@arriba.nm.org



# Message From the President

by Dr. Josefina Tinajero

**G**reetings! It is a privilege and an honor to be serving as your president this year. I accepted this challenge with a renewed sense of strength and commitment to our Association at the first meeting of the 1997-1998 Executive Board with one purpose in mind: to advance the goals of NABE — an organization which, for me, represents the highest ideals of our professional — a profession dedicated to promoting educational excellence for language-minority students and their families. My dedication to this organization and to those who embrace its mission and vision has been shaped to a large extent by my own personal experiences.

I come by my interest in bilingual education honestly and with a great deal of enthusiasm, an enthusiasm that many of you share. As a child I was identified and labeled “LEP” (limited English proficient). I was a “LEP child;” that will never go away. It all started when a note to my parents on my report card from my second grade teacher read: “Josefina needs to express herself in class and when she is playing with the other children. The ‘U’ (Unsatisfactory) grade in reading is because of her language difficulty.”



I'm certain that this kind of memory is shared by many of you and certainly by many children throughout the United States. The reason that I did not express myself in class was simple: I lacked the language proficiency that reflected my ability. I was able to conceive of the world in my own language in a way I could not express in English. My teacher could not or would not understand.

I don't remember ever talking to my teacher in that second grade class. I hardly remember talking with my classmates. I was ever vigilant never to be caught speaking Spanish. Mine became a world of social isolation and distance — a distance that produced some anxiety. To live in a world in which language is little more than garbled noises can be a frustrating experience for any second grader. Instead of feeling bitter, however, I became even more determined to do well in school and to do something so that *no* child would have to experience what I experienced.

Every child, *every child*, has an innate need to communicate

CONTINUED ON PAGE 16

# Message From the Executive Director

by James J. Lyons, Esq.

**H**appy New Year, NABE members! No, this is not a misprint, and I have not taken leave of my senses. NABE's “New Year” is this time of year.

Rather than a single day, the Association's “New Year” commemoration runs the course of nearly two months, June and July. There are two major NABE “New Year” events: the close of the Association's June 1 - May 31 fiscal year; and the July swearing-in of our new Executive Board of Directors and their election of the Association's officers for the next year.

Like all such commemorations, the NABE “New Year” provides an opportunity to take stock and to set new directions. And, with respect to both the accomplishments of the past year and the prospects for the year ahead, this has been a very happy “New Year” for NABE.

## Past Year's Accomplishments

NABE began the 1996-1997 fiscal year with low cash reserves, the result of poorer-than-projected attendance at NABE '96 in Orlando, Florida. Association staff acted immediately to cut costs and to accelerate and increase revenues. Staff were greatly assisted by the Albuquerque conference committee and the New Mexico Association for Bilingual Education, whose members worked



tirelessly to make NABE '97 an outstanding success, both programatically and financially. As a result of these concerted efforts, the Association increased net earnings by more than \$400,000 dollars and closed the 1996-1997 fiscal year with a comfortable cash position.

During the last year, NABE has focused on two primary policy-related objectives: restoring federal funding for ESEA Title VII Support Services and Training Programs; and preventing the enactment of federal official-English/English-only legislation.

With respect to Title VII funding, NABE succeeded in securing a substantial (approximately 50%) restoration of appropriations for the 1997 fiscal year. For the coming (1998) fiscal year, we expect to secure full funding for all Title VII programs as specified in the President's Budget request (see article on federal education appropriations elsewhere in this issue). This imminent victory was the result of intense collaborative effort. NABE members communicated to their elected representatives in Washington the crucial importance of Title VII Support Services and Training Programs while Association staff worked closely with the Congressional

CONTINUED ON PAGE 25

257

# House Appropriations Subcommittee on Labor, HHS, and Education FY 1998 Recommendations

PROGRAM	FY 1998 House Subcommittee Recommendation (in millions)	FY 1997 Funding Level (in millions)	Change in Funding (in millions)	Percentage Change
<b>TITLE VII - BILINGUAL EDUCATION</b>	<b>199.0</b>	<b>156.7</b>	<b>42.3</b>	<b>27%</b>
Instructional Services	160.0	141.7	18.3	13%
Support Services	14.0	10.0	4.0	40%
Professional Development	25.0	5.0	20.0	400%
<b>IMMIGRANT EDUCATION</b>	<b>150.0</b>	<b>100.0</b>	<b>50.0</b>	<b>50%</b>
<b>EDUCATION REFORM</b>	<b>685.5</b>	<b>675.8</b>	<b>9.7</b>	<b>1%</b>
Goals 2000	475.0	491.0	(16.0)	-3%
School to Work	200.0	199.9	0.1	0%
<b>TITLE I - EDUCATION FOR THE DISADVANTAGED</b>	<b>7,690.6</b>	<b>7,295.2</b>	<b>395.4</b>	<b>5%</b>
Basic Grants (to local education agencies)	6,191.4	6,273.2	(81.8)	-1%
Concentration Grants (to local education agencies)	949.2	1,022.0	(72.8)	-7%
Even Start	108.0	101.9	6.1	6%
State Agency Migrant Education Programs	305.5	305.5	0.0	0%
<b>SCHOOL IMPROVEMENT PROGRAMS</b>	<b>1,480.9</b>	<b>1,425.6</b>	<b>55.3</b>	<b>4%</b>
Comprehensive Regional Assistance Centers	25.6	25.6	0.0	0%
Professional Development	310.0	310.0	0.0	0%
Safe and Drug Free Schools	556.0	555.9	0.1	0%
Magnet Schools Assistance	105.0	95.0	10.0	11%
Women's Education Equity	2.0	2.0	0.0	0%
Training and Advisory Services (Civil Rts. IV-A)	7.3	7.3	0.0	0%
Education for Native Hawaiians	0.0	15.0	(15.0)	-100%
Alaska Native Education Equity	0.0	8.0	(8.0)	-100%
Foreign Language Assistance	5.0	5.0	0.0	0%
Charter Schools	75.0	50.9	24.1	47%
<b>IMPACT AID</b>	<b>796.0</b>	<b>730.0</b>	<b>66.0</b>	<b>9%</b>
<b>MIGRANT EDUCATION</b>	<b>9.7</b>	<b>9.5</b>	<b>0.2</b>	<b>2%</b>
High School Equivalency Program (HEP)	7.6	7.4	0.2	3%
College Assistance Migrant Program (CAMP)	2.1	2.0	0.1	5%
<b>INDIAN EDUCATION</b>	<b>59.8</b>	<b>58.0</b>	<b>1.8</b>	<b>3%</b>
<b>SPECIAL EDUCATION</b>	<b>4,348.6</b>	<b>4,035.9</b>	<b>312.7</b>	<b>8%</b>
<b>REHAB. SVCS. &amp; DISABILITY RESEARCH</b>	<b>2,586.2</b>	<b>2,509.4</b>	<b>76.8</b>	<b>3%</b>
<b>ADULT EDUCATION</b>	<b>349.8</b>	<b>354.6</b>	<b>(4.8)</b>	<b>-1%</b>
<b>VOCATIONAL EDUCATION</b>	<b>1,137.1</b>	<b>1,137.1</b>	<b>0.0</b>	<b>0%</b>
<b>STUDENT FINANCIAL ASSISTANCE</b>	<b>9,046.4</b>	<b>7,560.4</b>	<b>1,486.0</b>	<b>20%</b>
Pell Grants	7,438.0	5,919.0	1,519.0	26%
Perkins Loans	165.0	178.0	(13.0)	-7%
Federal Supplemental Ed. Opportunity Grants	583.4	583.4	0.0	0%
Federal Work Study	860.0	830.0	30.0	4%
<b>HIGHER EDUCATION</b>	<b>909.9</b>	<b>879.0</b>	<b>30.9</b>	<b>4%</b>
Hispanic Serving Institutions (HSIs)	12.0	10.8	1.2	11%
Strengthening Historically Black Colleges (HBCUs)	120.0	108.9	11.1	10%
Minority Teacher Recruitment (Title V - HEA)	2.5	2.2	0.3	14%
Minority Science Improvement	5.3	5.3	0.0	0%
International Ed. & Foreign Language (Title VI - HEA)	60.3	59.8	0.5	1%
<b>EDUCATION, RESEARCH, STATS &amp; IMP. (ERSI)</b>	<b>508.8</b>	<b>398.1</b>	<b>110.7</b>	<b>28%</b>
Education Technology	85.0	105.0	(20.0)	-19%
Research	81.0	72.6	8.4	12%
Regional Educational Laboratories	58.5	51.0	7.5	15%
Statistics	66.3	50.0	16.3	33%
National Assessment	35.5	29.8	5.7	19%
Eisenhower Professional Development Nat. Activities	21.0	13.3	7.7	58%
Eisenhower Regional Math & Science Ed. Consortia	15.0	15.0	0.0	0%
<b>OFFICE FOR CIVIL RIGHTS</b>	<b>55.4</b>	<b>54.9</b>	<b>0.5</b>	<b>1%</b>
<b>TOTAL DEPARTMENT OF EDUCATION</b>	<b>31,867.9</b>	<b>28,957.9</b>	<b>2,910.0</b>	<b>10%</b>

NOTE: The recommendation for bilingual education's FY 1998 Federal funding level is the same for both the House and Senate Appropriations Committee(s).

# NABE's Policy Education Program:

## A Mid-term Report

It has been just about a month since most of us arrived at 1220 L Street in Washington, DC for our sojourn as participants in NABE's Policy Education Program (PEP). Already, we feel we have learned and accomplished more than most interns do in a full year.

The PEP was designed to give us a solid base in the national issues and process affecting bilingual education and the communities it serves. To that end, the NABE staff has welcomed us as an active part of the organization. Their willingness to guide us, share their experiences and knowledge with us, and allow us to offer our own ideas, has given us an opportunity rarely offered to interns in the nation's capital.

Within the first few days, we were immersed in the legislative process. We set up appointments for informal interviews with the congressional staff of key members of the House Committee on Education and the Workforce (the Committee which authorizes the Bilingual Education Act). We talked to them about their role on Capitol Hill, their backgrounds and their interests — and, we shared a bit of our own experiences with them. Needless to say, we were impressed by the dedication and long hours put in by people in Washington — in Congress, and in places like NABE.

Our second week gave us our first taste of bilingual education advocacy at the federal level. We found ourselves in the

midst of the congressional hustle and bustle while trying to secure support from Members of Congress for Title VII. The task was coordinated by NABE staff, and (on the Hill) spearheaded by Congressman Rubén Hinojosa (D-TX) whose letter asked Congressman John Porter (R-IL), the Chairman of the House Subcommittee on Appropriations for Labor, Health & Human Services, and Education, for \$199 in

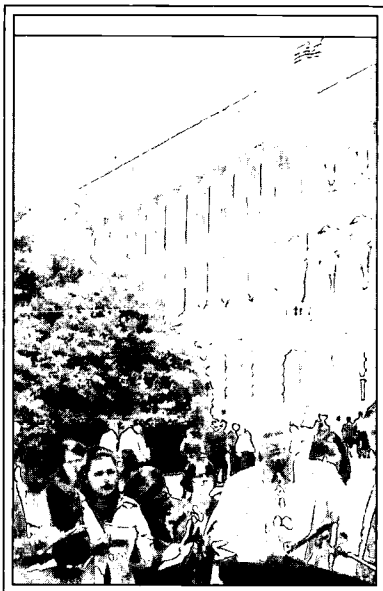

At a press conference on Capitol Hill: Susan Williams, Ana María Tinajero, Iris Cruz



Working hard: Carla Gutiérrez, Ana María Tinajero



NABE 1997 Summer Program Participants and Staff (Clockwise, Left to Right): Nicole Pichard, Jaime Zapata, Carla Gutiérrez, Betsy Cory, Iris Cruz, Susan Williams, Ana María Tinajero, Ana Christina Esqueda, Susanna Shin

Fiscal Year 1998 funding for federal bilingual education programs.

In the weeks that followed, there was never a dull moment. Each morning was spent surfing the internet to research issues pertaining to bilingual education: English-Only, Higher Education, and the shortage of bilingual education teachers, to mention just a few. Our afternoons were filled with an incredible number of (oftentimes surprisingly high level) meetings with various organizations and government officials. Alongside NABE staff, we discussed a wide range of topics: national testing, English-Only, congressional hearings and mark-ups, etc. Soon we began understanding the multifaceted components that shape federal policies and subsequently impact language minority children — and the initial shyness that

CONTINUED ON PAGE 7

# Meet the Members of NABE's Summer 1997 Policy Education Program

**T**he NABE Policy Education Program (PEP) program provides participants with an opportunity to deepen their understanding of the federal legislative and administrative process. Through direct involvement in NABE's policy-related activities, PEP participants help shape the policies that govern education and social programs affecting language minorities.

NABE is committed to helping bright young people become proactive and informed leaders who will effectively tackle the challenges confronting our communities. The PEP is NABE's chief tool in youth leadership development, and is representative of the Association's resolve to empower tomorrow's leaders and bilingual education advocates.

In the June 15, 1997 issue, *NABE News* introduced eight of the ten participants in NABE's Summer 1997 Policy Education Program. NABE is pleased to now introduce the remaining two.

## Interns

### Yolanda Bueno

Born in Zacatecas, Mexico

Sophomore, William Rainey Harper College, IL

Professional Goal: Policy work with the Hispanic community

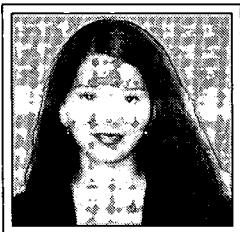

Yolanda Bueno is a native of Zacatecas, Mexico. She has lived in Los Angeles, California for seven years and Palatine, Illinois for ten years. She comes from a low middle-income family, from whom she has learned the traditional value of succeeding as an individual without sacrificing strong family and

community ties, contrary to contemporary mainstream American society which prizes individualism and competition. This traditional upbringing created within her a great desire to help her community and she considers this her mission in life. To accomplish this, she feels she must first better herself in order to help others. She has already started by attending leadership conferences and has been an active member of her community.

Yolanda attends William Rainey Harper College where she has been involved with several student organizations. She was the treasurer of the Student Organization of Latinos Unidos for the 1996-1997 school year and will serve as president for 1997-1998. Through this student organization she has been able to mentor junior high school students by inviting them to attend Latinos Unidos meetings and promoting the different types of Latino cultures. Yolanda discovered from these junior high school students the reason why many Latinos do not pursue a higher education. She states, "They do not have a helping hand that encourages them to see the light at the end of the tunnel that represents their success. Their only reality is their surroundings." Yolanda is also a member of Student Ambassadors, helping to plan activities such as promoting college education to high school students

and helping the community. These activities include speaking with high school students and volunteering in blood drives.

Yolanda recognizes February of 1996, when she was nominated to represent a Hispanic organization named Club Social de Adjuntas del Refugio which belongs to the Federation of Zacatecan Clubs, as the starting point for her lifelong commitment to her community. This group is composed of individuals who help youth be involved by organizing social events, networking, and aiding students financially for higher education. This is a very prosperous organization that also believes in going back to the community from which they came to rebuild churches, fence cemeteries, sanitize water, and build roads. For a year and a half Yolanda spent time identifying her roots through public speaking, participating in parades, and preparing for a cultural pageant. This experience led her to do extensive networking with Hispanic business owners and presidents of Chambers of Commerce who later sponsored Yolanda's internships at Western Illinois University and in Washington D.C.

Another factor that has helped shape her goals in life is attending leadership conferences. The first leadership conference she attended was the United States Hispanic Leadership Conference (USHCL) held in Chicago in October 1996. There she was able to meet successful Hispanic leaders who inspired her to strive to become one of them. Yolanda also realized how vital it was to become active in her community. "Although one person cannot change the whole world, one person can change a family, neighbors, and a community." The Learning to Lead Program at Western Illinois University is also a very important part of Yolanda's life because it is teaching her to become a Hispanic leader. The program consists of two phases: the first phase involves three weeks of intensive classroom study of public policy, computer science, and expository writing, and the second phase includes working as an intern at NABE for six weeks. Leadership conferences and the Learning to Lead Program will serve as stepping stones for her to become an expert in uplifting a community.

At NABE, Yolanda hopes to become more knowledgeable of issues affecting Hispanics. She feels that bilingual education is an issue which will allow her to become acquainted with the many common goals that diverse groups share. She looks forward to being involved in the public policy arena while in Washington, DC and, upon her return to Illinois, she feels this knowledge of the political scene will enhance her community activism by applying what she learns at NABE. Her experience at NABE will also shape her decision on what career she will choose. In the future she hopes to continue in the public policy arena and possibly the education field as well.

Yolanda's many experiences have defined her way of thinking about her future role as a leader. She continues to learn of the issues affecting minorities and what she can do to impact these issues. From her outreach to junior high school students to her internship

at NABE, she has been consistent in taking advantage of opportunities offered to her. Her source of power has been her self-motivation to become an activist who advocates for higher education and encourages diversity in a nation which has prospered from the contributions of both immigrants and those born in the U.S.

**Nancy San Jose**

Born in Riverside, CA

Languages: English/Spanish/limited Tagalog

Graduate Student at San Francisco State University

Professional Goal: Bilingual Educator, Professor of Education

*I owe my dreams and the attainment of those dreams to my mother who, although no longer here in body, left me with enough passion and love to educate and aid those who will become our future.*

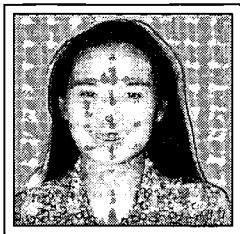

Many events and situations have led Nancy to her internship at NABE. Among the most influential are the death of her mother and her experiences through college. Growing up in a large Filipino community, Nancy was sheltered from the stereotypes and racism that existed outside her world. During the summer prior to her first year in

college, she traveled to Washington D.C. through the "Close Up Program", which educates students about governmental issues from the inside out. It was this trip, coupled with some experiences at the University of California at Santa Cruz, that made her consciously aware that being Filipino meant being different and being different meant not being accepted.

Nancy's ethnicity plays a crucial role in how she identifies herself; but who she was raised by is even more influential. Her role model and hero is her mother who, by immigrating from the Philippines, provided Nancy and her brother Jody more opportunities for successful lives. Watching her mother struggle and succeed, and then pass on, instilled in Nancy a passion for giving children the tools and strategies they need to lead successful lives of their own. "Educating children not only reminds me of the love that my mother has given me, but empowers me and the students I teach."

It was because of her fight to escape the pressures in her life, not being accepted, and the death of her mother, that Nancy decided to take a stand for what was important to her. Through the attainment of a BA in Psychology and BS in Human Development at the University of California at Davis, and presently in her work towards a Multiple Subject Teaching Credential at San Francisco State University, Nancy has discovered ways in which she can accomplish the dreams and goals she set for herself. She specifically chose the Credential Program at San Francisco State because of its emphasis on Multicultural Education. Because San Francisco is home to such a diverse population, Nancy felt it was the most appropriate place for her to learn how to educate linguistically and culturally diverse students.

Nancy often remarked about how she wanted to be a positive influence for all children, and she felt that the best was to do this was to become a teacher. "My main purpose for teaching is to

touch the lives of individual children. By teaching I make grass root changes within my community. I come into contact with students everyday and see their needs and dreams ... and I am at a place in time where I can help them meet those needs and attain those dreams."

Nancy has strengthened her ability to educate children by taking Spanish classes throughout her secondary and higher education career, teaching Sunday school at Jubilee Christian Center, volunteering in numerous LEP classes, substitute teaching, and investigating ways to further her knowledge of Spanish and Tagalog. She continues to pursue avenues that will create, within her, a stronger and more knowledgeable educator.

Nancy states that the next step in this process is her internship at NABE. She hopes to gain the necessary skills and experience to make changes from the outside of the classroom and bring them inside. By becoming more knowledgeable about educational policy and legislation, she knows she can further impact. Nancy states, "As a teacher you are not only an educator, but by profession are also obligated to be a child advocate." Her ultimate goal is to become an educator of teachers. Once she has more experience in the classroom environment and as an active child advocate, Nancy hopes to convince others to do the same.

« NABE »

comes with being new to a city, and to a world filled with people whose names are preceded by "the Honorable..." seemed forgotten.

We are currently in the process of drafting a proposal for funding of the Policy Education Program (PEP). Like NABE's staff, every current and past member of the PEP would like to see a fully-funded program in the near future. We feel it is a wonderful experience, and an important an undertaking. As current participants, we realize how fortunate we are, and we are cognizant of the fact that a successful internship program takes the kind of structure and commitment that is already in place at a place like NABE, but Conthat it also takes a great deal of resources. Next year NABE's PEP will undoubtedly build on the successes of this year's program and, like our group, will continue to spread the NABE "virus" of informed, empowered advocates. We hope the mark our group leaves behind is a positive one, and we know we take with us a wealth of knowledge, and a lifetime's worth of commitment to NABE and the communities it fights for!

*This article was co-authored by all the participants of NABE's 1997 Summer Policy Education Program: Ana Cristina Esqueda and Ana María Tinajero, Fellows; Susanna Shin, Intern Coordinator; and Interns Yolanda Bueno, Betsy Cory, Iris Cruz, Carla Gutiérrez, Nicole Pichard, Nancy San Jose and Susan Williams.*

« NABE »



# DISCOVER PERMA-BOUND BOOKS

## FOR YOUR BILINGUAL STUDENTS



**W**hen looking for a great selection of affordable titles for bilingual students, our Pre-Kindergarten-12 selection is great - including over 2,000 books in Spanish, plus Chinese, Vietnamese, French, German, Italian, and more.

- ❖ TRANSLATIONS
- ❖ ORIGINAL WORKS
- ❖ SHORT STORIES
- ❖ NOVELS
- ❖ SCIENCE
- ❖ DICTIONARIES
- ❖ BILINGUAL READERS
- ❖ VALE - IBM WRITING TO READ

262

Now Available! Books in Spanish to accompany Accelerated Reader Program.

One PERMA-BOUND book will outlast seven to ten paperbacks at about one-third the cost-and they're unconditionally guaranteed. If you're ever dissatisfied with a PERMA-BOUND book for any reason we'll replace it.

VANDALIA ROAD ❖ JACKSONVILLE, ILLINOIS 62650

CALL TOLL FREE: 1-800-637-6581 TOLL FREE FAX: 1-800-551-1169

**PERMA-BOUND**

# Resources for Bilingual Educators

by Nancy San Jose

**Best Evidence: Research Foundations of the Bilingual Education Act** by James Crawford, reviews the current research literature on the education of language minority students in light of the Congressional findings within Part A of Title VII of the Improving America's Schools Act of 1994. Crawford also addresses many of the assumptions surrounding bilingual education which have received wide circulation in the news media. Copies of this report are available from NCBE for \$10. To order, please send a check or purchase order with your request to: Orders Department, NCBE, 1118 22nd St., NW, Washington, DC. 20037. The document is also available on the NCBE website at: <http://www.ncbe.gwu.edu/ncbepubs/reports/bestevvid/html>.

**Dia's Story Cloth: The Hmong People's Journey of Freedom**, written by Dia Cha, stitched by Chue and Nhia Thao Cha. This book tells of one Hmong American's story of her people's search for freedom. (Dia's aunt and uncle, Chue and Nhia Thao Cha, made this story cloth in 1990 in the Chiang Kham refugee camp in Thailand.) There are Read-aloud level books for Grade 1 and up, and Grade 3 and up. This book incorporates such themes as Hmong Americans, Asian/Asian American History, War, Freedom, and Embroidery. ISBN 1-880000-34-2. To purchase the hardcover copy of this book for \$14.95 contact Lee and Low Books, 95 Madison Avenue, New York, NY, 10016, (212) 779-4400 or call your local Educational Distributor.

**Educating Citizens in a Multicultural Society**, by James A. Banks. In the eleven essays that make up this book, written over a 13-year period, Professor Banks describes how schools can both educate students to participate effectively in a society that reflects ethnic and cultural diversity. These essays provide comprehensive blending of the author's work in citizenship education and multicultural education. ISBN: 0-8077-3631-7. This paperback can be purchased for \$22.95 by writing to Teachers College Press, P.O. Box 20, Williston, VT, 05495-0020, calling 800-575-6566. or faxing an order to 802-864-7626.

**El Currículo Creativo para Educación Preescolar**, published by Teaching Strategies, Inc. is the Spanish translation of *The Creative Curriculum for Early Childhood*, which is an environmentally-based curriculum that provides a framework that enables teachers to make appropriate decisions about what children should learn and how they can learn it. It also shows teachers how to promote children's social skills through active learning within the context of a rich environment. *El Currículo Creativo* attempts to serve as large a portion of the Spanish-speaking community as possible by using "Standard Spanish" lexicon. The text is designed to be appropriate for the great majority of Spanish-speakers. ISBN 1-87953723-0. To obtain a copy of this publication, contact Teaching Strategies, Inc. at P.O. Box 42243, Washington, D.C., or call 800-637-3652.

**Español Dinámico**, from DYNED International, Inc. *Español Dinámico* is a two CD-ROM, beginner-level Spanish course which uses dialogues, narratives and lively popular songs to introduce learners to the language and culture of the Spanish-speaking world. Several language varieties are presented using native speaker models from Spain, Mexico, and Latin America. This course features DynEd's patented "Shuffler" technology which allows the courseware to adjust automatically to the ability of the student. The variability of content enables students to repeat lessons again and again, encountering new material each time. This course can be purchased from most educational software catalogs, selected educational dealers, or directly from DynEd by calling 1-800-765-4375 or sending e-mail to [sales@dyned.com](mailto:sales@dyned.com).

**Hosting Newcomers**, by Robert A. Dentler and Anne L. Hafner. The authors offer solutions to help schools improve the quality of learning opportunities and well-being of these newcomers. Drawing from 11 metropolitan school districts, the authors provide case examples highlighting successful and unsuccessful practices and demonstrating effective, cost-efficient ways for school boards, superintendents, and other educational leaders to improve the education of ethnic and language minority children. ISBN: 0-8077-3612-0. To obtain a paperback copy for \$21.95, write to Teachers College Press, P.O. Box 20, Williston, VT, 05495-0020, call 800-5756566, or fax an order to 802-864-7626.

**Let's Go**, from DYNED International, Inc. *Let's Go* is designed for children ages 3 to 10 who are learning ESL, and is a two level, four CD-ROM course that builds a strong foundation in both spoken and written English through a structured grammatical syllabus including dialogues, songs, vocabulary, phonics exercise and games. It is available in six native languages, including Spanish, Korean, and Japanese. The software also offers pre-reading and early reading instruction for native English speakers. This course can be purchased from most educational software catalogs, selected educational dealers or directly from DynEd by calling 1-800-765-4375 or sending e-mail to [sales@dyned.com](mailto:sales@dyned.com).

**Mirame/Look at Me!**, from the South Texas Health Research Center at the University of Texas Health Science Center at San Antonio. Used on their own or to augment existing curricula, *Mirame/Look at Me!* video sessions are upbeat, engaging, and fun. This package includes 18 complete programs: five minute videos, group discussion guides, hands-on activities, and take-home exercises. Real kids serve as role models to teach 9-13 year-olds the consequences of healthy and unhealthy behavior. Sample lessons include: Social influences—resisting pressures from family, adults, peers, and media; Positive social skills for a healthy self-image; and Finding support and resources: family, neighborhood, school and social services. This video session can be purchased for \$249.95. Order #375. Call 800-322-1468, fax 608-262-6346, Department 6B, or mail your order to:

CONTINUED ON PAGE 10

Wisconsin Clearinghouse, University of Wisconsin-Madison, Dept. 6B, P.O. Box 1468, Madison, WI, 53701-1468.

*Profiles in Two-Way Immersion Education* is the latest volume in the series *Language in Education: Theory and Practice* written by researchers from the National Center for Research on Cultural Diversity and Second Language Learning. This volume profiles three schools that are implementing different variations of the two-way immersion program including each program's evolution, current operations, and results. It is available for \$15.95, plus shipping and handling, from Delta Systems Co., Inc., 1400 Miller Parkway, McHenry, IL 60050. Telephone 800-323-8270.

*Restructuring Schools for Linguistic Diversity*, by Ofelia Miramontes, Adel Nadeau, and Nancy L. Commins. This book contains an integration of the most current knowledge regarding English as a Second Language and bilingual instruction across the curriculum presented with a process for incorporating them into a complete program that lies precisely within the goals and realities of schools. ISBN 0-8077-3603-1. The paperback copy of this book can be purchased for \$23.95 by contacting Leyli Shayegan at 212-678-3919.

*Twinbridge Chinese Partner v4.0* for Win CD-ROM is a Chinese word processing tools that allows insertion of Chinese characters into any word processor or desktop publishing Windows software and many other applications, including e-mail programs. There is a built in dictionary containing more than 20,000 characters and 50,000 two-to-four character (user modifiable) phrases. (Min. Requirements: chin Win 3.1 or English Win95; 386, 4MB RAM, VGA; 20MB hard drive space.) This software can be purchased for \$199.00. Mail order to Cheng & Tsui Company, P.O. Box 576, Williston, VT 05495 or call 800-554-1963.

*Valuing Diversity*. This closed-captioned 19 minute video gives kids a way to look at their own behavior, and think before they judge. It offers information about cultural differences, language barriers, judging appearances, and personal space. And it shows kids and teens how to decrease their discomfort communicating with diverse people. *Valuing Diversity* can be purchased for \$99.00 (Catalog # 9694-V) by calling 800-892-KIDS or mailing in an order to KIDSRIGHTS, 10100 Park Cedar Drive, Charlotte, NC, 28210.

*Nancy San Jose is a graduate student at San Francisco State University. She is a participant in NABE's Summer 1997 Policy Education Program.*

*Resources are listed for the information of the NABE membership. Listing does not imply endorsement of the resource by the National Association for Bilingual Education. If you want more information about any item listed in this column, you must contact the publisher/developer directly.*

• NABE •

## Publishers and Materials Developers

*Do you have new products to tell  
NABE Members about?*

Send a sample of your material to  
the *NABE NEWS* Editor at  
NABE, 1220 L Street, NW, Suite 605,  
Washington, DC 20005-4018.

Materials will be listed ONCE free of  
charge in the Resources for  
Bilingual Educators column.

## CLAS Seeks Materials

CLAS (Culturally and Linguistically Appropriate Services) Early Childhood Research Institute seeks materials that can be used with culturally and linguistically diverse children from birth to five years of age and their families, along with materials that can be used to prepare personnel who will work with them. Although we anticipate that many materials will be in English, we also are very interested in materials in other languages.

Print and non-print materials, including information packets for families, textbooks and other materials (such as journal articles and book chapters) useful for training personnel, teacher-produced materials, and related items will be described and disseminated by this project.

Please note that materials submitted cannot be returned. Videos will be reproduced for review purposes only. If you have materials suitable for this project, please send two copies to:

Harriet Gray, CLAS Coordinator  
The Council for Exceptional Children  
1920 Association Drive  
Reston, Virginia  
Phone: (703) 264-9488 . Fax: (703) 620-2521

E-mail: <harrietg@cec.sped.org>  
<<http://ericps.crc.uiuc.edu/clas/clashome.htm/>>

264



# NABE NEWS Book Reviews

Column Editor: Dr. Beti Leone, Paterson Public Schools, NJ

## *Adult ESL/Literacy: From the Community to the Community, A Guidebook for Participatory Literacy Training*

*Reviewed by Dr. Ana Huerta-Macías*

*Adult ESL/Literacy: From the Community to the Community, A Guidebook for Participatory Literacy Training*, by Elsa Auerbach with Byron Barahona, Julio Midy, Felipe Vauerano, Ana Zambrano and Joanne Arnaud. Mahwah, New Jersey: Lawrence Erlbaum Associates, 1996.

The field of family literacy has, in the past, been dominated by a deficit model which blames the victims for their own marginalization. The focus of many programs has been on the inadequacies of families and on prescribing solutions to help them succeed at school, at work, and in the home. Although educators and other staff involved in designing these programs are well-intentioned; they are, in fact, perpetuating the oppressive circumstances of these families by operating on a mainstreamist, dominant philosophy. This philosophy assumes that the problems lie with the program participants who often have little more than three or four years of formal education; who speak little or no English; and who, in the view of these educators, are in need of parenting skills. The attempts to "fix" these problems have come in the form of pre-packaged curricula consisting of a wide assortment of ESL, parenting, and early childhood classes which have the aim of transmitting practices within the dominant society to the participating families. The consequence has been that families felt alienated, confused, and devalued as there was no acknowledgment of the rich cultural and literate traditions with which they already came, and no recognition of those alternative forms of knowing that they possessed. Instead, participants were presented with lessons whose content was irrelevant and meaningless to them, and which assumed that the forms of knowledge which these parents and children brought was of little or no value because they were not congruent with those of the Euro-centric tradition. The success of these programs, moreover, was based on measures which indicated a transformation to "good" parents — "good" being interpreted as Americanized. Brizius and Foster (1993), in discussing the results of the evaluations of two family literacy programs, for example, judgementally write that "All the evaluations indicated that parents felt that they were better equipped to be good parents. Program staff also rated nearly all parents as showing 'some' or 'much' improvement in parenting skills" (p.66).

CONTINUED ON PAGE 12

## *Under Attack: The Case Against Bilingual Education*

*Reviewed by Dr. DeAnne Sobul*

*Under Attack: The Case Against Bilingual Education*. Stephen Krashen (1996). Culver City, CA: Language Education Associates. 100 pp.

Bilingual education is under attack constantly. Letters to the editor, editorials, and talk show hosts repeat the same arguments against bilingual programs daily. According to such sources, bilingual education does not work. Students do not learn English and students who have never had bilingual programs do very well without it. Critics also claim that parents and the public do not want bilingual education. Further, they argue that bilingual education undermines unity in the United States since it causes the erosion of English.

*Under Attack: The Case Against Bilingual Education* is a must for all who advocate primary language literacy development as the best method for limited English proficient students to acquire English proficiency. Many of us, as proponents of bilingual programs, experience difficulty in readily presenting arguments which emphatically counter the attacks on bilingual education. This volume provides the data and the information we need to support our views. In a concise 100 pages, Krashen's monograph presents the arguments essential answering the assault on bilingual education. Krashen empirically proves that bilingual education is the most effective method to assure language minority students access to English and to the higher level skills essential to academic success.

The book examines the following issues: Does the research show that bilingual education doesn't work? (NO!) Is English in trouble? (NO!) Are most parents and teachers against bilingual education? (NO!) Will bilingual education work for languages other than Spanish? (YES!) What about those who succeed without bilingual education? Is bilingual education good for English? (YES!) Can bilingual education be improved? (YES!) In the book's final chapter, "Inoculating Bilingual Education Against Attack," Krashen provides a formula for making bilingual education so successful that there is simply no doubt about its success. He suggests that we add a fourth characteristic to those commonly acknowledged as basic to successful programs: 1) Comprehensible input in English (ESL, sheltered subject matter teaching); 2) Subject matter knowledge, from classes taught in the primary language; 3) Literacy development in the primary language. And fourth: Continued development of the primary language, for economic, job-related and cognitive advantages. Krashen suggests that reading, especially free voluntary reading, can contrib-

265

CONTINUED ON PAGE 22

This model has been questioned in recent years, as researchers have increasingly recognized the complexity of the linguistic, cultural, sociological, and ideological issues involved in developing family literacy programs — particularly when working with bilingual or multilingual families. Auerbach (1989), for instance, questioned the false assumptions that were made in these types of programs. Some of these assumptions were that family literacy development could take place by having families do “school-like” literacy tasks together at home, that language minority children were disadvantaged by their parents’ inability to communicate with them in English, and that cultural differences and family structures were problematic obstacles that stood in the way of literacy development (Auerbach, 1989). Huerta-Macías and Quintero (1993) suggested a reconceptualization of family literacy which integrated the cultural and linguistic practices of the community and which viewed learning as a bi-directional process between families and educators. They maintained that it was essential for school staff to “...recognize that they themselves must be educated, through cross-cultural knowledge, concrete experiences, and self-reflection” as a pre-requisite to implementing a successful parent or family involvement program. Quintero and Huerta-Macías (1993) presented research findings that dictated a need for a “critical, whole language curriculum” which demanded that attention and respect be paid to “...experimental knowledge (including culture and language), knowledge of power (including facts and systems), and critical competence (where families examined and sought to improve their personal situations)” (p.45). They additionally suggested an instructional framework in which “...the potential for learning is not unidimensional or product-oriented, but rather multidimensional and process-oriented” (p.60). Street (1995) also recognized the need for change and wrote that “The crisis of illiteracy remains rooted in an assumption of a single, homogeneous society and a single, homogeneous literacy required of its members” (p.ii) and argued for a culturally-sensitive model of family literacy.

Auerbach’s new book, *Adult ESL Literacy: From the Community to the Community*, presents such a model — one which builds upon and extends the most recent research in the field of literacy development. *From the Community to the Community* is a product of a group which was involved in the implementation of a university-community collaborative literacy project. Three community-based agencies from the Boston area were involved in the project which was designed to train interns from immigrant and refugee communities to teach in their own communities. The interns were in many cases former ESL students, tutors, or individuals who had prior experience with literacy campaigns.

The collaborative also provided literacy instruction in Haitian Creole, in Spanish, and in English as a Second Language. The philosophy of the project was based on a participatory approach to learning. This approach 1) used the participants’ knowledge and experiences as a starting point for curriculum development; 2) recognized literacy as occurring in culturally-specific ways; and 3) operated on the belief that the importance of education rested on the learner’s ability to get involved in issues that affect their lives and on helping them to understand the social nature of problems such as unemployment, discrimination on the job, and raising

children in a new country. The philosophy of the program is reflected in the book itself, as all of the project staff contributed to the development of the book through their many discussions and meetings, interviews, field notes, quotes, work samples, and evaluation results. The book is very comprehensive in that it addresses all aspects of implementing a family literacy program and does an excellent job of connecting theory to practice. The book is, furthermore, written in a language that is accessible to various groups, including practitioners, policymakers, and community members.

### Description of the Book

The following briefly describes the content of each of the six chapters in the book. Chapter One presents the background and rationale for the project design; it also describes the key features of the project. Included in this chapter is a succinct discussion of the theoretical rationale for the project approach. The authors focus on Freirian perspectives as they outline the current research on adult learning theory, curriculum development, and literacy pedagogy; they advocate literacy instruction as a tool for enabling learners to understand and change their lives. Chapter Two provides an overview of the project structure and the participants. Included are several Inserts which describe each of the mentors’ (experienced literacy instructors who were already working at the sites) backgrounds, their rationale for participating in the project, and the selection process which was used for hiring the mentors. Another attractive feature of this chapter is a profile of the students with quotes which relate their reasons for joining the classes and provide a sense of the significance of the classes in their lives. Chapters Three and Four, respectively, describe the training components of the project and address the pedagogical issues which emerged from practice. Some of the features which practitioners will find most useful from these chapters include the discussion of issues which emerged during the training and teaching and how they were solved, the guidelines for workshops which resulted from these discussions, and the extensive descriptions of the teaching tools which were actually used in the classroom. Appendix C of the book augments chapter three by providing step-by-step accounts of fourteen of the university-based training workshops that took place and the feedback received on each of these sessions.

Chapter Five outlines the evaluation process — including the approach, the plan, and the tools. One of the guiding principles in the evaluation was that the processes and tools should be congruent with the instructional approach. Additionally, because the project’s focus was on training, the evaluation primarily looked at the impact of the project on interns, mentors, groups of learners and participating sites. Again, the many quotes from the interns and the mentors which are incorporated into this chapter vividly provide the reader with a very good sense of the change process which took place among the staff as they faced the many issues which emerged with respect to their conceptualization of literacy, their conceptions of teacher/student roles, their use of context-specific curriculum (as opposed to pre-packed, uniform curriculum), their abilities to find and create materials, and their increased

# NABE 1998

## BILINGUAL TEACHER OF THE YEAR CONTEST

Sponsored by Scholastic, Inc.

**INTRODUCTION:** In recognition of the efforts that bilingual classroom teachers make on behalf of linguistic-minority students, the National Association for Bilingual Education (NABE) established the *Bilingual Teacher of the Year Competition*. Each year, NABE and its affiliate organizations honor an outstanding bilingual teacher nominated by one of the NABE affiliates.

**AWARD:** The winner of NABE's 1998 Bilingual Teacher of the Year competition will receive a \$2,500 scholarship to further his/her education and/or to use for the students in his/her class. In addition, the winner will be flown to the 1998 NABE Conference in Dallas, Texas, to receive his/her award.

**NOMINATIONS:** **Only NABE affiliates in good standing are eligible to nominate candidates.** Nominations should be made and the winner will be chosen without regard to age, sex, race, national origin, handicapping conditions, or religion. Affiliates may use any method they choose for selecting candidates. Each affiliate may nominate only one candidate. The candidate must be a current NABE member in good standing and a current member of the NABE affiliate. Nominations which do not comply with these requirements will not be considered.

**QUALIFICATIONS:** Candidates must be exceptionally skilled and dedicated teachers in a bilingual program for pre-Kindergarten through grade twelve. Only bilingual classroom teachers who work full-time with students and have at least three years of experience qualify. Candidates must have distinguished themselves as leaders and outstanding teachers. Candidates should enjoy the respect and admiration of students, parents, and co-workers. They should play active and useful roles in their communities as well as in their schools. Finally, candidates should be poised and articulate and willing and able to grant public interviews and make presentations. He/she should be fluently bilingual. The most important qualification to consider is the candidate's proven ability to inspire limited English proficient students of various backgrounds and abilities to excel.

**PRESENTATION OF MATERIALS:** As part of the nomination process, the NABE affiliate is responsible for submitting a portfolio of materials for their candidate to be used by the selection committee in its deliberations. Material should be typed, double-spaced, and each section should be a maximum of four pages. Videos are acceptable as supplementary material, provided that six copies of the video are submitted. All materials become property of NABE and will not be returned. **Six (6) complete copies** of the following materials with no more than 24 total pages (in each copy) must be submitted:

- ◆ **Nomination Information** - a cover letter signed by a NABE affiliate officer and the attached Data Sheet providing basic information about the candidate.
- ◆ **Biographical Sketch** - a 4-page (maximum) narrative prepared by the teacher describing his/her formative environment and specific events or experiences leading to his/her involvement in education, particularly in bilingual education.
- ◆ **Photograph** - a photograph of the candidate (preferably 5" x 7" glossy black and white) must be submitted for publication in program. In addition, a minimum of three photographs of the teacher's classroom should be submitted.
- ◆ **Philosophy of Education** - a 4-page (maximum) statement by the candidate reflecting his/her commitment to the profession including a description of the candidate's educational values and belief in the effectiveness of bilingual education.
- ◆ **Professional Development** - a 4-page (maximum) description of the candidate's academic preparation and participation in professional organizations and service committees, commissions, task forces, workshops and conferences, etc.
- ◆ **Community Service** - a 4-page (maximum) description of the candidate's participation in organizations as well as personal efforts to improve education and social conditions of the community.
- ◆ **Recommendations** - One letter of recommendation from the teacher's immediate supervisor and a maximum of five (5) other letters of recommendation.

**DEADLINE:** All nominations must be **RECEIVED** by **November 1, 1997** at the address listed below. The winner will be notified by January 1, 1998. For additional information, contact:

Dr. Nancy F. Zelasko  
Deputy Director and Conference Coordinator  
National Association for Bilingual Education  
1220 L Street, NW -- Suite 605  
Washington, DC 20005-4018

267

NABE 1998 DATA SHEET  
BILINGUAL TEACHER OF THE YEAR/  
BILINGUAL INSTRUCTIONAL ASSISTANT OF THE YEAR

**Indicate Competition:**      \_\_\_ Teacher of the Year:      \_\_\_ Instructional Assistant of the Year

**Name:** \_\_\_\_\_ **NABE Membership ID #:** \_\_\_\_\_

**Position/Title:** \_\_\_\_\_

**Years in Present Position:** \_\_\_\_\_ **Grade Level(s):** \_\_\_\_\_

**Languages Spoken:** \_\_\_\_\_

**Name of School:** \_\_\_\_\_

**School Address:** \_\_\_\_\_

**School Telephone Number:** \_\_\_\_\_ **School Fax Number:** \_\_\_\_\_

**Name of School Principal:** \_\_\_\_\_

**Home Address:** \_\_\_\_\_

**Home Telephone Number:** \_\_\_\_\_

**Previous Work Experience:** \_\_\_\_\_

**Summary of Academic Training/Preparation**

**Dates:** \_\_\_\_\_ **Degree/Certificate Earned:** \_\_\_\_\_

**Institution Name & Address:** \_\_\_\_\_

\_\_\_\_\_

\_\_\_\_\_

**I hereby give my permission for any or all materials submitted by me for consideration for the Bilingual Teacher of the Year/Bilingual Instructional Assistant of the Year Award to be shared with persons involved in promoting this award:**

\_\_\_\_\_ **268** \_\_\_\_\_ (Signature of Candidate)

## NABE 1998

# BILINGUAL INSTRUCTIONAL ASSISTANT OF THE YEAR CONTEST

Sponsored by Scholastic, Inc.

**INTRODUCTION:** In recognition of the significant role that instructional assistants play in the education of linguistic-minority students, the National Association for Bilingual Education (NABE) established the *Bilingual Instructional Assistant of the Year Competition*. Each year NABE and its affiliate organizations honor an outstanding bilingual instructional assistant nominated by one of the NABE affiliates.

**AWARD:** The winner of NABE's 1998 Bilingual Instructional Assistant of the Year competition will receive a \$2,500 scholarship to further his/her education, and will be flown to the 1998 NABE Conference in Dallas, Texas to receive his/her award.

**NOMINATIONS:** Only NABE affiliates in good standing are eligible to nominate candidates. Nominations should be made and the winner will be chosen without regard to age, sex, race, national origin, handicapping conditions, or religion. Affiliates may use any method they choose for selecting candidates. Each affiliate may nominate only one candidate. The candidate must be a current NABE member in good standing and a current member of the NABE affiliate.

**QUALIFICATIONS:** Candidates must be exceptionally skilled and dedicated instructional assistants in a bilingual program for pre-Kindergarten through grade twelve. Only instructional assistants who work half-time or more with students and have at least three years of experience qualify. Candidates must be fluently bilingual. Nominees should also be participating in, or planning to participate in, a professional development program including one leading to certification as a bilingual teacher. The most important qualification, however, is the candidate's proven ability to inspire bilingual children to excel.

**PRESENTATION OF MATERIALS:** As part of the nomination process, the NABE affiliate is responsible for submitting a portfolio of materials for their candidate to be used by the selection committee in its deliberations. Material should be typed, double-spaced, and each section should be a maximum of four pages. Videos are acceptable as supplementary material, provided that six copies of the video are submitted. All materials become property of NABE and will not be returned. **Six (6) complete copies** of the following materials with no more than 24 total pages (in each copy) must be submitted:

- ◆ **Nomination Information** - a cover letter signed by a NABE affiliate officer and the attached Data Sheet providing basic information about the candidate.
- ◆ **Biographical Sketch** - a 4-page (maximum) narrative prepared by the teacher describing his/her formative environment and specific events or experiences leading to his/her involvement in education, particularly in bilingual education.
- ◆ **Photograph** - a photograph of the candidate (preferably 5" x 7" glossy black and white) must be submitted for publication in program. In addition, a minimum of three photographs of the instructional assistant's classroom should be submitted.
- ◆ **Philosophy of Education** - a 4-page (maximum) statement by the candidate reflecting his/her commitment to the profession including a description of the candidate's educational values and belief in the effectiveness of bilingual education.
- ◆ **Professional Development** - a 4-page (maximum) statement of the candidate's academic preparation and plans to advance his/her educational goals, including a information about the professional development program he/she is presently enrolled in or would enroll in if chosen as the recipient of NABE's Instructional Assistant of the Year Award. There should also be a description of the candidate's participation in professional organizations, service committees, commissions, task forces, workshops and conferences.
- ◆ **Community Service** - a 4-page (maximum) description of the candidate's participation in organizations as well as personal efforts to improve education and social conditions of the community.
- ◆ **Recommendations** - One letter of recommendation from the instructional assistant's immediate supervisor and a maximum of five (5) other letters of recommendation.

**DEADLINE:** All nominations must be RECEIVED by November 1, 1997 at the address listed below. The winner will be notified by January 1, 1998. For additional information, contact:

Dr. Nancy F. Zelasko  
Deputy Director and Conference Coordinator  
National Association for Bilingual Education  
1220 L Street, NW -- Suite 605  
Washington, DC 20005-4018

269

with a significant other, to have friends, to experience success, to feel a sense of belonging, and to participate actively in his or her own learning. Without being able to express himself or herself, a LEP child is cut off from communicating, from developing friendships, from experiencing success, from feeling a sense of belonging, and from active involvement in his or her own learning.

Unfortunately, not all children can tell a story with the happy ending that mine has had. For me the turning point came in the 7th grade. Finally, I knew enough English to feel comfortable to do academic tasks. It was not until then that I could express in English what my heart felt or my mind thought in Spanish. It was only then that I felt that I could belong and succeed. That year I did belong — to the Jr. Honor Society and later, when I graduated from high school, as class valedictorian.

Seven years. *It took me seven years to become in English what I already was in Spanish.* In part, I owe my ultimate success to the rich learning environment *in Spanish* that my parents sought to construct for their children. You see, my father, who was college educated in Mexico, was a LEP adult in Texas, and so Spanish was the only language we spoke at home. My parents were, in essence, my bilingual teachers.

My parents created for me and for *all* their nine children a world of literature; of "cuentos" (stories); of art, "con los colores del zarape: verde, rojo, anaranjado, amarillo, azul (with the colors of serapes: green, red, orange, yellow, blue); a world of geography, music, and poetry. They created for us a world that was rich *in culture and color and vibrancy!* This fully-formed, life-filled, over-flowing world was, for me, in English, a formless void.

I will always be a proponent native language instruction; of bilingual education. I lived the experiences. I lived the anxiety and like many of you, I heard the calling. Because of this, bilingual education has become my mission. Bilingual education is my passion. And the possibility of implementing quality bilingual programs that would change the lives of children who speak a language other than English is what inspired me to become a

teacher, and later a teacher of teachers. This also inspired me to join a team involved in producing the very best instructional materials possible for our children — and no less; materials that would whet the reading and imagination appetites of children whose language and culture are often disregarded in mainstream texts. As a teacher, I wanted to teach these children reading, writing, and 'rithmetic — the 3 R's — but I also wanted to teach them their language, their culture, their literature, "las 3 erres"!

For me, NABE represents those ideas and ideals that are very close to my heart. I am glad to be part of it and will work hard with my colleagues on the Executive Board and staff to continue to advance the Association's mission.

meeting by reading NABE's mission statement and thus provide the context for each meeting and the implications about decisions we make, concerning budget, staffing, activities, etc.

At this first meeting I also introduced the concept of conversation. As a Board and staff, we plan to hold a series of conversations throughout the year before each of our Board meetings, focused on important issues — service leadership, national testing, English-Only, teacher preparation, etc. We will invite key people to participate in these conversations. These conversations will form the basis for new directions for the Association.

Our administration will also be characterized by a sense of collaboration. Collaborative efforts provide the collective knowledge, the strength, and the synergism that will help us to continue to transform our communities into learning environments that will change the destiny of the children and the families we serve

This administration will also focus on improving communication — among and between all of us — Board members, staff, affiliates, and members. To that end, we are planning a series of regional institutes for the affiliates, led by Member-at-Large Paul Martínez. Board members will be accessible and our board meetings will be open. We invite affiliate presidents and members to join our Board meetings and to communicate with their Board liaisons.

I also presented the Board with a vision of human flourishing. As we look at history, we have a record of degrading social behavior. We also have a history of unparalleled generosity and kindness. We have an uneven record of human generosity and kindness. For the most part, humankind has had a very poor record of helping each other. This Executive Board will be characterized by this vision of human flourishing — to work together to support each other as we advance NABE's agenda.

The achievement of these goals will require all of us to work together to ensure that NABE continues to grow into the vibrant and important professional organization needed to advocate for children and their families. I look forward to working with all of you.

*Seven years.  
It took me seven years  
to become in English  
what I already was  
in Spanish.*

At the first meeting of the Executive Board in Washington, DC, I shared this sense of mission and vision and pledged that this Board would be characterized by a strong sense of service leadership, as well as a strong sense of collaboration, communication, openness and team work. We affirmed the fact that the 1997-1998 Board's business is to represent the interests of our members and to further NABE's development. To that end, we will work as a team — Board and staff. As a sign in the NABE Office says, "A team will always outperform a group of individuals." The bottom line of every decision we make will be "How will this help us serve people better, particularly our children and their families?". We will begin every Board

# Equal Access: Mask of Discrimination

by Oscar M. Cárdenas

It is the first day of the 97-98 school year in the Pick One Independent School District in Somewhere, Texas. A monolingual English speaking teacher with 18 years experience is assigned to teach a multi-ethnic class of 24 children in the Third Grade of La Esperanza Elementary School. The teacher, Ms. Educator, has a professional elementary certificate with a specialization in Reading.

The class is made up of 14 Hispanic, 2 African-American and 3 Asian-American students. The remaining five students are Anglo, or "White" as coded in the state's required reporting system. Since the teacher was transferred from another campus within the same school district for this school year, there was little opportunity for her to review the academic and linguistic characteristics of her assigned children.

As Ms. Educator proceeds to settle the class for structured learning, she quickly peruses each enrollment card. She notices rubber-stamped labels on each card. Silently, amidst the excitement and noise of a new school year, she reads one card, "Regular," then another, "Limited English Proficient/Exempt Testing" and "LEP/Level IV Spanish/Level I English/Bilingual." The third card reads, "Low SES/Accelerated Inst." Other cards read "LEP/Special Education," "Attention Deficit Disorder," "Non-LEP/School Lunch/Accelerated Instruction," "LEP/ESL-Level III," and then another "Regular." Yes, it is the first day of school and already Ms. Educator is frustrated. "What in the world are all of the labels for?" she ponders. "My job is to teach these children to meet the district, state and national goals in Reading. I can't discriminate. I have to teach all them to read. Someone else needs to work with them with any other problems they have."

The bell to start the instructional day is heard. Ms. Educator adjusts to her teaching mode, but first checks the attendance roll. "Jennifer," "Pitra"(for Petra), "Wakin"(for Joaquín), "Jimmy"(for Jaime), "Jacob" and so on. Most of the

children raise their hand when told by other children to raise it, some without realizing they were responding to another name as modified by the teacher. "OK children," Ms. Educator continues, "take out your Readers and turn to Chapter One. Some of you will be working on these wonderful computers, but I haven't gotten the list yet. So just listen to the other children who will be reading for us." The first day of school for many of these children with special needs will be no different from the other school days to follow. Teaching will be inappropriate, insensitive, and incomprehensible. This case scenario is fictitious, but the events that are profiled are very real. They occur in class-

*...educators and school systems may sincerely attempt to give every child an equal opportunity by treating each child alike, but we must focus on equal benefits for every child and not on equal access.*

rooms with children of diverse backgrounds and special needs throughout this country on a daily basis.

This fictitious case scenario focuses on sincere attempts by educators and school systems to give every child an equal opportunity by treating each child alike. These practices perpetuate the myth of equal opportunity. Day in and day out, children of diverse backgrounds are pushed into the American mold for education, either by design or neglect. These practices are nonetheless discriminatory by all accounts for they segregate children with special needs from appropriate and responsive services from specially trained staff.

Now alternative education is being heralded as the panacea to the challenges that these special populations pose. The concept of alternative education does have merit if it is instituted as an alternative to educate students and not as an alternative

site to serve as a holding tank for students at risk. For decades, minority and language minority children have been dumped in Special Education. Now, with the advent of Alternative Education in America, we must ensure that children are in school-houses and not warehouses.

We must focus on equal benefits for every child and not on equal access. We must dispel the erroneous concept of compensatory education and compensate for what the educational system has not provided up to now. Special programs for students with special needs should be understood and implemented as enhancements for, and not appendages to, the regular program offering. Above all, we must eradicate the pervasive notion that children come to schools with problems. They come to our schools with special needs that warrant special attention. Educational deprivation is not a characteristic of any segment of our pluralistic society. It is a by-product of an educational system that fails to recognize the needs of those to be served.

There are millions of these children with special needs throughout the country. Historically and invariably, these students are, or will become, the staggering statistics we continue to read about as academic failures, at risk, truant, hard core and dropouts. Let us hope that non-traditional approaches to appropriately impact these students with excellence and equity will become a salient feature of our educational system long before we get to the 21st Century... just around the proverbial corner.

*Oscar M. Cárdenas is an educator who serves on the staff of the Texas Education Agency in Austin, Texas. This article is expressing the views of the author. It should be expressly understood that these views do not represent the official posture of the Agency on these matters, directly or indirectly.*

*This article was originally published in the IDRA Newsletter; it may be freely reprinted provided that it is printed in its entirety and that proper credit is given both to IDRA and the author.*

• NABE •

sense of self-confidence, autonomy over their own work, and their identities as professionals. A useful, albeit brief, discussion of the tools used to assess student progress is also included in this chapter. Chapter Six ties it all together with an extensive discussion of the findings, challenges and recommendations resulting from the project in the areas of training, participatory instruction, first language literacy, collaboration, and dissemination of family literacy projects.

The following highlights some features of the design and content of the book which make it particularly useful as a resource:

- use of a large type and multiple graphics such as charts, boxes, and tables
- notes in the margin which readily identify the content of each page
- a question-answer format to address the major issues throughout the text
- a colloquial style of language which makes the narratives accessible to diverse groups
- the integration of quotes from participants as well as project staff which convey the complexities and impact of the issues discussed
- the thoroughness with which each of the topics is covered, including multiple examples taken from the Community-to-Community project
- the connections of theory to practice which are explicitly discussed in the first part of the book in the description of the context and rationale for the project and which continue to be addressed throughout the book in the "action-reflection" format — a format that engages the reader in praxis
- the scope of the contents; using the community-to-community project model, the book addresses just about every facet of the design and implementation of a family literacy project. Of particular interest to readers working with bilingual/multilingual populations might be the discussion on first language literacy, as well as bilingual transitional ESL classes.

*From the Community to the Community* represents a significant contribution to the field of family literacy, particularly at a time when immigrants, bilingual education, and multiculturalism are under attack. The model presented in the book is exemplary not only because it promotes literacy and biliteracy development, but also because the participatory approach which it advocates contributes to the development of the community as a whole. When residents of a community participate in such projects, they too become educators and in turn train others within their communities. The ultimate result of these collaborations is change; change which promotes social justice as these participants become critically literate of their world and those social conditions which have kept them marginalized. The book is highly recommended for teachers, tutors, program administrators, policymakers and anyone else that is interested in literacy program design and implementation.

### References

- Auerbach, E. (1989). "Toward a socio-contextual approach to family literacy." *Harvard Educational Review*, 59(2), 165-181.
- Brizius, J.A. and Foster, S.A. (1993). *Generation to generation: Realizing the promise of family literacy*. Ypsilanti, MI: High/Scope Press.
- Huerta-Macías, A. and Quintero, E. (1993). "Teaching language and literacy in the context of family and community." In J.F. Tinajero and A.F. Ada (Eds.), *The power of two languages*, (pp.152-157). New York: Macmillan/McGraw-Hill School Publishing Company.
- Street, B. (1995). Foreword. In G. Weinstein-Shr and E. Quintero (Eds.), *Literacy to connect the generations: Immigrant learners and their families* (pp.i-vii). Ill: Delta Systems Co., Inc.
- Quintero, E. and Huerta-Macías, A. (1993, fall/winter). "Whole language: Critical curriculum for family literacy." *The School Community Journal*, 3(2), 45-62.

*Dr. Ana Huerta-Macías, a faculty member in the Department of Curriculum and Instruction at New Mexico State University, researches and publishes in the areas of Bilingual Education, TESOL, and adult and family literacy.*

◀ NABE ▶

## Book Review Submission Guidelines

Reviews for publications in the **Book Review** column be sent to Dr. Beti Leone, Book Review column editor, at NABE 1220 L Street, NW, #605, Washington, DC, 20005, or by e-mail to <NABE\_NEWS@nabe.org>

Books from publishers should be clearly marked **BOOK REVIEW MATERIAL** and sent to the same address; **two complete sets of materials must be submitted.**



# ESL in Bilingual Education

Column Editor: Dr. Jack Milon, University of Nevada, Reno

## *When The Ideal Isn't Possible*

*by Dr. Joel B. Judd and  
Ms. Kimberley Kreicker*

Imagine this: you are a classroom teacher in a rural school of two buildings and 750 students. For nearly twenty years little has changed in the demographics of the community or district. Then a beef packing plant starts up just outside of town. Almost overnight, the student population has become 37 percent language minority, with students from a dozen different language backgrounds.

This scenario has become reality in countless Midwestern schools over the past half dozen years. Students whose family members have come to work in meat processing, agricultural, and other labor-intensive industries challenge the local schools' ability to provide them an effective and equitable education. Language minority students living in rural areas are not usually grouped together in large numbers, nor are they highly visible. Yet all told, tens of thousands of them are scattered throughout Kansas, Missouri and neighboring states.

In Kansas, for example, approximately 9,000 of the more than 13,000 language minority students in the state live and attend school in rural settings. In Missouri, this is true for as many as 6,000 of the state's 9,700 language minority students. Many of the affected districts were 100 percent English speaking as recently as five years ago. So while the staff in these schools may not have changed, the students have. The resulting atmosphere can range from enthusiastic acceptance, through panic, to outright hostility.

Adding to educators' frustrations, the kinds of learning environments considered ideal for language minority students are unrealistic for most rural settings. The Collier and Thomas (1997) work, for example, emphatically suggests that it is two-way bilingual education — or at least an ESOL language-maintenance approach — which shows long-term educational ben-

efits for language minority students. This type of instructional setting is simply not possible in settings where bilingual staff are not available, training existing staff is exceedingly difficult, and the number of students in question is small. In most rural districts the instructional approach will be content-based ESOL at best, and regular unmodified curriculum at worst. Long-term research optimistically points to the teacher as one of the most influential factors in the academic success of language-minority students. Therefore, it is critical that Limited English Proficient students in rural schools encounter regular and special services (e.g., Title I) staff who have training in and preparation for working with language minority students.

For this reason, states such as Missouri and Kansas have placed a major emphasis on encouraging mainstream classroom teachers to pursue additional training in the form of an ESOL endorsement to their teaching certificate. Through this training, teachers gain a better understanding of the process of second language acquisition, learn how to modify and develop curriculum to make it more accessible to language minority students (actually, all students), and develop a personal awareness of the psychological effects of acculturation. Focusing on effective pedagogy such as content-based ESOL, endorsed teachers can use English as a way of bringing LEP students into the lesson, while utilizing the lesson's content as a catalyst for developing English proficiency.

As previously mentioned, a serious challenge to this goal of teacher preservice and inservice is the availability and accessibility of ESOL endorsement programs. Rural teachers may live two to eight hours driving time from the nearest campus. Technology has offered some alternatives to the problem of distance, including video-based courses that allow small numbers of teachers in close proximity to take classes using a freer schedule. Even with such opportunities, full-time teachers may sim-

ply not feel they have the time to devote to training, or have any incentive to do so. For these teachers, periodic inservice — provided by colleagues, state departments of education, institutions of higher education, or other experts — is indispensable.

Another challenge lies in encouraging existing teacher preparation courses to give more than just lip service to the realities of teaching in today's rural and urban settings. Neither teacher-trainers nor their students should assume that there are any positions, anywhere, that can ensure a career of teaching homogenous, monolingual English-speaking students. Every year, dozens of school districts report enrolling language minority students for the first time. These districts invariably preface their request for help with "We didn't think we'd ever enroll a non-English speaking student..."

Because of the rapidly and continually changing demographics of the U.S. in general, school districts need to be more proactive in preparing for the enrollment of language minority students. Both Kansas and Missouri encourage or require a district plan for identifying, assessing and serving LEP students as a part of their school evaluation system. These plans should also take into account the availability of staff preservice and inservice resources for those teachers and administrators most involved with language minority students.

Finally, both school district and higher education personnel need to take advantage of state reform efforts both to secure funding for teacher preparation programs as well as to build a resource base — in technology, materials, and expertise — for the effective education of language minority students. Giving rural settings reasonable priority is the key to greater educational equity for these students.

While devoting attention to the issues discussed herein may not turn every rural school into an ideal setting for language minority students, it will dramatically in-

CONTINUED ON PAGE 22



# NABE PRODUCTS ORDER FORM

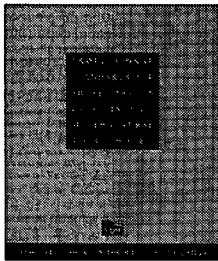
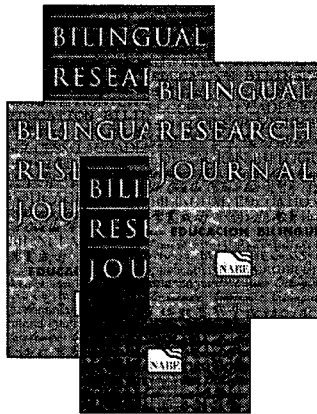

ITEM	PRICE	#	TOTAL
<b>PUBLICATIONS</b>			
<i>Bilingual Research Journal</i>	\$13.00		
Vol. 20, #2, Spring 1996 Current Journal Issue			
Vol. 19, #3&4, Spring/Summer 1995 Special issue: Role of ESL in Bilingual Education			
Vol. 19, #1, Fall 1994 Special issue: Native American Issues			
Vol. 16, #1&2, Spring/Summer 1995 Special issue: Ramirez study			
[earlier issues available (call for details)]			
<i>NABE Annual Conference Journal</i>	\$7.00		
1989-90 issue			
1991-92 issue			
1992-93 issue			
<i>1997 Annual Conference Program</i>	\$5.00		
<i>NABE News</i>	\$5.00		
write issue date or volume/number here			
write issue date or volume/number here			
[current volume always available; earlier issues may also be available (call for specifics)]			
<i>Professional Standards for the Preparation of Bilingual/Multicultural Education Teachers</i>	\$5.00		
<b>PRODUCTS</b>			
NABE logo pins	\$5.00		
NABE bumper stickers			
"Proud to be Bilingual"	\$1.00		
"Orgulloso de ser Bilingüe"	\$1.00		
NABE canvas tote bags	\$5.00		
<b>VIDEO: Making Connections: Learning, Language and Technology</b>	\$7.00		
<b>TOTAL</b>			

- Prices include shipping by USPS first class mail. Special shipping available - call for pricing.
- Payment must accompany all orders. Make checks and purchase orders payable to NABE.
- Orders shipped to the District of Columbia must include 6% sales tax.
- Credit card orders may also be placed by phone (202 - 898-1829) during business hours.

## SHIPPING INFORMATION

Name \_\_\_\_\_ Company \_\_\_\_\_

Address \_\_\_\_\_

City/State/Zip \_\_\_\_\_ Phone \_\_\_\_\_

## PAYMENT INFORMATION

Check#: \_\_\_\_\_ PO#: \_\_\_\_\_ CC#: \_\_\_\_\_ ExpDate: \_\_\_\_\_

MAIL TO: NABE PRODUCTS, Suite 605, 1220 L Street NW, Washington, DC 20005-4018

# Issues in American Indian/Alaskan Native Education

Column Editor: Dr. Jon Reyhner, Northern Arizona University

## *Fourth Annual Stabilizing Indigenous Languages Symposium*

by Dr. Jon Reyhner

The Fourth Annual Stabilizing Indigenous Languages Symposium, "Sharing Effective Language Renewal Practices," was held at Northern Arizona University (NAU) in Flagstaff, Arizona, on May 2nd and 3rd with almost 300 indigenous language educators and activists in attendance. Sponsored by the NAU's Bilingual Multicultural Education and Navajo Language Programs, the Symposium provided a forum for American Indian language educators and activists, through panels, workshops, and papers, to share ideas and materials for teaching American Indian languages.

This sharing was done through 39 separate sessions, ranging from Alice Taff's telling about teaching Deg Xinag (Ingalik Athabaskan) by long distance telephone to dispersed elders and their descendants, to Gordon Bronitsky's describing how to publish American Indian authors' writings in their native languages overseas, to Rangi Nicholson describing efforts to popularize the Maori language in New Zealand through marketing strategies. Several sessions focused on the Total Physical Response (TPR) method of teaching languages.

Keynote speeches included "The Power of Navajo Communication" by Dr. Evangeline Parsons Yazzie, Navajo language professor at NAU and Symposium Co-chair; "Some Rare and Radical Ideas for Native Language Preservation" by Dr. Richard Littlebear, Vice President of Dull Knife Memorial College; and "Keeping Indigenous Languages Alive: The School's Responsibility" by Dr. Gina Cantoni, NAU Regents Professor.

Throughout the Symposium there was both a sense of urgency based on the accelerated loss of indigenous languages and a sense of optimism based on the increasing awareness by tribal people that a concerted effort needs to be made to stem

that loss. Despite recent tribal language policies and the 1990 and 1992 Native American Languages Acts passed by Congress, fewer and fewer children are speaking American Indian languages. Mass communication, marketing, and transportation are breaking down the isolation that allowed American Indian languages to survive despite government efforts to wipe them out.

While there is now a legal right to maintain indigenous languages in the United States, the rhetoric of tribal and federal policy statements has yet to become a reality in terms of widespread successful community and school language restoration programs. More needs to be done to disseminate effective native language teaching methods and materials to communities and schools. For example, Dr. Littlebear notes that the ability to speak an Indian language is often incorrectly seen as all that is needed to teach that language in schools.

The importance that indigenous people attach to their languages is described in Dr. Parsons Yazzie's 1995 NAU doctoral dissertation, *A Study of Reasons for Navajo Language Attrition as Perceived by Navajo-Speaking Parents*. In it she describes how her Navajo informants felt about their language.

One informant told her, "It is through our language that safety is reached" and another, "Older people who speak only Navajo are alone... When learning Navajo, children are just learning nouns without verbs or without the whole sentence, because of it children don't think too deep, their minds cannot grasp difficult concepts... Culture can only be taught in Navajo; without language, knowledge cannot be transmitted." A third informant told why he thought the Navajo language was being lost: "You are asking questions about the reasons that we are moving out of our language; I know the reason. The television is robbing our children of language... It is not only at school that there are

teachings, teachings are around us and from us there are also teachings. Our children should not sit around the television. Those who are mothers and fathers should have held their children close to themselves and taught them well, then our grandchildren would have picked up our language." Dr. Parsons Yazzie concluded, "The use of the native tongue is like therapy, specific native words express love and caring... Knowing the language presents one with a strong self-identity, a culture with which to identify, and a sense of wellness" and "elder Navajos want to pass on their knowledge and wisdom to the younger generation. Originally, this was the older people's responsibility. Today the younger generation does not know the language and is unable to accept the words of wisdom."

Symposium participants received a copy of Dr. Cantoni's 256-page monograph *Stabilizing Indigenous Languages*, the proceedings of the 1st and 2nd symposia, and will receive by mail the proceedings of the Fourth Symposium in the Fall. The Fifth Annual Stabilizing Indigenous Languages Conference will take place on May 14-16, 1998, in Louisville, Kentucky, at The Galt House East.

The Louisville conference theme is "Strategies for Language Renewal and Revitalization," and it is being co-chaired by Robert N. St. Clair and Evangeline Parson-Yazzie. Dr. St. Clair co-edited the 1982 National Clearinghouse for Bilingual Education publication *Language Renewal Among American Indian Tribes: Issues, Problems, and Prospects*.

The deadline for proposals for sessions to be presented at the conference is January 12, 1998. Send abstracts to Dr. Robert N. St. Clair, Department of English, University of Louisville, Louisville, KY 40292. Fax: (502) 852-4182. Phone: (502) 852-6801. Or make contact via E-Mail: [rnstcl01@ulkyvm.louisville.edu.com](mailto:rnstcl01@ulkyvm.louisville.edu.com). An e-mail copy of the call for papers and a

CONTINUED ON PAGE 22

ute enormously to each of those aspects.

*There is good reason... to support reading in both the first language and the second language. Reading in the primary language can provide much of the common underlying proficiency (Cummins, 1981) that helps ensure English language development, and English reading will promote English language development directly. There is also evidence that a reading habit in the first language transfers to the second language. . . . [F]ree reading in the first language may mean more reading, and hence more literacy development in the second language (p. 66).*

If bilingual education is doing well now, just think of how well it could do if children had access to reading, in both the first and second language... If we took school libraries and reading seriously, we could do even better [than the 50th percentile that many children reach in fifth grade]: Our children would score in the 60th, 70th, 80th, and 90th percentiles in language and reading and bilingual education would be inoculated against attack (p. 69).

As a dividend, the appendix of the book provides a critique of Rossell and Baker's attack on bilingual programs published in *Research in the Teaching of English* ("The educational effectiveness of bilingual education," 1996: 30:7-74). Krashen finds numerous problems with Rossell and Baker's conclusion that submersion and immersion are superior to bilingual education. With regard to English reading comprehension, Rossell and Baker say that 20 studies show submersion to be superior to bilingual education. Of these 20, Krashen found that only 2 had been published in the professional literature, and he was able to get information on only one more. Rossell and Baker claim that immersion was more effective than bilingual education for English reading in eight studies. Krashen was able to find information on only six of the studies. None of these supported the findings claimed by Rossell and Baker for a variety of reasons including the fact that Canadian-style immersion is similar, if not identical, to bilingual education. One unpublished study cited by Rossell and Baker compares two

McAllen, Texas programs. Rossell and Baker label one immersion and the other bilingual education. However, the immersion program's goal was bilingualism — development of both languages; English instruction was taught in the morning and Spanish reading was taught in the afternoon. Also, the program labeled "bilingual education" by Rossell and Baker was not apparently a good program since the classes were taught concurrently, a method shown to be ineffective (Legarreta, 1979). In addition, Krashen reviews several published studies that were not cited or classified by Rossell and Baker as unacceptable. Krashen's conclusion is that the reason for omitting the studies or claiming that they were unacceptable is that they demonstrate that bilingual education works.

Krashen's passion is neither distracting or unprofessional; it provides the reader with information and data needed to counter the assault on bilingual education programs. *Under Attack* is a crucial document for supporters of bilingual education. But, even more importantly, it is essential for administrators and policy makers, those who have key roles regarding programs and policies affecting the education of limited English proficient students. The teachers I work with in professional development seminars often ask how they can develop concise and well — developed arguments to use to counter the intensity and hostility of those against primary language instruction. Now I hand them a copy of *Under Attack* and recommend they study it carefully.

*DeAnne Sobul works at Youth Education Services at the University of California - Los Angeles.*

• NABE •

conference registration form is available by e-mailing Jon.Reyhner@nau.edu.

For the Fifth Conference, the Co-chairs are especially interested in American Indian story telling and how this information can be used to create readers. They are also interested in American Indian art traditions and how this information can be used to teach philosophy of life. Furthermore, they seek workshops for beginners who want to start language and culture programs. They want those who are newcomers to join an extended family of teachers, researchers, parents, and who want to renew their traditions and revitalize their cultures. They seek strategies, insights, and knowledge.

**Editor's Note:** Contributions to the Issues in American Indian/Alaskan Native Education column should be sent to Dr. Jon Reyhner, Center for Excellence in Education, Northern Arizona University, P.O. Box 5774, Flagstaff, AZ 86011-5774, or E-mail to: jon.reyhner@nau.edu, (520)523-0580, fax: (520) 523-1929.

• NABE •

---

ESL — FROM PAGE 19

crease their opportunities for academic success.

*Dr. Joel B. Judd works at the Missouri Department of Education and Ms. Kimberley Kreicker is of the Kansas State Board of Education.*

**Editor's Note:** Contributions to the ESL in Bilingual Education column should be sent to Dr. Jack Milon, Department of Curriculum and Instruction/282, College of education, University of Nevada, Reno, NV 89557-0214. Fax: (702) 784-6298, or E-mail: jpmilon@unr.edu.

• NABE •

**NABE '98**

**February 24 - 28  
Dallas, TX**

276

# Upcoming Events

**August 1-3, 1997 - Third Annual Conference on Teaching Spanish to Native Speakers.** Las Cruces, NM. Contact NMSU at (505) 646-7876 fax.

**August 1-4, 1997 - American Association of Teachers of Korean 3rd Annual Conference.** Phoenix, AZ. Contact John Koo at (602) 965-7126.

**September 15 - October 15, 1997 - Hispanic Heritage Month.** Check for local activities.

**October 9-11, 1997 - National Association of State Boards of Education Annual Conference.** Charleston, SC. Contact NASBE at (703) 684-4000 <<http://www.nasbe.org>>

**October 15-19, 1997 - Council of Great City Schools Annual Conference.** Detroit, MI. Contact CGCS at (202) 393-2427 <<http://www/cgcs.org/conf>>

**October 15-21, 1997 - Society for Advancement of Chicanos and Native Americans in Science Annual Conference.** Houston, TX. Contact Mark Jordan at (408) 459-4272.

**October 16-18, 1997 - American Council on Education Conference "Educating One-Third of a Nation: Diversity, Opportunity and American Achievement."** Miami, FL. Contact Lachone Fuquay at (202) 785-8056.

**October 25-28, 1997 - Hispanic Association of Colleges and Universities 10th Annual Meeting.** San Antonio, TX. Contact HACU at (210) 692-3805.

## New Documentary on César Chávez to Air on PBS September 1st at 8pm

*The Fight in the Fields, César Chávez and the Farmworkers' Struggle*, a two-hour documentary, will air on PBS on September 1st, at 8:00 pm (check local listings). The companion book, published by Harcourt Brace, is available now in bookstores.

César Chávez was a great labor leader and community activist who was able to bridge the gap between migrant farmworkers and the American public. This film captures his message and philosophy of creative non-violence, and preserves an important chapter in our history.

Chávez inspired the Chicano activism of the 60's and 70's and united working-class Mexican Americans with students, religious people, unions, and ordinary people of good will throughout the country in a fight for social justice. Millions of Americans supported the grape boycott and won the farmworkers their first contracts.

The film is produced by Rick Tejada-Flores and Ray Telles, both veteran documentary producers, and is a presentation of the Independent Television Service. Major funding was provided by the National Endowment for the Humanities, with additional support from the Corporation for Public Broadcasting.

The companion book was written by Susan Ferris and Ricardo Sandoval, edited by Diana Hembree, with photo editor Michele MacKenzie. It offers an in-depth look at the life of César Chávez and the history of the farmworkers movement. The book includes guest essays by a variety of contemporary authors.

School, libraries, and community organizations can purchase videocassettes, copies of the companion book, study guides and posters by contacting (800) 903-7804 or [www.itvs.org/chavez](http://www.itvs.org/chavez) or writing: *The Fight in the Fields*, Dept. A, Box 3250 Sparks, NV 94332-3250.

**For more information, contact:**

**Rick Tejada-Flores**  
(415) 285-5687  
e-mail [grtf@igc.org](mailto:grtf@igc.org)

# 1998 NABE Bilingual Education Outstanding Dissertations Competition

## **ELIGIBILITY**

The competition is open to those who have completed doctoral dissertations in the field of bilingual education between June 1, 1994 and August 1, 1997. Studies using any research approach (historical, experimental, survey, etc.) are eligible. Each study will be assessed in light of the research approach used, the scholarly quality of the dissertation, and the significance of its contribution to knowledge in the bilingual education field.

## **APPLICATION**

Those who wish to apply should seek application information from their professors or from:

Alfredo G. de los Santos Jr., Chair  
NABE Outstanding Dissertations Competition - 1998  
Maricopa Community Colleges  
2411 West 14th Street  
Tempe, AZ 85281-6941  
(602) 731-8101

## **RECOGNITION**

In effect, there will be two types of winners:

- (a) the semifinalists — the writers of the top seven to ten abstracts from which the three finalists will be selected, and
- (b) the three finalists — the writers of the dissertations selected by a panel of judges as first, second, and third place winners.

All semifinalists will be presented at the 27th Annual International Bilingual-Bicultural Education Conference of the National Association for Bilingual Education in Dallas, Texas, on 24-28 February 1998. The National Association for Bilingual Education will pay for the travel expenses and per diem to the convention for the three finalists.

## **DEADLINE**

Six (6) copies of the dissertation abstract prepared as directed in the guidelines must be received by **September 5, 1997**. Send them to the competition chair at the above address.

Hispanic Caucus and other bilingual education allies in Congress to generate White House support for these programs.

During the last year, the individual efforts of NABE members and the educational work of Association staff thwarted the big-money lobbying campaign of the language-restrictionist organizations *U.S. English* and *English First*. Although the House of Representatives passed official-English/English-only legislation in the 104<sup>th</sup> Congress, the legislation was never brought to the Senate floor in the 104<sup>th</sup> Congress. And, despite intense lobbying by *U.S. English* and *English First*, there has been no action on official-English/English-only legislation in the 105<sup>th</sup> Congress.

Last year, NABE significantly expanded its successful three-year-old Policy Education Program (PEP). Seven policy interns, an intern coordinator, and two policy fellows worked in the Association's Washington office this summer developing their knowledge about the formulation of federal education policy and their leadership skills. This year's PEP participants played a major role in helping the Association achieve the policy victories noted above. As this is being written, the "PEPPers" are preparing to depart Washington to return to their jobs and college studies. We are saddened by their leaving, but grateful for the energy, enthusiasm, and fresh thinking they brought to NABE. They will, we are confident, work throughout their lives to improve the quality of education provided to language-minority students.

#### Directions for the New Year

NABE's "New Year" is off to a strong start. The Executive Board of Directors selected three outstanding individuals to lead the Association during the 1997-1998 term. Josefina Villamil Tinajero, from El Paso, Texas, was elected President; David Baez, from Buffalo, New York, was tapped to be Vice President; and Susan García, from Denver, Colorado, was chosen as Secretary/Treasurer.

Together with their colleagues on the Executive Board, NABE's new leaders are committed to advancing the Association's mission and empowering its members.

Even at this early stage of the Association's "New Year," a number of additional NABE priorities are clear. Let me share three of them.

First, the Clinton Administration's recently-announced plans to develop a "voluntary" national test of student achievement for implementation in 1999 presents us with a formidable challenge. In the past, minority students, particularly language-minority students, have been victimized by standardized testing. We cannot allow the new national test to become another instrument to deny opportunity to language-minority students. At the same time, we must use the debate over the national test to raise national standards for language development.

In mid-June, Education Secretary Riley convened a meeting of education association executives to discuss a broad range of policy issues. Near the end of the meeting, Secretary Riley cited the rise in U.S. student scores on the Third International Math and Science Survey (TIMMS) as evidence that school improvement and education reform efforts were working. The Secretary used the TIMMS test scores as a segue to his final point of the meeting — asking the assembled education association executives to rally

behind the President's plan to develop a voluntary national test of student achievement.

Although I knew the answer from prior discussions with Department of Education staff, I asked Secretary Riley to describe how the test would apply to limited-English-proficient students. The Secretary answered that the Department planned to develop a mathematics test in Spanish for native Spanish-speaking LEP students. With respect to language arts, the Secretary stated that the test would be in English, and LEP students would not be tested until they had been enrolled in an English-language instructional program for three years.

Secretary Riley seemed surprised when I expressed dismay over the plans. "Jim," he said, "I know that NABE believes in the importance of children learning English; and I'm sure you agree that the only way you can test English proficiency is in English." "To be fair to LEP students," he added, "we won't test them until they have had an opportunity to become proficient in English."

I responded to the Secretary by affirming NABE's commitment to developing students' English proficiency, and acknowledged that English proficiency is, indeed, best measured in English. "NABE's concerns," I continued, "are deeper than the test; they concern the nation's low standards and expectations for language development. We are one of the few nations in the world which views monolingualism and monoliteracy as an acceptable educational standard for language development. A national assessment of student language arts performance based on a monolingual English test will not only shortchange bilingual students, but will also retard the nation's progress toward meeting world-class standards of educational performance," I concluded. The Secretary responded that he and his staff welcomed further discussion about the test. "You can count on it," I promised.

A second priority for the "New Year" is to assist NABE members in California and our California Association for Bilingual Education (CABE) affiliate in preventing the passage of a proposed ballot initiative entitled "English for the Children." This initiative, conceived and promoted by a wealthy software entrepreneur named Ron Unz, would virtually eliminate native language instruction in the state, the most linguistically diverse in the nation. Mr. Unz, who bills himself as a conservative libertarian, ran unsuccessfully against Governor Pete Wilson for the Republican gubernatorial nomination in 1994. Unz distinguished himself from Wilson by opposing — largely on economic grounds — Proposition 187 barring public benefits, including education, to undocumented immigrants. Now claiming that children can learn English in a matter of months and that bilingual education is responsible for the poor performance of Hispanic students, Mr. Unz has launched his campaign to "end bilingual education in California by June 1998." Further information on the Unz initiative can be found on the Internet at <http://www.onenation.org>.

A third priority for this year is to make NABE '98, February 24-28, 1998 in Dallas, Texas the biggest and most valuable conference ever. Dallas, the eighth largest school district in the nation, enrolls nearly 150,000 students and had a 1995-96 budget of more than \$1 billion. The number of students speaking languages other than English has increased an average of 9.8% since 1985 with an

average growth of 15% since 1994. Current projections indicate that at this average rate of increase, the SOL (speakers of other languages) population will constitute 50% of the Dallas Public Schools (DPS) enrollment by the year 2003.

Under the leadership of Superintendent Yvonne González, the DPS has embarked on a major multilingual/multicultural program based on "a comprehensive, additive approach to cognitive and linguistic development." Together with Superintendents from other districts in the Dallas metropolitan area, Dr. González sees NABE '98 as a national staff development event with long-term impact. To maximize the staff development potential of the NABE conference, twelve full hours of workshops and presentations will be offered on Thursday and Friday. NABE '98 will offer a record number of sessions to a record number of participants.

I would like to close this message by sharing the "New Year" resolution of the Association's staff and Executive Board: to better serve you, NABE members, and to intensify our efforts to secure educational equity and excellence for all children in America. With your cooperation and active involvement, we can make the "New Year" the best ever for language-minority students and their families!

« NABE »

## NABE Action Alerts now available through the Internet

NABE sends special Action Alerts to members and subscribers to inform them of the latest developments in Washington concerning bilingual education. These Action Alerts are now available by e-mail. Before the end of the summer, current Action Alerts will also begin to be posted on the NABE World Wide Web site.

To subscribe to the Action Alert electronic mailing list, send an e-mail message to:  
<majordomo@nabe.org>,  
with the following text as the message body:  
subscribe actionalert <your e-mail address goes here>.

NABE's Web site can be accessed at  
<<http://www.nabe.org>>.

## Intern and Fellowship Positions Available at NABE

The NABE Policy Internship and Fellowship Program is a rigorous apprenticeship for individuals interested in policy issues of education, multiculturalism, language diversity or civil rights.

The heart of the NABE Policy program is direct participation of interns and fellows in NABE's central policy activities including:

- ◆ policy research and analysis
- ◆ advocacy before Congress
- ◆ collaboration with other national education or civil rights organizations
- ◆ administrative duties

Interns and fellows must have outside support to participate; no financial assistance is available from NABE.

To apply, please send a cover letter and resume, a short writing sample, and letter(s) of recommendation to Jaime A. Zapata, Associate Director for Legislation and Public Affairs, at NABE.

You may also check the NABE Web site at <http://www.nabe.org> beginning in June for more information.



# NATIONAL ASSOCIATION FOR BILINGUAL EDUCATION

## MEMBERSHIP APPLICATION



### Membership Type *(check one only)*

- \$48 Individual Membership**
- \$30 Discounted Individual Membership**
  - Parent:** must not be professional educator and must have a child currently enrolled in a bilingual education program. A letter written on school stationery from either the teacher or a school administrator must accompany the NABE membership application.
  - College/University Student:** must not be professional educator and must be enrolled on full-time basis. A copy of an official college or university document showing current enrollment status must accompany the NABE membership application.
  - Paraprofessional:** Must be working as an instructional aide in a public school system. A letter on school stationery from the supervising teacher or a school administrator must accompany the NABE membership application.
- \$43 Combined Membership Name of Affiliate:** \_\_\_\_\_
- \$125 Institutional Membership**
- \$1000 Lifetime Membership**

Memberships are valid for one year from the date of processing, and include one year subscription to NABE publications (except Lifetime, valid for life of member and includes lifetime subscription). Organizational membership is non-voting; all other memberships are voting. All memberships are non-transferrable and may not be cancelled. Membership dues are non-refundable.

### Name and Address Information



- Mr.
- Mrs.
- Ms.
- Dr.

\_\_\_\_\_ Last First Middle



**Preferred Mailing Address:**  Business  Home  
**Business Address**

Position: \_\_\_\_\_

Division: \_\_\_\_\_

Organization: \_\_\_\_\_

Street Address: \_\_\_\_\_

City: \_\_\_\_\_ State: \_\_\_\_\_ Zip: \_\_\_\_\_

Phone: ( ) \_\_\_\_\_ Ext. \_\_\_\_\_

Fax: ( ) \_\_\_\_\_ E-Mail: \_\_\_\_\_

### Home Address

Street Address: \_\_\_\_\_

City: \_\_\_\_\_ State: \_\_\_\_\_ Zip: \_\_\_\_\_

Phone: ( ) \_\_\_\_\_



### I am involved with bilingual education as *(check one)*

- Administrator
- College Instructor
- Consultant
- Full-Time Student
- Paraprofessional
- Parent/Community member
- Publisher Staff
- School Board Member
- Teacher
- Other



### I work in this type of organization *(check one)*

- Commercial organization
- College/university
- Local school district
- State education agency
- Other



### I usually work with this level of student *(check one)*

- Early childhood
- Elementary
- Secondary
- Higher education
- Adult



### I want to participate in the following Special Interest Group *(check one)*

- Adult/Vocational Education
- Asian & Pacific Islanders
- American Indian/Alaskan Native
- Critical Pedagogy
- Early Childhood Education
- Elementary Education
- ESL in Bilingual Education
- Gifted Education
- Global Education
- Higher Education
- Instructional Technology
- Language Policy
- Parent & Community
- Policy Makers
- Professional Development
- Research & Evaluation
- Secondary Education
- Special Education



### Payment Information

\$ \_\_\_\_\_ Membership dues

\$ \_\_\_\_\_ Contribution to help NABE counter the English-only movement

- Check or money order Check# \_\_\_\_\_
- Institutional purchase order # \_\_\_\_\_
- MasterCard  VISA Expiration Date: \_\_\_\_/\_\_\_\_/\_\_\_\_

□ □ □ □ - □ □ □ □ - □ □ □ □ - □ □ □ □

- Automatic Renewal:** Check this box if: you are paying by credit card, and you want NABE to automatically renew your membership annually, charging your credit card the standard renewal amount. This permission will remain in effect until you cancel it in writing.

\$ \_\_\_\_\_ **TOTAL DUE**



**SIGNATURE:** \_\_\_\_\_ **DATE:** \_\_\_\_/\_\_\_\_/\_\_\_\_



## In Memorium

NABE mourns the passing on July 8, 1997 of Gilman Hebert, bilingual education director for the Massachusetts State Department of Education. Born in St. David, Maine, Mr. Hebert's first language was French. After earning his master's degree in education at the University of Maine at Orono, he studied at the *Université de la Sorbonne* in Paris.

During his fifteen-year career with the Department of Education, Mr. Hebert was also director of the Bureau of Equity and Language Services. Previously he was a lecturer with the bilingual/ESL program at the University of Massachusetts-Boston, where he taught bilingual education methodology and Franco-American culture. He also was a guest lecturer at both Harvard and Boston Universities.

"Gil was an outstanding educator," said Robert Antonucci, Massachusetts state commissioner of education. "We will miss his expertise, strong work ethic and compassion for those he served. He made a difference in the lives of many students and educators across the state."

### **NABE NEWS**

National Association for Bilingual Education  
Suite 605  
1220 L Street, N.W.  
Washington, D.C. 20005-4018

NON-PROFIT ORG.  
U.S. POSTAGE  
PAID  
WASHINGTON, DC  
PERMIT NO. 4555



*U.S. Department of Education  
Office of Educational Research and Improvement (OERI)  
National Library of Education (NLE)  
Educational Resources Information Center (ERIC)*



## **NOTICE**

### **Reproduction Basis**



This document is covered by a signed "Reproduction Release (Blanket)" form (on file within the ERIC system), encompassing all or classes of documents from its source organization and, therefore, does not require a "Specific Document" Release form.



This document is Federally-funded, or carries its own permission to reproduce, or is otherwise in the public domain and, therefore, may be reproduced by ERIC without a signed Reproduction Release form (either "Specific Document" or "Blanket").

EFF-089 (5/2002)