

DOCUMENT RESUME

ED 460 829

SE 061 932

TITLE Scientific American Frontiers Teaching Guides for Shows
801-805, October 1997-April 1998.

INSTITUTION Connecticut Public Television, Hartford.; Public
Broadcasting Service, Washington, DC.

PUB DATE 1997-00-00

NOTE 84p.; Underwritten by GTE Corporation. Series produced by
The Chedd-Anglier Production Company with "Scientific
American" magazine. Classroom materials produced by Media
Management Services, Inc.

AVAILABLE FROM Scientific American Frontiers Program, 105 Terry Drive,
Suite 120, Newtown, PA 18940. Tel: 800-315-5010 (Toll Free);
Fax: 215-579-8589; e-mail: saf@pbs.org; Web site:
<http://www.pbs.org>.

PUB TYPE Guides - Classroom - Teacher (052)

EDRS PRICE MF01/PC04 Plus Postage.

DESCRIPTORS Animal Caretakers; Aquariums; *Art; Creativity; Ecology;
*Educational Television; Elementary Secondary Education;
*Science and Society; Science Instruction; Technological
Advancement; *Zoos

IDENTIFIERS *Panama; Panama Canal; *Pseudoscience; Scandinavia;
Smithsonian Institution

ABSTRACT

These teaching guides are meant to supplement the eighth season (1997-98) of the PBS Series "Scientific American Frontiers". Episode 801 is entitled "Expedition Panama: Science at the Smithsonian Tropical Research Institute" and the teaching guide contains information and activities on the ultrasonic communication of bats, communication among Panama's stingless bees, problems with the watershed of the Panama Canal, the role of leafcutter ants in the rainforest, and the impact Panama has had on the earth's climate and animals. The teaching guide for Episode 802, entitled "Beyond Science? Investigations into Pseudoscience," includes information and activities on dowsing to detect underground water, handwriting analysis, the debate over aliens landing at Roswell, New Mexico, perpetual motion and zero-point energy, and therapeutic touch. Episode 803 is entitled "Nordic Sagas: Science in Scandinavia" and features information and activities on Viking ships, the birth of an island from a volcano (Surtsey), the contamination of Lapland reindeer resulting from the Chernobyl disaster, studying genetics through Iceland's unique population, and the use of technology to enhance the lives of people with disabilities. Episode 804 is entitled "The Art of Science: Enhancing Creativity through Science and Technology" and contains information and activities on a 20th-century version of Ben Franklin's glass harmonica, the creation of a digital character for a speaking part, restoration of the Shaw Memorial, a robot programmed to conceive and create paintings, and an interactive opera performed by hyperinstruments. Episode 805 is entitled "The New Zoos: Enriching the Minds and Lives of Animals" and presents information and activities on polar bear enrichment at the San Diego Zoo, the study of orangutan psychology at Toronto's Metro Zoo, the medical center at the New England Aquarium, high-tech tracking of giant bluefin tuna, captive breeding programs, and a jungle boot camp for golden lion tamarins. (WRM)

Reproductions supplied by EDRS are the best that can be made
from the original document.

**Scientific American Frontiers
Teaching Guides for Shows 801-805
October 1997-April 1998**

- **Expedition Panama**
- **Beyond Science?**
- **Nordic Sagas**
- **The Art of Science**
- **The New Zoos**

Hosted By Alan Alda

GTE

PBS

PERMISSION TO REPRODUCE AND
DISSEMINATE THIS MATERIAL HAS
BEEN GRANTED BY

J. Gordon

TO THE EDUCATIONAL RESOURCES
INFORMATION CENTER (ERIC)

2

U.S. DEPARTMENT OF EDUCATION
Office of Educational Research and Improvement
EDUCATIONAL RESOURCES INFORMATION
CENTER (ERIC)

- This document has been reproduced as received from the person or organization originating it.
- Minor changes have been made to improve reproduction quality.

• Points of view or opinions stated in this document do not necessarily represent official OERI position or policy.

EOG1932

SCIENTIFIC
AMERICAN
FRONTIERS

OCTOBER 8, 1997 • 8-9 PM

TEACHING GUIDE FOR SHOW 801



Expedition Panama

Science at the Smithsonian Tropical Research Institute



A PBS SPECIAL



Hosted by
Alan Alda

GTE

Underwritten by GTE Corporation



Visit FRONTIERS on PBS Online!



Be sure to visit and bookmark our newly redesigned Web site (<http://www.pbs.org/saf/>). Many of the past years' teaching guides will be archived online, with an index to search by subject area. You'll also find activities, resources and more links.

GTE GIFT Grant



Each year, GTE Corporation awards grants of \$12,000 to 60 teams of one math and one science teacher from the same school. Teachers of grades 6-12 from selected states may apply for these grants, which are designated for school enrichment projects and professional development. Winning educators have used their grants to fund exciting projects, from weather stations to aquafarms, robotics labs and much more. It's a great way to develop original projects that connect math, science and technology. For an application or to learn if your state is among the 35 that are eligible, call 800-315-5010. Applications must be postmarked by January 16, 1998.

NEXT TIME ON FRONTIERS

Tune in November 19, 1997, when SCIENTIFIC AMERICAN FRONTIERS

investigates pseudoscience. Learn how to tell science fiction from science fact in **Beyond Science?**

VIEWER CHALLENGE

You and your students can enter the **Viewer Challenge** (p. 4) and have a chance to win a terrific FRONTIERS T-shirt! The correct answers to the **Viewer Challenge** questions are:

1. d
2. bats make sounds at frequencies higher than humans can hear
3. island created when dam built and area flooded to make canal
4. b, c
5. b
6. series of buzzes and a dance
7. c
8. oceans separated, Caribbean became warmer, new environments created and species evolved, Gulf Stream formed, Europe warmed, evolutionary pressure on early humans
9. 20%
10. c

Dear Science Educator,
We are delighted to present you with this teaching guide for **Expedition Panama**, an exciting television special that kicks off the 1997-98 season of SCIENTIFIC AMERICAN FRONTIERS. The season premiere is scheduled to air on PBS nationally on Wednesday, October 8, and will take viewers on an exciting scientific excursion to Panama's rain forest, an amazingly diverse and complex environment.

Over the past seven years, hundreds of thousands of educators across America have come to count on the FRONTIERS teaching guides for valuable ideas and interactive classroom activities designed to stimulate students' interest in science. This season, as in the past, educators who are enrolled in the FRONTIERS School Program will receive a free teaching guide to accompany each of the five specials. Look for your guide about two to three weeks before each show airs.

The five-part FRONTIERS series entertains and educates viewers of all ages, showing us interesting and life-changing science while profiling the men and women who make it all happen. Long-time science buff Alan Alda returns for his fifth season as series host to explore the relationship between science and art, to take us to Scandinavia, and to visit zoos where work is being done to improve the lives of animals both in captivity and in the wild.

GTE Corporation and *Scientific American* magazine are involved with SCIENTIFIC AMERICAN FRONTIERS for two key reasons: it provides intelligent television for the home and, even more important, it brings science to life in the classroom. It is our hope that FRONTIERS will help make science more exciting and meaningful to your students.

Let us take this opportunity to thank you for using SCIENTIFIC AMERICAN FRONTIERS in your classroom and for helping shape the lives of America's young students. We hope you'll find many uses for this resource in your classroom this year and beyond.

Sincerely,

Chuck Lee

Charles R. Lee
Chairman and CEO
GTE Corporation

John J. Hanley

John J. Hanley
President and CEO
Scientific American

TIPS FOR TEACHERS

TAPING THE SHOW:

- ✓ Always check TV listings to confirm air date and time.
- ✓ As a teacher, you have off-air taping rights in perpetuity for classroom use.
- ✓ If you can't find the show in your TV listings, call your local PBS station.
- ✓ Do you need help? Call the FRONTIERS School Program at 800-315-5010.
- ✓ Videotapes of past shows can be purchased (\$21.97 each). Call 800-315-5010.

FREE VIDEOTAPING & PHOTOCOPYING RIGHTS:

GTE Corporation, the series underwriter, makes available complete off-air taping rights in perpetuity for classroom use of SCIENTIFIC AMERICAN FRONTIERS. Educators may record each show when it airs on PBS and keep the tapes to use in the classroom year after year. Educators may also photocopy all materials in this guide for classroom use.

SCIENTIFIC AMERICAN FRONTIERS is closed-captioned for the hearing-impaired and is narrated by Descriptive Video Service (DVS) for visually impaired audiences. The series and School Program are endorsed by the National Science Teachers Association (NSTA) and the National Education Association (NEA).

Expedition Panama

SHOW 801 • OCTOBER 8, 1997 • 8 PM* ON PBS

ECHOES IN THE NIGHT 6

Scientist Elisabeth Kalko spends her nights in the forest with a bat detector, monitoring the ultrasonic communication of bats.

Activities: How much do you know about bats? . . . Echolocation techniques in bats and other animals.

BEE LINES 7

Panama's stingless bees communicate with pulses so precise they can let other bees know just where to find food.

Activity: Insects Rule! Trap and observe insects in action.

RAT SOUP 8

A pilot project involving Panamanian rodents could help solve problems in store for the Panama Canal.

Activities: How locks work. . . Watersheds and their problems.

CHAMPION CHOMPERS 10

Leafcutter ants and their fungus gardens enjoy a unique relationship in the tropical rain forest.

Activities: Champion weight lifters of the insect world. . . Thinking about the rain forest.

BRIDGE THAT CHANGED THE WORLD 12

The tiny Isthmus of Panama formed a land bridge with global consequences, from climate to animals to human evolution.

Activities: What's behind the Coriolis effect. . . A timeline of events.

Plus, in every issue . . .

VIEWER CHALLENGE: Quiz questions, T-shirt prizes! . . . 4

THE BIG PICTURE: Panama at a glance . . . 5

FRONTIERS ONLINE: Visit us at <http://www.pbs.org/saf/> . . . 14



AT-A-GLANCE



EXPEDITION PANAMA

NOTE: More detailed curriculum links are included on the activity sheets to individual stories.

STORY	RUNNING TIME	BIOLOGY	EARTH SCIENCE	GENERAL SCIENCE	LIFE SCIENCE	MATH	PHYSICAL SCIENCE
Echoes in the Night	12:18	•	•	•	•		•
Rat Soup	12:13	•	•	•	•		•
Bee Lines	9:38	•		•	•		
Champion Chompers	5:56	•	•	•	•		•
Bridge That Changed the World	7:40	•	•	•	•	•	•

*CHECK LOCAL TIME

SCIENTIFIC AMERICAN FRONTIERS is made possible by an underwriting grant from GTE Corporation. The series is produced by The Chedd-Angier Production Company in association with *Scientific American* magazine and presented to PBS by Connecticut Public Television. Classroom materials produced by Media Management Services, Inc.

Bat pictures in the cover artwork courtesy Elisabeth Kalko.





Expedition Panama

Show 801 / October 8, 1997, at 8 pm* on PBS



STUDENT'S NAME: _____

TEACHER'S NAME & COURSE: _____

*CHECK LOCAL LISTINGS

Watch **SCIENTIFIC AMERICAN FRONTIERS** for answers to questions on this page. Answer the 10 questions correctly and you'll be eligible to win a **FRONTIERS T-shirt!**

Echoes in the Night

1. What sense do bats seen on **FRONTIERS** primarily use to find their prey?
 a. touch b. smell c. sight d. hearing
2. Why can't humans hear bat calls?

Rat Soup

3. How was Barro Colorado Island created?

4. How are scientists at the rain forest pilot project getting rid of the aggressive grass? (choose 2)
 a. spraying with herbicide
 b. planting fast-growing bean trees
 c. cutting it down
 d. replacing with genetically engineered grass

Bee Lines

5. The Panama bees featured in the story are distinctive for all of the following reasons *except*:
 a. they are stingless
 b. they don't make honey
 c. they are selective about nests
 d. they communicate about height

6. How do the bees in the story communicate information?

Bridge That Changed the World

7. About how long did it take the Isthmus of Panama to form?
 a. 18 million years
 b. 4 million years
 c. 14 million years
 d. 20 million years
8. Identify at least *two* consequences of the formation of the Isthmus of Panama.

Champion Chompers

9. Scientists calculate that the leafcutter ants devour what percent of the forest foliage each year?

10. What happens to the leaves that the ants bring back to their nest?
 a. The ants eat them.
 b. The ants use them to mark trails.
 c. Fungus grows on them.
 d. The leaves are used to make nests.

EXTRA CREDIT CONTEST!



FOR TEACHERS ONLY

Have you ever been on a scientific expedition? If so, we'd like to hear about it! In 100 words or less, tell us about your experience and what you learned. Mail your entry by November 7, 1997 to Extra Credit Contest at the address to the right. The most unique entry will be posted in the Polls & Prizes section on the **FRONTIERS** Web site and the winner will get a T-shirt. Good luck!

Answers to the Viewer Challenge are listed on page 2 of this guide. T-shirt winners' names will be posted in the Polls & Prizes section of the FRONTIERS Web site.

When completed, this page can become an entry to the **FRONTIERS** T-shirt contest; 20 winners (10 students, 10 teachers) will be drawn at random for each show. To enter the T-shirt drawing, send all completed challenges in one envelope with a cover sheet to: **Viewer Challenge, SCIENTIFIC AMERICAN FRONTIERS, 105 Terry Drive, Suite 120, Newtown, PA 18940-3425.** Mail completed entries by **November 7, 1997.**

TIP: You can download these questions on the Web: <http://www.pbs.org/saf/>.

IMPORTANT!! Please include a separate cover sheet and tell us:

- number of challenges submitted
- teacher's name
- grade and course
- school name, address and phone number
- where your students watched the show — at home, at school or both
- the name of your students' favorite story in this show (conduct a quick poll to find out)

Thank you!



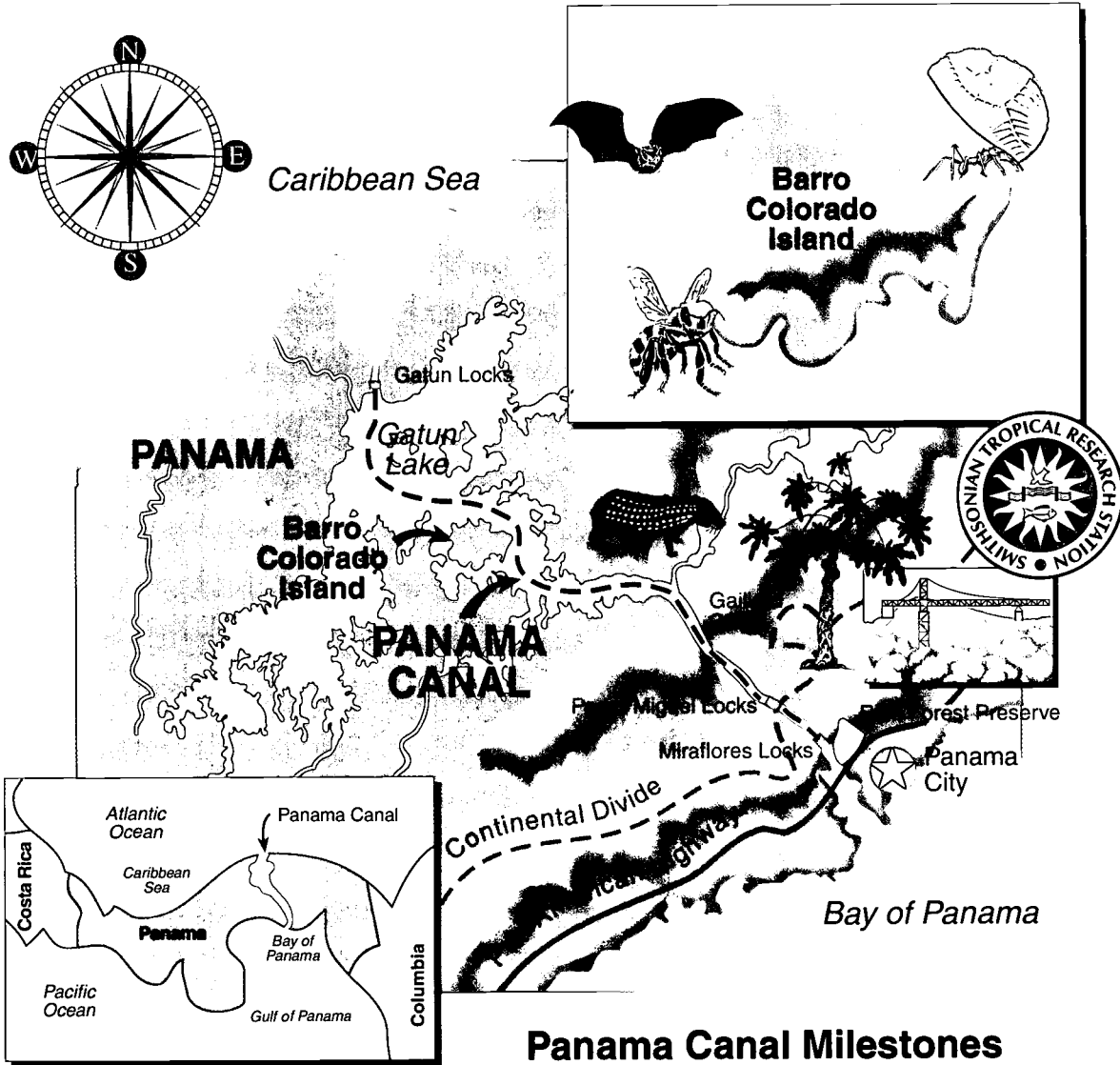

Panama at a Glance

Bienvenidos! Welcome to Panama, the subject for the season premiere of SCIENTIFIC AMERICAN FRONTIERS. Host Alan Alda and the crew have been filming some great science stories, including this visit to the bio-

logical riches of the Panama Canal watershed and the Smithsonian Tropical Research Institute (STRI). Here's a map to help you know where we're going on our expedition to Panama.



Panama Canal Milestones

- | | | | | |
|---|---|--|---|---|
|  |  |  |  |  |
| 1513
Balboa
discovers
Pacific from
the isthmus | 1878
French begin
digging
Panama
Canal | 1904
U.S. takes
over project | 1914
Panama
Canal opens | 1999
Panama
takes over
canal |

Echoes in the Night

What do bats do in the dark? Biologist Elisabeth Kalko has spent the last ten years at Barro Colorado Island, looking for answers to that question. Using a combination of modern technology and old-fashioned field observation, Kalko has made some astonishing discoveries about how bats use echolocation to identify and catch prey. Kalko's work studying bats in the tropical forest and interpreting bat calls will tell us more about these fascinating creatures of the night.

RUNNING TIME: 12:18

CURRICULUM LINKS:

BIOLOGY

animal communication, mammals, vertebrates

GENERAL SCIENCE

animal behavior

EARTH SCIENCE

ecosystems

LIFE SCIENCE

animal classification, pollination

PHYSICAL SCIENCE/PHYSICS

acoustics, echolocation, sound



RELATED FRONTIERS SHOWS & ACTIVITIES:

□ See "Whale Communication" in Show 103 for a story about orca songs.

How Much Do You Know?

How often have you heard someone say, "I'm as blind as a bat!" Bats are the subject of many popular misconceptions and false information; people are both fascinated and repelled by them. No matter how much bats are disliked, they are under-appreciated. As major predators of insects, bats are beneficial and essential to the balance of nature. A common brown bat can devour 600 mosquitoes in one hour!

How much do you know about these creatures of the night?

Answer True or False.

1. Bats are blind.
2. Bats are rodents.
3. Bats are the only flying mammal.
4. Some species of bats are threatened.
5. Bat droppings (guano) are used to make some antibiotics.
6. Bats cause a high percentage of rabies cases.

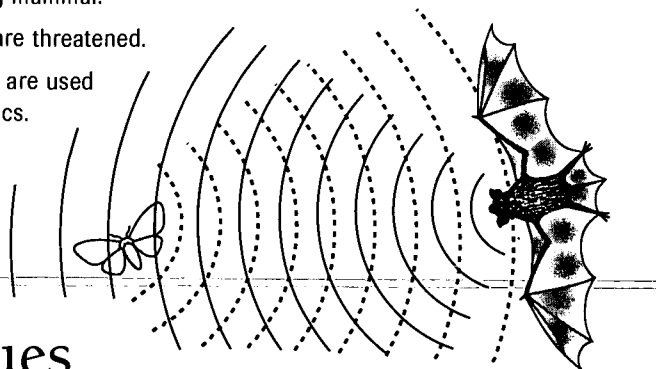

ACTIVITY Echolocation Techniques

Elisabeth Kalko, seen on FRONTIERS, captures, identifies and tracks some of the more than 70 species of bat on Barro Colorado Island as they hunt for fish, fruit and insects. She uses a "bat detector" to convert bat calls so she can hear them.

Bats that use echolocation gauge distance by sending high-frequency, ultrasonic calls (as pulses) and measuring the time it takes for the reflected pulses to return (echo + location). Signals reflected back can also provide information on the type and size of a prey item. Humans can't hear many of the signals bats generate. Bat calls can range from low frequencies (9kHz) to very high frequencies (greater than 200kHz).

The game of Marco Polo is a little bit like echolocation. Can you make up a game that demonstrates echolocation? For example, one game might designate one person as the bat and other people in the group as various "prey" (frogs, fish, insects), each with its own audible code. The bat is blindfolded and has to locate each of its prey by sound. (Another kind of game might be modeled on the game Battleship. "Prey" use codes to designate their locations and the "bat" has to find them.)

EXTENSIONS

1. Compare the ways bats and other animals (dolphins, whales, some birds and shrews) use echolocation.
2. How many references to bats can you find in movies and stories? Investigate some of the legends about bats. Compare the myths to reality. For example, how did the vampire bat get its name?

3. Interested in finding out more about bats? You can find plans for bat houses and bat detectors on the Web. Start with this ultimate Web site for bats: http://www.nyx.net/~jbuzbee/bat_house.html (see page 15 of this guide and the FRONTIERS Web site for more links).
4. Three of the animals featured in this episode of FRONTIERS (bats, bees, ants) are social creatures with complex societies. Compare their social organization.
5. Listen to bat calls at this Web site: <http://www.batcon.org/echo.html>.



Elisabeth Kalko, who appears in this segment, answers your questions online.

SEE PAGE 14 <http://www.pbs.org/eaf/>

HOW MUCH DO YOU KNOW? ANSWERS: 1. F; many bats have poor vision; they are active at night and have developed a keen sense of sound; one sub-order of bats uses sight and smell to find food. 2. F; bats belong to the order Chiroptera; rodents like the paca belong to Rodentia. 3. T. 4. T; over 50% of American bat species are in severe decline or endangered. 5. T. 6. F; most of the fatal cases of rabies in the U.S. are caused by rabid dogs; bats very rarely bite those who handle them.



Bee Lines

With more than 1,000 species of flowering plants to choose from, bees in a tropical rain forest live in paradise. With so many choices, how do they tell the bees back at the hive where a particular food is? STRI's resident bee expert David Roubik has made some remarkable discoveries about Panama's stingless bees. Using a special "bee code," bees can tell other bees exactly where nectar is located — even when the food source is at the top of a 120-foot tower.

RUNNING TIME: 9:38

CURRICULUM LINKS:

BIOLOGY

invertebrates, social insects

EARTH SCIENCE

ecosystems

GENERAL SCIENCE

insects, scientific process

LIFE SCIENCE

animal communication, pollination



RELATED FRONTIERS SHOWS & ACTIVITIES:

□ FRONTIERS has visited Barro Colorado Island before. See "Spider Strategems" in Show 303 for a story about spiders that trap bees.

ACTIVITY **Insects Rule!**

Using the sun as a compass, our familiar honeybees "talk" in a dance language to communicate the direction and distance of flowers to other bees.

Tropical stingless bees dance and also use a complex system of pulses to tell the other bees exactly where to find food. What scientists didn't know was how accurately the bees could pinpoint and direct other bees to the food. STRI scientist David Roubik and Cornell undergraduate James Nieh set up an experiment to find out. The experiment demonstrates the scientific process in action. After you catch or observe some insects (see the activities that follow), brainstorm a theory about insects and how to test it.

Entomologists, scientists who study insects, use several types of trap to collect insects so they can identify them later in the lab. We don't recommend capturing and numbering bees, even stingless ones, the way the scientists do on FRONTIERS. Instead, you can use some tried and true methods of trapping insects right in your own yard. By collecting insects from various locations where you live, you can get an idea just how diverse life on Earth can be.

OBJECTIVE

Learn about biodiversity by collecting insects from different sites.

MATERIALS

- black light or flashlight
- white sheet
- baby food or other small jar
- fruit or other insect bait
- funnel



PROCEDURE

Use the following collection techniques to sample insects from a variety of habitats. Standardize your techniques by collecting at a specific time and for a set amount of time. Be careful if you handle the insects, as some can sting, bite or pinch.

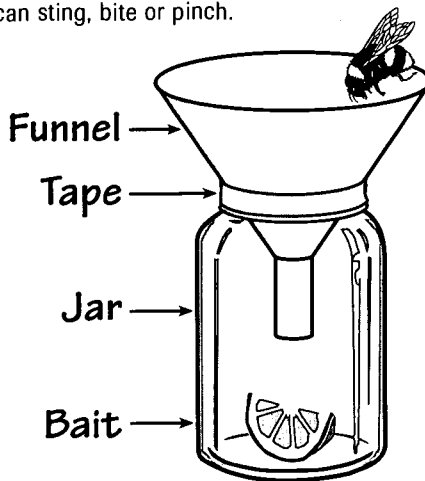

1. In this trap, place a piece of bait (a piece of fruit is good) at the bottom of a small jar. Place a funnel in the opening. Tape the funnel to the jar. Try setting the jar at different heights in trees as well as burying it with the funnel flush with the ground to sample insects from different habitats. How might you design experiments to test if insects are attracted to flower color or flower nectar?

2. Set up a simple insect trap with an ultra-violet "black" light (this wavelength is especially attractive to insects) and a white sheet. (You could use a flashlight instead of the black light.) Shine the light on the sheet. This way, the insects have a place to land and you can identify and count the insects that visit your site without having to capture and kill them. Use a field guide to identify species.

(Note: Some camping lights use black light. If you use any electric light outdoors, be sure to follow appropriate safety considerations.)

EXTENSIONS

1. Can you think of and design other traps that might capture insects for study?
2. Why do you think height is an important issue in the tropics?
3. At any given time, there are probably 10 quintillion insects on Earth. And they have been around for more than 400 million years, making them one of the most successful life forms on earth. Hymenoptera, the order that bees, ants and wasps belong to, is the most successful group of all. Why do you think this is so, and what are some of the adaptations that explain insects' success?
4. Honeybees are in trouble in the U.S. See "Bee Blight" in the June 1997 issue of *Scientific American*. Have honeybees in your region been affected? For more about honeybee talk, see "The Sensory Basis of the Honeybee's Dance Language" in the June 1994 issue.



David Ward Roubik, who appears in this segment, answers your questions online.

SEE PAGE 14 <http://www.pbs.org/saf/>

Rat Soup

It takes 26 million gallons of fresh water for one ship to pass through the Panama Canal — enough to supply Panama City for a whole day. To safeguard the canal, the surrounding watershed must be protected. Slash-and-burn agriculture threatens the watershed, so scientists are looking for ways that local farmers can use the rain forest, rather than cut it down. One of the keys to success is a popular rodent called a paca.

RUNNING TIME: 12:13

CURRICULUM LINKS:

- BIOLOGY**
mammals, vertebrates
- GENERAL SCIENCE**
animal behavior
- EARTH SCIENCE**
ecology, erosion, watersheds
- LIFE SCIENCE**
mammals
- PHYSICAL SCIENCE**
water pressure
- SOCIAL STUDIES**
Central America
- TECHNOLOGY**
dams and locks, engineering



RELATED FRONTIERS SHOWS & ACTIVITIES:

■ **Dragon Science** (Show 602): "Dams and Dolphins" (pp. 6-7)

A Man, A Plan, A Canal — Panama!

The building of the Panama Canal is considered one of the world's greatest engineering feats. Begun over 100 years ago, the 50-mile waterway took the efforts of two nations and more than 25,000 lives to complete. When the U.S. took over the canal project in 1904, American engineer John Stevens developed a plan to dig a canal not

at sea level, but one that would raise ships up and over Panama with a system of locks and gates. This ingenious design required much less excavation. The design depends on a plentiful supply of fresh water for its operation. For more about engineering the canal, see <http://fulton.seas.virginia.edu/~shj2n/case/1panama.html>.

ACTIVITY 1 Locks in Action

The Panama Canal begins at sea level, rises as it crosses the isthmus, then returns again to sea level. A system of lock chambers is used to raise and lower vessels along this up-and-down journey. Here's a simple model that demonstrates how locks work.

OBJECTIVE

Use modeling to understand how locks work.

MATERIALS

- small, clear plastic drawer or organizer, about 2" x 2" x 6", with removable dividers
- waterproof modeling clay
- small toy boat (or a boat molded from clay)
- small cup
- food coloring (optional)

PROCEDURE

1. Take one small plastic organizer with two inserts and identify the plastic slots into which the dividers will be inserted.
2. Roll out six thin strips of waterproof clay. Place the clay into the slot guides on either side of the drawer. Place another strip of clay along the bottom of the drawer. The U-shaped clay will produce a waterproof seal between the dividers and the drawer.
3. Slide the dividers into position, making sure the clay seals any gaps.
4. Carefully pour water into each of the three separate chambers so that the levels are as shown above. If you wish, add several drops of food coloring to the water to make the levels more visible.
5. Place a toy boat onto the surface of the lower chamber. Then use a small cup to carefully remove (and discard) water from the center lock chamber. Continue removing water until the water level matches the first chamber.
6. Gently open (slide out) the lower gate. Move the boat forward into the lock cham-

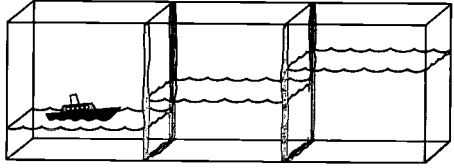

- ber. Reinsert the lower gate, making sure that the seal is once again waterproof.
- 7. Carefully add water to the center lock chamber until the water's surface reaches the higher water level of the last chamber.
- 8. Slide out the upper gate and move the boat into the upper portion of the "river." Replace the upper gate.

QUESTIONS

1. How is this model's operation similar to the actual lock system seen on FRONTIERS? How is it different?
2. What keeps the gate sealed in the lock seen on FRONTIERS?
3. Why is the water level within the center lock chamber, and not within either of the two adjoining compartments, raised and lowered?



Antonio Telesca, who appears in this segment, answers your questions online.

SEE PAGE 14 <http://www.pbs.org/saf/>

DESIGN CHALLENGES

1. Suppose the boat was going from the high water level to the low water level. Create a series of drawings to illustrate the sequence of events that would allow the boat to move through the lock.
2. The gates used in the canal are based on a design engineered by Leonardo da Vinci. Can you design a different model of a lock gate? Once you've designed a new gate, try building a model of it.

2. Trace the route of the Panama Canal on a map. Use clay or other materials to build a model on a piece of plywood. Label the bodies of water surrounding Panama.
3. Find other examples of an isthmus on a world map or globe.
4. Why did people in the 1800s want to build a canal through Central America?
5. You can see how the Panama Canal works on the Web at <http://www.panamet.com/pancanal/public/pictures.htm>. See a photo gallery and a Java animation of the canal in operation at <http://www.panamet.com/pancanal/pcc.htm>.

GEOGRAPHY & HISTORY CONNECTIONS

1. Use the timeline on page 5 of this guide as a starting point for a more elaborate timeline that shows the contributions of France, Panama and the U.S. to the building of the canal. You'll find more information on the Web or in the library.

ANSWERS TO QUESTIONS: 1. accept all reasonable answers 2. water pressure 3. the adjoining compartments are usually part of a large expanse of water.

Paca Parade

The paca (*Agouti paca*) is a large, nearly tailless rodent about 2½ feet long with white spots that lives in forests of Central and South America. A popular item on the menu, it has practically been hunted to extinction. With domestication of the paca, people in these regions look forward to once again buying paca meat at the market.

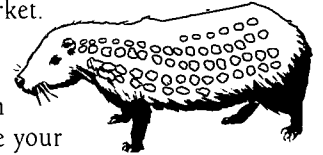

You can practice your Spanish and read about the paca at <http://www.ancon.org/Paca.html>.

Cross-Section of the Panama Canal

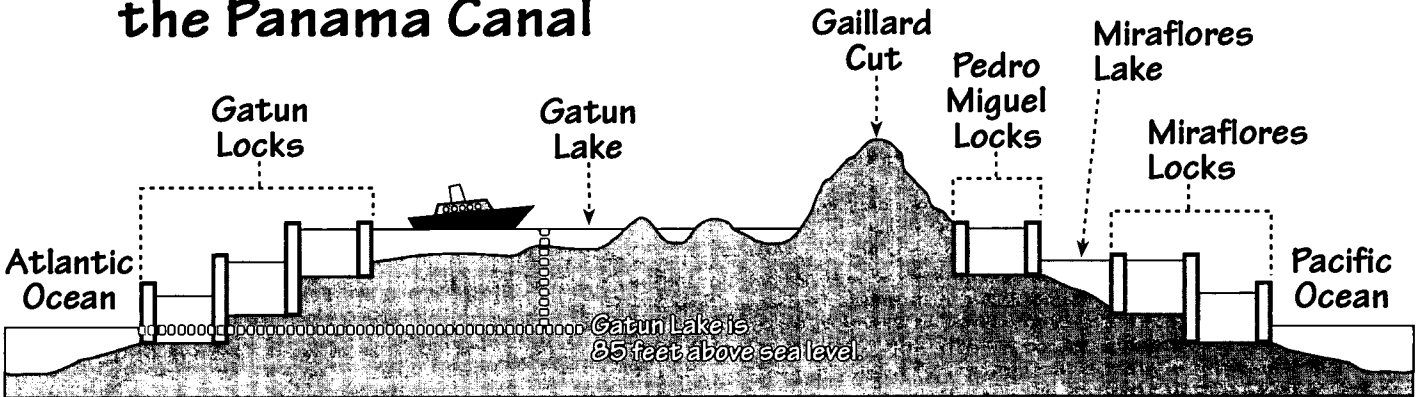

ACTIVITY 2 Know Your Watershed

A watershed (sometimes called a drainage area) is an area of land that is drained by a river or stream. Water flows across or under the land on its way to a stream, river or lake. Streams flow to rivers and eventually to the ocean. The watershed ecosystem around the Panama Canal has been disturbed by introduced grasses and slash-and-burn agricultural methods. Your watershed may have to contend with its own problems.

Use a topographic or physical map to identify your watershed. (One option is to use the "Surf Your Watershed" Web site, which will help you locate your watershed by clicking on a state map. Start at <http://www.epa.gov/surf/>.) Can you trace the

complete route of drainage from your street to the ocean?

Many local conservation groups sponsor watershed programs. Some schools are involved in projects that monitor water quality and are helping to clean up watersheds. Find out what environmental groups are doing near you.

FOR FURTHER THOUGHT

1. Illustrate the cycle of rainfall and evaporation in the Panama Canal watershed.
2. Explain how slash-and-burn agriculture affects the land.
3. The demonstration pilot program to raise paca is one way scientists are working with

local communities to enable people to find local solutions to problems of deforestation. Can you brainstorm any other solutions that involve local people?

4. Find items at your supermarket or health food store made from rain forest products.



Show 801: Expedition Panama



Rat Soup



Champion Chompers

Leafcutter ants have been called “the world’s first farmers.” For millions of years, they have been cutting up leaves from the tropical forest and carrying the pieces to fungus gardens grown in their nests. The ants use the leaves to cultivate the fungus, which in turn provides a home, nutrients and jobs for many different ants in the species. After a quick climb to the canopy, join FRONTIERS on the floor of the rain forest.

RUNNING TIME: 5:56

CURRICULUM LINKS:

- BIOLOGY**
fungi, invertebrates
- CHEMISTRY**
pheromones
- GENERAL SCIENCE**
animal behavior, insects
- EARTH SCIENCE**
rain forest ecology
- LIFE SCIENCE**
animal classification, insects, niche behavior
- MATH**
graphing



Champion Weight Lifters

Tropical leafcutter ants play a significant role in the rain forest ecosystem. One experiment suggests the ants cut as much as 20% of the foliage from trees. The ants do this by cutting leaves into manageable bits and carrying them back to their fungus gar-

dens. The ants don't eat the leaves, but they add the leaves to the fungus (think of a nice, organic mulch enriching the soil). The fungus grows on the leaves, consuming them in the process. Then the ants eat parts of the fungus. It's a great deal for all involved!

RELATED FRONTIERS SHOWS & ACTIVITIES:

- **About All You Can Eat**, Show 502: "Mushroom Mania" (pp. 13-14) □ **Science 911**, Show 404: "Panama Protection Racket" (pp. 9-10) □ Show 202: "Ants That Take Slaves" □ Show 102: "Test-Tube Truffles"

ACTIVITY 1: Weightlifting World Record

As you see on FRONTIERS, even though the ants are small, they are able to carry pieces of leaves that are much larger than their body size. But small size also has its limitations. An ant could never start a fire to keep warm, let alone get close enough to feed it fuel. To gain a new understanding of what it means to “be the right size,” try these mathematical problems.

human weight lifters compare with the champions of the insect world.

OBJECTIVE

Use graphing to compare weightlifting ability of ants and humans.



PROCEDURE

Scientists have found that some ants can lift more than ten times their body weight over their heads. Multiply by ten to find out how

1. Olympic weight lifters are divided into different classes by body weight. Look up records for different classes in the *Guinness Book of Records* or on the Internet (<http://www.usaw.org>).
2. Plot the records for the different classes on a graph. Use the horizontal axis (x) for weight class and the vertical axis (y) for the world record of weight lifted for each class. (Use the record for total amount of weight lifted rather than individual events like clean-and-jerk or snatch.)
3. For each weight class, plot the amount of weight champions should be able to lift if they could lift ten times their weight.

weight? Can you use this to argue that one weight class is performing at a higher level than others?

4. If you could lift an object ten times your weight, how much would the object weigh? Can you think of an object that weighs that amount?
5. If a forest loses 20% of its foliage, what might be the implications?

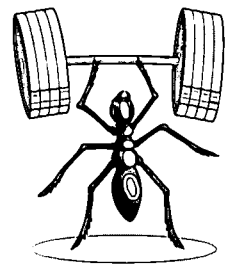

QUESTIONS

1. How far off was each weight class from the amount predicted, using the ant's formula?
2. Why do you think ants can lift so much more (relative to their weight) than humans?
3. Which weight class exhibits the greatest amount of weight lifted relative to body

EXTENSION

The mathematics behind size and its impact on life are much more complicated than the simple formula used above. *Life's Devices* by Steven Vogel and *On Size and Life* by Thomas A. McMahon and John Tyler Bonner provide more information on complex size and scale relationships.



Ulrich Mueller, who appears in this segment, answers your questions online. <http://www.pbs.org/saf/>

ACTIVITY 2 The Ants Go Marching . . .

- Ants produce pheromones to make invisible chemical trails for other ants to follow. You can observe ants at work outdoors.

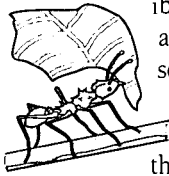

Crumble a cookie or other ant goodie. Then watch the ants make a trail back to the nest to communicate the location of the treat. What happens when you cover the trail with a leaf or piece of plastic?

- Leafcutter ants and fungi are co-dependent; one cannot exist without the other. Investigate the roles ants and fungi play in the forest ecology.

- Leafcutter ants exist only in the New World and mostly in the tropics. Why might this be so?

- Why can ants fall from great heights, yet remain unhurt?

What's Up in the Rain Forest?

The tropical rain forest is a region of incredible biodiversity.

Scientists right now are debating the issue of how rain forests evolved with such diversity. Can you theorize why life in the tropics is more diverse than life in temperate zones?

Why should we care about biodiversity?

The great variety of species in the rain forest may contain cures for illnesses, or genes that one day can be used to help engineer insect- and disease-resistant crops.

It's estimated that *one-fourth* of all medicines are derived from rain forest plants. Can you find examples of drugs derived from plants (digitalis from foxglove, for example)?

Do you know anyone who uses plant remedies?

Some people use aloe to relieve the pain of burns or tea to soothe nerves. Both are ethnobotanical remedies for common maladies. Read "The Ethnobotanical Approach to Drug Discovery" in the June 1994 issue of *Scientific American*.

Life at the top.

Illustrate the levels of the rain forest, from forest floor to the canopy. Where do most species live?

Visit the FRONTIERS Web site and click on "Resources" to learn more about life in the rain forest.

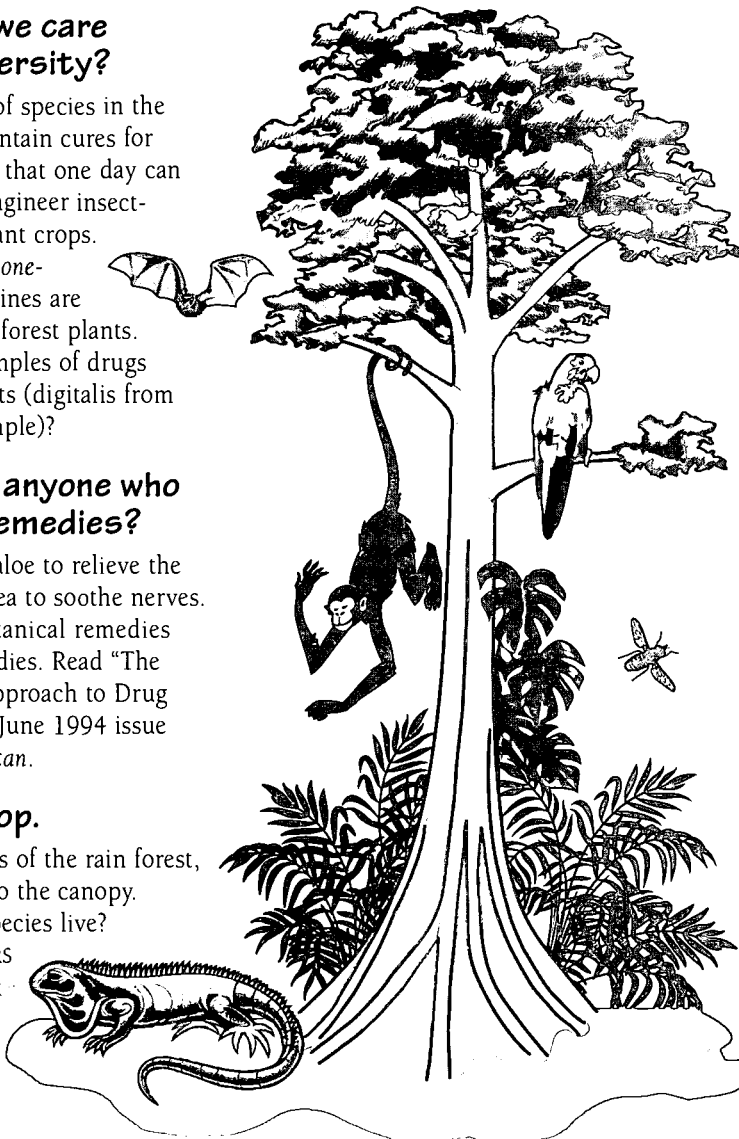

Exploring Insect Diversity



AN INTERACTIVE WEB ACTIVITY

As you see in this episode of FRONTIERS, Panama's rain forest is home to thousands of insect species. At *The Biology Place* (accessible through the FRONTIERS Web site), you'll have an opportunity to participate in online activities that investigate the diversity and abundance of insects worldwide.

- Use an online dichotomous key to identify various insect orders. Examine a photo of an unknown insect and begin by answering questions about observable characteristics. Does it have one or two pairs of wings? Does it have biting or sucking mouth parts?

- Do you want to start an insect collection and participate in collaborative research? Collect data and photographs on butterflies from your region and send them to *The Biology Place* where you can share your findings with other classrooms across the country and around the world. The collective data may contribute to ongoing scientific research. Go to the Web site for details on getting started with your project.



You will find inquiry-based activities like these and more at *The Biology Place* Web site. To get there, visit the FRONTIERS Web site (<http://www.pbs.org/saf/>), choose "Cool Science" and then select "biology.com."

For more information about *The Biology Place*, go to the Visitors' Center at <http://www.biology.com> and take a tour of the site.

SCIENTIFIC AMERICAN FRONTIERS

Show 801: Expedition Panama



Champion Chompers

Bridge That Changed the World

For most of Earth's history, the Isthmus of Panama did not exist. Once it formed and connected the continents of North and South America, the new land bridge produced global consequences. The oceans on either side of the isthmus changed. Currents flowed differently. Animals began migrating north and south. Climates changed and new species evolved. In the words of STRI Deputy Director Tony Coates, "It was the greatest event since the death of the dinosaurs."

RUNNING TIME: 7:40

CURRICULUM LINKS:

- BIOLOGY**
evolution
- GENERAL SCIENCE**
oceans
- GEOGRAPHY**
Central America, isthmus
- EARTH SCIENCE**
climate, ecology, ocean currents
- MATH**
linear speed, rotational speed
- PHYSICAL SCIENCE**
Coriolis effect



Put a Spin on Ocean Currents

The emergence of the Isthmus of Panama four million years ago had global consequences. The new isthmus blocked the flow between the Atlantic and Pacific oceans. As a result, the currents in the Atlantic began to flow northeast to form the Gulf Stream. But why did the water movements form a clockwise current system in the North Atlantic? Why didn't the blocked current flow southeast and produce a counterclockwise flow? By understanding the phenomenon known

as the Coriolis effect, you will be able to answer these questions. The Coriolis effect does not *create* currents, but it does cause them to flow in a particular direction. Once the isthmus blocked the flow, the spinning Earth caused ocean currents to deflect to the right in the Northern Hemisphere and deflect to the left in the Southern Hemisphere.

A difference in linear speeds produces the Coriolis effect. You can measure linear speeds at different places on the planet and

discover this differential for yourself. Remember that every place on Earth has the same rotational speed — it takes 24 hours to make one complete rotation. So points on Earth that have a longer distance to travel go faster. For example, the linear speed of San Francisco is 810 miles per hour, but in Nome, Alaska, it's 360 miles per hour. In the activity below, you will perform simple calculations to compare linear speeds as you learn how Earth's rotation puts a spin on current flow.

ACTIVITY 1 Linear Speed and the Earth

OBJECTIVE

Investigate the effects of Earth's rotation.

MATERIALS

- string
- globe
- ruler

PROCEDURE

1. Wrap a section of string around the equator of a globe. Measure this string against

the scale presented on the globe to determine the length of the equator. (If 2" = 1 mile and the string length is 10", then the length would be 5 miles.) Record the length.

2. Find the location of your town or a nearby city on the globe. Identify its latitude and use a string to measure the length of this latitude line as it encircles the entire globe. Use the globe's scale to determine the length. Record the length.

QUESTIONS

1. How long does it take for any surface point on the globe to travel in one complete rotation?
2. Find the linear speed of any point that lies on the equator. To determine this value, use this equation: speed = distance/time.

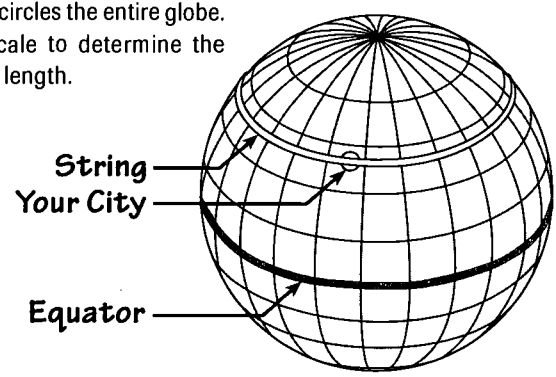

Tony Coates, who appears in this segment, answers your questions online.

SEE PAGE 14 <http://www.pbs.org/saf/>



For example: the circumference of the Earth at the equator measures 24,900 miles. Divide 24,900 by 24 (time). The linear speed for this latitude is 1,037 mph. Compare that speed with the linear speed for a latitude that measures 12,000 miles around the globe (500 mph).

- Find the linear speed for any point that lies on the latitude of your city (follow Step 2). What's the difference in linear speed between your latitude and the equator?
- Which point has a greater linear speed? In which direction is this speed applied?
- Imagine an ocean current that continually veers to the right. What pattern will be formed by this motion?

EXTENSIONS

- Suppose an object traveling on a point due north from the equator maintains its linear speed. How will its extra linear speed affect its path?
- Will the motion of objects and currents in the Southern Hemisphere behave the same as in the Northern Hemisphere? Explain.

EVERYDAY CONNECTIONS

- Examine a spinning phonograph record (if you can still find one!). Discuss how the linear speed varies from the rim of the disc to the center of the disc. How might this example be used to teach about current movements?
- One of the global consequences of changing ocean currents is the El Niño current. How do the Gulf Stream and El Niño affect your climate and weather?
- After the Isthmus of Panama formed, animals traveling south did better than animals that went north. In fact, only three species from the southern continent survive in North America today. Why do you think this happened?

ANSWERS TO QUESTIONS: 1. 24 hours 2. 1,037 miles per hour 3. answers will vary 4. the point on the equator has the greater linear speed; to the right 5. a clockwise circulation pattern

ANSWERS TO EXTENSIONS: 1. It will cause the object to veer to the right. As it moves northward, its speed to the right becomes increasingly greater than the speed of the spinning Earth below, causing it to veer to the right. 2. No. They will have a tendency to move to the left, forming a counterclockwise pattern.

ACTIVITY 2 It's All in the Timing

Four million years may seem like a long time, but in geological terms, it is relatively recent. This timeline should help put the timing of the formation of the Isthmus of Panama in perspective. You might elaborate on selected events in this abbreviated timeline. For example, make a timeline for the emergence and death of the dinosaurs. Or, make a timeline that includes various historic events on Earth, such as continental drift and the various changes in land

masses over the millennia, like Pangaea and Gondwanaland.

Another challenging activity is to figure out how to demonstrate the passage of time using a scale that begins in your classroom and ends somewhere outside you school.

For more information on the Smithsonian Tropical Research Institute's work at the isthmus, read "The Rise of an Isthmus Brings Change on a Grand Scale" in the December 1996 issue of *Smithsonian*.

c. 4.6 billion years ago:

Formation of Earth

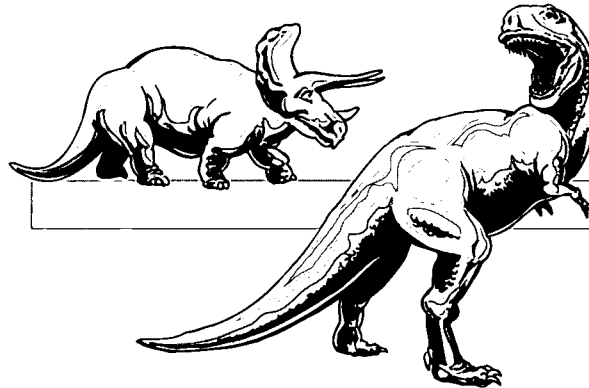

65 million years ago:

Death of dinosaurs

18 million years ago:

Isthmus of Panama begins to form

4 million years ago:

Land bridge between North and South America is completed

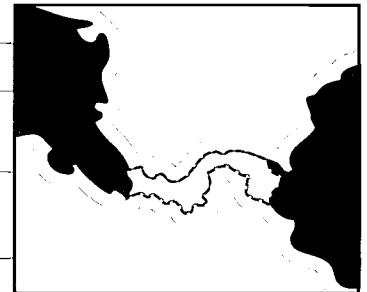

c. 4.2 to 3.5 million years ago:

Emergence of early hominids

Note: This timeline is not to scale.

SCIENTIFIC AMERICAN FRONTIERS

Show 801: Expedition Panama



Bridge That Changed the World

Explore Science in Panama with FRONTIERS Online!

Expedition Panama is an exciting scientific excursion that explores the incredibly diverse and complex environment of the rain forest. You can take this learning expedition even further by sending questions to scientists featured on this edition of FRONTIERS. The scientists on this page will be available to answer viewers' questions from October 8 to 24, 1997, via the FRONTIERS Web site: <http://www.pbs.org/saf/>.

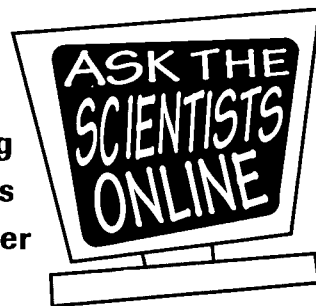

ECHOES IN THE NIGHT

Elisabeth Kalko of the Smithsonian Natural History Museum is one of the world's leading bat experts. In Panama, where she has catalogued more than 70 bat species, Kalko uses her invention — the "bat detector" — to figure out how these amazing creatures use different sounds. She's also interested in finding answers to the big questions of evolutionary biology, including why such a large diversity of bat life has developed in the tropics. Find out more about Kalko and her research by sending her your questions.



CHAMPION CHOMPERS

In Panama, biologist Ulrich Mueller keeps a close watch on the forest floor to study the activities of leaf-cutter ants. This fascinating species uses leaves to feed a "fungus garden" that provides food for the ants. Mueller has observed the specialized roles some ants take on, such as guarding their fellow ants as they carry leaves back to their nest, or throwing out dead fungus. Discover more about this — and the role of the ants in the complex ecology of the rain forest — as Mueller answers viewers' questions.



RAT SOUP

As a regional director of ANCON, the leading Panamanian conservation group, Antonio Telesca oversees environmental experiments that introduce innovative conservation ideas to the region. ANCON's goal is to protect the rain forest and the Panama Canal's vital watershed with projects that include raising pacas (the mammal made into soup in this story), growing edible nuts and reforesting areas of grassland. Submit your questions to learn more about these projects and what they mean to the future of Panama.



BRIDGE THAT CHANGED THE WORLD

The formation of the tiny Isthmus of Panama had a large impact on the Earth's climate and animals. Tony Coates, a geologist and deputy director of STRI, studies the geological evidence that tells us how the isthmus formed starting 18 million years ago. Ask Coates about this fascinating process and its far-reaching consequences by sending your questions to Ask the Scientists.



BEE LINES

What's the latest buzz about bee communication? David Ward Roubik, staff entomologist at the Smithsonian Tropical Research Institute (STRI), has devised a clever experiment to find out. By observing a colony of stingless bees that has an abundant choice of over 1,000 species of flowering plants, Roubik is learning how bees tell others in the colony where food can be found. Roubik answers your questions about how his research in Panama expands our knowledge of how bees communicate.



HERE'S HOW TO "ASK THE SCIENTISTS"

- Watch **Expedition Panama** and review this classroom guide to prepare your question(s) and decide which scientist(s) you'd like to contact.
- Visit **SCIENTIFIC AMERICAN FRONTIERS** on PBS Online at <http://www.pbs.org/saf/>. Click on the "Ask the Scientists" icon on the opening screen to send your question(s). Scientists' answers will be posted online for FRONTIERS viewers to read. Depending on the volume of questions received, only selected questions may be answered.
- Remember to e-mail your questions by **October 24, 1997!**



Expedition Panama airs on PBS on Wednesday, October 8, 1997, at 8 pm.*

*Check your TV listings to confirm local air time and date.

NOTE: SCIENTISTS ARE SUBJECT TO CHANGE.

Visit FRONTIERS on PBS Online

To launch a brand-new season, the FRONTIERS Web site has a great new look. Visit PBS Online soon to see the expanded array of online activities and resources designed to enhance every episode for you and your students. Before each show, stop by for online activities and recommended resources. And come back after the program to enter exciting contests, post questions for featured scientists or just tell us how you liked the show. Here is a preview of what's waiting for you this season:

This Season

- "Sneak preview" video clips
- Broadcast schedule
- Station air times

Search

- Find topics from past shows and teaching guides using keyword or subject-area searches

Ask the Scientists

- Scientists answer viewers' questions

In the Classroom

- Teaching Guides: activities and resources for current and previous shows
- FYI: news for science teachers
- Plus: order videotapes and join the mailing list

Cool Science

- Science Thing: interactive activity
- Don't Try This at Home: fun experimental activity
- Science Scavenger Hunt
- Link to exciting online projects (see page 13 for details of the current activity)

Polls and Prizes

- Vote for your Favorite Story
- Opinion Poll
- Viewer Challenge

Alan Alda

- E-Mail Alan
- Alan Answers
- Alda Facts
- An Interview with Alan
- Alan's Photo Album



Resources

- Complete show transcripts
- Links for further learning
- Scientific American* magazine articles

TRY THIS! Web-based Student Activity

Here's an exciting opportunity for your students to contribute information about your region's butterfly population to an international online databank! To find out more, see the complete instructions on page 13 of this guide or log on to <http://www.pbs.org/saf/> and click on "Cool Science" for the link to this activity at *The Biology Place*.

Thanks to *The Biology Place* for creating this activity in cooperation with SCIENTIFIC AMERICAN FRONTIERS. A service of Peregrine Publishers, Inc., *The Biology Place* provides resources and inquiry-based activities for science educators. For more information, visit Membership at <http://www.biology.com> or call 888-TBP-SITE.

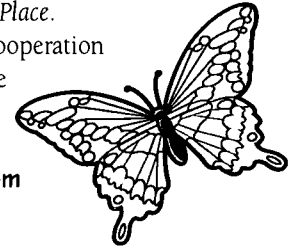

SCIENCE IN CYBERSPACE

Visit these sites to learn more about topics on Expedition Panama.

www.si.edu/organizational_centers/stri/stri.htm

Visit the Smithsonian Tropical Research Institute in Panama for more information about STRI's research and colorful pictures of Barro Colorado Island, the canopy crane and the region's plants and animals.

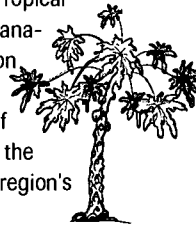

www.lonelyplanet.com.au/dest/cam/pan.htm

Take a virtual trip to Panama and enjoy this site's information about the country's environment, culture, events, eco-tours and attractions for Panama-bound travelers.

www.panamet.com/pancanal/pcc.htm

Find out more about the Panama Canal. Under "general information" this site gives you the canal's history, operations, a map and photos.



www.ifi.unit.no/~janne/bees.htm

Find photos and information about bee families, plus a detailed anatomical drawing.

www.panamainfo.com/tables/tourism_anc.html

Learn more about the mission and activities of ANCON, the conservation group that sponsors demonstration projects in the rain forest.

www.mpm.edu/collect/tirimbina/ants.html

See photos of leafcutter ants with informative text at this online exhibit from the Milwaukee Public Museum.

www.nyx.net/~jbuzbee/bat_house.html

Discover the ultimate Web site about bats! Here's everything you ever wanted to know about bats, plus projects, bat calls, jokes, stories and hundreds of links to bat pages all over the world.



www.batcon.org

Check out Bat Conservation International's site for educators' activities, projects, links, reading lists, photos and more. Learn how to build a bat house and download and listen to bat echolocations.

nmnhwww.si.edu/nmnhweb.html

Explore the Smithsonian National Museum of Natural History via its Web site, which includes exhibits from insects to dinosaurs. The vertebrate zoology department takes you to a taxonomic database.

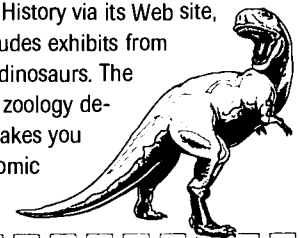

At press time, the online features and sites listed here were current. Due to the rapidly changing online world, some may have changed or may no longer be available.



Watch It On PBS

SCIENTIFIC AMERICAN FRONTIERS airs on PBS with five new programs each season, October through April. Each hour-long special includes a variety of fascinating science stories based on a single theme.

THIS ISSUE **SHOW 801: Expedition Panama**

WEDNESDAY, OCTOBER 8, 1997

Meet scientists working at the Smithsonian Tropical Research Institute, a living laboratory of incredible biodiversity on an island in the Panama Canal. Find out how the Isthmus of Panama changed the world millions of years ago and how a canal built in this century led to unintended consequences. Learn how a rodent could be a key to saving Panama's rain forest.

SHOW 802: Beyond Science?

WEDNESDAY, NOVEMBER 19, 1997

Science fact or fiction? See what scientists think about the stories behind the headlines, as they investigate a variety of well-known claims, from aliens to graphology, free energy machines and more.

SHOW 803: Nordic Sagas

INTERNATIONAL SPECIAL! WEDNESDAY, JANUARY 21, 1998

Travel around Scandinavia and see what scientists are working on in Iceland, Denmark and Sweden. From Iceland's volcanic land mass to Viking ships and radioactive reindeer, join us for a cool episode!

SHOW 804: The Art of Science

WEDNESDAY, FEBRUARY 18, 1998

FRONTIERS explores discoveries and events that marry the fields of science and art, including a behind-the-scenes look at how digital technology is revolutionizing the movie industry.

SHOW 805: The New Zoos

WEDNESDAY, APRIL 15, 1998

Modern zoos may be today's arks and the only hope for endangered species. See what pioneers in contemporary zoos are doing to improve and extend the lives of animals.



Join Host Alan Alda for the season premiere of SCIENTIFIC AMERICAN FRONTIERS, when he tours the Panama Canal and explores the rich diversity of Panama's rain forest on Barro Colorado Island.

Remember, teachers may videotape the show to use year after year. GTE Corporation, the series underwriter, grants educators free off-air taping rights in perpetuity for classroom use.



UNDERWRITTEN BY GTE CORPORATION



Bat scientist Elisabeth Kalko, and other scientists seen on EXPEDITION PANAMA, answer your questions online.

SEE PAGE 14

<http://www.pbs.org/saf/>



Connecticut Public Television

P.O. Box 260240

Hartford, CT 06126-0240

INSIDE:
Requested Teaching
Materials for
**EXPEDITION
PANAMA**

AIR DATE:
October 8, 1997



SCIENTIFIC
AMERICAN
FRONTIERS

NOVEMBER 19, 1997 • 8-9 PM

TEACHING GUIDE FOR SHOW 802



Beyond Science?

Investigations
into Pseudoscience

Underwritten by GTE Corporation

A PBS SPECIAL
Hosted by
Alan Alda

Beyond Science?



This episode explores topics that go beyond the realm of science; in other words, topics that are hard to explore in a rigorous scientific way. The more we know about science, the less sense pseudoscience makes — whether it is astrology, Bigfoot, spontaneous human combustion or visiting aliens. The scientific method gives us a way to evaluate claims and approach them critically. The scientists in this episode talk about why the scientific method is important to doing science. You can use their comments — and the activities in this guide — to help build students' critical evaluation skills.

GTE GIFT Grants

Watershed management, solar studies, a digital forest, a forensics lab, human-powered vehicle analysis — these are just a few of the projects the 1997 winners of the GTE GIFT grant program are working on this year.

Applications are now being accepted for the 1998 Growth Initiatives for Teachers (GIFT) grants. Each year, GTE Corporation, the underwriter of SCIENTIFIC AMERICAN FRONTIERS, awards \$12,000 grants to 60 teams of one math and one science teacher at the same school. Teachers of grades 6-12 from selected states may apply for these grants, which are designated for school-enrichment projects and

professional development. It's a great way to develop original projects that connect science, math and technology.

Participating states include: AL, AR, AZ, CA, CO, CT, DC, FL, GA, HI, IA, ID, IL, IN, KY, MA, MD, ME, MI, MN, MO, NC, NE, NH, NM, OH, OK, OR, PA, SC, TN, TX, VA, WA, WI and WV.

For an application, call 800-315-5010. **Applications must be post-marked by January 16, 1998.**

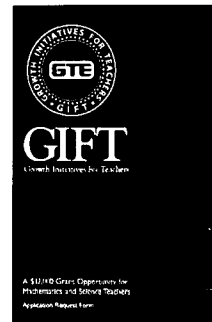

Resources You Can Use

You'll find fascinating articles in each issue of *Scientific American* magazine, with multiple links to your curriculum and to episodes of FRONTIERS. For example, "Science Versus Antiscience?" in January 1997 ties in perfectly with **Beyond Science?** Plus, look for an article on zero-point energy and pseudoscience in the December 1997 issue.

You can access the magazine directly on the Web (<http://www.sciam.com/>) and on America Online (keyword: sciam). To subscribe, write to: *Scientific American*, Dept. SAF, 415 Madison Ave., New York, NY 10017. A one-year subscription costs \$24.97.

Some books that explore pseudoscience include: *The Demon-Haunted World: Science as a Candle in the Dark* by Carl Sagan (Ballantine Books, 1996), *Why People Believe Weird Things* by Michael Shermer (W.H. Freeman, 1996) and *The Outer Edge: Classic Investigations of the Paranormal* (ed. by CSICOP, 1995).

TIPS FOR TEACHERS

TAPING THE SHOW:

- ✓ Always check TV listings to confirm air date and time.
- ✓ As a teacher, you have off-air taping rights in perpetuity for classroom use.
- ✓ If you can't find the show in your TV listings, call your local PBS station.
- ✓ Do you need help? Call the FRONTIERS School Program at 800-315-5010.
- ✓ Videotapes of past shows can be purchased (\$21.97 each). Call 800-315-5010.

FREE VIDEOTAPING & PHOTOCOPYING RIGHTS:

GTE Corporation, the series underwriter, makes available complete off-air taping rights in perpetuity for classroom use of SCIENTIFIC AMERICAN FRONTIERS. Educators may record each show when it airs on PBS and keep the tapes to use in the classroom year after year.

Educators may also photocopy all materials in this guide for classroom use.

NEW SIGN-UPS:

If you know of other educators who are interested in receiving these guides, they may sign up by calling the SCIENTIFIC AMERICAN FRONTIERS School Program at 800-315-5010.

LET US HEAR FROM YOU!

We appreciate and welcome your questions, comments, compliments and constructive criticism. *Please contact us . . .*

By mail:

SCIENTIFIC AMERICAN FRONTIERS
105 Terry Drive, Suite 120
Newtown, PA 18940-3425
By phone: 800-315-5010
By fax: 215-579-8589
By e-mail: saf@pbs.org

VISIT US ONLINE:

<http://www.pbs.org/saf/>

VIEWER CHALLENGE

You and your students can enter the **Viewer Challenge** (p. 4) and have a chance to win a terrific FRONTIERS T-shirt! The correct answers to the **Viewer Challenge** questions are:

1. b or c, variations in magnetic fields can reveal fractures in bedrock where water might be
2. conduct experiments using the scientific method
3. c
4. flower designs on the tape
5. free, unlimited energy for all the world
6. a
7. information about a person's personality and character
8. b and c
9. d
10. practitioners believe they can sense the patient's "energy field" and manipulate it, thus enabling healing to take place

NEXT TIME ON FRONTIERS

Tune in **January 21, 1998**, when FRONTIERS visits scientists in Iceland, Denmark and Sweden, in **Nordic Sagas**, a Scandinavian International Special.

CORRECTION: The educator's guide for SCIENTIFIC AMERICAN FRONTIERS Show 801, **Expedition Panama**, contained a misspelling of Colombia on the map on page 5. We regret the error.

Beyond Science?

SHOW 802 • NOVEMBER 19, 1997 • 8 PM* ON PBS

WATER, WATER EVERYWHERE... 6

Can dowsers detect underground water?
 Activities: Dowsing and science. . . . The power of suggestion.

PAPER PERSONALITY 7

What does your handwriting say about you?
 Activities: Understanding the phenomena behind graphology, astrology and more. . . . A test of handwriting.

ALIENS HAVE LANDED 8

Did aliens crash in the desert in 1947? FRONTIERS visits Roswell, New Mexico, to find out what really happened.
 Activities: Evaluating evidence. . . . Mathematical possibilities of life beyond the stars. . . . The value of eyewitnesses.

NEW ENERGY AGE 10

The idea of a perpetual motion machine once captured the imagination of inventors. Today, zero-point energy evokes similar reactions.
 Activities: Investigate perpetual motion. . . . Design competition: Build a machine powered by water.

HEALING TOUCH 12

Therapeutic touch is used in many hospitals across the country. One student's science project evaluates the claims.
 Activities: Applying the scientific process to experiments. . . . Evaluating pseudoscientific claims. . . . Emily Rosa's science project.

Plus, in every issue . . .

- VIEWER CHALLENGE: Quiz questions, T-shirt prizes! 4
- THE BIG PICTURE: Pseudoscience through the ages 5
- FRONTIERS ONLINE: Visit us at <http://www.pbs.org/saf/> 14



COVER PHOTO and ABOVE: Host Alan Alda conducts FRONTIERS' own "Alien Autopsy."

NOTE: The order of the activities in this guide does not reflect the actual order of the stories in the show. The At-A-Glance box below reflects the story sequence in the show.

AT-A-GLANCE						
STORY	RUNNING TIME	SCIENTIFIC AMERICAN FRONTIERS	BEYOND SCIENCE?	EARTH SCIENCE	GENERAL SCIENCE	PHYSICAL SCIENCE
				LIFE SCIENCE	MATH	PSYCHOLOGY
Water, Water Everywhere . . .	12:12			•	•	•
Aliens Have Landed	11:17			•	•	•
New Energy Age	7:57			•	•	•
Paper Personality	8:46			•	•	•
Healing Touch	7:23			•	•	•

*CHECK LOCAL TIME

SCIENTIFIC AMERICAN FRONTIERS is made possible by an underwriting grant from GTE Corporation. The series is produced by The Chedd-Angier Production Company in association with *Scientific American* magazine and presented to PBS by Connecticut Public Television. Classroom materials produced by Media Management Services, Inc.





Beyond Science?

Show 802 / November 19, 1997, at 8 pm* on PBS



STUDENT'S NAME: _____

TEACHER'S NAME & COURSE: _____

*CHECK
LOCAL
LISTINGS

Watch **SCIENTIFIC AMERICAN FRONTIERS** for answers to questions on this page.
Answer the 10 questions correctly and you'll be eligible to win a **FRONTIERS T-shirt!**

Water, Water Everywhere . . .

- A magnetometer (the instrument seen on the show) can find water deep underground by:
 - ESP.
 - detecting variations in magnetic fields.
 - detecting rock fractures.
 - sensing moisture.
- How can we make sure we don't fool ourselves by wanting a belief to be true?

Aliens Have Landed

- In what year was the alien spacecraft said to have crash landed at Roswell?
 - 1977
 - 1967
 - 1947
 - 1957
- What is the real explanation for the "hieroglyphic" markings allegedly found on the spacecraft at the crash site?

New Energy Age

- What is the promise of zero-point energy?
- Physicist Steven Weinberg believes that the amount of zero-point energy that exists in a volume of space the size of the earth is about the equivalent of a:
 - gallon of gasoline.
 - bushel of wheat.
 - kilogram of air.
 - ton of oil.

Paper Personality

- What do graphologists believe they learn from a person's handwriting?

- What are the problems with graphology?
 - Everyone's handwriting is too similar.
 - There is no proven link between handwriting and personality.
 - Graphologists may be influenced by content.
 - It takes too long to give a handwriting sample.

Healing Touch

- The phenomenon in which patients respond favorably when they believe they are being treated is known as a:
 - hypothesis.
 - double-blind experiment.
 - diagnosis.
 - placebo effect.
- What do practitioners believe happens in therapeutic touch?

EXTRA CREDIT CONTEST!

Do you believe in aliens? Or do you think stories of little green men in flying saucers are a whole lot of hype? In 100 words or less, tell us whether you think we're alone in the universe and why. Mail your entry by December 19, 1997, to Extra Credit Contest at the address to the right. The most persuasive entry will be posted in the Polls & Prizes section on the FRONTIERS Web site and the winner will get a T-shirt. Good luck!

Answers to the Viewer Challenge are listed on page 2 of this guide. T-shirt winners' names will be posted in the Polls & Prizes section of the FRONTIERS Web site.

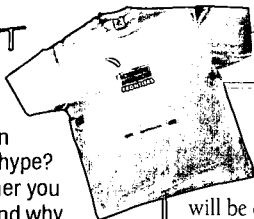

FOR TEACHERS ONLY

When completed, this page can become an entry to the FRONTIERS T-shirt contest; 20 winners (10 students, 10 teachers) will be drawn at random for each show. To enter the T-shirt drawing, send all completed challenges in one envelope with a cover sheet to: **Viewer Challenge, SCIENTIFIC AMERICAN FRONTIERS, 105 Terry Drive, Suite 120, Newtown, PA 18940-3425.** Mail completed entries by **December 19, 1997.**

TIP: You can download these questions on the Web: <http://www.pbs.org/saf/>.

IMPORTANT!! Please include a separate cover sheet and tell us:

- number of challenges submitted
- teacher's name
- grade and course
- school name, address and phone number
- where your students watched the show — at home, at school or both
- the name of your students' favorite story in this show (conduct a quick poll to find out)

Thank you!

Science and Pseudoscience Through the Ages

This episode of FRONTIERS investigates some of today's popular beliefs to see how they come out after scientific analysis and experimentation. Important aspects of science are careful observation,

measurement and experimentation. Here's a brief look at some popular ideas and beliefs from earlier times, each of which was later abandoned after careful scientific investigation.

Around 350 BC, the Greek philosopher Aristotle theorized that Earth is the center of the universe. Around the middle of the second century AD, Ptolemy developed this geocentric theory of the universe, which was accepted for almost 1,400 years.

Then in 1543, Copernicus published a revolutionary theory: Earth orbits around the sun. In the early 1600s Galileo Galilei studied the sky with a telescope for the first time. His observations confirmed the heliocentric theory. Isaac Newton worked out the physics of the solar system about 80 years later. ▶

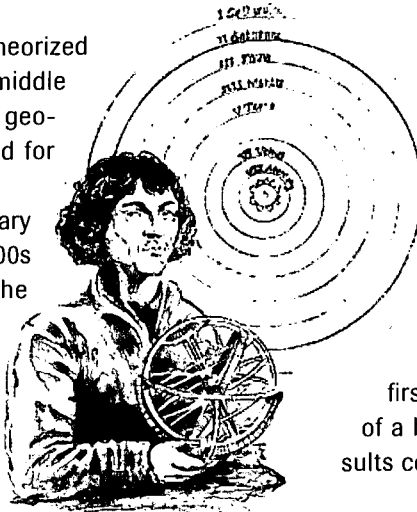

At the end of the 16th century, Galileo is reputed to have conducted the first scientific experiment at the Leaning Tower of Pisa to investigate the effects of gravity on different objects. No one knows if he really dropped a cannonball and a feather from the tower, but this would have been the first experimental test of a hypothesis. The results contradicted earlier assumptions. ▼

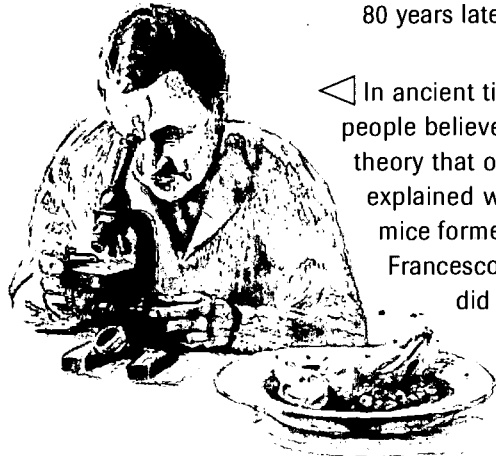

◀ In ancient times, people believed that spontaneous generation, the theory that organisms develop from nonliving matter, explained why flies developed from decaying meat and mice formed from piles of rags. In 1668, Italian biologist Francesco Redi demonstrated that maggots (fly larvae) did not appear in meat from which adult flies were excluded. But not until Pasteur's work with microorganisms in the mid-1800s did people completely abandon the idea of spontaneous generation.

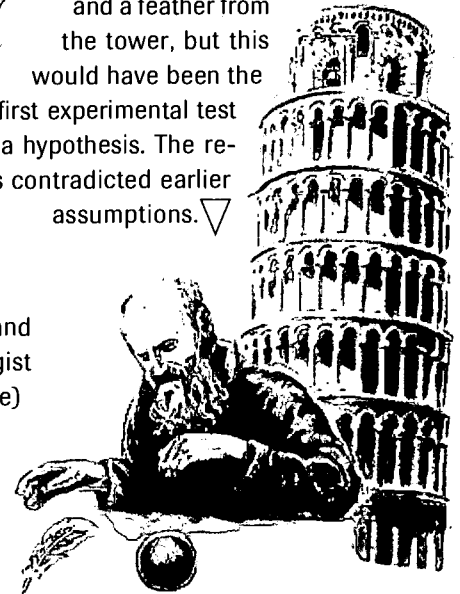

◀ Alchemists believed they could change lead and other metals into gold. They also searched for an "elixir of life" that would prevent aging. Alchemy, a blend of magic and mystical philosophy, remained popular until about the 1700s. After many experiments it became clear that alchemy did not work.

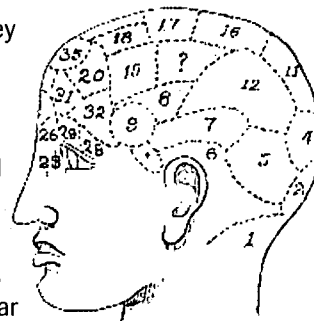

◀ Popular in the early 1800s, phrenology was the belief that the shape and bumps of a person's skull determined character and personality. Different areas on the skull were said to correspond to different traits; special bumps could identify a poet or a criminal, for example. The science of psychology and the brain in the 20th century found no relationship between skull shapes and personality.

Water, Water Everywhere . . .

Can people locate water or minerals hundreds of feet beneath the surface of the Earth simply by using their heads? Since ancient times, dowsers have claimed they can find water by using their senses — and a few special tools. FRONTIERS challenges an experienced dowser to undergo several trials of scientifically rigorous tests to find out if dowsing is reliable. It turns out the mind plays a role, but not quite the way dowsers say it does.

RUNNING TIME: 12:12

CURRICULUM LINKS:

EARTH SCIENCE
geology,
magnetic fields

GENERAL SCIENCE
electricity, magnetism

PHYSICAL SCIENCE/PHYSICS
electromagnetic fields

PSYCHOLOGY
paranormal beliefs, ideomotor actions

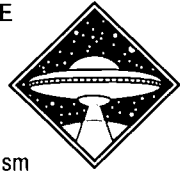

The Ancient Art of Dowsing

Dowsing is the ancient practice of searching for water, metal or other objects, usually underground. It is also called water witching, divining and doodlebugging.

Dowsers believe that objects, including water, possess a natural magnetic, electromagnetic or other unknown “energy” they can detect with their senses. To a dowser, sensing this energy is natural and can be developed through practice.

While many dowsers use favorite tools like dowsing rods and pendulums, some say the tool is only an “interface” or “com-

munication device” that acts as a connection between the hidden object or water and the subconscious.

Dowsing devices come in many shapes and sizes. For the experienced dowser, the choice of dowsing tool doesn’t really matter, because the ability to sense things is all in the mind and the tools are merely responding to the mind’s subconscious processes. Some dowsers operate totally free of a dowsing rod or other tool.

This ancient divining technique has many adherents, but it has never been sci-

entifically proven. Dowsing, common since medieval times in Europe, in Colonial America and even today, is still practiced the same as it was 1,000 years ago, as you see on FRONTIERS.

Even though some dowsers claim they have a special ability to detect electrostatic fields associated with water, skeptics say that without scientific instruments (like the magnetometer shown in the story), it is impossible for a person to detect minute differences in magnetic or electric fields that may be associated with groundwater.

ACTIVITIES Dowsing and Science

How can you find out if dowsing really works? Here are some scientific ways to evaluate dowsing.



- Repeat the experiment in which Jay tries to locate hidden weights, which you see on FRONTIERS. You can make your own dowsing rods with coat hangers (many dowsers do).
- How can you apply the scientific method to a dowsing experiment? Remember, the key to scientific testing is the ability to

test and repeat an experiment. If a dowsing technique works every time when done exactly the same way, can we say it is scientifically valid? (Read more about the scientific method on page 12.)

- Psychology tells us that the power of suggestion is very strong. How does the power of suggestion enable Alan Alda to “find” water after the dowser does? In this case, a phenomenon known as ideomotor action (subconscious thoughts cause involuntary movement) causes the rods to cross.
- Try the pendulum activity Alan Alda demonstrates on the show. Try the same activity, but blindfolded. Does it make a difference if you can’t see the pendulum?
- You may know of other activities, such as hanging a sewing needle on a thread over your wrist to determine the answer to a

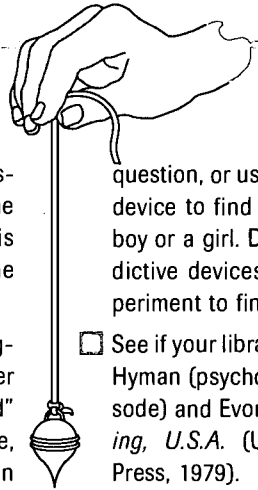

question, or using a similar pendulum device to find out if a baby will be a boy or a girl. Do you think these predictive devices work? Design an experiment to find out.

- See if your library has the book by Ray Hyman (psychologist seen in this episode) and Evon Z. Vogt, *Water Witching, U.S.A.* (University of Chicago Press, 1979).
- You can learn more about dowsing from the American Society of Dowsers (www.newhampshire.com/dowsers.org) and Ken Bannister’s consulting company (members.aol.com/dowser/index.html).
- Read the chapter on “Baloney Detection” in *The Demon-Haunted World: Science as a Candle in the Dark* by Carl Sagan.



Ray Hyman, who appears in this segment, answers your questions online. <http://www.pbs.org/saf/>

Paper Personality

What does your signature say about you? Is there a scientific basis for handwriting analysis? Reputable psychologists say no, but as you see on FRONTIERS, graphologists claim personality traits are revealed by such features as size and slant. This information is sometimes used to judge job and loan applicants. Host Alan Alda offers his handwriting as part of a test to determine if there is any validity to this method of character analysis.

RUNNING TIME: 8:46

CURRICULUM LINKS:

GENERAL SCIENCE

scientific process

PSYCHOLOGY

magic thinking
psychometrics



ACTIVITIES Sympathetic Magic and the Barnum Effect

Like palm reading and astrology, graphology relies on something called sympathetic magic. As we see on FRONTIERS, in sympathetic magic, "like begets like." For example, a long line running diagonally across one's palm is said to predict a long life. A broken line on the palm indicates a life cut short.

Following the same line of thought, graphologists analyze handwriting to interpret

as being written by a person who is outgoing, while handwriting that slants to the left reflects reserve.

OBJECTIVE

Design and evaluate scientific experiments.



PROCEDURE

1. Watch this episode of FRONTIERS and design an experiment to test how well handwriting matches or reflects personality.

One way to set up such a test would be to take random samples of handwriting from people in your class (have someone else set up a code so the "graphologists" do not know who wrote the samples), prepare an "analysis" based

on handwriting samples, and then compare the analysis to see if personality traits match up or if people recognize themselves in the descriptions. You'll find popular books on graphology in the library.

2. Something called the "Barnum effect" also comes into play in these situations. That is, people can convince themselves that a description applies. Psychologist Ray Hyman demonstrates this with palm reading in the introduction to the program. A similar phenomenon happens in astrology. How often have you read your horoscope in a newspaper or magazine and said, "That's me!"? This is the Barnum effect at work.

Try reading other horoscopes to see if they apply to you as well. Or, set up a test in which several students are given the same horoscope. Does the horoscope seem to "fit"? Another way to test the Barnum effect would be to cut out a number of horoscopes and distribute them without indicating which astrological sign is being read. Find out how many "fit" when you tell students they're reading their own horoscopes and when you tell students the horoscopes are distributed at random.



- Discuss the pros and cons of using handwriting analysis in a job application process. Would you want your handwriting used as the basis of a personality profile? Is it fair for employers to conduct an analysis on a writing sample without your knowledge? Explain.
- Compare graphology with the way handwriting analysis is used in forensics.

See *The Write Stuff* by Barry L. Beyerstein and Dale F. Beyerstein (Prometheus Books, 1992). Prometheus Books (www.prometheusbooks.com/) publishes books that challenge claims of paranormal believers.

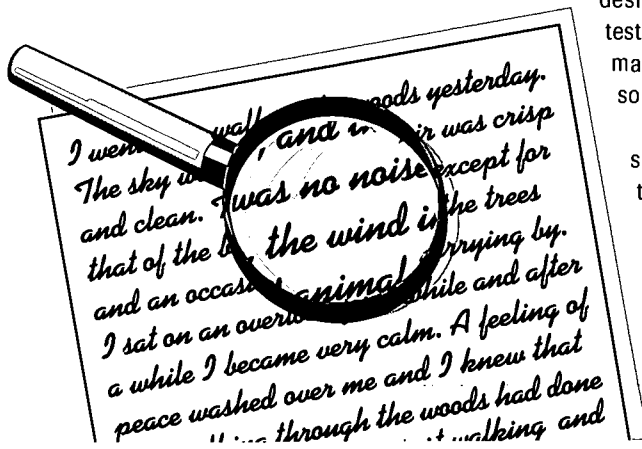

personality traits. The shape, size and style of the writing is said to reflect personality. Using this interpretation, a large, sprawling signature might indicate a strong ego and an extroverted character, while handwriting that is cramped and tiny is said to be associated with a very shy individual. Handwriting that slants to the right is in-

ASK THE
SCIENTISTS
ONLINE

SEE PAGE 14

Barry L. Beyerstein, who appears in this segment, answers your questions online.

<http://www.pbs.org/saf/>

Aliens Have Landed

In July 1947, an alien spacecraft crash landed in the desert near Roswell, New Mexico. Or did it? FRONTIERS travels to Roswell to find out. Something happened in the desert 50 years ago, but is there any evidence to prove that aliens visited Earth? Or that the government suppressed information? Or that the alien autopsy "documentary" is for real? This account investigates the pseudoscientific claims that have grown more and more extraordinary.

RUNNING TIME: 11:17

CURRICULUM LINKS:

- BIOLOGY
 - anatomy & physiology
- EARTH SCIENCE
 - solar system, space
- GENERAL SCIENCE
- LIFE SCIENCE
 - origins of life
- MATH
- PHYSICAL SCIENCE
 - radio waves



RELATED FRONTIERS SHOWS & ACTIVITIES:

- **Pieces of Mind** (Show 703): "True or False?" (pp. 8-9)
- **Life's Big Questions** (Show 501): "Are We Alone?" (p. 13)

What Really Happened in Roswell?

The foundation for the belief that a spaceship visited Roswell, New Mexico, is based on two constructs: First, an alien civilization capable of space travel exists; second,

visiting aliens left irrefutable evidence on Earth as proof. The following activities will allow you to explore the veracity of these ideas and evaluate accounts.

ACTIVITY 1 The Value of Experts

As you learn on FRONTIERS, a videotape of an "alien autopsy" allegedly filmed in 1947 surfaced decades later as "evidence" that aliens crash landed in the desert near Roswell. Reputable scientists deemed this film a hoax. However, beliefs persist that the film and 1947 event are real, and television stations continue to air the film as a "documentary," giving it legitimacy.

How can you use your critical thinking skills to evaluate evidence presented as *authentic* — whether on film, in print or gathered from eyewitness accounts? One way is by studying the film itself to determine whether it is a hoax. Another way is to consult scientists or other experts who can help analyze the evidence.

For more discussion on the film, see the Alien Autopsy page on the Web site of Truly Dangerous, a special effects company (www.trudang.com/). You'll find another related activity, "Alien Autopsy: A Case Study for Skeptical Inquiry," at www.primenet.com/~jllarsen.

OBJECTIVE

Use critical thinking skills to gather and evaluate evidence.

PROCEDURE

1. This episode of FRONTIERS shows a brief clip of the film "Alien Autopsy: Fact or Fiction?" Rent the videotape and watch the film. Then answer the question, "What evidence exists to prove or disprove that this is a real autopsy of an alien?"
2. You first need to make your own observations. Divide a paper in half lengthwise and write the word "prove" on one side and "disprove" on the other. As you watch the video, write down observations under the appropriate column.
3. Discuss your observations in small groups or as a class. How might an "expert" help support some of your observations?
4. If possible, invite a filmmaker, special effects person or a physician to your class to watch the film, if they haven't already seen it, and offer their observations. Consult your school's media specialist for possible contacts in the field.

you might ask: "What medical technology was available in 1947?")

2. What is the value of calling in experts to help evaluate evidence? Consider the role of expert witnesses in trials.
3. What kinds of bias might experts bring into their evaluations? Is this good or bad?
4. How does the ability to create special effects affect our ability to determine what is real and what is fake?

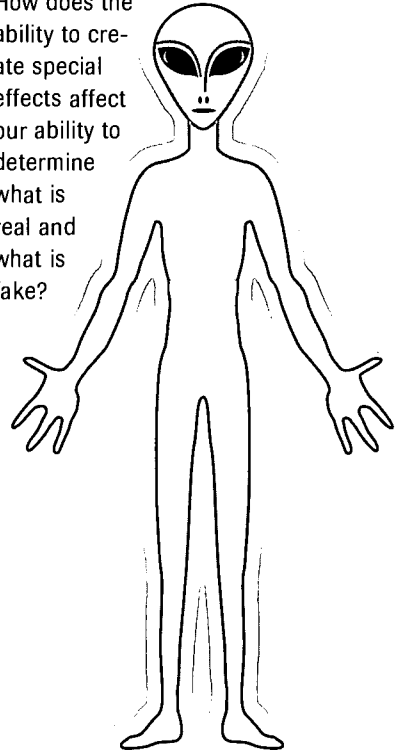

QUESTIONS

1. Can you refine your observations into a question that can be tested? (For example,



Philip J. Klass, who appears in this segment, answers your questions online. SEE PAGE 14 <http://www.pbs.org/saf/>

ACTIVITY 2

The Drake Equation: Is Anybody Out There?

Dr. Frank Drake, president of the SETI (Search for Extraterrestrial Intelligence) Institute developed an equation often cited as suggesting the possibility of alien life capable of contacting us. Even without doing the research involved to determine a numerical answer, what does the theoretical premise of the equation tell you?

OBJECTIVE

Examine the possibility that advanced civilizations exist.

PROCEDURE

Use the Drake Equation as a point of classroom discussion to answer the questions that follow.

$$N = R_* \cdot f_p \cdot n_e \cdot f_l \cdot f_i \cdot f_c \cdot L$$

The symbols in this equation represent:

- N** number of civilizations in the Milky Way with detectable radio emissions
- R_{*}** rate of formation of stars that might support planets with intelligent life
- f_p** fraction of these stars that have planets
- n_e** number of planets per star system that have basic conditions for life
- f_l** fraction of **n_e** planets where life actually develops
- f_i** fraction of **f_l** planets where intelligent life develops
- f_c** fraction of **f_i** planets where technology advanced enough for exploring space develops
- L** the length of time the civilizations on the **f_c** planets last

QUESTIONS

1. Contact a local astronomer or research the Internet to find values for the terms that make up this equation. What is a good estimate of **N** based on your research? Find out more about the Drake Equation at the SETI Web site at <http://www.seti-inst.edu>.
2. Have we discovered any stars with planets (**f_p**)?
3. Have we discovered any planets that might support life (**n_e**)?
4. What kind of conditions do you think must exist for intelligent life (**f_i**) to develop?
5. What might limit the length of time (**L**) that technological civilizations might last? How is our civilization doing?

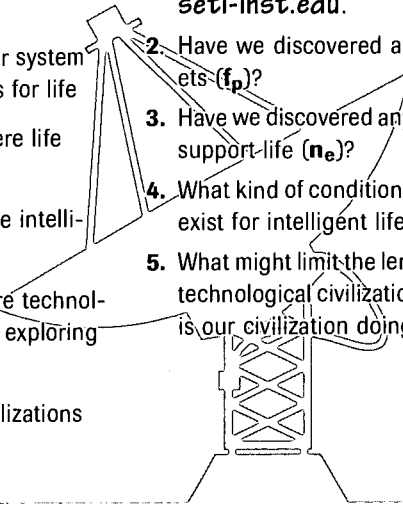
**ACTIVITY 3**

The Value of Eyewitnesses

Much of the evidence cited for proof of the Roswell incident is based on eyewitness accounts of what people saw 50 years ago, as well as on hearsay — what someone else heard from a supposed eyewitness. By staging an incident and studying the accuracy of eyewitness accounts, you can see how what people actually see and what people remember seeing might vary.

OBJECTIVE

Study the accuracy of eyewitness accounts.

PROCEDURE

1. Design and set up a scene in your class for observation by other students. The scene can be anything you want it to be — from an alien encounter to a mock crime. The key is to stage a scene with lots of details to observe.
2. Bring other students, in small groups, into your room to visit. Tell them they are going to watch a scene from a play your class is writing and you will have them critique the play later in the week.
3. One week later, have student teams interview the observers individually. Ask the

observers to describe, in detail, what they remember about the staged scene.

4. Have each team report back to class how accurate the observations were.
5. Repeat the interviews at selected intervals (two weeks, one month) after the staged event.

QUESTIONS

1. Would observations be more accurate if you didn't wait a week to interview?
2. Are some individuals particularly good at making observations? Why?
3. What do you think would happen if you interviewed witnesses six months after the incident? One year or more?

EXTENSIONS

1. Some of the evidence from Roswell is based on memories of third parties who were not eyewitnesses. Design a way to study how observations change when retold by someone other than the original observer.
2. Make your own staged videotape of a "UFO" and see if other students can fig-

ure out what it is. How do their accounts differ?

3. Bring in newspaper reports of UFOs. How would you prove or disprove the claims?
4. How does our current fascination with aliens compare with stories of other mysterious beings (witches, for example) who have captured our imagination in the past?
5. What do the studies of false memory suggest to us about recollections of events that took place long ago? See "Creating False Memories" in the September 1997 issue of *Scientific American*.
6. If you've seen or read *Contact*, use the ideas in the book and movie to discuss the possibility of life outside our solar system.

SCIENTIFIC AMERICAN FRONTIERS

Show 802:
Beyond
Science?

Aliens
Have Landed



New Energy Age

Imagine tapping into the energy believed to exist in the vacuum of space (called zero-point energy). Scientists we meet in this episode believe they are on the verge of harnessing this zero-point energy to power the world. But zero-point energy is scientifically very controversial. Scientists agree that it exists, but many, like Nobel Prize-winning physicist Steven Weinberg, say the amount that exists in our universe is too small to be useful.

RUNNING TIME: 7:57

CURRICULUM LINKS:

GENERAL SCIENCE

energy, machines

PHYSICAL SCIENCE/
PHYSICS

thermodynamics

TECHNOLOGY

engineering, inventions



RELATED FRONTIERS SHOWS & ACTIVITIES:

- Try the flying wing contest in "The Eternal Wing," Show 603, **Flying High**.
- The classroom guide for Show 403, **Special! Science Contests**, contains contest ideas. □ The "International Design Contest" in Show 303 (pp. 9-10) looks at good and bad designs. □ See "Simply Marvelous Machines" in Show 301 (p. 8) for another contest idea.

The Quest for Perpetual Motion

In earlier times, long before the concept of zero-point energy was introduced, inventors dreamt of building a perpetual motion machine that would run forever without any input of energy. Such a machine fits the definition of pseudoscience because the concept is based on faulty science.

Early inventors didn't know enough about physics to understand why their perpetual motion machines could not work. By

the 1850s, scientists discovered the first and second laws of thermodynamics. The first law states that energy cannot be created or destroyed (also known as the law of conservation of energy). Later, Scottish physicist James Maxwell observed that a perpetual motion machine violates the second law of thermodynamics, which states that heat cannot flow from a colder body to a hotter one without adding more energy

than is produced. To keep running, an engine must continually be supplied with energy. So far, no one has ever been able to build a machine that runs forever.

ACTIVITY 1 Waste Not, Want Not!

It's your turn to be an inventor. For this challenge, things will be easy. You won't have to invent a zero-point energy or perpetual motion machine. Instead, you'll redesign a basic machine so that its observable motion lasts for the longest possible period. Think you can do it? Good luck!

The basic machine is a water wheel. The wheel's spin is powered by drops of water that fall onto its paddles. Let's see how this basic machine works.

OBJECTIVE

Design and build a machine, then participate in a competition.

MATERIALS

- large funnel
- ring stand with 2 rings or alternate support
- sheet of thin, clear plastic (like a report cover)
- ruler
- wooden dowel or bamboo skewer
- scissors
- rubber bands
- empty spool from large spool of thread
- 1 cup of water
- large bowl
- small cork or piece of clay

PROCEDURE

1. Cut four rectangular pieces of the plastic. Each piece should be about 4 cm long and about the same width as the spool.

2. Trim off two corners producing a shape like this:

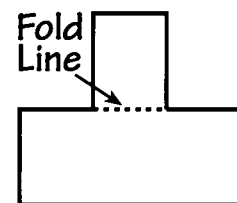

3. Crease and fold the shape along the dotted line.
4. Wrap the base of one "paddle" along the spool. Secure the base with two rubber bands — one placed along each edge of the spool.

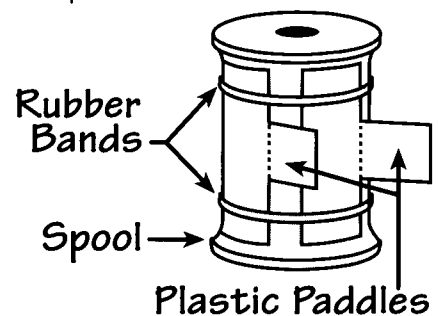

Physicists **Steven Weinberg** and **Hal Puthoff**, who appear in this segment, answer your questions online.

SEE PAGE 14 <http://www.pbs.org/eaf/>

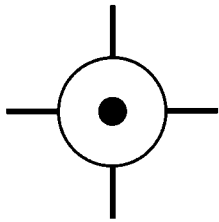

Spool Side View

- Slip the other three paddles under the rubber bands. Make sure that they are spaced evenly at one-quarter distances around the spool.
- Set up the ring stand and rings as shown at right.
- Slip the dowel through the center of the spool. Position the dowel in the center of the bottom ring so that the spool can spin freely. Use tape to secure the ends of the dowel to the ring.

- Position the large funnel in the upper ring so that the water stream is directed at the paddles. Position the bowl beneath the water wheel assembly.
- Place a small cork or plug of clay into the funnel spout.
- Pour one cup of water into the funnel. Begin timing when the plug is removed. Stop timing when the wheel no longer turns.

CHALLENGE

Redesign this machine so that the wheel spins for the longest time. You can change the size, shape and placement of any of the components. You can add objects or take them away. Change the machine in any way. Variations might include different sizes and shapes of paddles or different sizes of spools, but you must follow these two rules:

- You may use only one cup of water, which must be entirely poured into the funnel before you start.
- The height of the fall (measured from bottom of the funnel spout to the top of the dowel) must be less than one foot (30 cm).

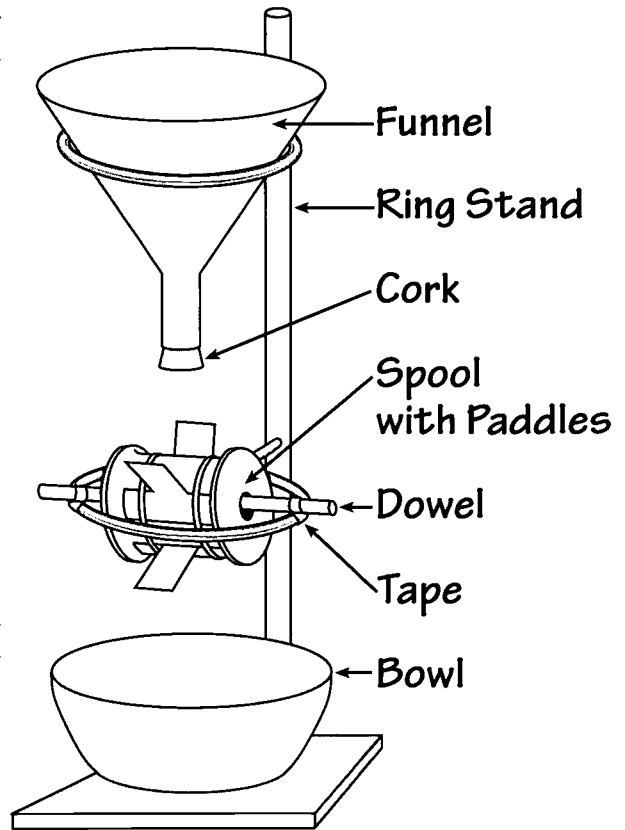

ACTIVITY 2 Think More About It

Perhaps you've seen ads in science or novelty catalogs for toys that seem to be powered by unknown energy sources, tapping into the idea of a perpetual motion machine. Examine the ad below and address the questions that follow.

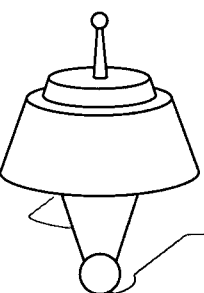

Perpetual Top

Invented in Roswell, New Mexico, this strange toy defies every physical law of nature. Flip the switch, and the UFO-like shape spins and spins. Cloaked in secrecy, its continual power supply arises from perpetual motion engines first developed by clandestine military scientists who knew the power of the pyramid and crystals, and *weren't afraid to use it!* 5 X 10²³ C-CELL BATTERIES REQUIRED/NOT INCLUDED.

OBJECTIVE

Apply critical analysis to an advertisement.

QUESTIONS

- If perpetual motion were possible, would its commercial application be limited to toys?
- Why might this device require several batteries?
- Why might the ad mention Roswell, UFOs, military scientists, pyramids and crystals?

CHALLENGE

Design a scientific experiment that would test whether this toy uses a perpetual motion engine.

FOR FURTHER THOUGHT

Each year the U.S. Patent Office receives about 100 applications to patent perpetual motion machines. Today, each application must be accompanied by a working model. The office doesn't test the inventions to see if they perform as claimed.

The patent office maintains that its responsibility is to ensure that the machine designs are original – not to test whether the claims are true. What do you think? Should a patent office be responsible for testing perpetual motion devices (or other inventions)? Does a patent convey endorsement of a product and suggest that the product works according to its claim?

**SCIENTIFIC
AMERICAN
FRONTIERS**

Show 802:
Beyond
Science?



New Energy Age

Healing Touch

Could balancing a patient's "energy patterns" cure cancer? Or heart disease? Therapeutic touch — a holistic, alternative form of therapy introduced in the 1970s — makes claims about healing that are not based on any scientific foundation. FRONTIERS shows how difficult it is to conduct experiments about medical treatments. Then we meet a Colorado student whose science fair project is one of the first attempts to subject therapeutic touch to a scientific study.

RUNNING TIME: 7:23

CURRICULUM LINKS:

GENERAL SCIENCE

scientific method

LIFE SCIENCE

medicine

PHYSICAL SCIENCE

magnetism

PSYCHOLOGY

experimental methods, placebo effect



ACTIVITY 1 The Scientific Method

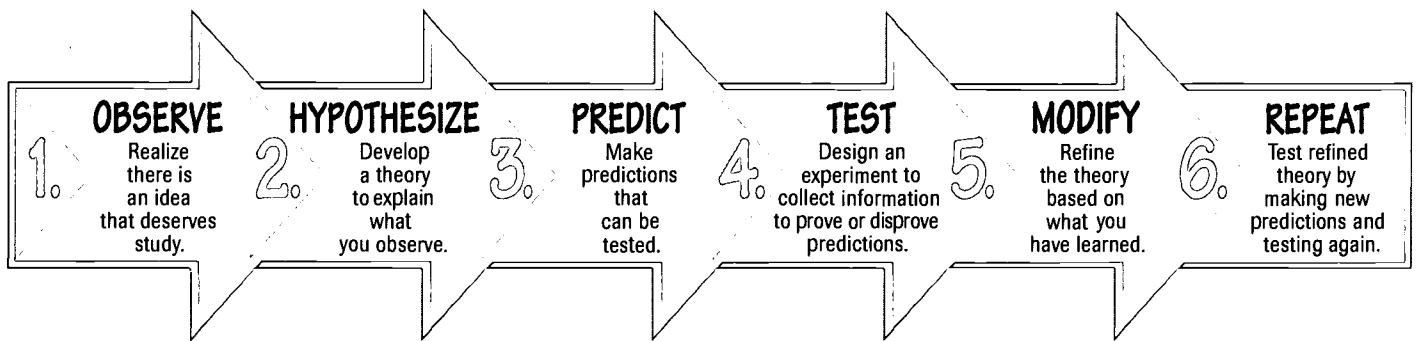

Claims for alternative healing, like those made for therapeutic touch, need to be supported by rigorous study. The scientific method is the best way we have to get at the truth behind exceptional claims.

OBJECTIVE

Practice using the scientific method.

PROCEDURE

In its simplest form, the scientific method is a way to help scientists collect information to support their observations. The steps are pictured above.

Practice the first steps in the scientific method by building a "Proposal for Study" form. Divide a paper into three parts lengthwise and label the sections: Observe, Hypothesize and Predict. Complete the form as follows:

Observe: Choose a topic that interests you; for example, basketball or music. Next, write a one-sentence observation about some aspect of your topic that deserves further study. For basketball, you might note: "I want to know why some players are good at making free throws while others are not."

Hypothesize: Write down a theory that helps explain your observation. Following the basketball example, you might hypothesize: "Anyone who is good at free throws must practice a lot," or, "A player who is good at free throws must be tall."

Predict: Make predictions that will support your hypothesis. For example: "I predict that if I interview every player on the basketball team, the best free throw shooters will practice free throws for about the same amount of time," and "The players who are bad at free throws will probably not practice much at all."

- Why is it important for your experiment to be repeated by others?
- What are some of the variables and biases experimenters must deal with in their studies? For example, how much does natural ability or height affect one's free-throwing ability? How could you test for these factors?
- Find examples of the ways researchers use the scientific method on FRONTIERS.
- How does the student's science fair project seen on FRONTIERS demonstrate scientific method?

QUESTIONS

- Is it important to choose something that interests you in order to study it?
- Why is it important to be able to test a theory rather than accepting claims on faith?
- How would you design a way to test your predictions?



Student Emily Rosa, who appears in this segment, answers your questions online.

SEE PAGE 14 <http://www.pbs.org/saf/>

*Extraordinary
claims require
extraordinary
proof.*

ACTIVITY 2 Magnetic Personality

Practitioners of therapeutic touch believe that by moving their hands over a patient's body to enhance "energy flow," healing can be achieved. Another popular therapy is the use of biomedical magnets. Claims have been made for magnets used to treat everything from back injuries to insomnia. As one example, Yankees pitcher Hideki Irabu plays baseball with tiny magnets taped to various parts of his body.

Conduct your own research into the "power of magnets" by designing a scientific test.

OBJECTIVE

Design a science project to study some of the claims of biomagnetic therapy.

PROCEDURE

Design an experiment to uncover the truth behind these claims:

Magnets help athletes' sore legs recover faster.

Magnets help people sleep better.

Magnets help bruises heal faster.

Magnets reduce wrinkles.

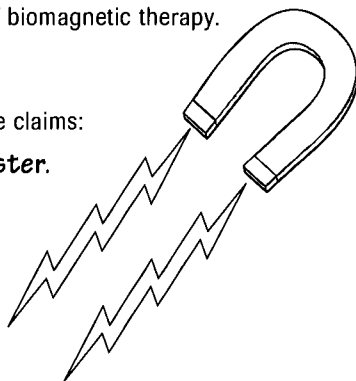

Before you design your experiment, make predictions based on these statements. Remember, your experiment must collect data that test these predictions. Review the scientific method and make sure you minimize the variables you are testing and have a control for comparison.

NOTE: If you do not have access to medical magnets, you can design an experiment, but not conduct it. Medical magnets that are used in biomagnetic therapy aren't like the magnets on your refrigerator. Medical magnets range from 800 to 4,000 gauss, but small ones measure around four gauss.

A Science Project on FRONTIERS

Although the practice of therapeutic touch has been around since 1972, when it was invented by a nurse, and although many hospitals perform this alternative therapy along with traditional medicine, the technique had not been scientifically tested until recently.

Enter nine-year-old Emily Rosa, whose science project put therapeutic touch to the test — a scientific test. Emily's mother, Linda Rosa, is a nurse investigating therapeutic touch. Watching a videotape of the practice with her mother, Emily came up with a way to test one of the claims — namely, that practitioners could sense "energy fields."

Emily, now 10, was a student in Thom Noell's fourth grade class at Rivendell School in Fort Collins, Colorado, when she set up the experiment that you see on this episode of SCIENTIFIC AMERICAN FRONTIERS.

Emily's therapeutic touch study has also been submitted to a journal for consider-

ation. When the editors found out who conducted the study, they expressed disbelief that a young student ran the experiment.

Said Emily, "It was easy!"

Linda Rosa, R.N., Emily Rosa's mother, is corresponding secretary for an organization of health professionals investigating the claims of therapeutic touch, the National Therapeutic Touch Study Group (NTTSG). You can read about NTTSG and other topics, including graphology and UFOs, at the Web site for REALL (Rational Examination Association of Lincoln Land), an educational organization dedicated to applying the scientific method to claims of paranormal and fringe-science, www.reall.org/.

You can ask Emily Rosa about her experiment in the Ask the Scientists feature on the FRONTIERS Web site. Go to www.pbs.org/saf/.

QUESTIONS

1. What is a double-blind study and how will it help in experimental design?
2. What is the placebo effect and how might it affect the results of some experiments?
3. How could you improve experimental design by first searching for information on magnet therapy in your library or on the Internet?

EXTENSIONS

1. Bring in examples from tabloid reports or popular magazines on healing by magnets or crystals and explain how they differ from reports in scientific journals. Contrast the science and pseudoscience of biomagnetic therapy.
2. Apply the concepts of the scientific method to investigating claims about other "alternative" products or practices.
3. You'll find dozens of online resources for investigating pseudoscience at http://physics.syr.edu/courses/modules/PSEUDO/pseudo_main.html.

Exploring Pseudoscience

AN INTERACTIVE WEB ACTIVITY

Learn more about graphology and the Barnum effect through an exciting new critical thinking activity at *The Psychology Place*. To get there, visit the FRONTIERS Web site (<http://www.pbs.org/saf/>), choose "Cool Science" and then select "psychplace.com."

SCIENTIFIC
AMERICAN
FRONTIERS

Show 802:
Beyond
Science?



Healing Touch

Go Beyond Science with FRONTIERS Online!

On *Beyond Science*? Alan Alda meets scientists investigating pseudoscience, from dowsing to aliens and more. What's science fact and what's fiction – and how do experts use scientific methods to find out? You can learn more by sending questions to FRONTIERS online at www.pbs.org/saf/. The individuals on this page will answer viewers' questions about *Beyond Science*? from November 19 to December 5, 1997.

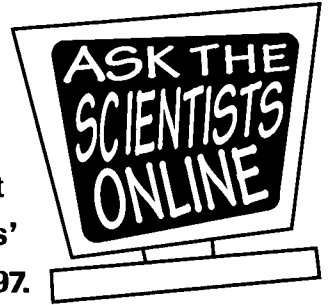

WATER, WATER EVERYWHERE

Ray Hyman, a cognitive psychologist, is a professor at the University of Oregon, where he focuses on several areas of study, including pseudocommunication in character reading. You'll see this critic of parapsychology setting up an experiment to test the validity of dowsing on "Water, Water Everywhere" and posing as a palm reader in the introduction to the program. Submit your questions to learn more about Hyman's research into parapsychology.



HEALING TOUCH

At 10 years old, Emily Rosa may be one of the youngest people to submit a paper for publication in a scientific journal. Her simple experiment applies the scientific method to objectively test the existence of therapeutic touch. Discover more about how Emily designed her experiment and her interest in science when she answers viewers' questions.



ALIENS HAVE LANDED

Noted UFO researcher, aerospace writer and engineer Philip J. Klass was senior editor of *Aviation Week & Space Technology* magazine for 35 years. Currently, he publishes the *Skeptics UFO Newsletter*. Klass has written several books; his latest is *Bringing UFOs Down to Earth*. Here's your opportunity to ask questions of this prominent UFO skeptic about Roswell and aliens.



STEVEN WEINBERG

Meet theoretical physicist Steven Weinberg in the introduction to this episode and in "New Energy Age." Nobel Laureate Weinberg (Physics, 1979) is now Jack S. Josey-Welch Foundation Chair in Science and Regental Professor at the University of Texas at Austin. His research spans a broad range of topics in quantum field theory, elementary particle physics and cosmology. He won a Nobel Prize for unifying two of the fundamental forces of nature. Weinberg answers your questions about topics on this program.



NEW ENERGY AGE

Is free, unlimited energy really a possibility? Visionary physicist Hal Puthoff investigates this question at his Institute for Advanced Studies in Austin, Texas, where he and his partner test inventors' machines — and some of their own. Ask Puthoff about his work and its consequences for the future.



PAPER PERSONALITY

Neuroscientist Barry L. Beyerstein, an associate professor in the Department of Psychology at Simon Fraser University in British Columbia, specializes in studying medical and psychological quackery. Discover more about Beyerstein's research and why he's critical of the use of handwriting analysis as a tool for psychological measurement by sending your questions to Ask the Scientists.



NOTE: SCIENTISTS ARE SUBJECT TO CHANGE.

HERE'S HOW TO "ASK THE SCIENTISTS"

- Watch *Beyond Science?* and review this classroom guide to prepare your question(s) and decide which scientist(s) you'd like to contact.
- Visit SCIENTIFIC AMERICAN FRONTIERS on PBS Online at <http://www.pbs.org/saf/>. Click on the "Ask the Scientists" icon on the opening screen to send your question(s). Scientists' answers will be posted online for FRONTIERS viewers to read. Depending on the volume of questions received, only selected questions may be answered.
- Remember to e-mail your questions by **December 5, 1997!**



Beyond Science? airs on PBS on Wednesday, November 19, 1997, at 8 pm.*

*Check your TV listings to confirm local air time and date.

In the Classroom with FRONTIERS Online

Looking for challenging activities for your students? You'll find new resources for every episode of FRONTIERS at PBS Online:

- **Cool Science:** activities and projects for students
- **Teaching Guides** for current and previous shows
- **FYI:** news for science teachers
- **Resources:** links to related sites and *Scientific American* magazine articles
- **Plus** news and photos of Alan Alda, polls and prizes, show schedule and **more!**



Cool Science
Students and Teachers –
Send us your favorite site!

We'll feature the coolest science sites in each issue of this guide. If we print your recommendation, you'll receive a FRONTIERS T-shirt. Please e-mail your suggestions to saf@pbs.org.

TRY THIS!

Web-based Student Activity

Want to learn more about graphology and the Barnum effect? The Internet is a great place to do it. You can start at *The Psychology Place*, which has a new critical thinking activity designed in cooperation with

SCIENTIFIC AMERICAN FRONTIERS for this episode,

Beyond Science? To find out more, log on to www.pbs.org/saf/ and click on **Cool Science** for the link to this activity at *The Psychology Place*.

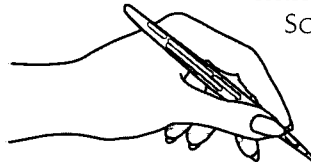

The Psychology Place, a service of Peregrine Publishers, Inc., provides resources and inquiry-based activities for science educators. For more information, visit membership at www.psychplace.com or call 888-TBP-SITE.

SCIENCE IN CYBERSPACE

Visit these sites to learn more about topics on **Beyond Science?**

www.ph.utexas.edu/~weintech/weinberg.html

Visit Professor Steven Weinberg's home page at the University of Texas at Austin for more information about his scientific career and publications, which include *The First Three Minutes* and *Dreams of a Final Theory*.

www.hypermind.com/universe/content/wgte01z.htm

Find more about physicist Steven Weinberg at this site, where you can read his answer to the question, "Does Physics Describe Reality?"

www.exit109.com/~ka/psi.shtml

Learn how psychologist Ray Hyman and others investigate parapsychology, plus links to skeptics' pages.

dcn.davis.ca.us/~btcarroll/skeptic/dictcont.html

Search the Skeptic's Dictionary to find definitions from acupuncture to zombies.

www.voicenet.com/~davek/phact/

Get the "PhACTs" from the Philadelphia Association for Critical Thinking (PhACT), a group that examines paranormal claims from a scientific point of view.

www.groundwater.com

Explore topics related to groundwater and geoscience, plus many online environmental resources.

www.livelinks.com/sumeria/free.html

Read about zero-point energy here. Click on "A New Rosetta Stone in Physics?" and "Everything for Nothing" to read papers by physicist Hal Puthoff.

www.csicop.org/si/95071/roswell.html

Find details of Charles Moore's investigation of the Roswell Incident.



www.datagraph.com/wm-study/WM-Study.html

Log on to DataGraph's site for more details about John Nezelek's study at William and Mary, which attempts to validate graphology data.

www.csicop.org/

Visit CSICOP, the Committee for the Scientific Investigation of Claims of the Paranormal, which also publishes the *Skeptical Inquirer*.

www.voicenet.com/~eric/skeptic

Check out Eric's Skeptic Page, a site that examines a variety of pseudoscientific claims, including dowsing, therapeutic touch, astrology, free energy and more.

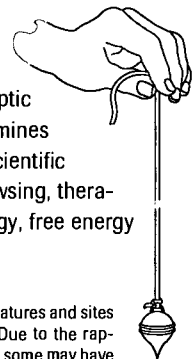

At press time, the online features and sites listed here were current. Due to the rapidly changing online world, some may have changed or may no longer be available.



Watch It On PBS

SCIENTIFIC AMERICAN FRONTIERS airs on PBS with five new programs each season, October through April. Each hour-long special includes a variety of fascinating science stories based on a single theme.

SHOW 801: Expedition Panama

WEDNESDAY, OCTOBER 8, 1997

Meet scientists working at the Smithsonian Tropical Research Institute, a living laboratory of incredible biodiversity on an island in the Panama Canal. Find out how the Isthmus of Panama changed the world.

THIS ISSUE SHOW 802: Beyond Science?

WEDNESDAY, NOVEMBER 19, 1997

Science fact or fiction? See what scientists have uncovered about the stories behind the headlines, as they investigate a variety of well-known claims, from aliens to graphology, therapeutic touch, perpetual motion machines and more.

SHOW 803: Nordic Sagas

INTERNATIONAL SPECIAL! WEDNESDAY, JANUARY 21, 1998

Travel around Scandinavia and see what scientists are working on in Iceland, Denmark and Sweden. From Iceland's volcanic land mass to Viking ships and radioactive reindeer, join us for a cool episode!

SHOW 804: The Art of Science

WEDNESDAY, FEBRUARY 18, 1998

FRONTIERS explores discoveries and events that marry the fields of science and art, including a behind-the-scenes look at digital technology in the movies.

SHOW 805: The New Zoos

WEDNESDAY, APRIL 15, 1998

Modern zoos may be the only hope for endangered species. See what contemporary zoos are doing to improve and extend the lives of animals in captivity and the wild.



In this episode of SCIENTIFIC AMERICAN FRONTIERS, host Alan Alda meets psychologist Ray Hyman (above), Nobel Prize-winning physicist Steven Weinberg and other scientists who investigate pseudoscientific claims.

Remember, teachers may videotape the show to use year after year. GTE Corporation, the series underwriter, grants educators free off-air taping rights in perpetuity for classroom use.



UNDERWRITTEN BY GTE CORPORATION



Physicist Steven Weinberg and other scientists seen on BEYOND SCIENCE? answer your questions online.

SEE PAGE 14 <http://www.pbs.org/saf/>



Connecticut Public Television

P.O. Box 260240

Hartford, CT 06126-0240

NON PROFIT
U.S. POSTAGE

PAID

Permit no. 51
Bristol, PA

INSIDE:

Requested Teaching
Materials for
**BEYOND
SCIENCE?**

AIR DATE:

November 19, 1997

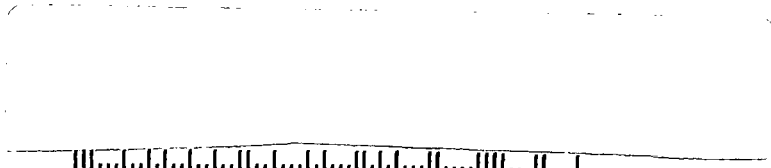

PRINTED ON RECYCLED PAPER

SCIENTIFIC
AMERICAN
FRONTIERS

JANUARY 21, 1998 • 8-9 PM

TEACHING GUIDE FOR SHOW 803



Nordic Sagas

Science in Scandinavia

A PBS SPECIAL



Hosted by
Alan Alda

Underwritten by GTE Corporation



Nordic Sagas



Join FRONTIERS and travel to Iceland, Sweden and Denmark to find out how Viking ships sailed from Scandinavia to North America 500 years before Columbus . . . what an island born in the 1960s is teaching us about evolution . . . what the scientific community is learning from Icelandic genes . . . how the 1986 nuclear accident at Chernobyl affected people in Lapland more than 1,000 miles away . . . and what technology is doing for people with disabilities.

Visit Us at the NSTA Convention

The 1998 National Science Teachers Association Convention is set for April 16 to 19 in Las Vegas, Nevada. FRONTIERS will be there, and we hope to see you, too! Stop by our booth to meet FRONTIERS School Program representatives and share your comments and ideas about FRONTIERS. We'd like to hear how you're using FRONTIERS in the classroom, what your students and colleagues think of the program and what we could do to make the School Program more useful for you.

Come join us for a **hands-on FRONTIERS workshop** at the convention. This is your chance to try creative activities

from the teaching guide. You'll learn valuable ways to integrate FRONTIERS into your classroom and enhance your curriculum while meeting current goals of science education. Interested? Call us at 800-315-5010 to sign up. Space is limited, so don't wait to call.

Are you planning your own workshop using FRONTIERS activities or materials? Let us help! We can provide free copies of our teaching guide and related materials for your participants. Just call, write or send us an e-mail to let us know what you're planning to do and how we can help.

Spend a Week in Scandinavia

Why not use this International Special to kick off a school-wide, multi-curricular focus on Scandinavia? You don't have to wait for Leif Ericson Day (Oct. 9), but instead use this show as a tie-in to history and geography studies. For English, research Nordic sagas. Norse myths gave us the names of some days of the week (Wednesday, Thursday, Friday). And don't forget the Nobel Prizes, awarded each year in Stockholm.

FRONTIERS Supports Science Standards

We'd like to know how you're using FRONTIERS programs and teaching guides to support national, state or local science standards in your classroom. We're currently compiling information on FRONTIERS usage and we want to hear from you. Let us know what science standards are important to you and how FRONTIERS can help you meet them.

TIPS FOR TEACHERS

TAPING THE SHOW:

- ✓ Always check TV listings to confirm air date and time.
- ✓ As a teacher, you have off-air taping rights in perpetuity for classroom use.
- ✓ If you can't find the show in your TV listings, call your local PBS station.
- ✓ Do you need help? Call the FRONTIERS School Program at 800-315-5010.
- ✓ Videotapes of past shows can be purchased (\$21.97 each). Call 800-315-5010.

FREE VIDEOTAPING & PHOTOCOPYING RIGHTS:

GTE Corporation, the series underwriter, makes available complete off-air taping rights in perpetuity for classroom use of SCIENTIFIC AMERICAN FRONTIERS. Educators may record each show when it airs on PBS and keep the tapes to use in the classroom year after year.

Educators may also photocopy all materials in this guide for classroom use.

NEW SIGN-UPS:

If you know of other educators who are interested in receiving these guides, they may sign up by calling the SCIENTIFIC AMERICAN FRONTIERS School Program at 800-315-5010.

LET US HEAR FROM YOU!

We appreciate and welcome your questions, comments, compliments and constructive criticism. *Please contact us . . .*

By mail:

SCIENTIFIC AMERICAN FRONTIERS
105 Terry Drive, Suite 120
Newtown, PA 18940-3425
By phone: 800-315-5010
By fax: 215-579-8589
By e-mail: saf@pbs.org

VISIT US ONLINE:

<http://www.pbs.org/saf/>

VIEWER CHALLENGE

You and your students can enter the **Viewer Challenge** (p. 4) and have a chance to win a terrific FRONTIERS T-shirt! The correct answers to the **Viewer Challenge** questions are (some answers will vary):

1. a
2. square sail, shallow keel or draft, side rudder, projection on side rudder, ability to shift quickly from sail to oar
3. d
4. population is isolated, homogeneous, not diverse and they have excellent genealogical and health records
5. b
6. arrival of birds
7. e
8. they use pictures or photos in the Pictorium
9. d
10. lichen acts like a sponge and absorbs nutrients from air and water, so it absorbed the radioactive fallout

NEXT TIME ON FRONTIERS

Tune in **February 18, 1998**, when FRONTIERS looks at **The Art of Science**, featuring stories on a robot that paints, Ben Franklin's glass harmonica, a digital Alan Alda and more.

Nordic Sagas

SHOW 803 • JANUARY 21, 1998 • 8 PM* ON PBS

VIKING SHIPS

6

Innovations developed more than 1,000 years ago helped Vikings dominate the seas from the 8th through the 11th centuries. Watch as archaeologists reconstruct and sail ancient ships.

Activities: Design and race model boats. . . Why the right side of a boat is called the starboard side.

ISLAND LIFE

8

The birth of an island from a volcano in 1963 provides a living laboratory to see how life arrives on the island. What scientists learn from Surtsey will last longer than the island itself — it has already begun to erode.

Activities: Model an underwater volcano. . . Invasion tactics by design.

RADIOACTIVE REINDEER

10

The 1986 Chernobyl nuclear disaster had widespread consequences, among them contamination of reindeer herded by Lapland's Sami people. Alan Alda helps round up reindeer to monitor radioactivity.

Activities: How radioactivity affects the soil. . . Calculating half-life.

ICELAND GENES

12

Iceland's remote population and unique genealogy help scientists hunt for disease genes.

Activity: Chart your own genealogy.

ISAAC AND FRIENDS

13

Swedish scientists are using technology to enable people with disabilities to connect to others.

Activity: Design your own personal digital assistant.

Plus, in every issue . . .

VIEWER CHALLENGE: Quiz questions, T-shirt prizes! 4

THE BIG PICTURE: Mapping Scandinavia 5

FRONTIERS ONLINE: Visit us at <http://www.pbs.org/saf/> 14



ABOVE: FRONTIERS visits a Sami reindeer herd.

COVER: Viking Ship in Heavy Seas: Leiv Eirikson Discovers America by Carl W. Barth and Iver A. Holme. Photo by Erik Solbakken, courtesy of the Norwegian Film Institute.

NOTE: The order of the activities in this guide does not reflect the actual order of the stories in the show. The At-A-Glance box below follows the story sequence in the show.

AT-A-GLANCE

SCIENTIFIC AMERICAN FRONTIERS

NORDIC SAGAS

NOTE: More detailed curriculum links are included on the activity sheets to individual stories.

STORY	RUNNING TIME	EARTH SCIENCE	LIFE SCIENCE	MEDICINE	PHYSICAL SCIENCE	PSYCHOLOGY	TECHNOLOGY
Viking Ships	10:41	•			•		•
Iceland Genes	6:45		•	•		•	•
Island Life	10:19	•	•				
Isaac and Friends	11:45			•	•	•	•
Radioactive Reindeer	13:04	•		•			•

*CHECK LOCAL DATE AND TIME

SCIENTIFIC AMERICAN FRONTIERS is made possible by an underwriting grant from GTE Corporation. The series is produced by The Chedd-Angier Production Company in association with *Scientific American* magazine and presented to PBS by Connecticut Public Television. Classroom materials produced by Media Management Services, Inc.





Nordic Sagas

Show 803 / January 21, 1998, at 8 pm* on PBS



STUDENT'S NAME: _____

TEACHER'S NAME & COURSE: _____

*CHECK
LOCAL
LISTINGS

**Watch SCIENTIFIC AMERICAN FRONTIERS for answers to the questions on this page.
Answer the 10 questions correctly and you'll be eligible to win a FRONTIERS T-shirt!**

Viking Ships

- Vikings dominated the seas in the northern hemisphere during this era:

<input type="checkbox"/> a. A.D. 700 to 1000	<input type="checkbox"/> c. 700 to 200 B.C.
<input type="checkbox"/> b. A.D. 100 to 400	<input type="checkbox"/> d. A.D. 1000 to 1400
- Identify three technological innovations made by Viking shipbuilders that enabled the Vikings to be such successful sailors.

Iceland Genes

- In this story, deCode Genetics is tracking the genes for which disease?

<input type="checkbox"/> a. Parkinson's
<input type="checkbox"/> b. macular degeneration
<input type="checkbox"/> c. Huntington's
<input type="checkbox"/> d. multiple sclerosis
- Why is the Icelandic population ideal for genetic research?

Island Life

- What do people in Iceland mainly use to heat their homes?

<input type="checkbox"/> a. wood stoves	<input type="checkbox"/> c. natural gas
<input type="checkbox"/> b. hot water	<input type="checkbox"/> d. oil
- What happened in 1986 that caused the number of new plant species on Surtsey to increase dramatically?

Isaac and Friends

- Who or what is Isaac?

<input type="checkbox"/> a. a computer	<input type="checkbox"/> d. a GPS satellite navigator
<input type="checkbox"/> b. a telephone	<input type="checkbox"/> e. all of the above
<input type="checkbox"/> c. a camera	
- How do Stig and Thomas, the two Swedish men in the story, communicate?

Radioactive Reindeer

- What is the principal source of food for the Sami people?

<input type="checkbox"/> a. whale meat	<input type="checkbox"/> c. musk ox
<input type="checkbox"/> b. caribou	<input type="checkbox"/> d. reindeer
- How did the lichen become contaminated?

EXTRA CREDIT CONTEST!

Do you have a question that's never been answered? Now is your chance to share it with SCIENTIFIC AMERICAN FRONTIERS. You may get your answer next season on FRONTIERS, when we answer "Life's Little Questions." Send your question by February 20, 1998, to Extra Credit Contest at the address to the right. If the producers choose your question for the show, you'll win a FRONTIERS T-shirt. Good luck!

Answers to the Viewer Challenge are listed on page 2 of this guide. T-shirt winners' names will be posted in the Polls & Prizes section of the FRONTIERS Web site.

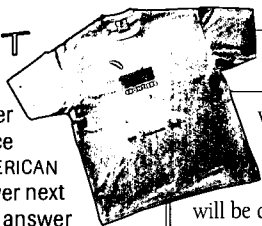

FOR TEACHERS ONLY

When completed, this page can become an entry to the FRONTIERS T-shirt contest; 20 winners (10 students, 10 teachers) will be drawn at random for each show. To enter the T-shirt drawing, send all completed challenges in one envelope with a cover sheet to: Viewer Challenge, SCIENTIFIC AMERICAN FRONTIERS, 105 Terry Drive, Suite 120, Newtown, PA 18940-3425. Mail completed entries by February 20, 1998.

TIP: You can download these questions on the Web: <http://www.pbs.org/saf/>.

IMPORTANT!! Please include a separate cover sheet and tell us:

- number of challenges submitted
- teacher's name
- grade and course
- school name, address and phone number
- where your students watched the show — at home, at school or both
- the name of your students' favorite story in this show (conduct a quick poll to find out)

Thank you!

FRONTIERS in Scandinavia

Welcome to Scandinavia, the subject for the international special on SCIENTIFIC AMERICAN FRONTIERS. As you watch the show on PBS, use this map to follow the crew to see where each story takes place.

FLAGS OF SCANDINAVIA

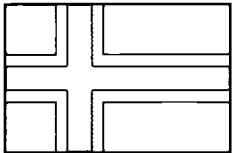

NORWAY

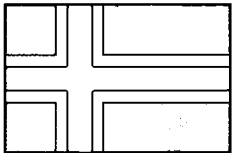

ICELAND

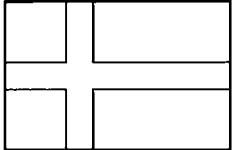

DENMARK

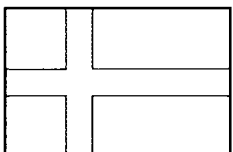

SWEDEN

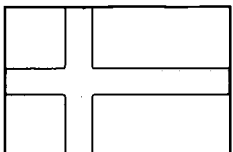

FINLAND



Educators:

Tips for using this page.

- Photocopy the map and distribute to your students before they watch the show.
- Suggest they note where each story they see takes place.

- Ask students to identify the icons on the map and explain their significance.

Note: A few of the icons are not featured in this episode. Students may want to do some extra research to learn more about them.

- You might extend lessons by assigning students to find out more about the countries featured on the show.
- Consider working with your school's social studies and geography teachers on these and other activities in this guide.

Viking Ships

For nearly three centuries, Vikings sailed the rough oceans in their sleek, streamlined ships, traveling far from Scandinavia to distant lands where they built settlements. How they sailed to North America and other parts of the world has long been a mystery, but ships buried in the mud of Danish fjords are providing some answers. FRONTIERS joins archaeologists reconstructing ships that will sail on the same waters traveled by Viking ancestors so long ago.

RUNNING TIME: 10:41

CURRICULUM LINKS:

EARTH SCIENCE

oceans

PHYSICAL SCIENCE/PHYSICS

forces, vortices

SOCIAL STUDIES

exploration, Leif Ericson, Vikings

TECHNOLOGY

engineering design



RELATED FRONTIERS SHOWS & ACTIVITIES:

- Show 203 or 305: "Rebuilding the Legendary Baidarka"

Viking Ship Design

From the 8th to the 11th centuries, Vikings dominated the seas in the northern hemisphere. Their superior ship design and physical prowess enabled them to sail many thousands of miles from their homes in Scandinavia and establish settlements in many areas, from what is now Russia to the Mediterranean, Britain, France and North America — 500 years before Columbus.

As you see on FRONTIERS, Viking boat builders employed technological advances for their age. Their ships' streamlined hulls and shallow keels meant the sleek vessels rode high in the water and skimmed the surface. A square sail that could be raised and lowered quickly meant sailors could easily shift from wind to muscle power.

Among the Vikings' technological innovations in ship design was a unique side

rudder. The method of attachment allowed the rudder to be lifted out of the water quickly, so ships could maneuver right up to shore. Not having to anchor ships in a harbor gave the Vikings another advantage.

Ships were so much a part of the Viking culture that great leaders were even buried in them. Archaeologists have found several ships buried long ago, complete with treasures intended to accompany the hero on his journey to the next world.

The Vikings, who lived in what is now Iceland, Denmark, Norway and Sweden, landed in North America by 1003. To commemorate the anniversary, the Leif Ericson Society has organized the Leif Ericson Millennium. The international celebra-

tion begins on Leif Ericson Day, October 9, 1999, and continues for one year. The celebration will re-enact Leif Ericson's voyage to North America or "Vinland" using replica Viking ships.

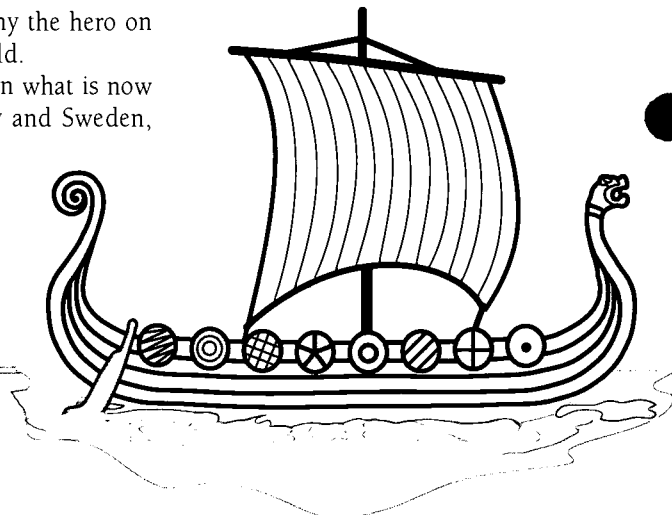

ACTIVITY 1 A Balance of Forces

Now it's your turn to be a naval architect. In this challenge you'll construct a wind-powered model of a Viking ship. The ship will have to follow a course set by your rudder. You'll need to build your model and examine the relationship between rudder shape, placement and steering angle.

OBJECTIVE

Observe and critically examine the role of the rudder in steering.

MATERIALS

- waterproof clay
- heavy stock paper
- tape
- thin wooden dowel or plastic coffee stirrers
- index card
- battery-powered fans
- small wading pool or large basin

NOTE: To prevent any possibility of electric shock, do not use a fan powered by an electrical outlet. Although this activity can be performed with a single fan, additional fans will produce uniform coverage of the water's surface. Several small battery-powered fans will work for the entire class setup.

PROCEDURE

PART 1: CONSTRUCTING A TEST SITE

1. Place the empty pool or basin either outdoors or in a classroom "wet area."
2. Fill the pool or basin with water to a depth of four inches (10 cm).



Ole Crumlin-Pedersen, who appears in this segment, answers your questions online.

SEE PAGE 14 <http://www.pbs.org/eaf/>

- Position the battery-powered fan(s) at one end of the pool or basin. The fans will simulate the "prevailing winds" that will power the ships. The fans should be secured on top of a stack of books or similar platform so that breezes flow unobstructed across the water's surface.

PART 2: BUILD A BOAT

- Shape the hull of your model Viking boat from a walnut-sized lump of waterproof modeling clay.
- Cut out a section of stiff paper for a sail. You may want to decorate the sail with Viking symbols and designs.
- Use a thin wooden stick or coffee stirrer as the model's mast. Tape the sail to the mast and position it in the clay hull. Secure the base of the mast with a small piece of clay.

PART 3: MAKE A RUDDER

- When you have your boat ready, draw a rudder on an index card and cut it out. (Part of your challenge is to experiment with shape and size of the rudder.)
- Press it into the hull on the right (starboard) side of the boat, near the rear (stern).

PART 4: THE LAUNCH

- Place your model ship in the pool or basin (closest to the fans). Set the rudder and sails so that the ship will travel a straight course. Release and observe its motion.
- Vary the rudder angle and observe how this affects the ship's course. Make sure to record your observations. Try to come up with a relationship between rudder angle and course heading.

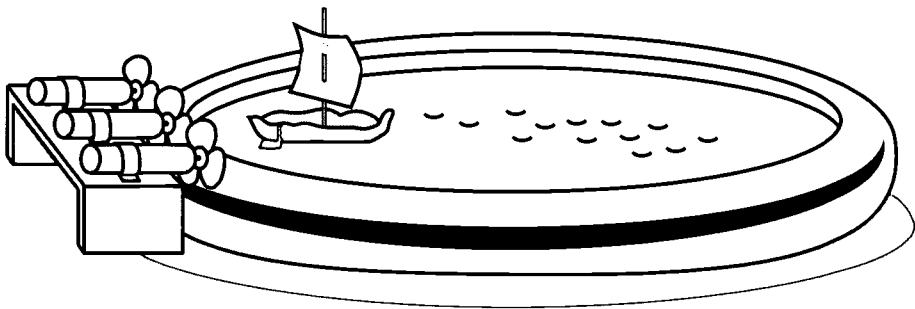

PART 5: THE CHALLENGE EXTENSIONS

- Your instructor will identify the starting point and the "sailing target" to which your boat must head. The winning model boat will come closest to the target.
- You may modify the rudder's position only before the trial begins. Once the boat has been placed and launched, you may not adjust the rudder. Good luck!

- Compare the side rudder to ships' rudders used today.
- For more about the Vikings, visit these Web sites:

www.natmus.dk/nmf/nb/indexgb.htm
Click on the May 1997 issue of *Maritime Archaeology* to find out more about the Roskilde ships.

www.lookoutnow.com/places/tenhour.htm
Take a photo tour of Iceland's Golden Circle.

www.pastforward.co.uk/vikings/museums.html

Travel back in time to the world of the Vikings and visit sites in many parts of the world.

- You can learn more about Viking ships, order a kit to build one and find out about re-enactments and other events from Leif Ericson Viking Ship, Inc., based near Philadelphia, Pa. Find out more at www.LibertyNet.org/~viking/.
- See the February 1998 issue of *Scientific American* for an article about Viking ships.
- Evidence suggests the Earth was much warmer during the Viking era. How would such a climate shift have made a difference to Viking sailors?
- During the Viking era, Polynesians sailed the South Pacific, colonizing what is now Hawaii and other islands. Compare ship designs and distances traveled by Polynesian and Viking sailors.

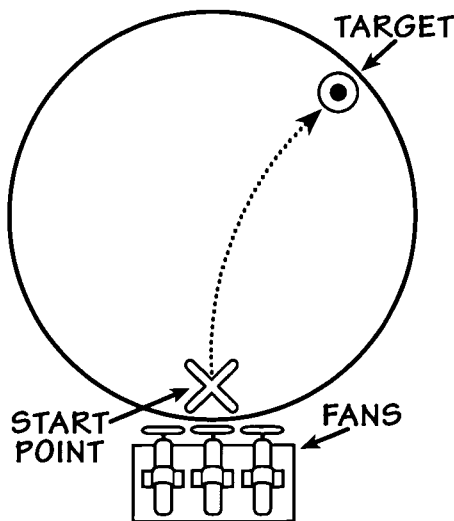

Viking ships were steered with an oar-like rudder called a *styri*, attached to the right-hand side of the ship near the stern. The Vikings called this side of the ship *stjornbordi*. Today the right-hand side of any boat is known as the starboard side.

As you see on *FRONTIERS*, the projection on the trailing edge of the rudder is theorized to break up the turbulence (vortices) caused by friction of the fluid/hull interface. Similarly, some 747s have a projection on the airfoil surface that breaks up turbulence caused by air flow.

In the late 9th century, Vikings invaded and settled areas in France. One region became Normandy, named after the Norsemen. In 1066, the Normans invaded and conquered Britain in the famous Battle of Hastings, commemorated in the Bayeux Tapestry. In the tapestry, you can clearly see Viking ship designs, complete with side rudder.



For more on a side rudder and vortices, see the *Cool Science* activity on the *FRONTIERS* Web site: www.pbs.org/saf/.

SCIENTIFIC AMERICAN FRONTIERS

Show 803:
Nordic Sagas



Viking Ships

Island Life

The explosion of an underwater volcano 20 miles south of Iceland in November 1963 gave scientists a rare chance to observe life developing on a new part of the Earth, from the beginning. The island of Surtsey became a living laboratory for ecologists, biologists and others to watch as nature took up residence. Scientists have been careful to preserve this small island in the North Atlantic, and FRONTIERS was privileged to accompany scientists on a field trip.

RUNNING TIME: 10:19

CURRICULUM LINKS:

- BIOLOGY
 - evolution
- CHEMISTRY
 - exothermic reactions
- EARTH SCIENCE
 - oceans, volcanoes
- LIFE SCIENCE
 - ecosystems, succession
- SOCIAL STUDIES
 - Iceland



RELATED FRONTIERS SHOWS & ACTIVITIES:

□ **Science Italian Style, Show 503: "Eruption!"** (pp. 11-12)

ACTIVITY 1 Birth of an Island

The creation of Surtsey from an undersea volcanic eruption has given scientists a unique natural laboratory where they can observe how life invades, colonizes and changes over time.

From the first signs of smoke, mistaken by a fisherman for a ship in trouble, Surtsey has been a focus of deep scientific interest. Surtsey is the result of a relatively shallow water volcano (about 130 meters below the surface) — unlike the Hawaiian Islands, which formed from eruptions originating deep on the ocean floor. The eruptions that created Surtsey sent material out in horizontal blasts, causing the island to spread out. The final eruptions that formed Surtsey sealed the island with a layer of rock that protected it from washing away immediately.

OBJECTIVE

Model a shallow underwater volcano to see what type of island forms.

MATERIALS

- hydrogen peroxide (household brand is fine)
- yeast (dry or rapid-rising)
- small glass jar with lid
- gallon jar or fish bowl (deep enough to hold small glass jar but not too wide)
- safety glasses
- hammer and nail or other tool to punch holes in jar lid
- notebook and pencil for observations



NOTE: Make sure yeast and hydrogen peroxide are fresh. The reaction will begin almost immediately when the yeast and peroxide are mixed. You may wish to place a small, clean rock in the bottom of the jar before mixing to prevent it from floating in the fish bowl.

PROCEDURE

1. Pour enough water in the fish bowl so it will cover the small jar by two inches.
2. Punch five to ten holes in the lid of the small jar.
3. Pour about 150 ml (1/2 cup) of hydrogen peroxide into the small jar.
4. Place about two teaspoons of yeast into the small jar, stir and cover quickly.
5. Place the small glass jar, with lid on top, into the water on the bottom of the bowl.
6. Observe how the "eruption" progresses. Draw the formation of the island at different intervals.

QUESTIONS

1. What happens as the hot "lava" contacts the cool "seawater"?
2. Examine the drawings of the "island" that forms when your volcano erupts. Can you identify different areas where life might begin to colonize? How might different forms of life get to these areas?

EXTENSIONS

1. Iceland and Surtsey lie in an area of the North Atlantic Ocean with extreme winds, up to 200 m.p.h. What effects do weather and climate have on island formation? How might weather affect the long-term survival of Surtsey?
2. What effect does modifying the model have on island formation? For example, what kind of island forms when the eruption occurs at a greater depth beneath the surface? What happens when the eruption occurs above the water line — like those in Hawaii?
3. Mixing hydrogen peroxide and yeast causes an exothermic chemical reaction. Explain.

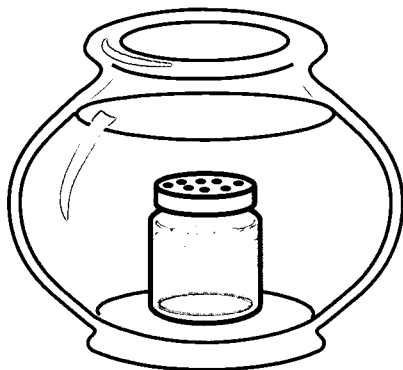

Ecologist Borgthor Magnusson, who appears in this segment, answers your questions online.

SEE PAGE 14 <http://www.pbs.org/saf/>

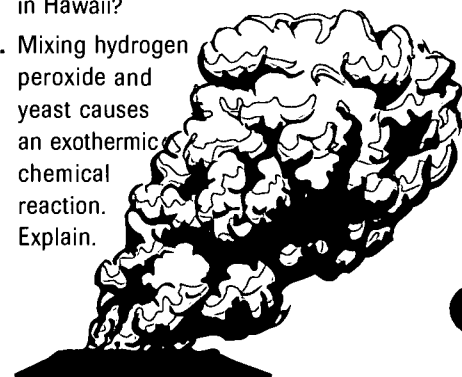

ACTIVITY 2 Invasion Tactics

Whether by water, wind or hitching a ride on other organisms, life found its way to Surtsey. Tough pioneer species were the first to establish a foothold. Plants, insects, birds and other organisms used a variety of devices to travel to a new land.

OBJECTIVE

Study different ways life can invade an island.

PART 1: PLANT INVASION

The first plant observed on Surtsey was the sea rocket, but the first flowering plant to really take hold was the sea sandwort. This plant's hardy seeds rode on ocean currents, surviving the extreme cold of the North Atlantic. Other seeds blew to the island or hitched a ride on (or in) birds. Collect various seeds where you live and determine their "preferred" mode of travel. If seeds are not available for collection, try a craft store for a variety of dried seeds. You can also use bird seed and packaged seeds for flowers and vegetables.

PROCEDURE

1. Place samples of each seed in water to determine if they float. Leave them in the water for several days to determine which float the longest and therefore have a better chance to "find" land.
2. Use a fan set on high, oriented to blow horizontally, to simulate the fierce winds

of the North Atlantic. Drop seeds into the "wind" and record which seeds fly the farthest.

3. Find a cat or dog that will cooperate and see which seeds stick to its coat and are carried away.
4. Examine each seed under a magnifying glass or microscope to see if there are any obvious adaptations that favor one form of travel over another.

EXTENSIONS

1. Does floating in water affect a seed's ability to grow? Design an experiment and explain your results.
2. What effect do you think substituting salt water for fresh water would have on the seeds' floating? Design an experiment and explain your results.
3. Some seeds get to Surtsey by traveling inside a bird to be excreted in bird droppings. Seeds that tend to travel this way are usually part of a berry or fruit. This is an example of mutualism. How do both organisms benefit from this relationship?
4. Sea beans are seeds that drift to tropical islands, where they are often found on beaches. Some well-armored seeds can float for two or three years in the ocean. Would tropical seeds have a better chance at survival than seeds floating in the North Atlantic? Explain.



PART 2: BIRD INVASION

Wing size and shape determine which birds fly where. The first birds to make use of Surtsey were shorebirds like gulls with wings that take advantage of brisk winds found along the shore. The snow bunting, the first passerine (perching) bird to take up breeding residence, was most likely blown to the island. The snow bunting is a robin-sized bird with elliptical wings for slow, steady flight.

Compare and contrast the wings of long-distance soaring birds capable of dealing with high winds (gulls) with the smaller, short-distance birds (buntings) that can be blown off course by the wind.

QUESTIONS

1. The shorelines of Surtsey were the first areas colonized by birds. Why do you think this was the case? Why do you think it took the birds a while to find the island?
2. As you see on FRONTIERS, more than half of the species now on Surtsey owe their origins to birds. Why are the contributions of birds so effective to colonizing new land?
3. Charles Darwin observed several species of finch on the Galapagos Islands and concluded they evolved from ancestors isolated from mainland populations. Would it be possible for new bird species to evolve in a similar manner on Surtsey? Why or why not?

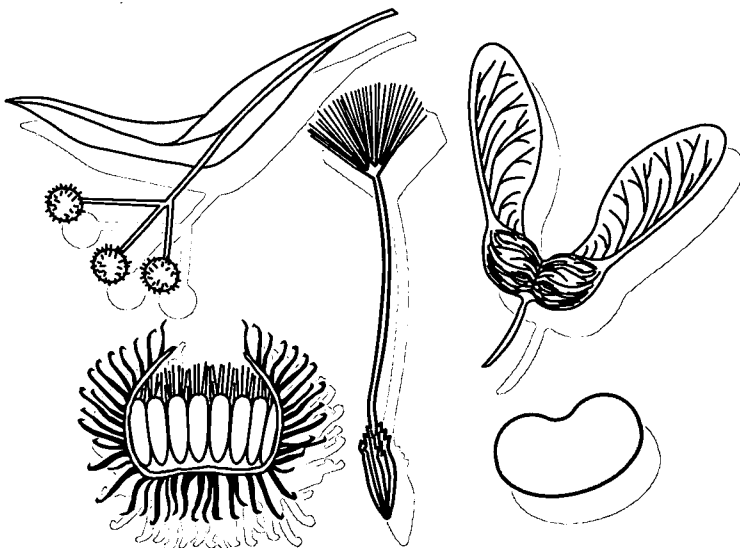

SCIENTIFIC
AMERICAN
FRONTIERS

Show 803:
Nordic
Sagas



Island Life

Radioactive Reindeer

In April 1986, the world's worst nuclear disaster occurred at the Chernobyl power plant in the Ukraine. Fallout carried by wind and rain contaminated Lapland over 1,000 miles to the northwest, where the Sami people live. Reindeer are central to Sami culture and the economy, so the first reports of radioactive contamination in reindeer were devastating to hear. Monitoring people and reindeer is a constant reminder of the long-term consequences of Chernobyl.

RUNNING TIME: 13:04

CURRICULUM LINKS:

- CHEMISTRY
 - half-life, nuclear chemistry, radioactivity
- EARTH SCIENCE
 - radon, tundra ecosystem
- FOOD SCIENCE
 - irradiation
- LIFE SCIENCE
 - food chains, lichen
- MEDICAL
 - nuclear medicine
- SOCIAL STUDIES
 - Lapland, Scandinavia, tundra
- TECHNOLOGY
 - nuclear power



RELATED FRONTIERS SHOWS & ACTIVITIES:

- **Life's Big Questions**, Show 501: "Get a Half-Life" (p. 12)

ACTIVITY 1 After Chernobyl

On April 26, 1986, a nuclear power reactor in the Ukraine (then part of the U.S.S.R.), became the site of the world's worst nuclear reactor accident. It happened when the cooling system in one of the reactors at the Chernobyl power plant failed during a test to see how the reactor would function in a power outage. The core overheated, causing an explosion and fire. Tons of nuclear fuel and other radioactive materials were released into the atmosphere. Scientists continue to assess the long-term effects on health and the environment.

Just two days after the accident, scientists in Sweden detected radioactivity in their air. Fallout carried by wind and rain contaminated large areas of Eastern Europe and Scandinavia, more than 1,000 miles (1,600 km) to the northwest. Tons of fresh produce and dairy products had to be destroyed in affected regions.

For the Sami people living in Lapland, the accident had multiple effects. Reindeer, their primary food source and export product, were contaminated by Cs-137, a radioactive isotope with a half-life of about 30 years. Lichen, which acts like a sponge to absorb nutrients from the air and rain, absorbed Cs-137 from the atmosphere. Because lichen is the principal food eaten by reindeer in the winter months, scientists knew the reindeer would also be contami-

nated from eating the radioactive lichen.

The first reports after Chernobyl suggested that the reindeer meat could not be consumed for 40 years (estimates based on the half-life of Cs-137). Fortunately for the Sami, whose entire culture is built around reindeer, Cs-137 has since fallen to more acceptable levels.

Soil in Scandinavia and other areas absorbed Cs-137 after the accident and is still contaminated. This activity will demonstrate how soil absorbs radioactivity. Like all radioactive fallout, Cs-137 is invisible and can be detected only by monitors like Geiger counters. Use your imagination to simulate fallout in the form of "rain."

OBJECTIVE

Simple modeling of Cs-137 absorption by soil and lichen.



MATERIALS

- clear plastic water or soda bottle(s) (1 L, 1.5 L or 2 L)
- knife for cutting the bottle
- 100 to 300 ml of rich, organic soil
- floral foam ("Oasis") or sponge
- food coloring
- water
- optional: watering can
- optional activity: play sand, fine net (fish net will do)

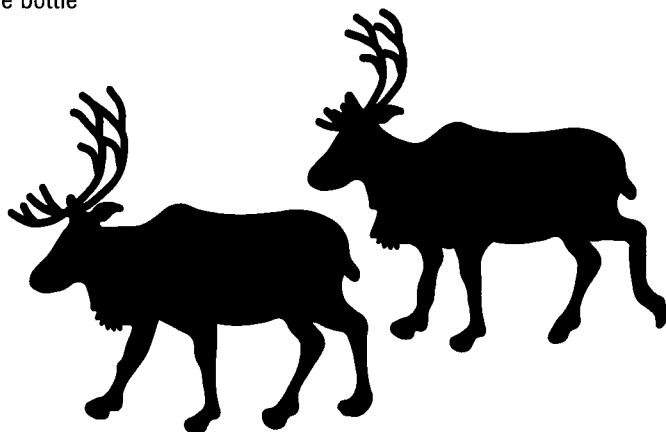

NOTE: Any size plastic bottle will work. Ideally, soil should be organic, from the ground. You don't need much. If you don't have access to a good soil sample, make a mix of gardening soil and peat moss. Regular potting soil alone is too fine for this purpose. Floral foam for fresh flower arrangements is sold at craft stores or supermarket flower departments. The amount and variety of supplies will depend on whether this is done as a demo or a student activity.



Birgitta Ahman, who appears in this segment, answers your questions online.

SEE PAGE 14 <http://www.pbs.org/saf/>

PROCEDURE

1. Cut off the tops of the soda bottles about one-third of the way down. Turn the top of the bottle upside-down and fit into its bottom portion.
2. Prepare setup as shown using soil. Keep the cap on the bottle to keep the soil from dribbling out until you are ready to pour the water.
3. Cut pieces of floral foam or a sponge to represent the lichen and place a piece on top of the soil in the bottle.
4. Mix the "radioactive rain" by filling a beaker with 100 ml of water and adding ten or more drops of food coloring. Stir.
5. Remove the bottle cap and slowly pour the radioactive rain over the soil sample. If you have a watering can, the effect will be more realistic.
6. Observe: What happens to the lichen? What happens to the soil?

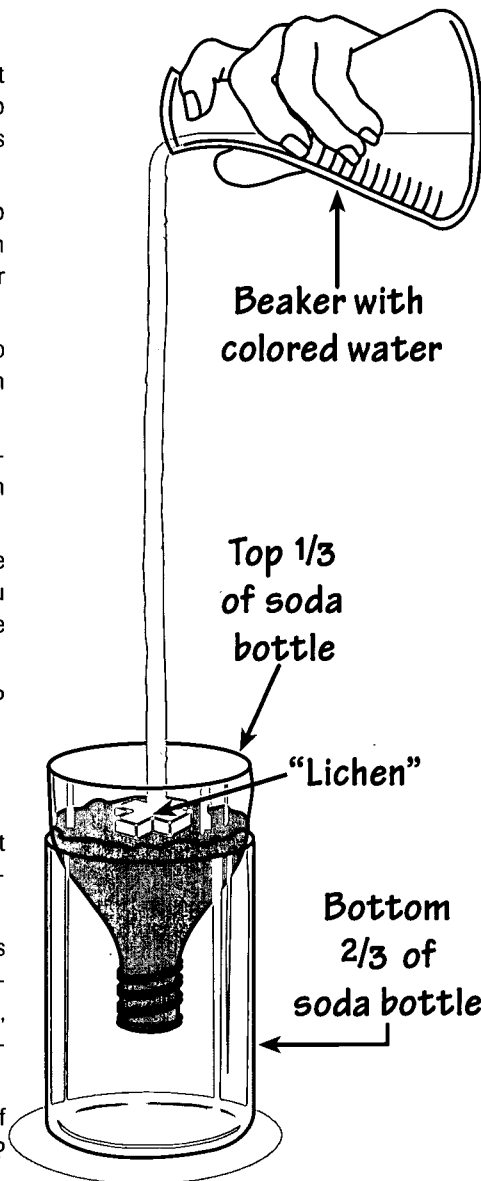

EXTENSIONS

You can make this simple activity into a more scientific experiment by using some other kinds of soils and making comparisons. Use beach or desert sand, clay or soil from different areas. Remember to measure how much water you pour on each sample and how long it takes to percolate through. For finer soil and sand, you will need to attach a screen to the top of the bottle so the sand does not fall out. Fish net works well for this purpose.

Real-Life Connection

Radon is a natural product of the decay of radioactive minerals that contain uranium-238. Radon from minerals in the earth can seep through cracks in basement floors. This invisible gas is denser than air, so it collects in lower levels of houses. Radon can be found in many parts of the U.S., but is more prevalent in a geological belt in the Northeast. The radioactive particles in radon cling to dust, which lodges in the lungs. If inhaled, radon is considered a health hazard. Testing is mandatory in many states when homes are sold. Has your home been tested? Kits are available at hardware stores.

QUESTIONS

1. What do your observations tell you about how soil absorbs Cs-137 (and other radioactive isotopes)?
2. What impact would Cs-137 have on plants growing in the soil? What about other radioactive isotopes falling on soil or grass, which are then consumed by other animals in the food chain?
3. What do you think would be the impact of Cs-137 on areas of tundra with permafrost?

ACTIVITY 2 Figuring Out Half-Life

Cesium-137, or Cs-137, is a radioisotope of cesium with a half-life of 30.14 years. Cs-137 is released into the atmosphere in two ways: nuclear bomb explosions and nuclear power plant leaks or accidents. Cs-137 is also used to treat cancer.

Half-life of radioactive matter is the time it takes for one-half of the atoms in a sample to decay. If Cs-137 has a half-life of 30 years, then in 30 years, one-half of the original sample will decay. One-half will remain. Then, in another 30 years, one-half of the remaining sample (or one-fourth of the original sample) will decay, leaving one-fourth of the original sample. Half of what remains will decay at each half-life.

DAYS	GRAMS
0	24
5	—
10	—
15	—
20	—
25	—

Some radioactive isotopes have a half-life of a few seconds; others, tens of thousands of years. When people have nuclear tests for thyroid or heart functions, radioactive isotopes with short half-lives of a few hours are used as tracers.

HERE'S AN EXAMPLE OF A HALF-LIFE PROBLEM:

A 24g radioactive sample has a half-life of five days. Fill in the blanks on the chart at left. What remains of the sample after five days? After 25 days?

ANSWERS: After 5 days, 12g remains. After 25 days, .75g remains.

SCIENTIFIC AMERICAN FRONTIERS

Show 803:
Nordic Sagas



Radioactive Reindeer

Iceland Genes

Imagine being able to trace your ancestors back more than 1,000 years. Many people who live in Iceland can do just that. Besides having extensive genealogy records, Iceland has an unusually isolated and homogeneous population, making it valuable for genetic research. FRONTIERS steps into the lab of a biotech company studying this unique population. Iceland's genetic heritage may one day contribute to the future health of the world.

RUNNING TIME: 6:45

CURRICULUM LINKS:

LIFE SCIENCE
genetics

SOCIAL STUDIES
Scandinavia



RELATED FRONTIERS SHOWS & ACTIVITIES:

- 21st Century Medicine, Show 605: "Bypass Genes" (pp. 12-13)
- Dragon Science, Show 602: "Food for Thought" (pp. 8-9)
- The Wild West, Show 601: "Dead Men's Tales" (pp. 8-9)
- Science 911, Show 404: "Tree Fingerprints" (p. 13)

ACTIVITY Go Back in Time

As you see on FRONTIERS, much of the current population of Iceland can trace its ancestry back to the founders, who first landed there in about A.D. 874. Icelanders kept written records from very early on. You may not be able to trace your heritage back as far as Icelanders do, but you can certainly capture two, three or four generations without extensive research. You can set up a simple family tree on paper or use one of the many genealogy software programs available. As you will find out, genealogy can become complicated. If you want to go back further in time, you'll have to do more digging. Many resources are available, including books, periodicals and Web sites on family history and genealogical research.

yourself, all women will be listed with odd numbers and men with even numbers.

FINDING OUT MORE

Good sources for more information are local libraries, census records, bureaus of vital statistics, church and cemetery records, and historical and genealogical societies. Tracing immigrants' records is difficult, but it can be done using ships' passenger lists, found in some libraries and the National Archives. Family History Centers (established by the Mormon Church) are excellent sources of genealogy records. Other organizations now exist to locate the histories of African Americans and others.

MEDICAL HISTORY

You can't do genetic studies, but you can track patterns of health and disease. This information can be valuable.

QUESTIONS

1. Why is a homogeneous population like Iceland's ideal for genetic research?
2. What other homogeneous populations are subjects of genetic research and what are scientists learning? (Old Order Amish, Ashkenazi Jews)

GETTING STARTED

Talking with relatives is the best way to begin. Take notes and use a tape recorder (with permission). Always write down who gives you information (the source) and the date. Genealogy is like doing detective work; stories will conflict. Write everything down, so you can verify information later on.

CHARTING YOUR FAMILY TREE

Genealogists use standard forms called pedigree charts. You are number 1, your father is number 2 and your mother 3. Your father's father is 4; his mother is 5. After you list

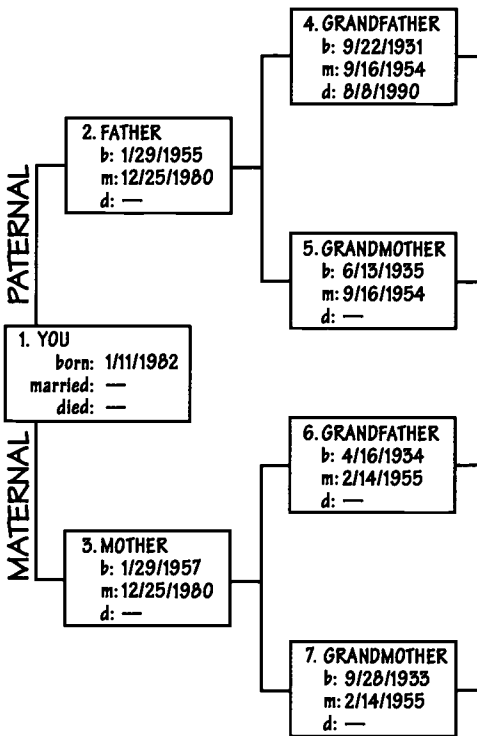

ICELAND FUN FACTS

- Icelanders do not use family names. They have a first name (like John or Inga) and a second name that combines the father's first name and *son* for a male or *dottir* for a female. Women do not change their names in marriage. These customs mean many Icelanders have the same names, so phone book listings also include people's occupations.
- The island lies over a fault line (the Mid-Atlantic Ridge) in the Earth's crust. Some of the volcanoes are still active, including Hekla, which last erupted in 1991. In 1973, a volcano that had been dormant for more than 5,000 years erupted on the nearby island of Heimaey. It poured volcanic ash over the island's only town, Vestmannaeyjar, forcing evacuation of all the residents.
- Iceland is often called the "Land of Ice and Fire" because glaciers lie next to steaming hot springs and geysers. Iceland uses geothermal energy for heat and power.



Kári Stefánsson, who appears in this segment, answers your questions online.

SEE PAGE 14 <http://www.pbs.org/saf/>

Isaac and Friends

Imagine if you could not make your wishes and needs known to others or even talk about your day unless you had a personal assistant with you at all times. Meet Stig and Thomas, two Swedish men who were unable to communicate until the invention of Isaac, a personal digital assistant (PDA). Using Isaac to create a database of photographs has enriched the lives of these two men and other adults in the program by increasing their mobility and independence.

RUNNING TIME: 11:45

CURRICULUM LINKS:

- PSYCHOLOGY
communication
- TECHNOLOGY
computers, engineering, PDA technology



RELATED FRONTIERS SHOWS & ACTIVITIES:

- **It's a Kid's World**, Show 505: "Speaking for Herself" (pp. 13-14)
- Show 305: "Design a Helpful Product" (p. 13)

ACTIVITY Design a PDA

After you watch this episode, brainstorm ideas of what features you would want to include in a personal digital assistant.

- How much of a photo archive would you need to describe events in a typical day?
- After you see the Pictorium, brainstorm applications for use in other situations. For example, how could the same concept be used with young children? With students learning a foreign language?
- Use available technology and/or future technology to design a PDA for people who are either physically or mentally impaired or who have limited mobility.
- What are some of the challenges disabled people face every day? How can you simulate their experiences? You could borrow a wheelchair and find out what it's like to be restricted to a chair. You could put Vaseline on your glasses and find out what it's like to see poorly. You could wear ear plugs for part of a day and find out what it's like to lose your hearing. These are some of the experiences people in rehabilitation engineering study, so they can find ways to assist people to live more fully.

WHAT IS ISAAC?

As you see on FRONTIERS, Isaac is a personal digital assistant (PDA) that combines a computer, a camera, a GPS navigator and

cell phone. Designed for individuals with cognitive dysfunctions, Isaac is just one project being developed by CERTEC.



WHAT IS CERTEC?

CERTEC is the Center for Rehabilitation Engineering Research at Lund University in Lund, Sweden. In this episode you meet Bodil Jönsson, CERTEC's founder, head of research and professor in the field of rehabilitation engineering.

Some other projects being developed at CERTEC include WALKY, an ultrasonic navigating mobile robot system for people with physical disabilities, and RAID, a robotic workstation that will enable people with disabilities to handle books, papers, disks, etc., in an office.

WHY WAS ISAAC DEVELOPED?

According to Jönsson, the Isaac idea grew out of her belief that differently abled people can communicate if they are able to use the language of pictures. The prototype was developed through CERTEC and a program in Lund, Sweden, at group homes for adults with cognitive dysfunctions. Find out more about Isaac at www.certec.lth.se/research/projects/isaac/index_e.html.

WHAT'S THE FUTURE OF ISAAC?

Since the first Isaac project in 1993, the project evolved into Isaac II and Isaac III, called *Science Piction*. Isaac III uses Isaac's picture database, complete with talking pictures and bar codes, but is posted on the

Internet. "*Science Piction* will make Isaac available to everyone," says Jönsson. "It is about empowerment." Visit www.certec.lth.se/research/projects/science_piction/index_e.html to learn more.

A MESSAGE FROM BODIL JÖNSSON

Bodil Jönsson, head of CERTEC, offers these suggestions to students:

- Search the Pictorium pages to get to know as much as you want to about Stig or Thomas or both of them.
- Produce a personal picture letter for Stig or Thomas or both men. To do this, you first have to decide what to tell the recipient of your letter. Then your task will be to "write" a letter containing a personal message, but without written words. You can use pictures, photographs, your own drawings, even music.
- If you wish, and have the digital capability, send your picture letters via the Internet to certec@certec.lth.se. Or, use regular mail and send to Stig or Thomas or Bodil, c/o CERTEC, LTH, Box 118, S 221 00, Lund, Sweden.
- You could also exchange picture letters with a friend in another class or school. Use a camera to take photos to convey your message. If you have a digital camera, you could send your letter via the Internet. You might want to take photos of a typical day at your school and send them to students in younger grades at another school who will be coming to your school next fall.

For more about CERTEC and how you can send questions to Bodil Jönsson, see page 14.



Bodil Jönsson, who appears in this segment, answers your questions online.
<http://www.pbs.org/saf/>

SEE PAGE 14

Explore Nordic Sagas with FRONTIERS Online!

This International Special introduces scientists in Iceland, Denmark and Sweden. After watching Nordic Sagas, learn more about science in Scandinavia from the scientists themselves. The five scientists featured on this page will answer viewers' questions about topics on the show from January 21 to February 6, 1998. To participate in Ask the Scientists, visit FRONTIERS online at www.pbs.org/saf/.



VIKING SHIPS

At the Viking Ship Museum in Roskilde, Denmark, Ole Crumlin-Pedersen investigates the remarkable vessels that gave Vikings supremacy over the seas. In addition to recovering 1,000-year-old ships from the bottom of the Roskilde fjord, Crumlin-Pedersen models the principles of their construction by building exact replicas with authentic materials and building techniques used in the originals. Crumlin-Pedersen answers your questions about his fascinating research and projects at the Viking Ship Museum.



ISAAC AND FRIENDS

As head of the Center for Rehabilitative Engineering Research (CERTEC) in Lund, Sweden, Bodil Jönsson passionately pursues her belief that technology can enhance the lives of individuals who are distanced from society by disability. She and her team have developed several tools including the Pictorium, a database of digital pictures that mentally disabled individuals can use to communicate with others. Ask Jönsson about her research and its promise for the disabled by sending your questions.



ICELAND GENES

Kári Stefánsson is president of deCode Genetics, an Icelandic company in search of genes that cause a variety of diseases, including multiple sclerosis. Iceland provides an especially valuable population for genetic research because of its relative isolation and history of carefully recording family genealogy. Send your questions to Stefánsson to find out more about his company's genetic research and how the Icelandic people are contributing knowledge to help diagnose and cure diseases.



RADIOACTIVE REINDEER

An ancient way of life continues on the tundra of central Sweden, where the Sami herd their reindeer. The modern world intruded suddenly 12 years ago when the Chernobyl nuclear explosion sent a radioactive plume over reindeer grazing lands. Since then, Birgitta Ahman of Uppsala University's animal husbandry unit has carefully monitored radioactivity levels in the reindeer. Discover more about Ahman and her work with the reindeer as she answers viewers' questions.



ISLAND LIFE

How does life colonize a new area on Earth? The island of Surtsey, formed by a volcanic explosion in 1963, offers an ideal natural laboratory for plant ecologists Borgthor Magnusson (right) and Sigurdur Magnusson to investigate this fascinating question. Once a completely sterile landscape, Surtsey is now home to birds, insects and more than 50 plant species. Here's your opportunity ask these two specialists about the processes nature is using to introduce life to Surtsey.



HERE'S HOW TO "ASK THE SCIENTISTS"

- Watch **Nordic Sagas** and review this classroom guide to prepare your question(s) and decide which scientist(s) you'd like to contact.
- Visit **SCIENTIFIC AMERICAN FRONTIERS** on PBS Online at <http://www.pbs.org/saf/>. Click on the "Ask the Scientists" icon on the home page to send your question(s). Scientists' answers will be posted online for FRONTIERS viewers to read. Depending on the volume of questions received, only selected questions may be answered.
- Remember to e-mail your questions by **February 6, 1998!**



Nordic Sagas airs on PBS on
Wednesday, January 21, 1998, at 8 pm.*

*Check your TV listings to confirm local air time and date.

NOTE: SCIENTISTS' AVAILABILITY IS SUBJECT TO CHANGE.

Cool Science

Fun and Games with FRONTIERS Online

For every show, FRONTIERS creates a variety of exciting and challenging online activities for you and your students. Visit us soon at PBS Online!



☐ Polls and

PBS ONLINE

Prizes: Vote for your favorite story on the show. Enter the *Science Scavenger Hunt* for a chance to win a FRONTIERS T-shirt. Tell us what you think in *Opinion Poll*. And see how you score in our *Viewer Challenge!*

☐ **Cool Science:** Try *Science Thing*, a challenging interactive activity. Have fun experimenting with *Don't Try This at Home*. Link to an exciting Web-based activity designed for every show.

☐ **Alan Alda:** Browse through *Alan's Photo Journal*. Learn more about FRONTIERS' host in *Alda Facts*. Send e-mail to Alan and read his answers to viewers' questions.

☐ **Plus:** Teaching guides and transcripts, resources and links for further learning, previews of upcoming shows and *Ask the Scientists!*



Let Us Cite Your Favorite Site!

We'll feature the coolest science sites in each issue of this guide.

If we print your recommendation, you'll receive a FRONTIERS T-shirt.

Please e-mail your suggestions to:
saf@pbs.org

SCIENCE IN CYBERSPACE

Visit these sites to learn more about topics on **Nordic Sagas:**

VIKING SHIPS

www.iau.dtu.dk/~lh/helge/helge.html

Visit the reconstructed *Helge*, a famous Viking ship, and meet the crew, plus many links to Viking sites and museums all over the world.

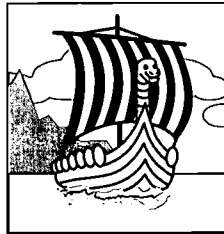

www.natmus.min.dk/nmf/nb/B/english/

Find out more about Viking ships from the *Maritime Archaeology* Newsletter, co-edited by Ole Crumlin-Pedersen.

ICELAND GENES

raven.umnh.utah.edu

Check out The Natural History of Genes, a new Web-based science education tool with resources for science educators and students of all levels, including hands-on experiments, classroom activities, plans for making low-cost lab equipment and a special section for teens who want to learn about genetic science.

www.altapartners.com/portfolio_decode.html

Learn more about the research being done at deCode Genetics.

ISLAND LIFE

www.eyjar.is/eyjar/eruption.html

See photos of the volcanic explosion that formed the island of Surtsey and read about the development of life there.

volcano.und.nodak.edu/vw.html

Explore Volcano World for information, photos and video clips of volcanoes around the world, plus a contest, quiz and a chance to send your question to a volcanologist.

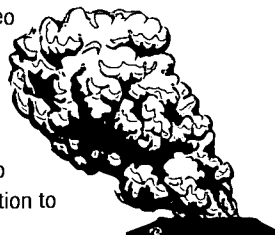

ISAAC AND FRIENDS

www.certec.lth.se

Investigate the vast site maintained by CERTEC, the Center for Rehabilitation Engineering Research at Lund University in Sweden. (Click "In English" on the home page for the English-language version of this site.)

www.tryckolera.certec.lth.se

Investigate the Pictorium at CERTEC. (Click on the U.S. flag for the English-language version.) Meet Thomas and Stig and check out the User's Guide.

www.certec.lth.se/publications/articles/tide/95/isaac/

Read more about Isaac, the personal digital assistant designed for individuals with cognitive dysfunctions, in this article co-written by Bodil Jönsson.



RADIOACTIVE REINDEER

www.itv.se/boreale/samieng.htm

Visit this site for an overview of the Sami people's history, homeland and politics and to learn more about reindeer and their role in Sami culture.

www.uilondon.org

Learn more about nuclear energy at the Uranium Institute home page. Select "Chernobyl: Ten Years On" for information about the accident at Chernobyl and its consequences. This site also features an alphabetical glossary of nuclear terms.

At press time, the online features and sites listed here were current. Due to the rapidly changing online world, some may have changed or may no longer be available. We recommend that you preview sites before passing them on to students.



Watch It On PBS

SCIENTIFIC AMERICAN FRONTIERS airs on PBS with five new programs each season, October through April. Each hour-long special includes a variety of fascinating science stories based on a single theme.

SHOW 801: Expedition Panama

WEDNESDAY, OCTOBER 8, 1997

Meet scientists at the Smithsonian Tropical Research Institute, a living laboratory in the Panama Canal. Find out how the Isthmus of Panama changed the world.

SHOW 802: Beyond Science?

WEDNESDAY, NOVEMBER 19, 1997

Science fact or fiction? Scientists investigate claims from aliens to graphology, therapeutic touch, perpetual motion machines and more.

THIS ISSUE SHOW 803: Nordic Sagas

INTERNATIONAL SPECIAL! WEDNESDAY, JANUARY 21, 1998

Travel to Scandinavia to see what's old and what's new in the land of the midnight sun. From Viking ships of the last millennium to the cutting edge of today's genetic research, join us in Iceland, Denmark and Sweden.

SHOW 804: The Art of Science

WEDNESDAY, FEBRUARY 18, 1998

FRONTIERS explores the marriage of science and art, including a behind-the-scenes look at digital technology in the movies and Alan 2.0 — a digital version of Alan Alda.

SHOW 805: The New Zoos

WEDNESDAY, APRIL 15, 1998

Modern zoos may be the only hope for endangered species. See what contemporary zoos are doing to improve and extend the lives of animals in captivity and the wild.

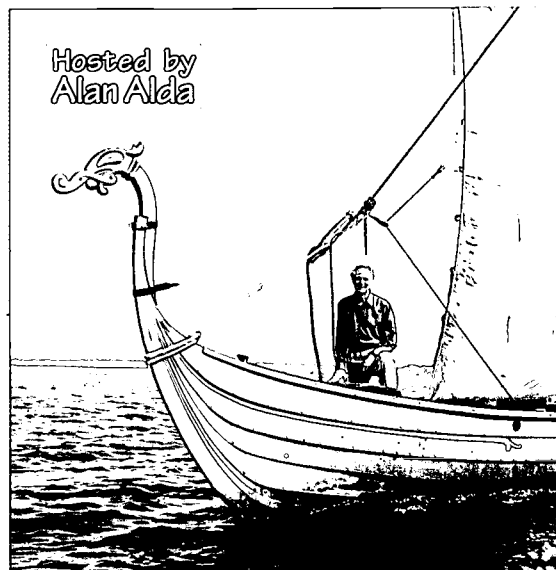

Hosted by Alan Alda

Host Alan Alda sails into a Danish fjord in an authentic replica of an 8th-century Viking ship. FRONTIERS visits the reconstruction site and covers other science stories in Scandinavia.

Remember, teachers may videotape the show to use year after year. GTE Corporation, the series underwriter, grants educators free off-air taping rights in perpetuity for classroom use.

This teaching guide contains cross-curricular activities appropriate for: Science and Studies/Geography. Why not share with your colleagues?



UNDERWRITTEN BY GTE CORPORATION



Connecticut Public Television
P.O. Box 260240
Hartford, CT 06126-0240

INSIDE:

Requested Teaching
Materials for
**NORDIC
SAGAS**

AIR DATE:

January 21, 1998

NON PROFIT
U.S. POSTAGE
PAID
Permit no. 51
Bristol, PA

SCIENTIFIC
AMERICAN
FRONTIERS

FEBRUARY 18, 1998 • 8-9 PM

TEACHING GUIDE FOR SHOW 804



The Art of Science

Enhancing
Creativity
Through
Science &
Technology

A PBS SPECIAL
Hosted by
ERIC Alda

Underwritten by GTE Corporation



The Art of Science

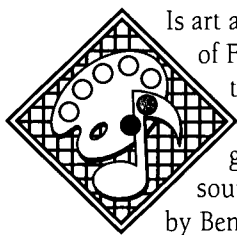

Is art a science? Is science an art? This episode of FRONTIERS gives you a chance to explore these questions and more. Join host Alan

Alda on a visit with a German-born glassblower and listen to the ethereal sounds of a glass harmonica, first invented by Ben Franklin in 1761. You'll also meet a digital version of Alan Alda, and a robot that paints, chooses its own colors and even cleans up after itself.

The Art of Science looks at the ways these two fields overlap and influence each other, and how computers are challenging our conventional ideas about art, while changing the very nature of everyday experience.

Talking with Alan Alda

The connection between art and science has long been a focus of SCIENTIFIC AMERICAN FRONTIERS host Alan Alda, as he mentions in the introduction to this episode. Although his acting career would typically be considered among the arts, Alan says that as a young boy he would often conduct "experiments" in his living room, trying to see what would happen if he combined various household ingredients. But, he says, his early interest in science took a back seat for a time. "I thought because I was interested in the arts that

that precluded an interest in science. I bought into that stereotype that science is dry and uninteresting — a lot of people in those days, especially, promoted that idea, and to some extent they still do today.

"For at least 100 years, maybe more, it's been a common way to denigrate science to say that the scientist cuts and dices nature and takes the life out of it by measuring it. In fact, by measuring it, they're learning the dimensions of the beloved. It's a way of loving nature. It's a way of understanding nature, far better than the way of people who stay ignorant of what constitutes its parts and how those parts work together. It's an amazing miracle the way nature puts itself together."

Alan says his work on FRONTIERS has been an opportunity to regain some of that early interest in science. "We often have hours of footage of just me having fun trying to learn as much as I can."

Visit Us at the NSTA Convention

It's not too late to make your travel plans for the National Science Teachers Association Convention, set to take place April 16 to 19 in Las Vegas, Nevada. FRONTIERS representatives will be there to meet educators, answer questions and award prizes! We hope to see you there.

We are also planning an **interactive, hands-on workshop** that will give educators the chance to try some of the activities taken from our teaching guide. If you would like to participate, **call us at 800-315-5010 to register**. Space is limited, so don't wait to call.

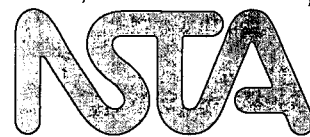

TIPS FOR TEACHERS

TAPING THE SHOW:

- ✓ Always check TV listings to confirm air date and time.
- ✓ As a teacher, you have off-air taping rights in perpetuity for classroom use.
- ✓ If you can't find the show in your TV listings, call your local PBS station.
- ✓ Do you need help? Call the FRONTIERS School Program at 800-315-5010.
- ✓ Videotapes of past shows can be purchased (\$21.97 each). Call 800-315-5010.

FREE VIDEOTAPING & PHOTOCOPYING RIGHTS:

GTE Corporation, the series underwriter, makes available complete off-air taping rights in perpetuity for classroom use of SCIENTIFIC AMERICAN FRONTIERS. Educators may record each show when it airs on PBS and keep the tapes to use in the classroom year after year.

Educators may also photocopy all materials in this guide for classroom use.

NEW SIGN-UPS:

If you know of other educators who are interested in receiving these guides, they may sign up by calling the SCIENTIFIC AMERICAN FRONTIERS School Program at 800-315-5010.

LET US HEAR FROM YOU!

We appreciate and welcome your questions, comments, compliments and constructive criticism. *Please contact us . . .*

By mail:

SCIENTIFIC AMERICAN FRONTIERS
105 Terry Drive, Suite 120
Newtown, PA 18940-3425

By phone: 800-315-5010

By fax: 215-579-8589

By e-mail: saf@pbs.org

VISIT US ONLINE:

<http://www.pbs.org/saf/>

VIEWER CHALLENGE

You and your students can enter the **Viewer Challenge** (p. 4) and have a chance to win a terrific FRONTIERS T-shirt! The correct answers to the **Viewer Challenge** questions are (some answers will vary):

1. to remove all the oils and to get better sound
2. d
3. b
4. words or speech
5. a circle or outline around the scribble
6. a, d
7. audience participates and plays music
8. d
9. Massachusetts 54th Regiment, first African-American regiment from the North in the Civil War
10. b

NEXT TIME ON FRONTIERS

Stay tuned **April 15, 1998**, for **The New Zoos**, the season finale of SCIENTIFIC AMERICAN FRONTIERS, which features an inside look at some of today's animal refuges — from game preserves to aquariums to metropolitan zoos.

SCIENTIFIC AMERICAN FRONTIERS is closed-captioned for the hearing-impaired and is narrated by Descriptive Video Service (DVS) for visually impaired audiences. The series and School Program are endorsed by the National Science Teachers Association (NSTA) and the National Education Association (NEA).

The Art of Science

SHOW 804 • FEBRUARY 18, 1998 • 8 PM* ON PBS

BEN FRANKLIN'S HARMONICA 6

Inspired by the sound of musical glasses he heard in Europe, Franklin invented a mechanical version of the glass harmonica. A 20th-century glassblower brings new life to Franklin's instrument.

Activities: The sounds of music. . . Singing wine glasses.

ALAN 2.0 8

Special effects companies produce the first digital character for a speaking part. Meet Alan 2.0.

Activities: Low-tech movie magic. . . Make a phenakistiscope.

RETURNED TO GLORY 10

Artisans used a combination of chemistry and archaeology to restore an American masterpiece created by Augustus Saint-Gaudens.

Activities: Make "gold" and "silver" pennies in the lab. . . Paint a fresco.

AARON THE ARTIST 12

An abstract painter programmed the first robot to conceive and create paintings. And the robot even cleans up when it's finished!

Activities: Brainstorming about art and computers. . . Make a pendulum for sand painting.

BRAIN MUSIC 13

The Brain Opera, created by MIT's Tod Machover, combines technology and music in an interactive musical event that features hyperinstruments and audience contributions.

Activity: Use homemade instruments to make your own version of *The Brain Opera*.

Plus, in every issue . . .

VIEWER CHALLENGE: Quiz questions, T-shirt prizes! . . . 4

THE BIG PICTURE: Science and Art with daVinci and Franklin . . . 5

FRONTIERS ONLINE: Visit us at <http://www.pbs.org/saf/> . . . 14



ABOVE: Alan Alda plays the glass harmonica with Thomas Bloch.

COVER: Computer-generated "Digital Alan" created by Lamb & Company, 1997.

NOTE: The order of the activities in this guide does not reflect the actual order of the stories in the show. The At-A-Glance box below follows the story sequence in the show.

AT-A-GLANCE						
STORY	RUNNING TIME	ART & MUSIC	CHEMISTRY	COMPUTER SCIENCE	PHYSICAL SCIENCE	PSYCHOLOGY
Franklin's Harmonica	10:47	•			•	•
Alan 2.0	13:48	•	•	•	•	•
Aaron the Artist	10:07	•	•	•	•	•
Brain Music	6:26	•	•	•	•	•
Returned to Glory	11:27	•	•	•		•

SCIENTIFIC AMERICAN FRONTIERS THE ART OF SCIENCE

NOTE: More detailed curriculum links are included on the activity sheets to individual stories.

*CHECK LOCAL DATE AND TIME

SCIENTIFIC AMERICAN FRONTIERS is made possible by an underwriting grant from GTE Corporation. The series is produced by The Chedd-Angier Production Company in association with *Scientific American* magazine and presented to PBS by Connecticut Public Television. Classroom materials produced by Media Management Services, Inc.





The Art of Science

Show 804 / February 18, 1998, at 8 pm* on PBS



STUDENT'S NAME: _____

TEACHER'S NAME & COURSE: _____

*CHECK
LOCAL
LISTINGS

Watch **SCIENTIFIC AMERICAN FRONTIERS** for answers to the questions on this page.
Answer the 10 questions correctly and you'll be eligible to win a **FRONTIERS T-shirt!**

Ben Franklin's Harmonica

1. Why does Alan Alda have to wash his hands so carefully before playing the glass harmonica?

2. Musician Thomas Bloch uses special spring water that contains _____ to improve contact between his fingers and the glass.

- a. quartz c. iron
 b. clay d. talc

Alan 2.0

3. The movie *Titanic* takes computer-generated special effects into new territory with its digital:

- a. rats.
 b. characters.
 c. smoke.
 d. seagulls.

4. A "waveform" is a visual representation of:

Aaron the Artist

5. Children beginning to draw follow a sequence that starts with a scribble. What do kids usually draw next?

6. Harold Cohen has programmed information about which of the following into Aaron? (Choose *two*.)

- a. posture
 b. landscapes
 c. fashion designs
 d. range of colors

Brain Music

7. What is unique about the role of the audience in *The Brain Opera*?

8. The rhythm tree, digital baton and sensor chair are examples of:

- a. new bands.
 b. musical scores.
 c. notation systems.
 d. hyperinstruments.

Returned to Glory

9. What does the original Shaw Memorial sculpture by Augustus Saint-Gaudens portray?

10. The restored sculpture seen in the story and exhibited at the National Gallery of Art is made of:

- a. bronze. c. brass.
 b. plaster. d. copper.

EXTRA CREDIT CONTEST!

Do you have a question that's never been answered? Now is your chance to share it with **SCIENTIFIC AMERICAN FRONTIERS**. You may get your answer next season on **FRONTIERS**, when we answer "life's little questions." Send your question by February 20, 1998, to Extra Credit Contest at the address to the right. If the producers choose your question for the show, you'll win a **FRONTIERS T-shirt**. Good luck!

Answers to the Viewer Challenge are listed on page 2 of this guide. T-shirt winners' names will be posted in the **Polls & Prizes** section of the **FRONTIERS Web site**.

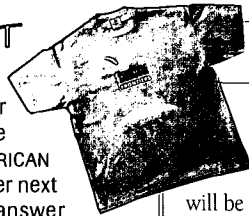

FOR TEACHERS ONLY

When completed, this page can become an entry to the **FRONTIERS T-shirt contest**; 20 winners (10 students, 10 teachers) will be drawn at random for each show. To enter the T-shirt drawing, send all completed challenges in one envelope with a cover sheet to: **Viewer Challenge**, **SCIENTIFIC AMERICAN FRONTIERS**, 105 Terry Drive, Suite 120, Newtown, PA 18940-3425. Mail completed entries by **March 20, 1998**.

TIP: You can download these questions on the Web: <http://www.pbs.org/saf/>.

IMPORTANT!! Please include a separate cover sheet and tell us:

- number of challenges submitted
- teacher's name
- grade and course
- school name, address and phone number
- where your students watched the show — at home, at school or both
- the name of your students' favorite story in this show (conduct a quick poll to find out)

Thank you!



Science & Art



In the introduction to this episode of *SCIENTIFIC AMERICAN FRONTIERS*, Alan Alda comments on how much scientists and artists have in common:

“They are both playful, precise, creative, inspired revolutionaries.” On *FRONTIERS* we meet many people who blend art and science in the work they’re doing today. But this isn’t just a 20th-century phenomenon. History offers examples of others on whose shoulders today’s innovators stand. Two of these exemplary individuals are described below. Can you name any others, past or present, whose lives and work combined science and art?

Leonardo da Vinci: Scientist, Artist, Inventor

Leonardo da Vinci was the original Renaissance man. His creative genius as artist, engineer, scientist, musician, inventor and sculptor was nothing short of remarkable.

- Born in 1452 in Vinci, near Florence, Italy.
- At the age of 17, he was apprenticed to a painter in Florence.
- In his early 20s, he experimented with a new painting medium, tempera.
- In 1482, he moved to Milan, where he worked as a military engineer, designing some remarkable machines, including a model tank.

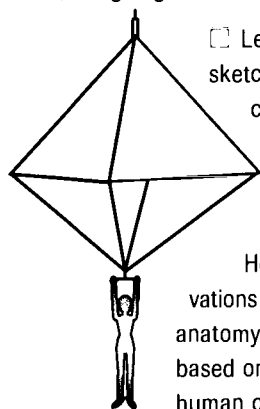
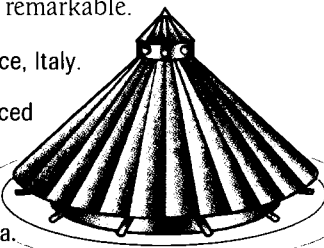

- Leonardo filled thousands of pages with sketches and notes written backwards so they could only be read in a mirror.

- Many of his sketches were of prophetic devices like flying machines and a parachute.

He also drew detailed observations of human anatomy. His anatomy studies were the first based on actual dissections of human corpses.

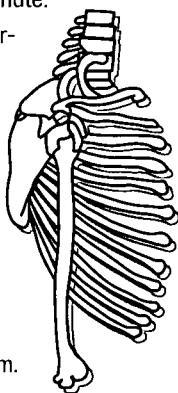

- Leonardo painted masterpieces like the *Mona Lisa* and *The Last Supper* fresco, and continued working on scientific and mathematical research until his death in 1519. Above all else, he was deeply curious about the world around him.

Try painting a fresco.
See pp. 10-11 of this guide.

Benjamin Franklin: Scientist & Statesman

A leading writer, scientist, inventor and founder of the U.S., Franklin was held in high regard in America and Europe as a distinguished scientist and statesman.

- Apprenticed at the age of 12 to his older brother, a printer, he ran away to Philadelphia at age 17, where he lived until his death in 1790.
- Franklin studied subjects from algebra to zoology, becoming one of the best self-educated people of his time.
- His first job in Philadelphia was as a printer, and then a publisher of newspapers and his now-famous *Poor Richard's Almanac*.

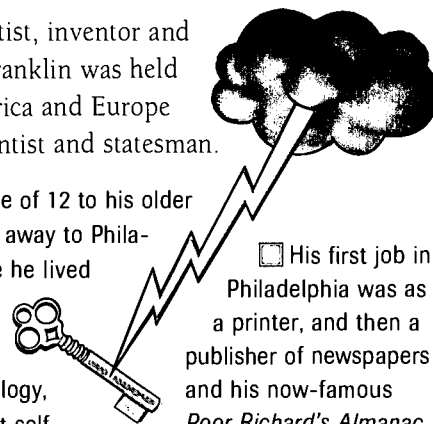

- He later became a famous statesman, and helped draft the Declaration of Independence.

- Franklin's major contribution as a scientist was the discovery of electricity. He demonstrated the electrical nature of lightning with the legendary key-and-kite experiment in 1752.



- Franklin was an accomplished musician. He played the violin, harp and guitar. In 1761, he built his mechanical glass “armonica,” as he called it. He wrote, “Of all my inventions, this has given me the greatest personal satisfaction.”

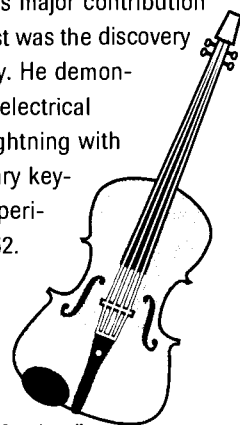

For more about the reinvention of the glass harmonica, see pp. 6-7 of this guide.

Ben Franklin's Harmonica

Inspired by musical wine glasses he heard played in Europe, Ben Franklin invented a mechanical glass harmonica in 1761. The instrument fell out of favor in the next century and was not heard again until 1982, when German-born glassblower Gerhard Finkenbeiner brought it back to life. Finkenbeiner heard about the instrument while living and working in Paris in the 1950s. Using original plans and drawings, he reinvented the modern glass harmonica.

RUNNING TIME: 10:47

CURRICULUM LINKS:

- CHEMISTRY
 - glass
- HISTORY
 - Ben Franklin
- MUSIC
- PHYSICAL SCIENCE/PHYSICS
 - acoustics, frequency, sound

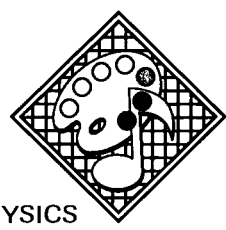

RELATED FRONTIERS SHOWS & ACTIVITIES:

- Expedition Panama, Show 801: "Echoes in the Night" (p. 6)
- Inventing the Future, Show 701: "Brain Music" (pp. 12-13)

Good Vibrations

Sound is created by vibrations that produce sound waves. The speed of the vibration, or frequency, determines the pitch — high or low — heard when the waves strike the ear drum, which translates the sound into a nerve impulse that is processed by the brain.

All materials have a natural frequency of vibration. Glass used to make glass instruments starts to "sing" when the vibration gets the molecules moving at their natural frequency. By building and playing homemade instruments, you can see how

various materials produce different sounds, and "exp-ear-ience" the good vibrations we call music!

ACTIVITY 1: See and Touch Sound

Some sounds are easily interpreted when they reach your ear. For example, when vocal cords vibrate at a high frequency (fast), a shrill or high-pitched sound will result, which might be an expression of fright. At a low frequency (slow), a low-pitched sound is produced, like a growl, which could be a warning of impending danger. Without a sense of hearing, can you determine what kind of sound is being produced?

OBJECTIVE

Explore the world of sound with hearing and other senses.

MATERIALS

- high- and low-pitched tuning forks (use forks of similar sizes)
- glass of water
- ear plugs
- blindfold

PROCEDURE

Students can work in pairs for this activity. One student is the observer or subject, the other student the assistant.

1. Blindfold subjects and have them listen to high- and low-pitched tuning forks until they can recognize the sound generated by each. Have the assistants strike the forks so subjects use only their ears to "gather data."
2. Remove the blindfolds and have the subjects put in ear plugs. (They may need to wrap a bandanna around their heads to further block the sound.)
3. Assistants should strike one of the tuning forks and hold it in a glass of water. Ask if the subjects can identify which frequency tuning fork it is by looking at the water.
4. Repeat the procedure with the other tuning fork.
5. Next, replace the blindfolds on the subjects (still wearing earplugs).
6. Give the subjects one of the tuning forks and tell them to strike it.
7. Ask subjects to try to identify which frequency tuning fork they are holding, just by how it feels when it vibrates.

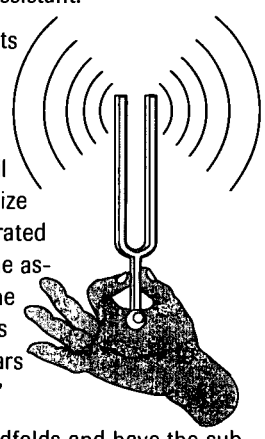

Note: If you use tuning forks for different notes, like A and C, you can detect a difference in how the vibrations cause water to move, but it is subtle. It takes practice to see and feel differences in the forks.

QUESTIONS

1. Is it possible to perceive sound without using your ears?
2. What evidence did you use to identify low and high frequencies?
3. How do animals interpret sound vibrations without using a sense of hearing (bats and snakes, for example)?
4. An easy way to "feel" vibrations is to place your index finger on your neck and start with a growl (low frequency) and increase the sound in your throat to a higher pitch (high frequency). Can you feel the speed of the vibration in your vocal cords with your fingertips?



Gerhard Finkenbeiner, who appears in this segment, answers your questions online.

SEE PAGE 14 <http://www.pbs.org/saf/>

ACTIVITY 2

The Sounds of Music

Some of the main instruments in an orchestra or band use “wind” to create a vibration in a reed to make a sound. In this activity, use a straw to make a crude reed-like instrument you can experiment with to produce sounds.

OBJECTIVE

Find out how different length straws influence sound by modifying frequency.



MATERIALS

- plastic straws

PROCEDURE

1. Cut the corners of a straw to form a mouth-piece. (These are rather crude reeds.)

Press the two sides of the cut straw together to flatten them.

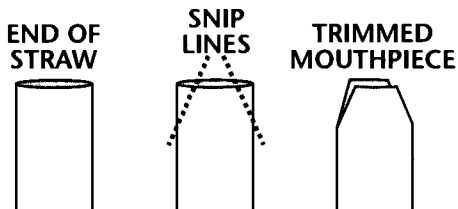

2. Place the cut end between your lips and close your lips to bring the two sides close together.
3. Blow through the straw until the cut end vibrates and produces a sound. You may need to blow very hard and vary the pressure with your lips to produce the sound.

If you can't make a sound, flatten the cut end more.

4. Once you are producing a sound, keep blowing and cut off small bits (1 or 2 cm at a time) of the straw to hear how the sound changes.

QUESTIONS

1. How does changing the length of the straw affect the sound?
2. How does the sound produced relate to frequency of the vibrations? (high frequency or pitch = fast vibrations; low = slow vibrations)
3. Can you use two straws (one slightly larger than the other) to create a trombone-like instrument?

ACTIVITY 3

Franklin's Inspiration

Franklin's instrument, which he called a glass “armonica” after the Italian word for harmonica, is a series of glass cups on a rotating, horizontal spindle. Each cup represents one note of the musical scale. One instrument is composed of two or three octaves. Today's glass harmonica is also made from a series of glass bowls or cups, but Gerhard Finkenbeiner uses only quartz or pure crystal glass. Impurities in the glass affect the vibrations; the purer the material, the more likely the molecules will all vibrate at the same frequency.

Musical experience helps in learning to master this sensitive instrument, but you don't need crystal to produce sound. You do need carefully washed hands, clean water and damp fingers to make music.

OBJECTIVE

Experiment with different glasses, much as Franklin did, to try to produce musical sounds.



MATERIALS

- glasses (a variety is good; wine glasses are best)
- butter knife, spoon or other metal utensil
- pitcher of water

Note: Glass wine glasses are recommended because of their shape and the thin glass. Water goblets will also work. Experiment with various shapes, sizes and kinds of glass. The thinner and purer the glass, the better the sound.

PROCEDURE

1. Start with one glass and tap it gently with the utensil.
2. While tapping the glass, pour water into it about 2.5 cm at a time. Listen and have another student record how the sound changes as the water level increases.
3. Repeat the procedure with different glasses and record the effect the shape or type of glass has on the sound generated.
4. Repeat Steps 1 through 3. Instead of tapping the glass with the utensil, wet your finger and rub it around the edge of the glass until a sound is produced. (Make sure your finger is clean before you start and keep it wet. It takes practice to produce the eerie sound.)
5. Try to fill separate glasses so that you are able to play a simple tune with the knife or your finger, like “Mary Had a Little Lamb.” If you can tune the glasses to specific notes, mark the notes on the glasses and indicate the water level with a marker.

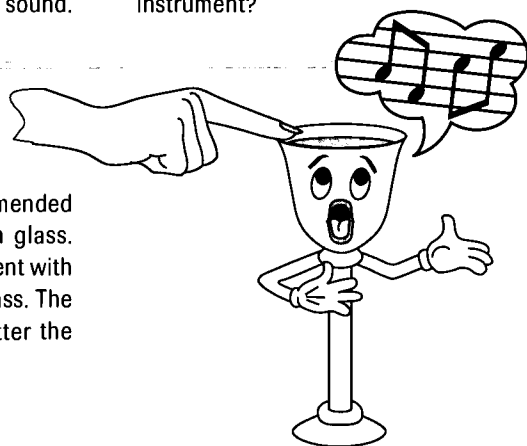

(In the glass harmonica seen on FRONTIERS, the cups with gold rims indicate sharps and flats.)

EXTENSIONS

- Visit the Web site www.blarg.net/~wildez/index/html, where you can hear Led Zepelin's “Stairway to Heaven.”
- Experiment and see who can master the glasses to play more complex music.
- Try to build different instruments (string, wind, percussion) and conduct a “silly symphony” at your next assembly.

SCIENTIFIC AMERICAN FRONTIERS

Show 804: The Art of Science

Ben Franklin's Harmonica



Alan 2.0

Until the movie *Titanic*, no one had used synthespians or digital characters in a feature film. Now, for the first time, computer pioneers have taken the process further and synthesized both speech and movement to produce Alan 2.0 — a digital version of Alan Alda. In this episode, watch as technology history is made and go behind the scenes with FRONTIERS to watch the creation. Then find out what happens when he meets a digital version of himself for the first time.

RUNNING TIME: 13:48

CURRICULUM LINKS:

- ART
movies, photography
- PSYCHOLOGY
perception
- TECHNOLOGY
computer graphics, digitized effects

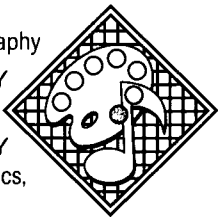

RELATED FRONTIERS SHOWS & ACTIVITIES:

- **21st Century Medicine**, Show 605: "Cybersurgery" (pp. 10-11)
- Show 301: "Science of Special Effects" (pp. 13-14)

At the Movies

It's a digital world. From aliens to angels, ocean liners to "flubber," movies increasingly rely on digital creations. As you see on FRONTIERS, for the first time, many extras in a feature film, *Titanic*, are not real people but synthespians — computer-generated actors.

Before the invention of motion pictures, people viewed photographs, then stereograms (two photos viewed through a stereoscope), and then inventors began tinkering

with ways to turn still images and photos into moving images. The first results were a long way from digitally enhanced movies, but even the earliest magic lanterns, rotoscopes and crude moving pictures delighted viewers with the illusion of motion.

In 1887, photographer Eadweard Muybridge pioneered photographic studies that answered fundamental questions about locomotion. His photos featured men or ani-

mals in successive stages of motion. The photos were viewed with a zoopraxiscope, a forerunner of cinematography that inspired Thomas Edison to invent the kinetoscope. In fact, Muybridge is sometimes called the "father of the motion picture." Try these low-tech activities and amuse your friends.

ACTIVITY 1 Movie Magic

Did you know that the motion you observe on a movie screen (or TV) is an optical illusion? This screen magic has to do with "persistence of vision" or the holdover of images in the brain. Even though we may be exposed to a quick flash of an object, its image is retained for a short time by the visual processing center. If another image is flashed during this retention period, the brain gets tricked into "smoothing" the transition, so what we see appears to be continuous movement.

If you examined a strip of movie film, you'd observe action captured as a sequence of still frames. At a slow projection speed, you'd observe the separate images, one following another. At a faster rate of 30 frames/second, your brain combines the frames into

a fluid and continuous motion, instead of interpreting them as separate pictures.

KEY FRAMES

To generate a sequence of frames, a computer artist uses photographs of an object at its beginning and ending positions. These positions form the "key frames" that enclose a motion sequence. Next, the artist instructs the computer to generate the in-between frames. As it crunches the key frame information, the computer compiles a set of intermediate actions that logically and smoothly transform the object from the start to the final key frame.

Now, it's your turn to take on the role of computer.

PROCEDURE

1. Examine the two key frames shown below. They define a frame sequence in which a character's face changes.
2. Your job is to draw the in-between frames. Create 10 frames to smooth the motion between the two key frames. When you finish, you can turn your illustrations into a flip book.

EXTRA CHALLENGE

Research the action of a piston, cylinder and connecting rod. Then create a flip book that illustrates how these engine parts work.



Nick Campbell, who appears in this segment, answers your questions online.

SEE PAGE 14 <http://www.pbs.org/saf/>

OBJECTIVE

Explore persistence of vision.

MATERIALS

- scrap paper
- marker, pen or pencil

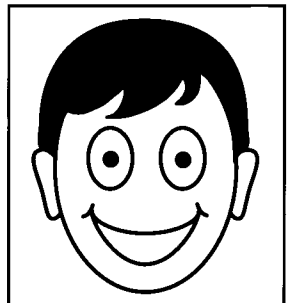
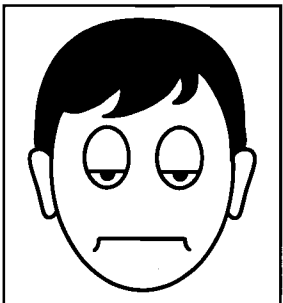

ACTIVITY 2

View a Spinning Disk

A spinning disk or phenakistiscope is a device that produces the illusion of movement (the word means "deceitful view"). It also uses the persistence of vision to trick the brain into thinking it is seeing motion. The original spinning disk device was invented independently by two European scientists in 1832. The disk featured a number of figures drawn in successive stages of motion. This version is adapted from *The Art Pack* by Christopher Frayling, Helen Frayling and Ron Van Der Meer (Knopf, 1993).

OBJECTIVE

Explore the illusion of movement.

**MATERIALS**

- light cardboard
- scissors
- modeling knife
- round toothpick or other device for the axle
- gluestick or spray adhesive

PROCEDURE

1. Photocopy the disk shown here and cut it out.
2. Use a gluestick to glue the disk onto a piece of light cardboard.
3. When the glue is dry, carefully cut out the circle and slits between each image. Poke a tiny hole in the center.
4. To view, hold the phenakistiscope up to a mirror at about eye level. The side with the images should face the mirror. Look through the slits as you spin the disk on the axle and watch the moving figures reflected in the mirror.

EXTENSIONS

1. Motion capture is often used as a special effect in movies and to study human movement. Try your own version of the motion capture you see on *FRONTIERS*. Wearing black pants and a black shirt, tape Ping-Pong balls (or pieces of white tape) along your arms and legs. See how your body looks under black light as you walk and move around. Try drawing a stick figure of the outline made by the glowing Ping-Pong balls.
2. For more about motion capture and computer simulation, see the March 1998 issue of *Scientific American* for a related article.
 3. Would it take away from your enjoyment of a movie to know that it is peopled by digital characters?
 4. Who do you think should own the rights to a digital character?
 5. Find out more about how speech is synthesized at www.itl.atr.co.jp/chatr/.

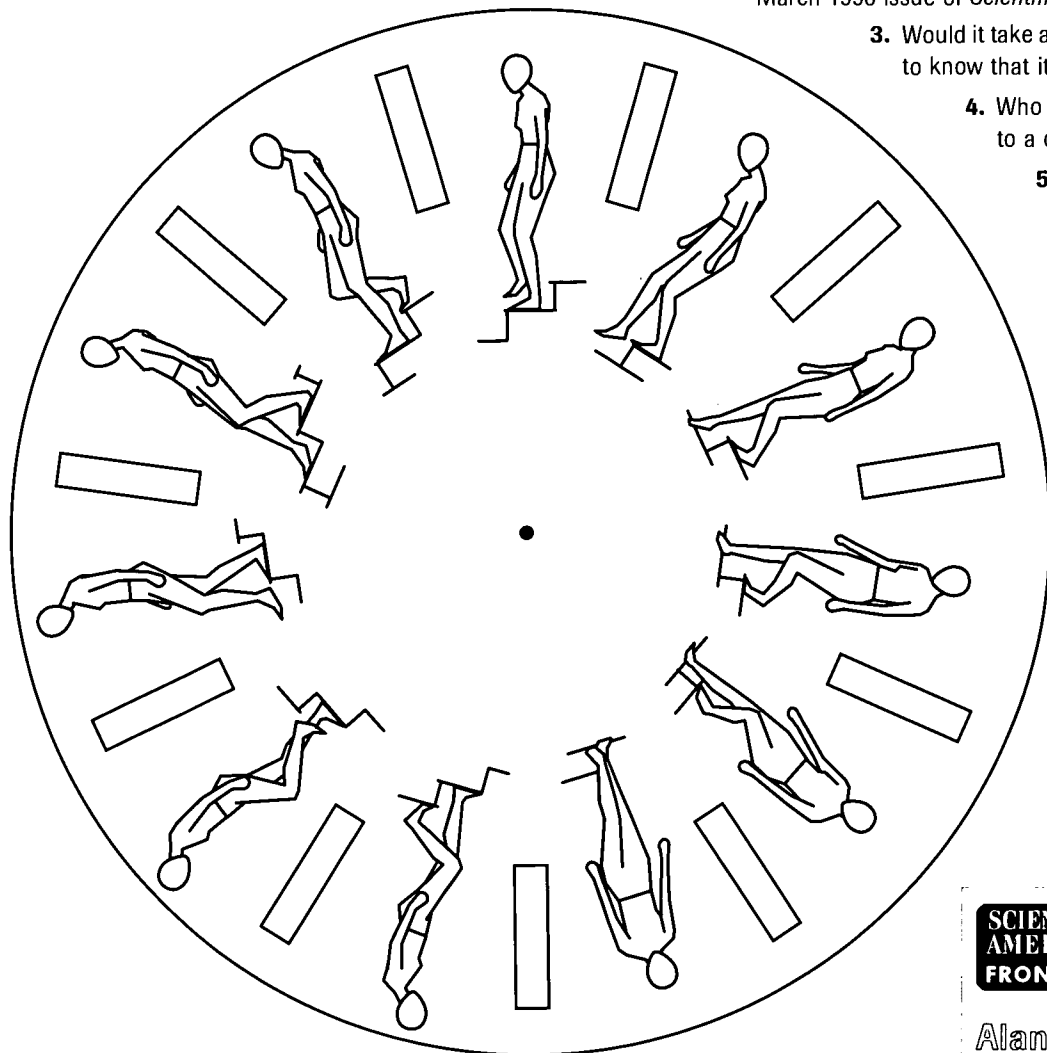

SCIENTIFIC AMERICAN FRONTIERS

Show 804: The Art of Science



Alan 2.0

Returned to Glory

When American artist Augustus Saint-Gaudens finished the Shaw Memorial in 1897, he could not have imagined that his masterpiece would become the subject of a major commemoration 100 years later. The Shaw Memorial, America's first monument to African-American soldiers, became an important part of American art and history. A plaster cast of the memorial, stored outdoors for decades, suffered the effects of weather until restored to life by 20th-century conservators.

RUNNING TIME: 11:27

CURRICULUM LINKS:

- ART
frescoes, paints, pigments
- CHEMISTRY
alloys, metallic elements, oxidation
- EARTH SCIENCE
metallurgy
- HISTORY
Civil War

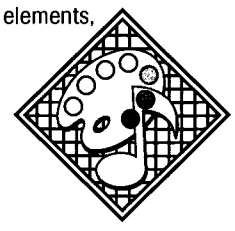

Metals and Alloys in Our Lives

Metallic elements silver (Ag), gold (Au) and copper (Cu) are lustrous, malleable, ductile and conductive. For millennia, each has been used to make sculptures, jewelry and structures large and small.

Artists often work with alloys like bronze, steel or brass because of their durability and color. Bronze is a mixture of copper and tin; brass, made in the activity below, is a mixture of zinc and copper. Steel is made of

iron and carbon. Alloys are used to make coins, jewelry, sculptures and other items.

When exposed, metals can become damaged. Why did the Statue of Liberty, a copper structure, turn blue-green? After many years of exposure to humidity and the sulfur compounds in acid rain, copper in the statue oxidized to form copper compounds that are blue-green in color. You may also see this on copper roofs and pen-

nies. This same process of oxidation similarly affects silver. Sulfur-containing compounds found in food or the atmosphere cause silver to oxidize and tarnish.

The original Shaw Memorial was made of bronze. Saint-Gaudens later made a plaster cast of the sculpture. As you see on FRONTIERS, 20th-century scientists restored the plaster to Saint-Gaudens's bright and shining vision.

ACTIVITY 1 Alchemy Lab: The Golden Dream

Alchemists in the Middle Ages believed they could turn ordinary metals into gold. In this lab, you become a 20th-century alchemist and turn pennies into shiny "silver" and "gold."

Note: We suggest that this lab be performed as a teacher demo or as a supervised chemistry experiment in the lab.

OBJECTIVE
Show students how an alloy is made.

- MATERIALS**
- 20 mL of 6 M NaOH
 - 0.1 g zinc dust
 - evaporating dish
 - hot plate
 - tongs
 - 200 mL beaker of water
 - penny
 - Bunsen burner

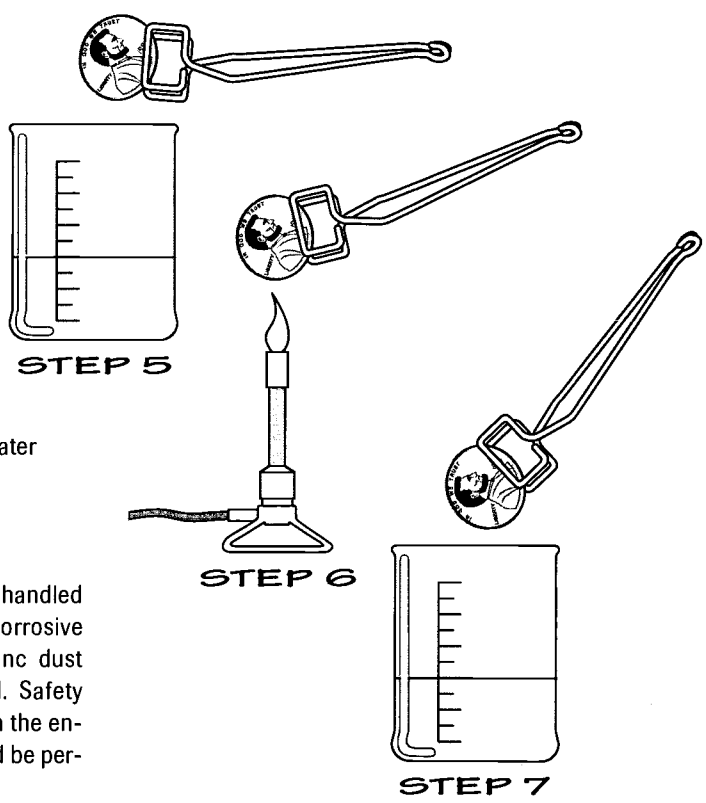

Shelley Sturman, who appears in this segment, answers your questions online. <http://www.pbs.org/saf/>

Note: NaOH should be handled with great care. It is corrosive and can burn skin. Zinc dust should not be inhaled. Safety goggles should be worn the entire time. This lab should be performed under a hood.

PROCEDURE

1. Place zinc dust in evaporating dish.
2. Add 20 mL of NaOH solution to the dish, on top of the zinc.
3. Set hot plate to medium heat and place the evaporating dish on top.
4. Heat for 5 minutes. **Do not boil.** When dish is **hot**, place a penny in it. Heat for two minutes or until the penny is coated and becomes silver in appearance.
5. Remove the penny from the dish with tongs and drop into water. When cool,



wipe the penny clean with a cloth to remove excess zinc.

6. Using tongs, hold the penny in the flame of a Bunsen burner and gently heat. The penny should turn "gold" (brass). (Do not overheat the penny.)
7. Dip the penny in the beaker of water and cool to touch.

WHAT HAPPENED?

In Step 4, the penny was coated with zinc atoms. In Step 6, when the penny was heated, the copper atoms of the penny and the zinc atoms coating the penny mixed and turned gold in color, but actually formed the alloy brass.

ACTIVITY 2

Plaster Activities

You may have made a plaster face mask in art class or mixed plaster of Paris for home repair projects. Plaster of Paris is actually calcium sulfate ($\text{CaSO}_4 \cdot 2\text{H}_2\text{O}$), more commonly called gypsum. It can be found in all parts of the world, but was named plaster of Paris because of its original use by the French building industry.

In making plaster of Paris, calcium sulfate is heated to the point where it loses most of its water, then ground into a powder or a calcined state. The plaster powder is remoistened and made into a liquid paste that hardens quickly. Before it becomes firm, it can be molded into casts, sculptures, ceramics, dental and surgical products, stucco walls, etc.

USING PLASTER OF PARIS, TRY THESE PROJECTS:



- Make a fresco!** Mix plaster following directions on the package. Pour it into a pie pan or other container. Try painting on damp plaster to make a fresco, in the style of Renaissance artists (or 20th-century artists like Diego Rivera). In authentic frescoes, painters use colors made of dry pigments mixed only with water. They mix and paint one small section of plaster at a time. As the lime in the plaster dries and the water evaporates, the color bonds with the plaster, forming a hard surface. Try mixing various paints and pigments and apply to wet and dry plaster.

- Create a 3D sculpture.** Pour the wet plaster into an empty milk carton and let it dry. Using tools borrowed from the art department, try your hand at carving.

- Try a restoration project.** Conservators who restored the Shaw Memorial found 25 layers of paint, gilt, wax and varnish in some portions of the plaster sculpture. Try exposing your plaster art to the weather or covering it with several layers of paint. Then try to clean or restore it using soap, detergent or other household solvents, and you'll have an idea of what conservators had to deal with.

EXTENSIONS

1. Look for other sculptures by Augustus Saint-Gaudens in many U.S. cities. You'll find a list and photos at the National Historic Site (www.valley.net/~stgaud/shawweb.html).
2. The Shaw Memorial is famous for being the first memorial to celebrate the heroism of African-American soldiers. It has been the subject of poetry by James Russell Lowell, John Berryman, Robert Lowell and Paul Laurence Dunbar, and part of a composition by American composer Charles Ives (*Three Places in New England*). The movie *Glory* tells the story of the Massachusetts 54th Regiment in the Civil War.

DISPOSAL OF CHEMICALS:

Pour off NaOH into a 250 mL beaker of water to dilute and pour the mixture down the sink. Wipe zinc residue and evaporating dish with a paper towel and dispose.

The Anatomy of a Painting

A Web-based Student Activity



A painted object can be made up of many layers, as you see in this episode of FRONTIERS. But what are the parts that make up a painting? Can we consider a painted object like the Shaw Memorial to be a painting? At The Chemistry Place (accessible from the FRONTIERS Web site), you can delve into the anatomy and chemistry of paintings in a new, interactive learning activity, "The Anatomy of a Painting." Students can participate online or teachers can print activity pages to hand out to students.

To visit The Chemistry Place, go to the FRONTIERS Web site (www.pbs.org/saf/), choose "Cool Science" and then select "The Chemistry Place."

The Chemistry Place (www.chemplace.com), a service of Peregrine Publishers, Inc., provides resources and inquiry-based activities for students and educators. For more information, please visit the site or call 800-456-0179.



SCIENTIFIC AMERICAN FRONTIERS

Show 804: The Art of Science

Returned to Glory



Aaron the Artist

For the first time in human history, a robot is painting original art. Abstract painter Harold Cohen began programming his robot Aaron more than 20 years ago. Today, Aaron turns out original paintings, mixes paints, colors portraits, even cleans its own paint pots! FRONTIERS takes you to watch the robot at work in its studio. As for theoretical questions, like "Is it art?" and "Whose painting is it, Harold's or Aaron's?", you'll have to judge for yourself.

RUNNING TIME: 10:07

CURRICULUM LINKS:

- ART
- COMPUTER SCIENCE
 - artificial intelligence, expert systems
- PSYCHOLOGY
 - creativity
- TECHNOLOGY
 - programming, robotics

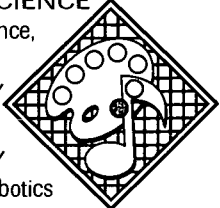

RELATED FRONTIERS SHOWS & ACTIVITIES:

□ **Robots Alive!**, Show 705: "Mazes and Squiggles" (pp. 6-7) and "Almost Human" (pp. 10-11)

Portrait of the Artist as a Robot

Aaron, the first robot in history that creates original paintings, is the result of 23 years of research by Harold Cohen. Aaron evolved from a few rules about generating simple shapes to a program capable of composing complex figures. The program draws autonomously, relying on its own knowledge, using a branching structure of rules and feedback paths that tell it how to proceed. Since 1974, Aaron's systems and artworks have been exhibited worldwide. Aaron's paintings have even been auctioned on the Internet. You can see photos of Aaron at work, plus some of its paintings,

at www.scinetphotos.com/aaron.html. Harold Cohen writes about the story of Aaron at shr.stanford.edu/shreview/4-2/text/cohen.html.

MINI-ACTIVITIES

- When Harold Cohen was first programming Aaron, he took his clues from the way young children learn to paint. See if you can find examples of the sequences in kids' art, as described on FRONTIERS.
- Cohen's robot raises complex issues about the nature of art. Do you think the works created by Aaron the painting robot are

art? Who is creating the art, Cohen or Aaron? What constitutes "art"?

- Work with a team to figure out and list all the information Aaron would need to know, if you wanted to program the robot to paint landscapes instead of portraits.
- Aaron is a "highly evolved expert system." Find other examples of expert systems, such as those used in medicine and manufacturing, for example.

ACTIVITY Make a Painting Pendulum

Pendulums are often used to make sand art designs. Your challenge is to construct a pendulum that will sprinkle sand in a design. Here is one idea that worked. Can you modify this design or think of another way to build a pendulum?

OBJECTIVE

Think critically about and design an autonomous tool that sprinkles sand.

MATERIALS

- 2 meter sticks
- empty gallon jug
- scissors
- string or twine
- 2 chairs
- play sand (use colored sand if you wish)
- large piece of construction or other paper
- sheet of plastic to catch any excess sand

PROCEDURE

1. Set up the meter sticks between two chairs as shown. (Or figure out another way to set up the basic pendulum.)
2. Fill the jug with sand. Keep the cap on until you are ready to start the pendulum.
3. Attach the jug to the meter sticks.
4. Place the paper underneath the pendulum.
5. Take the cap off the jug of sand and push the pendulum. What design is made by the sand?



Harold Cohen, who appears in this segment, answers your questions online.

SEE PAGE 14 <http://www.pbs.org/saf/>

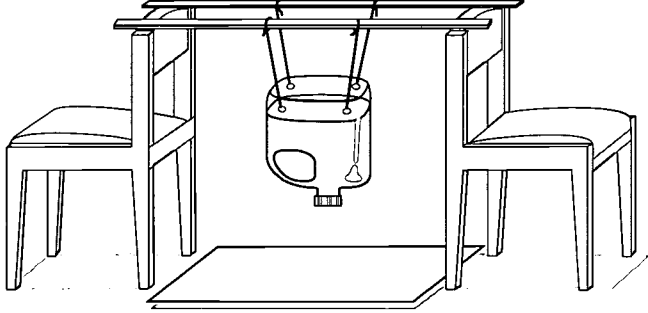

Brain Music

The *Brain Opera* combines music and technology in a one-of-a-kind interactive musical experience created by composer Tod Machover and a team of computer scientists and artists from the MIT Media Lab. The opera debuted at the Lincoln Center Festival in New York City in July 1996, and then went on to tour the world. In this segment, listen to the 20th-century sounds of hyperinstruments and join Alan Alda at the opera's premiere.

RUNNING TIME: 6:26

CURRICULUM LINKS:

COMPUTER SCIENCE

artificial intelligence

MUSIC

PHYSICAL SCIENCE/ PHYSICS

acoustics, pitch,
sound waves

PSYCHOLOGY

brain

TECHNOLOGY

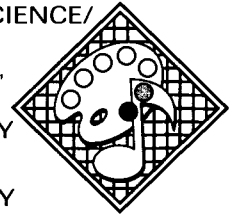

Tod Machover's *Brain Opera*

The Brain Opera is a true marriage of art, science and technology. Composer Tod Machover, along with a team of more than 50 musicians and scientists from the MIT Media Lab, created this musical event, which incorporates contributions of both online and live audiences.

What you see on FRONTIERS is a sample of the total event. *The Brain Opera* is based on Marvin Minsky's *Society of Mind*. Each

performance of *The Brain Opera* has two components. In the introductory period, people in the audience explore, experiment with and play Machover's instruments. The opera itself incorporates recordings just made by the audience, along with musical contributions sent by participants on the Internet.

In the performance itself, participants play hyperinstruments, electronically en-

hanced instruments Machover has been developing since 1986. The team at MIT has designed a hyperinstrument for cellist Yo-Yo Ma and a "sensor chair" for magicians Penn and Teller.

The interactive nature of *The Brain Opera* makes it an evolving piece of performance art. One of Machover's goals is to push the boundaries of how people experience music.

ACTIVITIES

Music and the Mind

Watch the performance on FRONTIERS and try these activities:

- Machover's hyperinstruments are high-tech devices. You can make music on low-tech instruments, like wine glasses and straw pipes (see pp. 6-7 in this guide).
- Using your homemade instruments, try conducting a musical event that invites different musicians to perform music of their choice. Record their contributions and make a mix that includes pieces of music from each participating musician.
- You can make musical "instruments" out of many items – try blowing into an empty bottle or jug, plucking a rubber band guitar, using plastic kitchenware for drums,
- even bending thin plastic sheets to make a twangy, watery kind of sound.
- In an interview with *Scientific American*, composer Tod Machover says: "There is a deep reason for interactivity. Works of art should be stimulating. They should wake people up rather than acting like a sedative. I hope that people will come out of *The Brain Opera* asking for more from their art." React to this statement. You can read the entire interview at www.sciam.com/interview/machover.html.
- You can find out much more about *The Brain Opera*, its story, the hyperinstruments and more at brainop.media.mit.edu/.
- The group at the MIT Media Lab has been designing next-generation interactive experiences for music, plus totally new interactive toys like a "musical jacket" played by touching embroidery on the jacket and "squeezeables," foam balls played by squeezing and stretching. The group is working on a "Toy Symphony" that will combine kids, technology and



symphony orchestras. What musical toys would you like to design? For more on current and future projects at MIT, see www.media.mit.edu/.

- Bands from the Beach Boys to Phish and classical groups use the theremin, an electronic instrument popular in experimental musical circles. The theremin is played by waving one's hands near two metal antennas: one for pitch and the other for volume. To find out more and hear sound clips, visit the theremin home page at www.nashville.net/~theremin.



Tod Machover,
who appears in
this segment,
answers your
questions online.

SEE PAGE 14 <http://www.pbs.org/saf/>

Explore The Art of Science with FRONTIERS Online!

After *The Art of Science* airs, scientists and artists from the show will respond to viewers' questions and provide further insights into how the fields of science and the arts are related. The five artists and scientists featured on this page will be available to answer your questions about stories in the show from February 18 to March 6, 1998. To participate in Ask the Scientists, visit FRONTIERS online at www.pbs.org/saf/.



BEN FRANKLIN'S HARMONICA

The glass harmonica, first invented by Benjamin Franklin and later banned, is enjoying a musical revival thanks to Gerhard Finkenbeiner. A glassblower who makes custom items for Boston's scientific and technical community, Finkenbeiner has been intrigued by the instrument's strangely beautiful sounds for decades and constructed his first glass harmonica in the 1980s from some of the original plans. Want to learn more about this historic instrument and its place in the contemporary music scene? Send your questions to Finkenbeiner.

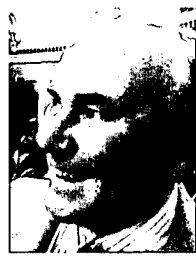

BRAIN MUSIC

In this story you meet Tod Machover, the visionary creator of *The Brain Opera*. This musical experience allows an audience to generate music on hyperinstruments and then incorporates the sounds into live musical performances. Machover tells you more about this collaborative event and gives FRONTIERS viewers an update on his latest projects with *The Brain Opera*.



ALAN 2.0

Ever wish you could be in two places at once? You'll see how it could be done as several technologies of the future are combined to create a "digital double" of Alan Alda. Nick Campbell and his team at ATR Interpreting Telecommunications in Kyoto, Japan, took on the challenging assignment of creating speech for "Digital Alan" using a voice synthesizing system called Chatr. Here's your opportunity to ask Campbell more about this new technology and how it will be used in the future.



RETURNED TO GLORY

At the National Gallery of Art in Washington, D.C., Shelley Sturman played a key role in restoring one of the nation's most significant works of heroic art. The original Robert Shaw Memorial was created by Augustus Saint-Gaudens to commemorate Colonel Robert Gould Shaw and the Massachusetts 54th Regiment, the first African-American regiment raised in the North during the Civil War. Let Sturman take you behind the scenes as she answers your questions about conservation and restoration at the National Gallery.



AARON THE ARTIST

Harold Cohen, a well-known British abstract expressionist who turned to computing in 1968, is the creator and mentor of Aaron, a painting robot. Aaron, a computer program Cohen has been modifying for more than 20 years, produces striking images that have been exhibited around the world and brought thousands of dollars at auctions. Cohen is now further refining Aaron to develop a robot that mixes its own paints, creates artwork and then washes its own brushes. Cohen answers your questions about Aaron and his creative process with this highly evolved expert system.



HERE'S HOW TO "ASK THE SCIENTISTS"

- Watch *The Art of Science* and review this classroom guide to prepare your question(s) and decide which scientist(s) you'd like to contact.
- Visit SCIENTIFIC AMERICAN FRONTIERS on PBS Online at www.pbs.org/saf/. Click on the "Ask the Scientists" icon on the opening screen, select "Scientists Now Appearing" and follow the simple instructions to send your question(s). Scientists' and artists' answers will be posted online for all FRONTIERS viewers to read. Depending on the volume of questions received, only selected questions may be answered.
- Remember to e-mail your questions by **March 6, 1998!**

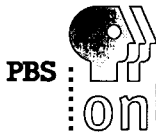

The Art of Science airs on PBS on Wednesday, February 18, 1998, at 8 pm.*

*Check your TV listings to confirm local air time and date.

NOTE: AVAILABILITY OF SCIENTISTS AND ARTISTS IS SUBJECT TO CHANGE.

SCIENCE IN CYBERSPACE

Visit these sites to learn more about topics on **The Art of Science:**

AN UPDATE ON THE BRAIN OPERA

Since this story first aired last season on FRONTIERS, *The Brain Opera* has been presented in Austria, Denmark, Japan, the U.S. and Portugal, and performances are planned this spring in Athens, Greece, and Toronto, Canada. Enhancements to *The Brain Opera* include improved Internet interaction, more integration of audience music into performances and fine-tuning of the interactive instruments. What's ahead for *The Brain Opera*? A new CD will be released this year by Erato/Warner and, in the spring of 1999,

The Brain Opera will be permanently installed in Vienna, Austria, where people from around the world will be able to contribute to, and observe, *The Brain Opera*

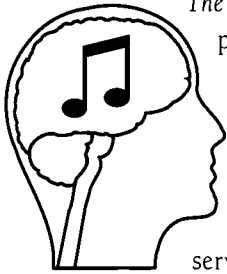

24 hours a day through the Internet. In addition, Machover's group at the MIT Media Lab is designing next-generation interactive experiences for music. Projects include a new underground interactive museum, opening in Essen, Germany, in June 1998; new musical instruments, experiences and toys for children; and a new opera, called *Resurrection* and based on Tolstoy's last novel, which is a commission from the Houston Grand Opera.



Let Us Cite Your Favorite Site!

We'll feature the coolest science sites in each issue of this guide.

If we print your recommendation, you'll receive a FRONTIERS T-shirt.

Please e-mail your suggestions to:
saf@pbs.org

BEN FRANKLIN'S HARMONICA

finkenbeiner.bcn.net/

Visit the home of the glass harmonica and read how Gerhard Finkenbeiner reproduced the instrument.

www.vex.net/Glass0/

Discover the history of glass music and access directories of composers, orchestras and performers of glass music.

sln.fi.edu/franklin/rotten.html

Explore the facets of Ben Franklin's life – scientist, inventor, musician.

[www.blarg.net/
~wildez/index.html](http://www.blarg.net/~wildez/index.html)

Hear William Wilde Zeitler, a glass harmonica composer and performer, play a 17-second version of Led Zeppelin's "Stairway to Heaven."

ALAN 2.0

www.viewpoint.com

Learn more about the creation of three-dimensional models at Viewpoint DataLabs.

www.itl.ATR.co.jp/

Take a trip to ATR Interpreting Telecommunications Research Labs in Japan, the company that pioneered Chatr, the speech synthesizing system used in the creation of "Digital Alan."

www.d2.com

Check out Digital Domain in Venice, California, creator of digital characters featured in the movie *Titanic*.

www.lamb.com

Visit Lamb & Company, an animation, special effects and post-production company for television, film and video.

AARON THE ARTIST

[www.tcm.org/info/
exhibits/aaron.html](http://www.tcm.org/info/exhibits/aaron.html)

Read how the robotic artist Aaron evolved and made its debut at Boston's Computer Museum in 1995.

[www.scinetphotos.com/
aaron.html](http://www.scinetphotos.com/aaron.html)

Click on "paintings" at this site to browse through an online gallery featuring works of art created by Aaron.

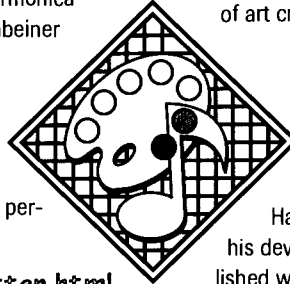

[visarts.ucsd.edu/
faculty/hcohen.htm](http://visarts.ucsd.edu/faculty/hcohen.htm)

Visit this site at the University of California, San Diego, to learn more about Harold Cohen's painting career, his development of Aaron and published writings.

BRAIN MUSIC

brainop.media.mit.edu/

Find out more about the interactive musical journey created by Tod Machover. You'll find a tour schedule and learn how you can participate in future performances.

www.media.mit.edu

Visits the MIT Media Lab, where you can learn more about upcoming events and new happenings. Click on "Noteworthy" to find electric postcards, smart clothes and more.

theremin.media.mit.edu/tod

Peek into the future at this site, which describes Tod Machover's upcoming musical performances and related projects.

RETURNED TO GLORY

www.nga.gov/feature/shaw/

Don't miss the Shaw Memorial Project home page, where you can tour the National Gallery exhibit and find out more about the restoration process.

[www.valley.net/
~stgaud/saga.html](http://www.valley.net/~stgaud/saga.html)

Take a virtual tour of the Saint-Gaudens National Historic Site in Cornish, New Hampshire, and see the home, gardens and studios of Augustus Saint-Gaudens, one of America's greatest sculptors.

At press time, the online features and sites listed here were current. Due to the rapidly changing online world, some may have changed or may no longer be available. We recommend that you preview sites before passing them on to students.

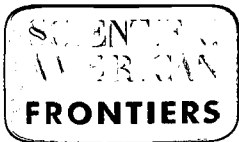

Watch It On PBS

SCIENTIFIC AMERICAN FRONTIERS airs on PBS with five new programs each season, October through April. Each hour-long special includes a variety of fascinating science stories based on a single theme.

SHOW 801: Expedition Panama

WEDNESDAY, OCTOBER 8, 1997

Meet scientists at the Smithsonian Tropical Research Institute, a living laboratory in the Panama Canal. Find out how the Isthmus of Panama changed the world.

SHOW 802: Beyond Science?

WEDNESDAY, NOVEMBER 19, 1997

Science fact or fiction? Scientists investigate claims from aliens to graphology, therapeutic touch, perpetual motion machines and more.

SHOW 803: Nordic Sagas

INTERNATIONAL SPECIAL! WEDNESDAY, JANUARY 21, 1998

Travel to Scandinavia to see what's old and what's new in the land of the midnight sun, from Viking ships of the last millennium to today's genetic research.

THIS ISSUE SHOW 804: The Art of Science

WEDNESDAY, FEBRUARY 18, 1998

FRONTIERS explores the marriage of science and art, including a robot that paints, the glass harmonica reborn, a behind-the-scenes look at digital technology in the movie *Titanic* and Alan 2.0 — a digital version of Alan Alda.

SHOW 805: The New Zoos

WEDNESDAY, APRIL 15, 1998

Modern zoos may be the only hope for endangered species. See what contemporary zoos are doing to improve and extend the lives of animals in captivity and the wild.



This painting is an original creation of Aaron, a robot that paints. Artist-turned computer-programmer Harold Cohen has been developing Aaron's capabilities for more than 20 years. Host Alan Alda meets Aaron and Cohen in this episode of FRONTIERS.

Remember, teachers may videotape the show to use year after year. GTE Corporation, the series underwriter, grants educators free off-air taping rights in perpetuity for classroom use.

This teaching guide contains cross-curricular activities appropriate for: Art, Music, Tech Ed and Photography. Why not share with your colleagues?



UNDERWRITTEN BY GTE CORPORATION



Connecticut Public Television
P.O. Box 260240
Hartford, CT 06126-0240

NON PROFIT
U.S. POSTAGE
PAID
Permit no. 51
Bristol, PA

INSIDE:
Requested Teaching
Materials for
**THE ART
OF SCIENCE**
AIR DATE:
February 18, 1998

SCIENTIFIC
AMERICAN
FRONTIERS

APRIL 15, 1998 • 8-9 PM

TEACHING GUIDE FOR SHOW 805



The
New
Zoos

Enriching the Minds
and Lives of Animals



Underwritten by GTE Corporation



The New Zoos

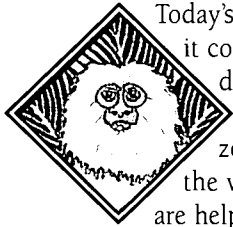

Today's zoos have taken on a new look. With it comes a new philosophy — work being done in “new zoos” can help wild animal populations survive and thrive. Where zoo residents were once captured from the wild, today's captive breeding programs are helping to replenish wild populations. And knowledge gained by studying animals in zoos is helping scientists learn how to protect many wild animals whose habitat is shrinking. Join SCIENTIFIC AMERICAN FRONTIERS and host Alan Alda on a tour of today's “new zoos.”

Visit Us at the NSTA Convention!

The 1998 NSTA Convention is just around the corner — April 16-19 in Las Vegas. FRONTIERS will be there, and we hope to see you too. Be sure to stop by our booth (#868) and take a chance at winning one of our newly redesigned FRONTIERS T-shirts. We're also planning a hands-on workshop where educators can try some of our classroom activities and learn new ways to use the FRONTIERS school program with students. Interested? To register, call us at 800-315-5010 or stop by our booth at the convention. Space is limited, so don't delay. See you in Las Vegas!

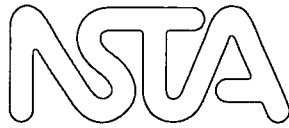

TIPS FOR TEACHERS

TAPING THE SHOW:

- ✓ Always check TV listings to confirm air date and time.
- ✓ As a teacher, you have off-air taping rights in perpetuity for classroom use.
- ✓ If you can't find the show in your TV listings, call your local PBS station.
- ✓ Do you need help? Call the FRONTIERS School Program at 800-315-5010.
- ✓ Videotapes of past shows can be purchased (\$21.97 each). Call 800-315-5010.

FREE VIDEOTAPING & PHOTOCOPYING RIGHTS:

GTE Corporation, the series underwriter, makes available complete off-air taping rights in perpetuity for classroom use of SCIENTIFIC AMERICAN FRONTIERS. Educators may record each show when it airs on PBS and keep the tapes to use in the classroom year after year.

Educators may also photocopy all materials in this guide for classroom use.

NEW SIGN-UPS:

If you know of other educators who are interested in receiving these guides, they may sign up by calling the SCIENTIFIC AMERICAN FRONTIERS School Program at 800-315-5010.

LET US HEAR FROM YOU!

We appreciate and welcome your questions, comments, compliments and constructive criticism. Please contact us . . .

By mail:

SCIENTIFIC AMERICAN FRONTIERS
105 Terry Drive, Suite 120
Newtown, PA 18940-3425
By phone: 800-315-5010
By fax: 215-579-8589
By e-mail: saf@pbs.org

VISIT US ONLINE:

www.pbs.org/saf/

Perpetual Motion in Maine

Rob Burke, a longtime FRONTIERS viewer, teaches middle school science at Reeds Brook Middle School in Hampden, Maine, combining life and physical science with many opportunities for links to FRONTIERS stories and activities.

“The kids really like contests and competitions,” Burke says. Recently, Burke's 8th-graders tried “Waste Not, Want Not,” the perpetual motion machine contest featured in the guide to **Beyond Science?** (Show 802). “I built a prototype and showed it to them. I told them, ‘I know you guys can do better,’ and they did. I gave them a standard — they had to get their machine to run at least one minute. They figured out the key tactic, how to get the water to drip slowly. I knew they were into it because they came in during study hall to work on their machines. Our all-time winner built a machine that ran on half a cup of water for 13 minutes!”

Educators: Are you looking for a FRONTIERS activity from a previous season? Teaching guides for the 300 through 800 seasons are archived on the FRONTIERS Web site. To find them, go to www.pbs.org/saf/ and click on “In the Classroom.”

VIEWER CHALLENGE

You and your students can enter the **Viewer Challenge** (p. 4) and have a chance to win a terrific redesigned FRONTIERS T-shirt. The correct answers to the **Viewer Challenge** questions are: **1. b 2. hide food, provide toys, play with animals, simulate life in the wild 3. a 4. obsessive grooming 5. it provides mental stimulation 6. they got too fat 7. smell 8. c 9. patience 10. a, d**

NEXT SEASON ON FRONTIERS

Stay tuned next October, when FRONTIERS returns to PBS for its ninth season. We'll explore **science in the Caribbean**, find out what astronauts will need when they travel to **Mars**, learn about **animal intelligence**, confront arachnophobia in an episode on **spiders**, and answer some of **life's little questions**. And be sure to visit our Web site (www.pbs.org/saf/) throughout the summer — we'll have new polls and Cool Science activities for you and your students.

SAFETY CAUTION: The teaching guide to **The Art of Science** (Show 804) contained an activity called “Alchemy Lab: The Golden Dream” (pp. 10-11). Because zinc dust and zinc residue are flammable, this lab should only be performed under supervision and care should be taken in disposing of ingredients. Do not use paper towel during the cleanup of this experiment. When the experiment is finished, make sure the evaporating dish has completely cooled. Using a chemical spatula in the lab, scrape off the waste into a plastic container and seal and label the container. Follow your school's storage procedure and save the residue for future activities. Thanks to Mike Woodside of Greene County Technical School in Paragould, Arkansas, for bringing this to our attention.

The New Zoos

SHOW 805 • APRIL 15, 1998 • 8 PM* ON PBS

POLAR BEAR PICNIC

6

Enrichment is not just an education catchword — in the San Diego Zoo, it's polar bears' way of life.

Activities: Design a habitat. . . . Measure thermal properties of color.

THE WILDER, THE BETTER

8

What does it take to really make an orangutan think? A psychologist at Toronto's Metro Zoo is trying to find out.

Activities: Spatial memory in primates. . . . Mirror self-recognition studies.

DOCTOR FISH

9

Check on a bridled burrfish in post-op and watch a sea lion eye exam at the New England Aquarium's Medical Center.

Activity: Model hearts of fish and mammals.

TUNA IN THE TANK

10

High-tech tracking of the giant bluefin tuna's travels may help save the species from extinction.

Activity: Play a tracking game.

ZOOS AS ARKS

11

Captive breeding programs, when successful, are one way zoos ensure a future for animals on the brink of extinction.

Activity: Graph human population growth.

RETURN TO THE WILD

12

Golden lion tamarins attend a jungle boot camp, where they learn survival skills that will help when they return to the wild.

Activities: Design a zoo. . . . The importance of genetic diversity.

Plus, in every issue . . .

VIEWER CHALLENGE: Quiz questions, T-shirt prizes! 4

THE BIG PICTURE: A Field Guide to The New Zoos 5

FRONTIERS ONLINE: Visit us at www.pbs.org/saf/ 14



ABOVE: Alan Alda and Guthrie the sea lion at the New England Aquarium.

AT-A-GLANCE

SCIENTIFIC AMERICAN FRONTIERS

THE NEW ZOOS

NOTE: More detailed curriculum links are included on the activity sheets to individual stories.

STORY	RUNNING TIME	BIOLOGY	ENVIRONMENTAL SCIENCE	LIFE SCIENCE	MEDICINE	PSYCHOLOGY	TECHNOLOGY
Polar Bear Picnic	8:07	•	•	•	•	•	
The Wilder, the Better	7:49	•		•		•	
Doctor Fish	9:24	•		•	•		•
Tuna in the Tank	9:18	•	•	•	•		•
Zoos as Arks	8:22	•	•	•	•	•	
Return to the Wild	9:47	•	•	•	•		

*CHECK LOCAL DATE AND TIME

SCIENTIFIC AMERICAN FRONTIERS is made possible by an underwriting grant from GTE Corporation. The series is produced by The Chedd-Angier Production Company in association with *Scientific American* magazine and presented to PBS by Connecticut Public Television. Classroom materials produced by Media Management Services, Inc.





The New Zoos

Show 805 / April 15, 1998, at 8 pm* on PBS



*CHECK LOCAL LISTINGS

STUDENT'S NAME: _____

TEACHER'S NAME & COURSE: _____

Watch SCIENTIFIC AMERICAN FRONTIERS for answers to the questions on this page. Answer the 10 questions correctly and you'll be eligible to win a FRONTIERS T-shirt!

Polar Bear Picnic

- What is the key to a successful enrichment program in a zoo?
 - a. secret hiding places
 - b. novelty
 - c. fewer visitors
 - d. low-fat foods
- List three examples of ways zoos provide enrichment.

The Wilder, the Better

- Which of the following facts is *not* true about orangutans?
 - a. They are happy in groups.
 - b. They don't compete for food.
 - c. They remember where food is located.
 - d. They figure out good strategies for finding food.
- For Saki monkeys, the behavioral equivalent of pacing the cage is:

Doctor Fish

- Why might training Guthrie the sea lion to perform be good for him?

Tuna in the Tank

- Why did vets at the Monterey Bay Aquarium stop feeding tuna the food they eat in the wild?

Zoos as Arks

- Pandas exchange information with other pandas through their sense of:

- Researchers at the San Diego Zoo found that the key to increasing the breeding potential of captive animals is:

- a. music
- b. good food
- c. more space
- d. toys to play with

Return to the Wild

- Zoo expert Ben Beck says that "99% of this business" [observing animals] is:

- Golden lion tamarins raised in captivity have problems finding food because they lack good (*choose two*):

- a. locomotion skills.
- b. senses of smell and taste.
- c. communication.
- d. mapping skills.

EXTRA CREDIT CONTEST!

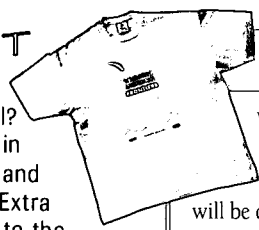

FOR TEACHERS ONLY

What is your favorite zoo animal? Why? Answer these questions in an essay of 100 words or less and send it by **May 15, 1998**, to Extra Credit Contest at the address to the right. The most colorful entry will be posted in the Polls & Prizes section of the FRONTIERS Web site and the winner will get a T-shirt. Good luck!

Answers to the Viewer Challenge are listed on page 2 of this guide. T-shirt winners' names will be posted in the Polls & Prizes section of the FRONTIERS Web site.

When completed, this page can become an entry to the FRONTIERS T-shirt contest; 20 winners (10 students, 10 teachers) will be drawn at random for each show. To enter the T-shirt drawing, send all completed challenges in one envelope with a cover sheet to: **Viewer Challenge, SCIENTIFIC AMERICAN FRONTIERS, 105 Terry Drive, Suite 120, Newtown, PA 18940-3425. Mail completed entries by May 15, 1998.**

TIP: You can download these questions on the Web: www.pbs.org/saf/.

IMPORTANT!! Please include a separate cover sheet and tell us:

- number of challenges submitted
- teacher's name
- grade and course
- school name, address and phone number
- where your students watched the show — at home, at school or both
- the name of your students' favorite story in this show (conduct a quick poll to find out)

Thank you!

A Field Guide to The New Zoos

The zoos and aquariums you see on this episode of SCIENTIFIC AMERICAN FRONTIERS provide enriched habitats for their animal residents. How do zookeepers know what to offer the animals? They need to know about each animal's native habitat, diet and behavior so they can anticipate the animals' needs. Use the Web and

other resources to fill in the information below and create your own field guide for one of the animals shown on this page or another species you choose. You can copy this page to create field guides for several species. When you finish, exchange your field guides with classmates to learn about the species they studied.



GIANT PANDA



GOLDEN LION TAMARIN



UGANDAN GIRAFFE

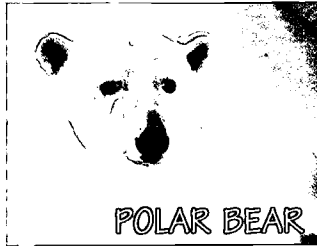

POLAR BEAR



ORANGUTAN



INDIAN RHINOCEROS

Common name: _____

Scientific name: _____

Physical characteristics: _____

Native country and habitat: _____

Diet and feeding habits: _____

Social organization: _____

Conservation status: _____

Other information: _____

RESOURCES

How do we know an animal is endangered? What does it take for an animal to get on the endangered species list – and how does it get off the list? To learn more about conservation status and to find out which animals are on the endangered species list, start your search with these Web sites:

World Wildlife Fund: www.wwf.org or www.panda.org

Species Under Threat: www.wcmc.org.uk/species/data/species_sheets/

World Conservation Monitoring Centre's Red List database:

www.wcmc.org.uk:80/species/animals/animal_redlist.html

© 1997 Jessie Cohen, National Zoological Park, Smithsonian Institution

Polar Bear Picnic

Polar bears at the San Diego Zoo spend their days frolicking in the water, following scent trails, playing with toys and generally having a great time — all in the name of enrichment. Unlike the zoos of yesteryear, where animals spent a lot of time pacing in their cages, today's zookeepers try to make zoo life more like life in the wild. Keeping animals healthy and happy is the priority of zoos today, as they focus on long-term survival.

RUNNING TIME: 8:07

CURRICULUM LINKS:

- ANATOMY & PHYSIOLOGY
- BIOLOGY
 - adaptations
- EARTH SCIENCE
 - polar ecosystem
- LIFE SCIENCE
 - mammals
- PHYSICAL SCIENCE
 - thermal properties



RELATED FRONTIERS SHOWS & ACTIVITIES:

- **Science Safari**, Show 702: "Ways of the Wild" (p. 12)
- **The Wild West**, Show 601: "Model Planet" (p. 13)

ACTIVITY 1 Design Your Lair

Everyone needs their space — the stuff in that space makes them feel comfortable and at home. Think about what it would be like to have to live in one room for the rest of your life. You can't leave it and all of the resources needed to keep you alive must be brought in. What kind of "space" and "stuff" would you need in the room, your habitat, to allow you to live in comfort?

OBJECTIVE

Investigate the difference between what is *essential* to survive and what is *desirable* in an enriched environment.

MATERIALS

- paper
- ruler
- colored pencils or markers
- other art supplies, as needed



PROCEDURE

1. Divide a piece of paper into two columns. Write "essential" above the left column and "desirable" above the right column.
2. Under the "essential" column, list all of the things you need to stay alive. This list would include the *absolute minimum* items like food and water. In the "desirable" column, list all the items you would like to

have to make your stay comfortable and to keep you from getting bored.

3. Compare your lists with those made by other students and discuss.
4. Draw a blueprint of your ideal habitat. Make sure your drawing incorporates as many items on your lists as possible. Label the key components and the dimensions of your room. You may prefer to design your habitat on a computer.
5. Display your ideal lair for others to view.

QUESTIONS

1. Did your "essential" list differ from any of your classmates' lists? How do you think your essential list would differ from one made by your parents?
2. What would be the difference in your quality of life between living in a room based on your essential needs versus your desirable needs?
3. How does this difference parallel the old and new zoos?
4. Compare early zoos, which housed animals in cages, with modern zoos. Which do

you think are cheaper in the short run? Over a longer term? Which provide a better view of the animals for visitors? Which are better for the health and happiness of the animals?

5. Imagine your design is part of an intergalactic zoo where you are part of an exhibit. Would you vary your design knowing you would be "on exhibit"?

EXTENSIONS

1. If your classroom has animals like iguana or fish housed in a cage or aquarium, think about how you could redesign their habitats to create enriched environments.
2. If you live near a zoo or wild animal park, visit it. Investigate how the zoo has changed its exhibits since it was built. Based on what you've learned from this episode, what changes would you like to see made?

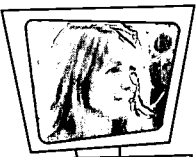
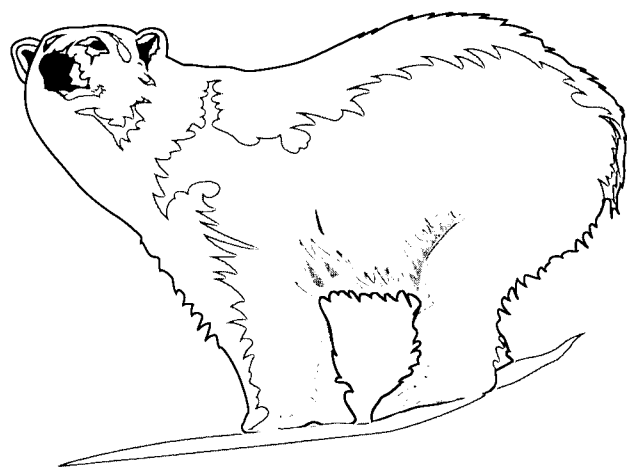

Joanne Simeron, who appears in this segment, answers your questions online.

SEE PAGE 14 www.pbs.org/saf/

ACTIVITY 2

Polar Bear Adaptations

When designing habitats for new zoos, it's important to pay attention to the physical adaptations that make an animal successful in its natural environment. The polar bear has several adaptations that make it an incredible hunter able to withstand the intense cold in the polar regions. These adaptations include a thick layer of fur, about 11 cm of blubber, paws that help it paddle, and keen senses of smell and vision. These bears are exceptionally strong swimmers.

Another of the polar bear's adaptations for living in extreme cold is the black mottled skin underneath its fur. Scientists think the fur — which is actually transparent, although it looks white — acts like optical fibers that concentrate solar energy down to the black skin to help warm the bear.

OBJECTIVE

Investigate how polar bears keep warm in their natural habitat.

MATERIALS

- black and white sheets of construction paper
- 3 thermometers
- 2 non-fluorescent lamps



PROCEDURE

1. Place a sheet of black paper and a sheet of white paper under a light source. Put a thermometer on each paper so that the light will shine directly and evenly onto each. The light source should be 12 to 20 cm away from the paper. Do not turn on the light yet.
2. Record the temperature for each thermometer in the appropriate column of the data table at right. Use the third thermometer to record the ambient room temperature.
3. Turn on the light. Collect temperature data every 30 seconds for five minutes. Record the data in your table.
4. Once you have collected the data, graph your data with time on the horizontal axis and temperature on the vertical axis. Be sure to label your graph and include a key for the different conditions you were testing.

QUESTIONS

1. Did the temperature for the black paper rise faster than the white? Why or why not?
2. Why did you record the temperature in the room?
3. How does the bear's black skin help keep it warm?
4. Adaptations to keep warm are important in the bear's natural habitat, but may be detrimental to its health in warmer environments like San Diego. What accommodations in the zoo habitat have designers made to keep the bears from overheating? Visit the polar bears at www.sandiegozoo.org/Zoo/pbear.html.

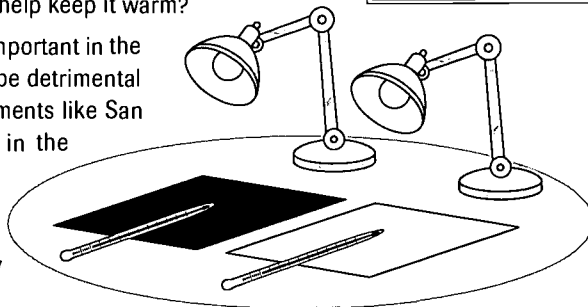

TEMPERATURE DATA TABLE

TIME	TEMPERATURE (IN CELSIUS)		
	AIR	BLACK PAPER	WHITE PAPER
START			
:30			
1:00			
1:30			
2:00			
2:30			
3:00			
3:30			
4:00			
4:30			
5:00			

The San Diego Zoo, founded in 1916 with 50 animals collected from menageries and kept in cage-like enclosures, has pioneered many innovations. The zoo's Polar Bear Plunge exhibit is a prime example of the revolutionary thinking in wildlife management. Designed to simulate an arctic summer, the Polar Bear Plunge holds 130,000 gallons of water cooled to 55° F. It's stocked with fish and kept clean and cool. The bears also have grassy areas for napping, a sandbox for digging and a special salt-water pool. This habitat provides not only a space, but also an enriched environment tuned to the bear's physical and behavioral adaptations. This type of "natural" enclosure reduces anxiety for the bears and increases the value of the zoo experience for the public.



Show 805:
The New
Zoos

Polar Bear
Picnic



The Wilder, the Better

FRONTIERS visits Toronto's Metro Zoo, where psychologist Suzanne MacDonald shows how zookeepers enrich animal habitats by mimicking aspects of life in the wild. We meet some playful, intelligent orangutans participating in activities designed to find out how they think and to keep them mentally active. Then we observe how animal behaviorists try to encourage Saki monkeys and gibbons to behave more naturally.

RUNNING TIME: 7:49

CURRICULUM LINKS:

- BIOLOGY**
nervous system
- LIFE SCIENCE**
animal behavior, primates
- PSYCHOLOGY**
spatial memory



RELATED FRONTIERS SHOWS & ACTIVITIES:

- **Scientific Breakthroughs in Germany**, Show 402: "Bird Navigation & Mapping" (pp. 9-10)

Working Memory

One of the biggest challenges in today's zoos and animal parks is figuring out ways to engage the animals' mental and emotional selves. One technique frequently used to challenge the minds of animals in captivity is hiding food. Having animals search for food, instead of delivering it to

them like room service, simulates the work they do naturally in the wild to forage and find their food.

Primates have a spatial memory that helps them remember where food might be found. Like monkeys and orangutans, we too are primates and have a powerful

memory of locations. You use spatial memory for playing card games like "Concentration," navigating your way through a maze or a mall or skiing a downhill course. Can you identify other ways your spatial memory is useful?

ACTIVITY Mirror Recognition

Psychologist Suzanne MacDonald, who you meet on FRONTIERS, is working on several other projects with primates. In one of her projects, she is studying the mirror self-recognition of orangutans. Similar studies of other primates are thought-provoking and somewhat controversial.

To study self-awareness in primates, scientists give them mirrors. Try this mirror-recognition activity and you may be surprised to learn how your own sense of self can become distorted when a reflection doesn't match the sense of body position and movement.

MATERIALS

- small round plastic mirror
- glue gun and glue or fast-drying glue
- two new unsharpened pencils

PROCEDURE

1. Place a spot of glue on the unsharpened wooden end of a pencil. Quickly position the "sticky" wooden end in the center of a plastic mirror.
2. Place another spot of glue on the unsharpened end of a second pencil. Stick this pencil to the other side of the mirror, directly aligned with the first pencil (as shown above).
3. When the glue is dry, grasp one pencil with each hand. Look at the mirror so that the reflection of your left hand replaces the spot where your right hand should be. Position the mirror so that it blocks out your view of your right hand.
4. Now, while watching the reflection of the left hand in the mirror, slowly rotate your right hand. How does that feel?
5. What happens when the information you detect with your eyes is contrary to the movements of your body? How can this

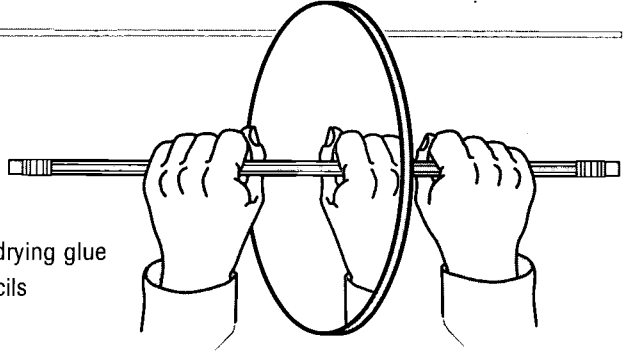

observation be applied to the concept of self? How do you think an orangutan would react in this situation?

EXTENSIONS

1. Do you think your pets possess self-awareness or a sense of self? How could you tell? What happens when your pets see their reflections?
2. As you watch this episode, look for and identify all the ways zoos are challenging and enriching animals psychologically.
3. Suzanne MacDonald is also working with elephants, gorillas and marmosets. Visit her Web site at www.atkinson.yorku.ca/~suzanne/index.html to learn more.
4. If you have a dog or cat, design an experiment that involves hiding food, similar to the way the food is hidden from the orangutans on the show. Does your pet remember where food is hidden?

OBJECTIVE

Test your conscious sense of self with reflections in a mirror.



Suzanne MacDonald, who appears in this segment, answers your questions online.

SEE PAGE 14

www.pbs.org/saf/

Looking for
a quick way
to find past FRONTIERS
activities that will work
with your botany lesson
in fifth hour?

Now you can search the
FRONTIERS Web site on PBS
Online by subject area or
key word to easily find what
you're looking for. To start
your search, go to **[www.pbs.org/saf/2_search/
2_search.html](http://www.pbs.org/saf/2_search/2_search.html)**. Past sea-
sons' teaching guides are
archived on the Web site, so
you can print the pages you
need. What could be easier?

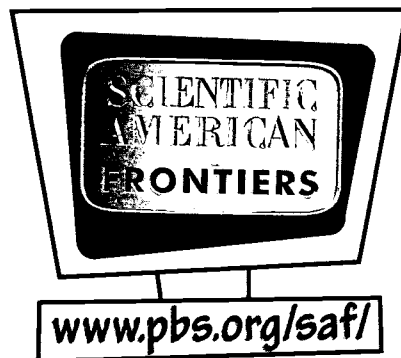

SEASON INDEX 1997-98

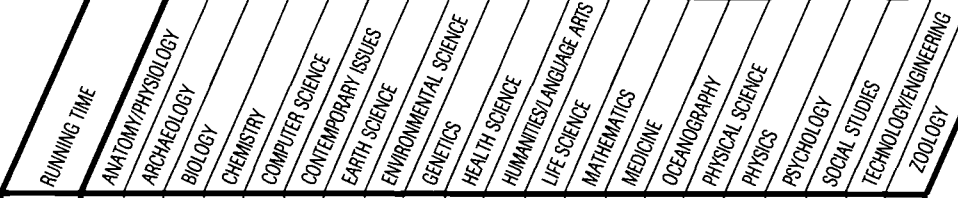
		RUNNING TIME																				
			ANATOMY/PHYSIOLOGY	ARCHAEOLOGY	BIOLOGY	CHEMISTRY	COMPUTER SCIENCE	CONTEMPORARY ISSUES	EARTH SCIENCE	ENVIRONMENTAL SCIENCE	GENETICS	HEALTH SCIENCE	HUMANITIES/LANGUAGE ARTS	LIFE SCIENCE	MATHEMATICS	MEDICINE	OCEANOGRAPHY	PHYSICAL SCIENCE	PHYSICS	PSYCHOLOGY	SOCIAL STUDIES	TECHNOLOGY/ENGINEERING
SHOW 801 • OCTOBER 1997 EXPEDITION PANAMA	Echoes in the Night	12:18	•	•	•	•						•				•	•			•	•	
	Rat Soup	12:13		•			•	•	•				•							•	•	•
	Bee Lines	9:38	•	•				•		•		•	•			•	•					•
	Champion Chombers	5:56	•	•	•				•	•		•	•									•
	Bridge That Changed the World	7:40		•	•				•	•	•		•			•				•	•	•
SHOW 802 • NOVEMBER 1997 BEYOND SCIENCE?	Water, Water Everywhere...	12:12						•	•							•	•	•			•	
	Aliens Have Landed	11:17	•					•	•				•	•	•					•	•	
	New Energy Age	7:57						•					•			•	•	•			•	
	Paper Personality	8:46						•					•									•
	Healing Touch	7:23	•					•				•	•	•	•	•	•	•				
SHOW 803 • JANUARY 1998 NORDIC SAGAS	Viking Ships	10:41		•					•							•	•			•	•	
	Iceland Genes	6:45	•	•	•		•	•		•		•	•							•	•	
	Island Life	10:19		•	•			•	•			•				•	•			•	•	
	Isaac and Friends	11:45					•			•			•							•	•	
	Radioactive Reindeer	13:04	•	•	•	•	•	•	•	•	•	•	•	•	•	•	•	•		•	•	•
SHOW 804 • FEBRUARY 1998 THE ART OF SCIENCE	Ben Franklin's Harmonica	10:47					•								•	•				•	•	
	Alan 2.0	13:48	•				•					•								•	•	
	Aaron the Artist	10:07					•					•								•	•	
	Brain Music	6:26	•				•					•								•	•	
	Returned to Glory	11:27		•		•		•				•								•	•	
SHOW 805 • APRIL 1998 THE NEW ZOOS	Polar Bear Picnic	8:07	•	•			•	•	•	•	•	•	•	•	•	•	•	•	•	•	•	
	The Wilder, the Better	7:49		•			•					•								•	•	
	Doctor Fish	9:24	•	•		•		•	•	•		•	•	•	•	•	•	•	•	•	•	
	Tuna in the Tank	9:18	•	•			•	•	•	•		•	•	•	•	•	•	•	•	•	•	
	Zoos as Arks	8:22	•	•			•	•	•	•	•	•	•	•	•	•	•	•	•	•	•	
	Return to the Wild	9:47	•	•			•	•	•	•	•	•	•	•	•	•	•	•	•	•	•	

For more information on the SCIENTIFIC AMERICAN FRONTIERS School Program, write to: 105 Terry Drive, Suite 120, Newtown, PA 18940-3425 or call 800-315-5010. Videotapes of past shows may be purchased (\$21.97 per one-hour show). Call 800-315-5010.

SCIENTIFIC AMERICAN FRONTIERS is made possible by an underwriting grant from GTE Corporation. Produced by The Chedd-Angier Production Company in association with Scientific American magazine. Classroom materials produced by Media Management Services, Inc. Permission is granted to teachers to reproduce this index for classroom use. © 1998, GTE Corporation.



SCIENTIFIC AMERICAN FRONTIERS 800 SERIES

SCIENTIFIC AMERICAN FRONTIERS is the prime-time PBS series hosted by Emmy Award-winning television star and science enthusiast Alan Alda. Each hour-long show explores fascinating science stories, featuring topics in the fields of technology, medicine, nature, genetics, human behavior and more.

Remember that GTE Corporation, the series underwriter, grants educators free off-air videotaping rights in perpetuity for classroom use of FRONTIERS. Educators may record each show when it airs on PBS and save the tapes to use whenever and wherever appropriate in the curriculum.

Expedition Panama Show 801

ORIGINAL AIR DATE: OCTOBER 1997

Meet scientists at the Smithsonian Tropical Research Institute, a living laboratory on an island in the Panama Canal. Find out how the Isthmus of Panama changed the world and how a canal built in this century led to unintended consequences. Explore the world of bats, bees, leafcutter ants and the paca, a rodent that might help save Panama's shrinking rain forest.

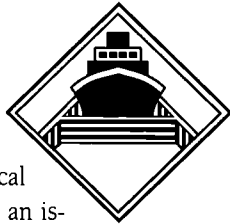

Beyond Science? Show 802

ORIGINAL AIR DATE: NOVEMBER 1997

Scientists investigate pseudoscience — aliens, perpetual motion machines, therapeutic touch, dowsing and graphology — in a quest to separate fact from fiction. Listen as scientists in this episode talk about how the scientific method helps them evaluate and think critically about popular claims and phenomena we do not understand.

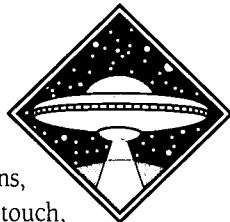

International Special

Nordic Sagas Show 803

ORIGINAL AIR DATE: JANUARY 1998

FRONTIERS travels to Scandinavia. See what archaeologists are learning about 8th-century Viking ships. Watch a volcano near Iceland give birth to an island. Visit Lapland to learn more about the impact of Chernobyl. Find out what we are learning from Icelandic genes and how technology helps disabled people communicate.

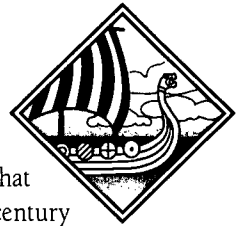

The Art of Science Show 804

ORIGINAL AIR DATE: FEBRUARY 1998

This episode explores the marriage between science and art. Meet a digital Alan Alda, whose creation marked a new development in technology history. Go behind the scenes of the movie *Titanic*. Listen to the ethereal tunes of a glass harmonica. Watch as a 19th-century sculpture is restored to glory and meet a robot that paints original pictures.

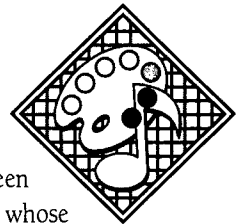

The New Zoos Show 805

ORIGINAL AIR DATE: APRIL 1998

Many of today's zoos, wildlife parks and aquariums exist not as showcases for exotic animals, but as places to enrich the lives of animals in captivity and the wild. For some endangered species, like the giant panda, zoos may be the last hope. A model reintroduction program with golden lion tamarins demonstrates what the best new zoos can do to assure a future for endangered animals.

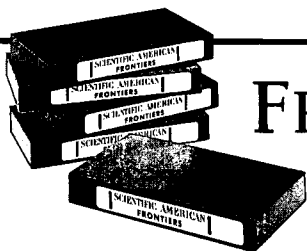
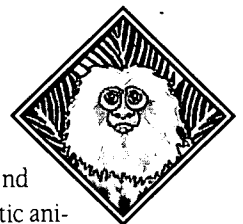

FRONTIERS on Videotape

Videotapes of past shows are available through the FRONTIERS School Program. If you missed a show or want to complete your FRONTIERS videotape library, call 800-315-5010. Tapes are \$21.97 each. (Orders accepted with purchase order, credit card or check.) Teaching guides for past shows are available on the FRONTIERS Web site on PBS ONLINE: www.pbs.org/saf/.

Let us hear from you!

Tell us what you think about the FRONTIERS School Program.

You can contact us . . .

By mail:

SCIENTIFIC AMERICAN FRONTIERS, 105 Terry Drive,
Suite 120, Newtown, PA 18940-3425

By phone: 800-315-5010

By E-mail: saf@pbs.org

Or visit us online! www.pbs.org/saf/

Doctor Fish

Alan Alda joins veterinarian Howard Krum on morning rounds at the New England Aquarium's Medical Center. On this visit, a bridled burrfish is scheduled for surgery. After the operation, a first for Dr. Krum, we meet Guthrie the sea lion, who has an appointment with the vet. After Guthrie passes his exams, Alan helps vets care for two other patients, abandoned harbor seals, who will be restored to health and later released into the ocean.

RUNNING TIME: 9:24

CURRICULUM LINKS:

ANATOMY & PHYSIOLOGY
fish, marine mammals

BIOLOGY
circulatory system

EARTH SCIENCE
ocean

LIFE SCIENCE

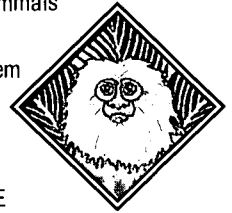

RELATED FRONTIERS SHOWS & ACTIVITIES:

□ **Going to Extremes**, Show 704: "Frozen Alive" (pp. 10-11)

ACTIVITY **Fish Tales**

Biologists trace the evolution of the heart and circulatory system in mammals by studying the anatomy of hearts in other animals. In fish, the heart is a simple tube with two chambers, the atrium and ventricle, that pushes blood to the gills for oxygen, then through the body.

Amphibians have a three-chambered heart with partial separation of oxygenated and deoxygenated blood. In mammals, the heart is four-chambered with a complete separation of oxygenated and deoxygenated blood.

Operating on different animals requires a knowledge of circulatory and other systems in various species.

OBJECTIVE

Model hearts of fish, amphibians and mammals.

MATERIALS

- clay of different colors
- anatomical heart models (optional)

PROCEDURE

Use clay to build simple models of the hearts illustrated here and compare. Consult biology texts and the Web to research how the blood flows to and from the heart in each class of animal. Source: A Web-based tutorial on the circulatory system by Dr. Kenneth Chan, Department of Anatomical Sciences, University



Howard Krum, who appears in this segment, answers your questions online.
www.pbs.org/saf/

of Queensland (www.uq.edu.au/anatomy/gmc/circulatory/intro.html).

QUESTIONS

1. How does the arrangement of chambers in a fish heart compare to chambers in a mammal heart? In amphibians?
2. How does a fish obtain oxygen and circulate it through its body? How does this differ from mammals and amphibians?
3. In the story you watch on FRONTIERS, how do the surgeons keep oxygen circulating in the fish while it's out of water?
4. Compare other systems and the anatomy features in fish, mammals and amphibians.

EXTENSIONS

1. How do the daily habits of the animal influence its circulatory needs? Why are most fish cold-blooded?
2. The bluefin tuna is warm-blooded, though not an endotherm like mammals. Some scientists believe the tuna has an adaptation in one of its eye muscles that allows it to shunt warm blood to the brain. Why do you think the tuna evolved this adaptation, but other fish didn't? Do any other marine mammals have special adaptations?
3. Write a script and/or draw story boards for a brief episode of an "Animal ER" drama.
4. If you found an abandoned harbor seal pup on the beach, would you know what to do? Find out at the New England Aquarium Web site (www.neaaq.org).

5. People often confuse sea lions and harbor seals. Despite their similar appearance, they are not closely related. Each evolved from different ancestors, but both are pin-nipeds, a suborder of marine animals. Sea lions have external ears and more developed limbs. Harbor seals are true seals. Next time you visit a zoo, see if you can tell them apart.

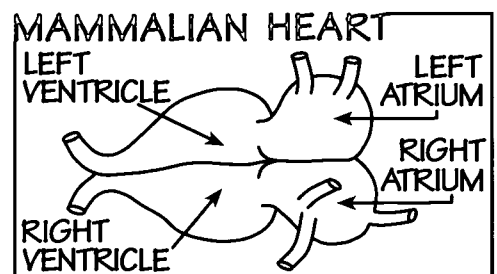
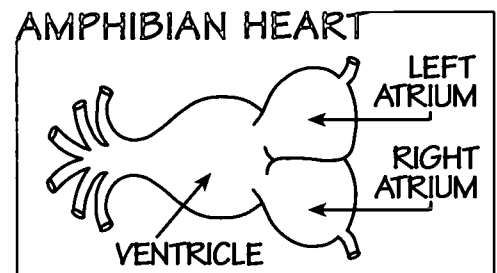
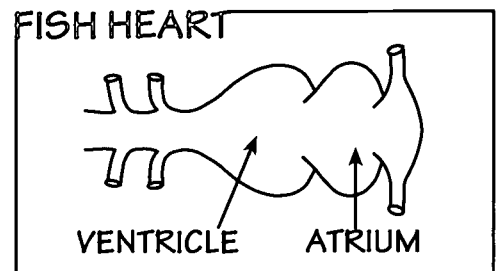

You can explore the human heart online at sln.fi.edu/biosci/heart.html.

Tuna in the Tank

Keeping fish healthy and happy is just one goal of the Outer Bay exhibit at California's Monterey Bay Aquarium. Rescuing fish and marine animals from extinction is a critical priority. One species being studied is the world's most prized and endangered fish, the giant bluefin tuna. Thanks to knowledge gained from other tuna in captivity, an ambitious world-wide program to track and save this fish has a greater chance of success.

RUNNING TIME: 9:18

CURRICULUM LINKS:

- ANATOMY & PHYSIOLOGY
fish
- BIOLOGY
- EARTH SCIENCE
oceans
- LIFE SCIENCE
animal behavior
- TECHNOLOGY
tracking devices



RELATED FRONTIERS SHOWS & ACTIVITIES:

- **Creatures of the Deep.** Show 604: "Shark Trackers" (pp. 6-7), "Hidden Depths" (pp. 8-9)

ACTIVITY: Play a Tracking Game

With prices up to \$90,000 for one fish, the Atlantic bluefin tuna is considered the world's most valuable fish. It's also one of the world's most endangered.

To understand why the population is declining, biologists from the National Marine Fisheries Service, the Monterey Bay Aquarium and Stanford University began tracking the migration of bluefin tuna in 1996. Scientists are collecting data on migratory routes and spawning areas, which will help answer critical questions about the bluefin tuna.

The transoceanic migration of bluefin tuna takes them from the Atlantic Ocean off New England as far north as Norway and as far south as Brazil. Researchers are tracking tuna using computers and high-tech archival tags — electronic data-logging devices. In this activity, you can use low-tech methods to track a teacher or student.

OBJECTIVE

Define the range of an individual based on observations made over the course of a day.

PROCEDURE

1. Construct a large map of your school or campus and mount it on the wall of your room. This is the map you will use to post tracking information.

2. A teacher or student should volunteer to be tracked for one day. This individual must agree to keep a log for the day showing his or her movements. Have the person being tracked pin a "tag" (a piece of bright ribbon) on his or her book bag or backpack. Part of the exercise is to see if other students can spot the tag of the person being tracked, so the person's identity should be kept secret.
3. Designate one full day to track the individual. Throughout the day, students will record sightings of the tagged individual. Each student should keep a log for the day of the tracking game. Write down the time, duration and location of sightings.
4. The next day in class, compile all the sighting data on the class map.
5. Compare the sightings made by your class with the log kept by the tagged individual.

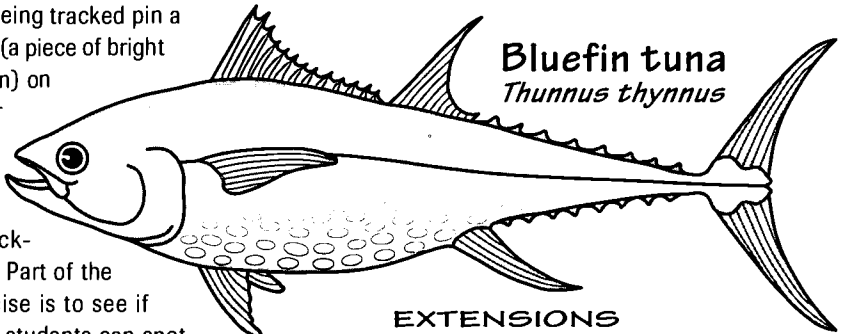

EXTENSIONS

1. Research the tuna's migration paths and plot them on a world map.
2. Researchers tracking the tuna use a tag that sends information about the tuna's location to a satellite, and is then communicated to the research team. Have the person being tracked write down time and location hints on pieces of paper or Post-it notes and place them in various places throughout the school. See if these "sightings" improve the tracking information.
3. In recognition of the importance of the marine environment, the United Nations has designated 1998 the "International Year of the Ocean." As a related project, research the status, overfishing and decline of the bluefin tuna.
4. For more on the tuna tracking project, consult these Web sites: the Monterey Bay Aquarium (www.mbayaq.org) and the NOAA Fisheries (kingfish.ssp.nmfs.gov).
5. Investigate why the bluefin tuna is considered warm-blooded. To learn more about the bluefin tuna, visit www.hp.com/abouthp/features/bluefin/.

QUESTIONS

1. How effective was your tracking effort at defining the places visited by the person being tracked?
2. How could you improve the accuracy of your tracking?
3. You observed your subject in a limited area. Is this an accurate reflection of the area where he or she might move about in a day? A week? A month?



Heidi Dewar and Tom Williams, who appear in this segment, answer your questions online.

SEE PAGE 14 www.pbs.org/saf/

Zoos as Arks

With about 1,000 giant pandas left in the wild, this roly-poly animal is on the verge of extinction. An effective captive breeding program is critical to the animal's survival. But captive breeding of pandas has had limited success, because their mating habits are poorly understood. Scientists working to learn more about panda biology and behavior hope to gain insights that will help the species survive in the wild.

RUNNING TIME: 8:22

CURRICULUM LINKS:

- BIOLOGY
- EARTH SCIENCE
 - habitat destruction
- LIFE SCIENCE
 - adaptations
- MATH
 - graphing



RELATED FRONTIERS SHOWS & ACTIVITIES:

- **Dragon Science**, Show 602: "Dams and Dolphins" (pp. 6-7)
- **Prime Time Primates**, Show 504: "Keeping the Peace" (pp. 7-8)

ACTIVITY Population Paradox

The growth of one animal's population, such as humans, can have a profound impact on other animals. This is the case with the giant pandas, whose habitat is gradually being destroyed by human encroachment, leaving fewer than 1,000 animals in the wild.

As you plot the world population graph in this activity, consider the effects of human population growth. The survival of endangered species like the panda often depends on the success of programs like the one at the San Diego Zoo, seen in this episode.

3. On the vertical axis, each centimeter equals an increase in population by 1 billion. Label this axis 1 through 10 billion.
4. Use the data in the World Population Table and place an X at each point represented by a year and population number. Or, consult an almanac or the Population Refer-

ence Bureau (www.prb.org) for specific data about human population statistics.

5. Connect the dots to see what kind of curve appears. Use the information to estimate the population for the year 2000 and beyond – 2010, 2020.

OBJECTIVE

Plot a graph to illustrate the impact of human population on endangered species.

MATERIALS

- graph paper
- ruler

PROCEDURE

1. On a sheet of graph paper, plot the horizontal (x) axis and vertical (y) axis for your graph. Each should be 10 cm long. Make a large mark every centimeter and a small mark every half centimeter on each axis.
2. On the horizontal axis, each centimeter equals 100 years. Start at the year 1000 and label each centimeter that follows until you get to the year 2000.

WORLD POPULATION TABLE

Year	Population (IN BILLIONS)
1000	0.31
1250	0.4
1500	0.5
1750	0.79
1800	0.98
1927	2
1960	3
1974	4
1987	5
1999	6 (EST.)

QUESTIONS

1. What shape is your graph? It should be a classic J-shape, indicative of a population with few limits to its growth. Most animal populations, other than humans, level off after a time. Their growth graph would look more like an S curve. What factors influence the growth of most populations?
2. The panda has become the symbol for endangered species. What consequences of human population growth have brought the panda population to the brink of extinction and limit its growth now?
3. At the rate the human population is growing, adding about a billion people every 10 to 12 years, what might happen to the panda and other endangered species?
4. What do you think a panda population curve would look like?
5. Data show that close to 99% of all species that have ever existed have become extinct. Why should we protect one species if this is the case?
6. Is a panda a bear? How much bamboo does one panda need? Why is it so difficult for the giant panda to breed in captivity? Find out the answers to these and other questions at www.sandiegozoo.org/Zoo/panda_home.html.



Don Lindburg, who appears in this segment, answers your questions online. www.pbs.org/saf/



SEE PAGE 14

Return to the Wild

Two decades ago, Washington's National Zoo joined scientists in Brazil in a groundbreaking captive breeding and reintroduction program of golden lion tamarins. Tamarins learn survival skills at a jungle "boot camp" and are later released into their native habitat in Brazil, where their population continues to increase. This model reintroduction program shows what new zoos can do to help ensure the survival of wild animals.

RUNNING TIME: 9:47

CURRICULUM LINKS:

- BIOLOGY
 - genetics
- EARTH SCIENCE
 - habitat
- LIFE SCIENCE
 - primates



RELATED FRONTIERS SHOWS & ACTIVITIES:

- **Dragon Science**, Show 602: "Food for Thought" (pp. 8-9)
- Show 305: "Rescuing the Black-Footed Ferret" (pp. 7-8)

The New Zoos

The first zoos can be traced back as far as the 12th century B.C. in China. Later, kings and queens of ancient Egypt and other civilizations kept exotic animal collections for their amusement. In the 18th century, zoos proliferated in Europe and became more public. These zoos, which were more like menageries, existed mainly for displaying animals to visitors for their entertainment.

As you see on FRONTIERS, zoos have changed dramatically over the past few decades. Zoos today assume multiple responsibilities, from education programs that increase public awareness to captive breeding of endangered animals.

For some critically endangered animals, like the golden lion tamarin, the zoo is the animal's last hope for survival. The tamarins' native habitat, the Atlantic coastal rain forests of Brazil, has been largely depleted. Some of the strategies being used to ensure tamarins' survival include captive breeding, managed wild breeding and reintroduction. We'll meet the scientists responsible for making sure the tamarins have a future.

ACTIVITY 1 "If I Ran the Zoo..."

Imagine that a zoo has just hired you to design its new wild animal park. It's your chance to answer the question, "What would you do if you ran the zoo?" (For a related activity on creating habitats, see pages 6-7 of this guide.)

OBJECTIVE

Design blueprints for an enriched "new zoo."

MATERIALS

- pencil
- graph paper
- ruler
- additional art supplies
- research materials



PROCEDURE

PART 1: RESEARCH

1. Choose two or three species you would like to include in your park. Will you focus solely on endangered species or one type of animal, like primates? (One trend of zoos is to specialize in animals.)

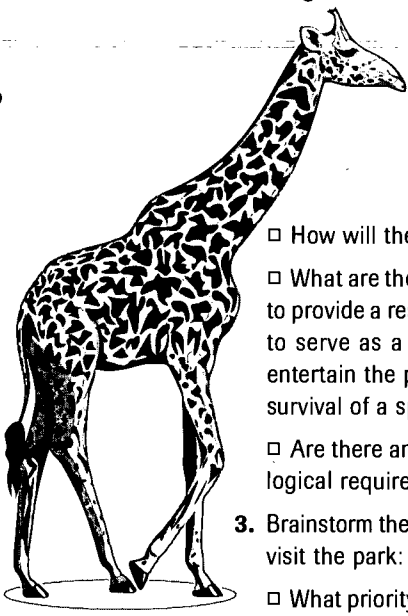

2. Research the needs of your selected animals. Consider the following questions:
 - How much area does each species need?
 - What kind of shelter or other structures will each species need for safety, play, sleeping, mating, etc.?
 - How many of the species will be placed in the park? What's the total area needed to support all the animals?
 - How will the species you choose interact with each other?

- How will the animals obtain food?
- What are the goals of your wildlife park: to provide a resource for captive breeding, to serve as a refuge for the animals, to entertain the public and/or to ensure the survival of a species?
- Are there any other physical or psychological requirements of the animals?
3. Brainstorm the needs of the public that will visit the park:
 - What priority will be given to the public's ability to see the animals?
 - How will the public view the animals?
 - What types of information will you want to supply? Do you want to educate the public? How will you earn the money necessary to house and feed the animals?
 - Will your zoo be more like a wildlife park in a rural setting or will it be a smaller facility in a city?
 - How will climate affect the animals and their needs?



Benjamin Beck, who appears in this segment, answers your questions online.

SEE PAGE 14 www.pbs.org/saf/



**PART 2:
CREATING THE BLUEPRINTS**

1. Determine the scale (for example, 1 cm = 10 M).
2. Outline the boundaries on graph paper.
3. Represent the geographical features that will be within the park (for example, streams, hills, caves).
4. Depict the species and location of plant life for the park. Will the plants become part of the animals' diets and have to be replenished?
5. Add all the necessary buildings that will be used for the zoo support staff.

QUESTIONS

1. How do you think this environment will enrich the lives of the animals within?
2. Does your design reflect the ability to conduct a captive breeding program? If so,

how? Will some of the animals later be released?

3. Where would you build your park? What factors determine its location? Consider climate, pollution and noise, for example.
4. How will the animals be cared for if they are ill?
5. How will the animals be fed?

EXTENSIONS

1. Create a three-dimensional model of your wild animal park.
2. Visit or research a zoo in your area. Does it provide any enriched habitats for the animals? Have any variations in animal behaviors been observed in comparison with less enriched habitats?
3. Design an enriched habitat for marine, microbial or extraterrestrial life.

4. Compare the golden lion tamarin project with other reintroduction programs (the black-footed ferret, the gray wolf, the California condor).
5. Use stuffed or beanbag animals to set up an educational "zoo" for younger kids.

RESOURCES

Before you design your zoo, visit other zoos on the Web at www.aza.org. The American Zoo and Aquarium Association (AZA) has created a Species Survival Plan for each endangered species. Learn about the AZA's plan for the golden lion tamarin:

www.aza.org/aza/ssp/goldtam.html

Can't visit the National Zoo? Visit its Web site:

www.si.edu/organiza/museums/zoo/

Find out more about the golden lion tamarin captive breeding program:

www.si.edu/glt/cbreed.htm

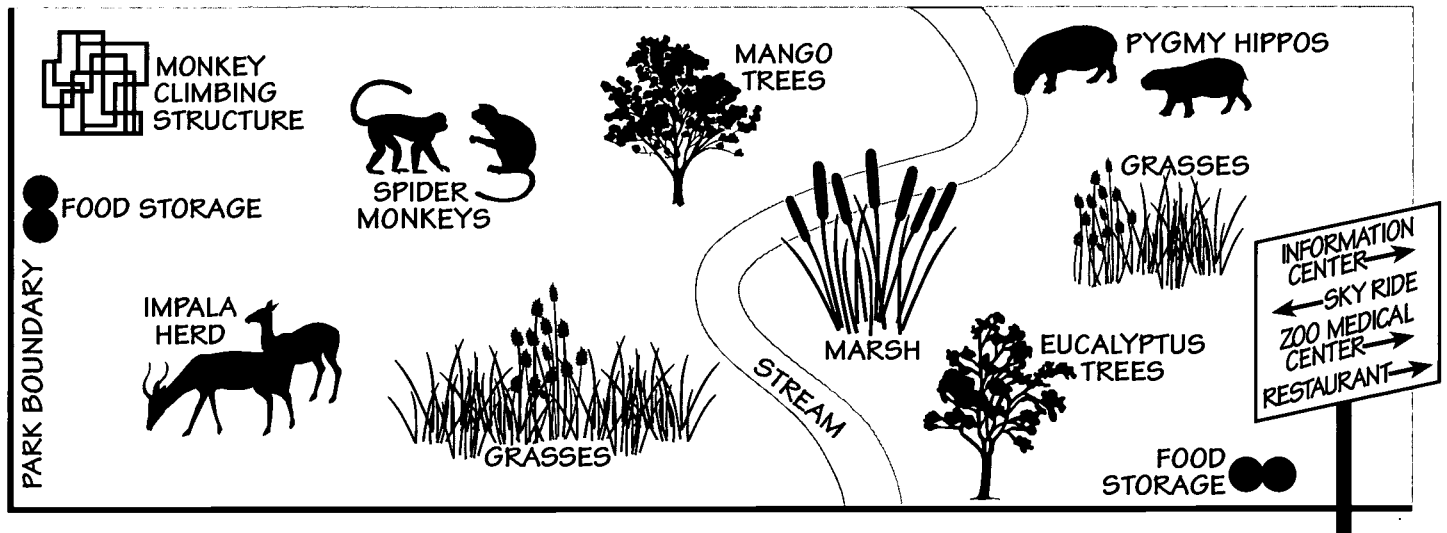

ACTIVITY 2 Genetic Probabilities

As zoos evolve from places of entertainment to scientific institutions dedicated to education and conservation, one of the most critical areas of research focuses on genetic diversity. Many endangered species (cheetahs and tamarins, for example) have become victims of inbreeding. The populations of wild animals are simply too small to sustain genetic vigor. As you see on *FRONTIERS*, promoting genetic diversity is key to the future existence of the tamarins and other endangered animals.

Because of the limited gene pool in a too-small group, the percentage of detri-

mental traits bred in the wild population is high. The captive breeding and reintroduction projects sponsored by the Golden Lion Tamarin Conservation Program have begun to restore genetic diversity in the golden lion tamarin population.

Do some research to find out more about genetic problems in captive animals.

1. What is a gene pool? Why is it important to promote genetic diversity?
2. Investigate inbreeding problems characteristic of endangered species like the cheetah. How is the Golden Lion Tamarin

Conservation Program working to address this issue?

3. How might genetic engineering affect the probability of detrimental genes for species in the future? What about cloning? Why not just clone endangered species?

SCIENTIFIC AMERICAN FRONTIERS

Show 805:
The New
Zoos



Return to
the Wild

Explore The New Zoos with FRONTIERS Online!

In this episode, Alan Alda discovers how contemporary aquariums and zoos are working to improve and extend the lives of animals in captivity and in the wild. After *The New Zoos* airs, animal specialists from the show will answer questions about their work and the future of the animals in their care. The scientists featured on this page will be available from April 15 to May 1, 1998. To participate in *Ask the Scientists*, visit FRONTIERS online at www.pbs.org/saf/.

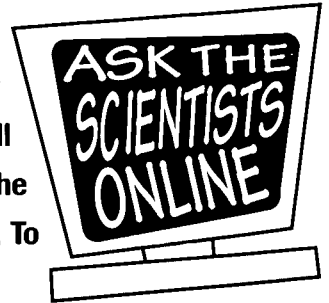

POLAR BEAR PICNIC

At the San Diego Zoo's Polar Bear Plunge exhibit, animal behaviorist **JoAnne Simerson** treats polar bears to a varied "enrichment program" designed to keep them happy and healthy. Simerson answers your questions about her career and the programs she creates for the bears.



ZOOS AS ARKS

Don Lindburg is with the Center for Reproduction of Endangered Species (CRES), part of the Zoological Society of San Diego devoted to conserving endangered animals. CRES has worked with many species in addition to the giant panda seen on this episode, including cheetahs, desert tortoise and the California condor. Send your question to Lindburg to learn more about animal conservation efforts.



THE WILDER, THE BETTER

Suzanne MacDonald, an animal behaviorist at the Metropolitan Toronto Zoo, creates enrichment programs by applying her knowledge of how animals think and their natural behaviors in the wild. Ask MacDonald to tell you more about her work with orangutans, Saki monkeys and other species.



RETURN TO THE WILD

Benjamin Beck, associate director for biological programs at the National Zoo in Washington, specializes in reintroducing animals to the wild by teaching them survival skills such as how to search for food. What's it like to run the "jungle boot camp" we see on this episode of FRONTIERS? Send your question to Beck for a firsthand report.

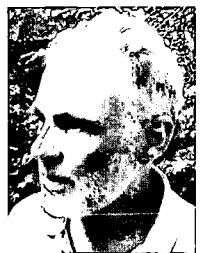

DOCTOR FISH

At Boston's New England Aquarium, the medical center is a real hospital where visitors can observe exams and emergency care for animal patients. Veterinarian **Howard Krum** and his team have operated on some unusual patients, like the bridled burrfish we see on this episode. Here's your opportunity to ask Krum about his work and his patients.



NOTE: AVAILABILITY OF SCIENTISTS IS SUBJECT TO CHANGE.

HERE'S HOW TO "ASK THE SCIENTISTS"

- Watch **The New Zoos** and review this classroom guide to prepare your question(s) and decide which scientist(s) you'd like to contact.
- Visit SCIENTIFIC AMERICAN FRONTIERS on PBS Online at www.pbs.org/saf/. Click on the "Ask the Scientists" icon on the opening screen, select "Scientists Now Appearing" and follow the simple instructions to send your question(s). Scientists' answers will be posted online for all FRONTIERS viewers to read. Depending on the volume of questions received, only selected questions may be answered.
- Remember to e-mail your questions by **May 1, 1998!**

TUNA IN THE TANK

The Monterey Bay Aquarium is known for pioneering new techniques in animal husbandry and its interpretation of living organisms. Ask aquarium veterinarian **Tom Williams** about his marine husbandry research. Or send a question to **Heidi Dewar** of the Aquarium's Tuna Research and Conservation Center about her projects with bluefin tuna.



PBS  **online** The New Zoos airs on PBS on Wednesday, April 15, 1998, at 8 pm.*

* Check your TV listings to confirm local air time and date.



We Cite Your Favorite Sites!

Thanks to all science teachers who sent us their favorite science sites. Please send your suggestion to saf@pbs.org and we'll compile another list in a future guide.

If we print a site you recommend, you'll receive a FRONTIERS T-shirt!

www.energy.ca.gov/education/index2.html

Energy Quest: Adventures in energy education from the California Energy Commission.

www.mistakes.com/fam.html

Amusing accounts of inventors' mistakes that became inventions.

www.exploratorium.edu

Exhibits and resources from the Exploratorium science museum in San Francisco to explore the science of hockey, track severe storms, dissect a cow's eye and more.



www.phys.virginia.edu/Education/Teaching/HowThingsWork/

How Things Work: Ask a question or search the archives to find out how things work.

www.newscientist.com/lastword/lastword.html

Last Word: Why are eggs egg-shaped? Why are some creatures translucent? Discover the answers to these questions and many more.

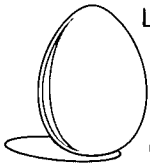

www.ipl.org/youth/projectguide/

Internet Public Library's Science Fair Project Resource Guide: Great resources for student projects.

planetk-12.planetsearch.com

Planet K-12: A search engine designed to help students find materials related to school projects and assignments.

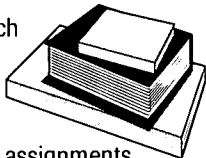

scifun.chem.wisc.edu/scifun.html

Science Is Fun: An innovative University of Wisconsin chemistry professor shares the fun of science through home science activities, demonstrations and more.

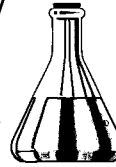

www.cotf.edu/ETE/scen/MSESE/explorer.html

Middle School Earth Science Explorer: Explorasorus guides students through this fascinating site, part of the NASA Classroom of the future.

www.nasa.gov

Start here for links to NASA's cool sites and educational resources.

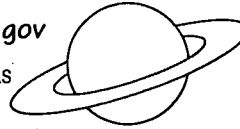

www.thetech.org

The Tech Museum of Innovation: Computers, satellites, robotics, lasers and more. A site that inspires young people to explore tomorrow's technologies.

www.cs.uidaho.edu/~casey931/mega-math/menu.html

MegaMathematics: An exciting place where math is a live science and mathematicians experiment with creative ideas.

www.innerbody.com

Human Anatomy Online: Fun, interactive and educational views of the human body.



www.jason.org/JASON/HTML/backgrnd.html

JASON Project: Founded in 1989 by Dr. Robert D. Ballard following his discovery of the *Titanic*, the Jason Project lets teachers and students take part in global explorations.

SCIENCE IN CYBERSPACE

Visit these sites to learn more about topics on **The New Zoos**:

www.sandiegozoo.org/Zoo/pbear.html



See the polar bears in their new Polar Bear Plunge at the San Diego Zoo.

www.neaq.org

Explore the New England Aquarium exhibits, including the medical center seen in "Doctor Fish."

www.mbayaq.org

Dive into the Monterey Bay Aquarium for a behind-the-scenes look at its pioneering efforts in marine husbandry research.

www.sandiegozoo.org/CRES/cres.html

Visit the Center for Reproduction of Endangered Species and learn more about the giant panda and other species.



www.si.edu/organizational/museums/zoo/

Can't travel to Washington, D.C., to visit the National Zoo in person? Take this virtual tour instead!

www.aza.org

Check out the American Zoo and Aquarium Association's links to zoos and aquariums in North America.

www.atkinson.yorku.ca/~suzanne/behavior.html

Learn more about Suzanne York's projects at the Metropolitan Toronto Zoo, including behavior modification of an African elephant.

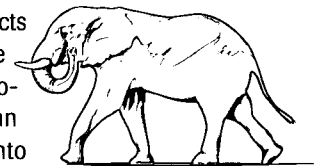

At press time, the online features and sites listed here were current. Due to the rapidly changing online world, some may have changed or may no longer be available. We recommend that you preview sites before passing them on to students.

Visit FRONTIERS on PBS Online

Back Forward Home Reload Images Open Print Find Stop

Netsite: <http://www.pbs.org/saf/>

A Series of Science Specials on PBS Hosted by Alan Alda and Sponsored by GTE Corporation

GTE

Produced in association with SCIENTIFIC AMERICAN magazine

online

SCIENTIFIC AMERICAN FRONTIERS

resources

polls & prizes

alan alda

cool science

In the classroom

ask the scientists

search

this season broadcast schedule

The New Zoos

Click on the smooching sea lion for a video preview of "The New Zoos," premiering Wednesday, April 15, 1998, at 8 p.m. on PBS.

Document: Done.

SCIENTIFIC AMERICAN FRONTIERS is not just on TV — we're also on the Web! The FRONTIERS Web site features interactive science activities and projects students can do at school or at home, archived issues of our teaching guides, broadcast schedules, show transcripts and video sneak previews.

You can search the site by subject or keyword, so sorting through past seasons is a snap. "Ask the Scientists" gives viewers the chance to send their questions to scientists and other participants in FRONTIERS programs. You'll also find interviews with host Alan Alda, plus an opportunity to send e-mail to him.

Be sure to visit the site over the summer — new activities, polls and prizes will be available all summer long!

www.pbs.org/saf/

UNDERWRITTEN BY GTE CORPORATION



SCIENTIFIC AMERICAN FRONTIERS

INSIDE:
Requested Teaching Materials for
THE NEW ZOOS
AIR DATE:
April 15, 1998

Connecticut Public Television
P.O. Box 260240
Hartford, CT 06126-0240

Join us for a LIVE WEBCAST on March 26 when Alan Alda will interview astronaut Andrew Thomas, LIVE from the MIR space station! Visit the Frontiers website for more information!

NON PROFIT
U.S. POSTAGE
PAID
Permit no. 51
Bristol, PA





U.S. Department of Education
Office of Educational Research and Improvement (OERI)
Educational Resources Information Center (ERIC)

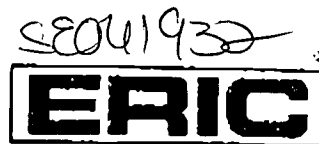

REPRODUCTION RELEASE

(Specific Document)

I. DOCUMENT IDENTIFICATION:

Title: <i>Scientific American Frontiers Teachers Guides</i>	
Author(s): <i>Media Management Services</i>	
Corporate Source: <i>Media Management Services & GTE</i>	Publication Date: <i>1997 - 2000</i>

II. REPRODUCTION RELEASE:

In order to disseminate as widely as possible timely and significant materials of interest to the educational community, documents announced in the monthly abstract journal of the ERIC system, *Resources in Education* (RIE), are usually made available to users in microfiche, reproduced paper copy, and electronic/optical media, and sold through the ERIC Document Reproduction Service (EDRS) or other ERIC vendors. Credit is given to the source of each document, and, if reproduction release is granted, one of the following notices is affixed to the document.

If permission is granted to reproduce and disseminate the identified document, please CHECK ONE of the following two options and sign at the bottom of the page.



Check here
For Level 1 Release:
Permitting reproduction in microfiche (4" x 6" film) or other ERIC archival media (e.g., electronic or optical) and paper copy.

The sample sticker shown below will be affixed to all Level 1 documents

PERMISSION TO REPRODUCE AND DISSEMINATE THIS MATERIAL HAS BEEN GRANTED BY

Sample

TO THE EDUCATIONAL RESOURCES INFORMATION CENTER (ERIC)

Level 1

The sample sticker shown below will be affixed to all Level 2 documents



Check here
For Level 2 Release:
Permitting reproduction in microfiche (4" x 6" film) or other ERIC archival media (e.g., electronic or optical), but not in paper copy.

PERMISSION TO REPRODUCE AND DISSEMINATE THIS MATERIAL IN OTHER THAN PAPER COPY HAS BEEN GRANTED BY

Sample

TO THE EDUCATIONAL RESOURCES INFORMATION CENTER (ERIC)

Level 2

Documents will be processed as indicated provided reproduction quality permits. If permission to reproduce is granted, but neither box is checked, documents will be processed at Level 1.

"I hereby grant to the Educational Resources Information Center (ERIC) nonexclusive permission to reproduce and disseminate this document as indicated above. Reproduction from the ERIC microfiche or electronic/optical media by persons other than ERIC employees and its system contractors requires permission from the copyright holder. Exception is made for non-profit reproduction by libraries and other service agencies to satisfy information needs of educators in response to discrete inquiries."

Sign here → please

Signature: <i>Jessani Gordon</i>	Printed Name/Position/Title: <i>Jessani Gordon Project Manager, Scientific American Frontiers</i>
Organization/Address: <i>Media Management Services 105 Terry Dr. Suite 120 Newtown, PA 18940</i>	Telephone: <i>800-523-5948</i> FAX: <i>215-579-8589</i> E-Mail Address: <i>jhgordon@edumedia.com</i> Date: <i>1/2/98</i>